

**L-101**

# The Industry's Premier Line of Wiring Devices

Including Power Delivery and Data Connection Devices for Construction & Maintenance



**THE FUTURE IS ON**



**The Largest Selection for Industrial, Commercial and Residential Construction**



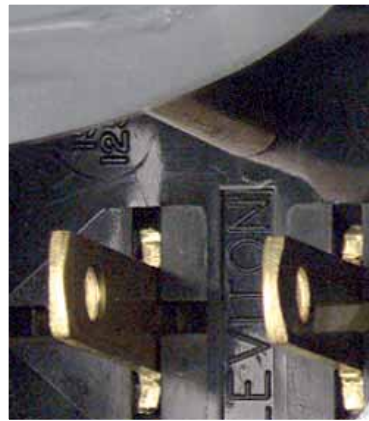
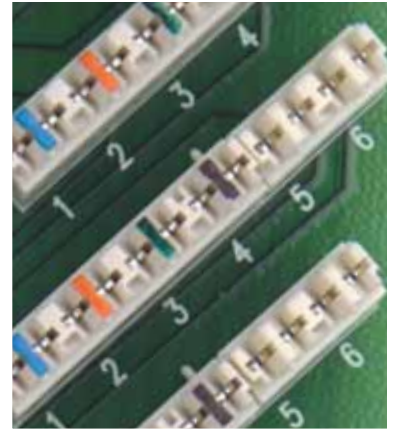

# TABLE OF CONTENTS with Quick Reference Index

ABOUT LEVITON—vi–ix; HOW TO USE THIS CATALOG—x, A8, C36, D28, G18, H8, J36, K18, T6, U6  
 CATALOG NUMBER ALPHANUMERIC INDEX (last section)—Index pages 1–16

SECTION **A**  
**Acenti Collection**

**Acenti® Collection**  
 Overview ..... A2  
**Acenti Lighting Controls**  
 Dimmers and Fan Speed Control ..... A3  
**Acenti Switches**  
 15A and 20A Switches ..... A4  
 Electronic Timer Switch ..... A4  
 Manual-ON Occupancy Sensor ..... A4

**Acenti Receptacles**  
 Triplex and Duplex ..... A5  
 Sixplex and Duplex Surge Protective Receptacles ..... A5  
**Acenti Wallplates and QuickPort® Connectors**  
 Wallplates ..... A6  
 QuickPort Snap-In Connectors ..... A7  
 QuickPort Wallplate Inserts ..... A7

SECTION **B**  
**Decora Devices**

General Overview ..... B2  
 Decora Switch Overview ..... B3  
**Commercial Grade Switches**  
 Decora *Plus* AC Quiet Rocker Switches ..... B4  
 Decora *Plus* Momentary and Maintained Switches ..... B5  
 Decora *Plus* Illuminated and Pilot Light Switches ..... B6  
**Residential Grade Switches**  
 Decora AC Quiet Rocker Switches ..... B7, B8  
 Illuminated, Pilot Light ..... B8  
 Decora 911 Emergency Flasher ..... B8  
**Industrial and Commercial Grade Receptacles**  
 Decora Receptacles Overview ..... B9  
 Decora *Plus* Receptacles ..... B10, B11  
**Residential Grade Receptacles**  
 Decora Quickwire and Side Wired ..... B12  
**Hospital and Industrial Grade Surge Protective Receptacles**  
 Decora Back and Side Wired ..... B13  
**SmartLockPRO® GFCI Receptacles**  
 SmartLockPRO® Overview ..... B14

GFCI Receptacles ..... B15  
 Combination Switch/GFCI Outlet ..... B15  
 Blank Face ..... B15  
**Commercial Grade Devices**  
 Decora Combination Devices ..... B16, B17  
 Decora Voice/Data/Video Devices ..... B18  
 Decora *Plus* Canadian 347V AC  
 Quiet Rocker Switches ..... B19  
 Canadian 347V Midway Nylon Wallplates ..... B19  
**Wallplates**  
 Decora *Plus* Screwless Snap-On ..... B20  
 Decora Thermoset, Thermoplastic and Metal ..... B21–B23  
 Adapters ..... B24  
 Replacement Screws ..... B24  
**Decora-Style Recessed Receptacles**  
 Overview ..... B25  
 Recessed Entertainment Box ..... B26  
 Duplex Recessed Receptacles ..... B26

SECTION **C**  
**Lighting and Fan Speed Controls**

**Architectural Lighting Control Systems**  
 Dimensions® D3200 ..... C2-C4  
 Dimensions® D4000 ..... C5, C6  
 Power Extenders ..... C7  
 a-2000 Modular Dimming Cabinets ..... C8, C9  
**Architectural Specification**  
 Overview ..... C10  
 Monet® Controls ..... C11, C12  
 Monet® Multi-Gang Wallplates ..... C13  
 Renoir® Preset Slide Controls ..... C14, C15  
 Van Gogh® Rotary Dimmers ..... C16  
**Ganging and Derating Lighting Controls**  
**Designer Controls**  
 Overview ..... C18  
 Vizia™ Digital Controls ..... C19  
 Vizia™ Remotes ..... C20  
 Vizia-RF™ Scene Capable Dimmers ..... C21  
 Vizia-RF™ Remotes ..... C22  
 Mural® Digital Controls ..... C23

Mural® Scene Controls ..... C24, C25  
**Touch Lighting Controls**  
 Overview ..... C26  
 True Touch™ Digital Touch Dimmer ..... C27  
 ToggleTouch™ Digital Dimmer ..... C28  
**Traditional Controls**  
 Overview ..... C29  
 IllumaTech™ Preset Slide Controls ..... C30  
 IllumaTech™ Rotary Controls ..... C31  
 SureSlide™ Slide Controls ..... C32  
 Trimatron™ Deluxe Rotary Controls ..... C33  
**Incandescent Lighting Controls**  
 Toggle Dimmers ..... C34  
 Decora 911 Flasher Switch ..... C34  
 4-Level Step Dimmer ..... C35  
 Feed-Through Lamp-Cord Dimmers ..... C35  
 Tabletop Dimmer ..... C35  
 Full-Range Dimmer Socket ..... C35

SECTION **D**  
**Energy Management Products**

**Occupancy Sensor Lighting Controls**  
 Overview ..... D2  
 Decora Wall Switch Infrared Occupancy Sensors ..... D3-D6  
 Decora Dual-Relay Wall Switch ..... D4  
 Infrared Occupancy Sensors ..... D4  
 Decora Wall Switch Multi-Tech Occupancy Sensor ..... D4  
 Manual-ON Wall Switch Occupancy Sensor ..... D6  
 Self-Contained Fixture Mount Occupancy Sensor ..... D7  
 Power Base Adaptor ..... D8  
 Self-Contained Infrared Ceiling Mount  
 Occupancy Sensor ..... D9  
 Multi-Tech Ceiling Mount Occupancy Sensor ..... D10  
 Ultrasonic Ceiling Mount Occupancy Sensor ..... D11  
 Infrared Ceiling Mount Occupancy Sensor ..... D12  
 Multi-Tech Wall Mount Occupancy Sensor ..... D13  
 Infrared Wide-View Wall Mount Occupancy Sensor ..... D14  
 Infrared High-Bay Wall Mount Occupancy Sensor ..... D14

Infrared Long-Range Wall Mount Occupancy Sensor ..... D14  
 Power Packs for Occupancy Sensors ..... D15  
 Infrared Outdoor Motion Sensors ..... D16  
**Centura System**  
 Centura® Fluorescent Energy  
 Management System ..... D17, D18  
**Timed Lighting Controls**  
 Decora *Plus* Electronic Timer Switches ..... D19  
 Decora Programmable Electronic Timer Switches ..... D20  
 Variable Countdown Timer Switch ..... D20  
 Z-MAX Relay Lighting Control Systems ..... D21-D27  
 Z-MAX Relay Cabinets ..... D22, D23  
 RRP-Remote 4-Relay Panel ..... D24  
 EZ-MAX Relay Cabinets ..... D25  
 Z-MAX Digital and Low Voltage Switch Stations ..... D26  
 miniZ™ Intelligent Daylight Management System ..... D27

SECTION **E**  
**Wallplates**

Decora® *Plus* Screwless Snap-On ..... E2, E4, E5  
 Decora® ..... E3, E4, E5  
 Wallplate Overview ..... E6  
 Toggle ..... E7–E9  
 Duplex Receptacle ..... E10, E11  
 Single Receptacle ..... E12  
 Telephone or Cable Outlet, Box Mount ..... E13, E14  
 Telephone or Cable Outlet, Strap Mount ..... E14, E15  
 Blank, Box Mount ..... E16, E17  
 Blank, Strap Mount ..... E17, E18  
 Power Outlet Receptacles ..... E19, E20  
 Two-Gang with Centered Opening ..... E21  
 Louvre Plates ..... E22  
 Combination Wallplates  
 Toggle and Single Receptacle ..... E23  
 Toggle and Duplex Receptacle ..... E23, E24

Toggle and Decora/GFCI ..... E25  
 Toggle and Blank ..... E26  
 Standard Combinations—2-Gang ..... E26–E28  
 Standard Combinations—3-Gang/4-Gang ..... E28  
 Sectional for Multi-Gang Installations ..... E29  
 Hot Stamped and Engraved ..... E29, E30  
 Voice/Data/CATV ..... E31  
 Weather Resistant Covers  
 Raintight While-In-Use ..... E32  
 Industrial Grade ..... E33  
 Die-cast Zinc ..... E34  
 Thermoplastic ..... E35  
 Stainless Steel Lockout ..... E34, E35  
 Accessories ..... E36  
 Custom Wallplates ..... E37–E40

# TABLE OF CONTENTS with Quick Reference Index

|   |  |  |
|---|--|--|
| <p style="text-align: center;">SECTION <b>F</b></p> <p style="text-align: center;"><b>AC Switches</b></p>                       | <p><b>Industrial Grade Switches</b></p> <p>Overview . . . . . F2</p> <p>Back and Side Wired . . . . . F3</p> <p>Toggle . . . . . F3</p> <p>Locking . . . . . F3</p> <p>Wire Lead Toggle . . . . . F3</p> <p>Canadian 347V AC . . . . . F3</p> <p>Pilot Light . . . . . F4</p> <p>Lighted Handle . . . . . F4</p> <p>Maintained Contact . . . . . F5</p> <p>Momentary Contact . . . . . F5</p> <p>Side Wired . . . . . F6</p> <p>Toggle . . . . . F6</p> <p>Locking . . . . . F6</p> <p>AC Manual Motor and Welder Starting . . . . . F7</p> <p>Safety Disconnect Switches . . . . . F8, F9</p>   | <p>Key Lock Power . . . . . F10</p> <p><b>Commercial Grade Switches</b></p> <p>Overview . . . . . F11</p> <p>Back and Side Wired . . . . . F12</p> <p>Toggle . . . . . F12</p> <p>Side Wired . . . . . F12</p> <p>Toggle . . . . . F12</p> <p>Hospital Call . . . . . F12</p> <p>Canadian 120/277V AC . . . . . F12</p> <p>Lighted Toggle . . . . . F13</p> <p>Canadian 347V AC . . . . . F13</p> <p>Framed Toggle . . . . . F13</p> <p><b>Residential Grade Switches</b></p> <p>Quickwire and Sidewire . . . . . F14</p> <p>Illuminated Toggle . . . . . F14</p> <p>CO/ALR . . . . . F14</p>  |
|   | <p><b>Overview</b> . . . . . G2</p> <p><b>Hospital Grade</b></p> <p>Back and Side Wired with Wire Leads . . . . . G3</p> <p>Isolated Ground . . . . . G3</p> <p>Four-In-One . . . . . G5</p> <p><b>Industrial Grade</b></p> <p>Back and Side Wired with Wire Leads . . . . . G4</p> <p>Side Wired . . . . . G4</p> <p>Isolated Ground . . . . . G4</p> <p>Dual Voltage . . . . . G4</p> <p>Clock Hanger . . . . . G4</p> <p>Four-In-One . . . . . G5</p>   | <p><b>Power Devices</b> . . . . . G6-G11</p> <p><b>Commercial Grade</b></p> <p>Overview . . . . . G12</p> <p>Back and Side Wired . . . . . G13, G15</p> <p>Dual Voltage . . . . . G13</p> <p>Side Wired . . . . . G14, G15</p> <p>Brass Floorbox Assembly . . . . . G14</p> <p>QuickPort® Snap-In Jacks with Brass Floorplate . . . . . G15</p> <p><b>Residential Grade</b></p> <p>Quickwire Push-In . . . . . G16</p> <p>Quickwire Push-In and Side Wired . . . . . G16</p> <p>Side Wired . . . . . G16, G17</p> <p>CO/ALR . . . . . G16</p> <p>Clock Hanger . . . . . G17</p> <p>Snap-In Devices . . . . . G17</p>   |
| <p style="text-align: center;">SECTION <b>H</b></p> <p style="text-align: center;"><b>GFCI Personnel Protection Devices</b></p> | <p><b>GFCI Personnel Protection Devices</b></p> <p>SmartLock<sup>Pro</sup>® GFCI Devices . . . . . H2-H4</p> <p>Overview . . . . . H2-H3</p> <p>Hospital Grade Receptacles . . . . . H4</p> <p>Commercial Grade Receptacles . . . . . H4</p> <p>Switch-Rated Blank Face . . . . . H4</p> <p>Combination Switch/GFCI Outlet . . . . . H4</p> <p>High-Current . . . . . H5</p> <p>Right-Angle GFCI Plug . . . . . H5</p>   | <p>Shallow Wallbox Extender for GFCI . . . . . H5</p> <p>GFCI Cordsets and Extension Cords . . . . . H6</p> <p>GFCI Accessories . . . . . H7</p> <p>Flush Cover Wallplates . . . . . H7</p> <p>Raintight While-In-Use Covers . . . . . H7</p> <p>Temporary Portable Power . . . . . H7</p> <p>Distribution Center/GFCI (The Box) . . . . . H7</p> <p>Power Cords for The Box . . . . . H7</p>  |
| <p style="text-align: center;">SECTION <b>I</b></p> <p style="text-align: center;"><b>Combination Devices</b></p>               | <p><b>Commercial Grade AC Combination Devices</b></p> <p>15A Devices . . . . . I2</p> <p>15A Switch/Receptacle . . . . . I2</p> <p>15A Switches . . . . . I2</p> <p>15A S.P. Switch/Neon Pilot Light . . . . . I2</p>  | <p>20A Devices . . . . . I2</p> <p>20A S.P. Switches . . . . . I2</p> <p>20A S.P. Switch/Receptacle . . . . . I2</p> <p>20A S.P. Switch/Neon Pilot Light . . . . . I2</p> <p>Decora® Combination Devices . . . . . I3</p> <p>Decora® Multi Switches . . . . . I4</p> <p>SmartLock<sup>PRO</sup>® GFCI/Switch . . . . . I4</p>  |
| <p style="text-align: center;">SECTION <b>J</b></p> <p style="text-align: center;"><b>Structured Media Components</b></p>       | <p><b>Structured Media™ Components</b></p> <p>Overview . . . . . J2</p> <p>Enclosures . . . . . J3-J5</p> <p>Media Versatile™ Panel . . . . . J5</p> <p>Enclosure for Multiple Dwelling Units (MDUs) . . . . . J6</p> <p>Cabling Panels . . . . . J7-J10</p> <p>Stand-Alone Modules and Boards . . . . . J10, J11</p> <p>Mounting Brackets . . . . . J11, J12</p> <p>Power and Surge Protective . . . . . J13, J14</p> <p>Networking and Internet Sharing . . . . . J15</p> <p>Video Distribution . . . . . J16-J18</p> <p>Home Video Monitoring System . . . . . J19-J21</p> <p>Residential Intercom System . . . . . J22</p> <p><b>Home Entertainment Components</b></p> <p><b>Leviton/JBL Products and Systems</b></p> <p>Indoor Speakers . . . . . J23</p> | <p>Outdoor Speakers . . . . . J24</p> <p>Home Theater Speakers . . . . . J24-J25</p> <p>Harman/Kardon Entertainment Center Components and Accessories . . . . . J26</p> <p><b>Leviton Architectural Edition™ Products</b></p> <p>Multi-Room Audio Amplifiers and Keypad System Accessories . . . . . J27</p> <p>Audio Volume Controls . . . . . J28-J30</p> <p>Audio Distribution Products . . . . . J31-J32</p> <p><b>SpecGrade Sound™ Products</b></p> <p>Indoor Speakers . . . . . J33</p> <p>Outdoor Speakers . . . . . J33</p> <p><b>Other Home Entertainment Products</b></p> <p>Decora Media System . . . . . J34</p> <p>Multi-Room IR Repeater System . . . . . J35</p> <p>Decora Recessed Receptacles . . . . . J35</p> |
| <p style="text-align: center;">SECTION <b>K</b></p> <p style="text-align: center;"><b>DHC Powerline Carrier Components</b></p>  | <p>Overview . . . . . K2</p> <p><b>Controllers—Green Line</b></p> <p>Toscana™ Deluxe Programmer . . . . . K3</p> <p>Wall Switch Controllers with 2-Way Communication . . . . . K4, K5</p> <p>Wall Switch Controllers with Scene Capability . . . . . K5</p> <p>RF Products . . . . . K6</p> <p><b>Controllers—Red Line</b></p> <p>Basic Programmer . . . . . K7</p> <p>Table Top Controller . . . . . K7</p> <p>Dry Contact Controllers . . . . . K7</p> <p><b>Receivers—Green Line</b></p> <p>Wall Switches with 2-Way Communication . . . . . K8</p> <p>Wall Switches with Scene Capability . . . . . K8, K9</p> <p>Plug-In Modules with Scene Capability . . . . . K10</p>  | <p><b>Receivers—Red Line</b></p> <p>Wall Switches . . . . . K11</p> <p>Remote Switches . . . . . K12</p> <p>Double-Pole 20A Wall Switch . . . . . K12</p> <p>Receptacles . . . . . K13</p> <p>Universal Low-Voltage Module . . . . . K14</p> <p>Fixture Modules . . . . . K14</p> <p><b>DHC Network Integrity Products</b></p> <p>Panel-Mounted Surge Protective Devices . . . . . K15</p> <p>System Amplifier/Coupler/Repeater . . . . . K16</p> <p>Couplers and Attenuators . . . . . K16</p> <p>Filters . . . . . K17</p> <p>Signal Strength Indicator . . . . . K17</p>  |

# TABLE OF CONTENTS with Quick Reference Index

SECTION **L**  
**Multimedia  
Structured  
Cabling Systems**

|                                |         |  |          |
|--------------------------------|---------|--|----------|
| Quick Reference Guide          | L2      | Accessories                                  | L47-L49  |
| <b>Connectors</b>              |         | <b>Enclosures</b>                            |          |
| QuickPort®                     | L3-L5   | Telecommunications                           | L50, L51 |
| Fiber Optic                    | L6, L7  | Wireless Access Point                        | L52      |
| <b>Wallplates and Housings</b> |         | <b>Cable Management and Rack Accessories</b> |          |
| QuickPort                      | L8-L16  | Versi-Duct®                                  | L53      |
| Acentii®                       | L17     | Rack and Frame                               | L54-L57  |
| Standard Telephone/Media Jacks | L18-L22 | Hook and Loop                                | L58      |
| Workstation Accessories        | L23     | <b>Labeling Products</b>                     | L59, L60 |
| <b>Copper Components</b>       |         | <b>Tools and Accessories</b>                 |          |
| Patch Panels                   | L24-L30 | Punchdown/Termination                        | L61      |
| Industrial Connectivity        | L31     | Fiber L62-L64 Tone Test                      | L65      |
| Patch Cords                    | L32     | Crimping/Stripping                           | L65      |
| 110-Style                      | L33-L38 | Craftsperson's Handset                       | L66      |
| 66-Block                       | L39-L40 | Modular Plug Breakout Adapter                | L66      |
| <b>Fiber Components</b>        |         |  |          |
| Enclosures                     | L41-L45 |  |          |
| Fiber Optic Cable Assemblies   | L46     |  |          |

SECTION **M**  
**Straight Blade  
Plugs and  
Connectors**

|  |    |   |     |
|--|----|---|-----|
| <b>Industrial Grade Plugs &amp; Connectors</b> |    | Python™   | M6  |
| Overview                                       | M2 | Integrated Inlets and Outlets                   |     |
| 15A 125V & 250V                                |    | with Weather-Resistant Covers                   | M7  |
| Hospital Grade                                 | M3 | Weather-Resistant Boots                         | M4  |
| Industrial Grade                               | M3 | 20 AMP Power Plugs                              | M8  |
| Flanged Inlets and Outlets                     | M3 | 30 AMP Nylon Angle Plugs                        | M8  |
| Wetguard®                                      | M5 | 50 AMP Nylon Angle Plugs                        | M9  |
| Dustguard®                                     | M5 | 60 AMP Nylon Angle Plugs                        | M10 |
| Python™  | M6 | <b>Commercial Grade Plugs &amp; Connectors</b>  |     |
| Integrated Inlets and Outlets with             |    | Overview  | M11 |
| Weather-Resistant Covers                       | M7 | 15A 125V & 250V                                 | M12 |
| 20A 125V & 250V                                |    | 20A 125V & 250V                                 | M13 |
| Hospital Grade                                 | M4 | 30 Amp and 50 Amp Dual Power Attachment Plugs   | M14 |
| Industrial Grade                               | M4 | <b>Residential Grade Plugs &amp; Connectors</b> |     |
| Flanged Inlets and Outlets                     | M4 | Parallel, Polarized and Non-Polarized           | M15 |
| Wetguard®                                      | M5 | Grounding                                       | M16 |
| Dustguard®                                     | M5 |   |     |

SECTION **N**  
**Locking and  
Corrosion Resistant  
Devices**

|   |          |  |     |
|---|----------|--|-----|
| <b>Industrial Specification Grade Locking Devices</b> |          | Non-NEMA Devices                               |     |
| Overview  | N2-N4    | 15 Amp   | N24 |
| 15 Amp Devices  | N5, N6   | 20 Amp   | N24 |
| 20 Amp Devices  | N7-N11   | 30 Amp   | N25 |
| 30 Amp Devices  | N12-N16  | 50 Amp   | N25 |
| Wetguard® Devices                                     |          | 50 Amp "California Style"                      | N26 |
| 15 Amp  | N17      | Weather Resistant Boots                        | N27 |
| 20 Amp  | N17, N18 | Power Interrupting Devices                     | N28 |
| 30 Amp  | N19      | Midget Straight Blade and Locking Devices      | N29 |
| Corrosion Resistant Devices                           |          | Combination Locking and Straight Blade Devices | N30 |
| 15 Amp  | N20      | Integrated Inlets and Outlets with             |     |
| 20 Amp  | N21      | Weather Resistant Covers                       | N30 |
| 30 Amp  | N22      |  |     |
| 50 Amp  | N23      |  |     |

SECTION **O**  
**Pin &  
Sleeve Devices**

|   |          |  |          |
|---|----------|--|----------|
| <b>North American Watertight Pin &amp; Sleeve Devices</b> |          | <b>Pin &amp; Sleeve Products</b>             |          |
| Overview  | O2, O3   | Back Boxes                                   | O21      |
| 20 & 30 Amp Devices                                       | O4       | Accessories                                  | O22      |
| 60 & 100 Amp Devices                                      | O5       | <b>Making the Right Connection</b>           |          |
| Dimensions  | O6, O7   | Color Code and Clock Position                | O23      |
| Specifications  | O8, O9   | Leviton Catalog Numbering System             | O23      |
| <b>PowerSwitch® by Leviton</b>                            |          | <b>PowerSwitch® by Leviton</b>               |          |
| <b>North American Watertight Mechanical Interlocks</b>    |          | <b>Watertight Safety Disconnect Switches</b> |          |
| Overview  | O10, O11 | Overview                                     | O24      |
| 20 & 30 Amp Devices                                       | O12      | 30, 60 & 100 Amp Devices                     | O25      |
| 60 & 100 Amp Devices                                      | O13      | Specifications                               | O26      |
| Dimensions  | O14      | Dimensions                                   | O27, O28 |
| Specifications  | O15      | Accessories                                  | O28      |
| <b>International-Rated Pin &amp; Sleeve Devices</b>       |          |  |          |
| 16, 32, 63 & 125 Amp Devices                              | O16      |  |          |
| Specifications  | O17      |  |          |
| Dimensions  | O18-O20  |  |          |

SECTION **P**  
**Single Pole Cam-Type  
Connectors and Stage  
Pin Devices**

|  |        |                                    |         |
|--|--------|------------------------------------|---------|
| <b>Cam Connectors and Stage Pin Devices for Commercial and Industrial Applications</b> |        | Up to 400 AMP                      |         |
| Stage Pin Devices—Overview, and Benefits   | P2     | 16 Series—Taper Nose               | P9, P10 |
| 20, 60 and 100 AMP Stage Pin Devices   | P3     | 18 Series—Ball Nose                | P12-P13 |
| Cam Connectors—Overview, and Benefits  | P4, P5 | Up to 690 AMP                      |         |
| Ampacity Chart   | P6     | 17 Series—Taper Nose               | P14     |
| Up to 140 AMP  |        | 19 Series—Ball Nose                | P15     |
| 15 Series—Taper Nose   | P7     | 22 Series—Latching Ball Nose       | P16     |
| Up to 300 AMP  |        | 23 Series—Latching Taper Nose      | P17     |
| 16 Series—Taper Nose   | P8     | Product Accessories                | P18     |
| 18 Series—Ball Nose  | P11    | Stage Pin Dimensional Drawings     | P19-20  |
|  |        | Cam Connector Dimensional Drawings | P21-26  |

# TABLE OF CONTENTS with Quick Reference Index

SECTION **Q**  
**Wire Mesh Safety Grips**

|                                     |          |
|-------------------------------------|----------|
| Wire Mesh Safety Grips              |          |
| Overview                            | .02      |
| Technical Reference                 | .03      |
| Selecting Pulling and Support Grips | .04–06   |
| Pulling Grips                       | .07–014  |
| Strain-Relief Grips                 | .015–018 |
| Support Grips                       | .019–026 |

SECTION **R**  
**Surge Protective Devices**

|  |         |  |          |
|--|---------|--|----------|
| <b>Industrial Surge Protective Devices</b> |         | <b>Commercial Surge Protection Devices</b>       |          |
| Overview                                   | .R2     | S1000 and S2000 Series Surge Strips              | R15      |
| Four-Outlet Plug-Ins                       | .R3     | 4950 Series Surge Strips                         | R15      |
| 5100 Series                                | .R3     | 5500 and 5505 Series PDU's with Surge Protection | R16      |
| Surge Strips                               | .R4     | <b>Rack-mounted Power Distribution Devices</b>   |          |
| Surge Protection Modules                   | .R5     | 4505 Series 19" Rack Mount PDUs                  | R17      |
| Surge Protection Panels                    | .R6, R7 | P1000 Series PDUs                                | R17      |
| 74000 Series                               | .R6     | Metered Series PDUs                              | R18      |
| 57000 Series                               | .R7     | Switched Series PDUs                             | R19      |
| 52000 Series                               | .R8     | <b>Residential Surge Protection Devices</b>      |          |
| 47000 and 52000-7M3 Series                 | .R9     | Meter Socket Surge Adapter                       | R20      |
| 42000 and 32000 Series                     | R10     | Secondary Surge Arrestors                        | R20      |
| Low Voltage Communications SPD's           |         | General Purpose Plug-Ins                         | R21      |
| 3400 and 3800 Series                       | .R11    | 51000 Series Surge Protection Panels             | R21      |
| Surge Counter: 51000 SMC                   | .R11    | 3950 Series Module Bracket                       | R22      |
| Equipment Cabinet SPD's                    | .R12    | 5950 Series Surge Modules                        | R22      |
| 3800 Series                                | .R12    | <b>Uninterruptible Power Supplies</b>            |          |
| Surge Protection Receptacles               | .R13    | Sine and Online Series UPS Systems               | R23      |
| Decora Series Four-In-One Series           | R14     | Pro, Slim and Strip Series UPS Systems           | R23, R24 |

SECTION **S**  
**Lampholders**

|  |         |   |          |
|--|---------|---|----------|
| Overview   | .S2     | Lampholders for Recessed Single Contact Lamps                           | S10      |
| <b>Incandescent Lampholders</b>                      |         | Lampholders for Metal Halide and Quartz Halogen Lamps                   | S10      |
| Outlet Box, Keyless and Pull Chain                   | .S3, S4 | Candle Sockets  | S10–S12  |
| Metal Shell and Interiors                            | .S5     | <b>Fluorescent Lampholders</b>  |          |
| Phenolic Cap and Shell                               | .S5     | Compact Fluorescent Ceiling Lampholder                                  | S4       |
| Multi-Lampholder Clusters                            | .S6     | Linear Fluorescent  | S13–S17  |
| Porcelain Par Connectors                             | .S6     | Medium Bi-Pin   | S13–S15  |
| Bayonet Socket–Single Contact                        | .S6     | High Output   | S13, S14 |
| Porcelain Mogul Base                                 | .S7     | Slimline  | S13, S14 |
| Socket Extensions                                    | .S8     | Miniature   | S16      |
| Appliance Heating Receptacle                         | .S8     | T-8 to T-5 Adapter  | S16      |
| Porcelain and Phenolic                               | .S8     | 4-Pin Long Twin Tube with 2G11 Base                                     | S17      |
| Porcelain Snap-In                                    | .S9     | Lamp Support Clips for Long Twin Tube                                   | S18      |
| Porcelain Keyless–Commercial Units                   | .S9     | Compact Fluorescent Lampholders (CFL's)                                 | S19–S22  |
| Porcelain Keyless Fixture Single Circuit-Medium Base | .S9     | <i>For a complete listing of OEM products, see the OEM-100 Catalog.</i> |          |
| Porcelain Keyless Medium Base–Side Angle Mounted     | S10     |   |          |
| Phenolic Keyless Fixture–Medium Base                 | S10     |   |          |

SECTION **T**  
**Appliance Switches**

|                                    |     |
|------------------------------------|-----|
| <b>Appliance Switches</b>          |     |
| Single Pole Pull Chain             | .T2 |
| Single Pole Rotary                 | .T2 |
| Two Circuit Rotary                 | .T3 |
| Single Pole Pushbutton             | .T3 |
| Door Jamb Switch                   | .T3 |
| Fluorescent Starter Pushbutton     | .T4 |
| Single Pole Toggle                 | .T4 |
| Feed-Through Cord Switch           | .T5 |
| Miniature Feed-Through Cord Switch | .T5 |

SECTION **U**  
**Electrical Accessories & Decorative Devices**

|  |    |
|--|----|
| <b>Residential Grade Electrical Accessories and Decorative Devices</b> |    |
| Taps and Adapters  | U2 |
| Night Lights   | U3 |
| Guide Lights   | U4 |
| Fluorescent Utility Lights   | U4 |
| Child Protection Devices   | U4 |
| Accessories  | U4 |
| Wallplates   | U5 |

SECTION **V**  
**Technical Information**

|   |           |  |          |
|---|-----------|--|----------|
| Abbreviations                                       | .V2       | Materials Used in Wiring Devices               | V15, V16 |
| National Electrical Code Requirements               | .V3       | ANSI Architectural Symbols                     | V17      |
| Associations, Organizations and Standards           | .V4, V5   | NEMA Straight Blade Configurations             | V18      |
| Certification Agencies and Markings                 | .V5       | NEMA Locking Configurations                    | V18      |
| UL, CSA and NEMA Standards Pertaining to Leviton    | .V6       | Horsepower Ratings for NEMA Configurations     | V20      |
| High-Abuse, UL Listed Hospital Grade Wiring Devices | .V7       | Circuit Wiring Diagrams                        | V21–V23  |
| Glossary of Electrical Wiring Device Terms          | .V8–V10   | Switch Wiring Diagrams                         | V24      |
| Switches  | .V11      | Diameter Ranges of Jacketed Cord               | V25      |
| Dimmers   | .V11      | Wallplate Dimensions                           | V26      |
| Receptacles   | .V11, V12 | Telephone Wiring Devices — Codes and Standards | V27      |
| Ground Fault Circuit Interrupters (GFCI's)          | .V12      | Wire Color Codes & Jack Pin Designations       | V28      |
| Enclosure Classifications                           | .V13–V15  |  |          |

# THE FUTURE IS ON



**2007** Don Hendler named CEO; Steve Sokolow named Chairman.  
New branding launched.

**2005** Don Hendler becomes President.

**2003** Opening of manufacturing facility in China.

**1986** Leviton begins operations in Mexico

**1979** Leviton devices used in refurbishing Statue of Liberty and Ellis Island.

**1975** Company moves corporate headquarters to Little Neck, NY.

**1973** Decora® designer-style devices introduced.

**1965** Harold Leviton becomes President and CEO.

**1961** Leviton devices installed in the White House.

**1953** Acquires Hale Brothers Companies, now known as Leviton Canada.

**1939** Leviton devices featured at the World's Fair.

**1932** Leviton devices used in Empire State Building.

**1929** Leviton relocates to Greenpoint, Brooklyn.

**1910** Leviton makes pullchain lampholders for Edison's new light bulbs.

**1906** Isidor Leviton opens a small shop in New York making gas mantle tips.





---

# Rooted in a Rich Tradition of Excellence

---



Isidor Leviton

## The Leviton Manufacturing Company

offers our customers the most comprehensive

selection of wiring devices for virtually every conceivable residential, commercial, industrial and OEM wiring application. From our simple roots at the dawn of the electrical age, our product offering has branched out to include more than 25,000 wiring devices, systems and components which meet the needs of today's rapidly changing global marketplace. And while times have changed, the core principles upon which the Leviton family business was formed remain the same. Quality, innovation and a rich heritage of unparalleled customer service and support are hallmarks of the Leviton name.

## From Modest Beginnings to Industry Leader

Like many large companies today, Leviton didn't start out that way. Our founding father Isidor Leviton opened up a small tinsmithing operation in Manhattan in 1906, after emigrating from Russia. The small startup company produced mantle tips for the gas lighting industry. As electricity quickly grew to become the dominant infrastructure for powering the lights and



Harold Leviton

the appliances of the day, the business retooled to produce a single electrical product — the pull-chain lampholder. Envisioning the widespread use of electricity in homes, businesses and factories at the turn of the century, the Leviton Company continued to anticipate marketplace needs. As times changed, so did we, and over ten decades, from simple beginnings, we evolved to become an industry leader with operations throughout North America and around the globe.

## Leading the Way through a Rich Family Heritage

Today, standing on the horizon of our second century in business, we're committed to remaining that rarity in the contemporary American business landscape — a third generation family-owned company dedicated to our core vision, philosophy and family culture. From the early days of Isidor Leviton, to the global expansion engineered by the "big-picture" thinking of our late CEO and Chairman, Harold Leviton, to our latest branding and strategic programs under his successor Don Hendler, Leviton's legacy and family tradition live on. Now in our second century, we continue to lead the industry with the most complete selection of products, programs and services.



Don Hendler

---

# No matter what markets you serve...

---

## Your Future Is On with Leviton

There's a good reason Leviton is the number one choice of builders,



architects, electrical contractors, specifying engineers and other electrical professionals we serve. We've set the highest levels of quality and efficiency as our benchmarks. Our products are backed by superior technical service, quality assurance, engineering, research and development, testing and the highest manufacturing standards. This combination of expertise and personal commitment has earned us a worldwide reputation for quality, precision and reliability.

## Pioneering Advances

Leviton engineers, designers and researchers apply leading-edge technology in the design of our products. Equipped with the latest



CAD/CAM tools, direct model-making capability and industry-leading R & D and testing facilities, our design staff is able to quickly develop products for every industrial and commercial grade wiring device application, as well as the latest offerings in lighting controls, lighting and energy management systems, structured media components, home automation and a host of other emerging new areas.

## Advanced Technologies

Through vertical integration of our manufacturing capabilities,



we fabricate all parts for the devices we produce. This assures unmatched quality, not only in finished products, but also in components and sub-assemblies. Industrial robotics and automated assembly improve our manufacturing process dramatically, so that we are able to measure production times in minutes, and often in seconds. And, our ability to make quick product changeovers enables us to operate at the cutting edge of responsiveness.



## Setting the Standard for Service

The true mark of leadership is customer satisfaction.

A centralized customer service department lets us service your needs with quick turnaround and maximum efficiency.

Strategically located warehouses throughout North America, equipped with state-of-the-art material handling technologies are interlinked by a computerized network that provides outstanding turnaround and order fill for our customers. Our electronic data interchange (EDI) and vendor managed inventory (VMI) satisfy a broad array of customer needs.



### **World-Class Quality**

Leviton's state-of-the-art manufacturing processes facilitate zero-defect factory output as well as lower production costs. Our quality assurance team has instituted an innovative inspection program that applies statistical process controls to improve product quality. Component parts are checked at every step to ensure that finished devices are perfect. In addition, we use UL as a registrar to secure ISO registration for our manufacturing plants, warehouses and office facilities.



All Leviton manufacturing facilities are ISO 9001 Certified. We are also committed to Six Sigma quality standards as an integral part of our operations. This leads to measurable quality enhancements in all phases of manufacturing, with the goal of achieving a performance standard of 99.9997%, or 3.4 defects per 1 million opportunities.



### **Powerful Marketing Maximizes Opportunity**

Leviton goes to market in the Retail, Distribution and OEM channels. Each has a dedicated Marketing Division applying its depth of expertise to identify opportunities for creating strong sales volume, increased share of market and sustained profitable growth for our customers. In addition, Leviton offers comprehensive marketing and merchandising support that includes advertising, collateral materials, sales aids, incentive programs, award-winning merchandising systems, promotions and in-depth training.



### **Leading the Industry**

Leviton has led the industry at the forefront of progress and innovation for over a century. We sustain this legacy with a continuing commitment to

pioneering new technologies, implementing enlightened business policies and providing outstanding responsiveness. The net result is that no matter what markets you serve, it's our pledge to serve you well.

### **Our Most Comprehensive Catalog to Date**

The L-101 Catalog reflects our commitment to support traditional as well as emerging new markets. We expanded this catalog with an extensive line of rugged, high-performance



Industrial Grade devices to satisfy the exacting needs of industrial and institutional users. Also included is a larger offering of devices for commercial and residential applications, including the latest structured wiring and multimedia solutions. Our most comprehensive catalog to date, the L-101 represents our dedicated commitment to serving your complete electrical wiring device needs.

**...Leviton will serve you well.**

# TABLE OF CONTENTS with Quick Reference Index

The L-101 Leviton Wiring Device Catalog is designed to help you find the device you're seeking in the quickest and easiest way possible. Most product sections are divided into three distinct categories in the following sequence—Industrial Grade, Commercial Grade and Residential Grade—and grouped according to amperage and voltage, lowest to highest. For example, if you need to order 15 Amp, 125 Volt Industrial Grade straight-blade duplex receptacles, begin your search with the main Table of Contents at the front of the book. Here you'll see that all straight blade receptacles are listed in Section G. Turn to Section G for a more detailed Table of Contents on the first page. Each section page contains product descriptions, ratings and catalog numbers. There are also helpful highlights including Specifications and Features, Testing and Code Compliance, Color listing, Material Characteristics and dimensioned color product photos. Any product page in the L-101 Catalog can be clearly copied or faxed to customers and prospects for use as a specifier sheet or as part of a presentation.

The Quick Reference Guide follows the main Table of Contents to help you pinpoint and locate specific products. Technical Section V provides general product and test data, industry standards, NEMA configuration charts, a glossary of wiring device terms, ANSI architectural symbols and other related information. Specific catalog numbers are listed in the exhaustive index at the back of the catalog.



## 15 AMP 125 and 250V • 20 AMP 125 and 250V

### Industrial Grade Straight Blade Receptacles



**Back and Side Wired** (Basic Cat. No. Denotes Brown Device\*)

| DESCRIPTION                             | CAT. NO./COLOR<br>15A/125V       | CAT. NO./COLOR<br>15A/250V | CAT. NO./COLOR<br>20A/125V | CAT. NO./COLOR<br>20A/250V |
|---|----------------------------------|----------------------------|----------------------------|----------------------------|
| LEVSPEC® Duplex Receptacle, Brass Strap | 5262<br>I, W, GY, R, E           | 5662<br>I                  | 5362<br>I, W, GY, R, E     | 5462<br>I, GY              |
| Single Receptacle                       | 5261<br>I, W, GY                 | 5661<br>I                  | 5361<br>I, W, A, T, GY     | 5461<br>I, A, T, GY        |
| Narrow Body Duplex Receptacle           | 5252<br>I, W, A, T, GY, R, E, BU |                            | 5352<br>I, W, A, T, GY, R, |                            |



5362-IG

For complete wallplate selection, see Section E.





5242-W

**SPECIFICATIONS AND FEATURES**

**Back & Side Wired Duplex**

- Impact-resistant thermoplastic nylon cover and body
- Smooth face does not collect dirt
- Four corner latches securely fasten face
- Single-piece brass mounting strap on LEVSPEC devices, multi-piece steel strap on other devices
- Large, triple-wipe, brass "T" contacts for superior contact and conductivity
- Back and side-wiring options
- Brass terminal screws to reduce conductor oxidation
- Break-off tabs for easy two-circuit conversion
- Apron barrier to prevent accidental contact between terminal screw heads and metal box
- Exclusive V-shaped, serrated back-wiring clips for superior contact and conductivity

**TESTING AND CODE COMPLIANCE**

- UL Listed 498 (UL File #13399); UL Federal Specification WC-596

- Meets NEMA WD-1 & 6, and ANSI standards
- Backed by a Limited 10-Year Warranty
- SPECCLASS devices backed by a Limited 2-Year Warranty

**\*COLOR**

Basic Cat. Nos. shown above denote Brown device, except for Isolated Ground (-IG) devices Basic Cat. No. denotes Orange. Isolated Ground Receptacle is distinguished by an orange triangle on its face. For other color selections, add suffix to the catalog number as follows: Ivory (-I), White (-W), Brown (For IG devices only, add -B), Almond (-A), Light Almond (-T), Gray (-G or -GY), Black (-E), Red (-R) and Blue (-BU; for IG devices only, add -BIG)

**MATERIAL CHARACTERISTICS**

Environmental: Flammability, Rated V2  
Operating Temperature: From -40° C (without impact) to 60° C maximum continuous

- |                                       |  |                                      |
|---------------------------------------|--|--------------------------------------|
| <b>A</b> RATING                       | <b>E</b> CATALOG NUMBER                      | <b>I</b> SPECIFICATIONS & FEATURES   |
| <b>B</b> Choose GRADE, if appropriate | <b>F</b> DESCRIPTION                         | <b>J</b> TESTING AND CODE COMPLIANCE |
| <b>C</b> DIMENSIONED PHOTOGRAPH       | <b>G</b> Check for NEMA CONFIGURATION        | <b>K</b> COLOR LISTING               |
| <b>D</b> WIRING/CERTIFICATIONS        | <b>H</b> WALLPLATE REFERENCE, if appropriate | <b>L</b> MATERIAL CHARACTERISTICS    |

**Acenti Collection**

Premium Grade

**INDEX**

|  |     |
|--|-----|
| <b>Acenti® Collection</b>                          |     |
| Overview   | .A2 |
| <b>Acenti Lighting Controls</b>                    |     |
| Dimmers and Fan Speed Control                      | .A3 |
| <b>Acenti Switches</b>                             |     |
| 15A and 20A Switches                               | .A4 |
| Electronic Timer Switch                            | .A4 |
| Manual-ON Occupancy Sensor                         | .A4 |
| <b>Acenti Receptacles</b>                          |     |
| Triplex and Duplex                                 | .A5 |
| Sixplex and Duplex Surge Protective Receptacles    | .A5 |
| <b>Acenti Wallplates and QuickPort® Connectors</b> |     |
| Wallplates   | .A6 |
| QuickPort Snap-In Connectors                       | .A7 |
| QuickPort Wallplate Inserts                        | .A7 |



# ACENTI® COLLECTION FEATURES

## Premium Grade Lighting Controls and Devices

### THE ACENTI COLLECTION OFFERS A FULL PORTFOLIO OF TECHNICALLY AND AESTHETICALLY SUPERIOR DEVICES FOR RESIDENTIAL APPLICATIONS.

Acenti lighting controls and switches respond alike; their push pads remain permanently graded. No line breaks or irregular shadow patterns detract from their pleasing, symmetrical appearance. The Collection includes the industry's first triplex receptacle, duplex and sixplex surge protective receptacles, GFCIs, screwless snap-on wallplates, and QuickPort® multimedia inserts and snap-in connectors.

### Acenti Lighting Controls

Lighting and fan speed controls feature a patent-pending return to neutral push pad, multi-location control with either matching or coordinating remotes, soothing blue LEDs and Acenti's unique surface alignment system.

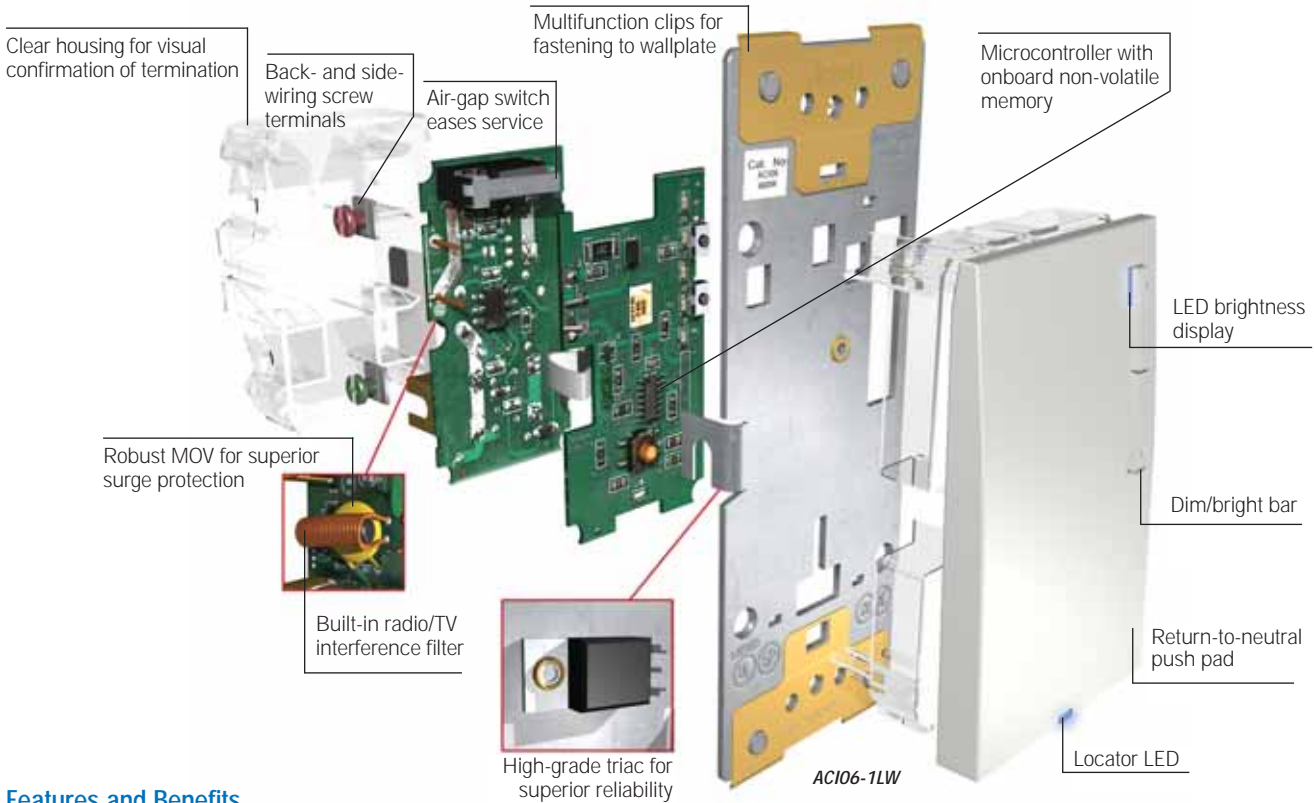

### Features and Benefits

- Efficient construction with consistent form factor, excellent ergonomic traits and precision feel
- Innovative contoured geometry\* offers an exclusive aesthetic design
- Clean multi-gang installation with no dividers between devices
- Devices and wallplates molded from engineering-grade polymer with subtle matte finish and flawless color match
- Screwless wallplates snap onto device's TOX®-fastened multifunction clips
- Brushed and polished metal finish wallplates available to coordinate with premium grade appliances
- Meet all applicable UL, CSA, NOM and FCC requirements
- Backed by a Five-Year Limited Warranty

\* U. S. and Foreign Patents Pending.  
TOX® is a registered trademark of TOX PRESSOTECHNIK, LLC.

ACENTI BY LEVITON...DOWN TO THE LAST DETAIL



#### Switches

Return-to-neutral push pad with blue LED locator. 15A electronic (single-pole or multi-location) and 20A electromechanical models (120 & 277V in SP, 3W, 4W).  
**AC15-1LW shown**

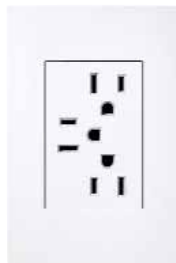

#### Triplex & Duplex Receptacles

Exclusive space-saving Triplex Receptacle in NEMA 5-15R and 5-20R configurations. Duplex models also available.  
**AC315-W shown**

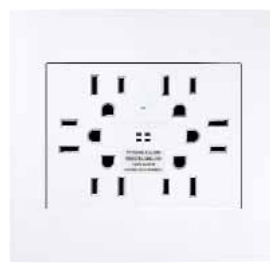

#### GFCI, Sixplex & Duplex Surge Protective Receptacles

GFCIs feature lockout action for added safety. Exclusive Sixplex Surge Receptacle saves space and helps protect sensitive electronic equipment.  
**ACSR6-W shown**



#### Wallplates

Screwless snap-on design provides smooth, clean look exclusively for all Acenti devices. Brushed stainless steel versions available.  
**ACWP1-W shown**



### Acenti Lighting Controls

All Acenti lighting controls provide single-pole (one location) and 3-way (multi-location) control when used with Remote unit.

#### Acenti Controls with LED Locator and Brightness Display 120V AC 60Hz Only

| DESCRIPTION   | CAT. NO. | RATING                  | COLOR*                 |
|---|----------|-------------------------|------------------------|
| Acenti Incandescent Dimmer  | ACI06-1L | 600W                    | W, Q, A, S, D, C, G, E |
| Acenti Magnetic Low-Voltage Dimmer  | ACM06-1L | 600VA (450W)            | W, Q, A, S, D, C, G, E |
| Acenti Incandescent/<br>Magnetic Low-Voltage Dimmer   | ACM10-1L | 1000W/<br>1000VA (800W) | W, Q, A, S, D, C, G, E |
| Acenti Electronic Low-Voltage Dimmer;<br>Neutral required   | ACE04-1L | 400W                    | W, Q, A, S, D, C, G, E |
| Acenti Electronic Low-Voltage Dimmer;<br>Neutral required   | ACE06-1L | 600W                    | W, Q, A, S, D, C, G, E |
| Acenti Advance Mark 10™ <i>Powerline</i> or<br>Tu-Wire™ Fluorescent Dimmer; Neutral required                                | ACX10-1L | 1000VA                  | W, Q, A, S, D, C, G, E |
| Acenti Hi-lume® or Eco-10™ (Eco-Series)<br>Fluorescent Dimmer; Neutral required   | ACH08-1L | 8 Amps                  | W, Q, A, S, D, C, G, E |
| Acenti Quiet Fan Speed Control<br>(LED Display denotes speed); Neutral required   | ACF01-1L | 1.5 Amps                | W, Q, A, S, D, C, G, E |
| Matching Remote Unit to 120V Dimmers/Fan<br>Speed Control for 3-Way or up to 5 locations;<br>Neutral required               | AC00R-1L | No load rating          | W, Q, A, S, D, C, G, E |
| Coordinating Remote Unit to 120V Dimmers/Fan<br>Speed Control for 3-Way or up to 10 locations,<br>no LED; Neutral required† | AC00R-10 | No load rating          | W, Q, A, S, D, C, G, E |

† Except when used with incandescent or magnetic low-voltage dimmers.

**CAUTION ON RETROFITS:** When retrofitting Mark 10™ *Powerline* dimming ballasts into fixtures that originally had Instant Start ballasts, the sockets MUST be replaced with Rapid Start sockets to allow proper dimmer operation and prevent damage to the dimming ballast. Refer to the instructions provided with the ballast and the Leviton dimmer.

#### Acenti Colors

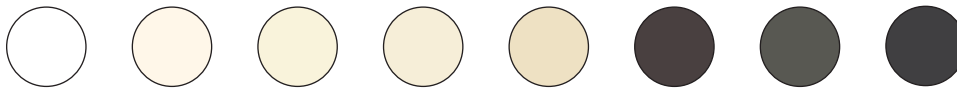

Note: Wallplates are also available in Brushed Stainless Steel, Polished Chrome and 24K Gold finishes.  
Custom premium colors available.

#### Maximum Load per Acenti Device

| CAT. NO. | SINGLE                  | 2-GANG                | MORE THAN 2-GANG      |
|----------|-------------------------|-----------------------|-----------------------|
| ACE04-1L | 400W                    | 350W                  | 250W                  |
| ACE06-1L | 600W                    | 500W                  | 400W                  |
| ACF01-1L | 1.5A                    | 1.5A                  | 1.5A                  |
| ACH08-1L | 8A                      | 8A                    | 8A                    |
| ACI06-1L | 600W                    | 600W                  | 500W                  |
| ACM06-1L | 600VA (450W)            | 600VA (450W)          | 500VA (375W)          |
| ACM10-1L | 1000W/<br>1000VA (800W) | 800W/<br>800VA (640W) | 650W/<br>650VA (520W) |
| ACX10-1L | 1000VA                  | 800VA                 | 650VA                 |

#### SPECIFICATIONS AND FEATURES

- Universal design provides crisp actuation with minimal travel
- Push pad always returns to neutral position regardless of load status
- Minimum brightness can be adjusted to comfortable level
- Dim-lock feature allows lights to turn on to a user-configured level every time
- Soothing blue LED Locator for easy location in the dark
- Subtle blue LED brightness level display
- Digital circuitry provides eye-pleasing soft-ON/fade-OFF and extended lamp life; fade rates are selectable

- Protected memory and voltage compensation maintain light levels after power outages
- Single-pole (one-location) and 3-way (multi-location) switching with Acenti Remote Units
- Built-in radio/TV interference filter
- Terminal screws (back- and side-wire) on select models ease installation
- Multifunction self-grounding clip snaps onto wallplate and ensures proper device alignment
- Screwless, snap-on wallplates in matching and coordinating colors

#### TESTING AND CODE COMPLIANCE

- UL Listed (File #E-31373)
- CSA Certified (File #LR-3413)

- NOM Certified (#057)
- Meets FCC Part 15
- Backed by a Limited Five-Year Warranty

#### \*COLOR

For color selection, add suffix to catalog number as follows: Alabaster (-W), Quartz (-Q), Natural (-A), Sand (-S), Driftwood (-D), Cocoa (-C), Slate (-G), Onyx (-E).

#### MATERIAL CHARACTERISTICS

Environmental: Flammability UL-94, V2 Rating  
Operating Temperature: 32°F to 130°F

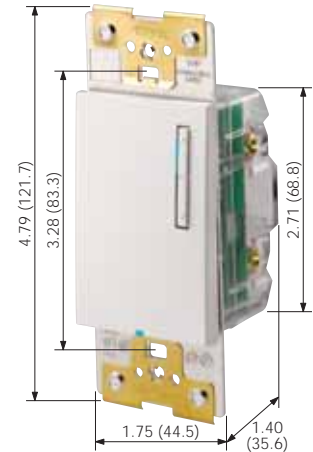

ACI06-1LW

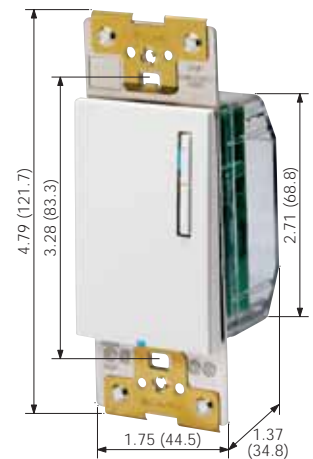

ACE06-1LW

Use Leviton Power Extenders to extend the load capacity of box-mounted dimmers. Leviton Power Extenders are available for incandescent, magnetic low-voltage, electronic low-voltage, Advance Mark 10™ *Powerline* fluorescent dimming ballasts or equivalents, and 0-10 VDC dimmable fluorescent ballasts such as Advance Mark 7™, OSRAM Sylvania Quicktronic Helios or equivalent ballasts.  
See Section C for more information.

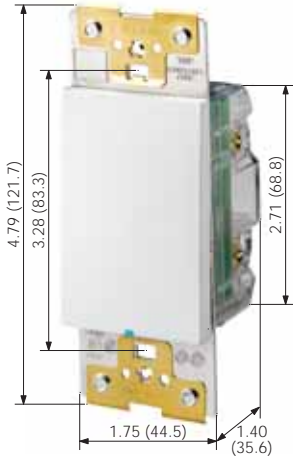

ACS15-1LW

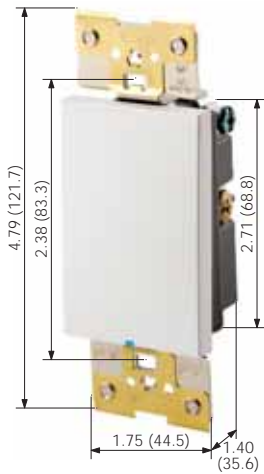

AC201-1LW



ACP15-CBW

### Acenti Switches

#### Acenti Switches 120V AC

| DESCRIPTION   | CAT. NO. | RATING         | COLOR*                 |
|---|----------|----------------|------------------------|
| Acenti 15-Amp Non-Dimming Electronic Switch for Single-Pole, 3-Way or More Applications, with LED Locator; Neutral required | ACS15-1L | 15 Amp         | W, Q, A, S, D, C, G, E |
| Matching Remote Unit to ACS15-1L Switch for 3-Way or up to 5 locations, with LED Locator; Neutral required                  | ACOSR-1L | No load rating | W, Q, A, S, D, C, G, E |
| Coordinating Remote Unit to ACS15-1L Switch for 3-Way or up to 10 locations, no LED; Neutral required                       | ACOSR-10 | No load rating | W, Q, A, S, D, C, G, E |
| Acenti 20-Amp Non-Dimming Electromechanical Switch for Single-Pole and Motor Loads, with LED Locator                        | AC201-1L | 20 Amp         | W, Q, A, S, D, C, G, E |
| Acenti 20-Amp Non-Dimming Electromechanical Switch for 3-Way Applications, with LED Locator                                 | AC203-1L | 20 Amp         | W, Q, A, S, D, C, G, E |
| Acenti 20-Amp Non-Dimming Electromechanical Switch for 4-Way Applications, with LED Locator                                 | AC204-1L | 20 Amp         | W, Q, A, S, D, C, G, E |

#### Acenti Switches 277V AC

| DESCRIPTION   | CAT. NO. | RATING | COLOR*                 |
|---|----------|--------|------------------------|
| Acenti 20-Amp Non-Dimming Electromechanical Switch for Single-Pole Applications, with LED Locator | AC201-7L | 20 Amp | W, Q, A, S, D, C, G, E |
| Acenti 20-Amp Non-Dimming Electromechanical Switch for 3-Way Applications, with LED Locator       | AC203-7L | 20 Amp | W, Q, A, S, D, C, G, E |
| Acenti 20-Amp Non-Dimming Electromechanical Switch for 4-Way Applications, with LED Locator       | AC204-7L | 20 Amp | W, Q, A, S, D, C, G, E |

### Acenti Adapted Devices

#### Acenti Electronic Timer Switch 120V AC 60Hz Only

| DESCRIPTION  | CAT. NO. | INTERVAL            | COLOR* |
|--|----------|---------------------|--------|
| Acenti Timer Switch with Four Preset Buttons and OFF, LED Locator; Neutral required. 3-Wire, Single-Pole, 1000W Incandescent, 20A Inductive, 1 HP @ 120V | ACT60-L  | 10-20-30-60 Minutes | W, A   |

#### Acenti Manual-ON Occupancy Sensor 120V AC 60Hz Only

| DESCRIPTION  | CAT. NO. | RATING   | COLOR*  |
|--|----------|--|---------|
| Manual-ON Occupancy Sensor, CEC Title 24 Compliant, Single-Pole, 3-Way or more when used with ACPOR Remote or Acenti Switch Remotes ACOSR-1L and ACOSR-10; Neutral required. With LED locator, 180° field of view, 900 sq. ft. coverage. | ACP15-CB | Incandescent: 1800VA, Fluorescent: 1800W at 120V AC. Motor: 1/2 HP @ 120V AC | W, A, E |
| Manual-ON Occupancy Sensor Remote Unit, 3-Way or more when used with ACP15 Occupancy Sensor or any Acenti Dimmer; Neutral required. With LED locator, 180° field of view, 900 sq. ft. coverage.  | ACPOR-CB | No load rating   | W, A, E |

#### SPECIFICATIONS AND FEATURES

##### Acenti Switches

- Universal design provides crisp actuation with minimal travel
- Push pad always returns to neutral position regardless of load status
- Soothing blue Locator LED for easy location in the dark
- ACS15-1L provides single-pole (one-location) and multi-location switching with Acenti Remote Units
- Terminal screws (back- and side-wire) ease installation
- Multifunction self-grounding clip snaps onto wallplate and ensures proper device alignment
- Screwless, snap-on wallplates in matching and coordinating colors

##### Acenti Electronic Timer Switch

- Four preset buttons plus OFF for timed control of lights and appliances
- LEDs indicate time elapsed and last LED flashes two-minutes-until-OFF warning

##### Acenti Occupancy Sensor

- Manual-ON/Automatic OFF operation in accordance with California Title 24 2005 requirements
- ACP15 provides true 3-way control when used with ACPOR Remote – ideal for L-shaped room or any large rooms
- ACP15 can be used with Acenti Switch Remotes for true 3-way control where a single sensor provides

complete room coverage – ideal for rooms with more than one entrance

- ACPOR Remote can be used with any Acenti dimmer for true 3-way control with combined occupancy sensor/dimmer functionality – ideal for Jack and Jill bathrooms

#### TESTING AND CODE COMPLIANCE

- Switches:** • UL Listed (File #E-7458)
- CSA Certified (File #LR-152105)
- Meets NEMA WD-1 & WD-6 requirements
- Timer:** • UL Listed (File #E-66800)
- CSA Certified (File #LR-68679)
- Occupancy Sensor:** • UL Listed (File #E-118904)
- CSA Certified (File #LR-152105)
- Conforms to California Title 24 Energy code and FCC regulations
- All Devices:** • NOM Certified (#057)
- Backed by a Limited Five-Year Warranty

#### \*COLOR

For color selection, add suffix to catalog number as follows: Alabaster (-W), Quartz (-Q), Natural (-A), Sand (-S), Driftwood (-D), Cocoa (-C), Slate (-G), Onyx (-E).

#### MATERIAL CHARACTERISTICS

Environmental: Flammability UL-94, V2 Rating  
Operating Temperature: 32°F to 130°F





Premium Grade Receptacles

Acenti Receptacles

Acenti Triplex and Duplex Receptacles 125V

| DESCRIPTION               | CAT. NO./COLOR*<br>15A/125V            | CAT. NO./COLOR*<br>20A/125V            |
|---------------------------|--|--|
|                           | 5-15R                                  | 5-20R                                  |
| Acenti Triplex Receptacle | <b>AC315</b><br>W, Q, A, S, D, C, G, E | <b>AC320</b><br>W, Q, A, S, D, C, G, E |
| Acenti Duplex Receptacle  | <b>AC215</b><br>W, Q, A, S, D, C, G, E | <b>AC220</b><br>W, Q, A, S, D, C, G, E |

Acenti GFCI, Sixplex and Duplex Surge Protective Receptacles 125V

| DESCRIPTION   | CAT. NO./COLOR*<br>15A/125V            | CAT. NO./COLOR*<br>20A/125V            |
|---|--|--|
|   | 5-15R                                  | 5-20R                                  |
| Acenti GFCI Receptacle,<br>20A/125V Feed-Through  | <b>ACGF1</b><br>W, Q, A, S, D, C, G, E | <b>ACGF2</b><br>W, Q, A, S, D, C, G, E |
| Acenti Sixplex Surge Protective<br>Receptacle, 2-Gang with 6" Leads,<br>Indicator Light and Audible Alarm | <b>ACSR6</b><br>W, Q, A, S, D, C, G, E | —                                      |
| Acenti Duplex Surge Protective<br>Receptacle with Indicator Light<br>and Audible Alarm                    | <b>ACSSR</b><br>W, Q, A, S, D, C, G, E | —                                      |

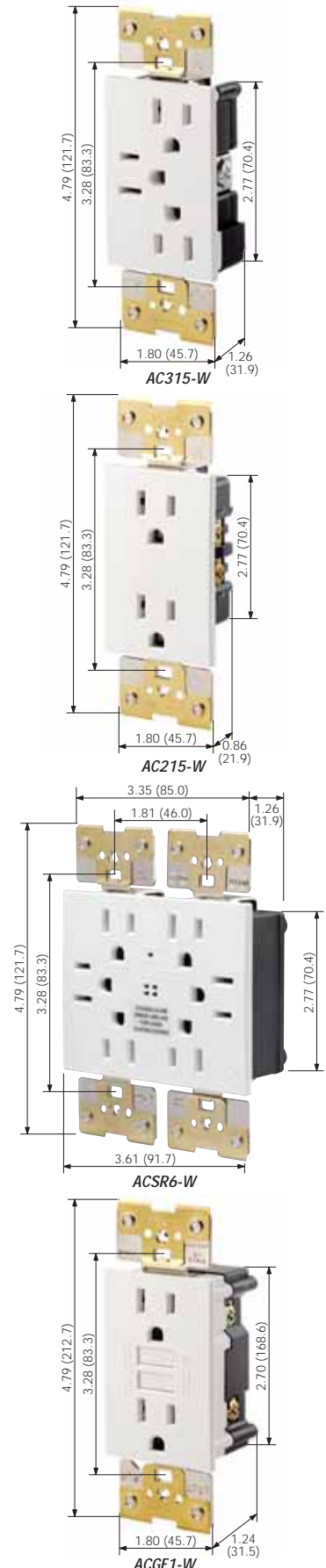

SPECIFICATIONS AND FEATURES

All Triplex and Duplex Receptacles

- Fit into a standard size wallbox
- Exclusive space-saving Triplex Receptacle accommodates 3 NEMA grounding plugs
- Neat multi-gang installation with no dividers between devices
- Terminal screws (back and side wire) available for easier installation
- Multifunction self-grounding clip snaps onto wallplate and ensures proper device alignment
- Subtle, matte finish complements fine décors
- Molded from engineering-grade polymer for uniformity and flawless color match
- Screwless, snap-on wallplates in matching and coordinating colors

GFCI Receptacles

- Patented bridge contact provides individual set of contacts for GFCI receptacle face and downstream receptacles
- Patented, advanced technology "dead-face" safety feature: no power to receptacle face if improperly wired (line-load reversal)
- Lockout feature for added safety
- Matching TEST and RESET buttons

Surge Protective Receptacles

- Exclusive space-saving Sixplex Surge Protective Receptacle provides six outlets
- Protect sensitive electronic equipment against transient voltage surges
- UL 1449 clamping level: 400V
- Audible alarm for protection status
- Soothing blue LED Monitor/Indicator

TESTING AND CODE COMPLIANCE

- UL Listed (Triplex/Duplex/Surge: File #E-13399, GFCI: File #E-48380)
- CSA Certified (Triplex/Duplex: File #LR-152105, GFCI: File #LR-57811, Surge: File #MC152105/LR-406)
- NOM Certified (#057)
- Meets NEMA WD-1 & WD-6 requirements
- Backed by a Limited Five-Year Warranty

\*COLOR

For color selection, add suffix to catalog number as follows: Alabaster (-W), Quartz (-Q), Natural (-A), Sand (-S), Driftwood (-D), Cocoa (-C), Slate (-G), Onyx (-E).

MATERIAL CHARACTERISTICS

Environmental: Flammability UL-94, V2 Rating  
Operating Temperature: 32°F to 130°F



# ACENTI® WALLPLATES

## Premium Grade Wallplates

### Acenti Screwless Snap-On Wallplates

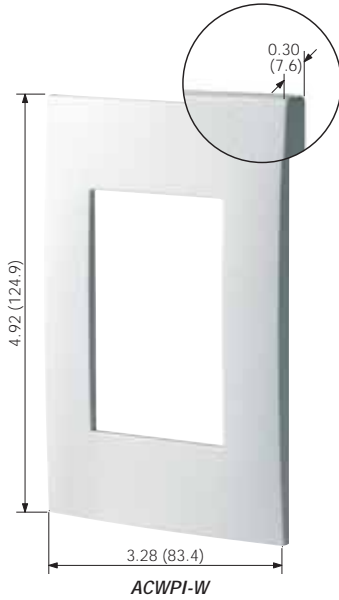

| DESCRIPTION            | COLOR*                    | ENGINEERING GRADE POLYMER CAT. NO. | BRUSHED STAINLESS STEEL CAT. NO.** | POLISHED CHROME CAT. NO.** | 24K GOLD CAT. NO.** |
|------------------------|---------------------------|------------------------------------|------------------------------------|----------------------------|---------------------|
| 1-Gang<br>1 Acenti     | W, Q, A, S,<br>D, C, G, E | ACWP1                              | ACWM1-STS                          | ACWM1-PCH                  | ACWM1-24K           |
| 2-Gang<br>2 Acenti     | W, Q, A, S,<br>D, C, G, E | ACWP2                              | ACWM2-STS                          | ACWM2-PCH                  | ACWM2-24K           |
| 3-Gang<br>3 Acenti     | W, Q, A, S,<br>D, C, G, E | ACWP3                              | ACWM3-STS                          | ACWM3-PCH                  | ACWM3-24K           |
| 4-Gang<br>4 Acenti     | W, Q, A, S,<br>D, C, G, E | ACWP4                              | ACWM4-STS                          | ACWM4-PCH                  | ACWM4-24K           |
| 5-Gang<br>5 Acenti     | W, Q, A, S,<br>D, C, G, E | ACWP5                              | ACWM5-STS                          | ACWM5-PCH                  | ACWM5-24K           |
| 6-Gang<br>6 Acenti     | W, Q, A, S,<br>D, C, G, E | ACWP6                              | ACWM6-STS                          | ACWM6-PCH                  | ACWM6-24K           |
| Blank Wallplate Insert | W, Q, A, S,<br>D, C, G, E | ACW14                              | —                                  | —                          | —                   |



ACWM1-STS



ACWM1-PCH



ACWM1-24K

#### SPECIFICATIONS AND FEATURES

- Exclusively for all Acenti devices
- Screwless snap-on design provides smooth, clean look
- Subtle, matte finish complements fine décor
- Available in engineering-grade polymer, brushed stainless steel, polished chrome and 24K Gold metal finishes
- Unique, screwless metal finish wallplates coordinate with premium-grade appliances
- Single-opening design of multi-gang wallplates means device frames rest side by side, without extra webbing between them to disrupt clean appearance
- Alignment plate with positioning pins ensures alignment of device and wallplate
- Snaps easily and directly onto device's multifunction, Tox®+fastened clips, which also provides self-grounding of device and metal wallplate (when used with a properly grounded metal wallbox)
- Custom premium colors and QuickPort® jack inserts available

#### TESTING AND CODE COMPLIANCE

- UL Listed and CSA Certified
- NOM Certified (#057)
- Meet NEMA Standards WD-1, WD-6 (plastic); Meet NEMA and ANSI standards (metal)
- Backed by a Limited Five-Year Warranty

#### \*COLOR

For color selection, add suffix to catalog number as follows: Alabaster (-W), Quartz (-Q), Natural (-A), Sand (-S), Driftwood (-D), Cocoa (-C), Slate (-G), Onyx (-E). \*\*STS denotes Stainless Steel, PCH denotes Polished Chrome and 24K denotes 24K Gold finishes.

*TOX® is a registered trademark of TOX PRESSOTECHNIK, LLC.*



### Acenti® QuickPort Snap-In Connectors and Wallplate Inserts

#### Acenti QuickPort® Snap-In Connectors

| DESCRIPTION                        | CAT. NO.  |
|------------------------------------|-----------|
| Cat 5e Jack                        | AC108-R*5 |
| RCA Jack w/Red Stripe              | AC830-B*R |
| RCA Jack w/Black Stripe            | AC830-B*E |
| RCA Jack w/Yellow Stripe           | AC830-B*Y |
| RCA 110 Termination, Orange Barrel | AC735-RO* |
| RCA 110 Termination, Red Barrel    | AC735-RR* |
| RCA 110 Termination, White Barrel  | AC735-RW* |
| RCA 110 Termination, Yellow Barrel | AC735-RY* |
| Banana Jack w/Red Stripe           | AC837-B*R |
| Banana Jack w/Black Stripe         | AC837-B*E |
| Binding Post w/Red Stripe          | AC833-B*R |
| Binding Post w/Black Stripe        | AC833-B*E |
| BNC Adapter, Nickel-Plated         | AC084-B*F |
| BNC Adapter, Gold-Plated           | AC832-OB* |
| F-Type Adapter, Nickel-Plated      | AC084-F*F |
| F-Type Adapter, Gold-Plated        | AC831-OB* |
| Blank Insert                       | AC084-B*B |
| S-Video Module, 110 Termination    | AC734-SV* |

#### Acenti QuickPort® Multimedia Wallplate Inserts

| DESCRIPTION             | CAT. NO. | COLOR*                 |
|-------------------------|----------|------------------------|
| 2-Port QuickPort Insert | AC642    | W, Q, A, S, D, C, G, E |
| 3-Port QuickPort Insert | AC643    | W, Q, A, S, D, C, G, E |
| 4-Port QuickPort Insert | AC644    | W, Q, A, S, D, C, G, E |
| 6-Port QuickPort Insert | AC646    | W, Q, A, S, D, C, G, E |

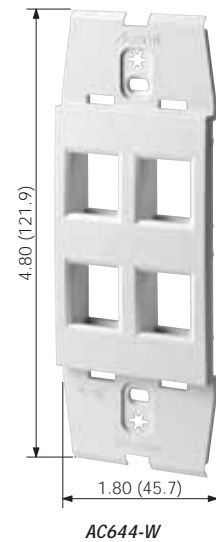

Alabaster (-W) Quartz (-Q) Natural (-A) Sand (-S) Driftwood (-D) Cocoa (-C) Slate (-G) Onyx (-E)

#### SPECIFICATIONS AND FEATURES

- Complements complete line of premium grade Acenti devices
- Provides voice, data, audio and video
- Compatible with the complete collection of Acenti screwless, snap-on wallplates

#### TESTING AND CODE COMPLIANCE

##### QuickPort Wallplate Inserts

- UL Listed and CSA Certified
- Meets NEMA Standards WD-1, WD-6

##### QuickPort Snap-In Connectors and Wallplate Inserts

- Backed by a Limited Five-Year Warranty

#### \*COLOR

When ordering Acenti QuickPort Snap-In Connectors, insert color description where (\*) is indicated. Alabaster (W), Quartz (Q), Natural (A), Sand (S), Driftwood (D), Cocoa (C), Slate (G) and Onyx (E).  
When ordering Acenti QuickPort Wallplate Inserts, add suffix to catalog number as follows: Alabaster (-W), Quartz (-Q), Natural (-A), Sand (-S), Driftwood (-D), Cocoa (-C), Slate (-G) and Onyx (E).

# HOW TO USE THIS CATALOG

The L-101 Leviton Wiring Device Catalog is designed to help you find the device you're seeking in the quickest and easiest way possible. Most product sections are divided into three distinct categories in the following sequence—Industrial Grade, Commercial Grade and Residential Grade—and grouped according to amperage and voltage, lowest to highest. For example, if you need to order 15 Amp, 125 Volt Industrial Grade straight-blade duplex receptacles, begin your search with the main Table of Contents at the front of the book. Here you'll see that all straight blade receptacles are listed in Section G. Turn to Section G for a more detailed Table of Contents on the first page. Each section page contains product descriptions, ratings and catalog numbers. There are also helpful highlights including Specifications and Features, Testing and Code Compliance, Color listing, Material Characteristics and dimensioned color product photos. Any product page in the L-101 Catalog can be clearly copied or faxed to customers and prospects for use as a specifier sheet or as part of a presentation.

The Quick Reference Guide follows the main Table of Contents to help you pinpoint and locate specific products. Technical Section V provides general product and test data, industry standards, NEMA configuration charts, a glossary of wiring device terms, ANSI architectural symbols and other related information. Specific catalog numbers are listed in the exhaustive index at the back of the catalog.

**15 AMP 125 and 250V ~ 20 AMP 125 and 250V**

**Industrial Grade Straight Blade Receptacles**

**5362-IG**

| DESCRIPTION                             | CAT. NO./COLOR<br>15A/125V    | CAT. NO./COLOR<br>15A/250V | CAT. NO./COLOR<br>20A/125V | CAT. NO./COLOR<br>20A/250V |
|---|-------------------------------|----------------------------|----------------------------|----------------------------|
| LEVSPEC® Duplex Receptacle, Brass Strap | 5262<br>I, W, GY, R, E        | 5662<br>I                  | 5362<br>I, W, GY, R, E     | 5462<br>I, GY              |
| Single Receptacle                       | 5261<br>I, W, GY              | 5661<br>I                  | 5361<br>I, W, A, T, GY     | 5461<br>I, A, T, GY        |
| Narrow Body Duplex Receptacle           | 5252<br>I, W, A, T, GY, R, BU |                            | 5352<br>I, W, A, T, GY, R, |                            |

80703-IG 80703-I 80704-GY 80716-R

84003-40 84004-40 84016-40

**For complete wallplate selection, see Section E.**

**SPECIFICATIONS AND FEATURES**

**Back & Side Wired Duplex**

- Impact-resistant thermoplastic nylon cover and body
- Smooth face does not collect dirt
- Four corner latches securely fasten face
- Single-piece brass mounting strap on LEVSPEC devices, multi-piece steel strap on other devices
- Large, triple-wipe, brass "T" contacts for superior contact and conductivity
- Back and side-wiring options
- Brass terminal screws to reduce conductor oxidation
- Break-off tabs for easy two-circuit conversion
- Apron barrier to prevent accidental contact between terminal screw heads and metal box
- Exclusive V-shaped, serrated back-wiring clamp for superior contact and conductivity

- Meets NEMA WD-1 & 6, and ANSI standards
- Backed by a Limited 10-Year Warranty
- SPECCLASS devices backed by a Limited 2-Year Warranty

**\*COLOR**

Basic Cat. Nos. shown above denote Brown device, except for Isolated Ground (-IG) devices Basic Cat. No. denotes Orange. Isolated Ground Receptacle is distinguished by an orange triangle on its face. For other color selections, add suffix to the catalog number as follows: Ivory (-I), White (-W), Brown (For IG devices only, add -B), Almond (-A), Light Almond (-T), Gray (-G or -GY), Black (-E), Red (-R) and Blue (-BU); for IG devices only, add -BIG)

**MATERIAL CHARACTERISTICS**

Environmental: Flammability, Rated V2  
Operating Temperature: From -40° C (without impact) to 60°C maximum continuous

**TESTING AND CODE COMPLIANCE**

- UL Listed 498 (UL File #13399); UL Federal Specification WC-596

- |                                       |  |                                      |
|---------------------------------------|--|--------------------------------------|
| <b>A</b> RATING                       | <b>E</b> CATALOG NUMBER                      | <b>I</b> SPECIFICATIONS & FEATURES   |
| <b>B</b> Choose GRADE, if appropriate | <b>F</b> DESCRIPTION                         | <b>J</b> TESTING AND CODE COMPLIANCE |
| <b>C</b> DIMENSIONED PHOTOGRAPH       | <b>G</b> Check for NEMA CONFIGURATION        | <b>K</b> COLOR LISTING               |
| <b>D</b> WIRING/CERTIFICATIONS        | <b>H</b> WALLPLATE REFERENCE, if appropriate | <b>L</b> MATERIAL CHARACTERISTICS    |

**Decora® Devices**

|   |            |
|---|------------|
| General Overview  | . B2       |
| Decora Switch Overview  | . B3       |
| <b>Commercial Grade Switches</b>                                  |            |
| Decora <i>Plus</i> AC Quiet Rocker Switches                       | . B4       |
| Decora <i>Plus</i> Momentary and Maintained Switches              | . B5       |
| Decora <i>Plus</i> Illuminated and Pilot Light Switches           | . B6       |
| <b>Residential Grade Switches</b>                                 |            |
| Decora AC Quiet Rocker Switches                                   | . B7, B8   |
| Illuminated, Pilot Light  | . B8       |
| Decora 911 Emergency Flasher                                      | . B8       |
| <b>Industrial and Commercial Grade Receptacles</b>                |            |
| Decora Receptacles Overview                                       | . B9       |
| Decora <i>Plus</i> Receptacles                                    | . B10, B11 |
| <b>Residential Grade Receptacles</b>                              |            |
| Decora Quickwire and Side Wired                                   | . B12      |
| <b>Hospital and Industrial Grade Surge Protective Receptacles</b> |            |
| Decora Back and Side Wired  | . B13      |
| <b>SmartLockPRO® GFCI Receptacles</b>                             |            |
| SmartLockPRO® Overview  | . B14      |
| GFCI Receptacles  | . B15      |
| Combination Switch/GFCI Outlet                                    | . B15      |
| Blank Face  | . B15      |
| <b>Commercial Grade Devices</b>                                   |            |
| Decora Combination Devices  | . B16, B17 |
| Decora Voice/Data/Video Devices                                   | . B18      |
| Decora <i>Plus</i> Canadian 347V AC Quiet Rocker Switches         | . B19      |
| Canadian 347V Midway Nylon Wallplates                             | . B19      |
| <b>Wallplates</b>   |            |
| Decora <i>Plus</i> Screwless Snap-On                              | . B20      |
| Decora Thermoset, Thermoplastic and Metal                         | . B21–B23  |
| Adapters  | . B24      |
| Replacement Screws  | . B24      |
| <b>Decora-Style Recessed Receptacles</b>                          |            |
| Overview  | . B25      |
| Recessed Entertainment Box  | . B26      |
| Duplex Recessed Receptacles                                       | . B26      |



# DECORA® DEVICE FEATURES

## Commercial Grade Wiring devices

### LEVITON'S DECORA DESIGNER LINE OF WIRING DEVICES ADDS CONTEMPORARY STYLING TO ANY RESIDENTIAL OR COMMERCIAL APPLICATION.

Decora Devices are built to the highest performance standards to provide a long, trouble-free service life. The Decora Devices line represents a broad selection of switches, receptacles, surge suppressor receptacles, SmartLock® GFCI receptacles, combination devices, wall jacks and wallplates.

#### Features and Benefits

- Decora Devices are engineered for beauty, versatility and durability
- All Decora Plus Commercial Grade devices feature heavy-duty construction
- All Decora devices meet or exceed applicable UL, CSA and NOM testing standards
- Backed by a Limited 10-Year Warranty

#### DECORA COLORS

Decora devices are offered in a wide range of colors and finishes, which includes Almond, Light Almond, White, Ivory, Gray, Red, Ebony (Black) and Mahogany Brown. A selection of metal Decora wallplates comes in Brushed Brass, Polished Brass, Stainless Steel and Aluminum.



#### Decora Switches

A complete range of single pole, double pole, 3 and 4-way switches in both residential and commercial grades. **5691-2E, 5621-2W shown**

#### Decora Receptacles

A broad selection of amperages and NEMA configurations in Industrial, Commercial and Residential grades with an array of colors from which to choose. **16352-GY shown**

#### Decora Illuminated Switches

Pilot Light, Illuminated Rocker, Maintained and Momentary Contact versions. **5631-2I, 5628-2A shown**



**Decora Hospital Grade Receptacles**  
Leviton's selection includes Isolated Ground, Tamper Resistant, Surge Protected, GFCI and Power Indication versions. **16262-IGR shown**



**Decora Combo Devices**  
Compact design fits dual or triple switch, switch/receptacle, or switch/GFCI receptacle into standard wallboxes. **7299-1 shown**



**Decora Communications Wiring Devices**  
Pre-configured and field-configurable jacks accommodate Decora wallplates, complementing other Decora wiring devices, and fit in standard NEMA wallboxes. **41658-W shown**

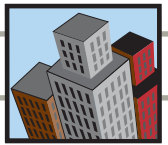

**DECORA PLUS SWITCHES ENHANCE EVERY INTERIOR**

Leviton's Decora line of designer-style switches are available in a complete range of single pole, double pole, 3 and 4-way switches in both residential and commercial grades. They come in a cascade of contemporary shades and add an air of distinction and value to contemporary commercial and residential design schemes.

**Features and Benefits**

- Engineered for fine tolerances and top performance
- Decora Plus Switches feature impact resistant thermoplastic construction for long service life
- All Decora devices meet or exceed applicable UL, CSA and NOM testing standards

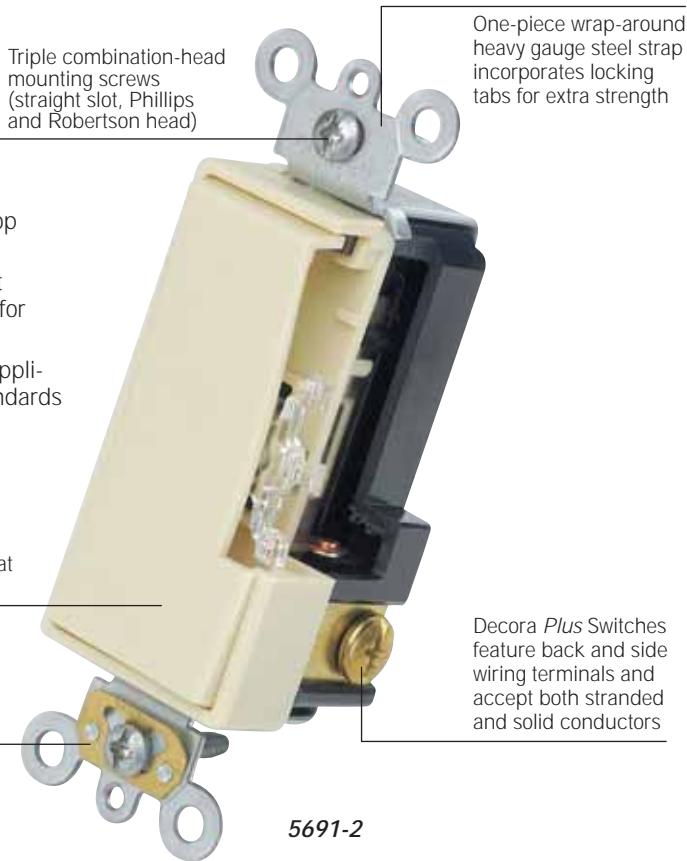

Decora Plus Switches have patented concave rockers that present a low profile

Self-grounding clip

One-piece wrap-around heavy gauge steel strap incorporates locking tabs for extra strength

Decora Plus Switches feature back and side wiring terminals and accept both stranded and solid conductors

5691-2



**Decora Plus Switches**

A complete range of rugged Commercial Specification Grade single pole, double pole, 3 and 4-way switches.  
5691-2E, 5621-2W shown



**Illuminated Switches**

Rocker lens is illuminated when load is OFF.  
5631-2I shown



**Pilot Light Switches**

Rocker lens is illuminated when load is ON.  
5628-2A shown



**Momentary Contact Switches**

Combines Decora styling and rugged construction for momentary contact closure (single-pole, double-throw, center OFF switching).  
5657-2A shown



**Maintained Contact Switches**

Rugged Decora styling for maintained contact closure (single-pole, double-throw, center OFF switching).  
5685-2E shown



**Residential Grade Switches**

Engineered for smooth, quiet operation and a long trouble-free service in fine residential interiors.  
5601-2I shown



# DECORA® PLUS SWITCHES 15 and 20 AMP 120/277V

## Commercial Grade Switches

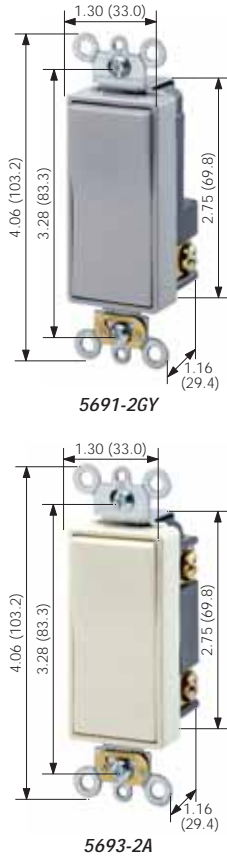

### Decora Plus AC Quiet Rocker Switches

Back and Side Wired 120/277V AC

| DESCRIPTION | 15 AMP | 20 AMP  | ROCKER & FRAME COLOR*<br><i>Basic Cat. No. Denotes Mahogany</i> |
|-------------|--------|---------|---|
| Single-Pole | 5691-2 | 5621-2† | I, W, A, T, GY, E   |
| Three-way   | 5693-2 | 5623-2† | I, W, A, T, GY, E   |
| Four-way    | —      | 5624-2  | I, W, A, T, GY  |

†Available in Red (-R)

### Wallplates

| THERMOPLASTIC |          | POLYCARBONATE SCREWLESS SNAP-ON |           | 302 STAINLESS STEEL |          |
|---------------|----------|---------------------------------|-----------|---------------------|----------|
|               |          |                                 |           |                     |          |
| 80401-NT      | 80409-NT | 80301-SGY                       | 80309-SGY | 84401-40            | 84409-40 |

For complete Decora wallplate selection, see pages B20–B24.

#### SPECIFICATIONS AND FEATURES

##### Back and Side Wired

- Full rated current capacity with tungsten, fluorescent or resistive loads. Motor capacity is 80% of switch rating
- Back and side-wiring terminals accept both solid and stranded wire to ease installation
- New architecturally-styled smooth-action concave rocker
- Heavy-duty impact-resistant thermoplastic construction for long service life in commercial applications
- Two ground connection options: a green grounding screw and a self-grounding clip
- For Canadian 347V Decora Plus Switches, see page B19

#### TESTING AND CODE COMPLIANCE

- UL Listed (File #E-7458)
- CSA Certified (File #LR-3413)
- NOM Certified (#057)
- Compliance with the latest Federal Specification WS-896
- Backed by a Limited 10-Year Warranty

#### \*COLOR

Colors available as listed. For other color selections, add suffix to catalog numbers as follows: Ivory (-I), White (-W), Almond (-A), Light Almond (-T), Gray (-GY), Black (-E), Red (-R).

##### Imprinted Decora Switches

Custom orders available in Ivory (-I), White (-W).

#### HORSEPOWER

| 15A        | 20A      |
|------------|----------|
| 1/2 @ 120V | 1 @ 120V |
| 2 @ 240V   | 2 @ 240V |

#### MATERIAL CHARACTERISTICS

Environmental: Flammability UL-94, V2 Rating  
Operating Temperature: -40°C to 120°C





### Decora Plus Momentary and Maintained Switches







#### Back and Side Wired Momentary Contact 15 AMP 120/277V AC

| DESCRIPTION                           | CAT. NO. | COLOR*            |
|---------------------------------------|----------|-------------------|
| Single-Pole, Double Throw, Center OFF | 5657-2   | I, W, A, T, GY, E |

#### Back and Side Wired Maintained Contact 15 AMP 120/277V AC

| DESCRIPTION                           | CAT. NO. | COLOR*                   |
|---------------------------------------|----------|--------------------------|
| Single-Pole, Double-Throw, Center OFF | 5685-2   | I, W, A, T, GY, E        |
| Double-Pole, Double-Throw, Center OFF | 5686-2   | I, W, A, T (No Mahogany) |

### Wallplates

| THERMOSET   |   | THERMOPLASTIC   |   | POLISHED BRASS  |  |
|---|---|---|---|---|--|
|  |  |  |  |  |  |
| 80401-W   | 80601-W<br>Midway Size  | 80401-NW  | 80409-NW  | 81401-PB  | 81409-PB   |

For complete Decora wallplate selection, see pages B20-B24.

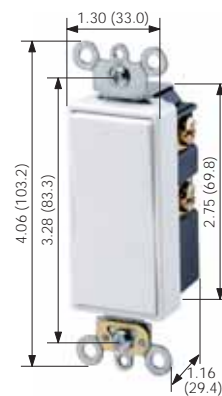

5657-2W

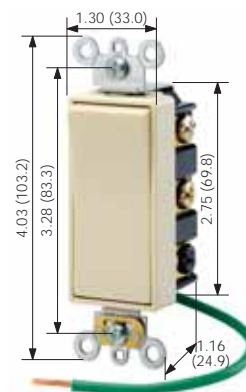

5686-2I

#### SPECIFICATIONS AND FEATURES

- Full rated current capacity with tungsten, fluorescent or resistive loads. Motor capacity is 80% of switch rating
- Wrap-around heavy-gauge strap with locking tabs for added strength
- Back and side-wiring terminals accept both solid and stranded wire to ease installation

#### TESTING AND CODE COMPLIANCE

- UL Listed (File #E-7458)
- CSA Certified (File #LR-3413)
- NOM Certified (#057)
- Meets requirements of latest Federal Specification WS-896
- Backed by a Limited 10-Year Warranty

#### \*COLOR

Colors available as listed. For other color selections, add suffix to catalog numbers as follows: Ivory (-I), White (-W), Almond (-A), Light Almond (-T), Gray (-GY), Black (-E).

#### HORSEPOWER

15A  
1/2 @ 120V  
2 @ 240V

#### MATERIAL CHARACTERISTICS

Environmental: Flammability UL-94, V2 Rating  
Operating Temperature: -40°C to 120°C



# DECORA® PLUS SWITCHES 20 AMP 120 and 277V

## Commercial Grade Switches

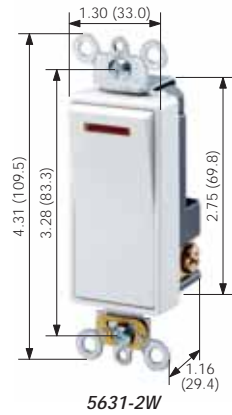

5631-2W

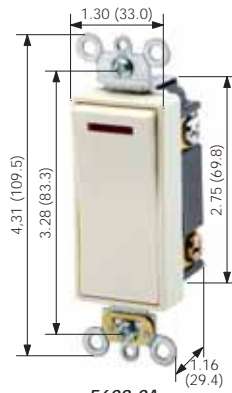

5628-2A

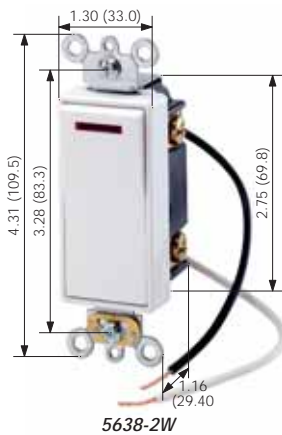

5638-2W

### Decora Plus Illuminated and Pilot Light Switches

**20 AMP Back and Side Wired Illuminated**   
(Illuminated when load is OFF—Does not require a neutral wire)

| DESCRIPTION          | CAT. NO. | COLOR*        |
|----------------------|----------|---------------|
| Single-Pole, 120V AC | 5631-2   | I, W, A, T, E |
| Three-way, 120V AC   | 5633-2   | I, W, A, T    |
| Single-Pole, 277V AC | 5649-2   | I, W          |
| Three-way, 277V AC   | 5659-2   | W             |

**20 AMP Back and Side Wired Pilot Light**   
(Illuminated when load is ON—Requires a neutral wire)

| DESCRIPTION          | CAT. NO. | COLOR*     |
|----------------------|----------|------------|
| Single-Pole, 120V AC | 5628-2   | I, W, A, T |
| Three-way, 120V AC   | 5638-2   | I, W, A    |
| Three-way, 277V AC   | 5639-2   | W          |

### Wallplates

| THERMOSET              |                        | THERMOPLASTIC |          | ALUMINUM |       |
|------------------------|------------------------|---------------|----------|----------|-------|
|                        |                        |               |          |          |       |
| 80601-A<br>Midway Size | 80609-A<br>Midway Size | 80401-NW      | 80409-NW | 83401    | 83409 |

For complete Decora wallplate selection, see pages B20–B24.

#### SPECIFICATIONS AND FEATURES

- 20A, 120 and 277V single-pole and 3-way versions
- Pilot Light rocker visible when ON even in bright light
- Back and side-wiring terminals accept both solid and stranded wire to ease installation
- Two ground connection options: a green grounding screw and a self-grounding clip

#### TESTING AND CODE COMPLIANCE

- UL Listed (File #E-7458)
- CSA Certified (File #LR-3413)
- NOM Certified (#057)
- Compliance with the latest Federal Specification WS-896
- Backed by a Limited 10-Year Warranty

#### \*COLOR

Colors available as listed. For other color selections, add suffix to catalog numbers as follows: Ivory (-I), White (-W), Almond (-A), Light Almond (-T), Black (E).

#### HORSEPOWER

**20A**  
1 @120V  
2 @ 240V

#### MATERIAL CHARACTERISTICS

Environmental: Flammability UL-94, V2 Rating  
Operating Temperature: -40°C to 120°C



### Decora AC Quiet Rocker Switches

15 AMP Quickwire Push-In and Side Wired 120/277V AC

| DESCRIPTION | CAT. NO.  | ROCKER/FRAME COLOR* |
|-------------|-----------|---------------------|
| Single-Pole | 5601      | Mahogany            |
|             | 5601-I    | Ivory               |
|             | 5601-W    | White               |
|             | 5601-2    | Mahogany            |
|             | 5601-2I   | Ivory               |
|             | 5601-2W   | White               |
|             | 5601-2A   | Almond              |
|             | 5601-2T   | Light Almond        |
|             | 5601-2E   | Ebony               |
|             | 5601-2GY  | Gray                |
|             | 5601-S2I† | Ivory               |
|             | 5601-S2W† | White               |
| 5601-S2A†   | Almond    |                     |
| Double-Pole | 5602-2    | Mahogany            |
|             | 5602-2I   | Ivory               |
|             | 5602-2W   | White               |
|             | 5602-2GY  | Gray                |
|             | 5602-2A   | Almond              |
|             | 5602-2T   | Light Almond        |
|             | 5602-2E   | Ebony               |
| Three-Way   | 5603      | Mahogany            |
|             | 5603-I    | Ivory               |
|             | 5603-W    | White               |
|             | 5603-2    | Mahogany            |
|             | 5603-2I   | Ivory               |
|             | 5603-2W   | White               |
|             | 5603-2A   | Almond              |
|             | 5603-2T   | Light Almond        |
|             | 5603-2E   | Ebony               |
|             | 5603-2GY  | Gray                |
|             | 5603-S2I† | Ivory               |
|             | 5603-S2W† | White               |
| 5603-S2A†   | Almond    |                     |
| Four-Way    | 5604-2    | Mahogany            |
|             | 5604-2I   | Ivory               |
|             | 5604-2W   | White               |
|             | 5604-2A   | Almond              |
|             | 5604-2T   | Light Almond        |
|             | 5604-2E   | Ebony               |
| 5604-2GY    | Gray      |                     |

Note: To order Decora rocker switches with grounding screw add suffix -2 (e.g. 5601-2I)

† Self-grounding when installed in a properly grounded metal wallbox.

### Wallplates

| THERMOSET |          | POLYCARBONATE SCREWLESS SNAP-ON |          | 302 STAINLESS STEEL |          |
|-----------|----------|---------------------------------|----------|---------------------|----------|
|           |          |                                 |          |                     |          |
| 80401-GY  | 80409-GY | 80301-SI                        | 80309-SI | 84401-40            | 84409-40 |

For complete Decora wallplate selection, see pages B20–B24.

#### SPECIFICATIONS AND FEATURES

- Switch frame shields against dust and fits in wallplate to prevent rocker binding
- Side Wire and Quickwire (No.12 or No.14 copper or copper-clad wire) push-in terminal wiring options
- Sturdy construction for long service life
- Full rated current capacity with tungsten, fluorescent or resistive loads. Motor capacity is 80% of switch rating
- Conform to all NEMA standard specifications

#### TESTING AND CODE COMPLIANCE

- UL Listed (File #E-7458)
- CSA Certified (File #LR-3413)
- NOM Certified (#057)
- Backed by a Limited Two-Year Warranty

#### \*COLOR

Rocker/Frame colors available as listed.

#### HORSEPOWER

**15A**  
1/2 @120V  
2 @ 240V

#### MATERIAL CHARACTERISTICS

Environmental: Flammability UL-94, V2 Rating  
Operating Temperature: -40°C to 120°C

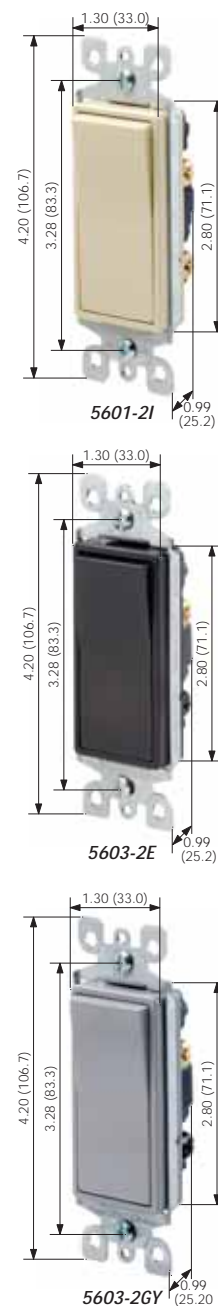



# DECORA® SWITCHES 15 AMP 120 and 120/277V

## Residential Grade Switches

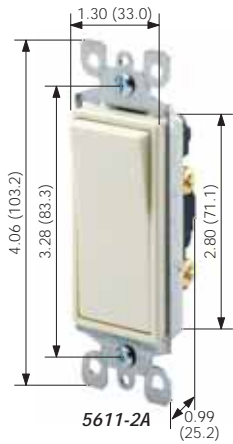

### Decora AC Quiet Rocker Switches

Quickwire® and Side Wired Illuminated 15 AMP 120/277V AC   
(Illuminated when load is OFF—Does not require a neutral wire)

| DESCRIPTION | CAT. NO. | COLOR*       |
|-------------|----------|--------------|
| Single-Pole | 5611-I   | Ivory        |
|             | 5611-W   | White        |
|             | 5611-2A  | Almond       |
|             | 5611-2T  | Light Almond |
| Three-Way   | 5613-I   | Ivory        |
|             | 5613-W   | White        |
|             | 5613-2A  | Almond       |
|             | 5613-2T  | Light Almond |
| Four-Way    | 5614-2I  | Ivory        |
|             | 5614-2W  | White        |
|             | 5614-2A  | Almond       |
|             | 5614-2T  | Light Almond |

Note: To order Decora rocker switches with grounding screw add suffix -2 (e.g. - 5611-2I)

Quickwire and Side Wired Pilot Light 15 AMP 120V AC   
(Illuminated when load is ON—Requires a neutral wire)

| DESCRIPTION | CAT. NO. | COLOR*     |
|-------------|----------|------------|
| Single-Pole | 5618-2   | I, W, A, T |

Quickwire and Side Wired Imprinted 15 AMP 120/277V AC

| DESCRIPTION                            | STOCK MESSAGES AVAILABLE  | CAT. NO. | COLOR* |
|--|---------------------------|----------|--------|
| Single-Pole, Stock or Custom Imprinted | FAN, DISPOSAL, OIL BURNER | 5601-Z2  | I, W   |

Quickwire and Side Wired Molded 15 AMP 120/277V AC

| DESCRIPTION                         | CAT. NO. | COLOR*        |
|-------------------------------------|----------|---------------|
| Single-Pole ON/OFF Molded in Rocker | 5601-X2  | I, W, A, T, E |

### 911 Flasher Switch

500 WATTS 120V

| DESCRIPTION                                | CAT. NO. | COLOR*  |
|--|----------|---------|
| 3-Position Emergency Flasher Rocker Switch | 911      | I, W, A |

### Wallplates

| THERMOSET |         |                        |                        | ALUMINUM |       |
|-----------|---------|------------------------|------------------------|----------|-------|
|           |         |                        |                        |          |       |
| 80401-W   | 80409-W | 80601-I<br>Midway Size | 80609-I<br>Midway Size | 83401    | 83409 |

For complete Decora wallplate selection, see pages B20–B24.

#### SPECIFICATIONS AND FEATURES

- Illuminated Switch rocker illuminated when load is OFF
- Pilot Light switch rocker visible when ON even in bright light
- Switch border shields against dust and fits in wallplate to prevent rocker binding
- Side-wiring terminals accept both solid and stranded wire to ease installation
- Full rated current capacity with tungsten, fluorescent or resistive loads. Motor capacity is 80% of switch rating
- Conform to all NEMA standard specifications

#### Imprinted Decora Switches

- Stock Decora switches available with choice of three imprints on rocker: FAN, DISPOSAL, OIL BURNER

#### 911 Switch

- 911 Switch provides standard ON/OFF control plus a special illuminated FLASH function will flash controlled lighting ON and OFF at one-second intervals
- Replaces standard single-pole switch-flash function alerts neighbors and helps emergency personnel locate a house quickly

#### TESTING AND CODE COMPLIANCE

- UL Listed (File #E-7458)
- CSA Certified (File #LR-3413)
- NOM Certified (#057)
- Backed by a Limited Two-Year Warranty

#### \*COLOR

For color choice add suffix as follows: Ivory (-I), White (-W), Almond (-A), Light Almond (-T).

#### HORSEPOWER

15A  
1/2 @120V  
2 @ 240V

#### MATERIAL CHARACTERISTICS

Environmental: Flammability UL-94, V2 Rating  
Operating Temperature: -40°C to 120°C

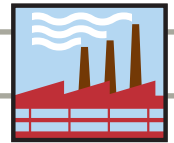

**THE BEAUTY, DURABILITY AND VERSATILITY OF DECORA RECEPTACLES**

Leviton's Decora line of designer-style receptacles are available in Industrial Grade (including Hospital Grade), Commercial Grade and Residential Grade, with a number of wiring options and features. They come in a variety of contemporary shades and add contemporary style to fine interiors everywhere.

**Features and Benefits**

- Engineered for fine appearance and top performance in demanding commercial and institutional applications using a durable, thermoplastic face and impact-resistant construction
- Shallow design for maximum wiring room in wallbox
- Back Wire and Side Wire terminal wiring options for ease of installation
- Heavy-gauge zinc-plated steel locked-in wrap-around strap
- Triple-wipe brass contacts for long service life
- Exclusive V-shaped, serrated back wiring clamps for superior contact and conductivity
- Available in an array of colors to coordinate with any interior
- Backed by a Limited 10-Year Warranty

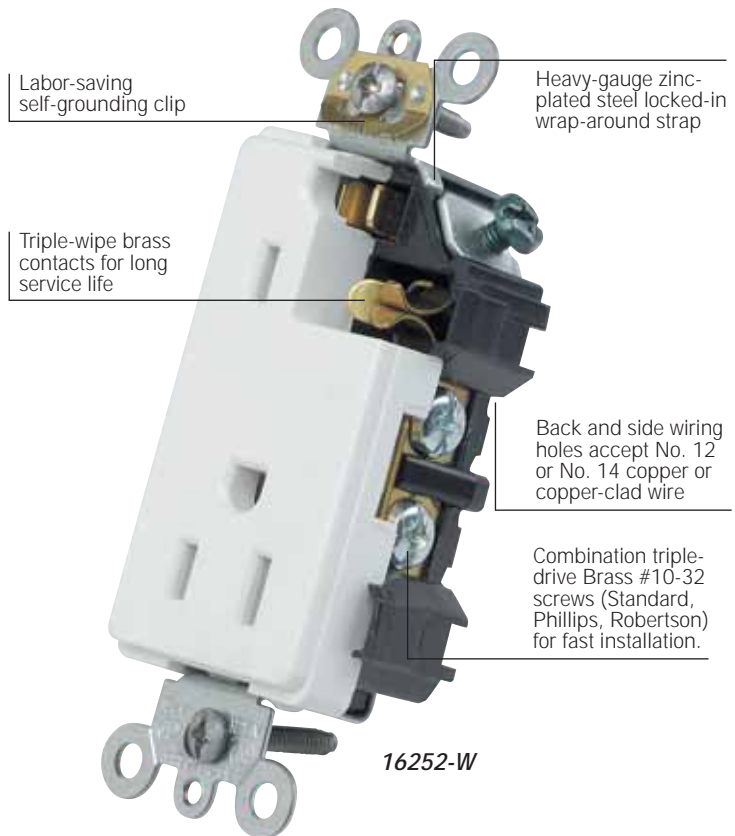

**Hospital Grade Tamper Resistant Receptacles**  
These Hospital Grade receptacles incorporate a unique shutter mechanism that opens easily for insertion of 2 or 3-prong plugs, but prevents the insertion of small objects into either slot.  
*16262-SGI shown*



**Dual Voltage Receptacles**  
Maintain the consistent look of Decora style receptacles throughout commercial settings even when the need arises for Dual Voltage 15A 125 and 15A 250V duplex receptacles.  
*16292-I shown*



**Surge Suppressor Receptacles**  
Decora-style single and duplex surge-protective receptacles, including versions with audible alarm, LED indicator light and Isolated Ground.  
*8280-IGB shown*



**Hospital Grade Power Indication™ Receptacles**  
Power Indication meets UL 498 Hospital Grade identification requirements and provides visual confirmation that the device is energized.  
*16362-PLR shown*



**SmartLockPRO® GFCI Receptacles**  
SmartLockPRO GFCI meets or exceeds UL 2006 requirements and features a patented lockout action that blocks RESET if GFCI protection has been compromised.  
*7599-W shown*



**Residential Grade Receptacles**  
Receptacles engineered for elegant appearance, speedy installation and a long trouble-free service life for fine residential applications.  
*5325-I shown*

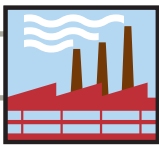

# DECORA® PLUS RECEPTACLES 15 and 20 AMP 125V • 20 AMP 250V

## Industrial Grade Receptacles

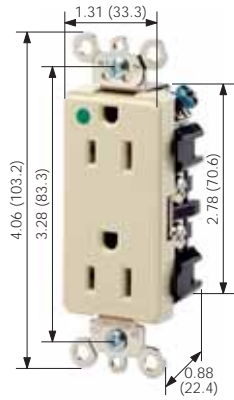

16262-HGI

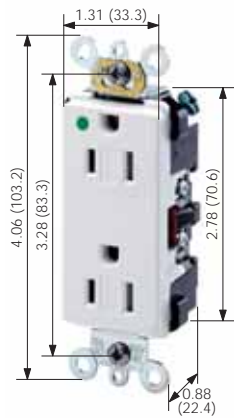

16262-SGW

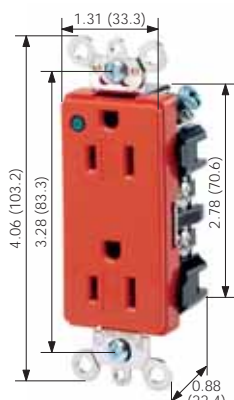

16262-PLR

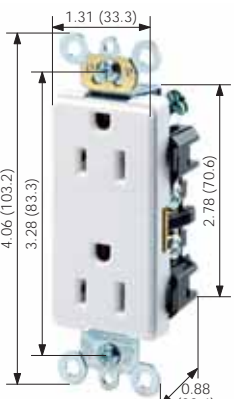



16262-W

### Decora Plus Receptacles

#### Back and Side Wired NEMA 5-15R & 5-20R

(Basic Cat. No. denotes Mahogany device except where noted)

| DESCRIPTION   | CAT. NO./COLOR*<br>15A-125V   | CAT. NO./COLOR*<br>20A-125V   |
|---|---|---|
|   | 5-15R  | 5-20R  |
| Hospital Grade, Duplex                                      | <b>16262-HG</b><br>I, W, G, R (No Mahogany)   | <b>16362-HG</b><br>I, W, A, G, R (No Mahogany)  |
| Hospital Grade, Tamper Resistant Duplex                     | <b>16262-SG</b><br>I, W, A, R   |   |
| Hospital Grade, Isolated Ground Duplex (Not Self-Grounding) | <b>16262-IG</b> (Basic Cat. No. Orange)<br>B, I, W, G, R, E                             | <b>16362-IG</b> (Basic Cat. No. Orange)<br>B, I, W, G, R                                  |
| Hospital Grade, Power Indication Duplex                     | <b>16262-PL</b><br>I, W, R (No Mahogany)  | <b>16362-PL</b><br>I, W, R (No Mahogany)  |
| Industrial Grade, Duplex                                    | <b>16262</b><br>I, W, GY, E   | <b>16362</b><br>I, W, A, T, GY, E   |









#### Back and Side Wired NEMA 6-20R

| DESCRIPTION            | CAT. NO./COLOR*<br>20A-250V   |
|------------------------|---|
|                        | 6-20R  |
| Hospital Grade, Duplex | <b>16462-HG</b><br>I, W (No Mahogany)   |

#### Wallplates for Isolated Ground Devices Engraved with "Isolated Ground"

| DESCRIPTION                 | CAT. NO.        | COLOR*      |
|-----------------------------|-----------------|-------------|
| Decora Receptacle Wallplate | <b>80401-IG</b> | Orange only |

#### Wallplates

| THERMOPLASTIC   |   |   |   | POLYCARBONATE SCREWLESS SNAP-ON  |   | 302 STAINLESS STEEL   |   |
|---|---|---|---|--|---|---|---|
|  |  |  |  |  |  |  |  |
| 80401-NI  | 80409-NI  | PJ26-I<br>Midway Size   | 80409-NR  | 80301-SW   | 80309-SW  | 84401-40  | 84409-40  |

For complete Decora wallplate selection, see pages B20-B24.

#### SPECIFICATIONS AND FEATURES

- Durable thermoplastic face in an array of contemporary colors
- Receptacles have a locked-in mounting strap with a self-grounding clip riveted to the strap (Except Isolated Ground devices)
- Hospital Grade Tamper-resistant receptacles include a unique shutter mechanism that opens easily for the insertion of 2 or 3-prong plugs while preventing entry by other small objects into either outlet slot
- Hospital Grade Isolated Ground receptacles (identified by an orange face or triangle on the face) protect sensitive electronic equipment and eliminate electromagnetic interference by providing a separate path to ground
- Power Indication meets UL 498 Hospital Grade identification requirements and provides visual confirmation that the device is energized.
- Back and side wiring terminals permit fast installation of up to No. 10 solid or stranded conductors
- Triple-wipe copper alloy contacts ensure maximum conductivity

#### TESTING AND CODE COMPLIANCE

- UL Listed (File #E-13399)
- CSA Certified (File #LR-406)
- NOM Certified (#057)
- Backed by a Limited 10-Year Warranty

#### \*COLOR

Basic Cat. Nos. denote Mahogany device (unless indicated) and Orange for Isolated Ground (-IG) Devices. Isolated Ground Receptacle is distinguished by an orange triangle on its face. For other color selections, add suffix to the catalog number as follows: Ivory (-I), White (-W), Almond (-A), Light Almond (-T), Mahogany (for IG devices only, add -B), Red (-R), Gray (-G or -GY) and Black (-E).

#### MATERIAL CHARACTERISTICS

Environmental: Flammability UL-94, V2 Rating  
Operating Temperature: -40°C to 60°C Maximum Continuous



**Decora Plus Receptacles**

Back and Side Wired, Self-Grounding† NEMA 5-15R, 6-15R, 5-20R & 6-20R

(Basic Cat. No. denotes Mahogany device\*)

| DESCRIPTION             | CAT. NO./COLOR<br>15A/125V              | CAT. NO./COLOR<br>15A/250V            | CAT. NO./COLOR<br>20A/125V        | CAT. NO./COLOR<br>20A/250V            |
|-------------------------|---|---------------------------------------|-----------------------------------|---------------------------------------|
|                         | 5-15R                                   | 6-15R                                 | 5-20R                             | 6-20R                                 |
| Duplex                  | <b>16252</b><br>I, W, A, T, GY, E       | <b>16662</b><br>I, W<br>(No Mahogany) | <b>16352</b><br>I, W, A, T, GY, E | <b>16462</b><br>I, W<br>(No Mahogany) |
| Single                  | <b>16251</b><br>I, W                    | <b>16651</b><br>I, W<br>(No Mahogany) | <b>16351</b><br>I, W              | <b>16451</b><br>I, W<br>(No Mahogany) |
| Tamper Resistant Duplex | <b>DR15S-G</b><br>I, W, A (No Mahogany) |                                       |                                   |                                       |

†Self-grounding when installed in a properly grounded metal wallbox

Side Wired, Self-Grounding† NEMA 5-15R, 6-15R, 5-20R & 6-20R

(Basic Cat. No. denotes Mahogany device\*)

| DESCRIPTION | CAT. NO./COLOR<br>15A/125V            | CAT. NO./COLOR<br>15A/250V            | CAT. NO./COLOR<br>20A/125V        | CAT. NO./COLOR<br>20A/250V                  |
|-------------|---------------------------------------|---------------------------------------|-----------------------------------|---|
|             | 5-15R                                 | 6-15R                                 | 5-20R                             | 6-20R                                       |
| Duplex      | <b>16242</b><br>I, W, E               |                                       | <b>16342</b><br>I, W, GY, E       |   |
| Single      | <b>16241</b><br>I, W<br>(No Mahogany) | <b>16641</b><br>I, W<br>(No Mahogany) | <b>16341</b><br>I, W, A, T, GY, E | <b>16441</b><br>I, W, A, T<br>(No Mahogany) |

†Self-grounding when installed in a properly grounded metal wallbox

Back and Side Wired, Self-Grounding† 125V/250V Dual Voltage  
NEMA 5-15R & 6-15R

| DESCRIPTION          | CAT. NO.     | COLOR* |
|----------------------|--------------|--------|
| Duplex, Dual Voltage | <b>16292</b> | I, W   |

†Self-grounding when installed in a properly grounded metal wallbox

**Wallplates**

| THERMOSET |                        | POLYCARBONATE SCREWLESS SNAP-ON |                         | THERMOPLASTIC |           |
|-----------|------------------------|---------------------------------|-------------------------|---------------|-----------|
|           |                        |                                 |                         |               |           |
| 80401     | 80609-A<br>Midway Size | SJ26-SA<br>Midway Size          | SJ262-SA<br>Midway Size | 80401-NGY     | 80409-NGY |

For complete Decora wallplate selection, see pages B20-B24.

**SPECIFICATIONS AND FEATURES**

- Back Wire and Side Wire terminal options
- Heavy-gauge zinc-plated steel locked-in wrap-around strap
- Terminal screws accept up to No. 10 copper or copper-clad wire, solid or stranded
- Back wire terminals accept up to No. 10 copper or copper-clad wire, solid or stranded
- Labor-saving self-grounding clip
- Heavy-duty triple-wipe brass contacts for long service life
- Impact-resistant thermoplastic construction

**TESTING AND CODE COMPLIANCE**

- UL Listed (File #E-13399)
- CSA Certified (File #LR-406)
- NOM Certified (#057)
- Backed by a Limited 10-Year Warranty

**\*COLOR**

Basic Cat. No. denotes Mahogany device (unless indicated). For other color selections, add suffix to the catalog number as follows: Ivory (-I), White (-W), Almond (-A), Light Almond (-T), Gray (-GY) and Black (-E).

**MATERIAL CHARACTERISTICS**

Environmental: Flammability UL-94, V2 Rating  
Operating Temperature: -40°C to 60°C Maximum Continuous

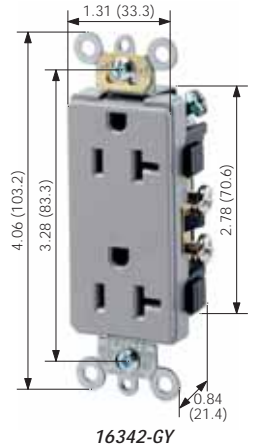
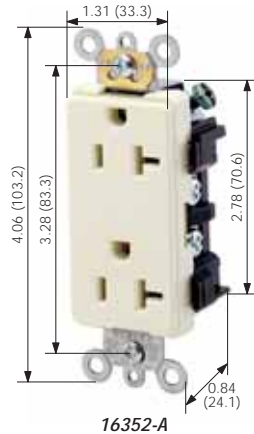
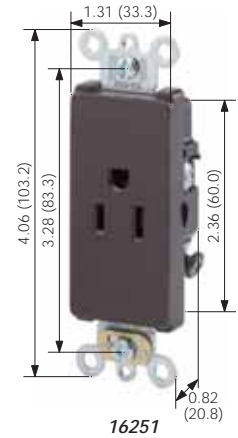



# DECORA® RECEPTACLES 15 AMP 125V

## Residential Grade Receptacles

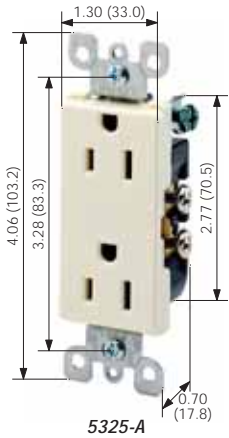

5325-A



5325-SW



5328-W

### Decora AC Receptacles

Side Wire and Quickwire NEMA 5-15R

| DESCRIPTION                 | CAT. NO.       | COLOR*                                 |
|-----------------------------|----------------|--|
|                             | 5-15R          | <i>Basic Cat. No. Denotes Mahogany</i> |
| Duplex                      | <b>5325</b>    | I, W, A, T, GY, E                      |
| Duplex, Self-Grounding Clip | <b>5325-S†</b> | I, W, A, T (No Mahogany)               |
| Duplex, 8-Hole Quickwire    | <b>5328</b>    | I, W, A (No Mahogany)                  |

†Self-grounding when installed in a properly grounded metal wallbox

### Wallplates

| THERMOSET |         |         | THERMOPLASTIC |          | POLISHED BRASS | 302 STAINLESS STEEL |          |
|-----------|---------|---------|---------------|----------|----------------|---------------------|----------|
|           |         |         |               |          |                |                     |          |
| 80401-A   | 80409-E | 80411-E | 80401-NT      | 80409-NT | 81401-PB       | 84401-40            | 84409-40 |

For complete Decora wallplate selection, see pages B20–B24.

#### SPECIFICATIONS AND FEATURES

- Side Wire and Quickwire™ holes accept No. 14 AWG copper wire for Cat. No. 5325
- Heavy-gauge zinc-plated steel mounting strap
- Heavy duty double-wipe brass contacts for long service life

#### TESTING AND CODE COMPLIANCE

- UL Listed (File #E-13399)
- CSA Certified (File #LR-406)
- NOM Certified (#057)
- Backed by a Limited One-Year Warranty

#### \*COLOR

Basic Cat. No. denotes Mahogany (Brown) device unless indicated. For other color selections, add suffix to the catalog number as follows: Ivory (-I), White (-W), Almond (-A), Light Almond (-T), Gray (-GY), and Black (-E).

#### MATERIAL CHARACTERISTICS

Environmental: Flammability UL-94, V2 Rating  
Operating Temperature: -40°C to 60°C Maximum Continuous



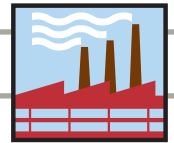

Decora Surge Protective Receptacles

Back and Side Wired NEMA 5-15R & 5-20R UL® SF®

(Basic Cat. No. denotes Mahogany device except where noted)

| DESCRIPTION  | CAT. NO./COLOR*<br>15A-125V                  | CAT. NO./COLOR*<br>20A-125V               |
|--|--|---|
|  | 5-15R  | 5-20R                                     |
| Hospital Grade, Surge Duplex with Indicator Light and Audible Alarm                  | 8280<br>I, W, A, T, R, B                     | 8380<br>I, W, GY, R, B                    |
| Hospital Grade, Surge Single with Indicator Light and Audible Alarm                  | —  | 8381<br>I (No Mahogany)                   |
| Hospital Grade, Isolated Ground, Surge Duplex with Indicator Light and Audible Alarm | 8280-IG<br>I, W, A, G, B, O<br>(No Mahogany) | 8380-IG<br>I, W, G, B, O<br>(No Mahogany) |
| Hospital Grade, Isolated Ground, Surge Single with Indicator Light and Audible Alarm | 8281-IG<br>I, O<br>(No Mahogany)             | 8381-IG<br>I, W, B<br>(No Mahogany)       |
| Industrial Grade, Surge Duplex with Indicator Light and Audible Alarm                | 7280<br>I, W, A, GY, B                       | 7380<br>I, W, GY, B                       |
| Industrial Grade, Surge Duplex with Indicator Light                                  | 5280<br>I, W, A, T, GY, B                    | 5380<br>I, W, GY, B                       |
| Industrial Grade, Isolated Ground, Surge Duplex with Indicator Light                 | 5280-IG<br>I, W, A, G, B, O                  | 5380-IG<br>I, W, G, B, O                  |

For more information regarding Surge Protective Devices, refer to Section R.

Wallplates

| THERMOSET                  | POLYCARBONATE SCREWLESS SNAP-ON | BRASS     | 302 STAINLESS STEEL |
|----------------------------|---------------------------------|-----------|---------------------|
| <br>80401-NB               | <br>80309-SA                    | <br>81401 | <br>84401-40        |
| <br>PJ26-BU<br>Midway Size | <br>SJ262-SA<br>Midway Size     | <br>81409 | <br>84409-40        |

For complete Decora wallplate selection, see pages B20–B24.

SPECIFICATIONS AND FEATURES

- Decora-styled TVSS receptacles protect sensitive electronic equipment against transient voltage surges
- UL 1449 Suppressed Voltage Ratings: 400V for all 3 modes (line-neutral, line-ground, neutral ground)
- Hospital Grade versions (indicated by green dot on receptacle face) are suitable for high-abuse health care, industrial and commercial applications
- Isolated Ground versions (indicated by orange color or orange triangle on receptacle face) provide a pure ground path for use with isolated grounding systems
- Monitor/Indicator LED is ON continuously when protection is active and OFF when protection circuit is deactivated due to excessive transients
- All Hospital Grade devices and Cat. Nos. 7280 and 7380 Industrial devices also provide an audible tone alert that sounds if protection is lost
- Maximum Continuous Operating Voltage: 150V
- Maximum single-pulse transient current (8 x 20µs Amps peak) 24,000A (L-N), 12,000A (L-G), 12,000 (N-G)
- Rated single pulse transient energy (10 x 1000µs, impulse) 320 Joules
- RFI and EMI noise filtration (-35db, @5KHz-5MHz)

TESTING AND CODE COMPLIANCE

- UL Listed (File #E-13399)
- CSA Certified (File #LR-406)
- NOM Certified (#057)
- UL Standard 1449-2nd ED
- Backed by a Limited 10-Year Warranty

\*COLOR

Basic Cat. Nos. denote Mahogany device, unless indicated. Isolated Ground Receptacle is distinguished by an orange triangle on its face. For other color selections, add suffix to the catalog number as follows: Ivory (-I), White (-W), Almond (-A), Light Almond (-T), Red (-R), Gray (-G or -GY), Blue (-B) and Orange (-O).

MATERIAL CHARACTERISTICS

Environmental: Flammability UL-94, V2 Rating  
Operating Temperature: -40°C to 120°C

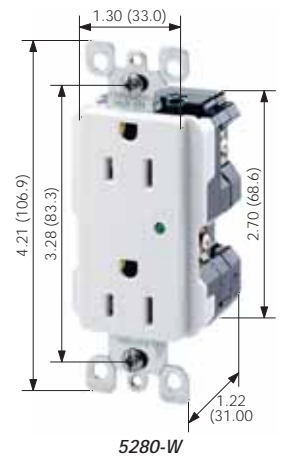
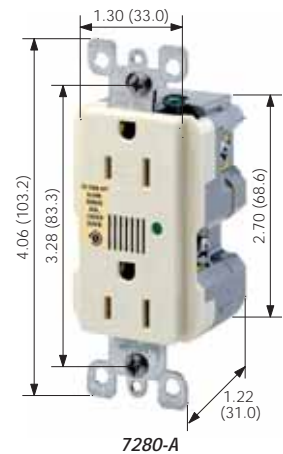
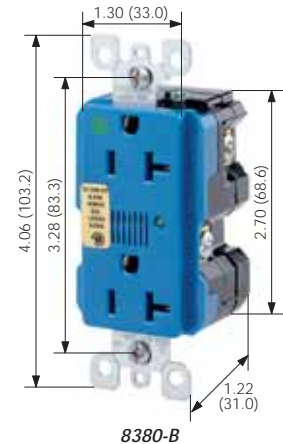



# DECORA® SMARTLOCKPRO® GFCI PERSONNEL PROTECTION DEVICE FEATURES

## Commercial Grade Decora Devices



### SmartLockPRO® GFCI with Professional Grade Lockout Action

Meets or exceeds Underwriters Laboratories (UL) 2006 UL943 GFCI Safety Standards

- Patented professional grade lockout action as end-of-life indication
- Prevents power from being connected to face and feed-through terminals when miswired (line-load reversal)
- Improved immunity to electrical noise to reduce false tripping
- Advanced electronics provide superior surge immunity
- Trip threshold meets or exceeds UL requirements for tripping time

### THE SMARTLOCKPRO® PROTECTION ADVANTAGE

*While other GFCI manufacturers may have taken the alternate route in the 2006 UL Standard by providing an indicator light for end-of-life indication, allowing reset and continued use of a GFCI with unprotected power to the GFCI face and downstream receptacles, the SmartLockPRO's reset button will not engage if protection has been compromised. The SmartLockPRO's unique patented professional grade end-of-life lockout action, reduces the possibility of end-users incorrectly assuming that a reset GFCI outlet is providing ground fault protection when it actually is not.*

### Ideal for a Wide Range of GFCI Applications

- **Residential** – Kitchens, bathrooms, garages, basements and other wet locations
- **Outdoors** – Outdoor receptacles by pools, cabanas, patios, decks and lanais
- **Hospital and Healthcare Facilities** – Scrub rooms, lavatories kitchenettes and other potentially wet locations
- **Educational Facilities** – Classrooms, restrooms, laboratories, dormitories and kitchens
- **Airports** – Bathrooms, general use areas and maintenance areas
- **Restaurants, Lodging and Retail Malls** – Bathrooms, general use areas and maintenance areas
- **Commercial Offices** – Bathrooms, basement areas, hallways and kitchens
- **Public Areas** – Near wet and damp locations



Professional Grade Protection

#### SPECIFICATIONS AND FEATURES

- Meets or exceeds UL 2006 Requirements
  - TEST and RESET functions work together so that a tripped GFCI cannot be reset if GFCI circuit no longer provides ground fault protection
  - RESET button is blocked if GFCI protection has been compromised, reducing the possibility of end-users incorrectly assuming that a reset GFCI is providing ground fault protection when it actually is not
  - Line-load diagnostic feature prevents GFCI from being reset and stops power from being fed to the GFCI receptacle face or through to downstream devices. This alerts installer to a line-load reversal. Indicator light will be ON to indicate line-load reversal.
  - The SmartLockPRO® GFCI with lockout action is designed and patented by Leviton
  - Trip threshold meets or exceeds UL requirements for tripping time
  - Impact-resistant thermoplastic cover and body
  - Silver-alloy contacts
  - Compatible with all Decora devices: available in selected Decora colors
- Combination Switch/SmartLockPRO® GFCI Outlet**
- Ideal for kitchens, bathrooms, modular kitchen units, bathroom cabinet fixtures, lamp cabinet fixtures and applications where combination devices are used.

#### TESTING AND CODE COMPLIANCE

- UL Standard 943 Class A (GFCI) and 498 (Receptacles)
- UL Listed (File # 48380)
- CSA Certified (File #LR-57811)
- NOM Certified (#057)
- Backed by a Limited Two-Year Warranty

#### \*COLOR

Basic Cat. Nos. denote Brown color unless indicated. For other color selections, add suffix to catalog number as follows: Ivory (-I), White (-W), Almond (-A), Light Almond (-T), Gray (-G or GY), Red (-R), Black (-E).

#### MATERIAL CHARACTERISTICS

Flammability: Rated V2  
Operating Temperature: -30°F (-35°C) to 151°F (66°C)



# SMARTLOCK<sup>PRO</sup>® GFCI RECEPTACLES 15 AMP 125V • 20 AMP 125V

## Commercial and Hospital Grade GFCI Personnel Protection Devices

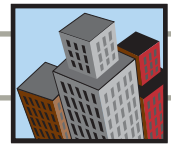

### Hospital Grade SmartLock<sup>PRO</sup>® GFCI Receptacles

#### Back and Side Wired 15 AMP 125V at Receptacle, 20 AMP Feed-Through

| DESCRIPTION  | CAT. NO. | COLOR*  | NEMA CONFIG.  |
|--|----------|---|---|
| Duplex with LED Indicator Light, buttons match face color  | 7599-HG  | I, W, A, T, G, R<br><small>Basic Cat. No. Denotes Brown</small> |   |
| Duplex with LED Indicator Light, buttons match face color. DIN-Rail mounting with terminal wiring block. UL Recognized Component | 7599-DIN | Black Only  | 5-15R  |

#### Back and Side Wired 20 AMP 125V at Receptacle and Feed-Through

| DESCRIPTION   | CAT. NO. | COLOR*           | NEMA CONFIG.  |
|---|----------|------------------|---|
| Duplex with LED Indicator Light, buttons match face color | 7899-HG  | I, W, A, T, G, R | 5-20R  |

### Commercial Grade SmartLock<sup>PRO</sup>® GFCI Receptacles

#### Back and Side Wired 15 AMP 125V at Receptacle, 20 AMP Feed-Through

| DESCRIPTION   | CAT. NO. | COLOR*  | NEMA CONFIG.  |
|---|----------|---|---|
| Duplex with Indicator Light, buttons match face color               | 7599     | I, W, A, T, GY, R, E<br><small>Basic Cat. No. Denotes Brown</small> |   |
| Duplex with LED Indicator Light, Black & Red buttons. With 6" leads | 7599-L   | I, W (No Brown)   | 5-15R  |

#### Back and Side Wired 20 AMP 125V at Receptacle and Feed-Through

| DESCRIPTION   | CAT. NO. | COLOR*   | NEMA CONFIG.  |
|---|----------|--|---|
| Duplex with LED Indicator Light, buttons match face color           | 7899     | I, W, A, T, GY, E<br><small>Basic Cat. No. Denotes Brown</small> |   |
| Duplex with LED Indicator Light, Black & Red buttons. With 6" leads | 7899-L   | I, W (No Brown)  | 5-20R  |

### Combination Switch/SmartLock<sup>PRO</sup>® GFCI Outlet

#### 15 AMP @ 125V Side Wired AC Switch Rating, 15 AMP 125V at Receptacle, 20 AMP Feed-Through

| DESCRIPTION  | CAT. NO. | COLOR*  | NEMA CONFIG.  |
|--|----------|---------|---|
| Single-Pole Switch and SmartLock GFCI-Protected Outlet, buttons match face color | 7299     | I, W, A | 5-15R  |



### Blank Face SmartLock<sup>PRO</sup>® GFCI

#### Back and Side Wired 20 AMP 125V Feed-Through

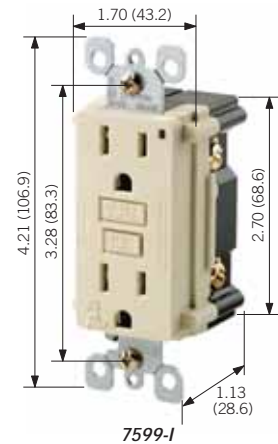
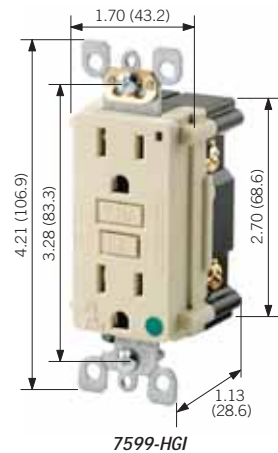
| DESCRIPTION  | CAT. NO. | COLOR*        |
|--|----------|---------------|
| Blank Face, No Indicator Light, buttons match face color | 8590     | I, W, A, T, E |

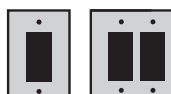

### Wallplates

| THERMOSET   | POLYCARBONATE SCREWLESS SNAP-ON   | POLISHED BRASS  | 302 STAINLESS STEEL  |
|---|---|---|--|
|  |  |  |  |
| 80401-NT 80409-NT   | 80301-SW 80309-SW   | 81401-PB 81409-PB   | 84401-40 84409-40  |

For complete Decora wallplate selection, see pages B20–B24.

Decora Devices



# DECORA® COMBINATION DEVICES 15 and 20 AMP • 120 and 120/277V

## Commercial Grade Combination Devices

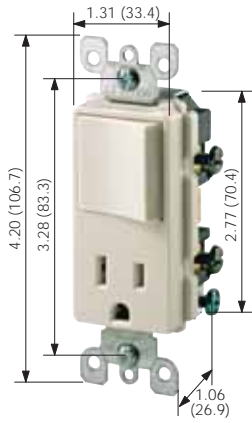

5625-T

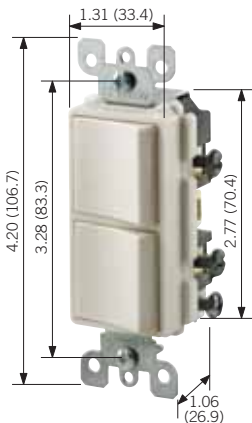

5634-T

### Decora Combination Devices

#### 15 AMP

| DESCRIPTION                     | RATING                                      | CAT. NO. | COLOR*            |
|---------------------------------|---|----------|-------------------|
| Single-Pole Switch/Receptacle   | Switch: 15A-120V AC<br>Receptacle: 15A-125V | 5625     | I, W, A, T, GY, E |
| Single-Pole Switch/Pilot Light  | Switch: 15A-120V AC<br>Pilot: 1/25W-125V AC | 5626     | I, W, A           |
| Two Single-Pole Switches        | 15A-120/277V AC                             | 5634     | I, W, A, T, GY, E |
| 3-Way Switch/Single-Pole Switch | 15A-120/277V AC                             | 5641     | I, W, A, T, E     |
| Two 3-Way Switches              | 15A-120/277V AC                             | 5643     | I, W, A, T        |
| 3-Way Switch/Receptacle         | Switch: 15A-120V AC<br>Receptacle: 15A-125V | 5645     | I, W, A, E        |
| 3-Way Switch/Pilot Light        | Switch: 15A-120V AC<br>Pilot: 1/25W-125V    | 5646     | I, W, A           |

#### 20 AMP

| DESCRIPTION                    | RATING                                      | CAT. NO. | COLOR*     |
|--------------------------------|---|----------|------------|
| Two Single-Pole Switches       | 20A-120/277V AC                             | 5627     | I, W, A, T |
| Single-Pole Switch/Receptacle  | Switch: 20A-120V AC<br>Receptacle: 20A-125V | 5636     | I, W, A    |
| Single-Pole Switch/Pilot Light | Switch: 20A-120V AC<br>Pilot: 1/25W-125V AC | 5637     | I, W, A    |
| Two 3-Way Switches             | 20A-120/277V AC                             | 5640     | I, W, A, T |

### Wallplates

| THERMOSET |         | THERMOPLASTIC | POLYCARBONATE SCREWLESS SNAP-ON |          | 302 STAINLESS STEEL |
|-----------|---------|---------------|---------------------------------|----------|---------------------|
|           |         |               |                                 |          |                     |
| 80401-W   | 80409-W | 80409-NI      | 80309-SI                        | 80311-SI | 84411-40            |

For complete Decora wallplate selection, see pages B20-B24.

#### SPECIFICATIONS AND FEATURES

- Elegant Decora styling provides multiple control in a single-gang wallbox
- All devices have grounding screw
- Fit standard wall boxes

#### TESTING AND CODE COMPLIANCE

- UL Listed (File #E-7458)
- CSA Certified (File #LR-3413)
- NOM Certified (#057)
- Backed by a Limited Two-Year Warranty

#### \*COLOR

Colors available as listed. For other color selections, add suffix to catalog numbers as follows: Ivory (-I), White (-W), Almond (-A), Light Almond (-T), Gray (-GY) and Black (-E).

#### HORSEPOWER

| 15A        | 20A      |
|------------|----------|
| 1/2 @ 120V | 1 @ 120V |
| 2 @ 240V   | 2 @ 240V |

#### MATERIAL CHARACTERISTICS

Environmental: Flammability UL-94, V2 Rating  
Operating Temperature: -40°C to 120°C

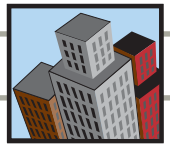

**Decora Combination Switches**

**Individual Switches: 15 AMP 120V/Device Total: 20 AMP-120V†**

| DESCRIPTION  | CAT. NO. | COLOR*     |
|--|----------|------------|
| Dual Rocker Switches   | 1754     | I, W, A, T |
| Dual Rocker Switches with Ground Screw   | 1754-2   | W          |
| Illuminated Dual Rocker Switches light is ON when top rocker is off                | 1754-IL  | I, W, A    |
| Three Rocker Switches  | 1755     | I, W, A, T |
| Three Rocker Switches with Ground Screw  | 1755-2   | I, W       |
| Three Rocker Switches (Double Pole ON-OFF-ON Top Switch; Two Single-Pole Switches) | 1759     | I, W       |

†WARNING: Although each individual rocker switch is rated up to 15A 120V, the total combined load for both duplex or all three triplex switches MUST NOT EXCEED 20 AMPS.

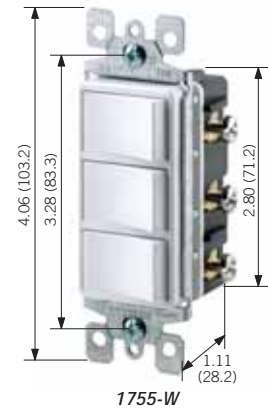

1755-W

**Decora Combination Switch/SmartLockPRO® GFCI Outlet**

**Receptacle: 15 AMP 125V/Feed-through: 20 AMP 125V**

| DESCRIPTION  | CAT. NO. | COLOR*  |
|--|----------|---------|
| Single-Pole Switch and SmartLockPRO GFCI-Protected Outlet with Indicator Light | 7299     | I, W, A |

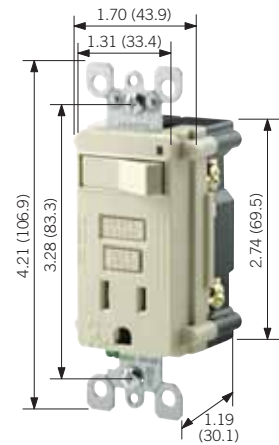

7299-I

**Wallplates**

| THERMOSET |         | POLYCARBONATE SCREWLESS SNAP-ON |          |          | BRASS |
|-----------|---------|---------------------------------|----------|----------|-------|
|           |         |                                 |          |          |       |
| 80401-I   | 80409-I | 80301-SW                        | 80309-SW | 80311-SW | 81401 |

For complete Decora wallplate selection, see pages B20–B24.

**SPECIFICATIONS AND FEATURES**

- Multi-switch combination devices save space and add convenience
- Common shunted internally to all switches
- Elegant Decora styling permits ganging with other Decora devices
- Switch/SmartLockPRO® GFCI Receptacle replaces standard switch/outlet combination devices in commercial or residential installations
- Space-saving SmartLockPRO® GFCI protection in new or retrofit construction
- Switch/SmartLockPRO® GFCI Receptacle permits multiple wiring options that allow six different applications

**SmartLockPRO® GFCI**

- Meets or exceeds UL 2006 Code Requirements for line-load reversal indication during installation and end-of-life indication
- Exclusive, patented lockout-action: RESET button is blocked if GFCI protection has been compromised, eliminating the risk of end-users incorrectly assuming that a reset GFCI is providing ground fault protection when it actually is not

**TESTING AND CODE COMPLIANCE**

**Decora Switches**

- UL Listed (File #7458)
- CSA (File #LR-3413)
- NOM Certified (#057)
- Backed by a Limited Two-Year Warranty

**Switch/SmartLockPRO® GFCI Receptacle**

- UL Listed (File #48380)
- Listed UL Standard 943, Class A
- CSA Certified (File #LR-57811)
- NOM Certified (#057)
- Backed by a Limited Two-Year Warranty

**\*COLOR**

Colors available as listed. For other color selections, add suffix to catalog numbers as follows: Ivory (-I), White (-W), Almond (-A), Light Almond (-T).

**MATERIAL CHARACTERISTICS**

Environmental: Flammability UL-94, V2 Rating  
Operating Temperature: -40°C to 120°C



# DECORA® VOICE, DATA and VIDEO DEVICES

## Commercial Grade Wall Jacks

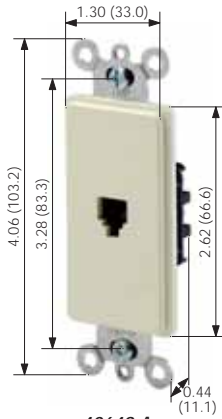

40649-A



40681



40682-GY

### Wall Jacks

#### Type 625 Single Telephone Wall Jacks

| DESCRIPTION | CAT. NO. | COLOR*   |
|-------------|----------|--|
| 4-Conductor | 40649    | I, W, A, GY, E<br><small>Basic Cat. No. Denotes Mahogany</small> |
| 6-Conductor | 40638    | I, W, A, T, GY, E  |
| 8-Conductor | 40680    | I, W   |

#### F Connector Wall Jacks\*

| DESCRIPTION  | CAT. NO. | COLOR*         |
|--|----------|----------------|
| Single F Connector   | 40681    | I, W, A, T, GY |
| Duplex F Connector   | 40682    | I, W, A, T, GY |
| Single F Connector<br>(includes Snap-On Decora Plus Wallplate) | 80381    | I, W, A, T, GY |

\*Standard bulkhead F connector for CATV or other video applications. These jacks are not rated UL94V-O.

#### Decora® Plus Voice/Data Jacks with QuickPort® Snap-in Modules

| DESCRIPTION   | CAT. NO. | COLOR*            |
|---|----------|-------------------|
| Empty, 2-Port Platform, No Jacks                            | 41642    | I, W, A, T, GY, B |
| Platform with Two 6-Conductor Jacks                         | 41666    | I, W              |
| Platform with Two 8-Conductor Jacks                         | 41688    | I, W, T           |
| Platform with One 6-Conductor Jack and One F Connector      | 41658    | I, W              |
| Platform with One 6-Conductor Jack and One 8-Conductor Jack | 41668    | I, W              |

### Wallplates

| THERMOSET                         | THERMOPLASTIC                       | POLYCARBONATE SCREWLESS SNAP-ON   |
|-----------------------------------|-------------------------------------|-----------------------------------|
| 80401-A<br>80601-A<br>Midway Size | PJ26-GY<br>Midway Size<br>80409-NGY | 80301-S<br>SJ262-S<br>Midway Size |

For complete Decora wallplate selection, see pages B20-B24.

#### SPECIFICATIONS AND FEATURES

- All wall jacks are compatible with Decora Plus snap-on wallplates and Decora standard wallplates
- All wall jacks can be used with single or multiple-gang wall boxes
- Modular Jacks have 50 micro-inches hard gold-plated phosphor bronze spring wire contacts.
- Jacks can be used for 75-OHM cable connections for televisions, VCR's and receivers
- Decora Plus Duplex Jack uses snap-in modules with quick-connect insulation displacement terminals for 22 or 24 AWG wire

#### TESTING AND CODE COMPLIANCE

- UL Listed (File #109712) in accordance with NEC Article 800-51(-1)
- CSA Certified (File #80287 for all cat. nos. except 80381, which is File #LR-20064)
- NOM Certified (#057)

- Decora F-Connector Wall Jacks meet specs. for UL 1863
- Meet FCC Part 68 requirements
- All Decora Plus Voice/Data Jack Snap-in QuickPort modules meet TIA-568A electrical, mechanical and transmission requirements
- Wall Jacks' housings of high-impact, self-extinguishing plastic, rated UL 94 V-O
- Backed by a Limited Two-Year Warranty

#### \*COLOR

Basic Cat. No. denotes Mahogany device (unless indicated). For other color selections, add suffix to catalog numbers as follows: Ivory (-I), White (-W), Almond (-A), Light Almond (-T), Gray (-GY), Black (-E), Brown (-B).

#### MATERIAL CHARACTERISTICS

Environmental Flammability: Meet specs for UL1863

For QuickPort® Snap-in Modules, see section "S"



### Canadian 347V AC Quiet Rocker Switches

#### Back and Side Wired 15 AMP 347V AC



| DESCRIPTION               | CAT. NO. | COLOR*        |
|---------------------------|----------|---------------|
| Single-Pole Rocker Switch | 5691-C   | I, W, A, G, E |
| 3-Way Rocker Switch       | 5693-C   | I, W, A, E    |
| 4-Way Rocker Switch       | 5694-C   | W             |

#### Back and Side Wired 20 AMP 347V AC

| DESCRIPTION               | CAT. NO. | COLOR*  |
|---------------------------|----------|---------|
| Single-Pole Rocker Switch | 5621-C   | I, W, G |
| 3-Way Rocker Switch       | 5623-C   | W, G    |
| 4-Way Rocker Switch       | 5624-C   | W       |

### Midway Nylon Wallplates

#### For Canadian 347V Decora Devices

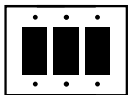
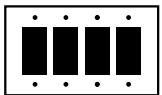
| DESCRIPTION   | CAT. NO. | COLOR*        |
|---|----------|---------------|
| 1-Gang 1-Decora    | 80401-CN | I, W, A, G, E |
| 2-Gang 2-Decora    | 80409-CN | I, W, A, G, E |
| 3-Gang 3-Decora   | 80411-CN | I, W, G, E    |
| 4-Gang 4-Decora  | 80412-CN | I, W, G       |

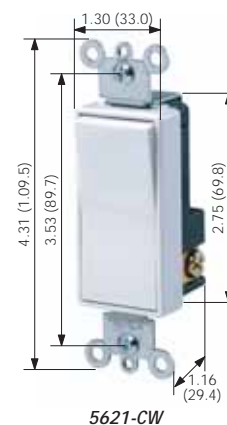
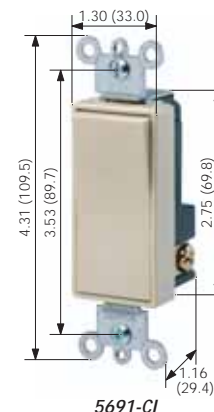

#### SPECIFICATIONS AND FEATURES

- New architecturally-styled smooth-action concave rocker
- Heavy-duty impact-resistant thermoplastic construction for long service life in commercial applications
- Full rated current capacity with tungsten, fluorescent or resistive loads. Motor capacity is 80% of switch rating
- Wrap-around heavy-gauge strap with locking tabs for added strength
- Back and side-wiring terminals accept both solid and stranded wire to ease installation
- Green grounding screw
- Canadian 347V Decora wallplates available in a number of colors
- **Note:** Decora Plus Canadian 347V switches fit only those wallplates designated for 347V AC devices
- **Note:** Canadian 347V Decora wallplates fit "Commander Type" boxes

#### TESTING AND CODE COMPLIANCE

##### Switches

- UL Listed (File #E-7458)
- CSA Certified (File #LR-3413)

##### Wallplates

- UL Listed (File #E-13397)
- CSA (File #LR-16347)
- NOM Certified (#057)
- Fully compliant with NEMA Standards WD-1
- Backed by a Limited 10-Year Warranty

#### \*COLOR

For color selection, add suffix to catalog number as follows: Ivory (-I), White (-W), Almond (-A), Gray (-G), Black (-E) and Red (-R).

#### MATERIAL CHARACTERISTICS

Environmental: Flammability UL-94, V2 Rating  
Operating Temperature: -40°C to 120°C



# DECORA® PLUS SCREWLESS SNAP-ON WALLPLATES

## Commercial Grade Wallplates

### Decora Plus Screwless Snap-On Wallplates

- Sleek, smooth contemporary architectural styling enhances fine décor
- Exclusive new design eliminates subplate screws
- "Hook and Snap" subplate and wallplate mounting provides easy, time saving installation
- Decora-compatible two-piece kit allows easy retrofit to any Decora installation
- Tough, unbreakable polycarbonate construction
- Now available in standard and midway sizes that can be mounted onto larger-volume wallboxes and/or used to hide wall irregularities.



80301-SW  
Standard Size



SJ26-SW  
Midway Size

Standard Size  
Single-Gang Screwless Snap-On Wallplate

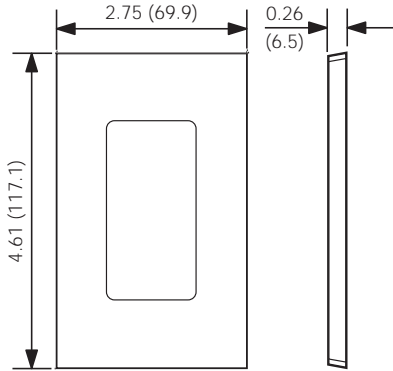

80301-S

Midway Size  
Single-Gang Screwless Snap-On Wallplate

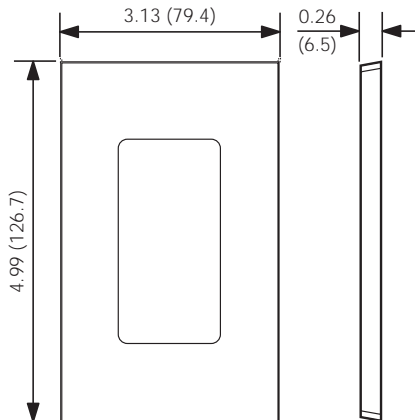

SJ26-S

Midway wallplates can be mounted onto larger-volume outlet boxes and/or used to hide wall irregularities. Midway wallplates are a full 0.375" higher and wider than standard size wallplates.

NOTE: Add 1.81" (46.0mm) for each additional gang.

### Decora Plus Screwless Snap-On Wallplates

| DESCRIPTION      | COLOR          | STANDARD  | MIDWAY    |
|------------------|----------------|-----------|-----------|
| 1-Gang 1-Decorra | Ivory          | 80301-SI  | SJ26-SI   |
|                  | Ebony/Black    | 80301-SE  | SJ26-SE   |
|                  | Gray           | 80301-SGY | SJ26-SGY  |
|                  | White          | 80301-SW  | SJ26-SW   |
|                  | Mahogany/Brown | 80301-S   | SJ26-S    |
|                  | Almond         | 80301-SA  | SJ26-SA   |
|                  | Light Almond   | 80301-ST  | SJ26-ST   |
| 2-Gang 2-Decorra | Ivory          | 80309-SI  | SJ262-SI  |
|                  | Ebony/Black    | 80309-SE  | SJ262-SE  |
|                  | Gray           | 80309-SGY | SJ262-SGY |
|                  | White          | 80309-SW  | SJ262-SW  |
|                  | Mahogany/Brown | 80309-S   | SJ262-S   |
|                  | Almond         | 80309-SA  | SJ262-SA  |
|                  | Light Almond   | 80309-ST  | SJ262-ST  |
| 3-Gang 3-Decorra | Ivory          | 80311-SI  | SJ263-SI  |
|                  | Ebony/Black    | 80311-SE  | SJ263-SE  |
|                  | White          | 80311-SW  | SJ263-SW  |
|                  | Almond         | 80311-SA  | SJ263-SA  |
|                  | Light Almond   | 80311-ST  | SJ263-ST  |
| 4-Gang 4-Decorra | Ivory          | 80312-SI  | SJ264-SI  |
|                  | White          | 80312-SW  | SJ264-SW  |
|                  | Almond         | 80312-SA  | SJ264-SA  |
|                  | Light Almond   | 80312-ST  | SJ264-ST  |
| 5-Gang 5-Decorra | Ivory          | 80321-SI  | SJ265-SI  |
|                  | White          | 80321-SW  | SJ265-SW  |
|                  | Almond         | 80321-SA  | SJ265-SA  |
|                  | Light Almond   | 80321-ST  | SJ265-ST  |
| 6-Gang 6-Decorra | Ivory          | 80326-SI  | SJ266-SI  |
|                  | White          | 80326-SW  | SJ266-SW  |
|                  | Almond         | 80326-SA  | SJ266-SA  |
|                  | Light Almond   | 80326-ST  | SJ266-ST  |

#### TESTING AND CODE COMPLIANCE

- UL Listed (File #E-13397)
- Meets NEMA Standards WD-1, WD-6
- CSA Certified (File #LR-16347)
- NOM Certified (File #057)
- Backed by a Limited Ten-Year Warranty

#### MATERIAL CHARACTERISTICS

Environmental: Flammability UL-94, V2 Rating  
Operating Temperature: -40°C to 120°C



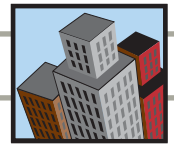

Residential and Commercial Grade Decora Wallplates

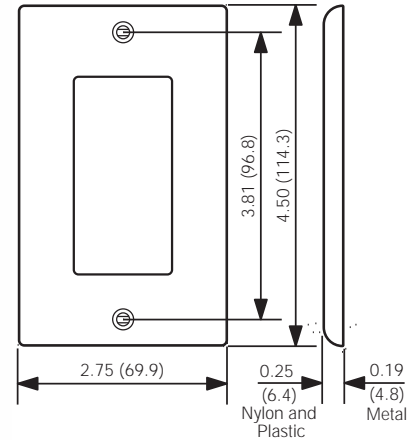

Standard Size Single-Gang

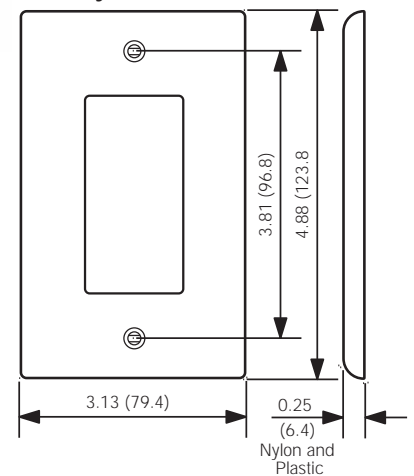

Midway Size Single-Gang

Midway wallplates can be mounted onto larger-volume outlet boxes and/or used to hide wall irregularities. Midway wallplates are a full 0.375" higher and wider than standard size wallplates.

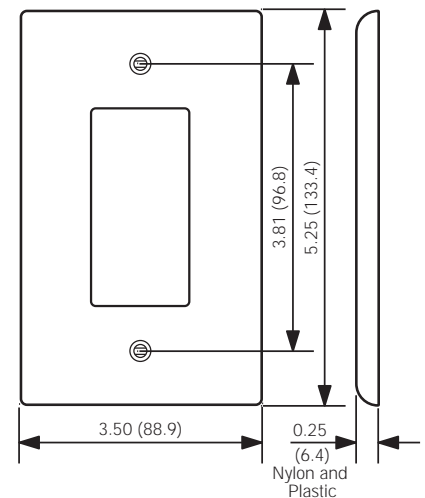

Oversized Single-Gang

Oversized wallplates are used to conceal greater wall irregularities than those hidden by Midway wallplates. Oversized wallplates are a full 0.75" higher and wider than standard size wallplates.

NOTE: Add 1.81" (46.0mm) for each additional gang.

All Decora Wallplates

- Accent any wall covering with a wide selection of colors and finishes
- Smooth face and rounded edges resist dust accumulation
- Individual plastic wrapping to protect wallplate's surface
- Color-matched metal mounting screws supplied

Residential Grade Thermoset Wallplates

- Photoelectrically color-matched to Leviton Decora devices
- Designed for high dielectric strength and arc resistance
- Meet or surpass UL 514 testing requirements
- Resistant to fading, discoloration, grease, oils, organic solvents and moisture scratches
- Backed by a Limited Two-Year Warranty

Commercial Grade Thermoplastic Wallplates

- Molded thermoplastic for maximum resistance to impact, abrasion, fading and discoloration
- Resistant to mechanical stress associated with high abuse applications
- Backed by a Limited Ten-Year Warranty

Commercial Grade Metal Wallplates

- Rounded edges to prevent injury and wall damage
- Deluxe stainless steel is non-magnetic Type 302, .032" thick
- Standard magnetic stainless steel Type 430, .032" thick, also available
- Brass is 70/30 alloy 260, .040" thick
- Aluminum is 3004 alloy, .040" thick
- Backed by a Limited Ten-Year Warranty

TESTING AND CODE COMPLIANCE

- Thermoplastic and Thermoset: UL Listed (File #E-13397)
- Metal: UL Listed (File #E-16347)
- Meets NEMA Standards WD-1, WD-6
- CSA Certified (File #LR-16347)
- NOM Certified (File #057)

MATERIAL CHARACTERISTICS

Environmental: Flammability UL-94, V2 Rating  
Operating Temperature: -40°C to 120°C



# DECORA® WALLPLATES

## Residential and Commercial Grade Decora Wallplates

| Thermoset | Thermoplastic | Screwless Snap-On Polycarbonate | Assorted Metals |
|-----------|---------------|---------------------------------|-----------------|
|-----------|---------------|---------------------------------|-----------------|

DESCRIPTION  
1-Gang  
1-Decora



| COLOR        | STANDARD P26 | MIDWAY SPJ26 | OVERSIZE P026 | STANDARD N26 | MIDWAY PJ26 | STANDARD  | MIDWAY   | MATERIAL       | STANDARD                  | OVERSIZE            |
|--------------|--------------|--------------|---------------|--------------|-------------|-----------|----------|----------------|---------------------------|---------------------|
| Ivory        | 80401-I      | 80601-I      | 86601         | 80401-NI     | PJ26-I      | 80301-SI  | SJ26-SI  | Chrome         | *                         | —                   |
| Black        | 80401-E      | —            | —             | 80401-NE     | PJ26-E      | 80301-SE  | SJ26-SE  | Aluminum       | <b>A26</b><br>83401       | —                   |
| Gray         | 80401-GY     | —            | —             | 80401-NGY    | PJ26-GY     | 80301-SGY | SJ26-SGY | Brass          | <b>B26</b><br>81401       | —                   |
| White        | 80401-W      | 80601-W      | 88601         | 80401-NW     | PJ26-W      | 80301-SW  | SJ26-SW  | Polished Brass | 81401-PB                  | —                   |
| Brown        | 80401        | 80601        | —             | 80401-N      | PJ26        | 80301-S   | SJ26-S   | 430 S/S        | *                         | *                   |
| Almond       | 80401-A      | 80601-A      | 82601         | 80401-NA     | PJ26-A      | 80301-SA  | SJ26-SA  | 302 S/S        | <b>SN26-N</b><br>84401-40 | <b>SO26</b><br>SO26 |
| Light Almond | 80401-T      | 80601-T      | —             | 80401-NT     | PJ26-T      | 80301-ST  | SJ26-ST  |                |                           |                     |
| Red          | —            | —            | —             | 80401-NR     | PJ26-R      | —         | —        |                |                           |                     |
| Blue         | —            | —            | —             | 80401-NB     | PJ26-BU     | —         | —        |                |                           |                     |

DESCRIPTION  
2-Gang  
2-Decora



| COLOR        | STANDARD P262 | MIDWAY SPJ262 | OVERSIZE P0262 | STANDARD N262 | MIDWAY PJ262 | STANDARD  | MIDWAY    | MATERIAL       | STANDARD                  | OVERSIZE              |
|--------------|---------------|---------------|----------------|---------------|--------------|-----------|-----------|----------------|---------------------------|-----------------------|
| Ivory        | 80409-I       | 80609-I       | 86602          | 80409-NI      | PJ262-I      | 80309-SI  | SJ262-SI  | Chrome         | *                         | —                     |
| Black        | 80409-E       | —             | —              | 80409-NE      | PJ262-E      | 80309-SE  | SJ262-SE  | Aluminum       | <b>A262</b><br>83409      | —                     |
| Gray         | 80409-GY      | —             | —              | 80409-NGY     | PJ262-GY     | 80309-SGY | SJ262-SGY | Brass          | <b>B262</b><br>81409      | —                     |
| White        | 80409-W       | 80609-W       | 88602          | 80409-NW      | PJ262-W      | 80309-SW  | SJ262-SW  | Polished Brass | 81409-PB                  | —                     |
| Brown        | 80409         | 80609         | —              | 80409-N       | —            | 80309-S   | SJ262-S   | 430 S/S        | *                         | *                     |
| Almond       | 80409-A       | 80609-A       | 82602          | 80409-NA      | PJ262-A      | 80309-SA  | SJ262-SA  | 302 S/S        | <b>S262-N</b><br>84409-40 | <b>SO262</b><br>SO262 |
| Light Almond | 80409-T       | 80609-T       | —              | 80409-NT      | PJ262-T      | 80309-ST  | SJ262-ST  |                |                           |                       |
| Red          | —             | —             | —              | 80409-NR      | —            | —         | —         |                |                           |                       |
| Blue         | —             | —             | —              | 80409-NB      | —            | —         | —         |                |                           |                       |

DESCRIPTION  
3-Gang  
3-Decora



| COLOR        | STANDARD P263 | MIDWAY SPJ263 | OVERSIZE | STANDARD N263 | MIDWAY PJ263 | STANDARD | MIDWAY   | MATERIAL       | STANDARD                  | OVERSIZE              |
|--------------|---------------|---------------|----------|---------------|--------------|----------|----------|----------------|---------------------------|-----------------------|
| Ivory        | 80411-I       | 80611-I       | —        | 80411-NI      | PJ263-I      | 80311-SI | SJ263-SI | Chrome         | *                         | —                     |
| Black        | 80411-E       | —             | —        | 80611-E       | —            | 80311-SE | SJ263-SE | Aluminum       | <b>A263</b><br>83411      | —                     |
| Gray         | 80411-GY      | —             | —        | 80411-NGY     | PJ263-GY     | —        | —        | Brass          | <b>B263</b><br>81411      | —                     |
| White        | 80411-W       | 80611-W       | —        | 80411-NW      | PJ263-W      | 80311-SW | SJ263-SW | Polished Brass | 81411-PB                  | —                     |
| Brown        | 80411         | 80611         | —        | 80411-N       | —            | —        | —        | 430 S/S        | *                         | *                     |
| Almond       | 80411-A       | 80611-A       | —        | 80411-NA      | PJ263-A      | 80311-SA | SJ263-SA | 302 S/S        | <b>S263-N</b><br>84411-40 | <b>SO263</b><br>SO263 |
| Light Almond | 80411-T       | 80611-T       | —        | 80411-NT      | PJ263-T      | 80311-ST | SJ263-ST |                |                           |                       |

\*Consult your Leviton representative for ordering details: allow 3-4 weeks for delivery.  
For Decora Combination Wallplates, see Section E.

**NOTE:** Where applicable, Industry Number indicated in BOLD FACE. For some wallplates, Industry Number and Leviton Catalog Number are identical.

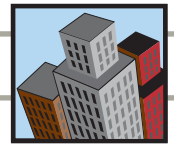

Residential and Commercial Grade Decora Wallplates

|  | Thermoset            |                      |                 | Thermoplastic        |                     | Screwless Snap-On Polycarbonate |               | Assorted Metals |                           |                 |
|--|----------------------|----------------------|-----------------|----------------------|---------------------|---------------------------------|---------------|-----------------|---------------------------|-----------------|
| <b>DESCRIPTION</b><br>4-Gang<br>4-Decora |                      |                      |                 |                      |                     |                                 |               |                 |                           |                 |
| <b>COLOR</b>                             | <b>STANDARD P264</b> | <b>MIDWAY SPJ264</b> | <b>OVERSIZE</b> | <b>STANDARD N264</b> | <b>MIDWAY PJ264</b> | <b>STANDARD</b>                 | <b>MIDWAY</b> | <b>MATERIAL</b> | <b>STANDARD</b>           | <b>OVERSIZE</b> |
| Ivory                                    | 80412-I              | 80612-I              | —               | 80412-NI             | PJ264-I             | 80312-SI                        | SJ264-SI      | Chrome          | *                         | —               |
| Black                                    | 80412-E              | —                    | —               | —                    | —                   | 80312-SE                        | SJ264-SE      | Brass           | <b>B264</b><br>81412      | —               |
| Gray                                     | 80412-GY             | —                    | —               | —                    | PJ264-GY            | —                               | —             | 430 S/S         | *                         | —               |
| White                                    | 80412-W              | 80612-W              | —               | 80412-NW             | PJ264-W             | 80312-SW                        | SJ264-SW      | 302 S/S         | <b>S264-N</b><br>84412-40 | —               |
| Brown                                    | 80412                | 80612                | —               | 80412-N              | —                   | 80312                           | —             |                 |                           |                 |
| Almond                                   | 80412-A              | 80612-A              | —               | 80412-NA             | PJ264-A             | 80312-SA                        | SJ264-SA      |                 |                           |                 |
| Light Almond                             | 80412-T              | 80612-T              | —               | 80412-NT             | PJ264-T             | 80312-ST                        | SJ264-ST      |                 |                           |                 |
| <b>DESCRIPTION</b><br>5-Gang<br>5-Decora |                      |                      |                 |                      |                     |                                 |               |                 |                           |                 |
| <b>COLOR</b>                             | <b>STANDARD P265</b> | <b>MIDWAY</b>        | <b>OVERSIZE</b> | <b>STANDARD N265</b> | <b>MIDWAY</b>       | <b>STANDARD</b>                 | <b>MIDWAY</b> | <b>MATERIAL</b> | <b>STANDARD</b>           | <b>OVERSIZE</b> |
| Ivory                                    | 80423-I              | —                    | —               | —                    | —                   | 80321-SI                        | SJ265-SI      | Brass           | <b>B265</b><br>81423      | —               |
| Black                                    | 80423-E              | —                    | —               | —                    | —                   | —                               | —             | 430 S/S         | *                         | —               |
| Gray                                     | 80423-GY             | —                    | —               | —                    | —                   | —                               | —             | 302 S/S         | <b>S265</b><br>84423-40   | —               |
| White                                    | 80423-W              | —                    | —               | —                    | —                   | 80321-SW                        | SJ265-SW      |                 |                           |                 |
| Brown                                    | 80423                | —                    | —               | —                    | —                   | —                               | —             |                 |                           |                 |
| Almond                                   | 80423-A              | —                    | —               | —                    | —                   | 80321-SA                        | SJ265-SA      |                 |                           |                 |
| Light Almond                             | 80423-T              | —                    | —               | 80423-NT             | —                   | 80321-ST                        | SJ265-ST      |                 |                           |                 |
| <b>DESCRIPTION</b><br>6-Gang<br>6-Decora |                      |                      |                 |                      |                     |                                 |               |                 |                           |                 |
| <b>COLOR</b>                             | <b>STANDARD P266</b> | <b>MIDWAY</b>        | <b>OVERSIZE</b> | <b>STANDARD N266</b> | <b>MIDWAY</b>       | <b>STANDARD</b>                 | <b>MIDWAY</b> | <b>MATERIAL</b> | <b>STANDARD</b>           | <b>OVERSIZE</b> |
| Ivory                                    | 80436-I              | —                    | —               | —                    | —                   | 80326-SI                        | SJ266-SI      | Brass           | <b>B266</b><br>*          | —               |
| Black                                    | 80436-E              | —                    | —               | —                    | —                   | —                               | —             | 430 S/S         | —                         | —               |
| Gray                                     | 80436-GY             | —                    | —               | —                    | —                   | —                               | —             | 302 S/S         | <b>S266-N</b><br>84436-40 | —               |
| White                                    | 80436-W              | —                    | —               | —                    | —                   | 80326-SW                        | SJ266-SW      |                 |                           |                 |
| Brown                                    | 80436                | —                    | —               | —                    | —                   | —                               | —             |                 |                           |                 |
| Almond                                   | 80436-A              | —                    | —               | 80436-NA             | —                   | 80326-SA                        | SJ266-SA      |                 |                           |                 |
| Light Almond                             | 80436-T              | —                    | —               | —                    | —                   | 80326-ST                        | SJ266-ST      |                 |                           |                 |
| <b>DESCRIPTION</b><br>7-Gang<br>7-Decora |                      |                      |                 |                      |                     |                                 |               |                 |                           |                 |
| <b>COLOR</b>                             | <b>STANDARD S607</b> | <b>MIDWAY</b>        | <b>OVERSIZE</b> | <b>STANDARD</b>      | <b>MIDWAY</b>       | <b>STANDARD</b>                 | <b>MIDWAY</b> | <b>MATERIAL</b> | <b>STANDARD</b>           | <b>OVERSIZE</b> |
| Ivory                                    | 80407-I†             | —                    | —               | —                    | —                   | —                               | —             | Brass           | <b>B607</b><br>*          | —               |
| White                                    | 80407-W†             | —                    | —               | —                    | —                   | —                               | —             | 430 S/S         | *                         | —               |
|  |                      |                      |                 |                      |                     |                                 |               | 302 S/S         | <b>S607-N</b><br>*        | —               |
| <b>DESCRIPTION</b><br>8-Gang<br>8-Decora |                      |                      |                 |                      |                     |                                 |               |                 |                           |                 |
| <b>COLOR</b>                             | <b>STANDARD S609</b> | <b>MIDWAY</b>        | <b>OVERSIZE</b> | <b>STANDARD</b>      | <b>MIDWAY</b>       | <b>STANDARD</b>                 | <b>MIDWAY</b> | <b>MATERIAL</b> | <b>STANDARD</b>           | <b>OVERSIZE</b> |
| Ivory                                    | —                    | —                    | —               | —                    | —                   | —                               | —             | Brass           | <b>B609</b><br>*          | —               |
| White                                    | 80408-W†             | —                    | —               | —                    | —                   | —                               | —             | 430 S/S         | *                         | —               |
|  |                      |                      |                 |                      |                     |                                 |               | 302 S/S         | <b>S609-N</b><br>*        | —               |

\*Consult your Leviton representative for ordering details: allow 3-4 weeks for delivery. †Painted metal

NOTE: Where applicable, Industry Number indicated in BOLD FACE. For some wallplates, Industry Number and Leviton Catalog Number are identical.



# DECORA® WALLPLATE ACCESSORIES

## Residential Grade







DECORA REPLACEMENT SCREWS

### Wallplate Replacement Screws (5/16" – 6x32 threads)

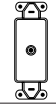
| DESCRIPTION                    | CAT. NO. | DESCRIPTION          | CAT. NO. |
|--------------------------------|----------|----------------------|----------|
| Almond<br>100 per box          | 82400    | Ivory<br>100 per box | 86400    |
| Stainless Steel<br>100 per box | 84400    | Gray<br>100 per box  | 87400    |
| Brown<br>100 per box           | 85400    | White<br>100 per box | 88400    |

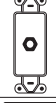
### Standard Size Plastic Adapters

| DESCRIPTION   | CAT. NO. | COLOR*                                 |
|---|----------|--|
|   |          | <i>Basic Cat. No. Denotes Mahogany</i> |
| <br>Dimmer Shaft (.406" hole)  | 80400    | I, W, A, T, GY, E                      |
| <br>Blank (no hole)  | 80414    | I, W, A, T, GY, E                      |
| <br>CATV Jack  | 40681-I  | I, W, A, T, GY, E                      |
| <br>Wallbox Adapter<br>Extends shallow wallbox<br>to fit GFCI/Decora devices | 6197     | I, W                                   |





80400-I



80414-W

### Decora® Plus Standard Size Plastic Adapters

| DESCRIPTION  | CAT. NO. | COLOR*            |
|--|----------|-------------------|
| <br>CATV Jack       | 80381    | I, W, A, T, GY, E |
| <br>Blank (no hole) | 80314    | I, W, A, T, GY, E |



6197-W

#### TESTING AND CODE COMPLIANCE

- Backed by a Limited Two-Year Warranty

#### \*COLOR

Colors available as listed. For other color selections, add suffix to catalog numbers as follows: Ivory (-I), White (-W), Almond (-A), Light Almond (-T), Gray (-GY), Black (-E).

#### MATERIAL CHARACTERISTICS

Environmental: Flammability UL-94, V2 Rating  
Operating Temperature: -40°C to 120°C



**GET A FLAWLESS FLUSH-MOUNTED INSTALLATION WITH LEVITON'S LINE OF RECESSED DEVICES**

For an almost invisible installation behind wall-mounted TVs, entertainment centers, monitors and more, connect with Leviton Recessed Devices. The Recessed Entertainment Box (REB) centralizes AC power and low-voltage connection points for audio, video, data and phones. For smaller applications, choose the Two-Gang Recessed Duplex Receptacle with openings for 6 installer-selected QuickPort® connectors or the One-Gang Recessed Duplex Receptacle.

**Features and Benefits**

- Recessed Entertainment Box (REB) centralizes points for AC power, audio, video, home theater, data and phone connections
- Recessed two-gang duplex receptacle with openings for 6 QuickPort® Connectors installs invisibly behind wall units and wall-mounted flat-panel TVs
- Two-gang duplex receptacle is fully compatible with Leviton's QuickPort snap-in modules, including component video and S-Video signal connectors (not included)
- Recessed One-Gang Duplex Receptacle supplies AC power for two components (flat panel TVs and video receiver)
- Meet all applicable UL and CSA requirements
- Backed by a Limited Two-Year Warranty

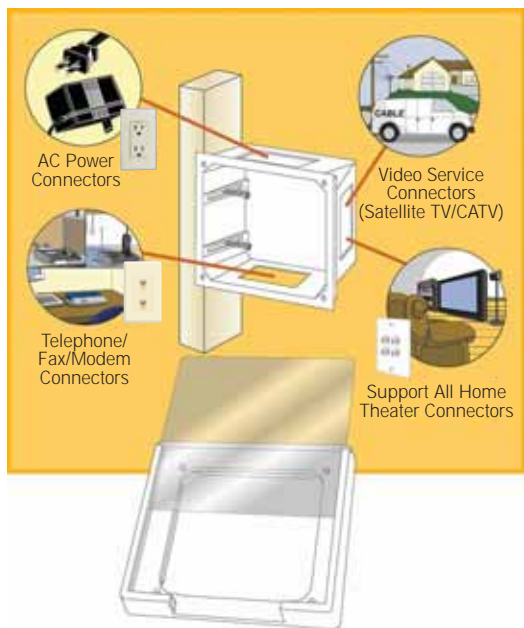

**The Recessed Entertainment Box**  
Centralizes home theater electronics in a single location. Ideal for new construction and retrofit applications. (QuickPort® connectors not included)  
**47617-REB shown**



**Recessed Duplex Receptacle with Connector Openings**  
Flush mounts to install invisibly behind wall units and flat panel TVs. Provides openings for 6 installer-selected QuickPort connectors.  
**690-W shown**



**Recessed One-Gang Duplex Receptacle**  
Supplies AC power for two components and provides sleek installation for signature artwork and flat panel TVs.  
**689-W shown**



# DECORA®-STYLE RECESSED DEVICES

## Residential Grade Recessed Devices

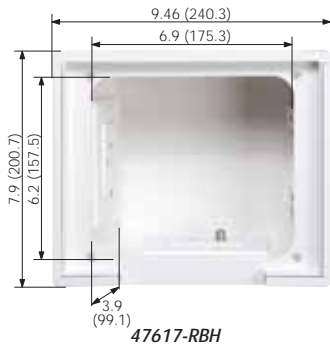

47617-RBH

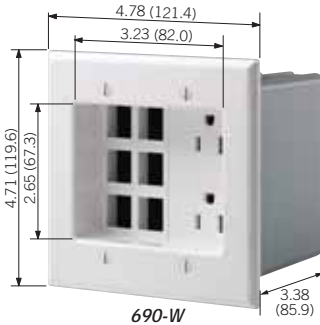

690-W

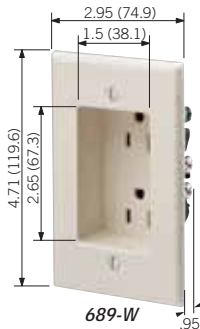

689-W



688-W

### Recessed Entertainment Box

| DESCRIPTION                        | CAT. NO.  | COLOR* |
|------------------------------------|-----------|--------|
| REB Box with Low-Profile Frame     | 47617-REB | White  |
| High-Profile Cover                 | 47617-HPC | White  |
| Low-Profile Frame                  | 47617-LPF | White  |
| Replacement Snap-In Plates (2/Bag) | 47617-PLT | White  |
| REB Box with High-Profile Cover    | 47617-RBH | White  |

### Decora Recessed Receptacles

#### Duplex Recessed Receptacles 15A-125V AC, 2-Pole, 3-Wire, NEMA 5-15R

| DESCRIPTION   | CAT. NO. | COLOR*     | NEMA CONFIG. |
|---|----------|------------|--------------|
| Two-Gang Duplex Receptacle with Openings for 6 QuickPort Connectors (4 blank inserts included)† | 690      | I, W, T, E | 5-15R        |
| One-Gang Duplex Receptacle  | 689      | I, W, T, E |              |

† QuickPort Connectors not included.

#### Single Recessed Receptacles Side-Wired 15A-125V AC, 2-Pole, 3-Wire, NEMA 5-15R

| DESCRIPTION                                       | CAT. NO. | COLOR*          | NEMA CONFIG. |
|---|----------|-----------------|--------------|
| One-Gang Single Receptacle with Clock Hanger Hook | 688      | I, W            | 5-15R        |
| One-Gang Single Receptacle with Clock Hanger Hook | 5261-CH  | Stainless Steel |              |

#### Side-Wired 20A-125V AC, 2-Pole, 3-Wire, NEMA 5-20R

| DESCRIPTION                                       | CAT. NO. | COLOR*          | NEMA CONFIG. |
|---|----------|-----------------|--------------|
| One-Gang Single Receptacle with Clock Hanger Hook | 5361-CH  | Stainless Steel | 5-20R        |

### SPECIFICATIONS AND FEATURES

#### Recessed Entertainment Box

- Manages home theater, satellite TV, Internet, whole-house audio/video and home-networking electronics from a single location
- Ideal for new construction (stud-mounted) and retrofit (wall-mounted) applications
- Low-profile frame provides neat, clean recessed installation
- Optional high-profile cover includes sliding plastic front panel and channels all wires through the bottom of the REB
- Any combination of line and low-voltage products can be configured in the three device opening
- Paintable white ABS molded plastic for structural integrity

#### Recessed Two-Gang Duplex Receptacle with QuickPort Openings

- Provides 2 15A/125V AC NEMA 5-15R power outlets and openings for 6 installer-selected QuickPort connectors or blank inserts (4 inserts included)
- Fully compatible with Leviton's QuickPort Snap-In modules, including component video and S-video signal connectors (not included)
- Includes plastic electrical box designed for use in new and retrofit construction and a barrier to separate line and low-voltage conductors
- Wallplate built into device

#### Recessed One-Gang Duplex Receptacle

- Installs invisibly behind wall units, signature artwork and wall-mounted flat-panel TVs
- Supplies AC power for two components (flat panel TVs and video receiver)
- Fits most common electrical boxes available (electrical box not included)

#### Recessed One-Gang Single Receptacles

- Includes clock-hanger hook
- Flush mount with square recess

### TESTING AND CODE COMPLIANCE

#### Recessed Receptacles

- cULus Listed
- NOM Certified (#057)

#### All Recessed Devices

- Backed by a Limited Two-Year Warranty

### \*COLOR

For color selection, add suffix to catalog number as follows: Ivory (-I), White (-W), Light Almond (-T) and Black (-E).

### MATERIAL CHARACTERISTICS

Environmental: Flammability UL-94, V2 Rating  
Operating Temperature: -40° to 120°C

# Lighting and Fan Speed Controls

## INDEX

### Architectural Lighting Control Systems

|                                      |        |
|--------------------------------------|--------|
| Dimensions® D3200.....               | C2-C4  |
| Dimensions® D4000.....               | C5, C6 |
| Power Extenders.....                 | C7     |
| a-2000 Modular Dimming Cabinets..... | C8, C9 |

### Architectural Specification

|   |          |
|---|----------|
| Overview.....                               | C10      |
| Monet® Controls.....                        | C11, C12 |
| Monet® Multi-Gang Wallplates.....           | C13      |
| Renoir® Preset Slide Controls.....          | C14, C15 |
| Van Gogh® Rotary Dimmers.....               | C16      |
| Ganging and Derating Lighting Controls..... | C17      |

### Designer Controls

|                                      |          |
|--------------------------------------|----------|
| Overview.....                        | C18      |
| Vizia™ Digital Controls.....         | C19      |
| Vizia™ Remotes.....                  | C20      |
| Vizia-RF™ Scene Capable Dimmers..... | C21      |
| Vizia-RF™ Remotes.....               | C22      |
| Mural® Digital Controls.....         | C23      |
| Mural® Scene Controls.....           | C24, C25 |

### Touch Lighting Controls

|                                       |     |
|---------------------------------------|-----|
| Overview.....                         | C26 |
| True Touch™ Digital Touch Dimmer..... | C27 |
| ToggleTouch™ Digital Dimmer.....      | C28 |

### Traditional Controls

|  |     |
|--|-----|
| Overview.....                          | C29 |
| IllumaTech™ Preset Slide Controls..... | C30 |
| IllumaTech™ Rotary Controls.....       | C31 |
| SureSlide™ Slide Controls.....         | C32 |
| Trimatron™ Deluxe Rotary Controls..... | C33 |

### Incandescent Lighting Controls

|                                     |     |
|-------------------------------------|-----|
| Toggle Dimmers.....                 | C34 |
| Decora 911 Flasher Switch.....      | C34 |
| 4-Level Step Dimmer.....            | C35 |
| Feed-Through Lamp-Cord Dimmers..... | C35 |
| Tabletop Dimmer.....                | C35 |
| Full-Range Dimmer Socket.....       | C35 |



# DIMENSIONS® ARCHITECTURAL LIGHTING CONTROL SYSTEM FEATURES

## Commercial Grade Lighting Controls

WHETHER IT'S ADVANCED ARCHITECTURAL LIGHTING CONTROL SYSTEMS THAT CAN BE CUSTOM-MANUFACTURED FOR ANY SITE-SPECIFIC REQUIREMENT OR INNOVATIVE BOX-MOUNTED CONTROLS FOR INCANDESCENT, LOW-VOLTAGE AND FLUORESCENT LIGHTING, LEVITON HAS THE PRODUCTS YOU CAN DEPEND ON.

Our designer preset systems and distributed programmable computer-controlled systems are ideal for large-scale, multi-use environments. Leviton's innovative line of box-mounted controls includes digital multi-location devices that provide maximum performance in architectural, commercial and residential settings.

### Dimensions Architectural Lighting Control Systems

Each Dimensions® System combines ease of operation with a wide range of entry stations and accessories to provide a powerful and flexible control solution. The bright LCD readout displays functions and scene information in plain English, and guides you step-by-step through setup and operation. They enable the optimal mix of lighting to be selected—to evoke the right mood—without the guesswork.

Triac with generous 1000W zone capacity

LCD with intuitive, menu-driven Wizard interface guides setup and operation

Zone information buttons display zone name and brightness level

Interchangeable covers

#### Features and Benefits

- Astronomical clock for event scheduling
- Programmable scene and zone names, fade rates and much more
- Join/separate functionality (D3208 and D4200)
- Optional setup software and handheld remote control
- Meets ASHRAE Standard 90.1 requirements
- Backed by a Limited Two-Year Warranty

NOTE: The Dimensions product line also includes the highly advanced D8000 system. Consult your Leviton representative for more information.

#### DIMENSIONS D3200 SYSTEM



##### D3200 Multizone Controller/Dimmer

Advanced, multipoint scene control and dimming with 4 to 6 dimming loads and 8 scene buttons. D3208 features join/separate for partitioning and the addition of two auxiliary zones via network power extenders. D3206-ILS shown



##### D3200 Scene Controller

Four-scene Decora® wall controller with Off switch. Ideal for secondary entranceways and residential applications. NE505 shown



##### D3200 LCnet SmartJack (with Software)

PC/laptop-to-network jack that enables D3200 Data Manager software. NE100-00C shown



##### D3200 Infrared Remote Control

Handheld remote control for use with any IR-receiving D3200 controller. NE210 shown

#### DIMENSIONS D4000 SYSTEM



##### D4000 Series Multizone Controller

32-zone digital lighting controller and entry station used with dimming cabinets, relay cabinets remote receivers, and accessory stations. D4200-00W shown



##### D4000 Series Remote Station

Decora-style wall controllers in 15 versions, each with unique range of D4000 functionality. D42PB-00W shown



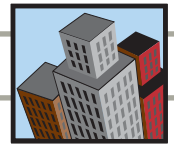

### Dimensions D3200 Architectural Lighting Control System

The Dimensions D3200 is a component-based lighting system flexible enough for a wide range of commercial and high-end residential lighting applications. The essential component is the Multizone Controller/Dimmer, a self-contained programmable dimmer and scene controller that will control up to eight zones of lighting. The unit will also function as a control unit for other devices attached to the Leviton Control Network (LCnet). By adding wall mounted scene controllers, a hand-held remote and a SmartJack for PC-based programming, the D3200 offers a comprehensive lighting control solution that can be expanded at any time.

#### Dimensions D3200 Multizone Controller/Dimmers

| DESCRIPTION   | CAT. NO.  | LOAD RATING  | COLOR*                       |
|---|-----------|--|------------------------------|
| D3204 Multizone Controller/ Dimmer—Self-contained dimmer with learning IR receiver. Controls up to 4 local zones and a maximum of 248 remote zones. Features 8 scene buttons and 32-scene capability. LCD with wizard menus. Supplies 24VDC @ 150mA power to hardwired control devices.               | D3204-1LW | 120V AC 60Hz:<br>1920W/VA total output,<br>1000W/VA max. per zone,<br>1200W/VA max. per side.<br>For use with Incandescent, Tungsten,<br>Magnetic Low Voltage Transformer,<br>Advance Mark 10™ Powerline<br>Electronic Fluorescent Dimming<br>Ballast, Neon, Cold Cathode<br>and non-dimming loads.<br>Electronic Low Voltage and 0-10V DC<br>Fluorescent Hi-Lume and<br>Eco-10 controlled with optional<br>power extenders. | W                            |
| Dimensions D3206 Multizone Controller/Dimmer—Self-contained dimmer with learning IR receiver. Controls up to 6 local zones and a maximum of 186 remote zones. Features 8 scene buttons and 32-scene capability. LCD with wizard menus. Supplies 24VDC @ 150mA power to hardwired control devices.     | D3206-1LW | Same as D3204-1LW  | W                            |
| Dimensions D3208 Multizone Controller/Dimmer—All features of the D3206 plus: Combine/separate functionality for 8 partitioned spaces in up to 256 configurations. Up to 64 scheduled scene changes. Easy access to 2 auxiliary loads from front panel. Controls 62 additional remote zones (248 max). | D3208-1LW | Same as D3204-1LW  | W                            |
| D3204 Multizone Controller/Dimmer—same as D3204-1L except rated for 230V loads.   | D3204-2LW | 230V AC 50–60Hz:<br>2400W/VA total output,<br>800W/VA max. per zone. For use with<br>Incandescent, Tungsten, Magnetic<br>Low Voltage Transformer,<br>Advance Mark 10™ Powerline<br>Electronic Fluorescent Dimming<br>Ballast, Neon, Cold Cathode<br>and non-dimming loads.   | W                            |
| D3206 Multizone Controller/Dimmer—same as D3206-1L except rated for 230V loads.   | D3206-2LW | Same as D3204-2LW  | W                            |
| Dimensions D320x Color Change Kits  | D32CK     | —  | II, WW,<br>AA, GG,<br>EE, SW |



D3208



#### \*COLOR/CONTROLLERS

Available with White Frame/White Cover (-1LW) or (-2LW). For other colors, order Cat. No. D32CK Color Change Kit and add suffix as follows: Ivory Frame/Ivory Cover (-II), White Frame/White Cover (-WW), Almond Frame/Almond Cover (-AA), Gray Frame/Gray Cover (-GG), Black Frame/Black Cover (-EE), White Frame/Smoke Cover (-SW).



# DIMENSIONS® ARCHITECTURAL LIGHTING CONTROL SYSTEM FEATURES

## Commercial Grade Lighting Controls

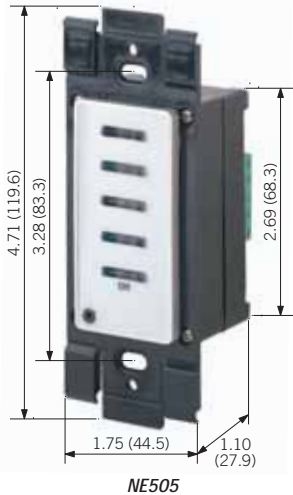

NE505



NE210

### Dimensions D3200 Architectural Lighting Control System

#### Dimensions D3200 System Components

| DESCRIPTION   | CAT. NO.                         | LOAD RATING   | COLOR*                         |
|---|----------------------------------|---|--------------------------------|
| Scene Controller—Decora-style 5-button wall controller with 4 scene recall buttons plus OFF. Features learning IR receiver.   | NE505                            | Input Voltage: 24VDC<br>Input Current: 24mA   | White with Ivory Color option* |
| NE505 Color Change Kit with Customizable Labels (wallplates sold separately)  | DCK05-0C                         | —   | I, W, A, G, E                  |
| Decora Partition Controller—with 5 buttons (4 walls and Reset). For use in D3208 system.  | NE515                            | Input Voltage: 24VDC<br>Input Current: 24mA   | White with Ivory Color option* |
| Infrared Remote Control—Handheld remote for use with any IR-receiving D3200 Controller. Provides 8 scene selections, group DIM/BRIGHT, Max and OFF buttons.                             | NE210                            | No load rating—<br>for use with any IR-receiving D3200 Controller   | Black                          |
| Terminator Block—For use with LCnets not terminated with D3200s and with total wire length greater than 10 ft.  | NE600                            | No load rating  | White                          |
| SmartJack—Decora-style jack enables D3200 Setup Software to be run from PC or laptop. Includes PC cable and Software CD. Essential for any LCnet system where PC interface is desired.† | NE100-00C                        | No load rating  | White with Ivory Color option* |
| Power Extenders—Extend the power handling capacity of any D3206/D3208 dimming zone or activates auxiliary zones.  | See page C7 for complete listing | Models available for incandescent, magnetic-low voltage, electronic low-voltage, Advance Mark 7™ 0-10V or equivalent and 0-10VDC dimmable electronic fluorescent ballasts. See page C8 for ratings. | See page C7                    |

†Software can be downloaded from [www.leviton.com/D3200](http://www.leviton.com/D3200)

#### Dimensions D3200

##### SPECIFICATIONS AND FEATURES

- D3204 and D3206**
- 41 internally-driven dimming loads (D3206); 4 for D3204
  - Controls up to 186 remote zones via Leviton Control Network (LCnet) bus (D3206); D3204 controls up to 248
  - 6 (D3206) and 4 (D3204) Scene buttons and 32-scene capability
  - 2-line, 32-character LCD with Wizards for easy setup
  - LED Light-level indicators
  - Group raise/lower buttons for changing all zone light levels at same time
  - Learning IR Receiver
  - Powers LCnet controllers and Leviton SmartJack
  - Mounts in 4-gang box with 4-gang device cover
  - UL Listed, CSA Certified
  - California Title 24 compliant and meets ASHRAE Standard 90.1 requirements
  - Backed by a Limited Two-Year Warranty
- D3208 Additional Features**
- Up to 64 scheduled scene changes based on time of day or astronomical clock
  - Combine/Separate functionality for 8 partitions in up to 256 different configurations
  - Controls up to 248 remote zones
  - Easy front panel access to 2 auxiliary LCnet dimming zones or switching loads

##### APPLICATIONS

- Home Theaters
- Great Rooms
- Ballrooms
- Conference Rooms
- Restaurants
- Executive Offices
- Surgical Suites
- Houses of Worship
- Light Commercial Applications

#### D3200 System Components

##### \*COLOR/COMPONENTS

Cat Nos. NE505, NE515 and NE100 come in White with matching wallplate. Include snap-on Ivory Color Change Kit. (Ivory wallplate sold separately). With DCK05-0C Color Change Kits add to suffix as follows: Ivory (I), White (W), Almond (A), Gray (G), and Black (E).

##### TESTING AND CODE COMPLIANCE

- UL Listed, CSA Certified, FCC Part 15 (where applicable)
- Backed by a Limited Two-Year Warranty

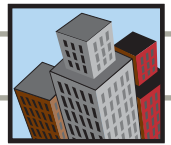

**Dimensions D4000 Series Architectural Lighting Control System**

The Dimensions D4000 Series offers a wide range of entry stations and accessories for a powerful and flexible lighting control solution. Easy to install, configure and operate, D4000 Series products are scalable for every application from stand-alone systems to a complete network environment.

**Product Compatibility Chart**

| D4000 Series Controllers | PRODUCTS BEING CONTROLLED |                          |                      |                      |     |             |       |       |       |                      |     |
|--------------------------|---------------------------|--------------------------|----------------------|----------------------|-----|-------------|-------|-------|-------|----------------------|-----|
|                          | D4200 Entrance Stations   | D4200 Partition Stations | iSeries e a-2000 MDS | Z-MAX Network Panels | NPC | D4104/D4106 | D4200 | D4206 | D4006 | Closure Input/Output | AV  |
| D4104/D4106              | Yes                       | Yes                      | —                    | —                    | —   | —           | —     | —     | —     | —                    | —   |
| D4200                    | Yes                       | Yes                      | Yes                  | Yes                  | Yes | —           | Yes   | Yes   | Yes   | Yes                  | Yes |
| D4206                    | Yes                       | Yes                      | Yes                  | Yes                  | Yes | —           | Yes   | Yes   | Yes   | Yes                  | Yes |
| D8000                    | —                         | —                        | Yes                  | Yes                  | Yes | —           | —     | Yes   | Yes   | Yes                  | Yes |



D4200



D42P8-00W

**SPECIFICATIONS AND FEATURES**

- Up to 32 zones/channels of control
- Up to 6 Internal Network Dimmers
- Scene memory 16 + 2
- Fade times for each scene
- Room partition control
- Remote dimmer configuration
- Includes Lockout and Sequencer
- Complete multi-event scheduler
- Integrated astronomical time clock
- Dimmer Rating for Incandescent, Advance Mark 10®, Lutron Tu-Wire® and Magnetic Low Voltage load types:
  - 120V: Max 1,000W per Dimmer; Max 1,920W per unit (continuous); Max 1,200W per side
  - 230V: Max 800W per Dimmer; Max 2,420W per unit (continuous); Max 1,200W per side

**D4104/D4106 Stand-Alone Systems**

- Compatible with Entry and Room Combine Stations
- Used when integration with other product or rooms is not required.
- 4 or 6 channels and dimmers

**D4200 Network Controller**

- Full network compatibility
- 32 control channels
- Used to control other dimmers or relays on the Luma-Net network

**D4206 Network Controller w/Dimmers**

- Full network and device compatibility
- 32 control channels
- Used to control other dimmers or relays on the Luma-Net network
- 6 internal dimmers

**D4006 Remote Dimmer**

- Full network compatibility
- Controllable by any network controller
- Start channel and Network ID (address) set from front panel
- Full configuration from any connected D4200 or D4206
- 6 internal dimmers

**Entrance Stations**

- Connect to controller via Luma-Net network
- Used to remotely control scenes and zones on a master station

**Command Stations**

- Connect to controller via Luma-Net network
- Used to execute commands on a master station

**Room Combine Stations**

- Connect to controller via Luma-Net network
- Requires 1 Master station in each room, addressed 10 for room 1, 20 for room 2, etc.
- Other room-combine options available, contact your local sales agent for more information

**APPLICATIONS**

- Ballrooms
- Cafeterias
- Auditoriums
- Lecture Halls
- Conference Rooms
- Hotel Suites
- Restaurants
- Museums
- Houses of Worship

\* Mark 10® is a registered trademark of Advance Transformer Company.  
Lutron Tu-Wire® is a registered trademark of Lutron Electronics Co., Inc.



# DIMENSIONS® ARCHITECTURAL LIGHTING CONTROL SYSTEMS

## Commercial Grade Lighting Controls



D42P8-00W

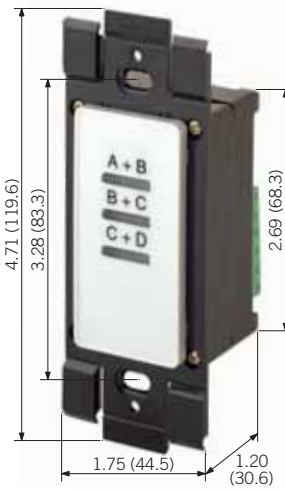

D42CS-03W



D42IR-16L

### Dimensions D4000 Series Architectural Lighting Controls

#### Dimensions D4000 Series Lighting Controller

| DESCRIPTION  | CAT. NO.  |
|--|-----------|
| 120V, 4 Channels/Dimmers, Stand-Alone System           | D4104-1LW |
| 230V, 4 Channels/Dimmers, Stand-Alone System           | D4104-2LW |
| 120V, 6 Channels/Dimmers, Stand-Alone System           | D4106-1LW |
| 230V, 6 Channels/Dimmers, Stand-Alone System           | D4106-2LW |
| Network Controller                                     | D4200-00W |
| 120V, 6 Channels/Dimmers, Network Controller w/Dimmers | D4206-1LW |
| 230V, 6 Channels/Dimmers, Network Controller w/Dimmers | D4206-2LW |
| 120V, 6 Channels/Dimmers, Remote Dimmer                | D4006-1LW |
| 230V, 6 Channels/Dimmers, Remote Dimmer                | D4006-2LW |

#### Dimensions D4000 Series Wall-Mounted Remote Stations

|   |           |
|---|-----------|
| One-button Start/Stop Sequencer   | D42SQ-00W |
| One-button Start/Stop Event Timer   | D42ET-00W |
| One-button Join/Separate Link   | D42LI-NKW |
| One-button Lock/Unlock  | D42LO-CKW |
| Two-button: Preset Scene 1 and OFF, built-in IR receiver                            | D42P1-00W |
| Two-button: Master Raise and Lower, built-in IR receiver                            | D42RL-00W |
| Two-button: Preset Scene Max and OFF, built-in IR receiver                          | D42MO-00W |
| Three-button: Preset Scene 1, Max and OFF, built-in IR receiver                     | D42P1-MOW |
| Four-button: Max, OFF, Master Raise and Lower, built-in IR receiver                 | D42MO-RLW |
| Five-button: Preset Scenes 1-4 and OFF, built-in IR receiver                        | D42P4-00W |
| Five-button: Preset Scene 1, Max, OFF, Master Raise and Lower, built-in IR receiver | D42P1-RLW |
| Eight-button: Preset Scenes 1-4, Max, OFF, Raise and Lower, built-in IR receiver    | D42P4-RLW |
| Eight-button: Preset Scenes 9-16  | D42P9-16W |
| Ten-button: Preset Scenes 1-8, Max and OFF, built-in IR receiver                    | D42P8-00W |
| Ten-button: Preset Scenes 9-16, Raise and Lower, built-in receiver                  | D42P9-RLW |

#### Dimensions D4000 Series Room-Combine Stations

|  |           |
|--|-----------|
| One-button: Combines 2 rooms with 1 partition    | D42CS-01W |
| Three-button: Combines 3 rooms with 3 partitions | D42CS-3AW |
| Four-button: Combines 4 rooms with 4 partitions  | D42CS-04W |
| Two-button: Combines 3 rooms with 2 partitions   | D42CS-02W |
| Three-button: Combines 4 rooms with 3 partitions | D42CS-03W |

#### Dimensions D4000 Series IR Handheld Controls†

|                       |           |
|-----------------------|-----------|
| Four Preset Scenes    | D42IR-04L |
| Eight Preset Scenes   | D42IR-08L |
| Sixteen Preset Scenes | D42IR-16L |

†Remote IR Ceiling-Mount Receivers available in single-gang and 2-gang models. Consult your Leviton representative for more information.

See page C5 For Dimensions D4000 Series Specifications and Features

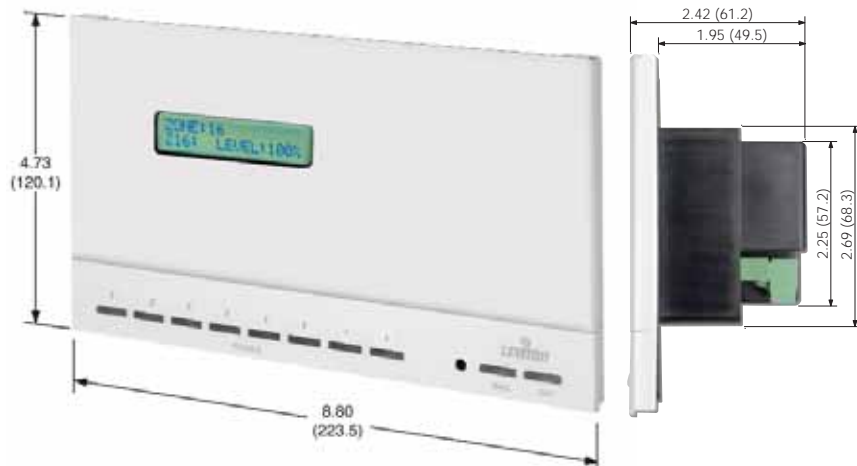

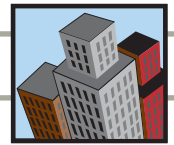

Standard Power Extenders

Power Extenders—PE100, PE200, PE300, PE400

| DESCRIPTION  | CAT. NO.  | RATING  |
|--|-----------|---|
| Extends dimming zone capacity to full 1920W/VA @ 120V for incandescent, magnetic low-voltage, halogen or neon/cold cathode lighting. Aluminum heat sink with snap-on white cover             | PE100-10W | Input Voltage: 120V 50/60Hz<br>Load Rating: 1920W/VA<br>Load Output Power: phase independent of control device<br>Dimmer Input: 120V 50/60Hz  |
| Extends dimming zone capacity to full 1920VA @ 120V for Mark 10™ Powerline, Hi-Lume®, or equivalent dimmable fluorescent ballast. Aluminum heat sink with snap-on white cover                | PE200-10W | Input Voltage: 120V 50/60Hz<br>Load Rating: 1920VA<br>Load Output Power: phase independent of control device<br>Dimmer Input: 120V 50/60Hz  |
| Extends dimming zone capacity to full 3000VA @ 277V for Mark 10™ Powerline, Hi-Lume®, or equivalent dimmable fluorescent ballast. Aluminum heat sink with snap-on white cover                | PE200-70W | Input Voltage: 277V 50/60Hz<br>Load Rating: 3000VA<br>Load Output Power: phase independent of control device<br>Dimmer Input: 120V 50/60Hz  |
| Extends dimming zone capacity to full control of a 20A circuit with 0–10 V DC Mark 7® 0–10V, Lutron 0–10V, OSRAM Sylvania Quicktronic® Helios™ or equivalent ballast. Metallic silver color. | PE300-D0W | Input Voltage: 120V AC to 277V AC, 60Hz<br>Load Rating: 20A–2400VA @ 120V AC, 5500VA @ 277V AC<br>Power Consumption: 6W @ 120V AC, 18W @ 277V AC<br>Output Ballast Control: 0–10V DC<br>Dimmer Input: 120V 60Hz |
| Extends dimming zone capacity to full control of a 1000W/VA @ 120V AC for electronic low voltage or incandescent lighting. Aluminum heat sink with snap-on white cover                       | PE400-10W | Input Voltage: 120V AC 50/60Hz<br>Load Rating: 1000W/VA<br>Load Output Power: phase independent of control device<br>Dimmer Input: 120V 60Hz  |

Mark 10™ and Mark 7™ are trademarks of Advance Transformer Company.  
Hi-Lume® is a registered trademark of Lutron Electronics Co., Inc.

Auxiliary-Zone Network Power Extenders (for D3200 Systems only)

| DESCRIPTION   | CAT. NO.  | RATING   |
|---|-----------|--|
| Enables 2 auxiliary zones on a D3200 Controller/Dimmer for full control over incandescent, magnetic low-voltage, or neon/cold cathode lighting. Aluminum heat sink with snap-on white cover                     | PEAUX-12W | Input Voltage: 120V AC 50/60Hz<br>Load Rating: 1920W/VA total, or 1000W/VA max. per zone<br>Load Output Power: phase independent of control device<br>Dimmer Input: D3200                |
| Enables 1 auxiliary zone on a D3200 Controller/Dimmer for full control over incandescent, magnetic low-voltage, or neon/cold cathode lighting Aluminum heat sink with snap-on white cover                       | PEAUX-AUW | Input Voltage: 230V AC 50/60Hz<br>Load Rating: 2400 W/VA total<br>Load Output Power: phase independent of control device<br>Dimmer Input: D3200  |
| Enables 1 auxiliary zone on a D3200 Controller/Dimmer for full control over Mark 7™ 0–10V, OSRAM Sylvania Quicktronic Helios, Lutron 0–10V, or equivalent ballasts. Aluminum heat sink with snap-on white cover | PEAU7-M1W | Input Voltage: 120–230V 50–60Hz<br>Output Ballast Control: 0–10V DC<br>Load Rating: 20A–120V & 10A–230V<br>Load Output Power: phase independent of control device<br>Dimmer Input: D3200 |

Power Extender Compatibility

Standard Power Extenders work with any Dimensions Multizone Controller/Dimmer and all Architectural Systems. Refer to the chart below for compatibility with Leviton Box-Mounted Dimmers.

| POWER EXTENDER         | BOX-MOUNTING DIMMER COMPATIBILITY  |
|------------------------|--|
| PE100-10W              | Must use 120V 600W Incandescent version of Acenti, IllumaTech, Mural, True Touch, ToggleTouch, Sure Slide and Home Controls. (or 600VA version of Acenti). For Monet, use 120V 600VA Magnetic Low-Voltage version (requires Neutral wire). For dimmers that include a Neutral wire, the dimmer Neutral wire must be connected. |
| PE200-10W<br>PE200-70W | Must use 120V 600VA Mark 10 version Acenti, of Monet, IllumaTech, and Mural. For dimmers that include a Neutral wire, the dimmer Neutral wire must be connected. For Hi-Lume ballasts, use incandescent dimmers. PE200-70W is compatible with all 600VA-220V box-mounted dimmers.  |
| PE300-D0W              | Must use 120V 600W Incandescent version of Acenti, IllumaTech, Mural, True Touch, ToggleTouch, Sure Slide and Home Controls. For Monet, use 120V 600VA Magnetic Low-Voltage version (requires Neutral wire). For dimmers that include a Neutral wire, the dimmer Neutral wire must be connected.                               |
| PE400-D0W              | Must use 120V 600W Incandescent version of Acenti, IllumaTech, Mural, True Touch, Trimatron and Sure Slide Home Controls. For Monet, use 120V 600VA Magnetic Low-Voltage version (requires Neutral wire). For dimmers that include a Neutral wire, the dimmer Neutral wire must be connected.                                  |

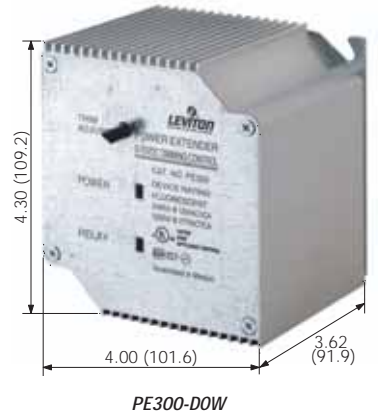

SPECIFICATIONS AND FEATURES

Standard Power Extenders

- Emulates characteristics of dimmer it is connected to in terms of dimming range and resolution
- Low-end trim available for setting minimum brightness level (PE100, PE200, PE300)
- PE100, PE200 and PE400 can be surface or flush mounted using 1900 Box and 2-gang raised cover
- PE300 mounts in 4" square box

APPLICATIONS

Standard Power Extenders

- Works with any D3200 Multizone Controller/Dimmer to extend load capacity of any zone
- Extends load capacity of box-mounted dimmers (see compatibility chart)
- Works with all families of Leviton Architectural Systems

Network Power Extenders

- Enables a D3200 Multizone Controller/Dimmer to accommodate extra loads
- Works with any D3200 Multizone Controller/Dimmer to extend load capacity of any zone

TESTING AND CODE COMPLIANCE

- UL Listed (except PEAUX-AUW), CSA Certified and NOM Certified
- Backed by a Limited Two-Year Warranty



# ARCHITECTURAL DIMMING CABINETS

## Commercial Grade Lighting Controls

### a-2000® Modular Dimming Cabinets

The a-2000® is a compact, high-performance dimming cabinet that combines theatrical grade performance with the ability to control a wide variety of architectural load types. Its modular design enables rapid servicing of both dimming modules and control electronics. The a-2000 digital module cabinets are easy to install and work with virtually all types of lighting, including 120 and 277VAC dimming fluorescent lamps. This state-of-the-art cabinet integrates seamlessly with preset or manual controls, building automation, daylight harvesting and time clock systems. The a-2000 is a highly versatile dimming platform supporting a broad array of control requirements.

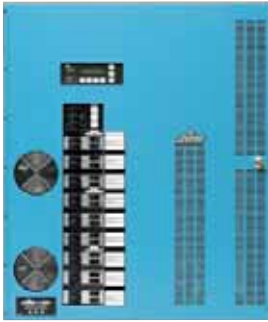

a-2000-24

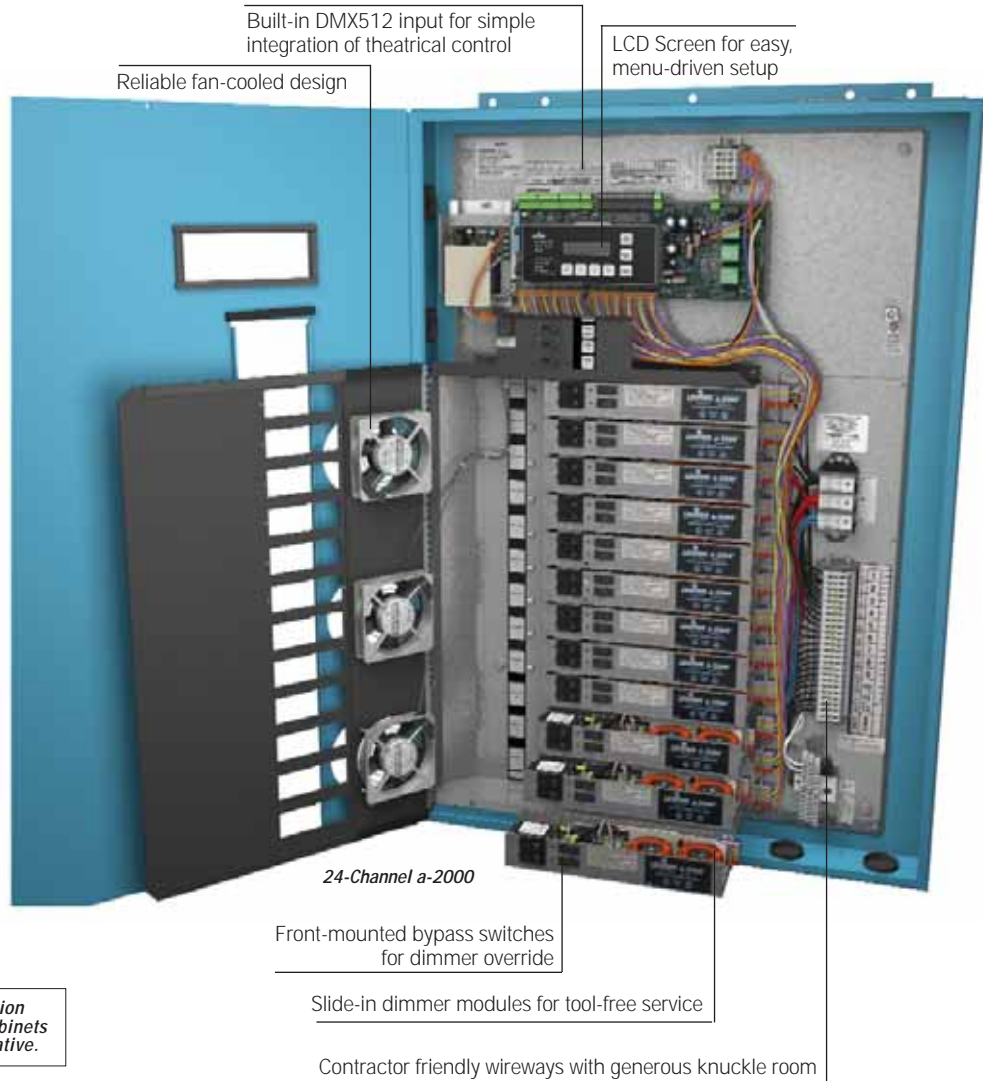

Built-in DMX512 input for simple integration of theatrical control

LCD Screen for easy, menu-driven setup

Reliable fan-cooled design

24-Channel a-2000

Front-mounted bypass switches for dimmer override

Slide-in dimmer modules for tool-free service

Contractor friendly wireways with generous knuckle room

For complete ordering information on Leviton a-2000 Dimming Cabinets consult your Leviton representative.

#### SPECIFICATIONS AND FEATURES

- Fully programmable from front panel
- Plug-in dimmer modules for easy maintenance
- Communication inputs: DMX512, Luma-Net III, RS485, full bright, emergency, and +0-10VDC analog
- Capacity of up to 48 dimmer circuits
- Each dimmer channel rated to 20A continuous (20A modules only)
- All load types supported
- Rugged dual-SCR dimmer circuitry for superior dimming performance and reliability over triac dimmers
- Individual bypass per-dimmer provides work-light function

- Restoration feature restores the last lighting look in the event of power failures
- Lifetime non-volatile memory
- Super-quiet, redundant ball-bearing fan design for added reliability
- Contractor-friendly design for easy installation with a large wiring space
- Compact 30-3/8 inch cabinet width holds up to 24 dimmer CCTS and fits between two stud widths
- Surface or recessed mounting
- Top, bottom or side feed

#### APPLICATIONS

- Office spaces
- Daylight harvesting
- Cafeterias
- Ballrooms
- Auditoriums
- Houses of worship
- Lecture halls
- Conference rooms
- Restaurants
- Multi-purpose rooms
- Office spaces
- Spaces requiring a single dimming source for a broad range of loads

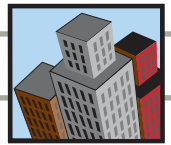

### a-2000® Dimmer Modules

The a-2000 uses a modular dimmer, allowing for ease of replacement and custom tailoring of module type to each project's specific needs. Leviton's a-2000 dimmer modules employ proven dual SCR dimming technology, inherited from Leviton's line of theatrical equipment.

| SUPPORTED LOAD TYPE  | UNIVERSAL | 240V | STANDARD |
|--|-----------|------|----------|
| Incandescent   | X         | X    | X        |
| Tungsten   | X         | X    | X        |
| Neon   | X         | X    | X        |
| Cold-Cathode   | X         | X    | X        |
| Magnetic Low Voltage   | X         | X    | X        |
| Electronic Low Voltage*  | X         | X    | X        |
| Fluorescent Dimming Ballasts                                       | X         | X    | X        |
| 0-10V Fluorescent Ballast Example†:<br>Advance Mark 7®             | X         | X    | X        |
| 2-Wire Fluorescent Ballast Example†:<br>Advance Mark 10®           | X         | —    | X        |
| 3-Wire Fluorescent Ballast Examples†:<br>Lutron Hi-lume® & Eco-10™ | X**       | —    | —        |

\* Electronic Low Voltage transformers are supported upon the manufacturer's approval for use with forward phase dimmers. When the use of Electronic Low Voltage is required that does not meet this requirement, Leviton's PE400 power extender may be used. Contact your local Leviton LMS representative for more information.

\*\* Supports all standard load types as well as 2 circuits of Hi-lume and other 3-wire fluorescent dimming ballasts.

† Mark 7® and 10® are registered trademarks of Advance Transformer Company.  
Eco-10™ is a trademark and Hi-lume® is a registered trademark of Lutron Electronics Co., Inc



a-2000-24 with Relay Cabinet

#### SPECIFICATIONS AND FEATURES

- 20A continuous duty rating (120V modules only)
- Voltage regulation: compensates for incoming line voltage variations
- 97% efficiency
- 350 μS rise time standard
- Ratings are for continuous use at 100% load

#### Universal Modules:

- Bypass switch has two modes: Normal and Bypass. When the switch is set to Bypass (red LED illuminated), the SCRs and relays are forced to turn on independent of the control module

- 277V Universal modules may be used in 120V cabinets.
- 120V Universal modules may be used only in 120V cabinets.

#### 240V Modules:

- Built-in bypass switches (240V): Bypasses control electronics permitting the cabinet to be used for work lights during construction.

#### Standard Modules:

- Built-in bypass switches (120V) or shunts (277V): Bypasses control electronics, permitting the cabinet to be used for work lights during construction.



# ARCHITECTURAL SPECIFICATIONS LIGHTING CONTROLS FEATURES

## Commercial Grade Lighting Controls

### Architectural Specification Lighting Controls

Inspired by the great painters, Leviton's Monet®, Renoir® and Van Gogh® dimmers and fan speed controls accent today's most beautiful interiors. Leviton's premier line of architectural lighting controls can accommodate high wattage loads and mate with screwless narrow- and wide-fin wallplates—for the ultimate flexibility in design.

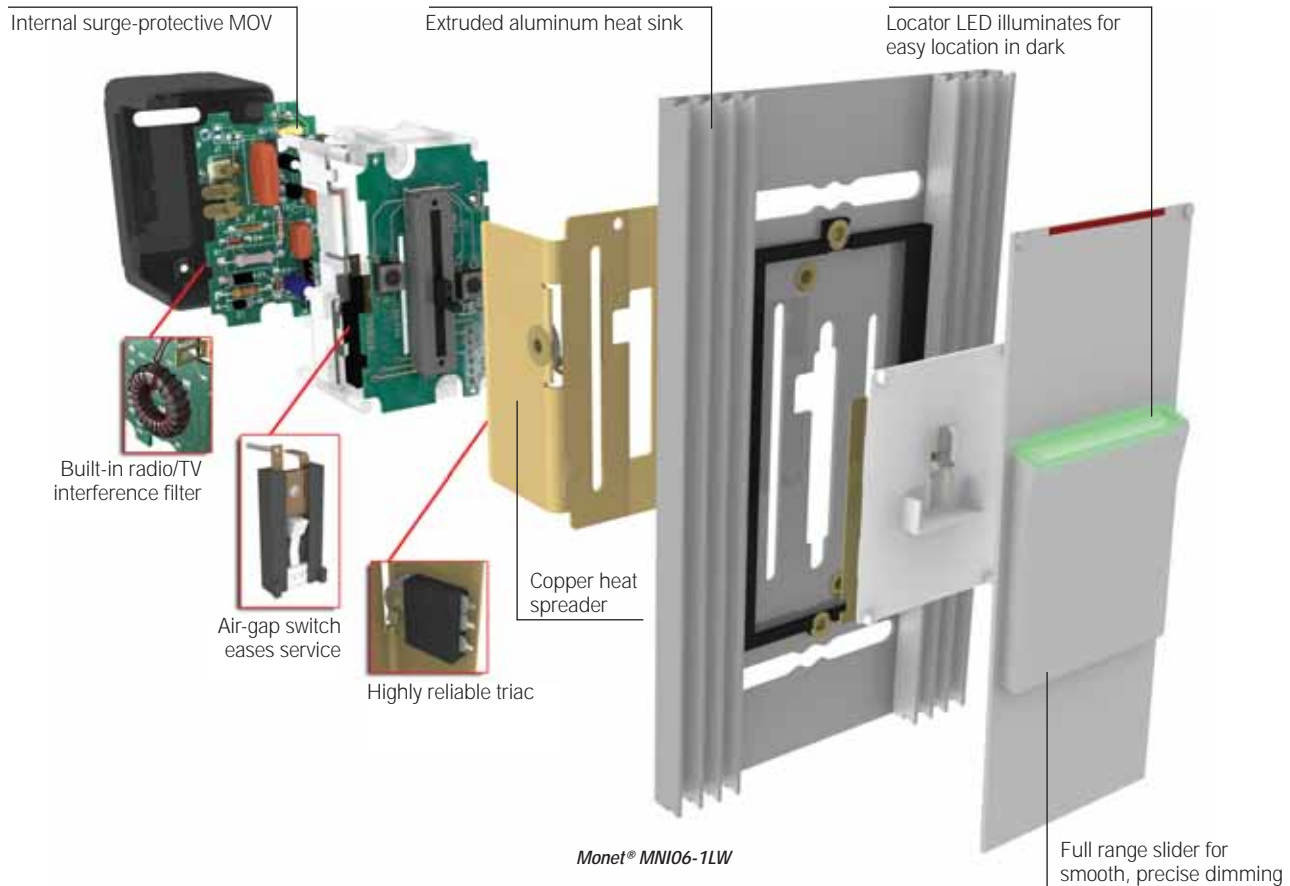

#### Features and Benefits

- Full-range dimming for both single-pole and multi-location control
- Accommodates high-power loads
- Low profile, designer styling; mates with narrow- and wide-fin screwless wallplates
- Wide range of colors available through convenient color change kits
- UL and CSA Listed
- Backed by a Limited Five-Year Warranty

### ARCHITECTURAL SPECIFICATION DIMMING AND FAN SPEED CONTROLS



**Monet® Slide Dimmer**  
 Low-profile architectural controls with advanced features. With narrow or wide fin. Matte finish. Custom-engraved wallplates available.  
**MNI06-1LW shown**



**Renoir® Slide Dimmer**  
 Rugged, full-range preset slide dimmer for high-power loads. With narrow or wide fin.  
**81000-W shown**



**Van Gogh® Rotary Dimmer**  
 Architectural yet classic full-range rotary dimmer for high-power incandescent loads. Rugged design.  
**60800-W shown**





**Monet Architectural Specification Grade Preset Controls**  
**120V and 277V AC 60Hz**

Low-profile Architectural Decora Digital Preset Slide Dimmers with LED locator light. Most Monet dimmers provide single-pole (1 location) and 3-way (multi-location) control with Switching Remote.

**Incandescent 120V AC**

| DESCRIPTION  | CAT. NO.  | RATING | COLOR CHANGE KIT |
|--|-----------|--------|------------------|
| Monet Dimmer (narrow fin)                                      | MNIO6-1LW | 600W   | I, W, A, G, E, B |
| Monet Dimmer (narrow fin)                                      | MNI10-1LW | 1000W  | I, W, A, G, E, B |
| Monet Dimmer (wide fin)  | MNI15-1LW | 1500W  | I, W, A, G, E, B |
| Monet Incandescent Dimmer, Single-Pole, Unlighted (narrow fin) | MNIO6-10W | 600W   | I, W, A, G, E    |
| Monet Incandescent Dimmer, Single-Pole, Unlighted (narrow fin) | MNI10-10W | 1000W  | I, W, A, G, E    |

**Low-Voltage 120V AC**

| DESCRIPTION                          | CAT. NO.  | RATING         | COLOR CHANGE KIT |
|--------------------------------------|-----------|----------------|------------------|
| Monet Dimmer (narrow fin) Electronic | MNEO4-1LW | 400VA (320W)   | I, W, A, G, E, B |
| Monet Dimmer (narrow fin) Magnetic   | MNMO6-1LW | 600VA (450W)   | I, W, A, G, E, B |
| Monet Dimmer (narrow fin) Magnetic   | MNM10-1LW | 1000VA (800W)  | I, W, A, G, E, B |
| Monet Dimmer (wide fin) Magnetic     | MNM15-1LW | 1500VA (1200W) | I, W, A, G, E, B |

**Mark 10™ Fluorescent Ballast 120 and 277V AC**

For Advance Mark 10™ Powerline fluorescent dimming ballasts.

| DESCRIPTION  | CAT. NO.  | RATING         | COLOR CHANGE KIT |
|--|-----------|----------------|------------------|
| Monet Mark 10 Fluorescent Dimmer (narrow fin)      | MXN10-1LW | 1000VA 120V AC | I, W, A, G, E, B |
| Monet Mark 10 Fluorescent Dimmer (wide fin)        | MXN15-1LW | 1500VA 120V AC | I, W, A, G, E, B |
| Monet Mark 10 277V Fluorescent Dimmer (narrow fin) | MXN20-7LW | 2000VA 277V AC | I, W, A, G, E, B |
| Monet Mark 10 277V Fluorescent Dimmer (wide fin)   | MXN30-7LW | 3000VA 277V AC | I, W, A, G, E, B |

**Fan Speed Controls 120V AC**

| DESCRIPTION                          | CAT. NO.  | RATING       | COLOR CHANGE KIT |
|--------------------------------------|-----------|--------------|------------------|
| Monet Fan Speed Control (narrow fin) | MNF07-1LW | 7.5A 120V AC | I, W, A, G, E, B |
| Monet Fan Speed Control (wide fin)   | MNF10-1LW | 10A 120V AC  | I, W, A, G, E, B |

**Monet Accessory Products**

| DESCRIPTION  | CAT. NO.                               | RATING  | COLOR CHANGE KIT |
|--|--|---|------------------|
| Monet Remote Non-Dimming Switching Unit for 3-Way Applications (Unlighted)   | MNOOR-DOW                              | No load rating, use with 120V & 277V Monet dimmers only | I, W, G, E, A    |
| Color Change Kits for MNOOR-DOW Monet 3-Way Switching Unit   | MNKOR-00                               | —   | I, W, G, E, A    |
| Color Change Kit for Narrow Fin Monet Lighted Controls   | MNKIT-SL                               | —   | I, W, A, G, E, B |
| Color Change Kit for Wide Fin Monet Lighted Controls   | MNKIT-1L                               | —   | I, W, A, G, E, B |
| Color Change Kit for Monet Unlighted Dimmers   | MNKIT-SO                               | —   | I, W, A, G, E    |
| Monet Adapter Plate: Allows any Decora strap-mount device to be ganged with either small or large-size Monet controls. In multi-gang installations, must use on ends | MNOLA-000 (large)<br>MNOSA-000 (small) | —   | Metal Heat Sink  |

Note: Mark 10® is a trademark of the Advance Transformer Company.

NOTE: Multi-gang wallplates are available for combining narrow and wide dimmers, with or without fins removed. Refer to page C13.

Note: Sharing a neutral wire may cause flickering. Connect all dimmers to the same phase or run a separate neutral to each phase. Consult Leviton Techline if problems persist.  
 Digital Lighting and Fan Speed Controls are polarity sensitive devices. Always follow the wiring instructions included with each device. They can be used in conventional 3-way and 4-way wiring circuits only when the Control is properly connected to the load as indicated by the device's wiring instructions.

See page C12 for Monet Specifications and Features



MNIO6-1LW



MNI15-1LW



MNOOR-DOW

**Monet Architectural Fin Width**  
 Narrow: 2.75" (69.9 mm)  
 Wide: 4.25" (108.0 mm)

**CAUTION ON RETROFITS:** When retrofitting Mark 10® Powerline dimming ballasts into fixtures that originally had Instant Start ballasts, the sockets MUST be replaced with Rapid Start sockets to allow proper dimmer operation and prevent damage to the dimming ballast. Refer to the instructions provided with the ballast and the Leviton dimmer.



MNS20-1LW

### Monet Architectural Specification Grade Controls

#### Monet Switches

| DESCRIPTION  | CAT. NO. | RATING          | COLOR*        |
|--|----------|-----------------|---------------|
| Monet Single-Pole Rocker Switch with Screw Terminals, Lighted (narrow fin) | MNS20-1L | 20A 120V AC     | I, W, A, G, E |
| Monet 3-Way Rocker Switch with Screw Terminals, Unlighted (narrow fin)     | MNS20-D3 | 20A 120/277V AC | I, W, A, G, E |
| Monet 4-Way Rocker Switch with Screw Terminals, Unlighted (narrow fin)     | MNS20-D4 | 20A 120/277V AC | I, W, A, G, E |

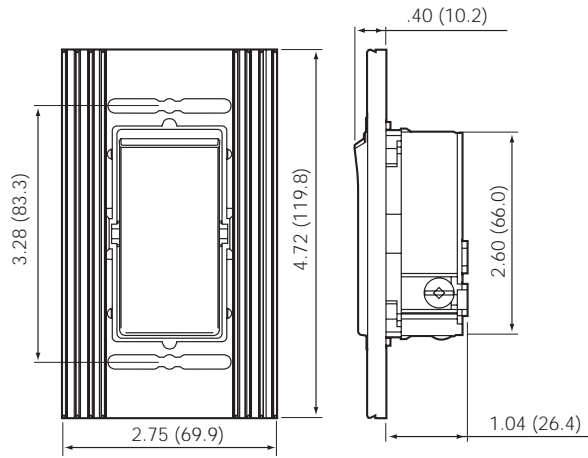

MNS20 shown

#### SPECIFICATIONS AND FEATURES

- Premier Architectural Specification Grade dimmer combines high load capability, esthetic appearance, digital circuitry and Scene Lighting capabilities
- Provides single-pole and 3-way switching with Monet Non-Dimming Remote Unit
- Low-profile architectural fins, even on wide-fin models, for a flush fit appearance
- Smooth slide-dimming operation. Push slider for ON/OFF preset
- Digital circuit provides Soft-ON/Fade-OFF for eye-pleasing effect and prolonged bulb life
- Specially designed to minimize shadows with non-reflective, easy-to-clean matte finish. Ideal for museums, art galleries, showrooms
- Soft, green locator LED discretely positioned on slider
- Square Law Dimming ensures linear slide control across entire dim and bright output range
- Hidden air-gap switch; slider moves into hidden key-way to access air-gap switch for servicing needs. When air gap switch is open, red line appears at top
- Small and large size adapter plates fit all Leviton Decora straps to make them compatible with Monet wallplates

- Screwless, designer Monet wallplates with matte finish included. Multi-gang wallplates also available for combining narrow and wide dimmers, with or without fins removed (see page C13)
- Customized wallplate engravings available—See your Leviton representative for more information
- Built-in radio/TV interference filter
- Protected memory during temporary power failures
- Internal MOV for surge protection

#### TESTING AND CODE COMPLIANCE

- UL Listed (File #E-31373)
- CSA Certified (File #LR-3413)
- Backed by a Limited Two-Year Warranty

#### \*COLOR

Cat. No. denotes White device. For other colors, order Color Change Kits and add suffix as follows: Ivory (-I), White (-W), Gray (-G), Black (-E), Brown (-B) and Almond (-A). Monet Rocker Switches listed above do not use Color Change Kits—Add suffix to basic Cat. No. for color selection.

#### MATERIAL CHARACTERISTICS

Environmental: Flammability UL-94, V2 Rating  
Operating Temperature: 32°F to 130°F

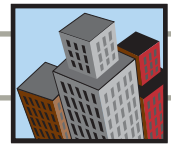

### Monet Multi-Gang Wallplates

**TABLE 1 — FOR INSTALLATIONS WITH NO FINNS BROKEN OFF**

| Wallplate Cat. No. | Number of Narrow Fin/Wide Fin Controls | Wallbox Requirements |
|--------------------|--|----------------------|
| MNW10-00           | 1 Narrow                               | 1-Gang               |
| MNW20-00           | 2 Narrow                               | 3-Gang               |
| MNW30-00           | 3 Narrow                               | 5-Gang               |
| MNW40-00           | 4 Narrow                               | 6-Gang               |
| MNW50-00           | 5 Narrow                               | 9-Gang               |
| MNW60-00           | 6 Narrow                               | 10-Gang              |
| MNW01-00           | 1 Wide                                 | 1-Gang               |
| MNW02-00           | 2 Wide                                 | 4-Gang               |
| MNW03-00           | 3 Wide                                 | 7-Gang               |
| MNW04-00           | 4 Wide                                 | 9-Gang               |
| MNW11-00           | 1 Narrow/1 Wide                        | 4-Gang               |
| MNW21-00           | 2 Narrow/1 Wide                        | 5-Gang               |
| MNW31-00           | 3 Narrow/1 Wide                        | 7-Gang               |
| MNW41-00           | 4 Narrow/1 Wide                        | 8-Gang               |
| MNW51-00           | 5 Narrow/1 Wide                        | 10-Gang              |
| MNW12-00           | 1 Narrow/2 Wide                        | 6-Gang               |
| MNW22-00           | 2 Narrow/2 Wide                        | 8-Gang               |
| MNW32-00           | 3 Narrow/2 Wide                        | 9-Gang               |
| MNW13-00           | 1 Narrow/3 Wide                        | 9-Gang               |
| MNW23-00           | 2 Narrow/3 Wide                        | 10-Gang              |

**TABLE 2 — FOR INSTALLATIONS WITH FINNS BROKEN OFF**

| Wallplate Cat. No. | Number of Narrow Fin/Wide Fin Controls | Wallbox Requirements |
|--------------------|--|----------------------|
| MNW20-FB           | 2 Narrow                               | 2-Gang               |
| MNW30-FB           | 3 Narrow                               | 3-Gang               |
| MNW40-FB           | 4 Narrow                               | 4-Gang               |
| MNW50-FB           | 5 Narrow                               | 5-Gang               |
| MNW60-FB           | 6 Narrow                               | 6-Gang               |
| MNW70-FB           | 7 Narrow                               | 7-Gang               |
| MNW80-FB           | 8 Narrow                               | 8-Gang               |
| MNW90-FB           | 9 Narrow                               | 9-Gang               |
| MNW02-FB           | 2 Wide                                 | 3-Gang               |
| MNW03-FB           | 3 Wide                                 | 5-Gang               |
| MNW04-FB           | 4 Wide                                 | 7-Gang               |
| MNW05-FB           | 5 Wide                                 | 9-Gang               |
| MNW11-FB           | 1 Narrow/1 Wide                        | 3-Gang               |
| MNW21-FB           | 2 Narrow/1 Wide                        | 4-Gang               |
| MNW31-FB           | 3 Narrow/1 Wide                        | 5-Gang               |
| MNW41-FB           | 4 Narrow/1 Wide                        | 6-Gang               |
| MNW51-FB           | 5 Narrow/1 Wide                        | 7-Gang               |
| MNW61-FB           | 6 Narrow/1 Wide                        | 8-Gang               |
| MNW71-FB           | 7 Narrow/1 Wide                        | 9-Gang               |
| MNW81-FB           | 8 Narrow/1 Wide                        | 10-Gang              |
| MNW12-FB           | 1 Narrow/2 Wide                        | 5-Gang               |
| MNW22-FB           | 2 Narrow/2 Wide                        | 6-Gang               |
| MNW32-FB           | 3 Narrow/2 Wide                        | 7-Gang               |
| MNW42-FB           | 4 Narrow/2 Wide                        | 8-Gang               |
| MNW52-FB           | 5 Narrow/2 Wide                        | 9-Gang               |
| MNW62-FB           | 6 Narrow/2 Wide                        | 10-Gang              |
| MNW13-FB           | 1 Narrow/3 Wide                        | 7-Gang               |
| MNW23-FB           | 2 Narrow/3 Wide                        | 8-Gang               |
| MNW33-FB           | 3 Narrow/3 Wide                        | 9-Gang               |
| MNW43-FB           | 4 Narrow/3 Wide                        | 10-Gang              |
| MNW14-FB           | 1 Narrow/4 Wide                        | 9-Gang               |
| MNW24-FB           | 2 Narrow/4 Wide                        | 10-Gang              |

Monet multi-gang wallplates are available for every permissible combination of small fin and large fin dimmers. Tables 1 and 2 can be used to determine if a specific combination of devices is possible. When small and large fin devices are combined, all the large fin devices must be placed to one side and all the small fin devices must be placed to the other side. In an installation where all the fins are broken off, do not remove the fins from the dimmers at each of the extreme ends of the installation.

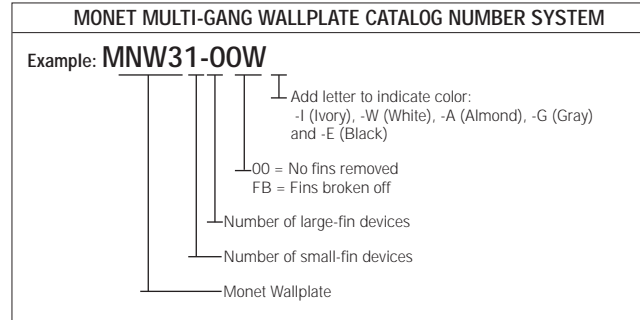

**Maximum Load per Monet Dimmer Multi-Gang with Fins Broken Off**

| Cat. No. | Single         | 2-Gang         | More Than 2-Gang |
|----------|----------------|----------------|------------------|
| MNE04    | 400VA (320W)   | 300VA (240W)   | 250VA (200W)     |
| MNF07    | 7.5A           | 6A             | 5.3A             |
| MNF10    | 10A            | 8A             | 7A               |
| MNI06    | 600W           | 500W           | 400W             |
| MNI10    | 1000W          | 800W           | 700W             |
| MNI15    | 1500W          | 1250W          | 1000W            |
| MNM06    | 600VA (450W)   | 500VA (375W)   | 400VA (300W)     |
| MNM10    | 1000VA (800W)  | 800VA (640W)   | 700VA (560W)     |
| MNM15    | 1500VA (1200W) | 1250VA (1000W) | 1000VA (800W)    |
| MNX10    | 1000VA (980W)  | 800VA (784W)   | 700VA (686W)     |
| MNX15    | 1500VA (1470W) | 1250VA (1225W) | 1000VA (980W)    |
| MNX20-7  | 2000VA (1960W) | 1600VA (1568W) | 1400VA (1372W)   |
| MNX30-7  | 3000VA (2940W) | 2500VA (2450W) | 2000VA (1960W)   |

*Note: For more information on Fin Removal, refer to the instruction sheet provided with each Monet device.*

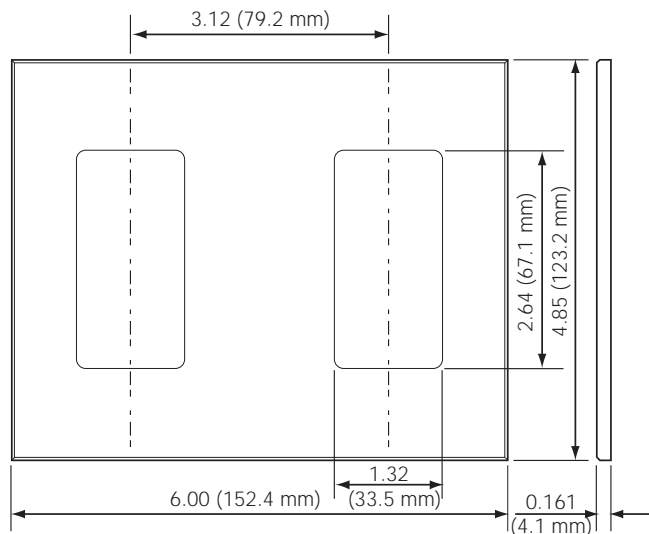

MNW20-00



Commercial Grade Lighting Controls

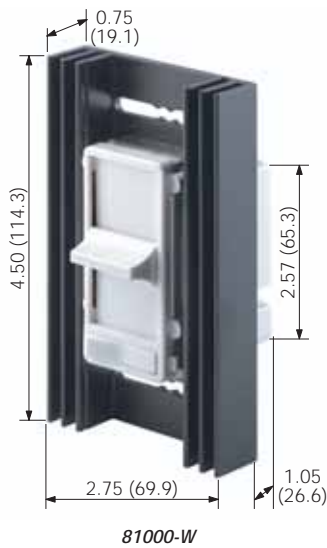

81000-W



82000-W

**Renoir Architectural Fin Width**  
Narrow: 2.75" (69.9 mm)  
Wide: 4.50" (108.0 mm)

**CAUTION ON RETROFITS:** When retrofitting Mark 10® Powerline dimming ballasts into fixtures that originally had Instant Start ballasts, the sockets MUST be replaced with Rapid Start sockets to allow proper dimmer operation and prevent damage to the dimming ballast. Refer to the instructions provided with the ballast and the Leviton dimmer.

Renoir Architectural Specification Preset Slide Dimmers

Renoir Incandescent 120V AC 60Hz Only

| DESCRIPTION                                  | CAT. NO. | RATING | COLOR*         |
|--|----------|--------|----------------|
| Renoir Single-Pole (narrow fin)              | 80800    | 800W   | I, W, GY, B    |
| Renoir 3-Way (narrow fin)                    | 80800-3  | 800W   | I, W, GY, B    |
| Renoir Single-Pole (narrow fin)              | 81000    | 1000W  | I, W, A, GY, B |
| Renoir Single-Pole, Illuminated (narrow fin) | 81000-L  | 1000W  | I, W           |
| Renoir 3-Way (narrow fin)                    | 81000-3  | 1000W  | I, W, A, GY, B |
| Renoir 3-Way, Illuminated (narrow fin)       | 81000-L3 | 1000W  | I, W           |
| Renoir Single-Pole (wide fin)                | 81500    | 1500W  | I, W, A, GY, B |
| Renoir 3-Way (wide fin)                      | 81500-3  | 1500W  | I, W, A, GY, B |
| Renoir Single-Pole (wide fin)                | 82000    | 2000W  | I, W, A, GY, B |
| Renoir Single-Pole, Illuminated (wide fin)   | 82000-L  | 2000W  | I, W           |
| Renoir 3-Way (wide fin)                      | 82000-3  | 2000W  | I, W, A, GY    |
| Renoir 3-Way, Illuminated (wide fin)         | 82000-L3 | 2000W  | I, W           |

Renoir Magnetic Low-Voltage 120V AC 60Hz Only

| DESCRIPTION                     | CAT. NO. | RATING         | COLOR*      |
|---------------------------------|----------|----------------|-------------|
| Renoir Single Pole (narrow fin) | 71111    | 1000VA (800W)  | I, W, GY, B |
| Renoir 3-Way (narrow fin)       | 71113    | 1000VA (800W)  | I, W, B     |
| Renoir Single Pole (wide fin)   | 71511    | 1500VA (1200W) | I, W        |
| Renoir 3-Way (wide fin)         | 71513    | 1500VA (1200W) | I           |

Renoir Fluorescent Dimming Ballasts 120V and 277V AC 60Hz Only

| DESCRIPTION   | CAT. NO. | RATING   | COLOR* |
|---|----------|--|--------|
| Renoir Fluorescent Dimmer, Single-Pole and 3-Way (wide-fin) | 26666-31 | 1200VA (900W) 120V AC Advance Mark 10™ Powerline fluorescent dimming ballast | White  |
| Renoir Fluorescent Dimmer, Single-Pole and 3-Way (wide-fin) | 26666-37 | 1200VA (900W) 277V AC Advance Mark 10™ Powerline fluorescent dimming ballast | White  |

Note: For complete information on installation, ganging and derating of High Wattage Dimmers, consult Leviton's Lighting Controls Product Selection Guide or the Dimmer Instruction Sheet provided with the device.

When ganging these units, no derating is necessary except on those units which have had both sets of snap-off, fins removed. These shall be derated as follows:

| Maximum Load per Renoir Dimmer Multi-Gang with Fins Broken Off |                |                |                  |
|--|----------------|----------------|------------------|
| Cat. No.   | Single         | 2-Gang         | More Than 2-Gang |
| 26666-31   | 1200VA         | 1100VA         | 1050VA           |
| 26666-37   | 1200VA         | 1200VA         | 1200VA           |
| 71111/3  | 1000VA (800W)  | 800VA (800W)   | 700VA (640W)     |
| 71511/3  | 1500VA (1200W) | 1300VA (1200W) | 1100VA (1040W)   |
| 80800  | 800W           | 700W           | 600W             |
| 81000  | 1000W          | 800W           | 700W             |
| 81500  | 1500W          | 1300W          | 1000W            |
| 82000  | 2000W          | 1800W          | 1500W            |

NOTE: For fin removal and switchbox requirements for ganging Leviton Renoir dimmers, refer to page C17.

Note: Sharing a neutral wire may cause flickering. Connect all dimmers to the same phase or run a separate neutral to each phase. Consult Leviton Techline if problems persist.

SPECIFICATIONS AND FEATURES

- ON/OFF rocker switch turns lights ON at last selected brightness level
- Smooth-action, linear slide control for easy, precise operation
- Available in single-pole (one location) and 3-way (multi-location) versions. 3-way dimmer is used with standard 3-way ON/OFF switch
- Decora-styling coordinates with Leviton's extensive line of Decora devices
- Decora-style screwless snap-on wallplates present an attractive appearance in any application
- Slim, compact housing easily fits in standard wall boxes
- Fins are easily removed for multi-gang applications
- Large radio/TV interference filter
- Illuminated versions available

TESTING AND CODE COMPLIANCE

- UL Listed (File #E-31373)
- CSA Certified (File #LR-3413)
- Backed by a Limited Five-Year Warranty

\*COLOR

Add suffix to catalog numbers as follows for color selection: Ivory (-I) White (-W), Almond (A), Gray (-GY), Brown (-B)

MATERIAL CHARACTERISTICS

Environmental: Flammability UL-94, V2 Rating  
Operating Temperature: 32°F to 130°F

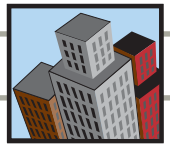

**Renoir Architectural Specification Preset Slide Fan Speed Controls**

Renoir Fan Speed Controls 120V AC 60Hz Only

| DESCRIPTION                     | CAT. NO. | RATING   | COLOR* |
|---------------------------------|----------|----------|--------|
| Renoir Single-Pole (narrow-fin) | 80827    | 7.5 Amps | I, W   |
| Renoir Single-Pole (wide-fin)   | 81127    | 10 Amps  | I, W   |
| Renoir Single-Pole (wide-fin)   | 81527    | 15 Amps  | I, W   |

*NOTE: For fin removal and switchbox requirements for ganging Leviton Renoir fan speed controls, refer to page C17.*

*Note: Sharing a neutral wire may cause flickering. Connect all dimmers to the same phase or run a separate neutral to each phase. Consult Leviton Techline if problems persist.*

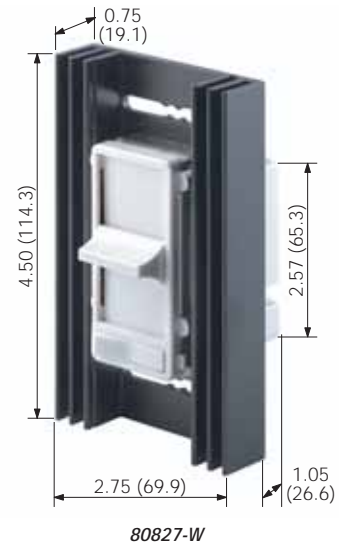

**Renoir Architectural Fin Width**  
 Narrow: 2.88" (73.2 mm)  
 Wide: 4.69" (119.1 mm)

**SPECIFICATIONS AND FEATURES**

- Smooth-action, linear slide control for easy, precise operation
- Manual low-end trim adjustment feature on fan speed controls allows precise adjustment of low-end fan settings when installing device
- Decora-styling coordinates with Leviton's extensive line of Decora devices
- Decora-style screwless snap-on wallplate present an attractive appearance in any application
- Slim, compact housing easily fits in standard wall boxes
- Fins are easily removed for multi-gang applications

**TESTING AND CODE COMPLIANCE**

- UL Listed (File # E-31373)
- CSA Certified (File #LR-3413)
- Backed by a Limited Five-Year Warranty

**\*COLOR**

Add suffix to catalog numbers as follows for color selection: Ivory (-I) White (-W).

**MATERIAL CHARACTERISTICS**

Environmental: Flammability UL-94, V2 Rating  
 Operating Temperature: 32°F to 130°F



Commercial Grade Lighting Controls

Van Gogh Architectural Specification Rotary Dimmers

Van Gogh Incandescent 120V AC 60Hz Only

| DESCRIPTION                                  | CAT. NO. | RATING | COLOR* |
|--|----------|--------|--------|
| Van Gogh Single-Pole Rotary (narrow fin)     | 60800    | 800W   | I, W   |
| Van Gogh 3-Way Push ON/Push OFF (narrow fin) | 60800-3  | 800W   | I, W   |
| Van Gogh Single-Pole Rotary (narrow fin)     | 61000    | 1000W  | I, W   |
| Van Gogh 3-Way Push ON/Push OFF (narrow fin) | 61000-3  | 1000W  | I, W   |
| Van Gogh Single-Pole Rotary (wide fin)       | 61500    | 1500W  | I, W   |
| Van Gogh Single-Pole Rotary (wide fin)       | 62000    | 2000W  | I, W   |

Note: Sharing a neutral wire may cause flickering. Connect all dimmers to the same phase or run a separate neutral to each phase. Consult Leviton Techline if problems persist.

When ganging these units, no derating is necessary except on those units which have had both sets of snap-off, fins removed. These shall be derated as follows:

| Maximum Load per Van Gogh Dimmer Multi-Gang with Fins Broken Off |        |        |                  |
|--|--------|--------|------------------|
| Cat. No.   | Single | 2-Gang | More Than 2-Gang |
| 60800  | 800W   | 700W   | 600W             |
| 61000  | 1000W  | 800W   | 700W             |
| 61500  | 1500W  | 1300W  | 1100W            |
| 62000  | 2000W  | 1800W  | 1500W            |

NOTE: For fin removal and switchbox requirements for ganging Leviton Van Gogh dimmers, refer to page C17.

Color Change Kits for 60800, 61000 Dimmer Units

| DESCRIPTION                                    | CAT. NO. |
|--|----------|
| Brown Cover and Matching Knob w/Gold Insert    | 60001    |
| Ivory Cover and Matching Knob w/Gold Insert    | 60001-I  |
| White Cover and Matching Knob w/ Silver Insert | 60001-W  |

Color Change Kits for 61500, 62000 Dimmer Units

| DESCRIPTION                                    | CAT. NO. |
|--|----------|
| Brown Cover and Matching Knob w/Gold Insert    | 60002    |
| Ivory Cover and Matching Knob w/Gold Insert    | 60002-I  |
| White Cover and Matching Knob w/ Silver Insert | 60002-W  |

Van Gogh™ Architectural Rotary Fan Speed Control 120V AC 60Hz Only

| DESCRIPTION                     | CAT. NO. | RATING  | COLOR* |
|---------------------------------|----------|---------|--------|
| Van Gogh Single-Pole (wide fin) | 61027    | 10 Amps | I, W   |

Note: When more than one ceiling fan is controlled, make sure the blades are rotating on all fans.



61000-W



62000-W

Van Gogh Architectural Fin Width  
Narrow: 2.75" (69.9 mm)  
Wide: 4.56" (115.8 mm)

SPECIFICATIONS AND FEATURES

- Classic rotary architectural-style dimmer is a popular choice in many installations
- Available in Rotary ON/OFF (single pole only) and Push-ON/Push-OFF (3-way).
- 3-way version is used with a standard 3-way ON/OFF switch
- Snap-on cover conceals heat fins
- Color-matched dimmer control knob with gold insert for an attractive appearance in any installation
- Snap-off fins permit easy ganging with other devices
- Slim, compact housing easily fits in standard wall box
- Large radio/TV interference filter

TESTING AND CODE COMPLIANCE

- UL Listed (File #E-31373, 62000 File #E-66800)
- CSA Certified (File #LR-3413)
- Backed by a Limited Five-Year Warranty

\*COLOR

Add suffix to catalog number as follows for colors: Ivory cover with Gold insert (-I), White cover with Silver insert (-W).

MATERIAL CHARACTERISTICS

Environmental: Flammability UL-94, V2 Rating  
Operating Temperature: 32°F to 130°F



### Ganging and Derating Box-Mounted Lighting Controls

Ganging is an installation practice where two or more lighting controls are mounted side-by-side using the required number of connected wallboxes. Ganging may require the removal of part of the fins on Architectural Dimmers or part of the mounting strap on strap-mounted devices. In Architectural Dimmers, the metallic fins help dissipate heat from within the device. Strap mounted dimmers use the mounting strap for the same purpose. Therefore, removing a portion of the fins or strap for ganging purposes will require derating the dimmers to prevent them from overheating.

### Ganging and Derating Leviton Lighting Controls

When ganging Mural, True Touch, ToggleTouch and IllumaTech controls, the side sections of the mounting strap must be removed. Use pliers to carefully bend side sections back and forth until they break off. The side sections of the strap dissipate heat, so removing them requires derating the dimmer's capacity. See Chart 1.

Note that Leviton SureSlide and Trimatron lighting controls can be ganged without removing any sections of their mounting straps. However, SureSlide and Trimatron controls must also be derated when they're ganged.

### Maximum Load Per Dimmer for Multi-Ganging All Strap-Mounted Dimmers

| Dimmer Rating | Single | 2-Gang | More Than 2-Gang |
|---------------|--------|--------|------------------|
| 500W          | 500W   | 400W   | 300W             |
| 600W          | 600W   | 500W   | 400W             |
| 1000W         | 1000W  | 800W   | 700W             |
| 400VA         | 400VA  | 350VA  | 250VA            |
| 600VA*        | 600VA  | 500VA  | 400VA            |
| 1000VA        | 1000VA | 800VA  | 700VA            |

\*Except IPX06-7, which requires no derating

### Maximum Bulb Wattage for Magnetic Low-Voltage Lighting

The capacity of a magnetic low-voltage dimmer is its VA rating. If a wattage rating is also listed (as in this book), it is merely an estimate of the lamp wattage that can be placed on a UL-approved magnetic low-voltage transformer without exceeding the dimmer's VA rating. (This is, in turn, based on an estimate of transformer efficiency.)

| Power To Transformer | Transformer Efficiency | Lamp Load |
|----------------------|------------------------|-----------|
| 1000VA               | X 80%                  | = 800W    |
| 600VA                | X 75%                  | = 450W    |

### Ganging and Leviton Renoir® and Van Gogh® Architectural Lighting Controls

When fins are broken off on wide and narrow controls for ganging purposes, the number of switch boxes required can be quickly determined by referring to the two charts below.

#### Ganging

Switch boxes required for ganging Leviton architectural controls when no fins are removed:

| Number of Wide Controls | Number of Narrow Controls* |    |    |    |    |
|-------------------------|----------------------------|----|----|----|----|
|                         | 0                          | 1  | 2  | 3  | 4  |
| 0                       | •                          | •  | •  | •  | •  |
| 1                       | 1                          | 3  | 5  | 7  | 8  |
| 2                       | 4                          | 6  | 7  | 9  | 11 |
| 3                       | 7                          | 9  | 10 | 11 | 13 |
| 4                       | 9                          | 11 | 12 | 14 | 16 |

Switch boxes required for ganging Leviton architectural controls when all inside fins are removed:

| Number of Wide Controls | Number of Narrow Controls |    |    |    |    |    |    |
|-------------------------|---------------------------|----|----|----|----|----|----|
|                         | 0                         | 1  | 2  | 3  | 4  | 5  | 6  |
| 0                       | 0                         | 1  | 2  | 3  | 4  | 5  | 6  |
| 1                       | 1                         | 3  | 4  | 5  | 6  | 7  | 8  |
| 2                       | 3                         | 5  | 6  | 7  | 8  | 9  | 10 |
| 3                       | 5                         | 7  | 8  | 9  | 10 | 11 | 12 |
| 4                       | 7                         | 9  | 10 | 11 | 12 | 13 | 14 |
| 5                       | 9                         | 11 | 12 | 13 | 14 | 15 | 16 |
| 6                       | 11                        | 13 | 14 | 15 | 16 | 17 | 18 |

\*Narrow controls must have fins broken off to be ganged.



## DESIGNER CONTROL FEATURES

### Commercial Grade Controls

#### Designer Lighting Controls

Brilliant inside and out — the Vizia® collection includes dimmers, fan speed controls and radio frequency (RF) products integrated into a stylish form factor. With Vizia RF, homeowners can automate lighting as well as select appliances and electronics. The Mural® line encompasses scene-capable enhancement products. These designer-style devices provide full-range dimming in a sleek, Decora body that will enhance any décor.

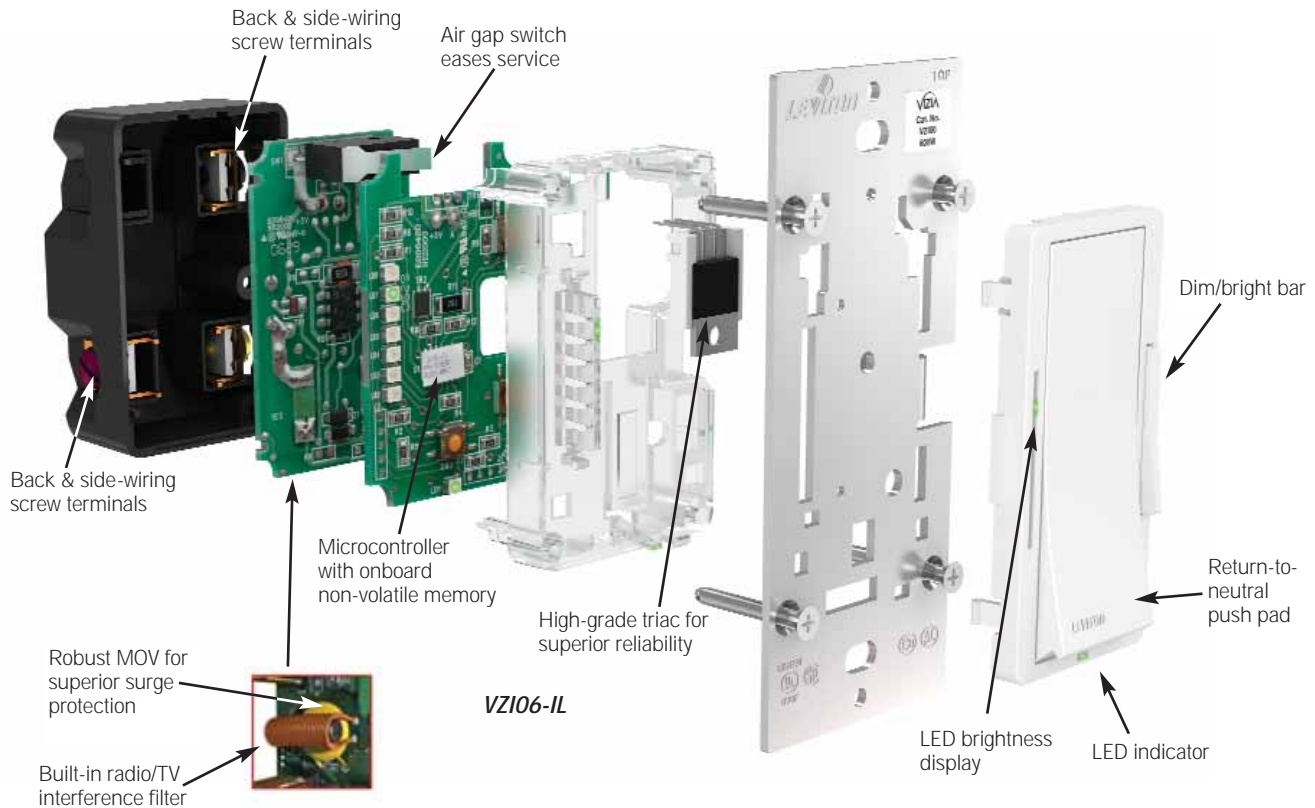

#### Features and Benefits

- Easy to operate for people of all ages and abilities
- Digital circuitry provides eye-pleasing soft-ON/fade-OFF that extends lamp life
- Compatible with Decora® screwless and Decora standard designer wallplates
- Wide range of colors available through convenient color change kits
- UL and CSA Listed
- Backed by a Limited Five-Year Warranty

#### LEVITON DESIGNER DIMMERS FOR FULL-RANGE DIMMING



**Vizia Controls**  
Vizia digital dimmer with LED brightness level indicators, intuitive Dim/Bright bar and return-to-neutral pushpad. Color-change kits available.  
**VZ106-1L shown**



**Vizia Remote Controls**  
Enables multi-location dimming or fan control when used in conjunction with Vizia Dimmer/Fan Speed Controls.  
**VZ00R-1L shown**



**Mural 7-Scene Controller**  
Decora style controller sends commands for up to 7 distinct scenes to individual Mural Scene-Capable Controllers.  
**MN00C-1LW shown**





## Vizia Digital Controls

All Vizia Preset Dimmers and Fan Speed Controls provide single-pole (one location) or 3-way (multi-location) control when used with a Vizia remote unit.

### Vizia Digital Controls with LED Locator and Brightness Display

Single-Pole, 3-Way or more applications

| DESCRIPTION   | CAT. NO. | RATING   | COLOR*                    |
|---|----------|--|---------------------------|
| Vizia Incandescent Dimmer†  | VZIO6-1L | 600W 120V AC 60Hz  | X, Z, W                   |
| Vizia Magnetic Low Voltage Dimmer†  | VZM06-1L | 600VA (450W)<br>120V AC 60Hz                                       | X, Z                      |
| Vizia Incandescent/Magnetic Low Voltage Dimmer†   | VZM10-1L | 1000W Incandescent,<br>1000VA Magnetic Low<br>Voltage 120V AC 60Hz | X, Z                      |
| Vizia Electronic Low Voltage Dimmer; neutral required†  | VZE04-1L | 400W 120V AC 60Hz  | X, Z                      |
| Vizia Electronic Low Voltage Dimmer; neutral required†  | VZE06-1L | 600W 120V AC 60Hz  | X, Z                      |
| Vizia Fluorescent Dimmer for Advance Mark 10®<br>Powerline or Tu-Wire® Ballasts; neutral required | VZX10-1L | 1000VA 120V AC 60Hz  | X, Z                      |
| Vizia Fluorescent Dimmer for Advance Mark 10®<br>Powerline Ballasts; neutral required             | VZX12-7L | 1200VA<br>277V AC 60Hz   | X, Z                      |
| Vizia Fluorescent Dimmer for Hi-Lume® or Eco-10®<br>(Eco Series) Ballasts; neutral required       | VZH08-1L | 8A 120V AC 60Hz  | X, Z                      |
| Vizia Fluorescent Dimmer for Hi-Lume® or Eco-10®<br>(Eco Series) Ballasts; neutral required       | VZH06-7L | 6A 277V AC 60Hz  | X, Z                      |
| Vizia Quiet Fan Speed Control; neutral required   | VZF01-1L | 1.5A 120V AC 60Hz  | X, Z                      |
| Vizia Switch with LED Locator; neutral required   | VZS15-1L | 15A 120V AC 60Hz   | X, Z                      |
| Vizia Matching Dimmer/Fan Speed<br>Color Change Kit   | VZKIT-MD | —  | I, W, A, T,<br>G, E, R, B |
| Vizia Coordinating Dimmer/Fan Speed<br>Color Change Kit; no LED                                   | VZKIT-CD | —  | I, W, A, T,<br>G, E, R, B |
| Vizia Matching Switch<br>Color Change Kit with LED Locator  | VZKIT-MS | —  | I, W, A, T,<br>G, E, R, B |
| Vizia Coordinating Switch<br>Color Change Kit, no LED   | VZKIT-CS | —  | I, W, A, T,<br>G, E, R, B |



VZIO6-1LX

Use Leviton Power Extenders to extend the load capacity of box-mounted dimmers. Leviton Power Extenders are available for incandescent, magnetic low-voltage, electronic low-voltage, Advance Mark 10® Powerline fluorescent dimming ballasts or equivalents, and 0–10 VDC dimmable fluorescent ballasts such as Advance Mark 7® 0-10V, OSRAM Sylvania Quicktronic Helios or equivalent ballasts.

† Contractor Packs are available in White (-W), Almond (-A) or Light Almond (-T), packaged 10 pieces/box. To order, add suffix -ML to catalog number followed by color designation. Ex.: VZIO6-ML\*

Eco-10® (Eco-Series) Tu-Wire® and Hi-Lume® are trademarks of Lutron Electronics Co., Inc.

See Page C7 for more information on Leviton Power Extenders

Note: Sharing a neutral wire may cause flickering. Connect all dimmers to the same phase or run a separate neutral to each phase. Consult Leviton Techline if problems persist. Digital Lighting and Fan Speed Controls are polarity sensitive devices. Always follow the wiring instructions included with each device.

CAUTION ON RETROFITS: When retrofitting Mark 10® Powerline dimming ballasts into fixtures that originally had Instant Start ballasts, the sockets MUST be replaced with Rapid Start sockets to allow proper dimmer operation and prevent damage to the dimming ballast. Refer to the instructions provided with the ballast and the Leviton dimmer.

#### SPECIFICATIONS AND FEATURES

- Streamlined Decora styling complements any interior, adds a “family look” when ganged with any Decora device
- Push pad always returns to neutral regardless of load status
- Digital circuitry provides Soft-ON/Fade-OFF lighting and prolonged lamp life or an option via simple programming for classic ON/OFF
- Green LED locator light illuminates when lights are OFF
- Air-gap switch completely disconnects power to unit for bulb changing or removal from service
- Provides single pole (one-location) or multi-location full range dimming when used with Vizia Dimmer Remotes (see P. C20 for Vizia Remotes)
- Vizia Six-Pack: Three color choices along with single pole or 3-way control provide 6 different options in each box, eliminating the need to stock a large variety of devices
- Color Change Kits are available in a wide range of colors, making it easy and economical to change decorating schemes

- Power failure recovery assures retention of lighting levels during long-term power interruptions
- Built-in radio/TV interference filter
- Quiet 1.5Amp Fan Speed Controls are perfect for libraries, study rooms and any areas where ceiling fan noise could become distracting
- Fits in standard wallbox – units may be ganged
- LED display alongside push pad indicates selected brightness /fan speed level
- Dim/Bright Bar allows user to set brightness level when lights are ON or OFF
- Minimum brightness level can be easily programmed from 1 to 50% of full brightness
- Dim Lock level feature determines preset light level regardless of last setting
- Selectable Fade Rate is easily programmable for desired Fade ON/OFF
- Press and hold push pad to turn lights on to full bright from any preset light level
- To use the Delayed OFF feature while lights are ON (10 seconds to OFF), press and hold the push pad
- Compatible with Decora PLUS screwless wallplates and Decora wallplates

#### TESTING AND CODE COMPLIANCE

- UL Listed (File #E-31373)
- CSA Certified (File #M/C 152105)
- Backed by a Limited Five-Year warranty

#### MATERIAL CHARACTERISTICS

Environmental: Flammability UL-94, V2 Rating  
Operating Temperature: 32°F to 130°F

#### \*COLOR

Vizia Controls come packaged with three colors. Controls with suffix (-X) include White, Ivory and Almond. Controls with suffix (-Z) include White, Ivory and Light Almond. Color Change Kits available in the following colors: Ivory (I), White (-W), Almond (-A), Light Almond (-T), Gray (-G), Black (-E), Red (-R) and Brown (-B).



Vizia Remotes

Vizia Remotes — No Load Rating  
 For Use with Vizia Dimmers, Switches and Fan Speed Controls  

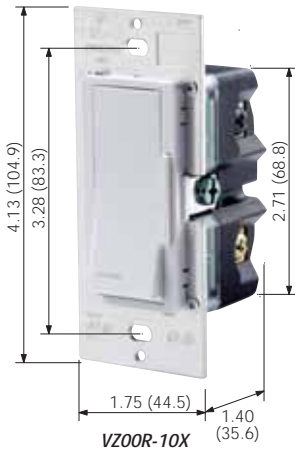

VZ00R-10X

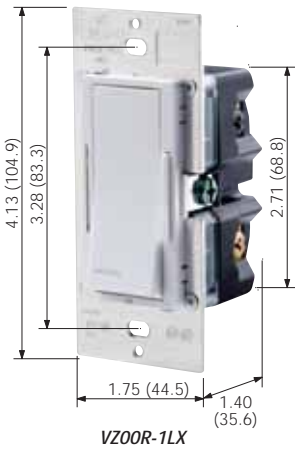

VZ00R-1LX

| DESCRIPTION  | CAT. NO. | RATING       | COLOR*<br>X=I+W+A<br>Z=I+W+T |
|--|----------|--------------|------------------------------|
| Vizia Matching Remote Unit to 120V Dimmers/Fan Speed Control for 3-way or up to 5 locations, with LED Locator and Brightness/Fan Speed Display; neutral required†  | VZ00R-1L | 120V AC 60Hz | X, Z, W                      |
| Vizia Matching Remote Unit to 277V Dimmers for 3-way or up to 5 locations, with LED Locator and Brightness Display; neutral required   | VZ00R-7L | 277V AC 60Hz | X, Z                         |
| Vizia Coordinating Remote Unit to 120V Dimmers/Fan Speed Control for 3-way or up to 10 locations, no LED; neutral required when used with a device that requires a neutral wire†                           | VZ00R-10 | 120V AC 60Hz | X, Z                         |
| Vizia Matching Switch Remote Unit to 120V Dimmers/Fan Speed Control and VZS15-1L Switch for 3-way or up to 5 locations, with LED Locator; neutral required   | VZ0SR-1L | 120V AC 60Hz | X, Z                         |
| Vizia Coordinating Switch Remote Unit to 120V Dimmers/Fan Speed Control and VZS15-1L Switch for 3-way or up to 10 locations, no LED; neutral required when used with a device that requires a neutral wire | VZ0SR-10 | 120V AC 60Hz | X, Z                         |
| Vizia Matching Dimmer/Fan Speed Remote Color Change Kit with LED Locator and Brightness Display  | VZKIT-MD | —            | I, W, A, T,<br>G, E, R, B    |
| Vizia Coordinating Dimmer/Fan Speed Remote Color Change Kit, no LED  | VZKIT-CD | —            | I, W, A, T,<br>G, E, R, B    |
| Vizia Matching Switch Remote Color Change Kit with LED Locator   | VZKIT-MS | —            | I, W, A, T,<br>G, E, R, B    |
| Vizia Coordinating Switch Remote Color Change Kit, no LED  | VZKIT-CS | —            | I, W, A, T,<br>G, E, R, B    |

† Contractor Packs are available in White (-W), Almond (-A) or Light Almond (-T), packaged 10 pieces/box. To order, add suffix -ML to catalog number followed by color designation. Ex.: VZ00R-ML\*

Note: Sharing a neutral wire may cause flickering. Connect all dimmers to the same phase or run a separate neutral to each phase. Consult Leviton Techline if problems persist. Digital Lighting and Fan Speed Controls are polarity sensitive devices. Always follow the wiring instructions included with each device.

SPECIFICATIONS AND FEATURES

- Can be used with all Vizia Dimmers, Switches and Fan Speed controls
- Streamlined Decora styling complements any interior, adds a "family look" when ganged with any Decora device
- Push pad returns to neutral regardless of load status
- Green LED locator light illuminates when lights are OFF (matching remotes only)
- Provides multi-location full range control when used with Vizia Dimmers/Fan Speed Controls
- Three color options in each box eliminates the need to stock a large variety of devices
- Color Change Kits are available in a wide range of colors, making it easy and economical to change decorating schemes
- Fits in standard wallbox – units may be ganged
- Matching Remotes have LEDs and provide control from up to 5 different locations (neutral wire required)
- Coordinating Remotes provide control from up to 10 different locations

TESTING AND CODE COMPLIANCE

- UL Listed (File #E-31373)
- CSA Certified (File #M/C 152105)
- Backed by a Limited Five-Year Warranty

MATERIAL CHARACTERISTICS

Environmental: Flammability UL-94, V2 Rating  
 Operating Temperature: 32°F to 130°F

\*COLOR

Vizia Remotes come packaged with three colors. Controls with suffix (-X) include White, Ivory and Almond. Controls with suffix (-Z) include White, Ivory and Light Almond. Color Change Kits available in the following colors: Ivory (I), White (-W), Almond (-A), Light Almond (-T), Gray (-G), Black (-E), Red (-R) and Brown (-B).

Use Leviton Power Extenders to extend the load capacity of box-mounted dimmers. Leviton Power Extenders are available for incandescent, magnetic low-voltage, electronic low-voltage, Advance Mark 10® Powerline fluorescent dimming ballasts or equivalents, and 0-10 VDC dimmable fluorescent ballasts such as Advance Mark 7® 0-10V, OSRAM Sylvania Quicktronic Helios or equivalent ballasts.



### Vizia RF Scene Capable Dimmers

All Vizia RF dimmers provide single-pole (one-location) and 3-way (multi-location) control when used with a Vizia coordinating (no LED) remote unit.

| DESCRIPTION  | CAT. NO. | RATING  | COLOR*<br>X=I+W+A         |
|--|----------|---|---------------------------|
| Vizia RF Incandescent Scene Capable Dimmer with LED Locator and Brightness Display         | RZI06-1L | 600W  | X                         |
| Vizia RF Incandescent Scene Capable Dimmer with LED Locator and Brightness Display         | RZI10-1L | 1000W   | X                         |
| Vizia RF Magnetic Low-Voltage Scene Capable Dimmer with LED Locator and Brightness Display | RZM10-1L | 1000VA  | X                         |
| Vizia RF ON/OFF Scene Capable Switch with LED Locator                                      | RZS15-1L | 15A<br>1800W Resistive<br>1800W Incandescent<br>1800VA Fluorescent<br>1800VA Inductive<br>1/2 HP Motor (9.8A) | X                         |
| Vizia RF Matching Dimmer Color Change Kit  | VZKIT-MD |   | I, W, A, T,<br>G, E, R, B |
| Vizia RF Matching Switch Color Change Kit with LED Locator and Brightness Display          | VZKIT-MS |   | I, W, A, T,<br>G, E, R, B |

See Page C20 for Vizia Non-RF remotes. See Page C22 for Vizia RF remotes.

### Vizia RF Plug-In Modules

| DESCRIPTION  | CAT. NO. | RATING  | COLOR* |
|--|----------|---|--------|
| Vizia RF Scene Capable Plug-In Lamp Dimming Module                 | RZP03-1L | 300W  | White  |
| Vizia RF Scene Capable Plug-In Appliance Module                    | RZP15-1L | 15A<br>1800W Resistive<br>1800W Incandescent<br>1800VA Fluorescent<br>1800VA Inductive<br>1/2 HP motor loads<br>@ 120V AC, 60Hz | White  |
| Vizia RF Plug-In Serial Interface Module ASCII to Z-Wave Interface | RZCOP-1L | —   | White  |



RZI06-1LX



RZM10-1LX

#### SPECIFICATIONS AND FEATURES

##### Vizia RF Scene Capable Dimmers

- Scene capable, wireless control via RF (Z-Wave® technology)
- Digital circuitry provides soft ON/fade OFF light switching and smooth full-range changes in brightness level for extended bulb life
- Push pad always returns to neutral position regardless of load status
- Compatible with Decora Plus screwless wallplates and Decora wallplates
- Complements Vizia Lighting Controls (see page C19 for more information)
- Color change kits are available to allow fast color changeover and simplify stocking inventory
- Vizia Six-Pack: Three color choices along with single pole or 3-way control provide 6 different options in each box, eliminating the need to stock a large variety of devices
- Easy adjustments for minimum brightness level, Dim-Lock and selectable fade rates
- Lights turn ON at the last selected brightness level or at user-programmable Dim-Lock setting
- Manual and remote ON/OFF/DIM/BRIGHT control of connected Dimmer
- ON/OFF/DIM/BRIGHT scene and zone control capability
- Responds to Vizia RF Controllers as well as selected Z-Wave certified controllers from other manufacturers
- Works with the Vizia RF 1-Zone Controller/Matching Dimmer Remote (RZCZ1-1L) for RF virtual 3-way control without the need for traditional 3-way wiring or for a dedicated traveler wire
- Works with Vizia™ (non-RF) Coordinating Remotes (VZ00R-10) for hardwired 3-way or up to 10-location control

- Enhanced 2-way communication
- Easy to clean, high gloss finish complements a wide range of décors
- DIM/BRIGHT bar allows user to select brightness level when lights are ON or OFF— green LED displays brightness level
- Power-failure memory allows light levels to return to the same levels set prior to power interruption
- RFI filtering for radio, audio and video equipment
- UL required air gap switch disconnects power from load locally. It is concealed during normal operation and is accessible without removing the wallplate

##### Vizia RF Scene Capable Plug-in Appliance Module (RZP15)

- Provides 15A-120VAC NEMA 5-15R grounding receptacle for use with a wide variety of lamps and appliances
- Provides Manual ON/OFF switching of plug-in load and remote scene and zone control compatibility

- Enhanced 2-way communication

##### Vizia RF Scene Capable Plug-in Lamp Dimming Module (RZP03)

- Provides NEMA polarized 1-15R 2-blade receptacle for use with incandescent lamps
- Load Sensing feature allows lamp to be turned ON manually using the lamp's switch or the integrated ON/OFF button
- Provides manual and remote ON/OFF/DIM/BRIGHT control of plug-in lamps
- Enhanced 2-way communication
- Provides ON/OFF/DIM/BRIGHT scene and zone control capability

#### TESTING AND CODE COMPLIANCE

- UL Listed (File #E-66800)
- CSA Certified (File #152105)
- NOM Certified (#057)
- Complies with FCC Part 15, Class B
- Z-Wave Certified
- Backed by a Limited Five-Year Warranty

#### \*COLOR

Vizia-RF Lighting Controls come packaged with three colors. Controls with suffix (-X) include White, Ivory and Almond. Color Change Kits available in the following colors: Ivory (-I), White (-W), Almond (-A), Light Almond (-T), Gray (-G), Black (-E), Red (-R) and Brown (-B).

#### MATERIAL CHARACTERISTICS

Environmental: Flammability UL-94, V2 Rating  
Operating Temperature: 32°F to 130°F



Vizia RF™ Remotes for Use with Vizia RF Scene-Capable Dimmers and Switches

Vizia RF™ Remotes

| DESCRIPTION  | CAT. NO.  | RATING                        | COLOR*<br>X=I+W+A<br>Z=I+W+T |
|--|-----------|-------------------------------|------------------------------|
| Vizia RF 1-Button Zone Dimming Controller  | RZCZ1-1L  | No load rating – 120V AC 60Hz | X                            |
| Vizia RF 4-Button Zone Controller  | RZCZ4-1L  | No load rating – 120V AC 60Hz | X                            |
| Vizia RF 1-Button Scene Controller   | RZCS1-1L  | No load rating – 120V AC 60Hz | X                            |
| Vizia RF 4-Button Scene Controller   | RZCS4-1L  | No load rating – 120V AC 60Hz | X                            |
| Vizia RF Handheld Remote Controller Programmer/Timer (Internal Astronomical Clock) | RZCPG-OSG | 2 AA batteries (Included)     | Silver                       |
| Vizia RF Handheld Remote Controller Programmer (Basic)                             | RZCPG-BSG | 2 AA batteries (Included)     | Silver                       |
| Vizia RF IR Handheld Remote Controller   | RZMR1-OSG | 2 AA batteries (Included)     | Silver                       |
| 4-Button Scene Controller Color Change Kit with LED Locator                        | VZKIT-S4  | —                             | I, W, A                      |
| 4-Button Zone Controller Color Change Kit with LED Locator                         | VZKIT-Z4  | —                             | I, W, A                      |
| Matching Dimmer Color Change Kit with LED Locator and Brightness Display for RZCZ1 | VZKIT-MD  | —                             | I, W, A                      |
| Matching Switch Color Change Kit with LED Locator for RZCS1                        | VZKIT-MS  | —                             | I, W, A                      |
| Coordinating Dimmer Remote for up to 10 location applications; neutral required    | VZ00R-10  | No load rating – 120V AC 60Hz | X, Z                         |



RZCS1-1LX

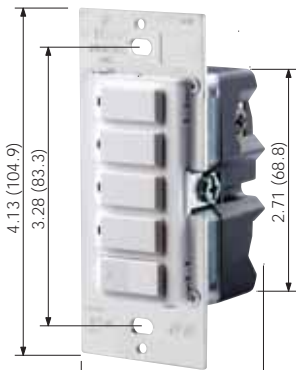

RZCS4-1LX



RZCPG-OSG

SPECIFICATIONS AND FEATURES

Vizia RF Controllers

- Compatible with Decora Plus screwless wallplates and Decora wallplates
- Enhanced 2-way communication
- Popular Vizia-style push pad on 1-button controllers blend seamlessly with other devices in the Vizia collection

Vizia RF 1-Button Scene Controller (RZCS1-1L)

- Provides remote ON/OFF control of one scene
- Virtual 3-way and multi-location remote ON/OFF control of selected Vizia RF switches without the need for traditional 3-way wiring or a dedicated traveler wire
- Controller fits in standard wall box and utilizes household 120VAC 60Hz wiring (when neutral wire is present) for easy "no-new-wires" installation
- Green LED illuminates to indicate controlled scene. When acting as a matching remote, LED will illuminate when the load is OFF

Vizia RF 1-Button Zone Dimming Controller (RZCZ1-1L)

- Provides remote ON/OFF/DIM/BRIGHT control of one Vizia RF Dimmer
- Virtual 3-way remote dimming control of selected Vizia RF dimmers without the need for traditional 3-way wiring or a dedicated traveler wire
- Controller fits in standard wall box and utilizes existing 120VAC 60Hz wiring to replace a regular switch (when neutral wire is present) for easy "no-new-wires" installation
- Green LED locator illuminates to indicate controlled zone or load is OFF

Vizia RF 4-Button Scene (RZCS4-1L) or Zone (RZCZ4-1L) Controllers

- Provides remote ON/OFF/DIM/BRIGHT control of four scenes (RZCS4-1L) or zones/areas (RZCZ4-1L) of selected Vizia RF devices
- Integrated infrared (IR) port
- Controller fits in standard wall box and utilizes existing 120VAC 60Hz wiring to replace a regular switch (when neutral wire is present) for easy "no-new-wires" installation
- Green LED illuminates when the assigned scene (RZCS4-1L) or zone/area (RZCZ4-1L) is ACTIVE

Vizia RF Handheld Remotes

RZCPG

- Primary device for creating and programming a Vizia RF system
- Provides user level control of up to 128 devices
- Can operate as a secondary remote control
- Provides remote control (ON/OFF/DIM/BRIGHT/ SCENE/ZONE) of all devices in the Vizia RF network

RZMR1

- Works with Vizia RF IR compatible controllers
- Controls four scenes and four zones

TESTING AND CODE COMPLIANCE

- UL Listed (File #-E-66800)
- CSA Certified (File #152105)
- NOM Certified (#057)
- Complies with FCC Part 15, Class B
- Z-Wave Certified
- Backed by a Limited Five-Year Warranty

Handheld Remotes

- Complies with FCC Part 15, Class B
- Z-Wave Certified

\*COLOR

Vizia-RF Home Controls come packaged with three colors. Controls with suffix (-X) include White, Ivory and Almond. Controls with suffix (-Z) include White, Ivory and Light Almond. Color Change Kits available in the following colors: Ivory (I), White (-W), Almond (-A).

MATERIAL CHARACTERISTICS

Environmental: Flammability UL-94, V2 Rating  
Operating Temperature: 32°F to 131°F

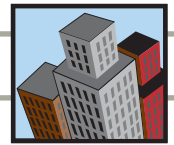

### Mural Digital Controls

All Mural controls provide single-pole (one location) or 3-way (multi-location) control when used with Multi-Remote unit.

#### Mural Digital Controls 120V AC 60Hz Only

| DESCRIPTION   | CAT. NO. | RATING         | COLOR*                        |
|---|----------|----------------|-------------------------------|
| Mural Incandescent Dimmer with LED Locator and Brightness Display   | MDI06-1L | 600W           | I, W, A<br>(G, E, B with Kit) |
| Mural Incandescent Dimmer with LED Locator and Brightness Display   | MDI10-1L | 1000W          | I, W, A<br>(G, E, B with Kit) |
| Mural Magnetic Low-Voltage Dimmer with LED Locator and Brightness Display   | MDM06-1L | 600VA (450W)   | I, W, A<br>(G, E, B with Kit) |
| Mural Magnetic Low-Voltage Dimmer with LED Locator and Brightness Display   | MDM10-1L | 1000VA (800W)  | I, W, A<br>(G, E, B with Kit) |
| Mural Electronic Low-Voltage Dimmer with LED Locator and Brightness Display   | MDE03-1L | 350VA (280W)   | W<br>(I, A, G, E, B with Kit) |
| Mural Quiet Fan Speed Control with LED Locator and Brightness Display; neutral required                                   | MDF01-1L | 1.5A           | I, W, A<br>(G, E, B with Kit) |
| Coordinating Remote Unit to Dimmers/<br>Fan Speed Controls for 3-way or up to<br>10 locations, no LED                     | MS00R-10 | No load rating | I, W, A<br>(G, E with Kit)    |
| Coordinating Remote Unit to Electronic<br>Low-Voltage Dimmer for 3-way or up to<br>10 locations, no LED; neutral required | MSE0R-10 | No load rating | W<br>(I, A, G, E with Kit)    |

#### Color Change Kits for Mural Controls

| DESCRIPTION   | CAT. NO. | COLOR*           |
|---|----------|------------------|
| Mural Dimmer Color Change Kit with LED Locator and Brightness Display | DRKDD-1L | I, W, A, G, E, B |
| Remote Color Change Kit, no LED Locator or Display                    | DRKOR-00 | I, W, A, G, E, B |

*Digital Lighting and Fan Speed Controls are polarity sensitive devices. Always follow the wiring instructions included with each device.*

See Page C7 for more information on Leviton Power Extenders

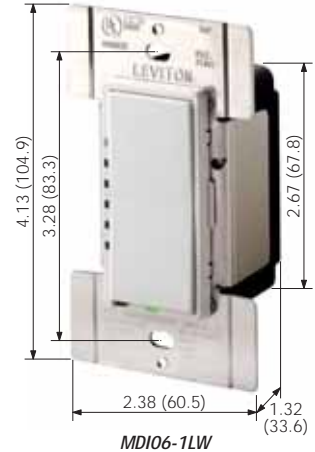

#### SPECIFICATIONS AND FEATURES

- Provides single-pole (one-location) or multi-location full range dimming when used with MS00R remote unit
- Streamlined popular Decora styling enhances any interior and adds a family look when ganged with other Decora devices
- Smooth ON/OFF and DIM/BRIGHT Decora rocker action provides ease of operation for people of all ages and abilities
- Digital circuitry provides Soft-ON/Fade-OFF switching for an eye-pleasing effect and extended lamp life
- Compatible with DecoraPLUS screwless and Decora wallplates
- Locator LED illuminated when lights are OFF
- Color change kits available in a wide range of choices, making it easy and economical to change decorating schemes
- Color change kits simplify inventory for distributors and contractors who can offer a complete range of colors without stocking a different device for each one
- Protected memory and voltage compensation maintain light levels after short-term power outages and during minor power fluctuations

- Coordinates with Leviton's DHC line of products
- Green LED display alongside rocker indicates selected brightness level on MD models
- Built-in radio/TV interference filter
- Air gap switch completely disconnects power to unit for bulb changing or removal from service

#### TESTING AND CODE COMPLIANCE

- UL Listed (File #E-31373)
- CSA Certified (File #LR-3413)
- Backed by a Limited Five-Year Warranty

#### \*COLOR

To order colors, add suffix to basic catalog number. Colors in parentheses must be ordered as Color Change Kits. Color suffixes are: Ivory (-I), White (-W), Almond (-A), Gray (-G), Black (-E) and Brown (-B).

#### MATERIAL CHARACTERISTICS

Environmental: Flammability UL-94, V2 Rating  
Operating Temperature: 32°F to 130°F

Use Leviton Power Extenders to extend the load capacity of box-mounted dimmers. Leviton Power Extenders are available for incandescent, magnetic low-voltage, electronic low-voltage, Advance Mark 10® Powerline fluorescent dimming ballasts or equivalents, and 0–10 VDC dimmable fluorescent ballasts such as Advance Mark 7® 0–10V, OSRAM Sylvania Quicktronic Heliios or equivalent ballasts.



Commercial Grade Lighting Controls

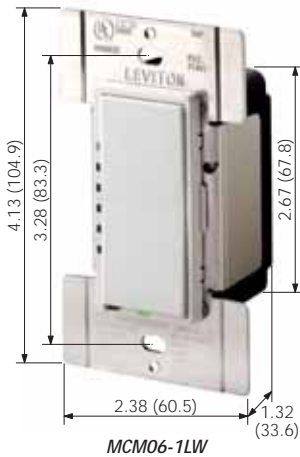

MCM06-1LW

Mural Scene Capable Digital Dimmers

Compatible with Scene Controller and Scene Enhancement Products — See page C25.

Mural Scene Capable Digital Dimmer 120V AC 60Hz Only

| DESCRIPTION  | CAT. NO. | RATING   | COLOR*                        |
|--|----------|--|-------------------------------|
| Mural Scene Capable Incandescent/Magnetic Low-Voltage Dimmer with LED Locator and Brightness Display                                   | MCM06-1L | 600W Incandescent<br>600VA Magnetic<br>Low Voltage   | I, W, A<br>(G, E, B with Kit) |
| Mural Scene Capable Incandescent/Magnetic Low-Voltage Dimmer with LED Locator and Brightness Display                                   | MCM10-1L | 1000W Incandescent<br>1000VA Magnetic<br>Low Voltage | I, W, A<br>(G, E, B with Kit) |
| Mural Scene Capable Preset Fluorescent Dimmer for Mark 10® Powerline Ballast with LED Locator and Brightness Display; neutral required | MCX10-1L | 1000VA   | W<br>(I, A, G, E, B with Kit) |
| Color Change Kits for Mural MC Scene Capable Dimmer  | DRKDD-1L | —  | I, W, A, G, E, B              |

See Page C7 for more information on Leviton Power Extenders

*Note: Sharing a neutral wire may cause flickering. Connect all dimmers to the same phase or run a separate neutral to each phase. Consult Leviton Techline if problems persist. Digital Lighting and Fan Speed Controls are polarity sensitive devices. Always follow the wiring instructions included with each device.*

**CAUTION ON RETROFITS:** When retrofitting Mark 10® Powerline dimming ballasts into fixtures that originally had Instant Start ballasts, the sockets MUST be replaced with Rapid Start sockets to allow proper dimmer operation and prevent damage to the dimming ballast. Refer to the instructions provided with the ballast and the Leviton dimmer.

SPECIFICATIONS AND FEATURES

- Responds to lighting level commands sent by the Cat. No. MN00C-1L Scene Controller (See Page C25). Users can program the desired lighting level for individual Mural Scene Dimmers in up to seven distinct lighting scenes, which are easily accessed by one or more Scene Controllers
- Smooth ON/OFF and DIM/BRIGHT Decora rocker action provides ease of operation for people of all ages and abilities
- Local DIM/BRIGHT adjustment on individual scene dimmers will not affect programmed scene lighting settings
- Compatible with Scene Enhancement Products including Contact Closure Interface, Infrared Hand-Held Remote and Infrared Receiver, and one-way and two-way Signal Repeater
- Streamlined, popular Decora styling enhances any interior and adds a “family look” when ganged with any Decora device
- Digital circuitry provides Soft-ON/Fade-OFF operation for an eye-pleasing effect and prolonged lamp life
- Green LED display alongside rocker indicates selected brightness level
- Locator LED illuminates when lights are OFF
- Color change kits available in a wide range of choices, making it easy and economical to change decorating schemes

- Color change kits simplify inventory for distributors and contractors who can offer a complete range of colors without stocking a different device for each one
- Minimum Brightness Adjustment sets comfortable minimum light level
- Protected memory and voltage compensation maintain light levels after power outages and during minor power fluctuations
- Built-in radio/TV interference filter
- Air-gap switch completely disconnects power to unit for bulb changing or removal from service

TESTING AND CODE COMPLIANCE

- UL Listed (File #E-31373)
- CSA Certified (File #LR-3413)
- Backed by a Limited Five-Year warranty

\*COLOR

To order colors, add suffix to basic catalog number. Colors in parentheses must be ordered as Color Change Kits. Color suffixes are: Ivory (-I), White (-W), Almond (-A), Gray (-G), Black (-E) and Brown (-B).

MATERIAL CHARACTERISTICS

Environmental: Flammability UL-94, V2 Rating  
Operating Temperature: 32°F to 130°F

Use Leviton Power Extenders to extend the load capacity of box-mounted dimmers. Leviton Power Extenders are available for incandescent, magnetic low-voltage, electronic low-voltage, Advance Mark 10® Powerline fluorescent dimming ballasts or equivalents, and 0–10 VDC dimmable fluorescent ballasts such as Advance Mark 7® 0–10V, OSRAM Sylvania Quicktronic Helios or equivalent ballasts.





## Mural Scene Controller and Accessories

### Scene Controller for Mural Scene Capable Lighting Controls

| DESCRIPTION  | CAT. NO. | RATING  | COLOR*   |
|--|----------|---|--|
| Mural Scene Controller:<br>7 Lighting-Scene Buttons plus<br>OFF and Group DIM/BRIGHT Buttons | MN00C-1L | No load rating,<br>use with 120V<br>Mural Scene<br>Dimmers only | White, for<br>other colors<br>use Color<br>Change Kits |
| Color Change Kits with Text for Mural<br>MN00C-1L Scene Controller                           | DCKS7-00 | —   | I, W, A, G, E  |
| Color Change Kit with Customizable Labels<br>for Mural Scene Controller                      | DCKS7-0C | —   | I, W, A, G, E  |

### Scene Enhancement Products—

### Compatible with Mural Scene Capable Lighting Controls

| DESCRIPTION  | CAT. NO.                | RATING                    | COLOR*   |
|--|-------------------------|---------------------------|--|
| Signal Repeater—Must be used if<br>controlling lighting on more<br>than one circuit. One-Way and<br>Two-Way versions available                               | 17100-1WY,<br>17100-2WY | No load rating<br>120V AC | —  |
| Contact Closure Interface—Allows control<br>of Mural Scene Capable devices from<br>home theater and building control systems<br>via momentary contact inputs | 177BI                   | No load rating<br>120V AC | (Non-color item)                                   |
| Infrared Receiver available with<br>Wall Mount and Ceiling Fan Bezels  | 177IR-IWA               | No load rating<br>120V AC | Supplied with<br>Ivory, White and<br>Almond bezels |
| Hand-Held Infrared Remote Control:<br>with 4 Scene Buttons plus OFF  | 177RC                   | No load rating<br>120V AC | E  |

Note: A Repeater must be used on any installation that uses more than one circuit.



MN00C-1LW

#### SPECIFICATIONS AND FEATURES

##### Scene Controller

- Sends commands for up to seven distinct scenes to individual Mural Scene Capable Dimmers
- Multiple Scene Controllers can be used for multi-point access to scenes.
- Provides OFF button and two arrow-shaped buttons for group Dim and Bright control
- Local DIM/BRIGHT adjustment on individual scene dimmers will not affect programmed scene settings
- Green LED display for each scene button indicates selected scene
- Fast, easy scene programming: Press scene button on MN00C, adjust individual level on Mural Scene Capable dimmer, press program button on dimmer
- Controls up to 20 scene dimmers per circuit
- Streamlined, popular Decora styling enhances any interior and adds a "family look" when ganged with any Decora device
- Use Decora Plus or any standard Decora wallplate
- Color change kits are available in a wide range of colors making it easy and economical to change decorating schemes
- Internal MOV for surge protection

- Customized lettering for each scene button available (maximum of 8 characters and spaces) — see your Leviton representative for ordering information

##### Scene Enhancement Products

- Two-Way Repeater provides scene control communication link between branch circuits. One-Way Repeater allows the creation of separate scene control zones

#### TESTING AND CODE COMPLIANCE

- UL Listed (File #E-31373 – Cat. Nos. MN00C and 177IR; File #E-66800 – Cat. Nos. 17100-1WY and 17100-2WY; File #E-600800 – Cat. No. 177BI)
- CSA Certified (File #LR-3413)
- Backed by a Limited Five-Year Warranty

#### \*COLOR

Basic Cat. No. denotes White device. For other colors, order Color Change Kits and add suffix as follows: Ivory (-I), White (-W), Almond (-A), Gray (-G) and Black (-E).

#### MATERIAL CHARACTERISTICS

Environmental: Flammability UL-94, V2 Rating  
Operating Temperature: 32°F to 130°F



# TOUCH LIGHTING CONTROL FEATURES

## Commercial Grade Lighting Controls

### Touch Lighting Controls

The Leviton Touch series includes two full-range dimming lines that use digital touch pad technology to enable dimming and switching with a touch of a finger: True Touch™ and ToggleTouch™.

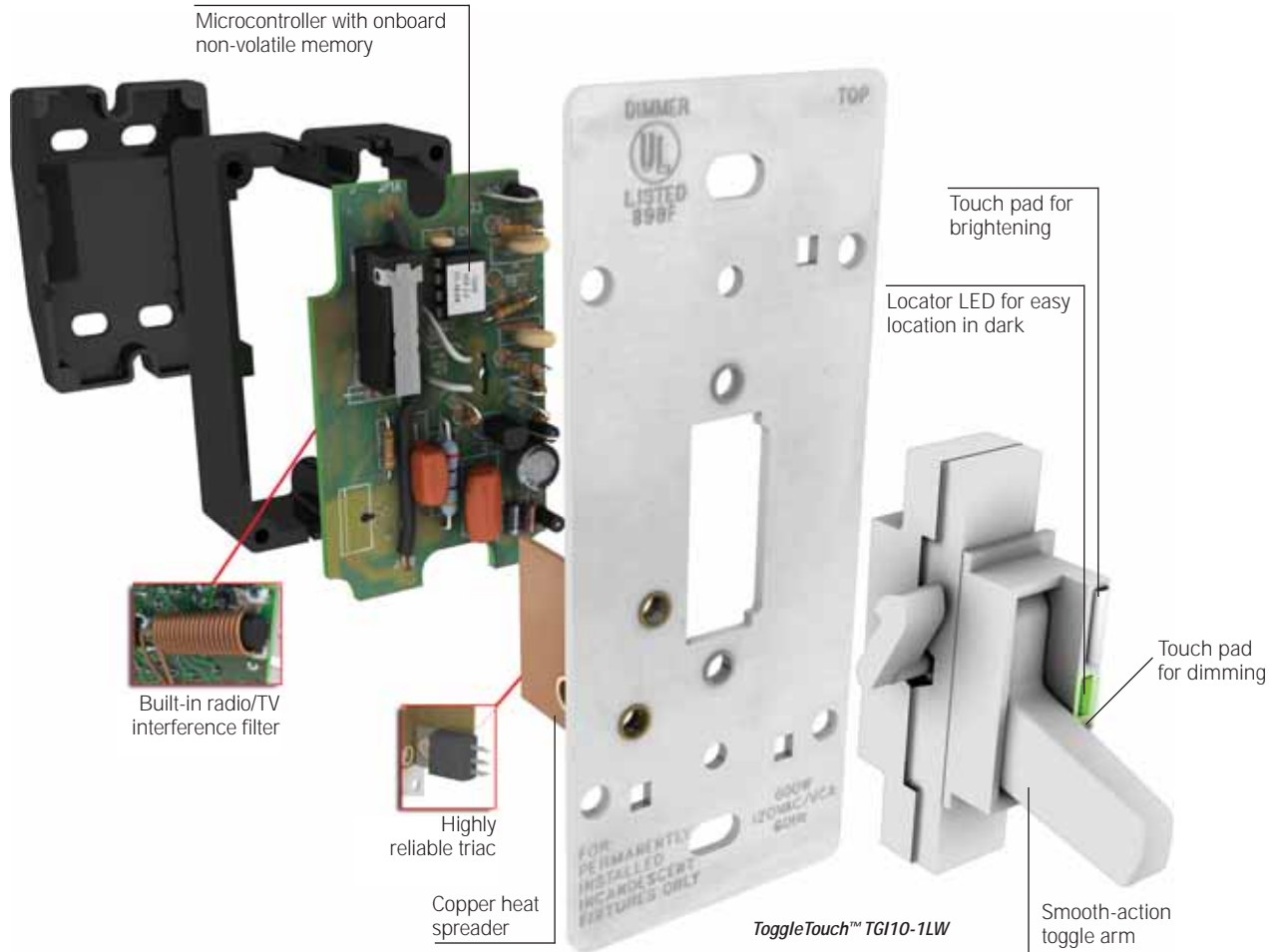

#### Features and Benefits

- Preset dimmers incorporate touchpad technology
- Digital circuitry provides eye-pleasing Soft-ON/ Fade-OFF that extends lamp life (most models)
- Single- and multi-location control available
- Wide range of colors coordinates with any décor
- UL and CSA Listed
- Backed by a Limited Five-Year Warranty

#### LEVITON TOUCH DIMMERS FOR FULL-RANGE DIMMING



**True Touch™ Dimmer**  
Decora-style digital touch dimmer. Provides fingertip full-range single-pole and multi-location dimming. Color change kits available. **T110-1LX shown**



**ToggleTouch™ Dimmer**  
Unique design features toggle-style ON/OFF switch with bright and dim digital touch pads alongside toggle and LED locator light. **TGI10-1LW shown**





### True Touch Digital Dimmers

All True Touch dimmers provide single-pole (one location) or 3-way (multi-location) control when used with TrueTouch Remote.

#### True Touch Digital Dimmer 120V AC 60Hz

| DESCRIPTION  | CAT. NO. | RATING         | COLOR*                         |
|--|----------|----------------|--------------------------------|
| True Touch Incandescent Dimmer with LED Locator  | TTI06-1L | 600W           | X, Z, GS<br>X=I+W+A<br>Z=I+W+T |
| True Touch Incandescent Dimmer with LED Locator  | TTI10-1L | 1000W          | X, Z, GS                       |
| True Touch Magnetic Low-Voltage Dimmer with LED Locator                                | TTM10-1L | 1000VA (800W)  | X, Z, GS                       |
| Coordinating Remote Unit to True Touch Dimmers for 3-way or up to 10 locations, no LED | TT00R-1  | No load rating | X, Z, GS                       |
| True Touch Dimmer Color Change Kit   | TTKIT    | —              | I, W, A, T, GY, E, WS, GI, BG  |
| True Touch Remote Dimmer Color Change Kit  | TTKTR    | —              | I, W, A, T, GY, E, WS, GI, BG  |

See Page C7 for more information on Leviton Power Extenders

*Digital Lighting and Fan Speed Controls are polarity sensitive devices. Always follow the wiring instructions included with each device. They can be used in conventional 3-way and 4-way wiring circuits only when the Control is properly connected to the load as indicated by the device's wiring instructions.*



TTI10-1LX

#### SPECIFICATIONS AND FEATURES

- Provides fingertip ease of use and precise adjustment of lighting levels. Simple one-touch for ON at preset level, or again for OFF. Touch and hold for BRIGHT/DIM lighting control
- Provides single-pole (one-location) and multi-location full range dimming when used with TT00R remote dimmer
- Attractive Decora styling blends with any interior
- Digital circuitry provides Soft-ON/Fade-OFF switching for an eye-pleasing effect and extended lamp life
- Compatible with DecoraPLUS screwless and Decora wallplates
- Locator LED is illuminated when lights are OFF (no LED on Remote Unit)
- Color change kits offered in a wide range of colors, making it easy and economical to change decorating schemes
- Protected memory maintains light levels after short-term power outages and during minor power fluctuations
- Built-in radio/TV interference filter
- Air gap switch completely disconnects power to unit for bulb changing or removal from service

#### TESTING AND CODE COMPLIANCE

- UL Listed (File #E-31373)
- CSA Certified (File #LR-3413)
- Backed by a Limited Five-Year Warranty

#### \*COLOR

TTI06, TTI10 and TTM10 products come packaged with three colors. Products with suffix (-X) include White, Ivory and Almond; products with suffix (-Z) include White, Ivory and Light Almond; products with suffix (-GS) include White, Gold and Silver. Color change kits available in the following colors: White (-W), Ivory (-I), Almond (-A), Light Almond (-T), Gray (-G), Black (-E), White Frame/Silver Touch (-WS), Ivory Frame/Gold Touch (-GI) and Brown Frame/Gold Touch (-BG).

#### MATERIAL CHARACTERISTICS

Environmental: Flammability UL-94, V2 Rating  
Operating Temperature: 32°F to 130°F

Use Leviton Power Extenders to extend the load capacity of box-mounted dimmers. Leviton Power Extenders are available for incandescent, magnetic low-voltage, electronic low-voltage, Advance Mark 10® Powerline fluorescent dimming ballasts or equivalents, and 0–10 VDC dimmable fluorescent ballasts such as Advance Mark 7® 0–10V, OSRAM Sylvania Quicktronic Helios or equivalent ballasts.



Commercial Grade Lighting Controls

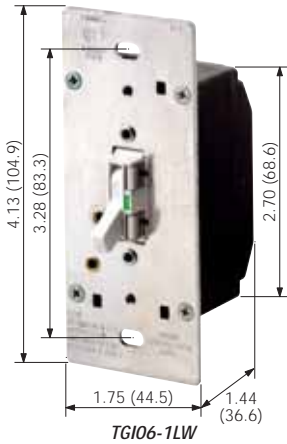

ToggleTouch Digital Dimmers

All ToggleTouch Preset Dimmers provide single-pole (one-location) or 3-way (multi-location) control when used with a 3-way switch, except where noted.

ToggleTouch Digital Touch Dimmer with LED Locator 120V AC 60Hz  

| DESCRIPTION                             | CAT. NO. | RATING        | COLOR*        |
|---|----------|---------------|---------------|
| ToggleTouch Incandescent Dimmer         | TGI06-1L | 600W          | W, I, A, T, B |
| ToggleTouch Incandescent Dimmer         | TGI10-1L | 1000W         | W, I, A, T, G |
| ToggleTouch Magnetic Low-Voltage Dimmer | TGM10-1L | 1000VA (800W) | W, I, A, T, G |

Note: Leviton does not recommend using the ToggleTouch Dimmer with metal wallplates.

See Page C7 for more information on Leviton Power Extenders

Digital Lighting and Fan Speed Controls are polarity sensitive devices. Always follow the wiring instructions included with each device. They can be used in conventional 3-way and 4-way wiring circuits only when the Control is properly connected to the load as indicated by the device's wiring instructions.

SPECIFICATIONS AND FEATURES

- Provides a unique combination of toggle-style ON/OFF switching and digital touch pad technology
- Designed for smooth ON/OFF toggle action and fingertip touch dimming control that's easy to operate
- Provides single-pole (one-location) and 3-way (multi-location) control when used with a 3-way switch
- Touch pads match color of toggle switch
- Fits and gangs perfectly with Leviton standard toggle wallplates and all Leviton toggle switches
- Provides preset dimming with Soft-ON feature (does not provide Fade-OFF)
- Locator LED is illuminated when lights are OFF
- Protected memory during temporary power failures ensures that ToggleTouch will retain last setting before power interruption
- Built-in radio/TV interference filter

TESTING AND CODE COMPLIANCE

- UL Listed (File #E-31373)
- CSA Certified (File #LR-3413)
- Backed by a Limited Five-Year Warranty

\*COLOR

To order colors, add suffix to catalog number as follows: Ivory (-I), White (-W), Almond (-A), Light Almond (-T), Gray (-G) and Brown (-B).

MATERIAL CHARACTERISTICS

Environmental: Flammability UL-94, V2 Rating  
Operating Temperature: 32°F to 130°F

Use Leviton Power Extenders to extend the load capacity of box-mounted dimmers. Leviton Power Extenders are available for incandescent, magnetic low-voltage, electronic low-voltage, Advance Mark 10® Powerline fluorescent dimming ballasts or equivalents, and 0–10 VDC dimmable fluorescent ballasts such as Advance Mark 7® 0–10V, OSRAM Sylvania Quicktronic Helios or equivalent ballasts.

# TRADITIONAL CONTROL FEATURES

## Commercial and Residential Grade Controls

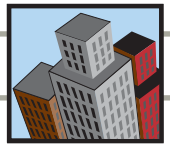

### Traditional Controls

Leviton offers a full line of slide, rotary and toggle dimmers and fan speed controls ideally suited to traditional interiors. The line includes IllumaTech™, SureSlide™, and Trimatron® brand devices as well as a number of specialty lighting devices. Leviton traditional controls are offered in a variety of colors.

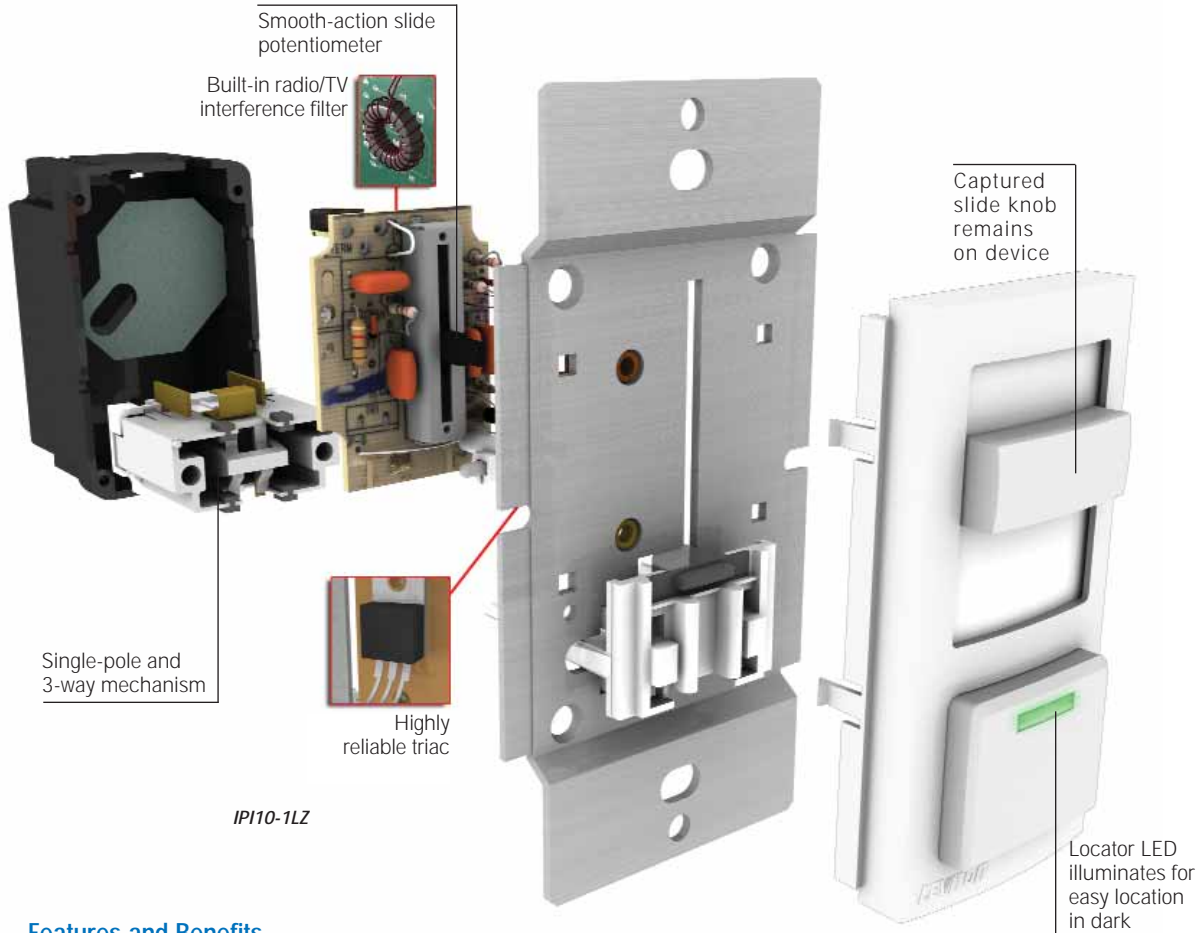

IPI10-1LZ

### Features and Benefits

- Features slide, rotary and toggle style dimmers
- Most with full-range dimming and built-in radio/TV interference filter
- Single- and multi-location control available
- UL and CSA Listed
- Backed by a Limited Five-Year Warranty

### TRADITIONAL STYLE SLIDE AND ROTARY LIGHTING CONTROLS



**IllumaTech™ Slide and Rotary Dimmers**  
Decora-style dimmer with full-range slide or rotary dimming for single- or multi-location dimming control. Color change kits available.  
*IPI06-1LZ and RPI06-1LZ shown*

**SureSlide™ Slide Controls**  
Smooth-action slide control for easy, precise operation. Slim design ideal for multi-gang installations. Preset and slide-to-off versions.  
*6633-PLW shown*

**Trimatron® Rotary Controls**  
Ultra-compact, full-range rotary dimmers.  
*6681-W shown*

**Specialty Lighting Controls**  
Specialty dimmers, sockets and switches. Emergency switch flashes lights on and off. Lamp-cord and 4-step dimmers also available.  
*911-W shown*



Commercial Grade Controls

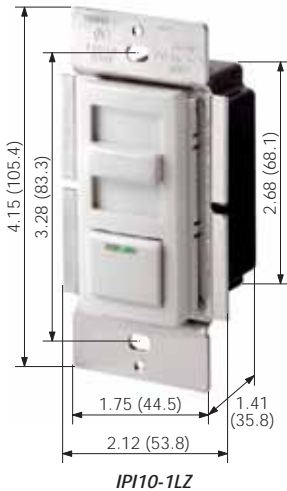

IllumaTech Preset Slide Controls

All IllumaTech Preset Dimmers provide single-pole (one-location) or 3-way (multi-location) control when used with a 3-way switch.

IllumaTech Slide Controls—Single Pole and 3-Way  

| DESCRIPTION  | CAT. NO. | RATING  | COLOR*                    |
|--|----------|---|---------------------------|
| IllumaTech Incandescent Dimmer with LED Locator  | IPI06-1L | 600W<br>120V AC 60Hz                                  | X, Z                      |
| IllumaTech Incandescent Dimmer with LED Locator  | IPI10-1L | 1000W<br>120V AC 60Hz                                 | X, Z                      |
| IllumaTech Electronic Low-Voltage Dimmer with LED Locator; neutral required                        | IPE04-1L | 400VA (320W)<br>120V AC 60Hz                          | X, Z                      |
| IllumaTech Magnetic Low-Voltage Dimmer with LED Locator  | IPM06-1L | 600VA (450W)<br>120V AC 60Hz                          | X, Z                      |
| IllumaTech Magnetic Low-Voltage Dimmer with LED Locator  | IPM10-1L | 1000VA (800W)<br>120V AC 60Hz                         | X, Z                      |
| IllumaTech Fluorescent Dimmer for Advance Mark 7® 0-10V Ballast with LED Locator; neutral required | IP710-DL | 1200VA @<br>120V AC 60Hz,<br>1500VA @<br>277V AC 60Hz | X, Z                      |
| IllumaTech Fluorescent Dimmer for Advance Mark 10® Powerline Ballasts, no LED; neutral required    | IPX06-10 | 600VA<br>120V AC 60Hz                                 | X, Z                      |
| IllumaTech Fluorescent Dimmer for Advance Mark 10® Powerline Ballasts, no LED; neutral required    | IPX10-10 | 1000VA<br>120V AC 60Hz                                | X, Z                      |
| IllumaTech Fluorescent Dimmer for Advance Mark 10® Powerline Ballasts, no LED; neutral required    | IPX06-70 | 600VA<br>277V AC 60Hz                                 | X, Z                      |
| IllumaTech Fluorescent Dimmer for Advance Mark 10® Powerline Ballasts, no LED; neutral required    | IPX12-70 | 1200VA<br>277V AC 60Hz                                | X, Z                      |
| IllumaTech Quiet Fan Speed Control with LED Locator; neutral required                              | IPF01-1L | 1.5 Amps<br>120V AC 60Hz                              | X, Z                      |
| IllumaTech Fully variable Fan Speed Control with LED Locator; neutral required                     | IPF05-1L | 5 Amps<br>120V AC 60Hz                                | X, Z                      |
| IllumaTech Color Change Kit with LED Locator   | IPKIT-00 | —   | I, W, A, T,<br>G, E, R, B |
| IllumaTech Color Change Kit, no LED  | IPKIT-0N | —   | I, W, A, T,<br>G, E, R, B |
| IllumaTech Color Change Kit for Fan Speed Control  | IPOFK-00 | —   | I, W, A, T,<br>G, E, R, B |

See Page C7 for more information on Leviton Power Extenders

**Note:** Sharing a neutral wire may cause flickering. Connect all dimmers to the same phase or run a separate neutral to each phase. Consult Leviton Techline if problems persist.

**CAUTION ON RETROFITS:** When retrofitting Mark 10® Powerline dimming ballasts into fixtures that originally had Instant Start ballasts, the sockets MUST be replaced with Rapid Start sockets to allow proper dimmer operation and prevent damage to the dimming ballast. Refer to the instructions provided with the ballast and the Leviton dimmer.

SPECIFICATIONS AND FEATURES

- Fluid slide movement allows fine adjustment of light level with minimum effort
- Captured, wrap-around slide bar stays in place and cannot fall off during use
- Easy-to-use pushbutton switch with conveniently positioned locator LED. Makes the pushbutton easier to find in the dark
- Provide single-pole (one-location) and multi-location lighting control when used with a 3-way switch
- IllumaTech Six-Pack: Three color choices, along with single- or multi-location control provide six different options in each box, eliminating the need to stock a large variety of devices
- Attractive Decora styling blends with any interior
- Compatible with Decora screwless and Decora standard designer wallplates
- Power failure recovery ensures retention of last setting before power interruption
- Built-in radio/TV interference filter
- Quiet 1.5 Amp Fan Speed Controls are ideal for libraries, study rooms and any area where ceiling fan noise could become distracting. Full range 5-amp fan speed controls also available

- Color change kits feature a self-aligning mechanism that automatically connects it to internal slider
- Snap-On Color Change Kits allow color changes on any device, eliminating the need to stock a separate device for every available color

TESTING AND CODE COMPLIANCE

- UL Listed (File #E-31373)
- CSA Certified (File #LR-3413)
- Backed by a Limited Five-Year Warranty

\*COLOR

IllumaTech Preset Controls come packaged with three colors. Controls with suffix (-X) include Ivory, White and Almond; controls with suffix (-Z) include Ivory, White and Light Almond. Color Change Kits available in the following colors: Ivory (-I), White (-W), Almond (-A), Light Almond (-T), Gray (-G), Black (-E), Brown (-B) and Red (-R).

MATERIAL CHARACTERISTICS

Environmental: Flammability UL-94, V2 Rating  
Operating Temperature: 32°F to 130°F

Use Leviton Power Extenders to extend the load capacity of box-mounted dimmers. Leviton Power Extenders are available for incandescent, magnetic low-voltage, electronic low-voltage, Advance Mark 10® Powerline fluorescent dimming ballasts or equivalents, and 0-10 VDC dimmable fluorescent ballasts such as Advance Mark 7® 0-10V, OSRAM Sylvania Quicktronic Helios or equivalent ballasts.



Residential Grade Controls

**IllumaTech Rotary Controls**

All IllumaTech Rotary Controls combine the ease of a traditional rotary dial with the contemporary look of Leviton Decora®.

**IllumaTech Rotary Controls 120V AC 60Hz**

| DESCRIPTION   | CAT. NO.        | RATING                              | COLOR*<br>X=I+W+A<br>Z=I+W+T |
|---|-----------------|-------------------------------------|------------------------------|
| IllumaTech Rotary Incandescent Dimmer, Single-Pole or 3-way, with LED Locator | <b>RPI06-1L</b> | 600W                                | X, Z                         |
| IllumaTech Rotary Incandescent Dimmer, Single-Pole or 3-way, no LED           | <b>RPI06-10</b> | 600W                                | X, Z                         |
| IllumaTech Rotary Quiet Fan Speed Control, Single-Pole, no LED                | <b>RTF01-1L</b> | 1.5A                                | X, Z                         |
| IllumaTech Rotary Quiet Fan Speed Control and Dimmer, Single-Pole, no LED     | <b>RTD01-10</b> | 1.5A<br>Fan Control/<br>300W Dimmer | X, Z                         |

See Page C7 for more information on Leviton Power Extenders



RPI06-1LX

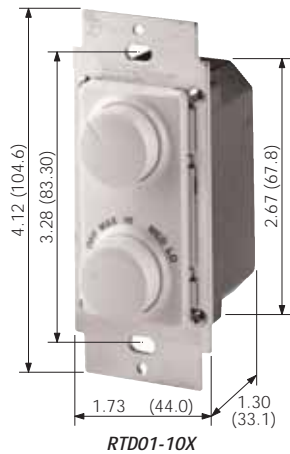

RTD01-10X

**SPECIFICATIONS AND FEATURES**

- Combines traditional rotary dial with contemporary Decora styling
- Dimmers provide single-pole (one-location) and 3-way (multi-location) control when used with a 3-way switch
- IllumaTech Six-Pack: Three color choices, along with single- or 3-way control provide six different options in each box, eliminating the need to stock a large variety of devices
- Dimmers available in illuminated and non-illuminated versions
- Quiet 1.5 Amp Fan Speed Controls are perfect for libraries, study rooms and any area where ceiling fan noise could become distracting
- Dual fan speed control and dimmer is ideal for ceiling fans with built-in light fixtures
- Attractive Decora styling coordinates perfectly with Leviton's complete line of Decora wiring devices
- Compatible with Decora Plus screwless and Decora standard designer wallplates
- Built-in radio/TV interference filter
- Slim, compact housing fits easily into a standard wallbox and is suitable for multi-gang installations

**TESTING AND CODE COMPLIANCE**

- UL Listed (File #E-31373)
- CSA Certified (File #LR-3413)
- Backed by a Limited Five-Year Warranty

**\*COLOR**

IllumaTech Rotary Controls come packaged with three colors. Controls with suffix (-X) include White, Ivory and Almond; controls with suffix (-Z) include Ivory, White and Light Almond.

**MATERIAL CHARACTERISTICS**

Environmental: Flammability UL-94, V2 Rating  
Operating Temperature: 32°F to 130°F

Use Leviton Power Extenders to extend the load capacity of box-mounted dimmers. Leviton Power Extenders are available for incandescent, magnetic low-voltage, electronic low-voltage, Advance Mark 10® Powerline fluorescent dimming ballasts or equivalents, and 0-10 VDC dimmable fluorescent ballasts such as Advance Mark 7® 0-10V, OSRAM Sylvania Quicktronic Helios or equivalent ballasts.



Residential Grade Controls

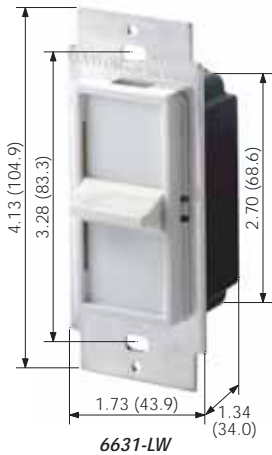

6631-LW

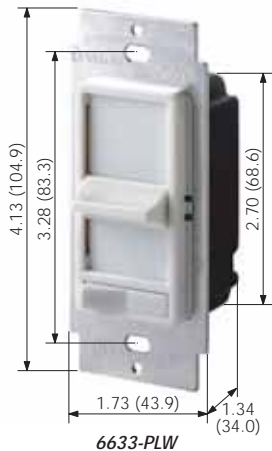

6633-PLW

SureSlide™ Full Range Slide Controls 120V AC 60Hz Only

Incandescent

| DESCRIPTION   | CAT. NO. | RATING                                      | COLOR*     |
|---|----------|---|------------|
| SureSlide Single-Pole Slide-To-Off Dimmer, with optional use LED                              | 6631-L   | 600W  | I, W, A, T |
| SureSlide Single-Pole or 3-Way Dimmer with Preset On/Off Switch, with optional use LED        | 6633-PL  | 600W  | I, W, A, T |
| SureSlide Incandescent or Magnetic Low-Voltage Dual Slide-To-Off Dimmer—two Single-Pole Loads | 6628     | 300W or 300VA per circuit; 600W/600VA Total | I, W, A    |

Low Voltage

| DESCRIPTION  | CAT. NO. | RATING       | COLOR*     |
|--|----------|--------------|------------|
| SureSlide Magnetic Low-Voltage Dimmer, Single-Pole or 3-Way with Preset On/OFF Switch, with optional use LED | 6613-PL  | 600VA (450W) | I, W, A, T |
| SureSlide Electronic Low-Voltage Dimmer, Single-Pole or 3-Way with Preset On/OFF Switch                      | 6615-P   | 300W         | W, T       |

Advance Mark 10® Powerline/Philips Marathon™

| DESCRIPTION  | CAT. NO. | RATING   | COLOR* |
|--|----------|--|--------|
| SureSlide Dimmer for Mark 10 PowerLine/Phillips Marathon Ballasts, Single-Pole | 6668     | Mark 10 500W-120V, Philips Dimmable Marathon—350W-120V | I, W   |

Full-Range Fan Speed Control

| DESCRIPTION                                       | CAT. NO. | RATING | COLOR*                         |
|---|----------|--------|--------------------------------|
| SureSlide Single-Pole                             | 6627-1   | 5A     | I, W (Also available in Brown) |
| SureSlide Single-Pole or 3-Way with Preset ON/OFF | 6637-P   | 5A     | I, W, A                        |

Quiet Step Fan Speed Controls

| DESCRIPTION  | CAT. NO. | RATING                        | COLOR* (Brown not available) |
|--|----------|-------------------------------|------------------------------|
| SureSlide Single-Pole or 3-way Quiet Step with Preset ON/OFF | 6629-3   | 1.5A                          | I, W, A, GY                  |
| SureSlide Dual Quiet Fan Speed Control and Dimmer            | 6630     | 1.5A Fan Control/ 300W Dimmer | I, W, A, T, GY               |

See Page C7 for more information on Leviton Power Extenders

CAUTION ON RETROFITS: When retrofitting Mark 10™ Powerline dimming ballasts into fixtures that originally had Instant Start ballasts, the sockets MUST be replaced with Rapid Start sockets to allow proper dimmer operation and prevent damage to the dimming ballast. Refer to the instructions provided with the ballast and the Leviton dimmer.

Use Leviton Power Extenders to extend the load capacity of box-mounted dimmers. Leviton Power Extenders are available for incandescent, magnetic low-voltage, electronic low-voltage, Advance Mark 10® Powerline fluorescent dimming ballasts or equivalents, and 0-10 VDC dimmable fluorescent ballasts such as Advance Mark 7® 0-10V, OSRAM Sylvania Quicktronic Helios or equivalent ballasts.

SPECIFICATIONS AND FEATURES

- All SureSlide devices have a permanently mounted smooth-action integrated linear slide control for easy, precise operation
- SureSlide features a slim, compact housing that fits easily into a standard wallbox and is suitable for multi-gang installations
- Preset versions provide single-pole (one-location) and 3-way (multi-location) lighting control when used with a 3-way switch
- Illuminated versions feature optional-use Locator LED
- SureSlide's attractive Decora styling coordinates perfectly with Leviton's complete line of Decora wiring devices
- Compatible with Decora screwless and Decora standard designer wallplates
- Built-in radio/TV interference filter
- Quiet 1.5 Amp Fan Speed Controls are ideal for libraries, study rooms and any area where ceiling fan noise could become distracting. Full range 5-amp fan speed controls also available
- SureSlide Cat. No. 6668 is specially designed to work with the Philips Dimmable Marathon™

TESTING AND CODE COMPLIANCE

- UL Listed (File #E-31373)
- CSA Certified (File #LR-3413)
- Limited Five-Year Warranty

\*COLOR

To order colors, add suffix to catalog number as follows: Ivory (-I), White (-W), Almond (-A), Light Almond (-T), Gray (-GY) and Black (-E). Basic Cat. No. denotes Brown where Brown is available.

MATERIAL CHARACTERISTICS

Environmental: Flammability UL-94, V2 Rating  
Operating Temperature: 32°F to 130°F



Trimatron™ Deluxe Full Range Rotary Controls

Trimatron Incandescent Rotary Dimmers 600 Watts

| DESCRIPTION   | CAT. NO. | RATING            | COLOR*   |
|---|----------|-------------------|--|
| Trimatron Incandescent Dimmer, push-ON/<br>push-OFF, Single-Pole                                    | 6681     | 600W-120V AC      | I, W, A  |
| Trimatron Incandescent Dimmer, push-ON/<br>push-OFF 3-Way   | 6683     | 600W-120V AC      | I, W, A  |
| Trimatron Incandescent Dimmer, Single-Pole  | 6602     | 600W-120V AC      | I, W   |
| Trimatron Incandescent Dimmer Single-Pole<br>(Not UL Listed or CSA Certified)                       | 6602-220 | 600W-220V<br>50Hz | W  |
| Decora Plastic Adapter for Rotary Dimmers —<br>plastic, standard size; fits over .406" dimmer shaft | 80400    | —                 | I, W, A, E<br>(Basic Cat. No.<br>denotes Brown)    |
| Dimmer Knobs with metal insert<br>(packed 25 per box)   | 26115    | —                 | I, W, A, T, E<br>(Basic Cat. No.<br>denotes Brown) |

Note: All dimmers have a ground wire.

Trimatron Fan Speed Controls 120V AC 60Hz Only

| DESCRIPTION                            | CAT. NO. | RATING       | COLOR* |
|--|----------|--------------|--------|
| Trimatron Full-Range Fan Speed Control | 6616-X   | 5A-120V AC   | I, W   |
| Trimatron Quiet Fan Speed Control      | 6639     | 1.5A-120V AC | I, W   |

See Page C7 for more information on Leviton Power Extenders

Use Leviton Power Extenders to extend the load capacity of box-mounted dimmers. Leviton Power Extenders are available for incandescent, magnetic low-voltage, electronic low-voltage, Advance Mark 10® Powerline fluorescent dimming ballasts or equivalents, and 0–10 VDC dimmable fluorescent ballasts such as Advance Mark 7® 0–10V, OSRAM Sylvania Quicktronic Helios or equivalent ballasts.

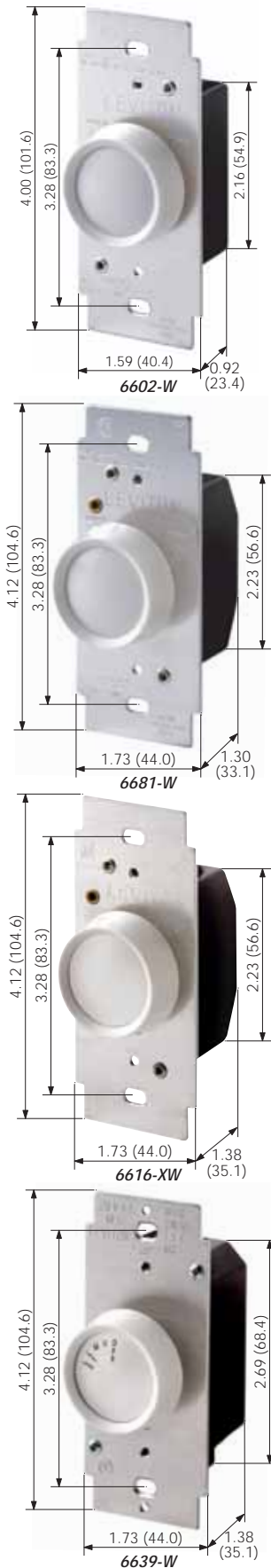

SPECIFICATIONS AND FEATURES

- Leviton Trimatron lighting controls are traditional rotary-style dimmers featuring an ultra-compact design that fits in even the tightest single-gang wallboxes and is suitable for multi-gang installations
- Built-in radio/TV interference filter
- Quiet 1.5 Amp Trimatron Fan Speed Controls are ideal for libraries, study rooms and any area where ceiling fan noise could become distracting. Full range 5-Amp fan speed controls also available
- Wire leads provided for fast, easy assembly and wiring

TESTING AND CODE COMPLIANCE

- UL Listed (File #E-31373)
- CSA Certified (File #LR-3413)
- Backed by a Limited Five-Year Warranty

\*COLOR

Add suffix to catalog numbers as follows to select colors: Ivory (-I), White (-W), Almond (-A), Light Almond (-T) and Black (-E). Cat. Nos. 80400 and 26115 also available in Brown (no suffix).

MATERIAL CHARACTERISTICS

Environmental: Flammability UL-94, V2 Rating  
Operating Temperature: 32°F to 130°F



Residential Grade Lighting Controls

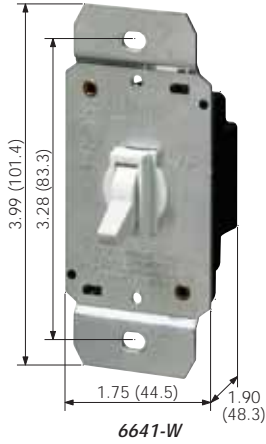

**Incandescent Lighting Controls**

**Toggle Dimmers 600 Watts 120V AC 60Hz Only**

| DESCRIPTION  | CAT. NO. | RATING       | COLOR*<br><i>(Basic Cat. No. Denotes Brown)</i> |
|--|----------|--------------|---|
| Incandescent Dimmer, Single-Pole                       | 6641     | 600W-120V AC | I, W,   |
| Incandescent Dimmer for Single-Pole or 3-Way           | 6643     | 600W-120V AC | I, W  |
| Incandescent Dimmer, Single-Pole, Illuminated          | 6691     | 600W-120V AC | Clear   |
| Incandescent Dimmer, Single-Pole or 3-way, Illuminated | 6693     | 600W-120V AC | Clear   |

**Decora® 911 Flasher 500 Watts 120V AC 60Hz Only**

| DESCRIPTION  | CAT. NO. | RATING       | COLOR*  |
|--|----------|--------------|---------|
| Decora 3-Position Emergency Flasher Rocker Switch, Incandescent only | 911      | 500W-120V AC | I, W, A |



**SPECIFICATIONS AND FEATURES**

**Toggle Dimmers**

- Easy-to-install shallow design replaces standard switch in single wallbox
- Built-in radio/TV interference filter
- Positive ON/OFF action with smooth, full-range brightness control

**911 Switch**

- 911 replaces standard single-pole switch and alerts neighbors and helps emergency personnel locate a house quickly
- 911 Switch has standard ON/OFF operation plus a special illuminated "FLASH" position that causes controlled lighting to flash ON and OFF at one second intervals

**TESTING AND CODE COMPLIANCE**

- UL Listed (File #E-31373)
- CSA Certified (File #LR-3413)
- Backed by a Limited Five-Year Warranty

**\*COLOR**

Basic Cat. No. denotes Brown where indicated. Add suffix to catalog number as follows for other colors: Ivory (-I), White (-W), and Almond (-A).

**MATERIAL CHARACTERISTICS**



Environmental: Flammability UL-94, V2 Rating  
Operating Temperature: 32°F to 130°F





Residential Grade Lighting Controls

Specialty Dimmers and Sockets

Incandescent Dimmers 120V AC 60Hz Only  

| DESCRIPTION  | CAT. NO. | RATING | COLOR*                                     |
|--|----------|--------|--|
| Decora 4-Level Step Dimmer<br>Incandescent only  | 6161     | 500W   | W, I, A                                    |
| HI-LO Feed-through Lamp-Cord Dimmer  | 1420     | 200W   | W<br><i>(Basic Cat. No. Denotes Brown)</i> |
| Full-Range Feed-through Lamp-Cord Dimmer<br>(Individually boxed)<br>(not UL Listed or CSA Certified) | 6250-3   | 200W   | I<br><i>(Basic Cat. No. Denotes Brown)</i> |
| Tabletop Dimmer for plug-in lamps  | TBI03    | 300W   | W, E                                       |

Dimmer Socket 120V AC 60Hz Only  

| DESCRIPTION  | CAT. NO. | RATING | COLOR*           |
|--|----------|--------|------------------|
| Full-Range Compact Dimmer Socket<br>(1/8 I.P.S Thread and Set Screw) | 6151     | 150W   | (Non-color item) |

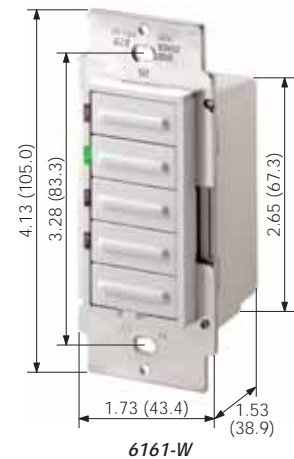

6161-W



6151

SPECIFICATIONS AND FEATURES

Four-Level Step Dimmer

- Eliminates guesswork — user selects one of four preset lighting levels (25%, 50%, 75%, 100%)
- Easily installs in place of single-pole switch
- LED indicates selected level of brightness
- Sleek designer styling; can be ganged with other Decora devices

Lamp Cord and Socket Dimmers

- Compact Dimmer Socket interchangeable with standard lampholder for dimmer conversion (eliminates need for expensive 3-way bulbs)
- Full-Range Feed-Through Lamp Cord Dimmer provides full-range dimming with positive ON/OFF action in a completely insulated plastic housing

TESTING AND CODE COMPLIANCE

- UL Listed (File #E-3810) – 6151; (File #E-7458) – 1420; (File #E-7442) – 6250-3
- CSA Certified (File #LR-1863) – 6151; (File #LR-3413) – 1420
- Backed by a Limited Five-Year Warranty

\*COLOR

Basic Cat. No. denotes Brown where indicated. Add suffix to catalog number as follows for other colors: Ivory (-I), White (-W).

MATERIAL CHARACTERISTICS

Environmental: Flammability UL-94, V2 Rating  
Operating Temperature: 32°F to 130°F

# HOW TO USE THIS CATALOG

The L-101 Leviton Wiring Device Catalog is designed to help you find the device you're seeking in the quickest and easiest way possible. Most product sections are divided into three distinct categories in the following sequence—Industrial Grade, Commercial Grade and Residential Grade—and grouped according to amperage and voltage, lowest to highest. For example, if you need to order 15 Amp, 125 Volt Industrial Grade straight-blade duplex receptacles, begin your search with the main Table of Contents at the front of the book. Here you'll see that all straight blade receptacles are listed in Section G. Turn to Section G for a more detailed Table of Contents on the first page. Each section page contains product descriptions, ratings and catalog numbers. There are also helpful highlights including Specifications and Features, Testing and Code Compliance, Color listing, Material Characteristics and dimensioned color product photos. Any product page in the L-101 Catalog can be clearly copied or faxed to customers and prospects for use as a specifier sheet or as part of a presentation.

The Quick Reference Guide follows the main Table of Contents to help you pinpoint and locate specific products. Technical Section V provides general product and test data, industry standards, NEMA configuration charts, a glossary of wiring device terms, ANSI architectural symbols and other related information. Specific catalog numbers are listed in the exhaustive index at the back of the catalog.

**15 AMP 125 and 250V • 20 AMP 125 and 250V**

**Industrial Grade Straight Blade Receptacles**

**Back and Side Wired** (Basic Cat. No. Denotes Brown Device\*)

| DESCRIPTION                             | CAT. NO./COLOR<br>15A/125V                   | CAT. NO./COLOR<br>15A/250V                | CAT. NO./COLOR<br>20A/125V            | CAT. NO./COLOR<br>20A/250V         |
|---|--|---|---------------------------------------|------------------------------------|
| LEVSPEC® Duplex Receptacle, Brass Strap | 5262<br><small>I, W, GY, R, E</small>        | 5662<br><small>I</small>                  | 5362<br><small>I, W, GY, R, E</small> | 5462<br><small>I, GY</small>       |
| Single Receptacle                       | 5261<br><small>I, W, GY</small>              | 5661<br><small>I</small>                  | 5361<br><small>I, W, A, T, GY</small> | 5461<br><small>I, A, T, GY</small> |
| Narrow Body Duplex Receptacle           | 5252<br><small>I, W, A, T, GY, R, BU</small> | 5352<br><small>I, W, A, T, GY, R,</small> |                                       |                                    |

**5362-IG**

**For complete wallplate selection, see Section E.**

**5424-W**

**SPECIFICATIONS AND FEATURES**

**Back & Side Wired Duplex**

- Impact-resistant thermoplastic nylon cover and body
- Smooth face does not collect dirt
- Four corner latches securely fasten face
- Single-piece brass mounting strap on LEVSPEC devices, multi-piece steel strap on other devices
- Large, triple-wipe, brass "T" contacts for superior contact and conductivity
- Back and side-wiring options
- Brass terminal screws to reduce conductor oxidation
- Break-off tabs for easy two-circuit conversion
- Apron barrier to prevent accidental contact between terminal screw heads and metal box
- Exclusive V-shaped, serrated back-wiring clamp for superior contact and conductivity

**TESTING AND CODE COMPLIANCE**

- UL Listed 498 (UL File #13399); UL Federal Specification WC-596

**COLOR**

Basic Cat. Nos. shown above denote Brown device, except for Isolated Ground (-IG) devices Basic Cat. No. denotes Orange. Isolated Ground Receptacle is distinguished by an orange triangle on its face. For other color selections, add suffix to the catalog number as follows: Ivory (-I), White (-W), Brown (For IG devices only, add -B), Almond (-A), Light Almond (-T), Gray (-G or -GY), Black (-E), Red (-R) and Blue (-BU); for IG devices only, add -BIG)

**MATERIAL CHARACTERISTICS**

Environmental: Flammability, Rated V2  
Operating Temperature: From -40° C (without impact) to 60°C maximum continuous

- |                                       |  |                                      |
|---------------------------------------|--|--------------------------------------|
| <b>A</b> RATING                       | <b>E</b> CATALOG NUMBER                      | <b>I</b> SPECIFICATIONS & FEATURES   |
| <b>B</b> Choose GRADE, if appropriate | <b>F</b> DESCRIPTION                         | <b>J</b> TESTING AND CODE COMPLIANCE |
| <b>C</b> DIMENSIONED PHOTOGRAPH       | <b>G</b> Check for NEMA CONFIGURATION        | <b>K</b> COLOR LISTING               |
| <b>D</b> WIRING/CERTIFICATIONS        | <b>H</b> WALLPLATE REFERENCE, if appropriate | <b>L</b> MATERIAL CHARACTERISTICS    |

# Energy Management Products

## INDEX

|  |          |
|--|----------|
| <b>Occupancy Sensor Lighting Controls</b>                |          |
| Overview   | D2       |
| Decora Wall Switch Infrared Occupancy Sensors            | D3-D6    |
| Decora Dual-Relay Wall Switch Infrared Occupancy Sensors | D4       |
| Decora Wall Switch Multi-Tech Occupancy Sensor           | D4       |
| Manual-ON Wall Switch Occupancy Sensor                   | D6       |
| Self-Contained Fixture Mount Occupancy Sensor            | D7       |
| Power Base Adaptor                                       | D8       |
| Self-Contained Infrared Ceiling Mount Occupancy Sensor   | D9       |
| Multi-Tech Ceiling Mount Occupancy Sensor                | D10      |
| Ultrasonic Ceiling Mount Occupancy Sensor                | D11      |
| Infrared Ceiling Mount Occupancy Sensor                  | D12      |
| Multi-Tech Wall Mount Occupancy Sensor                   | D13      |
| Infrared Wide-View Wall Mount Occupancy Sensor           | D14      |
| Infrared High-Bay Wall Mount Occupancy Sensor            | D14      |
| Infrared Long-Range Wall Mount Occupancy Sensor          | D14      |
| Power Packs for Occupancy Sensors                        | D15      |
| Infrared Outdoor Motion Sensors                          | D16      |
| <b>Centura System</b>                                    |          |
| Centura® Fluorescent Energy Management System            | D17, D18 |
| <b>Timed Lighting Controls</b>                           |          |
| DecoraPlus Electronic Timer Switches                     | D19      |
| Decora Programmable Electronic Timer Switches            | D20      |
| Variable Countdown Timer Switch                          | D20      |
| Z-MAX Relay Lighting Control Systems                     | D21-D27  |
| Z-MAX Relay Cabinets                                     | D22, D23 |
| RRP-Remote 4-Relay Panel                                 | D24      |
| EZ-MAX Relay Cabinets                                    | D25      |
| Z-MAX Digital and Low Voltage Switch Stations            | D26      |
| miniZ™ Intelligent Daylight Management System            | D27      |



## OCCUPANCY SENSOR LIGHTING CONTROL FEATURES

### Commercial and Residential Grade Energy Management Products

#### LEVITON OFFERS A RANGE OF PRODUCTS THAT REDUCE ENERGY COSTS WHILE INCREASING COMFORT AND SECURITY.

The modular Centura® Fluorescent Energy Management system offers "daylight harvesting" in commercial buildings through the use of photo sensors, occupancy sensors, dimmers and a PC-based lighting control interface. Occupancy sensors provide convenient, hands-free lights-ON/lights-OFF switching either independently or as part of the Centura system. Leviton's residential and commercial grade Electronic Timers reduce energy bills and can provide a "lived-in look" for added home security. Z-MAX™ timed relay lighting control panels combine time clock and switching contactor functions with innovative technology for advanced scheduling of lighting and other loads in commercial, educational and outdoor areas.

#### Occupancy Sensor Lighting Controls

Leviton offers a variety of space-monitoring Occupancy Sensor Lighting Controls for virtually any room, facility, home or office. Wall or ceiling mount, with passive infrared, ultrasonic or multi-technology sensing; end-users will benefit from the energy savings, convenience and security provided by Leviton Occupancy Sensors.

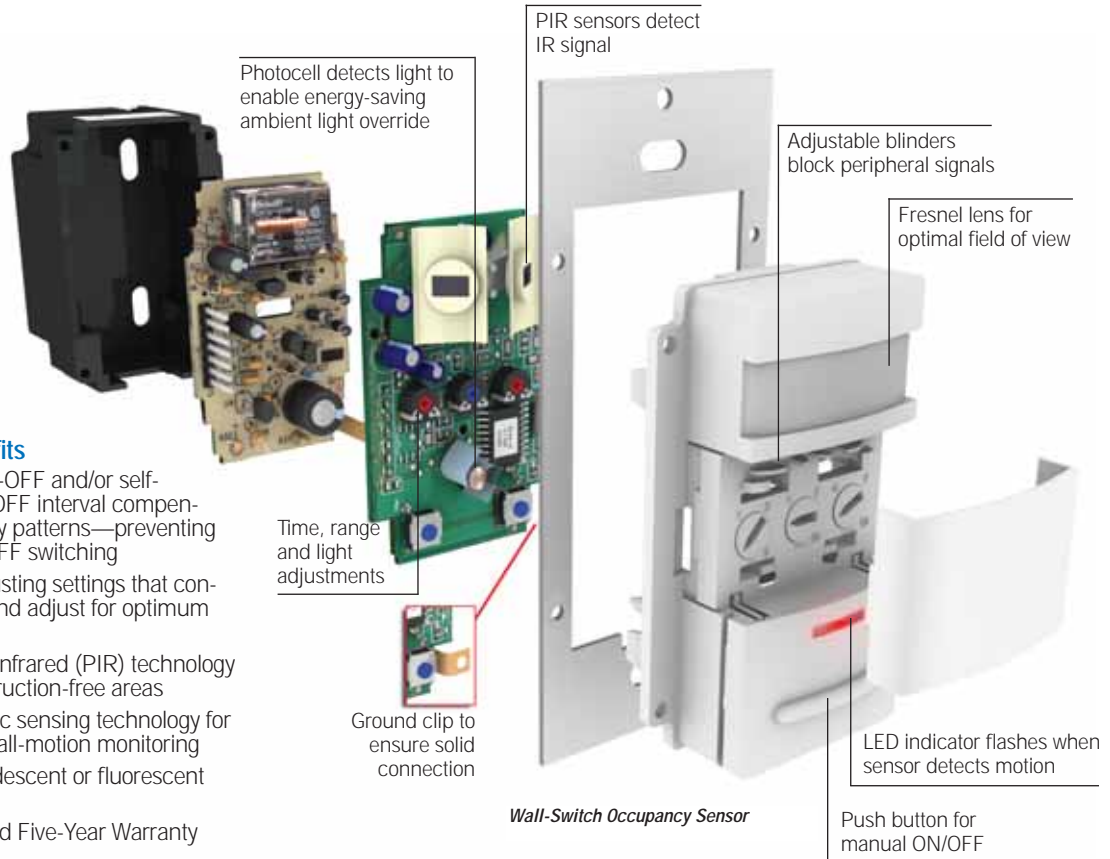

#### Features and Benefits

- Adjustable delayed-OFF and/or self-adjusting delayed-OFF interval compensates for occupancy patterns—preventing unnecessary ON/OFF switching
- Many with self-adjusting settings that continuously analyze and adjust for optimum performance
- Advanced passive infrared (PIR) technology for monitoring obstruction-free areas
- Advanced ultrasonic sensing technology for highly accurate small-motion monitoring
- For use with incandescent or fluorescent lighting
- Backed by a Limited Five-Year Warranty

#### OCCUPANCY SENSOR LIGHTING CONTROLS FOR COMMERCIAL AND RESIDENTIAL APPLICATIONS



**Decora® Wall-Switch Infrared Occupancy Sensor**  
Features automatic "walk-through" sensing and self-adjusting delayed-OFF. Dual relay versions available.  
**OSD15-IDW shown**

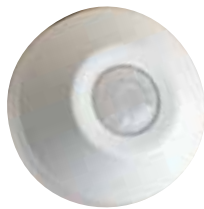

**Self-Contained Infrared Ceiling-Mount Occupancy Sensor**  
Features built-in relay and 360° coverage. For small spaces.  
**ODC05-11W shown**



**Multi-tech Ceiling-Mount Occupancy Sensor**  
IR and ultrasonic combine for accurate monitoring while minimizing false triggers. For larger, open areas. Self adjusting.  
**OSC20-MOW shown**



**Ultrasonic Ceiling-Mount Occupancy Sensor**  
Highly accurate small-motion detection. Self-adjusting sensitivity and time off.  
**OSC05-UOW shown**



**Wall-Mount Occupancy Sensor**  
Available with multi-technology sensing or IR wide-view, high-bay and long-range versions. Fits in corner.  
**OSW12-MOW shown**



**Infrared Outdoor Motion Sensor**  
Adjustable delayed-OFF plus sensitivity to reduce false triggers. For commercial and residential applications.  
**PS200 shown**

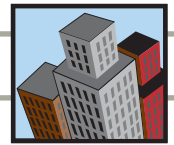

Wall Switch Occupancy Sensor Lighting Controls

Decora Wall Switch Infrared Occupancy Sensor (Incandescent or Fluorescent)

| DESCRIPTION  | CAT. NO.        | RATING  | COLOR*        |
|--|-----------------|---|---------------|
| Decora Wall Switch<br>PIR Occupancy Sensor,<br>180° field of view, 2100 sq. ft   | <b>ODS10-ID</b> | Incandescent: 800W @ 120V,<br>Fluorescent: 1200VA @ 120V,<br>2700VA @ 277V.<br>For 60 Hz AC only.<br>Motor: 1/4 HP @ 120V | I, W, A, T, G |
| Decora Wall Switch<br>PIR Occupancy Sensor<br>with Self-Adaptive Technology,<br>180° field of view, 2100 sq. ft                                  | <b>ODS15-ID</b> | Incandescent: 1800W @ 120V.<br>Fluorescent: 1800VA @ 120V,<br>4000VA @ 277V.<br>Motor: 1/4 HP @ 120V                      | I, W, A, T, G |
| Decora Wall Switch PIR<br>Occupancy Sensor with LED<br>Night Light, 180° field of view,<br>1200 sq. ft (neutral required)                        | <b>OSSNL-ID</b> | Incandescent: 800W @ 120V<br>Fluorescent: 1200VA @ 120V<br>2700VA @ 277V<br>Motor: 1/8HP @ 120V                           | I, W, A, T, G |
| CEC Title 24 Compliant Decora<br>Wall Switch PIR Manual-ON<br>Sensor with LED Night Light,<br>180° field of view, 1200 sq. ft (neutral required) | <b>OSS10-ID</b> | Incandescent: 800W @ 120V<br>Fluorescent: 1200VA @ 120V<br>2700VA @ 277V<br>Motor: 1/8HP @ 120V                           | I, W, A, T, G |

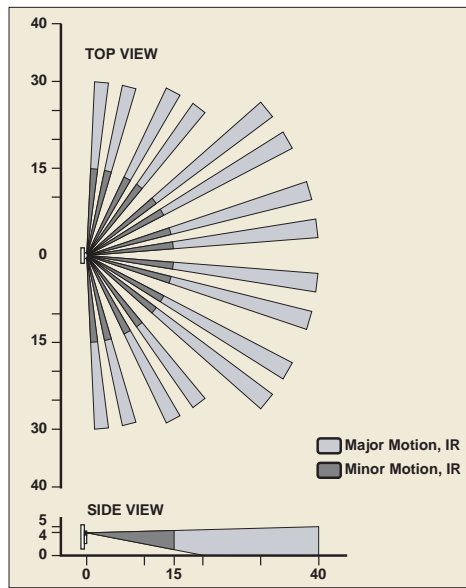

**SPECIFICATIONS AND FEATURES**

**All ODS Wall Switch Sensors**

- Ambient light override prevents these devices from switching lights ON when there is ample natural sunlight
- Push-button manual override is used to turn lights ON at any time, regardless of the override setting
- 180° field of view, 2100 sq. ft. of coverage
- One unit can be used for 120V or 277VAC 60Hz incandescent, low voltage and fluorescent lighting with either magnetic or electronic ballasts, and motor loads
- Fits in standard wallbox; gangable
- Elegant Decora styling; uses Decora wallplate

**ODS15-ID PIR Occupancy Sensor**

- For use in small offices, conference rooms, classrooms, stockrooms, lounges, restrooms, warehouses and commercial areas
- Exclusive automatic "Walk-Through" sensing increases energy savings by shutting lights within 2 1/2 minutes after momentary occupancy

- Delayed-OFF time interval (5, 10 and 20 minutes) compensates for real-time occupancy patterns, preventing unnecessary ON/OFF switching—with 30-second test mode

**ODS10-ID PIR Occupancy Sensor**

- For use in enclosed offices, storage rooms, copier rooms and closets
- Delayed-OFF time settings: 10, 20 and 30 minutes with 30-second test mode

**All Night Light Wall Switch Sensors**

- For use in conference rooms, classrooms, small offices, lounges, hotel/hospital/office restrooms
- 180° field of view, 1200 sq. ft. of coverage
- Night light with dim feature

**OSSNL-ID PIR Occupancy Sensor**

- Manual delayed-OFF time settings: 30 seconds, 30 minutes, 1 hour, 2 hours

**OSS10-ID PIR Occupancy Sensor**

- Manual delayed-OFF time settings: 30 seconds to 30 minutes

- Manual ON/Auto OFF operation for CEC Title 24 Compliance

**TESTING AND CODE COMPLIANCE**

- UL Listed (File #E-118904)
- CSA Certified (File #LR-91148M)
- NOM Certified (#057)
- Conforms to California Title 24 Energy Code
- Backed by a Limited Five-Year Warranty

**\*COLOR**

Colors available as listed, add suffix to catalog number as follows: Ivory (-I), White (-W), Almond (-A), Light Almond (-T), Gray (-G).

**MATERIAL CHARACTERISTICS**

Operating Temperature: 0°C to 50°C  
Storage Temperature: -10°C to 85°C  
Relative Humidity: 20% to 90% non-condensing



# DECORA® OCCUPANCY SENSOR LIGHTING CONTROLS • WALL SWITCH

## Commercial Grade Energy Management Products

### Wall Switch Occupancy Sensor Lighting Controls

#### Dual-Relay Decora Wall Switch Infrared Occupancy Sensor

| DESCRIPTION  | CAT. NO. | PHOTOCELL CONTROL OPTIONS PER RELAY  | RATING   | COLOR*        |
|--|----------|--|--|---------------|
| Dual-Relay Decora Wall Switch PIR Occupancy Sensor with Self-Adaptive Technology, 180° field of view, 2100 sq. feet  | ODSOD-ID | Default Setting: Conference Room Mode (Both Primary and Secondary Relays respond to Ambient Light Override.)<br>Alternate Setting: Classroom Mode (Primary Relay only responds to Ambient Light Override.) | Primary Relay: Fluorescent: 1200VA @ 120V, 2700VA @ 277V.<br>Incandescent: 800W @ 120V.<br>Secondary Relay: Fluorescent: 800VA @ 120V, 1200VA @ 277V.<br>Incandescent: 800W @ 120V | I, W, A, T, G |
| Dual-Relay Decora Wall Switch PIR Occupancy Sensor with Self-Adaptive Technology. Secondary relay provides Manual-ON only for CEC Title 24 compliance, 180° field of view, 2100 sq. ft | ODSOD-TD | Primary Relay provides Automatic ON switching and responds to Ambient Light Override. Secondary Relay provides Manual-ON switching only  | Primary Relay: Fluorescent: 1200VA @120V, 2700VA @ 277V.<br>Incandescent: 800W @ 120V.<br>Secondary Relay: Fluorescent: 800VA @ 120V, 1200VA @ 277V.<br>Incandescent: 800W @ 120V  | I, W, A, T, G |

#### Decora Wall Switch Multi-Tech (PIR & US) Occupancy Sensors

| DESCRIPTION   | CAT. NO. | RATING   | COLOR*        |
|---|----------|--|---------------|
| Decora Wall Switch Multi-Tech Occupancy Sensor with Self-Adaptive Technology, 180° field of view, 1200 sq. ft | OSSMT-MD | Incandescent/Tungsten: 800W @ 120V<br>Fluorescent: 1200VA @ 120V, 2700VA @ 277V<br>Motor: 1/4HP @ 120V | I, W, A, T, G |

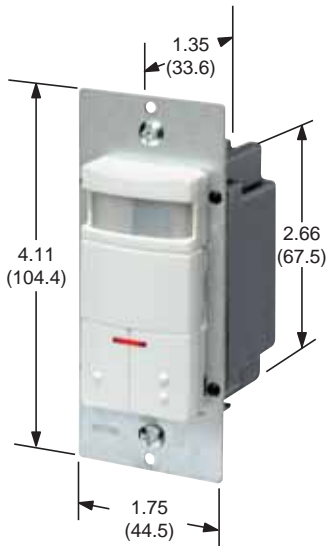

ODSOD-IDW/ODSOD-TDW

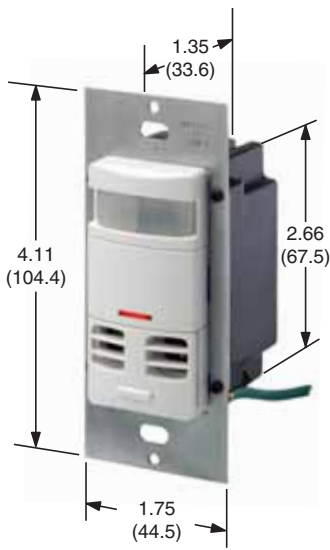

OSSMT-MD Multi-Tech Sensor

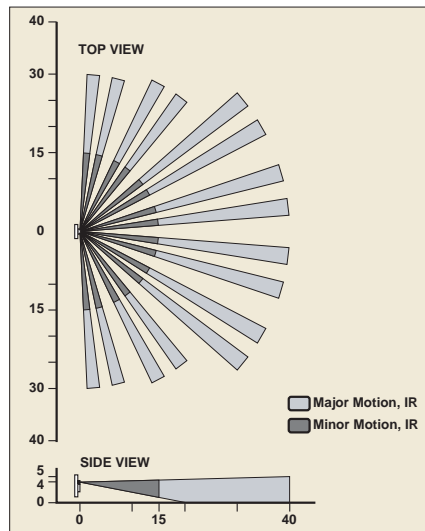

ODSOD-ID, -TD Field of View (in feet)

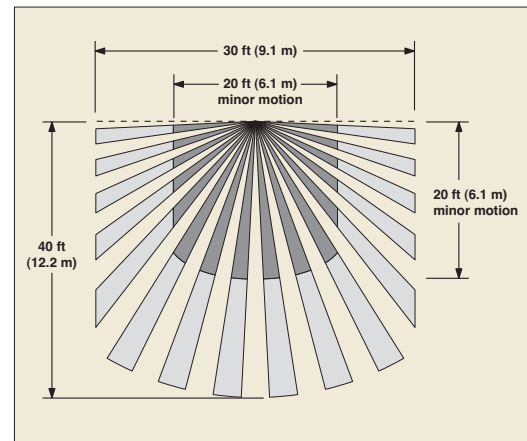

OSSMT-MD Field of View (in feet)

#### SPECIFICATIONS AND FEATURES

##### Dual-Relay PIR Occupancy Sensors

- Ideal for classrooms, multimedia and conference rooms, day care centers, office, and lounges
- Exclusive automatic "Walk-Through" sensing
- Provides automatic switching for 2 separate banks of fluorescent, incandescent, or low-voltage lighting from a single unit
- Delayed-OFF time interval (5, 10 and 20 minutes) compensates for real-time occupancy patterns, preventing unnecessary ON/OFF switching—with 30-second test mode
- ODSOD-TD provides Manual-ON/Auto-OFF operation for CEC Title 24 compliance

##### OSSMT-MD Multi-Tech Occupancy Sensor

- Ideal in offices, conference rooms, storage areas, restrooms, classrooms and lounges

- Combines passive infrared and ultrasonic technologies to provide maximum sensitivity with immunity to false triggering
- Ambient light override prevents lights from turning ON when there is ample natural light
- Exclusive automatic "Walk-Through" sensing
- Manual delayed-OFF time settings (30 seconds to 30 minutes)
- Manual-ON/Auto-OFF setting for CEC Title 24 compliance

#### TESTING AND CODE COMPLIANCE

- UL Listed (File #E-118904)
- Cat. No. ODSOD-ID is CUL/US Certified
- CSA Certified (File #LR-91148M)
- NOM Certified (#057)
- Conforms to California Title 24 Energy Code
- Backed by a Limited Five-Year Warranty

#### \*COLOR

Colors available as listed, add suffix to catalog number as follows: Ivory (-I), White (-W), Almond (-A), Light Almond (-T), Gray (-G).

#### MATERIAL CHARACTERISTICS

Operating Temperature: 0°C to 50°C  
Storage Temperature: -10°C to 85°C  
Relative Humidity: 20% to 90% non-condensing



Wall Switch Occupancy Sensor Lighting Controls

Decora Wall Switch Infrared Occupancy Sensor

| DESCRIPTION  | CAT. NO. | RATING  | COLOR*  |
|--|----------|---|---------|
| Decora Wall Switch PIR Occupancy Sensor, Single-Pole & 3-Way, 180° field of view, 400 sq. ft | PR180-1L | Incandescent: 500W, Rapid Start Magnetic Fluorescent only: 400VA @ 120V AC, | I, W, A |
| Decora Wall Switch PIR Occupancy Sensor, Single-Pole, 150° field of view, 350 sq. ft         | PR150-1L | Incandescent: 500W, Rapid Start Magnetic Fluorescent only: 400VA @ 120V AC, | I, W, A |

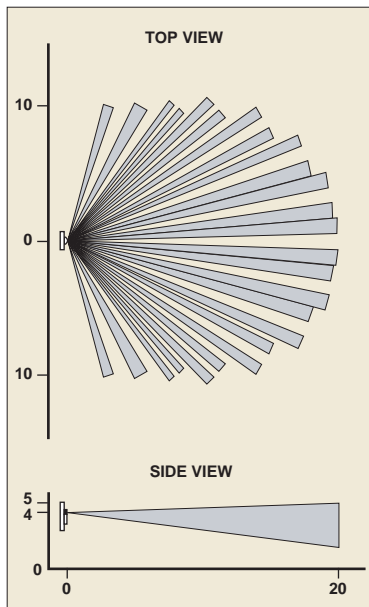

PR150-1L Field of View (in feet)

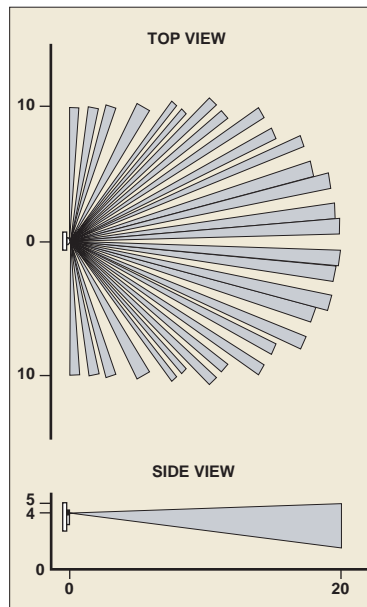

PR180-1L Field of View (in feet)

SPECIFICATIONS AND FEATURES

- PR180 with 180° field of view, 400 sq. ft. of coverage: For use in large rooms, home offices, and a variety of light commercial and residential applications
- PR150 with 150° field of view, 350 sq. ft. of coverage: For use in residential applications
- Ambient light override prevents these devices from switching lights ON when there is ample natural sunlight
- Manual override for use as a standard ON/OFF switch
- Adjustable delayed-OFF time interval (15 seconds to 15 minutes)
- Fits in standard wallbox; gangable
- Elegant Decora styling; uses Decora wallplate

TESTING AND CODE COMPLIANCE

- UL Listed (File #E-118904)
- CSA Certified (File #LR-91148M)
- Backed by a Limited Two-Year Warranty

\*COLOR

Colors available as listed; add suffix to catalog number as follows: Ivory (-I), White (-W), Almond (-A).

MATERIAL CHARACTERISTICS

Operating Temperature: 0°C to 50°C  
 Storage Temperature: -10°C to 85°C  
 Relative Humidity: 20% to 90% non-condensing



### Manual-ON Wall Switch Occupancy Sensor Lighting Controls

#### Decora Manual-ON Wall Switch Infrared Occupancy Sensor

| DESCRIPTION  | CAT. NO. | RATING   | COLOR*                     |
|--|----------|--|----------------------------|
| Decora Manual-ON Wall Switch PIR Occupancy Sensor, CEC Title 24 Compliant, Single-Pole, 3-Way or more when used with IPPOR Sensor Remote or Vizia Switch Remote, 180° field of view, 900 sq. ft (neutral required) | IPP15-1L | Incandescent: 1800W, Fluorescent: 1800VA at 120V AC, Motor: 1/2 HP @ 120V AC | I, W, A, T, E              |
| Decora Manual-ON Occupancy Sensor Remote, 180° field of view, 900 sq. ft (neutral required)  | IPPOR-1L | 120V AC—No load rating, For use with IPP15 Sensor or Vizia Dimmers           | I, W, A, T                 |
| Vizia™ Matching Switch Remote, lighted (neutral required)  | VZOSR-1L | 120V AC—No load rating   | X (I, W & A), Z (I, W & T) |
| Vizia™ Coordinating Switch Remote, unlighted (neutral required)  | VZOSR-10 | 120V AC—No load rating   | X (I, W & A), Z (I, W & T) |

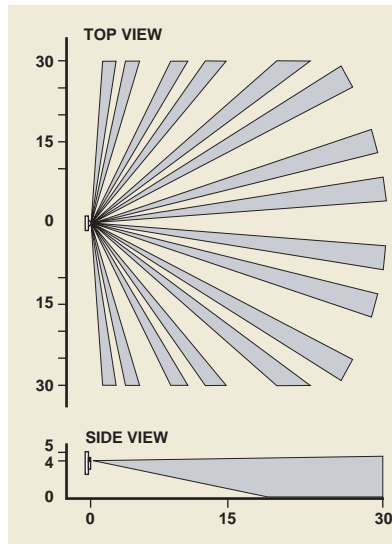

IPP15-IL Field of View (in feet)

#### SPECIFICATIONS AND FEATURES

- Manual-ON/Automatic OFF operation in accordance with California Title 24 2005 requirements
- 180° field-of-view provides approximately 900 sq. ft. of coverage suitable for bathrooms, basements, garages, utility rooms, and a variety of other residential areas
- Low-profile design eliminates an obtrusive “scanning-device” look
- Elegant Decora styling complements any interior and coordinates with Leviton’s popular line of Decora wiring devices and Vizia lighting controls
- IPP15 provides a true 3-Way feature when used with the IPPOR Manual-ON Occupancy Sensor Remote or the VZOSR Vizia Switch Remote
- Convenient push-button provides Manual ON/OFF light switching at any time
- Segmented Fresnel lens provides optimum sensitivity and performance
- Horizontal field of view may be adjusted between 180° and 32° of arc by using integral blinders located on either side of the lens
- Four optional manual adjustments for delayed-OFF time settings maximize energy savings: 30 seconds (for walk test), 5 minutes, 15 minutes and 30 minutes
- LED indicator light flashes when sensor detects motion to verify detection is active
- Fits in standard wallbox
- Requires a neutral (white) wire connection

#### TESTING AND CODE COMPLIANCE

- UL Listed (File #E-118904)
- CSA Certified (File #LR-152105)

- Conforms to California Title 24 Energy Code and FCC regulations
- Backed by a Limited Five-Year Warranty

#### \*COLOR

Colors available as listed, add suffix to catalog number as follows: Ivory (-I), White (-W), Almond (-A), Light Almond (-T) and Black (-E). Vizia Switch Remotes come packaged with three colors. Controls with suffix (-X) include White, Ivory and Almond. Controls with suffix (-Z) include White, Ivory and Light Almond.

#### MATERIAL CHARACTERISTICS

Operating Temperature: 0°C to 50°C  
Storage Temperature: -10°C to 85°C  
Relative Humidity: 20% to 90% non-condensing





### Self-Contained Infrared Fixture-Mount Occupancy Sensor

| DESCRIPTION  | CAT. NO.  | RATING   | MOUNTING HEIGHT  | COLOR |
|--|-----------|--|--|-------|
| Self-Contained Fixture-Mount High Bay Occupancy Sensor with 360° open area lens and 60 x 20 ft. aisle pattern lens | OSFHU-ITW | Fluorescent: 800VA @ 120V,<br>1200VA @ 277V,<br>1500VA @ 347V<br>Motor: 1/4HP @ 120V | 360° lens:<br>40 ft with 60 ft dia.<br>30 ft with 50 ft dia.<br>20 ft with 50 ft dia.<br>Aisle lens:<br>40 ft with 60 ft (length)<br>x 20 ft (width) | White |
| Offset Adapter Accessory for High Bay Fixture-Mount Occupancy Sensor   | OSFOA-00W | ---  | ---  | White |



OSFHU-ITW



360° Lens



OSFOA

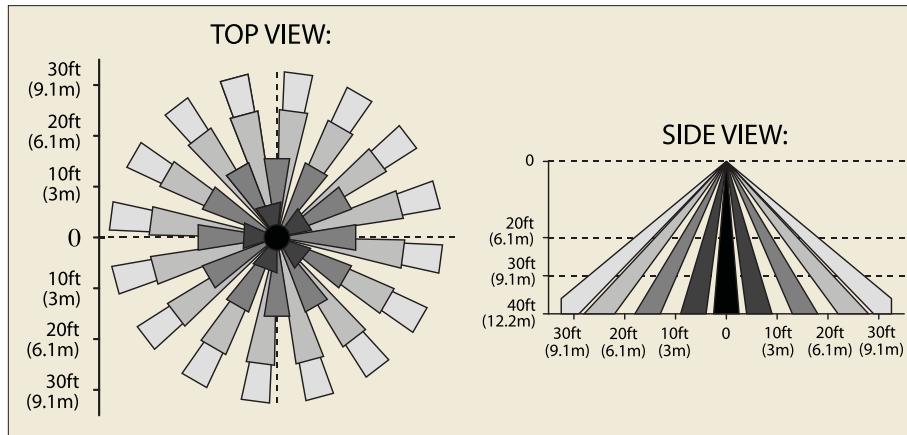

OSFHU-ITW 360° Field of View (in feet)

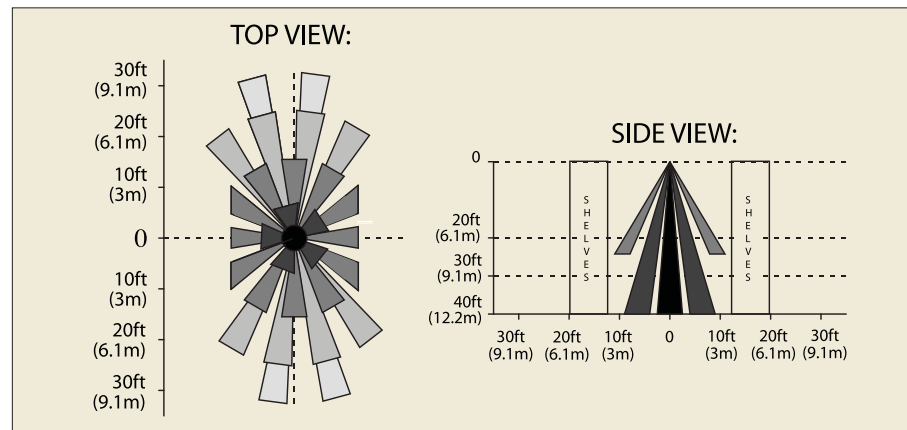

OSFHU-ITW Aisle Field of View (in feet)

#### SPECIFICATIONS AND FEATURES

- Ideal in commercial facilities with high ceilings, including warehouses, manufacturing and others
- Mounts directly to industrial-style fluorescent luminaires or electrical junction box
- Provided with an open area 360° lens installed in the sensor and an interchangeable 60 x 20 ft. aisle-pattern lens
- Self-contained PIR sensor and relay turn individual fixtures ON/OFF based on occupancy
- Accommodates high-bay 20-40 ft. mounting heights
- Relay uses zero-crossing circuitry for enhanced reliability and long-life operation

- Delayed-OFF time adjustment from 30 seconds to 20 minutes
- Two-piece accessory offset adapter (Cat. No. OSFOA-00W) that snaps into a 1/2" knockout on the end of an industrial fixture is also available
- Adapter allows positioning of the sensor below the fixture body to improve field of view for deep body fixtures

#### TESTING AND CODE COMPLIANCE

- UL and cUL Listed
- California Title 24 Compliant
- FCC Compliant
- Backed by a Limited Five-Year Warranty



OPB15-ODW

### Self-Contained Power Base Adaptor

#### Power Base Adaptor

Converts any Leviton low voltage ceiling or wall-mount occupancy sensor to a self-contained, line voltage unit with 15A, 120/277V load capacity

#### Power Base Adaptor

| DESCRIPTION        | CAT. NO.  | POWER INPUT/OUTPUT   | RATING  | COLOR |
|--------------------|-----------|--|---|-------|
| Power Base Adaptor | OPB15-ODW | Power Input:<br>120/277VAC<br>Control Output:<br>24VDC, 40mA | 15A Incandescent,<br>Electronic or<br>Magnetic<br>Fluorescent Ballast | White |

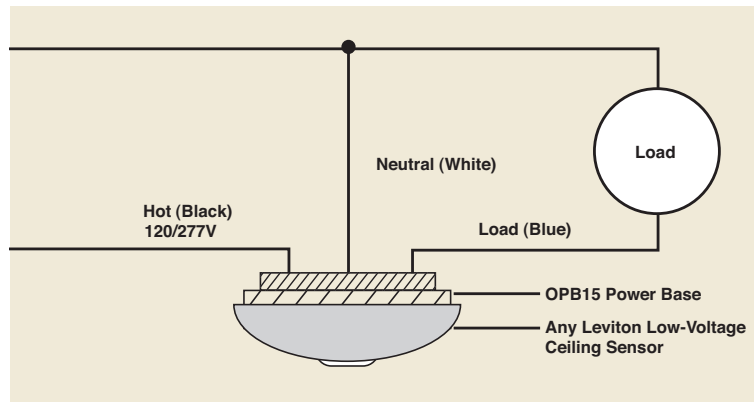

OPB15-ODW Power Base Adaptor Wiring Diagram

#### SPECIFICATIONS AND FEATURES

- Ideal for use in lavatories, remodels, hard ceiling spaces, energy conservation retrofits and any installation with limited access for low-voltage wiring
- Patent-pending design converts Leviton low-voltage ceiling sensors to line voltage
- Ideal for both existing buildings with limited access to low-voltage wiring and new construction with line-voltage circuiting only
- Mounts easily in a standard 2.125" deep x 4" octagon or 2.125" deep x 4" square electrical box with a 2-gang mud ring; flying leads provide fast line voltage connections

- Two-piece terminal block provides fast, easy low-voltage connections to the sensor
- Relay uses zero-crossing circuitry for enhanced reliability and long-life operation

#### TESTING AND CODE COMPLIANCE

- UL and cUL Listed
- NOM Certified
- California Title 24 Compliant
- Backed by a Limited Five-Year Warranty



### Ceiling-Mount Occupancy Sensor Lighting Controls

PIR Occupancy Sensor with built-in relay—Separate Power Pack not required

#### Self-Contained Infrared Ceiling-Mount Occupancy Sensor

| DESCRIPTION  | CAT. NO.         | RATING  | COVERAGE         | COLOR |
|--|------------------|---|------------------|-------|
| Self-Contained Ceiling-Mount Infrared Occupancy Sensor and Switching Relay | <b>ODCOS-11W</b> | Incandescent:<br>1000W @ 120V.<br>Fluorescent:<br>1000VA @ 120V.<br>1 HP @ 120V<br>For 60Hz AC only | 360°, 530 sq. ft | White |
| Self-Contained Ceiling-Mount Infrared Occupancy Sensor and Switching Relay | <b>ODCOS-12W</b> | Incandescent:<br>1000W @ 220V.<br>Fluorescent:<br>500VA @ 220V.<br>For 50Hz AC only                 | 360°, 530 sq. ft | White |
| Self-Contained Ceiling-Mount Infrared Occupancy Sensor and Switching Relay | <b>ODCOS-17W</b> | Fluorescent:<br>2700VA @ 277V.<br>For 60Hz AC only  | 360°, 530 sq. ft | White |
| Protective Cage  | <b>ODCCG</b>     | —   | —                | White |

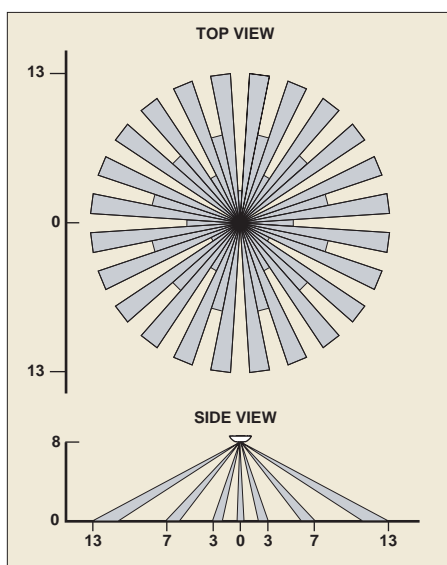

*ODCOS-I Field of View (in feet)*

#### SPECIFICATIONS AND FEATURES

- Ideal for use in storage areas, small bathrooms, copy rooms and a variety of small spaces without wall switches
- Full 360° view of a 530 sq. ft. area when surface mounted on standard, 8-foot ceiling
- Sensor and switching relay combined in a single self-contained unit—No control unit required
- Ambient light override option prevents lights from turning ON when there is ample natural light
- Adjustable Delayed-OFF time settings from 20 seconds (for test mode) to 15 minutes
- Small, unobtrusive self-contained unit: 4.3" (109.2 mm) diameter

#### TESTING & CODE COMPLIANCE

- UL Listed and CSA Certified
- California Title 24 compliant and meets ASHRAE Standard 90.1 requirements
- Backed by a Limited Five-Year Warranty



# OCCUPANCY SENSOR LIGHTING CONTROLS • CEILING MOUNT

## Commercial Grade Energy Management Products

### Ceiling-Mount Occupancy Sensor Lighting Controls

**Multi-Technology Ceiling-Mount Occupancy Sensor** <sup>UL</sup> <sup>CS</sup> (For use with Leviton Power Pack)\*  
 Advanced motion sensors combine infrared and ultrasonic technology for highly accurate monitoring without false triggering. All-digital self-adjusting technology provides "Install and Forget" solution for automatic lighting control.



OSC05-MOW



OSC20-MOW

| DESCRIPTION   | CAT. NO.  | COVERAGE          | OPERATING FREQUENCY | COLOR |
|---|-----------|-------------------|---------------------|-------|
| Multi-Tech Ceiling-Mount Occupancy Sensor           | OSC05-MOW | 180°, 500 sq. ft  | 40kHz               | White |
| Multi-Tech Ceiling-Mount Occupancy Sensor           | OSC10-MOW | 360°, 1000 sq. ft | 40kHz               | White |
| Multi-Tech Ceiling-Mount Occupancy Sensor           | OSC20-MOW | 360°, 2000 sq. ft | 32kHz               | White |
| Protective Cage for Ceiling-Mount Occupancy Sensors | ODCCG-000 | —                 | —                   | White |

\*Low-voltage wiring is used to connect Leviton Occupancy Sensors to Cat. No. OSP20 Power Pack or a Centura CN100 Power Pack (purchased separately). See page D15 for information on OSP20.

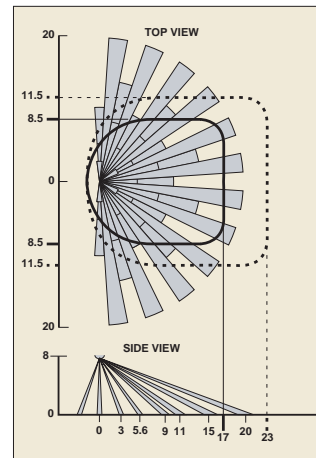
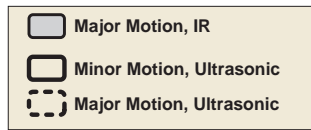

OSC05-MOW Field of View (in feet)

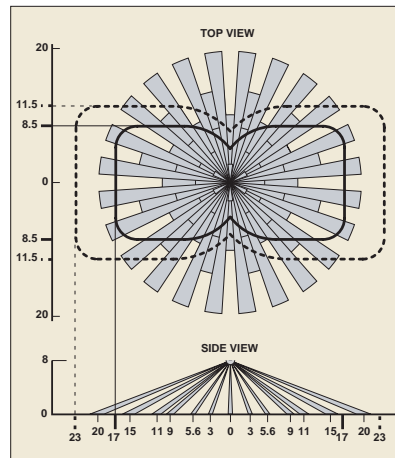

OSC10-MOW Field of View

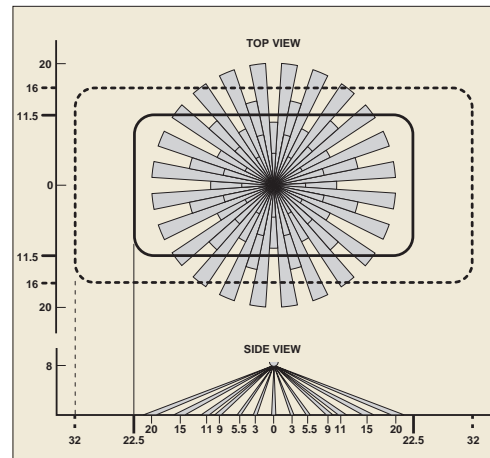

OSC20-MOW Field of View

#### SPECIFICATIONS AND FEATURES

- Ideal for office areas with cubicles, general work space, classrooms, cafeterias and public areas in commercial facilities
- Ultrasonic sensing for maximum sensitivity combined with Passive Infrared (PIR) sensing to prevent false triggering from air conditioning and corridor activity
- Self-adjusting settings continuously analyze and adjust for optimum performance
- Ambient light override prevents lights from turning ON when there is ample natural light
- Manual Delayed-OFF time settings of 30 seconds to 30 minutes
- Self-Adjusting Delayed-OFF time interval settings for 30 seconds to 30 minutes — Compensates for real-time occupancy patterns, preventing unnecessary ON/OFF switching

- Non-volatile memory preserves all automatic and manual settings during power outages
- Choice of coverage patterns to suit a variety of applications
- Small, unobtrusive size blends in with any décor
- Fast, simple installation using 4 color-coded low-voltage wires and a single mounting post
- Compatible with Wiremold® surface raceways for mounting to hard ceilings

#### TESTING AND CODE COMPLIANCE

- CUL/US, FCC and NOM Certified
- California Title 24 compliant and meets ASHRAE Standard 90.1 requirements
- Backed by a Limited Five-Year Warranty

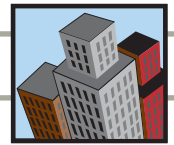

**Ceiling-Mount Occupancy Sensor Lighting Controls**

**Ultrasonic Ceiling-Mount Occupancy Sensor** (For use with Leviton Power Pack)\*

Advanced Ultrasonic sensing technology for highly accurate monitoring with excellent immunity to air currents and other interference. All-digital self-adjusting technology provides "Install and Forget" solution for automatic lighting control.

| DESCRIPTION   | CAT. NO.  | COVERAGE          | OPERATING FREQUENCY | COLOR |
|---|-----------|-------------------|---------------------|-------|
| Ultrasonic Ceiling-Mount Occupancy Sensor           | OSC05-UOW | 180°, 500 sq. ft  | 40kHz               | White |
| Ultrasonic Ceiling-Mount Occupancy Sensor           | OSC10-UOW | 360°, 1000 sq. ft | 40kHz               | White |
| Ultrasonic Ceiling-Mount Occupancy Sensor           | OSC20-UOW | 360°, 2000 sq. ft | 32kHz               | White |
| Protective Cage for Ceiling-Mount Occupancy Sensors | ODCCG-000 | —                 | —                   | White |

\*Low-voltage wiring is used to connect Leviton Occupancy Sensors to Cat. No. OSP20 Power Pack or a Centura CN100 Power Pack (purchased separately). See page D15 for information on OSP20.

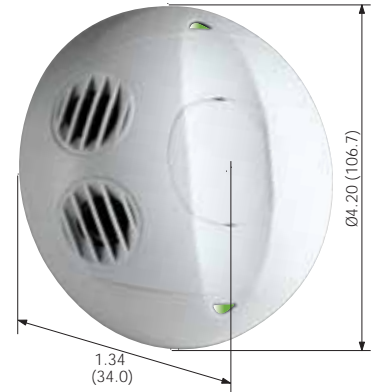

OSC05-UOW

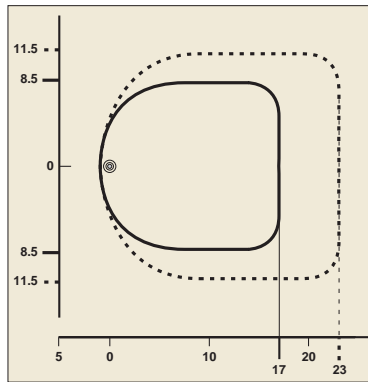
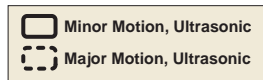

OSC05-UOW Field of View (in feet)

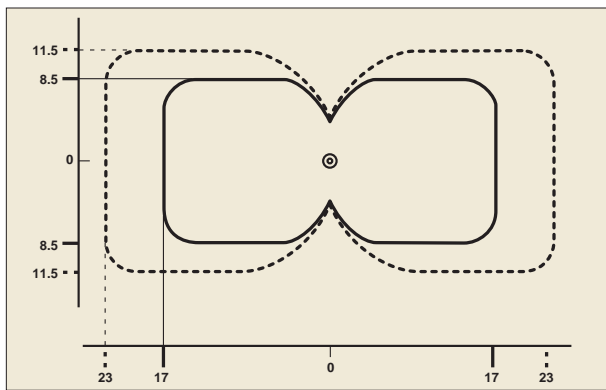

OSC10-UOW Field of View

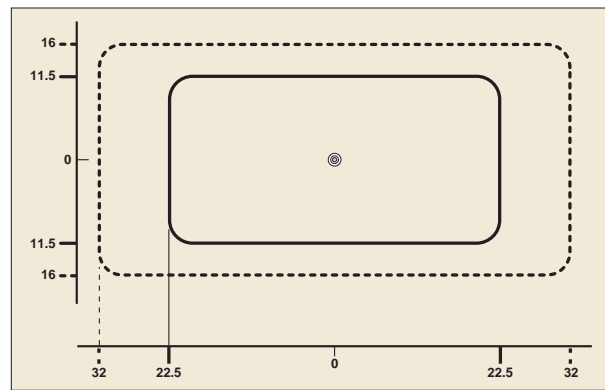

OSC20-UOW Field of View

**SPECIFICATIONS AND FEATURES**

- Ideal for restrooms, office areas with cubicles, general work space, warehouse and storage facilities, cafeterias and public areas in commercial facilities
- Ultrasonic sensing for maximum range and sensitivity combined with high immunity to false triggering from air currents and other interference
- Self-adjusting settings continuously analyze and adjust for optimum performance
- Ambient light override prevents lights from turning ON when there is ample natural light
- Manual Delayed-OFF time settings of 30 seconds to 30 minutes
- Self-Adjusting Delayed-OFF time interval settings for 30 seconds to 30 minutes — Compensates for real-time occupancy patterns, preventing unnecessary ON/OFF switching

- Non-volatile memory preserves all automatic and manual settings during power outages
- Choice of coverage patterns to suit a variety of applications
- Small, unobtrusive size blends in with any décor
- Fast, simple installation using 4 color-coded low-voltage wires and a single mounting post

**TESTING AND CODE COMPLIANCE**

- CUL/US Certified
- Meets ASHRAE Standard 90.1 requirements
- Backed by a Limited Five-Year Warranty



# OCCUPANCY SENSOR LIGHTING CONTROLS • CEILING MOUNT

## Commercial Grade Energy Management Products

### Ceiling-Mount Occupancy Sensor Lighting Controls

#### Infrared Ceiling-Mount Occupancy Sensor <sup>UL</sup> <sup>CS</sup> (For use with Leviton Power Pack)\*

Advanced Passive Infrared technology for highly accurate monitoring in a variety of commercial applications. All-digital self-adjusting technology provides "Install and Forget" solution for automatic lighting control.

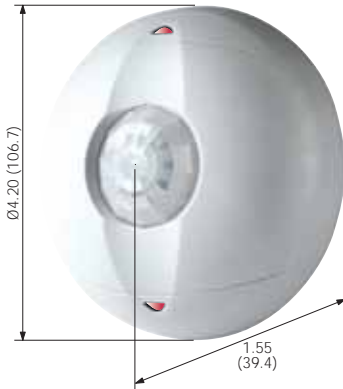

OSC04-IOW

| DESCRIPTION   | CAT. NO.  | COVERAGE          | COLOR |
|---|-----------|-------------------|-------|
| Infrared Ceiling-Mount Occupancy Sensor   | OSC04-IOW | 360°, 450 sq. ft  | White |
| Infrared Ceiling-Mount Occupancy Sensor with Ambient Light Override and Secondary Relay | OSC15-IOW | 360°, 1500 sq. ft | White |
| Protective Cage for Ceiling-Mount Occupancy Sensors                                     | ODCCG-000 | —                 | White |

\*Low-voltage wiring is used to connect Leviton Occupancy Sensors to Cat. No. OSP20 Power Pack or a Centura CN100 Power Pack (purchased separately). See page D15 for information on OSP20.

- Minor Motion, IR
- Major Motion, IR

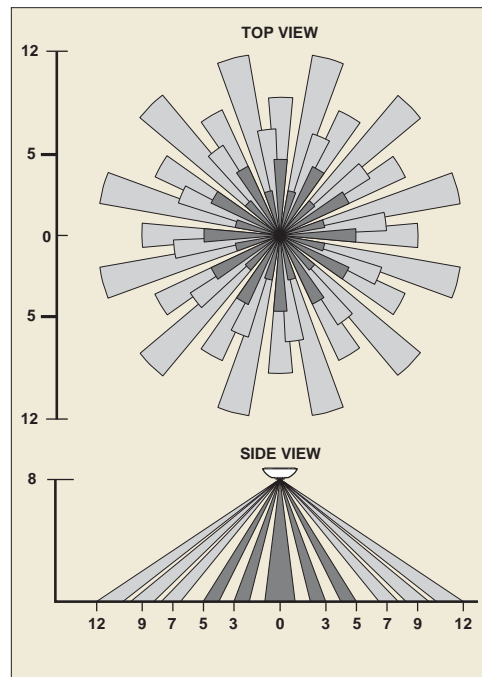

OSC04-IOW Field of View (in feet)

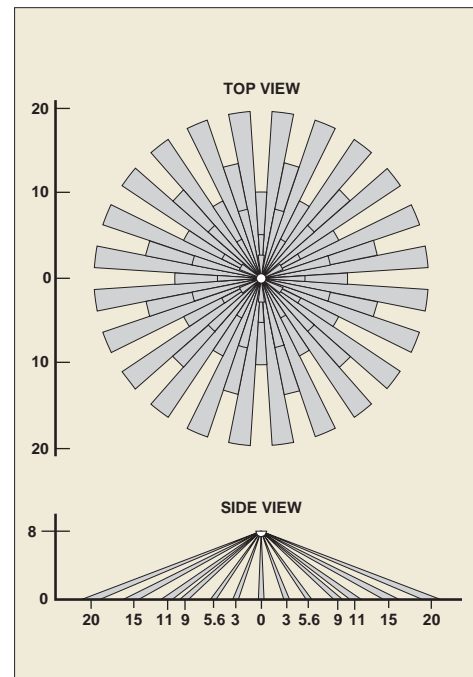

OSC15-IOW Field of View

#### SPECIFICATIONS AND FEATURES

- Ideal for use in small offices, closets, open offices, and other areas in commercial facilities with unobstructed view of the sensor
- Self-adjusting settings continuously analyze and adjust for optimum performance
- Ambient light override prevents lights from turning ON when there is ample natural light
- Manual Delayed-OFF time settings of 30 seconds to 30 minutes
- Self-Adjusting Delayed-OFF time interval settings for 30 seconds to 30 minutes — Compensates for real-time occupancy patterns, preventing unnecessary ON/OFF switching

- Non-volatile memory preserves all automatic and manual settings during power outages
- Small, unobtrusive size blends in with any décor
- Fast, simple installation using 4 color-coded low-voltage wires and a single mounting post

#### TESTING AND CODE COMPLIANCE

- Meets ASHRAE Standard 90.1 requirements
- Backed by a Limited Five-Year Warranty



### Wall-Mount Occupancy Sensor Lighting Controls

#### Multi-Technology Wall-Mount Occupancy Sensor (For use with Leviton Power Pack or Power Base Adaptor)\*

Advanced motion sensors combine infrared and ultrasonic technology for highly accurate monitoring without false triggering. All-digital self-adjusting technology provides “Install and Forget” solution for automatic lighting control.

| DESCRIPTION                            | CAT. NO.  | COVERAGE          | OPERATING FREQUENCY | COLOR |
|--|-----------|-------------------|---------------------|-------|
| Multi-Tech Wall-Mount Occupancy Sensor | OSW12-MOW | 115°, 1200 sq. ft | 32kHz               | White |

\*Low-voltage wiring is used to connect Leviton Occupancy Sensors to Cat. No. OSP20 Power Pack, OPB15 Power Base Adaptor or a Centura CN100 Power Pack (purchased separately). See page D15 for information on OSP20 and page D8 for information on OPB15.

Note: Canopy and neck allow the Wall-Mount Occupancy Sensor to be installed on the ceiling as well.



OSW12-MOW  
Wall Mount



OSW12-MOW  
Ceiling Mount

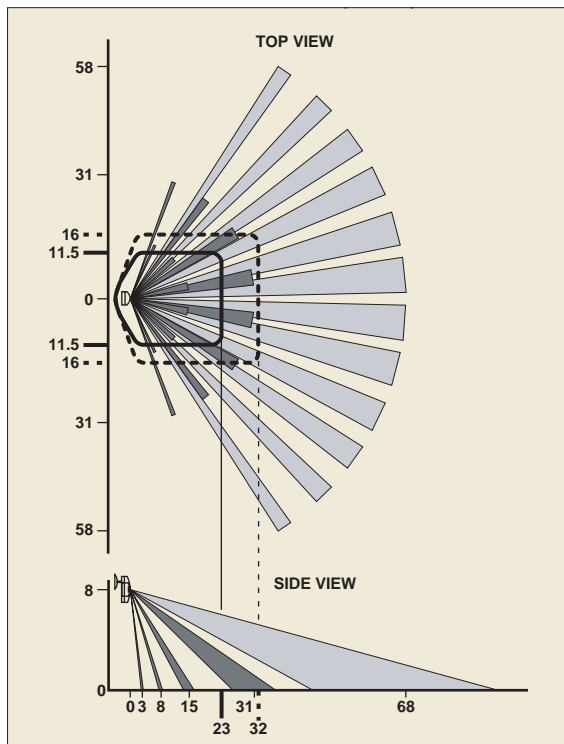

OSW12-MOW Field of View (in feet)

#### SPECIFICATIONS AND FEATURES

- Ideal for conference rooms, stairwells, high-ceiling rooms, open areas, storage rooms and classrooms. Also ideal for corner mounting in a variety of applications.
- Ultrasonic sensing for maximum sensitivity combined with Passive Infrared (PIR) sensing to prevent false triggering from air conditioning and corridor activity
- Adjustable swivel neck rotates 85° vertically and 60° horizontally— Can be used for ceiling or wall mounting
- Self-adjusting settings continuously analyze and adjust for optimum performance
- Ambient light override prevents lights from turning ON when there is ample natural light

- Manual Delayed-OFF time settings of 30 seconds to 30 minutes
- Self-Adjusting Delayed-OFF time interval settings for 30 seconds to 30 minutes — Compensates for real-time occupancy patterns, preventing unnecessary ON/OFF switching
- Non-volatile memory preserves all automatic and manual settings during power outages
- Fast, simple installation using 3 color-coded low-voltage wires and a single mounting post

#### TESTING AND CODE COMPLIANCE

- Meets ASHRAE Standard 90.1 requirements
- Backed by a Limited Five-Year Warranty
- California Title 24 Compliant



# OCCUPANCY SENSOR LIGHTING CONTROLS • WALL MOUNT

## Commercial Grade Energy Management Products

### Wall-Mount Occupancy Sensor Lighting Controls

#### Infrared Wide View, High-Bay and Long-Range Wall-Mount Occupancy Sensor <sup>UL</sup> <sup>CS</sup>

(For use with Leviton Power Pack or Power Base Adaptor)\*

Advanced Passive Infrared technology for highly accurate monitoring in a variety of commercial applications. All-digital self-adjusting technology provides "Install and Forget" solution for automatic lighting control.



OSWHB-IOW

| DESCRIPTION                                     | CAT. NO.  | COVERAGE                         | COLOR |
|---|-----------|----------------------------------|-------|
| Infrared Wide-View Wall-Mount Occupancy Sensor  | OSWWV-IOW | 115°, 2500 sq. ft                | White |
| Infrared High-Bay Wall-Mount Occupancy Sensor   | OSWHB-IOW | 55 ft., 7 ft. wide @ 30 ft. high | White |
| Infrared Long-Range Wall-Mount Occupancy Sensor | OSWLR-IOW | 100 ft., 110° @ 10 ft. high      | White |

\*Low-voltage wiring is used to connect Leviton Occupancy Sensors to Cat. No. OSP20 Power Pack, OPB15 Power Base Adaptor or a Centura CN100 Power Pack (purchased separately). See page D15 for information on OSP20 and page D8 for information on OPB15.

Note: Canopy and neck allow the Wall-Mount Occupancy Sensor to be installed on the ceiling as well.

Energy Management Products

#### SPECIFICATIONS AND FEATURES

- OSWWV-I: Ideal for conference rooms, stairwells, high-ceiling rooms, large open areas, parking garages, storage rooms and rooms with pendant fixtures. Also ideal for corner mounting in a variety of applications.
- OSWHB-I and OSWLR-I: Ideal for monitoring long, narrow spaces such as warehouse aisles, hallways, stairways, any narrow room, closets and storage areas. Also ideal for corner mounting in a variety of applications.
- Self-adjusting settings continuously analyze and adjust for optimum performance
- Ambient light override prevents lights from turning ON when there is ample natural light
- Adjustable swivel neck rotates 85° vertically and 60° horizontally—Can be used for ceiling or wall mounting
- Manual Delayed-OFF time settings of 30 seconds to 30 minutes
- Self-Adjusting Delayed-OFF time interval settings for 30 seconds to 30 minutes — Compensates for real-time occupancy patterns, preventing unnecessary ON/OFF switching
- Non-volatile memory preserves all automatic and manual settings during power outages
- Fast, simple installation using 3 color-coded low-voltage wires and a single mounting post

#### TESTING AND CODE COMPLIANCE

- Meets ASHRAE Standard 90.1 requirements
- Backed by a Limited Five-Year Warranty
- California Title 24 Compliant

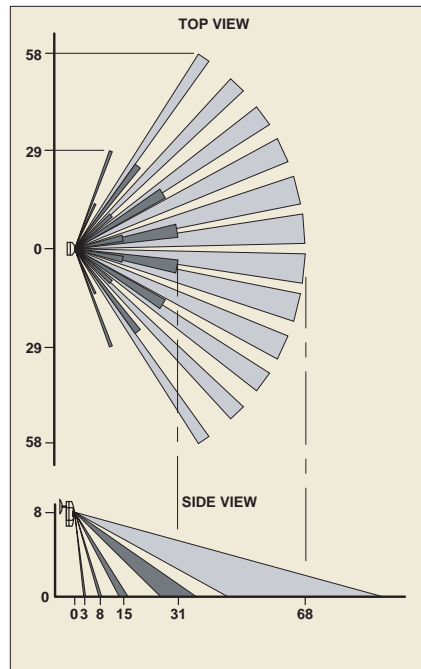

OSWWV Field of View (in feet)

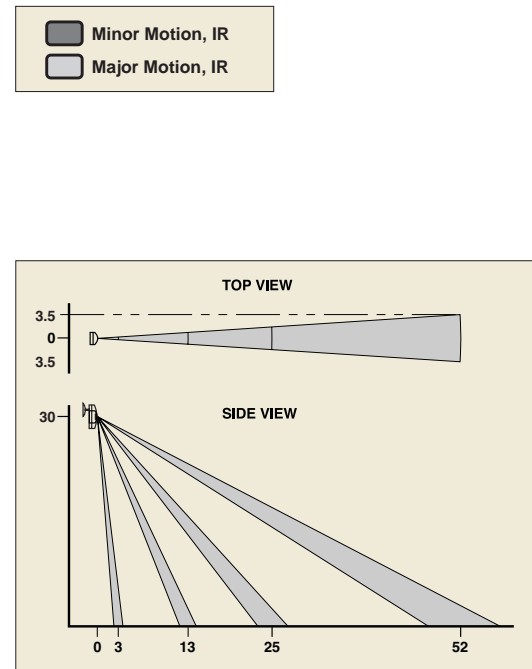

OSWHB Field of View

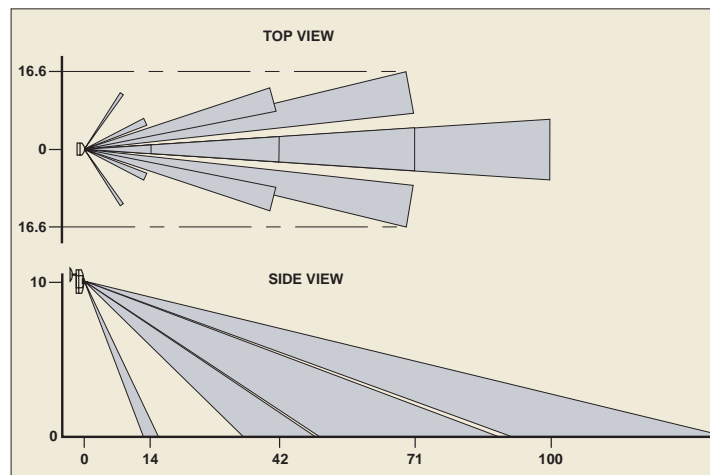

OSWLR Field of View



To learn more about Leviton's outstanding offering of devices visit our Website at: [www.leviton.com](http://www.leviton.com)



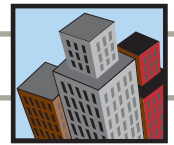

### Occupancy Sensor Power Packs

Power packs provide power for occupancy sensors as well as load switching circuitry. A Leviton Power Pack is required with any low voltage occupancy sensor. Add-A-Relay units can be used to expand control capability.

#### Power Packs and Accessories (For use with Leviton Occupancy Sensors on pages D10-D14)

| DESCRIPTION  | CAT. NO.  | POWER INPUT                 | RELAY RATING  | CONTROL INPUT | POWER SUPPLY OUTPUT |
|--|-----------|-----------------------------|---|---------------|---------------------|
| Power Pack   | OSP20-0D0 | 120/220/<br>277VAC,<br>60Hz | 20A fluorescent/<br>incandescent @ 120V,<br>20A fluor. @ 277V;<br>1HP @ 120V,<br>2HP @ 240V   | 5mA,<br>24VDC | 150mA,<br>24VDC     |
| Power Pack with<br>HVAC relay  | OSP20-RD0 | 120/220/<br>277VAC,<br>60Hz | 20A fluorescent/<br>incandescent @ 120V,<br>20A fluor. @ 277V;<br>1HP @ 120V, 2HP @ 240V;<br>HVAC: 0.5A @ 125VAC,<br>1A @ 30VDC       | 5mA,<br>24VDC | 150mA,<br>24VDC     |
| Power Pack with<br>HVAC relay  | OSP15-R30 | 347VAC,<br>60Hz             | 15A fluorescent @ 347V;<br>1HP @ 120V, 2HP @ 240V;<br>HVAC: 0.5A @ 125VAC,<br>1A @ 30VDC  | 5mA,<br>24VDC | 120mA,<br>24VDC     |
| Add-A-Relay Unit<br>with HVAC relay  | OSA20-R00 | —                           | 15A incandescent @ 120V,<br>20A fluorescent @ 120V,<br>20A fluor. @ 277V,<br>15A fluor. @ 347V;<br>HVAC: 0.5A @ 125VAC,<br>1A @ 30VDC | 5mA,<br>24VDC | —                   |
| Low-Voltage Nipple<br>Adapter with 1/2"<br>Lock Nut for Power<br>Pack and<br>Add-A-Relay units | OSPNA-000 | —                           | —   | —             | —                   |



### Power Pack Capacity Formula

Leviton power packs can be used to provide power to one or more occupancy sensors. Since current consumptions of occupancy sensors may vary, the best way to ensure you order the correct number of power packs and Add-A-Relays is by using this formula:

$$\left( \begin{array}{c} \text{Number of} \\ \text{Model A sensors} \\ \times \\ \text{Sensor A current} \\ \text{consumption rating} \end{array} \right) + \left( \begin{array}{c} \text{Number of} \\ \text{Model B sensors} \\ \times \\ \text{Sensor B current} \\ \text{consumption rating...} \end{array} \right) + \left( \begin{array}{c} \text{Number of} \\ \text{Add-A-Relays} \\ \times \\ 50\text{mA} \end{array} \right) \leq 150\text{mA per power pack}$$

| SENSOR                                      | CURRENT CONSUMPTION |
|---|---------------------|
| OSC04-I, OSC15-I, OSWHB-I, OSWLR-I, OSWWV-I | 20mA                |
| OSC05-M, OSC05-U, OSW12-M                   | 30mA                |
| OSC20-M, OSC20-U                            | 32mA                |
| OSC10-M, OSC10-U                            | 40mA                |
| OSA20-R00 Add-A-Relay                       | 50mA                |

#### SPECIFICATIONS AND FEATURES

##### Power Pack

- For use with all OS Series occupancy sensors
- Power supply for OS Series occupancy sensors
- Switches incandescent, magnetic and electronic fluorescent, magnetic and electronic low voltage, and motor loads
- Compact size and light weight allows easy mounting through knockout in junction box (from either inside or outside the box) with a simple twist-on nut

##### Add-A-Relay

- Expands power pack load capacity by functioning as a supplementary relay
- Provides ability to switch loads in different voltage systems

- Compatible with electronic ballasts
- Same compact size and mounting features as Power Pack

##### Nipple Adapter

- Simplifies the connection of occupancy sensor to the low-voltage side of a power pack mounted inside a fluorescent ballast cavity
- 1/2" conduit lock nut included

#### TESTING AND CODE COMPLIANCE

- cULus, FCC and NOM Certified
- Meets ASHRAE Standard 90.1 requirements
- Backed by a Limited Five-Year Warranty



# OCCUPANCY SENSOR LIGHTING CONTROLS • OUTDOOR

## Commercial and Residential Grade Energy Management Products



PS200

### Outdoor Motion Sensors

Passive Infrared (PIR) outdoor motion sensors provide outstanding value in security lighting, convenience, safety and energy savings for a wide range of commercial and residential applications.

#### COMMERCIAL GRADE

##### Professional Series Infrared Outdoor Occupancy Sensor

| DESCRIPTION   | CAT. NO. | RATING  | COVERAGE | COLOR |
|---|----------|---|----------|-------|
| Professional Series Outdoor PIR Motion Sensor                       | PS200-10 | Incandescent: 1000W @ 120V.<br>For 60Hz AC only | 200°     | White |
| Professional Series Outdoor PIR Motion Sensor with Dual Floodlights | PS200-1F | Incandescent: 1000W @ 120V.<br>For 60Hz AC only | 200°     | White |
| Professional Series Outdoor PIR Motion Sensor                       | PS110-10 | Incandescent: 1000W @ 120V.<br>For 60Hz AC only | 110°     | White |
| Professional Series Outdoor PIR Motion Sensor with Dual Floodlights | PS110-1F | Incandescent: 1000W @ 120V.<br>For 60Hz AC only | 110°     | White |

#### RESIDENTIAL GRADE

##### Residential Series Infrared Outdoor Occupancy Sensor

| DESCRIPTION  | CAT. NO. | RATING  | COVERAGE | COLOR |
|--|----------|---|----------|-------|
| Residential Series Outdoor PIR Motion Sensor                       | RS110-10 | Incandescent: 500W @ 120V.<br>For 60Hz AC only  | 110°     | White |
| Residential Series Outdoor PIR Motion Sensor with Dual Floodlights | RS110-1F | Incandescent: 500W @ 120V.<br>For 60Hz AC only. | 110°     | White |

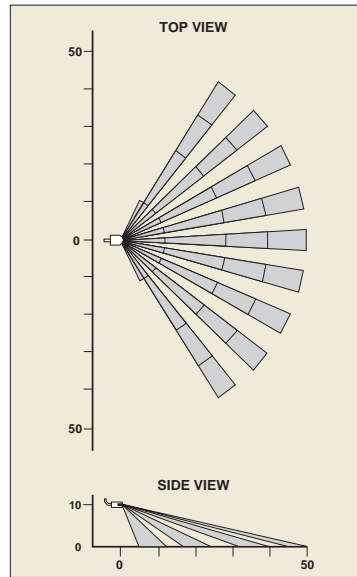

PS110/RS110 Field of View (in feet)

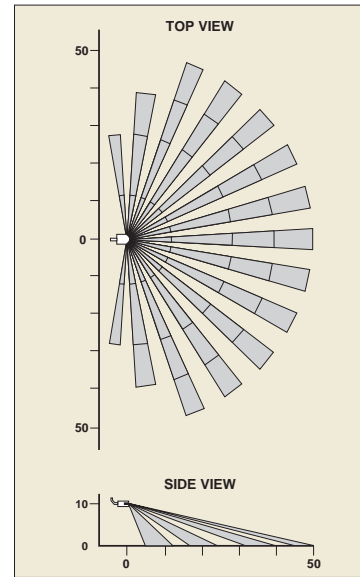

PS200 Field of View

#### SPECIFICATIONS AND FEATURES

##### Professional Series

- Ideal for a wide range of commercial/industrial settings including parking areas, storage facilities, warehouses, loading docks, marina, garages, walkways, campus grounds, meat lockers, walk-in refrigerators/freezers and outbuildings
- Adjustable Delayed-OFF time settings from 20 seconds (for test mode) to 15 minutes
- Adjustable sensitivity and immunity to RFI signals reduces false triggers
- Ambient light override prevents lights from turning ON when there is ample natural light
- Provides Automatic, Test and Continuous Modes—Test mode simulates automatic operation with short delayed-OFF time for ease of making adjustments. Continuous mode enables manual override for

constant "lights ON" operation (when used with standard ON/OFF switch)

- Surge suppression minimizes likelihood of damage due to electrical surges
- Temperature compensation feature ensures uniform performance in extreme hot or cold weather and during temperature fluctuations
- Sensor neck adjustment allows accurate area monitoring: 110° vertical, 180° horizontal, 110° rotational

##### Residential Series

- Ideal for a wide range of residential settings including backyards, garages, entranceways, porches, swimming pool areas, doorways and private docks
- Sensor neck adjustment allows accurate area monitoring: 110° vertical, 180° horizontal, 110° rotational
- Adjustable Delayed-OFF time settings from 20 seconds (for test mode) to 15 minutes

- Adjustable sensitivity reduces false triggers
- Provides Automatic, Test and Continuous Modes—Test mode simulates automatic operation with short Delayed-OFF time for ease of making adjustments. Continuous mode enables manual override for constant "lights ON" operation (when used with standard ON/OFF switch)

#### TESTING AND CODE COMPLIANCE

- UL Listed
- CSA Certified

#### MATERIAL CHARACTERISTICS

- Meets ASHRAE Standard 90.1 requirements
- Backed by a Limited Five-Year Warranty

# FLUORESCENT ENERGY MANAGEMENT SYSTEMS

## Commercial Grade Energy Management Products



### Centura® Fluorescent Energy Management System

Centura combines the technology of “daylight harvesting” with a host of innovative energy-efficient modular lighting controls, including dimmers, timers, occupancy sensors and photo-sensors that dim or turn off fluorescent lighting when a space is not being used. Centura incorporates the ability to interface with Leviton occupancy sensors to provide even greater energy savings. When single or multiple occupancy sensors are installed, programmed interior lighting is automatically turned OFF when the room is vacant and back ON to the programmed level when occupancy is detected. The use of movement sensors means energy savings up to a proven 50%.



### Leviton Occupancy Sensors Compatible with Centura System

| DESCRIPTION               | CAT. NO.  | COVERAGE                         | PAGE NO. |
|---------------------------|-----------|----------------------------------|----------|
| Multi-tech Ceiling Sensor | OSC05-M0W | 180°, 500 sq. ft.                | D10      |
| Multi-tech Ceiling Sensor | OSC10-M0W | 360°, 1000 sq. ft.               | D10      |
| Multi-tech Ceiling Sensor | OSC20-M0W | 360°, 2000 sq. ft.               | D10      |
| Ultrasonic Ceiling Sensor | OSC05-U0W | 180°, 500 sq. ft.                | D11      |
| Ultrasonic Ceiling Sensor | OSC10-U0W | 360°, 1000 sq. ft.               | D11      |
| Ultrasonic Ceiling Sensor | OSC20-U0W | 360°, 2000 sq. ft.               | D11      |
| PIR Ceiling Sensor        | OSC04-I0W | 360°, 450 sq. ft.                | D12      |
| PIR Ceiling Sensor        | OSC15-I0W | 360°, 1500 sq. ft.               | D12      |
| Multi-tech Wall Sensor    | OSW12-M0W | 115°, 1200 sq. ft.               | D13      |
| PIR Wide-View Sensor      | OSWWV-I0W | 115°, 2500 sq. ft.               | D14      |
| PIR Long Range Sensor     | OSWLR-I0W | 100 ft. @ 10 ft. high            | D14      |
| PIR High-Bay Sensor       | OSWHB-I0W | 55 ft., 7 ft. wide @ 30 ft. high | D14      |

Note: The Leviton Occupancy Sensors listed can be powered by the Centura Dimming Power Pack—Use of a separate Occupancy Sensor Power Pack is not required.

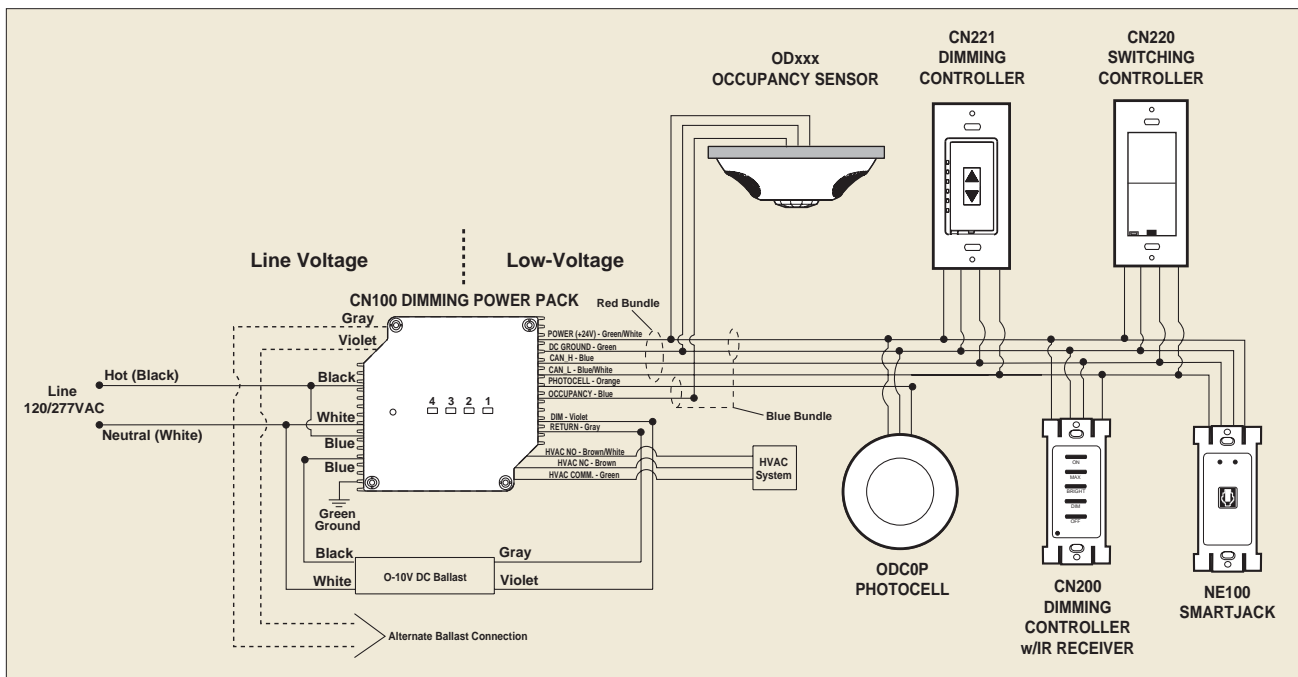

System Wiring Diagram

For more information on Commercial Fluorescent Energy Management Systems, visit Leviton's website at [www.leviton.com](http://www.leviton.com)



# FLUORESCENT ENERGY MANAGEMENT SYSTEMS

## Commercial Grade Energy Management Products

Energy Management Products

### Centura® Fluorescent Energy Management System

Leviton's Centura, a modular lighting control system for dimming fluorescent ballasts (Advance Mark 7™, OSRAM Sylvania Quicktronic® Helios™ and Energy Savings SuperDim™), brings increased energy savings to commercial spaces. Using a technique known as "daylight harvesting," Centura factors in the available daylight for the precise control of fluorescent light levels to achieve optimum comfort and energy efficiency.

#### Centura Fluorescent Energy Management System

| DESCRIPTION   | CAT. NO.  | RATING   | COLOR                                    |
|---|-----------|--|--|
| Centura Dimming Power Pack—ON/OFF and DIM/BRIGHT control of 0-10VDC dimming fluorescent ballasts. Responds to Wall Controller, Occupancy Sensor and Photocell input and provides +24 VDC power supply for these devices. Programmed via Wall Controller or via Leviton Personal Dimmer software from a PC. Secondary relay sends control signals to HVAC system. LEDs indicate operation mode | CN100-0D0 | 2400VA @ 120V AC 60Hz, 5500VA @ 277V AC 60Hz. For use with Advance Mark 7™ 0-10VDC, OSRAM Sylvania Quicktronic® Helios™, Energy Savings SuperDim™ and comparable ballasts only | Gray Metallic                            |
| Centura Dimming Controller with Infrared Receiver—Decora-style 5-button unit for ON/OFF, DIM/BRIGHT and MAX override. Built-in IR receiver for use with Centura NE200-00E Hand-Held Remote. Programs energy management functions  | CN200-00C | No load rating, for use with Centura Dimming Power Pack only   | White (Ivory color change kit included)  |
| Centura Hand-Held Remote Controller Infrared—Remote provides convenient ON/OFF, DIM/BRIGHT control presets and programming. Designed for use with Centura CN200   | NE200-00E | No load rating, for use with Centura CN200 Controller only   | Black                                    |
| Centura Switching Controller—Decora-style rocker for ON/OFF switching   | CN220-00C | No load rating   | White (Ivory color change kit included)  |
| Centura Dimming Controller—Decora-style rocker for ON/OFF switching with built-in arrow-shaped rocker for DIM/BRIGHT control. LED display indicates selected brightness level. Programs energy management functions—back of wallplate provides instruction label that lines up with LEDs to facilitate programming  | CN221-00C | No load rating, for use with Centura Dimming Power Pack only   | White (Ivory color change kit included)  |
| Centura Photocell—Detects available light levels for "Daylight Harvesting." Allows Centura system to maintain a programmed light level by constantly adjusting fluorescent light output to compensate for changes in available daylight   | ODCOP     | No load rating, for use with Centura Dimming Power Pack only. 0-70 foot candles  | White                                    |
| Centura Lcnet SmartJack—Includes a cable for connecting the SmartJack to a PC and a mini-CD containing server, administrator and user software. For the latest software upgrades, check Leviton's website at <a href="http://leviton.com/centura">leviton.com/centura</a>   | NE100-00C | No load rating, for use with Centura Power Pack  | White (Ivory color change kits included) |

For more information on Commercial Fluorescent Energy Management Systems, visit Leviton's website at [www.leviton.com](http://www.leviton.com)

#### SPECIFICATIONS AND FEATURES

- Ideal for commercial spaces and individual offices
- Reduces eyestrain and fatigue from glare, increasing comfort and productivity
- All functions conveniently accessed through Controllers or via Leviton Personal Dimmer software from a PC
- Dimming Power Pack provides low-voltage power supply for Controllers, Photocell and Occupancy Sensors
- Photocell provides energy savings through Daylight Harvesting technology
- Use with Leviton Occupancy Sensors for increased energy savings: Lights turn ON automatically to programmed levels when personnel enter area; OFF automatically when area becomes vacant

- Modular system design expands energy saving options with an interface for building emergency systems, load shedding programs and time clock systems
- Dimming Power Pack mounts in standard 4" square back box. Dimming and Switching Controllers mount in standard single-gang switch box

#### TESTING AND CODE COMPLIANCE

- Agency approvals for all Centura components are UL, CSA, NOM, FCC, and California Title 24 (where applicable) except for the hand-held remote controller
- Meets ASHRAE Standard 90.1 requirements
- Backed by a Limited Two-Year Warranty (except photocell: Backed by a Limited Five-Year Warranty)

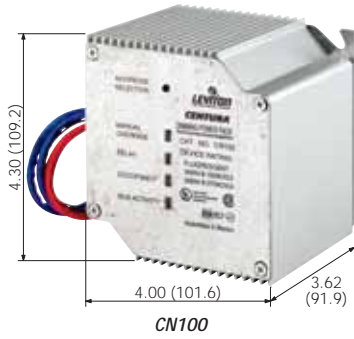

CN100



CN200

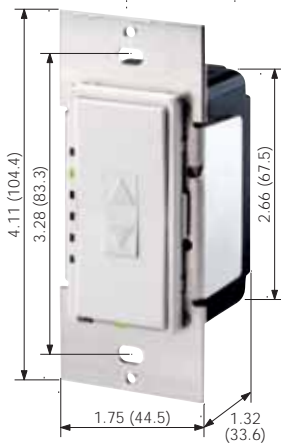

CN221

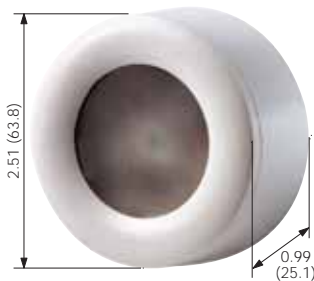

ODCOP

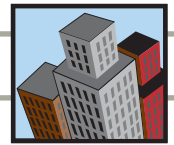

### Decora Plus Electronic Timer Switches

Leviton Timers add contemporary styling to any commercial or residential application. Built to the highest performance standards, Decora Electronic Timers provide long-lasting trouble-free service life.

Four Preset buttons plus an OFF button permit timed control of lights and appliances. Decora Plus Timers are ideal for heat lamps, foyer and outdoor lights, hot tubs, spas, attic and exhaust fans. LEDs indicate elapsed time and flash “Two Minutes Until OFF” warning.

#### COMMERCIAL GRADE

##### Electronic Timer Switches 120V AC 60Hz

| DESCRIPTION                                      | CAT. NO. | INTERVAL            | COLOR*     |
|--|----------|---------------------|------------|
| Four Preset Buttons and OFF                      | 6215M    | 2-5-10-15 Minutes   | I, W, A, T |
| 3-Wire, Single-Pole (Neutral Required)           | 6230M    | 5-10-15-30 Minutes  | I, W, A, T |
| 1000W Incandescent, 20A Inductive                | 6260M    | 10-20-30-60 Minutes | I, W, A, T |
| 1 HP @ 120V. Compatible with electronic ballasts | 6212H    | 2-4-8-12 Hours      | I, W, A    |

#### RESIDENTIAL GRADE

##### Electronic Timer Switches 120V AC 60Hz

| DESCRIPTION                 | CAT. NO. | INTERVAL            | COLOR*  |
|-----------------------------|----------|---------------------|---------|
| Four Preset Buttons and OFF | 6515M    | 2-5-10-15 Minutes   | I, W, A |
| 2-Wire, Single-Pole, 120V   | 6560M    | 10-20-30-60 Minutes | I, W, A |
| 500W Incandescent Only      | 6512H    | 2-4-8-12 Hours      | I, W, A |



#### SPECIFICATIONS AND FEATURES

- Electronic Timer Switch has four preset buttons plus OFF for timed control of lights and appliances
- Electronic Timer Switch LEDs indicate time elapsed and last LED flashes two minutes until OFF warning
- All install easily in single gang wallbox in place of standard switch
- Electronic keypad control
- Matching Decora wallplate included

#### TESTING AND CODE COMPLIANCE

- UL Listed (File #E-66800)
- CSA Certified (File #LR-68679)
- NOM Certified (#057)
- Meets ASHRAE Standard 90.1 requirements
- NOM Certified (#057)
- Backed by a Limited Two-Year Warranty

#### \*COLOR

Colors available as listed. For color selections, add suffix to catalog numbers as follows: Ivory (-I), White (-W), Almond (-A), Light Almond (-T).

#### MATERIAL CHARACTERISTICS

Environmental: Flammability UL-94, V2 Rating  
Operating Temperature: 32°F to 130°F

For more information regarding matching wallplates, colors, materials, single and multi-gang, refer to Wallplates, section E.



# DECORA® ELECTRONIC TIMER SWITCHES

## Commercial and Residential Grade Energy Management Products

Energy Management Products

### Decora Programmable Electronic Timer Switches

#### COMMERCIAL GRADE

#### 24-Hour Programmable Electronic Timer Switch 120V AC 60Hz

| DESCRIPTION   | CAT. NO. | INTERVAL   | COLOR*     |
|---|----------|--|------------|
| 24-Hour LCD Programmable Timer Switch—1200W Incandescent, 1200VA Inductive @ 120V AC 60Hz<br>Motor: 1 HP @ 120V AC 60Hz UL, 3/4 HP @ 120V AC 60Hz CSA<br>Neutral Connection Required<br>Compatible with electronic ballasts | 6124H    | 24-Hour ON/OFF scheduling in 30 minute intervals | I, W, A, T |

#### RESIDENTIAL GRADE

#### 14-Hour Programmable Electronic Timer Switch 120V AC 60Hz

| DESCRIPTION  | CAT. NO. | INTERVAL                                      | COLOR   |
|--|----------|---|---------|
| 14-Hour Segment Programmable Timer Switch—40W min, 500W max. @ 120V AC 60Hz, Incandescent only | 6651     | 14-Hour ON/OFF scheduling in hourly intervals | I, W, A |

#### Variable Countdown Timer Switch 120V AC 60Hz

| DESCRIPTION  | CAT. NO. | INTERVAL             | COLOR   |
|--|----------|----------------------|---------|
| Decora Style Rotary-Dial Variable Countdown Timer Switch—600W Incandescent, 20A Inductive<br>Motor: 1 HP @ 120V AC 60Hz<br>Neutral Connection Required | 6652     | 1 minute to 18 hours | I, W, A |

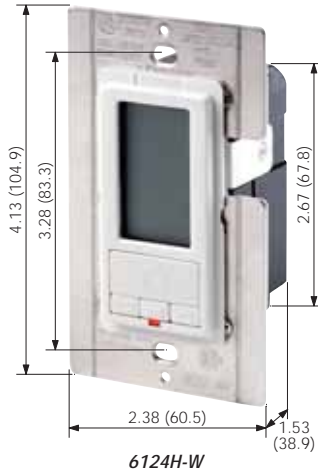

6124H-W

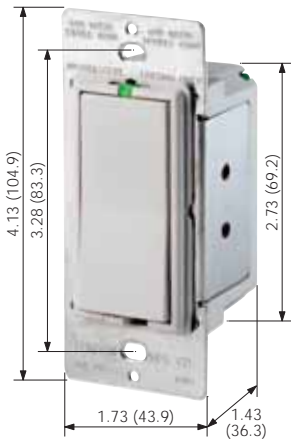

6651-W

#### SPECIFICATIONS AND FEATURES

##### 24-Hour Programmable Timer

- Ideal for a wide variety of commercial and residential applications including outdoor lighting, pools, motors, sprinklers, exhaust and attic fans, bathroom heat lamps, hot tubs and spas, whole-house exhaust fan scheduling, office lights, janitor closets, landscape and security lighting
- Permits separate ON or OFF scheduling for half-hour periods of the day; ON/OFF manual control available by using button below display panel
- Decora styling enhances any interior (NOTE: 6124H cannot be used with Decora Plus Screwless Snap-On Wallplates)

##### 14-Hour Programmable Timer

- Ideal for residential incandescent lighting control including indoor, outdoor and seasonal lighting
- “Set-it-and-forget convenience” provides automatic daily control with manual override
- Automates daily switching program (up to 14 hours) by responding to DIP switch ON or OFF position for each hour; repeats until function switch is moved to Manual or OFF mode

##### Countdown Timer Switch

- For residential and light commercial applications including indoor and outdoor lighting, office lights and ceiling paddle fans
- Simple rotary-dial time selection of settings from 1 minute to 18 hours: ON/OFF manual control available
- An illuminated LED indicates load is ON. Blinking LED accompanied by annunciator sound indicates end of time cycle

#### TESTING AND CODE COMPLIANCE

- UL Listed (File #E-66800)
- CSA Certified (File #LR-68679)
- Backed by a Limited Two-Year warranty

#### \*COLOR

Colors available as listed. For color selections, add suffix to catalog numbers as follows: Ivory (-I), White (-W), and Almond (-A).

#### MATERIAL CHARACTERISTICS

Environmental: Flammability UL-94, V2 Rating  
Operating Temperature: 32°F to 130°F

# TIMED LIGHTING CONTROL PANELS

## Commercial Grade Energy Management Products

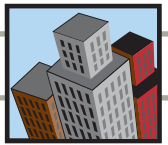

### Z-MAX Relay Overview

#### **Z-MAX** Lighting Control Relay Systems

The Leviton Z-MAX™ line of timed lighting controls and relays provides advanced scheduling of lighting and other loads in applications where a time clock is typically used in conjunction with switching contactors. All Z-MAX models feature easy-to-use menu-driven programming and configuration, a programmable time clock and output relays in a compact cabinet, and several optional accessories for remote control. Z-MAX relay panels are ideal for cafeterias, auditoriums, offices, parking facilities, gymnasiums, pools, educational facilities, and landscape and security lighting. A number of wall stations, flush trim kits and other accessories are available.

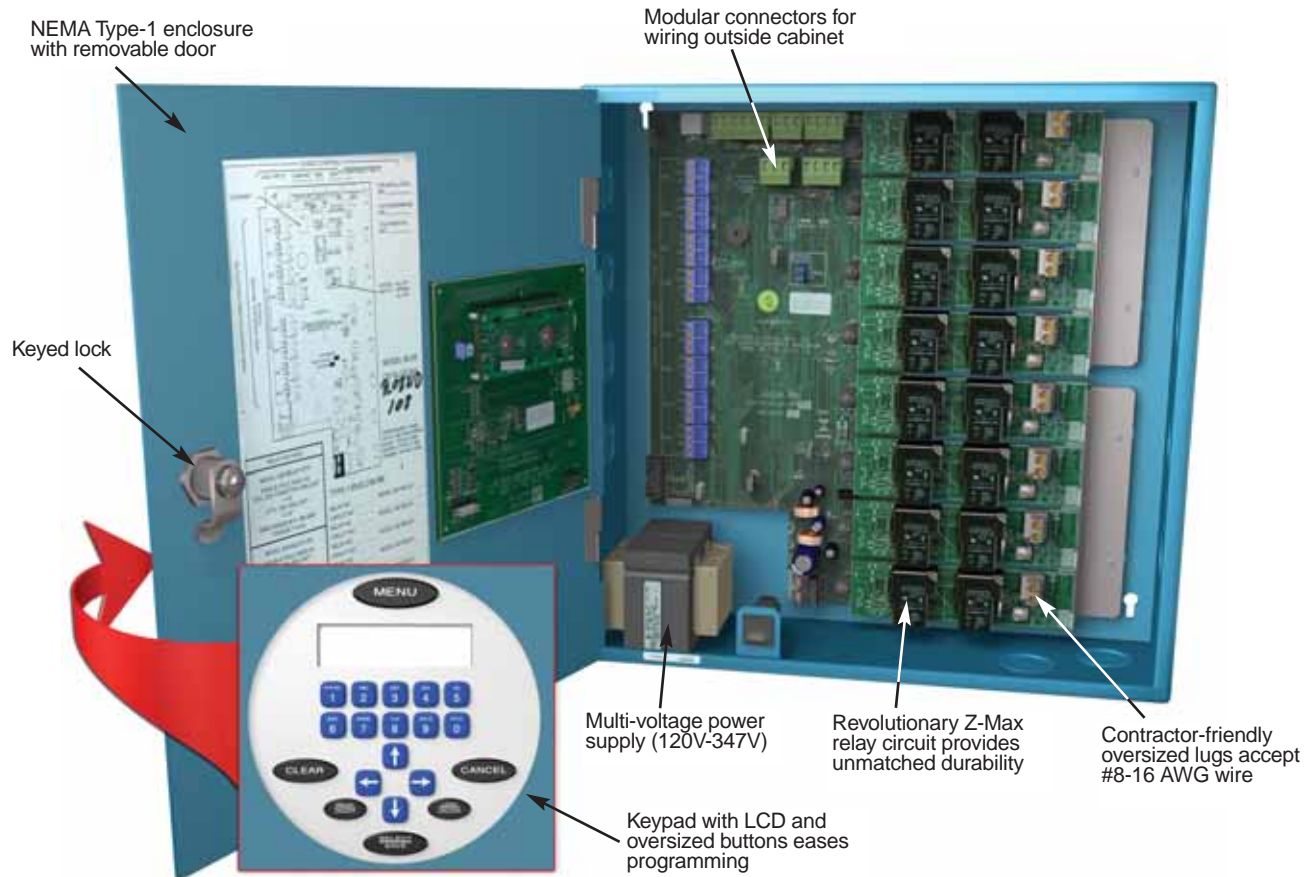

- In four versions: 8-relay non-networked and 8-relay, 24-relay, 48-relay networked
- Single-circuit relay cards simplify maintenance and expansion
- Integrated astronomical time clock
- Individually replaceable relays rated for all light sources as well as motors
- Single-pole and two-pole relays fit in the same location
- Normal or emergency panel capability
- Compatible with occupancy sensors, photocells, digital and low-voltage wall stations and more

### Available Color

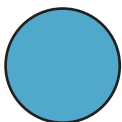

Blue



## TIMED LIGHTING CONTROL PANELS

### Commercial Grade Energy Management & Dimming Products



#### Z-MAX™ Relay Cabinets

Z-MAX Relay Cabinets provide complex scheduling of lighting and other loads in commercial and residential applications where a time clock would typically be used in conjunction with switching contactors. Z-MAX relay cabinets are ideal for cafeterias, auditoriums, offices, parking facilities, gymnasiums, pools, educational facilities, and landscape and security lighting. Unique to Z-MAX is the standard relay card's proprietary circuitry that eliminates arc shower pitting at the contacts for extended relay life. The stand-alone cabinets presented here are best suited to advanced scheduling of a single area (networked 8-relay cabinets are also available). The Z-MAX line features a wide range of accessories, including digital and low-voltage switch stations.

#### 8-Relay Stand-Alone Z-MAX Cabinets

With 8 switch inputs and 20A output relays

| DESCRIPTION                            | CAT. NO.  | INPUT POWER    | COLOR |
|--|-----------|----------------|-------|
| Standard 8-Relay Cabinet (no relays)   | R08BD-000 | 120, 277, 347V | Blue  |
| 8-Relay Cabinet with 4 Standard Relays | R08BD-104 | 120, 277, 347V | Blue  |
| 8-Relay Cabinet with 8 Standard Relays | R08BD-108 | 120, 277, 347V | Blue  |
| 8-Relay Cabinet with 4 2-Pole Relays   | R08BD-204 | 120, 277, 347V | Blue  |
| 8-Relay Cabinet with 8 2-Pole Relays   | R08BD-208 | 120, 277, 347V | Blue  |
| 8-Relay Cabinet with 4 347V Relays     | R08BD-C04 | 120, 277, 347V | Blue  |
| 8-Relay Cabinet with 8 347V Relays     | R08BD-C08 | 120, 277, 347V | Blue  |

*For network versions replace B in middle of catalog number with N for network. 24-relay and 48-relay cabinets with 12 switch inputs (in master and slave versions) are also available. For digital and low-voltage switch stations, see page D26.*

#### Z-MAX Relay Cards

For incandescent, electronic fluorescent, magnetic fluorescent, electronic low voltage, neon cold cathode, high intensity discharge and motor loads

| DESCRIPTION                          | CAT. NO.  | INPUT POWER |
|--------------------------------------|-----------|-------------|
| Standard 20A Single-Pole Relay Card* | RELAY-STD | 120-277V    |
| 2-Pole 20A Relay Card                | RELAY-2PL | 240/480V    |
| 347V Single-Pole 20A Relay Card      | RELAY-347 | 120-347V    |
| Normally Closed Relay Card           | RELAY-NCL | 120-347V    |

\*NOTE: Relay cabinets ship with RELAY-STD modules unless otherwise specified.

*For the complete line of Z-MAX components, visit Leviton's website at [www.leviton.com](http://www.leviton.com).*

#### SPECIFICATIONS AND FEATURES

- Easy-to-program keypad control module with LCD screen and straightforward menus—in plain English (not code)
- Internal time clock with astronomical clock, daylight savings time, and holiday scheduling features
- Generous wiring space and easy-to-wire terminals
- Switch inputs with override capability for each relay
- Hinged, removable door with keyed lock
- Works with analog controllers, low voltage switches, discrete and analog photocells, and occupancy sensors
- Accessories include: Z-MAX Switch Stations, telephone and modem interface modules, additional

switch input board, Ethernet module, photocell, flush trim kits, voltage barriers, and PC-based programming software

- Enclosure Dimensions: 13.00 (330.2) x 13.00 (330.2) x 4.34 (110.6)

#### TESTING AND CODE COMPLIANCE

- UL Listed (for individual load types) and CUL Listed under both Industrial Control Equipment and Energy Management Equipment
- California Title 24 compliant and meets ASHRAE Standard 90.1 requirements
- NOM certified
- Limited Two-Year Warranty on cabinets





### Z-MAX Relay Product Listing

#### Z-MAX Relay Cabinets with Integrated Electrical Distribution

Z-MAX Relay Panels with an integrated electrical distribution system offer the convenience of a single feed with the flexibility of our popular Z-MAX relay system. Each includes all the award winning features of the Z-MAX product line, integrated with a standard system of electrical distribution and over current protection. These integrated systems use commonly available Cutler Hammer breakers.



Z-MAX Relay Cabinets with Integrated Electrical Distribution

#### 120V Systems Stock Configurations

| CAT. NO.  | VOLTS   | PHASE | POWER FEED        | NO. OF CIRCUIT BREAKERS (20A SINGLE POLE) | NO. OF Z-MAX RELAY MODULES (STANDARD SINGLE POLE) |
|-----------|---------|-------|-------------------|---|---|
| RB423-L11 | 120/208 | 3Ø    | Main Lug          | 42  | 42  |
| RB423-B11 | 120/208 | 3Ø    | 225A Main Breaker | 42  | 42  |
| RB421-L11 | 120/240 | 1Ø    | Main Lug          | 42  | 42  |
| RB421-B11 | 120/240 | 1Ø    | 225A Main Breaker | 42  | 42  |
| RB243-L11 | 120/208 | 3Ø    | Main Lug          | 24  | 24  |
| RB243-B11 | 120/208 | 3Ø    | 225A Main Breaker | 24  | 24  |
| RB241-L11 | 120/240 | 1Ø    | Main Lug          | 24  | 24  |
| RB241-B11 | 120/240 | 1Ø    | 225A Main Breaker | 24  | 24  |

#### 277V Systems Stock Configurations

| CAT. NO.  | VOLTS   | PHASE | POWER FEED        | NO. OF CIRCUIT BREAKERS (20A SINGLE POLE) | NO. OF Z-MAX RELAY MODULES (STANDARD SINGLE POLE) |
|-----------|---------|-------|-------------------|---|---|
| RB423-L21 | 277/480 | 3Ø    | Main Lug          | 42  | 42  |
| RB423-B21 | 277/480 | 3Ø    | 200A Main Breaker | 42  | 42  |
| RB243-L21 | 277/480 | 3Ø    | Main Lug          | 24  | 24  |
| RB243-B21 | 277/480 | 3Ø    | 200A Main Breaker | 24  | 24  |

Custom configurations are available upon request.

Contact your local Leviton LMS representative for additional information or visit [www.leviton.com/LMS](http://www.leviton.com/LMS).

#### SPECIFICATIONS AND FEATURES

- Single or Three Phase configurations
- 120V, 277V or 347V systems
- Main lugs or main breaker
- Custom load center configuration
- Field replaceable standard breakers
- All standard Z-MAX operational features
- Uses Cutler-Hammer CH, GHQ and GBH frame snap-in breakers, locked in place by the enclosure
- Ships as one complete pre-wired assembly

- Up to 100,000A AIC, short Circuit Current Rating, available on all panelboards (Consult factory for details)
- 277/480V panelboards, main lugs, 65k AIC @ 120/208V, 14k AIC @ 277/480V standard
- 277/480V panelboard, main breaker, 35k AIC standard
- 120/208V or 120/240V panelboards, main lugs, 10k AIC standard
- 120/208V or 120/240V panelboards, main breaker, 25k AIC standard depending on main breaker

- 347/600V panelboards, main lugs, 10k AIC standard
- 347/600V panelboards, main breaker, 19k AIC standard

#### TESTING AND CODE COMPLIANCE

- UL and cUL Listed

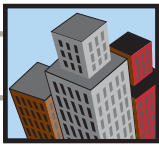

## TIMED LIGHTING CONTROL PANELS

### Commercial Grade Energy Management & Dimming Products

#### Z-MAX Relay Product Listing

##### RRP—Remote 4-Relay Panel (Controlled by Z-MAX Master Cabinet)

The RRP (Remote Relay Panel) provides distributed switching of up to four 20 amp lighting circuits, enabling multiple units to be networked and controlled from a Z-MAX Master Relay Panel. With photocell, occupancy sensor and local switch inputs, the RRP is an ideal solution for applications such as school classrooms where daylight harvesting, occupancy sensor control, local switching and central control scheduling are desired. Revolutionary Z-MAX switching circuit with 10,000,000 cycle life employed in the 120-277V standard relay model.

##### RRP—Remote 4-Relay Panel

| DESCRIPTION   | CAT. NO.  | RATING        |
|---|-----------|---------------|
| Remote Relay Panel with 4, Single Pole 20 Amp Relays for use with Z-MAX. 120/277V | RE4SD-104 | 20A per relay |
| Remote Relay Panel with 4, Double Pole 20 Amp Relays for use with Z-MAX. 120/277V | RE4SD-204 | 20A per relay |
| Remote Relay Panel with 4, Single Pole 20 Amp Relays for use with Z-MAX. 347V     | RE4SD-304 | 20A per relay |

*Dimensions: 10.0 (254.0) H x 10.0 (254.0) W x 4.0 (101.6) D*



RRP – Remote 4-Relay Panel

*For more information on Z-MAX Remote Relay Panels and Accessories, refer to Z-MAX data sheets.*

#### SPECIFICATIONS AND FEATURES

- Network ready for up to 96 total relays
- USB port for software updates and network configuration
- 120/277V dual voltage standard
- 347V available
- Removable interior allows rough-in without risk of damage to components
- Rated for 100% load capacity
- Handles in-rush currents in excess of 50 times load current
- Low-voltage switch inputs support Leviton low voltage switches and GE-style, ON/OFF switches with optional LED output

#### ACCESSORIES

- Low-voltage switch adapter (reduces required wire count of GE style switch by 1)
- 1-10 Button low voltage switches
- Indoor and outdoor 0-10V photocells
- Atrium and skylight 0-10V photocells



### EZ-MAX Relay Product Listing

#### EZ-MAX Relay Cabinets

EZ-MAX relay lighting control panels combine the power and performance of the larger Z-MAX relay cabinets in a cost-effective four-circuit package that's housed in a compact 10" X 10" standard electrical enclosure. It is the ideal contractor friendly, quick-to-install solution for smaller, stand-alone applications that do not require the field configuration or advanced networking features of the larger Z-MAX cabinets. It serves as a smart replacement for time clock/contactor installations for any application requiring reliable and cost-effective automatic lighting control.



EZ-MAX Relay Cabinet

#### EZ-MAX Relay Cabinets

| DESCRIPTION                          | CAT. NO.  | RATING        |
|--------------------------------------|-----------|---------------|
| EZ-MAX with 4 120-277V relays        | RE4BD-104 | 20A per relay |
| EZ-MAX with 4 208-480V 2-pole relays | RE4BD-204 | 20A per relay |
| EZ-MAX with 4 120-347V relays        | RE4BD-C04 | 20A per relay |

For more information on EZ-MAX Relay Cabinets, refer to EZ-MAX data sheets.

*Dimensions: 10.0 (254.0) H x 10.0 (254.0) W x 4.0 (101.6) D*

*See pages D10-D15 for information on compatible Leviton Occupancy Sensors.*

*For digital and low-voltage switch stations, see page D26.*

#### SPECIFICATIONS AND FEATURES

##### Relay Cabinets

- 120-277V standard relay model features revolutionary, patent-pending Z-MAX switching circuit with an unprecedented 10,000,000 cycle life
- 347V available
- Low-voltage inputs allow connection of photocells, occupancy sensors and low-voltage switches for a comprehensive, easy-to-install energy management solution
- Refer to pages D21-D22 for Z-MAX general features

##### Accessories

- Modem module for touch tone control or remote configuration

- Low-voltage switch adapter (reduces required wire count of GE style switch by 1)
- 1-4 Button low voltage switches
- Indoor and outdoor 0-10V photocells
- Atrium and skylight 0-10V photocells

#### TESTING AND CODE COMPLIANCE

- ASHRAE 90.1 compliant
- CEC Title 24 compliant
- Limited Ten-Year Warranty

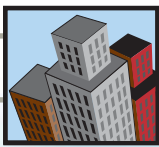

## TIMED LIGHTING CONTROL PANELS

### Commercial and Residential Grade Energy Management Products

#### Z-MAX Relay Product Listing

##### Z-MAX Digital and Low Voltage Switch Stations

The Z-MAX system can incorporate either digital or low-voltage stations. Although they look identical, there are a few differences in how they operate. Both contain buttons that are programmable to a variety of functions and custom labels are available.

##### Z-MAX Switch Stations

| DESCRIPTION   | DIGITAL SWITCH CAT. NO.* | LOW-VOLTAGE SWITCH CAT. NO.** | COLOR |
|---------------|--------------------------|-------------------------------|-------|
| On/Off switch | ZMDSW-01W                | LVS-01W                       | White |
| Zones 1 and 2 | ZMDSW-02W                | LVS-02W                       | White |
| Zones 1 to 3  | ZMDSW-03W                | LVS-03W                       | White |
| Zones 1 to 4  | ZMDSW-04W                | LVS-04W                       | White |
| Zones 1 to 5  | ZMDSW-05W                | LVS-05W                       | White |
| Zones 1 to 6  | ZMDSW-06W                | LVS-06W                       | White |
| Zones 1 to 8  | ZMDSW-08W                | LVS-08W                       | White |
| Zones 1 to 10 | ZMDSW-10W                | LVS-10W                       | White |

Note: Wallplate sold separately

\*Support network and master Z-MAX versions only

\*\*Support EZ-MAX and Z-MAX stand-alone and slave versions only

##### miniZ™ Low-Voltage Switch Stations

| DESCRIPTION   | CAT. NO.  | COLOR |
|---|-----------|-------|
| 5-Button dimming controller with On/Off, for use with miniZ only. | LV200-00W | White |
| On/Off switch controller for use with miniZ, Z-MAX and EZ-MAX     | LV240-00W | White |

Dimensions: 4.71 (119.7) H x 1.76 (44.7) W x 1.26 (32.0) D for Switch Stations



ZMDSW-03W



LVS-08W

#### SPECIFICATIONS AND FEATURES

##### Common Features

- Available in 8 configurations
- Programmable functions include: on, off, and group and scene select
- Compatible with standard and midway size Decora® wallplates
- Custom labeling available; contact a factory representative

##### Digital Station

- Wired via Luma-Net® to compatible products including D4200, D8000, a-2000, i Series e, i Series Quad, and Z-MAX Relay Cabinets
- Networks with up to 127 devices
- Compatible with handheld IR remote control

##### Low-Voltage Station

- Compatible with EZ-MAX and Z-MAX Relay Cabinets, MDS cabinets, a-2000 cabinets (with analog card), network protocol converter, and other low-voltage devices
- Cat. No. LV240 for use with miniZ Intelligent Daylight Management System, Z-MAX and EZ-MAX
- Cat. No. LV200 for use with miniZ Intelligent Daylight Management System only

#### WARRANTY

- Limited Two-Year Warranty



### miniZ™ Product Listing

#### miniZ™ Intelligent Daylight Management System

miniZ combines occupancy sensing, daylight harvesting and flexible lighting control functions into a single, easily installed package. miniZ features several methods of ladderless commissioning, including the AutoCal™ feature, the world's first 100% self-configuring daylight harvesting system. Installation requires little more than any other power-pack type product. The performance features and capabilities of the miniZ product provide a package that surpasses all others in the industry at a price anyone can afford.

#### miniZ™ Intelligent Daylight Management System

20A output relays (120/277V); 15A output relays (347V); Fluorescent, non-dimmed and 1-10V dimmed (0,2 or 3 zones); 120mA/24V output for operation of occupancy sensors, etc.

| CAT. NO.   | 20A POWER CIRCUITS | 0-10V DIMMING CIRCUITS | CONTROL INPUT VOLTAGE | NETWORK FUNCTIONALITY |
|------------|--------------------|------------------------|-----------------------|-----------------------|
| MZB00-102  | 2                  | 0                      | 120/277VAC            | No                    |
| MZD20-102  | 2                  | 2                      | 120/277VAC            | No                    |
| MZD30-101  | 1                  | 3                      | 120/277VAC            | No                    |
| MZN20-102* | 2                  | 2                      | 120/277VAC            | Yes                   |
| MZN30-101* | 1                  | 3                      | 120/277VAC            | Yes                   |
| MZB00-C02  | 2                  | 0                      | 220/347VAC            | No                    |
| MZD20-C02  | 2                  | 2                      | 220/347VAC            | No                    |
| MZD30-C01  | 1                  | 3                      | 220/347VAC            | No                    |
| MZN20-C02* | 2                  | 2                      | 220/347VAC            | Yes                   |
| MZN30-C01* | 1                  | 3                      | 220/347VAC            | Yes                   |

\*Consult with factory for availability.

#### Dual Room miniZ™ Intelligent Daylight Management System

The dual room miniZ offers the same performance features as the miniZ, but instead of working in one room using one photocell to control three zones, it provides dual room/ one zone per room daylight harvest control using a separate photocell and occupancy sensor for each room.

| CAT. NO.   | 20A POWER CIRCUITS | 0-10V DIMMING CIRCUITS | CONTROL INPUT VOLTAGE | NETWORK FUNCTIONALITY |
|------------|--------------------|------------------------|-----------------------|-----------------------|
| MZB02-102  | 2                  | 0                      | 120/277VAC            | No                    |
| MZD22-102  | 2                  | 2                      | 120/277VAC            | No                    |
| MZN22-102* | 2                  | 2                      | 120/277VAC            | Yes                   |
| MZB02-C02  | 2                  | 0                      | 220/347VAC            | No                    |
| MZD22-C02  | 2                  | 2                      | 220/347VAC            | No                    |
| MZN22-C02* | 2                  | 2                      | 220/347VAC            | Yes                   |

\*Consult with factory for availability.



miniZ/ Dual Room miniZ

#### SPECIFICATIONS AND FEATURES

- Automatic Correction setting for Light Loss Factor (LLF) recognizes and corrects for lumen maintenance issues
- Cost-effective energy code compliance
- Ladderless Commissioning™ provides install-and-forget convenience
- Automatic closed-loop, multi-zone daylight control
- Convenient occupancy sensor and photocell integration
- Simplified daylight harvesting with 3% to 100% dimming capabilities (0-10V fluorescent dimming ballasts required)
- Autocal™ (patent pending) automatic photocell calibration
- Accepts external time clock inputs

- Simplified integration with emergency and building automation systems
- Automatic Daylight Harvest Mode provides optimum lighting output for additional energy savings potential
- Daylight switching full range 0-10V dimming and network models available
- Cost effective energy code compliance
- Accepts external time clock inputs
- Closed loop or open loop daylight control
- Isolated contacts for HVAC relay
- miniZ works in one room using one photocell and occupancy sensor to control three zones
- Dual Room miniZ controls one zone per room using a separate photocell and occupancy sensor for each room

#### NETWORK FEATURES

- Luma-CAN® Network support
- Network digital switch support
- Z-MAX master/slave network participation
- Remote shared network inputs
- Scalable system expansion

#### TESTING AND CODE COMPLIANCE

- UL and cUL Listed
- CEC Title-24 Listed
- Limited Two-Year Warranty

# HOW TO USE THIS CATALOG

The L-101 Leviton Wiring Device Catalog is designed to help you find the device you're seeking in the quickest and easiest way possible. Most product sections are divided into three distinct categories in the following sequence—Industrial Grade, Commercial Grade and Residential Grade—and grouped according to amperage and voltage, lowest to highest. For example, if you need to order 15 Amp, 125 Volt Industrial Grade straight-blade duplex receptacles, begin your search with the main Table of Contents at the front of the book. Here you'll see that all straight blade receptacles are listed in Section G. Turn to Section G for a more detailed Table of Contents on the first page. Each section page contains product descriptions, ratings and catalog numbers. There are also helpful highlights including Specifications and Features, Testing and Code Compliance, Color listing, Material Characteristics and dimensioned color product photos. Any product page in the L-101 Catalog can be clearly copied or faxed to customers and prospects for use as a specifier sheet or as part of a presentation.

The Quick Reference Guide follows the main Table of Contents to help you pinpoint and locate specific products. Technical Section V provides general product and test data, industry standards, NEMA configuration charts, a glossary of wiring device terms, ANSI architectural symbols and other related information. Specific catalog numbers are listed in the exhaustive index at the back of the catalog.

## 15 AMP 125 and 250V ~ 20 AMP 125 and 250V

### Industrial Grade Straight Blade Receptacles

**Back and Side Wired** (Basic Cat. No. Denotes Brown Device\*)

| DESCRIPTION                             | CAT. NO./COLOR<br>15A/125V                         | CAT. NO./COLOR<br>15A/250V | CAT. NO./COLOR<br>20A/125V                | CAT. NO./COLOR<br>20A/250V         |
|---|--|----------------------------|---|------------------------------------|
| LEVSPEC® Duplex Receptacle, Brass Strap | 5262<br><small>I, W, GY, R, E</small>              | 5662<br><small>I</small>   | 5362<br><small>I, W, GY, R, E</small>     | 5462<br><small>I, GY</small>       |
| Single Receptacle                       | 5261<br><small>I, W, GY</small>                    | 5661<br><small>I</small>   | 5361<br><small>I, W, A, T, GY</small>     | 5461<br><small>I, A, T, GY</small> |
| Narrow Body Duplex Receptacle           | 5252<br><small>I, W, A, T, GY, R,<br/># BU</small> |                            | 5352<br><small>I, W, A, T, GY, R,</small> |                                    |

5362-IG

80703-IG 80703-I 80704-GY 80716-R

STAINLESS STEEL

84003-40 84004-40 84016-40

*For complete wallplate selection, see Section E.*

**SPECIFICATIONS AND FEATURES**

**Back & Side Wired Duplex**

- Impact-resistant thermoplastic nylon cover and body
- Smooth face does not collect dirt
- Four corner latches securely fasten face
- Single-piece brass mounting strap on LEVSPEC devices, multi-piece steel strap on other devices
- Large, triple-wipe, brass "T" contacts for superior contact and conductivity
- Back and side-wiring options
- Brass terminal screws to reduce conductor oxidation
- Break-off tabs for easy two-circuit conversion
- Apron barrier to prevent accidental contact between terminal screw heads and metal box
- Exclusive V-shaped, serrated back-wiring clamp for superior contact and conductivity

**TESTING AND CODE COMPLIANCE**

- UL Listed 498 (UL File #13399); UL Federal Specification WC-596

**COLOR**

Basic Cat. Nos. shown above denote Brown device, except for Isolated Ground (-IG) devices Basic Cat. No. denotes Orange. Isolated Ground Receptacle is distinguished by an orange triangle on its face. For other color selections, add suffix to the catalog number as follows: Ivory (-I), White (-W), Brown (For IG devices only, add -B), Almond (-A), Light Almond (-T), Gray (-G or -GY), Black (-E), Red (-R) and Blue (-BU); for IG devices only, add -BIG)

**MATERIAL CHARACTERISTICS**

Environmental: Flammability, Rated V2  
Operating Temperature: From -40° C (without impact) to 60°C maximum continuous

- |                                       |  |                                      |
|---------------------------------------|--|--------------------------------------|
| <b>A</b> RATING                       | <b>E</b> CATALOG NUMBER                      | <b>I</b> SPECIFICATIONS & FEATURES   |
| <b>B</b> Choose GRADE, if appropriate | <b>F</b> DESCRIPTION                         | <b>J</b> TESTING AND CODE COMPLIANCE |
| <b>C</b> DIMENSIONED PHOTOGRAPH       | <b>G</b> Check for NEMA CONFIGURATION        | <b>K</b> COLOR LISTING               |
| <b>D</b> WIRING/CERTIFICATIONS        | <b>H</b> WALLPLATE REFERENCE, if appropriate | <b>L</b> MATERIAL CHARACTERISTICS    |

# Wallplates

## INDEX

|  |            |
|--|------------|
| Decora® Plus Screwless Snap-On . . . . .         | E2, E4, E5 |
| Decora® . . . . .                                | E3, E4, E5 |
| Wallplate Overview . . . . .                     | E6         |
| Toggle . . . . .                                 | E7–E9      |
| Duplex Receptacle . . . . .                      | E10, E11   |
| Single Receptacle . . . . .                      | E12        |
| Telephone or Cable Outlet, Box Mount . . . . .   | E13, E14   |
| Telephone or Cable Outlet, Strap Mount . . . . . | E14, E15   |
| Blank, Box Mount . . . . .                       | E16, E17   |
| Blank, Strap Mount . . . . .                     | E17, E18   |
| Power Outlet Receptacles . . . . .               | E19, E20   |
| Two-Gang with Centered Opening . . . . .         | E21        |
| Louvre Plates . . . . .                          | E22        |
| Combination Wallplates                           |            |
| Toggle and Single Receptacle . . . . .           | E23        |
| Toggle and Duplex Receptacle . . . . .           | E23, E24   |
| Toggle and Decora/GFCI . . . . .                 | E25        |
| Toggle and Blank . . . . .                       | E26        |
| Standard Combinations—2-Gang . . . . .           | E26–E28    |
| Standard Combinations—3-Gang/4-Gang . . . . .    | E28        |
| Sectional for Multi-Gang Installations . . . . . | E29        |
| Hot Stamped and Engraved . . . . .               | E29, E30   |
| Voice/Data/CATV . . . . .                        | E31        |
| Weather Resistant Covers                         |            |
| Raintight While-In-Use . . . . .                 | E32        |
| Industrial Grade . . . . .                       | E33        |
| Die-cast Zinc . . . . .                          | E34        |
| Thermoplastic . . . . .                          | E35        |
| Stainless Steel Lockout . . . . .                | E34, E35   |
| Accessories . . . . .                            | E36        |
| Custom Wallplates . . . . .                      | E37–E40    |



# DECORA® PLUS SCREWLESS SNAP-ON WALLPLATES

## Residential and Commercial Grade Wallplates

### Decora Plus Screwless Snap-On Wallplates

- Sleek, smooth contemporary architectural styling enhances fine décor
- Exclusive new design eliminates subplate screws
- "Hook and Snap" subplate and wallplate mounting provides easy, time saving installation
- Decora-compatible two-piece kit allows easy retrofit to any Decora installation
- Tough, unbreakable polycarbonate construction
- Now available in standard and midway sizes that can be mounted onto larger-volume wallboxes and/or used to hide wall irregularities.



80301-SW  
Standard Size



SJ26-SW  
Midway Size

Standard Size  
Single-Gang Screwless Snap-On Wallplate

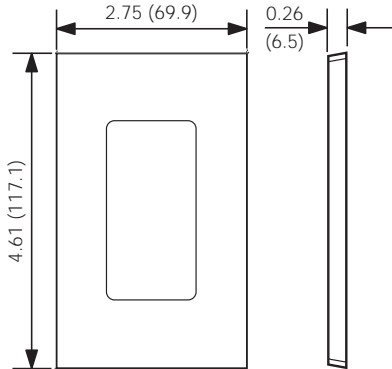

80301-S

Midway Size  
Single-Gang Screwless Snap-On Wallplate

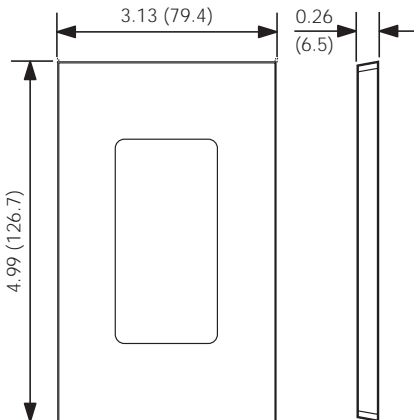

SJ26-S

Midway wallplates can be mounted onto larger-volume outlet boxes and/or used to hide wall irregularities. Midway wallplates are a full 0.375" higher and wider than standard size wallplates.

NOTE: Add 1.81" (46.0mm) for each additional gang.

### Decora Plus Screwless Snap-On Wallplates

| DESCRIPTION     | COLOR          | STANDARD  | MIDWAY    |
|-----------------|----------------|-----------|-----------|
| 1-Gang 1-Decora | Ivory          | 80301-SI  | SJ26-SI   |
|                 | Ebony/Black    | 80301-SE  | SJ26-SE   |
|                 | Gray           | 80301-SGY | SJ26-SGY  |
|                 | White          | 80301-SW  | SJ26-SW   |
|                 | Mahogany/Brown | 80301-S   | SJ26-S    |
|                 | Almond         | 80301-SA  | SJ26-SA   |
|                 | Light Almond   | 80301-ST  | SJ26-ST   |
| 2-Gang 2-Decora | Ivory          | 80309-SI  | SJ262-SI  |
|                 | Ebony/Black    | 80309-SE  | SJ262-SE  |
|                 | Gray           | 80309-SGY | SJ262-SGY |
|                 | White          | 80309-SW  | SJ262-SW  |
|                 | Mahogany/Brown | 80309-S   | SJ262-S   |
|                 | Almond         | 80309-SA  | SJ262-SA  |
|                 | Light Almond   | 80309-ST  | SJ262-ST  |
| 3-Gang 3-Decora | Ivory          | 80311-SI  | SJ263-SI  |
|                 | Ebony/Black    | 80311-SE  | SJ263-SE  |
|                 | White          | 80311-SW  | SJ263-SW  |
|                 | Almond         | 80311-SA  | SJ263-SA  |
|                 | Light Almond   | 80311-ST  | SJ263-ST  |
| 4-Gang 4-Decora | Ivory          | 80312-SI  | SJ264-SI  |
|                 | White          | 80312-SW  | SJ264-SW  |
|                 | Almond         | 80312-SA  | SJ264-SA  |
|                 | Light Almond   | 80312-ST  | SJ264-ST  |
| 5-Gang 5-Decora | Ivory          | 80321-SI  | SJ265-SI  |
|                 | White          | 80321-SW  | SJ265-SW  |
|                 | Almond         | 80321-SA  | SJ265-SA  |
|                 | Light Almond   | 80321-ST  | SJ265-ST  |
| 6-Gang 6-Decora | Ivory          | 80326-SI  | SJ266-SI  |
|                 | White          | 80326-SW  | SJ266-SW  |
|                 | Almond         | 80326-SA  | SJ266-SA  |
|                 | Light Almond   | 80326-ST  | SJ266-ST  |

#### TESTING AND CODE COMPLIANCE

- UL Listed (File #E-13397)
- Meets NEMA Standards WD-1, WD-6
- CSA Certified (File #LR-16347)
- NOM Certified (File #057)
- Backed by a Limited Ten-Year Warranty

#### MATERIAL CHARACTERISTICS

Environmental: Flammability UL-94, V2 Rating  
Operating Temperature: -40°C to 120°C



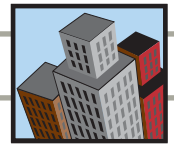

Residential and Commercial Grade Decora Wallplates

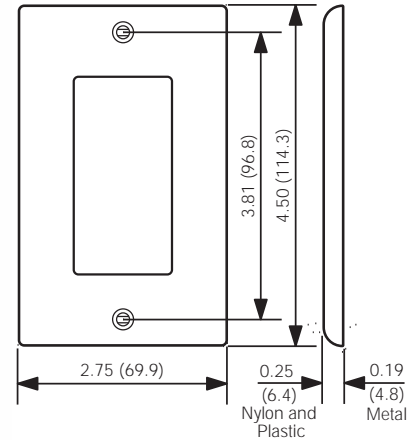

Standard Size Single-Gang

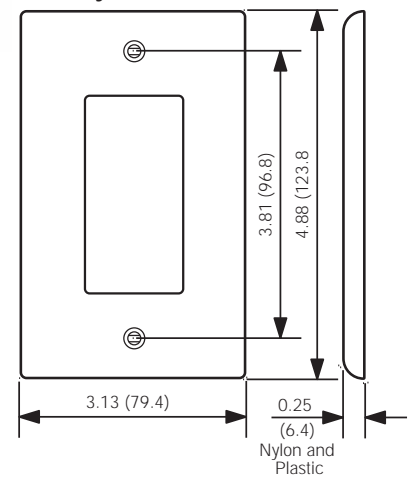

Midway Size Single-Gang

Midway wallplates can be mounted onto larger-volume outlet boxes and/or used to hide wall irregularities. Midway wallplates are a full 0.375" higher and wider than standard size wallplates.

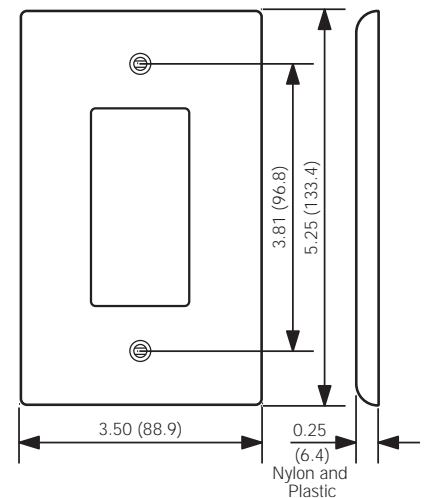

Oversized Single-Gang

Oversized wallplates are used to conceal greater wall irregularities than those hidden by Midway wallplates. Oversized wallplates are a full 0.75" higher and wider than standard size wallplates.

NOTE: Add 1.81" (46.0mm) for each additional gang.

All Decora Wallplates

- Accent any wall covering with a wide selection of colors and finishes
- Smooth face and rounded edges resist dust accumulation
- Individual plastic wrapping to protect wallplate's surface
- Color-matched metal mounting screws supplied

Residential Grade Thermoset Wallplates

- Photoelectrically color-matched to Leviton Decora devices
- Designed for high dielectric strength and arc resistance
- Meet or surpass UL 514 testing requirements
- Resistant to fading, discoloration, grease, oils, organic solvents and moisture scratches
- Backed by a Limited Two-Year Warranty

Commercial Grade Thermoplastic Wallplates

- Molded thermoplastic for maximum resistance to impact, abrasion, fading and discoloration
- Resistant to mechanical stress associated with high abuse applications
- Backed by a Limited Ten-Year Warranty

Commercial Grade Metal Wallplates

- Rounded edges to prevent injury and wall damage
- Deluxe stainless steel is non-magnetic Type 302, .032" thick
- Standard magnetic stainless steel Type 430, .032" thick, also available
- Brass is 70/30 alloy 260, .040" thick
- Aluminum is 3004 alloy, .040" thick
- Backed by a Limited Ten-Year Warranty

TESTING AND CODE COMPLIANCE

- Thermoplastic and Thermoset: UL Listed (File #E-13397)
- Metal: UL Listed (File #E-16347)
- Meets NEMA Standards WD-1, WD-6
- CSA Certified (File #LR-16347)
- NOM Certified (File #057)

MATERIAL CHARACTERISTICS

Environmental: Flammability UL-94, V2 Rating  
Operating Temperature: -40°C to 120°C

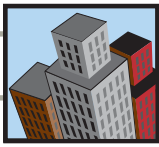

# WALLPLATES

## Residential and Commercial Grade Decora Wallplates

### Decora

| DESCRIPTION<br>1-Gang<br>1-Decora | Thermoset       |                 |                  | Thermoplastic   |                | Screwless Snap-On<br>Polycarbonate |          | Assorted Metals   |                           |                     |
|-----------------------------------|-----------------|-----------------|------------------|-----------------|----------------|------------------------------------|----------|-------------------|---------------------------|---------------------|
|                                   | STANDARD<br>P26 | MIDWAY<br>SPJ26 | OVERSIZE<br>PO26 | STANDARD<br>N26 | MIDWAY<br>PJ26 | STANDARD                           | MIDWAY   | MATERIAL          | STANDARD                  | OVERSIZE            |
| Ivory                             | 80401-I         | 80601-I         | 86601            | 80401-NI        | PJ26-I         | 80301-SI                           | SJ26-SI  | Chrome            | *                         | —                   |
| Black                             | 80401-E         | —               | —                | 80401-NE        | PJ26-E         | 80301-SE                           | SJ26-SE  | Aluminum          | <b>A26</b><br>83401       | —                   |
| Gray                              | 80401-GY        | —               | —                | 80401-NGY       | PJ26-GY        | 80301-SGY                          | SJ26-SGY | Brass             | <b>B26</b><br>81401       | —                   |
| White                             | 80401-W         | 80601-W         | 88601            | 80401-NW        | PJ26-W         | 80301-SW                           | SJ26-SW  | Polished<br>Brass | 81401-PB                  | —                   |
| Brown                             | 80401           | 80601           | —                | 80401-N         | PJ26           | 80301-S                            | SJ26-S   | 430 S/S           | *                         | *                   |
| Almond                            | 80401-A         | 80601-A         | 82601            | 80401-NA        | PJ26-A         | 80301-SA                           | SJ26-SA  | 302 S/S           | <b>SN26-N</b><br>84401-40 | <b>S026</b><br>S026 |
| Light Almond                      | 80401-T         | 80601-T         | —                | 80401-NT        | PJ26-T         | 80301-ST                           | SJ26-ST  |                   |                           |                     |
| Red                               | —               | —               | —                | 80401-NR        | —              | —                                  | —        |                   |                           |                     |
| Blue                              | —               | —               | —                | 80401-NB        | PJ26-BU        | —                                  | —        |                   |                           |                     |

| DESCRIPTION<br>2-Gang<br>2-Decora | Thermoset        |                  |                   | Thermoplastic    |                 | Screwless Snap-On<br>Polycarbonate |           | Assorted Metals   |                           |                       |
|-----------------------------------|------------------|------------------|-------------------|------------------|-----------------|------------------------------------|-----------|-------------------|---------------------------|-----------------------|
|                                   | STANDARD<br>P262 | MIDWAY<br>SPJ262 | OVERSIZE<br>PO262 | STANDARD<br>N262 | MIDWAY<br>PJ262 | STANDARD                           | MIDWAY    | MATERIAL          | STANDARD                  | OVERSIZE              |
| Ivory                             | 80409-I          | 80609-I          | 86602             | 80409-NI         | PJ262-I         | 80309-SI                           | SJ262-SI  | Chrome            | *                         | —                     |
| Black                             | 80409-E          | —                | —                 | 80409-NE         | PJ262-E         | 80309-SE                           | SJ262-SE  | Aluminum          | <b>A262</b><br>83409      | —                     |
| Gray                              | 80409-GY         | —                | —                 | 80409-NGY        | PJ262-GY        | 80309-SGY                          | SJ262-SGY | Brass             | <b>B262</b><br>81409      | —                     |
| White                             | 80409-W          | 80609-W          | 88602             | 80409-NW         | PJ262-W         | 80309-SW                           | SJ262-SW  | Polished<br>Brass | 81409-PB                  | —                     |
| Brown                             | 80409            | 80609            | —                 | 80409-N          | PJ262           | 80309-S                            | SJ262-S   | 430 S/S           | *                         | *                     |
| Almond                            | 80409-A          | 80609-A          | 82602             | 80409-NA         | PJ262-A         | 80309-SA                           | SJ262-SA  | 302 S/S           | <b>S262-N</b><br>84409-40 | <b>S0262</b><br>S0262 |
| Light Almond                      | 80409-T          | 80609-T          | —                 | 80409-NT         | PJ262-T         | 80309-ST                           | SJ262-ST  |                   |                           |                       |
| Red                               | —                | —                | —                 | 80409-NR         | —               | —                                  | —         |                   |                           |                       |
| Blue                              | —                | —                | —                 | 80409-NB         | —               | —                                  | —         |                   |                           |                       |

| DESCRIPTION<br>3-Gang<br>3-Decora | Thermoset        |                  |          | Thermoplastic    |                 | Screwless Snap-On<br>Polycarbonate |          | Assorted Metals   |                           |                       |
|-----------------------------------|------------------|------------------|----------|------------------|-----------------|------------------------------------|----------|-------------------|---------------------------|-----------------------|
|                                   | STANDARD<br>P263 | MIDWAY<br>SPJ263 | OVERSIZE | STANDARD<br>N263 | MIDWAY<br>PJ263 | STANDARD                           | MIDWAY   | MATERIAL          | STANDARD                  | OVERSIZE              |
| Ivory                             | 80411-I          | 80611-I          | —        | 80411-NI         | PJ263-I         | 80311-SI                           | SJ263-SI | Chrome            | *                         | —                     |
| Black                             | 80411-E          | —                | —        | —                | —               | 80311-SE                           | SJ263-SE | Aluminum          | <b>A263</b><br>83411      | —                     |
| Gray                              | 80411-GY         | —                | —        | 80411-NGY        | PJ263-GY        | —                                  | —        | Brass             | <b>B263</b><br>81411      | —                     |
| White                             | 80411-W          | 80611-W          | —        | 80411-NW         | PJ263-W         | 80311-SW                           | SJ263-SW | Polished<br>Brass | 81411-PB                  | —                     |
| Brown                             | 80411            | 80611            | —        | 80411-N          | —               | —                                  | —        | 430 S/S           | *                         | *                     |
| Almond                            | 80411-A          | 80611-A          | —        | 80411-NA         | PJ263-A         | 80311-SA                           | SJ263-SA | 302 S/S           | <b>S263-N</b><br>84411-40 | <b>S0263</b><br>S0263 |
| Light Almond                      | 80411-T          | 80611-T          | —        | 80411-NT         | PJ263-T         | 80311-ST                           | SJ263-ST |                   |                           |                       |

\*Consult your Leviton representative for ordering details: allow 3-4 weeks for delivery.

**NOTE: Where applicable, Industry Number indicated in BOLD FACE. For some wallplates, Industry Number and Leviton Catalog Number are identical.**

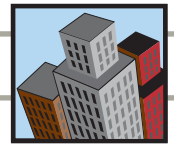

Residential and Commercial Grade Decora Wallplates

Decora

|  | Thermoset            |                      |                 | Thermoplastic        |                     | Screwless Snap-On Polycarbonate |               | Assorted Metals |                           |                 |
|--|----------------------|----------------------|-----------------|----------------------|---------------------|---------------------------------|---------------|-----------------|---------------------------|-----------------|
| <b>DESCRIPTION</b><br>4-Gang<br>4-Decora |                      |                      |                 |                      |                     |                                 |               |                 |                           |                 |
| <b>COLOR</b>                             | <b>STANDARD P264</b> | <b>MIDWAY SPJ264</b> | <b>OVERSIZE</b> | <b>STANDARD N264</b> | <b>MIDWAY PJ264</b> | <b>STANDARD</b>                 | <b>MIDWAY</b> | <b>MATERIAL</b> | <b>STANDARD</b>           | <b>OVERSIZE</b> |
| Ivory                                    | 80412-I              | 80612-I              | —               | 80412-NI             | PJ264-I             | 80312-SI                        | SJ264-SI      | Chrome          | *                         | —               |
| Black                                    | 80412-E              | —                    | —               | —                    | —                   | 80312-SE                        | SJ264-SE      | Brass           | <b>B264</b><br>81412      | —               |
| Gray                                     | 80412-GY             | —                    | —               | —                    | PJ264-GY            | —                               | —             | 430 S/S         | *                         | —               |
| White                                    | 80412-W              | 80612-W              | —               | 80412-NW             | PJ264-W             | 80312-SW                        | SJ264-SW      | 302 S/S         | <b>S264-N</b><br>84412-40 | —               |
| Brown                                    | 80412                | —                    | —               | 80412-N              | —                   | —                               | —             |                 |                           |                 |
| Almond                                   | 80412-A              | 80612-A              | —               | 80412-NA             | PJ264-A             | 80312-SA                        | SJ264-SA      |                 |                           |                 |
| Light Almond                             | 80412-T              | 80612-T              | —               | 80412-NT             | PJ264-T             | 80312-ST                        | SJ264-ST      |                 |                           |                 |
| <b>DESCRIPTION</b><br>5-Gang<br>5-Decora |                      |                      |                 |                      |                     |                                 |               |                 |                           |                 |
| <b>COLOR</b>                             | <b>STANDARD P265</b> | <b>MIDWAY</b>        | <b>OVERSIZE</b> | <b>STANDARD N265</b> | <b>MIDWAY</b>       | <b>STANDARD</b>                 | <b>MIDWAY</b> | <b>MATERIAL</b> | <b>STANDARD</b>           | <b>OVERSIZE</b> |
| Ivory                                    | 80423-I              | —                    | —               | —                    | —                   | 80321-SI                        | SJ265-SI      | Brass           | <b>B265</b><br>81423      | —               |
| Black                                    | 80423-E              | —                    | —               | —                    | —                   | —                               | —             | 430 S/S         | *                         | —               |
| Gray                                     | 80423-GY             | —                    | —               | —                    | —                   | —                               | —             | 302 S/S         | <b>S265</b><br>84423-40   | —               |
| White                                    | 80423-W              | —                    | —               | —                    | —                   | 80321-SW                        | SJ265-SW      |                 |                           |                 |
| Brown                                    | 80423                | —                    | —               | —                    | —                   | —                               | —             |                 |                           |                 |
| Almond                                   | 80423-A              | —                    | —               | —                    | —                   | 80321-SA                        | SJ265-SA      |                 |                           |                 |
| Light Almond                             | 80423-T              | —                    | —               | 80423-NT             | —                   | 80321-ST                        | SJ265-ST      |                 |                           |                 |
| <b>DESCRIPTION</b><br>6-Gang<br>6-Decora |                      |                      |                 |                      |                     |                                 |               |                 |                           |                 |
| <b>COLOR</b>                             | <b>STANDARD P266</b> | <b>MIDWAY</b>        | <b>OVERSIZE</b> | <b>STANDARD N266</b> | <b>MIDWAY</b>       | <b>STANDARD</b>                 | <b>MIDWAY</b> | <b>MATERIAL</b> | <b>STANDARD</b>           | <b>OVERSIZE</b> |
| Ivory                                    | 80436-I              | —                    | —               | —                    | —                   | 80326-SI                        | SJ266-SI      | Brass           | <b>B266</b><br>*          | —               |
| Black                                    | 80436-E              | —                    | —               | —                    | —                   | —                               | —             | 430 S/S         | —                         | —               |
| Gray                                     | 80436-GY             | —                    | —               | —                    | —                   | —                               | —             | 302 S/S         | <b>S266-N</b><br>84436-40 | —               |
| White                                    | 80436-W              | —                    | —               | —                    | —                   | 80326-SW                        | SJ266-SW      |                 |                           |                 |
| Brown                                    | 80436                | —                    | —               | —                    | —                   | —                               | —             |                 |                           |                 |
| Almond                                   | 80436-A              | —                    | —               | 80436-NA             | —                   | 80326-SA                        | SJ266-SA      |                 |                           |                 |
| Light Almond                             | 80436-T              | —                    | —               | —                    | —                   | 80326-ST                        | SJ266-ST      |                 |                           |                 |
| <b>DESCRIPTION</b><br>7-Gang<br>7-Decora |                      |                      |                 |                      |                     |                                 |               |                 |                           |                 |
| <b>COLOR</b>                             | <b>STANDARD S607</b> | <b>MIDWAY</b>        | <b>OVERSIZE</b> | <b>STANDARD</b>      | <b>MIDWAY</b>       | <b>STANDARD</b>                 | <b>MIDWAY</b> | <b>MATERIAL</b> | <b>STANDARD</b>           | <b>OVERSIZE</b> |
| Ivory                                    | 80407-I†             | —                    | —               | —                    | —                   | —                               | —             | Brass           | <b>B607</b><br>*          | —               |
| White                                    | 80407-W†             | —                    | —               | —                    | —                   | —                               | —             | 430 S/S         | *                         | —               |
|  |                      |                      |                 |                      |                     |                                 |               | 302 S/S         | <b>S607-N</b><br>*        | —               |
| <b>DESCRIPTION</b><br>8-Gang<br>8-Decora |                      |                      |                 |                      |                     |                                 |               |                 |                           |                 |
| <b>COLOR</b>                             | <b>STANDARD S609</b> | <b>MIDWAY</b>        | <b>OVERSIZE</b> | <b>STANDARD</b>      | <b>MIDWAY</b>       | <b>STANDARD</b>                 | <b>MIDWAY</b> | <b>MATERIAL</b> | <b>STANDARD</b>           | <b>OVERSIZE</b> |
| Ivory                                    | 80408-I†             | —                    | —               | —                    | —                   | —                               | —             | Brass           | <b>B609</b><br>*          | —               |
| White                                    | 80408-W†             | —                    | —               | —                    | —                   | —                               | —             | 430 S/S         | *                         | —               |
|  |                      |                      |                 |                      |                     |                                 |               | 302 S/S         | <b>S609-N</b><br>*        | —               |

\*Consult your Leviton representative for ordering details: allow 3-4 weeks for delivery. †Painted metal



# LARGER SIZE WALLPLATES

## Residential and Commercial Grade Wallplates

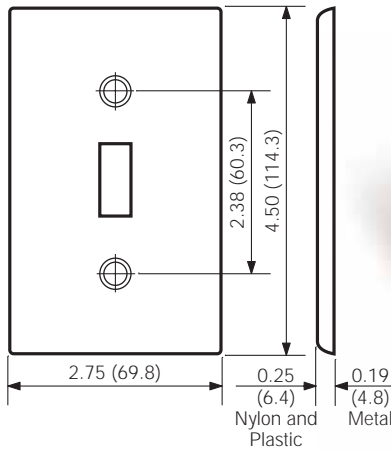

Standard Size Single-Gang

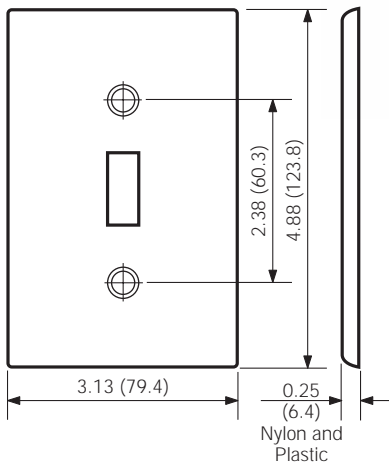

Midway Size Single-Gang

Midway wallplates can be mounted onto larger-volume outlet boxes and/or used to hide wall irregularities. Midway wallplates are a full 0.375" higher and wider than standard size wallplates.

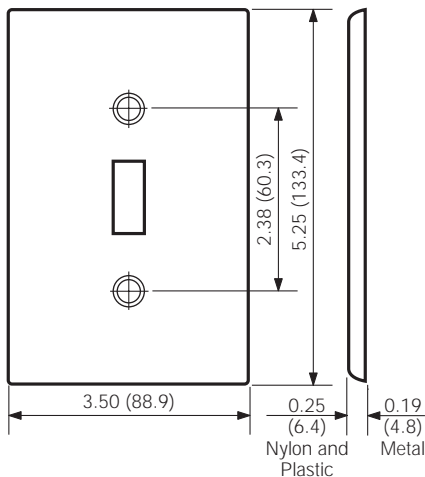

Oversized Single-Gang

Oversized wallplates are used to conceal greater wall irregularities than those hidden by Midway wallplates. Oversized wallplates are a full 0.75" higher and wider than standard size wallplates.

NOTE: Add 1.81" (46.0mm) for each additional gang.

### A COMPLETE SELECTION OF WALLPLATES FOR INDUSTRIAL, COMMERCIAL AND RESIDENTIAL APPLICATIONS



### Features and Benefits of All Leviton Wallplates

- Easy to Clean, smooth finish
- Noncombustible
- Individual plastic wrapping to protect wallplate surface
- Color-matched metal mounting screws supplied in an envelope to protect plate from scratches
- UL Listed and CSA Certified
- Conform to NEMA and ANSI Standards

### Residential Grade Thermoset (Plastic) Wallplates

- Photoelectrically color-matched to Leviton Decora devices
- Designed for high dielectric strength and arc resistance
- Meet or surpass UL 514 testing requirements
- Resistant to fading, discoloration, grease, oils, organic solvents and moisture scratches
- Backed by a Limited Two-Year Warranty

### Commercial Grade Thermoplastic (Nylon) Wallplates

- Molded thermoplastic for maximum resistance to impact, abrasion, fading and discoloration
- Resistant to mechanical stress associated with high abuse applications
- Backed by a Limited Ten-Year Warranty

### Commercial Grade Metal Wallplates

- Rounded edges to prevent injury and wall damage
- Deluxe stainless steel is non-magnetic Type 302, .032" thick
- Standard magnetic stainless steel Type 430, .032" thick, also available
- Brass is 70/30 alloy 260, .040" thick
- Aluminum is 3004 alloy, .040" thick
- Backed by a Limited Ten-Year Warranty

#### TESTING AND CODE COMPLIANCE

- UL Listed
- Meets NEMA Standards WD-1, WD-6
- CSA Certified

#### MATERIAL CHARACTERISTICS

Environmental: Flammability UL-94, V2 Rating  
Operating Temperature: -40°C to 120°C

Residential and Commercial Grade Wallplates



Toggle

|                     |                       |                 |
|---------------------|-----------------------|-----------------|
| Thermoset (Plastic) | Thermoplastic (Nylon) | Assorted Metals |
|---------------------|-----------------------|-----------------|

| DESCRIPTION<br>1-Gang<br>1-Toggle |             |             |              |             |            |                |                         |                          |
|-----------------------------------|-------------|-------------|--------------|-------------|------------|----------------|-------------------------|--------------------------|
| COLOR                             | STANDARD P1 | MIDWAY SPJ1 | OVERSIZE PO1 | STANDARD N1 | MIDWAY PJ1 | MATERIAL       | STANDARD                | OVERSIZE                 |
| Ivory                             | 86001       | 80501-I     | 86101        | 80701-I     | PJ1-I      | Chrome         | <b>C1</b><br>1901       | —                        |
| Black                             | —           | —           | —            | 80701-E     | PJ1-E      | Aluminum       | <b>A1</b><br>83001      | —                        |
| Gray                              | 87001       | —           | —            | 80701-GY    | PJ1-GY     | Brass          | <b>B1</b><br>81001      | —                        |
| Red                               | —           | —           | —            | 80701-R     | —          | Polished Brass | 81001-PB                | —                        |
| White                             | 88001       | 80501-W     | 88101        | 80701-W     | PJ1-W      | 430 S/S        | <b>S1</b><br>84001      | <b>S01</b><br>84101      |
| Brown                             | 85001       | 80501       | 85101        | 80701       | PJ1        | 302 S/S        | <b>S1-N</b><br>84001-40 | <b>S01-N</b><br>84101-40 |
| Almond                            | 82001       | 80501-A     | —            | 80701-A     | PJ1-A      |                |                         |                          |
| Light Almond                      | 78001       | 80501-T     | —            | 80701-T     | PJ1-T      |                |                         |                          |

| DESCRIPTION<br>2-Gang<br>2-Toggles |             |             |              |             |            |                |                         |                          |
|------------------------------------|-------------|-------------|--------------|-------------|------------|----------------|-------------------------|--------------------------|
| COLOR                              | STANDARD P2 | MIDWAY SPJ2 | OVERSIZE PO2 | STANDARD N2 | MIDWAY PJ2 | MATERIAL       | STANDARD                | OVERSIZE                 |
| Ivory                              | 86009       | 80509-I     | 86109        | 80709-I     | PJ2-I      | Chrome         | 1909                    | —                        |
| Black                              | —           | —           | —            | 80709-E     | PJ2-E      | Aluminum       | <b>A2</b><br>83009      | —                        |
| Gray                               | 87009       | —           | —            | 80709-GY    | PJ2-GY     | Brass          | <b>B2</b><br>81009      | —                        |
| Red                                | —           | —           | —            | 80709-R     | —          | Polished Brass | 81009-PB                | —                        |
| White                              | 88009       | 80509-W     | 88109        | 80709-W     | PJ2-W      | 430 S/S        | <b>S2</b><br>84009      | —                        |
| Brown                              | 85009       | 80509       | 85109        | 80709       | —          | 302 S/S        | <b>S2-N</b><br>84009-40 | <b>S02-N</b><br>84109-40 |
| Almond                             | 82009       | 80509-A     | —            | 80709-A     | PJ2-A      |                |                         |                          |
| Light Almond                       | 78009       | 80509-T     | —            | 80709-T     | PJ2-T      |                |                         |                          |

| DESCRIPTION<br>3-Gang<br>3-Toggles |             |             |              |             |            |                |                         |                          |
|------------------------------------|-------------|-------------|--------------|-------------|------------|----------------|-------------------------|--------------------------|
| COLOR                              | STANDARD P3 | MIDWAY SPJ3 | OVERSIZE PO3 | STANDARD N3 | MIDWAY PJ3 | MATERIAL       | STANDARD                | OVERSIZE                 |
| Ivory                              | 86011       | 80511-I     | 86111        | 80711-I     | PJ3-I      | Chrome         | *                       | —                        |
| Black                              | —           | —           | —            | 80711-E     | PJ3-E      | Aluminum       | <b>A3</b><br>83011      | —                        |
| Gray                               | 87011       | —           | —            | 80711-GY    | —          | Brass          | <b>B3</b><br>81011      | —                        |
| Red                                | —           | —           | —            | 80711-R     | —          | Polished Brass | 81011-PB                | —                        |
| White                              | 88011       | 80511-W     | 88111        | 80711-W     | PJ3-W      | 430 S/S        | <b>S3</b><br>84011      | —                        |
| Brown                              | 85011       | 80511       | —            | 80711       | PJ3        | 302 S/S        | <b>S3-N</b><br>84011-40 | <b>S03-N</b><br>84111-40 |
| Almond                             | 82011       | 80511-A     | —            | 80711-A     | PJ3-A      |                |                         |                          |
| Light Almond                       | 78011       | 80511-T     | —            | 80711-T     | PJ3-T      |                |                         |                          |

\*Consult your Leviton representative for ordering details: allow 3-4 weeks for delivery.

**NOTE: Where applicable, Industry Number indicated in BOLD FACE. For some wallplates, Industry Number and Leviton Catalog Number are identical.**



# WALLPLATES

## Residential and Commercial Grade Wallplates

### Toggle

|                                    | Thermoset (Plastic) |                |          | Thermoplastic (Nylon) |               | Assorted Metals |                         |                          |
|------------------------------------|---------------------|----------------|----------|-----------------------|---------------|-----------------|-------------------------|--------------------------|
| DESCRIPTION<br>4-Gang<br>4-Toggles |                     |                |          |                       |               |                 |                         |                          |
| COLOR                              | STANDARD<br>P4      | MIDWAY<br>SPJ4 | OVERSIZE | STANDARD<br>N4        | MIDWAY<br>PJ4 | MATERIAL        | STANDARD                | OVERSIZE                 |
| Ivory                              | 86012               | 80512-I        | —        | 80712-I               | PJ4-I         | Chrome          | *                       | —                        |
| Black                              | —                   | —              | —        | 80712-E               | —             | Aluminum        | <b>A4</b><br>83012      | —                        |
| Gray                               | 87012               | —              | —        | —                     | —             | Brass           | <b>B4</b><br>81012      | —                        |
|                                    |                     |                |          |                       |               | Polished Brass  | 81012-PB                | —                        |
| White                              | 88012               | 80512-W        | —        | 80712-W               | PJ4-W         | 430 S/S         | <b>S4</b><br>84012      | *                        |
| Brown                              | 85012               | 80512          | —        | —                     | —             | 302 S/S         | <b>S4-N</b><br>84012-40 | <b>S04-N</b><br>84112-40 |
| Almond                             | 82012               | 80512-A        | —        | 80712-A               | PJ4-A         |                 |                         |                          |
| Light Almond                       | 78012               | 80512-T        | —        | 80712-T               | PJ4-T         |                 |                         |                          |
| DESCRIPTION<br>5-Gang<br>5-Toggles |                     |                |          |                       |               |                 |                         |                          |
| COLOR                              | STANDARD<br>P5      | MIDWAY         | OVERSIZE | STANDARD<br>N5        | MIDWAY        | MATERIAL        | STANDARD                | OVERSIZE                 |
| Ivory                              | 86023               | —              | —        | 80723-I               | —             | Chrome          | *                       | —                        |
| White                              | 88023               | —              | —        | 80723-W               | —             | Aluminum        | <b>A5</b><br>*          | —                        |
| Brown                              | 85023               | —              | —        | —                     | —             | Brass           | <b>B5</b><br>81023      | —                        |
| Almond                             | 82023               | —              | —        | —                     | —             | Polished Brass  | 81023-PB                | —                        |
| Light Almond                       | 78023               | —              | —        | —                     | —             | 430 S/S         | <b>S5</b><br>*          | —                        |
|                                    |                     |                |          |                       |               | 302 S/S         | <b>S5-N</b><br>84023-40 | —                        |
| DESCRIPTION<br>6-Gang<br>6-Toggles |                     |                |          |                       |               |                 |                         |                          |
| COLOR                              | STANDARD<br>P6      | MIDWAY         | OVERSIZE | STANDARD<br>N6        | MIDWAY        | MATERIAL        | STANDARD                | OVERSIZE                 |
| Ivory                              | 86036               | —              | —        | 80736-I               | —             | Chrome          | *                       | —                        |
| White                              | 88036               | —              | —        | 80736-W               | —             | Aluminum        | <b>A6</b><br>*          | —                        |
| Brown                              | 85036               | —              | —        | —                     | —             | Brass           | <b>B6</b><br>81036      | —                        |
| Almond                             | 82036               | —              | —        | —                     | —             | 430 S/S         | <b>S6</b><br>*          | —                        |
| Light Almond                       | 78036               | —              | —        | —                     | —             | 302 S/S         | <b>S6-N</b><br>84036-40 | —                        |

\*Consult your Leviton representative for ordering details; allow 3–4 weeks for delivery.

**NOTE:** Where applicable, Industry Number indicated in BOLD FACE. For some wallplates, Industry Number and Leviton Catalog Number are identical.

Residential and Commercial Grade Wallplates



Toggle

|                                    | Thermoset (Plastic) |        |          | Thermoplastic (Nylon) |        | Assorted Metals |                           |          |
|------------------------------------|---------------------|--------|----------|-----------------------|--------|-----------------|---------------------------|----------|
| DESCRIPTION<br>7-Gang<br>7-Toggles |                     |        |          |                       |        |                 |                           |          |
| COLOR                              | STANDARD<br>S601    | MIDWAY | OVERSIZE | STANDARD              | MIDWAY | MATERIAL        | STANDARD                  | OVERSIZE |
| Ivory                              | S601-I†             | —      | —        | —                     | —      | Chrome          | *                         | —        |
| White                              | S601-W†             | —      | —        | —                     | —      | Brass           | <b>B601</b><br>*          | —        |
|                                    |                     |        |          |                       |        | 430 S/S         | *                         | —        |
|                                    |                     |        |          |                       |        | 302 S/S         | <b>S601-N</b><br>84070-40 | —        |

†Painted metal wallplate.

| DESCRIPTION<br>8-Gang<br>8-Toggles |                  |        |          |                |        |          |                           |          |
|------------------------------------|------------------|--------|----------|----------------|--------|----------|---------------------------|----------|
| COLOR                              | STANDARD<br>S602 | MIDWAY | OVERSIZE | STANDARD<br>N6 | MIDWAY | MATERIAL | STANDARD                  | OVERSIZE |
| Ivory                              | S602-I†          | —      | —        | —              | —      | Chrome   | *                         | —        |
| White                              | S602-W†          | —      | —        | —              | —      | Brass    | <b>B602</b><br>*          | —        |
|                                    |                  |        |          |                |        | 430 S/S  | *                         | —        |
|                                    |                  |        |          |                |        | 302 S/S  | <b>S602-N</b><br>84048-40 | —        |

†Painted metal wallplate.

| DESCRIPTION<br>9-Gang<br>9-Toggles |                  |        |          |          |        |          |                           |          |
|------------------------------------|------------------|--------|----------|----------|--------|----------|---------------------------|----------|
| COLOR                              | STANDARD<br>S603 | MIDWAY | OVERSIZE | STANDARD | MIDWAY | MATERIAL | STANDARD                  | OVERSIZE |
| Ivory                              | S603-I†          | —      | —        | —        | —      | Chrome   | *                         | —        |
| White                              | S603-W†          | —      | —        | —        | —      | Brass    | <b>B603</b><br>*          | —        |
|                                    |                  |        |          |          |        | 430 S/S  | *                         | —        |
|                                    |                  |        |          |          |        | 302 S/S  | <b>S603-N</b><br>84049-40 | —        |

†Painted metal wallplate.

| DESCRIPTION<br>10-Gang<br>10-Toggles |                  |        |          |          |        |          |                           |          |
|--------------------------------------|------------------|--------|----------|----------|--------|----------|---------------------------|----------|
| COLOR                                | STANDARD<br>S604 | MIDWAY | OVERSIZE | STANDARD | MIDWAY | MATERIAL | STANDARD                  | OVERSIZE |
| Ivory                                | S604-I†          | —      | —        | —        | —      | Chrome   | *                         | —        |
| White                                | S604-W†          | —      | —        | —        | —      | Brass    | <b>B604</b><br>*          | —        |
|                                      |                  |        |          |          |        | 302 S/S  | <b>S604-N</b><br>84050-40 | —        |

†Painted metal wallplate.

\*Consult your Leviton representative for ordering details: allow 3-4 weeks for delivery.

**NOTE: Where applicable, Industry Number indicated in BOLD FACE. For some wallplates, Industry Number and Leviton Catalog Number are identical.**



# WALLPLATES

## Residential and Commercial Grade Wallplates

### Receptacle

|  | Thermoset (Plastic) |                    |                 | Thermoplastic (Nylon) |                   | Assorted Metals |                         |                          |
|--|---------------------|--------------------|-----------------|-----------------------|-------------------|-----------------|-------------------------|--------------------------|
| <b>DESCRIPTION</b><br>1-Gang<br>1-Duplex |                     |                    |                 |                       |                   |                 |                         |                          |
| <b>COLOR</b>                             | <b>STANDARD P8</b>  | <b>MIDWAY SPJ8</b> | <b>OVERSIZE</b> | <b>STANDARD N8</b>    | <b>MIDWAY PJ8</b> | <b>MATERIAL</b> | <b>STANDARD</b>         | <b>OVERSIZE</b>          |
| Ivory                                    | 86003               | 80503-I            | 86103           | 80703-I               | PJ8-I             | Chrome          | <b>C8</b><br>1903       | —                        |
| Black                                    | —                   | —                  | —               | 80703-E               | PJ8-E             | Aluminum        | <b>A8</b><br>83003      | —                        |
| Gray                                     | 87003               | —                  | —               | 80703-GY              | PJ8-GY            | Brass           | <b>B8</b><br>81003      | —                        |
| Red                                      | —                   | —                  | —               | 80703-R               | PJ8-R             | Polished Brass  | 81003-PB                | —                        |
| White                                    | 88003               | 80503-W            | 88103           | 80703-W               | PJ8-W             | 430 S/S         | <b>S8</b><br>84003      | <b>S08</b><br>84103      |
| Brown                                    | 85003               | 80503              | 85103           | 80703                 | PJ8               | 302 S/S         | <b>S8-N</b><br>84003-40 | <b>S08-N</b><br>84103-40 |
| Blue                                     | —                   | —                  | —               | 80703-BU              | PJ8-BU            |                 |                         |                          |
| Almond                                   | 82003               | 80503-A            | —               | 80703-A               | PJ8-A             |                 |                         |                          |
| Light Almond                             | 78003               | 80503-T            | —               | 80703-T               | PJ8-T             |                 |                         |                          |

|  |                     |                     |                 |                     |                    |                 |                          |                           |
|--|---------------------|---------------------|-----------------|---------------------|--------------------|-----------------|--------------------------|---------------------------|
| <b>DESCRIPTION</b><br>2-Gang<br>2-Duplex |                     |                     |                 |                     |                    |                 |                          |                           |
| <b>COLOR</b>                             | <b>STANDARD P82</b> | <b>MIDWAY SPJ82</b> | <b>OVERSIZE</b> | <b>STANDARD N82</b> | <b>MIDWAY PJ82</b> | <b>MATERIAL</b> | <b>STANDARD</b>          | <b>OVERSIZE</b>           |
| Ivory                                    | 86016               | 80516-I             | 86116           | 80716-I             | PJ82-I             | Chrome          | <b>C82</b><br>*          | —                         |
| Black                                    | —                   | —                   | —               | 80716-E             | PJ82-E             | Aluminum        | <b>A82</b><br>83016      | —                         |
| Gray                                     | 87016               | —                   | —               | 80716-GY            | PJ82-GY            | Brass           | <b>B82</b><br>81016      | —                         |
| Red                                      | —                   | —                   | —               | 80716-R             | PJ82-R             | Polished Brass  | *                        | —                         |
| White                                    | 88016               | 80516-W             | 88116           | 80716-W             | PJ82-W             | 430 S/S         | <b>S82</b><br>84016      | <b>S082</b><br>84116      |
| Brown                                    | 85016               | 80516               | 85116           | 80716               | PJ82               | 302 S/S         | <b>S82-N</b><br>84016-40 | <b>S082-N</b><br>84116-40 |
| Orange                                   | —                   | —                   | —               | 80716-ORG           | —                  |                 |                          |                           |
| Blue                                     | —                   | —                   | —               | 80716-BU            | —                  |                 |                          |                           |
| Almond                                   | 82016               | 80516-A             | —               | 80716-A             | PJ82-A             |                 |                          |                           |
| Light Almond                             | 78016               | 80516-T             | —               | 80716-T             | PJ82-T             |                 |                          |                           |

|  |                     |               |                 |                 |               |                 |                          |                           |
|--|---------------------|---------------|-----------------|-----------------|---------------|-----------------|--------------------------|---------------------------|
| <b>DESCRIPTION</b><br>3-Gang<br>3-Duplex |                     |               |                 |                 |               |                 |                          |                           |
| <b>COLOR</b>                             | <b>STANDARD P83</b> | <b>MIDWAY</b> | <b>OVERSIZE</b> | <b>STANDARD</b> | <b>MIDWAY</b> | <b>MATERIAL</b> | <b>STANDARD</b>          | <b>OVERSIZE</b>           |
| Ivory                                    | 86030               | —             | —               | 80730-I         | —             | Chrome          | *                        | —                         |
|  |                     |               |                 |                 |               | Aluminum        | *                        | —                         |
| Gray                                     | —                   | —             | —               | 80730-GY        | —             | Brass           | *                        | —                         |
| Red                                      | —                   | —             | —               | 80730-R         | —             | 430 S/S         | <b>S83</b><br>*          | —                         |
| White                                    | 88030               | —             | —               | 80730-W         | —             | 302 S/S         | <b>S83-N</b><br>84030-40 | <b>S083-N</b><br>84130-40 |
| Brown                                    | 85030               | —             | —               | —               | —             |                 |                          |                           |
| Light Almond                             | —                   | —             | —               | 78030           | —             |                 |                          |                           |

\*Consult your Leviton representative for ordering details: allow 3-4 weeks for delivery.

**NOTE:** Where applicable, Industry Number indicated in **BOLD FACE**. For some wallplates, Industry Number and Leviton Catalog Number are identical.



Residential and Commercial Grade Wallplates

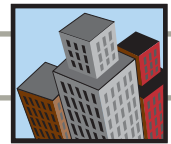

Duplex Receptacle

|  |                     |  |  |                       |  |                 |  |  |
|--|---------------------|--|--|-----------------------|--|-----------------|--|--|
|  | Thermoset (Plastic) |  |  | Thermoplastic (Nylon) |  | Assorted Metals |  |  |
|--|---------------------|--|--|-----------------------|--|-----------------|--|--|

DESCRIPTION  
4-Gang  
4-Duplex

| COLOR | STANDARD<br>P84 | MIDWAY | OVERSIZE | STANDARD | MIDWAY | MATERIAL | STANDARD            | OVERSIZE |
|-------|-----------------|--------|----------|----------|--------|----------|---------------------|----------|
| Ivory | 86041           | —      | —        | —        | —      | Chrome   | *                   | —        |
| White | 88041           | —      | —        | —        | —      | Aluminum | *                   | —        |
| Brown | 85041           | —      | —        | —        | —      | Brass    | *                   | —        |
|       |                 |        |          |          |        | 430 S/S  | <b>S84</b><br>84041 | *        |
|       |                 |        |          |          |        | 302 S/S  | <b>S84-N</b><br>*   | *        |

DESCRIPTION  
5-Gang  
5-Duplex

| COLOR | STANDARD | MIDWAY | OVERSIZE | STANDARD | MIDWAY | MATERIAL | STANDARD                 | OVERSIZE |
|-------|----------|--------|----------|----------|--------|----------|--------------------------|----------|
|       |          |        |          |          |        | Chrome   | *                        | —        |
|       |          |        |          |          |        | Brass    | <b>B85</b><br>*          | —        |
|       |          |        |          |          |        | 302 S/S  | <b>S85-N</b><br>84055-40 | —        |

DESCRIPTION  
6-Gang  
6-Duplex

| COLOR | STANDARD | MIDWAY | OVERSIZE | STANDARD | MIDWAY | MATERIAL | STANDARD                 | OVERSIZE |
|-------|----------|--------|----------|----------|--------|----------|--------------------------|----------|
|       |          |        |          |          |        | Chrome   | *                        | —        |
|       |          |        |          |          |        | Brass    | <b>B86</b><br>*          | —        |
|       |          |        |          |          |        | 302 S/S  | <b>S86-N</b><br>84056-40 | —        |

DESCRIPTION  
7-Gang  
7-Duplex

| COLOR | STANDARD | MIDWAY | OVERSIZE | STANDARD | MIDWAY | MATERIAL | STANDARD         | OVERSIZE |
|-------|----------|--------|----------|----------|--------|----------|------------------|----------|
|       |          |        |          |          |        | Chrome   | *                | —        |
|       |          |        |          |          |        | Brass    | <b>B608</b><br>* | —        |
|       |          |        |          |          |        | 430 S/S  | <b>S608</b><br>* | —        |
|       |          |        |          |          |        | 302 S/S  | *                | —        |

DESCRIPTION  
8-Gang  
8-Duplex

| COLOR | STANDARD | MIDWAY | OVERSIZE | STANDARD | MIDWAY | MATERIAL | STANDARD          | OVERSIZE |
|-------|----------|--------|----------|----------|--------|----------|-------------------|----------|
|       |          |        |          |          |        | Chrome   | *                 | —        |
|       |          |        |          |          |        | Brass    | <b>B6082</b><br>* | —        |
|       |          |        |          |          |        | 430 S/S  | <b>S6082</b><br>* | —        |
|       |          |        |          |          |        | 302 S/S  | *                 | —        |

\*Consult your Leviton representative for ordering details: allow 3-4 weeks for delivery.

NOTE: Where applicable, Industry Number indicated in BOLD FACE. For some wallplates, Industry Number and Leviton Catalog Number are identical.



# WALLPLATES

## Residential and Commercial Grade Wallplates

Single Receptacle—15 Amp and 20 Amp Straight Blade and 15 Amp Locking  
 Thermoset (Plastic)      Thermoplastic (Nylon)

Assorted Metals

**DESCRIPTION**

1-Gang  
 1-Single 1.406" dia. Hole



| COLOR        | STANDARD P7 | MIDWAY SPJ7 | OVERSIZE | STANDARD N7 | MIDWAY PJ7 | MATERIAL | STANDARD                | OVERSIZE                 |
|--------------|-------------|-------------|----------|-------------|------------|----------|-------------------------|--------------------------|
| Ivory        | 86004       | 80504-I     | —        | 80704-I     | PJ7-I      | Chrome   | *                       | —                        |
| Black        | —           | —           | —        | 80704-E     | —          | Aluminum | <b>A7</b><br>83004      | —                        |
| Gray         | —           | —           | —        | 80704-GY    | —          | Brass    | <b>B7</b><br>81004      | —                        |
| Red          | —           | —           | —        | 80704-R     | PJ7-R      | 430 S/S  | <b>S7</b><br>*          | *                        |
| White        | 88004       | 80504-W     | —        | 80704-W     | PJ7-W      | 302 S/S  | <b>S7-N</b><br>84004-40 | <b>S07-N</b><br>84104-40 |
| Brown        | 85004       | 80504       | —        | 80704       | —          |          |                         |                          |
| Orange       | —           | —           | —        | 80704-ORG   | —          |          |                         |                          |
| Almond       | 82004       | 80504-A     | —        | 80704-A     | PJ7-A      |          |                         |                          |
| Light Almond | 78004       | 80504-T     | —        | 80704-T     | PJ7-T      |          |                         |                          |

**DESCRIPTION**

2-Gang  
 2-Singles 1.406" dia. Holes



| COLOR | STANDARD P72 | MIDWAY SPJ82 | OVERSIZE | STANDARD N82 | MIDWAY PJ82 | MATERIAL | STANDARD                 | OVERSIZE |
|-------|--------------|--------------|----------|--------------|-------------|----------|--------------------------|----------|
| Ivory | 86052        | —            | —        | —            | —           | Chrome   | *                        | —        |
| White | 88052        | —            | —        | —            | —           | Aluminum | *                        | —        |
| Brown | 85052        | —            | —        | —            | —           | Brass    | *                        | —        |
|       |              |              |          |              |             | 430 S/S  | <b>S72</b><br>*          | —        |
|       |              |              |          |              |             | 302 S/S  | <b>S72-N</b><br>84052-40 | —        |

**DESCRIPTION**

3-Gang  
 3-Singles 1.406" dia. Holes

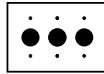

| COLOR | STANDARD | MIDWAY | OVERSIZE | STANDARD | MIDWAY | MATERIAL | STANDARD              | OVERSIZE |
|-------|----------|--------|----------|----------|--------|----------|-----------------------|----------|
|       |          |        |          |          |        | Brass    | *                     | —        |
|       |          |        |          |          |        | 430 S/S  | <b>S73</b><br>*       | —        |
|       |          |        |          |          |        | 302 S/S  | <b>S73-N</b><br>S73-N | —        |

**DESCRIPTION**

4-Gang  
 4-Singles 1.406" dia. Holes

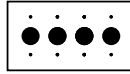

| COLOR | STANDARD | MIDWAY | OVERSIZE | STANDARD | MIDWAY | MATERIAL | STANDARD        | OVERSIZE |
|-------|----------|--------|----------|----------|--------|----------|-----------------|----------|
|       |          |        |          |          |        | Brass    | *               | —        |
|       |          |        |          |          |        | 430 S/S  | <b>S74</b><br>* | —        |
|       |          |        |          |          |        | 302 S/S  | <b>S74-N</b>    | —        |

**DESCRIPTION**

5-Gang  
 5-Singles 1.406" dia. Holes

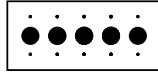

| COLOR | STANDARD | MIDWAY | OVERSIZE | STANDARD | MIDWAY | MATERIAL | STANDARD        | OVERSIZE |
|-------|----------|--------|----------|----------|--------|----------|-----------------|----------|
|       |          |        |          |          |        | Brass    | *               | —        |
|       |          |        |          |          |        | 430 S/S  | <b>S75</b><br>* | —        |
|       |          |        |          |          |        | 302 S/S  | <b>S75-N</b>    | —        |

**DESCRIPTION**

6-Gang  
 6-Singles 1.406" dia. Holes

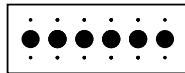

| COLOR | STANDARD | MIDWAY | OVERSIZE | STANDARD | MIDWAY | MATERIAL | STANDARD        | OVERSIZE |
|-------|----------|--------|----------|----------|--------|----------|-----------------|----------|
|       |          |        |          |          |        | Brass    | *               | —        |
|       |          |        |          |          |        | 430 S/S  | <b>S76</b><br>* | —        |
|       |          |        |          |          |        | 302 S/S  | <b>S76-N</b>    | —        |

\*Consult your Leviton representative for ordering details: allow 3-4 weeks for delivery.

**NOTE: Where applicable, Industry Number indicated in BOLD FACE. For some wallplates, Industry Number and Leviton Catalog Number are identical.**



To learn more about Leviton's outstanding offering of devices visit our Website at: [www.leviton.com](http://www.leviton.com)

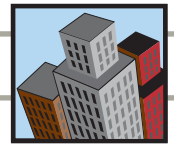

Residential and Commercial Grade Wallplates

Telephone or Cable Outlet Wallplates—Box Mounted

|                     |                       |                 |
|---------------------|-----------------------|-----------------|
| Thermoset (Plastic) | Thermoplastic (Nylon) | Assorted Metals |
|---------------------|-----------------------|-----------------|

DESCRIPTION  
1-Gang  
Phone/Cable .312" dia. Hole, Box Mount



| COLOR        | STANDARD | MIDWAY<br>SPJ738 | OVERSIZE | STANDARD | MIDWAY | MATERIAL       | STANDARD                | OVERSIZE |
|--------------|----------|------------------|----------|----------|--------|----------------|-------------------------|----------|
| Ivory        | —        | 80513-I          | —        | —        | —      | Aluminum       | <b>A738</b><br>83013    | —        |
| White        | —        | 80513-W          | —        | —        | —      | Brass          | <b>B738</b><br>81013    | —        |
| Almond       | —        | 80513-A          | —        | —        | —      | Polished Brass | 81013-PB                | —        |
| Light Almond | —        | 80513-T          | —        | —        | —      | 430 S/S        | <b>S738</b><br>84013    | —        |
|              |          |                  |          |          |        | 302 S/S        | <b>S7-N</b><br>84013-40 | —        |

DESCRIPTION  
1-Gang  
Phone/Cable .406" dia. Hole, Box Mount



| COLOR        | STANDARD<br>P11 | MIDWAY | OVERSIZE | STANDARD | MIDWAY<br>PJ11 | MATERIAL | STANDARD                 | OVERSIZE |
|--------------|-----------------|--------|----------|----------|----------------|----------|--------------------------|----------|
| Ivory        | 86013           | —      | —        | —        | PJ11-I         | Aluminum | *                        | —        |
| Black        | —               | —      | —        | —        | PJ11-E         | Brass    | *                        | —        |
| Gray         | —               | —      | —        | —        | PJ11-GY        | 430 S/S  | *                        | —        |
| White        | 88013           | —      | —        | —        | PJ11-W         | 302 S/S  | <b>S11-N</b><br>84061-40 | *        |
|              |                 |        |          |          |                | —        | —                        | —        |
| Almond       | 82013           | —      | —        | —        | PJ11-A         | —        | —                        | —        |
| Light Almond | 78013           | —      | —        | —        | PJ11-T         | —        | —                        | —        |

DESCRIPTION  
1-Gang  
Phone/Cable .625" dia. Hole, Box Mount



| COLOR | STANDARD<br>P737 | MIDWAY | OVERSIZE | STANDARD | MIDWAY | MATERIAL | STANDARD                  | OVERSIZE |
|-------|------------------|--------|----------|----------|--------|----------|---------------------------|----------|
| Ivory | 86017            | —      | —        | —        | —      | Aluminum | <b>A737</b><br>*          | —        |
| White | 88017            | —      | —        | —        | —      | Brass    | <b>B737</b><br>81017      | —        |
|       |                  |        |          |          |        | 430 S/S  | <b>S737</b><br>*          | —        |
|       |                  |        |          |          |        | 302 S/S  | <b>S737-N</b><br>84017-40 | —        |

DESCRIPTION  
2-Gang  
Phone/Cable .406" dia. Hole, Box Mount



| COLOR | STANDARD<br>P21 | MIDWAY | OVERSIZE | STANDARD | MIDWAY | MATERIAL | STANDARD                 | OVERSIZE |
|-------|-----------------|--------|----------|----------|--------|----------|--------------------------|----------|
| Ivory | 86062           | —      | —        | —        | —      | Brass    | *                        | —        |
| White | 88062           | —      | —        | —        | —      | 430 S/S  | *                        | —        |
|       |                 |        |          |          |        | 302 S/S  | <b>S21-N</b><br>84062-40 | —        |

DESCRIPTION  
3-Gang  
Phone/Cable .406" dia. Hole, Box Mount

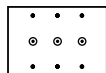

| COLOR | STANDARD | MIDWAY | OVERSIZE | STANDARD | MIDWAY | MATERIAL | STANDARD     | OVERSIZE |
|-------|----------|--------|----------|----------|--------|----------|--------------|----------|
|       |          |        |          |          |        | Brass    | *            | —        |
|       |          |        |          |          |        | 430 S/S  | *            | —        |
|       |          |        |          |          |        | 302 S/S  | <b>S31-N</b> | —        |

\*Consult your Leviton representative for ordering details: allow 3-4 weeks for delivery.

NOTE: Where applicable, Industry Number indicated in BOLD FACE. For some wallplates, Industry Number and Leviton Catalog Number are identical.





# WALLPLATES

## Residential and Commercial Grade Wallplates

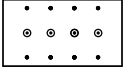
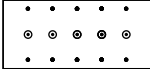
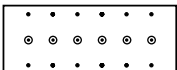
### Telephone or Cable Outlet Wallplates—Box Mounted

| Thermoset (Plastic)  |          |        | Thermoplastic (Nylon) |          |        | Assorted Metals |                   |          |
|--|----------|--------|-----------------------|----------|--------|-----------------|-------------------|----------|
| <b>DESCRIPTION</b><br>4-Gang<br>Phone/Cable .406" dia. Hole, Box Mount  |          |        |                       |          |        |                 |                   |          |
| COLOR  | STANDARD | MIDWAY | OVERSIZE              | STANDARD | MIDWAY | MATERIAL        | STANDARD          | OVERSIZE |
|  |          |        |                       |          |        | Brass           | *                 | —        |
|  |          |        |                       |          |        | 430 S/S         | *                 | —        |
|  |          |        |                       |          |        | 302 S/S         | <b>S41-N</b><br>* | —        |
| <b>DESCRIPTION</b><br>5-Gang<br>Phone/Cable .406" dia. Hole, Box Mount  |          |        |                       |          |        |                 |                   |          |
| COLOR  | STANDARD | MIDWAY | OVERSIZE              | STANDARD | MIDWAY | MATERIAL        | STANDARD          | OVERSIZE |
|  |          |        |                       |          |        | Brass           | *                 | —        |
|  |          |        |                       |          |        | 430 S/S         | *                 | —        |
|  |          |        |                       |          |        | 302 S/S         | <b>S51-N</b><br>* | —        |
| <b>DESCRIPTION</b><br>6-Gang<br>Phone/Cable .406" dia. Hole, Box Mount  |          |        |                       |          |        |                 |                   |          |
| COLOR  | STANDARD | MIDWAY | OVERSIZE              | STANDARD | MIDWAY | MATERIAL        | STANDARD          | OVERSIZE |
|  |          |        |                       |          |        | Brass           | *                 | —        |
|  |          |        |                       |          |        | 430 S/S         | *                 | —        |
|  |          |        |                       |          |        | 302 S/S         | <b>S61-N</b><br>* | —        |

### Telephone or Cable Outlet Wallplates—Strap Mounted

| Thermoset (Plastic)  |               |        | Thermoplastic (Nylon) |              |        | Assorted Metals |                           |                            |
|--|---------------|--------|-----------------------|--------------|--------|-----------------|---------------------------|----------------------------|
| <b>DESCRIPTION</b><br>1-Gang<br>Phone/Cable .406" dia. Hole, Strap Mount<br>With knockout to enlarge hole to .625"  |               |        |                       |              |        |                 |                           |                            |
| COLOR  | STANDARD P12  | MIDWAY | OVERSIZE              | STANDARD     | MIDWAY | MATERIAL        | STANDARD                  | OVERSIZE                   |
| Ivory  | 86018         | —      | —                     | —            | —      | Aluminum        | *                         | —                          |
| White  | 88018         | —      | —                     | —            | —      | Brass           | *                         | —                          |
| Brown  | 85018         | —      | —                     | —            | —      | 430 S/S         | <b>S12</b><br>*           | —                          |
|  |               |        |                       |              |        | 302 S/S         | <b>S12-N</b><br>84018-40  | —                          |
| <b>DESCRIPTION</b><br>1-Gang<br>Phone/Cable .406" dia. Hole, Strap Mount    |               |        |                       |              |        |                 |                           |                            |
| COLOR  | STANDARD      | MIDWAY | OVERSIZE PO12         | STANDARD N12 | MIDWAY | MATERIAL        | STANDARD                  | OVERSIZE                   |
| Ivory  | —             | —      | 86113                 | 80718-I      | —      | Brass           | *                         | —                          |
| Black  | —             | —      | —                     | 80718-E      | —      | 430 S/S         | *                         | —                          |
| Gray   | —             | —      | —                     | 80718-GY     | —      | 302 S/S         | *                         | —                          |
| White  | —             | —      | 88113                 | 80718-W      | —      |                 |                           |                            |
| Brown  | —             | —      | —                     | 80718        | —      |                 |                           |                            |
| <b>DESCRIPTION</b><br>1-Gang<br>Phone/Cable .625" dia. Hole, Strap Mount    |               |        |                       |              |        |                 |                           |                            |
| COLOR  | STANDARD P730 | MIDWAY | OVERSIZE              | STANDARD     | MIDWAY | MATERIAL        | STANDARD                  | OVERSIZE                   |
| White  | 88037         | —      | —                     | —            | —      | Brass           | *                         | —                          |
|  |               |        |                       |              |        | 430 S/S         | *                         | <b>S0730</b><br>*          |
|  |               |        |                       |              |        | 302 S/S         | <b>S730-N</b><br>84037-40 | <b>S0730-N</b><br>84137-40 |

\*Consult your Leviton representative for ordering details: allow 3–4 weeks for delivery.

**NOTE:** Where applicable, Industry Number indicated in BOLD FACE. For some wallplates, Industry Number and Leviton Catalog Number are identical.

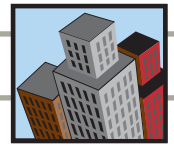

Residential and Commercial Grade Wallplates

Telephone or Cable Outlet Wallplates—Strap Mounted

|                     |                       |                 |
|---------------------|-----------------------|-----------------|
| Thermoset (Plastic) | Thermoplastic (Nylon) | Assorted Metals |
|---------------------|-----------------------|-----------------|

DESCRIPTION  
2-Gang  
Phone/Cable .406" dia. Hole, Strap Mount



| COLOR | STANDARD | MIDWAY | OVERSIZE | STANDARD | MIDWAY | MATERIAL | STANDARD     | OVERSIZE |
|-------|----------|--------|----------|----------|--------|----------|--------------|----------|
| Ivory | P22-1†   | —      | —        | —        | —      | Brass    | —            | —        |
|       |          |        |          |          |        | 430 S/S  | *            | —        |
|       |          |        |          |          |        | 302 S/S  | <b>S22-N</b> | *        |

†Painted metal wallplate.

DESCRIPTION  
3-Gang  
Phone/Cable .406" dia. Hole, Strap Mount

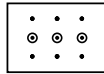

| COLOR | STANDARD | MIDWAY | OVERSIZE | STANDARD | MIDWAY | MATERIAL | STANDARD     | OVERSIZE |
|-------|----------|--------|----------|----------|--------|----------|--------------|----------|
|       | P32      | —      | —        | —        | —      | Brass    | —            | —        |
|       |          |        |          |          |        | 430 S/S  | *            | —        |
|       |          |        |          |          |        | 302 S/S  | <b>S32-N</b> | *        |

†Painted metal wallplate.

DESCRIPTION  
4-Gang  
Phone/Cable .406" dia. Hole, Strap Mount

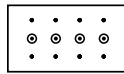

| COLOR | STANDARD | MIDWAY | OVERSIZE | STANDARD | MIDWAY | MATERIAL | STANDARD     | OVERSIZE |
|-------|----------|--------|----------|----------|--------|----------|--------------|----------|
|       |          |        |          |          |        | Brass    | *            | —        |
|       |          |        |          |          |        | 430 S/S  | *            | —        |
|       |          |        |          |          |        | 302 S/S  | <b>S42-N</b> | *        |

†Painted metal wallplate.

DESCRIPTION  
5-Gang  
Phone/Cable .406" dia. Hole, Strap Mount

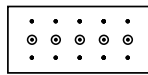

| COLOR | STANDARD | MIDWAY | OVERSIZE | STANDARD | MIDWAY | MATERIAL | STANDARD     | OVERSIZE |
|-------|----------|--------|----------|----------|--------|----------|--------------|----------|
|       |          |        |          |          |        | Brass    | *            | —        |
|       |          |        |          |          |        | 430 S/S  | *            | —        |
|       |          |        |          |          |        | 302 S/S  | <b>S52-N</b> | *        |

†Painted metal wallplate.

DESCRIPTION  
6-Gang  
Phone/Cable .406" dia. Hole, Strap Mount

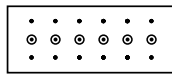

| COLOR | STANDARD | MIDWAY | OVERSIZE | STANDARD | MIDWAY | MATERIAL | STANDARD     | OVERSIZE |
|-------|----------|--------|----------|----------|--------|----------|--------------|----------|
|       |          |        |          |          |        | Brass    | *            | —        |
|       |          |        |          |          |        | 430 S/S  | *            | —        |
|       |          |        |          |          |        | 302 S/S  | <b>S62-N</b> | *        |

†Painted metal wallplate.

\*Consult your Leviton representative for ordering details: allow 3–4 weeks for delivery.



**NOTE: Where applicable, Industry Number indicated in BOLD FACE. For some wallplates, Industry Number and Leviton Catalog Number are identical.**



# WALLPLATES

## Residential and Commercial Grade Wallplates

### Blank Wallplates—Box Mounted

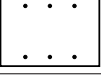
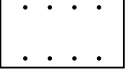
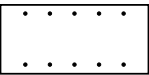
| Thermoset (Plastic)   |              |              | Thermoplastic (Nylon) |              |             | Assorted Metals |                          |                           |
|---|--------------|--------------|-----------------------|--------------|-------------|-----------------|--------------------------|---------------------------|
| <b>DESCRIPTION</b><br>1-Gang<br>1-Blank, Box Mounted     |              |              |                       |              |             |                 |                          |                           |
| COLOR   | STANDARD P13 | MIDWAY SPJ13 | OVERSIZE P013         | STANDARD N13 | MIDWAY PJ13 | MATERIAL        | STANDARD                 | OVERSIZE                  |
| Ivory   | 86014        | 80514-I      | 86114                 | 80714-I      | PJ13-I      | Chrome          | *                        | —                         |
| Black   | —            | —            | —                     | 80714-E      | PJ13-E      | Aluminum        | <b>A13</b><br>83014      | —                         |
| Gray  | 87014        | —            | —                     | 80714-GY     | PJ13-GY     | Brass           | <b>B13</b><br>81014      | —                         |
| Red   | —            | —            | —                     | 80714-R      | PJ13-R      | 430 S/S         | <b>S13</b><br>84014      | <b>S013</b><br>84114      |
| White   | 88014        | 80514-W      | 88114                 | 80714-W      | PJ13-W      | 302 S/S         | <b>S13-N</b><br>84014-40 | <b>S013-N</b><br>84114-40 |
| Brown   | 85014        | 80514        | 85114                 | 80714        | PJ13        |                 |                          |                           |
| Almond  | 82014        | 80514-A      | —                     | 80714-A      | PJ13-A      |                 |                          |                           |
| Light Almond  | 78014        | 80514-T      | —                     | 80714-T      | PJ13-T      |                 |                          |                           |
| <b>DESCRIPTION</b><br>2-Gang<br>2-Blanks, Box Mounted    |              |              |                       |              |             |                 |                          |                           |
| COLOR   | STANDARD P23 | MIDWAY SPJ23 | OVERSIZE              | STANDARD N24 | MIDWAY PJ23 | MATERIAL        | STANDARD                 | OVERSIZE                  |
| Ivory   | 86025        | 80525-I      | —                     | 80725-I      | PJ23-I      | Aluminum        | 83025                    | —                         |
| Black   | —            | —            | —                     | 80725-E      | —           | Brass           | <b>B23</b><br>81025      | —                         |
| Gray  | 87025        | —            | —                     | 80725-GY     | PJ23-GY     | Polished Brass  | 81025-PB                 | —                         |
| White   | 88025        | 80525-W      | —                     | 80725-W      | PJ23-W      | 430 S/S         | <b>S23</b><br>84025      | —                         |
| Brown   | 85025        | 80525        | —                     | 80725        | —           | 302 S/S         | <b>S23-N</b><br>84025-40 | <b>S023-N</b><br>84125-40 |
| Almond  | 82025        | 80525-A      | —                     | 80725-A      | PJ23-A      |                 |                          |                           |
| Light Almond  | 78025        | 80525-T      | —                     | 80725-T      | PJ23-T      |                 |                          |                           |
| <b>DESCRIPTION</b><br>3-Gang<br>3-Blanks, Box Mounted  |              |              |                       |              |             |                 |                          |                           |
| COLOR   | STANDARD P33 | MIDWAY       | OVERSIZE              | STANDARD     | MIDWAY      | MATERIAL        | STANDARD                 | OVERSIZE                  |
| Ivory   | 86033        | 80533-I      | —                     | 80735-I      | —           | Aluminum        | *                        | —                         |
| Black   | —            | —            | —                     | 80735-E      | —           | Brass           | *                        | —                         |
| Gray  | —            | —            | —                     | 80735-GY     | —           | 430 S/S         | *                        | —                         |
| White   | 88033        | 80533-W      | —                     | 80735-W      | —           | 302 S/S         | <b>S33-N</b><br>84033-40 | <b>S033-N</b><br>84133-40 |
| Brown   | 85033        | —            | —                     | —            | —           |                 |                          |                           |
| Almond  | —            | —            | —                     | 80735-A      | —           |                 |                          |                           |
| <b>DESCRIPTION</b><br>4-Gang<br>4-Blanks, Box Mounted  |              |              |                       |              |             |                 |                          |                           |
| COLOR   | STANDARD P43 | MIDWAY       | OVERSIZE              | STANDARD     | MIDWAY      | MATERIAL        | STANDARD                 | OVERSIZE                  |
| Ivory   | 86064        | —            | —                     | —            | —           | Aluminum        | *                        | —                         |
| White   | 88064        | —            | —                     | —            | —           | Brass           | *                        | —                         |
| Brown   | 85064        | —            | —                     | —            | —           | 430 S/S         | <b>S43</b><br>84064      | *                         |
|   |              |              |                       |              |             | 302 S/S         | <b>S43-N</b><br>84064-40 | *                         |
| <b>DESCRIPTION</b><br>5-Gang<br>5-Blanks, Box Mounted  |              |              |                       |              |             |                 |                          |                           |
| COLOR   | STANDARD     | MIDWAY       | OVERSIZE              | STANDARD     | MIDWAY      | MATERIAL        | STANDARD                 | OVERSIZE                  |
|   |              |              |                       |              |             | Brass           | *                        | —                         |
|   |              |              |                       |              |             | 302 S/S         | <b>S53-N</b><br>84065-40 | —                         |

\*Consult your Leviton representative for ordering details: allow 3–4 weeks for delivery.

**NOTE:** Where applicable, Industry Number indicated in BOLD FACE. For some wallplates, Industry Number and Leviton Catalog Number are identical.

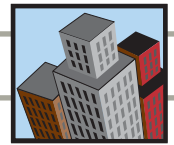

Residential and Commercial Grade Wallplates

Blank Wallplates—Box Mounted

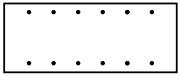
| Thermoset (Plastic)  |          |        | Thermoplastic (Nylon) |          |        | Assorted Metals |                          |          |
|--|----------|--------|-----------------------|----------|--------|-----------------|--------------------------|----------|
| DESCRIPTION<br>6-Gang<br>6-Blanks, Box Mounted  |          |        |                       |          |        |                 |                          |          |
| COLOR  | STANDARD | MIDWAY | OVERSIZE              | STANDARD | MIDWAY | MATERIAL        | STANDARD                 | OVERSIZE |
|  |          |        |                       |          |        | Brass           | *                        | —        |
|  |          |        |                       |          |        | 302 S/S         | <b>S63-N</b><br>84066-40 | —        |

| DESCRIPTION<br>7-Gang<br>7-Blanks, Box Mounted  |          |        |          |          |        |          |                            |          |
|--|----------|--------|----------|----------|--------|----------|----------------------------|----------|
| COLOR  | STANDARD | MIDWAY | OVERSIZE | STANDARD | MIDWAY | MATERIAL | STANDARD                   | OVERSIZE |
|  |          |        |          |          |        | Brass    | *                          | —        |
|  |          |        |          |          |        | 302 S/S  | <b>S6013-N</b><br>84067-40 | —        |

| DESCRIPTION<br>8-Gang<br>8-Blanks, Box Mounted  |          |        |          |          |        |          |                            |          |
|--|----------|--------|----------|----------|--------|----------|----------------------------|----------|
| COLOR  | STANDARD | MIDWAY | OVERSIZE | STANDARD | MIDWAY | MATERIAL | STANDARD                   | OVERSIZE |
|  |          |        |          |          |        | Brass    | *                          | —        |
|  |          |        |          |          |        | 302 S/S  | <b>S6023-N</b><br>84068-40 | —        |

Blank Wallplates—Strap Mounted

| Thermoset (Plastic)   |          |        | Thermoplastic (Nylon) |          |        | Assorted Metals |                          |                           |
|---|----------|--------|-----------------------|----------|--------|-----------------|--------------------------|---------------------------|
| DESCRIPTION<br>1-Gang<br>1-Blank, Strap Mounted  |          |        |                       |          |        |                 |                          |                           |
| COLOR   | STANDARD | MIDWAY | OVERSIZE              | STANDARD | MIDWAY | MATERIAL        | STANDARD                 | OVERSIZE                  |
| Ivory   | 86019    | —      | —                     | 80719-I  | —      | Aluminum        | *                        | —                         |
| Black   | —        | —      | —                     | 80719-E  | —      | Brass           | *                        | —                         |
| Gray  | —        | —      | —                     | 80719-GY | —      | 430 S/S         | <b>S14</b><br>84019      | *                         |
| Red   | —        | —      | —                     | 80719-R  | —      | 302 S/S         | <b>S14-N</b><br>84019-40 | <b>S014-N</b><br>84119-40 |
| White   | 88019    | —      | —                     | 80719-W  | —      |                 |                          |                           |
| Brown   | 85019    | —      | —                     | 80719    | —      |                 |                          |                           |

| DESCRIPTION<br>2-Gang<br>2-Blank, Strap Mounted  |          |        |          |          |        |          |                          |                           |
|---|----------|--------|----------|----------|--------|----------|--------------------------|---------------------------|
| COLOR   | STANDARD | MIDWAY | OVERSIZE | STANDARD | MIDWAY | MATERIAL | STANDARD                 | OVERSIZE                  |
| Ivory   | 86034    | —      | —        | 80734-I  | —      | 430 S/S  | *                        | —                         |
| Black   | —        | —      | —        | 80734-E  | —      | 302 S/S  | <b>S24-N</b><br>84034-40 | <b>S024-N</b><br>84134-40 |
| Red   | —        | —      | —        | 80734-R  | —      |          |                          |                           |
| White   | 88034    | —      | —        | 80734-W  | —      |          |                          |                           |

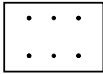
| DESCRIPTION<br>3-Gang<br>3-Blank, Strap Mounted  |          |        |          |          |        |          |                          |          |
|---|----------|--------|----------|----------|--------|----------|--------------------------|----------|
| COLOR   | STANDARD | MIDWAY | OVERSIZE | STANDARD | MIDWAY | MATERIAL | STANDARD                 | OVERSIZE |
| Ivory   | 86035    | —      | —        | —        | —      | Brass    | *                        | —        |
| White   | 88035    | —      | —        | —        | —      | 430 S/S  | *                        | *        |
|   |          |        |          |          |        | 302 S/S  | <b>S34-N</b><br>84035-40 | —        |

\*Consult your Leviton representative for ordering details: allow 3–4 weeks for delivery.

NOTE: Where applicable, Industry Number indicated in BOLD FACE. For some wallplates, Industry Number and Leviton Catalog Number are identical.



# WALLPLATES

## Residential and Commercial Grade Wallplates

### Blank Wallplates—Strap Mounted

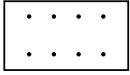
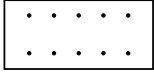
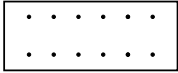
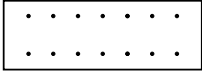
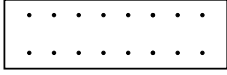
| Thermoset   |          |        | Thermoplastic |          |        | Assorted Metals |                          |          |
|---|----------|--------|---------------|----------|--------|-----------------|--------------------------|----------|
| DESCRIPTION<br>4-Gang<br>4-Blank, Strap Mounted    |          |        |               |          |        |                 |                          |          |
| COLOR   | STANDARD | MIDWAY | OVERSIZE      | STANDARD | MIDWAY | MATERIAL        | STANDARD                 | OVERSIZE |
| Ivory   | 86057    | —      | —             | —        | —      | Brass           | *                        | —        |
| White   | 88057    | —      | —             | —        | —      | 430 S/S         | *                        | *        |
|   |          |        |               |          |        | 302 S/S         | <b>S44-N</b><br>84057-40 | —        |
| DESCRIPTION<br>5-Gang<br>5-Blank, Strap Mounted    |          |        |               |          |        |                 |                          |          |
| COLOR   | STANDARD | MIDWAY | OVERSIZE      | STANDARD | MIDWAY | MATERIAL        | STANDARD                 | OVERSIZE |
|   |          |        |               |          |        | Brass           | *                        | —        |
|   |          |        |               |          |        | 430 S/S         | *                        | —        |
|   |          |        |               |          |        | 302 S/S         | <b>S54-N</b><br>S54-N    | —        |
| DESCRIPTION<br>6-Gang<br>6-Blank, Strap Mounted    |          |        |               |          |        |                 |                          |          |
| COLOR   | STANDARD | MIDWAY | OVERSIZE      | STANDARD | MIDWAY | MATERIAL        | STANDARD                 | OVERSIZE |
|   |          |        |               |          |        | Brass           | *                        | —        |
|   |          |        |               |          |        | 430 S/S         | *                        | —        |
|   |          |        |               |          |        | 302 S/S         | <b>S64-N</b><br>*        | —        |
| DESCRIPTION<br>7-Gang<br>7-Blank, Strap Mounted   |          |        |               |          |        |                 |                          |          |
| COLOR   | STANDARD | MIDWAY | OVERSIZE      | STANDARD | MIDWAY | MATERIAL        | STANDARD                 | OVERSIZE |
|   |          |        |               |          |        | Brass           | *                        | —        |
|   |          |        |               |          |        | 430 S/S         | *                        | —        |
|   |          |        |               |          |        | 302 S/S         | <b>S6014-N</b><br>*      | —        |
| DESCRIPTION<br>8-Gang<br>8-Blank, Strap Mounted  |          |        |               |          |        |                 |                          |          |
| COLOR   | STANDARD | MIDWAY | OVERSIZE      | STANDARD | MIDWAY | MATERIAL        | STANDARD                 | OVERSIZE |
|   |          |        |               |          |        | Brass           | *                        | —        |
|   |          |        |               |          |        | 430 S/S         | *                        | —        |
|   |          |        |               |          |        | 302 S/S         | <b>S6024-N</b><br>*      | —        |

\*Consult your Leviton representative for ordering details: allow 3-4 weeks for delivery.

**NOTE:** Where applicable, Industry Number indicated in BOLD FACE. For some wallplates, Industry Number and Leviton Catalog Number are identical.



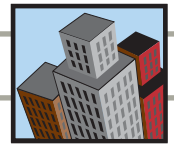

Residential and Commercial Grade Wallplates

Power Outlet Receptacle – One Gang  
Thermoset (Plastic)

Thermoplastic (Nylon)

Assorted Metals

DESCRIPTION  
20A & 30A Locking Receptacles  
1-Gang 1.60" dia. Hole



| COLOR | STANDARD | MIDWAY | OVERSIZE | STANDARD<br>N726 | MIDWAY | MATERIAL | STANDARD                  | OVERSIZE |
|-------|----------|--------|----------|------------------|--------|----------|---------------------------|----------|
| Ivory | —        | —      | —        | 80720-I          | —      | Brass    | *                         | —        |
| Black | —        | —      | —        | 80720-E          | —      | 430 S/S  | *                         | —        |
| Gray  | —        | —      | —        | 80720-GY         | —      | 302 S/S  | <b>S720-N</b><br>84020-40 | —        |
| Red   | —        | —      | —        | 80720-R          | —      |          |                           |          |
| White | —        | —      | —        | 80720-W          | —      |          |                           |          |
| Brown | —        | —      | —        | 80720            | —      |          |                           |          |

DESCRIPTION  
30A & 50A Power Receptacle  
1-Gang 2.15" dia. Hole  
Use with 278, 279, 5206, 5207, 5371, 5372, 5373, 5374



| COLOR | STANDARD | MIDWAY<br>P724 | OVERSIZE | STANDARD | MIDWAY<br>N724 | MATERIAL                  | STANDARD               | OVERSIZE |
|-------|----------|----------------|----------|----------|----------------|---------------------------|------------------------|----------|
| Ivory | —        | 80528-I        | —        | —        | 80728-I        | Aluminum                  | <b>A724</b><br>83028   | —        |
| Black | —        | 80528-BLK      | —        | —        | 80728-E        | Steel,<br>Brass Finish    | <b>B724</b><br>4928    | —        |
| Gray  | —        | —              | —        | —        | 80728-GY       | Steel,<br>Aluminum Finish | <b>S724-GY</b><br>4927 | —        |
| White | —        | 80528-W        | —        | —        | 80728-W        | 430 S/S                   | <b>S724</b><br>84028   | —        |
| Brown | —        | —              | —        | —        | 80728          |                           |                        |          |

Power Outlet Receptacle—Two Gang  
Thermoset (Plastic)

Thermoplastic (Nylon)

Assorted Metals

DESCRIPTION  
30A & 50A Power Receptacle  
2-Gang 2.15" dia. Hole  
For use with 278,279, 5206, 5207, 5371, 5372, 5373, 5374



| COLOR | STANDARD | MIDWAY<br>PJ 703 | OVERSIZE | STANDARD | MIDWAY<br>N703 | MATERIAL        | STANDARD               | OVERSIZE |
|-------|----------|------------------|----------|----------|----------------|-----------------|------------------------|----------|
| Ivory | —        | 80526-I          | —        | —        | 80726-I        | Brass           | <b>B703</b><br>*       | —        |
| Black | —        | 80526-BLK        | —        | —        | —              | Alum            | <b>A703</b><br>83026   | —        |
| White | —        | 80526-W          | —        | —        | 80726-W        | Steel,Alum Fin. | <b>S703-GY</b><br>4934 | —        |
| Brown | —        | —                | —        | —        | 80726          | 430 S/S         | <b>S703</b><br>84026   | —        |

\*Consult your Leviton representative for ordering details: allow 3-4 weeks for delivery.

NOTE: Where applicable, Industry Number indicated in BOLD FACE. For some wallplates, Industry Number and Leviton Catalog Number are identical.



# WALLPLATES

## Residential and Commercial Grade Wallplates

### Power Outlet Receptacle – Two Gang

Thermoset (Plastic)

Thermoplastic (Nylon)

Assorted Metals

#### DESCRIPTION

2-Gang  
2.15" dia. Hole Offset



| COLOR | STANDARD | MIDWAY | OVERSIZE | STANDARD | MIDWAY | MATERIAL | STANDARD             | OVERSIZE |
|-------|----------|--------|----------|----------|--------|----------|----------------------|----------|
|       |          |        |          |          |        | 430 S/S  | <b>S705</b><br>84022 | —        |

#### DESCRIPTION

30A & 50A Power Receptacle  
2-Gang 2.465" dia. Hole



| COLOR        | STANDARD | MIDWAY    | OVERSIZE | STANDARD | MIDWAY | MATERIAL        | STANDARD                  | OVERSIZE |
|--------------|----------|-----------|----------|----------|--------|-----------------|---------------------------|----------|
| Ivory        | —        | 80530-I   | —        | —        | —      | Steel, Alum Fin | <b>S701-GY</b><br>S701-GY | —        |
| Black        | —        | 80530-BLK | —        | —        | —      | 430 S/S         | <b>S701</b><br>*          | —        |
| White        | —        | 80530-W   | —        | —        | —      | 302 S/S         | S701-40                   | —        |
| Almond       | —        | 80530-A   | —        | —        | —      |                 |                           |          |
| Light Almond | —        | 80530-T   | —        | —        | —      |                 |                           |          |

\*Consult your Leviton representative for ordering details: allow 3–4 weeks for delivery.

**NOTE:** Where applicable, Industry Number indicated in **BOLD FACE**. For some wallplates, Industry Number and Leviton Catalog Number are identical.

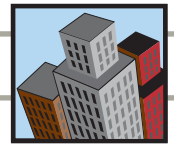

Residential and Commercial Grade Wallplates

Two Gang with Centered Opening  
Thermoset (Plastic)

Thermoplastic (Nylon)

Assorted Metals

| DESCRIPTION<br>2-Gang<br>1-Toggle |          |        |          |          |        |          |                           |          |
|-----------------------------------|----------|--------|----------|----------|--------|----------|---------------------------|----------|
| COLOR                             | STANDARD | MIDWAY | OVERSIZE | STANDARD | MIDWAY | MATERIAL | STANDARD                  | OVERSIZE |
|                                   |          |        |          |          |        | Brass    | 81040                     | —        |
|                                   |          |        |          |          |        | 430 S/S  | —                         | —        |
|                                   |          |        |          |          |        | 302 S/S  | <b>S740-N</b><br>84040-40 | —        |

| DESCRIPTION<br>2-Gang 1-Phone/Cable<br>.406" Hole, Box Mount |          |        |          |          |        |          |          |          |
|--|----------|--------|----------|----------|--------|----------|----------|----------|
| COLOR  | STANDARD | MIDWAY | OVERSIZE | STANDARD | MIDWAY | MATERIAL | STANDARD | OVERSIZE |
|  |          |        |          |          |        | Brass    | *        | —        |
|  |          |        |          |          |        | 430 S/S  | *        | —        |
|  |          |        |          |          |        | 302 S/S  | *        | —        |

| DESCRIPTION<br>2-Gang 1-Phone/Cable<br>.406" Hole, Strap Mount |          |        |          |          |        |          |          |          |
|--|----------|--------|----------|----------|--------|----------|----------|----------|
| COLOR  | STANDARD | MIDWAY | OVERSIZE | STANDARD | MIDWAY | MATERIAL | STANDARD | OVERSIZE |
|  |          |        |          |          |        | Brass    | *        | —        |
|  |          |        |          |          |        | 430 S/S  | *        | —        |
|  |          |        |          |          |        | 302 S/S  | *        | —        |

| DESCRIPTION<br>2-Gang Blank<br>Box Mount |          |        |          |          |        |          |          |          |
|--|----------|--------|----------|----------|--------|----------|----------|----------|
| COLOR                                    | STANDARD | MIDWAY | OVERSIZE | STANDARD | MIDWAY | MATERIAL | STANDARD | OVERSIZE |
|  |          |        |          |          |        | Brass    | *        | —        |
|  |          |        |          |          |        | 430 S/S  | *        | —        |
|  |          |        |          |          |        | 302 S/S  | *        | —        |

| DESCRIPTION<br>2-Gang Blank<br>Strap Mount |          |        |          |          |        |          |          |          |
|--|----------|--------|----------|----------|--------|----------|----------|----------|
| COLOR                                      | STANDARD | MIDWAY | OVERSIZE | STANDARD | MIDWAY | MATERIAL | STANDARD | OVERSIZE |
|  |          |        |          |          |        | Brass    | —        | —        |
|  |          |        |          |          |        | 430 S/S  | —        | —        |
|  |          |        |          |          |        | 302 S/S  | *        | —        |

| DESCRIPTION<br>2-Gang<br>1-Decora |          |        |          |          |        |          |                         |          |
|-----------------------------------|----------|--------|----------|----------|--------|----------|-------------------------|----------|
| COLOR                             | STANDARD | MIDWAY | OVERSIZE | STANDARD | MIDWAY | MATERIAL | STANDARD                | OVERSIZE |
|                                   |          |        |          |          |        | Brass    | —                       | —        |
|                                   |          |        |          |          |        | 430 S/S  | *                       | —        |
|                                   |          |        |          |          |        | 302 S/S  | <b>S746-N</b><br>S746-N | —        |

| DESCRIPTION<br>2-Gang<br>1 Single Outlet<br>1.406" dia. Hole |          |        |          |          |        |          |                           |          |
|--|----------|--------|----------|----------|--------|----------|---------------------------|----------|
| COLOR  | STANDARD | MIDWAY | OVERSIZE | STANDARD | MIDWAY | MATERIAL | STANDARD                  | OVERSIZE |
|  |          |        |          |          |        | Brass    | —                         | —        |
|  |          |        |          |          |        | 430 S/S  | *                         | —        |
|  |          |        |          |          |        | 302 S/S  | <b>S747-N</b><br>84092-40 | —        |

| DESCRIPTION<br>2-Gang<br>1-Duplex |          |        |          |          |        |          |                           |          |
|-----------------------------------|----------|--------|----------|----------|--------|----------|---------------------------|----------|
| COLOR                             | STANDARD | MIDWAY | OVERSIZE | STANDARD | MIDWAY | MATERIAL | STANDARD                  | OVERSIZE |
|                                   |          |        |          |          |        | 302 S/S  | <b>S748-N</b><br>84039-40 | —        |

\*Consult your Leviton representative for ordering details: allow 3-4 weeks for delivery.

NOTE: Where applicable, Industry Number indicated in BOLD FACE. For some wallplates, Industry Number and Leviton Catalog Number are identical.



# WALLPLATES

## Residential and Commercial Grade Wallplates

### Louvre Plates

Thermoset (Plastic)

Thermoplastic (Nylon)

Assorted Metals

DESCRIPTION  
1-Gang Center  
1-Louvre Plate  
Horizontal Box Mount



| COLOR | STANDARD<br>P760 | MIDWAY | OVERSIZE | STANDARD | MIDWAY | MATERIAL | STANDARD                  | OVERSIZE |
|-------|------------------|--------|----------|----------|--------|----------|---------------------------|----------|
| Ivory | 86079†           | —      | —        | —        | —      | Brass    | <b>B760</b><br>81079      | —        |
| White | 88079†           | —      | —        | —        | —      | 430 S/S  | *                         | —        |
|       |                  |        |          |          |        | 302 S/S  | <b>S760-N</b><br>84079-40 | —        |

DESCRIPTION  
1-Gang  
1-Louvre Plate  
Strap Mount



| COLOR  | STANDARD<br>P771 | MIDWAY | OVERSIZE | STANDARD | MIDWAY | MATERIAL | STANDARD                  | OVERSIZE |
|--------|------------------|--------|----------|----------|--------|----------|---------------------------|----------|
| Ivory  | 86080†           | —      | —        | —        | —      | Brass    | <b>B771</b><br>81080      | —        |
| White  | 88080†           | —      | —        | —        | —      | 430 S/S  | *                         | —        |
| Almond | 82080†           | —      | —        | —        | —      | 302 S/S  | <b>S771-N</b><br>84080-40 | —        |

DESCRIPTION  
2-Gang  
2-Louvre Plate  
Strap Mount



| COLOR | STANDARD | MIDWAY | OVERSIZE | STANDARD | MIDWAY | MATERIAL | STANDARD                  | OVERSIZE |
|-------|----------|--------|----------|----------|--------|----------|---------------------------|----------|
|       |          |        |          |          |        | Brass    | *                         | —        |
|       |          |        |          |          |        | 430 S/S  | *                         | —        |
|       |          |        |          |          |        | 302 S/S  | <b>S772-N</b><br>84081-40 | —        |

DESCRIPTION  
3-Gang  
3-Louvre Plate  
Strap Mount



| COLOR | STANDARD | MIDWAY | OVERSIZE | STANDARD | MIDWAY | MATERIAL | STANDARD | OVERSIZE |
|-------|----------|--------|----------|----------|--------|----------|----------|----------|
|       |          |        |          |          |        | Brass    | *        | —        |
|       |          |        |          |          |        | 430 S/S  | *        | —        |
|       |          |        |          |          |        | 302 S/S  | *        | —        |

†Painted metal wallplate.

\*Consult your Leviton representative for ordering details: allow 3–4 weeks for delivery.

**NOTE: Where applicable, Industry Number indicated in BOLD FACE. For some wallplates, Industry Number and Leviton Catalog Number are identical.**

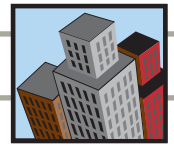

Residential and Commercial Grade Wallplates

Combination Wallplates  
Toggle Switch and Single Receptacle  
Thermoset (Plastic)

Thermoplastic (Nylon)

Assorted Metals

DESCRIPTION

2-Gang  
1-Toggle 1-Single 1.406" dia. Hole



| COLOR | STANDARD P17 | MIDWAY | OVERSIZE | STANDARD | MIDWAY | MATERIAL | STANDARD                 | OVERSIZE |
|-------|--------------|--------|----------|----------|--------|----------|--------------------------|----------|
| Ivory | 86007        | ---    | ---      | ---      | ---    | Aluminum | *                        | ---      |
| White | 88007        | ---    | ---      | ---      | ---    | Brass    | *                        | ---      |
|       |              |        |          |          |        | 430 S/S  | <b>S17</b><br>84007      | ---      |
|       |              |        |          |          |        | 302 S/S  | <b>S17-N</b><br>84007-40 | ---      |

DESCRIPTION

3-Gang  
2-Toggles 1-Single 1.406" dia. Hole



| COLOR | STANDARD | MIDWAY | OVERSIZE | STANDARD | MIDWAY | MATERIAL | STANDARD                 | OVERSIZE |
|-------|----------|--------|----------|----------|--------|----------|--------------------------|----------|
|       |          |        |          |          |        | Aluminum | *                        | ---      |
|       |          |        |          |          |        | Brass    | *                        | ---      |
|       |          |        |          |          |        | 430 S/S  | *                        | ---      |
|       |          |        |          |          |        | 302 S/S  | <b>S27-N</b><br>84088-40 | ---      |

DESCRIPTION

4-Gang  
3-Toggles 1-Single 1.406" dia. Hole



| COLOR | STANDARD | MIDWAY | OVERSIZE | STANDARD | MIDWAY | MATERIAL | STANDARD                 | OVERSIZE |
|-------|----------|--------|----------|----------|--------|----------|--------------------------|----------|
|       |          |        |          |          |        | Aluminum | *                        | ---      |
|       |          |        |          |          |        | Brass    | *                        | ---      |
|       |          |        |          |          |        | 430 S/S  | *                        | ---      |
|       |          |        |          |          |        | 302 S/S  | <b>S37-N</b><br>84042-40 | ---      |

Combination Wallplates  
Toggle Switch and Duplex Receptacle  
Thermoset (Plastic)

Thermoplastic (Nylon)

Assorted Metals

DESCRIPTION

2-Gang  
1-Toggle 1-Duplex



| COLOR        | STANDARD P18 | MIDWAY SPJ18 | OVERSIZE P018 | STANDARD N18 | MIDWAY | MATERIAL | STANDARD                 | OVERSIZE                  |
|--------------|--------------|--------------|---------------|--------------|--------|----------|--------------------------|---------------------------|
| Ivory        | 86005        | 80505-I      | 86105         | 80705-I      | PJ18-I | Aluminum | <b>A18</b><br>83005      | ---                       |
| Black        | ---          | ---          | ---           | 80705-E      | PJ18-E | Brass    | <b>B18</b><br>81005      | ---                       |
| Gray         | 87005        | ---          | ---           | 80705-GY     | ---    | 430 S/S  | <b>S18</b><br>84005      | *                         |
| Red          | ---          | ---          | ---           | 80705-R      | ---    | 302 S/S  | <b>S18-N</b><br>84005-40 | <b>S018-N</b><br>84105-40 |
| White        | 88005        | 80505-W      | 88105         | 80705-W      | PJ18-W |          |                          |                           |
| Brown        | 85005        | 80505        | ---           | 80705        | ----   |          |                          |                           |
| Almond       | 82005        | 80505-A      | ---           | 80705-A      | PJ18-A |          |                          |                           |
| Light Almond | 78005        | 80505-T      | ---           | 80705-T      | PJ18-T |          |                          |                           |

\*Consult your Leviton representative for ordering details: allow 3-4 weeks for delivery.

NOTE: Where applicable, Industry Number indicated in BOLD FACE. For some wallplates, Industry Number and Leviton Catalog Number are identical.



# WALLPLATES

## Residential and Commercial Grade Wallplates

### Combination Wallplates Toggle Switch and Duplex Receptacle

| Thermoset (Plastic)   |                 |                 | Thermoplastic (Nylon) |                 |        | Assorted Metals |                          |                           |
|---|-----------------|-----------------|-----------------------|-----------------|--------|-----------------|--------------------------|---------------------------|
| DESCRIPTION<br>3-Gang<br>2-Toggles 1-Duplex  |                 |                 |                       |                 |        |                 |                          |                           |
| COLOR   | STANDARD<br>P28 | MIDWAY<br>SPJ28 | OVERSIZE              | STANDARD<br>N28 | MIDWAY | MATERIAL        | STANDARD                 | OVERSIZE                  |
| Ivory   | 86021           | 80521-I         | —                     | 80721-I         | —      | Aluminum        | *                        | —                         |
| Black   | —               | —               | —                     | 80721-E         | —      | Brass           | <b>B28</b><br>81021      | —                         |
|   |                 |                 |                       |                 |        | 430 S/S         | *                        | *                         |
| White   | 88021           | 80521-W         | —                     | 80721-W         | —      | 302 S/S         | <b>S28-N</b><br>84021-40 | <b>S028-N</b><br>84121-40 |
| Brown   | 85021           | 80521           | —                     | —               | —      |                 |                          |                           |
| Almond  | 82021           | 80521-A         | —                     | —               | —      |                 |                          |                           |
| Light Almond  | 78021           | 80521-T         | —                     | —               | —      |                 |                          |                           |

| DESCRIPTION<br>4-Gang<br>3-Toggles 1-Duplex  |                 |        |          |          |        |          |          |          |
|---|-----------------|--------|----------|----------|--------|----------|----------|----------|
| COLOR   | STANDARD<br>P38 | MIDWAY | OVERSIZE | STANDARD | MIDWAY | MATERIAL | STANDARD | OVERSIZE |
| Ivory   | P38-I           | —      | —        | 80743-I  | —      | Aluminum | *        | —        |
| White   | P38-W           | —      | —        | 80743-W  | —      | Brass    | *        | —        |
| Brown   | P38             | —      | —        | —        | —      | 430 S/S  | 84043    | *        |
| Almond  | P38-A           | —      | —        | —        | —      | 302 S/S  | *        | —        |
| Light Almond  | P38-T           | —      | —        | —        | —      |          |          |          |

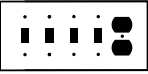
| DESCRIPTION<br>5-Gang<br>4-Toggles 1-Duplex  |                 |        |          |          |        |          |                       |          |
|---|-----------------|--------|----------|----------|--------|----------|-----------------------|----------|
| COLOR   | STANDARD<br>P48 | MIDWAY | OVERSIZE | STANDARD | MIDWAY | MATERIAL | STANDARD              | OVERSIZE |
| Ivory   | P48-I†          | —      | —        | —        | —      | Brass    | *                     | —        |
| White   | P48-W†          | —      | —        | —        | —      | 430 S/S  | *                     | —        |
|   |                 |        |          |          |        | 302 S/S  | <b>S48-N</b><br>S48-N | —        |

†Painted Metal Wallplate

\*Consult your Leviton representative for ordering details: allow 3–4 weeks for delivery.

**NOTE:** Where applicable, Industry Number indicated in **BOLD FACE**. For some wallplates, Industry Number and Leviton Catalog Number are identical.

Residential and Commercial Grade Wallplates



Combination Wallplates

Toggle Switch and Decora/GFCI

|                     |                       |                 |
|---------------------|-----------------------|-----------------|
| Thermoset (Plastic) | Thermoplastic (Nylon) | Assorted Metals |
|---------------------|-----------------------|-----------------|

DESCRIPTION

2-Gang 1-Toggle 1-Decora/GFCI



| COLOR        | STANDARD P126 | MIDWAY SPJ126 | OVERSIZE P0126 | STANDARD | MIDWAY PJ126 | MATERIAL | STANDARD     | OVERSIZE |
|--------------|---------------|---------------|----------------|----------|--------------|----------|--------------|----------|
| Ivory        | 80405-I       | 80605-I       | 86605          | 80707-I  | PJ126-I      | Brass    | *            | —        |
| Black        | 80405-E       | —             | —              | 80707-E  | —            | 430 S/S  | S126<br>S126 | —        |
| Gray         | 80405-GY      | —             | —              | 80707-GY | —            | 302 S/S  | *            | —        |
| Red          | —             | —             | —              | 80707-R  | —            |          | —            | —        |
| White        | 80405-W       | 80605-W       | 88605          | 80707-W  | PJ126-W      |          | —            | —        |
| Brown        | 80405         | 80605         | —              | 80707    | PJ126        |          | —            | —        |
| Almond       | 80405-A       | 80605-A       | 82605          | 80707-A  | PJ126-A      |          | —            | —        |
| Light Almond | 80405-T       | 80605-T       | —              | 80707-T  | PJ126-T      | —        | —            | —        |

DESCRIPTION

3-Gang 2-Toggles 1-Decora/GFCI



| COLOR        | STANDARD P226 | MIDWAY SPJ226 | OVERSIZE | STANDARD | MIDWAY SPJ226 | MATERIAL | STANDARD           | OVERSIZE |
|--------------|---------------|---------------|----------|----------|---------------|----------|--------------------|----------|
| Ivory        | 80421-I       | —             | —        | 80745-I  | PJ226-I       | Brass    | *                  | —        |
| Black        | 80421-E       | —             | —        | —        | —             | 430 S/S  | *                  | —        |
| White        | 80421-W       | —             | —        | 80745-W  | PJ226-W       | 302 S/S  | S226-N<br>84421-40 | —        |
| Brown        | 80421         | —             | —        | —        | PJ226         |          | —                  | —        |
| Almond       | 80421-A       | —             | —        | 80745-A  | PJ226-A       |          | —                  | —        |
| Light Almond | 80421-T       | —             | —        | —        | PJ226-T       |          | —                  | —        |

DESCRIPTION

3-Gang 2-Decora/GFCI 1 - Toggle



| COLOR        | STANDARD P1262 | MIDWAY | OVERSIZE | STANDARD | MIDWAY | MATERIAL | STANDARD | OVERSIZE |
|--------------|----------------|--------|----------|----------|--------|----------|----------|----------|
| Ivory        | 80431-I        | —      | —        | 80731-I  | —      | Brass    | *        | —        |
| Black        | —              | —      | —        | 80731-E  | —      | 430 S/S  | *        | —        |
| Gray         | 80431-GY       | —      | —        | 80731-GY | —      | 302 S/S  | *        | —        |
| White        | 80431-W        | —      | —        | 80731-W  | —      |          | —        | —        |
| Brown        | 80431          | —      | —        | —        | —      |          | —        | —        |
| Almond       | 80431-A        | —      | —        | —        | —      |          | —        | —        |
| Light Almond | 80431-T        | —      | —        | —        | —      |          | —        | —        |

DESCRIPTION

4-Gang 2-Toggles 2-Decora/GFCI



| COLOR        | STANDARD P326 | MIDWAY | OVERSIZE | STANDARD | MIDWAY | MATERIAL | STANDARD | OVERSIZE |
|--------------|---------------|--------|----------|----------|--------|----------|----------|----------|
| Ivory        | P326-I        | —      | —        | 80732-I  | —      | Brass    | *        | —        |
| White        | P326-W        | —      | —        | 80732-W  | —      | 430 S/S  | *        | —        |
| Brown        | P326          | —      | —        | —        | —      | 302 S/S  | *        | —        |
| Almond       | P326-A        | —      | —        | —        | —      |          | —        | —        |
| Light Almond | P326-T        | —      | —        | —        | —      |          | —        | —        |

DESCRIPTION

4-Gang 3-Toggles 1-Decora/GFCI



| COLOR | STANDARD P2262 | MIDWAY | OVERSIZE | STANDARD | MIDWAY SPJ826 | MATERIAL | STANDARD | OVERSIZE |
|-------|----------------|--------|----------|----------|---------------|----------|----------|----------|
| Ivory | P2262-It       | —      | —        | —        | —             | Brass    | *        | —        |
| White | P2262-Wt       | —      | —        | —        | —             | 430 S/S  | *        | —        |
|       |                |        |          |          |               | 302 S/S  | *        | —        |

DESCRIPTION

5-Gang 4-Toggles 1-Decora/GFCI

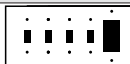

| COLOR | STANDARD | MIDWAY | OVERSIZE | STANDARD | MIDWAY SPJ826 | MATERIAL | STANDARD         | OVERSIZE |
|-------|----------|--------|----------|----------|---------------|----------|------------------|----------|
|       |          |        |          |          |               | Brass    | *                | —        |
|       |          |        |          |          |               | 430 S/S  | *                | —        |
|       |          |        |          |          |               | 302 S/S  | S426-N<br>S426-N | —        |

<sup>1</sup>Painted metal wallplate.

\*Consult your Leviton representative for ordering details: allow 3-4 weeks for delivery.





# WALLPLATES

## Residential and Commercial Grade Wallplates

### Combination Wallplates Toggle Switch and Blank—Box Mount and Strap Mount

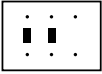
| Thermoset (Plastic)  |     |     | Thermoplastic (Nylon) |          | Assorted Metals |          |                           |          |          |          |
|--|-----|-----|-----------------------|----------|-----------------|----------|---------------------------|----------|----------|----------|
| DESCRIPTION<br>2-Gang<br>1-Toggle 1-Blank, Strap Mount  |     |     | STANDARD              | MIDWAY   | OVERSIZE        | STANDARD | MIDWAY                    | MATERIAL | STANDARD | OVERSIZE |
| Ivory  | --- | --- | ---                   | 80706-I  | ---             | Aluminum | *                         | ---      |          |          |
| Gray   | --- | --- | ---                   | 80706-GY | ---             | Brass    | *                         | ---      |          |          |
| Red  | --- | --- | ---                   | 80706-R  | ---             | 430 S/S  | *                         | ---      |          |          |
| White  | --- | --- | ---                   | 80706-W  | ---             | 302 S/S  | <b>S114-N</b><br>84077-40 | ---      |          |          |
| Almond   | --- | --- | ---                   | 80706-A  | ---             |          |                           |          |          |          |
| Light Almond   | --- | --- | ---                   | 80706-T  | ---             |          |                           |          |          |          |

|   |  |  |          |        |          |          |                         |          |          |          |
|---|--|--|----------|--------|----------|----------|-------------------------|----------|----------|----------|
| DESCRIPTION<br>3-Gang<br>2-Toggles 1-Blank, Strap Mount  |  |  | STANDARD | MIDWAY | OVERSIZE | STANDARD | MIDWAY                  | MATERIAL | STANDARD | OVERSIZE |
|   |  |  |          |        |          | Brass    | *                       | ---      |          |          |
|   |  |  |          |        |          | 430 S/S  | *                       | ---      |          |          |
|   |  |  |          |        |          | 302 S/S  | <b>S214-N</b><br>S214-N | ---      |          |          |

|  |             |               |              |        |          |          |                           |          |          |          |
|--|-------------|---------------|--------------|--------|----------|----------|---------------------------|----------|----------|----------|
| DESCRIPTION<br>2-Gang<br>1-Toggle 1-Blank, Box Mount  |             |               | STANDARD     | MIDWAY | OVERSIZE | STANDARD | MIDWAY                    | MATERIAL | STANDARD | OVERSIZE |
|  | <b>P113</b> | <b>SPJ113</b> | <b>P0113</b> |        |          | Brass    | *                         | ---      |          |          |
| Ivory  | 86006       | 80506-I       | 86106        | ---    | ---      | 430 S/S  | *                         | ---      |          |          |
| White  | 88006       | 80506-W       | 88106        | ---    | ---      | 302 S/S  | <b>S113-N</b><br>84006-40 | ---      |          |          |
| Brown  | 85006       | 80506         | ---          | ---    | ---      |          |                           |          |          |          |

### Combination Wallplates Standard Combinations—Two Gang

| Thermoset (Plastic)   |            |     | Thermoplastic (Nylon) |        | Assorted Metals |          |                          |                           |          |          |
|---|------------|-----|-----------------------|--------|-----------------|----------|--------------------------|---------------------------|----------|----------|
| DESCRIPTION<br>2-Gang<br>1-Single 1.406" dia. hole 1-Duplex  |            |     | STANDARD              | MIDWAY | OVERSIZE        | STANDARD | MIDWAY                   | MATERIAL                  | STANDARD | OVERSIZE |
|   | <b>P78</b> |     |                       |        |                 | Aluminum | *                        | ---                       |          |          |
| Ivory   | 86046†     | --- | ---                   | ---    | ---             | Brass    | *                        | ---                       |          |          |
| White   | 88046†     | --- | ---                   | ---    | ---             | 430 S/S  | *                        | *                         |          |          |
|   |            |     |                       |        |                 | 302 S/S  | <b>S78-N</b><br>84046-40 | <b>S078-N</b><br>84146-40 |          |          |

†Painted metal wallplate.

\*Consult your Leviton representative for ordering details: allow 3–4 weeks for delivery.

**NOTE:** Where applicable, Industry Number indicated in BOLD FACE. For some wallplates, Industry Number and Leviton Catalog Number are identical.



Residential and Commercial Grade Wallplates



Combination Wallplates  
Standard Combinations—Two Gang  
Thermoset (Plastic)

Thermoplastic (Nylon)

Assorted Metals

DESCRIPTION

2-Gang  
1-Duplex 1-Decora/GFCI



| COLOR        | STANDARD P826 | MIDWAY | OVERSIZE | STANDARD | MIDWAY PJ826 | MATERIAL | STANDARD                  | OVERSIZE |
|--------------|---------------|--------|----------|----------|--------------|----------|---------------------------|----------|
| Ivory        | 80455-I       | —      | —        | 80746-I  | —            | Aluminum | *                         | —        |
| Black        | —             | —      | —        | 80746-E  | —            | Brass    | *                         | —        |
| Gray         | —             | —      | —        | 80746-GY | —            | 430 S/S  | *                         | —        |
| Red          | —             | —      | —        | 80746-R  | —            | 302 S/S  | <b>S826-N</b><br>84455-40 | —        |
| White        | 80455-W       | —      | —        | 80746-W  | —            |          |                           |          |
| Brown        | 80455         | —      | —        | 80746    | —            |          |                           |          |
| Almond       | 80455-A       | —      | —        | 80746-A  | —            |          |                           |          |
| Light Almond | 80455-T       | —      | —        | 80746-T  | —            |          |                           |          |

DESCRIPTION

2-Gang  
1-Toggle 1-Phone/Cable .406" dia. hole, Strap Mount



| COLOR | STANDARD P112 | MIDWAY | OVERSIZE | STANDARD | MIDWAY | MATERIAL | STANDARD                | OVERSIZE |
|-------|---------------|--------|----------|----------|--------|----------|-------------------------|----------|
| Ivory | 86077         | —      | —        | —        | —      | Brass    | *                       | —        |
| White | 88077         | —      | —        | —        | —      | 430 S/S  | *                       | —        |
|       |               |        |          |          |        | 302 S/S  | <b>S112-N</b><br>S112-N | —        |

DESCRIPTION

2-Gang  
1-Phone/Cable .406" dia. hole, Strap Mount 1 – Duplex



| COLOR | STANDARD | MIDWAY | OVERSIZE | STANDARD | MIDWAY | MATERIAL | STANDARD                  | OVERSIZE |
|-------|----------|--------|----------|----------|--------|----------|---------------------------|----------|
| Ivory | 86078    | —      | —        | —        | —      | Brass    | *                         | —        |
| White | 88078    | —      | —        | —        | —      | 430 S/S  | *                         | —        |
|       |          |        |          |          |        | 302 S/S  | <b>S128-N</b><br>84078-40 | —        |

DESCRIPTION

2-Gang  
1-Phone/Cable .406" dia. hole 1 – Blank, Strap Mount



| COLOR | STANDARD | MIDWAY | OVERSIZE | STANDARD | MIDWAY | MATERIAL | STANDARD | OVERSIZE |
|-------|----------|--------|----------|----------|--------|----------|----------|----------|
|       |          |        |          |          |        | Brass    | *        | —        |
|       |          |        |          |          |        | 430 S/S  | *        | —        |
|       |          |        |          |          |        | 302 S/S  | *        | —        |

DESCRIPTION

2-Gang  
1-Phone/Cable .406" dia. hole 1 – Blank, Strap Mount



| COLOR | STANDARD P1226 | MIDWAY | OVERSIZE | STANDARD | MIDWAY | MATERIAL | STANDARD | OVERSIZE |
|-------|----------------|--------|----------|----------|--------|----------|----------|----------|
| Ivory | 80479-I        | —      | —        | —        | —      | Brass    | *        | —        |
| White | 80479-W        | —      | —        | —        | —      | 430 S/S  | *        | —        |
|       |                |        |          |          |        | 302 S/S  | *        | —        |

DESCRIPTION

2-Gang  
1-Blank 1- Duplex, Box Mount



| COLOR | STANDARD P138 | MIDWAY SPJ138 | OVERSIZE P0138 | STANDARD N138 | MIDWAY | MATERIAL | STANDARD                  | OVERSIZE |
|-------|---------------|---------------|----------------|---------------|--------|----------|---------------------------|----------|
| Ivory | 86008         | 80508-I       | 86108          | N138-I        | —      | Brass    | *                         | —        |
| White | 88008         | 80508-W       | —              | —             | —      | 430 S/S  | *                         | —        |
| Brown | 85008         | —             | —              | —             | —      | 302 S/S  | <b>S138-N</b><br>84008-40 | —        |

\*Consult your Leviton representative for ordering details: allow 3–4 weeks for delivery.

NOTE: Where applicable, Industry Number indicated in BOLD FACE. For some wallplates, Industry Number and Leviton Catalog Number are identical.



# WALLPLATES

## Residential and Commercial Grade Wallplates

### Combination Wallplates Standard Combinations—Two Gang Thermoset (Plastic)

| DESCRIPTION<br>2-Gang<br>1-Blank 1- Duplex, Strap Mount | Thermoset (Plastic) |        |          | Thermoplastic (Nylon) |        | Assorted Metals |                           |          |
|---|---------------------|--------|----------|-----------------------|--------|-----------------|---------------------------|----------|
|   | STANDARD<br>P148    | MIDWAY | OVERSIZE | STANDARD<br>PJ826     | MIDWAY | MATERIAL        | STANDARD                  | OVERSIZE |
| Ivory   | 86087†              | —      | —        | —                     | —      | Brass           | *                         | —        |
| White   | 88087†              | —      | —        | —                     | —      | 430 S/S         | *                         | —        |
|   |                     |        |          |                       |        | 302 S/S         | <b>S148-N</b><br>84087-40 | —        |

### DESCRIPTION 2-Gang 1-Blank 1-Single 1.406" dia. hole, Strap Mount

| DESCRIPTION<br>2-Gang<br>1-Blank 1-Single 1.406" dia. hole, Strap Mount | Thermoset (Plastic) |        |          | Thermoplastic (Nylon) |        | Assorted Metals |                           |          |
|---|---------------------|--------|----------|-----------------------|--------|-----------------|---------------------------|----------|
|   | STANDARD<br>P147-I  | MIDWAY | OVERSIZE | STANDARD              | MIDWAY | MATERIAL        | STANDARD                  | OVERSIZE |
| Ivory   | 86085†              | —      | —        | —                     | —      | Aluminum        | *                         | —        |
| White   | 88085†              | —      | —        | —                     | —      | Brass           | *                         | —        |
|   |                     |        |          |                       |        | 430 S/S         | *                         | —        |
|   |                     |        |          |                       |        | 302 S/S         | <b>S147-N</b><br>84085-40 | —        |

### DESCRIPTION 2-Gang 1-Blank 1-Decora/GFCI, Strap Mount

| DESCRIPTION<br>2-Gang<br>1-Blank 1-Decora/GFCI, Strap Mount | Thermoset (Plastic) |                   |          | Thermoplastic (Nylon) |        | Assorted Metals |                           |          |
|---|---------------------|-------------------|----------|-----------------------|--------|-----------------|---------------------------|----------|
|   | STANDARD<br>P1426   | MIDWAY<br>SPJ1326 | OVERSIZE | STANDARD              | MIDWAY | MATERIAL        | STANDARD                  | OVERSIZE |
| Ivory   | P1426-I†            | 80608-I           | —        | 80708-I               | —      | Brass           | *                         | —        |
| Black   | —                   | —                 | —        | 80708-E               | —      | 430 S/S         | *                         | *        |
| Gray  | —                   | —                 | —        | 80708-GY              | —      | 302 S/S         | <b>S1426-N</b><br>S1426-N | *        |
| White   | P1426-W†            | 80608-W           | —        | 80708-W               | —      |                 |                           |          |
| Brown   | —                   | 80608             | —        | 80708                 | —      |                 |                           |          |
| Almond  | —                   | 80608-A           | —        | 80708-A               | —      |                 |                           |          |
| Light Almond  | —                   | 80608-T           | —        | 80708-T               | —      |                 |                           |          |

### STANDARD COMBINATIONS—THREE GANG DESCRIPTION 3-Gang 1-Toggle 2-Duplex

| DESCRIPTION<br>3-Gang<br>1-Toggle 2-Duplex | Thermoset (Plastic) |        |          | Thermoplastic (Nylon) |        | Assorted Metals |                           |                            |
|--|---------------------|--------|----------|-----------------------|--------|-----------------|---------------------------|----------------------------|
|  | STANDARD<br>P182    | MIDWAY | OVERSIZE | STANDARD              | MIDWAY | MATERIAL        | STANDARD                  | OVERSIZE                   |
| Ivory                                      | 86047               | —      | —        | 80747-I               | —      | Brass           | *                         | —                          |
| White                                      | 88047               | —      | —        | 80747-W               | —      | 430 S/S         | *                         | *                          |
| Brown                                      | 85047               | —      | —        | —                     | —      | 302 S/S         | <b>S182-N</b><br>84047-40 | <b>S0182-N</b><br>84147-40 |

### STANDARD COMBINATIONS—FOUR GANG DESCRIPTION 4-Gang 2-Toggle 2-Duplex

| DESCRIPTION<br>4-Gang<br>2-Toggle 2-Duplex | Thermoset (Plastic) |        |          | Thermoplastic (Nylon) |        | Assorted Metals |                           |          |
|--|---------------------|--------|----------|-----------------------|--------|-----------------|---------------------------|----------|
|  | STANDARD<br>P1226   | MIDWAY | OVERSIZE | STANDARD              | MIDWAY | MATERIAL        | STANDARD                  | OVERSIZE |
|  |                     |        |          |                       |        | Aluminum        | *                         | —        |
|  |                     |        |          |                       |        | Brass           | <b>B282</b><br>81045      | —        |
|  |                     |        |          |                       |        | 430 S/S         | *                         | —        |
|  |                     |        |          |                       |        | 302 S/S         | <b>S282-N</b><br>84045-40 | —        |

†Painted metal wallplate.

\*Consult your Leviton representative for ordering details: allow 3–4 weeks for delivery.

**NOTE: Where applicable, Industry Number indicated in BOLD FACE. For some wallplates, Industry Number and Leviton Catalog Number are identical.**

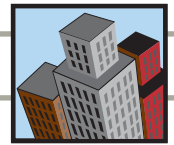

### Sectional Wallplates for Multi-Gang Installations† Thermoplastic Construction

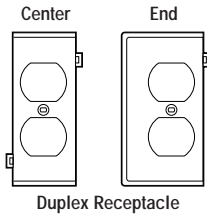

| DESCRIPTION                            | COLOR          | CENTER PANELS<br>CAT. NO. | END PANELS<br>CAT. NO. |
|--|----------------|---------------------------|------------------------|
| Duplex Receptacle                      | White<br>Ivory | PSC 8-W<br>PSC 8-I        | PSE 8-W<br>PSE 8-I     |
| Toggle Switch                          | White<br>Ivory | PSC 1-W<br>PSC 1-I        | PSE 1-W<br>PSE 1-I     |
| Single Receptacle,<br>1.406" dia. hole | White<br>Ivory | PSC 7-W<br>PSC 7-I        | PSE 7-W<br>PSE 7-I     |
| Blank, Strap-Mount                     | White<br>Ivory | PSC 14<br>PSC14-I         | PSE 14-W<br>PSE 14-I   |
| Decora                                 | White<br>Ivory | PSC 26-W<br>PSC 26-I      | PSE 26-W<br>PSE 26-I   |

† Outer dimensions of wallplates created from two or more sectional panels will be the same as standard multi-gang plates.

### Horizontal Split Plate for Terminated Cable

DESCRIPTION  
Horizontal Split Plate for Terminated Cable  
1-Gang .625" dia. Hole w/Grommet .406" inner dia.



| COLOR | CAT. NO. | IND. NO. | METAL   | CAT. NO. | IND. NO. |
|-------|----------|----------|---------|----------|----------|
| Ivory | N751-I   | N751-I   | BRASS   | *        | —        |
| White | N751-W   | N751-W   | 430 S/S | *        | —        |
|       |          |          | 302 S/S | S751-N   | S751-N   |

### Hot Stamped And Engraved Plates Thermoset (Plastic)

DESCRIPTION  
1-Gang 1-Duplex  
Stamped And Engraved  
"EMERGENCY"



| COLOR | STANDARD | MIDWAY | OVERSIZE | STANDARD | MIDWAY | MATERIAL | STANDARD  | OVERSIZE |
|-------|----------|--------|----------|----------|--------|----------|-----------|----------|
| Red   | —        | —      | —        | 80703-RE | PJ8-RE | 302 S/S  | 84003-E40 | —        |

2-Gang 2-Duplex  
Stamped And Engraved  
"EMERGENCY"



| COLOR | STANDARD | MIDWAY | OVERSIZE | STANDARD | MIDWAY  | MATERIAL | STANDARD  | OVERSIZE |
|-------|----------|--------|----------|----------|---------|----------|-----------|----------|
| Red   | —        | —      | —        | 80716-RE | PJ82-RE | 302 S/S  | 84016-E40 | —        |

1-Gang 1-Duplex  
Stamped And Engraved  
"ISOLATED GROUND"



| COLOR  | STANDARD | MIDWAY | OVERSIZE | STANDARD  | MIDWAY | MATERIAL | STANDARD | OVERSIZE |
|--------|----------|--------|----------|-----------|--------|----------|----------|----------|
| Orange | —        | —      | —        | 80703-IG  | PJ8-IG | 302 S/S  | 84003-IG | —        |
| White  | —        | —      | —        | 80703-IGW | —      |          |          |          |

2-Gang 2-Duplex  
Stamped And Engraved  
"ISOLATED GROUND"



| COLOR  | STANDARD | MIDWAY | OVERSIZE | STANDARD | MIDWAY | MATERIAL | STANDARD | OVERSIZE |
|--------|----------|--------|----------|----------|--------|----------|----------|----------|
| Orange | —        | —      | —        | 80716-IG | —      | 302 S/S  | *        | —        |

1-Gang 1-Single, 1.406" Dia. Hole  
Stamped And Engraved  
"ISOLATED GROUND"



| COLOR  | STANDARD | MIDWAY | OVERSIZE | STANDARD | MIDWAY | MATERIAL | STANDARD | OVERSIZE |
|--------|----------|--------|----------|----------|--------|----------|----------|----------|
| Orange | —        | —      | —        | 80704-IG | —      | 302 S/S  | *        | —        |

\*Consult The End Of This Wallplate Section For Ordering Details: Allow 3-4 Weeks For Delivery.



# ENGRAVED WALLPLATES

## Residential and Commercial Grade Wallplates

### Hot Stamped and Engraved Plates

| Thermoset (Plastic)  |                 |               | Thermoplastic (Nylon) |                 |               | Assorted Metals (Engraved) |                 |                 |
|--|-----------------|---------------|-----------------------|-----------------|---------------|----------------------------|-----------------|-----------------|
| <b>DESCRIPTION</b>   |                 |               |                       |                 |               |                            |                 |                 |
| 1-Gang 1-Single, 1.60" Dia. Hole<br>Stamped And Engraved "ISOLATED GROUND"<br>For Use With 20A & 30A Single Locking<br>Receptacles |                 |               |                       |                 |               |                            |                 |                 |
|  |                 |               |                       |                 |               |                            |                 |                 |
| <b>COLOR</b>   | <b>STANDARD</b> | <b>MIDWAY</b> | <b>OVERSIZE</b>       | <b>STANDARD</b> | <b>MIDWAY</b> | <b>MATERIAL</b>            | <b>STANDARD</b> | <b>OVERSIZE</b> |
| Orange   | _____           | _____         | _____                 | 80720-IG        | _____         | 302 S/S                    | *               | _____           |
| <b>1-Gang 1-Toggle<br/>Stamped And Engraved<br/>"EMERGENCY"</b>  |                 |               |                       |                 |               |                            |                 |                 |
|  |                 |               |                       |                 |               |                            |                 |                 |
| <b>COLOR</b>   | <b>STANDARD</b> | <b>MIDWAY</b> | <b>OVERSIZE</b>       | <b>STANDARD</b> | <b>MIDWAY</b> | <b>MATERIAL</b>            | <b>STANDARD</b> | <b>OVERSIZE</b> |
| Red  | _____           | _____         | _____                 | 80701-RE        | _____         | 302 S/S                    | 84001-E40       | _____           |
| <b>1-Gang 1-Duplex<br/>No Stamp</b>  |                 |               |                       |                 |               |                            |                 |                 |
|  |                 |               |                       |                 |               |                            |                 |                 |
| <b>COLOR</b>   | <b>STANDARD</b> | <b>MIDWAY</b> | <b>OVERSIZE</b>       | <b>STANDARD</b> | <b>MIDWAY</b> | <b>MATERIAL</b>            | <b>STANDARD</b> | <b>OVERSIZE</b> |
| Orange   | _____           | _____         | _____                 | 80703-ORG       | _____         | _____                      | _____           | _____           |
| <b>1-Gang 1-Duplex<br/>Stamped<br/>"GFCI PROTECTED"</b>  |                 |               |                       |                 |               |                            |                 |                 |
|  |                 |               |                       |                 |               |                            |                 |                 |
| <b>COLOR</b>   | <b>STANDARD</b> | <b>MIDWAY</b> | <b>OVERSIZE</b>       | <b>STANDARD</b> | <b>MIDWAY</b> | <b>MATERIAL</b>            | <b>STANDARD</b> | <b>OVERSIZE</b> |
| Ivory  | _____           | _____         | _____                 | 80703-GFI       | _____         | 302 S/S                    | *               | _____           |
| White  | _____           | _____         | _____                 | 80703-GRW       | _____         | 302 S/S                    | *               | _____           |
| <b>1-Gang 1-Duplex<br/>Stamped<br/>"COMPUTER ONLY"</b>   |                 |               |                       |                 |               |                            |                 |                 |
|  |                 |               |                       |                 |               |                            |                 |                 |
| <b>COLOR</b>   | <b>STANDARD</b> | <b>MIDWAY</b> | <b>OVERSIZE</b>       | <b>STANDARD</b> | <b>MIDWAY</b> | <b>MATERIAL</b>            | <b>STANDARD</b> | <b>OVERSIZE</b> |
| Ivory  | _____           | _____         | _____                 | 80703-COI       | _____         | 302 S/S                    | *               | _____           |
| White  | _____           | _____         | _____                 | 80703-COW       | _____         | 302 S/S                    | *               | _____           |
| Orange   | _____           | _____         | _____                 | 80703-COO       | _____         | _____                      | _____           | _____           |
| <b>1-Gang 1-Decora<br/>Stamped<br/>"SURGE PROTECTED"</b>   |                 |               |                       |                 |               |                            |                 |                 |
|  |                 |               |                       |                 |               |                            |                 |                 |
| <b>COLOR</b>   | <b>STANDARD</b> | <b>MIDWAY</b> | <b>OVERSIZE</b>       | <b>STANDARD</b> | <b>MIDWAY</b> | <b>MATERIAL</b>            | <b>STANDARD</b> | <b>OVERSIZE</b> |
| _____  | _____           | _____         | _____                 | *               | _____         | 302 S/S                    | *               | _____           |
| <b>1-Gang 1-Decora<br/>Stamped<br/>"ISOLATED GROUND"</b>   |                 |               |                       |                 |               |                            |                 |                 |
|  |                 |               |                       |                 |               |                            |                 |                 |
| <b>COLOR</b>   | <b>STANDARD</b> | <b>MIDWAY</b> | <b>OVERSIZE</b>       | <b>STANDARD</b> | <b>MIDWAY</b> | <b>MATERIAL</b>            | <b>STANDARD</b> | <b>OVERSIZE</b> |
| Orange   | _____           | _____         | _____                 | 80401-IG        | _____         | 302 S/S                    | *               | _____           |
| <b>1-Gang 1-Decora<br/>Stamped<br/>"GFCI"</b>  |                 |               |                       |                 |               |                            |                 |                 |
|  |                 |               |                       |                 |               |                            |                 |                 |
| <b>COLOR</b>   | <b>STANDARD</b> | <b>MIDWAY</b> | <b>OVERSIZE</b>       | <b>STANDARD</b> | <b>MIDWAY</b> | <b>MATERIAL</b>            | <b>STANDARD</b> | <b>OVERSIZE</b> |
| Ivory  | _____           | _____         | _____                 | 80401-GFI       | _____         | 302 S/S                    | *               | _____           |
| White  | _____           | _____         | _____                 | 80401-GFW       | _____         | 302 S/S                    | *               | _____           |
| <b>1-Gang 1-Decora<br/>Stamped<br/>"COMPUTER ONLY"</b>   |                 |               |                       |                 |               |                            |                 |                 |
|  |                 |               |                       |                 |               |                            |                 |                 |
| <b>COLOR</b>   | <b>STANDARD</b> | <b>MIDWAY</b> | <b>OVERSIZE</b>       | <b>STANDARD</b> | <b>MIDWAY</b> | <b>MATERIAL</b>            | <b>STANDARD</b> | <b>OVERSIZE</b> |
| Ivory  | _____           | _____         | _____                 | 80401-COI       | _____         | 302 S/S                    | *               | _____           |
| White  | _____           | _____         | _____                 | 80401-COW       | _____         | 302 S/S                    | *               | _____           |

\*Consult The End Of This Wallplate Section For Ordering Details: Allow 3-4 Weeks For Delivery.



**Voice/Data/CATV Wallplates**

These sturdy, high-impact wallplates for the 46000 series voice/data devices are available for single-gang applications with standard or Decora-compatible styling.



**Standard Size  
Voice/Data/Catv Wallplates\***

| DESCRIPTION  |  | COLOR (NYLON) | METAL   | CAT. NO. |
|--|--|---------------|---------|----------|
| 1-Gang<br>Type "F" Connector                         |  | Ivory         | —       | 80781-I  |
|  |  | White         | —       | 80781-W  |
|  |  | Almond        | —       | 80781-A  |
|  |  | Light Almond  | —       | 80781-T  |
| 1-Gang<br>Duplex<br>Type "F" Connector               |  | Ivory         | —       | 80782-I  |
|  |  | White         | —       | 80782-W  |
|  |  | Almond        | —       | 80782-A  |
|  |  | Light Almond  | —       | 80782-T  |
| 1-Gang*<br>Db9 Data Connector<br>Db15 Data Connector |  | —             | 302 S/S | 84441-40 |
|  |  | —             | 302 S/S | 84442-40 |
| 1-Gang*<br>Bnc/Tnc "D" Connector                     |  | —             | 302 S/S | 84444-40 |

For more information regarding Voice/Data/CATV Wallplates, refer to Section L.



# WEATHER-RESISTANT COVERS

## Commercial Grade

### Features and Benefits

#### Plastic

- Impact resistant thermoplastic construction
- Pre-installed gasket for easy, reliable installation
- Tongue and groove plate-to-cover construction
- Offset device opening (horizontal only) for easier cord exit
- Thermoplastic inserts prevent insect and debris accumulation

#### Plastic and Metal

- Self-closing
- Vertical and horizontal mounting
- Die cast aluminum or impact-resistant thermoplastic covers and bases
- Weather-resistant gaskets
- Stainless steel springs
- Gray or clear finish



### Raintight While-In-Use Covers

| DESCRIPTION  | MOUNTING   | CAT. NO. |
|--|------------|----------|
| Telescoping While-In-Use Smoked Cover  | Vertical   | T5979-W  |
| With Colored Base And Matching Duplex, Decora And Single Receptacle Wallplates | Vertical   | T5979-T  |
|  | Vertical   | T5979-GY |
|  | Vertical   | T5979    |
| Duplex Receptacle, Gray, Standard  | Vertical   | 5976-GY  |
| Duplex Receptacle, Gray, Extra Deep  | Vertical   | 5976-DGY |
| Duplex Receptacle, Clear, Standard   | Vertical   | 5976-CL  |
| Duplex Receptacle, Clear, Extra Deep   | Vertical   | 5976-DCL |
| Decora/GFCI, Clear, Standard   | Vertical   | 5977-CL  |
| Decora/GFCI, Clear, Extra Deep   | Vertical   | 5977-DCL |
| Single Receptacle, Gray, Standard  | Vertical   | 5978-GY  |
| Single Receptacle, Clear, Standard   | Vertical   | 5978-CL  |
| Single Receptacle, Gray, Extra Deep  | Vertical   | 5978-DGY |
| Single Receptacle, Clear, Extra Deep   | Vertical   | 5978-DCL |
| Duplex Receptacle, Gray, Standard  | Horizontal | 5996-GY  |
| Duplex Receptacle, Gray, Extra Deep  | Horizontal | 5996-DGY |
| Duplex Receptacle, Clear, Standard   | Horizontal | 5996-CL  |
| Decora/GFCI, Gray, Standard  | Horizontal | 5997-GY  |
| Decora/GFCI, Gray, Extra Deep  | Horizontal | 5997-DGY |
| Decora/GFCI, Clear, Standard   | Horizontal | 5997-CL  |
| Decora/GFCI, Clear, Extra Deep   | Horizontal | 5997-DCL |
| Single Receptacle, Gray, Standard  | Horizontal | 5998-GY  |
| Single Receptacle, Gray, Extra Deep  | Horizontal | 5998-DGY |
| Single Receptacle, Clear, Standard   | Horizontal | 5998-CL  |

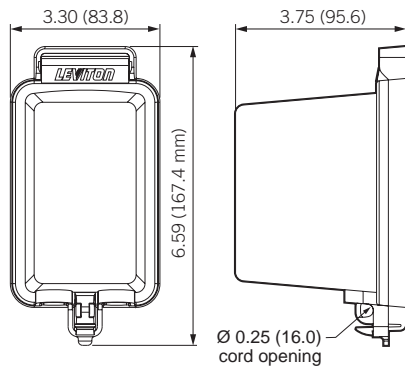
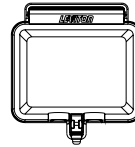
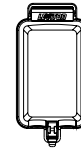

**VERTICAL MOUNT, EXTRA DEEP**  
5976-D

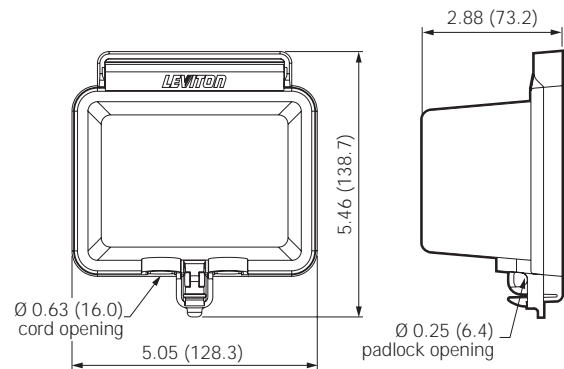

**HORIZONTAL MOUNT, STANDARD**  
5997

#### SPECIFICATIONS & FEATURES

- Mounting Screws and rubber gasket included for fast, easy installation onto surface-mounted outdoor-type boxes or flush-mounted wall boxes
- Easy-grip self-closing covers with durable, non-corrosive stainless steel screws
- acked by a Limited Two-Year Warranty

#### TESTING AND CODE COMPLIANCE

- Full compliance with UL, CSA and NEC Section 410-57 requirements for damp and wet locations with cover closed
- Raintight while-in-use covers are NEMA 3R rated for use with unattended plugs engaged in "live" receptacles in wet or damp locations

#### \*COLOR

Basic Cat. No. denotes Brown. For other color selections, add suffix to catalog numbers as follows: White (-W), Light Almond (-T), Gray (-GY).

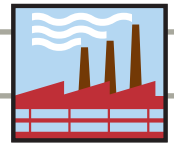

### Features and Benefits

- Glass-filled thermoplastic cover and plate for outstanding impact resistance and durability
- UL 94-VO Flammability Rating
- Superior IP 54 Suitability rating protects against dust particles and splashing water
- NEMA Type 3R enclosure rating ensures protection against rain, sleet and damage from external ice formation
- Dual gaskets, one under plate and one under lid, for weather-resistant fit
- Stainless steel hinge-pin, spring and mounting screws for excellent corrosion resistance
- Triple-combination screws accept Phillips, straight-blade or Robertson-head screwdrivers
- Oversized cover tab for easier opening with gloved hands
- Mounts to panel or FS/FD boxes
- UL Listed and CSA certified for wet locations with cover closed



### Industrial Weather-Resistant Covers

| DESCRIPTION  | COLOR  | CAT. NO. |
|--|--------|----------|
| For use with 15-amp locking, 15-amp and 20-amp straight-blade flanged inlets and outlets   | GRAY   | WP1      |
| For use with 20-amp and 30-amp 3-, 4-, and 5-wire locking flanged inlets and outlets; 30-amp and 50-amp 3-wire power receptacles | GRAY   | WP2      |
| For use with 20-amp and 30-amp and FS/FD boxes single locking receptacles  | YELLOW | 7420-CR  |

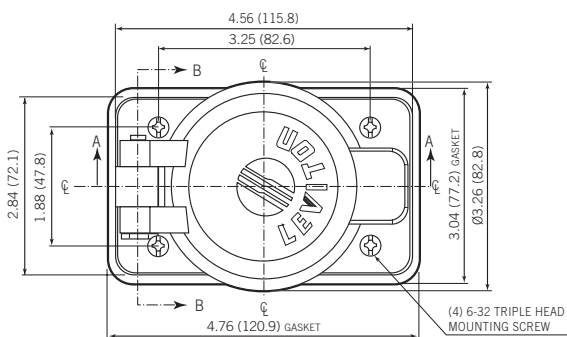

WATER RESISTANT COVER  
WP1 and 7420-CR

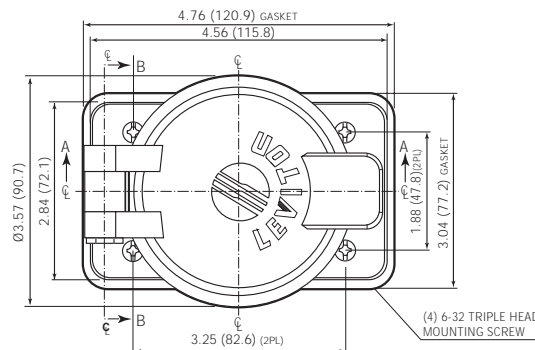

WATER RESISTANT COVER  
WP2

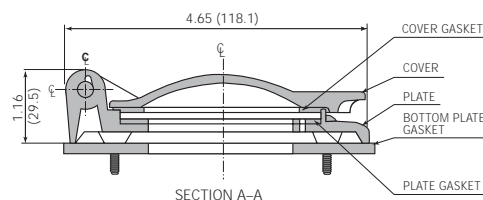
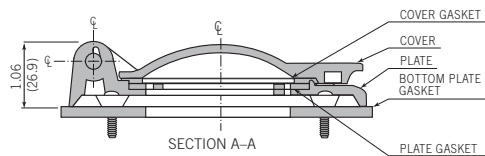

#### TESTING AND CODE COMPLIANCE

- UL Listed (File # E-13397)
- CSA Certified (File # LR-16347)
- NOM Certified (# 057)
- IP 54 Suitability rating (protected against dust and splashing water)
- NEMA Type 3R enclosure rating
- Backed by a Limited 10-Year Warranty

#### MATERIAL CHARACTERISTICS



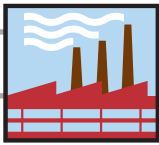



Environmental: VO Flammability Rating per UL 94  
Operating Temperature: -40°C to 75°C

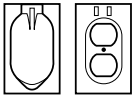
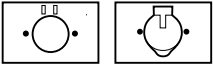
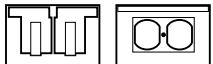
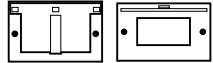
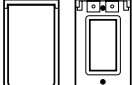

# WEATHER-RESISTANT COVERS

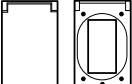
## Industrial Grade

### Die-Cast Zinc Weather-Resistant Covers

| DESCRIPTION   |   | MOUNTING                     | CAT. NO.  |
|---|---|------------------------------|-----------|
| Duplex Receptacle<br>1-GANG   |    | Vertical                     | 4926      |
| Single Receptacle<br>1-GANG Self-Closing Lid<br>1.406 Dia. Hole                               |    | Horizontal                   | 4925-2    |
| Duplex Receptacle or<br>Combination Device<br>1-GANG<br>Two Independent<br>Self-Closing Lids★ |    | Horizontal                   | 4970      |
| Decora/GFCI<br>1-GANG<br>Self-Closing Lid   |    | Horizontal                   | 4990      |
| Decora/GFCI<br>1-GANG<br>Self-Closing Lid★  |    | Vertical                     | 4992      |
| Decora/GFCI<br>1-GANG<br>Self-Closing Lid<br>for mounting on FS type box                      |    | Horizontal                   | 6196-FS   |
| Decora/GFCI<br>1-GANG<br>Self-Closing Lid<br>for mounting on FS type box                      |   | Vertical                     | 6196-VFS  |
| Weatherproof<br>Wallplate & Switch<br>15A 120V AC   |  | Horizontal<br>or<br>Vertical | 1432      |
| NEMA 1 Steel Enclosure<br>without Switch  |  | Vertical                     | N13NC     |
| DESCRIPTION   |   | COLOR                        | CAT. NO.  |
| Lockout Wallplate<br>(lock sold separately)   |  | S/S                          | 84001-LOK |

All devices are UL Listed . Also CSA Certified except where indicated by★



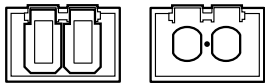
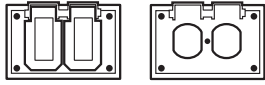
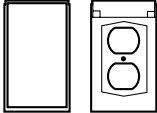
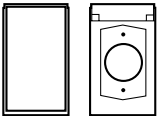
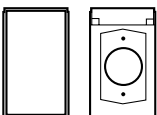
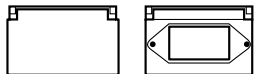
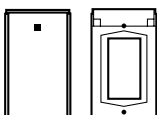
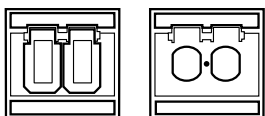

### Thermoplastic Weather-Resistant Covers

| DESCRIPTION  |   | MOUNTING   | CAT. NO.          |
|--|---|------------|-------------------|
| Duplex Receptacle or Combination Device 1-GANG<br>Two Independent Self-Closing Lids                |    | Horizontal | 4976-GY<br>4976-W |
| Duplex Receptacle or Combination Device 1-GANG for mounting on FS type box<br>Two Independent Lids |    | Horizontal | 4976-FS           |
| Duplex Receptacle or Combination Device 1-GANG<br>Self-Closing Lid                                 |    | Vertical   | 4978-GY<br>4978-W |
| Single Receptacle 1-GANG<br>Self-Closing Lid<br>1.406" Dia. Hole                                   |    | Vertical   | 4979-GY           |
| Single 20A or 30A Locking Receptacle 1-GANG<br>Self-Closing Lid<br>1.60" Dia. Hole                 |    | Vertical   | 4980-GY           |
| Decora/GFCI 1-GANG<br>Self-Closing Lid   |   | Horizontal | 4996-GY<br>4996-W |
| Decora/GFCI 1-GANG<br>Self-Closing Lid   |  | Vertical   | 4998-GY<br>4998-W |
| Oversized Duplex 1-GANG<br>Two Independent Self-Closing Lids                                       |  | Horizontal | 4986-GY           |

### Blank Box Mounted Wallplates with Gasket

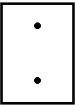
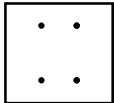
| DESCRIPTION                   |   | MOUNTING | CAT. NO.  |
|-------------------------------|---|----------|-----------|
| 1-GANG<br>Aluminum, Box Mount |  | N/A      | 83014-EXT |
| 2-GANG<br>Aluminum, Box Mount |  | N/A      | 83025-EXT |

### Type 302 Stainless Steel Wallplate—Box Mount

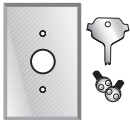
| DESCRIPTION   |   | COLOR | CAT. NO. |
|---|---|-------|----------|
| Type 302 Stainless Steel Wallplate w/Tamper-Resistant Screws and Spanner Tool |  | S/S   | 84071-40 |

All devices are UL Listed and CSA Certified.



# WALLPLATE ACCESSORIES

## Commercial Grade

### Wallplate Screws

| DESCRIPTION   | COLOR  | CAT. NO.   |
|---|--|--|
| Oval Head Milled Slot<br>5/16" long—6-32 thread 100 per box | Ivory<br>Gray<br>White<br>Brown<br>Almond<br>S/S | 86400-PRT<br>87400-PRT<br>88400-PRT<br>85400-PRT<br>82400-PRT<br>84400-PRT |
| Oval Head Milled Slot<br>1/2" long—6-32 thread 100 per box  | Ivory<br>Black<br>Gray<br>White<br>Brown<br>S/S  | 86000-PRT<br>83000-PRT<br>87000-PRT<br>88000-PRT<br>85000-PRT<br>84000-PRT |
| Oval Head Milled Slot<br>7/8" long—6-32 thread 50 per box   | Ivory<br>Red<br>White<br>Brown<br>S/S            | 86500-PRT<br>89500-PRT<br>88500-PRT<br>85500-PRT<br>84500-PRT              |

### Pilot Light Jewels

| DESCRIPTION   | COLOR        | CAT. NO.        |
|---|--------------|-----------------|
| Round<br>Fits single receptacle hole<br>1.375–1.406" dia.   | Green<br>Red | 405 GR<br>405 R |
| Rectangular<br>Fits toggle switch hole<br>.406 x .942"  | Green<br>Red | 406 GR<br>406 R |
| Lampholder Assembly<br>for use with jewels or<br>louvre plates—use with<br>standard 2.5" box and 4 watt bulb<br>(bulb included) |              | 2152            |

### Mounting Screws

| DESCRIPTION   | COLOR | CAT. NO. |
|---|-------|----------|
| Phillips/Standard<br>7/8" long—6-32 thread 50 per bag | S/S   | 84440    |

### Decora Plus Standard Size Plastic Adapters

| DESCRIPTION      | COLOR   | CAT. NO.  |
|------------------|---|---|
| CATV Jack        | Ivory<br>Black<br>Gray<br>White<br>Almond<br>Light Almond | 80381-I<br>80381-E<br>80381-GY<br>80381-W<br>80381-A<br>80381-T |
| Blank<br>No Hole | Ivory<br>Black<br>Gray<br>White<br>Almond<br>Light Almond | 80314-I<br>80314-E<br>80314-GY<br>80314-W<br>80314-A<br>80314-T |

All devices are UL Listed and CSA Certified.

### Tamper-Resistant Spanner Head Screws

| DESCRIPTION   | COLOR | CAT. NO.  |
|---|-------|-----------|
| Spanner Head<br>1/2" long—6-32 thread, 100 per box            | S/S   | 84000-T   |
| Screwdriver<br>for Spanner head or<br>Tamper-Resistant screws | Black | 84000-TSD |

### Plastic Wallplate Adapters

| DESCRIPTION   | COLOR   | CAT. NO.   |
|---|---|--|
| These adapters permit the use of rotary dimmers in multi-gang Decora installations or fill blank holes in multi-device Decora or toggle wallplates. |   |  |
| Dimmer Shaft<br>.406" dia. Hole   | Ivory<br>Black<br>Gray<br>Brown<br>White<br>Almond<br>Light<br>Almond | 80400-I<br>80400-E<br>80400-GY<br>80400<br>80400-W<br>80400-A<br>80400-T |
| Blank Decora<br>No Hole   | Ivory<br>Black<br>Gray<br>Brown<br>White<br>Almond<br>Light<br>Almond | 80414-I<br>80414-E<br>80414-GY<br>80414<br>80414-W<br>80414-A<br>80414-T |
| Blank Toggle<br>No Hole   | Ivory<br>Gray<br>Brown<br>White<br>Almond<br>Light<br>Almond          | 80700-I<br>80700-GY<br>80700<br>80700-W<br>80700-A<br>80700-T            |
| Wallbox Adapter<br>Extends shallow wallbox<br>to fit GFCI/Decora devices  | Ivory<br>Brown<br>White   | 6197-I<br>6197<br>6197-W   |

|  |       |       |
|--|-------|-------|
| Snap in Grommet<br>reduces 1.406" to 1.00"<br>for use with single<br>receptacle wallplates | Black | 403-E |
|--|-------|-------|

|   |  |     |
|---|--|-----|
| Thermoplastic<br>Yoke/Mounting Strap w/screws<br>Custom wallplate configurations<br>11, 23, 27 and 31 are supplied<br>with strap kits. See page G42 |  | 404 |
|---|--|-----|

### Special Wallplates

The Order Form and instructions requesting custom wallplate configurations are found on the following pages. Custom wallplates are available in a variety of metals and can be requested from Leviton through special order, beginning on the next page.

All devices are UL Listed and CSA Certified.



How to Order Custom Wallplates



General Information

Custom wallplates, up to twelve gangs in size, made of brass, stainless steel, painted steel, aluminum or chrome, can be special ordered from Leviton. Any combination of the configurations shown can be specified to meet your needs. In addition, standard and custom metal wallplates can be engraved, and standard nylon wallplates can be hot stamped, with the message of your choice. Follow the steps below to fill out the Custom Wallplate Order Form completely and accurately. The finished order form must include:

1. The wallplate catalog number
2. The type of wallplate material desired (from the Material Code Chart)
3. The quantity of wallplates desired
4. The wallplate configurations in proper order (from the Configuration Code Chart)
5. The wallplate color, selected from the Wallplate Color Code Chart
6. Engraved or hot stamped message, if desired, with message location and letter size
7. Engraved or hot stamped message filler color, selected from the Fill-In Color Chart

Photocopy the blank Custom Wallplate Order Form at the back of this section and refer to the completed sample Custom Wallplate Order Form shown when filling out your order. Your Leviton representative can provide you with additional forms if needed. The sample order grid below shows the custom wallplate pictured at right:

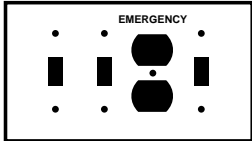

Sample Grid

CAT. NO. 90004 MATERIAL CODE S3 QTY. 1

(1) (2) (3) (4) (5) (6) (7) (8) (9) (10) (11) (12)

|    |    |                 |    |  |  |  |  |  |  |  |  |
|----|----|-----------------|----|--|--|--|--|--|--|--|--|
| 01 | 01 | EMERGENCY<br>03 | 01 |  |  |  |  |  |  |  |  |
|----|----|-----------------|----|--|--|--|--|--|--|--|--|

COLOR CODE ENGRAVED  HOT STAMPED LETTER SIZE 3/8"

FILLER CODE XR PRICE



# WALLPLATES

## How to Order Custom Wallplates

### How to Fill Out the Custom Wallplate Order Form

#### STEP 1: DETERMINE THE WALLPLATE CATALOG NUMBER

The catalog number for a custom wallplate is determined as follows: a single-gang custom wallplate is Cat. No. 90001, a double-gang custom wallplate is Cat.No. 90002, a three-gang custom wallplate is Cat. No. 90003, and so on through the sequence to Cat. No. 90010 for the ten-gang custom wallplate. Enter the number in the space on the Order Form marked "CAT. NO." If you are ordering a standard metal wallplate for custom engraving, use the 90000 series number. If you are ordering a standard nylon wallplate for custom hot stamping, enter that wallplate's catalog number in the space on the Order Form marked "CAT. NO."

#### STEP 2: SELECT THE WALLPLATE MATERIAL

Choose the custom wallplate material desired from the Wallplate Material Chart below. Enter the Material Code for the material selected in the space marked "MATERIAL CODE" on the Order Form. When ordering Custom Hot Stamped wallplates, enter NYLON.

| MATERIAL  | MATERIAL CODE |
|---|---------------|
| Aluminum <sup>†</sup>                               | AL            |
| Brass (Satin)<br>Polished Brass                     | BR<br>PB      |
| Non-Magnetic Stainless Steel-Type 302/304           | S3            |
| Oversize Non-Magnetic Stainless Steel-Type 302/304* | S30           |
| Painted Steel                                       | S5            |
| Oversize Painted Steel*                             | S50           |
| Chrome  | CRM           |
| Raw Steel   | RAW           |

<sup>†</sup>6-Gang maximum size, standard size only























\*4-Gang maximum size

#### STEP 3: DETERMINE THE QUANTITY OF THE WALLPLATE ORDER

Enter the quantity of wallplates needed in the space marked "QUANTITY" on the Order Form.

#### STEP 4: DETERMINE THE CUSTOM WALLPLATE CONFIGURATION

The Wallplate Configuration Chart below shows all the configurations that can be specified for Leviton custom metal wallplates. Each configuration has a specific Configuration Code number in the lower right-hand corner of its corresponding space on the chart. Enter this configuration code in the center of the corresponding square on the Order Form Grid to match its desired position on the finished custom wallplate. Refer to the Sample Order Form Grid for clarification on configurations and their placement, if necessary (page G43).

|   |   |   |  |  |   |
|---|---|---|--|--|---|
| <br>Toggle Switch<br>01                          | <br>Duplex Receptacle<br>03                | <br>Louvre Horizontal Mount<br>05      | <br>Louvre Vertical Mount*<br>07            | <br>Blank Box Mount<br>09   | <br>Blank Strap Mount<br>11                    |
| <br>Decora/<br>GFCI<br>13                        | <br>Single 1.406" dia.<br>Receptacle<br>15 | <br>1.60" dia.<br>Hole<br>17           | <br>2.15" dia.<br>Hole**<br>19              | <br>2.647" dia.<br>Hole**<br>21   | <br>.312" dia. Hole<br>Strap Mount<br>23       |
| <br>.312" dia. Hole<br>Box Mount<br>25           | <br>.406" dia. Hole<br>Strap Mount<br>27   | <br>.406" dia. Hole<br>Box Mount<br>29 | <br>.625" dia. Hole<br>Strap Mount<br>31    | <br>.625" dia. Hole<br>Box Mount<br>33  | <br>Interchangeable<br>1-Device Vertical<br>35 |
| <br>Interchangeable<br>1-Device Horizontal<br>37 | <br>Interchangeable<br>2-Device<br>39      | <br>Interchangeable<br>3-Device<br>41  | <br>2.460" dia. Hole<br>2-Gang Only**<br>47 | 0.880" dia. Hole for Key Lock Power Switch**. Tamper-resistant screws and screwdriver included w/Key Lock configurations. Device mount unless specified otherwise. For 1-gang, order 84071-40. |   |
|   |   |   | <br>49                                    |  |   |

Enter the code number for the configurations you select in the center box on each desired wallplate position on the Custom Wallplate Order Form.

\*3-Gang minimum

\*\*2-Gang minimum

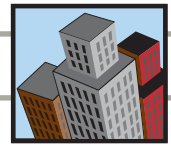

How to Fill Out the Custom Wallplate Order Form (continued)

**STEP 5: SELECT THE WALLPLATE COLOR**

For painted metal, select one of the following colors and enter its color code in the space marked "COLOR CODE" on the order form:

| COLOR  | WALLPLATE COLOR CODE |
|--------|----------------------|
| Almond | PA                   |
| Black  | PE                   |
| Brown  | PB                   |
| Gray   | PG                   |
| Ivory  | PI                   |
| Orange | PO                   |
| Red    | PR                   |
| White  | PW                   |

**STEP 6: ENTER ENGRAVING INFORMATION**

**NOTE: WE CAN ENGRAVE NYLON AND PAINTED AND UNPAINTED METAL WALLPLATES. After completing steps 1-5:**

**6A)** Type or clearly print the message(s) (i.e., TURN OFF) as you wish it to appear on the lines provided in the appropriate Grid box(es). **6B)** Select the size of the letters you desire for the wallplate message from the dimensions shown below and enter that size in the space marked "LETTER SIZE" on the Order Form. **6C)** Select the fill-in color for the message letter from the chart below and enter the code for the color chosen in the space marked "FILLER CODE."

**FILLER COLOR CODES** for Engraved Wallplates

| COLOR     | CODE |
|-----------|------|
| Black     | XE   |
| White     | XW   |
| Red       | XR   |
| No Filler | XX   |

**LETTER SIZE GAUGE** for Engraved Wallplates

| 1/8" | 3/16" | 1/4" | 5/16" | 3/8" |
|------|-------|------|-------|------|
| E    | E     | E    | E     | E    |

**STEP 7: ENTER HOT STAMPING INFORMATION**

**7A)** Select the message(s) desired from the Message Library below. Enter the message on the lines provided in the appropriate Grid box(es) where they should appear. The message will be stamped in 3/16"-high text.

**HOT STAMPING MESSAGE LIBRARY FOR CUSTOM NYLON WALLPLATES**

|                    |             |                |                       |                 |
|--------------------|-------------|----------------|-----------------------|-----------------|
| 1. SHOWER          | 7. HEAT     | 13. ON         | 19. ISOLATED          | 25. EQUIP       |
| 2. VANITY          | 8. DATA     | 14. PROTECTED  | 20. GROUND            | 26. FLUORESCENT |
| 3. VOICE           | 9. COMPUTER | 15. OFF        | 21. CONDITIONED       | 27. OIL         |
| 4. ONLY            | 10. GFCI    | 16. OIL BURNER | 22. CONDITIONED POWER | 28. POWER       |
| 5. ISOLATED GROUND | 11. SURGE   | 17. PC         | 23. CRITICAL          | 29. UPS         |
| 6. EMERGENCY       | 12. FAN     | 18. DEDICATED  | 24. ELEC.             |                 |

**7B)** Select the fill-in color for the message letter from the chart below and enter the code for the color chosen in the space marked "FILLER CODE."

| COLOR     | CODE |
|-----------|------|
| Black     | XE   |
| White     | XW   |
| Red       | XR   |
| No Filler | XX   |

To order nylon wallplates with custom hot stamped message, contact your Leviton salesman or customer service representative.

**8)** NOTE: Sequential engraving is available. Consult factory for ordering instructions.



# WALLPLATES

## How to Order Custom Wallplates

### Custom Wallplate Order Form

BILL TO:

SHIP TO:

\_\_\_\_\_  
 \_\_\_\_\_  
 \_\_\_\_\_  
 \_\_\_\_\_

\_\_\_\_\_  
 \_\_\_\_\_  
 \_\_\_\_\_  
 \_\_\_\_\_

CAT. NO. \_\_\_\_\_ MATERIAL CODE \_\_\_\_\_ QTY. \_\_\_\_\_

(1) (2) (3) (4) (5) (6) (7) (8) (9) (10) (11) (12)

|                          |                          |                          |                          |                          |                          |                          |                          |                          |                          |                          |                          |
|--------------------------|--------------------------|--------------------------|--------------------------|--------------------------|--------------------------|--------------------------|--------------------------|--------------------------|--------------------------|--------------------------|--------------------------|
| <input type="checkbox"/> | <input type="checkbox"/> | <input type="checkbox"/> | <input type="checkbox"/> | <input type="checkbox"/> | <input type="checkbox"/> | <input type="checkbox"/> | <input type="checkbox"/> | <input type="checkbox"/> | <input type="checkbox"/> | <input type="checkbox"/> | <input type="checkbox"/> |
|--------------------------|--------------------------|--------------------------|--------------------------|--------------------------|--------------------------|--------------------------|--------------------------|--------------------------|--------------------------|--------------------------|--------------------------|

COLOR CODE \_\_\_\_\_ ENGRAVED \_\_\_\_\_ HOT STAMPED \_\_\_\_\_ LETTER SIZE \_\_\_\_\_

FILLER CODE \_\_\_\_\_ PRICE \_\_\_\_\_

### ENGRAVING INFORMATION (Please print per corresponding gang number.)

(1)

(2)

(3)

(4)

(5)

(6)

(7)

(8)

(9)

(10)

(11)

(12)

#### DESCRIPTION

(Use this space to add additional information that may be helpful.)

#### TERMS

- Please take care to complete your order carefully. Custom wallplates cannot be returned
- Custom orders are shipped in three to four weeks
- All engraving shall be centered within its corresponding gang unless specifically instructed to span across multiple gangs
- All engravings on toggle configurations shall appear above the mounting screw holes unless specifically instructed otherwise
- All engravings on GFCI/Decora configurations shall appear below the mounting screw hole unless specifically instructed otherwise

# AC Switches

## INDEX

|                                     |        |
|-------------------------------------|--------|
| <b>Industrial Grade Switches</b>    |        |
| Overview                            | F2     |
| Back and Side Wired                 | F3     |
| Toggle                              | F3     |
| Locking                             | F3     |
| Wire Lead Toggle                    | F3     |
| Canadian 347V AC                    | F3     |
| Pilot Light                         | F4     |
| Lighted Handle                      | F4     |
| Maintained Contact                  | F5     |
| Momentary Contact                   | F5     |
| Side Wired                          | F6     |
| Toggle                              | F6     |
| Locking                             | F6     |
| AC Manual Motor and Welder Starting | F7     |
| Safety Disconnect Switches          | F8, F9 |
| Key Lock Power                      | F10    |
| <b>Commercial Grade Switches</b>    |        |
| Overview                            | F11    |
| Back and Side Wired                 | F12    |
| Toggle                              | F12    |
| Side Wired                          | F12    |
| Toggle                              | F12    |
| Hospital Call                       | F12    |
| Canadian 120/277V AC                | F12    |
| Lighted Toggle                      | F13    |
| Canadian 347V AC                    | F13    |
| Framed Toggle                       | F13    |
| <b>Residential Grade Switches</b>   |        |
| Quickwire and Sidewire              | F14    |
| Illuminated Toggle                  | F14    |
| CO/ALR                              | F14    |

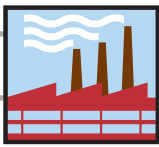

# AC SWITCH FEATURES

## Industrial Grade AC Switches

LEVITON OFFERS A FULL LINE OF 15, 20 AND 30 AMP AC SWITCHES, AVAILABLE IN INDUSTRIAL, COMMERCIAL AND RESIDENTIAL GRADE, WITH A WIDE VARIETY OF COLORS, WIRING OPTIONS AND OTHER FEATURES.

Leviton's AC switches are for control of resistive and inductive loads and motors. A full selection of ratings is available in Industrial Grade, Commercial Grade and Residential Grade.

The following pages provide a comprehensive overview of the complete Leviton AC Quiet Switch product line. Ordering information will help you select the switches best suited to meet your application requirements.

Leviton's Industrial Grade AC switches for heavy-duty applications represent top-of-the-line quality and peak performance. Leviton uses the finest materials available and the highest production standards to produce industrial switches of unmatched versatility and reliability.

### Features and Benefits—**LEVSPEC** Industrial Grade Switches

- Top-of-the-line industrial-grade quality for peak performance and rugged, long-lasting service
- All screws are triple-drive and accept Standard, Phillips and Robertson screwdrivers
- External clamp-type wiring terminals provides secure connection of solid or stranded wire for back or side wiring
- Back or side-wired grounding terminal offers wiring flexibility
- Sturdy, long-lasting thermoplastic toggles provide smooth switching action and long life
- UL 20 Listed; meets latest Federal Specifications WS-896, CSA Specification C22.2.2 No. 11 Certified; NOM Certified; complies with NEMA and ANSI requirements
- Backed by a Limited 10-Year Warranty



**Back and Side Wired**  
External clamp-type terminals for maximum wiring versatility. **1203-21 shown**



**Pilot Light**  
Toggle is illuminated when load is on for visual confirmation. **1201-PLC shown**



**Locking**  
Designed to prevent tampering and unauthorized switching. **1121-2L shown**



**Maintained and Momentary Contact**  
Positive switching action with center-off position. **1285 shown**

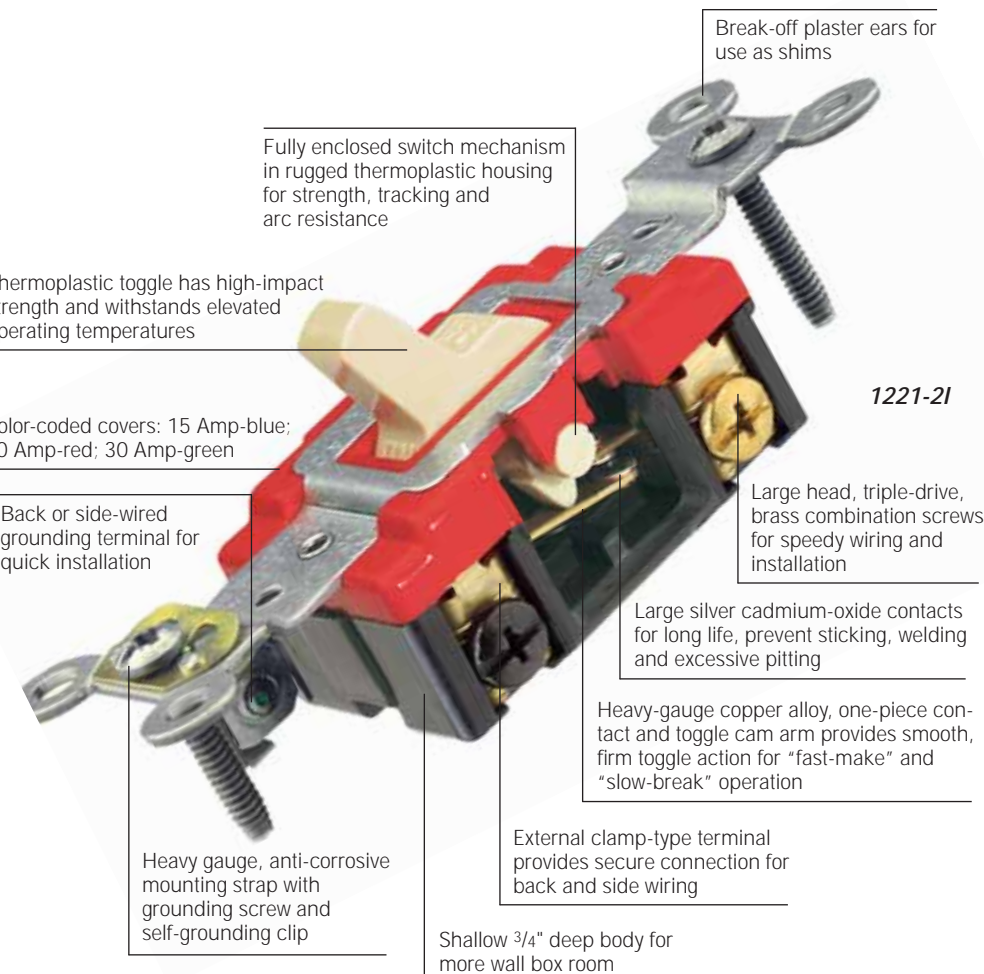



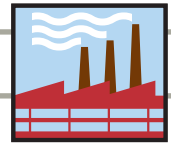

Industrial Grade AC Quiet Switches

Back and Side Wired 120/277V AC Quiet Switches

| DESCRIPTION<br>LEVSPEC® | 15 AMP  | 20 AMP  | 30 AMP  | COLOR*<br><i>Basic Cat. No. Denotes Brown</i>              |
|-------------------------|---------|---------|---------|--|
| Single-Pole Toggle      | 1201-2  | 1221-2  | 3031-2  | 15A: I, W, GY, R<br>20A: I, W, A, T, GY, R, E<br>30A: I, W |
| Single-Pole Locking†    | 1201-2L | 1221-2L | 3031-2L | 15A: I; 20A: I, W, G, R                                    |
| Double-Pole Toggle      | 1202-2  | 1222-2  | 3032-2  | 15A: I, W, GY<br>20A: I, W, GY, R, E<br>30A: I, W, E, R    |
| Double-Pole Locking†    | 1202-2L | 1222-2L | 3032-2L | 20A: I   |
| 3-Way Toggle            | 1203-2  | 1223-2  | 3033-2  | 15A: I, W, GY, R<br>20A: I, W, GY, R, E, A, T<br>30A: I, W |
| 3-Way Locking†          | 1203-2L | 1223-2L | 3033-2L | 15A: I; 20A: I, W, G                                       |
| 4-Way Toggle            | 1204-2  | 1224-2  | —       | 15A: I, W, GY<br>20A: I, W, GY, R, E, T                    |
| 4-Way Locking†          | 1204-2L | 1224-2L | —       | 20A: I, G, W   |

SPECCASS® General Duty Switches

|                    |   |        |   |                  |
|--------------------|---|--------|---|------------------|
| Single Pole Toggle | — | 1221-S | — | 20A: I, W, R, GY |
| Double Pole Toggle | — | 1222-S | — | 20A: I, W, GY    |
| 3-Way Toggle       | — | 1223-S | — | 20A: I, W, R, GY |
| 4-Way Toggle       | — | 1224-S | — | 20A: I, W, GY    |

†Key for Locking Switch: Cat. No. 55500-PRT.

Wire Lead 120/277V AC Quiet Switches

| DESCRIPTION                     | 15 AMP | 20 AMP | COLOR           |
|---------------------------------|--------|--------|-----------------|
| SPECCASS® General Duty Switches |        |        |                 |
| Single-Pole Toggle              | 1241   | 1243   | 15A & 20A: I, W |
| 3-Way Toggle                    | 1242   | 1244   | 15A & 20A: I, W |

Back and Side Wired Canadian 347V AC Quiet Switches

| DESCRIPTION        | 15 AMP | 20 AMP | COLOR**<br><i>See Canadian Color</i> |
|--------------------|--------|--------|--------------------------------------|
| Single-Pole Toggle | 18201  | 18221  | 15A & 20A: I, W, B, R, G             |
| Double-Pole Toggle | 18202  | 18222  | 15A: I only<br>20A: I, B             |
| 3-Way Toggle       | 18203  | 18223  | 15A & 20A: I, W, B, R, G             |
| 4-Way Toggle       | 18204  | 18224  | 15A: I, B, R, G<br>20A: I, B         |

NOTE: Cat. Nos. 1201, 1221, 18201, 18221, 1203, 1223, 18203 and 18223 feature external clamp-type wiring termination for back and side wiring

Wallplates

| THERMOPLASTIC |         |         | 302 STAINLESS STEEL |           |          |          |
|---------------|---------|---------|---------------------|-----------|----------|----------|
|               |         |         |                     |           |          |          |
| 80701-I       | 80709-E | 80711-W | 84001-40            | 84001-E40 | 84009-40 | 84011-40 |

For complete wallplate selection, see Section E.

SPECIFICATIONS AND FEATURES

- Top-of-the-line industrial quality
- Heavy gauge copper alloy one-piece arm for top performance
- Large silver cadmium-oxide contacts for long life, prevent sticking, welding and excessive pitting
- Color-coded covers: 15 Amp-blue; 20 Amp-red; 30 Amp-green
- Fully enclosed switch mechanism in rugged housing for strength, tracking and arc resistance
- Brass combination-head terminal screws on LEVSPEC devices, steel combination head terminal screws on other devices
- Self-grounding clip on LEVSPEC devices (self-grounding when used with a grounded metal wallbox)
- Wire lead switches for fast and easy installation

TESTING AND CODE COMPLIANCE

- Meets all NEMA WD 1 & 6, and ANSI requirements
- Meets Federal Specification WS-896
- UL Listed (File #E-7458)
- CSA Certified (File #152105)
- NOM Certified (#057)
- Backed by a Limited 10-Year Warranty
- SPECCASS devices backed by a Limited 2-Year Warranty

\*COLOR

Basic Cat. Nos. shown above denote Brown color. Other color available as listed, add suffix to catalog number as follows: Ivory (-I), White (-W), Gray (-GY or -G), Red (-R), Black/Ebony (-E), Almond (-A) and Light Almond (-T). For locking switch colors, use the following suffixes: Ivory (-2IL), White (-2WL), Gray (-2GL), Red (-2RL).

\*\* CANADIAN COLOR

For color selection, add suffix to catalog number as follows: Ivory (-I), White (-W), Brown (-B), Red (-R), and Gray (-G).

HORSEPOWER

| 15A        | 20A      | 30A      |
|------------|----------|----------|
| 1/2 @ 120V | 1 @ 120V | 2 @ 120V |
| 2 @ 240V   | 2 @ 240V | 2 @ 240V |

MATERIAL CHARACTERISTICS

Environmental: Flammability, Rated V2  
Operating Temperature: -40°C to 65°C.

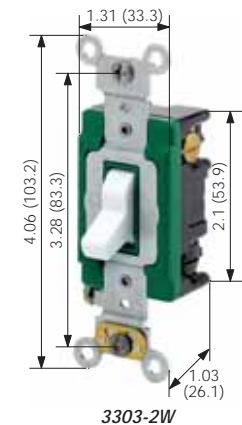
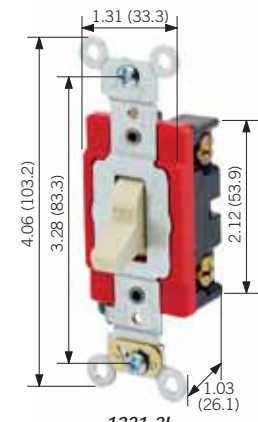
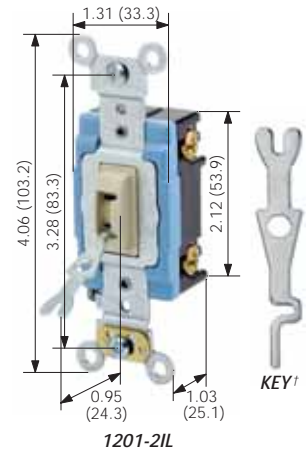

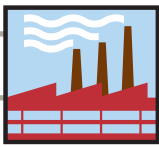

# 15, 20 and 30 AMP 120V and 20 AMP 277V

## Industrial Grade AC Switches

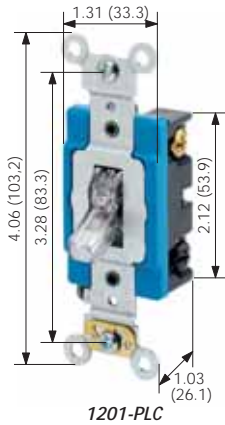

1201-PLC

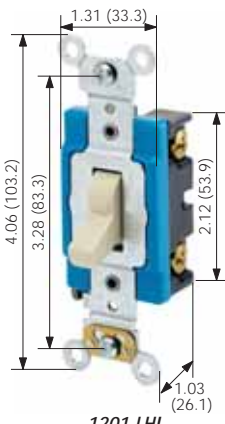

1201-LHI

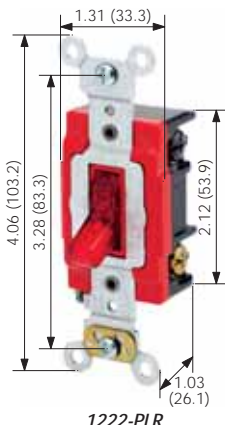

1222-PLR

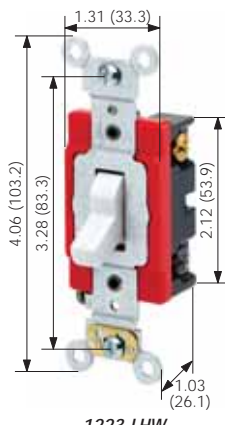

1223-LHW

### Pilot Light and Lighted Handle

#### Back and Side Wired Pilot Light

| DESCRIPTION* | 15 AMP<br>120V | 20 AMP<br>120V | 30 AMP<br>120V | 20 AMP<br>277V |
|--------------|----------------|----------------|----------------|----------------|
| Single-Pole  | 1201-PL        | 1221-PL        | 3031-PL✓       | 1221-7P✓       |
| Double-Pole  | 1202-PL+       | 1222-PL        | 3032-PL✓       | 1222-7P+       |
| 3-Way        | 1203-PL        | 1223-PL        | —              | 1223-7P+       |

Note: Pilot light switches require a neutral wire; lighted handle switches do not require a neutral wire.

\*Available toggles for these devices: Clear (-PLC), Red (-PLR), Green (-PLG).

+Available in red toggle only.

✓Available in clear or red toggle only.

#### Back and Side Wired Lighted Handle

| DESCRIPTION† | 15 AMP<br>120V | 20 AMP<br>120V | 30 AMP<br>120V | 20 AMP<br>277V |
|--------------|----------------|----------------|----------------|----------------|
| Single-Pole  | 1201-LH        | 1221-LH        | 3031-LH*       | 1221-7L        |
| 3-Way        | 1203-LH        | 1223-LH        | —              | 1223-7L        |

Note: Pilot light switches require a neutral wire; lighted handle switches do not require a neutral wire.

†Available toggles for these devices: Clear (-LHC), Ivory (-LHI), White (-LHW).

\*Available in ivory toggle only.

### Wallplates

| THERMOPLASTIC |         |         | 302 STAINLESS STEEL |           |          |          |
|---------------|---------|---------|---------------------|-----------|----------|----------|
|               |         |         |                     |           |          |          |
| 80701-I       | 80709-I | 80711-W | 84001-40            | 84001-E40 | 84009-40 | 84011-40 |

For complete wallplate selection, see Section E.

#### SPECIFICATIONS AND FEATURES

- Pilot light and lighted handle switches provide top performance in punishing industrial applications
- Lighted handle illuminated when load is OFF. Pilot light toggle illuminated when load is ON.
- 120 and 277V versions in single pole and 3-way
- Fully enclosed switch mechanism in rugged housing for strength, track and arc resistance
- Self-grounding clip (self-grounding when used with a grounded metal wallbox)

#### TESTING AND CODE COMPLIANCE

- Meets all NEMA WD 1 & 6, and ANSI requirements
- Meets Federal Specification WS-896
- UL Listed (File #E-7458)
- CSA Certified (File #152105)
- NOM Certified (#057)
- Backed by a Limited 10-Year Warranty

#### HORSEPOWER

| 15A        | 20A      | 30A      |
|------------|----------|----------|
| 1/2 @ 120V | 1 @ 120V | 2 @ 120V |

#### MATERIAL CHARACTERISTICS

Environmental: Flammability, Rated V2  
Operating Temperature: -40°C to 65°C.

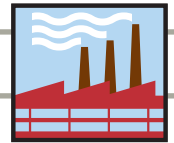

Maintained and Momentary Contact

Back and Side Wired Maintained Contact 120/277V AC

| DESCRIPTION                                     | 15 AMP | 20 AMP | 30 AMP | COLOR*                               |
|---|--------|--------|--------|--------------------------------------|
| Single-Pole, Double Throw, Center Off           | 1281   | 1285   | 1287   | 15A: I, W<br>20A: I, W, GY<br>30A: I |
| Single-Pole, Double Throw, Center Off, Locking† | 1281-L | 1285-L | 1287-L | 15, 20 & 30A: Black only             |
| Double-Pole, Double Throw, Center Off           | 1282   | 1286   | 1288   | 15A: I, W<br>20A: I, W<br>30A: I, W  |
| Double-Pole, Double Throw, Center Off, Locking† | —      | —      | 1288-L | 30A: Black only                      |

†Key for Locking Switch: Cat. No. 55500-PRT

Back and Side Wired Momentary Contact 120/277V AC

| DESCRIPTION                                     | 15 AMP | 20 AMP  | 30 AMP | COLOR*   |
|---|--------|---------|--------|--|
| Single-Pole, Double-Throw, Center Off           | 1256   | 1257    | 1260★  | 15: I, W, GY<br>20A: I, W, GY<br>30A: Brown only |
| Single-Pole, Double-Throw, Center Off, Locking† | —      | 1257-L★ | —      | 20A: Black only                                  |
| Double-Pole, Double-Throw, Center Off           | —      | —       | 1262★  | 30A: Brown only                                  |

†Key for Locking Switch: Cat. No. 55500-PRT.

CSA Certified except where indicated by ★

Wallplates

| THERMOPLASTIC |         |         | 302 STAINLESS STEEL |           |          |          |
|---------------|---------|---------|---------------------|-----------|----------|----------|
|               |         |         |                     |           |          |          |
| 80701-I       | 80709-E | 80711-W | 84001-40            | 84001-E40 | 84009-40 | 84011-40 |

For complete wallplate selection, see Section E.

SPECIFICATIONS AND FEATURES

- Single-Pole and Double-Pole versions, toggle or locking
- Positive switching action with center-off position
- Large silver cadmium-oxide contacts for long life, prevent sticking, welding and excessive pitting
- Clamp-type terminals accept up to #10 CU wire
- Full rated current capacity on fluorescent, tungsten and resistive loads; motor load capacity up to 80% switch current rating

TESTING AND CODE COMPLIANCE

- Meets all NEMA WD 1 & 6, and ANSI requirements
- UL Listed (File #E-7458)
- CUL (File #E-63969)
- NOM Certified (#057)
- Backed by a Limited 10-Year Warranty

\*COLOR

Basic Cat. Nos. shown above denote Brown color except for Locking Devices (Black). Other colors available as listed, add suffix to catalog number as follows: Ivory (-I), White (-W) and Gray (-GY).

HORSEPOWER

| 15A        | 20A      | 30A      |
|------------|----------|----------|
| 1/2 @ 120V | 1 @ 120V | 2 @ 120V |
| 2 @ 240V   | 2 @ 240V | 2 @ 240V |

MATERIAL CHARACTERISTICS

Environmental: Flammability, Rated V2  
Operating Temperature: -40°C to 65°C.

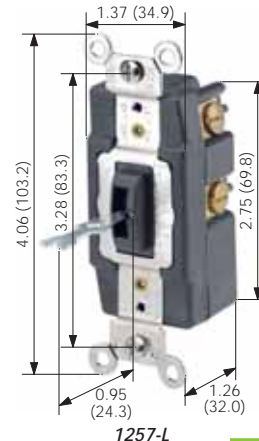
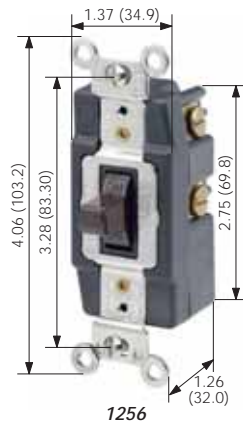
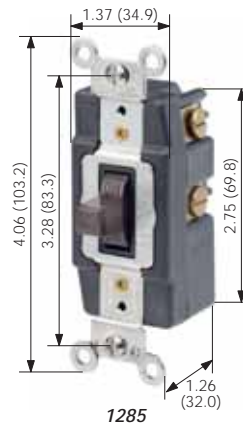
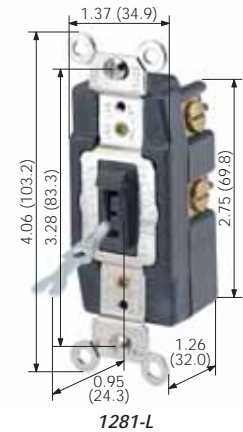

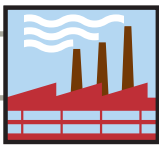

# 15 and 20 AMP 120/277V Industrial Grade AC Quiet Switches

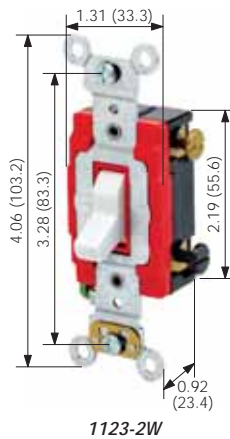
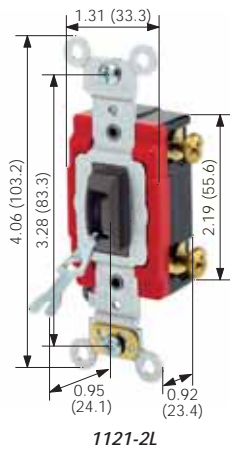
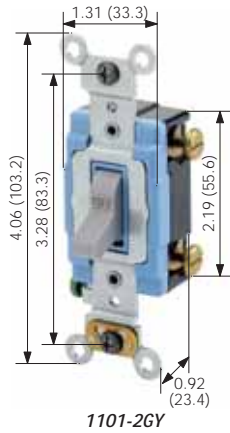

## Side Wired 120/277V AC Quiet Switches

| DESCRIPTION          | 15 AMP  | 20 AMP  | COLOR*                              |
|----------------------|---------|---------|-------------------------------------|
| Single-Pole Toggle   | 1101-2  | 1121-2  | 15A: I, W, GY<br>20A: I, W, GY, R   |
| Single-Pole Locking† | 1101-2L | 1121-2L | 15A & 20A: Brown Only               |
| Double-Pole Toggle   | 1102-2  | 1122-2  | 15A: I<br>20A: I, W, GY             |
| Double-Pole Locking  | 1102-2L | 1122-2L | 15A & 20A: Brown Only               |
| 3-Way Toggle         | 1103-2  | 1123-2  | 15A: I, W, GY<br>20A: I, W, GY, R   |
| 3-Way Locking†       | 1103-2L | 1123-2L | 15A & 20A: Brown Only               |
| 4-Way Toggle         | 1104-2  | 1124-2  | 15A: Ivory only<br>20A: I, W, GY, R |
| 4-Way Locking†       | 1104-2L | 1124-2L | 15A & 20A: Brown Only               |

†Key for Locking Switch: Cat. No. 55500-PRT.

## Wallplates

| THERMOPLASTIC |         |         | 302 STAINLESS STEEL |           |          |          |
|---------------|---------|---------|---------------------|-----------|----------|----------|
|               |         |         |                     |           |          |          |
| 80701         | 80709-1 | 80711-W | 84001-40            | 84001-E40 | 84009-40 | 84011-40 |

For complete wallplate selection, see Section E.

### SPECIFICATIONS AND FEATURES

- Rugged construction for trouble-free service in industrial environments
- Heavy-gauge copper alloy one-piece arm for smooth, quiet, firm toggle action
- Large silver cadmium-oxide contacts for long life, prevent sticking, welding and excessive pitting
- Large head, deep-slotted terminal screws for fast, easy wiring; accept up to #10 copper and copper-clad wire
- Self-grounding clip (self-grounding when used with a metal wallbox)

### TESTING AND CODE COMPLIANCE

- Meets all NEMA WD 1 & 6, and ANSI requirements
- UL Listed (File #E-7458) to meet the latest Federal Specification, WS-896
- CSA Certified (File #152105)
- NOM Certified (#057)
- Backed by a Limited 10-Year Warranty

### \*COLOR

Basic Cat. Nos. shown above denote Brown color. Other colors available as listed, add suffix to catalog number as follows: Ivory (-I), White (-W), Gray (-GY), Red (-R), Black/Ebony (-E).

### HORSEPOWER

| 15A        | 20A      |
|------------|----------|
| 1/2 @ 120V | 1 @ 120V |
| 2 @ 240V   | 2 @ 240V |

### MATERIAL CHARACTERISTICS

Environmental: Flammability, Rated V2  
Operating Temperature: -40°C to 65°C.

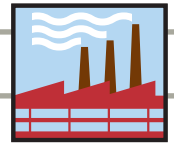

# Industrial Grade AC Manual Motor and Welder Starting Switches

## Back and Side Wired AC Manual Motor Starting Switches 30 AMP 600V AC

| DESCRIPTION  | MAX. HP RATING   | IN TYPE 1 ENCL. | IN TYPE 3R ENCL. | SWITCH ONLY |
|--|--|-----------------|------------------|-------------|
| Double-pole, single-throw AC manual motor starting switch, without overload protection. Color: Black | 2HP 120V AC<br>5HP 240V AC<br>10HP 480V AC<br>15HP 600V AC   | N1302           | N3302            | MS302       |
| Same as above – Short Toggle   |  |                 |                  | MS302-S     |
| Three-pole, single-throw AC manual motor starting switch, without overload protection. Color: Black  | 3HP 120V AC<br>7.5HP 240V AC<br>15HP 480V AC<br>20HP 600V AC | N1303           | N3303            | MS303       |
| Same as above – Short Toggle   |  |                 |                  | MS303-S     |



## Back and Side Wired AC Manual Motor Starting Switches 40 AMP 600V AC

| DESCRIPTION  | MAX HP RATING  | CAT. NO. |
|--|--|----------|
| Double-pole, single-throw AC manual motor starting switch, without overload protection. Color: Black | 2HP 120V AC<br>5HP 240V AC<br>10HP 480V AC<br>15HP 600V AC   | MS402    |
| Three-pole, single-throw AC manual motor starting switch, without overload protection. Color: Black  | 3HP 120V AC<br>7.5HP 240V AC<br>15HP 480V AC<br>20HP 600V AC | MS403    |



## Back or Front Wired AC Manual Motor Starting Switches 60 AMP 600V AC

| DESCRIPTION  | MAX. HP RATING                               | IN NEMA 3R ENCL. | SWITCH ONLY |
|--|--|------------------|-------------|
| Double-pole, single-throw AC manual motor starting switch, without overload protection. Back Wired. Color: Black | 10HP 240V AC<br>15HP 480V AC<br>20HP 600V AC | N3602            | MS602-BW    |
| Same as above except Front Wired   |  |                  | MS602-FW    |
| Three-pole, single-throw AC manual motor starting switch, without overload protection. Back Wired. Color: Black  | 10HP 240V AC<br>25HP 480V AC<br>30HP 600V AC | N3603            | MS603-BW    |
| Same as above except Front Wired   |  |                  | MS603-FW    |

## Side Wired AC Manual Welder Starting Switches 40 AMP 600V AC

| DESCRIPTION  | MAX. HP RATING | CAT. NO. |
|--|----------------|----------|
| Double-pole, single-throw AC manual welder starting switch. Color: Black | 5HP 250V AC    | WS402    |

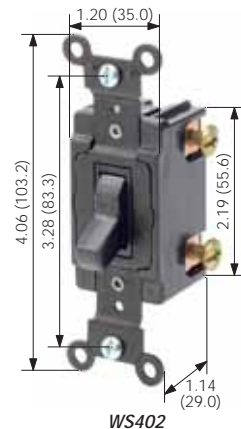

## Enclosures and Wallplates

| TYPE 1 STEEL ENCLOSURE WITHOUT SWITCH For 30A MS Switches                                 | TYPE 3R ENCLOSURE WITHOUT SWITCH For 30A MS Switches                                      | 302 STAINLESS STEEL LOCKOUT WALLPLATE w/TAMPER-RESISTANT SCREWS and SPANNER TOOL    | TYPE 1 ENCLOSURES w/THERMOPLASTIC COVER and w/30A 2-P (N1302-T) or 30A 3-P (N1303-T) Switch   | TYPE 3R ENCLOSURE WITHOUT SWITCH For 40 or 60A MS Switches                                  |
|---|---|---|---|---|
| 2 Knockouts 1/2" and 3/4" Top and Bottom  | 2 Bottom Knockouts #1 Allows: 1/2", 3/4" #2 Allows: 1", 1 1/4"                            | 84001-LOK (Lock purchased separately)   | N1303-T (w/30A Switch) N1303-T (Cover Only)   | 2 Bottom Knockouts both allow: 1/2", 3/4", 1", 1 1/4"                                       |
|  N13NC |  N33NC |  |  N1303-T  N1303-T |  N36NC |

Note: For Type 3R Enclosure lockout, padlock with 5/16" or equivalent shackle recommended (min. 1/4" Dia.). For complete wallplate selection, see Section E.

### SPECIFICATIONS AND FEATURES

#### MS Switches

- All molded parts are thermoplastic to resist impacts, chemicals, temperature, tracking and arcing
- Positive-contact design enhances fast-make/ slow-break
- Silver-alloy contacts for maximum conductivity and service life
- Back and side wire terminals accept up to #10 AWG solid copper wire. For stranded #8 AWG wire, remove terminal clamp and use ring terminal
- Oversized #10 triple-combination terminal screws are vibration resistant
- Insulating barrier between terminals provide isolation from each phase

- Nickel-plated brass mounting yoke for superior corrosion resistance
- Large toggle provides positive actuation, even with gloved hand

#### WS Switches

- Capable of accommodating bus bar termination in multi-gang applications
- Hole for mounting hardware supports panel mounting with self-threading fasteners or pop rivets
- Terminal screws accept up to # 10 AWG solid copper wire. For stranded # 8 AWG wire, remove terminal clamp and use ring terminal
- Fast-threading, corrosion-resistant brass triple-combination screws for fast, easy installation

### TESTING AND CODE COMPLIANCE

- MS devices: UL & CUL Listed (File #E-63969)
- WS devices: UL Recognized Component (File #E-63969)
- MS & WS devices comply with UL 508
- Backed by a Limited Ten-Year Warranty

### MATERIAL CHARACTERISTICS

UL94 V0 Flammability Rating  
Operating Temperature: -40°C to 65°C

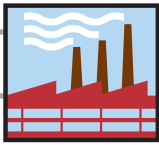

## SAFETY DISCONNECT SWITCH FEATURES

### Industrial Grade Watertight Safety Disconnect Switches UL 98 & UL 508 Listed, CUL per CSA Specification, C22.2 No. 14 Certified

2 YEAR LIMITED  
**WARRANTY**

Liquid-tight conduit fitting can be installed for top or bottom feed

- One fitting supplied:
- 30 Amp – 1"
  - 60 Amp – 1 1/4"
  - 100 Amp – 1 1/2"

Stainless steel screws are captive and will not fall out when cover is opened

- Impact UV and chemical-resistant Valox enclosure rated to UL and IEC watertight standards
- Type 3R, 4X & 12K
  - IP67

**Fused Models Accept  
"Class J" Time-Delay Fuses**

Pre-wired grounding plates (top and bottom of enclosure) connect to metal conduit grounding system

Brass threaded inserts will not strip, provide higher torque, and form tighter seal between back box and cover

Rugged hinge mechanism pivots 180° for easy access during installation and maintenance

Red "pistol grip" handle provides visual confirmation of switch's status

Integrated lockout handle meets OSHA safety regulations

**Watertight Safety Disconnect Switches Include —  
30 Amp Fused, 60 & 100 Amp  
(Fused & Non-Fused)**

**Meets 2002 NEC® Requirements  
430.102 (A) and 430.102 (B)**

Circuit identification pad for means of identifying specific equipment loads

DS60-FAX



Handle with padlock installed

Generous wiring space for top to bottom wiring

- Disconnect switch with integrated fuse holder offers proven performance in a compact package
- Fused cartridges accept "Class J" fuses (not included)
  - 1 Factory installed Auxiliary Contact (Normally Open – 10 Amp)
  - Additional Auxiliary Contact Available (Normally Closed – 10 Amp)
  - Easily accessible neutral and ground terminal blocks

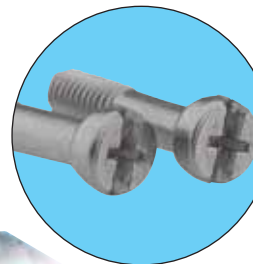

**Cover Screws:** 1 1/8" deep slotted. LG stainless steel.  
**Mounting Screws:** 10-24 x 1/2" deep slotted. LG stainless steel.

DS60-FAX



#### STANDARDS & CERTIFICATIONS

##### Safety Disconnect Switches

| UL 98 Fused<br>(Including 100A Non-Fused - DS) | UL 508<br>Non-Fused | CSA C22.2<br>No. 14 | NOM | CE | IEC<br>947-3 |
|--|---------------------|---------------------|-----|----|--------------|
| E63969   |                     | ✓                   | ✓   | ✓* | ✓            |

\* Not available on DS30-AX



To learn more about Leviton's outstanding offering of devices visit our Website at: [www.leviton.com](http://www.leviton.com)

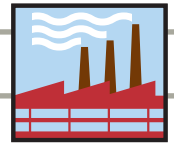

Industrial Grade Watertight Safety Disconnect Switches



Engineered to UL & IEC Watertight Standards

Meets 2002 NEC® Requirements 430.102 (A) and 430.102 (B)



DS30-AX (Non-Fused)



DS60-FAX (Fused)



DS100-AX (Non-Fused)

2 YEAR LIMITED WARRANTY

Ordering Information for Watertight Safety Disconnect Switches

| AMPS | MAX VOLTAGE | INTERRUPTED RATINGS — RMS SYMMETRICAL AMPERES  |                   |
|------|-------------|--|-------------------|
|      |             | Non-Fused are suitable for use on circuits capable of delivering not more than (see chart below for catalog no. and value) RMS symmetrical amperes.  |                   |
|      |             | Fused, when protected by Class J fuses, 600V AC maximum, are suitable for use on circuits capable of delivering not more than (see chart below for catalog no. and value) RMS symmetrical amperes. |                   |
|      |             | CATALOG NO. NON-FUSED  | CATALOG NO. FUSED |
| 30   | 600V AC     | DS30-AX  | DS30-FAX          |
| 60   | 600V AC     | DS60-AX  | DS60-FAX          |
| 100  | 600V AC     | DS100-AX   |                   |

| ELECTRICAL            |   |                 |          |
|-----------------------|---|-----------------|----------|
|                       | Device  | Current Applied | Duration |
| Ground Path Integrity | 30 A  | 60 A            | 2 min    |
|                       | 60 A  | 120 A           | 4 min    |
|                       | 100 A   | 200 A           | 6 min    |
| Current Interrupting  | Certified for current interrupting at full-rated current and voltage    |                 |          |
| Endurance             | 6000 operations at rated current and voltage (Power factor 0.75 – 0.80) |                 |          |
| Dielectric            | 1000 V plus twice rated voltage for 1 minute                            |                 |          |

| MECHANICAL                              |  |
|---|--|
| Mold Stress Relief                      | 70°C for 7 hours                                       |
| Knockout Test                           | Remains in place with 20 lb push                       |
| Crush                                   | 100 lb   |
| Impact                                  | 1.2 lb steel ball dropped from 5 ft                    |
| Cold Impact                             | Same as above, after conditioning to -35°C             |
| Strength of Insulating Base and Support | 110% of specified tightening torque on terminal screws |
| Pullout                                 | 18 lb pull on internal wires                           |

| ENVIRONMENTAL           |   |
|-------------------------|---|
| Flammability            | V2 or better per UL 94 or CSA 22.2 No 0.6; V-0 for watertight enclosure |
| Rain (3R) per UL 50     | Water spray @ 5 psi from all sides for 1 hr                             |
| Hosedown (4X) per UL 50 | Water spray @ 65 gal/min for 5 minutes                                  |
| Dust (12K) per UL 50    | Cement Dust Circulated @ 1000 ft/minute for 5 minutes                   |
| Gasket Aging            | 70°C for 168 hours  |
| UV Resistance           | Exposed plastic materials are UV stabilized                             |
| Operating Temperature   | -40°C to +60°C (-40°F to +140°F)  |

| VOLTS            | MAX. HP RATINGS PER UL508 NON-FUSED SAFETY DISCONNECT SWITCHES |         |          |
|------------------|--|---------|----------|
|                  | DS30-AX  | DS60-AX | DS100-AX |
| 120V AC          | 1  | 2       | 5        |
| 208V AC          | 5  | 20      | 25       |
| 240V AC          | 2.5  | 10      | 15       |
| 480V AC          | 5  | 20      | 25       |
| 600V AC          | NA   | 20      | 20       |
| 3Ø Y 120/208V AC | 5  | 20      | 25       |
| 3Ø 240V AC       | 5  | 20      | 30       |
| 3Ø 480V AC       | 15   | 40      | 50       |
| 3Ø 600V AC       | 15   | 40      | 50       |

| VOLTS            | MAX. HP RATINGS PER UL508 FUSED SAFETY DISCONNECT SWITCHES |          |
|------------------|--|----------|
|                  | DS30-FAX   | DS60-FAX |
| 120V AC          | 2  | NR       |
| 208V AC          | 7.5  | 15       |
| 240V AC          | 3  | NR       |
| 480V AC          | 15   | NR       |
| 600V AC          | 20   | NR       |
| 3Ø Y 120/208V AC | 7.5  | 15       |
| 3Ø 240V AC       | 7.5  | 15       |
| 3Ø 480V AC       | 15   | 30       |
| 3Ø 600V AC       | 20   | 50       |

NR = Not Rated

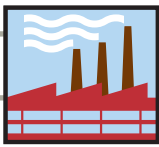

# 20 AMP 120/277V

## Industrial Grade AC Key Lock Power Switches

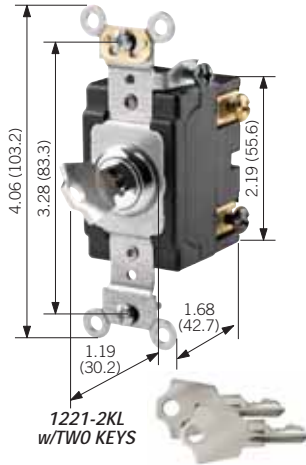

### Back and Side Wired Key Lock Power Switches 20 AMP 120/277V AC

| DESCRIPTION  | CAT. NO. |
|--|----------|
| Single-Pole Key Lock Power Switch, 2 keys provided | 1221-2KL |
| Double-Pole Key Lock Power Switch, 2 keys provided | 1222-2KL |
| 3-Way Key Lock Power Switch, 2 keys provided       | 1223-2KL |
| 4-Way Key Lock Power Switch, 2 keys provided       | 1224-2KL |
| Replacement Keys, 2 per pack                       | 2KL      |

### Wallplates and Wallboxes

| 302 STAINLESS STEEL COMES WITH TAMPER-RESISTANT SCREWS and SPANNER TOOL | FD or DEEP WALLBOX RECOMMENDED MINIMUM INTERNAL DEPTH 2 <sup>3</sup> / <sub>4</sub> " SINGLE COVER/GANG | ADAPTER EXTENDS SHALLOW WALLBOX, USE WITH STAINLESS WALLPLATE—CAT. NO. 84071-40           |
|---|---|---|
| <p>84701-40</p>   |   | <p>COLOR<br/>Brown<br/>Ivory<br/>White</p> <p>CAT. NO.<br/>6197<br/>6197-I<br/>6197-W</p> |
| 2-GANG STAINLESS STEEL WALLPLATE  | 3-GANG STAINLESS STEEL WALLPLATE  |   |
| <p>84072-40</p>   | <p>84073-40</p>   |   |

For complete wallplate selection, see Section E.

Key Lock Power Switches are not recommended for use on Master or Emergency Power Systems.

#### SPECIFICATIONS AND FEATURES

- Key-operated locking mechanism for maximum tamper-proof operation in schools, institutions, public housing, trailer parks, loading docks, freight yards and other areas
- Chrome lock dome with 2 keys provided per switch
- Back and side wire terminals accept up to #14 – #10 AWG copper or copper clad wire
- Large, combination head terminal screws with external clamps
- 4-Way switch has internal, back-wire clamps
- Triple-combination mounting screws for fast, easy installation
- Heavy-gauge rust-resistant mounting strap with steel grounding screw and self-grounding clip (self grounding when used in a properly grounded metal wallbox)
- Key removable in ON or OFF positions

#### TESTING AND CODE COMPLIANCE

- Meets NEMA WD-1, WD-6 & ANSI requirements
- Meets Federal Specifications WS-896
- UL Listed (File #E-7458)
- CSA Certified (File #152105)
- NOM Certified (#057)
- Backed by a Limited Ten-Year Warranty

#### HORSEPOWER

**20A**  
1 @ 120V  
2 @ 240V  
16 Amp Max.

#### MATERIAL CHARACTERISTICS

Environmental: Flammability, Rated V2  
Operating Temperature: -40°C to 65°C.



# AC QUIET SWITCH FEATURES

## Commercial Grade AC Quiet Switches



LEVITON OFFERS A LARGE SELECTION OF 15 AND 20 AMP COMMERCIAL SWITCHES, AVAILABLE IN A WIDE VARIETY OF COLORS, WIRING OPTIONS AND OTHER FEATURES.

*Leviton's Commercial Grade switches are designed to offer outstanding reliability and top performance in commercial settings. Ideal applications include municipal facilities, government buildings, malls, department stores, hospital and health care facilities, office buildings, schools, colleges, universities, houses of worship and cultural institutions.*

### Features and Benefits

- Listed UL Federal Specification, WS-896
- Heavy-duty pre-plated steel mounting strap for maximum strength
- All screws are brass combination-head for fast installation with Standard, Phillips and Robertson head screwdrivers
- External clamp-type wiring terminals provides secure connection of solid or stranded wire for back or side wiring (CSB1 and CSB3)
- Backed by a Limited 10-Year Warranty

**Back and Side Wired**  
External clamp-type terminals for maximum wiring versatility.  
*CSB1-20 shown*

**Side Wired**  
Sturdy, rugged, cost effective.  
*CS120-2W shown*

**Framed Toggle**  
For neater finished appearance.  
*54501-2I shown*

**Lighted Toggle**  
Lights up, when power is off, easy to locate in darkened rooms.  
*5501-LHI shown*

**Hospital Call Switch**  
Turns on when toggle is pulled down with cord (included).  
*5501-8 shown*

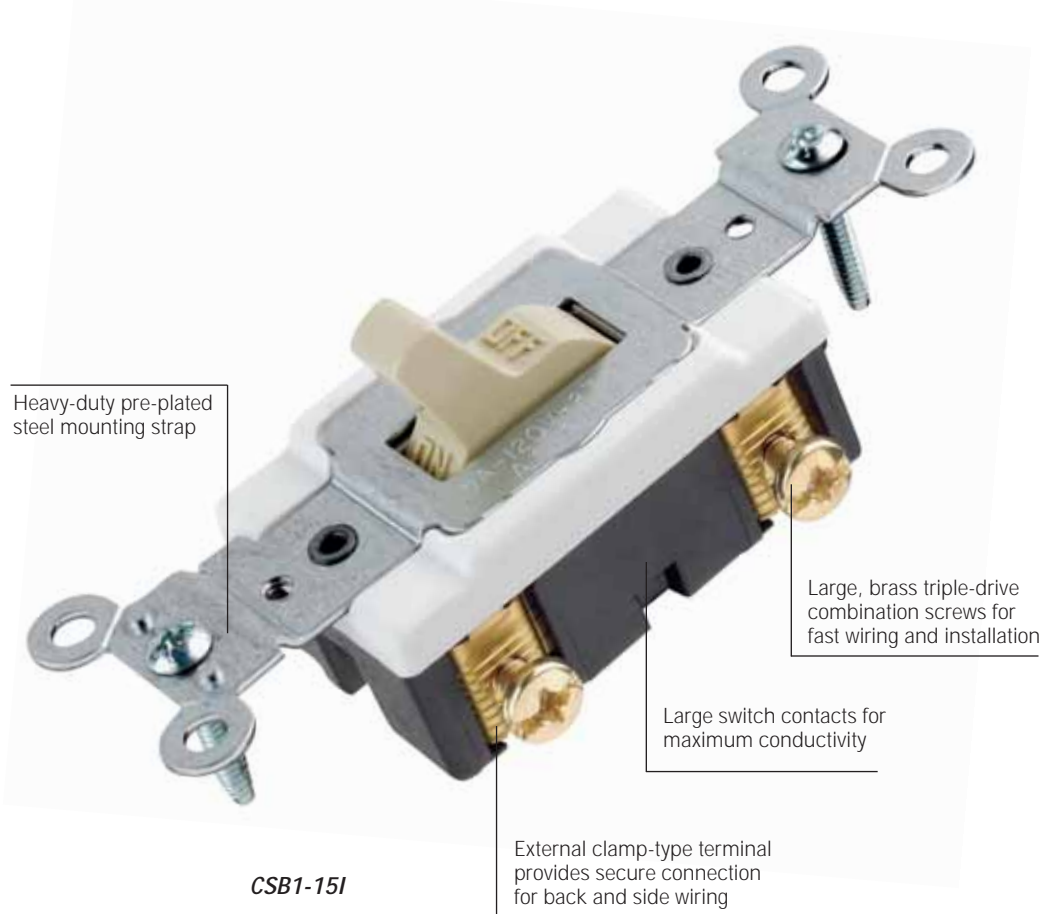

*CSB1-151*



# 15 and 20 AMP 120/277V • 15 and 20 AMP CANADIAN 120/277V

## Commercial Grade AC Quiet Switches

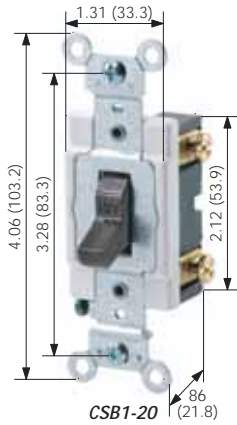

CSB1-20

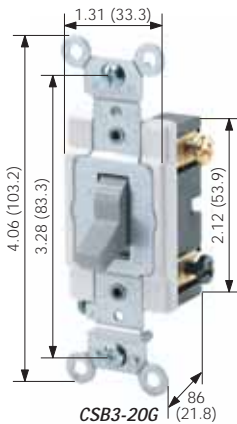

CSB3-20G

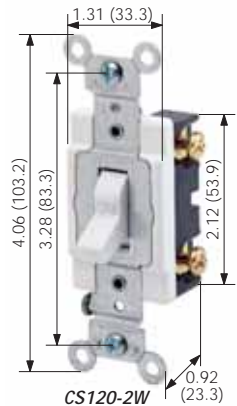

CS120-2W

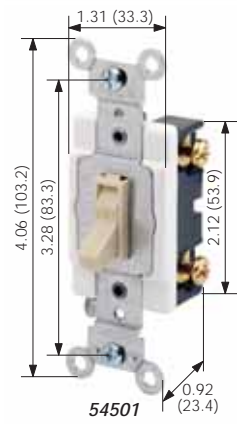

54501

### Back and Side Wired 120/277V AC Quiet Switches

| DESCRIPTION        | 15 AMP  | 20 AMP  | COLOR*                                |
|--------------------|---------|---------|---------------------------------------|
| Single-Pole Toggle | CSB1-15 | CSB1-20 | 15A & 20A: I, W, A, T, G              |
| Double-Pole Toggle | CSB2-15 | CSB2-20 | 15A: I, W, A, T<br>20A: I, W, A, T, G |
| 3-Way Toggle       | CSB3-15 | CSB3-20 | 15A: I, W, A, T<br>20A: I, W, A, T, G |
| 4-Way Toggle       | CSB4-15 | CSB4-20 | 15A: I, W, A<br>20A: I, W, A, G       |

### Side Wired 120/277V AC Quiet Switches

| DESCRIPTION                       | 15 AMP  | 20 AMP  | COLOR*  |
|-----------------------------------|---------|---------|---|
| Single-Pole Toggle                | CS115-2 | CS120-2 | 15A & 20A: I, W, A, T, GY, E                  |
| Single-Pole Hospital Call Switch† | 5501-8  | —       | 15A: I  |
| Double-Pole Toggle                | CS215-2 | CS220-2 | 15A: I, W, GY<br>20A: I, W, A, T, GY, E       |
| Double-Pole Hospital Call Switch† | 5502-8  | —       | 15A: Ivory Only                               |
| 3-Way Toggle                      | CS315-2 | CS320-2 | 15A: I, W, A, T, GY<br>20A: I, W, A, T, GY, E |
| 4-Way Toggle                      | CS415-2 | CS420-2 | 15A: I, W, A, T, GY<br>20A: I, W, A, T, GY, E |
| Single-Pole, Framed Toggle        | 54501-2 | 54521-2 | 15A & 20A: I, W, GY                           |
| Double-Pole, Framed Toggle        | 54502-2 | 54522-2 | 15A: I, W<br>20A: I, W                        |
| 3-Way, Framed Toggle              | 54503-2 | 54523-2 | 15A & 20A: I, W, GY                           |
| 4-Way, Framed Toggle              | 54504-2 | 54524-2 | 15A: I, W, A, T, GY<br>20A: I, W, GY          |

†Hospital Call Switch turns on when toggle is pulled down with cord (3-ft braided cord included)

NOTE: Cat. Nos. CSB1 and CSB3 feature external clamp-type wiring termination for back and side wiring

### Side Wired Canadian 120/277V AC Quiet Switches

Note: Cat. No. 54501-2 series is identified in Canada by the following catalog numbers:

| DESCRIPTION                | 15 AMP | 20 AMP  | COLOR**                               |
|----------------------------|--------|---------|---------------------------------------|
| Single-Pole, Framed Toggle | 1101-C | 54521-2 | 15A: I, W, B, G, E<br>20A: I, W, B, G |
| Double-Pole, Framed Toggle | 1102-C | 54522-2 | 15A & 20A: I, W, B, G                 |
| 3-Way, Framed Toggle       | 1103-C | 54523-2 | 15A: I, W, B, E<br>20A: I, W, B, G    |
| 4-Way, Framed Toggle       | 1104-C | 54524-2 | 15A: I, W, B, E<br>20A: I, W, B, G    |

### Wallplates

| THERMOPLASTIC |       |         | 302 STAINLESS STEEL |           |          |          |
|---------------|-------|---------|---------------------|-----------|----------|----------|
|               |       |         |                     |           |          |          |
| 80701-I       | 80709 | 80711-W | 84001-40            | 84001-E40 | 84009-40 | 84011-40 |

For complete wallplate selection, see Section E.

#### SPECIFICATIONS AND FEATURES

- Large head triple-drive combination screws (Standard, Phillips and Robertson) for fast wiring
- Heavy-gauge, rust-resistant steel mounting strap
- Accepts #14-#12 AWG copper or copper-clad wire
- Convenient break-off plaster ears for best alignment
- Large switch contacts for maximum conductivity

#### TESTING AND CODE COMPLIANCE

- UL Listed to meet the latest Federal Specification, WS-896 (File #E-748)
- Meets all NEMA WD 1 & 6, and ANSI requirements
- CSA Certified (File #LR-3413)
- NOM Certified (#057)
- Backed by a Limited 10-Year Warranty

#### \*COLOR

Basic Cat. Nos. shown above denote Brown color. Other colors available as listed, add suffix to catalog number as follows: Ivory (-I), White (-W), Almond (-A), Light Almond (T), Gray (-GY), Black (-E).

#### \*\* CANADIAN COLOR

For color selection, add suffix to catalog number as follows: Ivory (-I), White (-W), Brown (-B), and Gray (-G).

#### HORSEPOWER

| 15A        | 20A      |
|------------|----------|
| 1/2 @ 120V | 1 @ 120V |
| 2 @ 240V   | 2 @ 240V |

#### MATERIAL CHARACTERISTICS

Environmental: Flammability, Rated V2  
Operating Temperature: -40°C to 65°C.

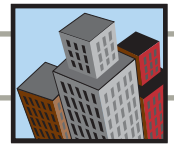

**Side Wired Lighted Toggle 15 AMP 120V AC Only**

| DESCRIPTION                | CAT. NO. | COLOR*    |
|----------------------------|----------|-----------|
| Single-Pole Lighted Toggle | 5501-LH  | 15A: I, W |
| 3-Way Lighted Toggle       | 5503-LH  | 15A: I, W |

**Side Wired Canadian 15 AMP 347V AC**

| DESCRIPTION                | CAT. NO. | COLOR**<br><i>See Canadian Color</i> |
|----------------------------|----------|--------------------------------------|
| Single-Pole, Framed Toggle | 18201-C  | 15A: I, W, B, G                      |
| Double-Pole, Framed Toggle | 18202-C  | 15A: I, W                            |
| 3-Way, Framed Toggle       | 18203-C  | 15A: I, W, B, G                      |
| 4-Way, Framed Toggle       | 18204-C  | 15A: I, W, G                         |

**Wallplates**

| THERMOPLASTIC |         |         | 302 STAINLESS STEEL |           |          |          |
|---------------|---------|---------|---------------------|-----------|----------|----------|
|               |         |         |                     |           |          |          |
| 80701-I       | 80709-I | 80711-W | 84001-40            | 84001-E40 | 84009-40 | 84011-40 |

For complete wallplate selection, see Section E.

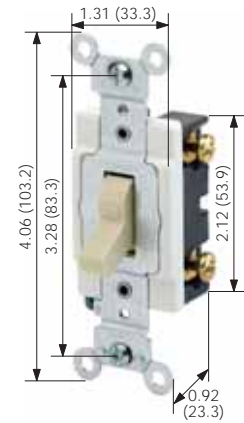

5501-LH1

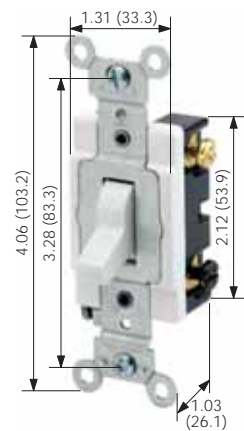

5503-LHW

**SPECIFICATIONS AND FEATURES**

- Quiet, reliable mechanical action
- Large head triple-drive combination screws (Standard, Phillips and Robertson) for fast wiring installation
- Accepts #14–#12 AWG copper or copper-clad wire
- Large switch contacts for maximum conductivity

**TESTING AND CODE COMPLIANCE**

- UL listed to meet the latest Federal Specification, WS-896 (File #E-748)
- Meets all NEMA WD 1 & 6, and ANSI requirements
- CSA Certified (File #LR-3413)
- NOM Certified (#057)
- Backed by a Limited 10-Year Warranty

**\* COLOR**

Basic Cat. Nos. shown above denote Brown color except for Lighted Toggle Switches. Other colors available as listed, add suffix to catalog number as follows: Ivory (-I), White (-W).

**\*\* CANADIAN COLOR**

For color selection, add suffix to catalog number as follows: Ivory (-I), White (-W), Brown (-B), and Gray (-G)

**HORSEPOWER**

**15A**  
1/2 @120V

**MATERIAL CHARACTERISTICS**

Environmental: Flammability, Rated V2  
Operating Temperature: -40°C to 65°C.



15 AMP 120V

Residential Grade AC Quiet Switches

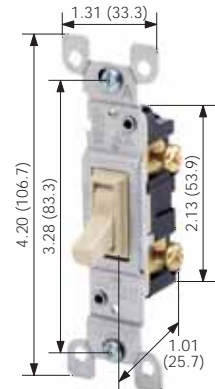

1451

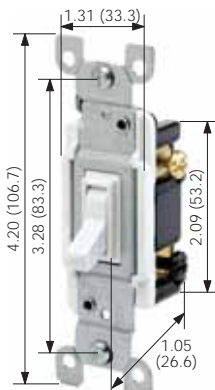

1453

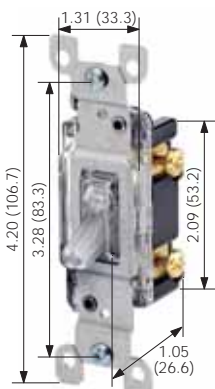

1461-LHC

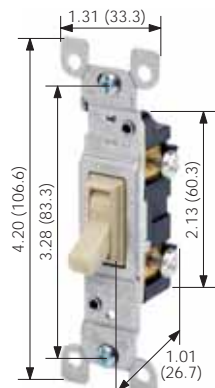

2651-2

Quickwire and Side Wired Framed Toggle 15 AMP 120V AC Quiet Switches

| DESCRIPTION                                 | CAT. NO. | COLOR*         |
|---|----------|----------------|
| Single-Pole                                 | 1451     | I, W           |
| 3-Way                                       | 1453     | I, W, A, T     |
| Single-Pole with grounding screw            | 1451-2   | I, W, A, T, E  |
| 3-Way with grounding screw                  | 1453-2   | I, W, A, T, E  |
| 4-Way with grounding screw                  | 54504-2  | I, W, A, GY, T |
| Single-Pole, less ears with grounding screw | 1451-4   | I, W           |
| 3-Way, less ears with grounding screw       | 1453-4   | I, W           |

Note: Available in Convenience Packs.

Quickwire and Side Wired Illuminated Toggle 15 AMP 120V AC

| DESCRIPTION                      | CAT. NO. | COLOR (Toggle & Frame)* |
|----------------------------------|----------|-------------------------|
| Single-Pole (Amber Illumination) | 1461-LH  | C                       |
| 3-Way (Amber Illumination)       | 1463-LH  | C                       |
| Single-Pole (Green Illumination) | 1461-GH  | I, W, A, T, E           |
| 3-Way (Green Illumination)       | 1461-GH  | I, W, A, T, E           |

Note: Illuminated switches do not require a neutral wire.

CO/ALR Side Wired Framed Toggle

15 AMP 120V AC

| DESCRIPTION                      | CAT. NO. | COLOR* |
|----------------------------------|----------|--------|
| Single-Pole with grounding screw | 2651-2   | I, W   |
| 3-Way with grounding screw       | 2653-2   | I, W   |



Note: CO/ALR devices are for connection to 12 or 10 AWG aluminum conductors.

Wallplates

| THERMOPLASTIC |       |         | 302 STAINLESS STEEL |           |          |          |
|---------------|-------|---------|---------------------|-----------|----------|----------|
|               |       |         |                     |           |          |          |
| 80701-I       | 80709 | 80711-W | 84001-40            | 84001-E40 | 84009-40 | 84011-40 |

For complete wallplate selection, see Section E.

SPECIFICATIONS AND FEATURES

- Faster installation with combination of side wiring and Quickwire push-in wiring
- Quickwire accepts conductors up to #12 AWG; #14 AWG in Canada
- Side wire accepts conductors up to #12 AWG
- Large head triple-drive combination screws (Standard, Phillips, Robertson) for fast wiring installation
- Impact-resistant, durable thermoplastic toggle and frame

TESTING AND CODE COMPLIANCE

- UL Listed (File # E-7458)
- CSA Certified (File #LR-3413)
- NOM Certified (#057)
- Backed by a Limited Two-Year Warranty

\*COLOR

Basic Cat. Nos. shown above denote Brown color. Other colors available as listed, add suffix to catalog number as follows: Ivory (-I), White (-W), Almond (-A), light Almond (T), Black/Ebony (-E), Clear (-C), Grey (-GY)

HORSEPOWER

15A  
1/2 @120V

MATERIAL CHARACTERISTICS

Environmental: Flammability, Rated V2  
Operating Temperature: -40°C to 65°C.



# Straight Blade Receptacles

## INDEX

|   |           |
|---|-----------|
| Overview  | .G2       |
| <b>Hospital Grade</b>                             |           |
| Back and Side Wired with Wire Leads               | .G3       |
| Isolated Ground                                   | .G3       |
| Four-In-One                                       | .G5       |
| <b>Industrial Grade</b>                           |           |
| Back and Side Wired with Wire Leads               | .G4       |
| Side Wired  | .G4       |
| Isolated Ground                                   | .G4       |
| Dual Voltage                                      | .G4       |
| Clock Hanger                                      | .G4       |
| Four-In-One                                       | .G5       |
| <b>Power Devices</b>                              | .G6-G11   |
| <b>Commercial Grade</b>                           |           |
| Overview  | .G12      |
| Back and Side Wired                               | .G13, G15 |
| Dual Voltage                                      | .G13      |
| Side Wired  | .G14, G15 |
| Brass Floorbox Assembly                           | .G14      |
| QuickPort® Snap-In Jacks<br>with Brass Floorplate | .G15      |
| <b>Residential Grade</b>                          |           |
| Quickwire Push-In                                 | .G16      |
| Quickwire Push-In and Side Wired                  | .G16      |
| Side Wired  | .G16, G17 |
| CO/ALR  | .G16      |
| Clock Hanger                                      | .G17      |
| Snap-In Devices                                   | .G17      |

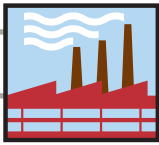

# STRAIGHT BLADE RECEPTACLE FEATURES

## Industrial Grade Straight Blade Receptacles

LEVITON'S INDUSTRIAL GRADE STRAIGHT BLADE RECEPTACLES ARE BUILT TO THE MOST DEMANDING STANDARDS FOR PERFORMANCE AND RELIABILITY. THEY'RE DESIGNED TO WITHSTAND THE HIGHEST ABUSE AND RESIST IMPACT, CRACKING AND HARSH CHEMICALS.



**Hospital Grade, Tamper Resistant**  
Approved for emergency circuits and pediatric/psychiatric care areas.  
8300-SGW shown



**Hospital Grade, Isolated Ground**  
Provides a pure ground path to a building's isolated ground system.  
8200-IG shown



**Industrial Grade Back & Side Wired**  
Features interlocking thermoplastic body and cover with one-piece brass strap.  
5262-W shown



**Four-In-One**  
Hardwire device converts a duplex receptacle installation into four receptacles without multiple installation labor and material costs.  
5490-BU shown

All Leviton Hospital Grade Receptacles undergo the most stringent UL testing to assure continuous, safe operation in any application requiring high-abuse tolerance, including health care facilities, manufacturing plants and schools.

### Features and Benefits

- UL 498 for Hospital Grade (UL File #E-13399); UL Federal Specification WC-596 Listing
- CSA Certified where applicable (CSA File #LR-406)
- NOM Certified
- Meets NEMA WD-1 and 6 and ANSI standards
- All industrial back and side wired receptacles have #10-32 triple combination head terminal screws; straight, Phillips and Robertson.
- Back and side wiring options accept #14-#10 AWG stranded or solid wire
- Power Indication™ circuit board integrates 100,000 hour LED and components in a compact fail-safe assembly
- Apron barrier to prevent accidental contact between terminal screw heads and metal box
- Exclusive V-shaped, serrated back-wiring clamps for superior contact and conductivity
- Backed by a Limited 10-Year Warranty
- Hospital Grade Receptacles also available with Decora® designer-styling (See Decora® Plus devices, Section B)

### POWER INDICATION™

Face and body locked together with exclusive four-corner latch construction, remains securely fastened

Power Indication™ meets UL498 Hospital Grade identification requirements and offers visual confirmation that the device is energized

Large, triple-wipe, nickel plated brass "T" contacts for superior contact and conductivity

Nickel-plated brass bushing for additional assembly security

Thick-walled impact-resistant thermoplastic nylon cover and body withstands abuse

Smooth face, easy to clean and soil resistant

Exclusive nickel-plated brass, staked on, self-grounding clip will never fall off

Nickel-plated brass, one piece mounting strap with integral ground contact, for superior ground path

Back and side-wire grounding terminal for quick ground installation

Exclusive V-shaped, serrated back-wiring clamps for superior contact and conductivity

Back and side-wiring options

Exclusive triple combination #10-32 nickel-plated brass terminal screws, straight slot, Phillips #2, Robertson #1, for excellent torque

Apron barrier to prevent accidental contact of terminal screw heads with metal box

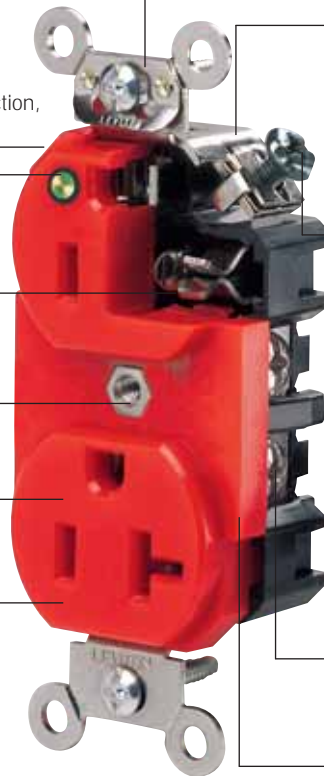

8300-PLR shown

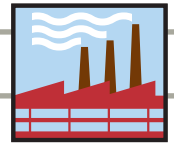

**Hospital Grade**

**Back and Side Wired/Wire Lead** (Basic Cat. No. Denotes Brown Device\*)

| DESCRIPTION                         | CAT. NO./COLOR<br>15A/125V               | CAT. NO./COLOR<br>15A/250V | CAT. NO./COLOR<br>20A/125V           | CAT. NO./COLOR<br>20A/250V |
|-------------------------------------|--|----------------------------|--------------------------------------|----------------------------|
|                                     | 5-15R                                    | 6-15R                      | 5-20R                                | 6-20R                      |
| Duplex Receptacle                   | <b>8200</b><br>I, W, GY, R               | <b>8600</b><br>I           | <b>8300</b><br>I, W, A, T, GY, R, E  | <b>8400</b><br>I           |
| Single Receptacle                   | <b>8210</b><br>I, W, R                   | —                          | <b>8310</b><br>I, W, GY, R           | —                          |
| Slim Design Receptacle              | <b>8200-H</b><br>I, W, GY, R             | —                          | <b>8300-H</b><br>I, W, GY, R         | —                          |
| Duplex Receptacle, Tamper-Resistant | <b>8200-SG</b><br>I, W, G, R             | —                          | <b>8300-SG</b><br>I, W, A, T, G, R   | —                          |
| Illuminated Duplex Receptacle       | <b>8200-HL</b><br>I, W, G, R, (No Brown) | —                          | <b>8300-HL</b><br>I, W, R (No Brown) | —                          |
| Power Indication™ Duplex Receptacle | <b>8200-PL</b><br>I, W, R, (No Brown)    | —                          | <b>8300-PL</b><br>I, W, R (No Brown) | —                          |
| Duplex Receptacle, w/6" Wire Leads  | <b>8200-L</b><br>I, W, GY, R             | —                          | <b>8300-L</b><br>I, W, A, GY, R, E   | —                          |

Note: Single, Slim Design, Illuminated, Power Indication and Tamper-Resistant Receptacles meet specifications for UL Hospital Grade listing but have a different construction and design from standard Hospital Grade Duplex Receptacles listed above. There are dimensional differences between 8200-SG and 8300-SG devices. 8200-SG contains a nickel-plated steel yoke with riveted ground contacts. 8300-SG contains a one-piece, nickel-plated brass yoke.

**Isolated Ground Receptacles** (Basic Cat. No. Denotes Orange Device\*)

| DESCRIPTION                        | CAT. NO./COLOR<br>15A/125V      | CAT. NO./COLOR<br>15A/250V | CAT. NO./COLOR<br>20A/125V      | CAT. NO./COLOR<br>20A/250V |
|------------------------------------|---------------------------------|----------------------------|---------------------------------|----------------------------|
| Duplex Receptacle                  | <b>8200-IG</b><br>B, I, W, G, R | —                          | <b>8300-IG</b><br>B, I, W, G, R | —                          |
| Duplex Receptacle w/6" Ground Lead | <b>8200-LIG</b><br>Orange Only  | —                          | <b>8300-LIG</b><br>Orange Only  | —                          |
| Single Receptacle w/6" Ground Lead | <b>8210-IG</b><br>Orange Only   | —                          | <b>8310-IG</b><br>Orange Only   | —                          |

**Wallplates**

| THERMOPLASTIC |          |         |          |         | 302 STAINLESS STEEL |          |          |
|---------------|----------|---------|----------|---------|---------------------|----------|----------|
|               |          |         |          |         |                     |          |          |
| 80703-IG      | 80704-IG | 80703-I | 80704-GY | 80716-R | 84003-40            | 84004-40 | 84016-40 |

For complete wallplate selection, see Section E.

See Page G4 for Leviton's full line of Four-In-One Receptacles.  
See Section R for Leviton's full line of Surge Protective Devices.

**SPECIFICATIONS AND FEATURES**

**Duplex Receptacles**

- Impact-resistant thermoplastic nylon cover and body
- Smooth face does not collect dirt
- Four corner latches securely fasten face
- Large, triple-wipe, brass "T" contacts for superior contact and conductivity
- High-performance brass #10-32 terminal screws to reduce conductor oxidation
- Back and side-wire ground termination brass strap version
- Back and side-wiring options
- Break-off tabs for easy two-circuit conversion
- Apron barrier to prevent accidental contact between terminal screw heads and metal box
- Exclusive V-shaped, serrated back-wiring clamps for superior contact
- Power Indication™ provides permanent "green dot" lens with 100,000 hour LED status indicator
- Wire lead receptacles for fast and easy installation

Note: Cat. Nos. 8200-HL and 8300-HL construction features differ from those listed above.

**TESTING AND CODE COMPLIANCE**

- UL Listed 498 for Hospital Grade (UL File #13399); UL Federal Specification WC-596
- CSA Certified (CSA File #152105)
- NOM Certified (#057)
- Meets NEMA WD-1 & 6, and ANSI standards
- Backed by a Limited 10-Year Warranty

**\*COLOR**

Basic Cat. Nos. shown above denote Brown for Hospital Grade and Orange for Isolated Ground (-IG) Devices. Isolated Ground Receptacle is distinguished by an orange triangle on its face. For other color selections, add suffix to the catalog number as follows: Ivory (-I), White (-W), Almond (-A), Brown (for IG devices only, add -B), Red (-R), Gray (-G or -GY) and Black (-E).

**MATERIAL CHARACTERISTICS**

Environmental: Flammability, Rated V2  
Operating Temperature: From -40° C (without impact) to 60°C maximum continuous

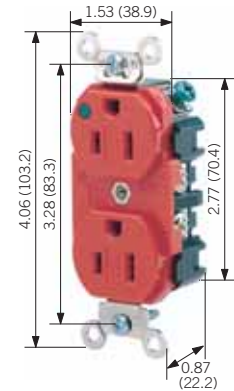

8200-PLR

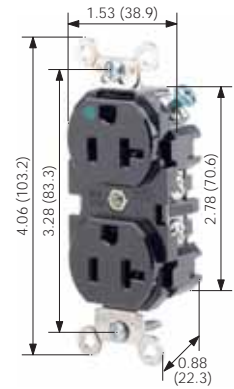

8300-E

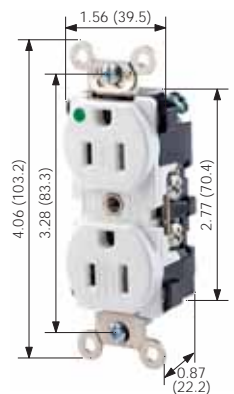

8200-SGW

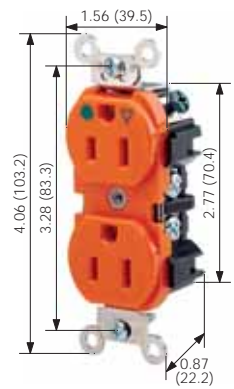

8200-IG

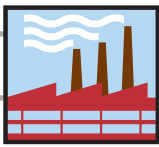

15 AMP 125 and 250V • 20 AMP 125 and 250V

## Industrial Grade Straight Blade Receptacles

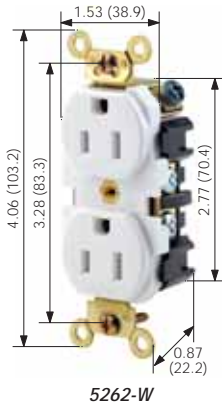

5262-W

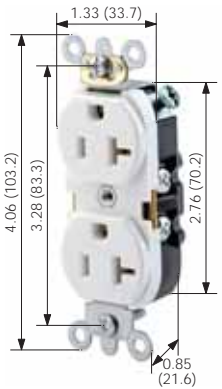

5362-SW

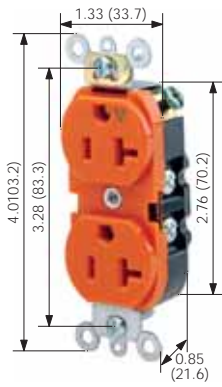

5362-IG

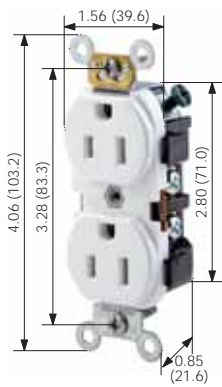

5242-W

### Back and Side Wired/Wire Lead (Basic Cat. No. Denotes Brown Device\*)

| DESCRIPTION  | CAT. NO./COLOR<br>15A/125V                | CAT. NO./COLOR<br>15A/250V | CAT. NO./COLOR<br>20A/125V                | CAT. NO./COLOR<br>20A/250V |
|--|---|----------------------------|---|----------------------------|
|  | 5-15R                                     | 6-15R                      | 5-20R                                     | 6-20R                      |
| LEVSPEC® Duplex Receptacle, Brass Strap                    | <b>5262</b><br>I, W, GY, R, E             | <b>5662</b><br>I           | <b>5362</b><br>I, W, GY, R, E             | <b>5462</b><br>I, GY       |
| Single Receptacle  | <b>5261</b><br>I, W, GY                   | <b>5661</b><br>I           | <b>5361</b><br>I, W, A, T, GY, E          | <b>5461</b><br>I, A, T, GY |
| Narrow Body Duplex Receptacle                              | <b>5252</b><br>I, W, A, T, GY, R, E, BU   | —                          | <b>5352</b><br>I, W, A, T, GY, R, E, BU   | —                          |
| Single Receptacle, Clockhanger                             | <b>5261-CH</b><br>Stainless Steel         | —                          | <b>5361-CH</b><br>Stainless Steel         | —                          |
| SPECCCLASS® General Duty Duplex Receptacle                 | <b>5262-S</b><br>I, W, A, T, GY, R, E, BU | —                          | <b>5362-S</b><br>I, W, A, T, GY, R, E, BU | —                          |
| SPECCCLASS® General Duty Duplex Receptacle w/6" Wire Leads | <b>5262-L</b><br>I, W, A, GY, R, E        | —                          | <b>5362-L</b><br>I, W, A, GY, R, E        | —                          |

Note: Single Receptacles meet Federal Specifications WC-596 but have a different construction and design than Duplex Receptacles listed above.

### Back and Side Wired — Isolated Ground Receptacles (-IG) (Basic Cat. No. Denotes Orange Device\*)

| DESCRIPTION                   | CAT. NO./COLOR<br>15A/125V           | CAT. NO./COLOR<br>15A/250V | CAT. NO./COLOR<br>20A/125V                 | CAT. NO./COLOR<br>20A/250V |
|-------------------------------|--------------------------------------|----------------------------|--|----------------------------|
| Slim Design Duplex Receptacle | <b>5262-IG</b><br>B, I, W, G, R, BIG | <b>5662-IG</b>             | <b>5362-IG</b><br>B, I, W, A, T, G, R, BIG | <b>5462-IG</b>             |

### Side Wired (Basic Cat. No. Denotes Brown Device\*)

| DESCRIPTION       | CAT. NO./COLOR<br>15A/125V | CAT. NO./COLOR<br>15A/250V | CAT. NO./COLOR<br>20A/125V | CAT. NO./COLOR<br>20A/250V |
|-------------------|----------------------------|----------------------------|----------------------------|----------------------------|
| Duplex Receptacle | <b>5242</b><br>I, W, GY, R | —                          | <b>5342</b><br>I, W, GY, R | —                          |
| Single Receptacle | <b>5251</b><br>I           | <b>5651</b><br>I, W        | <b>5351</b><br>I           | —                          |

### Back and Side Wired Dual Voltage (Basic Cat. No. Denotes Brown Device\*)

| DESCRIPTION       | RATING            | CAT. NO.    | COLOR |
|-------------------|-------------------|-------------|-------|
| Duplex Receptacle | 15A 125V/15A 250V | <b>5292</b> | I     |

### Wallplates

#### THERMOPLASTIC

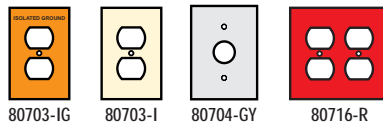

80703-IG 80703-I 80704-GY 80716-R

#### 302 STAINLESS STEEL

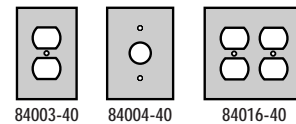

84003-40 84004-40 84016-40

For complete wallplate selection, see Section E.

#### SPECIFICATIONS AND FEATURES

##### Back & Side Wired Duplex

- Impact-resistant thermoplastic nylon cover and body
- Smooth face does not collect dirt
- Four corner latches securely fasten face
- Single-piece brass mounting strap on LEVSPEC devices, multi-piece steel strap on other devices
- Large, triple-wipe, brass "T" contacts for superior contact and conductivity
- Back and side-wiring options
- Brass terminal screws to reduce conductor oxidation
- Break-off tabs for easy two-circuit conversion
- Apron barrier to prevent accidental contact between terminal screw heads and metal box
- Exclusive V-shaped, serrated back-wiring clamps for superior contact and conductivity
- Wire lead receptacles for fast and easy installation

#### TESTING AND CODE COMPLIANCE

- UL Listed 498 (UL File #13399); UL Federal Specification WC-596

- CSA Certified where applicable (CSA File #LR-406)
- NOM Certified (#057)
- Meets NEMA WD-1 & 6, and ANSI standards
- Backed by a Limited 10-Year Warranty
- SPECCCLASS devices backed by a Limited 2-Year Warranty

#### \*COLOR

Basic Cat. Nos. shown above denote Brown device, except for Isolated Ground (-IG) devices Basic Cat. No. denotes Orange. Isolated Ground Receptacle is distinguished by an orange triangle on its face. For other color selections, add suffix to the catalog number as follows: Ivory (-I), White (-W), Brown (For IG devices only, add -B), Almond (-A), Light Almond (-T), Gray (-G or -GY), Black (-E), Red (-R) and Blue (-BU; for IG devices only, add -BIG)

#### MATERIAL CHARACTERISTICS

Environmental: Flammability, Rated V2  
Operating Temperature: From -40° C (without impact) to 60°C maximum continuous



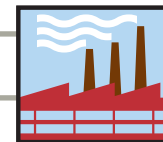



# Industrial Grade Straight Blade Receptacles

## Four-In-One 2-Pole 3-Wire Grounding

(Basic Cat. No. denotes Brown device, except Isolated Ground devices—Basic Cat. No. denotes Orange device)

| DESCRIPTION  | CAT. NO./COLOR*<br>15A-125V   | CAT. NO./COLOR*<br>20A-125V   |
|--|---|---|
|  | 5-15R  | 5-20R  |
| Industrial Grade                                       | <b>1254</b><br>I, W, GY, R, E   | <b>21254</b><br>I, W, GY, R, E, Y   |
| Hospital Grade   | <b>1254-H</b><br>I, W, R  | <b>21254-H</b><br>I, W, GY, R   |
| Hospital Grade, Isolated Ground                        | <b>1254-IG</b>  | <b>21254-IG</b><br>I, W   |
| Industrial Grade, Surge Protective                     | <b>5480</b><br>I, W, GY, R, BU (No Brown)   | <b>5490</b><br>I, W, GY, BU (No Brown)  |
| Industrial Grade, Surge Protective/<br>Isolated Ground | <b>5480-IG</b><br>Orange only   | <b>5490-IG</b><br>Orange, I, B  |
| Hospital Grade, Surge Protective/<br>Isolated Ground   | <b>8480-IG</b><br>I, W, B   | <b>8490-IG</b><br>I, B  |
| Hospital Grade, Surge Protective                       | <b>8480</b><br>I, W, R (No Brown)   | <b>8490</b><br>I, W, R (No Brown)   |

For surge protective performance data, see page R14.

## Four-In-One Adapter Plates

| CAT. NO.    | COLOR*                  |
|-------------|-------------------------|
| <b>3254</b> | I, W, GY, R, E, OR, BLU |

## Four-In-One Portable Boxes

| CAT. NO.    | COLOR*                     |
|-------------|----------------------------|
| <b>4254</b> | I, GY, E, OR, Y (No Brown) |

Portable boxes are not UL Listed. UL Listing does not apply when Four-in-One Receptacles are used with portable boxes for extension cord applications.

## Four-In-One Receptacle Wallbox Mounting

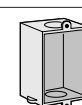
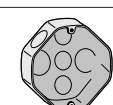
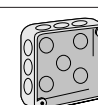
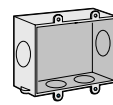
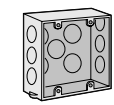
| MOUNTS DIRECTLY   |  |   | MOUNTS WITH ADAPTER PLATE   |  |
|---|--|---|---|--|
|  |  |  |  |  |
| Single-Gang   | 4" Octagonal   | 4" Square   | 2-Gang  | 4 1/16" Square   |

### SPECIFICATIONS AND FEATURES

- Terminal wiring screws fit inside a standard single-gang wallbox; adapter plate not required (optional)
- Heavy-impact nylon cover and base for strength and resistance to chemicals and corrosives
- Smooth face; easy to clean surface
- Easy-to-read voltage and amperage rating molded onto face
- Heavy-duty, T-type triple-wipe bronze contacts for maximum performance
- Ground holes configured up or down to be outside the device, accommodating up to 4 Fed Spec size straight or angle plugs
- No. 8 terminal screws accept up to No. 12 solid or stranded copper wire
- Termination anchor holes for easy conductor wiring
- Deep cut mill-slotted screws resist slippage
- Exclusive shield-wall design protects ground connection from contact with live circuit conductors
- "A" and "B" molded on face and back for easy identification of receptacle pairs for split-circuit conversion. (Note: Split circuit not available on surge models).
- Convenient built-in strip-gauge

### TESTING AND CODE COMPLIANCE

- UL Listed 498 for Hospital Grade (UL File #13399); UL Federal Specification WC-596; UL Listed Adapter Plates (File #E-13397)
- CSA Certified where applicable (CSA File #152105); CSA Certified Adapter Plates (File #LR-16347)
- NOM Certified (#057)
- Complies with NEMA WD-1 & 6, and ANSI standards
- Backed by a Limited 10-Year Warranty

### \*COLOR

Basic Cat. Nos. denote Brown device, except for Isolated Ground (-IG) devices-Basic Cat. No. denotes Orange. Isolated Ground receptacle distinguished by orange triangle on its face. For other color selections, add suffix to the catalog number as follows: Ivory (-I), White (-W), Red (-R), Gray (-G or -GY), Black (-E), Orange (For adapter plates and portable boxes only, -OR), Blue (-BU, -BLU, -B) and Yellow (-Y).

### MATERIAL CHARACTERISTICS

Environmental: Flammability, Rated V2  
Operating Temperature: From -40° C (without impact) to 60° C maximum continuous

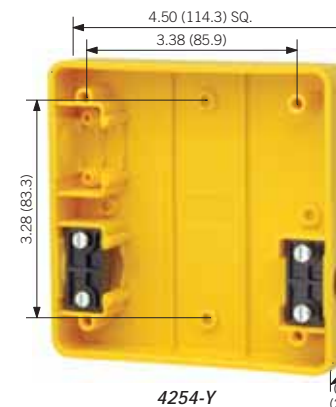
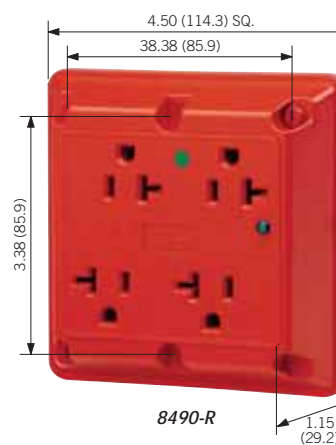
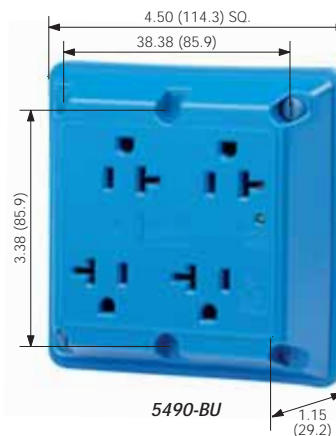

Straight Blade Receptacles

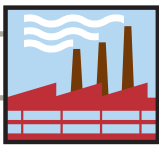

20 AMP 120/208V • 30 AMP 125V

## Industrial Grade Straight Blade Receptacles

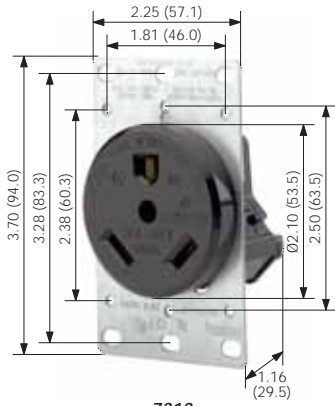

7313

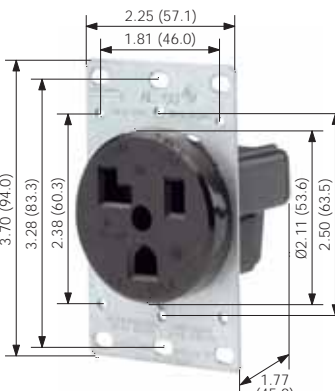

5371

### Power Devices

#### 20 AMP 120/208V 3ØY 4-Pole 4-Wire Non-Grounding

| DESCRIPTION            | CAT. NO. | WALLPLATE INFORMATION  |
|------------------------|----------|--|
| Flush Mount Receptacle | 7250-FR  | Fits any standard single gang receptacle plate with 1.41" diameter center hole. See Section E for more information |
|                        | 18-20R   |  |
| Matching Plug          | 7251-C   |  |
|                        | 18-20P   |  |

#### 30 AMP 125V 2-Pole 3-Wire Grounding

| DESCRIPTION                            | CAT. NO. | WALLPLATE INFORMATION   |
|--|----------|---|
| Flush Mount Receptacle                 | 5371     | Fits all wallplates with 2.15" diameter center hole. See Section E for more information |
|  | 5-30R    |   |
| Flush Mount Receptacle Isolated Ground | 5371-IG  | As above  |
| Matching Angle Plug                    | 9530-P   |   |
|  | 5-30P    |   |

#### 30 AMP 125V 2-Pole 3-Wire Grounding

| DESCRIPTION                                      | CAT. NO.                   |
|--|----------------------------|
| Flush Mount Receptacle for Recreational Vehicles | 7313                       |
|  | TT-30R                     |
| Matching Angle Plug                              | 830-T                      |
|  | TT-30P<br>ANSI STD. C73.13 |

### Wallplates

| THERMOPLASTIC      | 430 STAINLESS STEEL |             | ALUMINUM           | WEATHER-RESISTANT COVER |
|--------------------|---------------------|-------------|--------------------|-------------------------|
| 2.15" Dia. Opening | 2.15" Dia. Opening  |             | 2.15" Dia. Opening | IP64 Rated              |
|                    |                     |             |                    |                         |
| 80728-E            | 80726-I             | 84028 84026 | 84004              | 83028                   |
|                    |                     |             |                    |                         |
| WP2                |                     |             |                    |                         |

For complete wallplate selection, see Section E.

#### SPECIFICATIONS AND FEATURES

- Heavy-gauge, double-wipe copper alloy contacts
- Easy-to-wire terminals accept up to No. 4 AWG conductors
- Terminals marked for easy identification and fast wiring
- All mounting hardware included
- Flush-mount devices fit single or two-gang outlet boxes

#### TESTING AND CODE COMPLIANCE

- UL Listed for copper or aluminum conductors—except Cat. Nos. 7250, 7313, 830-T (File #E-13399); Angle Plugs (File #E-13393)

- UL Test 498
- CSA Certified for copper or aluminum conductors (File #152105); Receptacle for Recreational Vehicles (File #2781); CSA Test 42
- NOM Certified (#057)
- Meets NEMA and ANSI standards
- Backed by a Limited 10-Year Warranty

#### MATERIAL CHARACTERISTICS

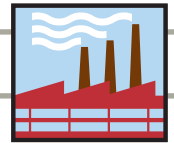

Environmental: Flammability, Rated V2  
Operating Temperature: From -40° C (without impact) to 60°C maximum continuous



## Industrial Grade Straight Blade Receptacles

### Power Devices

#### 30 AMP 250V 2-Pole 3-Wire Grounding

| DESCRIPTION                            | CAT. NO.  | WALLPLATE INFORMATION  |
|--|---|--|
| Flush Mount Receptacle                 | 5372  | Fits all wallplates with 2.15" diameter center hole. See Section E for more information. |
|  | 6-30R  |  |
| Flush Mount Receptacle Isolated Ground | 5372-IG   | As above   |
| Surface Mount Receptacle               | 5376  |  |
| Matching Angle Plug                    | 9630-P  |  |
|  | 6-30P  |  |

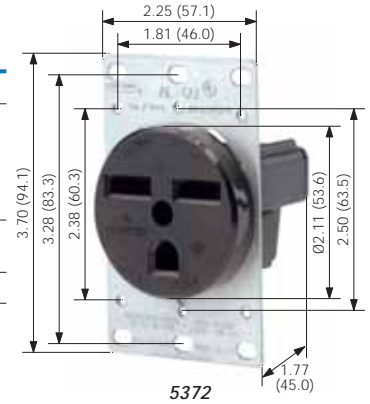



#### 30 AMP 277V 2-Pole 3-Wire Grounding

| DESCRIPTION            | CAT. NO.  | WALLPLATE INFORMATION  |
|------------------------|---|--|
| Flush Mount Receptacle | 9730-A  | Fits all wallplates with 2.15" diameter center hole. See Section E for more information. |
|                        | 7-30R  |  |



#### 30 AMP 125/250V 3-Pole 3-Wire Non-Grounding

| DESCRIPTION              | CAT. NO.   | WALLPLATE INFORMATION  |
|--------------------------|--|--|
| Flush Mount Receptacle   | 5207   | Fits all wallplates with 2.15" diameter center hole. See Section E for more information. |
|                          | 10-30R   |  |
| Surface Mount Receptacle | 5054   |  |
| Matching Angle Plug      | 9332-P   |  |
|                          | 10-30P  |  |

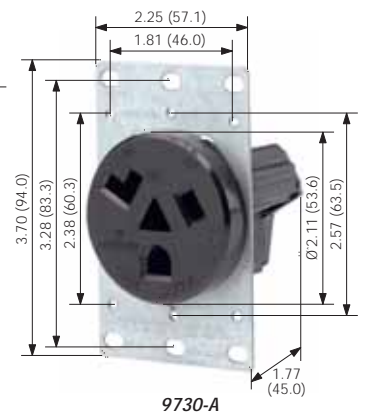

### Wallplates

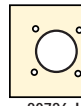
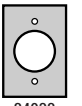
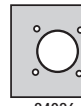
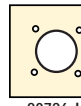
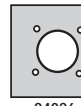
| THERMOPLASTIC   | 430 STAINLESS STEEL   | ALUMINUM  | WEATHER-RESISTANT COVER   |
|---|---|---|---|
| 2.15" Dia. Opening  | 2.15" Dia. Opening  | 2.15" Dia. Opening  | IP64 Rated  |
|  80728-E |  80726-I |  84028 |  84026 |
|   |   |  83028 |  WP2  |

For complete wallplate selection, see Section E.

#### SPECIFICATIONS AND FEATURES

- Made of durable thermoplastic
- Heavy-gauge, double-wipe copper alloy contacts
- Easy-to-wire terminals accept up to No. 4 AWG conductors
- Terminals marked for easy identification and fast wiring
- All mounting hardware included
- Flush-mount devices fit single or two-gang outlet boxes
- Surface-mount devices are COMMERCIAL GRADE and have concentric knockouts for 3/4" and 1" conduit and adjustable cord clamp for back and bottom entrance of cable

#### TESTING AND CODE COMPLIANCE

- UL Listed for copper or aluminum conductors (File #E-13399); Angle Plugs (File #E-13393, File #E-3810)
- UL Test 498
- CSA Certified for copper or aluminum conductors (File #152105); CSA Test 42
- NOM Certified (#057)
- Meets NEMA and ANSI standards
- Backed by a Limited 10-Year Warranty

#### MATERIAL CHARACTERISTICS

Environmental: Flammability, Rated V2  
Operating Temperature: From -40° C (without impact) to 75° C maximum continuous



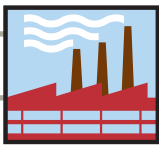

# 30 AMP 125/250V • 30 AMP 250V 3Ø • 30 AMP 120/208V 3ØY

## Industrial Grade Straight Blade Receptacles

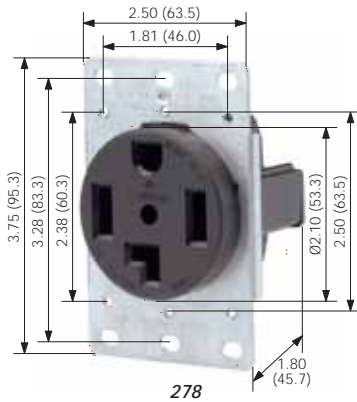

278



55054

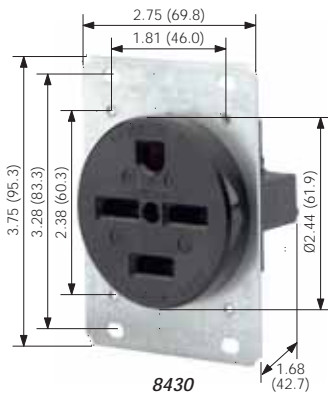

8430

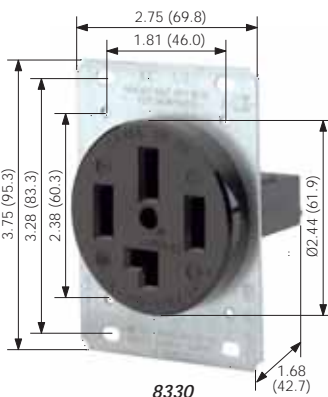

8330

### Power Devices

#### 30 AMP 125/250V 3-Pole 4-Wire Grounding

| DESCRIPTION               | CAT. NO. | WALLPLATE INFORMATION  |
|---------------------------|----------|--|
| Flush Mount Receptacle    | 278      | Fits all wallplates with 2.15" diameter center hole, (shown on page G9). See Section E for more information. |
|                           | 14-30R   |  |
| Panel Mount Receptacle    | 278-PM   | Same dimensions as Cat. No. 279-PM (except for NEMA config.) shown on page G10.                              |
| Surface Mount Receptacles | 55054    |  |
| Matching Angle Plug       | 9432-P   |  |
|                           | 14-30R   |  |

#### 30 AMP 250V 3Ø 3-Pole 4-Wire Grounding

| DESCRIPTION            | CAT. NO. | WALLPLATE INFORMATION   |
|------------------------|----------|---|
| Flush Mount Receptacle | 8430     | Fits 2-gang wallplates w/2.465" diameter center hole. See Section E for more information. |
|                        | 15-30R   |   |
| Matching Angle Plug    | 8432-P   |   |
|                        | 15-30P   |   |

#### 30 AMP 120/208V 3ØY 4-Pole 4-Wire Non-Grounding

| DESCRIPTION            | CAT. NO. | WALLPLATE INFORMATION   |
|------------------------|----------|---|
| Flush Mount Receptacle | 8330     | Fits 2-gang wallplates w/2.465" diameter center hole. See Section E for more information. |
|                        | 18-30R   |   |
| Matching Angle Plug    | 8332-P   |   |
|                        | 18-30R   |   |

### Wallplates

| 302 STAINLESS STEEL<br>2.465" Dia. Opening | 430 STAINLESS STEEL<br>2.465" Dia. Opening | STEEL-ALUMINUM FINISH<br>2.465" Dia. Opening |
|--|--|--|
|  |  |  |
| S701-40                                    | S701                                       | S701-GY                                      |

For Cat. No. 278, see recommended wallplates (with 2.15" Dia. Opening) on page G9  
For complete wallplate selection, see Section E.

#### SPECIFICATIONS AND FEATURES

- Made of durable thermoplastic
- Heavy-gauge, double-wipe copper alloy contacts
- Easy-to-wire terminals accept up to No. 4 AWG conductors
- Terminal marked for easy identification and fast wiring
- All mounting hardware included
- Flush-mount devices fit single or two-gang outlet boxes
- Surface mount devices are COMMERCIAL GRADE and have concentric knockouts for 3/4" and 1" conduit and adjustable cord clamp and back and bottom entrance of cable

#### TESTING AND CODE COMPLIANCE

- UL Listed for copper or aluminum conductors (File #E-13399); Angle Plugs (File #E-13393, File #E-3810)
- UL Test 498
- CSA Certified for copper or aluminum conductors (File #152105); CSA Test 42
- NOM Certified (#057)
- Meets NEMA and ANSI standards
- Backed by a Limited 10-Year Warranty

#### MATERIAL CHARACTERISTICS

Environmental: Flammability, Rated V2  
Operating Temperature: From -40° C (without impact) to 75° C maximum continuous

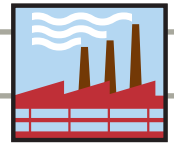

# Industrial Grade Straight Blade Receptacles

## Power Devices

### 50 AMP 125V 2-Pole 3-Wire Grounding

| DESCRIPTION            | CAT. NO. | WALLPLATE INFORMATION  |
|------------------------|----------|--|
| Flush Mount Receptacle | 5373     | Fits all wallplates with 2.15" diameter center hole. See Section E for more information. |
|                        | 5-50R    |  |
| Matching Angle Plug    | 9550-P   |  |
|                        | 5-50P    |  |

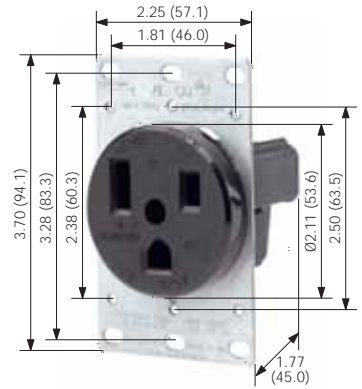

5373

### 50 AMP 250V 2-Pole 3-Wire Grounding

| DESCRIPTION                            | CAT. NO. | WALLPLATE INFORMATION  |
|--|----------|--|
| Flush Mount Receptacle                 | 5374     | Fits all wallplates with 2.15" diameter center hole. See Section E for more information. |
|  | 6-50R    |  |
| Flush Mount Receptacle Isolated Ground | 5374-IG  | As above   |
| Surface Mount Receptacle               | 5378     |  |
| Matching Angle Plug                    | 9650-P   |  |
|  | 6-50P    |  |



5378

### 50 AMP 277V 2-Pole 3-Wire Grounding

| DESCRIPTION            | CAT. NO. | WALLPLATE INFORMATION  |
|------------------------|----------|--|
| Flush Mount Receptacle | 9750-A   | Fits all wallplates with 2.15" diameter center hole. See Section E for more information. |
|                        | 7-50R    |  |
| Matching Angle Plug    | 9750-P   |  |
|                        | 7-50P    |  |

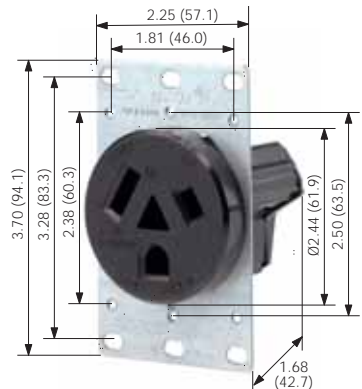

9750-A

## Wallplates

| THERMOPLASTIC      | 430 STAINLESS STEEL | ALUMINUM           | WEATHER-RESISTANT COVER |
|--------------------|---------------------|--------------------|-------------------------|
| 2.15" Dia. Opening | 2.15" Dia. Opening  | 2.15" Dia. Opening | IP64 Rated              |
| 80728-E            | 84028               | 83028              | WP2                     |
| 80726-I            | 84026               |                    |                         |

For complete wallplate selection, see Section E.

#### SPECIFICATIONS AND FEATURES

- Made of durable thermoplastic
- Heavy-gauge, double-wipe copper alloy contacts
- Easy-to-wire terminals accept up to No. 4 AWG conductors
- Terminal marked for easy identification and fast wiring
- All mounting hardware included
- Flush-mount devices fit single or two-gang outlet boxes
- Surface-mount devices are COMMERCIAL GRADE and have concentric knockouts for 3/4" and 1" conduit and adjustable cord clamp and back and bottom entrance of cable

#### TESTING AND CODE COMPLIANCE

- UL Listed for copper or aluminum conductors (File #E-13399); Angle Plugs (File #E-13393, File #E-3810)
- UL Test 498
- CSA Certified for copper or aluminum conductors (File #152105); CSA Test 42
- NOM Certified (#057)
- Meets NEMA and ANSI standards
- Backed by a Limited 10-Year Warranty

#### MATERIAL CHARACTERISTICS

Environmental: Flammability, Rated V2  
 Operating Temperature: From -40° C (without impact) to 75° C maximum continuous

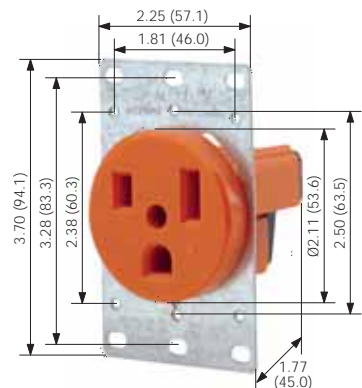

5374-IG

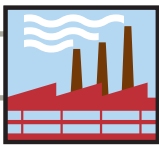

# 50 AMP 125/250 and 250V 3Ø

## Industrial Grade Straight Blade Receptacles

Straight Blade Receptacles

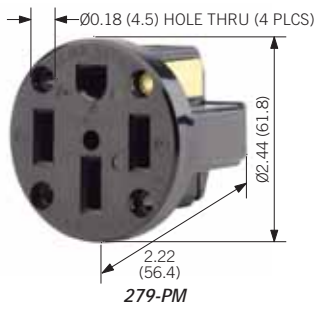

279-PM

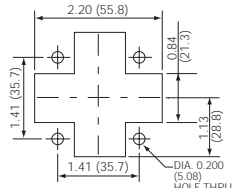

279-PM Recommended Panel Cutout

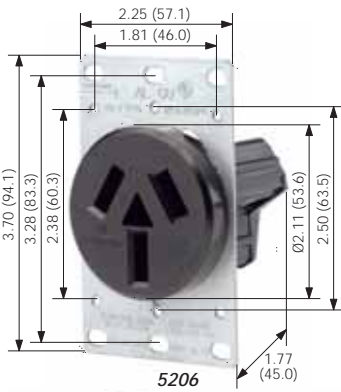

5206



55050

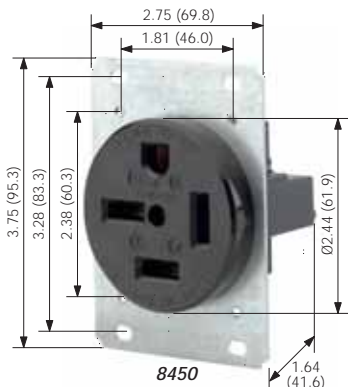

8450

### Power Devices

#### 50 AMP 125/250V 3-Pole 3-Wire Non-Grounding

| DESCRIPTION              | CAT. NO.         | WALLPLATE INFORMATION  |
|--------------------------|------------------|--|
| Flush Mount Receptacle   | 5206<br>10-50R   | Fits all wallplates with 2.15" diameter center hole. See Section E for more information. |
| Surface Mount Receptacle | 5050             |  |
| Matching Angle Plug      | 9450-P<br>10-50P |  |

#### 50 AMP 125/250V 3-Pole 4-Wire Grounding

| DESCRIPTION              | CAT. NO.         | WALLPLATE INFORMATION   |
|--------------------------|------------------|---|
| Flush Mount Receptacle   | 279<br>14-50R    | Same dimensions as Cat. No. 278 (except for NEMA config.) shown on page G8. Fits all wallplates with .215" diameter hole. See Section E for more information. |
| Panel Mount Receptacle   | 279-PM           | Same dimensions (except for NEMA config.) and recommended panel cutout as Cat. No. 278-PM listed on page G8.  |
| Surface Mount Receptacle | 55050            |   |
| Matching Angle Plug      | 9452-P<br>14-50P |   |

#### 50 AMP 250V 3Ø 3-Pole 4-Wire Grounding

| DESCRIPTION                            | CAT. NO.         | WALLPLATE INFORMATION   |
|--|------------------|---|
| Flush Mount Receptacle                 | 8450<br>15-50R   | Fits wallplates with 2.465" diameter center hole. See Section E for more information. |
| Flush Mount Receptacle Isolated Ground | 8450-IG          | As above  |
| Matching Angle Plug                    | 8452-P<br>15-50P |   |

### Wallplates

| 430 STAINLESS STEEL                        | 302 STAINLESS STEEL                     | WEATHER-RESISTANT COVER |
|--|---|-------------------------|
| 2.15" Dia. Opening—For use with 279 & 5206 | 2.465" Dia. Opening—For use with 8450-A | IP64 Rated              |
| 84028                                      | S701-40                                 | WP2                     |

For complete wallplate selection, see Section E.

#### SPECIFICATIONS AND FEATURES

- Made of durable thermoplastic
- Heavy-gauge, double-wipe copper alloy contacts
- Easy-to-wire terminals accept up to No. 4 AWG conductors
- Terminal marked for easy identification and fast wiring
- All mounting hardware included
- Flush-mount devices fit single or two-gang outlet boxes
- Surface-mount devices are COMMERCIAL GRADE and have concentric knockouts for 3/4" and 1" conduit and adjustable cord clamp and back and bottom entrance of cable

#### TESTING AND CODE COMPLIANCE

- UL Listed for copper or aluminum conductors (File #E-13399); Angle Plugs (File #E-13393, File #E-3810)
- UL Test 498
- CSA Certified for copper or aluminum conductors (File #152105); CSA Test 42
- NOM Certified (#057)
- Meets NEMA and ANSI standards
- Backed by a Limited 10-Year Warranty

#### MATERIAL CHARACTERISTICS

Environmental: Flammability, Rated V2  
 Operating Temperature: From -40° C (without impact) to 75°C maximum continuous

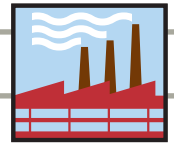

## Industrial Grade Straight Blade Receptacles

### Power Devices

#### 50 AMP 120/208V 3ØY 4-Pole 4-Wire Non-Grounding

| DESCRIPTION            | CAT. NO.                | WALLPLATE INFORMATION                             |
|------------------------|-------------------------|---|
| Flush Mount Receptacle | <b>8350</b><br>18-50R   | Fits wallplates with 2.465" diameter center hole. |
| Matching Angle Plug    | <b>8352-P</b><br>18-50P |   |

#### 60 AMP 125/250V 3-Pole 4-Wire Grounding

| DESCRIPTION                            | CAT. NO.                | WALLPLATE INFORMATION                      |
|--|-------------------------|--|
| Flush Mount Receptacle                 | <b>9460</b><br>14-60R   | Fits wallplates with 2.465" diameter hole. |
| Flush Mount Receptacle Isolated Ground | <b>9460-IG</b>          | As above                                   |
| Matching Angle Plug                    | <b>9462-P</b><br>14-60P |  |



#### 60 AMP 250V 3Ø 3-Pole 4-Wire Grounding

| DESCRIPTION            | CAT. NO.                | WALLPLATE INFORMATION                      |
|------------------------|-------------------------|--|
| Flush Mount Receptacle | <b>8460</b><br>15-60R   | Fits wallplates with 2.465" diameter hole. |
| Matching Angle Plug    | <b>8462-P</b><br>15-60P |  |

#### 60 AMP 120/208V 3ØY 4-Pole 4-Wire Non-Grounding

| DESCRIPTION            | CAT. NO.                | WALLPLATE INFORMATION                      |
|------------------------|-------------------------|--|
| Flush Mount Receptacle | <b>8360</b><br>18-60R   | Fits wallplates with 2.465" diameter hole. |
| Matching Angle Plug    | <b>8362-P</b><br>18-60P |  |

### Wallplates

| 302 STAINLESS STEEL  | 430 STAINLESS STEEL   | STEEL-ALUMINUM FINISH   |
|--|---|---|
| 2.465" Dia. Opening  | 2.465" Dia. Opening   | 2.465" Dia. Opening   |
| <br>S701-40 | <br>S701 | <br>S701-GY |

For complete wallplate selection, see Section E.

#### SPECIFICATIONS AND FEATURES

- Made of durable thermoplastic
- Heavy-gauge, double-wipe copper alloy contacts
- Easy-to-wire terminals accept up to No. 4 AWG conductors
- Terminal marked for easy identification and fast wiring
- All mounting hardware included
- Flush-mount devices fit single or two-gang outlet boxes

#### TESTING AND CODE COMPLIANCE

- UL Listed for copper or aluminum conductors (File #E-13399); Angle Plugs (File #E-13393, File #E-3810)
- UL Test 498
- CSA Certified for copper or aluminum conductors (File #152105); CSA Test 42
- NOM Certified (#057)
- Meets NEMA and ANSI standards
- Backed by a Limited 10-Year Warranty

#### MATERIAL CHARACTERISTICS

Environmental: Flammability, Rated V2  
Operating Temperature: From -40° C (without impact) to 75°C maximum continuous

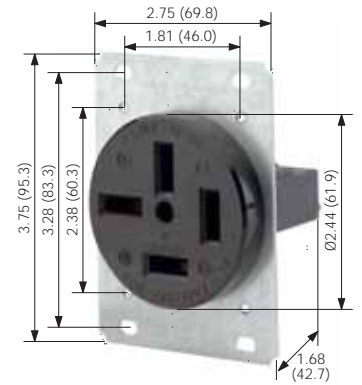

8350

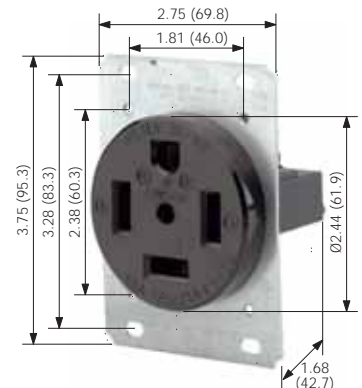

9460

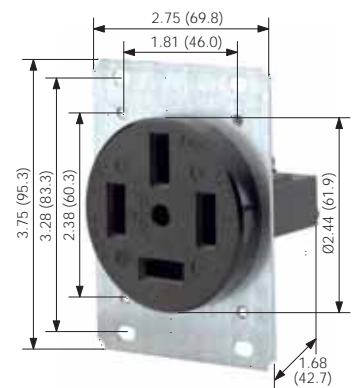

8360

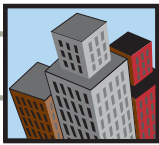

# STRAIGHT BLADE RECEPTACLE FEATURES

## Commercial Grade Straight Blade Receptacles

LEVITON OFFERS A LARGE SELECTION OF 15 AND 20 AMP COMMERCIAL GRADE RECEPTACLES, AVAILABLE IN A WIDE VARIETY OF COLORS, WIRING OPTIONS AND OTHER FEATURES.



**Back & Side Wired**  
Constructed of high impact resistant thermoplastic, power contacts are triple wipe for good conductivity.  
*BR15-W shown*



**Side Wired**  
Available with back and side-wired options, it can operate at either 125 or 250V volts.  
*CR15-W shown*



**Dual Voltage**  
Smooth face, self-grounding clip, easily accessible break-off tabs for split-circuit wiring.  
*5844 shown*



**Brass Floor Box Assembly**  
Complete with brass plate, receptacle, brass screw-in cap and O-ring.  
*5249-FBA shown*

*Leviton's Commercial Receptacles are manufactured to withstand the demands of commercial and institutional applications. These commercial receptacles provide long-lasting service life and are a cost-saving alternative to the industrial devices.*

### Features and Benefits

- Cost-efficient alternative to industrial receptacles
- Manufactured to withstand the demands of commercial and institutional applications
- Power contacts available in triple and double wipe for maximum conductivity and plug retention
- Shallow design for maximum wiring room in box
- UL Listed 498 (UL File #E-13399)
- CSA Certified where applicable (CSA File #LR-406)
- NOM Certified (#057)
- Meets NEMA WD-1 & 6, and ANSI standards
- Backed by a Limited 10-Year Warranty
- All commercial side-wired receptacles have #8-32 triple combination head terminal screws
- All commercial back and side-wired receptacles have #10-32 triple combination head terminal screws

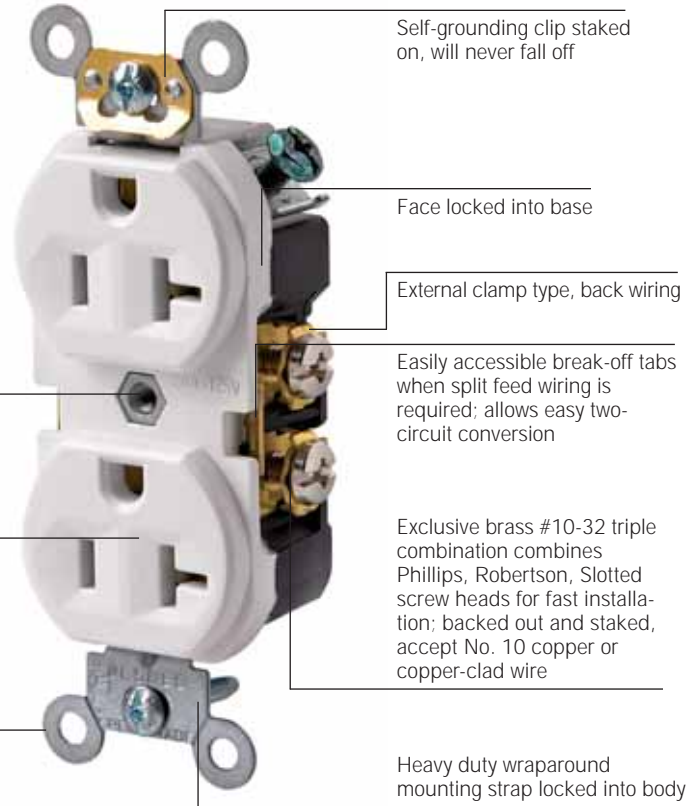

Self-grounding clip staked on, will never fall off

Face locked into base

External clamp type, back wiring

Easily accessible break-off tabs when split feed wiring is required; allows easy two-circuit conversion

Exclusive brass #10-32 triple combination combines Phillips, Robertson, Slotted screw heads for fast installation; backed out and staked, accept No. 10 copper or copper-clad wire

Heavy duty wraparound mounting strap locked into body

Zinc die-cast bushing for additional assembly security

Base and face made of high impact thermoplastic

Convenient washer-type break-off plaster ears for best flush alignment

*BR20 shown*

Back-wiring clamps accept up to No. 10 solid or stranded copper wire

Exclusive V-shaped, serrated back-wiring clamps for superior contact and conductivity





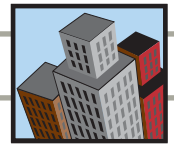

# 15 AMP 125 and 250V • 20 AMP 125 and 250V Commercial Grade Straight Blade Receptacles





## Back and Side Wired 15 AMP 125V & 250V 20 AMP 125V & 250V Grounding

(Basic Cat. No. Denotes Brown Device\*)



| DESCRIPTION       | CAT. NO./COLOR<br>15A/125V  | CAT. NO./COLOR<br>15A/250V  | CAT. NO./COLOR<br>20A/125V  | CAT. NO./COLOR<br>20A/250V  |
|-------------------|---|---|---|---|
|                   | 5-15R  | 6-15R  | 5-20R  | 6-20R  |
| Duplex Receptacle | BR15<br>I, W, GY, E, A, T   |   | BR20<br>I, W, GY, E, A, T   | 5824<br>I   |
| Single Receptacle | 5088<br>I, A  | 5089<br>I (No Brown)  | 5891<br>W   | 5823<br>I   |

## Dual Voltage Back and Side Wired 20 AMP 125V & 20 AMP 250V Grounding



(Basic Cat. No. Denotes Brown Device\*)

| DESCRIPTION                        | CAT. NO.<br>20A/125V  | CAT. NO.<br>20A/250V  | COLOR*<br>Basic Cat. No. Denotes Brown |
|------------------------------------|---|---|--|
|                                    | 5-20R  | 6-20R  |  |
| Duplex Receptacle,<br>Dual Voltage | 5844  | 5844  | I                                      |







## Dual Voltage Side Wired 15 AMP 125V & 15 AMP 250V Grounding

| DESCRIPTION                                      | CAT. NO.<br>15A/125V  | CAT. NO.<br>15A/250V  | COLOR*<br>Basic Cat. No. Denotes Brown |
|--|---|---|--|
|  | 5-15R  | 6-15R  |  |
| Duplex, Grounding,<br>Dual Voltage (Triple Wipe) | 5031  | 5031  | I, W                                   |

## Dual Voltage Side Wired 20 AMP 125V & 20 AMP 250V Grounding

| DESCRIPTION                                      | CAT. NO.<br>20A/125V  | CAT. NO.<br>20A/250V  | COLOR*<br>Basic Cat. No. Denotes Brown |
|--|---|---|--|
|  | 5-20R  | 6-20R  |  |
| Duplex Receptacle,<br>Dual Voltage (Triple Wipe) | 5842  | 5842  | I                                      |

## Wallplates

| THERMOPLASTIC   |   |   | 302 STAINLESS STEEL   |   |   |
|---|---|---|---|---|---|
|  |  |  |  |  |  |
| 80703-I   | 80704-W   | 80716-I   | 84003-40  | 84004-40  | 84016-40  |

For complete wallplate selection, see Section E.

### SPECIFICATIONS AND FEATURES

- Large-head, triple-drive terminal screws, backed out and staked, accept No. 10 copper or copper-clad wire
- Back-wiring clamps accept up to No. 10 copper or copper-clad wire
- All power contacts are triple wipe for maximum conductivity and plug retention
- Heavy-gauge, rust-resistant steel mounting strap
- Shallow design for maximum wiring room in box
- Convenient washer-type break-off plaster ears for best flush alignment
- Captive mounting screws for fast installation
- Break-off tabs on duplex receptacles for easy two-circuit conversion

### TESTING AND CODE COMPLIANCE

- UL Listed 498
- CSA Certified where applicable (File #LR-406)
- NOM Certified (#057)
- Meets or exceeds NEMA WD-1, & 6, and ANSI standards
- Backed by a Limited 10-Year Warranty

### \*COLOR

Basic Cat. Nos. shown above denote Brown color. For other color selections, add the suffix to catalog number as follows: Ivory (-I), White (-W), Black (-E), Almond (-A), Light Almond (-T), Gray (-GY).

### MATERIAL CHARACTERISTICS

Environmental: Flammability, Rated V2  
Operating Temperature: From -40° C (without impact) to 60° C maximum continuous

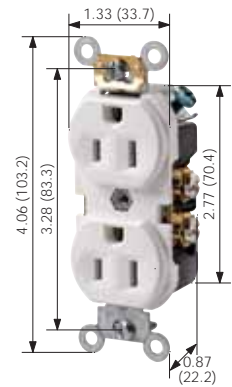

BR15-W

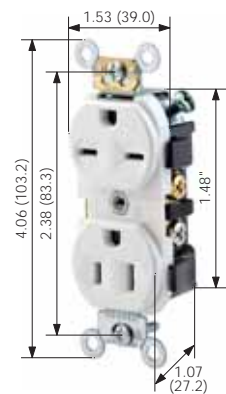

5031-W

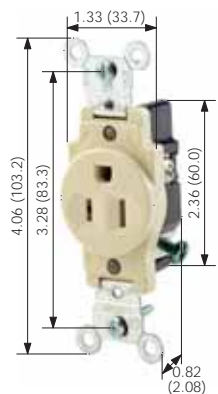

5088-I

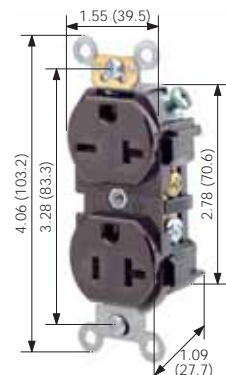

5844



# 15 AMP 125 and 250V • 20 AMP 125 and 250V

## Commercial Grade Straight Blade Receptacles

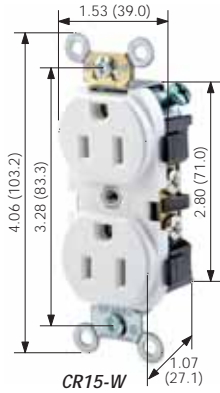

CR15-W

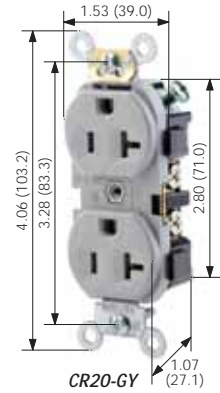

CR20-GY



CR15S-GI

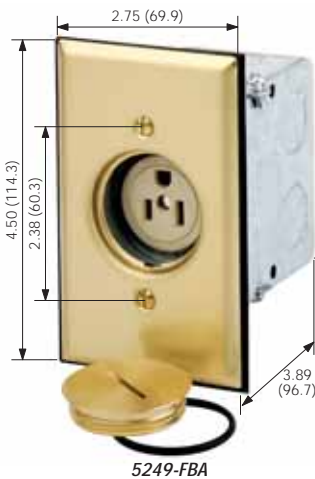

5249-FBA

### Side Wired 15 AMP 125 and 250V 20 AMP 125 and 250V

(Basic Cat. No. Denotes Brown Device\*)

| DESCRIPTION   | CAT. NO./COLOR<br>15A/125V    | CAT. NO./COLOR<br>15A/250V | CAT. NO./COLOR<br>20A/125V | CAT. NO./COLOR<br>20A/250V |
|---|-------------------------------|----------------------------|----------------------------|----------------------------|
|   | 5-15R                         | 6-15R                      | 5-20R                      | 6-20R                      |
| Duplex Receptacle   | CR15<br>I, W, A, T, GY, E     | 5028*<br>I                 | CR20<br>I, W, A, T, GY, E  | 5822*<br>I, W              |
| Duplex Receptacle,<br>Smooth Face   | CR15<br>I, W, GY              | —                          | CR20<br>I, W, GY           | —                          |
| Duplex Receptacle,<br>on 4" Cover★  | 5042<br>Zinc plated steel     | —                          | —                          | —                          |
| Single Receptacle   | 5015<br>I, W, A, T            | 5029<br>I                  | 5801<br>I, W, A, T         | 5821<br>I, W, A, T         |
| Single Receptacle<br>on 4" Cover  | 5059<br>Zinc plated steel     | —                          | —                          | —                          |
| Duplex Receptacle<br>with Pigtail Leads★  | 5040<br>I, W (No Brown)       | —                          | 5340<br>I, W, GY, A        | —                          |
| Single Receptacle,<br>Short Strap, 8-32<br>Tapped Mounting<br>Holes on 1 3/4" Centers | 5258-SS<br>E Only             | 5658-SS<br>E Only          | —                          | 5458-SS<br>E Only          |
| Tamper Resistant<br>Duplex Receptacle   | CR15S-G<br>I, W, T (No Brown) | —                          | —                          | —                          |
| Single Display Receptacle<br>w/Solid Brass Plate.                                     | 5250<br>Brass                 | —                          | —                          | —                          |
| Single Brass Floorbox<br>Assembly.  | 5249-FBA<br>Brass             | —                          | 5349-FBA<br>Brass          | —                          |
| Duplex Brass Floorbox<br>Assembly   | 25249-FBA<br>Brass            | —                          | 25349-FBA<br>Brass         | —                          |
| Duplex Nickel-Plated<br>Floorbox Assembly   | 25249-SBA                     | —                          | —                          | —                          |

Floorbox Replacement Screw Cap with O-Ring—Single, Brass—5249-CAP; Duplex, Brass—25249-CAP

CSA Certified except where indicated by ★

### Wallplates

| THERMOPLASTIC |         |         | 302 STAINLESS STEEL |          |          |
|---------------|---------|---------|---------------------|----------|----------|
|               |         |         |                     |          |          |
| 80703-I       | 80704-W | 80716-I | 84003-40            | 84004-40 | 84016-40 |

For complete wallplate selection, see Section E.

### SPECIFICATIONS AND FEATURES

#### Side Wired Duplex Receptacles

- Large-head terminal screws, backed out and staked, accept No. 10 copper or copper-clad wire
- All power contacts are triple wipe for maximum conductivity and plug retention — except CR series
- Heavy-gauge, rust-resistant steel mounting strap
- Shallow design for maximum wiring room in box
- Convenient washer-type break-off plaster ears for best flush alignment
- Captive mounting screws for fast installation where applicable

#### Brass Floorbox Assembly

- Complies with NEC 370-27(b)
- All-in-one, ready-to-wire unit provides quick, easy installation
- Plate gasket and O-ring combine to seal out moisture and contaminants
- Thick brass plate and screw cap resist abuse and prevent contaminant from entering device
- Durable nylon receptacle face and body resist breakage
- Brass screw cap threaded to fit flush to plate
- Green grounding screw

### TESTING AND CODE COMPLIANCE

- UL Listed 498 (File #E-13399)
- CSA Certified where applicable (File #LR-406)
- NOM Certified (#057)
- Meets or exceeds NEMA WD-1, and -6, and ANSI standards
- Backed by a Limited 10-Year Warranty

#### \*COLOR

Basic Cat. Nos. shown above denote Brown color device. For other color selections, add suffix to the catalog number as follows: Ivory (-I), White (-W), Almond (-A), Light Almond (-T), Gray (-GY) and Black (-E).

### MATERIAL CHARACTERISTICS

Environmental: Flammability, Rated V2  
Operating Temperature: From -40° C (without impact) to 60°C maximum continuous

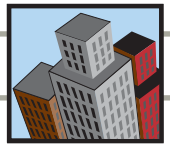

Commercial Grade QuickPort® Jacks w/Brass Floorplate • Straight Blade Receptacles

QuickPort® Snap-In Jacks and Modules with Brass Floorplate

| DESCRIPTION  | CAT. NO.  | COLOR* |
|--|-----------|--------|
| Floor Jack Housing with Brass Plate and 6-Conductor Jack                             | 41650-6   | Brass  |
| Floor Jack Housing with Brass Plate and Coaxial F-Connector                          | 41650-F   | Brass  |
| Duplex Floor Jack Housing with Brass Plate and Two 6-Conductor Jacks                 | 41652-6   | Brass  |
| Duplex Floor Jack Housing with Brass Plate, 6-Conductor Jack and Coaxial F-Connector | 41652-6F  | Brass  |
| Duplex Floor Jack Housing only; 1 Blank Filler Provided                              | 41652-000 | Brass  |

Back and Side Wired 15 AMP 277V AC Grounding

| DESCRIPTION                     | CAT. NO. | COLOR*     |
|---------------------------------|----------|------------|
| Duplex Receptacle (Double Wipe) | 5585     | Brown Only |



Side Wired 20 AMP 125/250V Non-Grounding

| DESCRIPTION  | CAT. NO. | COLOR* |
|--|----------|--------|
| Single Receptacle (Double Wipe)<br>(9151-N matching plug on page M4) | 5032     | I      |



**SPECIFICATIONS AND FEATURES**

- Receptacles**
- Terminal screws, backed out and staked, accept No. 10 copper or copper-clad wire
  - Power contacts are double wipe for maximum conductivity and plug retention
  - Heavy gauge, rust-resistant steel mounting strap
  - Shallow design for maximum wiring room in box
  - Convenient washer-type break-off plaster ears for best flush alignment
  - Captive mounting screws for fast installation

**TESTING AND CODE COMPLIANCE**

- UL Listed 498
- CSA Certified where applicable (File #LR-406)
- NOM Certified (#057)
- Meets or exceeds NEMA WD-1 and -6, and ANSI standards
- Backed by a Limited 10-Year Warranty

**\*COLOR**

Basic Cat. Nos. shown above denote Brown color. For other color selections, add the suffix to catalog number as follows: Ivory (-I).

**MATERIAL CHARACTERISTICS**

Environmental: Flammability, Rated V2  
 Operating Temperature: From -40° C (without impact) to 60° C maximum continuous

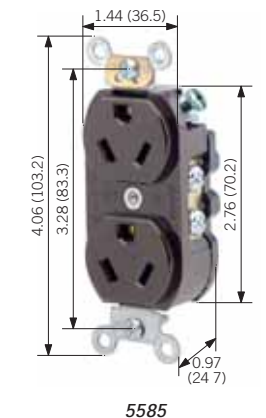
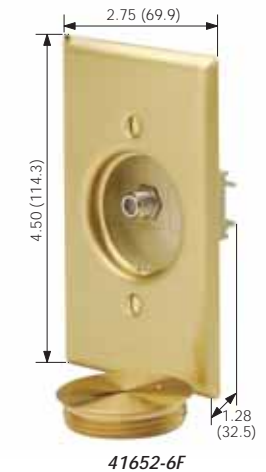

Straight Blade Receptacles



# 15 AMP 125V • 15 AMP 125V CO/ALR

## Residential Grade Straight Blade Receptacles

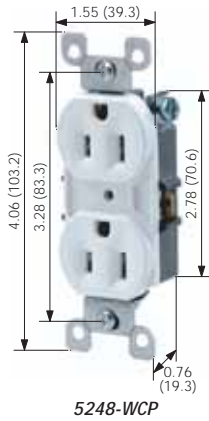

5248-WCP

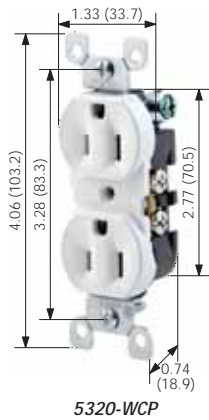

5320-WCP

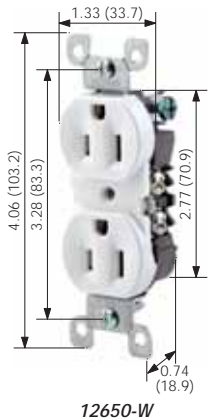

12650-W

### 8-Hole Quickwire Push-In 15 AMP 125V Grounding

| DESCRIPTION                                     | CAT. NO.  | COLOR*<br><small>Basic Cat. No. Denotes Brown</small> |
|---|---|---|
| Duplex Receptacle,<br>CONTRACTOR PACK (10 BULK) | 5248-CP   | I, W  |
|   | 5-15R  |   |
| Duplex Receptacle, Less Plaster Ears (200 BULK) | 5248-4  | I, W  |

### Quickwire Push-In and Side Wired 15 AMP 125V Grounding

| DESCRIPTION  | CAT. NO.  | COLOR*<br><small>Basic Cat. No. Denotes Brown</small> |
|--|---|---|
| Duplex Receptacle, All Screws Backed Out,<br>CONTRACTOR PACK (10 BULK) | 5320-CP   | I, W, A, T  |
|  | 5-15R  |   |
| Duplex Receptacle, Self-Grounding                                      | 5320-S  | I, W, A, T  |
| Duplex Receptacle, Less Plaster Ears★,<br>All Screws Backed Out        | 5320-4  | I, W  |

### Side Wired 15 AMP 125V Grounding

| DESCRIPTION                    | CAT. NO.  | COLOR*<br><small>Basic Cat. No. Denotes Brown</small> |
|--------------------------------|---|---|
| Duplex Receptacle, on 4" Cover | 1228  | Brown Only  |
|                                | 5-15R  |   |

CONTRACTOR PACK is a box of 10 bulk-packed devices (no individual packaging) for speedy on-the-job installation.







### Side Wired CO/ALR 15 AMP 125V Grounding

| DESCRIPTION  | CAT. NO.  | COLOR*<br><small>No Brown</small> |
|--|---|-----------------------------------|
| Duplex Receptacle,<br>UL Listed for direct connection to No. 12 or<br>No. 10 aluminum conductors | 12650   | I, W                              |
|  | 5-15R  |                                   |



CSA Certified except where indicated by ★

### Wallplates

| THERMOSET   |   | THERMOPLASTIC   |  | 302 STAINLESS STEEL   |   |
|---|---|---|--|---|---|
|  |  |  |  |  |  |
| 85003   | 86016   | 80703-I   | 80716-I  | 84003-40  | 84016-40  |

For complete wallplate selection, see Section E.

#### SPECIFICATIONS AND FEATURES

- Terminal screws accept up to No. 12 copper or copper-clad wire
- Quickwire push-in terminals accept No. 14 solid copper wire only
- Double-wipe power contacts for maximum conductivity and plug retention
- Thermoplastic construction
- Heavy-gauge, rust-resistant steel mounting strap
- Shallow design for maximum wiring room
- Break-off plaster ears for best flush alignment
- Captive mounting screws
- Break-off tabs allow easy two-circuit conversion

#### TESTING AND CODE COMPLIANCE

- UL Listed 498
- CSA Certified where applicable (File #LR-406)
- NOM Certified (#057)
- Meets or exceeds NEMA standards
- Backed by a Limited Two Year Warranty
- CO/ALR UL Listed 1561

#### \*COLOR

Basic Cat. Nos. shown above denote Brown color. For other color selections, add the suffix to catalog number as follows: Ivory (-I), White (-W), Almond (-A), Light Almond (-T).

#### MATERIAL CHARACTERISTICS

Environmental: Flammability, Rated V2  
Operating Temperature: From -40° C (without impact) to 60° C maximum continuous



# Residential Grade Straight Blade Receptacles

## Side Wired 15 AMP/125V Non-Grounding

| DESCRIPTION   | CAT. NO. | COLOR*<br><small>Basic Cat. No. Denotes Brown</small> |
|---|----------|---|
| Duplex Receptacle, ★ Plaster Ears                                   | 223      | I, W  |
|   | 1-15R    |   |
| Duplex Receptacle ★ T-SLOT, Not UL Listed; for replacement use only | 5000     | I<br><small>(No Brown)</small>                        |

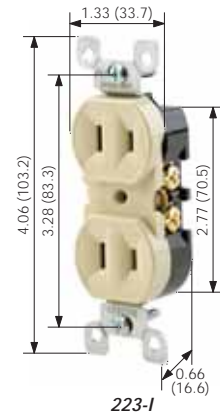

## Snap-In Devices 15 AMP/125V

| DESCRIPTION   | CAT. NO. | PANEL THICKNESS (inches) | PANEL OPENING (inches) | COLOR*<br><small>No Brown</small> |
|---|----------|--------------------------|------------------------|-----------------------------------|
| 2-Wire Polarized Outlet.<br>Leads No. 14 AWG, 105°C Plastic, 6" Long, Stripped 1/2"                                   | 1306     | .028 -.060               | .97 x .52              | E, W                              |
|   | 1-15R    |                          |                        |                                   |
| 2-Wire Polarized Outlet.<br>Back Strap Mounting,<br>Leads No. 14 AWG, 105°C Plastic, 6" Long, Stripped 1/2"           | 306      | .015 -.093               | .97 x .52              | E, W                              |
|   | 1-15R    |                          |                        |                                   |
| 3-Wire Grounding Outlet.<br>Leads No. 14 AWG, 105°C Plastic, 6" Long, Stripped 1/2".<br>Grounding Wire No. 16 AWG     | 1374     | .031 -.080*              | .95 x .95              | E, W                              |
|   | 5-15R    |                          |                        |                                   |
| 3-Wire Grounding Power Plug.<br>Leads No. 14 AWG, 105°C Plastic, 6" Long, Stripped 1/2".<br>Grounding Wire No. 16 AWG | 1373     | .031 -.080               | .95 x .95              | E                                 |
|   | 5-15P    |                          |                        |                                   |

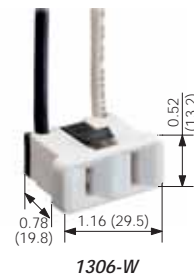

\*Other panel thicknesses available.

## Side Wired Clock Hanger 15 AMP/125V Grounding

| DESCRIPTION                    | CAT. NO. | COLOR*<br><small>No Brown</small> |
|--------------------------------|----------|-----------------------------------|
| Flush Mount with Square Recess | 688      | I, W                              |
|                                | 5-15R    |                                   |

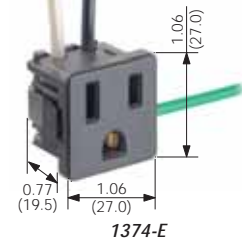

CSA Certified except where indicated by ★

### SPECIFICATIONS AND FEATURES

#### 223-I & 5000

- Terminal screws accept up to No. 12 copper or copper-clad wire for side wiring
- Double-wipe power contacts for maximum conductivity and plug retention
- Heavy-gauge, rust-resistant steel mounting strap
- Shallow design for maximum wiring room
- Break-off plaster ears for best flush alignment
- Captive mounting screws
- Break-off tabs allow easy two-circuit conversion

#### Snap-In Devices

- All 1306 product come with dual exiting capabilities
- Snap-in devices with other mounting clips and terminations available upon request

### TESTING AND CODE COMPLIANCE

- UL Listed 498
- CSA Certified where applicable (File #LR-406)
- NOM Certified (#057)
- Meets or exceeds NEMA standards
- Backed by a Limited Two-Year Warranty

### \*COLOR

Basic Cat. Nos. shown above denote Brown color. For other color selections, add the suffix to catalog number as follows: Ivory (-I), White (-W), Black (-E).

### MATERIAL CHARACTERISTICS

Environmental: Flammability, Rated V2  
Operating Temperature: From -40° C (without impact) to 60°C maximum continuous

#### Snap-In Devices

Environmental: Flammability, Rated V2  
Operating Temperature: From -40° C (without impact) to 65°C maximum continuous



Straight Blade Receptacles

# HOW TO USE THIS CATALOG

The L-101 Leviton Wiring Device Catalog is designed to help you find the device you're seeking in the quickest and easiest way possible. Most product sections are divided into three distinct categories in the following sequence—Industrial Grade, Commercial Grade and Residential Grade—and grouped according to amperage and voltage, lowest to highest. For example, if you need to order 15 Amp, 125 Volt Industrial Grade straight-blade duplex receptacles, begin your search with the main Table of Contents at the front of the book. Here you'll see that all straight blade receptacles are listed in Section G. Turn to Section G for a more detailed Table of Contents on the first page. Each section page contains product descriptions, ratings and catalog numbers. There are also helpful highlights including Specifications and Features, Testing and Code Compliance, Color listing, Material Characteristics and dimensioned color product photos. Any product page in the L-101 Catalog can be clearly copied or faxed to customers and prospects for use as a specifier sheet or as part of a presentation.

The Quick Reference Guide follows the main Table of Contents to help you pinpoint and locate specific products. Technical Section V provides general product and test data, industry standards, NEMA configuration charts, a glossary of wiring device terms, ANSI architectural symbols and other related information. Specific catalog numbers are listed in the exhaustive index at the back of the catalog.

## 15 AMP 125 and 250V ~ 20 AMP 125 and 250V

### Industrial Grade Straight Blade Receptacles

**Back and Side Wired** (Basic Cat. No. Denotes Brown Device\*)

| DESCRIPTION                             | CAT. NO./COLOR<br>15A/125V       | CAT. NO./COLOR<br>15A/250V | CAT. NO./COLOR<br>20A/125V | CAT. NO./COLOR<br>20A/250V |
|---|----------------------------------|----------------------------|----------------------------|----------------------------|
| LEVSPEC® Duplex Receptacle, Brass Strap | 5262<br>I, W, GY, R, E           | 5662<br>I                  | 5362<br>I, W, GY, R, E     | 5462<br>I, GY              |
| Single Receptacle                       | 5261<br>I, W, GY                 | 5661<br>I                  | 5361<br>I, W, A, T, GY     | 5461<br>I, A, T, GY        |
| Narrow Body Duplex Receptacle           | 5252<br>I, W, A, T, GY, R,<br>BU |                            | 5352<br>I, W, A, T, GY, R, |                            |

80703-IG 80703-I 80704-GY 80716-R

84003-40 84004-40 84016-40

*For complete wallplate selection, see Section E.*

**SPECIFICATIONS AND FEATURES**

**Back & Side Wired Duplex**

- Impact-resistant thermoplastic nylon cover and body
- Smooth face does not collect dirt
- Four corner latches securely fasten face
- Single-piece brass mounting strap on LEVSPEC devices, multi-piece steel strap on other devices
- Large, triple-wipe, brass "T" contacts for superior contact and conductivity
- Back and side-wiring options
- Brass terminal screws to reduce conductor oxidation
- Break-off tabs for easy two-circuit conversion
- Apron barrier to prevent accidental contact between terminal screw heads and metal box
- Exclusive V-shaped, serrated back-wiring clamp for superior contact and conductivity

**TESTING AND CODE COMPLIANCE**

- UL Listed 498 (UL File #13399); UL Federal Specification WC-596

**COLOR**

Basic Cat. Nos. shown above denote Brown device, except for Isolated Ground (-IG) devices Basic Cat. No. denotes Orange. Isolated Ground Receptacle is distinguished by an orange triangle on its face. For other color selections, add suffix to the catalog number as follows: Ivory (-I), White (-W), Brown (For IG devices only, add -B), Almond (-A), Light Almond (-T), Gray (-G or -GY), Black (-E), Red (-R) and Blue (-BU); for IG devices only, add -BIG)

**MATERIAL CHARACTERISTICS**

Environmental: Flammability, Rated V2  
Operating Temperature: From -40° C (without impact) to 60°C maximum continuous

|  |   |  |
|--|---|--|
| <p><b>A</b> RATING</p> <p><b>B</b> Choose GRADE, if appropriate</p> <p><b>C</b> DIMENSIONED PHOTOGRAPH</p> <p><b>D</b> WIRING/CERTIFICATIONS</p> | <p><b>E</b> CATALOG NUMBER</p> <p><b>F</b> DESCRIPTION</p> <p><b>G</b> Check for NEMA CONFIGURATION</p> <p><b>H</b> WALLPLATE REFERENCE, if appropriate</p> | <p><b>I</b> SPECIFICATIONS &amp; FEATURES</p> <p><b>J</b> TESTING AND CODE COMPLIANCE</p> <p><b>K</b> COLOR LISTING</p> <p><b>L</b> MATERIAL CHARACTERISTICS</p> |
|--|---|--|

G  
18

# GFCI Personnel Protection Devices

## INDEX

|   |       |
|---|-------|
| <b>GFCI Personnel Protection Devices</b>                    |       |
| SmartLockPro® GFCI Devices                                  | H2-H4 |
| Overview  | H2-H3 |
| Hospital Grade Receptacles                                  | H4    |
| Commercial Grade Receptacles                                | H4    |
| Switch-Rated Blank Face                                     | H4    |
| Combination Switch/GFCI Outlet                              | H4    |
| High-Current  | H5    |
| Right-Angle GFCI Plug                                       | H5    |
| Shallow Wallbox Extender for GFCI                           | H5    |
| GFCI Cordsets and Extension Cords                           | H6    |
| GFCI Accessories  | H7    |
| Flush Cover Wallplates                                      | H7    |
| Raintight While-In-Use Covers                               | H7    |
| Temporary Portable Power Distribution Center/GFCI (The Box) | H7    |
| Power Cords for The Box                                     | H7    |





# SMARTLOCKPRO® GFCI PERSONNEL PROTECTION DEVICE FEATURES

## Commercial Grade GFCI Personnel Protection Devices

LEVITON IS THE LEADING DESIGNER AND MANUFACTURER OF GROUND FAULT CIRCUIT INTERRUPTERS (GFCIs) IN THE ELECTRICAL INDUSTRY. FOR MORE THAN A QUARTER OF A CENTURY, LEVITON HAS DEVELOPED — AND CONTINUES TO DEVELOP — GFCI RECEPTACLES AND OTHER PRODUCTS TO HELP REDUCE THE HAZARD OF SERIOUS ELECTRICAL SHOCK.

The National Electric Code requires GFCI protection in specific locations within residential, commercial and industrial installations. New and revised GFCI applications appear with each new edition of the code. Leviton offers the largest and most diverse line of high quality, reliable devices to meet the demand for ground fault protection. Following is a complete listing of Leviton's GFCI product line.



### SmartLockPRO® GFCI with Professional Grade Lockout Action

Meets or exceeds Underwriters Laboratories (UL) 2006 UL943 GFCI Safety Standards

- Patented professional grade lockout action as end-of-life indication
- Prevents power from being connected to face and feed-through terminals when miswired (Line-load reversal)
- Improved immunity to electrical noise to reduce false tripping
- Advanced electronics provide superior surge immunity
- Trip threshold meets or exceeds UL requirements for tripping time

### THE SMARTLOCKPRO® PROTECTION ADVANTAGE

While other GFCI manufacturers may have taken the alternate route in the 2006 UL Standard by providing an indicator light for end-of-life indication, allowing reset and continued use of a GFCI with unprotected power to the GFCI face and downstream receptacles, the SmartLockPRO's reset button will not engage if protection has been compromised. The SmartLockPRO's unique patented professional grade end-of-life lock-out action, reduces the possibility of end-users incorrectly assuming that a reset GFCI outlet is providing ground fault protection when it actually is not

### Ideal for a Wide Range of GFCI Applications

- Residential – Kitchens, bathrooms, garages, basements and other wet locations
- Outdoors – Outdoor receptacles by pools, cabanas, patios, decks and lanais
- Hospital and Healthcare Facilities – Scrub rooms, lavatories kitchenettes and other potentially wet locations
- Airports – Bathrooms, general use areas and maintenance areas
- Educational Facilities – Classrooms, restrooms, laboratories, dormitories and kitchens
- Restaurants, Lodging and Retail Malls – Bathrooms, general use areas and maintenance areas
- Commercial offices – Bathrooms, basement areas, hallways and kitchens
- Public Areas – Near wet and damp locations



Professional Grade Protection

#### SPECIFICATIONS AND FEATURES

- Meets or exceeds UL 2006 Requirements
  - TEST and RESET functions work together so that a tripped GFCI cannot be reset if GFCI circuit no longer provides ground fault protection
  - RESET button is blocked if GFCI protection has been compromised, providing a true "dead-face" design that ensures no power at GFCI receptacle face or downstream-fed receptacles
  - Line-load diagnostic feature prevents GFCI from being reset and stops power from being fed to the GFCI receptacle face or through to downstream devices. This alerts installer to a line-load reversal. Indicator light will be ON to indicate line/load reversal.
  - The SmartLockPRO GFCI with lockout action is designed and patented by Leviton
  - Trip threshold meets or exceeds UL requirements for tripping time
  - Impact-resistant thermoplastic cover and body
  - Silver-alloy contacts
  - Compatible with all Decora devices: available in selected Decora colors
- Combination Switch/SmartLockPRO® GFCI Outlet**
- Ideal for kitchens, bathrooms, modular kitchen units, bathroom cabinet fixtures, lamp cabinet fixtures and applications where combination devices are used.

#### TESTING AND CODE COMPLIANCE

- UL Standard 943 Class A (GFCI) and 498 (Receptacles)
- UL Listed (File # 48380)
- CSA (#LR-57811)
- NOM Certified (#057)
- Backed by a Limited Two-Year Warranty

#### COLOR

Basic Cat. Nos. denote Brown color unless indicated. For other color selections, add suffix to catalog number as follows: Ivory (-I), White (-W), Almond (-A), Light Almond (-T), Gray (-G or GY), Red (-R), Black (-E).

#### MATERIAL CHARACTERISTICS

Flammability: Rated V2

Operating Temperature: -30°F (-35°C) to 151°F (66°C)







**UL Standard 943 Class A (GFCI) & 498 (Receptacles)**  
**CSA Certified (File #057)**  
**Meets July 28, 2006 UL Requirements**



Thick-walled, impact-resistant thermoplastic nylon cover and body withstands abuse

"Surge hardened" electronics offer superior resistance to surges and overvoltages.

Silver alloy contacts for reliable make/break switching.

Triple drive combination terminal screws.



Eight back-wire holes (two per terminal) and back-wire ground.

Provisions for back- or side-wiring.

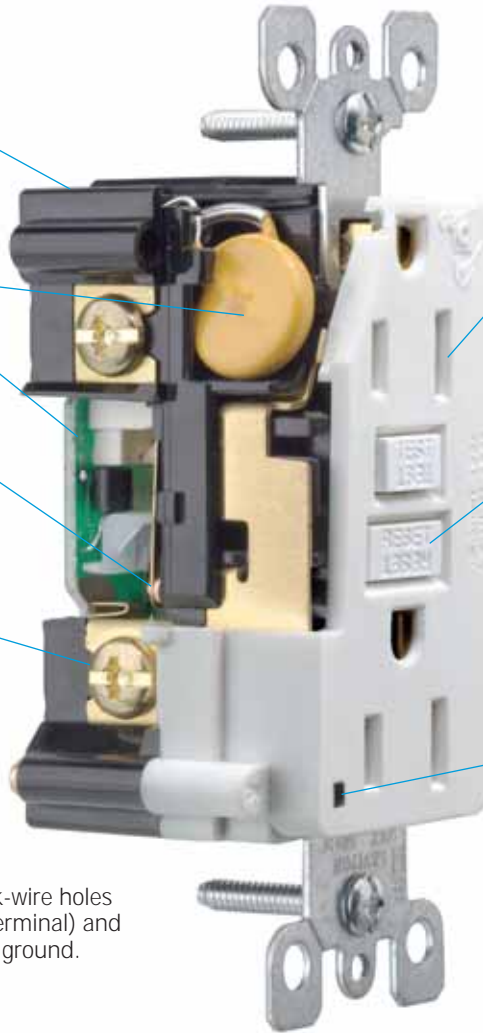

7599-W

Heavy duty double wipe for 15 Amp contacts and triple wipe for 20 Amp contacts

Patented lockout feature prevents "RESET" if GFCI is not functioning properly or miswired due to reversal of line and load leads.

Dual function LED offers indication of line/load reversal & power availability.



Leviton SmartLockPRO® icon ensures improved GFCI product design.



Lockout action blocks the "RESET" button if GFCI protection has been compromised.



Dual function LED offers indication of line/load reversal & power availability.



# 15 AMP 125V • 20 AMP 125V

## Commercial Grade GFCI Personnel Protection Devices



7599-HGI

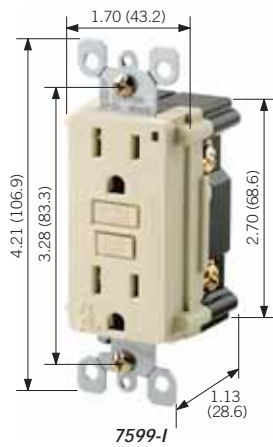

7599-I

### Hospital Grade SmartLock<sup>PRO</sup>® GFCI Receptacles — Back and Side Wired

#### 15 AMP 125V at Receptacle, 20 AMP Feed-Through

| DESCRIPTION  | CAT. NO. | COLOR*<br><small>Basic Cat. No. Denotes Brown</small> | NEMA CONFIG. |
|--|----------|---|--------------|
| Duplex with LED Indicator Light, buttons match face color  | 7599-HG  | I, W, A, G, R, T                                      |              |
| Duplex with LED Indicator Light, buttons match face color. DIN-Rail mounting with terminal wiring block. UL Recognized Component | 7599-DIN | Black Only  |              |

#### 20 AMP 125V at Receptacle and Feed-Through

| DESCRIPTION   | CAT. NO. | COLOR*<br><small>Basic Cat. No. Denotes Brown</small> | NEMA CONFIG. |
|---|----------|---|--------------|
| Duplex with LED Indicator Light, buttons match face color | 7899-HG  | I, W, A, G, R, T                                      |              |

### Commercial Grade SmartLock<sup>PRO</sup>® GFCI Receptacles — Back & Side Wired

#### 15 AMP 125V at Receptacle, 20 AMP Feed-Through

| DESCRIPTION  | CAT. NO. | COLOR*<br><small>Basic Cat. No. Denotes Brown</small> | NEMA CONFIG. |
|--|----------|---|--------------|
| Duplex, with Indicator Light, buttons match face color               | 7599     | I, W, A, T, GY, E, R                                  |              |
| Duplex, with LED Indicator Light, Black & Red buttons. With 6" leads | 7599-L   | I, W (No Brown)                                       |              |

#### 20 AMP 125V at Receptacle and Feed-Through

| DESCRIPTION   | CAT. NO. | COLOR*<br><small>Basic Cat. No. Denotes Brown</small> | NEMA CONFIG. |
|---|----------|---|--------------|
| Duplex, with Indicator Light, buttons match face color              | 7899     | I, W, A, T, GY, E, R                                  |              |
| Duplex with LED Indicator Light, Black & Red buttons. With 6" leads | 7899-L   | I, W  |              |

### Combination Switch/ SmartLock<sup>PRO</sup>® GFCI Outlet — Side Wired

#### 15 AMP @ 125V AC Switch Rating, 15 AMP 125V at Receptacle, 20 AMP Feed-Through

| DESCRIPTION  | CAT. NO. | COLOR*<br><small>No Brown</small> | NEMA CONFIG. |
|--|----------|-----------------------------------|--------------|
| Single-Pole Switch and SmartLock GFCI-Protected Outlet, buttons match face color | 7299     | I, W, A                           |              |

### Switch-Rated SmartLock<sup>PRO</sup>® GFCI — Back and Side Wired

#### 20 AMP 125V Feed-Through

| DESCRIPTION  | CAT. NO. | COLOR*<br><small>No Brown</small> |
|--|----------|-----------------------------------|
| Blank Face, No Indicator Light, buttons match face color | 8590     | I, W, A, T, E                     |

#### GFCI Wallbox Extender

| DESCRIPTION                       | CAT. NO. | COLOR*<br><small>Basic Cat. No. Denotes Brown</small> |
|-----------------------------------|----------|---|
| Shallow Wallbox extender for GFCI | 6197     | I, W  |

#### TESTING AND CODE COMPLIANCE

- UL Standard 943 Class A (GFCI) and 498 (Receptacles)
- UL Listed (File # 48380)
- CSA (#LR-57811)
- NOM Certified (#057)
- Backed by a Limited Two-Year Warranty

#### \*COLOR

Basic Cat. Nos. listed on page denote Brown color unless indicated. For other color selections, add suffix to catalog number as follows: Ivory (-I), White (-W), Almond (-A), Light Almond (-T), Gray (-G or GY), Red (-R), Black (-E).

#### MATERIAL CHARACTERISTICS

Flammability: Rated V2  
Operating Temperature: -30°F (-35°C) to 151°F (66°C)

#### Wallplates

| THERMOSET |          | POLYCARBONATE SCREWLESS SNAP-ON |          | POLISHED BRASS |          | 302 STAINLESS STEEL |          |
|-----------|----------|---------------------------------|----------|----------------|----------|---------------------|----------|
|           |          |                                 |          |                |          |                     |          |
| 80401-NT  | 80409-NT | 80301-SW                        | 80309-SW | 81401-PB       | 81409-PB | 84401-40            | 84409-40 |

For complete Decora wallplate selection, see pages B20–B24.



**High Current SmartLock® GFCI — Back and Side Wired**

| DESCRIPTION   | CAT. NO.    | COLOR*              |
|---|-------------|---------------------|
| High Current GFCI Contact rating at GFCI: 20A 125V, load capability with 125V control relay: 80A @ 240V max.<br><i>Note: The 8895 is wired in conjunction with a switching contactor or relay supplied by the customer. Each 8895 and contactor combination MUST be reviewed and approved by UL. Consult Leviton, Little Neck, for a list of combinations approved to date.</i> | <b>8895</b> | No Brown<br>I, W, E |

**Right Angle GFCI Plug**

| DESCRIPTION                     | CAT. NO.      | COLOR | NEMA CONFIG. |
|---------------------------------|---------------|-------|--------------|
| Rated 15A-125V, Automatic Reset | <b>16592†</b> | Black | 1-15P        |
| Rated 15A-125V, Automatic Reset | <b>16593†</b> | Black | 5-15P        |
| Rated 20A-125V, Automatic Reset | <b>16893†</b> | Black | 5-20P        |

† Wiring module accepts No. 18 (.300") thru No. 12 (.432") cord sizes

**Waterproof Cover for Right Angle GFCI Plugs**

| DESCRIPTION  | CAT. NO.     | COLOR | NEMA CONFIG. |
|--|--------------|-------|--------------|
| Waterproof Cover for Right Angle GFCI Plugs with ground pin up orientation | <b>86593</b> | Clear |              |

**Heavy Duty Right Angle GFCI Plug**

| DESCRIPTION                     | CAT. NO.      | COLOR  | NEMA CONFIG. |
|---------------------------------|---------------|--------|--------------|
| Rated 15A-125V, Automatic Reset | <b>6593††</b> | Black  | 5-15P        |
| Rated 15A-125V, Manual Reset    | <b>6594††</b> | Yellow | 5-15P        |
| Rated 20A-125V, Manual Reset    | <b>6893††</b> | Black  | 5-20P        |
| Rated 20A-125V, Automatic Reset | <b>6894††</b> | Yellow | 5-20P        |

†† Wiring module accepts No. 18 (.300") thru No. 12 (.607") cord sizes

**SPECIFICATIONS AND FEATURES**

**High Current GFCI**

- Adds ground fault protection to heavy equipment powered through 3- and 4-wire circuits grounded with neutral
- Meets or exceeds UL 2003 Code Requirements for increased surge immunity, corrosion resistance, resistance to false tripping and diagnostic indication for line-load wiring reversal
- Exclusive, patented lockout-action: RESET button is blocked if GFCI protection has been compromised, eliminating the risk of end-users incorrectly assuming that a reset GFCI is providing ground fault protection when it actually is not
- Test and Reset buttons confirm proper operation
- Ideal for use with spas, heater packs, high pressure washers, industrial mixers and other equipment

**Right Angle GFCI Plug**

- UL 943 Class A GFCI operation with open-neutral protection
- May be pre-wired to cable of any specified length
- Power indicator light goes off if GFCI trips or unit is unplugged

**TESTING AND CODE COMPLIANCE**

**Right Angle GFCI Plug**

- UL Standard 943 Class A (GFCI) and 498 (receptacles)
- UL Recognized Component (File #48380)
- CSA Certified (LR-57811)
- Backed by a Limited One-Year Warranty

**\* COLOR**

Basic Cat. Nos. shown above denote color as indicated. For other color selections, add the suffix to catalog number as follows: Ivory (-I), White (-W), Black (-E).

**MATERIAL CHARACTERISTICS**

Flammability: Rated V2  
Operating Temperature: -30°F (-35°C) to 151°F (66°C)



8895-W



6594



16593



# 15 and 20 AMP 125V • 15 and 20 AMP 240V

## Commercial Grade GFCI Personnel Protection Devices



### Automatic Reset GFCI Cord Sets and Extension Cord — Black Body

| DESCRIPTION                                    | CAT. NO.  | LENGTH  | NEMA CONFIG. |              |
|--|-----------|---------|--------------|--------------|
| 15A-125V GFCI Cord Set                         | 66591-2C  | 2 feet  |              |              |
| 15A-125V GFCI Cord Set                         | 66591-6C  | 6 feet  |              |              |
| 15A-125V GFCI Cord Set                         | 66591-25C | 25 feet | 5-15P        | 5-15R        |
| 15A-125V GFCI Cord Set, with Fluorescent Light | 66591-WL  | 20 feet |              |              |
| 15A-125V GFCI Cord Set, Triple Outlet          | 66593-3   | 3 feet  |              |              |
| 15A-125V Locking GFCI Cord Set                 | 66597-3   | 3 feet  | L5-15P       | L5-15R       |
| 20A-125V GFCI Cord Set                         | 66891-3   | 3 feet  | 5-20P        | 5-20R        |
| 20A-125V Locking GFCI Cord Set                 | 66897-3   | 3 feet  | L5-20P       | L5-20R       |
| 15A-125V GFCI Extension Cord*                  | 26591-37C | 37 feet | 5-15P        | No Connector |
| 15A-125V GFCI Cord Set                         | 66591-2C  | 2 feet  | 5-15P        | 5-15R        |
| 15A-240V GFCI Extension Cord*                  | 26592-E   | 35 feet | 6-15P        | No Connector |
| 20A-240V GFCI Extension Cord*                  | 36592-E   | 35 feet | 6-20P        | No Connector |

### Manual Reset GFCI Cord Sets — High Visibility Yellow Body

| DESCRIPTION                                 | CAT. NO.  | LENGTH  | NEMA CONFIG. |       |
|---|-----------|---------|--------------|-------|
| 15A-125V                                    | 69591-3   | 3 feet  |              |       |
| 15A-125V                                    | 69591-25  | 25 feet | 5-15P        | 5-15R |
| Triple-tap, 15A-125V                        | 69593-3   | 3 feet  |              |       |
| 20A-125V                                    | 69891-3   | 3 feet  | 5-20P        | 5-20R |
| 15A-125V, w/Wetguard® Plugs and Connectors  | 69591-W3  | 3 feet  | 5-15P        | 5-15R |
| 15A-125V, w/Wetguard® Plugs and Connectors  | 69591-W25 | 25 feet | 5-15P        | 5-15R |
| 20A-125V, w/Wetguard® Plugs and Connectors★ | 69891-W3  | 3 feet  | 5-20P        | 5-20R |

\*UL recognized component  
CSA Certified except where indicated by ★



#### SPECIFICATIONS AND FEATURES

- UL 943 Class A GFCI operation with open-neutral protection
- Automatic Reset Cord Sets (black body) will automatically reset ON when power is restored after a power interruption
- Manual Reset Cord Sets (yellow body) will not automatically reset ON when power is restored after a power interruption—Reset button must be pushed in
- Trip threshold meets or exceeds UL requirements for tripping time
- Impact-resistant thermoplastic cover and body
- Silver alloy contacts
- Water-resistant enclosure is sealed by ultrasonic welding
- Power indicator light goes off if GFCI trips or unit is unplugged

#### TESTING AND CODE COMPLIANCE

- UL Standard 943 Class A (GFCI)
- UL Listed (File #48380)
- Backed by a Limited One-Year Warranty

#### MATERIAL CHARACTERISTICS

Flammability: Rated V2  
Operating Temperature: -30°F (-35°C) to 151°F (66°C)

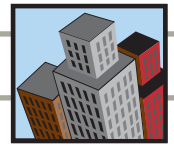

Commercial Grade GFCI Personnel Protection Devices

Single Gang Flush Cover Wallplates — Gray Finish

| MOUNTING POSITION & DESCRIPTION | CAT. NO. | FITS TYPE OF BOX |
|---------------------------------|----------|------------------|
| Vertical — Die-Cast Zinc        | 6196-V   | Standard         |
| Horizontal — Die-Cast Zinc      | 6196     | Standard         |
| Vertical — Die-Cast Zinc        | 6196-VFS | FS (Four Screws) |
| Horizontal — Die-Cast Zinc      | 6196-FS  | FS (Four Screws) |
| Horizontal — Die-Cast Zinc      | 4990     | Standard         |
| Vertical — Die-Cast Zinc        | 4992     | Standard         |
| Horizontal — Plastic            | 4996     | Standard         |
| Vertical — Plastic              | 4998     | Standard         |



Raintight While-In-Use Covers

| DESCRIPTION                               | CAT. NO. | COLOR |
|---|----------|-------|
| GFCI, Vertical Mount                      | 5977-GY  | Gray  |
| GFCI, Vertical Mount w/Extra Deep Cover   | 5977-DGY | Gray  |
| GFCI, Vertical Mount                      | 5977-CL  | Clear |
| GFCI, Vertical Mount w/Extra Deep Cover   | 5977-DCL | Clear |
| GFCI, Horizontal Mount                    | 5997-GY  | Gray  |
| GFCI, Horizontal Mount w/Extra Deep Cover | 5997-DGY | Gray  |
| GFCI, Horizontal Mount                    | 5997-CL  | Clear |
| GFCI, Horizontal Mount w/Extra Deep Cover | 5997-DCL | Clear |

Temporary Portable Power Distribution Center/GFCI (The Box)

| DESCRIPTION   | CAT. NO.  | INLET<br>Non-NEMA<br>California Style | OUTLET<br>Non-NEMA<br>California Style | NEMA CONFIG.        |
|---|-----------|---------------------------------------|--|---------------------|
| Power Distribution Box.<br>GFCI-Protected Receptacles:<br>(6) 20A/125V Locking, GFCI Protected<br>(1) 30A/250V Locking, <b>GFCI Protected</b>           | PB101-SGF | 50A,<br>125/250V                      | 50A,<br>125/250V                       |                     |
| Power Distribution Box<br>GFCI Protected Receptacles:<br>(6) 20A/125V Locking, GFCI Protected<br>(1) 30A/250V Locking, <b>Non-GFCI Protected</b>        | PB101-000 | 50A<br>125/250V                       | 50A<br>125/250V                        | 6: L5-20R 1:L 6-30R |
| Power Distribution Box,<br>GFCI-Protected Receptacles:<br>(6) 20A/125V Straight Blade, GFCI Protected<br>(1) 30A/250V Locking, <b>GFCI Protected</b>    | PB103-SGF | 50A,<br>125/250V                      | 50A,<br>125/250V                       |                     |
| Power Distribution Box<br>GFCI Protected Receptacles:<br>(6) 20A/125V Straight Blade, GFCI Protected<br>(1) 30A/250V Locking, <b>Non-GFCI Protected</b> | PB103-000 | 50A<br>125/250V                       | 50A<br>125/250V                        | 6: 5-20R 1: L6-30R  |

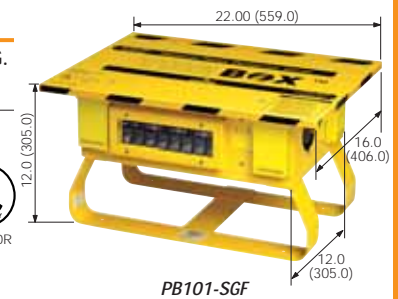

Power Cords

| DESCRIPTION   | CAT. NO.  | NON-NEMA CONFIG. |
|---|-----------|------------------|
| 50 ft. Temporary Power Cord<br>w/Weather-Resistant 50A, 125/250 Plug & Connector  | KRS-A9519 |                  |
| 100 ft. Temporary Power Cord<br>w/Weather-Resistant 50A, 125/250 Plug & Connector | KUS-A9519 | <br>NON-NEMA     |



SPECIFICATIONS AND FEATURES

- The Box**
- For temporary use in industrial & commercial maintenance & repair stations (construction, entertainment, amusement sites, trade shows, convention halls) where portable power is needed
  - Weatherproof covers prevent nuisance tripping; prevent moisture from entering contacts
  - Clear port hole panel for circuit breaker viewing
  - Reinforced metal housing & legs withstand abuse
- Power Cords**
- Flexible, abrasion-resistant construction for reliable performance to -31°F

TESTING AND CODE COMPLIANCE

- Raintight covers satisfy NEC Article 410-57(b) requirements
  - Raintight covers are rated NEMA 3R
- The Box**
- Meets OSHA Regulation 20, Part 1926, Subpart K for open-neutral GFCI & circuit overload protection
  - UL Listed for outdoor use
  - Backed by a Limited One-Year Warranty
- Power Cords**
- UL Listed (File #E-48380)

GFCI Personnel Protection Devices

# HOW TO USE THIS CATALOG

The L-101 Leviton Wiring Device Catalog is designed to help you find the device you're seeking in the quickest and easiest way possible. Most product sections are divided into three distinct categories in the following sequence—Industrial Grade, Commercial Grade and Residential Grade—and grouped according to amperage and voltage, lowest to highest. For example, if you need to order 15 Amp, 125 Volt Industrial Grade straight-blade duplex receptacles, begin your search with the main Table of Contents at the front of the book. Here you'll see that all straight blade receptacles are listed in Section G. Turn to Section G for a more detailed Table of Contents on the first page. Each section page contains product descriptions, ratings and catalog numbers. There are also helpful highlights including Specifications and Features, Testing and Code Compliance, Color listing, Material Characteristics and dimensioned color product photos. Any product page in the L-101 Catalog can be clearly copied or faxed to customers and prospects for use as a specifier sheet or as part of a presentation.

The Quick Reference Guide follows the main Table of Contents to help you pinpoint and locate specific products. Technical Section V provides general product and test data, industry standards, NEMA configuration charts, a glossary of wiring device terms, ANSI architectural symbols and other related information. Specific catalog numbers are listed in the exhaustive index at the back of the catalog.

## 15 AMP 125 and 250V ~ 20 AMP 125 and 250V

### Industrial Grade Straight Blade Receptacles

**Back and Side Wired** (Basic Cat. No. Denotes Brown Device\*)

| DESCRIPTION                             | CAT. NO./COLOR<br>15A/125V       | CAT. NO./COLOR<br>15A/250V | CAT. NO./COLOR<br>20A/125V | CAT. NO./COLOR<br>20A/250V |
|---|----------------------------------|----------------------------|----------------------------|----------------------------|
| LEVSPEC® Duplex Receptacle, Brass Strap | 5262<br>I, W, GY, R, E           | 5662<br>I                  | 5362<br>I, W, GY, R, E     | 5462<br>I, GY              |
| Single Receptacle                       | 5261<br>I, W, GY                 | 5661<br>I                  | 5361<br>I, W, A, T, GY     | 5461<br>I, A, T, GY        |
| Narrow Body Duplex Receptacle           | 5252<br>I, W, A, T, GY, R,<br>BU |                            | 5352<br>I, W, A, T, GY, R, |                            |

5362-IG

80703-IG 80703-I 80704-GY 80716-R

84003-40 84004-40 84016-40

**For complete wallplate selection, see Section E.**

**SPECIFICATIONS AND FEATURES**

**Back & Side Wired Duplex**

- Impact-resistant thermoplastic nylon cover and body
- Smooth face does not collect dirt
- Four corner latches securely fasten face
- Single-piece brass mounting strap on LEVSPEC devices, multi-piece steel strap on other devices
- Large, triple-wipe, brass "T" contacts for superior contact and conductivity
- Back and side-wiring options
- Brass terminal screws to reduce conductor oxidation
- Break-off tabs for easy two-circuit conversion
- Apron barrier to prevent accidental contact between terminal screw heads and metal box
- Exclusive V-shaped, serrated back-wiring clamp for superior contact and conductivity

**TESTING AND CODE COMPLIANCE**

- UL Listed 498 (UL File #13399); UL Federal Specification WC-596

- Meets NEMA WD-1 & 6, and ANSI standards
- Backed by a Limited 10-Year Warranty
- SPECCLASS devices backed by a Limited 2-Year Warranty

**COLOR**

Basic Cat. Nos. shown above denote Brown device, except for Isolated Ground (-IG) devices Basic Cat. No. denotes Orange. Isolated Ground Receptacle is distinguished by an orange triangle on its face. For other color selections, add suffix to the catalog number as follows: Ivory (-I), White (-W), Brown (For IG devices only, add -B), Almond (-A), Light Almond (-T), Gray (-G or -GY), Black (-E), Red (-R) and Blue (-BU); for IG devices only, add -BIG)

**MATERIAL CHARACTERISTICS**

Environmental: Flammability, Rated V2  
Operating Temperature: From -40° C (without impact) to 60°C maximum continuous

- |                                       |  |                                      |
|---------------------------------------|--|--------------------------------------|
| <b>A</b> RATING                       | <b>E</b> CATALOG NUMBER                      | <b>I</b> SPECIFICATIONS & FEATURES   |
| <b>B</b> Choose GRADE, if appropriate | <b>F</b> DESCRIPTION                         | <b>J</b> TESTING AND CODE COMPLIANCE |
| <b>C</b> DIMENSIONED PHOTOGRAPH       | <b>G</b> Check for NEMA CONFIGURATION        | <b>K</b> COLOR LISTING               |
| <b>D</b> WIRING/CERTIFICATIONS        | <b>H</b> WALLPLATE REFERENCE, if appropriate | <b>L</b> MATERIAL CHARACTERISTICS    |

# Combination Devices

## INDEX

**Commercial Grade**  
**AC Combination Devices**

|                                  |     |
|----------------------------------|-----|
| 15A Devices                      | .I2 |
| 15A Switch/Receptacle            | .I2 |
| 15A Switches                     | .I2 |
| 15A S.P. Switch/Neon Pilot Light | .I2 |
| 20A Devices                      | .I2 |
| 20A S.P. Switches                | .I2 |
| 20A S.P. Switch/Receptacle       | .I2 |
| 20A S.P. Switch/Neon Pilot Light | .I2 |
| Decora® Combination Devices      | .I3 |
| Decora® Multi Switches           | .I4 |
| SmartLockPRO® GFCI/Switch        | .I4 |





# 15 and 20 AMP 120V and 120/277V

## Commercial Grade AC Combination Devices

LEVITON OFFERS THE MOST COMPREHENSIVE LINE OF DURABLE COMBINATION DEVICES ON THE MARKET TODAY.

Combination devices permit installation of two devices in a space normally occupied by only one, resulting in reduced installation time and increased convenience.

The following pages provide a detailed listing of the complete line of Leviton combination devices.



5225-W



5224-2W

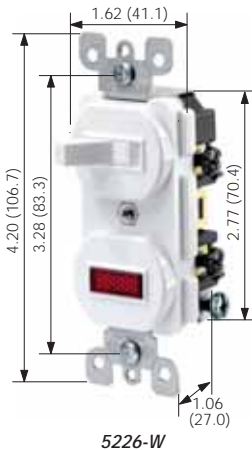

5226-W

### Combination Devices†

#### 15 AMP

| DESCRIPTION                              | RATING  | CAT. NO. | COLOR*<br><small>Basic Cat. No. Denotes Brown</small> |
|--|---|----------|---|
| Two Single-Pole Switches (Non-Grounding) | 15A-120/277V AC                                   | 5224     | I, W  |
| Two Single-Pole Switches                 | 15A-120/277V AC                                   | 5224-2   | I, W, A, T  |
| Single-Pole Switch/Receptacle            | Switch: 15A-120V AC<br>Receptacle: 15A-125V       | 5225     | I, W, A, T  |
| Single-Pole Switch/Pilot Light           | Switch: 15A-120V AC<br>Pilot Light: 1/25W-125V AC | 5226     | I, W, A, T  |
| 3-Way Switch/ Single-Pole Switch         | 15A-120/277V AC                                   | 5241     | I, W, A, T  |
| Two 3-Way Switches                       | 15A-120/277V AC                                   | 5243     | I, W, A, T  |
| 3-Way Switch/Receptacle                  | Switch: 15A-120V AC<br>Receptacle: 15A-125V       | 5245     | I, W  |
| 3-Way Switch/Pilot Light                 | Switch: 15A-120V AC<br>Pilot light: 1/25W-125V AC | 5246     | I, W  |

#### 20 AMP

| DESCRIPTION                    | RATING  | CAT. NO. | COLOR*<br><small>Basic Cat. No. Denotes Brown</small> |
|--------------------------------|---|----------|---|
| Two Single-Pole Switches       | 20A-120/277V AC                                   | 5334     | I, W  |
| Single-Pole Switch/Receptacle  | Switch: 20A-120V AC<br>Receptacle: 20A-125V       | 5335     | I, W, E   |
| Single-Pole Switch/Pilot Light | Switch: 20A-120V AC<br>Pilot Light: 1/25W-125V AC | 5336     | I   |

† All devices are grounded except where noted.

### Wallplates

| THERMOSET | THERMOPLASTIC | 302 STAINLESS STEEL |
|-----------|---------------|---------------------|
| <br>88003 | <br>80703-W   | <br>84003-40        |

For complete wallplate selection, see Section E.

#### SPECIFICATIONS AND FEATURES

- AC quiet switches have silver-cadmium oxide contacts and receptacles have double-wipe contacts for maximum conductivity
- All devices have grounding screw, except where noted
- Side wired with terminal screws that accept up to #12 copper or copper-clad wire
- Fit standard wallboxes
- Break-off tabs on devices with AC quiet switches permit conversion to separate feeds

#### TESTING AND CODE COMPLIANCE

- UL Listed (File #7458)
- CSA (File #LR-3413)
- NOM Certified (#057)
- Backed by a Limited Two-Year Warranty

#### \*COLOR

Basic Cat. Nos. shown above denote Brown color. For other color selections, add suffix to the catalog number as follows: Ivory (-I), White (-W), Almond (-A), Light Almond (-T), Black (-E).

#### HORSEPOWER

| 15A        | 20A      |
|------------|----------|
| 1/2 @ 120V | 1 @ 120V |
| 2 @ 240V   | 2 @ 240V |

#### MATERIAL CHARACTERISTICS

Environmental: Flammability UL-94, V2 Rating  
Operating Temperature: -40°C to 120°C



# 15 and 20 AMP 120V and 120/277V Commercial Grade AC Combination Devices



## Decora® Combination Devices





### 15 AMP

| DESCRIPTION                     | RATING                                      | CAT. NO. | COLOR*            |
|---------------------------------|---|----------|-------------------|
| Two Single-Pole Switches        | 15A-120/277V AC                             | 5634     | I, W, A, T, GY, E |
| Single-Pole Switch/Receptacle   | Switch: 15A-120V AC<br>Receptacle: 15A-125V | 5625     | I, W, A, T, GY, E |
| Single-Pole Switch/Pilot Light  | Switch: 15A-120V AC<br>Pilot: 1/25W-125V AC | 5626     | I, W, A           |
| 3-Way Switch/Single-Pole Switch | 15A-120/277V AC                             | 5641     | I, W, A, T, E     |
| Two 3-Way Switches              | 15A-120/277V AC                             | 5643     | I, W, A, T        |
| 3-Way Switch/Receptacle         | Switch: 15A-120V AC<br>Receptacle: 15A-125V | 5645     | I, W, A, E        |
| 3-Way Switch/Pilot Light        | Switch: 15A-120V AC<br>Pilot: 1/25W-125V AC | 5646     | I, W, A           |

### 20 AMP

| DESCRIPTION                    | RATING                                      | CAT. NO. | COLOR*     |
|--------------------------------|---|----------|------------|
| Two Single-Pole Switches       | 20A-120/277V AC                             | 5627     | I, W, A, T |
| Single-Pole Switch/Receptacle  | Switch: 20A-120V AC<br>Receptacle: 20A-125V | 5636     | I, W, A    |
| Single-Pole Switch/Pilot Light | Switch: 20A-120V AC<br>Pilot: 1/25W-125V AC | 5637     | I, W, A    |
| Two 3-Way Switches             | 20A-120/277V AC                             | 5640     | I, W, A, T |

### Wallplates

| THERMOSET   | THERMOPLASTIC  | POLYCARBONATE SCREWLESS SNAP-ON  |  | 302 STAINLESS STEEL   |
|---|--|--|--|---|
| <br>80401-I | <br>80401-NW | <br>80301-ST | <br>80301-SW | <br>84401-40 |

For complete Decora wallplate selection, see pages B20–B24.

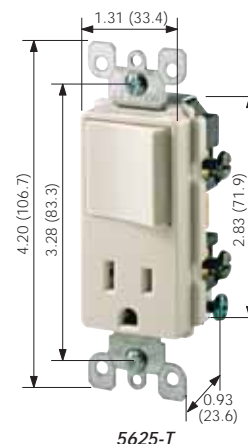

AC Combination Devices

#### SPECIFICATIONS AND FEATURES

- Elegant Decora styling provides multiple control in a single-gang wallbox
- All devices have grounding screw
- Fit standard wall boxes

#### TESTING AND CODE COMPLIANCE

- UL Listed (File #E-7458)
- CSA Certified (File #LR-3413)
- NOM Certified (#057)
- Backed by a Limited Two-Year Warranty

#### \*COLOR

Colors available as listed. For other color selections, add suffix to catalog numbers as follows: Ivory (-I), White (-W), Almond (-A), Light Almond (-T), Gray (-GY) and Black (-E).

#### HORSEPOWER

| 15A        | 20A      |
|------------|----------|
| 1/2 @ 120V | 1 @ 120V |
| 2 @ 240V   | 2 @ 240V |

#### MATERIAL CHARACTERISTICS

Environmental: Flammability UL-94, V2 Rating  
Operating Temperature: -40°C to 120°C



# 15 AMP 120V

## Commercial Grade AC Combination Devices

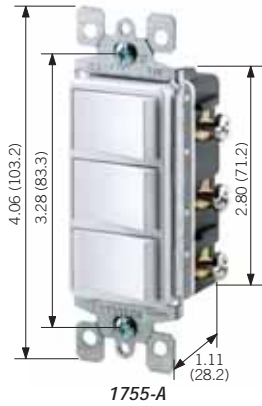

1755-A



7299-NI

### Decora® Combination Switches

Individual Switches: 15 AMP 120V/Device Total: 20 AMP-120V †

| DESCRIPTION  | CAT. NO. | COLOR*     |
|--|----------|------------|
| Dual Rocker Switches with Ground Screw   | 1754-2   | I, W, A, T |
| Illuminated Dual Rocker Switches light is ON when top rocker is OFF                | 1754-IL  | I, W, A    |
| Three Rocker Switches with Ground Screw  | 1755-2   | I, W, A, T |
| Three Rocker Switches (Double Pole ON-OFF-ON Top Switch; Two Single-Pole Switches) | 1759     | I, W       |

†Warning: Although each individual rocker switch is rated up to 15A 120V, the total combined load for both duplex or all three triplex switches **must not exceed 20 AMPS.**

### Decora® Combination Switch/SmartLockPRO® GFCI Outlet

Receptacle: 15 AMP 125V/Feed-through: 20 AMP 125V  
Switch Rating: 15 AMP, 1800 WATTS @ 120V AC

| DESCRIPTION   | CAT. NO. | COLOR*     |
|---|----------|------------|
| Single-Pole Switch and SmartLockPRO® GFCI-Protected Outlet with Indicator Light | 7299     | NI, NW, NA |

### Wallplates

| THERMOSET | THERMOPLASTIC | POLYCARBONATE SCREWLESS SNAP-ON |          | BRASS |
|-----------|---------------|---------------------------------|----------|-------|
|           |               |                                 |          |       |
| 80401-I   | 80401-NW      | 80301-ST                        | 80301-SW | 81401 |

For complete Decora wallplate selection, see pages B20–B24.

#### SPECIFICATIONS AND FEATURES

- Multi-switch combination devices save space and add convenience
- Common shunted internally to all switches
- Elegant Decora styling permits ganging with other Decora devices
- Switch/SmartLockPRO® GFCI Receptacle replaces standard switch/outlet combination devices in commercial or residential installations
- Space-saving SmartLockPRO® GFCI protection in new or retrofit construction
- Switch/SmartLockPRO® GFCI Receptacle permits multiple wiring options that allow six different applications

#### SmartLockPRO® GFCI

- Meets or exceeds UL 2006 Code Requirements for increased surge immunity, corrosion resistance, resistance to false tripping and diagnostic indication for line-load wiring reversal
- Exclusive, patented lockout-action: RESET button is blocked if GFCI protection has been compromised, eliminating the risk of end-users incorrectly assuming that a reset GFCI is providing ground fault protection when it actually is not

#### TESTING AND CODE COMPLIANCE

##### Decora Switches

- UL Listed (File #7458)
- CSA (File #LR-3413)
- NOM Certified (#057)
- Backed by a Limited Two-Year Warranty

##### Switch/SmartLockPRO® GFCI Receptacle

- UL Listed (File #48380)
- Listed UL Standard 943, Class A
- CSA Certified (File #LR-57811)
- NOM Certified (#057)
- Backed by a Limited Two-Year Warranty

#### \*COLOR

Colors available as listed. For other color selections, add suffix to catalog numbers as follows: Ivory (-I), White (-W), Almond (-A), Light Almond (-T).

#### MATERIAL CHARACTERISTICS

Environmental: Flammability UL-94, V2 Rating  
Operating Temperature: -40°C to 120°C

# Structured Media Components

Leviton Integrated Networks™

## INDEX

### Structured Media™ Components

|  |          |
|--|----------|
| Overview                                     | J2       |
| Enclosures                                   | J3–J5    |
| Media Versatile™ Panel                       | J5       |
| Enclosure for Multiple Dwelling Units (MDUs) | J6       |
| Cabling Panels                               | J7–J10   |
| Stand-Alone Modules and Boards               | J10, J11 |
| Mounting Brackets                            | J11, J12 |
| Power and Surge Protective                   | J13, J14 |
| Networking and Internet Sharing              | J15      |
| Video Distribution                           | J16–J18  |
| Home Video Monitoring System                 | J19–J21  |
| Residential Intercom System                  | J22      |

### Home Entertainment Components

#### Leviton/JBL Products and Systems

|   |         |
|---|---------|
| Indoor Speakers   | J23     |
| Outdoor Speakers  | J24     |
| Home Theater Speakers   | J24–J25 |
| Harman/Kardon Entertainment Center Components and Accessories | J26     |

#### Leviton Architectural Edition™ Products

|   |         |
|---|---------|
| Multi-Room Audio Amplifiers and Keypad System Accessories | J27     |
| Audio Volume Controls                                     | J28–J30 |
| Audio Distribution Products                               | J31–J32 |

#### SpecGrade Sound™ Products

|                  |     |
|------------------|-----|
| Indoor Speakers  | J33 |
| Outdoor Speakers | J33 |

#### Other Home Entertainment Products

|                               |     |
|-------------------------------|-----|
| Decora Media System           | J34 |
| Multi-Room IR Repeater System | J35 |
| Decora Recessed Receptacles   | J35 |





## STRUCTURED MEDIA COMPONENTS

### STRUCTURED MEDIA™ COMPONENTS—LEVITON INTEGRATED NETWORKS™

*The information and communication revolution will have as much impact on America's homes and businesses as did the electrical revolution of the 20th Century. To fully enable the modern home, Leviton has developed Leviton Integrated Networks as the upgrade path to the future. Leviton Integrated Network's Structured Media components and systems deliver the capacity, bandwidth and speed that today's and tomorrow's information and entertainment technologies will demand.*

### Innovative Technology Blends Multiple Options Into One System

*Leviton Integrated Networks takes the concept of structured cabling, as practiced in demanding commercial applications, and combines it with multimedia. This blending accommodates the convergence of telephone communications, computer and Internet services and much more. An innovative series of modules and media centers—configured for either essential platforms or more customized enhanced platforms—manage and distribute voice, data, audio and video in flexible configurations that best suit each homeowner's individual requirements. These requirements can range from something as simple as cable TV and telephone in several rooms, to a local area network (LAN) for a small office or home-based business.*

*Entertainment products built into the home should have no compromises — in quality, performance, reliability or value. That's why Leviton offers a wide variety of state-of-the-art residential entertainment products that represent today's most advanced audio/video technologies, including indoor and outdoor speakers, on-wall home theater systems, A/V entertainment center products, controls and distribution components.*

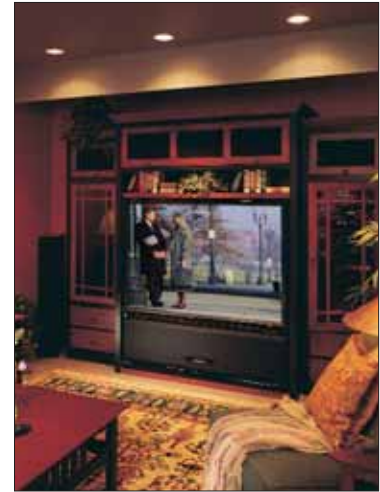



47605-140 Panel Enclosure with Cover



Series 140 Panel Premium Hinged Cover

### Series 140 Structured Media Enclosure

This 14" professional-grade whole-house media enclosure creates one distribution point in the home for all low voltage cables. It will accommodate two Pre-Configured Structured Cabling Panels. The sturdy design and functionality facilitate installation, reducing job-site labor costs, and making it ideal for essential home networking.

#### SPECIFICATIONS

|                              |   |
|------------------------------|---|
| <b>Dimensions:</b>           |   |
| Enclosure:                   | 14.38"H x 14.38"W x 3.60"D  |
| Cover:                       | 16.10"H x 16.10"W   |
| <b>Materials:</b>            | White, powder-coated enclosure (20 gauge steel), cover (18 gauge steel) |
| <b>Standards Compliance:</b> | ACA and cULus Listed. UL Listed for fire and burglary                   |

#### Series 140 Structured Media Enclosures and Covers

| DESCRIPTION                                      | CAT. NO.  |
|--|-----------|
| Series140 Enclosure and Flush-Mount Cover, empty | 47605-140 |
| Series140 Enclosure only                         | 47605-14E |
| Series 140 Flush Mount Cover                     | 47605-14C |
| Series 140 Hinged Cover–Economy                  | 47605-14D |
| Series 140 Hinged Cover–Premium                  | 47605-14P |
| Series140 Enclosure only (6 per pack)            | 47605-14G |
| Series 140 Flush Mount Cover (6 per pack)        | 47605-14B |

#### SPECIFICATIONS AND FEATURES

- Accommodates up to two full-width Pre-Configured Structured Cabling Panels—delivering audio/ video, voice and data to any room of the home or office.
- Positive “stops” on housing sidewalls prevent the enclosure from falling through studs during installation.
- One piece white steel unit holds full and half-width expansion modules.
- Can be surface-mounted or recessed. Ideal for new installations or retrofits.
- Mounting guides on the cover align screw-holes and reduce the chances of dropping during attachment.
- Powder-coated white cover features a 3/4" overlap to hide irregular drywall cuts.
- Combine two or more enclosures for larger installations or future expansion.
- Multiple knock-outs on top and bottom including two new 2" knockouts on top, facilitate cable entry and routing.
- Cut-out in base of enclosure for mounting single gang J-Box kit
- Six 3" square self-healing foam grommets accommodate cable bundles



# STRUCTURED MEDIA™ CENTERS

## Series 280 and 420 Structured Media Enclosures

Command central for home media convergence, Leviton's SMC-280 and SMC-420 home technology enclosures put the home or small office on the cutting edge of the Information Age. By bringing every conceivable technology distribution point together in one place, they make running cable and managing media both simple and more cost-effective. Designed to incorporate a hospital-grade power quality module for maximum protection from line surges, the 28" and 42" high units accommodate all the latest in functions such as home networking, fax, internet (including high speed services such as DSL, cable modems and ISDN), multi-line telephones, security camera, coaxial cable and satellite video distribution, and speaker and volume controls, when equipped with the correct accessories.

The Series 280 enclosure can comfortably accommodate up to 8 different Distribution Modules, depending on selection and density, and the 420 enclosure, with its generous size and capacity for up to 12 modules, can simultaneously manage many diverse functions. Perfect for home office and home entertainment. Make sure you plan all modules before starting the project, and specify the correct size media center.

*Note: Module count will depend on the type used; some are larger than others.*



Series 280 Panel enclosure with cover

### SPECIFICATIONS

#### Dimensions:

|                    |                         |
|--------------------|-------------------------|
| SMC-280 Enclosure: | 28"H x 14.38"W x 3.00"D |
| SMC-280 Cover:     | 29.25"H x 15.62"W       |
| SMC-420 Enclosure: | 42"H x 14.38"W x 3.60"D |
| SMC-420 Cover:     | 43.25"H x 15.62"W       |

**Materials:** White, powder-coated enclosure (20 gauge steel), cover (18 gauge steel)

**Standards Compliance:** ACA and CULUS Listed. UL Listed for fire and burglary



Series 280 Premium Hinged Cover

## Series 280 and 420 Structured Media Enclosures and Covers

| DESCRIPTION                                       | CAT. NO.  |
|---|-----------|
| Series 280 Enclosure and Flush-Mount Cover, empty | 47605-28W |
| Series 280 Enclosure, only                        | 47605-28N |
| Series 280 Flush-Mount Cover                      | 47605-F28 |
| Series 280 Hinged Cover—Economy                   | 47605-28D |
| Series 280 Hinged Cover—Premium                   | 47605-28P |
| Series 280 Enclosure, only (3 per pack)           | 47605-28G |
| Series 280 Flush-Mount Cover (3 per pack)         | 47605-28B |
| Series 420 Enclosure and Flush-Mount Cover, empty | 47605-42W |
| Series 420 Enclosure, only                        | 47605-42N |
| Series 420 Flush-Mount Cover                      | 47605-F42 |
| Series 420 Hinged Cover—Economy                   | 47605-42D |
| Series 420 Hinged Cover—Premium                   | 47605-42P |
| Lock and Key for Structured Media Centers         | 5L000-LOK |



Series 420 Premium Hinged Cover

### SPECIFICATIONS AND FEATURES

- Multiple knock-outs (up to 2") on top, bottom, sides and back, including two new 2" knock-outs on top, facilitate cable entry and routing from every desired room.
- Six 3" square self-healing foam grommets accommodate cable bundles and protect them from being cut
- Sturdy, one-piece white steel construction.
- Combine two or more enclosures for larger installations or future expansions.
- Holds 1/4, 1/2 and full-width expansion modules with the ability to mount most modules vertically or horizontally.
- Large capacity provides multiple functionality for "wired" homes.
- Powder-coated white cover features a 3/4" overlap to hide irregular drywall cuts.

- Mounting hooks on the cover align screw-holes and reduce the chances of dropping during attachment.
- Holds a broad range of current and future distribution modules, delivering audio, video, voice, data, security, and more to any room of the home or office.
- Threaded inserts added to enclosure to ensure accurate threading of screws when mounting cover
- Can be surface-mounted or recessed. Ideal for new installations or retrofits.
- Knock-out in base of enclosure for mounting of either a single gang J-Box kit or an AC power module
- Designed to accommodate safe, high-quality hospital-grade power module with surge suppression.



### Extender Brackets for Leviton Series 280 and 420 Structured Media Centers

The Extender Brackets provide an additional 2" of depth and enhanced ventilation with Leviton's Series 280 and 420 Structured Media Centers (SMCs). The Extender Brackets, which are attached between the enclosure and the cover, form a frame assembled from four 2"-deep sheet metal rails with louvers on each side. The greater depth allows for better cable management and for larger modules, such as audio amplifiers, to be mounted within the Structured Media Centers.

#### Series 280 and 420 Structured Media Enclosures

| DESCRIPTION   | CAT. NO.  |
|---|-----------|
| Extender Bracket 2" depth extension package for Series 280 Structured Media Centers | 47612-28B |
| Extender Bracket 2" depth extension package for Series 420 Structured Media Centers | 47612-42B |

#### SPECIFICATIONS AND FEATURES

##### Extender Brackets

- Made of sturdy white powder-coated 18-gauge sheet metal
- Louvers in the Extender Brackets enhance ventilation for added protection against heat build-up from installed modules
- Two-Year Product Warranty



### Media Versatile Panel— For Custom Retrofits and Remodeling

Ideal for custom retrofits and remodeling applications, the Media Versatile™ Panel with 3/8" plywood backing allows an open architecture for consolidating low voltage electronics and distribution components for phone, fax/modem, data, home networking, audio, video and home control. The 24" high cold-rolled steel panel with securable door will accommodate a wide variety of Structured Media Distribution Modules by simply removing the Push-Lock Pins and attaching directly to the plywood backing. The sturdy construction is built to industrial-grade standards, and the panel can be surface mounted or recessed in the wall. (Optional mounting brackets may be used for non-standard stud spacing). Ideal for custom retrofits and remodeling applications. Available in black powder coat finish. UL Listed.

#### SPECIFICATIONS

|                       |  |
|-----------------------|--|
| Dimensions:           | 24"H x 14"W x 6"D                                      |
| Materials:            | Powder-coated 18 gauge steel with 3/8" plywood backing |
| Standards Compliance: | UL Listed.   |

#### Media Versatile Panel

| DESCRIPTION                  | CAT. NO.  |
|------------------------------|-----------|
| Media Versatile Panel        | 47602-24E |
| Mounting Brackets—(set of 4) | 47602-BKE |

#### SPECIFICATIONS AND FEATURES

- Eight 1" or 1.5" conduit fittings on top and bottom facilitate cable entry and routing
- Wall-mount or recess. Ideal for new installations or retrofits
- Securable door provides maximum protection from dust and abuse
- Plywood backing allows open architecture for customizing layout and can accommodate a wide variety of Structured Media Distribution Modules.



### Compact Structured Media Enclosure—For Multi-Dwelling Units (MDU's)

Leviton's new Compact Structured Media Enclosure for Multi-Dwelling Units offers a compact, cost-effective distribution point for basic telephone and video to owners/managers of multi-unit buildings. The unit accommodates a variety of telephone/video distribution configurations by hosting up to three Telephone Expansion Boards and one Passive Video Splitter.

#### SPECIFICATIONS

|                                |  |
|--------------------------------|--|
| <b>Dimensions:</b> (Enclosure) | 8.03"(204.0) H x 14.40"(365.6) W x 3.71"(94.2) D |
| (Cover)                        | 9.01"(228.9) H x 15.39"(390.8) L                 |
| <b>Materials:</b>              | ABS molded plastic                               |
| <b>Standards Compliance:</b>   | UL94 VO flame-retardant fire rating              |

#### Compact Structured Media Enclosure for MDU's

| DESCRIPTION  | CAT. NO.  |
|--|-----------|
| Compact Structured Media Enclosure and Cover, empty  | 47605-MDU |
| MDU Kit (Compact Structured Media Enclosure & Cover plus 1x6 Telephone Expansion Board)                    | 47604-F6  |
| MDU Kit (Compact Structured Media Enclosure & Cover plus 1x6 Telephone Expansion Board and 6-Way Splitter) | 47604-F6S |

#### SPECIFICATIONS AND FEATURES

- Unique modular design has fewer parts and is made exclusively from ABS molded plastic to provide customers with cost savings in installation time
- Flexibility to accommodate a variety of telephone/video distribution configurations
- Snap-on cover requires no tools or fasteners
- Molded-in brackets provide quick snap-in convenience for Telephone Expansion Boards
- Angled video splitter shelf for easy installation
- Hosts up to three Telephone Expansion Boards and one Passive Video Splitter
- Available empty with cover or in two kitted versions with a 1x6 Telephone Expansion Board or with a 1x6 Telephone Expansion Board and a 6-Way Splitter













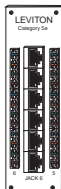

## Pre-Configured Structured Cabling Panels

Route telephone, data and video services throughout your home or office with one simple panel. Leviton's Pre-configured Structured Cabling Panels combine some of our most popular voice, data and RF modules to create an economical one-stop home and office media distribution point. See the following pages for available configurations. Some modules are available in expansion styles to fill unused panel slots (see this page). Choose the pre-configured combination that best meets your needs, and enhance with expansion boards or stand-alone brackets.

### Panel Components and Expansion Boards

Pre-configured Panels are assembled at the factory and will contain one or more of the following distribution modules.

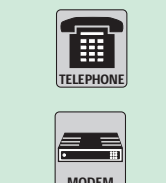



| COMPONENTS   | APPLICATION   | FEATURES   | AVAILABLE AS   |
|--|---|--|--|
|  <p><b>1x9 Bridged Telephone Board</b></p> <p>Basic telephone distribution</p>                  |    | <ul style="list-style-type: none"> <li>Bridge up to 4 telephone lines to 9 locations</li> <li>Connect up to 9 separate telephones per line</li> <li>Printed circuit board module</li> <li>4-pair 110-type IDC punchdowns</li> </ul>  | <ul style="list-style-type: none"> <li>Part of a Pre-configured Panel</li> <li>Stand-alone module with bracket</li> <li>Expansion board without bracket</li> </ul> |
|  <p><b>Category 5e Voice &amp; Data Board</b></p> <p>Basic home networking</p>                  |    | <ul style="list-style-type: none"> <li>Patch phone or data connections to 6 locations</li> <li>Combine with a TLDM, key system, or network hubs for additional applications</li> <li>Printed circuit board module</li> <li>4-pair 110-type IDC punchdowns and 6 CAT 5e RJ-45 ports</li> </ul>                                      | <ul style="list-style-type: none"> <li>Part of a Pre-configured Panel</li> <li>Stand-alone module with bracket</li> <li>Expansion board without bracket</li> </ul> |
|  <p><b>Category 6 Voice &amp; Data Board</b></p> <p>Basic home networking</p>                  |   | <ul style="list-style-type: none"> <li>Patch phone or data connections to 6 locations</li> <li>Combine with a TLDM, key system, or network hubs for additional applications</li> <li>Printed circuit board module</li> <li>4-pair 110-type IDC punchdowns and 6 CAT 6 RJ-45 ports</li> </ul>                                       | <ul style="list-style-type: none"> <li>Part of a Pre-configured Panel</li> <li>Stand-alone module with bracket</li> <li>Expansion board without bracket</li> </ul> |
|  <p><b>Telephone Patching Board</b></p> <p>Expanded 4-line telephone distribution</p>         |  | <ul style="list-style-type: none"> <li>Bridge up to 4 telephone lines to 7 locations</li> <li>Printed circuit board module</li> <li>One incoming 4-pair 110-type IDC punchdown and 7 outgoing RJ-45 jack connections</li> <li>Combine with a Category 5e Board to route telephone to remote locations</li> </ul>                   | <ul style="list-style-type: none"> <li>Part of a Pre-configured Panel</li> <li>Expansion board without bracket</li> </ul>  |
|  <p><b>Telephone Security Board</b></p> <p>Route simple telephone with security interface</p> |  | <ul style="list-style-type: none"> <li>Bridge up to 4 telephone lines to 6 locations</li> <li>Connect up to 6 separate telephones per line</li> <li>Connect to security system</li> <li>Printed circuit board module</li> <li>4-pair 110-type IDC punchdowns</li> </ul>  | <ul style="list-style-type: none"> <li>Stand-alone module with bracket</li> </ul>  |
|  <p><b>DSL Filter Board</b></p> <p>Filters DSL signal from telephone line</p>                 |  | <ul style="list-style-type: none"> <li>Filters DSL signal from phone line before distribution throughout a home or office.</li> <li>Eliminates need for individual filters at each wallplate.</li> <li>Use with any phone distribution module.</li> <li>Printed circuit board module with RJ-45 jack and 110 punchdowns</li> </ul> | <ul style="list-style-type: none"> <li>Stand-alone module with bracket</li> <li>Expansion board without bracket</li> </ul>   |



# STRUCTURED MEDIA™ PANELS/MODULES

## Panel Components and Expansion Boards (continued)

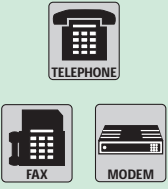
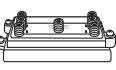
Pre-configured Panels are assembled at the factory and will contain one or more of the following distribution modules.

| COMPONENTS  | APPLICATION   | FEATURES  | AVAILABLE AS  |
|---|---|---|---|
|  <p><b>Telephone Line Distribution Board (TLDM)</b></p> <p>Enhanced telephone distribution</p> |  | <ul style="list-style-type: none"> <li>• 19 multi-line telephone connections in combinations of 2 or 4 lines</li> <li>• Bridge "Line 1" service to 12 locations and 4-line service to 8 locations</li> <li>• Connect to CAT 5e Voice &amp; Data Board(s) or additional panels for more connections and easier adds/moves/changes</li> <li>• Independent RJ-45 jack and punchdown security interface to accommodate alarm systems</li> </ul> | <ul style="list-style-type: none"> <li>• Part of a Pre-configured Panel ONLY</li> <li>• Expansion board with bracket</li> </ul> |
|  <p><b>4x12 Telephone Distribution Board</b></p>   |  | <ul style="list-style-type: none"> <li>• Fits easily into any Leviton Structured Media enclosure, or can be used as a stand-alone unit.</li> <li>• Distribute up to 4 telephone lines through 12 telephone connections</li> <li>• Links with other distribution boards, modules, or panels to expand the system</li> <li>• 12 modular RJ-45 jack outputs.</li> <li>• 4-pair 110 type IDC inputs.</li> </ul>                                 | <ul style="list-style-type: none"> <li>• Part of a Pre-configured Panel ONLY</li> </ul>   |
|  <p><b>Video Splitters</b></p> <p>Basic video distribution</p>                                 |  | <ul style="list-style-type: none"> <li>• Cable TV or off-air antenna signals</li> <li>• 4-way or 6-way RF Splitter</li> <li>• Die-cast housing</li> <li>• Available in 1GHz and 2GHz models</li> </ul>  | <ul style="list-style-type: none"> <li>• Part of a Pre-configured Panel</li> <li>• Stand-alone module with bracket</li> </ul>   |



47606-BTV



47606-BNP

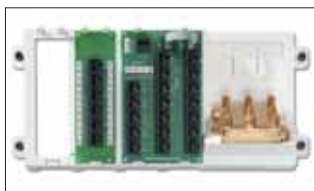

47606-AHT

## Pre-configured Structured Cabling Panels—Full Width

Leviton has a Pre-Configured Structured Cabling Panel to fit any application. See opposite for explanations of individual boards. Use the Panels as they are, expand with easy snap-in Expansion Boards, or combine with other Panels or Stand-alone Modules to create a Structured Media solution tailored to your specific needs. Ideal for all installations, from basic to high-end. The new non-conductive synthetic bracket features a rugged construction and a "shelf-style" design with enhanced cable management and easier installation. Boards quickly snap on and off for easy adds/moves/changes.

| DESCRIPTION                                 | CAT. NO.         | CONSISTS OF  |
|---|------------------|--|
| Basic Telephone and Video Panel (BTVP)      | <b>47606-BTV</b> | <ul style="list-style-type: none"> <li>• (1) 1x9 Bridged Telephone Board</li> <li>• (1) 6-way 2GHz Video Splitter</li> <li>• Bridge up to 4 telephone lines to 9 locations</li> <li>• Route video to 6 locations</li> </ul>  |
| Basic Home Networking Plus Panel (BNP)      | <b>47606-BNP</b> | <ul style="list-style-type: none"> <li>• (1) Telephone Patching Board</li> <li>• (1) Category 5e Voice &amp; Data Module</li> <li>• (1) 6-way 2GHz Video Splitter</li> <li>• 6 4-line telephone connections</li> <li>• Route video to 6 locations</li> <li>• Patch data or telephone service to 6 remote locations</li> <li>• Comes with 6 8-inch 8p8c Flat Patch Cords</li> </ul>   |
| Advanced Home Telephone & Video Panel (AHT) | <b>47606-AHT</b> | <ul style="list-style-type: none"> <li>• (1) Telephone Line Distribution Module</li> <li>• (1) Category 5e Voice &amp; Data Board</li> <li>• (1) 6-way 2GHz Video Splitter</li> <li>• 19 multi-line telephone connections (in various combinations of 2 or 4 lines)</li> <li>• Route video to 6 locations</li> <li>• Patch data or telephone service to 6 remote locations</li> <li>• Comes with 6 8-inch 8p8c Flat Patch Cords</li> </ul> |

Full-width panel dimensions: 6.25"H x 13.06"W x 2.50"D

For detailed features and dimensions, please consult individual specification sheets at [www.leviton.com](http://www.leviton.com)



| DESCRIPTION  | CAT. NO.         | CONSISTS OF   |
|--|------------------|---|
| Advanced Home Office Panel                         | <b>47606-ASO</b> | <ul style="list-style-type: none"> <li>• (1) Telephone Line Distribution Module</li> <li>• (2) Category 5e Voice &amp; Data Boards</li> <li>• (1) 6-Way 2GHz Video Splitter</li> <li>• (1) 19 multi-line telephone connections (in various combinations of 2 or 4 lines)</li> <li>• Route video to 6 locations</li> <li>• Patch data or telephone service to 6 remote locations</li> <li>• Comes with (6) 8-inch 8p8c Flat Patch Cords</li> </ul> |
| 12-Port Structured Media Panel (12P)               | <b>47603-12P</b> | <ul style="list-style-type: none"> <li>• (1) Telephone Line Distribution Module</li> <li>• (2) Category 5e Voice &amp; Data Boards</li> <li>• 19 multi-line telephone connections (in various combinations of 2 or 4 lines)</li> <li>• Patch data or telephone service to 12 remote locations</li> <li>• Comes with 12 8-inch 8p8c Flat Patch Cords</li> </ul>  |
| 18-Port Structured Media                           | <b>47603-18P</b> | <ul style="list-style-type: none"> <li>• (1) Telephone Line Panel (18P) Distribution Module</li> <li>• (3) Category 5e Voice &amp; Data Boards</li> <li>• 19 multi-line telephone connections (in various combinations of 2 or 4 lines)</li> <li>• Patch data or telephone service to 18 remote locations</li> <li>• Comes with 18 8-inch 8p8c Flat Patch Cords</li> </ul>  |
| 24-Port Structured Media Panel (24P)               | <b>47603-24P</b> | <ul style="list-style-type: none"> <li>• (1) Telephone Line Distribution Module</li> <li>• (4) Category 5e Voice &amp; Data Boards</li> <li>• 19 multi-line telephone connections (in various combinations of 2 or 4 lines)</li> <li>• Patch data or telephone service to 24 remote locations</li> <li>• Comes with 24 8-inch 8p8c Flat Patch Cords</li> </ul>  |
| 4 x 12 Telephone Distribution Panel                | <b>47603-12M</b> | <ul style="list-style-type: none"> <li>• (1) 4 x 12 Telephone Dist. Board</li> <li>• Handles up to 4 telephone lines through 12 connections</li> </ul>  |
| 4 x 12 Telephone Distribution Panel w/ Splitter    | <b>47603-412</b> | <ul style="list-style-type: none"> <li>• (1) 4 x 12 Telephone Dist. Board</li> <li>• (1) 8-way 2GHz Video Splitter</li> <li>• Handles up to 4 telephone lines through 12 connections</li> <li>• Features output for up to 8 video connections</li> </ul>  |
| 4 x 18 Telephone Distribution Panel                | <b>47603-18M</b> | <ul style="list-style-type: none"> <li>• (1) 4 x 18 Telephone Dist. Board</li> <li>• Handles up to 4 telephone lines through 18 connections</li> </ul>  |
| 4 x 18 Telephone Distribution Panel w/CAT 5e Board | <b>47603-8C1</b> | <ul style="list-style-type: none"> <li>• (1) 4 x 18 Telephone Dist. Board</li> <li>• (1) Category 5e Voice &amp; Data Module</li> <li>• Handles up to 4 telephone lines through 18 connections</li> <li>• Provides voice and data service to 6 remote locations via CAT 5e voice and data boards</li> </ul>   |

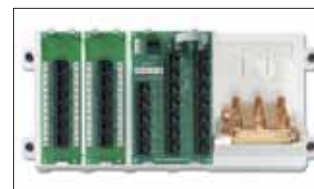

47606-ASO

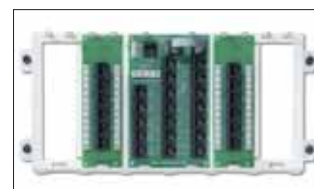

47603-12P

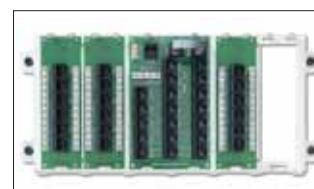

47603-18P

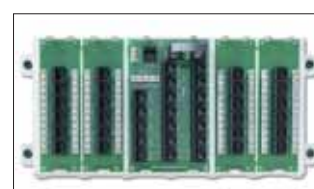

47603-24P

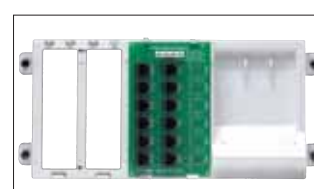

47603-12M

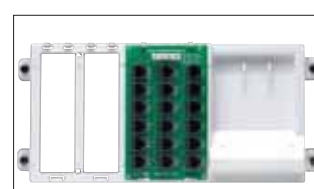

47603-18M

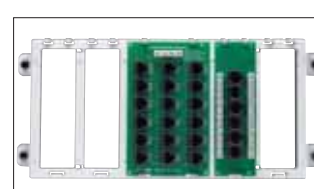

47603-8C1

Full-width panel dimensions: 6.25"H x 13.06"W x 2.50"D

For detailed features and dimensions, please consult individual specification sheets at [www.leviton.com](http://www.leviton.com)



# STRUCTURED MEDIA™ PANELS and BOARDS



47603-1G4



47603-1G6



47603-TSV



47603-1G8

## Pre-Configured Structured Cabling Panels—Compact Series

Leviton's simple solution for basic telephone and video distribution. These compact panels, with their space-saving profile provide simple bridged telephone to 9 locations and 1GHz video to four or six locations, respectively. Compact Series Panels are ideal for MDUs and apartments, installations with space constraints and/or installations where budget is the driving concern.

| DESCRIPTION                      | CAT. NO.  | CONSISTS OF   |
|----------------------------------|-----------|---|
| Telephone & 4-Way Video          | 47603-1G4 | <ul style="list-style-type: none"> <li>• (1) 1x9 Bridged Telephone Board</li> <li>• (1) 4-way 1GHz Video Splitter</li> <li>• Bridge up to 4 telephone lines to 9 locations</li> <li>• Route video to 4 locations</li> </ul>   |
| Telephone & 6-Way Video          | 47603-1G6 | <ul style="list-style-type: none"> <li>• (1) 1x9 Bridged Telephone Board</li> <li>• (1) 6-way 1GHz Video Splitter</li> <li>• Bridge up to 4 telephone lines to 9 locations</li> <li>• Route video to 6 locations</li> </ul>   |
| Telephone Security & 6-Way Video | 47603-TSV | <ul style="list-style-type: none"> <li>• (1) Telephone Security Board</li> <li>• (1) 6-way 1GHz Video Splitter</li> <li>• Bridge up to 4 telephone lines to 6 locations</li> <li>• RJ-45 Port for Security Interface</li> <li>• Route video to 6 locations</li> </ul> |
| Telephone & 8-Way Video          | 47603-1G8 | <ul style="list-style-type: none"> <li>• (1) 1x9 Bridged Telephone Board</li> <li>• (1) 8-way 1GHz Video Splitter</li> <li>• Bridge up to 4 telephone lines to 9 locations</li> <li>• Route video to 8 locations</li> </ul>   |

Compact panel dimensions: 6.5"H x 6.5"W

For detailed features and dimensions, please consult individual specification sheets at [www.levitonvoicedata.com](http://www.levitonvoicedata.com)

## Stand-Alone Modules and Expansion Boards

### Stand-Alone Modules

| DESCRIPTION—MODULE with BRACKET     | CAT. NO.  |
|-------------------------------------|-----------|
| A—1x9 Bridged Telephone Module      | 47689-00B |
| B—Category 5e Voice and Data Module | 47605-C5B |
| C—Telephone Security Module         | 47609-TSV |
| D—DSL Filter Module                 | 47616-DSB |
| Category 6 Voice and Data Module    | 47616-C6B |

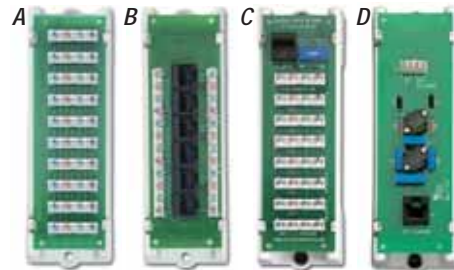

### Expansion Boards

| DESCRIPTION  | CAT. NO.  |
|--|-----------|
| E—1x9 4-Line Bridged Telephone Board                           | 47603-110 |
| F—1 x 6 4-Line Bridged Telephone Expansion Board               | 47609-F6  |
| G—1 x 4 6-Line Bridged telephone Expansion Board               | 47609-S4  |
| H—1 x 10 6-Line Bridged Telephone Security Expansion Board     | 47609-S10 |
| I—1x5 4-Line Bridged Phone w/Data Pass Through Expansion Board | 47609-D5P |
| J—1x4 4-Line Bridged Phone and 4-Port CAT 5e Expansion Board   | 47609-4DP |
| K—1x4 Bridged Phone Board                                      | 47609-004 |
| L—Category 5e Voice and Data Expansion Board                   | 47603-C5  |
| Category 6 Voice and Data Expansion Board                      | 47611-C6  |

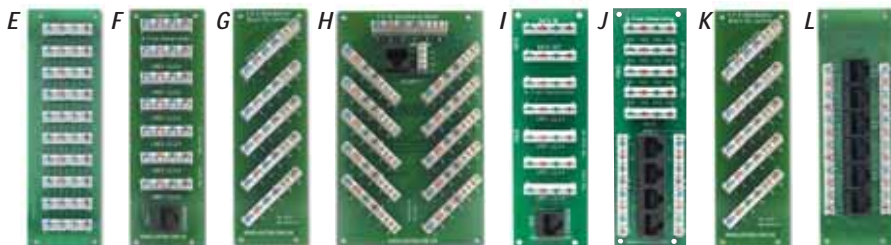



## Expansion Boards

| DESCRIPTION  | CAT. NO.  |
|--|-----------|
| M-Telephone Patching Expansion Board   | 47609-EMP |
| N-DSL Filter Board   | 47616-DSF |
| O-Telephone Line Distribution Module and 19 Multi-Line Connections (in various combinations of 2 or 4 lines) Board | 47603-TDM |
| P-4x12 Telephone Distribution Board  | 47603-12B |
| Q-4x18 Telephone Distribution Board  | 47603-18B |

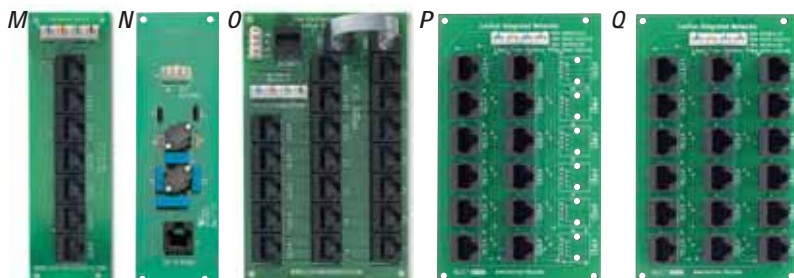

## Plastic Mounting Brackets for Leviton Structured Media Centers

The Single Plastic Bracket accepts mounting of any single Leviton phone, data, security or DSL Filter Board within the Structured Media Center to enhance an existing system, for use as a stand-alone solution for voice (with or without security), data and DSL filtering services. The Expansion Plastic Bracket is a full-width bracket that can be populated with up to five Leviton phone, data, security or DSL Filter Expansion Boards in a Leviton Series 140, 280 or 420 Structured Media Center. This unit offers a universal design that accommodates installation of a variety of manufacturers' products.

| DESCRIPTION  | CAT. NO.  |
|--|-----------|
| A-Single Plastic Bracket for mounting a single Leviton phone, data, security or DSL Filter Expansion Board in a Leviton Series 140, 280 or 420 Structured Media Center       | 47612-SBK |
| B-Expansion Plastic Bracket for mounting up to five Leviton phone, data, security or DSL Filter Expansion Boards in a Leviton Series 140, 280 or 420 Structured Media Center | 47612-EBK |
| C-Half Plastic Bracket for mounting up to 3 Leviton Phone, Data, Security or DSL Filter Expansion Boards in Series 140, 280 or 420 SMC                                       | 47612-HBK |
| D-Data Plastic Bracket for mounting switches, routers, and modems within a Leviton Series 140, 280 or 420 Structured Media Center  | 47612-DBK |

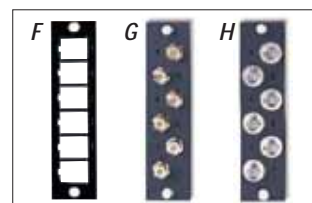
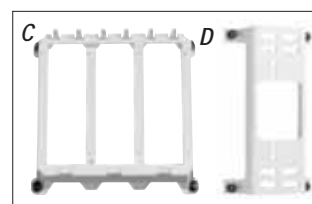
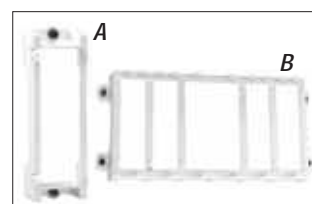

## Multimedia Adapter Bracket and Mounting Plates

Create a custom audio/video, copper or fiber mini-panel in your Structured Media Center with the Multi-Media Adapter Bracket. The bracket supports your choice of two 6-pack mounting plates, and snaps easily into any of Leviton's Structured Media Centers with push-pins. Pre-loaded mounting plates are available for BNC and F-connectors, or create a custom configuration with unloaded 6-pack QuickPort® plates. QuickPort plates accept any combination of the following QuickPort adapters or connectors: BNC, F-Connector, ST, FC, SC and MT-RJ Fiber Optics, Banana Jacks, Speaker Binding Posts, RCA, S-Video, Voice Grade, and Category 5, 5e or 6. Bracket mounts vertically or horizontally.

| DESCRIPTION                                  | CAT. NO.  |
|--|-----------|
| E-Multimedia Bracket                         | 47612-MMA |
| F-BNC Mounting plate, 6-pack, loaded         | 5F100-BNC |
| G-F-Connector Mounting plate, 6-pack, loaded | 5F100-6VF |
| H-QuickPort Mounting plate, 6-pack, unloaded | 5F100-6QP |

## Accessories

| DESCRIPTION  | CAT. NO.  |
|--|-----------|
| 8-Conductor Flat Telephone Patch Cord, 8" long ((1 each) | 42400-8FG |

### SPECIFICATIONS AND FEATURES

#### All Plastic Brackets

- Made of sturdy white ABS plastic
- Come with push-lock pins
- Snap-in installation in any Leviton series 140, 280 or 420 Structured Media Center
- Allow for cable management via routing under bracket



# STRUCTURED MEDIA™ BRACKETS

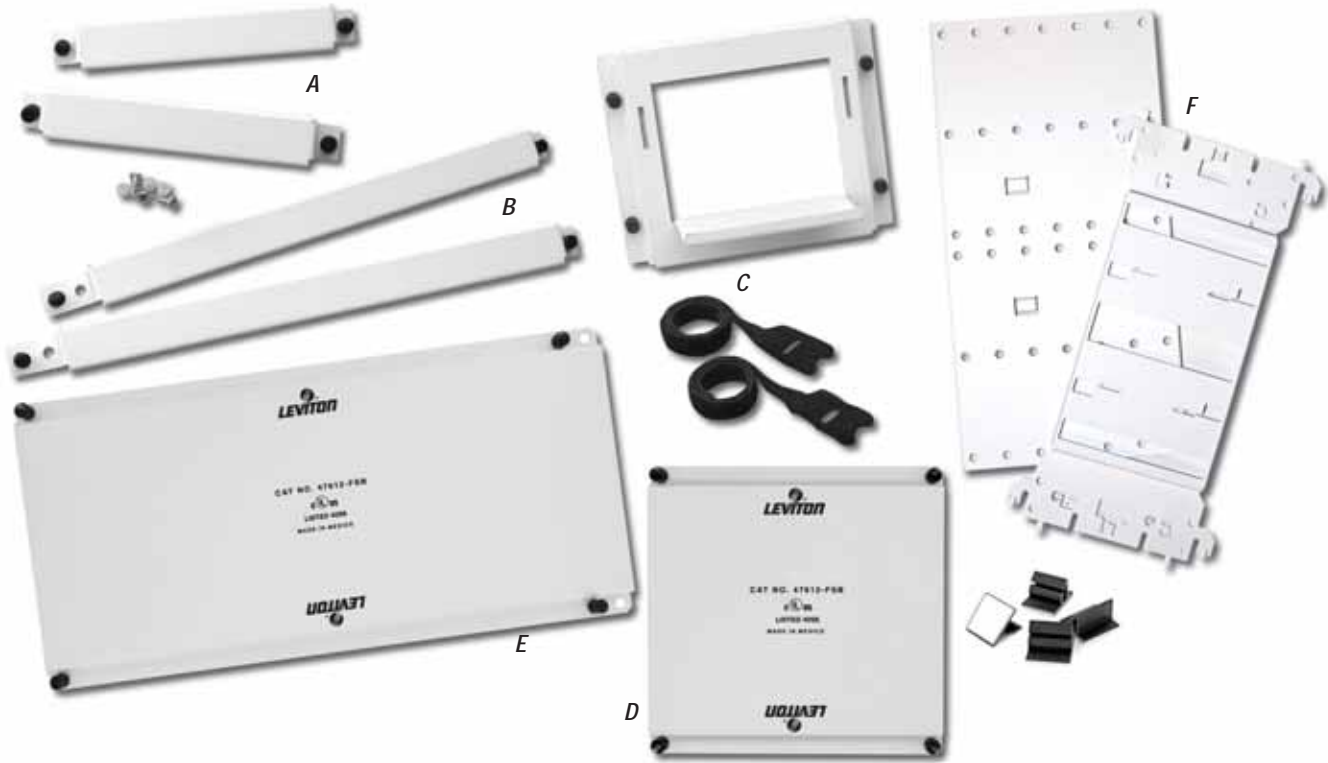

## Universal Security & Shelf Brackets for Leviton Structured Media Centers

The Universal Security Brackets allow for consolidation and integration of security products into any of Leviton's Series 140, 280 or 420 Structured Media Center enclosures. The 6" and 12" Universal Security Brackets accommodate the widest variety of security alarm panels. These 1"-wide brackets are sold in pairs with self-tapping screws and insulating spacers for easy attachment to the panels. The Universal Shelf Bracket provides space for security batteries of various sizes as well as other products to be mounted within Leviton's Series 140, 280 or 420 Structured Media Centers. The bracket comes with four 8" long Velcro® strips to strap down products to the shelf, ensuring both vertical and horizontal stability.

### Universal Security & Shelf Brackets for Leviton 140, 280 or 420 Structured Media Centers

| DESCRIPTION   | CAT. NO.  |
|---|-----------|
| A-6" Universal Security Bracket. Comes a set of two 6"-long, 1"-wide brackets with self-tapping screws and spacers for mounting within Leviton's Series 140, 280 or 420 Structured Media Centers                            | 47612-6SB |
| B-12" Universal Security Bracket. Comes a set of two 12"-long, 1"-wide brackets with self-tapping screws and spacers for mounting within Leviton's Series 140, 280 or 420 Structured Media Centers                          | 47612-1SB |
| C-Universal Shelf Bracket. Comes with four 8"-long Velcro strips to strap down security batteries of various sizes as well as other products to be mounted within Leviton's Series 140, 280 or 420 Structured Media Centers | 47612-UBK |
| D-Half-Width Universal Security Plate. Comes with a 6" long plate with four adhesive clips for mounting with Leviton's Series 140, 280 or 420 Structured Media Centers  | 47612-HSB |
| E-Full-Width Universal Security Plate. Comes with a 12" long plate with four adhesive clips for mounting with Leviton's Series 140, 280 or 420 Structured Media Centers   | 47612-FSB |
| F-Combo Bracket is designed to accommodate Leviton products to be installed in most structured wiring enclosures on the market  | 47612-CBK |

#### SPECIFICATIONS AND FEATURES

##### All Brackets

- Made of white powder-coated 18 gauge sheet metal
- Come with push-lock pins

##### Universal Security Brackets

- Allow an unlimited number of upgrades (limited only by the enclosure's size) to be added to an existing security system terminated within any Leviton Structured Media Center
- Sold in pairs with self-tapping screws and spacers to easily connect the largest number of security alarm manufacturers' panels

##### Universal Shelf Bracket

- Allows security batteries and other products to be mounted inside any Leviton Structured Media Center
- Vertical and horizontal slots on bracket to accommodate Velcro strips, ensuring vertical and horizontal stability

##### Combo Bracket

- Allows Leviton products to be installed in most non-Leviton structured wiring enclosures



### Surge-Protective and Standard AC Power Modules and J-Box Kits

Surge AC Power Module or J-Box kit models add clean, safe power to the Series 280 or 420 Structured Media Enclosures (Series 140 enclosure only accepts J-Box kits). Two non-surge protected AC Power Module or J-Box kit units offer an economical method of providing power to distribution modules and, except for built-in surge suppression, offer the same features as the respective surge-protected units. In extremely excessive surge conditions, an alarm will sound to warn the user that power is unprotected. Consists of one (J-Box kit) or two (AC Power Module) 15 Amp Hospital Grade duplex receptacles housed in a powder-coated steel enclosure. They feature EMI/RFI filtering and meet UL 1449 standards.

#### AC Power Modules for 280 and 420 Series Structured Media Enclosures

**SPECIFICATIONS**

|  |                      |
|--|----------------------|
| Dimensions:                              | 10"H x 2.8"W x 2.3"D |
| Standards Compliance (Surge model only): | UL 1449              |
| Input:                                   | 2 @ 15A 120V AC      |

#### AC Power Modules for 280 and 420 Series Structured Media Enclosures

| DESCRIPTION                                       | CAT. NO.  |
|---|-----------|
| Surge AC Power Module, Two Duplex Receptacle      | 47605-DP  |
| Non-Surge AC Power Module, Two Duplex Receptacles | 47605-NDP |

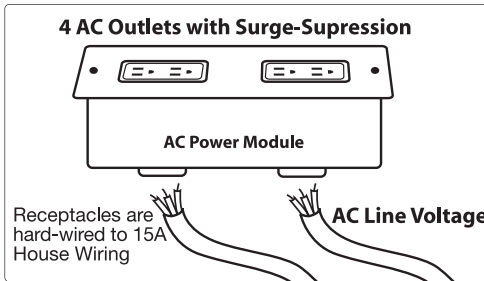

#### J-Box Kits for 140, 280 and 420 Series Structured Media Enclosures

**SPECIFICATIONS**

|  |                    |
|--|--------------------|
| Dimensions:                              | 3"H.x 2"W.x 2.5"D. |
| Standards Compliance (Surge model only): | UL 1449            |
| Input:                                   | 1 @ 15A 120V AC    |

#### J-Box Kits for 140, 280 and 420 Series Structured Media Enclosures

| DESCRIPTION                                | CAT. NO.  |
|--|-----------|
| Surge J-Box Kit, One Duplex Receptacle     | 47605-ACS |
| Non-Surge J-Box Kit, One Duplex Receptacle | 47605-ACN |

### Universal Mini DC Power Supplies

These compact units are designed specifically to fit into Leviton's Series 140, 280 and 420 Structured Media enclosures. They are compatible with any incoming AC voltage in the range of 90 to 264V. The 47605-PSA's 9 12VDC connectors provide up to 40 watts of power and the 47605-PSB's 3 12VDC connectors provide up to 10 watts of power while providing short circuit overload and surge protection as well as EMI/RFI filtering to connected equipment.

| DESCRIPTION  | CAT. NO.  |
|--|-----------|
| Universal DC Power Supply, 9 12VDC connectors      | 47605-PSA |
| Universal Mini DC Power Supply, 3 12VDC connectors | 47605-PSB |

**SPECIFICATIONS AND FEATURES**

- Hospital grade surge-protected units provide greater protection for line-voltage modules, including multi-stage defense (L-N, L-G, N-G)
- Non-surge suppressor units provide an economical method of providing power to active components
- Available with one (J-Box kits) or two (AC Power Modules) 15 Amp duplex receptacles

- Safety clips protect outlets against dust, dirt and debris
- One (J-Box kits) or two (AC Power Modules) cable knock-outs on bottom for power service connection
- Saves valuable real estate by mounting on outside of Structured Media Enclosures
- Meets UL 1449 standards



47605-ACN Non-Surge J-Box Kit



47605-PSB, 47605-PSA  
Universal Mini DC Power Supplies



## MEDIA CENTER POWER



Snap-In Surge Protection Modules

### SPECIFICATIONS AND FEATURES

- Interchangeable modules accommodate changing surge protection needs
- All modules easily snap in to the Cat. No. 3950 Surge Module Bracket
- User-friendly design—no wiring required
- Telephone/Fax/Modem Module acts as a splitter, allowing the connection of two devices



3950-BKT



### SPECIFICATIONS AND FEATURES

- Contains six removable double screw terminal jacks.
- Each jack utilizes slot-drive screws.
- Shipped with 6 wires containing 18 gauge connectors and 2.1 mm power plugs.
- Fully regulated (12 volt DC regulated output).

## Snap-In Modules for Structured Media Enclosure Surge Module Bracket

Leviton's snap-in surge protective modules provide customized surge protection for all low-voltage communication and data lines in the Structured Media Enclosure. All Series 5950 modules can snap-in to the Cat. No. 3950-BKT Surge Module Bracket. The bracket, allows you to add and change modules to fit specific protection needs. Choose from a selection of protection modules for Digital Satellite Systems, Ethernet systems, Cable TV, Telephone/Fax/Modem and DSL/ADSL equipment. All devices attached to the modules are covered under the Leviton \$50,000 Connected Equipment Warranty.

| DESCRIPTION   | CAT. NO.  |
|---|---|
| Satellite System/Cable TV Protection Module—4 Standard F-connectors. 3-Amp fuse for over-current. Max. line voltage: 75V DC. Breakdown Voltage Range: 70.4-110 Volts/Sec  | Beige—5951-SA<br>Grey—5951-SAT<br>Ice—5951-SAC  |
| Ethernet Protection Module (10 Base-T Applications)—Two RJ45 connectors to protect two pair of transmit/receive lines. 10-Amp automatic Resettable PTC fuses. Max. operating voltage: 16.6V DC. Breakdown Voltage Range: 2.62-19.2 Volts/Sec  | Beige—5952-ET<br>Grey—5952-ETH                  |
| Cable TV System Protection Module—Two Standard F-type connectors. 3-Amp fuse for over-current. Max. line voltage: 75V DC. Breakdown Voltage Range: 70.4-110 Volts/Sec   | Beige—5953-PC<br>Grey—5953-PCG<br>Ice—5953-PCC  |
| Telephone/Fax/Modem Protection Module—Three RJ11, 4-wire/2-pair connectors. 3-Position splitter allows for connection to a common line. 3-Amp fuse for over-current protection. Max. operating voltage: 150V rms (including ring voltage). Breakdown Voltage Range: 162-331 Volts/Sec | Beige—5954-AT4<br>Grey—5954-PT4<br>Ice—5954-CT4 |
| DSL/ADSL Subscriber Equipment Protection Module—Three RJ11, 4-wire/2pair connectors. 3-Amp fuse for over-current protection. Max. operating voltage: 150V rms (including ring voltage). Breakdown Voltage Range: 162-331 Volts/Sec  | Beige—5955-DT<br>Grey—5955-DTG                  |
| Cat. 5 Ethernet Module<br>Two RJ45 Connectors with Ground Pin for Ethernet - Cat. 5   | Beige—5957-OCS<br>Grey—5957-C5G                 |
| Two Line Telephone Module<br>One Input, One Output RJ11 Connector for 4-Wire POTS   | Beige—5958-AT4<br>Grey—5958-PT4                 |
| Four Line Telephone Module<br>One Input, One Output RJ45 Connector for 8-Wire POTS  | Beige—5959-BT8<br>Grey—5959-GT8                 |
| Surge Module Bracket  | 3950-BKT  |

### TESTING AND CODE COMPLIANCE

| CAT. NO. | MCOV (VDC) | CLAMPING VOLTAGE (VDC) | TESTED TO | MEET STANDARDS |
|----------|------------|------------------------|-----------|----------------|
| 5951     | 60         | 388                    | UL 452    | ANSI/IEEE      |
| 5952     | 16.6       | 23                     | UL497B    | C-62.36        |
| 5953     | 60         | 388                    | UL452     |                |
| 5954     | 288        | 715                    | UL497A    | CSA            |
| 5955     | 205        | 210                    | UL497A    | (#LR-94773)    |
| 5957     | 16.6       | 23                     | UL497B    |                |
| 5958     | 288        | 715                    | UL497A    |                |
| 5959     | 288        | 715                    | UL497A    |                |

## DC Power Distribution Module

The DC Power Distribution Module is a unique solution to the need for high quality electrical power for the separate DC-powered components in the Structured Media Enclosure. This module reduces clutter and opens-up space in the Structured Media Enclosure by eliminating the need for multiple DC transformers. Powered by a single DC power supply, the Power Distribution module provides fully-regulated 12 VDC power for up to 6 devices.

### SPECIFICATIONS

|                                |  |
|--------------------------------|--|
| Input:                         | 110V AC  |
| Output:                        | Provides 13V DC power for up to 6 devices 1500mA |
| Compliance (Surge model only): | UL 1449  |
| Dimensions:                    | 6.58"H x 2.5"W x 1.5"D                           |
| Wire Gauge:                    | Up to 12 gauge                                   |

## DC Power Distribution Module

| DESCRIPTION                  | CAT. NO.  |
|------------------------------|-----------|
| DC Power Distribution Module | 48212-ODC |





## Structured Media™ Modules—Internet Connection Sharing and Multi-Location Networking

### 10/100 Internet Gateway Cable/DSL Broadband Router\*

Leviton's 10/100Mbps Internet Gateway (a.k.a router) allows multiple users to securely share a single, protected high-speed Internet connection.

### 10/100 base-t switches\*

At 10/100Mbps speeds, these units are excellent choices for networking PC's to meet a wide range of residential needs such as sharing files, printers and other peripherals.

\*Networked PC's and peripherals require compatible networking cards or adapters and associated software.



Cat No. 47611-GT4  
10/100Mbps Internet Gateway Router

### 10/100 Base-T Switches and 10/100 Base-T Internet Gateway Router

| SPECIFICATIONS       | 10/100BASE-T 5-PORT (OR 8-PORT) SWITCHES  | 10/100 BASE-T INTERNET GATEWAY ROUTER   |
|----------------------|---|---|
| Data Transfer Rate   | 10/100 Mbps   |   |
| Connectors           | 5 (or 8) ports, 1 AC Power Adapter Jack   | 4 LAN ports, 1 WAN port, 1 Uplink port, 1 AC Power Adapter Jack                                     |
| Cabling Requirements | Standard Cat 5/5e UTP   |   |
| LED Indicators       | One Power Indicator, 5 (or 8) Link/Activity and 5 (or 8) 100Mbps                        | One Power Indicator, one Diagnostic Indicator, five Link/Activity, five FDX/Col and five 10/100Mbps |
| Power Supply         | 12VDC, 1000mA   |   |
| Dimensions           | 5.85" x 3.2" x 1.03"  | 5.54" x 3.92" x 1.05"   |
| Standards Compliance | IEEE 802.3 10 Base-T Ethernet<br>IEEE 802.3u 100 Base-TX Fast Ethernet, and FCC Class B |   |

### 10/100 Base-T Switches and 10/100 Base-T Internet Gateway Router

| DESCRIPTION   | CAT. NO.  |
|---|-----------|
| 10/100 Base-T 5-Port Ethernet Switch, with Power Adapter  | 47611-5PT |
| 10/100 Base-T 8-Port Ethernet Switch, with Power Adapter  | 47611-8PT |
| 10/100 Base-T Internet Gateway Router, with Power Adapter | 47611-GT4 |

### Cable Distribution—Modem Outside the Structured Media Center

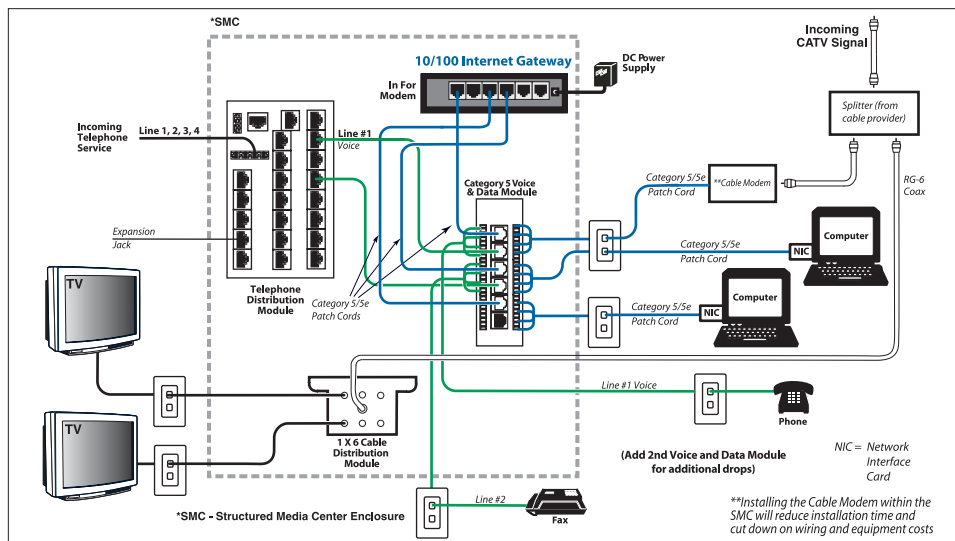

47611-5PT



47611-8PT

#### SPECIFICATIONS AND FEATURES

- Connects up to 4 devices directly (up to 253 computers via a series of cascaded devices) to the Internet using a single shared high-speed DSL, cable modem, or Satellite connection
- Allows fast Internet access at up to 100 Mbps
- Permits creation of a private high-speed home area network (HAN) or local area network (LAN) in small office/home office (SOHO) environments for all connected computers with its fast, integral 10/100Mbps auto-sensing Ethernet ports
- High performance suitable for demanding home office and telecommuting applications, including sharing of high-speed and high-capacity devices such as storage devices and back-up systems.
- Network Address Translation technology (NAT) creates a firewall that securely cloaks the private network from outside access
- Pass-through IPSEC and ISAKMP protocols allow attached LAN users to implement secure Virtual Private Network (VPN) communication applications on their PC's.
- Built-in DHCP server for easy setup and allocation of IP addresses on the LAN.
- Connections are made by running cable from desired locations to a Category 5e Voice and Data Module (either a stand-alone module page J10, or one of the units in the Pre-Configured Structured Cabling Panels page J9). From there, Category 5 or 5e patch cord can be used to connect the Gateway to the Category 5e Module.
- Network protocols: TCP/IP, DHCP, DNS, NAT, TFTP, HTTP, PPOE. Not PPOA
- Auto detect uplink: Use any port to cascade additional switches, hubs or routers



47693-ESM



47693-GSM



47693-3BY



47693-G3Y

## CATV 1GHz Video Distribution Modules

Cable service providers are converting to digital systems. These new systems will squeeze hundreds of channels plus Internet service onto the coax line. Leviton's high-performance CATV modules can support these new systems while limiting noise and other artifacts. Modules can distribute standard inputs such as CATV and antennas, and modulated inputs such as VCR's, DVD's and security camera/CCTV on coaxial cable throughout the house. Signals can be precisely controlled through the modules' built-in amplifier/attenuator (-5 to +15db) to compensate for variations in incoming signal strength for the clearest possible reception\*.

Incorporates state-of-the-art bi-directional signal paths to support cable modem or cable box communications throughout a home or office. Choose from one or three-input models; both come with 8 outputs. One and three-input models come in both nickel-plated and gold-plated connector versions.

Dimensions: 3.50"H x 6.50"W x 3.20"D, Connector: F-Type, Impedance: 75 Ohm, Power Input: 12 VDC, 500 mA (1x8 & 3x8).

\*Not for use in-line between 1 satellite dish (LNB) and DBS satellite TV receiver.

### 1x8 CATV Distribution Modules (1GHz)

| Parameter                   | Bandwidth  | Forward Path | Return Path |
|-----------------------------|------------|--------------|-------------|
| Band                        | --         | 52-1000Mhz   | 5-42Mhz     |
| Gain (Loss)                 | --         | 4dB          | (-0.5dB)    |
| Flatness                    | --         | ±0.75dB      | ±1.5dB      |
| Return Loss – Input         | --         | 22.0dB       | 21.0dB      |
| Return Loss – Output        | --         | 22.0dB       | 21.0dB      |
| Port Isolation – Output     | --         | 25.0dB       | 27.0dB      |
| Group Delay (span 3.58Mhz)  | 54-60Mhz   | 15ns         | --          |
|                             | 61-1000Mhz | 7ns          | --          |
| Group Delay (span 1Mhz)     | 5-42 MHz   | --           | 17ns        |
|                             | 10-40 MHz  | --           | 10ns        |
| Power to RF Input Isolation | 5-1000 MHz | 100dB (min)  |             |
| RFI Isolation               | 5-1000 MHz | -110dBc      |             |
| Noise Figure                | 5-1000 MHz | 3.5dB        |             |
| Distortions*                | CSO        | -65dBc       |             |
|                             | CTB        | -74dBc       |             |
|                             | Xmod       | -75dBc       |             |

\* Input level at +10dBmV flat 77 channels & 200Mhz noise for QAM test from 550 to 790Mhz

Operating Temperature: -40°C to +60 °C

### 3x8 CATV Distribution Modules (1GHz)

| Parameter                   | Bandwidth  | Forward Path | Return Path |
|-----------------------------|------------|--------------|-------------|
| Band                        | --         | 52-1000Mhz   | 5-42Mhz     |
| Gain (Loss)                 | --         | 3.5dB        | (-11.0dB)   |
| Flatness                    | --         | ±1.0dB       | ±1.5dB      |
| Return Loss – Input         | --         | 22.0dB       | 21.0dB      |
| Return Loss – Output        | --         | 20.0dB       | 21.0dB      |
| Port Isolation – Output     | --         | 25.0dB       | 25.0dB      |
| Group Delay (span 3.58Mhz)  | 54-60Mhz   | 15ns         | --          |
|                             | 61-1000Mhz | 7ns          | --          |
| Group Delay (span 1Mhz)     | 5-42 MHz   | --           | 17ns        |
|                             | 10-40 MHz  | --           | 10ns        |
| Power to RF Input Isolation | 5-1000 MHz | 100dB (min)  |             |
| RFI Isolation               | 5-1000 MHz | -110dBc      |             |
| Noise Figure                | 5-1000 MHz | 6.5dB        |             |
| Distortions*                | CSO        | -65dBc       |             |
|                             | CTB        | -74dBc       |             |
|                             | Xmod       | -75dBc       |             |

\* Input level at +10dBmV flat 77 channels & 200Mhz noise for QAM test from 550 to 790Mhz

Operating Temperature: -40°C to +60 °C

### CATV Distribution Modules

| DESCRIPTION                                      | CAT. NO.  |
|--|-----------|
| 1x8 CATV Module, 1 GHz, Nickel-plated Connectors | 47693-ESM |
| 1x8 CATV Module, 1 GHz, Gold-plated Connectors   | 47693-GSM |
| 3x8 CATV Module, 1 GHz, Nickel-plated Connectors | 47693-3BY |
| 3x8 CATV Module, 1 GHz, Gold-plated Connectors   | 47693-G3Y |



### Video Amplifier

Run cable TV and other video service signals, such as antenna or other modulated input through this Video Amplifier Module and boost video signal strength up to 25 dB. Features a variable attenuator for signal amplification level setting, and an FM trap to eliminate unwanted FM interference.

**SPECIFICATIONS**

|                        |                         |
|------------------------|-------------------------|
| Dimensions:            | 6.58"H x 3.67"W x 4.4"D |
| Frequency Range MHz:   | 50-1000                 |
| Gain Control Range dB: | 10-25dB                 |
| FM Trap dB:            | 25                      |
| Impedance:             | 75 Ohm                  |
| Connector Type:        | F-type                  |
| Power Source:          | 12 VDC 500 mA           |

### Video Amplifier

| DESCRIPTION            | CAT. NO. |
|------------------------|----------|
| Video Amplifier Module | 48210-VA |



48210-VA

**SPECIFICATIONS AND FEATURES**

- Run cable TV or other video signals through the Video Amplifier before splitting and distributing throughout the home or office.
- Boost signal strength by up to 25 dB.

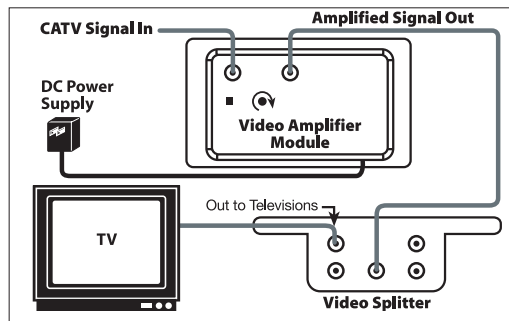



## VIDEO DISTRIBUTION



1 GHz Modules



1 GHz Video Splitters

### SPECIFICATIONS AND FEATURES

- Splits video signals. Outputs for up to 4, 6 or 8 televisions.
- Provide digital cable, cable TV and other video services, via coaxial cable, to any room in the house.
- Die-cast housing and printed circuit board.
- Use with the Video Amplifier for increased signal strength.
- Units for SMC 140, 280, 420 come with mounting bracket.
- Gold-flashed contacts on 2 GHz units provide lowest conductive resistance.



47691-3MS



47691-5MS

### SPECIFICATIONS AND FEATURES

- Distributes digital satellite signals to up to 4 TVs (47691-3MS) or 8 TVs (47691-5MS).
- Combines signals from digital satellite with off-air antenna onto single coax cable.
- DSS 75 Ohm and 2.0 GHz Combiner/Diplexer with DC Blocking, Cat. No. 40856-DSS, is available to separate antenna and cable signals.

## Passive Components

Use 4-, 6- and 8-way Passive Video Splitters to split digital cable, quality cable TV and off-air antenna signals to 4, 6, or 8 televisions throughout the home or office. They feature die-cast housing and printed circuit board construction. Use with the Video Amplifier for increased signal strength.

### 1x4, 1x6, 1x8 Passive Video Splitters

| ITEM | CAT NO.   | DIMENSION                | RANGE |
|------|-----------|--------------------------|-------|
| 1x4  | 47690-4C  | 2.14"H x 6.58"W x 1.40"D | 1 GHz |
|      | 47690-004 | 1.65"H x 3.34"W x 1.14"D | 1 GHz |
|      | 47690-4C2 | 2.14"H x 6.58"W x 1.40"D | 2 GHz |
|      | 47690-G4  | 1.65"H x 3.34"W x 1.14"D | 2 GHz |
| 1x6  | 47690-6C  | 3.00"H x 6.58"W x 1.40"D | 1 GHz |
|      | 47690-006 | 2.64"H x 3.34"W x 1.14"D | 1 GHz |
|      | 47690-6C2 | 3.00"H x 6.58"W x 1.40"D | 2 GHz |
|      | 47690-G6  | 2.64"H x 3.34"W x 1.14"D | 2 GHz |
| 1x8  | 47690-8C  | 3.00"H x 6.58"W x 1.40"D | 1 GHz |
|      | 47690-008 | 2.64"H x 3.34"W x 1.14"D | 1 GHz |
|      | 47690-8C2 | 3.00"H x 6.58"W x 1.40"D | 2 GHz |
|      | 47690-G8  | 2.64"H x 3.34"W x 1.14"D | 2 GHz |

### 1x4, 1x6, 1x8 Passive Video Splitters

|  |           |
|--|-----------|
| 1x4 Passive Video Splitter Module for SMC 140, 280, 420 (1 GHz)          | 47690-4C  |
| 1x4 Passive Video Splitter For Compact Structured Media Enclosure        | 47690-004 |
| 1x6 Passive Video Splitter Module for SMC 140, 280, 420 (1 GHz)          | 47690-6C  |
| 1x6 Passive Video Splitter For Compact Structured Media Enclosure        | 47690-006 |
| 1x8 Passive Video Splitter Module for SMC 140, 280, 420 (1 GHz)          | 47690-8C  |
| 1x8 Passive Video Splitter For Compact Structured Media Enclosure        | 47690-008 |
| 1x4 Passive Video Splitter Module for SMC 140, 280, 420 (2 GHz)          | 47690-4C2 |
| 1x4 Passive Video Splitter For Compact Structured Media Enclosure (2GHz) | 47690-G4  |
| 1x6 Passive Video Splitter Module for SMC 140, 280, 420 (2 GHz)          | 47690-6C2 |
| 1x6 Passive Video Splitter For Compact Structured Media Enclosure (2GHz) | 47690-G6  |
| 1x8 Passive Video Splitter Module for SMC 140, 280, 420 (2 GHz)          | 47690-8C2 |
| 1x8 Passive Video Splitter For Compact Structured Media Enclosure (2GHz) | 47690-G8  |

## Satellite Distribution Components

**3x4 Multi-Switch**—Passive module combines signals from dual incoming LNB digital satellite systems with off-air antenna signals on a single coaxial cable, enabling distribution to up to 4 TV's. Module incorporates a separate input for TV antenna signals (best used in combination with a video amplifier).

**5x8 Multi-Switch**—Active module combines signals from two dual incoming LNB digital satellite systems with an off-air antenna or cable signals on a single coaxial cable, enabling distribution to up to 8 TV's. Works with HDTV or standard receivers and with integrated multi-switches at the satellite dish; also works with DirecTV® systems. Equipped with built-in low noise amplifier and 24VDC power supply.

| SPECIFICATIONS                   | CAT. NO. 47691-3MS   |
|----------------------------------|--|
| <b>3x4 Multi-Switch</b>          |  |
| <b>Dimensions:</b>               | 4.77"H x 6.58"W x 2.37"D   |
| <b>Frequency:</b>                | Terrestrial: 40-860 MHz<br>Satellite: 950-2150 MHz<br>Receiver Output: 40-2150 MHz |
| <b>Connectors:</b>               | F-type, 75 Ohms  |
| <b>LNB Input Selection:</b>      | LNBA: 13/14VDC<br>LNBB: 17/18VDC   |
| <b>Insertion Loss (typical):</b> | Terrestrial: -7dB<br>Satellite: -3dB   |
| <b>Return Loss (typical):</b>    | Terrestrial: -10dB<br>Satellite: -10dB   |
| <b>Isolation (typical):</b>      | Output to Opposite Input -22dB   |
| <b>DC Power Passing:</b>         | 500ma (max.)   |

| SPECIFICATIONS                   | CAT. NO. 47691-5MS  |
|----------------------------------|---|
| <b>5x8 Multi-Switch</b>          |   |
| <b>Dimensions:</b>               | 7.14"H x 13.25"W x 2.33"D   |
| <b>Frequency:</b>                | Terrestrial: 54-806 MHz<br>Satellite: 950-2150 MHz<br>Receiver Output: 54-2150 MHz    |
| <b>Connectors:</b>               | F-type, 75 Ohms   |
| <b>LNB Input Selection:</b>      | 13/18VDC or 22kHz tone  |
| <b>Insertion Loss (typical):</b> | Terrestrial: -2dB<br>Satellite: -5dB  |
| <b>Rejection:</b>                | Satellite-Terrestrial: 30dB<br>Terrestrial-Satellite: 20dB<br>Receiver-Receiver: 30dB |
| <b>Switching Isolation:</b>      | Terrestrial: N/A<br>Satellite: 30dB   |
| <b>Noise Figure:</b>             | Terrestrial: 5dB<br>Satellite: 4.8dB  |
| <b>Max. Current to LNBS:</b>     | 500mA   |
| <b>DC Power:</b>                 | 24VDC, 600mA  |

| DESCRIPTION      | CAT. NO.  |
|------------------|-----------|
| 3x4 Multi-Switch | 47691-3MS |
| 5x8 Multi-Switch | 47691-5MS |



## Leviton Video Monitoring System

Leviton's easy-to-install, high-resolution color video cameras only require one CAT 5e cable for video and power connections, both of which are supplied by a Camera Hub in the SMC. The Camera Hub installs in a single Leviton bracket space in the SMC and the cameras mount with only two screws on a low voltage ring (Indoor Camera) or outdoor electrical box (Outdoor Camera). Standard 110 IDC terminations and 8P8C jacks make the UTP cable connections quick, simple and reliable. Indoor Camera fits in a Decora style wallplate and comes with clear and tinted lens covers. The Outdoor Camera provides 0 Lux operation with IR illumination.

The Leviton IP/Quad Module enables users to view a full-screen single Indoor or Outdoor camera view or multiple cameras, up to four at once in the same "quad" view, on one or more TV sets in the home, or via the Internet from any location using an Internet browser on a PC. Mount s directly in SMC with integral mounting bracket.

### Video Monitoring System Components

| DESCRIPTION          | CAT. NO.  |
|----------------------|-----------|
| Indoor Color Camera  | VSIND-OSC |
| Outdoor Color Camera | VSOUT-00W |
| Camera Hub           | VSHUB-000 |
| IP/Quad Module       | VSQIP-000 |



VSIND-OSC



VSOUT-00W



VSHUB-000



VSQIP-000

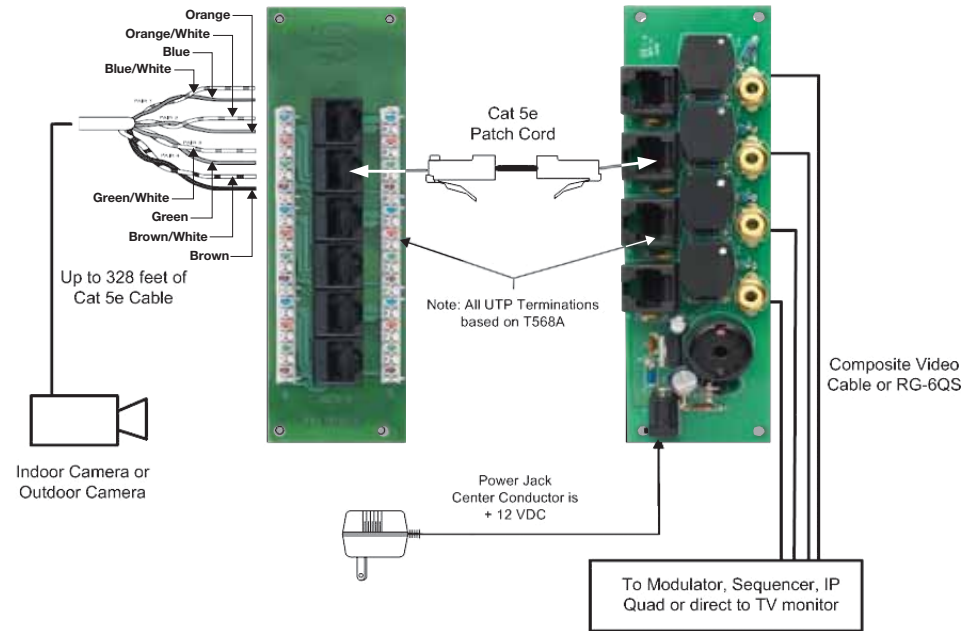

### SPECIFICATIONS AND FEATURES

#### Camera Hub

- Powers camera engines over UTP connection up to 100 meters

#### Indoor Camera

- Includes balun for clear video over UTP cable
- Includes 15VDC input power terminals for separate power cable where UTP run exceeds 100 meter limit
- Internal strap allows viewing angle adjustment
- Fits standard Decora plate with snap-in clear or smoked inserts

#### Outdoor camera

- Auto-on infrared LEDs for B&W video images in zero Lux conditions
- Includes balun for clear video over UTP cable

- Includes 15VDC input power terminals for separate power cable where UTP run exceeds 100 meter limit
- Mounts via special single-gang wallplate.
- Ball-joint strut allows 360° rotation and +/- 90° tilt viewing angle adjustment

#### IP/Quad Module

- Mounts directly to the SMC with integral mounting bracket
- Enables user to view Indoor and Outdoor Cameras on one or more TV sets in the home or via the Internet from any location using an Internet browser on a PC
- Easy browser setup and control of all cameras, including camera name, sensitivity, brightness, contrast, saturation, hue, and single or multiple camera display mode



# HOME VIDEO MONITORING SYSTEM



48213-VMA

### SPECIFICATIONS AND FEATURES

- RCA video and audio inputs.
- F-Connector output: 14-69 UHF; 70-94, 100-125 CATV.
- DC power supply.

## Media Center Modulator

The Media Center Modulator takes the signal from a video device such as a security camera (or multiple cameras using the Video Sequencer) and modulates the signal to one unused cable TV channel, which can then be combined with the CATV signal to multiple locations anywhere in the home, effectively providing a whole-house security channel.

Select the broadcast channel to be programmed via dip-switch button programming. The modulator provides 0, 10, 20 or 30 dBmV RF output.

*Note: Modulator broadcasts mono audio only. In a Structured Media System, when used with Structured Media Video Distribution modules, the Modulator must be used with a Leviton Notch Filter (PN 47690-NFA) to clear the target cable channel and avoid interference.*

### SPECIFICATIONS

|                              |                                |
|------------------------------|--------------------------------|
| <b>Dimensions:</b>           | 3.2"H x 2.25"W x 1"D           |
| <b>Inputs:</b>               | RCA video, RCA audio inputs    |
| <b>Outputs:</b>              | 1 F-connector for RF signal    |
| <b>Operational channels:</b> | 14-69 UHF; 70-94, 100-125 CATV |
| <b>Bandwidth:</b>            | 50MHZ-860MHZ                   |
| <b>Power:</b>                | 12V DC 400mA                   |

## Media Center Modulator

| DESCRIPTION            | CAT. NO.  |
|------------------------|-----------|
| Media Center Modulator | 48213-VMA |



48213-CVS

### SPECIFICATIONS AND FEATURES

- Inputs for up to four video cameras and audio sources.
- Automatic switching between cameras.
- 1-30 second variable time setting between cameras.
- RCA composite audio/video inputs and outputs.

## Video Sequencer

The Structured Media Video Sequencer, which automatically switches between video cameras, is a security product engineered for long-term home use. With the Video Sequencer, up to four Decora Cameras\* may be monitored sequentially. The Sequencer allows a variable time-interval setting from 1-30 seconds on each camera to allow thorough surveillance of any perimeter or interior. The Video Sequencer has four composite RCA audio/video inputs and two sets of RCA outputs to connect with a monitor or modulator. It snaps into a 280 or 420 Structured Media Center.

### SPECIFICATIONS

|                               |  |
|-------------------------------|--|
| <b>Dimensions:</b>            | 7.4"H x 4.75"W x 2"D                       |
| <b>Power:</b>                 | 12 VDC @ 300mA                             |
| <b>Inputs:</b>                | Four RCA video; Eight RCA left/right audio |
| <b>Outputs:</b>               | 2 RCA video and 4 RCA left/right audio     |
| <b>Time interval:</b>         | 1-30 seconds, variable/adjustable          |
| <b>Signal to Noise Ratio:</b> | <1.2dB                                     |
| <b>Bandwidth:</b>             | 5MHz                                       |

## Video Sequencer

| DESCRIPTION     | CAT. NO.  |
|-----------------|-----------|
| Video Sequencer | 48213-CVS |

*\*Not for use with Indoor/Outdoor B&W Camera with built-in modulator (Cat. No. 48213-BMC).*



**Indoor/Outdoor B&W Camera with Built-in Modulator**

The Indoor/Outdoor B&W Camera allows monitoring of front doors, back yards, and anywhere an extra eye is desirable. It is designed to withstand temperature and environmental extremes when mounted in a suitable location.\* The camera uses a single wire for power and video making installation easy. Output is controlled by a dip-switch inside the camera housing. Permits 360° horizontal adjustment and 180° vertical adjustment.

*\*Recommended mounting is in a sheltered location such as under an eave or overhang and away from direct exposure to rain and snow.*

*Not for use with video sequencer*

**SPECIFICATIONS**

|                              |                                |
|------------------------------|--------------------------------|
| <b>Dimensions:</b>           | Base 5.5" x 4.5"               |
| <b>Power:</b>                | 12 VDC, 300mA                  |
| <b>Output Connection:</b>    | F-Connector, 75 Ohm            |
| <b>Camera Lens:</b>          | 3.6 mm                         |
| <b>Resolution:</b>           | 350+ lines                     |
| <b>Minimum Illumination:</b> | 0.7 lux                        |
| <b>Output Level:</b>         | 27 dBmV                        |
| <b>Output Frequency:</b>     | UHF 14-69, CATV 70-94, 100-125 |
| <b>Cable Type:</b>           | RG 59, RG6 or better           |



48213-BMC

**Indoor/Outdoor B&W Camera with Built-in Modulator**

| DESCRIPTION                                       | CAT. NO.  |
|---|-----------|
| Indoor/Outdoor B&W Camera with Built-in Modulator | 48213-BMC |

**RF Notch Filter**

The RF Notch Filter is an essential element of Home Security Monitoring and Multi-Room Video. It blocks incoming cable TV channels 75-80, allowing the Media Center Modulator or Component Modulator to broadcast an in-house "security" or "entertainment" channel over the coaxial cable system without interference. The Notch Filter simply couples to the coaxial cable TV input on either a splitter or an active video distribution device. Once installed, it filters out six cable channels to make room for any home security or entertainment video application. It also blocks outgoing signals, such as cameras, from being broadcast outside the home.

**SPECIFICATIONS**

|                           |                     |
|---------------------------|---------------------|
| <b>Dimensions/Weight:</b> | 3"L x .9"W – 2lbs   |
| <b>Type:</b>              | Passive RF filter   |
| <b>Bandwidth:</b>         | CATV channels 75-80 |
| <b>Input:</b>             | Female F-connector  |
| <b>Output:</b>            | Male F-connector    |



47690-NFA

**RF Notch Filter**

| DESCRIPTION     | CAT. NO.  |
|-----------------|-----------|
| RF Notch Filter | 47690-NFA |



# RESIDENTIAL INTERCOM SYSTEM



A



C, D, E

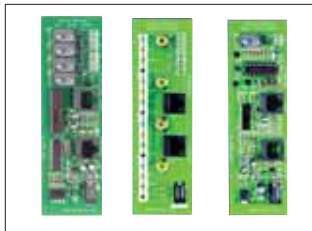

F, G, H

## RESIDENTIAL INTERCOM SYSTEM

Leviton brings the home intercom into the 21st century with the introduction of its new Residential Intercom system for Structured Media™ installations. Available as a series of easy-to-install components, the Residential Intercom system is designed to incorporate easily into the category 5-based modular structured wiring systems that have become a standard feature of today's high-tech homes.

| DESCRIPTION  | CAT. NO.  |
|--|-----------|
| A-Intercom Kit (includes Main Controller Board, 1 Interface Board on a bracket with 1 Outdoor station) | 47000-MKB |
| B-Main Controller Board  | 47000-00M |
| C-Outdoor Station (Brushed nickel finish)  | 47000-0D1 |
| D-Indoor Station (White)   | 47000-0W1 |
| E-Indoor Station (Black)   | 47000-0E1 |
| F-Door Strike Module   | 47000-STR |
| G-Interface Board with 4 additional ports  | 47000-PRT |
| H-Door Chime Module  | 47000-CHM |

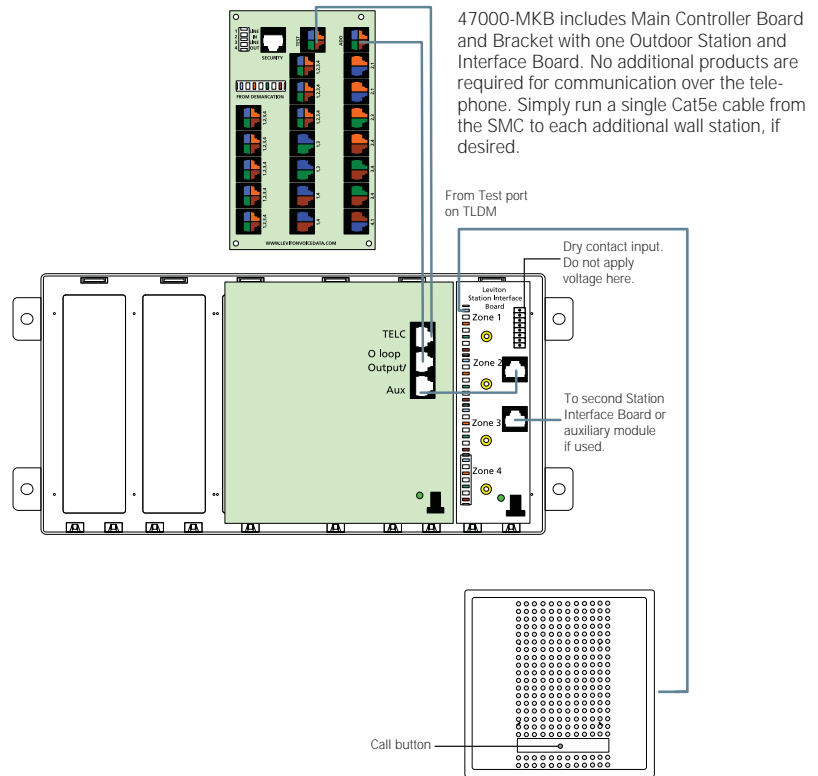

### SPECIFICATIONS AND FEATURES

- Main controller board installs easily in SMC
- System integrates with other services in SMC (phone system, door strike, lighting controls, door bell, dry contact security devices and Indoor and Outdoor Stations)
- Supports up to 12 wall station locations in four zones
- Onboard firmware for music-on-hold
- Answering machine function for message and message taking for intercom activations
- Allows call-on-hold for hang-up at one location and pick-up at another
- Allows whole-house paging, including phone-to-phone paging
- CCTV capability integrated in Interface Board





**Leviton Architectural Edition™ powered by JBL Products and Systems**

When music and film professionals who create and record sound for a living have to “get it right,” they insist on JBL. Because they know JBL systems will faithfully deliver all the clarity, accuracy and impact of the original performance. When it comes to entertaining at home, why settle for less than the recording industry’s best? Especially when Leviton makes it easy to build premium JBL sound right into the home and enjoy music, movies and more with the same legendary quality heard in concerts, clubs, recording studios, and from behind the screens of the best theaters in the world.

The Leviton Architectural Edition powered by JBL program transforms a living room into a cinema, a deck into an outdoor concert, a kitchen into an elegant bistro, a dining room into a dance hall. Even a master bath turns into a luxurious private retreat. Most important, Leviton/JBL systems are the product of precision engineering, advanced audio technology, painstaking craftsmanship and the latest advances in materials— the same technologies, features and performance that make JBL the first choice of professionals. And they are offered through a select network of quality homebuilders and trained installation professionals working with Leviton, the leader in residential connectivity and home networking systems.

**Leviton Architectural Edition™ powered by JBL Indoor In-Wall and In-Ceiling Speakers**

Leviton/JBL multi-room In-Wall and In-Ceiling Speakers can deliver a professional listening experience in the home because they incorporate the same features and technologies found in JBL’s renowned family of professional studio monitors, including an Elliptical Oblate Spheroidal™ (EOS) Waveguide for improved high-frequency dispersion throughout a listening area, Titanium-laminate drivers to ensure musical accuracy and clarity, and HeatScape™ magnetic structures for impact and bass realism.

**6.5-Inch (170mm) Two-Way In-Wall Loudspeaker**

Acoustically transparent paintable baffles and grilles. 1” (25mm) Titanium laminate dome tweeter and 6.5” (170mm) Titanium-laminate woofer, Frequency Response (-10dB): 38 Hz-20 kHz, Sensitivity (2.83V/1m): 88 dB, Power Handling: 80 Watts, Impedance: Nominal 8 Ohms, Dimensions: 11” (279mm) H x 8.5” (226mm) W x 3.87” (98mm) D. Weight: 5 lb/2.3 kg per speaker. Sold in pairs.

| DESCRIPTION                          | CAT NO. |
|--------------------------------------|---------|
| 6.5-Inch Two-Way In-Wall Loudspeaker | AEI65   |

**8-Inch (200mm) Two-Way In-Wall Loudspeaker**

Acoustically transparent paintable baffles and grilles. 1” (25mm) Titanium laminate dome tweeter and 8” (200mm) Titanium-laminate woofer, Frequency Response (-10dB): 30 Hz-20 kHz, Sensitivity (2.83V/1m): 89 dB, Power Handling: 100 Watts, Impedance: Nominal 8 Ohms, Dimensions: 13.12” (333mm) H x 10.12” (257mm) W x 4” (102mm) D. Weight: 7.8 lb/3.5kg per speaker. Sold in pairs.

| DESCRIPTION                        | CAT NO. |
|------------------------------------|---------|
| 8-Inch Two-Way In-Wall Loudspeaker | AEI80   |

**6.5-Inch (170mm) Two-Way In-Ceiling Loudspeaker**

Acoustically transparent paintable baffles and grilles. 1” (25mm) Titanium laminate dome tweeter and 6.5” (170mm) Titanium-laminate woofer, Frequency Response (-10dB): 40 Hz-20 kHz, Sensitivity (2.83V/1m): 88dB, Power Handling: 80 Watts, Impedance: Nominal 8 Ohms, Dimensions: 9.18” (233mm) Diameter x 4.25” (108mm) Depth. Weight: 4.5 lb/2.0 kg per speaker. Sold in pairs.

| DESCRIPTION                             | CAT NO. |
|---|---------|
| 6.5-Inch Two-Way In-Ceiling Loudspeaker | AEC65   |

**8-Inch (200mm) Two-Way In-Ceiling Loudspeaker**

Acoustically transparent paintable baffles and grilles. 1” (25mm) Titanium laminate dome tweeter and 8” (200mm) Titanium-laminate woofer, Frequency Response (-10dB): 32 Hz-20 kHz, Sensitivity (2.83V/1m): 89 dB, Power Handling: 100 Watts, Impedance: Nominal 8 Ohms, Dimensions: 10.87” (275mm) Diameter x 4.25” (108mm) Depth. Weight: 5.3 lb/2.5 kg per speaker. Sold in pairs.

| DESCRIPTION                           | CAT NO. |
|---------------------------------------|---------|
| 8-Inch Two-Way In-Ceiling Loudspeaker | AEC80   |

**6.5-Inch (170mm) Two-Channel/Single Location Two-Way In-Ceiling Loudspeaker**

Acoustically transparent paintable baffles and grilles. Reproduces two channels of stereo from one location. Dual .75” (19mm) Titanium laminate dome tweeters and 6.5” (170mm) Dual voice-coil Titanium-laminate woofer, Frequency Response (-10dB): 40 Hz-20 kHz, Sensitivity (2.83V/1m): 88 dB with both channels driven, Power Handling: 100 Watts total, Impedance: Nominal 8 Ohms, Dimensions: 9.8” (233mm) Diameter x 4.25” (108mm) Depth. Weight: 4 lb/1.8kg per speaker. Sold individually.

| DESCRIPTION   | CAT NO. |
|---|---------|
| 6.5-Inch Two-Channel/Single Location Two-Way In-Ceiling Loudspeaker | AEM65   |

Note: See page J24 for In-Wall and In-Ceiling Preconstruction Kits



AEI65



AEI80



AEC65



AEC80



AEM65



AEN24



AES36



AEI55



AECCS



AESUB

## Pre-Construction Kits for Leviton/JBL In-Wall and In-Ceiling Speakers

| DESCRIPTION  | CAT NO.   |
|--|-----------|
| Pre-Construction Kit - 6.5" In-Ceiling Speakers      | PCC55-KIT |
| Pre-Construction Kit - 8" In-Ceiling Speakers        | AEPC8-KIT |
| Pre-Construction Kit - 6.5" In-Wall Speakers         | AEPI6-KIT |
| Pre-Construction Kit - 8" In-Wall Speakers           | AEPI8-KIT |
| In-Wall Shelf Pre-Construction (for use with AAEI55) | AEPI8-KIT |

## Leviton Architectural Edition™ powered by JBL Outdoor/All-Weather Speakers

As the brand delivering sound in more concert venues than any other (including all three Woodstock festivals) JBL is extremely qualified to bring premium sound outdoors. These outdoor speakers are engineered to withstand long-term exposure to the elements right down to their weatherized grilles and input connectors. They are also ideal for indoor pools, atriums and other large open spaces where enclosure speakers with large-area coverage are desired.

### Outdoor/All-Weather Two-Way Loudspeaker

Professional-grade injection-molded weather-resistant ported base-reflex enclosure with metal-mesh grille, .75" (19mm) Titanium laminate dome tweeter and 4" (100mm) WeatherPlas™ (polymer-coated cellulose fiber cone) woofer with rubber surround, high-temperature/oversized Kapton® voice coil and HeatScape™ motor structure, Frequency Response (-3dB): 75 Hz-20 kHz, Sensitivity (2.83V/1m): 86 dB, Power Handling: 100 Watts, Impedance: Nominal 8 Ohms, Dimensions: 9.5" (241mm) H x 6.25" (159mm) W x 4.75" (121mm) D. Weight: 4.5 lb/2.1 kg per speaker. Sold in pairs.

| DESCRIPTION                             | CAT NO. |
|---|---------|
| Outdoor/All-Weather Two-Way Loudspeaker | AEN24   |

### Outdoor/All-Weather Three-Way Loudspeaker

"Extreme performance" three-way professional-grade sealed enclosure speaker with all-metal, gold-plated binding posts for outdoor applications and for music and home theater installations (as a satellite with a subwoofer system). 1" (25mm) Pure Titanium laminate dome tweeter, 4" (100mm) WeatherPlas™ shielded midrange with Linear Field Proximity (LFP) bezel and 6" (150mm) WeatherPlas™ (polymer-coated cellulose fiber cone) woofer with rubber surround, high-temperature/oversized Kapton® voice coil, Frequency Response (-3dB): 60 Hz-20 kHz, Sensitivity (2.83V/1m): 90 dB, Power Handling: 150 Watts, Impedance: Nominal 8 Ohms, Dimensions: 10.25" (260mm) H x 14.62" (371mm) W x 5" (127mm) D. Weight: 11 lb/5 kg per speaker. Sold in pairs

| DESCRIPTION                               | CAT NO. |
|---|---------|
| Outdoor/All-Weather Three-Way Loudspeaker | AES36*  |

\* See Leviton.com for current Leviton part number.

## Leviton Architectural Edition™ powered by JBL Home Theater Speaker Components

JBL systems measure-up to higher standards than "home" theater, because more JBL speakers are found in film recording studios and behind the screens of the worlds best movie theaters than any other brand. This select group of installed and enclosed speakers for residential home-theater applications can bring cinema realism to any living room.

### Two-Way In-Wall Center Channel Speaker

Can be used in front-speaker home theater applications either singly with Leviton/JBL In-Wall left and right speakers or in a matched set of three left/right/center speaker in ultra-premium installations. Acoustically-transparent paintable baffle and grille. 1" (25mm) Pure Titanium dome tweeter and two 5" (125mm) Polymer-coated aluminum woofers, Frequency Response (-10dB): 40 Hz-20 kHz, Sensitivity (2.83V/1m): 88 dB, Power Handling: 120 Watts, Impedance: Nominal 8 Ohms, Dimensions: 7.5" (191mm) H x 15.37" (391mm) W x 3.87" (98mm) D. Weight: 5.7 lb/2.5 kg per speaker. Sold individually

| DESCRIPTION                            | CAT NO. |
|--|---------|
| Two-Way In-Wall Center Channel Speaker | AEI55   |

### Dual 5-Inch (125mm) Two-Way Shelf-Mount Center Channel Loudspeaker

Enclosed free-standing, shelf-mounted center-channel speaker to accompany in-wall installed left and right speakers like the Leviton/JBL AEI65, AEI80 and AEI55. .75" (19mm) Titanium laminate dome shielded tweeter and two 5" (130mm) PolyPlas™ shielded woofers, Frequency response (-3dB): 75 Hz-20 kHz, Sensitivity (2.83V/1m): 90 dB, Power Handling: 75 Watts, Impedance: Nominal 8 Ohms, Dimensions: 6.5" (165mm) H x 20.25" (514mm) W x 9.62" (244mm) D. Weight: 9.6 lb/4.4 kg per speaker. Sold individually..

| DESCRIPTION  | CAT NO. |
|--|---------|
| Dual 5-Inch (130mm) Two-Way Shelf-Mount Center Channel Loudspeaker | AECCS   |



**Powered 12-Inch Subwoofer**

Freestanding front firing, powered (amplified) subwoofer to reinforce in-wall and in-ceiling installed systems in home theater viewing. High-efficiency, high current switched amplifier. Variable low-pass crossover and output level (volume) control. 12" (300mm) PolyPlas™ woofer with heat-resistant voice coil, front-firing enclosure. Amplifier output (RMS): 300 Watts, Dynamic power (peak): 600 Watts, Frequency response (+/- 3dB): 25 Hz low-pass crossover setting (variable), Dimensions: 19.75" (502mm) H x 14.37" (365mm) W x 18" (457mm) D. Weight: 39.5 lb/18 kg. Sold individually.

| DESCRIPTION           | CAT NO. |
|-----------------------|---------|
| Powered 12" Subwoofer | AESUB   |

**Leviton Architectural Edition™ powered by JBL On-Wall Home Cinema Speaker System**

An ideal solution for home theater locations where an in-wall/ in-ceiling installed home theater speaker solution is impractical but full performance is desired (such as in room corner installations). This is a 5-channel surround-sound package that is expandable to 6.1 or 7.1 surround-sound operation with the addition of optional matched AESS5 Expansion Satellite Speaker(s). Includes 5 mounting brackets and subwoofer input RCA cable. Available in White or black finish



**Home Cinema Speaker System**

Speaker Complement: Five 2-way magnetically shielded satellite speakers with high-output 2.5" (63.5mm) woofer and precision .5" (12.7mm) tweeter, and one 8" (200mm) 100 watt powered subwoofer with LFE input, adjustable level control, and built-in crossover network for use with speaker-level outputs. Enclosure: Bass-reflex with FreeFlow™ flared port, Recommended power range: 10-100 Watts, Subwoofer Frequency Response (+/- 3dB): 150 Hz-20kHz, Satellite Speaker Sensitivity (2.83V/1m): 86dB, Satellite Impedance: Nominal 8 Ohms, Dimensions (Subwoofer): 16.25" (413mm) H x 11" (279mm) W x 13.75" (349mm) D, Dimensions (Satellite Speaker): 5" (127mm) H x 3.5" (88mm) W x 3.5" (88mm) D Subwoofer weight: 28 lb/12.7 kg.

**Expansion Satellite Speaker**

One 2-way magnetically shielded satellite speaker with high-output 2.5" (63.5mm) woofer and precision .5" (12.7mm) tweeter. Recommended power range: 10-100 Watts, Frequency Response (+/- 3dB): 150 Hz-20kHz, Speaker Sensitivity (2.83V/1m): 86dB, Impedance: Nominal 8 Ohms, Dimensions (Satellite Speaker): 5" (127mm) H x 3.5" (88mm) W x 3.5" (88mm) D Weight: 1.8lb/0.8kg per speaker.

| DESCRIPTION  | CAT NO.  |
|--|----------|
| 5-Channel Surround-Sound Home Cinema Speaker System with 100 Watt Powered subwoofer and 5 Satellite Speakers - Black | AEH50-BL |
| 5-Channel Surround-Sound Home Cinema Speaker System with 100 Watt Powered subwoofer and 5 Satellite Speakers - White | AEH50-WH |
| Optional AEH50 System matched satellite Speaker for 6.1 and 7.1 surround-sound operation – Black                     | AESS5-BL |
| Optional AEH50 System matched satellite Speaker for 6.1 and 7.1 surround-sound operation – White                     | AESS5-WH |

**Rough-In Kit/Adapter Wallplate for JBL Satellite Speaker**

Decorative Satellite Speaker Adapter Wallplate. Dimensions: 4.5" (114mm) H x 2.75" (70mm) W x .25" (6mm) D Weight : 1 oz./0.3 kg

| DESCRIPTION  | CAT NO.  |
|--|----------|
| Rough-In Kit/Adapter Wallplate for JBL Satellite Speaker - White | AEPHK-WH |
| Rough-In Kit/Adapter Wallplate for JBL Satellite Speaker - Black | AEPHK-BL |



HKAVR-XXX



HKDVD-038



HKDC-000



HKPOD-000



HKABV-000

### Audio/Video Entertainment Center Components and Accessories from Harman/Kardon™

There is no better way to assure the highest performance and value from a state-of-the-art Leviton/JBL than to power it with matched Harman/Kardon Entertainment Center. The Harman/Kardon components available as part of the Leviton/JBL program represent a summary of today's most advanced analog and digital audio and video technologies—and ensure full compatibility with the home entertainment formats and platforms of the future.

#### Harman/Kardon Audio/Video Receivers

Harman/Kardon 7.1-channel digital audio/video receivers offer a wealth of listening and viewing options, including high-current amplifier design for accurate tracking of musical and audio/video source information, the latest HDMI audio/video input and switching, auto speaker calibration for surround sound perfection, multi-room audio, XM Satellite Radio and I-Pod capability, and much more, all in a elegant package.

| DESCRIPTION   | CAT NO.    |
|---|------------|
| 7.1 Channel Surround Sound A/V Receiver, w/HDMI™ Switching and A-BUS® | HKAVR-XXX* |
| 7.1 Channel Surround Sound A/V Receiver, w/HDMI™ Switching            | HKAVR-XXX* |

#### High-Performance Single-Disc DVD Player

Advanced video performance requires a maximum resolution source, because the best TV screen is only as good as what's fed into it. The Harman/Kardon progressive-scan DVD Player is equal to the task, with HDMI output, DCDi by Faroudja video processing, and up-scaling to 1080i high-definition playback.

| DESCRIPTION  | CAT NO.    |
|--|------------|
| High-Performance Single-Disc DVD Player with HDMI Output and 1080i Upscaling | HKDVD-038* |

#### High-Definition 5-Disc CD Carousel Changer

The Harman/Kardon Changer compliments your multi-room audio system by delivering hours of music with a wide range of programming options to customize the mix – and advanced digital signal processors and digital output capability to ensure that every musical note is delivered free from distortion.

| DESCRIPTION                                | CAT NO.   |
|--|-----------|
| High-Definition 5-Disc CD Carousel Changer | HKDC-000* |

#### The Bridge™ iPod Docking Station

The Bridge docking station allows your favorite iPod tracks and playlists to be controlled and heard through an entire home entertainment system when used with a compatible Harman/Kardon A/V Receiver.

| DESCRIPTION                      | CAT NO.    |
|----------------------------------|------------|
| The Bridge™ iPod Docking Station | HKPOD-000* |

#### Infrared Remote Sensor

The low-profile IR remote sensor can be placed conveniently to control audio and video components with a compatible receiver's remote control even when they are in a cabinet or entertainment center. All Harman/Kardon AV products can be connected together so that one IR Sensor can operate them all.

| DESCRIPTION      | CAT NO.    |
|------------------|------------|
| IR Remote Sensor | HKRMS-000* |

### Harman/Kardon™ A-BUS® System

Multi-room music is easy with these amplified volume controls and distribution hub. The hub simply plugs into the back of an A-BUS Ready® Harman/Kardon (or other brand) A/V Receiver, and sends a selected sound source to up to four rooms/zones where the amplified volume controls take over. The system is ideal for background and casual indoor audio entertaining applications.

#### Amplified In-Wall A-BUS Volume Control

A Decora up/down amplified rocker-style volume control for dedicated speakers in a single room/zone for use with any A-BUS Ready Harman/Kardon A/V Receiver. Also accepts control commands to A/V receiver or other compatible components via a built-in IR sensor.

| DESCRIPTION                             | CAT NO.    |
|---|------------|
| Amplified In-Wall A-BUS® Volume Control | HKABV-000* |

#### A-BUS® Hub 4-Zone System Expansion

When used with the A-BUS interface on compatible HKAVR A/V Receivers, it allows the A/V Receiver to operate up to four rooms/zones of distributed audio (with HKABV Volume Controls and connected speakers).

| DESCRIPTION                        | CAT NO.    |
|------------------------------------|------------|
| A-BUS® Hub 4-Zone System Expansion | HKABH-000* |

\* See Leviton.com to confirm current Leviton part number. Check with your Leviton salesperson for product availability.



### Leviton Architectural Edition™ Multi-Room Audio Amplifiers

Leviton's AE6MA and AE6MC Architectural Edition Multi-Room Audio Amplifiers combine advanced audio engineering, high-current performance and tremendous value in a single low-profile chassis that delivers superior multi-channel amplification to meet the needs of the most demanding residential multi-zone systems. Combining "audiophile" sound quality with commercial reliability, these amplifiers are a no-compromise solution for large, high-output multi-room listening systems. The amplifiers are designed for long-term use with advanced circuit protection and a thermostatically-controlled cooling fan. The AE6MA is a perfect balance of performance and simplicity, with input source flexibility through a unique "electronic channel link" feature that enables different single sources to be assigned to different rooms/zones. The AE6MC is the ultimate in listening flexibility, with advanced LCD keypads that enable the selection of up to seven different audio sources in any room with full independent control.



AE6MA



AE6MA-back

#### Single-Source 12 Channel (6 Stereo Pairs) Six-Room/Zone Multi-Channel Power Amplifier

Output power: 50 Watts nominal (40 watts per channel 20Hz to 20kHz @ <0.2% THD, all channels driven into 8 ohms); Peak output power: 100 watts per channel; Inputs: Gold-plated RCA jacks with adjustable input gain; Outputs: 5-way gold-plated binding posts; Total Harmonic Distortion (THD): Less than 0.1% 20 Hz to 20 kHz; Signal-to-noise ratio: Over 105 dB; Fan noise: Quiet 28 dB; Dimensions: 3.5 in (89mm) H x 17 in (432mm) W x 11.5 in (292mm) D

| DESCRIPTION                                 | CAT NO. |
|---|---------|
| 12 Channel (6 Stereo Pairs) Power Amplifier | AE6MA   |



AE6MC



AE6MC-back

#### Seven-Source 12 Channel (6 Stereo Pairs) Six-Room/Zone Multi-Channel Power Controller/Amplifier

Output power: 50 Watts nominal (40 watts per channel 20Hz to 20kHz @ <0.2% THD, all channels driven into 8 ohms); Peak output power: 100 watts per channel; Inputs: 14 gold-plated RCA jacks with adjustable input gain and a fully buffered RCA jack output for each; Outputs: Removable screw terminal, accepts 12-20 gauge wire; Total Harmonic Distortion (THD): Less than 0.1% 20 Hz to 20 kHz; Signal-to-noise ratio: Over 105 dB; Fan noise: Quiet 26 dB; Dimensions: 3.5 in (89mm) H x 17 in (432mm) W x 11.5 in (292mm) D

| DESCRIPTION   | CAT NO.   |
|---|-----------|
| Seven-Source, Six-Room Multi-Channel Controller-Amplifier | AE6MC     |
| Keypad Controller for AE6MC                               | AE6MC-PAD |
| Remote Control for AE6MC                                  | AE6MC-RMT |



AE6MC-PAD

#### SPECIFICATIONS AND FEATURES

##### Single-Source 12 Channel (6 Stereo Pairs) Six-Room/Zone Multi-Channel Power Amplifier

- Automatic protection circuitry
- Individual input gain adjustment
- External power ON/OFF through external controllers
- Channel Link allows channels to have individual sources or share a common source
- Cooling fan prevents overheating and maximizes energy efficiency

##### Single-Source 12 Channel (6 Stereo Pairs) Six-Room/Zone Multi-Channel Power Amplifier

- Seven source input selection for each amplifier

- RS-232 port for use with whole-house and PC-based compatible control systems
- Six internal 80+ position stereo volume controls
- High efficiency/small space.
- Automatic protection circuitry
- Individual bass, treble and balance adjustment of speakers in each room
- External power ON/OFF through external controllers
- All-zone control through use of AE6MC keypad
- Cooling fan prevents overheating and maximizes energy efficiency



An entertainment system is like a chain – it can only be as strong as its weakest link. The Leviton Architectural Edition series of products was developed to make sure that every link in the system—volume controls, distribution and connection components, even multi-room amplifiers—have no weak points and are as “state-of-the-art” in performance as the systems’ speakers. The Leviton Architectural Edition is a complete solution for entertainment system designers and installers. Leviton’s award-winning System Matching module and Strauss™ Transformer-Free volume controls use advanced aerospace technology to deliver ruler-flat frequency response to every zone of a multi-room audio system. The Architectural Edition multi-room audio amplifiers combine advanced audio engineering, high-current performance and tremendous value in a single low-profile chassis that delivers superior multi-channel amplification to meet the needs of the most demanding residential multi-zone systems. The advanced circuit engineering inside Leviton’s home theater and multi-room wallplates means that audiophile-grade connectivity can be easy and quick to install.

## Composer Series Volume Controls

Leviton’s Composer Series controls are built to a single quality standard, which means system designers can specify them for any distributed sound application with total confidence. (Leviton’s Strauss and Chopin Digital Volume controls use the same heat-dissipation technology used on the space shuttle and resistive switching to achieve ruler-flat frequency response.) On the Brahms rotary controls, tapped auto-transformer design provides a stable interface between high-current amplification and speakers of virtually any type while resisting contamination from dust and dirt. All audio power ratings are UL referenced. All volume controls feature screw connectors for long-term connection integrity.

## Decora® Strauss™ Transformer-Free™ and Impedance Matching Transformer-Free™ Volume Controls

In multi-room distributed audio systems, the source of undesirable speaker coloration (usually perceived as a “muffled” sound) is often the volume control itself, because the audio transformers (AKA: autoformers) used in conventional controls can actually filter the bass and treble frequencies. The Decora Strauss Transformer-Free Volume Controls use audio-grade Cermetile resistors to change volume levels while leaving the audio signal unaffected, resulting in ruler-flat frequency response across the entire audible frequency range. Moreover, Decora Strauss Transformer-Free Volume Controls eliminate the problem of “saturation” associated with conventional volume controls and can handle tremendous amounts of music power. Available in standard and impedance-matched versions.



SGVST-00W

### SPECIFICATIONS

|                     |   |
|---------------------|---|
| Speaker Impedance:  | 2-16 Ohms (nominal 8 Ohms)  |
| Power Handling:     | 200W peak/100W RMS  |
| Frequency Response: | 20Hz-20KkHz +/- 1dB   |
| Dimensions:         | 4.06"(103.1) H x 1.32"(33.5) W x 2.5"(63.5) D   |
| Mounting:           | Standard single-gang design with a mounting depth of 2.5"                                     |
| Wire Gauge:         | Detachable cable connectors are compatible with all standard speaker wire sizes (14-18 gauge) |
| Color:              | White (Optional color change kits available)  |

### Decora Strauss Transformer-Free Volume Control

| DESCRIPTION  | CAT NO.–WHITE |
|--|---------------|
| Decora Strauss Transformer-Free Impedance-Matched Volume Control | SGVSM-00W     |
| Decora Strauss Transformer-Free Volume Control                   | SGVST-00W     |
| Color change kit converts to Ivory and Almond                    | SGVCK-IA      |
| Color change kit converts to Ebony                               | SGVCK-00E     |
| Color change kit converts to Light Almond                        | SGVCK-OLA     |

### SPECIFICATIONS AND FEATURES

- Decora slide control with precision 12-position switch (including fully-OFF position)
- Transformer-Free™ volume controls deliver rich, full sound at any volume level in any room
- Aerospace-grade Cermetile resistors replace conventional autoformers to maintain audio signal purity
- Detachable cable connector is compatible with all standard speaker wire (14-18 gauge)



### Decora Digital™ Chopin™ Volume Control

Fill a room with high-quality audio at the touch of a button, replacing traditional transformers and rotary controls with this advanced interface module and one-touch Decora Chopin Rocker-Switch Wall Unit. Attractive Decora styling and transformer-less design delivers simplicity and superior sound-quality, and enables “three-way” volume control operation in larger rooms/zones. The Volume Control mounts in a standard wall box or low-voltage mounting bracket and connects via Category 5 cable to the Interface Module.

#### SPECIFICATIONS

|  |  |
|--|--|
| Peak RMS Power Rating:                                 | 200 Watts per channel                                |
| Continuous Power Rating:                               | 100 Watts RMS per channel                            |
| Frequency Response, all rated power levels, +/-0.1 dB: | DC-50,000 Hz   |
| Speaker Impedance:                                     | 4-16 Ohms nominal                                    |
| Speaker/Amplifier Connection:                          | Removable, snap-in audio monoblock w/screw terminals |
| Power:   | 12 Volts DC, 200 mA                                  |



48211-WVK



48211-WVC

### Decora Digital Volume Control Systems

| DESCRIPTION   | CAT. NO.  |
|---|-----------|
| Decora Digital Volume Control Kit (Includes Interface Module and Wall Unit with Power Supply) | 48211-WVK |
| Decora Digital Volume Control Wall Unit   | 48211-WVC |

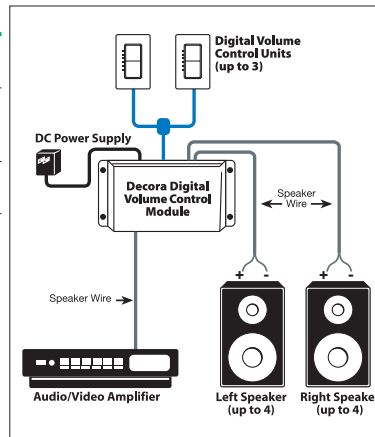

### Brahms Autoformer Volume Controls

On the Brahms series of rotary controls, tapped auto-transformer design provides a stable interface between high-current amplification and speakers of virtually any type while resisting contamination from dust and dirt.

#### Brahms™ Stereo Volume Controls—75 Watt Audio

The 75 Watt Brahms series (25 Watts RMS) of volume controls is designed for low to moderate power installations in the home. The units accommodate 4, 8 or 16 Ohm speakers and amplifiers up to 75 Watts. All controls are impedance matching.

Attenuation: -34 dB in 12 steps. Attenuator Type: Tapped auto transformer. Power Rating: UL Listed @ 75 Watts audio, 25 Watts RMS continuous. Frequency Response: 35 Hz–20 kHz. Screw type connections, 12 position rotary switch.

#### Decora® Brahms™ Stereo Volume Controls—75 Watt Audio

Control stereo volume from convenient wall-mounted location.

| DESCRIPTION  | CAT NO.—WHITE |
|--|---------------|
| Decora Brahms Stereo Volume Control, 75 Watt, 25 Watt RMS with insert, knob and plate. Boxed unit pack, rack pack carton | 40841-ODW     |



40841-ODW

#### SPECIFICATIONS AND FEATURES

##### Decora Digital Chopin Volume Control

- Connects to Interface Module with a single RJ-45 connection. No direct speaker/amplifier connections required at the controller.
- Microprocessor-controlled relays for silent switching.
- Provides impedance matching with speakers from 4–16 Ohms.
- Terminates all amplifier and speaker connections using high-quality audio connection block.
- Digital, transformer-free design uses aerospace-quality cermet resistors for proper heat dissipation and superior performance.
- Each audio zone requires one Digital Volume Control module.
- Each Digital Volume Control module can support up to three volume control units.
- Each Digital Volume Control module can control up to 4 pairs of speakers.
- Tap mute feature activated when center of rocker panel is pressed.



## OTHER HOME ENTERTAINMENT PRODUCTS



40905-25W

### Decora® Brahms™ Stereo Volume Control with ON/OFF Switch—75 Watt Audio

Control of ON/OFF, as well as volume control.

| DESCRIPTION  | CAT NO.—WHITE |
|--|---------------|
| Decora Brahms Stereo Volume Control, 75 Watt, 25 Watt RMS with insert, knob and plate. Boxed unit pack, rack pack carton | 40905-25W     |

### Decora® Brahms™ Stereo Volume Controls—216 Watt Audio

The 216 Watt Audio (72 Watt RMS) Strauss volume control series is designed for higher power installations in the home. Their heavy-duty autoformer construction is designed to resist saturation and degradation even after years of high-volume use. The units accommodate 4, 8 or 16 Ohm speakers and amplifier systems rated up to 216 Watts. All controls are impedance matching.

Attenuation: -34 dB in 12 steps. Attenuator Type: Tapped auto transformer. Power Rating: UL Listed @ 216 Watts Audio, 72 Watts RMS continuous. Frequency Response: 35 Hz–20 kHz. Screw type connectors, 12 position rotary switch.

### Decora® Brahms™ Stereo Control with ON/OFF Switch—216 Watt Audio

Convenience of ON/OFF, as well as volume control.

| DESCRIPTION   | CAT NO.—WHITE |
|---|---------------|
| Decora Brahms Stereo Volume Control, 216 Watt, 72 Watt RMS with two-gang plate. Boxed unit pack, rack pack carton | 40888-72W     |



40888-72W





## Leviton Architectural Edition System Matching Module with AutoSurge™ Technology

The System Matching Module is used to match the impedance of all speakers and volume controls automatically at a central wiring point. It allows connecting up to six rooms of speakers to a stereo amplifier, and is a cost-effective way to design a passive, impedance-matched multi-room music system.

**NOTE: Do not use the System Matching Module with impedance-matched volume controls.**

### SPECIFICATIONS

|                            |   |
|----------------------------|---|
| <b>Dimensions:</b>         | 2.57"(68.6) H x 6.38"(161.9) W x 5.38"(136.5) D   |
| <b>Mounting Location:</b>  | Mounts in Leviton Structured Media™ Centers   |
| <b>Power Handling:</b>     | 150W RMS per channel/225W peak  |
| <b>Frequency Response:</b> | 10Hz-40kHz, +/- .5dB  |
| <b>Wire Gauge:</b>         | Detachable cable connectors are compatible with all standard speaker wire sizes (18-14 AWG) |

### System Matching Module

| DESCRIPTION                                      | CAT NO.-WHITE |
|--|---------------|
| System Matching Module with AutoSurge Technology | SGAMP-000     |



SGAMP-000

### 1x6 Passive Audio Module

Easy, centralized audio system distribution module connects up to six pairs of speakers from an entertainment center or amplifier. Note: To ensure a correct impedance match with an amplifier, only use the passive audio module with impedance-matched volume controls.

### SPECIFICATIONS

|                      |   |
|----------------------|---|
| <b>Dimensions:</b>   | 6.58"H x 2.89"W x 1.42"D                                      |
| <b>Wire Gauge:</b>   | 18-14 AWG   |
| <b>Requirements:</b> | Product should be used with impedance-matched volume controls |



48211-06A

### 1x6 Passive Audio Module

| DESCRIPTION              | CAT. NO.  |
|--------------------------|-----------|
| 1x6 Passive Audio Module | 48211-06A |

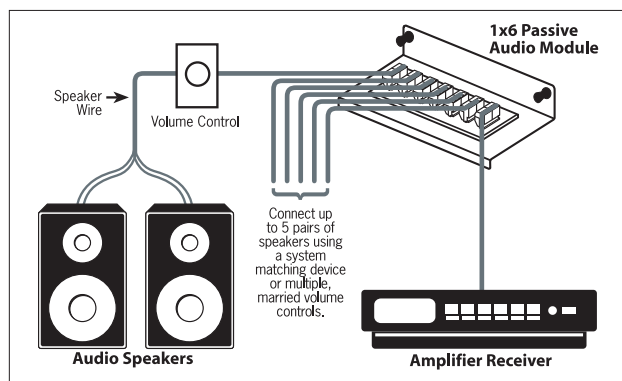

### SPECIFICATIONS AND FEATURES

#### System Matching Module

- Connects up to six rooms/zones
- Convenient single-point connection for all speakers
- Combine with Decora® Strauss™ Transformer-Free-Volume™ Controls or equivalent to control up to six locations of speakers from one amplifier or receiver\*
- User-removable connectors facilitate installation
- Transformer-Free impedance-matching design ensures linear frequency response, signal integrity and high power handling capacity

#### 1x6 Passive Audio Module

- Supports up to six pairs of speakers.
- Parallel connection scheme insures the best sound quality.
- User-removable connectors facilitate installation.
- Connects with standard fire-rated speaker wire.



## Home Theater and Multi-Room Integrated Wallplates

Both integrated wallplates combine the convenience of a ready-made plate with pre-configured wiring terminations with the performance and connection quality of "audiophile-grade" connectors. These plates are complete and ready-to-use, and make a "custom quality" statement in any installed entertainment system.

### Home Theater Interface Wallplate

Connector Type (Front of module): 14 audiophile-grade, gold-plated black and red spring clips, 2 RCA connectors, 2 QuickPort openings; Connector Type (Back of module): 8-pin and 6-pin in-line pluggable screw terminals; Wallplate: High quality impact-resistant white plastic, standard 3-gang with matching painted screws; Mounting Depth: 2.5" (64mm); Wiring: 14-16 gauge speaker wire

| DESCRIPTION                      | CAT NO.   |
|----------------------------------|-----------|
| Home Theater Interface Wallplate | AEHTK-000 |



AEHTK-000

### Multi-Room Stereo Speaker Wallplate

Connector Type (Front of module): 4 audiophile-grade, gold-plated black and red spring clips, 2 QuickPort openings; Connector Type (Back of module): Two 2-pin in-line pluggable screw terminals; Wallplate: High quality impact-resistant white plastic, standard single-gang with matching painted screws; Mounting Depth: 2.5" (64mm); Wiring: 14-16 gauge speaker wire

| DESCRIPTION                         | CAT NO.   |
|-------------------------------------|-----------|
| Multi-Room Stereo Speaker Wallplate | AEMRK-000 |



AEMRK-000

## Specialized Audio/Video Wallplates

These high-value plates are quick to install and intuitive to use when connecting a multi-room entertainment system.

### Single Spring Clip Wallplate

Equipped with spade terminals. Mounted on break resistant polymer wallplate.

| DESCRIPTION   | CAT NO.-WHITE | CAT NO.-IVORY |
|---|---------------|---------------|
| Single Spring Clip Wallplate.<br>Carded unit pack, rack pack carton | 40951-1PW     | 40951-1PI     |



40951-1PW

### Double Spring Clip Wallplate

Equipped with spade terminals. Mounted on break resistant polymer wallplate.

| DESCRIPTION   | CAT NO.-WHITE | CAT NO.-IVORY |
|---|---------------|---------------|
| Double Spring Clip Wallplate.<br>Carded unit pack, rack pack carton | 40952-2PW     | 40952-2PI     |



40952-2PW

### SPECIFICATIONS AND FEATURES

#### Home Theater Interface Wallplate

- Accommodates from 5.1 to 7.1 channel surround-sound systems
- For use with low voltage rings and standard low voltage junction boxes
- Features RCA connectors for connecting subwoofers
- Two extra openings for additional QuickPort connectors

#### Multi-Room Stereo Speaker Wallplate

- Integrated wallplate for connecting left and right audio speakers (+/- connections)
- For use with low voltage rings and standard low voltage junction boxes
- Two extra openings for additional QuickPort connectors



SGC65-00W



SGI65-00W



SGI80-00W



SGO99-00W

## Spec Grade Sound™ Indoor and Outdoor Speakers

Leviton's award-winning\* Spec-Grade Sound™ indoor and outdoor speaker line takes installed home audio to a new level in both technical innovation and value. Leviton's Spec-Grade Sound™ indoor and outdoor speakers can be used with Leviton's innovative, exclusive Decora® Strauss™ Transformer-Free™ Volume Controls and Leviton's System Matching Module and other audio distribution products to form complete systems. All of Leviton Spec Grade Sound™ indoor speakers incorporate exceptionally strong, light and rigid AeroNylon tweeters and Kevlar®-composite woofers for exceptional clarity, detail and impact. They come with built-in AutoSurge protection to help protect the speakers from possible damage due to overdriving. The outdoor/utility speaker is constructed of weather resistant materials inside and out.

\*Electronic House Magazine "Product of the Year"

Kevlar is a registered trademark of E.I. du Pont de Nemours and company

### 6.5-inch Two-Way In-Ceiling Loudspeaker\*

Paintable grill and frame. 6.5-inch Composite Kevlar cone low-frequency transducer, .5-inch AeroNylon dome high-frequency transducer, 2-way balanced precision crossover network with AutoSurge circuit protection, Frequency Response: 50-20kHz +/- 3dB, Sensitivity: 87.0 dB SPL @ 1Watt/1 Meter, Power Handling: 120W peak/60W RMS, Impedance: Nominal 8 Ohms/Minimum 6 Ohms, Dimensions: Diameter: 9.03 in (229.4mm); Depth: 4.06 in (103.1mm)

| DESCRIPTION                             | CAT NO.-WHITE ONLY |
|---|--------------------|
| 6.5-inch Two-Way In-Ceiling Loudspeaker | SGC65-00W          |

### 6.5-inch Two-Way In-Wall Loudspeaker\*

Paintable grill and frame. 6.5-inch Composite Kevlar cone low-frequency transducer, .5-inch AeroNylon dome high-frequency transducer, 2-way balanced precision crossover network with AutoSurge circuit protection, Frequency Response: 50-20kHz +/- 3dB, Sensitivity: 88.0 dB SPL @ 1Watt/1 Meter, Power Handling: 120W peak/60W RMS, Impedance: Nominal 8 Ohms/Minimum 6 Ohms, Dimensions: 12.31 in (312.8mm) H x 9.02 in (229mm) W x 4.06 in (103mm) D

| DESCRIPTION                          | CAT NO.-WHITE ONLY |
|--------------------------------------|--------------------|
| 6.5-inch Two-Way In-Wall Loudspeaker | SGI65-00W          |

### 8-inch Two-Way In-Wall Loudspeaker\*

Paintable grill and frame. 8-inch Composite Kevlar cone low-frequency transducer, 1-inch AeroNylon dome high-frequency transducer with phase/time alignment guide, 2-way balanced precision crossover network with AutoSurge circuit protection, Frequency Response: 44-20kHz +/- 3dB, Sensitivity: 86.5 dB SPL @ 1Watt/1 Meter, Power Handling: 160W peak/80W RMS, Impedance: Nominal 8 Ohms/Minimum 6 Ohms, Dimensions: 14.25 in (362mm) H x 10.24 in (260mm) W x 4.06 in (103mm) D

| DESCRIPTION                        | CAT NO.-WHITE ONLY |
|------------------------------------|--------------------|
| 8-Inch Two-Way In-Wall Loudspeaker | SGI80-00W          |

\*Require separate back box for use in fire rated applications

### Outdoor/Utility Two-Way Loudspeaker

5.25-inch Silicate-fiber cone low-frequency transducer with butyl surround, .5-inch Polydome high-frequency transducer, 2-way balanced precision crossover network with AutoSurge circuit protection, Element-resistant polypropylene enclosure, gold-plated binding posts, and aluminum mounting. Frequency Response: 50-20kHz +/- 3dB, Sensitivity: 87 dB SPL @ 1Watt/1 Meter, Power Handling: 120W peak/60W RMS, Impedance: Nominal 8 Ohms/Minimum 6 Ohms, Dimension: 8.75 in (222.3mm) H x 6.33 in (161mm) W x 5.5 in (140mm) D (without bracket)

| DESCRIPTION                         | CAT NO.-WHITE ONLY |
|-------------------------------------|--------------------|
| Outdoor/Utility Two-Way Loudspeaker | SGO99-00W          |

### Spec Grade Sound Pre-Construction Brackets

The Spec Grade Sound Speaker rough in brackets are designed to save time during the rough-in and trim-out phases. The built-in wire management loops ensure that the wire is securely placed and easily located during speaker installation.

| DESCRIPTION                                      | CAT NO.-WHITE ONLY |
|--|--------------------|
| Pre-Construction kit for 6.5" In-Ceiling Speaker | PCC55-KIT          |
| Pre-Construction kit for 6.5" In-Wall Speaker    | PCI65-KIT          |
| Pre-Construction kit for 8" In-Wall Speaker      | PCI80-KIT          |

### Spec Grade Sound Speaker Grills

| DESCRIPTION                     | CAT NO.-WHITE ONLY |
|---------------------------------|--------------------|
| Speaker Grill for Speaker SGC65 | SGC65-GRL          |
| Speaker Grill for Speaker SGI65 | SGI65-GRL          |
| Speaker Grill for Speaker SGI80 | SGI80-GRL          |



## OTHER HOME ENTERTAINMENT PRODUCTS



### Decora Media™ System

Send analog audio and video signals through up to 1,000 feet (300 meters) of Category-5 cable with no discernible distortion. The Decora Media System is ideal for connecting source components back to a multi-room audio amplifier located elsewhere in a system. DMS is comprised of: a Send Unit for transmitting audio/video signals, a Receive Unit for receiving signals and a Media Hub. The DMS can operate several ways: in a "hub" configuration with one Send unit sending a single audio/video signal to up to six Receiver units, and point-to-point where Send and Receive units are linked directly together to replace expensive specialized cables or baluns with simple Category-5 cabling..

Send and receive units run on 12VDC, hub runs on 15VDC and can be powered independently or through the Media Hub.

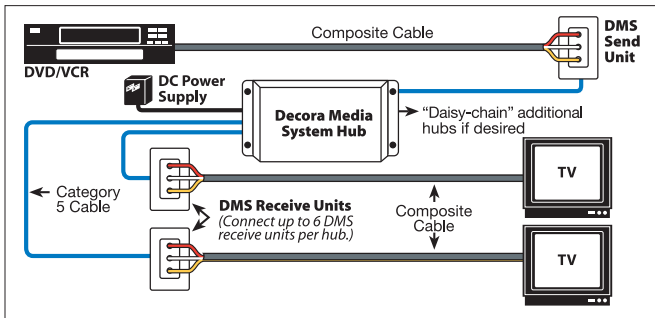

| SPECIFICATIONS          | SEND UNIT  | RECEIVE UNIT  | MEDIA HUB   |
|-------------------------|--|---|---|
| Dimensions:             | 4.1"H x 1.4"W x 2.0"D  | 4.1"H x 1.4"W x 2.0"D   | 6.5"H x 3.4"W x 1.75"D  |
| Video Bandwidth:        | 50 M Hz @ -3 dB  | 50 M Hz @ -3 dB   | 50 M Hz @ -3 dB   |
| Video THD:              | 75 dBc   | -75 dBc   | -75 dBc   |
| Video Input:            | —  | 0.5V to 2V composite  | 0.5V to 2V composite  |
| Video Output:           | 0.5V to 2V composite   | —   | —   |
| Slew Rate:              | 800V/us  | 800V/us   | 800V/us   |
| Audio Input Impedance:  | —  | 20k Ohms, max 3Vp-p   | 20k Ohms, max 3Vp-p   |
| Audio Output Impedance: | 51 Ohms, max 2Vp-p   | —   | —   |
| Audio Freq. Response:   | 5 Hz-100k Hz, ±3 dB  | 5 Hz-100k Hz, ±3 dB   | 5 Hz-100k Hz, ±3 dB   |
| Audio THD:              | 0.002% 20 Hz-20k Hz  | 0.004% 20 Hz-20k Hz   | 0.002% 20 Hz-20k Hz   |
| Audio S/N Ratio:        | 100 dB typical, 80 dB min 20 Hz-20k Hz   | 100 dB typical, 80 dB min 20 Hz-20k Hz  | 100 dB typical, 80 dB min 20 Hz-20k Hz  |
| Input Noise:            | 4.5nV/( Hz), 1/2 typical @ 1k Hz   | 6nV/( Hz), 1/2 typical @ 1k Hz  | 4.5nV/( Hz), 1/2 typical @ 1k Hz  |
| Input and Outputs:      | 3 RCA input jacks<br>1 set RJ-45 in/out jacks<br>1 110 punchdown out<br>1 DC power input | 3 RCA output jacks<br>1 set RJ-45 in/out jacks<br>1 110 punchdown out<br>1 DC power input | 3 RCA input jacks<br>1 RJ-45 input jack<br>6 RJ-45 output jacks<br>1 DC power input |
| Power:                  | 12VDC  | 12VDC   | 15VDC   |

### Decora Media System

| DESCRIPTION  | CAT. NO.  |
|--|-----------|
| Decora Media System Media Hub with Power Supply                  | 48210-MCH |
| Decora Media System Send and Receive Unit Pair with Power Supply | 48210-SRU |
| Decora Media System Send Unit with Power Supply                  | 48210-MSU |
| Decora Media System Receive Unit                                 | 48210-MRU |

#### SPECIFICATIONS AND FEATURES

- Cascade hub units to distribute audio/video signals to over 20 locations.
- Send and Receive units are equipped with RJ-45 jacks and 110 punchdown blocks for maximum flexibility in installation.
- Composite RCA inputs for connectivity directly from AV source.
- Send and Receive units fit standard wallboxes and Decora wallplates.
- Advanced circuitry with automatic equalization streams analog stereo audio and video signals over long distances with less distortion.
- Stereo audio input/output handles Dolby® ProLogic™ surround signals.
- RJ-45 input for Send unit.



### Multi-Room Infrared (IR) Repeater System

The IR Repeater System consists of three pieces: an IR Target, IR Emitter and a distribution block for distributing control signals to multiple emitters. The IR Target takes the signal from a remote control for an audio/video component and converts it to a low-voltage electrical signal, sending it back to a component to be controlled by the IR emitter. The flush-mount IR Target easily installs in a ceiling or wall, and connects with Category 5 cable to the IR Emitter. Multiple IR Emitters connect to controlled A/V components through the distribution block in the Structured Media Enclosure. Distribution block (Cat. No. 47689-B) available separately. Dimensions: 2"L x 1"W, Power: 12V DC @200mA, Target Output: 4 signal leads, Target Input: 2 power leads (DC + and -), Emitter Output: Infrared to control source component, Emitter Input: 2 signal leads, Power Supply (included): 12V DC @5mA

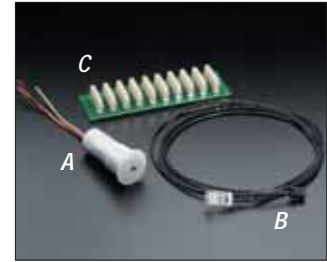

#### IR Repeater System

| DESCRIPTION  | CAT. NO.  |
|--|-----------|
| A-Target   | 47621-CMS |
| B-Emitter  | 47621-MIE |
| C-1x9 Bridged Telephone Module for IR Repeater, w/o bracket. Individ. boxed unit pack, rack pack carton. | 47603-110 |

### Recessed Entertainment Box

| DESCRIPTION                        | CAT. NO.  | COLOR* |
|------------------------------------|-----------|--------|
| REB Box with Low-Profile Frame     | 47617-REB | White  |
| High-Profile Cover                 | 47617-HPC | White  |
| Low-Profile Frame                  | 47617-LPF | White  |
| Replacement Snap-In Plates (2/Bag) | 47617-PLT | White  |
| REB Box with High-Profile Cover    | 47617-RBH | White  |

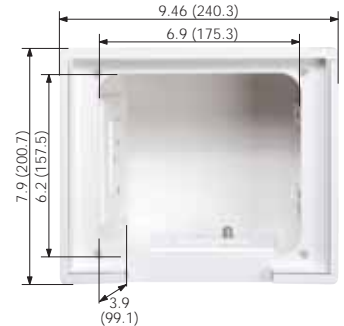

### Decora Recessed Receptacles

#### Duplex Recessed Receptacles 15A-125V AC, 2-Pole, 3-Wire, NEMA 5-15R

| DESCRIPTION  | CAT. NO. | COLOR*     | NEMA CONFIG.  |
|--|----------|------------|---|
| Two-Gang Duplex Receptacle with Openings for 6 QuickPort Connectors (4 blank inserts included) † | 690      | I, W, T, E | 5-15R  |
| One-Gang Duplex Receptacle   | 689      | I, W, T, E |   |

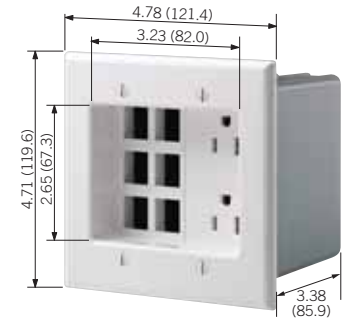

#### Single Recessed Receptacles

#### Side-Wired 15A-125V AC, 2-Pole, 3-Wire, NEMA 5-15R

| DESCRIPTION                                       | CAT. NO. | COLOR*          | NEMA CONFIG.  |
|---|----------|-----------------|---|
| One-Gang Single Receptacle with Clock Hanger Hook | 688      | I, W            | 5-15R  |
| One-Gang Single Receptacle with Clock Hanger Hook | 5261-CH  | Stainless Steel |   |

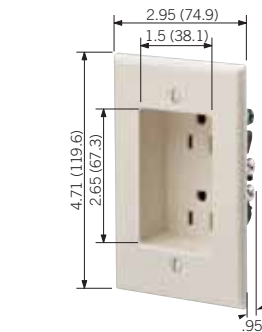

#### Side-Wired 20A-125V AC, 2-Pole, 3-Wire, NEMA 5-20R

| DESCRIPTION                                       | CAT. NO. | COLOR*          | NEMA CONFIG.  |
|---|----------|-----------------|---|
| One-Gang Single Receptacle with Clock Hanger Hook | 5361-CH  | Stainless Steel | 5-20R  |



† QuickPort Connectors not included.

#### SPECIFICATIONS AND FEATURES

##### Recessed Entertainment Box

- Provides single location for line and low-voltage connections
- Stud- and wall-mountable
- Neat, clean recessed installation
- Optional high-profile cover includes sliding plastic front panel and channels all wires through the bottom of the REB
- Paintable white ABS plastic

##### Recessed Two-Gang Duplex Receptacle with QuickPort Openings

- Provides 2 15A/125V AC NEMA 5-15R power outlets and openings for any 6 installer-selected QuickPort connectors or blank inserts (4 inserts included)
- Includes plastic electrical box and a barrier to separate line and low-voltage conductors
- Wallplate built into device

##### Recessed One-Gang Duplex Receptacle

- Installs invisibly behind wall units, signature artwork and wall-mounted flat-panel TVs
- Supplies AC power for two components

- Fits most common electrical boxes available (electrical box not included)

##### Recessed One-Gang Single Receptacles

- Includes clock-hanger hook
- Flush mount with square recess

#### TESTING AND CODE COMPLIANCE

##### Recessed Receptacles

- cULus Listed
- NOM Certified (#057)

##### All Recessed Devices

- Backed by a Limited Two-Year Warranty

#### \*COLOR

For color selection, add suffix to catalog number as follows: Ivory (-I), White (-W), Light Almond (-T) and Black (-E).

#### MATERIAL CHARACTERISTICS

Environmental: Flammability UL-94, V2 Rating  
Operating Temperature: -40° to 120°C

# HOW TO USE THIS CATALOG

The L-101 Leviton Wiring Device Catalog is designed to help you find the device you're seeking in the quickest and easiest way possible. Most product sections are divided into three distinct categories in the following sequence—Industrial Grade, Commercial Grade and Residential Grade—and grouped according to amperage and voltage, lowest to highest. For example, if you need to order 15 Amp, 125 Volt Industrial Grade straight-blade duplex receptacles, begin your search with the main Table of Contents at the front of the book. Here you'll see that all straight blade receptacles are listed in Section G. Turn to Section G for a more detailed Table of Contents on the first page. Each section page contains product descriptions, ratings and catalog numbers. There are also helpful highlights including Specifications and Features, Testing and Code Compliance, Color listing, Material Characteristics and dimensioned color product photos. Any product page in the L-101 Catalog can be clearly copied or faxed to customers and prospects for use as a specifier sheet or as part of a presentation.

The Quick Reference Guide follows the main Table of Contents to help you pinpoint and locate specific products. Technical Section V provides general product and test data, industry standards, NEMA configuration charts, a glossary of wiring device terms, ANSI architectural symbols and other related information. Specific catalog numbers are listed in the exhaustive index at the back of the catalog.

**15 AMP 125 and 250V • 20 AMP 125 and 250V**

**Industrial Grade Straight Blade Receptacles**

**Back and Side Wired** (Basic Cat. No. Denotes Brown Device\*)

| DESCRIPTION                             | CAT. NO./COLOR<br>15A/125V                         | CAT. NO./COLOR<br>15A/250V | CAT. NO./COLOR<br>20A/125V                | CAT. NO./COLOR<br>20A/250V         |
|---|--|----------------------------|---|------------------------------------|
| LEVSPEC® Duplex Receptacle, Brass Strap | 5262<br><small>I, W, GY, R, E</small>              | 5662<br><small>I</small>   | 5362<br><small>I, W, GY, R, E</small>     | 5462<br><small>I, GY</small>       |
| Single Receptacle                       | 5261<br><small>I, W, GY</small>                    | 5661<br><small>I</small>   | 5361<br><small>I, W, A, T, GY</small>     | 5461<br><small>I, A, T, GY</small> |
| Narrow Body Duplex Receptacle           | 5252<br><small>I, W, A, T, GY, R,<br/>* BU</small> |                            | 5352<br><small>I, W, A, T, GY, R,</small> |                                    |

5362-IG

**For complete wallplate selection, see Section E.**

5242-W

**SPECIFICATIONS AND FEATURES**

**Back & Side Wired Duplex**

- Impact-resistant thermoplastic nylon cover and body
- Smooth face does not collect dirt
- Four corner latches securely fasten face
- Single-piece brass mounting strap on LEVSPEC devices, multi-piece steel strap on other devices
- Large, triple-wipe, brass "T" contacts for superior contact and conductivity
- Back and side-wiring options
- Brass terminal screws to reduce conductor oxidation
- Break-off tabs for easy two-circuit conversion
- Apron barrier to prevent accidental contact between terminal screw heads and metal box
- Exclusive V-shaped, serrated back-wiring clamp for superior contact and conductivity

**TESTING AND CODE COMPLIANCE**

- UL Listed 498 (UL File #13399); UL Federal Specification WC-596

**COLOR**

Basic Cat. Nos. shown above denote Brown device, except for Isolated Ground (-IG) devices Basic Cat. No. denotes Orange. Isolated Ground Receptacle is distinguished by an orange triangle on its face. For other color selections, add suffix to the catalog number as follows: Ivory (-I), White (-W), Brown (For IG devices only, add -B), Almond (-A), Light Almond (-T), Gray (-G or -GY), Black (-E), Red (-R) and Blue (-BU); for IG devices only, add -BIG)

**MATERIAL CHARACTERISTICS**

Environmental: Flammability, Rated V2  
Operating Temperature: From -40° C (without impact) to 60°C maximum continuous

|                                       |  |                                      |
|---------------------------------------|--|--------------------------------------|
| <b>A</b> RATING                       | <b>E</b> CATALOG NUMBER                      | <b>I</b> SPECIFICATIONS & FEATURES   |
| <b>B</b> Choose GRADE, if appropriate | <b>F</b> DESCRIPTION                         | <b>J</b> TESTING AND CODE COMPLIANCE |
| <b>C</b> DIMENSIONED PHOTOGRAPH       | <b>G</b> Check for NEMA CONFIGURATION        | <b>K</b> COLOR LISTING               |
| <b>D</b> WIRING/CERTIFICATIONS        | <b>H</b> WALLPLATE REFERENCE, if appropriate | <b>L</b> MATERIAL CHARACTERISTICS    |

J  
36

# DHC Powerline Carrier Components

## INDEX

|  |        |
|--|--------|
| Overview .....   | K2     |
| <b>Controllers—Green Line</b>                          |        |
| Toscana™ Deluxe Programmer .....                       | K3     |
| Wall Switch Controllers with 2-Way Communication ..... | K4, K5 |
| Wall Switch Controllers with Scene Capability .....    | K5     |
| RF Products .....                                      | K6     |
| <b>Controllers—Red Line</b>                            |        |
| Basic Programmer .....                                 | K7     |
| Table Top Controller .....                             | K7     |
| Dry Contact Controllers .....                          | K7     |
| <b>Receivers—Green Line</b>                            |        |
| Wall Switches with 2-Way Communication .....           | K8     |
| Wall Switches with Scene Capability .....              | K8, K9 |
| Plug-In Modules with Scene Capability .....            | K10    |
| <b>Receivers—Red Line</b>                              |        |
| Wall Switches .....                                    | K11    |
| Remote Switches .....                                  | K12    |
| Double-Pole 20A Wall Switch .....                      | K12    |
| Receptacles .....                                      | K13    |
| Universal Low-Voltage Module .....                     | K14    |
| Fixture Modules .....                                  | K14    |
| <b>DHC Network Integrity Products</b>                  |        |
| Panel-Mounted Surge Protective Devices .....           | K15    |
| System Amplifier/Coupler/Repeater .....                | K16    |
| Couplers and Attenuators .....                         | K16    |
| Filters .....  | K17    |
| Signal Strength Indicator .....                        | K17    |



# DHC POWERLINE CARRIER COMPONENTS FEATURES

## Residential Grade Controllers

**LEVITON'S DECORA HOME CONTROLS (DHC) RESIDENTIAL POWERLINE CARRIER COMPONENTS PROVIDE HOMEOWNERS WITH EVERYTHING NEEDED FOR PROGRAMMED AND MANUAL CONTROL OF LIGHTING AND APPLIANCES USING THEIR HOME'S EXISTING AC WIRING.**

Our current listing of DHC components features new programmers, controllers and receivers with Scene Lighting Capability for coordinated, whole-house lighting control. This includes models offering two-way communication, which enables controllers in remote locations to show the On/Off status of individual lighting loads. Many new DHC components feature Intellisense™, a Leviton exclusive technology. Intellisense reduces noise sensitivity without reducing command signal sensitivity, resulting in the most reliable performance of any powerline carrier home automation system available today.

### Features and Benefits

- A network of controllers and DHC switch, dimmer, fixture and receptacle receivers that communicate via unique coded switching signals over a home's AC wiring to automate control of lights and appliances
- DHC components replace switches and outlets, which simplifies installation compared with other automation systems that require dedicated proprietary wiring backbones.
- An effective way to contribute to energy conservation and extend bulb and appliance life
- Offers significant security benefits to today's homeowner, including programmed automatic and manual home security features

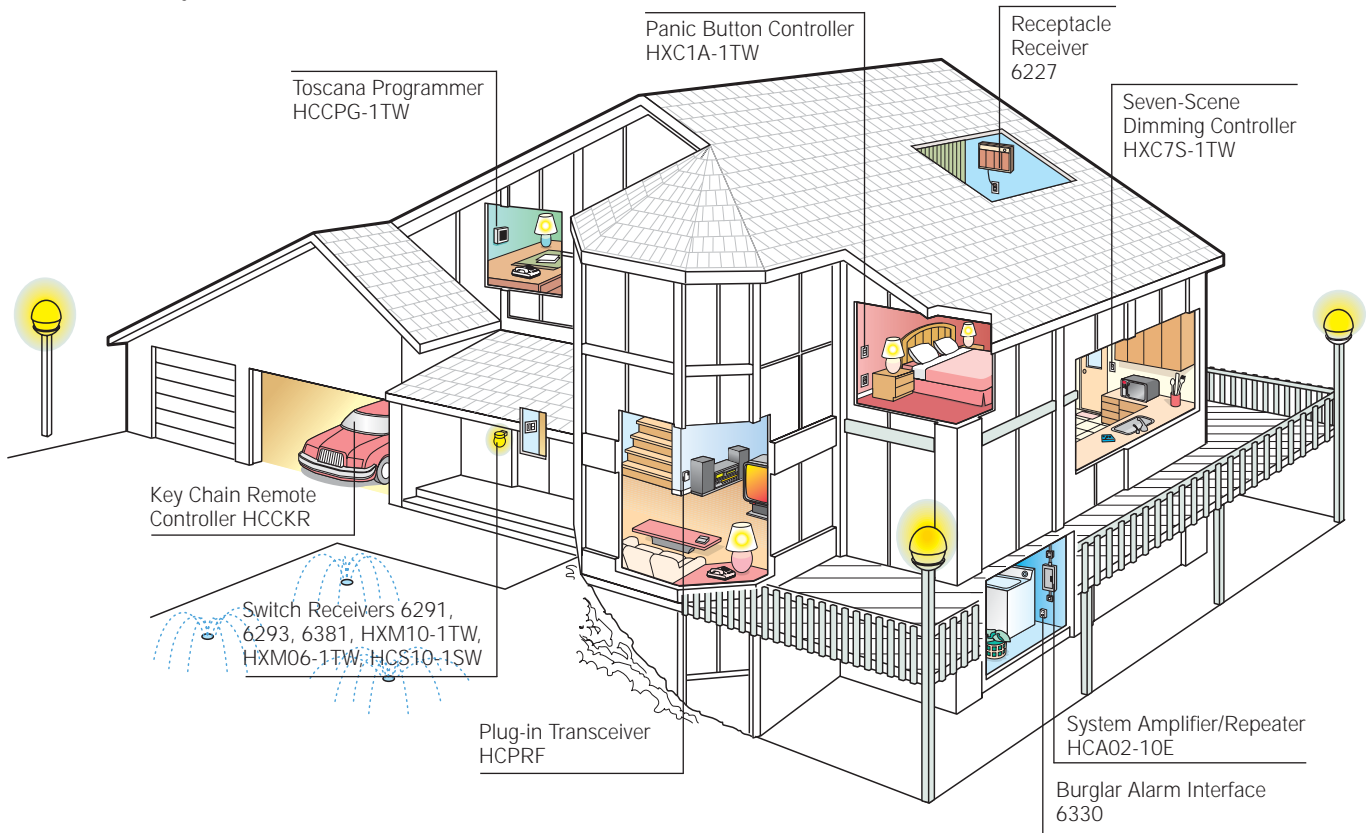

### DHC CONTROLLERS, RECEIVERS AND NETWORK INTEGRITY PRODUCTS



**DHC Controllers**  
DHC Controllers send control signals to user-specified DHC address throughout the network. Offering includes wall-mounted programmable, plug-in, tabletop, wireless hand-held, wall switch/dimmer and sensor units, plus models with 2-way communication.  
**HXC7S-1TW shown**



**DHC Receivers**  
DHC Receivers can be set to any of 256 DHC address codes for remote/manual control of incandescent, inductive, fluorescent, or low-voltage loads. They are available as receptacle, plug-in, fixture and multi-location wall switches and dimmer switches.  
**HXM10-1TW shown**



**Network Integrity Products**  
Leviton highly recommends installing these products in every DHC application. The System Coupler/Repeater ensures DHC signal integrity throughout the house. Panel-mount surge devices protect DHC components from transient voltage surges.  
**51120-1 shown**





Toscana™ Deluxe Programmer

Toscana is a simple central access station that expands DHC control capability with easy one-touch access for up to 64 whole-house lighting scenes along with direct remote control of up to 256 devices. Scenes can be accessed by an IR remote or from remote scene lighting control keypads. Toscana provides complex date/time and macro automated programming of lights and appliances.

Timed events or up to 8 groups of timed events can be selected and run on a recurring basis using a highly accurate internal astronomical clock. Toscana registers status changes when DHC receivers with 2-way communication are manually changed.



HCCPG-1TW

Toscana Deluxe Programmer

| DESCRIPTION  | CAT. NO.  |
|--|-----------|
| Toscana Deluxe Programmer—Rated: 120V 60Hz AC only. Power consumption: 3 watts. White frame and white cover. Color change kits available for other colors. | HCCPG-1TW |

COLOR CHANGE KITS FOR TOSCANA

| Cat. No. Ivory Cover/<br>Ivory Frame | Cat. No. White Cover/<br>White Frame | Cat. No. Almond Cover/<br>Almond Frame | Cat. No. Smoke Cover/<br>White Frame |
|--------------------------------------|--------------------------------------|--|--------------------------------------|
| DCKPG-0II                            | DCKPG-0WW                            | DCKPG-0AA                              | DCKPG-0SW                            |

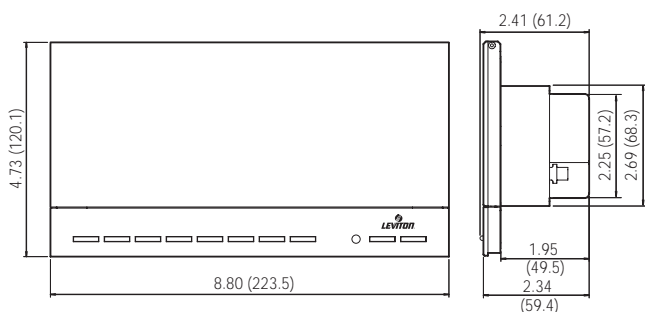

HCCPG-1TW

SPECIFICATIONS AND FEATURES

- Simple central access station for manual control of whole-house system
- No programming experience required—Use simple wizards for setup
- Automatically turn appliances ON/OFF and lights ON/OFF/DIM/BRIGHT
- Controls up to 256 devices in a DHC home system
- Leviton's patented IntelliSense™ Technology virtually eliminates signal problems due to line noise
- 2-Way communication capability registers status changes when receivers with 2-way communication are manually changed
- Permits input of real device names to specify control (such as "wall sconce") rather than cryptic house and device codes (e.g. B5)
- Automatically turns lights ON/OFF at dusk and/or at dawn (astronomical clock)
- Allows creation of up to 64 timed events that can reoccur year annually
- Each timed event can be part of up to 8 "time schedules"
- Create and download complex timed events and macros using a PC with RS-232 port
- Backup and restore all system data; allows cloning of devices using a PC with RS-232 port
- Mounts in standard 4-gang box
- No external wall transformer or powerline interface required
- Rated 120V AC Hz, requires neutral and ground connections

Whole House Lighting Scenes

- Create up to 64 whole-house lighting scenes to create lighting moods
- Access any of the 64 scenes from the Toscana front panel (8 at any one time)
- Access any seven of the scenes remotely using the HXC7S-1TW scene keypads
- Access any of the scenes using 10 learned infrared codes
- Learned infrared codes could be taught using any standard IR remote

TESTING AND CODE COMPLIANCE

- UL Listed (File #E-66800)
- CSA Certified (File #LR-54628)
- NOM Certified (#057)

COLOR

Shipped with White frame and White Cover. See chart for color change kits.

MATERIAL CHARACTERISTICS

Engineering Thermoplastic UL-94, V2 Rating  
 Operating Temperature: 32°F to 130°F

**Note: A Cat. No. HCA02-10E System Amplifier must be installed in all panels in every DHC installation to ensure adequate signal strength.**



# DECORA® HOME CONTROLS (DHC)



## Residential Grade Controllers—Green Line

### Wall Switch Controllers with 2-Way Communication INTELLISENSE™

#### DESCRIPTION

**One Address ON/OFF Controller**—One ON/OFF rocker transmits ON/OFF commands to one address. Shipped in White—Color change kits available for other colors. **CAT. NO. HXC10-1TW**

**All Lights ON/All OFF Controller**—One ALL LIGHTS ON/ALL OFF rocker transmits commands to all receivers set to the same letter code as this controller. Provides “Panic Button” lighting control for safety and security. NOTE: Receptacle receivers and Universal Low-Voltage Module (6337) do not respond to ALL ON command. Shipped in White—Color change kits available for other colors. **HXC1A-1TW**

**One-Address Dimming Controller**—One ON/OFF rocker transmits ON/OFF commands to one address in the same letter code as this controller. Built-in arrow-shaped rocker transmits DIM/BRIGHT commands to that same address. Shipped in White—Color change kits available for other colors. **HXC1D-1TW**

**Two-Address Dimming Controller**—Two sets of ON/OFF buttons transmit ON/OFF commands to two sequential addresses in the same letter code as this controller. One set of DIM/BRIGHT buttons transmits BRIGHT/DIM commands to the most recently selected address. Shipped in White—Color change kits available for other colors. **HXC2D-1TW**

*No more than 4 Controllers should be installed on a single branch circuit.*

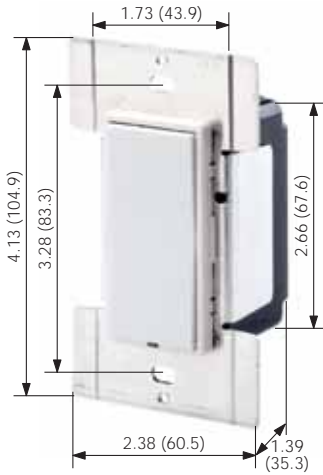

HXC10-1TW

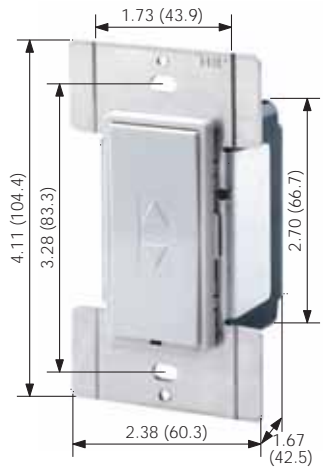

HXC1D-1TW



HXC2D-1TW

#### COLOR CHANGE KITS

| Controller Cat. No.  | Cat. No. Ivory                 | Cat. No. White                 | Cat. No. Almond                | Cat. No. Gray | Cat. No. Black |
|----------------------|--------------------------------|--------------------------------|--------------------------------|---------------|----------------|
| HXC10-1TW, HXC1A-1TW | DRK0S-0LI                      | DRK0S-0LW                      | DRK0S-0LA                      | DRK0S-0LG     | DRK0S-0LE      |
| HXC1D-1TW            | DRK1D-00I                      | DRK1D-00W                      | DRK1D-00A                      | —             | —              |
| HXC2D-1TW            | DCK2D-00I                      | DCK2D-00W                      | DCK2D-00A                      | —             | —              |
|                      | DCK2D-0CI (w/printable labels) | DCK2D-0CW (w/printable labels) | DCK2D-0CA (w/printable labels) | —             | —              |

#### SPECIFICATIONS AND FEATURES

- Fit in standard wallboxes and replace regular switches to provide DHC control capability as indicated in “Description”
- 2-Way Communication allows status of receivers changed manually to be reflected in the controller
- Leviton’s patented IntelliSense™ Technology virtually eliminates signal problems due to line noise
- Uses existing 120V AC 60Hz wiring to send command signals
- Compatible with Decora screwless and standard Decora wallplates
- Green LED illuminates to confirm ON command sent or STATUS ON report received
- Decora styling coordinates with Leviton’s popular Decora line; complements any interior
- Backed by a Limited Two-Year Warranty

#### TESTING AND CODE COMPLIANCE

- UL Listed (File #E-66800)
- CSA Certified (File #LR-54628)
- UL 224A Tested (and others as appropriate)

#### COLOR

All devices are shipped in White only. See chart for compatible color change kits.

#### MATERIAL CHARACTERISTICS

Environmental: Flammability (Engineering Thermoplastic) UL-94, V2 Rating  
Operating Temperature: 32°F to 130°F

*Note: A Cat. No. HCA02-10E System Amplifier must be installed in all panels in every DHC installation to ensure adequate signal strength.*



Wall Switch Controllers with 2-Way Communication

| DESCRIPTION   | CAT. NO.  |
|---|-----------|
| <b>Three-Address Dimming Controller</b> —Three sets of ON/OFF buttons transmit ON/OFF commands to three sequential addresses in the same letter code group as this controller. One set of DIM/BRIGHT buttons transmits DIM/BRIGHT commands to the most recently selected address. Shipped in White—Color change kits available for other colors.  | HXC3D-1TW |
| <b>Four-Address Dimming Controller</b> —Four sets of ON/OFF buttons transmit ON/OFF commands to four sequential addresses in the same letter code group as this controller. One set of DIM/BRIGHT buttons transmits DIM/BRIGHT commands to the most recently selected. Shipped in White—Color change kits available for other colors.   | HXC4D-1TW |
| <b>Three-Address Dimming, ALL LIGHTS ON/ALL OFF Controller</b> —Three sets of ON/OFF buttons transmit ON/OFF commands to three sequential addresses in the same letter code group as this controller. One set of DIM/BRIGHT buttons transmits DIM/BRIGHT commands to the most recently selected address. One set of ALL LIGHTS ON/ALL OFF buttons transmits commands to all receivers set to the same letter code as this transmitter. Receptacle receivers and Universal Low-Voltage Module (6337) will not respond to ALL ON command. Shipped in White—Color change kits available for other colors.  | HXC4A-1TW |
| <b>Seven-Scene Dimming Controller</b> —Each of seven SCENE buttons transmits ON commands at preset levels to 12 sequential addresses in the same letter code as this controller. (Note: 12-address sequence continues at address 1 if address 16 is reached before all sequential addresses are completed). May be used with all Leviton scene-capable receivers. One set of SCENE DIM/SCENE BRIGHT buttons transmits SCENE DIM/BRIGHT commands to most recently selected scene. One OFF button transmits OFF command to most recently selected scene. Green LEDs illuminate to indicate ON command sent or SCENE ON command detected. Shipped in White—Color change kits available for other colors. | HXC7S-1TW |

The HXC7S-1TW utilizes extended code format. This command structure is compatible with Cat. No. HCA02-10E DHC System Amplifier/Coupler /Repeater but is not compatible with the older version of the System Amplifier Cat. No. 6201.



No more than 4 Controllers should be installed on a single branch circuit.

COLOR CHANGE KITS

| Controller Cat. No. | Cat. No. Ivory                 | Cat. No. White                 | Cat. No. Almond                | Cat. No. Gray                  | Cat. No. Black                 |
|---------------------|--------------------------------|--------------------------------|--------------------------------|--------------------------------|--------------------------------|
| HXC3D-1TW           | DCK3D-00I                      | DCK3D-00W                      | DCK3D-00A                      | —                              | —                              |
|                     | DCK3D-0CI (w/printable labels) | DCK3D-0CW (w/printable labels) | DCK3D-0CA (w/printable labels) | —                              | —                              |
| HXC4A-1TW           | DCK4A-00I                      | DCK4A-00W                      | DCK4A-00A                      | —                              | —                              |
|                     | DCK4A-0CI (w/printable labels) | DCK4A-0CW (w/printable labels) | DCK4A-0CA (w/printable labels) | —                              | —                              |
| HXC4D-1TW           | DCK4D-00I                      | DCK4D-00W                      | DCK4D-00A                      | —                              | —                              |
|                     | DCK4D-0CI (w/printable labels) | DCK4D-0CW (w/printable labels) | DCK4D-0CA (w/printable labels) | —                              | —                              |
| HXC7S-1TW           | DCKS7-00I                      | DCKS7-00W                      | DCKS7-00A                      | DCKS7-00G                      | DCKS7-00E                      |
|                     | DCKS7-0CI (w/printable labels) | DCKS7-0CW (w/printable labels) | DCKS7-0CA (w/printable labels) | DCKS7-0CG (w/printable labels) | DCKS7-0CE (w/printable labels) |

SPECIFICATIONS AND FEATURES

- Fit in standard wallboxes and replace regular switches to provide DHC control capability as indicated in "Description"
- 2-Way Communication allows status of receivers changed manually to be reflected in the controller
- Leviton's patented IntelliSense™ Technology virtually eliminates signal problems due to line noise
- Uses existing 120V AC 60Hz wiring to send command signals
- Compatible with Decora Plus screwless and standard Decora wallplates
- Green LED illuminates to confirm ON command sent or STATUS ON report received
- Decora styling coordinates with Leviton's popular Decora line; complements any interior
- Backed by a Limited Two-Year Warranty

TESTING AND CODE COMPLIANCE

- UL Listed (File #E-66800)
- CSA Certified (File #LR-54628)
- UL 224A Tested (and others as appropriate)

COLOR

All devices are shipped in White only. See chart for compatible color change kits.

MATERIAL CHARACTERISTICS

Engineering Thermoplastic UL-94, V2 Rating  
Operating Temperature: 32°F to 130°F

**Note: A Cat. No. HCA02-10E System Amplifier must be installed in all panels in every DHC installation to ensure adequate signal strength.**



# DECORA® HOME CONTROLS (DHC)



## Residential Grade Controllers—Green Line

### RF Components



HCCUR

HCCKR-E

| DESCRIPTION  | CAT. NO.  |
|--|-----------|
| <p><b>Universal Remote Control</b>—Hand-held wireless remote control sends RF (radio frequency) command signals to DHC Plug-In Transceiver Cat. No. HCPRF for up to 256 DHC addresses. With an operating range of up to 50 ft. through wall and ceilings, it sends ON/OFF, DIM/BRIGHT and ALL ON/ALL OFF commands for lighting and ON/OFF commands for appliances. The Universal Remote will also control audio and video equipment, including TV's, VCR's, cable boxes, satellite receivers, DVD and CD players and more. Functions as an all-in-one controller for lighting and audio/video systems, making it ideal for home theaters. Universal design also makes it suitable for the elderly and physically challenged. Dual built-in timers can shut off TV and/or DHC devices up to ninety minutes after setting. Uses 2 AAA batteries. Must be used with HCPRF Transceiver. Color: Black.</p>  | HCCUR     |
| <p><b>Plug-In Transceiver</b>—Accepts Radio Frequency DHC commands from the Universal Remote Cat. No. HCCUR for ON/OFF, DIM/BRIGHT and ALL ON/ALL OFF, as well as ON/OFF commands from the Key Chain Remote Cat. No. HCCKR. The Plug-In Transceiver works with all DHC receivers by re-transmitting commands signals onto the home's existing electrical wiring. Plugs into any standard receptacle and provides a built-in outlet for ON/OFF switching of incandescent lamps rated 300W max. @ 120V AC. The lamp can be controlled remotely or locally via the programming button on the face of the Transceiver, which can also be used to change the unit's DHC address. Features IntelliSense™ Technology to ensure optimum system performance. 2-Way communication permits local status of attached lamp to show on all 2-Way capable DHC controllers. Multiple HCPRF Transceivers can be used to increase coverage in large homes. Unit will re-transmit commands for up to 256 DHC addresses. Color: White.</p> | HCPRF-1TW |
| <p><b>Key Chain Remote Controller</b>—Designed to fit on a key chain and send RF (radio frequency) command signals to DHC Plug-In Transceiver Cat. No. HCPRF. With an operating range of up to 50 ft. through wall and ceilings, it sends ON/OFF commands for any 2 sequential DHC addresses (addresses are user programmable). Ideal for control of home lighting from a vehicle when entering garage or driveway. Uses long-life 3V CR2032 lithium battery (included). Must be used with HCPRF Transceiver. Color: Black.</p>  | HCCKR-E   |



#### SPECIFICATIONS AND FEATURES

- Leviton's Universal Remote Control works with DHC-controlled lighting and appliances as well as audio/video system components
- Ultra-compact Key Chain Remote adds to home security by allowing users to turn ON lighting as they approach entranceway, garage or driveway
- Plug-In Transceiver features IntelliSense™ Technology for optimum reliability, 2-way signaling capability, and easy one-button programming. Must be used with Universal Remote and Key Chain Remote.
- Backed by a Limited Two-Year Warranty

#### TESTING AND CODE COMPLIANCE

- UL Listed (File #E-66800)
- CSA Certified (File #LR-69519)
- NOM Certified (#057)
- UL 224A Tested (and others as appropriate)

#### COLOR

Colors available as listed.

#### MATERIAL CHARACTERISTICS

Environmental: Flammability (Engineering Thermoplastic) UL-94, V2 Rating  
Operating Temperature: 32°F to 130°F

*Note: Cat. No. HCCUR is CSA Certified only. Cat. No. HCPRF-1TW is UL Listed, CSA Certified and NOM Certified. UL and CSA not required for Cat. No. HCCKR-E*



### Programmer/Controller Products

#### DESCRIPTION

#### CAT. NO.

**Basic Wall Mounted Programmer**—A powerful home automation controller that is easy to install and use. Compact, low-profile unit fits in single-gang wallbox. Accepts up to four addresses; maximum two ON and two OFF commands per address. SECURITY mode randomly selects ON and OFF times to make an empty home appear occupied. ALL LIGHTS ON switch acts as a panic-button lighting system, switching on all DHC switch modules with one touch. DIM/BRIGHTEN command can automatically adjust lighting levels of all fixtures controlled by DHC dimming receivers. LED readout shows time and program status; battery back-up protects clock setting and program status for ten hours during power interruption. Available in Ivory, White, and Almond.

6312

**Table Top Controller**★—Provides manual remote control for all 256 DHC addresses. Command functions include ON/OFF, ALL LIGHTS ON/ALL OFF and DIM/BRIGHTEN. The 6320 plugs into any 120 volt AC receptacle to transmit command signals over existing AC wiring.

6320

**Dry Contact Controllers**★—Allow monitoring of up to four dry contact closures. No. 6315 Maintained Contact Transmitter sends ON or OFF command signals in response to contact opening or closure. No. 6316 Momentary Contact Transmitter sends ON or OFF command signals in response to contact closure, and no command signal upon contact openings. These units can be used with photocells, infrared sensors, security system, motion sensors, and any other dry-contact-based sensors. Installs in a single-gang wallbox. Color: Ivory.

6315

6316

Power to control side: 125V 60Hz AC Only.

| LV LEAD COLOR | TRANSMITS TO |
|---------------|--------------|
| Blue          | A1*          |
| Orange        | A2*          |
| Yellow        | A3*          |
| Brown         | A4*          |

\*Or any four sequential address codes within the same Letter Code group as the Transmitter.

CSA Certified except where indicated by★

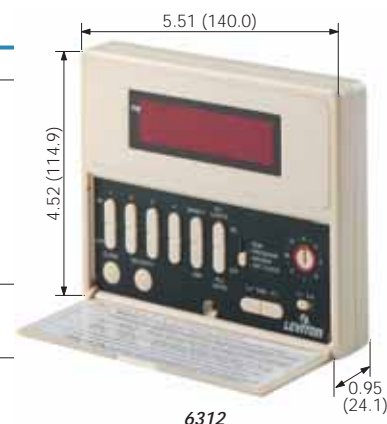

No more than 4 Controllers should be installed on a single branch circuit.

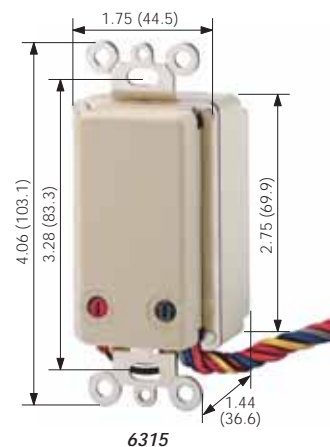

#### SPECIFICATIONS AND FEATURES

- Programmer adds user-devised scheduling to DHC automated control of lights and appliances for greater convenience, energy savings and security
- Programmer and Controllers send DHC switching commands over existing 60Hz 120V AC house wiring.
- Dry Contact Transmitters link signaling from photocells, infrared sensors, security systems, motion sensors, and other dry contact transmitters to DHC controlled devices
- Backed by a Limited Two-Year Warranty

#### TESTING AND CODE COMPLIANCE

- UL Listed (File #E-66800)
- CSA Certified (File #LR-54628)
- NOM Certified (#057)

#### COLOR

Colors available as indicated. Cat. No. 6312 available in Ivory (-I), White (-W) and Almond (-A).

#### MATERIAL CHARACTERISTICS

Engineering Thermoplastic UL-94, V2 Rating  
Operating Temperature: 32°F to 130°F

**Note:** A Cat. No. HCA02-10E System Amplifier must be installed in all panels in every DHC installation to ensure adequate signal strength.



# DECORA® HOME CONTROLS (DHC)



## Residential Grade Receivers—Green Line

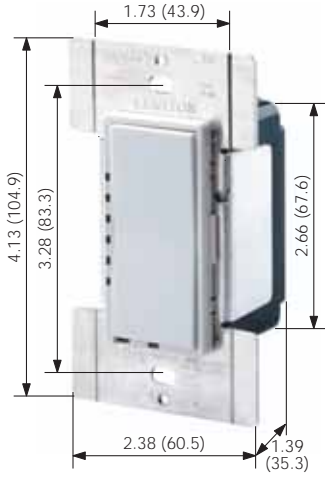

**HCM06-1TW**

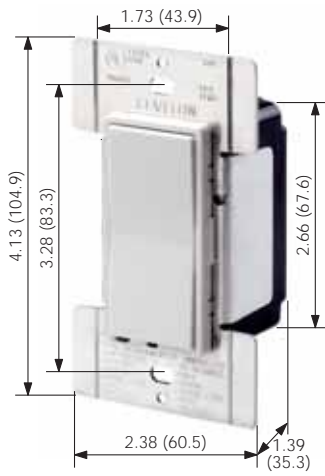

**HXM06-1TW**

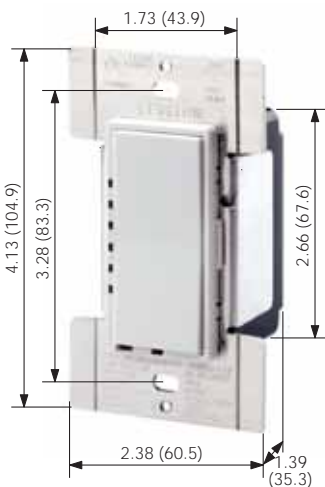

**HXS08-1TW**

### Scene-Capable Wall Dimmers and Switches

The new DHC Scene-Capable Receivers provide one-button programming for scene and address capturing. All feature Leviton's exclusive IntelliSense® to ensure top performance and reliability even when noise is present on the AC powerline.

Dimming Wall Switch Receivers provide manual and remote ON/OFF switching and full-range dimming for incandescent and magnetic low-voltage lighting loads. The new HXS08-1TW Electronic Switch Receiver (non-dimming) provides manual and remote ON/OFF switching for incandescent, magnetic low-voltage, fluorescent and compact fluorescent lighting. All Switch Receivers come with a locator LED. Dimming models feature an LED brightness level display and a preset feature that turns lights ON at the last selected brightness level. Double Tap feature immediately adjusts light to full brightness without affecting the last selected brightness level. All -T Receivers allow 2-way status tracking with the DHC Toscana™ Deluxe Programmer and new 2-way capable controllers when receivers are changed locally.

Typical applications include home theaters, dining rooms, chandeliers, living rooms with multiple high-hats, entranceways, and a wide range of mood lighting applications.

| DESCRIPTION  | CAT. NO.         | RATING @ 120V 60Hz   | COLOR                      |
|--|------------------|--|----------------------------|
| <b>600 Watt Scene-Capable Dimming Wall Switch Receiver with One-Button Programming and LED brightness display. 3-Way capable when used with MS00R-10 Multi-Remote</b>  | <b>HCM06-1DW</b> | Incandescent 600W, (450W) Magnetic Low-Voltage Lighting 600VA                        | White (Ivory kit included) |
| <b>1000 Watt Scene-Capable Dimming Wall Switch Receiver with One-Button Programming and LED brightness display. 3-Way capable when used with MS00R-10 Multi-Remote</b> | <b>HCM10-1DW</b> | 1000W Incandescent, 1000VA (750W) Magnetic Low-Voltage Lighting                      | White (Ivory kit included) |
| <b>600 Watt Scene-Capable Dimming Wall Switch Receiver with One-Button Programming, 2-Way Communication and LED brightness display. Neutral connection required</b>    | <b>HXM06-1TW</b> | 600W Incandescent, 600VA (450W) Magnetic Low-Voltage Lighting                        | White (Ivory kit included) |
| <b>1000 Watt Scene-Capable Dimming Wall Switch Receiver with One-Button Programming, 2-Way Communication and LED brightness display. Neutral connection required</b>   | <b>HXM10-1TW</b> | 1000W, 120V AC 60Hz Incandescent, 1000VA (750W) Magnetic Low-Voltage Lighting        | White (Ivory kit included) |
| <b>8 Amp Scene-Capable Electronic Switch Receiver (non-dimming) with One-Button Programming and 2-Way Communication. Neutral connection required</b>                   | <b>HXS08-1TW</b> | 8 Amp, 1000W Incandescent, 1000VA (750W) Fluorescent & Magnetic Low-Voltage Lighting | White (Ivory kit included) |

*Special Note: As with any dimmer, derating for multiple gang installations is required for Wall Switch Receivers.*

Use Leviton Power Extenders to extend the load capacity of DHC Dimming Wall Switch Receivers.

### COLOR CHANGE KITS FOR WALL DIMMERS AND SWITCHES

| Receiver Cat. No. | Cat. No. Ivory | Cat. No. White | Cat. No. Almond | Cat. No. Gray | Cat. No. Black |
|-------------------|----------------|----------------|-----------------|---------------|----------------|
| HCM06/10-1DW      | DRKDD-1LI      | DRKDD-1LW      | DRKDD-1LA       | DRKDD-1LG     | DRKDD-1LE      |
| HXM06/10-1TW      | DRKDD-1LI      | DRKDD-1LW      | DRKDD-1LA       | DRKDD-1LG     | DRKDD-1LE      |
| HXS08-1TW         | DRKOD-1LI      | DRKOD-1LW      | DRKOD-1LA       | DRKOD-1LG     | DRKOD-1LE      |

### SPECIFICATIONS AND FEATURES

- New One Button Programming
- Provide Scene Control capability when used with DHC Scene Controller HXCS7-1TW and HCPCG-1TW Toscana Programmer. Also backward compatible with 16400/16450-S and 16400/16450-SD Scene Controllers
- HCM06/10-1DW provides 3-way and multi-location capability when used with MS00R-10 Multi-Remote
- Soft On/Fade Off brightness levels extend bulb life
- Fits in standard wall boxes
- Leviton's patented IntelliSense™ Technology virtually eliminates signal problems due to line noise
- Protected memory during minor power fluctuations
- LED brightness display alongside rocker
- Packed with Ivory and White snap-on rocker/frame kit: optional snap-on rocker/frame color change kits sold separately. See color change kit chart

- Decora-styled to coordinate with Leviton's Decora line of wiring devices
- Backed by a Limited Two-Year Warranty

### TESTING AND CODE COMPLIANCE

- UL Listed to File No. E31373
- CSA Certified to File No. LR3413
- NOM Certified #057

### COLOR

Colors available as indicated. See chart for Rocker and Frame Kits (must be purchased separately)

### MATERIAL CHARACTERISTICS

Engineering Thermoplastic UL-94, V2 Rating  
Operating Temperature: 32°F to 130°F

*Note: A Cat. No. HCA02-10E System Amplifier must be installed in all panels in every DHC installation to ensure adequate signal strength.*





**Scene-Capable Wall Dimmers**

Dimming Wall Switch Receivers provide manual and remote ON/OFF switching and full range dimming for incandescent and magnetic low-voltage loads. Receivers are scene-capable when used with Leviton's Toscana Programmer HCCPG-1TW and Seven-Scene Controller HXC7S. Receivers will respond to ON, OFF, DIM, BRIGHT, ALL LIGHTS ON/ALL OFF AND SCENE commands. Receivers also provide single-pole and 3-way (multi-location) ON/OFF switching and full range dimming when used with MS00R-10 Multi-Remote. Preset feature turns lights ON at last selected brightness level. Soft ON/Fade OFF feature provides eye-pleasing effect and extended bulb life. Cat. No. HCS10-1SW is a non-dimming ON/OFF Receiver. All receivers feature IntelliSense™ Technology to ensure top performance and reliability even when noise is present on the AC powerline.

Packed with Ivory and White Rocker and Frame Kits. Kits for other colors must be purchased separately.

| DESCRIPTION   | CAT. NO.  | RATING   | COLOR                      |
|---|-----------|--|----------------------------|
| <b>600 Watt Scene-Capable Dimming Switch</b> —<br>Single-pole and 3-way (multi-location) when used with MS00R Multi-Remote. Neutral not required for incandescent loads.  | HCM06-1SW | 600W Incandescent, 600VA (450W)<br>Magnetic Low-Voltage<br>120V AC 60Hz                      | White (Ivory kit included) |
| <b>1000 Watt Scene-Capable Dimming Switch</b> —<br>Single-pole and 3-way (multi-location) when used with MS00R Multi-Remote. Neutral not required for incandescent loads.   | HCM10-1SW | 1000W Incandescent, 1000VA (750W)<br>Magnetic Low-Voltage<br>120V AC 60Hz                    | White (Ivory kit included) |
| <b>10 Amp Scene-Capable Switch (Non-Dimming)</b> —<br>Single-pole and 3-way (multi-location) when used with MS00R Multi-Remote. Neutral required. Requires Cat. No. 6287 when used with electronic loads such as compact fluorescent lamps. | HCS10-1SW | 1200W Incandescent, 1200VA Fluorescent and Magnetic Low-Voltage Lighting<br>10A-120V AC 60Hz | White (Ivory kit included) |

**ROCKER AND FRAME KITS FOR HCM10-1SW AND HCM06-1SW**

| Cat. No. Ivory | Cat. No. White | Cat. No. Almond | Cat. No. Gray | Cat. No. Black |
|----------------|----------------|-----------------|---------------|----------------|
| DRKOD-1LI      | DRKOD-1LW      | DRKOD-1LA       | DRKOD-1LG     | DRKOD-1LE      |

**ROCKER AND FRAME KITS FOR HCS10-1SW**

| Cat. No. Ivory | Cat. No. White | Cat. No. Almond | Cat. No. Gray | Cat. No. Black |
|----------------|----------------|-----------------|---------------|----------------|
| DRKOS-0LI      | DRKOS-0LW      | DRKOS-0LA       | DRKOS-0LG     | DRKOS-0LE      |

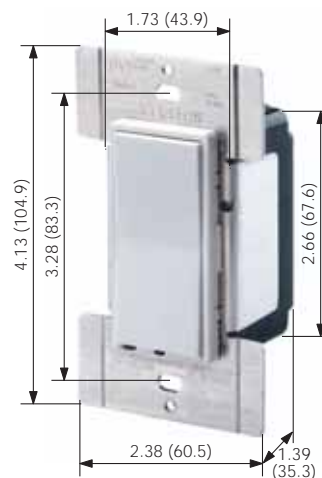

HCM06-1SW

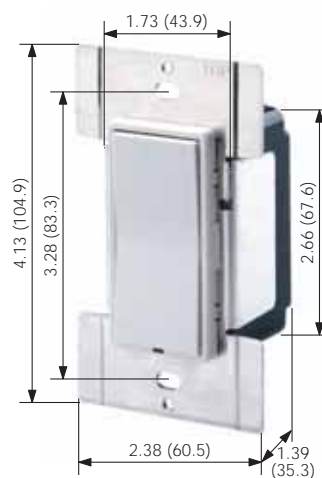

HCS10-1SW

**SPECIFICATIONS AND FEATURES**

- Provide Scene Control capability when used with DHC Scene Controller HXCS7-1TW and HCCPG-1TW Toscana Programmer. Also backward compatible with 16400/16450-S and 16400/16450-SD Scene Controllers
- Provides 3-way and multi-location capability when used with MS00R-10 Multi-Remote
- Soft On/Fade Off brightness levels allowing extended bulb life
- Fits in standard wall boxes
- Leviton's patented IntelliSense™ Technology virtually eliminates signal problems due to line noise
- Protected memory during minor power fluctuations
- Packed with Ivory and White snap-on rocker/frame kit; optional snap-on rocker/frame color change kits sold separately. See color change kit chart
- Decora-styled to coordinate with Leviton's Decora line of wiring devices
- Backed by a Limited Two-Year Warranty

**TESTING AND CODE COMPLIANCE**

- UL Listed to File No. E31373
- CSA Certified to File No. LR3413
- NOM Certified #057

**COLOR**

Colors available as indicated. See chart for Rocker and Frame Kits (must be purchased separately)

**MATERIAL CHARACTERISTICS**

Engineering Thermoplastic UL-94, V2 Rating  
Operating Temperature: 32°F to 130°F



HXP15-1TW



HCP03-10W

Scene-Capable Plug-In Receiver Modules



| DESCRIPTION   | CAT. NO.  |
|---|-----------|
| <p><b>Scene-Capable Plug-In Appliance Module with One-Button Programming and 2-Way Communication</b>—Provides 1-button programming through address capturing. No wiring necessary; plugs into any 15A-125V grounding receptacle and provides NEMA 5-15R grounding receptacle for lights and appliances. Provides manual and remote ON/OFF switching for a variety of free-standing lights and appliances. Provides scene capability (ON/OFF switching) when used with the HXCS7-1TW Seven-Scene Controller and the HCCPG-1TW Toscana Deluxe Programmer. Responds to ON, OFF, ALL LIGHTS ON/ALL OFF and SCENE COMMANDS. Push button allows manual ON/OFF control. Provides status tracking to notify 2-way capable controllers of manual status changes. Features IntelliSense™ Technology for the utmost in reliability even when noise exists on the AC powerline. With LED locator light. Color: White.</p> <p><b>Rated:</b> 120V AC 60 Hz, 1800W Incandescent, 1800VA Fluorescent, 15A Resistive, 1/2 HP Motor loads @ 120V AC</p> | HXP15-1TW |
| <p><b>Scene-Capable Plug-In Lamp Module with One-Button Programming</b>—Provides 1-button programming through address capturing. Provides remote ON/OFF switching, manual ON switching, and remote full-range dimming for plug-in incandescent lamps. No wiring necessary; plugs into 15 Amp AC outlet. Allows local control of any lamp plugged into it. Available in White (-W) only. Provides Scene Control capability when used with DHC Scene Controller HXCS7-1TW and HCCPG-1TW DHC Toscana Deluxe Programmer. Also backward compatible with 16400/16450-S and 16400/16450-SD DHC Scene Controllers. Equipped with Leviton's IntelliSense® advanced circuitry for the utmost in reliability, even where electrical "noise" exists on the power line. Responds to ON, OFF, DIM, BRIGHT, ALL LIGHTS ON/ALL OFF and SCENE LIGHTING commands.</p> <p><b>Rated:</b> 120V 60Hz, 300W Incandescent</p>   | HCP03-10W |

SPECIFICATIONS AND FEATURES

- Plug-in design requires no wiring
- HXP15-1TW provides manual and remote ON/OFF switching of plug-in lamps and appliances
- HCP03-10W provides manual and remote ON/OFF switching and full-range dimming for plug-in incandescent lamps
- One-button programming through address capturing
- Scene-capable when used with when used with the HXCS7-1TW Seven-Scene Controller and the HCCPG-1TW Toscana Deluxe Programmer.
- Protected memory maintains status of plug-in loads and address programming during minor power fluctuations
- HXP15-1TW provides status tracking to notify 2-way capable controllers of manual status changes
- Leviton's patented IntelliSense™ Technology virtually eliminates signal problems due to line noise
- Backed by a Limited Two-Year Warranty

TESTING AND CODE COMPLIANCE

- UL Listed (File #E-66800)
- CSA Certified (File #LR-54628)
- NOM Certified (#057)

MATERIAL CHARACTERISTICS

Engineering Thermoplastic UL-94, V2 Rating  
Operating Temperature: 32°F to 130°F





Wall Switch Receivers INTELLISENSE™

**DESCRIPTION**

**CAT. NO.**

**Single-Pole (One Location) Switch**—Equipped with Intellisense (gated automatic gain control) and provides manual and remote ON/OFF control. Can be set to any of 256 DHC address codes to switch incandescent, inductive or resistive loads where dimming is not required. Responds to ON, OFF, ALL LIGHTS ON/ALL OFF commands. Wires easily into standard wall box using terminal screws. Neutral Connection Required. Pilot light is ON when switch is ON. Code wheels are located beneath rocker plate. Packed with Ivory and White Rocker and Frame. Kits for other colors must be purchased separately (See Chart). Requires Cat. No. 6287 when used with electronic loads such as compact fluorescent lamps.

**6291-WI**

**Rated:** 15A 120V AC 60Hz Incandescent, Inductive or Resistive

**3-Way (Multi-Location) Switch**—Equipped with Intellisense (gated automatic gain control). Provides manual and remote ON/OFF control in multi-station switching circuits when used in conjunction with one or more Cat. No. 6294 Remote Switches. The 6293 can be set to any of 256 DHC address codes to switch incandescent, inductive or resistive loads where dimming is not required. Responds to ON, OFF, ALL LIGHTS ON/ALL OFF commands. Wires easily into standard wall box using terminal screws. Neutral Connection Required. Pilot light is ON when switch is ON. Code wheels are located beneath rocker plate. For proper operation, the total length of traveler wire between Multi-Location Switch and Remote should not exceed 90 feet. Packed with Ivory and White Rocker and Frame. Kits for other colors must be purchased separately (See Chart).

**6293-WI**

**Rated:** 15A 120V AC 60Hz Incandescent, Inductive or Resistive



**ROCKER AND FRAME KITS FOR 6383 SWITCH**

| Cat. No. Ivory | Cat. No. White |
|----------------|----------------|
| 6081-I         | 6081-W         |

**ROCKER AND FRAME KITS FOR 6291 AND 6293 SWITCH**

| Cat. No. Ivory |
|----------------|
| 6091-I         |

**SPECIFICATIONS AND FEATURES**

- Fit in standard wallboxes and replace regular switches to provide manual and remote ON/OFF switching of lighting and appliances. 6381-WI dimming switch rated for incandescent lighting only
- Leviton's patented Intellisense™ Technology virtually eliminates signal problems due to line noise
- Use existing 60Hz 120V AC house wiring to add multi-location switching without resorting to complicated and costly conventional wiring means
- Decora styled to coordinate with Leviton's Decora line of wiring devices
- Backed by a Limited Two-Year Warranty

**TESTING AND CODE COMPLIANCE**

- UL Listed (File #E-66800)
- CSA Certified (File #LR-54628)

**MATERIAL CHARACTERISTICS**

Engineering Thermoplastic UL-94, V2 Rating  
Operating Temperature: 32°F to 130°F



# DECORA® HOME CONTROLS (DHC)



## Residential Grade Receivers—Red Line

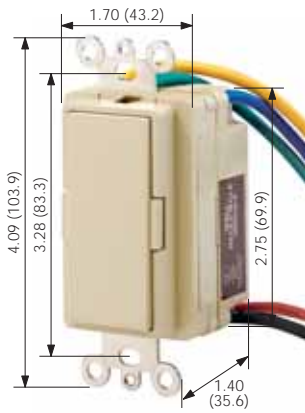

6371-I

### Wall Switch Remotes and Receivers

| DESCRIPTION  | CAT. NO. |
|--|----------|
| <p><b>3-Way and 4-Way (Multi-Location) Remote Switch</b>—For use with DHC Cat. Nos. 6383 and 6293 Multi-Location Switches as a remote switch. The 6294 provides 3-Way, 4-Way and higher-level control in conjunction with these units. It cannot be used for any other purpose in the DHC network. The unit wires easily into standard wall box using terminal screws. For proper operation, the total length of traveler wire between Multi-Location Switch and Remote should not exceed 90 feet. Available in Ivory (-I), White (-W) and Almond (-A). Specify color(s) when ordering, as snap-on cover and frame kits cannot be used with the 6294.</p> <p><b>No Load Rating</b>—For use with 6293 and 6383 units only</p> | 6294     |
| <p><b>Double Pole Wall Switch</b>—Equipped with IntelliSense (gated automatic gain control). Provides local and remote ON/OFF control. Responds to ON/OFF and ALL OFF commands from controllers. Can be set to any of the 256 DHC address codes. Intended for control of pool pumps, air conditioning units, spa heaters and pumps, and other large residential loads. Wire easily into any standard wall box by means of six-inch leads. Available in Ivory only.</p> <p><b>Rated:</b> 20A 2 HP 250V AC 60Hz</p>  | 6371-I   |



### ROCKER AND FRAME KITS FOR MSOOR-10 REMOTE SWITCH

| Cat. No. Ivory | Cat. No. White | Cat. No. Almond | Cat. No. Gray | Cat. No. Black |
|----------------|----------------|-----------------|---------------|----------------|
| DRKOR-00I      | DRKOR-00W      | DRKOR-00A       | DRKOR-00G     | DRKOR-00E      |

#### SPECIFICATIONS AND FEATURES

- Remote Units add multi-location capability to dimmer and switch receivers
- Fit in standard wallboxes to replace regular switches
- Leviton's patented IntelliSense™ Technology virtually eliminates signal problems due to line noise (Cat. No. 6371-I)
- 6371-I Heavy-duty appliance switch available for automated control of heavy-duty loads such as air conditioning and pool pumps
- Decora styled to coordinate with Leviton's Decora line of wiring devices
- Backed by a Limited Two-Year Warranty

#### TESTING AND CODE COMPLIANCE

- UL Listed (File #E-66800)
- CSA Certified (File # LR-54628)

#### COLOR

Colors available as indicated.

#### HORSEPOWER

Cat. No 6371-I: 2 HP @ 250V 20A

#### MATERIAL CHARACTERISTICS

Engineering Thermoplastic UL-94, V2 Rating  
Operating Temperature: 32°F to 130°F





RECEPTACLE Receivers

DESCRIPTION

**Split Duplex Wall Receptacle**—Equipped with Intellisense (gated automatic gain control). Top outlet provides remote ON/OFF load control in response to controller command signals. Bottom outlet is continuously live. Local control of any light or appliance plugged into the controlled outlet can be achieved by switching the load ON/OFF switch once or twice. Will not respond to ALL LIGHTS ON command. Fits standard wall boxes and supplied with leads for easy installation.

**Rated:** 15A 120V 60Hz AC only. NEMA 5-15R.

CAT. NO.

6227-I  
6227-W  
6227-A



**Duplex Wall Receptacle**—Equipped with Intellisense (gated automatic gain control). Same as 6227, but with both top and bottom outlets providing ON/OFF control in response to controller command signals. Feed-through load allows control of receptacles downstream. Will not respond to ALL LIGHTS ON command. No local control available.

**Rated:** 15A 120V 60Hz AC only. NEMA 5-15R

6280-W



**Single Wall Receptacle★**—Equipped with Intellisense (gated automatic gain control). Provides ON/OFF control. No local control available. Wires easily into standard wallbox using supplied six-inch leads. Will not respond to ALL LIGHTS ON command.

**Rated:** 20A 120V 60Hz AC only. NEMA 5-20R

6296-I  
6296-W



**Single Wall Receptacle★**—Equipped with Intellisense (gated automatic gain control). Provides ON/OFF control. No local control available. Wires easily into standard wallbox using supplied six-inch leads. Will not respond to ALL LIGHTS ON command.

**Rated:** 20A 250V 60Hz AC only. NEMA 6-20R

6298-W



CSA Certified except where indicated by★

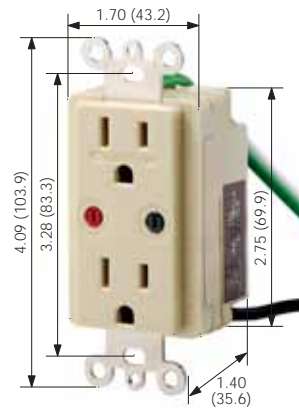

6227-I

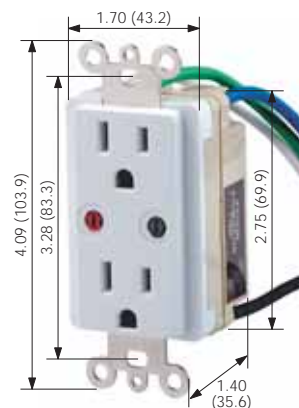

6280-W

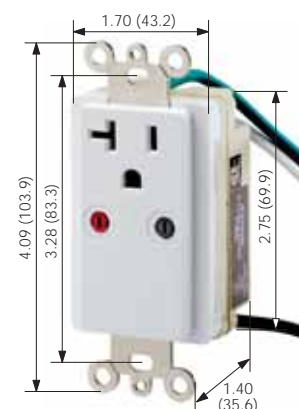

6296-W

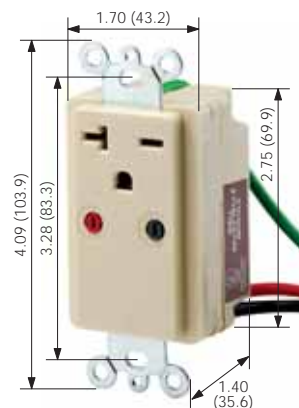

6298-I

SPECIFICATIONS AND FEATURES

- Available in commonly used NEMA configurations
- Fit in standard wallboxes and replace standard receptacles
- Leviton's patented Intellisense™ Technology virtually eliminates signal problems due to line noise
- Decora styled to coordinate with Leviton's Decora line of wiring devices
- Backed by a Limited Two-Year Warranty

TESTING AND CODE COMPLIANCE

- UL Listed (File #E-66800)
- CSA Certified (File # LR-54628)
- NOM Certified (#057)

COLOR

Colors available as indicated in Ivory (-I), White (-W) and Almond (-A).

MATERIAL CHARACTERISTICS

Engineering Thermoplastic UL-94, V2 Rating  
Operating Temperature: 32°F to 130°F



# DECORA® HOME CONTROLS (DHC)



## Residential Grade Receivers—Red Line



6337



6375

### Receiver Modules

| DESCRIPTION   | CAT. NO. |
|---|----------|
| <p><b>Universal Low Voltage Module</b>—Almost any device operated at low voltages can now be automated using the 6337. This receiver interfaces between the low voltage device and the 120V AC wiring network. It receives an ON or OFF command from DHC Transmitters and can operate sprinkler systems, designated lighting, skylight closures, heating systems, garage door openers and other lighting and motor loads. Simply connect LV wiring to the screw terminal on the module and plug it into any 120V wall outlet.</p> <p>In addition to switching contacts, the 6337 has a built-in alarm that can be set to sound whenever the switch contacts are closed. The 6337 can be set to operate the relay only, the alarm only, or both the relay and the alarm.</p> <p>The 6337 can also be set for momentary operation so that the relay and/or the alarm will be turned on for approximately two seconds in response to any ON command. Does not respond to ALL LIGHTS ON or DIM/BRIGHT commands.</p> <p><b>Rated:</b> 120V 60Hz AC only.      <b>Contacts:</b> 5A 12V DC, 100VA 30V DC Inductive</p> | 6337     |
| <p><b>Fixture Relay Module</b>—Can be mounted at either an incandescent or fluorescent fixture by means of adhesive strips. Responds to ON/OFF and ALL LIGHTS ON/ALL OFF commands from controllers. Equipped with leads for easy installation.</p> <p><b>Rated:</b> 15A 120V 60Hz AC only, incandescent, inductive, or resistive.</p>   | 6375     |
| <p><b>Dimming Fixture Module</b>—Can be mounted at an incandescent fixture by means of adhesive strips. Responds to ON/OFF, DIM/BRIGHTEN and ALL LIGHTS ON/ALL OFF commands from controllers. Equipped with leads for easy installation.</p> <p><b>Rated:</b> 300W incandescent 120V 60Hz AC only.</p>  | 6376     |

See Lighting Controls Section C for more information on Leviton Power Extenders.

Use Leviton Power Extenders to extend the load capacity of DHC Dimming Wall Switch Receivers.

#### SPECIFICATIONS AND FEATURES

- Universal Low Voltage Module can automate devices operated at low voltages such as sprinklers, skylights, and heating/AC systems
- Fixture modules provide direct control for fixtures where only remote control is necessary
- Backed by a Limited Two-Year Warranty

#### TESTING AND CODE COMPLIANCE

- UL Listed (File #E-66800)
- CSA Certified (File #LR-54628)
- NOM Certified (#057)

#### MATERIAL CHARACTERISTICS

Engineering Thermoplastic UL-94, V2 Rating  
Operating Temperature: 32°F to 130°F





**DHC Network Integrity Products**

Panel Mounted Surge Protective Devices (SPD)—Provides homes with protection from high-energy transient voltage surges that can damage sensitive electronic circuits in computers, audio and video components and electronic appliances. DHC components incorporate micro circuitry and Leviton highly recommends protecting the DHC network from powerline surges. Leviton Panel Mount devices feature unique hybrid suppression circuitry for outstanding surge protection. The following devices are compatible with all DHC components.

| DESCRIPTION  | CAT. NO.  | MAX. SURGE CURRENT (8 X 20µs wave) L-N      | UL 1449 RATING L-N                 |
|--|-----------|---|------------------------------------|
| <b>120/240V AC, Single-Phase</b> —Standard J-box metal enclosure with pre-punched standard knockouts.  | 51120-1   | 50kA  | 500V                               |
| <b>120/208V AC, 3-Phase WYE</b> —Standard J-box metal enclosure with pre-punched standard knockouts.   | 51120-3   | 50kA  | 500V                               |
| <b>120/240V AC, Single-Phase</b> —NEMA 3R enclosure suitable for outdoor use   | 51120-3R  | 50kA  | 800V                               |
| <b>120/240V AC, Single-Phase</b> —Features sine wave tracking, redundant protection and replaceable/surge modules. NEMA 12 enclosure with hinged cover.  | 52120-M2H | 100kA                                       | 400V                               |
| <b>120/240V AC, Single-Phase Multimedia Panel</b> —Provides surge protection for AC powerline, 2-pairs of phone/fax/modem connections, and dual CATV/Satellite feeds using F connectors. Painted steel NEMA 1 enclosure with four perforated 7/8" knockouts. | 51110-PTC | AC: 48kA<br>Tel: 1.9kA @ 3.8kV<br>CATV: 2kA | AC: 400V<br>Tel: 220V<br>CATV: 25V |



51110-PTC



51120-1

*Note: A Panel Mount Surge Protective Device should be installed at the service panel in every DHC installation.*

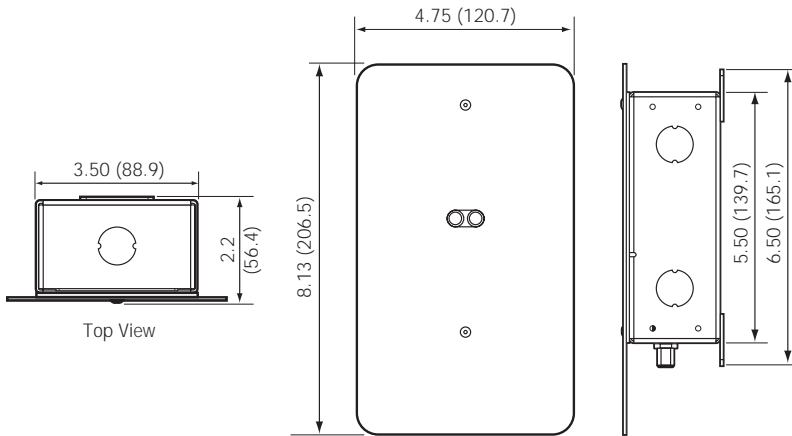

*Multimedia Panel Surge Protective Device  
Cat. No. 51110-PTC*

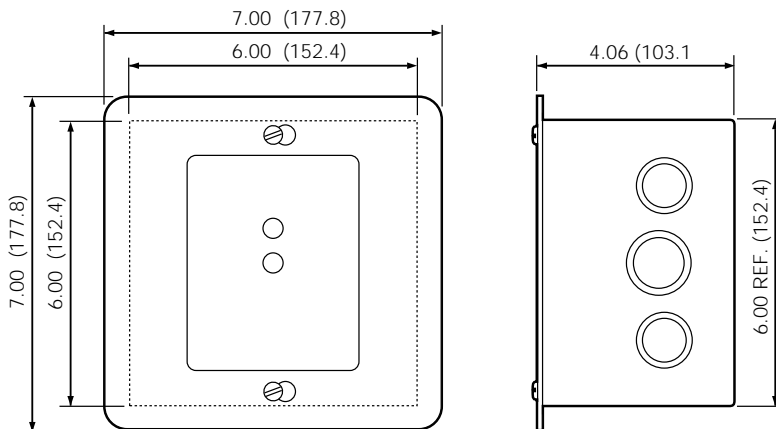

*PANEL MOUNTED SURGE PROTECTIVE DEVICE  
Cat. No. 51120-1,-3*

**SPECIFICATIONS AND FEATURES**

- Real-time diagnostic visual indicator shows power and suppression status for each (protected) phase
- Cat. No. 51110-PTC Multimedia Panel protects AC, phone/fax/modem, and CATV/Satellite lines from transient voltage surges
- Cat. No. 52120-M2H features user-replaceable surge modules
- Backed by a Limited 10-Year Warranty

**TESTING AND CODE COMPLIANCE**

- Listed to UL 1449 (2nd edition) Standards
- UL Listed (File #E-146315)
- CSA Certified (File #LR94773)

**MATERIAL CHARACTERISTICS**

Engineering Thermoplastic UL-94, V2 Rating  
Operating Temperature: -10°C to 60°C



HCA02-10E

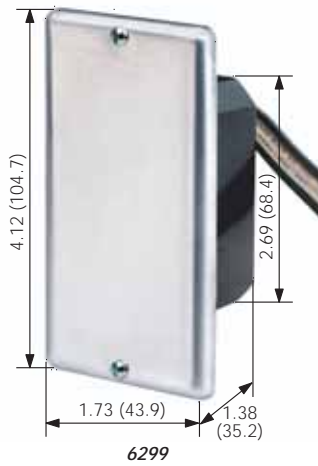

6299

DHC Network Integrity Products

| DESCRIPTION   | CAT. NO.  |
|---|-----------|
| <p><b>System Amplifier/Coupler/Repeater with Built-in Test Signal Generator</b>—Performs a variety of functions to ensure outstanding DHC system performance and reliability. Couples transmitter (programmer and controller) signals generated on the 120V leg where the transmitter draws power onto the other leg in a 120/240V single-phase 3-wire residential wiring system. The HCA02-10E also amplifies and repeats command signals to maintain proper signal strength through the DHC system. Green pilot light indicates unit has power. Lamp will indicate when signal is being transmitted. Features IntelliSense™ Technology to help ensure top performance even when noise is present on the AC powerline. The error lamp indicates the IntelliSense feature is activated. The unit provides convenient test signal transmission for easy signal strength verification at individual DHC module locations using Leviton's Cat. No. 6386 Signal Strength Indicator.</p> <p>The HCA02-10E should be installed at the main panel on its own dedicated 15A breaker in accordance with NEC requirements. <b>The HCA02-10E cannot be used in a 3-phase system.</b></p> <p><i>Note: A Cat. No. HCA02-10E System Amplifier must be installed in all panels in every DHC installation to ensure adequate signal strength.</i></p> | HCA02-10E |
| <p><b>Signal Bridge/Passive System Coupler</b>—Couples the DHC command signal onto the 120V legs of the power system to ensure sufficient command signal strength throughout the DHC network. (NOTE: 6299 should NOT be installed in the same panel as HCA02-10E).<br/><b>Rated:</b> 120/240V 60Hz AC only.</p>   | 6299      |
| <p><b>Signal Attenuator, 2-Phase</b>—Attenuates “(knocks down”) external noise and signal levels entering the DHC network. The 6285 can be used to block interference from appliances, electronic ballasts and home electronics to ensure top performance from DHC network. Also used to block signal leakage (attenuation) caused by capacitive filters and electronic power supplies.<br/><b>Rated:</b> 2-Phase 120/240V &amp; 120/208V 60Hz AC only.</p>   | 6285      |
| <p><b>Multi-Phase Blocking Coupler</b>—The 6284 is installed between the incoming electrical service and the service panel in apartment buildings, condominiums, attached-unit dwellings and homes sharing the same side of the electrical transformer. Keeps extraneous electronic noise and signals from entering or leaving the DHC network.<br/><b>Rated:</b> 120V, 120/240V &amp; 120/208V 60Hz AC—Max. 200 Amp panel.</p>   | 6284      |



SPECIFICATIONS AND FEATURES

- Cat. No. HCA02-10E System Amplifier/Coupler/Repeater must be installed in all DHC installations to ensure adequate signal strength.
- Cat. Nos. 6284 and 6285 are used to stop extraneous noise and signals from degrading DHC network operation
- Backed by a Limited Two-Year Warranty

TESTING AND CODE COMPLIANCE

- UL Listed (File #E-66800)
- CSA Certified (File #LR3413)
- UL 244A Tested (and others where applicable)

MATERIAL CHARACTERISTICS

Engineering Thermoplasti UL-94, V2 Rating  
Operating Temperature: 32°F to 130°F



**DHC Residential Grade Network Integrity Products**

**DHC Network Integrity Products**

| DESCRIPTION   | CAT. NO. |
|---|----------|
| <p><b>Noise Block</b>—The 6287 is designed for use with DHC switch modules that include a means for connection to neutral. This device may be wired on the LOAD side of a DHC switch module (except 6383), or on the LINE side of any fixture using an electronic ballast, a low-voltage ballast, or any noise-generating source that does not require more than 5A 120V AC. The 6287 prevents interference generated by fixture components from interfering with DHC signals.</p> <p><b>Rated:</b> 5A 120V 60Hz AC only.</p> | 6287     |
| <p><b>Plug-in Noise Filter</b>—electrical appliances may generate “noise” that could interfere with proper signal transmission. When the offending appliance is isolated and plugged into the 6288 Noise Filter, which is in turn plugged into a receptacle, stray noise is filtered out, ensuring a clear signal. Color: Brown.</p> <p><b>Rated:</b> 5A 120V 60Hz AC only.</p>   | 6288     |
| <p><b>In-Line Noise Reducer</b>—the 6289 Noise Reducer filters electrical “noise” and signals with frequencies above and below the 121 kHz signal. The 6289 may be installed at the “noise” or signal source or at the module affected by the interference. Depending on the source of the interference, the 6289 may be wired phase to neutral or phase to phase.</p>  | 6289     |

**DHC Powerline Carrier Test Equipment**

|  |      |
|--|------|
| <p><b>Signal Strength Indicator</b>—Measures command signal strength at individual module locations. Minimum signal strength required for proper DHC Powerline Carrier component operation is 100mV.</p> | 6386 |
|--|------|

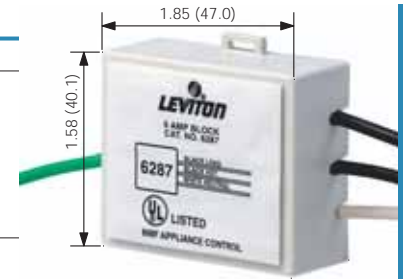

6287



6288



6289



6386

**SPECIFICATIONS AND FEATURES**

- These devices are designed to eliminate interference from appliances, electronic ballasts and home electronics in order to insure top performance from DHC systems
- Backed by a Limited Two-Year Warranty
- Signal Strength Indicator**
- Signal strength testing equipment used to ensure proper operation of DHC system
- Backed by a Limited Two-Year Warranty

**TESTING AND CODE COMPLIANCE**

- NOM Certified (#057)
- UL Listed (E-66800)
- Signal Strength Indicator**
- UL Listed (File #E-66800)
- NOM Certified (#057)

**MATERIAL CHARACTERISTICS**

Engineering Thermoplastic UL-94, V2 Rating  
Operating Temperature: 32°F to 130°F

# HOW TO USE THIS CATALOG

The L-101 Leviton Wiring Device Catalog is designed to help you find the device you're seeking in the quickest and easiest way possible. Most product sections are divided into three distinct categories in the following sequence—Industrial Grade, Commercial Grade and Residential Grade—and grouped according to amperage and voltage, lowest to highest. For example, if you need to order 15 Amp, 125 Volt Industrial Grade straight-blade duplex receptacles, begin your search with the main Table of Contents at the front of the book. Here you'll see that all straight blade receptacles are listed in Section G. Turn to Section G for a more detailed Table of Contents on the first page. Each section page contains product descriptions, ratings and catalog numbers. There are also helpful highlights including Specifications and Features, Testing and Code Compliance, Color listing, Material Characteristics and dimensioned color product photos. Any product page in the L-101 Catalog can be clearly copied or faxed to customers and prospects for use as a specifier sheet or as part of a presentation.

The Quick Reference Guide follows the main Table of Contents to help you pinpoint and locate specific products. Technical Section V provides general product and test data, industry standards, NEMA configuration charts, a glossary of wiring device terms, ANSI architectural symbols and other related information. Specific catalog numbers are listed in the exhaustive index at the back of the catalog.

## 15 AMP 125 and 250V ~ 20 AMP 125 and 250V

### Industrial Grade Straight Blade Receptacles

**Back and Side Wired** (Basic Cat. No. Denotes Brown Device\*)

| DESCRIPTION                             | CAT. NO./COLOR<br>15A/125V                         | CAT. NO./COLOR<br>15A/250V | CAT. NO./COLOR<br>20A/125V                | CAT. NO./COLOR<br>20A/250V         |
|---|--|----------------------------|---|------------------------------------|
| LEVSPEC® Duplex Receptacle, Brass Strap | 5262<br><small>I, W, GY, R, E</small>              | 5662<br><small>I</small>   | 5362<br><small>I, W, GY, R, E</small>     | 5462<br><small>I, GY</small>       |
| Single Receptacle                       | 5261<br><small>I, W, GY</small>                    | 5661<br><small>I</small>   | 5361<br><small>I, W, A, T, GY</small>     | 5461<br><small>I, A, T, GY</small> |
| Narrow Body Duplex Receptacle           | 5252<br><small>I, W, A, T, GY, R,<br/># BU</small> |                            | 5352<br><small>I, W, A, T, GY, R,</small> |                                    |

5362-IG

80703-IG 80703-I 80704-GY 80716-R

84003-40 84004-40 84016-40

**For complete wallplate selection, see Section E.**

**SPECIFICATIONS AND FEATURES**

- Meets NEMA WD-1 & 6, and ANSI standards
- Backed by a Limited 10-Year Warranty
- SPECCLASS devices backed by a Limited 2-Year Warranty

**\*COLOR**

Basic Cat. Nos. shown above denote Brown device, except for Isolated Ground (-IG) devices Basic Cat. No. denotes Orange. Isolated Ground Receptacle is distinguished by an orange triangle on its face. For other color selections, add suffix to the catalog number as follows: Ivory (-I), White (-W), Brown (For IG devices only, add -B), Almond (-A), Light Almond (-T), Gray (-G or -GY), Black (-E), Red (-R) and Blue (-BU); for IG devices only, add -BIG)

**MATERIAL CHARACTERISTICS**

Environmental: Flammability, Rated V2  
Operating Temperature: From -40° C (without impact) to 60°C maximum continuous

- |                                       |  |                                      |
|---------------------------------------|--|--------------------------------------|
| <b>A</b> RATING                       | <b>E</b> CATALOG NUMBER                      | <b>I</b> SPECIFICATIONS & FEATURES   |
| <b>B</b> Choose GRADE, if appropriate | <b>F</b> DESCRIPTION                         | <b>J</b> TESTING AND CODE COMPLIANCE |
| <b>C</b> DIMENSIONED PHOTOGRAPH       | <b>G</b> Check for NEMA CONFIGURATION        | <b>K</b> COLOR LISTING               |
| <b>D</b> WIRING/CERTIFICATIONS        | <b>H</b> WALLPLATE REFERENCE, if appropriate | <b>L</b> MATERIAL CHARACTERISTICS    |



# Structured Cabling Systems

## INDEX

|  |          |
|--|----------|
| Quick Reference Guide                        | L2       |
| <b>Connectors</b>                            |          |
| QuickPort®                                   | L3-L5    |
| Fiber Optic                                  | L6, L7   |
| <b>Wallplates and Housings</b>               |          |
| QuickPort                                    | L8-L16   |
| Acenti®                                      | L17      |
| Standard Telephone/Video Jacks               | L18-L22  |
| Workstation Accessories                      | L23      |
| <b>Copper Components</b>                     |          |
| Patch Panels                                 | L24-L30  |
| Industrial Connectivity                      | L31      |
| Patch Cords                                  | L32      |
| 110-Style                                    | L33-L38  |
| 66-Block                                     | L39-L40  |
| <b>Fiber Components</b>                      |          |
| Enclosures                                   | L41-L45  |
| Fiber Optic Cable Assemblies                 | L46      |
| Accessories                                  | L47-L49  |
| <b>Enclosures</b>                            |          |
| Telecommunications                           | L50, L51 |
| Wireless Access Point                        | L52      |
| <b>Cable Management and Rack Accessories</b> |          |
| Versi-Duct®                                  | L53      |
| Rack and Frame                               | L54-L57  |
| Hook and Loop                                | L58      |
| <b>Labeling Products</b>                     | L59, L60 |
| <b>Tools and Accessories</b>                 |          |
| Punchdown/Termination                        | L61      |
| Fiber  | L62-L64  |
| Tone Test                                    | L65      |
| Crimping/Stripping                           | L65      |
| Craftsman's Handset                          | L66      |
| Modular Plug Breakout Adapter                | L66      |

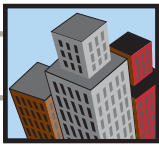

# STRUCTURED CABLING DEVICE FEATURES

## Quick Reference Guide

The following terms are used throughout this section to help users quickly identify special product features.

### eXtreme® 10G

Our Category 6A solution enables advanced technologies, including new 10G and IP-based services. eXtreme 10G connectors feature patent-pending Cone of Silence and patented Retention Force Technology® (RFT) for unparalleled signal integrity.

### eXtreme® 6+

Leviton's Category 6 solution with patented Retention Force Technology. Includes connectors, patch cords and a variety of patch panels. Exceeds TIA specifications for channel, permanent link and component-rated Category 6 systems.

### GigaMax® 5e

Leviton's Category 5e channel and component rated solution. Includes connectors, patch cords and a variety of universal and pre-configured panels. Exceeds TIA specifications for channel-and component-rated Category 5e systems.

### Category 5

Leviton's Category 5 solution for fast reliable voice and data applications from frame to workstation. Includes connectors, patch cords and universal panels. Exceeds TIA specifications for channel and category-rated Category 5 systems.

### Opt-X®

Opt-X is Leviton's full solution Fiber Optic System incorporating a wide range of fiber optic components, including adapters, mounting plates, connectors, enclosures, cable assemblies, tools, consumables and workstation products with features and options to meet all types of customer and application needs.

### FastCAM™

Leviton's FastCAM fiber connectors are pre-terminated and factory polished to provide precision termination of single-mode or multimode fiber.

### Thread-Lock®

Award-winning Thread-Lock mechanical connectors are part of Leviton's full line of connectors. Ideal for quick installations, the reusable connectors make field-installation simple and cost-effective.

### Fast-Cure

Reliable, cost-effective fiber optic connectors with quick, adhesive termination featuring precision pre-radiused zirconia ferrules, high retention strength, and patented non-optical disconnect spacer design.

### Versa-Cleave®

The Versa-Cleave tool is your award-winning solution for cleaving fiber perfectly every time.

### Versi-Duct®

Leviton's versatile horizontal and vertical slotted duct system for fiber and copper cable organization and management. A high-quality system with a variety of solution-based accessories.

### LabelWare™

A TIA/EIA-606-A compliant tool to label and help identify your cabling infrastructure.

### 110 ChannelMax®

110 channel duct allows extra space for routing cables by increasing the vertical channel depth to 3 or 5 inches.

### Retention Force Technology®

Patented features included in eXtreme 6+ and Gigamax 5e+ products, which provide enhanced connection integrity and promote consistent performance over the life of the system. Increased wire retention reduces time contact failure. Improved gas-tight connection prevents corrosion.

### QuickPort®

Leviton's extensive line of snap-in modules allows complete field-configurability for the installer. Leviton QuickPort housings, such as wallplates, MOS housings and modular furniture faceplates, can be configured with a custom combination of QuickPort modules which easily snap in or out of ports.

### Decora®

The original Decora QuickPort module wallplate is designed to match Decora electrical devices manufactured by Leviton.

### Lifetime Performance Warranty

Leviton Voice & Data Division offers a Lifetime Performance Warranty when approved components are installed by a Leviton Certified Installer through the Certified Cabling System (CCS) program.

### TIA Guidelines

The TIA, or Telecommunications Industries Association, is the industry regulatory body which defines industry standards, such as the following:

- TIA/EIA-568-B:** Commercial Building Telecommunications Cabling Standard
- TIA/EIA-569-B:** Commercial Building Standards for Telecommunications Pathways & Spaces
- TIA/EIA-570-B:** Residential and Light Commercial Wiring Standard
- TIA/EIA-606-A:** Administration Standard for the Telecommunications Infrastructure of Commercial Buildings
- TIA/EIA-607:** Telecommunications Bonding and Grounding Standard

### Styles, Features, etc.

These color bars are found throughout this catalog to indicate additional information about a given product. They point out unique features and configurations, or other technical notes to help you in understanding, choosing or using Leviton products.

STYLES

FEATURES

TESTING AND CODE COMPLIANCE

\*COLOR

MATERIAL CHARACTERISTICS

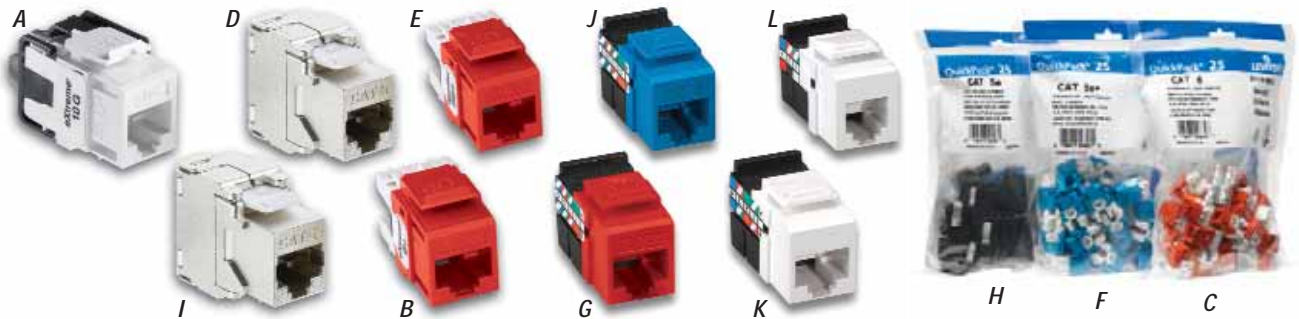

## QuickPort Connectors for UTP and STP Copper Cable

**A-I** Leviton offers a variety of copper connectors from advanced CAT 6A (10G) to CAT 3 solutions. CAT 6A eXtreme® 10G, our highest performing connector featuring the Cone of Silence and Retention Force Technology®, (RFT), resists alien crosstalk (AXT) and offers unparalleled signal integrity. eXtreme 6+ and component rated GigaMAX 5e+ connectors also feature patented RFT for long term performance.

Shielded connectors in CAT 5e and CAT 6 ratings feature a robust, die-cast housing, provide protection from electromagnetic interference, and offer increased data security. Category 5 and Category 3 connectors offer an economical solution for a variety of applications.

All connectors feature standard QuickPort compatibility and universal color coded wiring labels and exceed industry performance standards. Available in 14 colors.



Use a Leviton Field-Termination Coaster to quickly and easily punch down wires on any Leviton Category or Multimedia Connector. For more information, call Sales Support at 1-800-922-6229.

### Color Choices



Note: Protect your Category 5e and 6 connectors from damage and debris with Leviton's field installable Shutters and Icons. See Labeling Products Page L60.

## Quickport Snap-In Connectors

### eXtreme® 10G Snap-In Connectors cULus

| DESCRIPTION  | CAT. NO.               |
|--|------------------------|
| [A] eXtreme 10G channel-rated connector<br>Cone of Silence™ replacement pack (bag of 13) | 6110G-R*6<br>61C05-B13 |

### eXtreme® 6+ Connectors cULus

| DESCRIPTION   | CAT. NO.  |
|---|-----------|
| [B] 8-conductor eXtreme 6+ component-rated connector                              | 61110-R*6 |
| [C] 8-conductor eXtreme 6+ component-rated connectors<br>QuickPack™ (25 per pack) | 61110-B*6 |
| [D] eXtreme 6+ shielded channel-rated connector                                   | 6S180-SH6 |

### GigaMax® 5e Connectors cULus

| DESCRIPTION  | CAT. NO.  |
|--|-----------|
| [E] 8-conductor GigaMax 5e+ component-rated connector                              | 5G110-R*5 |
| [F] 8-conductor GigaMax 5e+ component-rated connectors<br>QuickPack™ (25 per pack) | 5G110-B*5 |
| [G] 8-conductor GigaMax 5e channel-rated connector                                 | 5G108-R*5 |
| [H] 8-conductor GigaMax 5e channel-rated connectors<br>QuickPack™ (25 per pack)    | 5G108-B*5 |
| [I] GigaMax 5e shielded channel-rated connector                                    | 5S180-SH5 |

### Category 5 Connectors

| DESCRIPTION                          | CAT. NO.  |
|--------------------------------------|-----------|
| [J] 8-conductor Category 5 connector | 41108-R*5 |

### Category 3 Connectors

| DESCRIPTION               | CAT. NO.  |
|---------------------------|-----------|
| [K] 8-conductor connector | 41108-R*3 |

### Voice Grade Connectors

| DESCRIPTION                    | CAT. NO.  |
|--------------------------------|-----------|
| [L] 6-conductor USOC connector | 41106-R*6 |
| 8-conductor USOC connector     | 41108-R*8 |

#### \*COLOR/CONNECTORS

For color selection, add suffix to catalog number as follows: Ivory (I), White (W), Gray (G), Black (E), Orange (O), Blue (L), Crimson Red (C), Yellow (Y), Green (V), Purple (P), Almond (A), Light Almond (T), Brown (B), Dark Red (R).

#### MATERIAL CHARACTERISTICS

- All module bodies are fire-retardant plastic rated UL 94V-0
- Jack spring contacts are the highest quality phosphor bronze, plated with 50 microinches of gold over 100 microinches of nickel for lowest contact resistance, maximum life

#### TESTING AND CODE COMPLIANCE

- All category-rated connectors comply with TIA-568-A requirements
- UL Listed
- Fully compliant with NEC Article 800
- Meet FCC Part 68



# QUICKPORT® for AUDIO/VIDEO

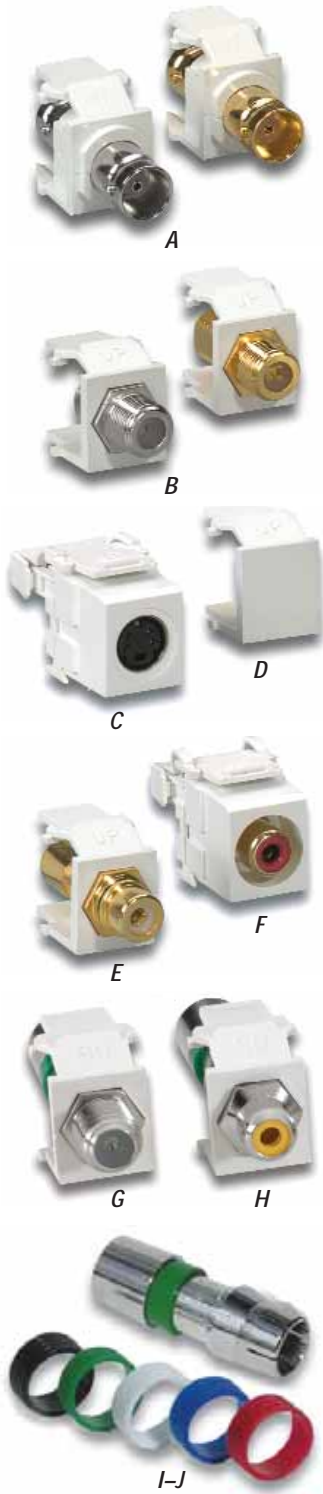

## QuickPort Adapters & Connectors for Audio/Video

Mix & match QuickPort Snap-In Audio/Video Adapters and Connectors to create a customized multimedia center. Make connections with standard industry tools. For Compression Connectors, use Leviton's Master Compression Tool.

- A BNC QuickPort Adapter:** Gold-plated female-to-female connector with twist-on front and rear connections using BNC plugs. Applications: high-end video, home theater, CCTV, LAN. Cable: shielded video & data cable.
- B F-Type QuickPort Adapter:** Nickel or gold-plated female-to-female connector with screw-on front and rear connections. Applications: TV, VCR, DVD, satellite, home theater. Cable: coaxial cable terminated with "F" plugs.
- C S-Video QuickPort Connector:** Flush-mount S-Video connector on the front with 110 punchdowns on the rear. Applications: audio/video, conference rooms, classrooms, computers, projectors. Cable: UTP Category 5, 5e or 6 cable.
- D QuickPort Blank Inserts:** Cover up unused QuickPort housing openings. Order in packages of 10.
- E RCA QuickPort Adapters:** Black, yellow or red striped color-coded module for front and rear connections using RCA plugs. Applications: audio/video, home theatre. Cable: shielded audio/video cable with terminated RCA plugs.
- F RCA-110 QuickPort Connector:** Standard RCA connector on the front with 110 punchdowns on the rear. Applications: audio/video, VCR, DVD, computers and gaming consoles. Cable: UTP Category 5, 5e or 6 cable.
- G, H F-Type and RCA QuickPort Compression Connectors:** Time saving solution for robust terminations right at the wall plate. Applications: HDTV, cameras, component video, CATV and satellite signal delivery. Cable: RG6 Quad.
- I, J RCA and F-Type Compression Connectors:** Female style connectors feature radial crimp for increased audio/video signal integrity. Applications: HDTV, cameras, component video, CATV and satellite signal delivery. Cable: RG6 Quad.

All modules meet or exceed industry standards. All QuickPort connectors and modules are UL certified, fully compliant with NEC® Article 800, and meet FCC Part 68.

For product specifications and recommendations, please visit our web resource at [www.leviton.com/](http://www.leviton.com/).

## Quickport Modules

### Audio/Video Adapters

| DESCRIPTION  | CAT. NO. IVORY  | CAT. NO. WHITE  | CAT. NO. ALMOND                               | CAT. NO. BLACK        | CAT. NO. GRAY         |
|--|---|---|---|-----------------------|-----------------------|
| [A] BNC Adapter, nickel-plated†<br>BNC Adapter, gold-plated  | 41084-BIF<br>40832-OB1  | 41084-BWF<br>40832-OBW  | 41084-BAF<br>40832-OBA                        | 41084-BEF<br>—        | 41084-BGF<br>—        |
| [B] F-type Adapter, nickel-plated†<br>F-type Adapter, gold-plated  | 41084-FIF<br>40831-OB1  | 41084-FWF<br>40831-OBW  | 41084-FAF<br>40831-OBA                        | 41084-FEF<br>—        | 41084-FGF<br>—        |
| [C] S-Video Connector,<br>110 termination†   | 40734-SVI   | 40734-SVW   | 40734-SVA                                     | 40734-SVE             | 40734-SVG             |
| [D] Blank Insert (pack of 10)†   | 41084-BIB   | 41084-BWB   | 41084-BAB                                     | 41084-BEB             | 41084-BGB             |
| [E] RCA Jack, gold-plated<br>w/black stripe†<br>RCA Jack, gold-plated<br>w/red stripe†<br>RCA Jack, gold-plated<br>w/yellow stripe†<br>RCA Jack, gold-plated<br>w/green stripe†<br>RCA Jack, gold-plated<br>w/blue stripe† | 40830-BIE<br>40830-BIR<br>40830-BIY<br>40830-BIV<br>40830-BIL | 40830-BWE<br>40830-BWR<br>40830-BWY<br>40830-BWV<br>40830-BWL | 40830-BAE<br>40830-BAR<br>40830-BAY<br>—<br>— | —<br>—<br>—<br>—<br>— | —<br>—<br>—<br>—<br>— |
| [F] RCA-110 Connector†   | 40735-R*I   | 40735-R*W   | 40735-R*A                                     | 40735-R*E             | 40735-R*G             |

Part numbers shown are for individual polybag packages in standard cartons. Some carded and contractor packs also available. Call customer service at 1-800-722-2082.

† Note: Also available in Light Almond (\*T\*)

### Compression Connectors and Adapters

| DESCRIPTION                            | CAT. NO. F-STYLE | CAT. NO. RCA |
|--|------------------|--------------|
| [G-H] QuickPort Compression Connectors | 40782-CPF        | 40782-R*W    |
| [I-J] Compression Connectors           | 40985-CPF        | 40985-CRU    |

Note: See Tools & Accessories Page L59 for Master Compression Tool.

#### \*COLOR/CONNECTORS

For color selection, add suffix to catalog number as follows: [F] RCA-110 Connector Inner Barrel Color—Orange (O), Red (R), White (W), Yellow (Y). [G-H] Insert Color—Red (R), Black (E), Yellow (Y), Blue (L), Green (V).

#### MATERIAL CHARACTERISTICS

• All module bodies are fire-retardant plastic rated UL 94V-0



## QuickPort Snap-In Adapters & Connectors for Audio

- A, B Banana Jack Adapters:** One black striped or one red striped color-coded module per unit pack. Screw-on rear-side connections. Front-side connections use standard banana plugs. Applications: speaker connections. Cable: speaker wire terminated with banana plugs.
- C, D Binding Post Adapters:** One black striped or one red striped color-coded module per unit pack. Screw-on rear-side connections. Optional front-side connections—either screw-on or push-in—for banana plugs, speaker tip, spade tip, or bare wire. Applications: audio speaker connections. Cable: speaker wire.

All modules meet or exceed industry standards. All QuickPort connectors and modules are UL certified, fully compliant with NEC® Article 800, and meet FCC Part 68.

## QuickPort Snap-In Modules

### Audio Adapters

| DESCRIPTION   | CAT. NO.<br>IVORY | CAT. NO.<br>WHITE | CAT. NO.<br>ALMOND | CAT. NO.<br>LIGHT ALMOND |
|---|-------------------|-------------------|--------------------|--------------------------|
| [A] Banana Jack Adapter, gold-plated w/black stripe | 40837-BIE         | 40837-BWE         | 40837-BAE          | 40837-BTE                |
| [B] Banana Jack Adapter, gold-plated w/red stripe   | 40837-BIR         | 40837-BWR         | 40837-BAR          | 40837-BTR                |
| [C] Binding Post Adapter gold-plated w/black stripe | 40833-BIE         | 40833-BWE         | 40833-BAE          | 40833-BTE                |
| [D] Binding Post Adapter gold-plated w/red stripe   | 40833-BIR         | 40833-BWR         | 40833-BAR          | 40833-BTR                |

Part numbers shown are for individual polybag packages in standard cartons. Some carded and contractor packs also available. Call customer service at 1-800-722-2082.

## Push-On, Twist-On & Crimp-On F Connectors

- E, F Push-On F-Connectors:** Quick, cost-effective 75 Ohm coaxial cable terminations, require no crimping tools. Quick and Universal versions accommodate RG-59, RG-6, and RG-6 Quad coax diameters.
- G-K 1-Piece and 2-Piece Crimp-On F-Connectors:** Terminates 75 Ohm coaxial cable with a crimp-on male F-Connector. 2-piece version with separate crimp ring, or one-piece version with crimp ring attached. Both RG-59 and RG-6 versions available. Crimping tool required.
- L, M Twist-On F-Connectors:** Twist-on male F-Connector for 75 Ohm coaxial cable. No crimping required. RG-59 and RG-6 versions.

### Push-On, Crimp-On and Twist-On Connectors

| DESCRIPTION   | CAT. NO.  |
|---|-----------|
| [E] Universal F-Connector (bag of 100 with installation tool) | 40985-HPC |
| [F] Quick F-Connector (bag of 20 with installation tool)      | 40985-HPM |
| [G] One-piece Crimp-on for RG-6 quad shield (bag of 100)      | 40985-0Q6 |
| [H] One-piece Crimp-on for RG-59 (bag of 100)                 | 40985-1P9 |
| [I] One-piece Crimp-on for RG-6 (bag of 100)                  | 40985-1P6 |
| [J] Two-piece Crimp-on for RG-59 (bag of 100)                 | 40985-2P9 |
| [K] Two-piece Crimp-on for RG-6 (bag of 100)                  | 40985-2P6 |
| [L] Twist-On Connector for RG-59 (bag of 100)                 | 40985-TW9 |
| [M] Twist-On Connector for RG-6 (bag of 100)                  | 40985-TW6 |

Note: See Tools & Accessories Section Page L63 for Crimping Tool.

## HDMI and DVI Connectors

| DESCRIPTION                        | CAT. NO.<br>WHITE | CAT. NO.<br>IVORY |
|------------------------------------|-------------------|-------------------|
| 3.5mm Stereo Connector             | 40839-SWS         | 40839-SIS         |
| [N] HDMI Feed Through-Decora Style | 41647-00W         | 41647-00I         |
| [O] DVI Feed Through               | 41648-00W         | 41648-00I         |

### MATERIAL CHARACTERISTICS

- All module bodies are fire-retardant plastic rated UL 94V-0

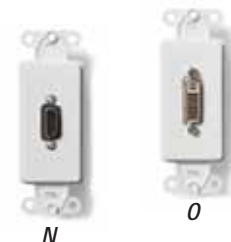
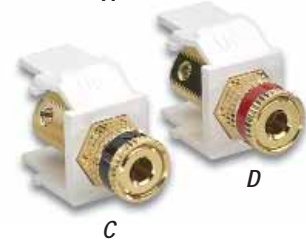
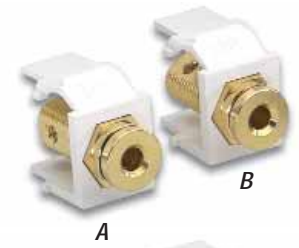



# FIBER OPTIC CONNECTORS



A B C



D E F



G H



I J



K



M

L

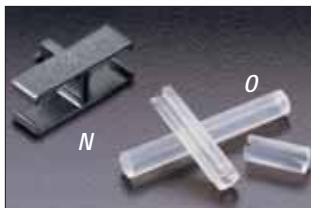

N

O

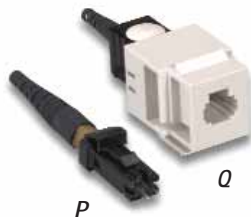

P

Q

## FastCAM™ Factory Polished Fiber Connectors

Pre-terminated and factory polished to provide precision termination of single-mode and multimode fiber. Available in LC, ST and SC styles to fit 250µm and 900µm cables with standard single-mode and standard multimode or laser-optimized multimode fiber options

### FastCAM Fiber Connectors

| DESCRIPTION  | CAT. NO.  |
|--|-----------|
| [A] FastCAM ST Multimode 62.5µm Connector          | 49991-MST |
| [B] FastCAM ST Multimode 50µm Connector            | 49991-5ST |
| [C] FastCAM ST Single-mode Connector               | 49991-SST |
| FastCAM Laser Optimized ST Multimode Connector     | 49991-LST |
| [D] FastCAM SC Multimode 62.5µm Connector          | 49991-MSC |
| [E] FastCAM SC Multimode 50µm Connector            | 49991-5SC |
| [F] FastCAM SC Single-mode Connector               | 49991-SSC |
| FastCAM Laser Optimized SC Multimode Connector     | 49991-LSC |
| [G] FastCAM LC Multimode 62.5µm Connector          | 49991-MLC |
| [H] FastCAM LC Multimode 50µm Connector            | 49991-5LC |
| [I] FastCAM LC Single-mode Connector               | 49991-SLC |
| [J] FastCAM Laser Optimized LC Multimode Connector | 49991-LLC |

## Thread-Lock® Reusable Fiber Connectors, Multimode And Single-mode

**K-M** Award-winning Thread-Lock Connectors, available in SC, FC and ST® styles, are reusable, field-terminable fiber optic connectors with a simple, craft-friendly installation. Available in 62.5/125 and 50/125 multimode or single-mode versions. Each box of 50 connectors includes one tightening tool.

### Thread-Lock Fiber Connectors

| DESCRIPTION                  | CAT. NO. SINGLEMODE | CAT. NO. MULTIMODE |
|------------------------------|---------------------|--------------------|
| [K] SC Thread-Lock Connector | 49884-SSC (blue)    | 49884-MSC (beige)  |
| [L] FC Thread-Lock Connector | 49883-SFC           | 49883-MFC          |
| [M] ST Thread-Lock Connector | 49882-SST           | 49882-MST          |

### Thread-Lock Accessories

| DESCRIPTION  | CAT. NO.  |
|--|-----------|
| [N] SC Duplex Clip for Thread-Lock Connector, black (bag of 25)        | 49884-DPC |
| [O] Silicon Build-up Sleeve Kit, includes one of each type (bag of 10) | 49885-SBS |
| Nylon Retention Sleeve (bag of 10)                                     | 49855-SLV |

## MT-RJ Fiber Connectors, Multimode

**P, Q** Leviton MT-RJ Workstation connectors offer innovative push-button fiber termination, and plug directly into our MOS adapters (see page L14). Frame-Station connectors use a cam technology to lock the fiber into a terminated position for use in frame or, with adapters, in the workstation. Both feature a pre-polished ribbon fiber ferrule that eliminates polishing.

### MT-RJ Fiber Connectors

| DESCRIPTION  | CAT. NO.  |
|--|-----------|
| [P] High-Density MT-RJ Frame-Station Connector, multimode, 62.5 µm | 49888-6SF |
| High-Density MT-RJ Frame-Station Connector, multimode, 50.0 µm     | 49888-5SF |
| [Q] High-Density MT-RJ Workstation Connector, multimode, 62.5 µm   | 49888-6SW |
| High-Density MT-RJ Workstation Connector, multimode, 50.0 µm       | 49888-5SW |

Note: For a complete listing of Fiber Optic Tools, see the Tools section, Pages L62–L64.

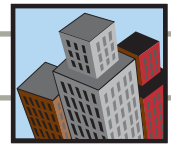

## Fast Cure Adhesive Connectors

**A-D** Leviton Fast-Cure adhesive connectors, available in ST, SC, FC, and LC styles, are reliable, cost-effective fiber optic connectors with quick, adhesive termination. Feature precision pre-radiused zirconia ferrules, high cable retention crimp, and patented non-optical disconnect spacer design. Available in multimode or singlemode versions.

### Adhesive Connectors

| DESCRIPTION   | CAT. NO. SINGLE-MODE   | CAT. NO. MULTIMODE     |
|---|------------------------|------------------------|
| [A] ST Fast Cure Connector  | 49990-SST              | 49990-MST              |
| [B] SC Fast Cure Connector  | 49990-SSC              | 49990-MSC              |
| [C] FC Fast Cure Connector  | 49990-SFC              | 49990-MFC              |
| [D] LC Fast Cure Connector with 3mm boot<br>LC Fast Cure Connector with .9mm boot | 49990-SL2<br>49990-SDL | 49990-ML2<br>49990-MDL |

### Fast Cure Accessories

| DESCRIPTION   | CAT. NO. SINGLE-MODE | CAT. NO. MULTIMODE |
|---|----------------------|--------------------|
| [E] SC Duplex Clip for Fast Cure Connector, black (bag of 25) |                      | 49886-DSC          |
| [F] LC Duplex Clip for Fast Cure Connector, blue (bag of 25)  | 49886-DLS            |                    |
| [G] LC Duplex Clip for Fast Cure Connector, beige (bag of 25) |                      | 49886-DLM          |

## QuickPort® Snap-In Fiber Adapters

**H-L** Leviton offers QuickPort adapters to bring Thread-Lock and Fast-Cure fiber to any QuickPort wallplate or housing. FC, SC, ST, LC and MT-RJ adapters, in various colors.

### Fiber Adapters

| DESCRIPTION  | CAT. NO.               |
|--|------------------------|
| [H] QuickPort MT-RJ Adapter, for Frame-Station Connector   | 49889-QF*              |
| [I] QuickPort ST Fiber Optic Adapter, SM/MM, Phos. Bronze Sleeve†<br>QuickPort ST Fiber Optic Adapter, SM/MM, Zirconia Sleeve                | 41084-S*F<br>41084-S*Z |
| [J] QuickPort Simplex FC Fiber Optic Adapter, SM/MM, Phos. Bronze Sleeve<br>QuickPort Simplex FC Fiber Optic Adapter, SM/MM, Zirconia Sleeve | 41084-F*P<br>41084-F*Z |
| [K] QuickPort Multimode Simplex SC Adapter Module, Phos Bronze<br>QuickPort Singlemode Simplex SC Adapter Module, Zirconia Ceramic           | 41085-M*C<br>41085-S*C |
| [L] QuickPort Duplex LC Adapter, SM/MM, Phos. Bronze Sleeve<br>QuickPort Duplex LC Adapter, SM/MM, Zirconia Ceramic Sleeve                   | 41085-ML*<br>41085-SL* |

[H] Use with MOS 1 Port Adapter 41291-1M\* Page L15

† Note: Cat. No. 41084 also available in Light Almond (-STF)

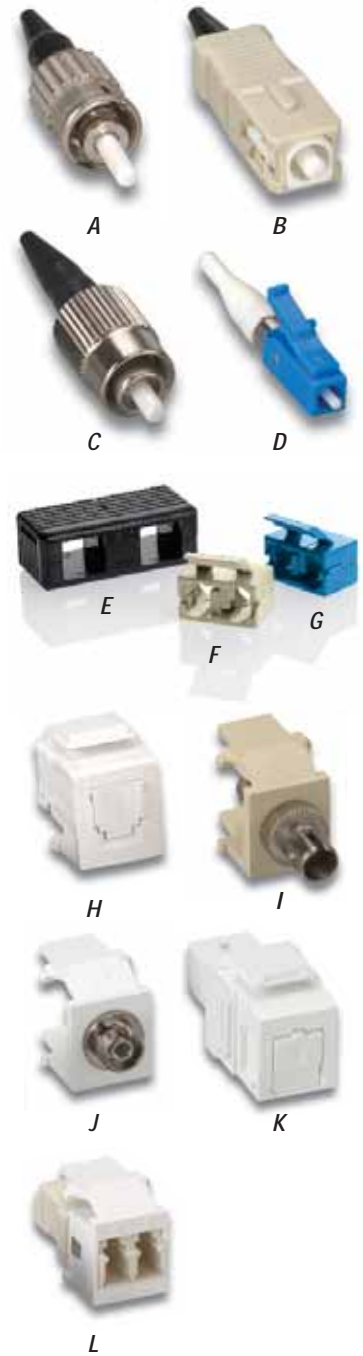

Connectors

#### \*COLOR/FIBER ADAPTERS

[H-M] For color selection, add suffix to catalog number as follows: Ivory (I), White (W), Gray (G), Black (E).



Leviton QuickPort fiber adapters fit into any Leviton QuickPort wallplate or housing, providing a high-density fiber-to-the-workstation solution, see pages L8-L17 for workstation options.



Leviton's Fiber Optic Consumables Kits provide the products you need to quickly and efficiently polish, clean and terminate all our fiber connectors. See Page L63.



# QUICKPORT® FLUSH MOUNT WALLPLATES and INSERTS

## QuickPort Flush Mount Wallplates and Inserts

Leviton offers one of the largest selections of field-configurable, flush mount wallplates and inserts available on today's market. They provide the adaptability and performance required in a voice/data wiring interface in a sleek low-profile wallplate.

Choose from a full range of materials and styles, including: nylon, urea and stainless steel; standard and midsize; single- and dual-gang; and Decora® designer styling. All Leviton flush mount devices fit standard NEMA openings for easy installation on new or existing wallboxes.



### Styles

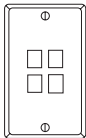

#### QuickPort

Wallplates with standard-sized openings designed to accommodate QuickPort connectors or adapters.

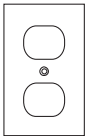

#### Flush Mount

Wallplates designed to fit smoothly against a wall, with a minimum profile.

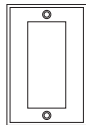

#### Decora®

Wallplates with standard-sized openings designed to accommodate Decora Inserts.



#### Decora Insert

Standard, Decora-sized inserts designed to adapt high and low voltage applications to a single wallplate profile.

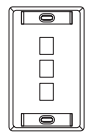

#### Single-gang

The standard wallplate width of 2.75" W x 4.53" H.

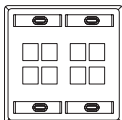

#### Dual-Gang

The standard double wallplate width of 4.625" W x 4.53" H.

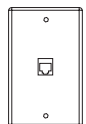

#### Wall Jack

A wallplate preconfigured with some kind of connector or adapter.

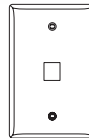

#### Midsize

A wider (3.12" W x 4.87" H) single-gang wallplate designed to disguise flaws in drywall or provide a designer silhouette.

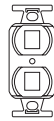

#### Type 106 (Duplex)

The Standard NEMA-style form, with two openings, which is most common among electrical outlets.



#### Type 105 (Single)

The Standard NEMA-style form with one opening—less common than the Type 106.

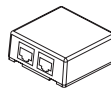

#### Type 104 (Duplex)

A NEMA-style of surface-mount box, with two outlets or openings, common for use with telephone jacks on walls or along baseboards.

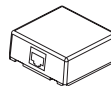

#### Type 103 (Single)

Identical to the type 104 box, but featuring only one outlet.



#### Acenti™ Insert

QuickPort inserts designed to snap into Acenti wallplates.

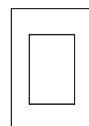

#### Acenti Wallplate

Sleek, low-profile plates available in 1–6 gang styles accept a variety of QuickPort and other inserts for voice, data, electro-mechanical, lighting control, GFCI and more.





## QuickPort Decora Multimedia Inserts

Combine voice, data, audio and video in one compact, attractive Decora wallplate. QuickPort Decora Wallplate Inserts offer designer style to match Leviton Decora electrical switches and outlets, with the capacity and flexibility to support high-tech communications for boardrooms or workstations. QuickPort snap-in modules fit neatly into a single gang Decora wallplate and can be combined with Decora electrical devices (with a barrier box) in a multi-gang wallplate. Simply snap in the QuickPort connectors of your choice to customize multimedia options. Compatible with all standard Decora wallplates and Decora Plus snap-on wallplates with hidden mounting screws and standard NEMA openings. UL Listed and CSA Certified.



For Decora-style F-connector and Telephone Wall Jack Inserts, see page L19.

### QuickPort Decora Multimedia Inserts

| DESCRIPTION    | CAT. NO. IVORY | CAT. NO. WHITE | CAT. NO. GRAY | CAT. NO. BLACK | CAT. NO. ALMOND | CAT. NO. BROWN |
|----------------|----------------|----------------|---------------|----------------|-----------------|----------------|
| 2-Port Insert† | 41642-00I      | 41642-00W      | 41642-0GY     | 41642-0OE      | 41642-00A       | 41642-00B      |
| 3-Port Insert† | 41643-00I      | 41643-00W      | 41643-0GY     | 41643-0OE      | 41643-00A       | 41643-00B      |
| 4-Port Insert† | 41644-00I      | 41644-00W      | 41644-0GY     | 41644-0OE      | 41644-00A       | 41644-00B      |
| 6-Port Insert† | 41646-00I      | 41646-00W      | 41646-0GY     | 41646-0OE      | 41646-00A       | 41646-00B      |
| Blank Insert†  | 80414-00I      | 80414-00W      | 80414-0GY     | 80414-0OE      | 80414-00A       |                |

### QuickPort 2-Port Insert/Connector Kits

| DESCRIPTION                                 | CAT. NO. IVORY | CAT. NO. WHITE |
|---|----------------|----------------|
| 2-Port Insert w/two 6-conductor connectors  | 41666-00I      | 41666-00W      |
| 2-Port Insert w/two 8-conductor connectors† | 41688-00I      | 41688-00W      |

### Decora Plus Voice/Data Connectors with QuickPort Snap-In Modules

| DESCRIPTION   | CAT. NO. IVORY | CAT. NO. WHITE |
|---|----------------|----------------|
| Insert with one 6-conductor jack and one F-connector      | 41658-00I      | 41658-00W      |
| Insert with one 6-conductor jack and one 8-conductor jack | 41668-00I      | 41668-00W      |

Note: Order QuickPort Snap-In Modules on pages L3–L7. Configured versions also meet FCC Part 68.

† Note: Also available in Light Almond (00T)

### Decora Wallplates

| DESCRIPTION                  | CAT. NO. UREA | CAT. NO. NYLON | CAT. NO. DECORA PLUS SNAP-ON |
|------------------------------|---------------|----------------|------------------------------|
| Single-Gang Decora Wallplate | 80401-00*     | 80401-0N*      | 80301-0S*                    |
| Dual-Gang Decora Wallplate   | 80409-00*     | 80409-0N*      | 80309-0S*                    |
| Three-Gang Decora Wallplate  | 80411-00*     | 80411-0N*      | 80311-0S*                    |
| Four-Gang Decora Wallplate   | 80412-00*     | 80412-0N*      | 80312-0S*                    |

Note: Additional Decora Wallplate ordering information can be found on page L9.

#### \*COLOR/WALLPLATES

For color selection, add suffix to catalog number as follows: 1- and 2-Gang—Ivory (I), White (W), Gray (G), Black (E), Almond (A), Light Almond (T) and Brown (no additional suffix indicates Brown); 3-Gang—Ivory (I), White (W), Black (E), Almond (A) and Light Almond (T); 4-Gang—Ivory (I), White (W), Almond (A) and Light Almond (T).



# QUICKPORT® SINGLE- and DUAL-GANG WALLPLATES



Leviton's LabelWare® System is TIA/EIA-606-A compliant and designed to help you label all our copper and fiber products. User-friendly software makes it quick, easy, and completely configurable or use pre-printed labels. See pages L59-L60.

## QuickPort Single- and Dual-Gang Wallplates

### QUICKPORT SINGLE-GANG MULTI-PORT WALLPLATES WITH OR WITHOUT DESIGNATION WINDOWS

**A, B** Single-gang flush mount wallplates offer field-configurable flexibility in an attractive single-piece housing. Fully compatible with all QuickPort Snap-in Modules including connectors or blank fillers. Options for port identification include LabelWare® wallplate and housing labels, typed or handwritten labels for designation windows, or the use of different color QuickPort modules. All windows are field-label compatible, and cover the wallplate security screw. UL Listed, CSA Certified, NEC Article 800 compliant.

### QuickPort Single-Gang Inserts

| DESCRIPTION       | CAT. NO. IVORY | CAT. NO. WHITE | CAT. NO. GRAY | CAT. NO. BLACK | CAT. NO. ALMOND | CAT. NO. BROWN |
|-------------------|----------------|----------------|---------------|----------------|-----------------|----------------|
| 6-Port Wallplate* | 41080-6IP      | 41080-6WP      | 41080-6GP     | 41080-6EP      | 41080-6AP       | 41080-6BP      |
| 4-Port Wallplate* | 41080-4IP      | 41080-4WP      | 41080-4GP     | 41080-4EP      | 41080-4AP       | 41080-4BP      |
| 3-Port Wallplate* | 41080-3IP      | 41080-3WP      | 41080-3GP     | 41080-3EP      | 41080-3AP       | 41080-3BP      |
| 2-Port Wallplate* | 41080-2IP      | 41080-2WP      | 41080-2GP     | 41080-2EP      | 41080-2AP       | 41080-2BP      |
| 1-Port Wallplate* | 41080-1IP      | 41080-1WP      | 41080-1GP     | 41080-1EP      | 41080-1AP       | 41080-1BP      |

\* Note: Cat. No. 41080 also available in Light Almond (41080-TP)

### QuickPort Single-Gang Wallplates with Designation ID Windows

| DESCRIPTION      | NO. OF WINDOWS | CAT. NO. IVORY | CAT. NO. WHITE | CAT. NO. GRAY | CAT. NO. BLACK |
|------------------|----------------|----------------|----------------|---------------|----------------|
| 6-Port Wallplate | 2              | 42080-6IS      | 42080-6WS      | 42080-6GS     | 42080-6ES      |
| 4-Port Wallplate | 2              | 42080-4IS      | 42080-4WS      | 42080-4GS     | 42080-4ES      |
| 3-Port Wallplate | 2              | 42080-3IS      | 42080-3WS      | 42080-3GS     | 42080-3ES      |
| 2-Port Wallplate | 2              | 42080-2IS      | 42080-2WS      | 42080-2GS     | 42080-2ES      |
| 1-Port Wallplate | 1              | 42080-1IS      | 42080-1WS      | 42080-1GS     | 42080-1ES      |

Note: Housings are sold empty. Snap-in Connectors must be ordered separately. (See pages L3-L7.)

### QUICKPORT DUAL-GANG MULTI-PORT WALLPLATES WITH DESIGNATION WINDOWS

**C** Dual-gang flush mount wallplates with designation windows are designed in a single-piece housing and a wide choice of port counts for maximum density. Field configure with any combination of QuickPort Snap-in Modules. Use different color QuickPort modules for port identification, or type or hand-write labels for designation windows. All windows are field-label compatible, and cover the wallplate security screw. QuickPort wallplates are UL Listed, CSA Certified, and listed in compliance with NEC Article 800.

### QuickPort Dual-Gang Wallplates with Designation ID Windows

| DESCRIPTION       | NO. OF WINDOWS | CAT. NO. IVORY | CAT. NO. WHITE | CAT. NO. GRAY | CAT. NO. BLACK |
|-------------------|----------------|----------------|----------------|---------------|----------------|
| 12-Port Wallplate | 4              | 42080-12I      | 42080-12W      | 42080-12G     | 42080-12E      |
| 8-Port Wallplate  | 4              | 42080-8IP      | 42080-8WP      | 42080-8GP     | 42080-8EP      |
| 6-Port Wallplate  | 4              | 42080-6IP      | 42080-6WP      | 42080-6GP     | 42080-6EP      |
| 4-Port Wallplate  | 4              | 42080-4IP      | 42080-4WP      | 42080-4GP     | 42080-4EP      |
| 3-Port Wallplate  | 2              | 42080-3IP      | 42080-3WP      | 42080-3GP     | 42080-3EP      |
| 2-Port Wallplate  | 2              | 42080-2IP      | 42080-2WP      | 42080-2GP     | 42080-2EP      |
| 1-Port Wallplate  | 2              | 42080-1IP      | 42080-1WP      | 42080-1GP     | 42080-1EP      |

Note: Housings are sold empty. Snap-in Connectors must be ordered separately. (See pages L3-L7.)

### QUICKPORT MIDWAY WALLPLATES

**D** Midway wallplates provide QuickPort modularity with .375" more coverage than standard wallplates. Expanded silhouette provides designer look and easily hides irregular drywall cuts or flaws around outlets. The 4.875" x 3.125" plate is .375" wider and taller, and matches Leviton's Midway Wallplates for electrical devices and lighting controls. .25" depth ensures a clean fit with various devices. Crafted from durable, smooth-finish nylon, wallplates fit a single-gang electrical box. UL listed and CSA certified.

### QuickPort Midway Single-Gang Wallplates, Nylon

| DESCRIPTION                       | CAT. NO. IVORY | CAT. NO. WHITE | CAT. NO. ALMOND | CAT. NO. BROWN | CAT. NO. LT ALMOND |
|-----------------------------------|----------------|----------------|-----------------|----------------|--------------------|
| 6-Port Midway QuickPort Wallplate | 41091-6IN      | 41091-6WN      | 41091-6AN       | 41091-6BN      | 41091-6TN          |
| 4-Port Midway QuickPort Wallplate | 41091-4IN      | 41091-4WN      | 41091-4AN       | 41091-4BN      | 41091-4TN          |
| 3-Port Midway QuickPort Wallplate | 41091-3IN      | 41091-3WN      | 41091-3AN       | 41091-3BN      | 41091-3TN          |
| 2-Port Midway QuickPort Wallplate | 41091-2IN      | 41091-2WN      | 41091-2AN       | 41091-2BN      | 41091-2TN          |
| 1-Port Midway QuickPort Wallplate | 41091-1IN      | 41091-1WN      | 41091-1AN       | 41091-1BN      | 41091-1TN          |

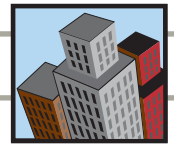

## QuickPort Stainless Steel Wallplates

### QUICKPORT STAINLESS STEEL SINGLE-GANG AND DUAL-GANG WALLPLATES

**A, B** Leviton's single-gang and dual-gang QuickPort Stainless Steel Wallplates provide elegant designer styling, and accept any QuickPort connector or adapter. Ideal in environments that demand durable, easy-to-clean solution. Use different color QuickPort modules or the LabelWare System for port identification. Fit standard NEMA electrical boxes. cULus Listed, meet FCC Part 68, and are listed in compliance with TIA/EIA-568-B.

#### QuickPort Stainless Steel Wallplates

| DESCRIPTION | CAT. NO.<br>1-PORT | CAT. NO.<br>2-PORT | CAT. NO.<br>3-PORT | CAT. NO.<br>4-PORT | CAT. NO.<br>6-PORT | CAT. NO.<br>8-PORT | CAT. NO.<br>12-PORT |
|-------------|--------------------|--------------------|--------------------|--------------------|--------------------|--------------------|---------------------|
| Single-Gang | 43080-1S1          | 43080-1S2          | 43080-1S3          | 43080-1S4          | 43080-1S6          | —                  | —                   |
| Dual-Gang   | —                  | 43080-2S2          | —                  | 43080-2S4          | 43080-2S6          | 43080-2S8          | 43080-S12           |

Note: Housings are sold empty. Snap-in Connectors must be ordered separately. (See pages L3-L7.)

### QUICKPORT STAINLESS STEEL WALLPHONE WALLPLATES

**C** Bring Stainless Steel elegance to your wallphone. Easily mount any standard wallphone on this sturdy, standard-sized wallplate with durable rivets. Single port accepts any Leviton QuickPort Connector. Recessed design fits cleanly with slide-rail mechanisms.

#### QuickPort Stainless Steel Wallphone Wallplates

| DESCRIPTION                                   | CAT. NO.  |
|---|-----------|
| Stainless Steel Wallphone Wallplate, recessed | 4108W-1SP |
| Stainless Steel Wallphone Wallplate           | 4108W-OSP |

Note: Leviton also offers Voice-Grade Wall Phone Jacks. (See pages L3-L7.)

## QuickPort Wallplate Inserts

### QUICKPORT DUPLEX/QUAD 106 INSERTS

**D, E** The QuickPort Duplex and Quad 106 Units are ideal for applications where two or four individual modular ports are desired, within the standard '106/NEMA-style' outline that prevails among electrical outlets. Accepts all QuickPort Snap-in Modules and fits standard NEMA wallboxes and most floor boxes and monuments. A recess above each module port on the Duplex 106 Unit accommodates Leviton Designation Labels (page L60) or hand-written port ID. Uses standard duplex wallplates (sold separately, see Section E). UL & CSA listed and NEC Article 800 compliant.

#### QuickPort Duplex 106 Insert

| DESCRIPTION                      | CAT. NO.<br>LT. ALMOND | CAT. NO.<br>IVORY | CAT. NO.<br>WHITE | CAT. NO.<br>GRAY | CAT. NO.<br>BLACK |
|----------------------------------|------------------------|-------------------|-------------------|------------------|-------------------|
| QuickPort Duplex 106 Insert only | 41087-2TP              | 41087-2IP         | 41087-2WP         | 41087-2GP        | 41087-2EP         |
| QuickPort Quad 106 Insert only   | 41087-QTP              | 41087-QIP         | 41087-QWP         | 41087-QGP        | 41087-QEP         |

Note: Inserts are sold empty. Snap-in Connectors must be ordered separately. (See pages L3-L7.)

### QUICKPORT FLOOR JACK INSERTS

**F** Rugged and fully field-configurable, this device provides point-of-use connectivity for a broad range of applications where convenience or building requirements dictate the use of a floor-mounted communications outlet. Each floorplate is made of .06" thick solid brass to hold up under heavy furniture or foot traffic. When not in use, a flush-fitting brass screw cap keeps internal components free from dirt and dust.

The two individual ports are configured easily with any combination of QuickPort. QuickPort floor jacks will fit standard metal boxes 3" x 2", 3" x 2 1/8" and larger.

#### QuickPort Duplex Floor Jack Insert with Brass Plate and Screw Cap

| DESCRIPTION  | CAT. NO.  |
|--|-----------|
| Insert with one F-connector, one blank module, and brass plate w/cap           | 41650-00F |
| Insert with one 6-conductor connector, one blank module, and brass plate w/cap | 41650-006 |
| Insert with one blank module and brass plate w/cap                             | 41652-000 |
| Insert with two 6-conductor jacks and brass plate w/cap                        | 41652-006 |
| Insert with one 6-conductor connector, one F-connector, and brass plate w/cap  | 41652-06F |

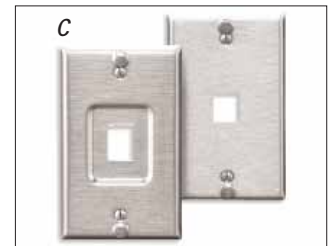
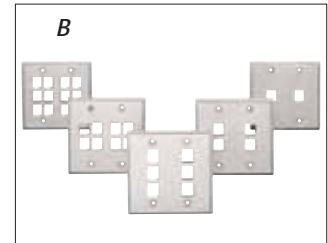
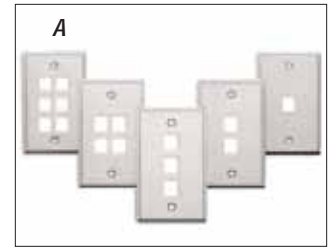

NOTE: Wallplate included with each QuickPort Floor Jack Insert.



# QUICKPORT® MODULAR FURNITURE FACEPLATES



Steelcase Series



Herman Miller® series (shown with 49910-SE4 and Herman Miller's "Reducer" G1189A)



Haworth® Panels

## QuickPort Modular Furniture Faceplates

Bring a simple snap-in installation, attractive streamlined appearance and easy identification to your modular furniture environments. QuickPort Modular Furniture Faceplates accept all QuickPort Snap-In Modules—supporting virtually any application—and snap easily and snugly into standard modular furniture. Features faceplate windows with clear plastic covers that allow easy insertion of ID labels. Labor-saving QuickPort jack design and tool-less plate installation simplifies installations, adds, moves and changes, and allows access to the connectors without removing the furniture channel cover. Available in 2- and 4-port versions, and in four colors: ivory, white, gray and black. cULus Listed and A-Tick Certified.



QuickPort furniture faceplates come in many styles to fit all major modular furniture brands.

### Standard Modular Furniture Faceplates with ID Windows

| DESCRIPTION                        | CAT. NO.  | HERMAN MILLER® | STEELCASE | HAWORTH® | HON | OTHERS |
|------------------------------------|-----------|----------------|-----------|----------|-----|--------|
| 2-Port                             | 49910-S*2 | ●              | ●         | ●        | ●   | ●      |
| 4-Port (w/1 blank)                 | 49910-S*4 | ●              | ●         | ●        | ●   | ●      |
| 4-Port Extended-depth† (w/1 blank) | 49910-E*4 | ●              | ●         | ●        | ●   | ●      |

Note: Standard modular furniture faceplates above fit openings of approximately 1.38" x 2.63".

†4-port extended plate provides 1/2" added depth (3/4" total) for installation into shallow raceway channels, e.g., some powered channels.

● Compatible when used with Herman Miller G1189A Reducer available from Herman Miller dealers.

### Herman Miller Modular Furniture Faceplates

| DESCRIPTION                        | CAT. NO.  | HERMAN MILLER® | STEELCASE | HAWORTH® | HON | OTHERS |
|------------------------------------|-----------|----------------|-----------|----------|-----|--------|
| 2-Port HM Faceplate†               | 49910-H*2 | ●              | —         | —        | —   | —      |
| 4-Port HM Faceplate (with 1 Blank) | 49910-H*4 | ●              | —         | —        | —   | —      |

Note: Herman Miller faceplates above fit openings of approximately 1.88" x 2.98".

†Fits most Herman Miller furniture. To ensure compatibility with specific models call Applications Engineering.

#### \*COLOR/FACEPLATES

For color selection, add suffix to catalog number as follows: Ivory (I), White (W), Gray (G), Black (E).

#### MATERIAL CHARACTERISTICS

High-impact, fire-retardant, plastic rated UL 94V-0.



## QuickPort Multimedia Outlet System (MOS)

The innovative QuickPort Multimedia Outlet System is designed to provide the highest level of application and installation flexibility for fiber optic and twisted-pair connectivity. It consists of a surface mount box and single- and dual-gang wallplates, which accept a variety of copper, fiber, and A/V QuickPort snap-in modules.

The MOS line is distinguished from other QuickPort housings by several features: front-load installation capability so that changes can be made without dismantling the entire device; duplex modules and fiber coupling types for SC, ST, MT-RJ and other applications; the addition of S-video and RCA adapters for high-definition audio/video; and design elements for enhanced routing, storage and bend radius protection of fiber and copper cabling. See individual product descriptions for more features.

For product specifications and recommendations, please visit our web resource at [www.leviton.com](http://www.leviton.com).



### Features and Benefits

- A** Multiple connector termination stations provide stabilized punchdown support.
- B** Leviton's exclusive dual rings store the fiber loop and provide multiple straight paths to each port.
- C** Single latch cover with security option restricts access if desired.
- D** Multi-directional mounting and raceway access allow complete installation flexibility.
- E** Front-loading inserts simplify configuration, while strong latches keep them in place during use.
- F** Fiber storage/spacer ring fits between wallbox/mud ring and MOS dual-gang plate for fiber loop storage and management.
- G** 45° angled jack insert optimizes bend radius compliance of cable exiting QuickPort® snap-in connectors.
- H** Load up to 12 devices in a dual-gang wallplate.

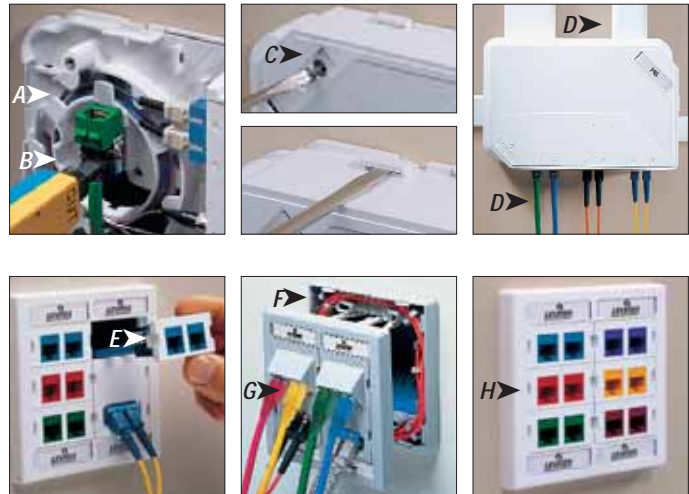



# QUICKPORT® MULTIMEDIA OUTLET SYSTEM (MOS)

## Styles

Configurations for MOS Wallplates

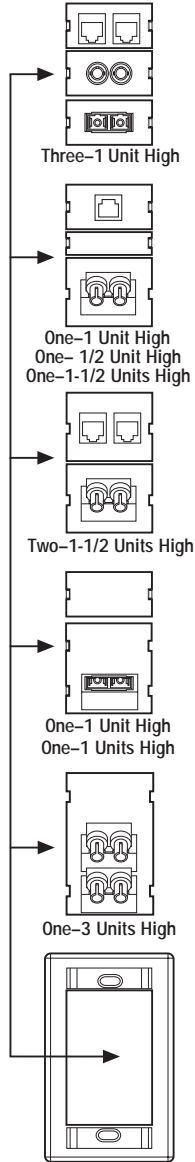

### COLOR/INSERTS and WALLPLATES

For color selection, add suffix to catalog number as follows:

- \* Ivory (I), White (W), Gray (G), Black (e)
- ° Light Almond (T), Ivory (I), White (W), Gray (G), Black (E)
- Ivory (I), White (W)

### MATERIAL CHARACTERISTICS

High-impact, fire-retardant, plastic rated UL 94V-0.

## QuickPort Multimedia Outlet System (MOS)

### MOS Surface Mount Boxes and Wallplates

|  |                           |                       |
|--|---------------------------|-----------------------|
|  | 6-Port Surface Mount Box  | 41296-MM <sup>o</sup> |
|  | Single-Gang Wallplate     | 41290-SM <sup>o</sup> |
|  | Dual-Gang Wallplate       | 41290-DM <sup>o</sup> |
|  | Fiber Storage/Spacer Ring | 41290-DR*             |

### MOS Inserts for Surface Mount Boxes and Wallplates

|  |  |                       |
|--|--|-----------------------|
|  | 2-Port QuickPort Adapter, flush, (1 unit high)   | 41291-2Q <sup>o</sup> |
|  | 1-Port QuickPort Adapter, flush, (1 unit high)   | 41291-1M <sup>o</sup> |
|  | 1 S-video Insert Module, (1 unit high)   | 41291-1V <sup>o</sup> |
|  | 1 RCA Insert Module, 2-port, screw terminal (1 unit high) (red and white stripe)               | 41291-1R <sup>o</sup> |
|  | 1 RCA Insert Module, 3-port, female-to-female adapters (1 unit high) (yellow and white stripe) | 41292-3R <sup>o</sup> |
|  | 1 HD-15 Insert Module, female-to-female (1 unit high)  | 41293-HD <sup>o</sup> |
|  | 1 HD-15 Screw Terminal   | 41295-HD*             |
|  | 1 Duplex ST® Adapter, (1 unit high) (phos. bronze sleeve)                                      | 41291-2T*             |
|  | 1 Duplex ST® Adapter, (1 unit high) (zirconia ceramic sleeve)                                  | 41291-2T*             |
|  | 1 Duplex FC Adapter (1 unit high) (phos. bronze sleeve)  | 41291-PF*             |
|  | 1 Duplex FC Adapter (1 unit high) (zirconia ceramic sleeve)                                    | 41291-ZF*             |
|  | 1 Duplex SC Adapter (1 unit high) (phos. bronze sleeve)  | 41291-PC*             |
|  | 1 Duplex SC Adapter (1 unit high) (zirconia ceramic sleeve)                                    | 41291-2C*             |
|  | Blank Module (1 unit high)   | 41291-1B*             |
|  | Blank Module HD-15 Insert Module   | 41291-DB <sup>o</sup> |
|  | 1 RCA Component (Y, W, R) 110  | 41292-AV*             |
|  | 1 RCA Component (R, G, B) 110  | 41292-DV*             |
|  | 1 Decora Converter Strap   | 41649-00*             |

### MOS Inserts for use with MOS Wallplates

|  |   |                       |
|--|---|-----------------------|
|  | 2-Port QuickPort Adapter, 45° exit (1.5 units high)                             | 41294-2Q <sup>o</sup> |
|  | Blank Module (0.5 unit high)  | 41295-5B <sup>o</sup> |
|  | Blank Module (1.5 units high)   | 41294-2B <sup>o</sup> |
|  | Blank Module (2 units high)   | 41292-2B <sup>o</sup> |
|  | 1 Duplex ST® Adapter 45° exit, SM/MM (1.5 units high) (phos. bronze sleeve)     | 41294-2T*             |
|  | 1 Duplex ST® Adapter 45° exit, SM/MM (1.5 units high) (zirconia ceramic sleeve) | 41294-2T*             |
|  | 1 Duplex FC Adapter 45° exit, SM/MM (1.5 units high) (phos. bronze sleeve)      | 41294-PF*             |
|  | 1 Duplex FC Adapter 45° exit, SM/MM (1.5 units high) (zirconia ceramic sleeve)  | 41294-ZF*             |
|  | 1 Duplex SC® Adapter 45° exit, SM/MM (1.5 units high) (phos. bronze sleeve)     | 41294-PC*             |
|  | 1 Duplex SC® Adapter 45° exit, SM/MM (1.5 units high) (zirconia ceramic sleeve) | 41294-2C*             |
|  | 1 Duplex ST® Adapter 45° exit, SM/MM (2 units high) (phos. bronze sleeve)       | 41292-2T*             |
|  | 1 Duplex ST® Adapter 45° exit, SM/MM (2 units high) (zirconia ceramic sleeve)   | 41292-2T*             |
|  | 1 Duplex FC Adapter 45° exit, SM/MM (2 units high) (phos. bronze sleeve)        | 41292-PF*             |
|  | 1 Duplex FC Adapter 45° exit, SM/MM (2 units high) (zirconia ceramic sleeve)    | 41292-ZF*             |
|  | 2 Duplex SC® Adapter 45° exit, SM/MM (2 units high) (phos. bronze sleeve)       | 41292-2C*             |
|  | 2 Duplex SC® Adapter 45° exit, SM/MM (2 units high) (zirconia ceramic sleeve)   | 41292-2C*             |
|  | 2 Duplex ST® Adapter 45° exit, SM/MM (3 units high) (phos. bronze sleeve)       | 41293-4T*             |
|  | 2 Duplex ST® Adapter 45° exit, SM/MM (3 units high) (zirconia ceramic sleeve)   | 41293-4T*             |
|  | 2 Duplex FC Adapter 45° exit, SM/MM (3 units high) (phos. bronze sleeve)        | 41293-PF*             |
|  | 2 Duplex FC Adapter 45° exit, SM/MM (3 units high) (zirconia ceramic sleeve)    | 41293-ZF*             |
|  | 2 Duplex SC® Adapter 45° exit, SM/MM (3 units high) (phos. bronze sleeve)       | 41293-PC*             |
|  | 2 Duplex SC® Adapter 45° exit, SM/MM (3 units high) (zirconia ceramic sleeve)   | 41293-4C*             |



## QuickPort Surface Mount Housings

Leviton's surface mount housings offer fast, economical installation and field configuration for applications where it may not be practical to add a wallbox, such as modular furniture environments or retrofit situations. As with all QuickPort field-configurable products, you configure the housing to your specific needs using Snap-In Modules—easily rearranged if applications change. These housings can be adapted for mounting on all types of surfaces, including walls and furniture with tape or screws (both included) modular furniture with a modular furniture bracket (page L23) or to metal surfaces with magnets (page L23).

Note: Identify all your connections with Leviton LabelWare System wallplate and housing labels (See page L60.)

Designation window accepts hand-written indications, field-printed labeling systems, Leviton LabelWare™ or pre-printed port ID labels (see page L59).



4-, 6- and 12-port housing feature raceway knockouts on all non-ported sides which are compatible with major raceway brands.

For large installations, silkscreen the cover with words, numbers, icons or company logos. Call Applications Engineering for advice on artwork and minimum quantity requirements.

Port identification areas reside next to numbered ports.



4-, 6- and 12-port surface-mount housings are compatible with Leviton's modular furniture mounting brackets and magnets (see page L24).

In-port connector termination stations provide stability during punchdown.



# QUICKPORT® SURFACE MOUNT HOUSINGS



## QuickPort 1-, 2-, 4-, 6-, and 12-Port Surface Mount Housings

**A-E** Leviton has a surface mount housing to suit your need. 1-, 2-, 4-, 6- and 12-Port housings are easily field configured with QuickPort Connectors (sold separately, pages L3-L7). The 2-port version comes with a blank filler to cover and protect one unused opening. The 4- and 6-port housings are sized to completely cover a single-gang NEMA wallbox opening, while the 12-port fits over a single- or dual-gang NEMA box opening. Housings contain knockouts to accommodate raceway and cable entry, with built-in strain relief to assure undisturbed connections, and easy cover latches allow easy adds, moves and changes.

All housings can be mounted with screws or adhesive mounting tape (both provided), or with magnets or modular furniture brackets (sold separately on page L24). Identify ports and stations by using ample space next to each port or the designation window. All housings are UL Listed and compliant with NEC Article 800.

### QuickPort Surface Mount Housings

| DESCRIPTION  | CAT. NO.  |
|--|-----------|
| [A] 1-Port Surface Mount Housing                           | 41089-1*P |
| [B] 2-Port Surface Mount Housing (includes 1 blank module) | 41089-2*P |
| [C] 4-Port Surface Mount Housing                           | 41089-4*P |
| [D] 6-Port Surface Mount Housing                           | 41089-6*P |
| [E] 12-Port Surface Mount Housing                          | 41089-12* |

*Note: Connectors must be ordered separately. (See pages L3-L7)*

*Leviton also offers Pre-configured Voice-Grade Surface Mount Jacks. (See page L23)*

#### \*COLOR/INSERTS and WALLPLATES

For color selection, add suffix to catalog number as follows: Ivory (I), White (W), Gray (G), Black (E).

#### MATERIAL CHARACTERISTICS

High-impact, fire-retardant, plastic rated UL 94V-0.



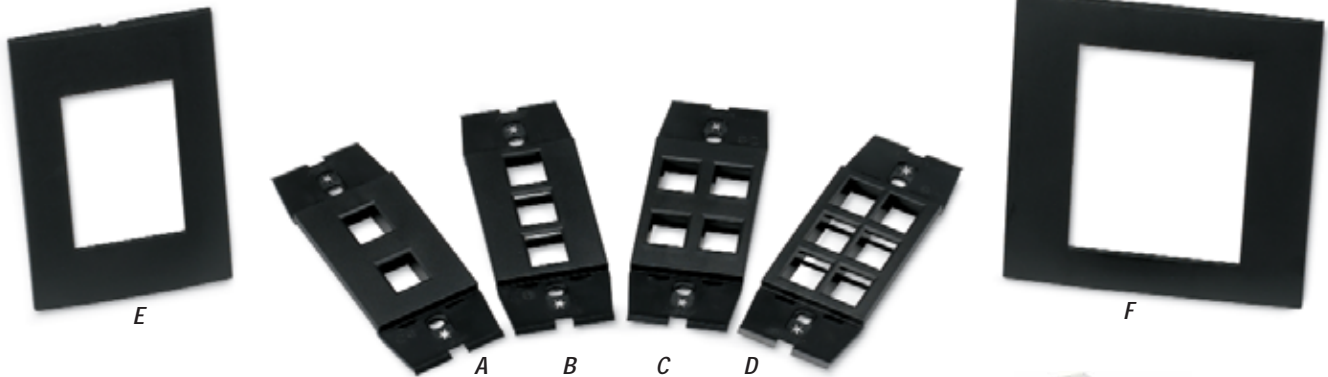

**Acenti Wallplates, QuickPort® Inserts and Connectors**

Leviton's new Acenti wallplates are sleek and smooth and come in 7 soft neutral colors to perfectly complement any home or office environment. The soft radius design with low-profile corners adds personality with clean simple lines. Available in 1-, 2-, 3-, 4-, 5- and 6-gang styles. Choose from a wide variety of inserts for voice, data, electro-mechanical, lighting control, GFCI, and more. QuickPort inserts give all your voice, data, audio/visual and even fiber connections a sleek new look. See all the options at [Leviton.com/acenti](http://Leviton.com/acenti) or call Leviton Customer Service at 1(800) 323-8920.

**Acenti QuickPort Multimedia Inserts**

| DESCRIPTION                        | CAT. NO. |
|------------------------------------|----------|
| [A] 2-Port Acenti QuickPort Insert | AC642    |
| [B] 3-Port Acenti QuickPort Insert | AC643    |
| [C] 4-Port Acenti QuickPort Insert | AC644    |
| [D] 6-Port Acenti QuickPort Insert | AC646    |

**Acenti Wallplates**

| DESCRIPTION                      | CAT. NO. |
|----------------------------------|----------|
| [E] Single-Gang Acenti Wallplate | ACWP1    |
| [F] Dual-Gang Acenti Wallplate   | ACWP2    |
| Three-Gang Acenti Wallplate      | ACWP3    |
| Four-Gang Acenti Wallplate       | ACWP4    |
| Five-Gang Acenti Wallplate       | ACWP5    |
| Six-Gang Acenti Wallplate        | ACWP6    |

Note: Order QuickPort Snap-In Connectors on page L3-L7. Configured versions also meet FCC Part 68

**Acenti® QuickPort® Snap-In Connectors**

| DESCRIPTION  | CAT. NO.  |
|--|-----------|
| GigaMax® Cat 5e Channel-Rated Connector              | AC108-R*5 |
| [G] BNC Adapter, Nickel-Plated                       | AC084-B*F |
| BNC Adapter, Gold-Plated                             | AC832-OB* |
| F-Type Adapter, Nickel-Plated                        | AC084-F*F |
| [H] F-Type Adapter, Gold-Plated                      | AC831-OB* |
| [I] S-Video Module, 110 Termination                  | AC734-SV* |
| [J] Blank Insert (Pack of 10)                        | AC084-B*B |
| RCA Jack, Gold-Plated w/Red Stripe                   | AC830-B*R |
| [K] RCA Jack, Gold-Plated w/Black Stripe             | AC830-B*E |
| RCA Jack, Gold-Plated w/Yellow Stripe                | AC830-B*Y |
| [L] Banana Jack, Gold-Plated w/Red Stripe            | AC837-B*R |
| Banana Jack, Gold-Plated w/Black Stripe              | AC837-B*E |
| Binding Post Adapter, Gold-Plated w/Red Stripe       | AC833-B*R |
| [M] Binding Post Adapter, Gold-Plated w/Black Stripe | AC833-B*E |
| RCA 110 Termination Connector, Orange Inner Barrel   | AC735-R0* |
| RCA 110 Termination Connector, Red Inner Barrel      | AC735-RR* |
| RCA 110 Termination Connector, White Inner Barrel    | AC735-RW* |
| RCA 110 Termination Connector, Yellow Inner Barrel   | AC735-RY* |



**\*COLOR/ACENTI**

For color selection, add suffix to catalog number as follows: Neutral Colors—Alabaster (ALA), Onyx (ONX) and Slate (SLT). Off-White Colors—Quartz (QTZ), Sand (SND), Driftwood (DFT) and Natural (NTL).



# STANDARD TELEPHONE/VIDEO WALL JACKS

**A**



## Standard Telephone/Video Wall Jacks

### TYPE 625B4 MODULAR WALL JACK

Includes jack, plate, and mounting hardware. Fits standard NEMA wallboxes. Screw terminals. UL Listed and CSA Certified or cULus Listed. Standard 6P4C (item A) 625B4 Modular Wall Jacks feature lead-frame design for reliability and ease of installation.

#### Type 625B4 Modular Wall Jack—Smooth Finish cULus, Standard Plate

| DESCRIPTION                 | CAT. NO.<br>BROWN | CAT. NO.<br>IVORY | CAT. NO.<br>WHITE | CAT. NO.<br>ALMOND | CAT. NO.<br>LT ALMOND |
|-----------------------------|-------------------|-------------------|-------------------|--------------------|-----------------------|
| [A] 6-Position, 4-Conductor | 40249-000†        | 40249-001†        | 40249-00W†        | 40249-00A†         | 40249-00T†            |
| 6-Position, 6-Conductor     | —                 | 40238-00I         | 40238-00W         | —                  | 40238-00T             |
| 8-Position, 8-Conductor     | —                 | 40280-00I         | 40280-00W         | —                  | 40280-00T             |

**B**



#### Type 625B4 Modular Wall Jack—Smooth Finish , Midway Plate

| DESCRIPTION                 | CAT. NO.<br>BROWN | CAT. NO.<br>IVORY | CAT. NO.<br>WHITE | CAT. NO.<br>LT ALMOND |
|-----------------------------|-------------------|-------------------|-------------------|-----------------------|
| 6-Position, 4-Conductor     | 40549-000         | 40549-00I         | 40549-00W         | 40549-00T             |
| [B] 8-Position, 8-Conductor | 40580-00I         | 40580-00W         | —                 | —                     |

#### Type 625B4 Modular Wall Jack—Smooth Finish , alternate construction (not shown)

| DESCRIPTION             | CAT. NO.<br>IVORY | CAT. NO.<br>WHITE | CAT. NO.<br>GRAY | CAT. NO.<br>ALMOND | CAT. NO.<br>BROWN |
|-------------------------|-------------------|-------------------|------------------|--------------------|-------------------|
| 6-Position, 4-Conductor | 4625B-44I         | 4625B-44W         | 4625B-44G        | 4625B-44A          | 4625B-044         |
| 6-Position, 6-Conductor | 4625B-46I         | 4625B-46W         | 4625B-46G        | —                  | —                 |
| 8-Position, 8-Conductor | 4625B-48I         | 4625B-48W         | —                | —                  | —                 |

Note: Robertson/Slot Drive screws available for 4625B series, call customer service for ordering information.  
†These products are cULus Listed.

**C**



### TYPE 625D F-CONNECTOR WALLPLATES

**C** F-Connector wallplates have one or two F-Connectors. Wallplates have a smooth finish. UL Listed and CSA certified.

#### F-Connector Wallplate

| DESCRIPTION                        | CAT. NO.<br>IVORY | CAT. NO.<br>WHITE | CAT. NO.<br>ALMOND | CAT. NO.<br>LT ALMOND |
|------------------------------------|-------------------|-------------------|--------------------|-----------------------|
| [B] Flush-Mount Single F-Connector | 80781-00I         | 80781-00W         | 80781-00A          | 80781-00T             |
| Flush-Mount Duplex F-Connector     | 80782-00I         | 80782-00W         | 80782-00A          | 80782-00T             |

**D**



### TYPE 625D COMBINATION WALL JACKS AND F-CONNECTOR WALLPLATES

**D** The Type 625D jacks include one modular jack (with screw terminals) for voice, and one F-connector for cable TV or other video applications using RG6 or RG59 coax. UL Listed and CSA Certified.

#### Type 625D Combination Wall Jacks and F-Connector Wallplates

| DESCRIPTION                                 | CAT. NO.<br>IVORY | CAT. NO.<br>WHITE | CAT. NO.<br>GRAY | CAT. NO.<br>ALMOND | CAT. NO.<br>LT ALMOND |
|---|-------------------|-------------------|------------------|--------------------|-----------------------|
| [C] 6-Position, 4-Conductor and F-Connector | 40259-00I         | 40259-00W         | 40259-00G        | 40259-00A          | 40259-00T             |
| 6-Position, 6-Conductor and F-Connector     | 40258-00I         | 40258-00W         | —                | —                  | 40258-00T             |



## Decora® Telephone Wall Jack Inserts

### DECORA MODULAR SINGLE OR DUPLEX WALL JACK INSERTS

**A** These single or duplex flush-mount voice-grade connectors fit in Leviton's popular Decora line of devices. Screw terminals. Includes matching Decora wallplate.

#### Decora Modular Wall Jack

| DESCRIPTION   | CAT. NO.<br>IVORY | CAT. NO.<br>WHITE | CAT. NO.<br>LT ALMOND |
|---|-------------------|-------------------|-----------------------|
| Decora Single Modular Wall Jack, 6-position 4-conductor | 40949-0ID         | 40949-0WD         | 40949-0TD             |
| Decora Duplex Modular Wall Jack, 6-position 4-conductor | 40944-0ID         | 40944-0WD         | 40944-0TD             |

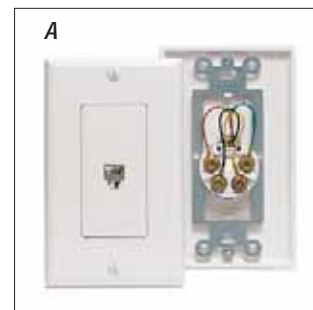

### TYPE 625 DECORA MODULAR WALL JACKS

**B** Single flush mount jack for use with Decora or Decora Plus wallplates. Mount in standard or multi-gang electrical box. Screw terminals. UL Listed and CSA Certified.

#### Type 625 Decora Modular Wall Jack

| DESCRIPTION             | CAT. NO.<br>IVORY | CAT. NO.<br>WHITE | CAT. NO.<br>GRAY | CAT. NO.<br>BLACK | CAT. NO.<br>ALMOND | CAT. NO.<br>BROWN |
|-------------------------|-------------------|-------------------|------------------|-------------------|--------------------|-------------------|
| 6-position 4-conductor  | 40649-00I         | 40649-00W         | 40649-0GY        | 40649-00E         | 40649-00A          | 40649-000         |
| 6-position 6-conductor† | 40638-00I         | 40638-00W         | 40638-0GY        | 40638-00E         | 40638-00A          | 40638-000         |
| 8-position 8-conductor  | 40680-00I         | 40680-00W         | 40680-0GY        | —                 | —                  | —                 |

† Note: Cat. No. 40680 also available in Light Almond (40680-00T)

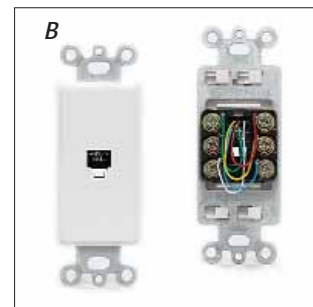

### DECORA TV/PHONE COMBINATION JACK

**C** Combination jack with 4-Conductor modular jack for UTP telephone connections and F-Connector for video (coaxial cable) connections. Includes matching Decora wallplate.

#### Decora TV/Phone Combination Jack

| DESCRIPTION  | CAT. NO.<br>IVORY | CAT. NO.<br>WHITE | CAT. NO.<br>LT ALMOND |
|--|-------------------|-------------------|-----------------------|
| Decora TV/Phone Combination Jack, 6-position 4-conductor | 40959-0ID         | 40959-0WD         | 40959-0TD             |

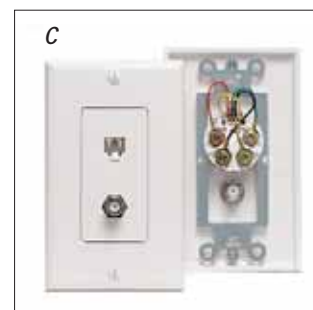

## Midway Telephone and Telephone/F-Connector Wall Jacks

### MIDWAY WALL JACKS

**D, E** Midway wall jacks provide a larger silhouette for a more designer look, and to easily hide irregular drywall cuts. Choose a voice grade connector for UTP cable or an F-connector (filled or empty) for coaxial cable. Crafted from durable, UV-resistant nylon.

#### QuickPort® Midway Wallplates

| DESCRIPTION   | CAT. NO.  |
|---|-----------|
| [D] Midway Video Wallplate with F-Connector†                            | 40539-0M* |
| [E] Midway Video Wallplate without F-Connector (hexagonal opening only) | 40539-HM* |
| Midway Phone Wallplate with 6P4C Voice Grade Connector                  | 40539-PM* |
| Midway Wallplate with 6P4C Voice Grade Connector & F-Connector          | 40539-CM* |

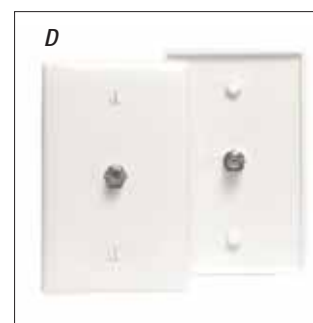

### TYPE 625B MIDWAY DUPLEX WALL JACKS

These smooth finish midway units include 2 jacks, wallplate and mounting hardware. Wire to provide the same dial tone on both jacks or separate lines. Screw terminals. UL Listed & CSA Certified.

#### Type 625B Duplex Wall Jack

| DESCRIPTION   | CAT. NO.<br>IVORY | CAT. NO.<br>WHITE |
|---|-------------------|-------------------|
| Type 625B Duplex Wall Jack, 6-position 4-conductor, Midway Plate† | 40544-00I         | 40544-00W         |
| Type 625B Duplex Wall Jack, 6-position 6-conductor, Midway Plate  | 40566-00I         | —                 |
| Type 625B Duplex Wall Jack, 8-position 8-conductor, Midway Plate† | 40588-00I         | 40588-00W         |

Note: Part Numbers 40544 and 40588 are also available in Light Almond (40544-00T and 40588-00T)

#### \*COLOR/MIDWAY WALLPLATES

For color selection, add suffix to catalog number as follows: Ivory (I), White (W), Almond (A), Brown (B), Light Almond (T)



# TELEPHONE WALL PHONE JACKS

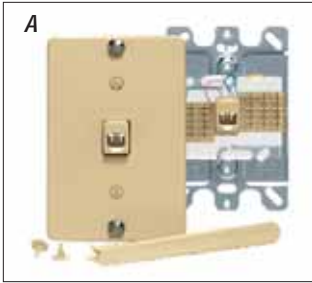

## Telephone Wall Phone Jacks

### TYPE 630A QUICK-CONNECT WALL PHONE JACK WITH PLASTIC WALL PLATE

**A** Features quick-connect terminals, screw-on wallplate, metal bracket, mounting lugs, and installation tool. Removable lugs and color-matched plastic inserts (included) permit conversion from wall phone jack to flush mount jack. UL Listed and CSA Certified.

#### Type 630A Quick-Connect Jack with Plastic Wallplate

| DESCRIPTION             | CAT. NO. IVORY | CAT. NO. WHITE | CAT. NO. GRAY | CAT. NO. ALMOND | CAT. NO. LT ALMOND |
|-------------------------|----------------|----------------|---------------|-----------------|--------------------|
| 6-Position, 4-Conductor | 40253-00I      | 40253-00W      | 40253-0GY     | 40253-00A       | 40253-00T          |
| 6-Position, 6-Conductor | 40263-00I      | 40263-00W      | —             | —               | 40263-00T          |



### TYPE 630A QUICK-CONNECT WALL PHONE JACK WITH STAINLESS STEEL WALLPLATE

**B** Includes 4- or 6-conductor jack with screw terminals, stainless steel screw-on wallplate, mounting screws and installation tool.

#### Type 630A Quick-Connect Jack with Stainless Steel Wallplate

| DESCRIPTION                                       | CAT. NO.  |
|---|-----------|
| 6-Position, 4-Conductor w/ QuickPort terminations | 40223-00S |
| 6-Position, 6-Conductor w/ screw terminations     | 40226-00S |

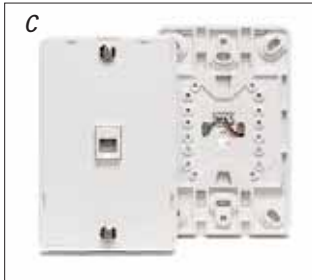

### WALL PHONE JACK

**C** Single phone jack for standard wall phone. Four color-coded screw-down connections.

#### Wall Phone Jack

| DESCRIPTION     | CAT. NO. IVORY | CAT. NO. WHITE | CAT. NO. ALMOND | CAT. NO. LT ALMOND |
|-----------------|----------------|----------------|-----------------|--------------------|
| Wall Phone Jack | 40914-00I      | 40914-00W      | 40914-00A       | 40914-00T          |



### TYPE 625B3 DUPLEX WALL JACK

**D** These smooth finish units include 2 jacks, wallplate and mounting hardware. Wire to provide the same dialtone on both jacks or separate lines. Screw terminals. UL Listed & CSA Certified.

#### Type 625B3 Duplex Wall Jack

| DESCRIPTION   | CAT. NO. IVORY | CAT. NO. WHITE |
|---|----------------|----------------|
| Type 6255B3 Duplex Wall Jack, 6-position 4-conductor, Standard Plate* | 40244-00I      | 40244-00W      |
| Type 6255B3 Duplex Wall Jack, 6-position 6-conductor, Standard Plate† | 40266-00I      | 40266-00W      |

\* NOTE: Part Number 40244 is also available in Almond (40244-00A), Light Almond (40244-00T) and Brown (40244-000) versions.

† NOTE: Part Number 40266 is also available in Light Almond (40266-00T)



### TYPE 630A SCREW TERMINAL WALL JACK WITH PLASTIC WALLPLATE

**E** Features 4-conductor jack, screw terminals, screw-on wallplate and removable mounting lugs can be converted to a flush-mount jack by replacing lugs with color-keyed plastic inserts (included). UL Listed and CSA Certified.

#### Type 630A Screw Terminal Wall Jack with Plastic Wallplate

| DESCRIPTION             | CAT. NO. IVORY | CAT. NO. WHITE | CAT. NO. LT ALMOND |
|-------------------------|----------------|----------------|--------------------|
| 6-position, 4-conductor | 40257-00I      | 40257-00W      | 40257-00T          |



### TYPE 630A SCREW TERMINAL WALL JACK WITH SNAP-ON PLASTIC WALLPLATE

**F** Includes snap-on wallplate, mounting screws, and factory installed legs. UL Listed and CSA Certified.

#### Type 630A Screw Terminal Wall Jack with Snap-On Plastic Wallplate

| DESCRIPTION             | CAT. NO. IVORY | CAT. NO. WHITE | CAT. NO. ALMOND | CAT. NO. LT ALMOND |
|-------------------------|----------------|----------------|-----------------|--------------------|
| 6-position, 4-conductor | 40214-00I      | 40214-00W      | 40214-00A       | 40214-00T          |
| 6-position, 6-conductor | 40216-00I      | 40216-00W      | —               | 40216-00T          |

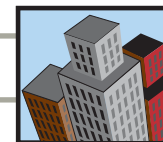



## Telephone Wall Jack Inserts

### TYPE 106 DUPLEX FLUSH MOUNT MODULAR JACK WITH 110-TYPE TERMINATION

**A** The Type 106 duplex jack accommodates two voice and/or data terminals in the same jack location, using standard duplex electrical wallplates. Jack choices include 4-, 6-, and 8-conductor modular jacks for voice or data, with 8-conductor keyed versions typically used for data. Mounts easily in standard electrical boxes, most floor monuments, raceways, and many cellular or raised floor boxes without adapters. May be ganged for multiple-port applications. Installation is fast and easy with 110-type insulation displacement connectors for 22-26 AWG inside wiring. UL Listed, CSA Certified, and meets FCC Part 68 requirements.

#### Type 106 Flush Mount Modular Jack

| DESCRIPTION  | PORT DESIGNATIONS           |        | CAT. NO. IVORY | CAT. NO. WHITE | CAT. NO. GRAY |
|--|-----------------------------|--------|----------------|----------------|---------------|
|  | Two 4-Conductor USOC Jacks† | Line 1 | Line 2         | 41364-IDI      | 41364-IDW     |
| Two 6-Conductor USOC Jacks   | Line 1                      | Line 2 | 41366-IDI      | 41366-IDW      | 41366-IDG     |
| One 6-Conductor USOC Jack and one 8-conductor T568B CAT 3 jack   | Voice                       | Data   | 41365-IDI      | 41365-IDW      | —             |
| Two 8-Conductor USOC Jacks   | Line 1                      | Line 2 | 41368-IDI      | —              | —             |
| Two 8-Conductor T568B CAT 3 Jacks  | Line 1                      | Line 2 | 41367-IDI      | 41367-IDW      | —             |
| Two 8-Conductor T568B Jacks                                       | Voice                       | Data   | 41361-IDI      | —              | —             |
| One 8-Conductor T568B Jack, and one 8-conductor keyed T568B jack  | Voice                       | Data   | 41360-IDI      | —              | —             |

† Note: Part Numbers 41364 and 41361 are also available in Light Almond (41364-00T and 41361-00T)  
 Note: Wallplate ordering information can be found on pages L8-L12.

### TYPE 105 FLUSH MOUNT MODULAR JACK WITH 110-TYPE TERMINATION

**B** The 105 single-port flush mount jack fits a standard single opening (1.406" diameter) electrical wallplate. It is available in 4-, 6-, or 8-conductor configurations for voice and data, with the 8-conductor keyed version typically used for data. Mounts easily in standard single-, double-, or multi-gang electrical boxes, most floor monuments, and many cellular or raised floor boxes. Installs quickly using industry standard 110-type insulation displacement connectors for 22-26 AWG inside wiring. UL Listed, CSA Certified, and meets FCC Part 68 requirements.

#### Type 105 Flush Mount Modular Jack

| DESCRIPTION   | CAT. NO. IVORY | CAT. NO. WHITE | CAT. NO. LT ALMOND |
|---|----------------|----------------|--------------------|
| One 6-Position, 4-Conductor Jack  | 41054-IDD      | —              | 41054-TDD          |
| One 8-Position, 8-Conductor Jack, T568B  | 41058-IDA      | 41058-WDA      | —                  |

Note: Wallplate ordering information can be found on pages L8-L11.

### TYPE 625B ROUND MODULAR JACK WALLPLATE INSERT

**C** A 4-conductor jack with Type 43A mounting bracket attached. Mounts in any standard electrical box. Slotted holes facilitate alignment. Can be used indoors or outdoors with corresponding Leviton wallplate. For use with 4-conductor modular line cord. Screw terminals. UL Listed & CSA Certified.

#### Type 625B Round Modular Jack Wallplate Insert and Wallplate

| DESCRIPTION                  | CAT. NO. IVORY | CAT. NO. LT ALMOND |
|------------------------------|----------------|--------------------|
| Type 625B Round Modular Jack | 40201-00I      | 40201-00T          |
| Round Modular Jack Wallplate | 80704-00I      | 80704-00T          |

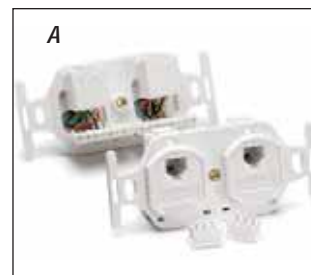

#### MATERIAL CHARACTERISTICS

##### Flush Mount Modular Jacks

- Housing: High-impact, fire-retardant plastic rated UL 94V0.
- Spring wire contacts: Phosphor bronze, plated with 50 microinches hard gold over 100 microinches nickel.
- Wire leads: PVC-insulated, tinned solid copper.
- Mounting screws: Combination Phillips/Straight blade head.

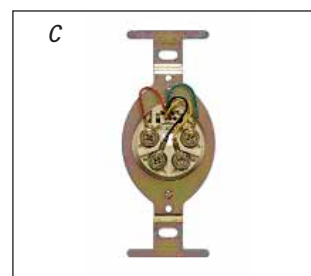



# SURFACE MOUNT TELEPHONE JACKS

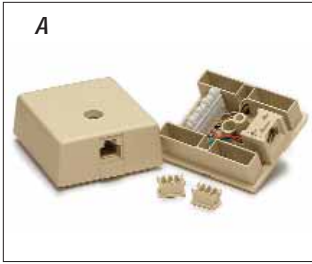

### MATERIAL CHARACTERISTICS

#### 103 Jacks

- Housings: High-impact, fire-retardant plastic rated UL 94V0.
- Spring wire contacts: Phosphor bronze, plated with 50 microinches gold over 100 microinches nickel.
- 110 clips: Solder-plated phosphor bronze.



### MATERIAL CHARACTERISTICS

#### 104 Jacks

- Housings: High-impact, fire-retardant plastic rated UL 94V0.
- Spring wire contacts: Phosphor bronze, plated with 50 microinches gold over 100 microinches nickel.
- 110 clips: Solderplated phosphor bronze.

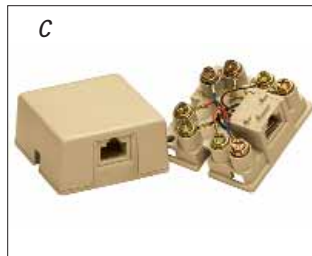

## Surface Mount Telephone Jacks

### TYPE 103 SURFACE MOUNT MODULAR JACK WITH 110-TYPE TERMINATION

**A** The 103 single-port surface mount jack is available in 4-, 6-, or 8-conductor configurations for voice and data. Mounts using screws or doublesided tape (both included), or optional magnets (see page L24). UL Listed and CSA Certified.

#### Type 103 Single-Port Surface Mount Modular Jack

| DESCRIPTION   | CAT. NO. IVORY | CAT. NO. WHITE | CAT. NO. LT ALMOND |
|---|----------------|----------------|--------------------|
| 6-Position, 4-conductor Jack                            | 41034-IDA      | —              | 41034-TDA          |
| 6-Position, 6-conductor Jack                            | 41036-IDA      | —              | 41036-TDA          |
| 8-Position, 8-conductor USOC Jack                       | 41038-IDA      | —              | 41038-TDA          |
| 8-Position, 8-conductor T568B Category 3 compliant Jack | 41038-IDB      | 41038-WDB      | 41038-TDB          |

### TYPE 104 DUPLEX SURFACE MOUNT MODULAR JACK WITH 110-TYPE TERMINATION

**B** The 104 Duplex Surface Mount Jack accommodates two voice and/or data ports. Available in 4-, 6-, or 8-conductor configurations for voice and data. Mounts easily using screws or doublesided tape (both included), or optional magnets (see page L23). UL Listed and CSA Certified.

#### Type 104 Duplex Surface Mount Modular Jack

| DESCRIPTION   | PORT DESIGNATIONS |        | CAT. NO. IVORY | CAT. NO. LT ALMOND |
|---|-------------------|--------|----------------|--------------------|
| Two 4-Conductor Jacks   | Line 1            | Line 2 | 41044-IDA      | 41044-TDA          |
| Two 6-Conductor Jacks   | Line 1            | Line 2 | 41046-IDA      | 41046-TDA          |
| One 6-Conductor Jack and one 8-conductor T568B Category 3 compliant jack      | Voice             | Data   | 41086-IDB      | —                  |
| Two 8-Conductor USOC Jacks  | Line 1            | Line 2 | 41048-IDA      | —                  |
| Two 8-Conductor T568B Category 3 compliant Jacks                              | Line 1            | Line 2 | 41048-IDB      | 41048-TDB          |
| Two 8-Conductor T568B Category 3 compliant Jacks, one keyed and one non-keyed | Data              | Data   | 41088-IDB      | —                  |

### TYPE 625A2 SURFACE MOUNT JACK

**C** The compact design of this “biscuit block” jack offers improved appearance and space savings for surface-mount applications, and includes many features to facilitate installation. Unit comes with your choice of modular jacks prewired to combo-head screw terminals. High-reliability features include retainer comb to assure proper contact between jack and plug. Self-tapping screws and adhesive pad are included. UL Listed and CSA Certified.

#### Type 625A2 Surface Mount Jack

| DESCRIPTION                                       | CAT. NO. IVORY | CAT. NO. WHITE | CAT. NO. GRAY | CAT. NO. LT ALMOND |
|---|----------------|----------------|---------------|--------------------|
| 6-Position 4-Conductor                            | 4625A-24I      | 4625A-24W      | —             | 4625A-24T          |
| 6-Position 6-Conductor                            | 4625A-26I      | 4625A-26W      | —             | 4625A-26T          |
| 8-Position 8-Conductor                            | 40278-00I      | 40278-00W      | 40278-00G     | 40278-00T          |
| 8-Position 8-Conductor (with shorting bar, RJ31X) | 40278-SBI      | —              | —             | 40278-SBT          |
| 8-Position 4-Conductor (with shorting bar, RJ31X) | 40274-SBI      | —              | —             | —                  |



## Workstation Accessories

### SINGLE- AND DUAL-GANG SURFACE MOUNT BACKBOXES

These two-piece Surface Mount Backboxes snap snugly together to adapt Leviton flush mount products for surface mounting. Available in two sizes with knockouts on all sides for cable entry. Mounting options include screws and double-sided tape (installer-supplied); modular furniture brackets (F, G, H below) or magnet mounting (E below).

#### Single- and Dual-Gang Surface Mount Backboxes

| DESCRIPTION                | CAT. NO.<br>IVORY | CAT. NO.<br>WHITE | CAT. NO.<br>GRAY | CAT. NO.<br>BLACK |
|----------------------------|-------------------|-------------------|------------------|-------------------|
| [A] Single-Gang 1.89" deep | 42777-1IA         | 42777-1WA         | 42777-1GA        | 42777-1EA         |
| [B] Single-Gang 1.45" deep | 42777-1IB         | 42777-1WB         | 42777-1GB        | 42777-1EB         |
| [C] Dual-Gang 1.89" deep   | 42777-2IA         | 42777-2WA         | 42777-2GA        | 42777-2EA         |
| [D] Dual-Gang 1.45" deep   | 42777-2IB         | 42777-2WB         | 42777-2GB        | 42777-2EB         |

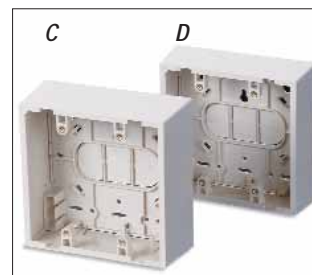
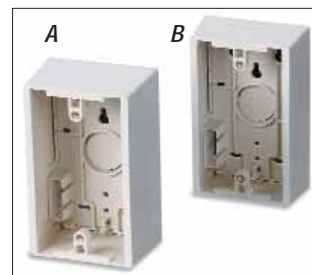

### MAGNETS

Mount surface mount products on desks and other metal surfaces.

#### Magnets

| DESCRIPTION              | CAT. NO.  |
|--------------------------|-----------|
| [E] Magnets (4 per pack) | 41030-SMJ |

*Use 1 Magnet for 2-port Surface Mount Housing. Use 2 Magnets for 4-, 6-, and 12-port Surface Mount Housings, Single & Dual-Gang Surface Mount Backboxes, 103 & 104 type Modular Jacks.*



### MODULAR FURNITURE BRACKETS

Use to install Leviton surface mount outlets (or flush mount devices with backbox) in many types of modular offices. Can also be used with Leviton backboxes and surface mount 4-, 6- and 12- port housings. Cold-rolled steel units snap securely into modular partitions. A cutout allows rear cable entry for a clean, uncluttered look and tangle-free installation. Available in black.

#### Modular Furniture Brackets

| DESCRIPTION   | CAT. NO.  |
|---|-----------|
| [F] For Steelcase 9000®, Haworth®, Knoll Morrison®, Allsteel®, Teknion® and Westinghouse® | 49222-BLK |
| [G] For Herman Miller Ethospace® and Steelcase Avenir®                                    | 49222-ESP |
| [H] For Herman Miller Action Office®  | 49222-HAO |



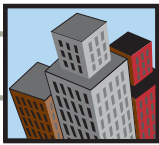

## PATCH PANELS



24-Port [1.75" H x 19.0" W]

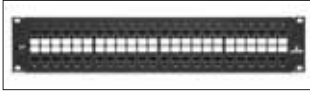

48-Port [3.5" H x 19.0" W]



Recessed Angled 48-Port  
[3.5" H x 19.0" W x 4.8" D]

### Category 6A (10G) Performance System

Leviton's eXtreme® 10G System, featuring Cone of Silence™ and Retention Force Technology®, supports backwards compatibility for 1G and 10/100 Ethernet, as well as advanced new 10G Base-T applications. Patent pending Cone of Silence blocks alien crosstalk (AXT) between neighboring connectors. Retention Force Technology ensures error-free performance over the life of the system by reinforcing time contacts even when 4- or 6-pin plugs have been used.

#### EXTREME 10G QUICKPORT® PATCH PANELS

Preloaded with black eXtreme 10G connectors, panels offer universal T568A/B wiring compatibility, 110-style IDC termination field, and labeling surfaces. Available in standard and angled styles.

#### CAT 6A Performance QuickPort® Patch Panels

| DESCRIPTION  | CAT. NO.  |
|--|-----------|
| 24-Port QuickPort Patch Panel preloaded with eXtreme® 10G Connectors, 1RU                                      | 6910G-U24 |
| 48-Port QuickPort Patch Panel preloaded with eXtreme 10G Connectors, 2RU                                       | 6910G-U48 |
| 48-Port High-Density QuickPort Patch Panel kitted with 48 eXtreme 10G connectors and cable management bar, 1RU | 6910G-D48 |

#### SPECIFICATIONS AND FEATURES

- Guaranteed to exceed the current TIA CAT 6A specifications for all AXT, NEXT, FEXT, PSNEXT, PSELFEXT, PSACR Insertion Loss and Return Loss, with tested transmission performance
- Exceeds TIA 568 B.2-10 channel performance when installed with Leviton approved 10G cable
- ETL verified to comply with and guaranteed to meet IEEE 802.3an 10GBASE-T and TIA Cat 6A standards
- Proprietary technology allows the channel to surpass proposed \*6 around 1" Alien Crosstalk (AXT) test requirements



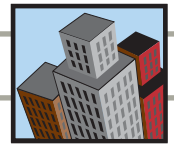

### eXtreme® 6+ Universal Patch Panels

Craft-friendly eXtreme 6+ Universal Patch Panels exceed published Category 6 standards and feature patented Retention Force Technology™ for robust long-term performance and mechanical integrity.

These 12-, 24-, 48- and 96-port panels (and 12-port patch block) come pre-configured with craft-friendly 110-style punchdowns on the rear and six-port RJ-45 front modules. Rear designation labels are reversible, with color-coded diagrams for T568A, T568B and 25-pair wiring configurations.

Patch panels feature advanced cable management and accommodate top, bottom or side cable entry.

All eXtreme 6+ panels mount in standard 19" equipment racks, are cULus Listed and A-tick compliant.

#### eXtreme 6+ Universal Patch Panels

| DESCRIPTION   | CAT. NO.<br>12-PORT<br>PATCH BLOCK* | CAT. NO.<br>12-PORT<br>PANEL | CAT. NO.<br>24-PORT<br>PANEL | CAT. NO.<br>48-PORT<br>PANEL | CAT. NO.<br>CENTRAL LABEL<br>48-PORT PANEL | CAT. NO.<br>96-PORT<br>PANEL |
|---|-------------------------------------|------------------------------|------------------------------|------------------------------|--|------------------------------|
| High-density, Pre-Configured Patch Panel with wire management bar | 69586-U89                           | 69586-U12                    | 69586-U24                    | 69586-U48                    | 69586-C48                                  | 69586-U96                    |
| Dimensions:   | 10.0"H x 2.30"W                     | 1.75"H x 19.0"W              | 1.75"H x 19.0"W              | 3.5"H x 19.0"W               | 3.5"H x 19.0"W                             | 7"H x 19.0"W                 |

\*12-Port Patch Block does not include wire management bar.

### eXtreme 6+ QuickPort® Patch Panels

QuickPort Category 6 Patch Panels are provided in a kit with black eXtreme 6+ connectors and are available in 24- and 48-port versions. IRU 48-port panel provides extra density in minimal space. Connector rear-termination field ensures easy accessibility and accommodates T568A or T568B wiring configurations. cULus listed.

#### QuickPort Category 6 Patch Panels

| DESCRIPTION  | DIMENSIONS    | CAT. NO.  |
|--|---------------|-----------|
| 24-Port, IRU Patch Panel with eXtreme 6+ Connectors  | 1.75"H x 19"W | 69270-U24 |
| 48-Port, 2RU Patch Panel with eXtreme 6+ Connectors  | 3.5"H x 19"W  | 69270-U48 |
| 48-port, IRU QuickPort High Density Patch Panel with eXtreme 6+ Connectors with cable mgmt bar |               | 69270-D48 |



#### MATERIAL CHARACTERISTICS

- Panels and blocks are 16 gauge steel, black painted finish with white write-on areas silkscreened beside the connectors. Printed circuit boards and plastic components are fire-retardant materials rated UL 94V-0.

12-Port Patch Block

#### STYLES



12-Port Panel



24-Port Panel



48-Port Panel



48-Port Panel with Centralized Labels



96-Port Panel

#### FEATURES



Universal printed circuit-board modules— with 110 connections and rear termination field for easy-field configurability— can be used for T568A, T568B or 25-pair wiring schemes.

- Patch panel labeling kit features colored slide-in front port identification labels.
- Reversible rear label slides easily into redesigned slot and shows color-coded diagrams for T568A, T568B and 25-pair wiring.



# PATCH PANELS and BLOCKS

UNIVERSAL T568A & T568B



## GigaMax® 5e and Category 5 Universal Patch Panels and Patch Blocks

GigaMax 5e and Category 5 Universal Patch Panels and Patch Blocks come in a variety of port densities. Both the blocks and panels come pre-configured with 110-punchdowns on the back and either Category 5 or GigaMax 5e six-port modules on the front. Both versions can be used for T568A or T568B wiring configurations. The panels, available with 12 to 96 pre-configured ports, mount in standard 19" equipment racks and accommodate top, bottom or side cable entry. For smaller, wall-mount installations, the 12-port patch blocks are an ideal low-profile solution.

GigaMax 5e panels are rated for both component and channel-level performance.

All panels and blocks are cULus Listed and meet all requirements of the latest published TIA guidelines.

### Universal GigaMax 5e Patch Panels

| DESCRIPTION | CAT. NO. 12-PORT | CAT. NO. 24-PORT | CAT. NO. 48-PORT | CAT. NO. CENTRAL LABEL 48-PORT | CAT. NO. 96-PORT |
|-------------|------------------|------------------|------------------|--------------------------------|------------------|
| T568B/T568A | 5G596-U12        | 5G596-U24        | 5G596-U48        | 5G596-C48                      | 5G596-U96        |
| Dimensions: | 1.75"H x 19.0"W  | 1.75"H x 19.0"W  | 3.5"H x 19.0"W   | 3.5"H x 19.0"W                 | 7.0" H x 19.0" W |

### Universal Category 5 Patch Panels

| DESCRIPTION | CAT. NO. 12-PORT | CAT. NO. 24-PORT | CAT. NO. 48-PORT | CAT. NO. 96-PORT |
|-------------|------------------|------------------|------------------|------------------|
| T568B/T568A | 59596-U12        | 59596-U24        | 59596-U48        | 59596-U96        |
| Dimensions: | 1.75"H x 19.0"W  | 1.75"H x 19.0" W | 3.5"H x 19.0"W   | 7.0"H x 19.0"W   |

### Universal Category 5 and GigaMax 5e Patch Blocks (including Mounting Brackets)

| DESCRIPTION | CAT. NO. 12-PORT CATEGORY 5 | CAT. NO. 12-PORT GigaMax 5e |
|-------------|-----------------------------|-----------------------------|
| T568B/T568A | 59596-U89                   | 5G596-U89                   |
| Dimensions: | 10.0"H x 2.30"W             | 10.0"H x 2.30"W             |

## GigaMax 5e QuickPort® Patch Panels

QuickPort Category 5e Patch Panels are provided in a kit with with black GigaMax 5e+ connectors and are available in 24- and 48-port versions. Connector rear-termination field ensures easy accessibility and accommodates T568A or T568B wiring configurations. UL listed.

### QuickPort Category 5e Patch Panels

| DESCRIPTION  | DIMENSIONS    | CAT. NO.  |
|--|---------------|-----------|
| 24-Port, 1RU Patch Panel with GigaMax 5e+ Connectors                 | 1.75"H x 19"W | 5G270-U24 |
| 48-Port, 2RU Patch Panel with GigaMax 5e+ Connectors                 | 3.5"H x 19"W  | 5G270-U48 |
| 48-port, 1RU Patch Panel with GigaMax 5e+ Connectors, cable mgmt bar |               | 5G270-D48 |

Note: Use Leviton's LabelWare™ System to quickly label your QuickPort panels. See Page L57.

### STYLES



12-Port



24-Port



48-Port



48-Port

with Centralized Labels



96-Port

### FEATURES

- Connector spring wire contacts are highest quality phosphor bronze, plated with 50 microinches gold over 100 microinches of nickel.
- Universal printed circuit-board modules with 110 IDC punchdowns can be used for T568A, T568B and 25-pair wiring configurations.



### MATERIAL CHARACTERISTICS

- Panels and blocks are 16 gauge steel, black painted finish with white write-on areas silkscreened beside the connectors. Printed circuit boards and plastic components are fire-retardant materials rated UL 94V-0.

Copper Components





## extreme® 6+, GigaMax™ 5e and QuickPort® Angled Patch Panels

Simplify cable management, ease patch cord access, and increase rack density with Angled Patch Panels from Leviton.

Panels are available in eXtreme 6+ or GigaMax 5e Universal/110-style Angled versions. Field-configurable QuickPort versions accommodate any style of QuickPort connector, and are available empty, or as kits with either Gigamax 5e+ or extreme 6+ QuickPort connectors.

All Universal panels feature 110-style punchdowns and reversible rear designation labels with color-coded wiring diagrams for T568A, T568B and 25-pair configurations.

An array of accessories, including Horizontal Ring, 1RU and 2RU Angled Blank Panel Inserts, Transitional Cover and Angled Cable Management Bar improves rack management.

All panels mount in standard 19" equipment racks and accommodate side cable entry. All panels are cULus Listed and meet or exceed all requirements of applicable Category ratings.

### Angled Universal/110 Patch Panels

| DESCRIPTION                                 | DIMENSIONS          | CAT. NO.  |
|---|---------------------|-----------|
| eXtreme 6+ Angled Patch Panel, 48-Port, 2RU | 3.5" x 19.0" x 4.8" | 69587-U48 |
| GigaMax 5e Angled Patch Panel, 48-Port, 2RU | 3.5" x 19.0" x 4.8" | 5G597-U48 |

### Angled QuickPort Panels

| DESCRIPTION   | DIMENSIONS          | CAT. NO.  |
|---|---------------------|-----------|
| eXtreme 6+ Angled Pre-configured Patch Panel, 48-Port                       | 3.5" x 19.0" x 4.8" | 69271-U48 |
| GigaMax 5e Angled Pre-configured Patch Panel, 48-Port                       | 3.5" x 19.0" x 4.8" | 5G271-U48 |
| High Density Angled Patch Panel, 72-Port, 2RU, w/cable mgmt bar, sold empty |                     | 49256-D72 |
| QuickPort Angled Patch Panel, 1RU, sold empty                               |                     | 49256-H24 |
| QuickPort Angled Patch Panel, 48-Port, sold empty                           | 3.5" x 19.0" x 4.8" | 49256-H48 |

Note: See Section L3-L5 for QuickPort connector options.

### Angled Panel Accessories

| DESCRIPTION  | CAT. NO.  |
|--|-----------|
| [A] Angled Cable Management Bar, rear (4 Hook and Loop fasteners included) | 49006-AMB |
| [B] Vertical Transition Ring (Horizontal Cable Ring), 2/box                | 49262-HR1 |
| [C] Front Blank Angled Panel, 2RU  | 49254-BA2 |
| [D] Front Blank Angled Panel, 1RU  | 49254-BA1 |
| [E] Transitional Cover   | 49254-BC1 |
| Angled Horizontal Patch Cord Organizer, 1RU                                | 49254-LPM |
| Angled Horizontal Patch Cord Organizer, 2RU                                | 49254-BCM |

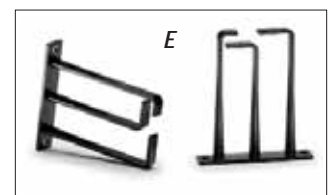
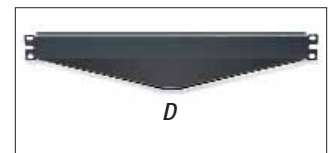
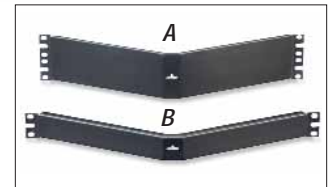

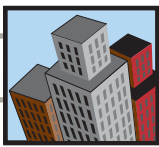

# MULTIMEDIA PATCH PANELS AND PATCH BLOCKS



## STYLES



A 24-Port



B 32-Port



C 24-Port High Density



D 48-Port High Density

## FEATURES

- Cable-tie down slots accommodate Hook and Loop Cable Management tie-wraps and plastic cable ties. Built-in cable management organizes cable and helps maintain optimum bend radii.
- Exclusive Quick Termination Stations can be used to temporarily hold connectors for more convenient termination and cable dressing on 24- and 32-port standard QuickPort panels.
- QuickPort panels accept all Leviton QuickPort snap-in connectors, modules and blanks. Use with Category 6, 5e or 5 connectors for outstanding performance.
- Rugged dual-wall reinforced construction provides secure, flush mount module retention.

## QuickPort® Multimedia Patch Panels and Patch Blocks

Create a Category 5, 5e, 6 or multimedia panel instantly by matching Leviton Performance connectors with versatile QuickPort patch panels and patch blocks. Field-configure with any QuickPort Snap-in Modules for voice, data, audio and video, including: Category 5, GigaMax® 5e, and eXtreme® 6+ (sold separately), to configure the panel to your exact needs.

Configure patch blocks with up to 12 QuickPort modules. Patch panels range in port density from 24 to 48 ports. 24- and 32-port panels incorporate Leviton's exclusive 'Quick Termination Station', and a cable management tray. The high-density panels include a wire management bar. An 89D mounting bracket is sold separately for patch blocks.

### QuickPort Multimedia Patch Panels with Cable Tray

| DESCRIPTION  | DIMENSIONS     | CAT. NO.               |
|--|----------------|------------------------|
| [A] 24-Port Patch Panel with Cable Tray (Order 1 Port identification kit)  | (3.5"H x 19"W) | 49255-Q24<br>49257-QID |
| [B] 32-Port Patch Panel with Cable Tray (Order 2 Port identification kits) | (3.5"H x 19"W) | 49255-Q32<br>49257-QID |

### QuickPort High Density Multimedia Patch Panels with Wire Management Bar

| DESCRIPTION  | DIMENSIONS      | CAT. NO.               |
|--|-----------------|------------------------|
| [C] High Density 24-Port Patch Panel w/Wire Management Bar (Order 1-Port identification kit)   | (1.75"H x 19"W) | 49255-H24<br>49257-QHD |
| [D] High Density 48-Port Patch Panel w/Wire Management Bar. (Order 2-Port identification kits) | (3.5"H x 19"W)  | 49255-H48<br>49257-QHD |

### QuickPort High Multimedia Patch Blocks

| DESCRIPTION  | DIMENSIONS        | CAT. NO.  |
|--|-------------------|-----------|
| QuickPort 12-Port Patch Block, (mounting bracket sold separately)                  | (10"H x 2.375" W) | 49255-Q89 |
| QuickPort Patch Block mounting bracket, shown above (89D)                          |                   | 40089-00D |
| QuickPort 12-Port Multimedia Patch Block, (extra deep) (mounting bracket included) | (10"H x 2.375"W)  | 47689-00P |

*Note: The above QuickPort Multimedia Patch Panels and Blocks are sold empty. See pages L3-L7 for our full line of QuickPort Connectors.*

*Note: Use Leviton's LabelWare™ System to quickly label your QuickPort panels. See Page L59.*

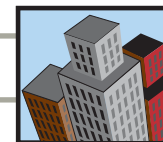

## High Density Patch Panels

Leviton's high density 1RU 48-port and 2RU 72-port style patch panels provide the extra density you need along with robust performance. The 1RU 48-port patch panels feature industry-first, die-cast aluminum construction for high-strength and low weight and include a heavy-duty cable management bar to support the terminated cables. They are sold empty or kitted with 48 category-rated QuickPort connectors. The 72-port super-high density panels are sold empty in flat, angled and recessed-angle configurations.

### High Density Patch Panels

| DESCRIPTION   | CAT. NO.  |
|---|-----------|
| High-Density 48-Port Patch Panel w/ CAT 6A connectors, cable management bar | 6910G-D48 |
| High-Density 48-Port Patch Panel w/CAT 6 connectors, cable management bar   | 69270-D48 |
| High-Density 48-Port Patch Panel w/CAT 5e connectors, cable management bar  | 5G270-D48 |
| [A] High-Density 48-Port Patch Panel, empty, w/cable management bar         | 49255-D48 |
| High-Density Cable Management Bar, sold separately                          | 49005-DMB |
| [B] High-Density 72-Port Patch Panel  | 49255-D72 |
| High-Density 72-Port Angled Patch Panel                                     | 49256-D72 |
| High-Density 72-Port Recessed Angled Patch Panel                            | 4W256-D72 |

## VertiGO™ Zero-U Patch Panels

Leviton's new VertiGO Zero-U Patch Panels with Opt-X® and QuickPort Adapter Plate compatibility (sold separately) provide the ideal solution for copper and fiber connectivity in limited space without taking up any horizontal rack space.

### VertiGO Zero-U Panels

| DESCRIPTION  | CAT. NO.  |
|--|-----------|
| [C] QuickPort 12-Port Zero-U Patch Panels, panel only            | 49280-QP0 |
| QuickPort 12-Port Zero-U Patch Panel, panel w/ 3" wire channel   | 49280-QP3 |
| QuickPort 12-Port Zero-U Patch Panel, panel w/ 6" wire channel   | 49280-QP6 |
| [D] Opt-X Adapter Plate Zero-U Patch Panel, panel only           | 49280-AP0 |
| Opt-X Adapter Plate Zero-U Patch Panel, panel w/ 3" wire channel | 49280-AP3 |
| Opt-X Adapter Plate Zero-U Patch Panel, panel w/ 6" wire channel | 49280-AP6 |

### QuickPort & Opt-X Adapter Plates

| DESCRIPTION  | CAT. NO.  |
|--|-----------|
| [E] Opt-X Adapter Plate, 6-Pack QuickPort, sold empty                                  | 5F100-QP6 |
| [F] Opt-X Adapter Plate, Blank   | 5F100-BLK |
| [G] Opt-X Adapter Plate, 6-Pack Duplex LC MM, (12-fiber) beige, phos. bronze sleeve    | 5F100-12P |
| [H] Opt-X Adapter Plate, 6-Pack Duplex LC MM, (12-fiber) aqua, zirconia ceramic sleeve | 5F100-12A |

## Shielded Patch Panel

Shielded patch panel provides both EMI protection and data security. Panel accepts Leviton's QuickPort Shutter Kit for labeling options and includes grounding wire and nickel-plating for improved grounding, cable management bar and cable ties

### QuickPort Shielded Patch Panel

| DESCRIPTION                                      | CAT. NO.  |
|--|-----------|
| [I] QuickPort Shielded Patch Panel, 24-Port, 1RU | 4S255-S24 |

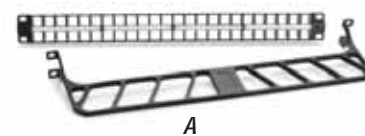

A

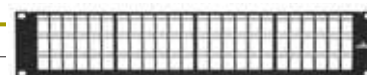

B



C



D



E



F



G



H



I

#### VERTIGO FEATURES

- Ideal for data center cabinets and other high-density network spaces.
- Mounts on the back rail of cabinets utilizing industry standard RU fastener spacing.
- Can be installed on the right or left of the cabinet.
- Can share mounting hardware with servers or other existing equipment.



# HIGH DENSITY AND ZERO-U PATCH PANELS



## STYLES



24-Port



48-Port

## FEATURES



Cable management bar available separately to facilitate dressing and organization of cable.

- Printed circuit-board modules with 110 IDC-style punchdowns or industry standard RJ21X connector termination.
- Connector spring wire contacts are highest quality phosphor bronze, plated with 50 microinches gold over 100 microinches of nickel.

## Voice Grade Patch Panels

Leviton's Voice Grade Patch Panels are the perfect solution for bringing voice to your cable rack. Pre-configured in 24- and 48-Port densities, and designed specifically for voice grade applications, these low-cost panels are available in pre-connectorized and 110-IDC versions. A unique rear label is provided for the 110-IDC style patch panels that delineates 1-pair, 2-pair and 4-pair termination, in addition to showing 25-pair color coded termination.

### Voice Grade Patch Panels, 110-Style

| DESCRIPTION                       | CAT. NO.<br>24-PORT | CAT. NO.<br>48-PORT |
|-----------------------------------|---------------------|---------------------|
| Voice 8P4C Jacks, 110 termination | 49013-P24           | 49013-P48           |
| Dimensions:                       | 1.75"H x 19.0"W     | 3.5"H x 19.0"W      |
| Cable Management Bar              | 49005-CMB           | 49005-CMB           |

### Voice Grade Patch Panels, Pre-Connected

| DESCRIPTION                         | CAT. NO.<br>24-PORT | CAT. NO.<br>48-PORT |
|-------------------------------------|---------------------|---------------------|
| Voice 8P2C Jacks, 25-pair connector | 49012-J24           | 49012-J48           |
| Voice 8P4C Jacks, 25-pair connector | 49014-J24           | 49014-J48           |
| Voice 8P8C Jacks, 25-pair connector | 49018-J24           | 49018-J48           |
| Dimensions:                         | 1.75"H x 19.0"W     | 3.5"H x 19.0"W      |
| Cable Management Bar                | 49005-CMB           | 49005-CMB           |

Note: 49004 comes without label holders, and is available only in black painted finish with white write-on areas next to the connectors.



## DuraPort™ Industrial Connectivity

Moisture, dust, corrosion, acids, detergents, oils, and vibration – each presents a serious threat to network connectivity, especially with repeated exposure. Defeat these threats with patent pending DuraPort Industrial Connectivity products, Leviton's IP67-rated line of connector housings, patch cords, and wallplates.

### DuraPort™ Industrial Connector Housings

| DESCRIPTION  | CAT. NO.  |
|--|-----------|
| [A] CAT 6 Industrial Connector Housing w/Connector Cap | D6706-00E |
| " CAT 5e+ Industrial Connector Housing w/Connector Cap | D675E-00E |
| " Connector Cap  | D6701-00E |



A Connector Housings

### DuraPort™ Industrial Stainless Steel Wallplates

| DESCRIPTION  | CAT. NO.  |
|--|-----------|
| [B] Industrial Wallplate, S/S, 1-Port, Single-Gang | D6710-1S1 |
| " Industrial Wallplate, S/S, 2-Port, Single-Gang   | D6710-1S2 |
| " Industrial Wallplate, S/S, 2-Port, Dual-Gang     | D6710-2S2 |
| " Industrial Wallplate, S/S, 4-Port, Dual-Gang     | D6710-2S4 |

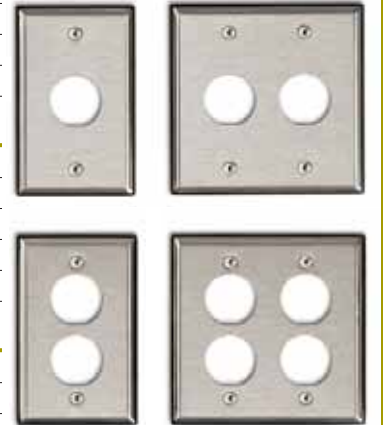

B Stainless Steel Wallplates

### DuraPort™ Industrial Patch Cords, CAT 6

| DESCRIPTION                                  | CAT. NO.  |
|--|-----------|
| [C] Industrial Plug-to-Industrial Plug, 3-ft | D6720-03E |
| " Industrial Plug-to-Industrial Plug, 5-ft   | D6720-05E |
| " Industrial Plug-to-Industrial Plug, 7-ft   | D6720-07E |
| " Industrial Plug-to-Industrial Plug, 10-ft  | D6720-10E |
| " Industrial Plug-to-Industrial Plug, 15-ft  | D6720-15E |
| " Industrial Plug-to-Industrial Plug, 20-ft  | D6720-20E |
| [D] Industrial Plug-to-RJ45 Plug, 3-ft       | D6721-03E |
| " Industrial Plug-to-RJ45 Plug, 5-ft         | D6721-05E |
| " Industrial Plug-to-RJ45 Plug, 7-ft         | D6721-07E |
| " Industrial Plug-to-RJ45 Plug, 10-ft        | D6721-10E |
| " Industrial Plug-to-RJ45 Plug, 15-ft        | D6721-15E |
| " Industrial Plug-to-RJ45 Plug, 20-ft        | D6721-20E |



C Plug-to-Industrial Plug

### Duraport™ Industrial Outlet Kits

| DESCRIPTION   | CAT. NO.  |
|---|-----------|
| [E] Industrial Outlet Kit, S/S, 1-Port, Single-Gang | D670K-1S1 |
| Industrial Outlet Kit, S/S, 2-Port, Single-Gang     | D670K-1S2 |
| Industrial Outlet Kit, S/S, 2-Port, Dual-Gang       | D670K-2S2 |
| Industrial Outlet Kit, S/S, 4-Port, Dual-Gang       | D670K-2S4 |



D Industrial Plug-to-RJ45



E Outlet Kits

#### SPECIFICATIONS AND FEATURES

##### DuraPort™ Industrial Connector Housings

- Made of Polybutylene Terephthalate (PBT) for strength and chemical resistance.

##### DuraPort™ Industrial Wallplates

- Molded gasket with embedded sealing feature for wallplate mounting holes, ensures a watertight fit.

##### DuraPort™ Industrial Patch Cords

- Sheathed in Thermoplastic Elastomer to resist heat, abrasion, and tearing.

##### DuraPort™ Industrial Outlet Kits

- Pre-assembled stainless steel wallplate with an appropriate number of connector housings and connector caps.



# PATCH CORDS

Copper Components

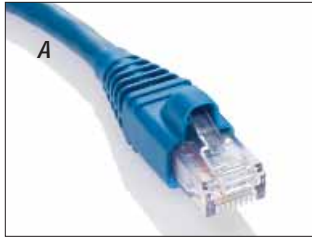

## Performance Patch Cords

**A** Leviton's eXtreme 10G, eXtreme 6+, GigaMax 5e and Category 5 patch cords meet or exceed industry standard specifications and use compliant stranded wire as specified by the latest TIA guidelines, to ensure adequate "flex life". All have quality construction to maintain the integrity of signal transmission at the cross-connect, which is critical to the performance of the entire cabling system. Available in lengths of 3', 5', 7', 10', 15' and 20', in seven colors.

*NOTE: Leviton Performance Patch Cords are required to qualify for the Leviton Lifetime Warranty on Certified installations.*



## Standard Patch Cords <sup>UL</sup>

| DESCRIPTION             | CAT. NO.<br>eXtreme 10G | CAT. NO.<br>eXtreme 6+ | CAT. NO.<br>GigaMax 5e | CAT. NO.<br>CATEGORY 5 |
|-------------------------|-------------------------|------------------------|------------------------|------------------------|
| 3-foot length (.91 m)   | 6210G-03*               | 62460-03*              | 5G460-03*              | 52455-03*              |
| 5-foot length (1.52 m)  | 6210G-05*               | 62460-05*              | 5G460-05*              | 52455-05*              |
| 7-foot length (2.13 m)  | 6210G-07                | 62460-07*              | 5G460-07*              | 52455-07*              |
| 10-foot length (3.05 m) | 6210G-10                | 62460-10*              | 5G460-10*              | 52455-10*              |
| 15-foot length (4.57 m) | 6210G-15                | 62460-15*              | 5G460-15*              | 52455-15*              |
| 20-foot length (6.10 m) | 6210G-20                | 62460-20*              | 5G460-20*              | 52455-20*              |

\* = Colors: White(W), Yellow(Y), Red(R), Blue(B), Green(G), Grey(S), Black(E)

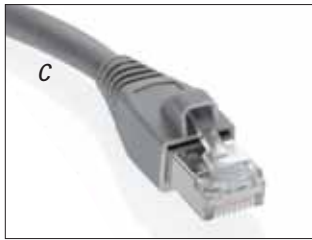

## Slimline Patch Cords

SlimLine Patch Cords make it easy to get connected in both traditional and high-density applications. Bootless design and narrow Slimline profile are ideal in environments where rack space is especially tight. The snagless design prevents plugs from becoming entangled in nearby cables and the easy-access quick-release tab makes connections and disconnections easier. Flexible two-piece strain relief boot ensures excellent connectivity. Available in Category 5e and 6 ratings.

### SlimLine Patch Cords

| DESCRIPTION             | CAT. NO.  | CAT. NO.  |
|-------------------------|-----------|-----------|
| 3-foot length (.91 m)   | 5D460-03* | 6D460-03* |
| 5-foot length (1.52 m)  | 5D460-05* | 6D460-05* |
| 7-foot length (2.13 m)  | 5D460-07* | 6D460-07* |
| 10-foot length (3.05 m) | 5D460-10* | 6D460-10* |
| 15-foot length (4.57 m) | 5D460-15* | 6D460-15* |
| 20-foot length (6.10 m) | 5D460-20* | 6D460-20* |

\* = Colors: White(W), Yellow(Y), Red(R), Blue(B), Green(G), Grey(S), Black(E)

## Shielded Patch Cords

Shielded Patch Cords, part of Leviton's full line of shielded products, provide enhanced EMI/RFI protection and increased data security for government, financial, and other critical applications. These Category 5e and Category 6 patch cords are available in 6 lengths. Grey only.

### SlimLine Patch Cords

| DESCRIPTION             | CAT. NO.  | CAT. NO.  |
|-------------------------|-----------|-----------|
| 3-foot length (.91 m)   | 5S460-03S | 6S460-03S |
| 5-foot length (1.52 m)  | 5S460-05S | 6S460-05S |
| 7-foot length (2.13 m)  | 5S460-07S | 6S460-07S |
| 10-foot length (3.05 m) | 5S460-10S | 6S460-10S |
| 15-foot length (4.57 m) | 5S460-15S | 6S460-15S |
| 20-foot length (6.10 m) | 5S460-20S | 6S460-20S |

*NOTE: Leviton Patch Cords (Standard, SlimLine or Shielded) are required to qualify for the Leviton Lifetime Warranty on Certified installations.*

#### \* COLOR/PATCH CORDS

For color selection, add suffix to catalog number as follows: Ivory (I), White (W), Gray (G), Black (E), Blue (L), Red (R), Green (G), Yellow (Y).



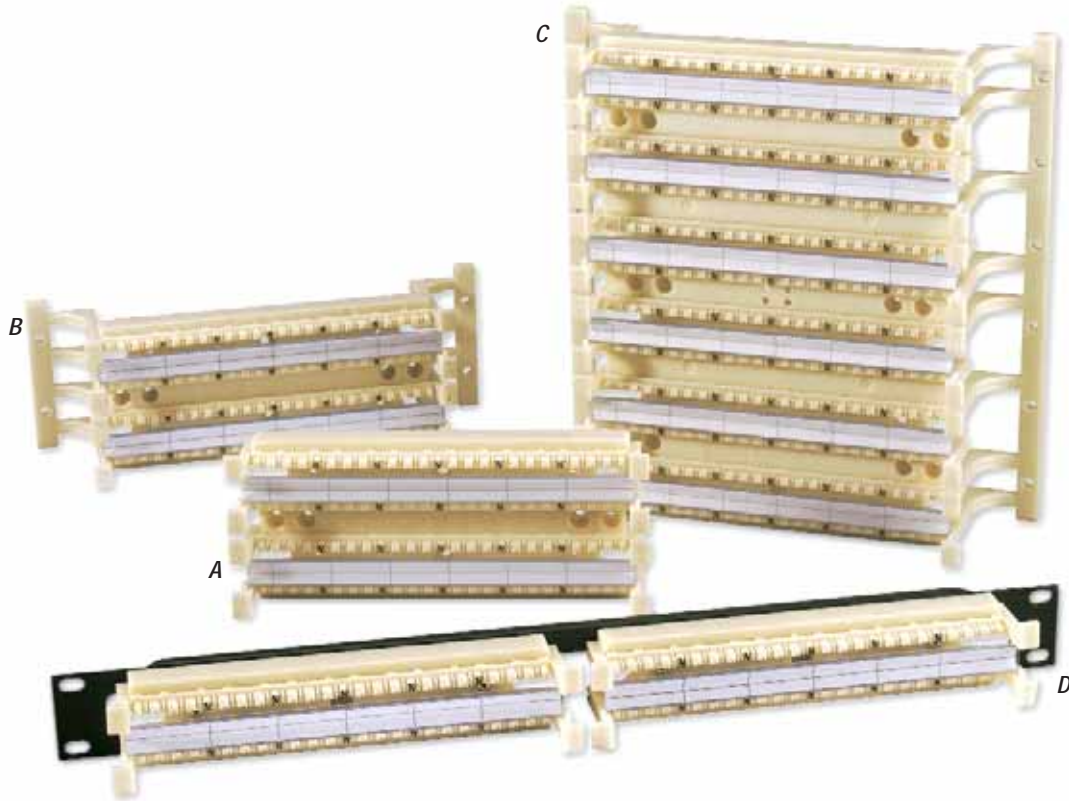
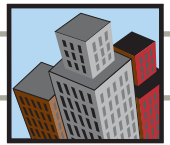

### eXtreme 6+ 110-Style Wiring Products

Leviton's 110-Style Wiring Products are perfect for quick and easy cross connects in a minimum of space. Achieve top performance and network integrity at consolidation points, even at Category 6 levels. Building a cross-connect system for voice and data is effortless.

eXtreme 6+ 110-Style Wiring Blocks are available in 96- and 288-Pair units, with or without legs for wall mount applications. We also offer 96-, 192- and 288-pair rack-mount units. All kits include C-4 clips.

A full selection of patch cords is available for easy connection to network equipment. All units meet or exceed Category 6 transmission requirements.

#### eXtreme 6+ Cat 6 110-Style Wiring Block – Kitted Versions

| DESCRIPTION  | CAT. NO.  |
|--|-----------|
| [A] eXtreme 6+ 110-Style Wiring Block, Wall-Mount w/o legs, CAT 6, 96-Pair | 41NB6-1F4 |
| [B] eXtreme 6+ 110-Style Wiring Block, Wall-Mount w/legs, CAT 6, 96-Pair   | 41AB6-1F4 |
| [C] eXtreme 6+ 110-Style Wiring Block, Wall-Mount w/legs, CAT 6, 288-Pair  | 41AB6-3F4 |
| [D] eXtreme 6+ 110-Style Wiring Block, Rack-Mount, CAT 6, 96-Pair          | 41DR6-1F4 |
| eXtreme 6+ 110-Style Wiring Block, Rack-Mount, CAT 6, 192-Pair             | 41DR6-2F4 |
| eXtreme 6+ 110-Style Wiring Block, Rack-Mount, CAT 6, 288-Pair             | 41DR6-3F4 |

Note: Category 5e and 6 110 wiring block legs are non-removable.

Note: Identify all of your 110 products with LabelWare™ 110 wiring product labels. See page L59.

Note: All kits include C-4 clips.

#### MATERIAL CHARACTERISTICS

- C-4 connector clips (sold separately or included in kitted versions) are fire-retardant UL 94V-0 plastic with solder-plated IDC's.

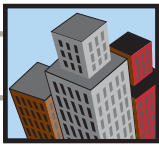

# EXTREME® 6+ 110-STYLE PATCH CORDS and CONNECTOR CLIPS



## eXtreme 6+ 110-Style Patch Cords

**A, B** Make your network connections with eXtreme 6+ 110-style Patch Cords, a quick solution for 110 to 110 and 110 to RJ45 applications (in both T568A and T568B wiring configurations). Cords are gray with gray boots and are offered in 1', 2', 3', 5', 7' and 10' lengths. All cords meet or exceed all Category 6 transmission requirements.

### eXtreme 6+ Cat 6 110-Style Patch Cords

| DESCRIPTION                                   | CAT. NO.<br>1-FOOT | CAT. NO.<br>2-FOOT | CAT. NO.<br>3-FOOT | CAT. NO.<br>5-FOOT | CAT. NO.<br>7-FOOT | CAT. NO.<br>10-FOOT |
|---|--------------------|--------------------|--------------------|--------------------|--------------------|---------------------|
| [A] CAT 6 110 to 110-Style Patch Cord, 4 pair | 62240-01S          | 62240-02S          | 62240-03S          | 62240-05S          | 62240-07S          | 62240-10S           |
| [B] CAT 6 110 to T568A Patch Cord, 4 pair     | 6234A-01S          | 6234A-02S          | 6234A-03S          | 6234A-05S          | 6234A-07S          | 6234A-10S           |
| CAT 6 110 to T568B Patch Cord, 4 pair         | 6234B-01S          | 6234B-02S          | 6234B-03S          | 6234B-05S          | 6234B-07S          | 6234B-10S           |

## eXtreme 6+ 110-Style Connector Clips

**C** Choose these connector clips for a high-quality, gas-tight connection to ensure signal integrity in your Category 6 applications. Clips withstand 200 re-terminations and are made of fire-retardant plastic rated UL 94V-0 with solder-plated IDCs.

### eXtreme 6+ Cat 6 110-Style C-4 Clip

| DESCRIPTION                                | CAT. NO.  |
|--|-----------|
| [C] eXtreme 6+ C-4 Clip, CAT 6 (bag of 10) | 69104-IDC |

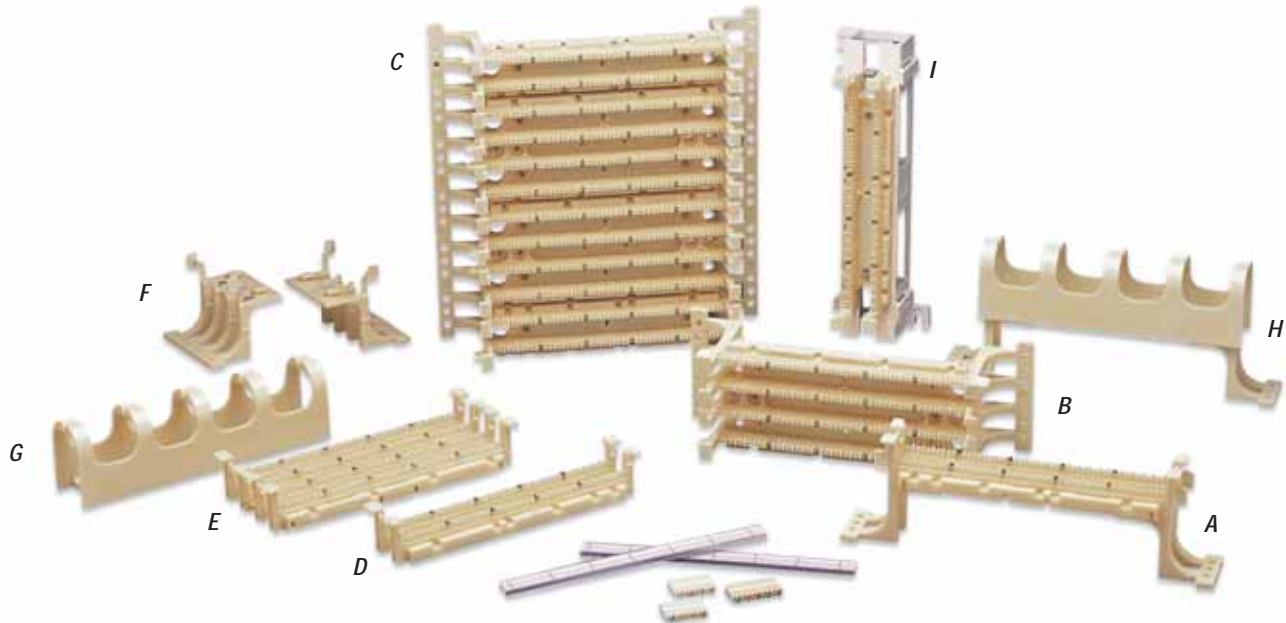

## GigaMax 5e 110-Style Wiring Products

### WALL-MOUNT 110-STYLE WIRING PRODUCTS

Create compact, adaptable 110 termination fields for voice and data by mounting 110 wiring bases to the wall or a backboard. Bases come in 50-, 100- or 300-pair densities. The 50- and 100-pair bases may be ordered with or without standoff legs. All 300-pair bases include stand-off legs, label strip holders and white paper labels. A 50-pair 89D bracket configuration is also available (89D bracket sold separately, page L39).

Complete kits are available for 100- and 300-pair wall-mount units and 89D wiring base, and include bases, C-4 or C-5 connecting blocks, label holders and white paper labels.

All components are UL listed and exceed the latest TIA-568-B standards and Category 5e transmission requirements. Verified by independent testing.

### GigaMax 5e 110-Style Wall-Mount Wiring Products

| DESCRIPTION  | CAT. NO.  |
|--|-----------|
| [A] GigaMax 5e 110-Style Wiring Block, Wall-Mount w/legs, Cat 5e, 50-Pair    | 41AW1-050 |
| [B] GigaMax 5e 110-Style Wiring Block, Wall-Mount w/legs, Cat 5e, 100-Pair   | 41AW2-100 |
| [C] GigaMax 5e 110-Style Wiring Block, Wall-Mount w/legs, Cat 5e, 300-Pair   | 41AW2-300 |
| [D] GigaMax 5e 110-Style Wiring Block, Wall-Mount w/o legs, Cat 5e, 50-Pair  | 41DW1-050 |
| [E] GigaMax 5e 110-Style Wiring Block, Wall-Mount w/o legs, Cat 5e, 100-Pair | 41DW2-100 |
| GigaMax 5e 110-Style legs (2 ea) for use with 41DW1                          | 410L2-050 |
| [F] GigaMax 5e 110-Style legs (2 ea) for use with 41DW2                      | 410L2-100 |
| [G] GigaMax 5e 110-Style Horizontal Cord Manager w/o legs                    | 41D10-HCM |
| [H] GigaMax 5e 110-Style Horizontal Cord Manager w/ legs                     | 41A10-HCM |
| [I] GigaMax 5e 110-Style 50-Pair 89-D Base                                   | 41DW1-589 |

### GigaMax 5e 110-Style Wall-Mount Wiring Products – Kitted Versions

| DESCRIPTION   | CAT. NO.<br>C-4 CLIPS | CAT. NO.<br>C-5 CLIPS |
|---|-----------------------|-----------------------|
| [J] Wiring Block, Wall-Mount w/legs kit, Cat 5e, 100-Pair | 41AB2-1F4             | 41AB2-1F5             |
| Wiring Block, Wall-Mount w/o legs kit, Cat 5e, 100-Pair   | 41NB2-1F4             | 41NB2-1F5             |
| Wiring Block, Wall-Mount w/legs kit, Cat 5e, 300-Pair     | 41AB2-3F4             | 41AB2-3F5             |

Note: Category 5e and 6 110 wiring block legs are non-removable.

#### MATERIAL CHARACTERISTICS

- Horizontal cord managers and 110 wiring bases feature sturdy construction of fire-retardant plastic rated UL 94V-0. C-4 and C-5 connector blocks (sold separately or included in kitted versions) are fire-retardant UL 94V-0 plastic with solder-plated IDC's.



## RACK-MOUNT 110-STYLE WIRING PRODUCTS

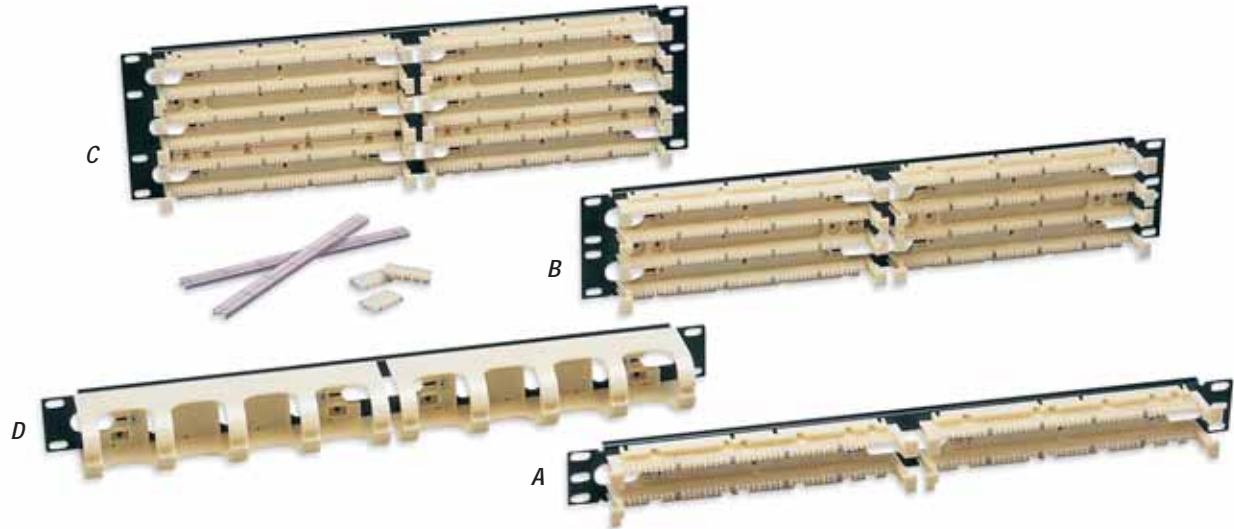

### Rack-Mount 110-Style Wiring Products

Rack-Mount 110 Wiring Products attach to standard 19" wide racks to create compact, adaptable 110 termination fields for voice and data. Panels come in 100-, 200- or 300-pair densities and terminate 22-26 AWG solid copper wire. Cord management is provided by horizontal cord managers (sold separately).

Kits for 100-, 200- and 300-pair rack-mount panels include the panel, C-4 and C-5 connecting blocks, label strip holders and white paper labels.

Horizontal cord managers and 110 wiring bases feature sturdy single-piece construction of fire-retardant plastic rated UL 94V-0. Wiring bases are attached to 19" wide steel rack-mount panels, painted black. Screws are included for mounting the panels onto 19" racks. C-4 and C-5 connector blocks are fire-retardant UL 94V-0 plastic with solder-plated IDC's.

All components are UL Listed, and exceed Category 5e transmission requirements. Verified by independent testing.

#### GigaMax® 5e 110-Style Rack-Mount Wiring Blocks

| DESCRIPTION  | CAT. NO.  |
|--|-----------|
| [A] GigaMax 5e 110-Style Wiring Block, Rack-Mount, Cat 5e, 100 Pair                  | 41DR2-100 |
| [B] GigaMax 5e 110-Style Wiring Block, Rack-Mount, Cat 5e, 200 Pair                  | 41DR2-200 |
| [C] GigaMax 5e 110-Style Wiring Block, Rack-Mount, Cat 5e, 300 Pair                  | 41DR2-300 |
| [D] Rack-Mount Horizontal Cord Manager<br>(for part numbers listed above and below). | 41D1R-HCM |

#### GigaMax 5e 110-Style Rack-Mount Wiring Products – Kitted Versions

| DESCRIPTION   | CAT. NO.<br>C-4 CLIPS | CAT. NO.<br>C-5 CLIPS |
|---|-----------------------|-----------------------|
| GigaMax 5e 110-Style Wiring Block, Rack-Mount kit, Cat 5e, 100-Pair     | 41DBR-1F4             | 41DBR-1F5             |
| [E] GigaMax 5e 110-Style Wiring Block, Rack-Mount kit, Cat 5e, 200-Pair | 41DBR-2F4             | 41DBR-2F5             |
| GigaMax 5e 110-Style Wiring Block, Rack-Mount kit, Cat 5e, 300-Pair     | 41DBR-3F4             | 41DBR-3F5             |

*Note: Leviton's Label Holders and Strips are ideal for identification of all your key 110 connections. See page L60.*

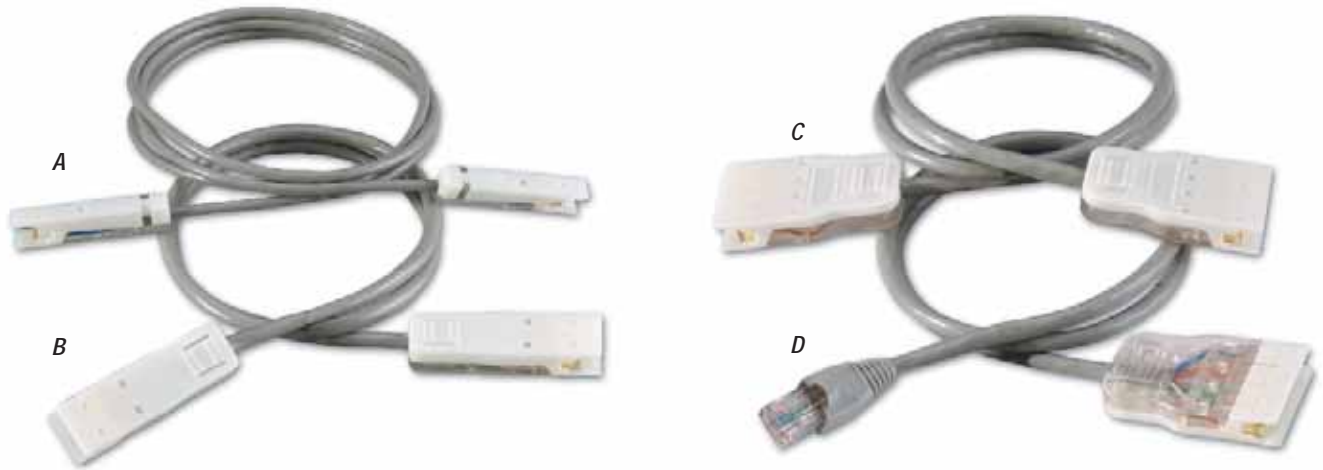
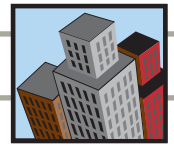

### GigaMax 5e 110-Style Patch Cords

A–D Make quick connections with GigaMax 110-Style Patch Cords. Available in 110 to 110 for cross connects and 110 to RJ45 (in both T568A and T568B wiring configurations) to connect to a panel or nearby workstation. The cords are offered in 1', 2', 3', 5', and 10' lengths, in gray with gray boots.

#### GigaMax 5e 110-Style Patch Cords A-Tick

| DESCRIPTION                                | CAT. NO.<br>1-FOOT | CAT. NO.<br>2-FOOT | CAT. NO.<br>3-FOOT | CAT. NO.<br>5-FOOT | CAT. NO.<br>7-FOOT | CAT. NO.<br>10-FOOT |
|--|--------------------|--------------------|--------------------|--------------------|--------------------|---------------------|
| [A] 110 to 110 Patch Cord, 1 pair          | 5G210-01S          | 5G210-02S          | 5G210-03S          | 5G210-05S          | 5G210-07S          | 5G210-10S           |
| [B] 110 to 110 Patch Cord, 2 pair          | 5G220-01S          | 5G220-02S          | 5G220-03S          | 5G220-05S          | 5G220-07S          | 5G220-10S           |
| [C] CAT 5e, 110 to 110 Patch Cord, 4 pair  | 5G240-01S          | 5G240-02S          | 5G240-03S          | 5G240-05S          | 5G240-07S          | 5G240-10S           |
| [D] CAT 5e, 110 to 568A Patch Cord, 4 pair | 5G34A-01S          | 5G34A-02S          | 5G34A-03S          | 5G34A-05S          | 5G34A-07S          | 5G34A-10S           |
| CAT 5e, 110 to 568B Patch Cord, 4 pair     | 5G34B-01S          | 5G34B-02S          | 5G34B-03S          | 5G34B-05S          | 5G34B-07S          | 5G34B-10S           |



### GigaMax 5e 110-Style Connector Clips

E These high-quality connector clips securely seat the wires on 110 wiring bases, providing a gas-tight IDC connection that maintains signal integrity for high performance applications. Available in three Category 5/5e pair-count sizes: C-3, C-4 and C-5. These clips withstand 200 reterminations, and are made of fire-retardant plastic rated UL 94V-0 with solder-plated insulation displacement connectors.

#### GigaMax 5e 110-Style Connector Clip

| DESCRIPTION  | CAT. NO.  |
|--|-----------|
| GigaMax 5e 110-Style C-3 Connector Clips (bag of 10) | 49103-IDC |
| GigaMax 5e 110-Style C-4 Connector Clips (bag of 10) | 49104-IDC |
| GigaMax 5e 110-Style C-4 Connector Clips (bag of 50) | 49104-I50 |
| GigaMax 5e 110-Style C-5 Connector Clips (bag of 10) | 49105-IDC |



## 110-STYLE WALL-MOUNT FRAMES



### 110-Style Wall-Mount Frames

**A–D** For 110 wall-mount applications, mounting frames provide additional options for cord/cable management, access, and density via a rear cable channel, side slots, horizontal cord managers and a bottom cable tray. Components are offered individually or in kits (see ordering information below for description of included parts).

Begin with the basic mounting frames and vertical cord managers. Each has a 300-pair capacity—room for three 100-pair wiring bases, with 100-pair horizontal cord managers in between. The capacity for each mounting frame or vertical manager may be increased to 600 or 900 pairs with the addition of up to two 300-pair extension units.

Frames, trays and vertical cord managers are composed of sturdy steel, painted black; wiring bases, connector blocks and horizontal cord managers are fire-retardant plastic rated UL 94V-0. Kits include screws for attaching wiring bases and cord managers to the mounting frame. All components are UL Listed and exceed Category 5e transmission requirements. Verified by independent testing.



### Wall-Mounting Frame 110-Style Wiring Products

| DESCRIPTION   | CAT. NO.  |
|---|-----------|
| [A] 300-pair Basic Mounting-Frame Unit (sheet metal frame and bottom cable tray only).  | 41MB2-SMF |
| [B] 300-pair Extension Mounting-Frame Unit (sheet metal frame only).  | 41MB2-SME |
| Basic Mounting Frame Kit with three 100-pair bases; mounting frame; cable tray; C-4 connector blocks; three horizontal cord managers; label strip holders and white label strips. | 41MB2-3FT |
| Extension Mounting Frame Kit with three 100-pair bases; mounting frame; C-4 connector blocks; three horizontal cord managers; label strip holders and white label strips.         | 41MB2-EXT |
| [C] 300-pair Vertical Cord Manager, Basic unit; includes bottom cable tray.   | 41880-300 |
| [D] 300-pair Vertical Cord Manager, Extension unit.   | 41880-EXT |
| Rack-Mount Horizontal Cord Manager (Not Shown)  | 41D1R-HCM |

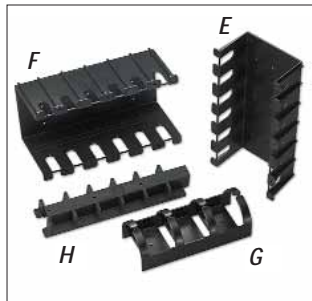

### 110-Style ChannelMax™ System

**E–H** Manage your cable with the 110 ChannelMax System, perfect to maximize control in minimum space. Cable channel provides extra room in the rear, cable trough allows a clean connection at the CP/frame, and vertical spool manager helps to dress cross-connect cables.

### 110-Style Channel System

| DESCRIPTION                                 | CAT. NO.  |
|---|-----------|
| [E] 3" Deep Vertical Cable Channel          | 41CMS-300 |
| [F] 5" Deep Vertical Cable Channel          | 41CMS-500 |
| [G] Horizontal Cable Management Trough      | 41CMS-HCM |
| [H] Vertical Spool Manager Mounting Bracket | 41CMS-VSM |



### 66-Clip Connecting Blocks

A variety of M Blocks, including 25-pair and split 50-pair styles, provide versatile cross connect points in equipment and telecommunications rooms. Install individually or in pairs. Constructed of high-impact, fire-retardant UL 94V-0 plastic with phosphor bronze quick-connect insulation displacement 66-clips. Install individually or in pairs in a cross-connect system using jumper wires or bridging clips.

#### 66-Clip Connecting Blocks

| DESCRIPTION  | CAT. NO.  |
|--|-----------|
| [A] M Block: 25-pair (66M1-25) 10"H x 3 <sup>5</sup> / <sub>16</sub> "W x 1 <sup>3</sup> / <sub>16</sub> "D                            | 40066-M25 |
| Split M Block: 50-pair (66M1-50) 10"H x 3 <sup>5</sup> / <sub>16</sub> "W x 1 <sup>3</sup> / <sub>16</sub> "D                          | 40066-M50 |
| M Block with female connector (66M1-50W) 10"H x 3 <sup>5</sup> / <sub>16</sub> "W x 1 <sup>3</sup> / <sub>16</sub> "D                  | 40066-0MW |
| [B] M Block with female and male connectors (66M1-50W2) 10"H x 3 <sup>5</sup> / <sub>16</sub> "W x 1 <sup>3</sup> / <sub>16</sub> "D   | 40066-MW2 |
| [C] Connectorized Demarc Block (66M1-50R) 10"H x 3 <sup>13</sup> / <sub>32</sub> "W x 2 <sup>3</sup> / <sub>4</sub> "D female amphenol | 40066-0MR |

### 66-Clip Connecting Block Accessories

Accessories include Covers for M Blocks and Demarc Blocks, M-Block Brackets for Jack/Connector Mounting, Wire Distribution Spools, Modular Adapters and Bridging Clips.

#### Bridging Clips

| DESCRIPTION                          | CAT. NO.  |
|--------------------------------------|-----------|
| [D] Bridging Clips (SA-1), bag of 50 | 40067-0BC |

#### Hinged Covers and Snap-On Covers

| DESCRIPTION   | CAT. NO.  |
|---|-----------|
| Snap-on Cover for M blocks (66MC-4) 9-15/16" H x 2-5/16" W x 5/16" D          | 40050-MCV |
| Hinged Cover for Demarc blocks: orange (66MC4LH-O) 10" H x 2-7/16" W x 3/4" D | 40050-MHO |
| Hinged Cover for M blocks: grey (66MC4LH-G) 10" H x 2-7/16" W x 3/4" D        | 40050-MHG |

#### Bracket for M Blocks and Connector Mounting

| DESCRIPTION  | CAT. NO.  |
|--|-----------|
| [E] M-block Bracket for connector mounting (89-D/QuickPort Blocks) 10" H x 3-13/32" W x 1-1/2" D | 40089-00D |

Note: Numbers in parentheses refer to industry product designation.

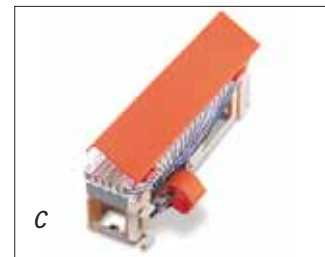
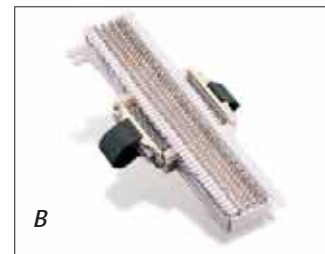
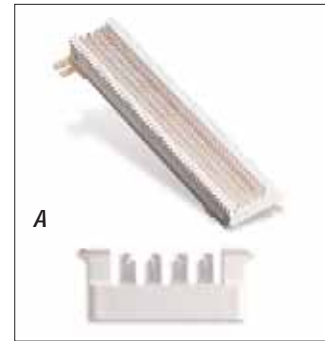

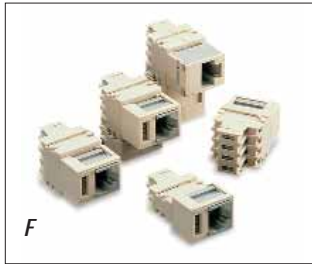

## 66-Clip Connecting Block Accessories (continued)

### Modular Adapters

| DESCRIPTION   | CAT. NO.  |
|---|-----------|
| [F] Position Modular Adapter (Tap™-2) - Converts two 66-clip contacts into a 6P2C modular jack            | 40072-0T2 |
| 4-Position Modular Adapter (Tap™-4) - Converts four contacts into a 6P4C modular jack                     | 40072-0T4 |
| 6-Position Modular Adapter (Tap™-6) - Converts six contacts into a 6P6C modular jack                      | 40072-0T6 |
| 8-Position Modular Adapter, T568B wiring (Tap™-008) - Converts eight contacts 8P8C non-keyed modular jack | 40072-0T8 |



### Wire Distribution Spools

| DESCRIPTION  | CAT. NO.  |
|--|-----------|
| [G] Wire Distribution Spool (20-A) 1-3/4" Dia. x 3" H            | 40054-ODS |
| [H] Wire Distribution Spool with screw (20-B) 1-3/4" Dia. x 3" H | 40054-DSS |

*Note: Number in parentheses refers to industry product designation.*

### Surface-Mount Mini Patch Panels

For applications with space limitations or simple breakout patching, the Mini Patch Panel with modular connectors can be mounted almost anywhere. Combine two or more panels in-line and use patch cords to make and change connections.



### Surface-Mount Mini Patch Panels

| DESCRIPTION  | CAT. NO.  |
|--|-----------|
| [I] 25 6-position 2-conductor (RJ11) FCC Spec Jacks connected to a circuit board with one male 25-pair connector in surface-mount housing. Wired in standard T-R sequence (26-1, 27-2, 28-3, etc). | 41600-001 |
| [J] 25 6-position 4-conductor (RJ14) FCC Spec Jacks wired into two male 25-pair connectors in standard T-R sequence.   | 41610-001 |
| [K] 25 6-position 2-conductor (RJ11) FCC Spec Jacks connected to a circuit board with two bridged 25-pair connectors (one male and one female) in standard T-R sequence for series connection.     | 41620-001 |
| Mounting Magnets (20 Per Package)  | 49200-00M |



# OPT-X® 1000 1RU FIBER OPTIC ENCLOSURES

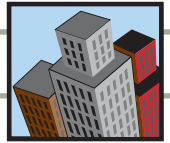

SEE FIBER DENSITY CHART, PAGE L48

Front and rear tilt-up lids that provide unobstructed access to adapters and mounting plates.

Slide rail option allows easy installation and re-entry regardless of equipment or enclosures above.



Mounting brackets are reversible for mid- or flush-mounting in 19" racks.

High-density adapter enclosure houses up to 24 ST® or 12 duplex SC adapters. Another version accepts three six-fiber mounting plates; configure with ST, FC, SC, LC and MT-RJ or add a QuickPort plate to create a multimedia enclosure.

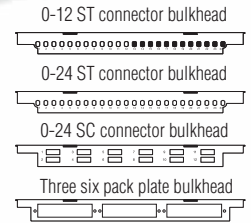

## Opt-X 1000 Low-Profile Rack-Mount Enclosures (1RU) 1.75"H x 19.0"W x 12.0"D

| DESCRIPTION   | CAT. NO. W/O RAILS | CAT. NO. W/RAILS |
|---|--------------------|------------------|
| 24 Fiber w/6 ST adapters                              | 5R030-OAB          | 5P030-OAB        |
| 24 Fiber w/3 duplex SC adapters                       | 5R030-OHB          | 5P030-OHB        |
| 72 Fiber, empty (accepts 3 adapter plates, sold sep.) | 5R130-00N          | 5P130-00N        |
| 24 Fiber, loaded w/12 ST adapters                     | 5R230-OAB          | 5P230-OAB        |
| 24 Fiber, loaded w/6 duplex SC adapters               | 5R230-OHB          | 5P230-OHB        |
| 24 Fiber, unloaded, punched for ST adapters           | 5R330-OAA          | 5P330-OAA        |
| 24 Fiber, unloaded, punched for duplex SC adapters    | 5R330-OHA          | 5P330-OHA        |
| 24 Fiber loaded w/24 ST adapters                      | 5R330-OAB          | 5P330-OAB        |
| 24 Fiber loaded w/12 duplex SC adapters               | 5R330-OHB          | 5P330-OHB        |

### Add-On Slide Rail Kit

| DESCRIPTION                            | CAT. NO.  |
|--|-----------|
| Slide Rail Kit for IRU enclosures only | 5S100-SLM |

### Replacement Door

| DESCRIPTION                                    | CAT. NO.  |
|--|-----------|
| 24 Fiber Rack-Mount Metal 1RU Replacement Door | 5D000-1RM |

**LOADED** = The enclosure's bulkhead contains the specified couplings.

**UNLOADED** = The enclosure includes a bulkhead which has openings for, but does not include, the specified couplings.

**EMPTY** = No bulkhead coupling plates are included.

Note: For mounting plates and accessories, see pages L47-49.

Note: Custom lengths and configurations on pigtails available; call customer service for more information: 1-800-722-2082



Opt-X 1000 Low-Profile Rack-Mount shown in open view.



# OPT-X® 1000 2RU FIBER OPTIC ENCLOSURES

Horizontal entry ports in the front and back and vertical entry ports in the rear offer egress/ ingress for distribution of patch cables.

SEE FIBER DENSITY CHART, PAGE L48



Front and rear tilt-up lids that provide unobstructed access to adapters and mounting plates.

Room for up to 6 Mounting Plates, housing a wide variety of SC, FC, ST, LC and MT-RJ adapters. See Fiber Density Chart on page L47.

Metal or smoked polycarbonate doors. Metal doors are available with or without a lock.

Fiber Components



## Opt-X 1000 Fiber Optic Enclosures (2RU) 3.5"H x 19.0"W x 12.0"D <sup>UL</sup>

| DESCRIPTION                                    | CAT. NO.  |
|--|-----------|
| 2RU Enclosure with Metal Door (no lock)        | 5R430-00N |
| 2RU Enclosure with Metal Door and one Lock/key | 5R440-00N |
| 2RU Enclosure with Poly Door (No Lock)         | 5R460-00N |

### Replacement Doors

| DESCRIPTION                | CAT. NO.  |
|----------------------------|-----------|
| 2RU Replacement Metal Door | 5D000-2RM |
| 2RU Replacement Poly Door  | 5D000-2RP |

### Accessories

| DESCRIPTION                            | CAT. NO.  |
|--|-----------|
| 12 Splice Tray                         | 5T000-00T |
| 3M Fibrlock™ Splice Holder             | 5T000-3MT |
| AT&T Rotary Splice Holder              | 5T000-ATT |
| Lock and Key                           | 5L000-LOK |
| Slide mounts (kit)                     | 5S100-SLM |
| Fiber rings, 2 per pack, 2.5" diameter | 5R100-0FR |

**PLEASE NOTE:** All STOCK configurations of this rack-mount enclosure are sold 'empty,' or without any mounting plates installed. Capacity is dependent upon configuration of mounting plates as shown in note. Rack-mount enclosures DO include grounding/strain relief, grommets, labels, and the appropriate number of cable management rings.

Note: For mounting plates and accessories. See pages L47-L49.

Note: Custom lengths and configurations on pigtails available; call customer service for more information: 1-800-722-2082



Wall mount or rack mount for maximum flexibility. Mid- or flush-mount the 2RU in any space on a standard 19" or 23" rack, or use the universal mounting brackets to flush mount on a wall.

# OPT-X® 1000 3RU and 6RU FIBER OPTIC ENCLOSURES

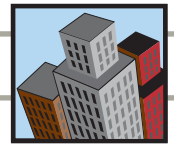

Tilt-up rear door provides unobstructed access to the fiber loop.

SEE FIBER DENSITY CHART, PAGE L48

Front and rear doors drop down flat to act as a workshelf, or can be removed completely. Available in metal or smoked polycarbonate.

Reversible mounting brackets allow mounting on 19" or 23" industry standard equipment frames; move forward for flush mount positioning in NEMA enclosures.

## Opt-X 1000 Rack-Mount Enclosures, 3 Rack Units High (3RU) 5.25"H x 19.0"W x 12.0"D <sup>UL</sup>

| DESCRIPTION  | CAT. NO.  |
|--|-----------|
| 3RU, Empty with metal door, no lock                | 5R730-00N |
| 3RU, Empty with metal door and one lock/key        | 5R740-00N |
| 3RU, Empty with smoked polycarbonate door, no lock | 5R760-00N |

## Opt-X 1000 Rack-Mount Enclosures, 6 Rack Units High (6RU) 10.25"H x 19.0"W x 12.0"D <sup>UL</sup>

| DESCRIPTION  | CAT. NO.  |
|--|-----------|
| 6RU, Empty with metal door, no lock                | 5R930-00N |
| 6RU, Empty with metal door and one lock/key        | 5R940-00N |
| 6RU, Empty with smoked polycarbonate door, no lock | 5R960-00N |

## Add-On Slide Rail Kit

| DESCRIPTION  | CAT. NO.  |
|--|-----------|
| Slide rail kit for 3RU or 6RU fiber Rack-Mount enclosures only | 5S100-SLM |

## Replacement Doors

| DESCRIPTION                                 | CAT. NO.  |
|---|-----------|
| 3RU Rack-Mount replacement metal door       | 5D000-3RM |
| 3RU Rack-Mount replacement smoked poly door | 5D000-3RP |

## Add-On Lock and Key

| DESCRIPTION   | CAT. NO.  |
|---|-----------|
| Add security to an existing door for this enclosure—simply remove the black plastic plug on the door front, and replace with lock mechanism. Lock and Key | 5L000-LOK |

**PLEASE NOTE:** All STOCK configurations of this rack-mount enclosure are sold 'empty,' or without any mounting plates installed. Capacity is dependent upon configuration of mounting plates as shown in note. Rack-mount enclosures DO include grounding/strain relief, grommets, labels, 8 or 16 blank plastic mounting plates, and the appropriate number of cable management rings.

Note: For mounting plates and accessories. See pages L47-49.



## FEATURES

- Includes 8 (3RU) or 16 (6RU) plastic blank mounting plates to inexpensively fill up any unused locations.
- Houses up to 12 (3RU) or 24 (6RU) mounting plates for assorted fiber or multimedia applications. See chart on page L48.



# OPT-X® 1000 WALL-MOUNT FIBER OPTIC ENCLOSURES

Doors are L-shaped for maximum access to couplings through the open sidewall.

Door options:

- Split with single lock
- Split with two locks (custom option)
- Solid with single lock
- Solid without lock

Houses 2 (small), 4 (medium) or 12 mounting plates for assorted fiber or multimedia applications. See chart on page L47.

SEE FIBER DENSITY CHART, PAGE L48



Unique cable management ring is adjustable and stackable to simplify fiber loop installation, bend radius compliance, and future maintenance/additions. Stores 3 meters of 900 micron fiber per adapter.

Sidewall cutout gives completely unobstructed access to the mounting plates when door is open (covered when door is closed).



## Opt-X 1000 Small Wall-Mount Enclosures 8.0"H x 13.0"W x 3.5"D <sup>UL</sup>

| DESCRIPTION  | CAT. NO.  |
|--|-----------|
| Small, Empty with solid metal door, no lock, holds no splice trays         | 5W110-00N |
| Small, Empty with split metal door and one lock/key, holds no splice trays | 5W120-00N |
| Small, Empty with solid metal door and lock/key, holds no splice trays     | 5W170-00N |

## Opt-X 1000 Medium Wall-Mount Enclosures 14.0"H x 12.0"W x 5.25"D <sup>UL</sup>

| DESCRIPTION  | CAT. NO.  |
|--|-----------|
| Medium, Empty with solid metal door, no lock, holds 6 splice trays         | 5W310-00N |
| Medium, Empty with split metal door and one lock/key, holds 6 splice trays | 5W320-00N |
| Medium, Empty with solid metal door and one lock/key, holds 6 splice trays | 5W370-00N |



## Opt-X 1000 Large Wall-Mount Enclosures 17.0"H x 15.0"W x 5.25"D <sup>UL</sup>

| DESCRIPTION   | CAT. NO.  |
|---|-----------|
| Large, Empty with solid metal door, no lock, holds 6 splice trays         | 5W710-00N |
| Large, Empty with split metal door and one lock/key, holds 6 splice trays | 5W720-00N |
| Large, Empty with solid metal door and lock/key, holds 6 splice trays     | 5W770-00N |

## Add-On Lock and Key

| DESCRIPTION   | CAT. NO.  |
|---|-----------|
| Add security to an existing metal enclosure door. Simply remove the black plastic plug on the door front, and replace with lock mechanism. Lock and Key | 5L000-LOK |

**PLEASE NOTE:** All STOCK configurations of this wall-mount enclosure are sold 'empty,' or without any mounting plates installed. Capacity is dependent upon configuration of mounting plates shown on page L48. The wall-mount enclosures DO include grounding/strain relief, grommets, labels, and the appropriate number of cable management rings. Large Wall-Mount Enclosure includes 8 blank plastic mounting plates.

Note: For mounting plates and accessories. See page L48.



## Opt-X 500 1RU, 2RU and 3RU Fiber Optic Enclosures

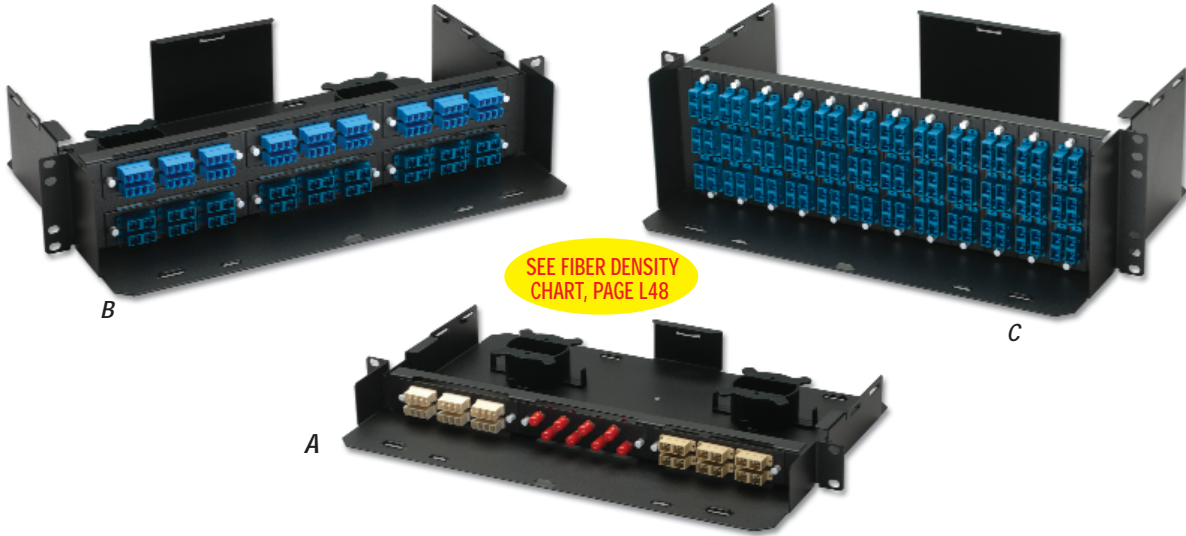

### Opt-X 500 Fiber Enclosures, 3 Rack Units High (3RU) 5.25"H x 19.0"W x 12.0"D

| DESCRIPTION                              | CAT. NO.  |
|--|-----------|
| [A] 1RU, empty with metal cover, no lock | 5R1UA-A03 |
| [B] 2RU, empty with metal cover, no lock | 5R2UA-A06 |
| [C] 3RU, empty with metal cover, no lock | 5R3UA-A12 |



1RU with cover



2RU with cover



3RU with cover

## Opt-X 250 1RU Fiber Optic Panel



### Opt-X 250 Fiber Panel 1.75"H x 19.0"W x 7.7"D

| DESCRIPTION                             | CAT. NO.  |
|---|-----------|
| 1RU, empty with no metal cover, no lock | 5R1UE-A03 |

#### SPECIFICATIONS AND FEATURES

##### Opt-X 500 Fiber Enclosure

- One-piece removable cover protects and conceals patch cords and allows for complete accessibility to the back of the enclosure.
- Mounting brackets allow for installation on any rack space.
- Stores 3 meters of 900 micron tight buffered fiber per adapter.
- Multiple bend radius and cable management features including 2 cable tie down features in front, and 4 in back, protect and organize cables.

##### Opt-X 250 Fiber Panel

- Perfect for small to medium installations with excellent flexibility at a competitive price.
- Utilizes minimum rack space while providing space for up to three (3) adapter plates or splice trays (more splice trays if no obstructions).
- Two fiber management rings easily attach to low profile mounting clips for customized positioning. Includes multiple bend radius and cable management features.
- Open back allows easy access and management in all directions.
- Mounting brackets allow panel to be installed on any rack space.



# FIBER OPTIC CABLE ASSEMBLIES

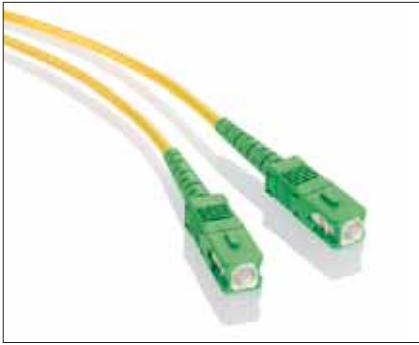

## Fiber Optic Cable Assemblies

Leviton offers an extensive line of high quality fiber optic cable assemblies, including laser optimized versions as well as pigtails for frame and workstation. Strenuously tested for return and insertion loss, and held to strict internal quality standards, these cable assemblies are developed to exceed TIA 568-B.3 standards.

Choose from standard & hybrid combinations of connectors, in single-mode and multimode, for cable assemblies and pigtails in ST, SC, FC, LC and MT-RJ styles. Laser optimized assemblies are available in a 50µm core style with a variety of connection configurations including combinations of MT-RJ, ST, SC and LC connectors and provide 10-gig performance for higher bandwidth requirements at greater distances.

We also provide custom lengths and configurations manufactured to your exact specifications—simply call customer service for more information. PLEASE NOTE: CUSTOM LENGTHS MAY REQUIRE A WAITING PERIOD. All cables are OFNR\* rated and meet all applicable TIA/EIA and industry standards.

\*OFNP-rated cables are available as a special order. See below.

## Configure Your Catalog Number

Fiber Optic Cable Assemblies, OFNR Rated — Configure your Catalog Number by following the key below



Examples: 50DSC-M05 = 50 micron Duplex SC-SC multimode connector – 5 meters

| Step 1                              |      | Step 2  |      | Step 3                        |      |               |      | Step 4   |      | Step 5            |                  |      |
|-------------------------------------|------|---|------|-------------------------------|------|---------------|------|--|------|-------------------|------------------|------|
| CORE STYLE/POLISH TYPE (AA)         |      | CABLE TYPE (B)  |      | CONNECTOR COMBINATIONS (CC)   |      |               |      | MODE (D)   |      | CABLE LENGTH (EE) |                  |      |
| <b>Multimode Core</b>               | Code | <b>Cable Type</b>   | Code | <b>Standard &amp; Pigtail</b> | Code | <b>Hybrid</b> | Code | <b>Mode Type</b>   | Code | <b>Length/m</b>   | <b>Length/ft</b> | Code |
| 50µm size                           | 50   | Simplex   | S    | MT-RJ-to-MT-RJ                | MJ   | SC-to-ST      | CT   | Single-mode  | S    | 1 meter           | 3.3'             | 01   |
| 62.5µm size                         | 62   | Duplex  | D    | ST-to-ST                      | ST   | SC-to-FC      | CF   | Multimode  | M    | 2 meters          | 6.6'             | 02   |
| 50µm laser optimized                | 5L   | Pigtail   | P    | SC-to-MT-RJ                   | CM   | ST-to-MT-RJ   | TM   | <i>Note: This will depend on selected Core Size/Polish as indicated in Step 1.</i>                                 |      |                   |                  |      |
| <b>Singlemode Core</b>              |      | <i>Note: MT-RJ is always duplex. Simplex and duplex cannot be combined.</i> |      | SC-to-SC                      | SC   | ST-to-FC      | TF   | 3 meters 9.8' 03   |      |                   |                  |      |
| UPC polish (ultra physical contact) | UP   |   |      | FC-to-FC                      | FC   | ST-to-LC      | CL   | 5 meters 16.4' 05  |      |                   |                  |      |
| APC polish (angle physical contact) | AP   |   |      | LC-to-LC                      | LC   | ST-to-LC      | TL   | 10 meters 32.8' 10   |      |                   |                  |      |
|                                     |      |   |      |                               |      | FC-to-LC      | FL   | <i>Note: Custom lengths available upon request. Call Customer Service at 1(800) 722-2082 for more information.</i> |      |                   |                  |      |
|                                     |      |   |      |                               |      | LC-to-MT-RJ   | ML   |  |      |                   |                  |      |

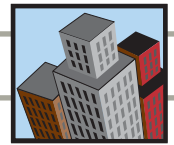

## OPT-X® Fiber Adapter Plates\*

| DESCRIPTION   | CAT. NO.  |
|---|-----------|
| [A] 6-Pack ST MM, (6-fiber) phos. bronze sleeve                                   | 5F100-1ST |
| 6-Pack ST SM, (6-fiber) zirconia ceramic sleeve                                   | 5F100-6ZT |
| [B] 8-Pack ST MM, (8-fiber) phos. bronze sleeve                                   | 5F100-8ST |
| 8-Pack ST SM, (8-fiber) zirconia ceramic sleeve                                   | 5F100-8ZT |
| 6-Pack FC MM, (6-fiber) phos. bronze sleeve                                       | 5F100-6PF |
| 6-Pack FC SM, (6-fiber) zirconia ceramic sleeve                                   | 5F100-6ZF |
| 8-Pack FC MM, (8-fiber) phos. bronze sleeve                                       | 5F100-8PF |
| 8-Pack FC SM, (8-fiber) zirconia ceramic sleeve                                   | 5F100-8ZF |
| [C] 3-Pack Duplex SC MM, (6-fiber) beige, phos. bronze sleeve                     | 5F100-3BC |
| [D] 3-Pack Duplex SC SM, (6-fiber) blue, phos. bronze sleeve                      | 5F100-3SC |
| [E] 3-Pack Duplex SC SM, (6-fiber) green, zirconia ceramic sleeve                 | 5F100-3CA |
| 3-Pack Duplex SC SM, (6-fiber) blue, zirconia ceramic sleeve                      | 5F100-3ZC |
| 3-Pack Duplex SC MM Laser Optimized, (6-fiber) aqua, zirconia ceramic sleeve      | 5F100-3AC |
| [F] 6-Pack Duplex SC MM, (12-fiber) beige, phos. bronze sleeve                    | 5F100-6BC |
| [G] 6-Pack Duplex SC SM, (12-fiber) blue, phos. bronze sleeve                     | 5F100-CSC |
| [H] 6-Pack Duplex SC MM laser optimized, (12-fiber) aqua, zirconia ceramic sleeve | 5F100-6AC |
| 6-Pack Duplex SC SM, (12-fiber) blue, zirconia ceramic sleeve                     | 5F100-6ZC |
| 6-Pack Duplex SC SM, (12-fiber) green, zirconia ceramic sleeve                    | 5F100-6CA |
| [I] 6-Pack MT-RJ MM, (12-fiber) beige, dual polarity                              | 5F100-6MC |
| [J] 12-Pack MT-RJ MM, (24-fiber) beige, dual polarity                             | 5F100-12M |
| [K] 6-Pack Duplex LC MM, (12-fiber) beige, phos. bronze sleeve                    | 5F100-12P |
| [L] 6-Pack Duplex LC SM, (12-fiber) blue, zirconia ceramic sleeve                 | 5F100-12Z |
| 6-Pack Duplex LC SM, (12-fiber) green, zirconia ceramic sleeve                    | 5F100-12V |
| [M] 6-Pack Duplex LC MM laser optimized, (12-fiber) aqua, zirconia ceramic sleeve | 5F100-12A |
| [N] 6-Pack Quad LC MM, (24-fiber) beige, phos. bronze sleeve                      | 5F100-24P |
| [O] 6-Pack Quad LC SM, (24-fiber) blue, zirconia ceramic sleeve                   | 5F100-24Z |
| [P] 6-Pack Quad LC MM, (24-fiber) laser optimized aqua, zirconia ceramic sleeve   | 5F100-24A |
| [Q] Blank, metal  | 5F100-BLK |
| Blank, plastic  | 5F100-BPP |

\*NOTE: Not for use with LightSpace™ Enclosures.

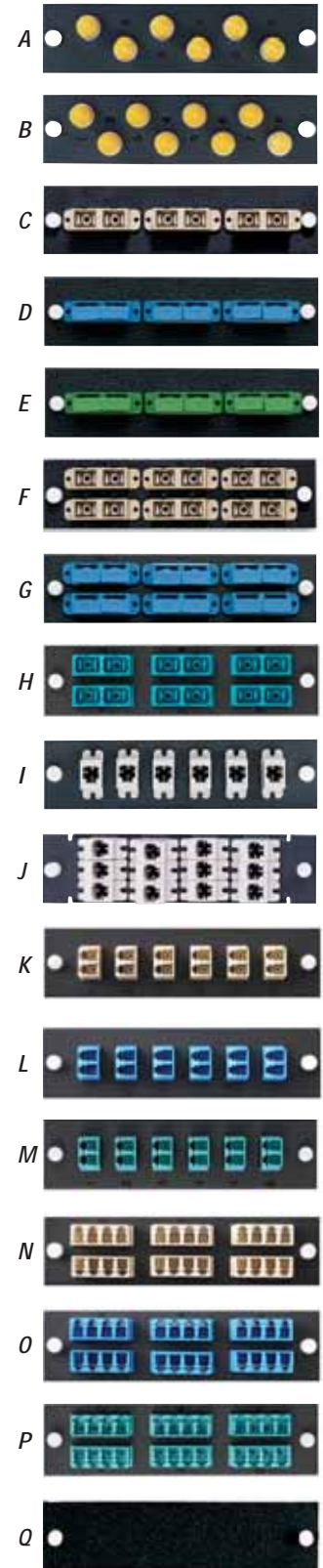

3-pack, 6-pack, 8-pack, 12-pack = capacity of up to 3, 6, 8 or 12 connectors, respectively.

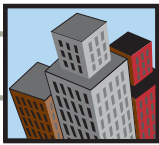

## Fiber Density Chart

### Styles

#### RACK MOUNT DENSITY

##### Low Profile 1RU

*Holds 1 Bulkhead w/or w/o 3 Mounting Plates*

- 6-pack ST = up to 18 Fibers
- 8-pack ST = up to 24 Fibers
- 6-pack FC = up to 18 Fibers
- 8-pack FC = up to 24 Fibers
- 3-pack Duplex SC = up to 18 Fibers
- 6-pack Duplex SC = up to 24 Fibers
- 6-pack MT-RJ = up to 36 Fibers
- 12-pack MT-RJ = up to 72 Fibers

##### 2RU Holds up to 6 Mounting Plates

- 6-pack ST = up to 36 Fibers
- 8-pack ST = up to 48 Fibers
- 6-pack FC = up to 36 Fibers
- 8-pack FC = up to 48 Fibers
- 3-pack Duplex SC = up to 36 Fibers
- 6-pack Duplex SC = up to 72 Fibers
- 6-pack MT-RJ = up to 72 Fibers
- 12-pack MT-RJ = up to 144 Fibers

##### 3RU Holds up to 12 Mounting Plates

- 6-pack ST = up to 72 Fibers
- 8-pack ST = up to 96 Fibers
- 6-pack FC = up to 72 Fibers
- 8-pack FC = up to 96 Fibers
- 3-pack Duplex SC = up to 72 Fibers
- 6-pack Duplex SC = up to 144 Fibers
- 6-pack MT-RJ = up to 144 Fibers
- 12-pack MT-RJ = up to 288 Fibers

##### 6RU Holds up to 24 Mounting Plates

- 6-pack ST = up to 144 Fibers
- 8-pack ST = up to 192 Fibers
- 6-pack FC = up to 144 Fibers
- 8-pack FC = up to 192 Fibers
- 3-pack Duplex SC = up to 144 Fibers
- 6-pack Duplex SC = up to 288 Fibers
- 6-pack MT-RJ = up to 288 Fibers
- 12-pack MT-RJ = up to 576 Fibers

#### WALL MOUNT DENSITY

##### Small Holds up to 2 Mounting Plates

- 6-pack ST = up to 12 Fibers
- 8-pack ST = up to 16 Fibers
- 6-pack FC = up to 12 Fibers
- 8-pack FC = up to 16 Fibers
- 3-pack Duplex SC = up to 12 Fibers
- 6-pack Duplex SC = up to 24 Fibers
- 6-pack MT-RJ = up to 24 Fibers
- 12-pack MT-RJ = up to 48 Fibers

##### Medium Holds up to 4 Mounting Plates

- 6-pack ST = up to 24 Fibers
- 8-pack ST = up to 32 Fibers
- 6-pack FC = up to 24 Fibers
- 8-pack FC = up to 32 Fibers
- 3-pack Duplex SC = up to 24 Fibers
- 6-pack Duplex SC = up to 48 Fibers
- 6-pack MT-RJ = up to 48 Fibers
- 12-pack MT-RJ = up to 96 Fibers

##### Large Holds up to 12 Mounting Plates

- 6-pack ST = up to 72 Fibers
- 8-pack ST = up to 96 Fibers
- 6-pack FC = up to 72 Fibers
- 8-pack FC = up to 96 Fibers
- 3-pack Duplex SC = up to 72 Fibers
- 6-pack Duplex SC = up to 144 Fibers
- 6-pack MT-RJ = up to 144 Fibers
- 12-pack MT-RJ = up to 288 Fibers





## Fiber Adapters

| DESCRIPTION  | CAT. NO.  |
|--|-----------|
| [A] ST® Adapter MM w/Phosphor Bronze Sleeve                  | 49882-SAD |
| [B] ST Adapter SM w/Zirconia Sleeve                          | 49882-ZAD |
| [C] FC Adapter SM w/Phosphor Bronze Sleeve                   | 49883-SAD |
| [D] FC Adapter MM w/Zirconia Sleeve                          | 49883-MAD |
| [E] SC Duplex Adapter SM (blue) w/Zirconia Sleeve            | 49884-SAD |
| SC Duplex Adapter SM (blue) w/Phosphor Bronze Sleeve         | 49884-MAD |
| [F] SC Duplex Adapter MM (beige) w/Phosphor Bronze Sleeve    | 49884-BAD |
| [G] SC Duplex Adapter MM aqua, zirconia ceramic sleeve       | 49884-AAD |
| [H] SC Simplex Adapter SM blue, zirconia ceramic sleeve      | 49884-SAS |
| [I] SC Simplex Adapter MM beige, phos. Bronze sleeve         | 49884-MAS |
| [J] SC Simplex Adapter SM APC green, zirconia ceramic sleeve | 49884-VAS |
| [K] MT-RJ Adapter MM (beige)                                 | 49889-MAD |
| [L] Quad LC Adapter MM (aqua)                                | 5F100-QLA |
| [M] Quad LC Adapter MM (beige)                               | 5F100-QLC |
| [N] Quad LC Adapter SM (blue)                                | 5F100-QLZ |
| [O] Duplex LC Adapter MM (beige)                             | 5F100-DLC |
| [P] Duplex LC Adapter SM (blue)                              | 5F100-DLZ |
| [Q] LC Duplex Adapter MM aqua, zirconia ceramic sleeve       | 5F100-DLA |
| LC Simplex Adapter MM green, zirconia ceramic sleeve         | 5F100-DLV |



A-D

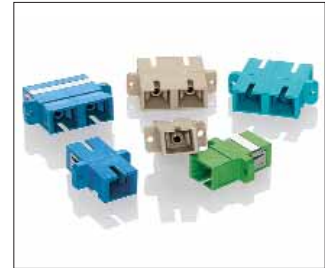

E-J



K-Q

## FIBER OPTIC FAN-OUT KIT

**R** Protect your bare fiber and prepare loose-tube cable for direct termination to connectors with these simple 6- or 12-strand kits. Available in 24" or 36" lengths. Kits separate 250 µm fibers and route them into color-coded 900 µm buffer tubes. No proprietary tools required. Can be used with any manufacturers loose-tube cabling, and any industry standard connectors.

### Fiber Optic Fan-Out Kit

| DESCRIPTION                              | CAT. NO.  |
|--|-----------|
| [R] 24" Fiber Optic Fan-Out Kit, 6-fiber | 49887-06S |
| 24" Fiber Optic Fan-Out Kit, 12-fiber    | 49887-12S |
| 36" Fiber Optic Fan-Out Kit, 6-fiber     | 49887-06L |
| 36" Fiber Optic Fan-Out Kit, 12-fiber    | 49887-12L |

## FIBER OPTIC FAN-OUT CONSUMABLES KIT

**S** Leviton's Fan-Out Consumables Kit contains everything to properly terminate at least 10 Fiber Optic Fan-Out Kits, including lint-free wipes, alcohol pads, d'Gel™ packets, sealant, and talc powder

### Fiber Optic Fan-Out Consumables Kit

| DESCRIPTION                 | CAT. NO.  |
|-----------------------------|-----------|
| [S] Fan-Out Consumables Kit | 49800-FAN |



R

## SPLICE TRAY KITS

### Splice Tray Kits

| DESCRIPTION   | CAT. NO.  |
|---|-----------|
| 12-splice Splice Tray Kit<br>(Comes standard with Fusion/Heatshrink splice holders) | 5T000-00T |

## EXTRA CABLE MANAGEMENT RINGS

### Extra Cable Management Rings

| DESCRIPTION   | CAT. NO.  |
|---|-----------|
| Additional Fiber Cable Management Rings (package of 2)—<br>Can be stacked on top of existing rings for additional<br>cable storage or management. | 5R100-0FR |



S



# ACTIVE ZONE CABLING



## Telecommunications Enclosures for Active Zone Cabling

Leviton's telecommunications enclosures add flexibility and manageability to cabling infrastructure. Active ceiling enclosures install flush with the drop ceiling for a clean, unobtrusive look. Recessed panels in doors may be fitted with a ceiling tile. Fully hinged, drop down doors support installed equipment and open to face the technician for safe, easy access. Manufactured of aluminum, all ceiling enclosures are plenum rated and include two edge-protected cable access ports with fire rated foam sealing kits.

Fiber Components



### 2' x 2' Active Ceiling Enclosure

**A** Accommodates one removable assembly with total 2RU of active electronics and up to 5RU (2U+1U+2U) of 19" rack-mount patch panels and wire management. Units are AC Power ready and include a 9 CFM fan with transformer capable of providing more than 100 air changes per hour. UL Listed.

**2' x 2' Active Ceiling Enclosure** 12.0"H x 24.0"W x 24.0"L

| DESCRIPTION                           | CAT. NO.  |
|---------------------------------------|-----------|
| [A] Active Ceiling Enclosure, 2' x 2' | Z1000-AC2 |



### 2' x 4' Active Ceiling Enclosure

**B** For hubs, switches and patch panels in high density areas, these enclosures house two removable rack-mount assemblies each with 4RU (total 8RU) of mounting space for active components and up to 10RU divided (2U+1U+2U) of 19" rack-mount patch panels and wire management. Units are AC Power ready and include a 9 CFM fan with transformer capable of providing more than 100 air changes per hour. UL listed.

**2' x 4' Active Ceiling Enclosure** 12.0"H x 24.0"W x 48.0"L

| DESCRIPTION                           | CAT. NO.  |
|---------------------------------------|-----------|
| [B] Active Ceiling Enclosure, 2' x 4' | Z1000-AC4 |

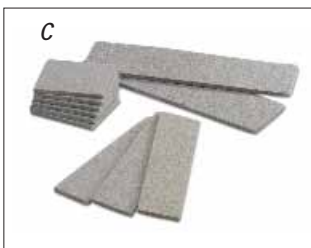

## Accessories

### Enclosure Accessories

| DESCRIPTION                              | CAT. NO.  |
|--|-----------|
| [C] Foam kit for zone ceiling enclosures | Z1000-FM1 |
| Chrome Lock Kit                          | Z1000-LOK |
| Replacement Keys (2)                     | Z1000-KEY |



### Telecommunications Enclosures for Passive Zone Cabling

These easy-to-install enclosures provide flexible consolidation point placement in the floor or ceiling. Manufactured of aluminum, enclosures are plenum rated and include fire-rated foam sealing kits.

#### 2' x 2' Passive Ceiling Enclosure

**A** For consolidation points within the ceiling, these enclosures accommodate up to 5RU (2U+1U+2U) of 19" rack-mount patch panels and or wire management. Enclosures install flush with the drop ceiling and recessed panels in doors may be fitted with a ceiling tile for a clean, unobtrusive look. Fully hinged, drop down doors support installed equipment and open to face the technician for safe, easy access. UL listed.

#### 2' x 2' Passive Ceiling Enclosure

| DESCRIPTION                            | CAT. NO.  |
|--|-----------|
| [A] Passive Ceiling Enclosure, 2' x 2' | Z1000-PC2 |



#### 2' x 2' Passive Raised Floor Enclosure

For consolidation points in air handling spaces under 8" deep raised floors, this enclosure holds two 4RU (8U total) racks to accommodate any combination of standard 19" rack-mountable patch panels or wire management. Rotating patch panel mounting locations provide easy access to rear of patch panels for easy terminations. UL listed.

#### 2' x 2' Passive Raised Floor Enclosure

| DESCRIPTION                              | CAT. NO.  |
|--|-----------|
| Passive Raised Floor Enclosure, 8" depth | Z1000-PF2 |



## WIRELESS ACCESS POINT ENCLOSURES



A

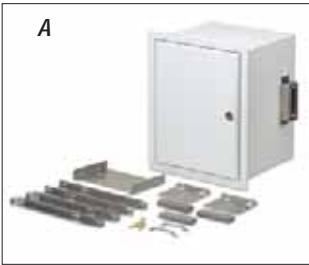

### Wireless Access Point Enclosures

#### WIRELESS ACCESS POINT CEILING ENCLOSURES, 10" AND 5"

**A-B** Mount these enclosures into standard 2' x 2' ceiling tiles for a clean look and easy access. Each unit is designed to house a variety of wireless access points. Single edge-protected access port includes a fire-rated foam sealing kit, making it suitable for air handling spaces. Doors are fully hinged and lockable. The enclosure is painted white to blend with ceiling tiles. Multiple door faceplates, including a blank one, are sold separately to accommodate a variety of wireless equipment. UL listed.

B



#### WIRELESS ACCESS POINT CEILING ENCLOSURE, 4" DEEP

**C** This ceiling mount enclosure accommodates one wireless access point or bridge. The removable door mounted bracket supports equipment up to 10<sup>1</sup>/<sub>2</sub>" wide by 5<sup>1</sup>/<sub>2</sub>" deep by 1<sup>7</sup>/<sub>8</sub>" high. Fully hinged door is lockable for security and is stamped with two obround holes centered 5" apart allowing antennas to extend below the drop ceiling. UL listed.

#### Wireless Access Point Ceiling Enclosures

| DESCRIPTION   | CAT. NO.  |
|---|-----------|
| [A] Wireless Access Point Ceiling Enclosure, 10" Depth, w/o Faceplate | W1000-WCE |
| [B] Wireless Access Point Ceiling Enclosure, 5" Depth, w/o Faceplate  | W1000-WC5 |
| [C] Wireless Access Point Ceiling Enclosure, 4" Depth                 | W1000-WC0 |

C



### Faceplates

#### Wireless Access Point Ceiling Enclosure Faceplates

| DESCRIPTION  | CAT. NO.  |
|--|-----------|
| Blank Faceplate (Fits 10" Wireless Access Point Enclosure)                         | W1000-F01 |
| Faceplate for Cisco Aironet™ 350 (Fits 5" and 10" Wireless Access Point Enclosure) | W1000-F02 |
| Faceplate for Cisco Aironet 1100 (Fits 5" and 10" Wireless Access Point Enclosure) | W1000-F03 |
| Faceplate for Cisco Aironet 1200 (Fits 5" and 10" Wireless Access Point Enclosure) | W1000-F04 |
| [D] Faceplate for Leviton AP200 Wireless Access Point w/mounting bracket           | W1000-WC5 |

D

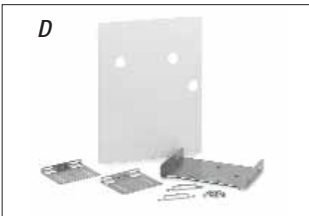

#### WIRELESS ACCESS POINT WALL-MOUNT ENCLOSURE

**E** Constructed of rugged steel with a lock assembly these enclosures are perfect for areas where there is limited floor or ceiling space and a need for security. Inside space accommodates a Cisco® Aironet® 350 or equivalent equipment sized 9" wide by 6<sup>1</sup>/<sub>2</sub>" high by 2<sup>3</sup>/<sub>4</sub>" deep. UL listed.

#### Wireless Access Point Wall-Mount Enclosure

| DESCRIPTION                                    | CAT. NO.  |
|--|-----------|
| [E] Wireless Access Point Wall-Mount Enclosure | W1000-WWO |

E





## Versi-Duct Slotted Duct Cable Management System

Leviton's unique Versi-Duct Slotted Duct System provides a versatile simple solution for fiber and copper cable organization and management. The horizontal duct is available in both one rack (1RU-1.75") or two-rack (2RU-3.5") unit sizes to accommodate both small and large cable systems. Vertical slotted ducts come in a 35" half or 80" full rack height version. Both the horizontal and vertical slotted ducts come in Front Only or Front & Back configurations with cable-concealing covers and an assortment of accessories. Versi-Duct is the ideal system for efficient, adaptable rack and frame cable management.

### Versi-Duct Slotted Duct Cable Management Systems

| DESCRIPTION                                     | CAT. NO.  |
|---|-----------|
| [A] Vertical Front & Rear Duct, 80" high        | 4980L-VFR |
| [B] Vertical Front-only Duct, 80" high          | 4980L-VFO |
| [C] Vertical Front & Rear Duct, 35" high        | 4935L-VFR |
| [D] Vertical Front-only Duct, 35" high          | 4935L-VFO |
| [E] Horizontal Front & Rear Duct, 2RU           | 492RU-HFR |
| [F] Horizontal Front & Rear Duct, 1RU           | 491RU-HFR |
| [G] Horizontal Front-only Duct, 2RU             | 492RU-HFO |
| [H] Horizontal Front-only Duct, 1RU             | 491RU-HFO |
| [I] Vertical Channel Divider                    | 49265-DV1 |
| [J] Slack Loop Storage Organizer, extended (2") | 49265-SL2 |
| [K] Bend-radius Compliant Funnel, rear only     | 49265-FN4 |
| [L] Duct Cover Hinge, 4 per package             | 49265-HNG |
| [M] Extended Cover, Front-only 2RU              | 49265-EX3 |
| [N] Extended Cover, Front-only 1RU              | 49265-EX1 |
| [O] Slack Loop Storage Organizer                | 49265-SL1 |
| [P] Cable Retainer                              | 49265-WR1 |
| [Q] Mounting Bracket, 2 per package             | 49265-BRK |

### FEATURES

#### Versi-Duct

- Versatile accessories solve a variety of cable management challenges
- Suitable for copper and fiber applications
- Slack loop control feature
- Helps maintain proper cable bend radii
- Offered in Front & Back and Front Only versions (for both vertical and horizontal ducts)
- Horizontal Duct offered in 1RU (1.75") and 2RU (3.50") sizes
- Horizontal Duct offered in 35" and 80" lengths
- Cable concealing covers with optional hinges



# RACK AND FRAME CABLE MANAGEMENT

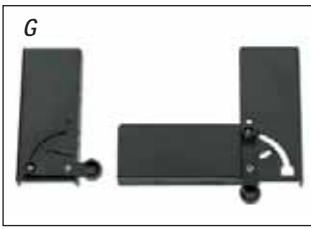

## Horizontal Cable Management

Create a first class cabling infrastructure and reduce network administration time using Leviton's Horizontal Cable Management System. Options include cable management bars, patch cord organizers, slack organizers, and the patent-pending Front Hinge Bracket.

### Cable Management Bars

| DESCRIPTION                                 | HEIGHT | RINGS | CAT NO.   |
|---|--------|-------|-----------|
| [A] Rear Cable Manager for Active Equipment | 2RU    |       | 41188-SM2 |
| [B] Extended Cable Management Bar           |        |       | 49005-EMB |
| [C] Cable Management Bar                    |        |       | 49005-CMB |
| [D] High Density Cable Management Bar       |        |       | 49005-DMB |

### Horizontal Patch Cord Organizers

| DESCRIPTION  | HEIGHT | RINGS | CAT NO.   |
|--|--------|-------|-----------|
| [E] Horizontal Patch Cord Organizer                  | 2RU    | 2"    | 49253-2CM |
| Horizontal Patch Cord Organizer                      | 2RU    | 4"    | 49253-BCM |
| Horizontal Patch Cord Organizer                      | 1RU    | 4"    | 49253-LPM |
| [F] Horizontal Patch Cord Organizer                  | 4RU    | 5"    | 49253-4CM |
| Horizontal Patch Cord Organizer                      | 4RU    | 7"    | 49253-6CM |
| Horizontal Patch Cord Organizer (Angled)             | 1RU    | 2"    | 4W254-LPM |
| Horizontal Patch Cord Organizer (Angled)             | 2RU    | 2"    | 4W254-BCM |
| Horizontal Patch Cord Organizer (w/ metal cover)     | 1RU    | 4"    | 4925C-LPM |
| [G] Horizontal Patch Cord Organizer (w/ metal cover) | 2RU    | 4"    | 4925C-BCM |
| Horizontal Patch Cord Organizer (w/ metal cover)     | 4RU    | 5"    | 4925C-4CM |
| Horizontal Patch Cord Organizer (w/ metal cover)     | 4RU    | 7"    | 4925C-6CM |

### Front Hinge Bracket

| DESCRIPTION             | HEIGHT | RINGS | CAT NO.   |
|-------------------------|--------|-------|-----------|
| [H] Front Hinge Bracket | 3RU    |       | 49400-FHB |

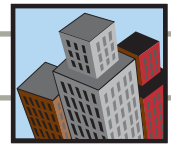

## Rack Cable Management and Accessories

### CORD ORGANIZERS

Two-Position Cord Organizer combines horizontal and vertical distribution rings with individual routing clips for patch cord organization between patch panels. One-Position Cord Organizer is 1RU with vertical distribution rings and individual routing clips.

#### Cord Organizers

| DESCRIPTION                                      | CAT. NO.  |
|--|-----------|
| [A] Two-Position Organizer Panel (19" wide, 2RU) | 49252-P02 |
| [B] One-Position Organizer Panel (19" wide, 1RU) | 49252-P01 |

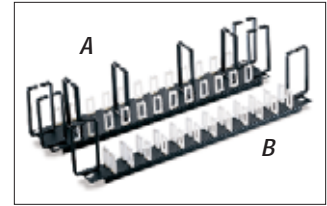

### COMBO FRONT/REAR MANAGEMENT

Manage front and rear cables/cords in a 2RU standard rack space. Oversized front rings meet larger-capacity requirements for patch cords. Rear management maintains bend radius of cables routed from vertical channels. Retention rings and fixed anchor points for 'loose-fit' or tie-wrapped bundles.

#### Combo Front/Rear Management

| DESCRIPTION                                  | CAT. NO.  |
|--|-----------|
| [C] Combo Front/Rear Manager (19" wide, 2RU) | 49252-PCM |



### RECLOSEABLE CABLE BARS

Manage cable vertically and horizontally on relay racks and cabinets. 19" metal-clad horizontal bar with attached loops (Hook and Loop-Style) screws into rack to manage cables horizontally.

#### Recloseable Cable Bars

| DESCRIPTION  | CAT. NO. 3RU |
|--|--------------|
| [D] Metal Clad Horizontal Bar (for 19" Racks, 1RU) | 41150-019    |



### THE WRAP BAR

Mounts to the rear of standard TIA/EIA racks to support cable bundles and help maintain bend radius near cable terminations. Fixed anchor points for 'loose-fit' tie wrapped cables.

#### The Wrap Bar

| DESCRIPTION                                       | CAT. NO.  |
|---|-----------|
| [E] Tie Wrap Bar (19" wide, 1.0" high, 1.5" deep) | 49258-TWB |



### SPACEMAKER CABLE MANAGER

Mounts to front or rear of standard TIA/EIA racks to support cable bundles and help maintain bend radius. Allows retrofit of current configurations without the need to move existing patch panels. Using existing panel screws, simply loosen screws, slide in SpaceMaker, and re-tighten screws.

#### Spacemaker Cable Manager

| DESCRIPTION  | CAT. NO.  |
|--|-----------|
| [F] SpaceMaker Cable Manager (19" wide, 1RU, 2RU, 3RU) | 41188-SM1 |



### VERTICAL MANAGEMENT COMPONENTS

Flexible front and rear vertical management. "Open-ring" system can be changed as needed for total customization and on-site adaptability. An optional tie bracket and divider panel can be added to provide cord and cable separation between racks.

#### Vertical Management Components

| DESCRIPTION   | CAT. NO.  |
|---|-----------|
| [G] 3" Vertical Manager Ring (4-pair cable capacity: 180 rear, 250 front) | 49260-MR3 |
| [H] 6" Vertical Manager Ring (4-pair cable capacity: 360 rear, 500 front) | 49260-MR6 |
| [I] Tie Bracket to secure vertical manager ring to adjacent rack          | 49261-BKT |

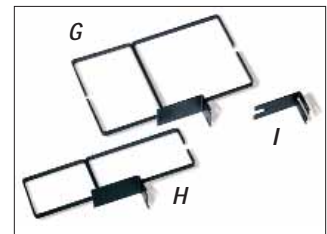



# RACK AND FRAME CABLE MANAGEMENT

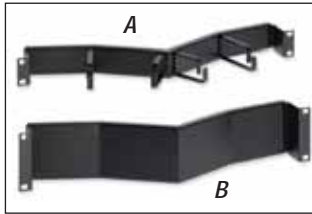

## Angled Panel Cable Management

Angled panels and accessories provide improved access to 110 punch down fields and allow the option to increase rack density. Angled Cable Management Accessories, suitable for Category 5e, 6, or 10G Angled Patch Panels, provide enhanced cable management and organization via the Angled Cable Management Bar, Vertical Transition Rings, 1RU and 2RU Angled Blank Panel Inserts, and Transitional Covers. Recessed Angled and Angled styles available.

### RECLOSABLE TIE-WRAPS

A Hook & Loop tie-wrap that easily reopens for moves, adds and changes, this general purpose Hook & Loop strap is available in 5", 8" and 12" lengths 1/2" wide.

### Recessed Angled Panel Cable Management Accessories

| DESCRIPTION   | CAT. NO.  |
|---|-----------|
| [A] Recessed Angled Horizontal Patch Cord Organizer, 1RU                            | 4W254-LPM |
| Recessed Angled Horizontal Patch Cord Organizer, 2RU                                | 4W254-BCM |
| 1RU Recessed Angled Blank Panel Inserts   | 4W254-BA1 |
| [B] 2RU Recessed Angled Blank Panel Inserts   | 4W254-BA2 |
| [C] Recessed Angled Cable Management Bar, rear (4 hook and loop fasteners included) | 4W006-AMB |
| [D] Recessed Angled Transitional Cover  | 4W254-BC1 |
| Vertical Transition Rings (Horizontal Cable Ring), 2/box                            | 49262-HR1 |

### Angled Panel Cable Management Accessories

| DESCRIPTION  | CAT. NO.  |
|--|-----------|
| Angled Horizontal Patch Cord Organizer, 1RU                                | 49254-LPM |
| Angled Horizontal Patch Cord Organizer, 2RU                                | 49254-BCM |
| [E] 1RU Angled Blank Panel Inserts   | 49254-BA1 |
| [F] 2RU Angled Blank Panel Inserts   | 49254-BA2 |
| [G] Angled Cable Management Bar, rear (4 hook and loop fasteners included) | 49006-AMB |
| [H] Angled Transitional Cover  | 49254-BC1 |
| Vertical Transition Ring (Horizontal Cable Ring), 2/box                    | 49262-HR1 |



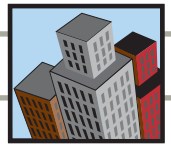

## Rack Cable Management and Accessories

### RACK AND PANEL ACCESSORIES

The Hinged Wall-Mount Bracket is designed for use in installations where space is constrained or racks are not used. Available in 2RU, 3RU, and 4RU sizes.

Blank Panels provide a seamless look until additional rack space is needed for future expansion.

### Rack and Panel Accessories

| DESCRIPTION                          | CAT. NO.  |
|--------------------------------------|-----------|
| [A] Hinged Wall-Mount Bracket, 2RU   | 49251-W62 |
| Hinged Wall-Mount Bracket, 3RU       | 49251-W63 |
| Hinged Wall-Mount Bracket, 4RU       | 49251-W64 |
| [B] Front Blank Panel, Standard, 4RU | 49254-BP4 |
| [C] Front Blank Panel, Standard, 2RU | 49254-BP2 |
| [D] Front Blank Panel, Standard, 1RU | 49254-BP1 |

### 110 CHANNELMAX® SYSTEM

Route and manage cables and cross connect wires in 110-style installations with the 110 ChannelMax System. 3" and 5" Cable Channels, provide two to three times the space of typical 110 blocks with legs, and the non-proprietary design works with all standard 110 blocks. Vertical Spool Managers and Horizontal Cable Management Troughs organize and support cables while allowing easy access for re-configuration. Vertical Spool Manager works with Wire Distribution Spools, PN 40054-DSS, sold separately.

### 110 ChannelMax® System

| DESCRIPTION                                 | CAT. NO.  |
|---|-----------|
| [E] Horizontal Cable Management Trough      | 41CMS-HCM |
| [F] Vertical Spool Manager Mounting Bracket | 41CMS-VSM |
| [G] 5" Deep Vertical Cable Channel          | 41CMS-500 |
| [H] 3" Deep Vertical Cable Channel          | 41CMS-300 |
| Wire Management Spools                      | 40054-DSS |

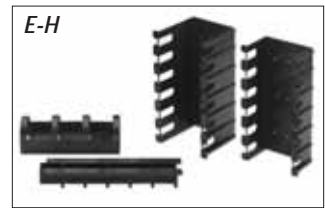



# HOOK AND LOOP CABLE MANAGEMENT



## General Purpose Hook and Loop Cable Management

Whatever your cable management needs, Leviton has a Hook and Loop product to keep your cable under wraps. These innovative solutions are perfect for the messy cables that accumulate around the workstation.

### Recloseable Saddle Ties

| DESCRIPTION  | CAT NO.   |
|--|-----------|
| [A] Recloseable Saddle Tie with 10/32 metal rack screw (10 per pack) | 41020-SPR |
| [B] Recloseable Saddle Tie with #8 wood screw (10 per pack)          | 41010-SPW |

### Recloseable Compression Strap

| DESCRIPTION                       | CAT NO.   |
|-----------------------------------|-----------|
| [C] Recloseable Compression Strap | 45224-RCS |

### Recloseable "J" Hook

| DESCRIPTION              | CAT NO.   |
|--------------------------|-----------|
| [D] Recloseable "J" Hook | 46700-SLG |

### Bulk Hook and Loop Wrap

| DESCRIPTION                               | CAT NO.   |
|---|-----------|
| [E] Bulk Hook and Loop Wrap, 75 Foot Roll | 43115-075 |
| [F] Bulk Hook and Loop Wrap, 15 Foot Roll | 43115-015 |

### Recloseable Tie-Wraps

| DESCRIPTION                            | CAT NO.   |
|--|-----------|
| [G] Tie Wrap, 5" Length (25 per pack)  | 43105-005 |
| [H] Tie Wrap, 8" Length (25 per pack)  | 43108-008 |
| [I] Tie Wrap, 12" Length (25 per pack) | 43112-012 |

### Hook and Loop Workstation Cable Management

| DESCRIPTION   | CAT NO.   |
|---|-----------|
| [J] Individual Loops with Peel-off Adhesive (25 per pack) | 41225-SAP |

### Recloseable Fastener

| DESCRIPTION                                      | CAT NO.   |
|--|-----------|
| [K] Recloseable Fasteners (orange) (10 per pack) | 41030-OFT |

### Recloseable Storage Rings

| DESCRIPTION  | CAT NO.   |
|--|-----------|
| [L] Recloseable Storage Ring, Inside Plant (11.75" diameter) | 48900-IFR |
| Recloseable Storage Ring, Outside Plant (24" diameter)       | 48900-OFR |

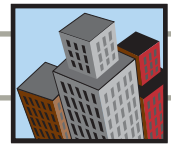

## LableWare

LabelWare is the perfect tool to create TIA/EIA-606-A compliant labels for cabling infrastructure components. Laser print surface on pre-cut, perforated 8.5" x 11" sheets provides simple application with permanent legibility. User-friendly software includes label templates designed specifically for Leviton patch panels, patch cords, 110 wiring products and wallplates. The context sensitive Help Module includes step-by-step instructions to easily create and customize complex label builds in minutes. The Build Editor allows integration of fonts and symbols from your word processing software. Download LabelWare software at [www.levitonvoicedata.com/labelware](http://www.levitonvoicedata.com/labelware).

### Cable and Wallplate Product Labels

| DESCRIPTION   | CAT. NO.  |
|---|-----------|
| [A] Cable Wrap-around Labels (8mm), 48 self-adhesive labels per sheet             | 59260-00W |
| [B] Wallplate & Housing Labels, 10 sheets, 80 card-stock labels per sheet (white) | 59259-C0W |
| [C] Port Labels, 10 sheets, 324 self-adhesive labels per sheet (clear)            | 59259-ACL |

### Patch Panel and 110 Wiring Product Labels

| DESCRIPTION  | CAT. NO.<br>WHITE | CAT. NO.<br>PUR/YEL | CAT. NO.<br>BLU/GRY | CAT. NO.<br>RED/ORG | CAT. NO.<br>GRE/BRN |
|--|-------------------|---------------------|---------------------|---------------------|---------------------|
| [D] 110 Wiring Product Labels, 10 sheets, 16 labels/sheet              | 59258-00W         | 59258-0PY           | 59258-0LG           | 59258-0RO           | 59258-0VB           |
| [E] Patch Panel and Block Labels, 10 sheets, 40 labels/sheet           | 59256-00W         | 59256-0PY           | 59256-0LG           | 59256-0RO           | 59256-0VB           |
| [F] QuickPort Patch Panel and Block Labels, 10 sheets, 40 labels/sheet | 59257-00W         | 59257-0PY           | 59257-0LG           | 59257-0RO           | 59257-0VB           |

### TIA/EIA-606-A Color Code Chart

| TERMINATION TYPE    | TYPICAL APPLICATION                                | COLOR  |
|---------------------|--|--------|
| Demarcation Point   | Central office connection                          | Orange |
| Network Connections | User side of central office connection             | Green  |
| Common Equipment    | Connections to PBX, mainframe, LAN, multiplexer    | Purple |
| 1st Level Backbone  | Terminations of building backbone cable MCs to ICs | White  |
| 2nd Level Backbone  | Terminations of building backbone cable ICs to HCs | Gray   |
| Horizontal Cabling  | Terminations of horizontal cable in TEs            | Blue   |
| Campus Backbone     | Termination of backbone cable between buildings    | Brown  |
| Auxiliary Circuits  | Alarms, security, or energy management             | Yellow |
| Key Circuits        | Connections to key telephone systems               | Red    |

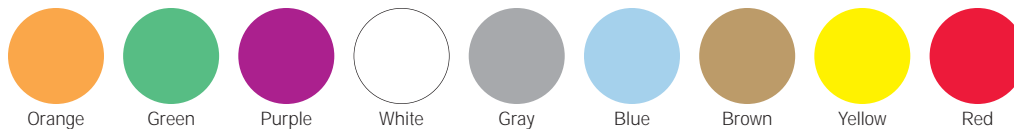



# LABELING ACCESSORIES



## QuickPort® Shutters and Icons

Leviton's field-installable QuickPort Shutters protect connectors from dust and debris with a unique, one-piece hinged door. Suitable for commercial and residential applications. Shutters feature labels and recessed windows and fit on Leviton Category 6, 5e, 5, and 3 and 8-Position Voice Grade connectors, when used in a QuickPort wallplate or housing. Optional label kits are available. *NOTE: SHUTTERS DO NOT WORK WITH CONNECTOR INTERFACE BEZELS.*

### QuickPort Shutters and Icons

| DESCRIPTION  | CAT. NO.  |
|--|-----------|
| [A] QuickPort Shutter Kit w/Leviton logo and miscellaneous icons | 51084-ICN |
| Accessory Kit w/pre-printed icons on white paper                 | 51084-XLB |
| [B] Color Label Kit w/pre-printed icons on colored paper*        | 51084-CLB |



## Patch Panel and Port Accessories

### Patch Panel Port Identification Kits

| DESCRIPTION   | CAT. NO.  |
|---|-----------|
| [C] QuickPort 32-port ID kit (for 24- and 32-port panels)                   | 49257-QID |
| [C] QuickPort High Density ID kit (for 24- and 48-port high density panels) | 49257-QHD |



### PRE-PRINTED PORT DESIGNATION LABELS

[D] Identify ports on any QuickPort Housings with these attractive and versatile jack designation labels. Printed on clear self-adhesive backing. Commercial or residential labels available.

### Port Designation Labels

| DESCRIPTION   | CAT. NO.  | CAT. NO.  |
|---|-----------|-----------|
|   | BLACK INK | WHITE INK |
| Commercial Labels—10 sheets per kit, 94 labels per sheet  | 41080-LEB | 41080-LWB |
| Residential Labels—10 sheets per kit, 94 labels per sheet | 40740-OBE | _____     |

|          |          |         |         |
|----------|----------|---------|---------|
| VOICE 1  | VOICE 1  | VOICE   | VOICE   |
| VOICE 1  | VOICE 1  | DATA    | DATA    |
| VOICE 2  | VOICE 2  | FAX     | FAX     |
| VOICE 2  | VOICE 2  | PRINTER | PRINTER |
| VOICE 3  | VOICE 3  | SPARE   | SPARE   |
| VOICE 4  | VOICE 4  |         |         |
| DATA 1   | DATA 1   |         |         |
| DATA 1   | DATA 1   |         |         |
| DATA 2   | DATA 2   |         |         |
| DATA 2   | DATA 2   | 1       | 1       |
| DATA 3   | DATA 3   | 1       | 1       |
| DATA 3   | DATA 3   | 2       | 2       |
| DATA 4   | DATA 4   | 2       | 2       |
| DATA 4   | DATA 4   | 3       | 3       |
| PHONE    | PHONE    | 4       | 4       |
| PHONE    | PHONE    | 5       | 5       |
| PHONE    | PHONE    | 6       | 6       |
| 10BASE-T | 10BASE-T | A       | A       |

41080-LEB Shown

## 110 Product Labeling Holders and Strips

E Identify all your 110 ports quickly and easily with these label holders and slide-in label strips. The clear plastic holders attach to all types of 110 wiring bases including wall, rack and wall-mounting frame styles. Labeling strips are lined for 2-, 3-, 4- or 5-pair spacing and available in white for Cat 6 110 Wiring Products. Cat 5e labeling strips are available in your choice of nine colors.

### 110 Product Labeling Holders and Strips

| DESCRIPTION  | CAT. NO.  |
|--|-----------|
| [E] Clear Label Holders (bag of 6)   | 41100-HLD |
| [E] CAT 6 Label Strips lined for 4-pair spacing (bag of 6) (available in white only)                     | 411BL-60W |
| [E] CAT 5e Label Strips lined for 2-, 3-, 4- or 5-pair spacing (bag of 6) (available in one of 9 colors) | 411BL-00* |

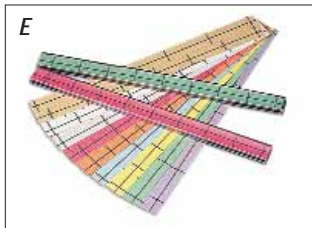

#### \*COLOR/LABELS

##### QuickPort Shutter Kit

For color selection, add suffix to catalog number as follows: Gray (G), Orange (O), Blue (L), Yellow (Y), Green (V), Purple (P), Brown (B), Red (R).

##### 110 Product Labels

For color selection, add suffix to catalog number as follows: White (W), Gray (G), Orange (O), Blue (L), Yellow (Y), Green (V), Purple (P), Brown (B), Red (R).



## 110 Punchdown Tool

### WIRE PUNCHDOWN/TERMINATION TOOL

**A** A versatile punchdown/termination tool with changeable blades (sold separately) that enables installers to make reliable connections on a variety of wire termination blocks. Terminate/punch down wire with one simple push on the handle. An adjustable impact setting allows you to terminate wire with less effort than other impact tools. Handle can be fitted with several interchangeable custom blades to cover many termination types: 110 IDC, 66 IDC, Krone, BIX (Northern Telecom BIX system), and an awl (woodscrew starter punch). A spare blade can be kept in a storage chamber in the handle.

**B-E** These special application blades are for use with the Wire Punchdown Tool for terminating 22, 24 or 26 gauge wire. Krone and BIX blades feature scissor-action trim

### D814 Wire Puchdown/Termination Tool and D814 Tool Blades

| DESCRIPTION   | CAT. NO.  |
|---|-----------|
| [A] Wire Punchdown/Termination Tool (Blade Sold Separately) | 49553-814 |
| [B] 110 IDC Blade   | 49553-110 |
| [C] 66-IDC Blade  | 49553-066 |
| [D] BIX® Blade  | 49553-BIX |
| [E] Krone® Blade  | 49553-KRN |
| AWL (Woodscrew starter punch)                               | 49553-AWL |

### MULTI-PAIR TERMINATION TOOL

**F** The Multi-pair Termination Tool is designed for use with Leviton's Category 6 110-style wiring products. The high-impact, spring-loaded handle, makes it easy to terminate multiple pairs with just one punch. Use "Blade In" and "Blade Out" options for daisy chain or full termination. Category 5e and 6 heads are available separately. Handle works with both Category 5e and 6 heads.

### Multi-Pair Termination Tools and Accessories

| DESCRIPTION   | CAT. NO.  |
|---|-----------|
| [F] Mass Termination Multi-Pair Tool Handle with CAT 6, 4-Pair Head | 49553-TTH |
| Mass Termination Replacement Head, CAT 6, 4-Pair                    | 49553-64H |
| Mass Termination Replacement Head, CAT 5e, 5-Pair                   | 49553-55H |

### MASTER COMPRESSION TOOL

**G** The Multi-pair Termination Tool is designed for use with Leviton's Category 6 110-style wiring products. The high-impact, spring-loaded handle, makes it easy to terminate multiple pairs with just one punch. Use "Blade In" and "Blade Out" options for daisy chain or full termination. Category 5e and 6 heads are available separately. Handle works with both Category 5e and 6 heads.

### Master Compression Tool

| DESCRIPTION                 | CAT. NO.  |
|-----------------------------|-----------|
| [G] Master Compression Tool | 40989-CPT |

*Compression Connectors are sold on page L4.*

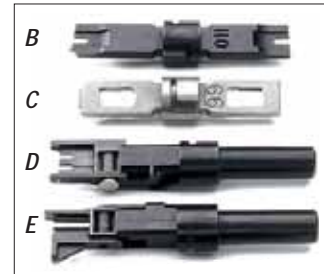



## FIBER OPTIC TOOLS



### Opt-X Fiber Tool Kits

#### OPT-X LIGHT TOOL KIT

**A** All the essential tools for quick field-termination of fiber optic connectors. Includes 100X inspection scope, scribe, polishing fixture, polishing pad, 900µm buffer remover tool, jacket stripper, Thread-Lock® tightening tool, and scissors.

#### OPT-X PRO TOOL KIT

**B** Use with any SC, ST, or FC Thread-Lock connectors. Includes Thread-Lock Versa-Cleave® Tool, 200X inspection scope, Thread-Lock tightening tool, one 250µm and one 900µm buffer remover, polishing pad, safety glasses, scissors, jacket stripper, polishing fixture, and music wire.



#### OPT-X FAST-CURE TOOL KIT

**C** Use with single-mode or multimode Fast-Cure adhesive connectors - SC, ST, FC, or LC. Includes 200X inspection scope, one 250µm and one 900µm buffer remover, polishing pad, standard 2.5mm and LC 1.25mm polishing fixtures, LC scope adapter, fiber crimp tool, safety glasses, scissors, jacket stripper, music wire and lapping film. Adhesive/Accelerator Kit sold separately on page K5.

#### OPT-X MT-RJ ACCESSORY KIT

Adds MT-RJ capability to existing tool kits.



### Fiber Optic Tool Kits

| DESCRIPTION                                    | CAT. NO.  |
|--|-----------|
| [A] Opt-X Light Tool Kit                       | 49800-MTK |
| [B] Opt-X Pro Tool Kit (includes Versa-Cleave) | 49800-UTP |
| [C] Opt-X Fast-Cure Tool Kit                   | 49800-FTK |
| Opt-X MT-RJ Accessory Kit                      | 49800-SLA |



## Fiber Optic Tools and Consumables Sold Individually

### Individual Components

| DESCRIPTION  | CAT. NO.  |
|--|-----------|
| <b>Universal Tools</b>                                   |           |
| [A] 250 µm Buffer Remover                                | 49886-BR2 |
| [B] 900 µm Buffer Remover                                | 49886-BR9 |
| [C] Jacket Stripper                                      | 49886-STP |
| [D] Aramid Strand Scissors                               | 49886-SIS |
| Marking Pen  | 49886-SMP |
| Safety Glasses   | 49886-GLS |
| Sapphire Scribe  | 49886-SCR |
| 2.5mm Polishing Puck                                     | 49886-PUC |
| 3" x 6" Polishing Pad                                    | 49886-PAD |
| Opt-X® Tool Kit Carrying Case                            | 49886-CSE |
| <b>Tightening Tools</b>                                  |           |
| [E] ST/SC Combination Tightening Tool                    | 49886-CTT |
| [F] FC Tightening Tool                                   | 49883-FCT |
| <b>FastCAM Installation Kits</b>                         |           |
| [G] Multi/Single-Mode Installation Kit                   | 49800-SMK |
| [H] Multimode Installation Kit                           | 49800-MMK |
| <b>MT-RJ Specific Tools</b>                              |           |
| Strip Length Gauge                                       | 49886-SLG |
| Frame-Station Connector Assembly Tool                    | 49886-FIT |
| Workstation Connector Lead-in Crimp Tool                 | 49886-SLC |
| Versa-Cleave® Adapter for MT-RJ Workstation Connectors   | 49886-VWA |
| Versa-Cleave Adapter for MT-RJ Frame-Station Connectors  | 49886-VFA |
| Opt-X 20/20 Lenses                                       | 49886-OTT |
| MT-RJ Tool Kit Carrying Case                             | 49886-CST |
| MT-RJ Accessory Kit Carrying Case                        | 49886-CSA |
| <b>Fast-Cure Specific Tools</b>                          |           |
| [G] Fiber Optic Crimp Tool with .128, .151, .178 hex die | 49886-FCT |
| LC Scope Adapter   | 49886-LCS |
| 1.25mm (LC) Polishing Puck                               | 49886-LCP |
| Fast-Cure Tool Kit Carrying Case                         | 49886-FCC |
| <b>Consumables</b>                                       |           |
| Music Wire   | 49886-WRE |
| Lint Free Dry Wipes 100/pack                             | 49886-DWP |
| Alcohol Pads 100/pack                                    | 49886-APD |
| 12 µm Aluminum Oxide Lapping Film, 100/pack              | 49886-12F |
| 3 µm Aluminum Oxide Lapping Film, 100/pack               | 49886-03F |
| 0.3 µm Aluminum Oxide Lapping Film, 100/pack             | 49886-X3F |
| Replacement Needles 25/pack                              | 49886-FCN |
| Replacement Syringes 25/pack                             | 49886-SYR |

### CONSUMABLES KITS

**H-J** Leviton's Consumables Kits contain everything you need to clean and polish connectors, such as polyester wipes, alcohol pads, music wire, and 12-, 3- and 0.3 µm lapping film. Fast-Cure kit adds needles and syringes, plus adhesive and accelerator. Adhesive/Accelerator kit is also sold separately. Fan-Out Consumables Kits are also available.

### Consumables Kits

| DESCRIPTION                                 | CAT. NO.  |
|---|-----------|
| [H] Universal Consumables Kit               | 49800-CON |
| [I] Fast-Cure Consumables Kit               | 49800-FAC |
| [J] Adhesive/Accelerator Kit                | 49800-680 |
| Fan-Out Consumables Kit (shown on page L51) | 49800-FAN |





## Fiber Optic Tools

### THREAD-LOCK® VERSA-CLEAVE® TOOL

**A-C** Diamond blade cleaves fiber perfectly every time, eliminating the need for a craft-sensitive scribe procedure. The ergonomic stop-watch design fits comfortably in the hand, works with any style or brand of mechanical 2.5mm ferrule connector, and cleaves with a simple push of the button. The integrated debris cup catches and retains fiber debris for safe disposal. Versa-Cleave can be ordered separately, or as part of the Opt-X® Pro Tool Kit

#### Thread-Lock Versa-Cleave

| DESCRIPTION  | CAT. NO.  |
|--|-----------|
| [A] Versa-Cleave Tool                                      | 49886-TVC |
| [B] Versa-Cleave Adapter for MT-RJ Workstation Connector   | 49886-VWA |
| [C] Versa-Cleave Adapter for MT-RJ Frame-Station Connector | 49886-VFA |



#### SAFETY PAD

**D** Provides a flexible, shatterproof, non-slip surface perfect for terminating all Leviton Fiber Optic Connectors.

#### Safety Pad

| DESCRIPTION    | CAT. NO.  |
|----------------|-----------|
| [D] Safety Pad | 49886-SPD |



#### INSPECTION SCOPES

**E, F** Leviton's 100x and 200x Inspection Scopes allow techs to view multimode and singlemode end-face polishes safely, and reduce the chances of over-polishing (a side-effect of many coaxial inspection scopes). 200x Scope features oblique viewing technology, ergonomic grip, 200X magnification and full laser eye protection through wavelengths of 850-1550 nanometer. Both scopes feature rugged construction that stands up to jobsite abuse.

#### Inspection Scopes

| DESCRIPTION               | CAT. NO.  |
|---------------------------|-----------|
| [E] 100x Inspection Scope | 49886-SCP |
| [F] 200x Inspection Scope | 49886-FSP |







### Tone Test Set

**A** Use the Leviton Tone Test Set in low voltage wire applications to test for continuity, check for shorts or opens, and provide talk battery for a communication line on a vacant pair. Connect toner across a wire pair and set to transmit either a continuous 1000 Hz or alternating 500/1000 Hz tone. Use with the Speaker Probe (below) to trace pairs and locate broken pairs/cables in walls.

Also identifies Tip and Ring polarity, and line condition for CLEAR LINE with dial tone, BUSY LINE and RINGING LINE. Features "O" ring seals on the case, test leads for water resistance, support leash, tri-color, and nylon-braided tinsel wire test leads. Telco-standard, 6A-type alligator clips with piercing pins securely grip 66-clips, screw heads, screw bodies, and wire-wrapped or threaded terminals. A 6-position, 2-conductor plug lead is also provided for connection to modular jacks.

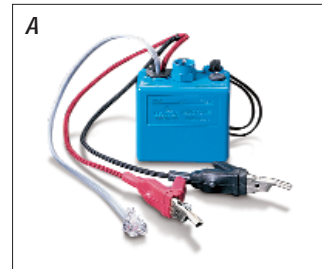

### Inductive Speaker Probe

**B** The streamlined inductive speaker probe detects audible frequency tones quickly for accurate tracing and identification of wires, cables, and metallic circuits. Use with the tone test set (above) to trace and isolate pairs in virtually any type of wire application, without damage to the insulation. Identifies single wires or individual pairs in multiple-pair cables at terminals or closures; identifies station wiring or cables to specific equipment in closets or on distribution frames; and identifies the ends of drop wires. Probe can also be used to locate prewiring, or opens in wires, after wall covering is installed. Features both needlepoint and duckbill tips and a non-locking slide switch.



#### Tone Test Set, Inductive Speaker Probe — Individual Items and Combinations

| DESCRIPTION   | CAT. NO.  |
|---|-----------|
| [A] Tone Test Set (includes 9 volt battery)   | 49560-TTS |
| [B] Inductive Speaker Probe only (includes 9 volt battery; one duckbill tip; and one needlepoint tip) | 49561-SSP |
| [C] Leather Belt Holster for Tone Test Set  | 49560-LCC |
| [D] Leather Belt Holster for inductive speaker probe  | 49561-LCC |
| Spare duckbill and needlepoint tip set  | 49561-TIP |
| Kit containing tone test set with belt holster, and inductive speaker probe with belt holster         | 49562-TSK |
| Kit containing 5 tone test sets with belt holsters, and 5 inductive speaker probes with belt holsters | 49562-KIT |

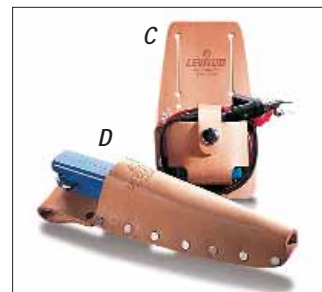

Optional leather belt holsters.

### Crimping Tool for Coaxial Connectors

**E** For use in crimping coaxial connectors onto RG-59 or RG-6 cables. Rugged metal construction with cushioned handles. Carded package for display in merchandising racks.

#### Crimping Tool for Coaxial Connectors

| DESCRIPTION                              | CAT. NO.  |
|--|-----------|
| [E] Crimping Tool for Coaxial Connectors | 40988-000 |



### UTP Stripping Tool

**F** Use this versatile tool to strip unshielded twisted pair (UTP) cable. Carded package for display in merchandising racks.

#### UTP Stripping Tool

| DESCRIPTION        | CAT. NO.  |
|--------------------|-----------|
| [F] Stripping Tool | 49660-00C |





### Craftsman's Handset

**A** This handset is used by installers, repair technicians, and other authorized personnel for basic line testing and essential on-site temporary communications. Line-powered to provide either DTMF (Touch Tone) or dial pulse output. Features all standard 'butset' line tests, including polarity check, line monitoring, and signaling.

#### Craftsman's Handset

| DESCRIPTION             | CAT. NO.  |
|-------------------------|-----------|
| [A] Craftsman's Handset | 49575-CTS |

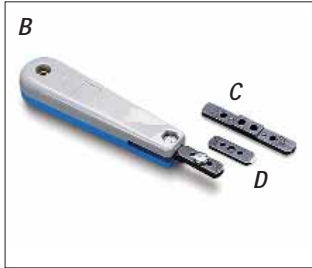

### Termination Tool (66-BT)

**B** This 'pocket friendly' tool quickly punches down 20 through 26 gauge unstripped wire in devices using 66-clip terminals. It adjusts to accommodate variation in wire size and blade sharpness. Replaceable blades reverse to let you terminate and cut wire in a single stroke, or terminate without.

#### Replacement Stem for Termination Tool (66-BT02)

**C** The replaceable stem for the termination tool blade.

#### Replacement Blade for Termination Tool (66-BT01)

**D** This blade reverses so wires can be terminated and cut, or terminated without cutting. It also adjusts to accommodate variation in wire size or blade sharpness.

#### Termination Tool, Replacement Stem and Replacement Blade

| DESCRIPTION  | CAT. NO.  |
|--|-----------|
| [B] Termination Tool (66-BT)                         | 46666-0BT |
| [C] Replacement Stem for Termination Tool (66-BT02)  | 46666-BTS |
| [D] Replacement Blade for termination Tool (66-BT01) | 46666-BTB |

*Note: Numbers in parentheses refer to industry product designation.*

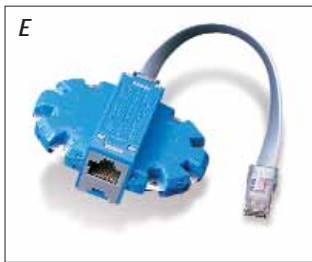

### Modular Plug Breakout Adapter

**E** For testing any 6- or 8-position modular jack with the Tone Test Set or Craftsman's Handset. Includes contacts to connect, via alligator clip leads, to any test apparatus or Lineman's Test Set. Can be used in series with any cable with a 6- or 8-conductor modular plug.

#### Modular Plug Breakout Adapter

| DESCRIPTION                       | CAT. NO.  |
|-----------------------------------|-----------|
| [E] Modular Plug Breakout Adapter | 40070-MDP |

# Straight Blade Plugs and Connectors

## INDEX

|  |     |
|--|-----|
| <b>Industrial Grade Plugs &amp; Connectors</b>                 |     |
| Overview   | M2  |
| 15A 125V & 250V  |     |
| Hospital Grade   | M3  |
| Industrial Grade   | M3  |
| Flanged Inlets and Outlets                                     | M3  |
| Wetguard®  | M5  |
| Dustguard®   | M5  |
| Python™  | M6  |
| Integrated Inlets and Outlets with<br>Weather-Resistant Covers | M7  |
| 20A 125V & 250V  |     |
| Hospital Grade   | M4  |
| Industrial Grade   | M4  |
| Flanged Inlets and Outlets                                     | M4  |
| Wetguard®  | M5  |
| Dustguard®   | M5  |
| Python™  | M6  |
| Integrated Inlets and Outlets with<br>Weather-Resistant Covers | M7  |
| Weather-Resistant Boots  | M4  |
| 20 AMP Power Plugs   | M8  |
| 30 AMP Nylon Angle Plugs                                       | M8  |
| 50 AMP Nylon Angle Plugs                                       | M9  |
| 60 AMP Nylon Angle Plugs                                       | M10 |
| <b>Commercial Grade Plugs &amp; Connectors</b>                 |     |
| Overview   | M11 |
| 15A 125V & 250V  | M12 |
| 20A 125V & 250V  | M13 |
| 30 Amp and 50 Amp Dual Power                                   |     |
| Attachment Plugs   | M14 |
| <b>Residential Grade Plugs &amp; Connectors</b>                |     |
| Parallel, Polarized and Non-Polarized                          | M15 |
| Grounding  | M16 |

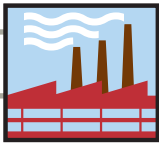

# STRAIGHT BLADE PLUG AND CONNECTOR FEATURES

## Industrial Grade Straight Blade Plugs and Connectors

### A COMPLETE LINE OF PLUGS AND CONNECTORS THAT STANDS UP TO THE HARSHTEST ENVIRONMENTS

The Leviton line of straight blade plugs and connectors includes: Black & White™ Industrial Grade devices that resist impact, corrosion and chemicals; Hospital Grade devices that meet the highest standards for dependable, long-term performance; Wetguard® for water and moisture resistance; Dustguard® to resist dust and dirt; Python™, with an innovative interlocking design; rugged nylon flanged inlets and outlets; and integrated inlets and outlets with weather resistant covers.



**Hospital Grade**  
Superior design, heavy-duty, impact-resistant, all nylon construction for long-lasting performance and reliability in the demanding healthcare environment.  
**8215-C shown**



**Angle Plugs and Connectors**  
For hospital and industry use where power cords must lay close to walls and floors: 8 plug positions.  
**8215-CAT shown**



**Wetguard®**  
Specifically developed for wet or damp locations. EPTR thermoplastic rubber body and rugged design resist water, alkalis, grease, oils and solvents.  
**14W48 shown**



**Python™**  
Hinged design provides speedy, simple wiring and installation, delivers top performance, stands up to rough-duty applications.  
**5456-VY shown**



**Flanged Inlets and Outlets**  
Fit flush on equipment mounting panels and require only 2 mounting screws for easy panel assembly.  
**5278-C shown**



**Leviton's 15 and 20 Amp nylon plugs and connectors offer superior performance and long-lasting reliability features; from ergonomic design details to rugged construction that resists impact, punishing application environments, chemicals and corrosives.**

#### Features and Benefits

- UL 498 Listed; meets latest Federal Specifications WC-598; CSA Specification C22.2 No. 42 Certified
- Cord clamp with removable strain relief insert accepts cables rated from 10-3 ST to 18-3 SVT (.245"-.700")
- One-piece, rivetless triple-wipe brass connector contacts offer enlarged contact surface area
- Husk is constructed of ST801 Super Tough Nylon for superior impact resistance in rugged environments
- Beveled back edges prevent body from catching on corners and rough surfaces
- Ergonomic, fluted body design with radial gripping edge is ideal for gripping and pulling

Positive contact plate bundles stranded wire maximizing surface contact resulting in improved termination

NEMA configuration and device rating are molded on front of device to assist with identification

Dead front solid containment barrier prevents accidental contact with internal parts

Wiring module keyed to body for easy assembly and a tight fit

External cord grip utilizes deep triple drive steel screws that are backed out and positioned inside shrouded pockets. External clamps accepts wire mesh grips. Catalog and NEMA numbers printed on cord clamp

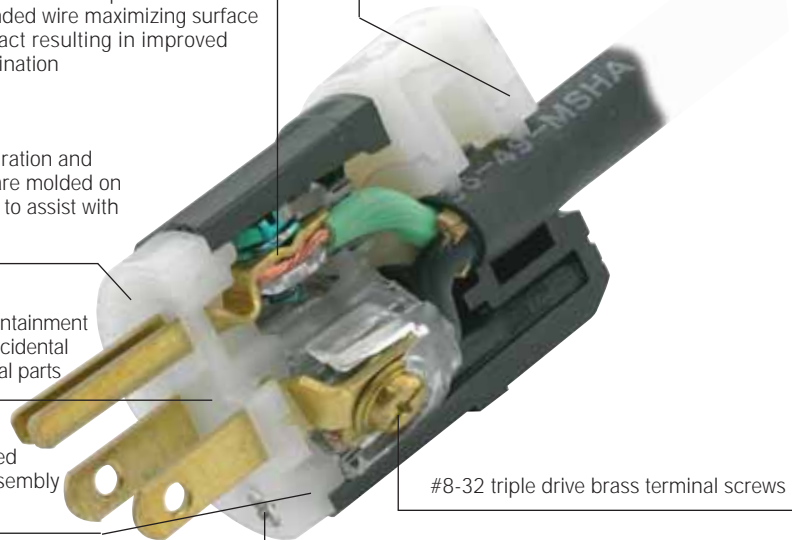

**5266-C**

#8-32 triple drive brass terminal screws

Three "U" type fast-threading, triple drive, steel screws secure wiring module to body

Wire clamps move in individual chamber — provide positive crimp lock without cutting wire strand

Captive, color-coded brass #8 terminal screws



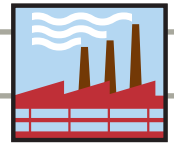

Individual deep-funnelled chamfered wire wells. Clear housing allows inspection of wire termination and provides molded-in wire strip gage



## Industrial Grade Straight Blade Plugs and Connectors



### Hospital Grade —15 AMP 125V 2-Pole, 3-Wire Grounding

| DESCRIPTION                                   | CAT. NO. PLUG<br><small>NEMA 5-15P</small>  | CAT. NO. CONNECTOR<br><small>NEMA 5-15R</small>  |
|---|--|--|
| Hospital Grade, Black & White Body            | 8215-C   | 8219-C   |
| Hospital Grade, Transparent Body              | 8215-CT  | 8219-CT  |
| Hospital Grade, Power Indication™ Transparent | 8215-PLC   | 8219-PLC   |
| Hospital Grade Angle, Transparent Body        | 8215-CAT   | —  |

### Industrial Grade —15 AMP 125V 2-Pole, 3-Wire Grounding

|   |          |          |
|---|----------|----------|
| Black & White Nylon Body                    | 5266-C   | 5269-C   |
| High-Visibility Yellow Nylon Body           | 5266-CY  | 5269-CY  |
| All-Black Nylon for Stage and Studio        | 5266-CB  | 5269-CB  |
| All-Black Nylon, Power Indication™          | 5266-PLB | 5269-PLB |
| Orange & White Body                         | 5266-CO  | 5269-CO  |
| Gray Nylon Body                             | 5266-CG  | 5269-CG  |
| Black & White Nylon Body, Power Indication™ | 5266-PLC | 5269-PLC |
| Angle, Black & White Nylon Body             | 5266-CA  | 5269-CA  |
| Black 2-Piece Nylon Shell                   | 5266-N   | 5269-N   |
| Flanged Inlet, White Nylon Body             | 5278-C   | —        |
| Flanged Outlet, White Nylon Body            | —        | 5279-C   |

### Industrial Grade —15 AMP 250V 2-Pole, 3-Wire Grounding

| DESCRIPTION                       | CAT. NO. PLUG<br><small>NEMA 6-15P</small>  | CAT. NO. CONNECTOR<br><small>NEMA 6-15R</small>  |
|-----------------------------------|---|---|
| Black & White Nylon Body          | 5666-C  | 5669-C  |
| High-Visibility Yellow Nylon Body | 5666-CY   | 5669-CY   |
| Angle, Black & White Nylon Body   | 5666-CA   | —   |
| Flanged Inlet, White Nylon Body   | 15678-C   | —   |
| Flanged Outlet, White Nylon Body  | —   | 15679-C   |

For Weather Resistant Plug and Connector Boots, see page M4.

#### SPECIFICATIONS AND FEATURES

##### Hospital Grade

- Unmatched quality and performance confirmed by rigorous UL 498 testing
- Clearly identified by green dot

##### Industrial Grade

- Rugged construction resists impact, sunlight, chemicals and rough use
- All contacts are solid one-piece brass for better conductivity
- Triple-wipe, heavy-duty power contacts set in deep pockets to resist damage
- Captive, color-coded brass #8 terminal screws
- Unique cord clamp accepts wide range of cord sizes (.245"-.700"), providing secure grip without damaging cord jacket: SVT 18-3 to SO 14-3 with strain relief insert, up to ST 10-3 when strain relief insert is removed.
- Power Indication™ devices equipped with green neon bulb rated at 30,000 hours (24/7) for 3.5 years

#### TESTING AND CODE COMPLIANCE

- Meet NEMA WD 1 & 6, ANSI requirements
- UL Listed & meets UL Fed. Spec. requirements: Industrial Plugs & Connectors (File #13393); Hospital Grade (UL 498, File #E-13393)
- CSA Certified (File #LR-406)
- NOM Certified (#057)
- Backed by a Limited 10-Year Warranty

#### MATERIAL CHARACTERISTICS

Environmental: Flammability, Rated V2  
Operating Temperature: -40°C to 65°C

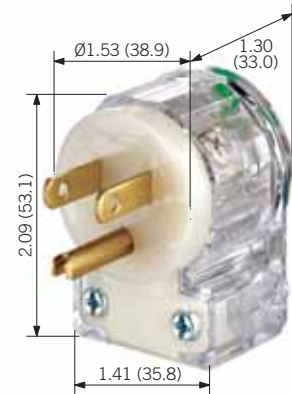

8215-CAT

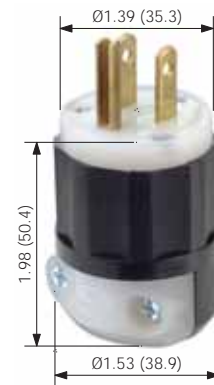

5266-C



5269-C



5278-C

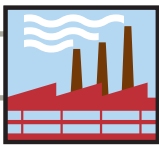

## 20 AMP 125 and 250V

### Industrial Grade Straight Blade Plugs and Connectors



8315-PLC



5366-CA

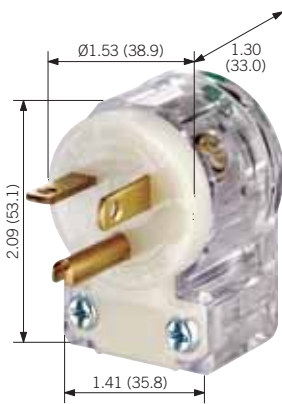



8415-CAT



6017-Y

#### Hospital Grade — 20 AMP 125V 2-Pole, 3-Wire Grounding





| DESCRIPTION                                   | CAT. NO. PLUG   | CAT. NO. CONNECTOR   |
|---|---|--|
|   | NEMA 5-20P  | NEMA 5-20R  CSA config. in Canada  |
| Hospital Grade, Black & White Body            | 8315-C  | 8319-C   |
| Hospital Grade, Transparent Body              | 8315-CT   | 8319-CT  |
| Hospital Grade, Power Indication™ Transparent | 8315-PLC  | 8319-PLC   |
| Hospital Grade Angle, Transparent Body        | 8315-CAT  | —  |

#### Industrial Grade — 20 AMP 125V 2-Pole, 3-Wire Grounding

|   |          |          |
|---|----------|----------|
| Black & White Nylon Body                    | 5366-C   | 5369-C   |
| Black & White Nylon Body, Power Indication™ | 5366-PLC | 5369-PLC |
| All-Black Nylon, Power Indication™          | 5366-PLB | 5369-PLB |
| High-Visibility Yellow Nylon Body           | 5366-CY  | 5369-CY  |
| Gray Nylon Body                             | 5366-CG  | 5369-CG  |
| Angle, Black & White Nylon Body             | 5366-CA  | 5369-CA  |
| Flanged Inlet, White Nylon Body             | 15378-C  | —        |
| Flanged Outlet, White Nylon Body            | —        | 15379-C  |

#### Hospital Grade — 20 AMP 250V 2-Pole, 3-Wire Grounding

| DESCRIPTION                            | CAT. NO. PLUG   | CAT. NO. CONNECTOR   |
|--|---|--|
|  | NEMA 6-20P  | NEMA 6-20R  CSA config. in Canada  |
| Hospital Grade Angle, Transparent Body | 8415-CAT  | —  |

#### Industrial Grade — 20 AMP 250V 2-Pole, 3-Wire Grounding

|                                   |         |         |
|-----------------------------------|---------|---------|
| Black & White Nylon Body          | 5466-C  | 5469-C  |
| High-Visibility Yellow Nylon Body | 5466-CY | 5469-CY |
| Flanged Inlet, White Nylon Body   | 5478-C  | —       |
| Flanged Outlet, White Nylon Body  | —       | 5479-C  |

#### Weather-Resistant Boots

Our outstanding Industrial Grade boots feature a triple-seal design to protect straight blade and locking plugs and connectors against the harmful effects of dirt and moisture in harsh environments. Boots are available in black or high-visibility yellow. The fluted surface and grip-ring design provide a non-slip grip even in wet conditions.

| DESCRIPTION  | CAT. NO. |
|--|----------|
| Weather-Resistant Straight Blade Plug Boot, Black Rubber.<br>For 15A & 20A Straight Blade Industrial Nylon Plugs                         | 6017     |
| Weather-Resistant Straight Blade Plug Boot, High Visibility Yellow Rubber.<br>For 15A & 20A Straight Blade Industrial Nylon Plugs        | 6017-Y   |
| Weather-Resistant Straight Blade Connector Boot, Black Rubber.<br>For 15A & 20A Straight Blade Industrial Nylon Connectors               | 6018     |
| Weather-Resistant Straight Blade Connector Boot, High Visibility Yellow Rubber. For 15A & 20A Straight Blade Industrial Nylon Connectors | 6018-Y   |

#### SPECIFICATIONS AND FEATURES

##### Hospital Grade

- Unmatched quality and performance confirmed by rigorous UL 498 testing
- Clearly identified by green dot

##### Industrial Grade

- Rugged construction resists impact, sunlight, chemicals and rough use
- All connector contacts are solid one-piece brass for superior conductivity
- Triple-wipe, heavy-duty power contacts set in deep pockets to resist damage
- Captive, color-coded brass #8 terminal screws
- Unique cord clamp accepts wide range of cord sizes (.245"–.700"), providing secure grip without damaging cord jacket: SVT 18-3 to SO 14-3 with strain relief insert, up to ST 10-3 when strain relief insert is removed.

- Power Indication™ devices equipped with green neon bulb rated at 30,000 hours (24/7) for 3.5 years

#### TESTING AND CODE COMPLIANCE

- Meet NEMA WD 1 & 6, ANSI requirements
- UL Listed & meets Fed. Spec. requirements: Industrial Plugs & Connectors (File #13393); Hospital Grade (UL 498, File #E-13393)
- CSA Certified (File #LR-406)
- NOM Certified (#057)
- Backed by a Limited 10-Year Warranty

#### MATERIAL CHARACTERISTICS





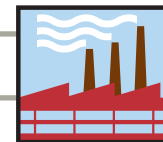







Environmental: Flammability, Rated V2  
Operating Temperature: -40°C to 65°C

# 15 AMP 125 and 250V • 20 AMP 125 and 250V Industrial Grade Straight Blade Plugs and Connectors



**Wetguard®** Wetguard® Devices Engineered to IP66 & IP67 Watertight Standards

## Wetguard Straight Blade Plugs and Connectors

| DESCRIPTION                            | CAT. NO. PLUG  | CAT. NO. CONNECTOR   |
|--|--|--|
| Rubber Yellow, 15A-125V 2-Pole, 3-Wire | <b>14W47</b><br>NEMA 5-15P    | <b>15W47</b><br>NEMA 5-15R    |
| Black Rubber, 15A-125V 2-Pole, 3-Wire  | <b>14W47-B</b><br>NEMA 5-15P  | <b>15W47-B</b><br>NEMA 5-15R  |
| Yellow Rubber, 15A-250V 2-Pole, 3-Wire | <b>14W49</b><br>NEMA 6-15P    | <b>15W49</b><br>NEMA 6-15R    |
| Yellow Rubber, 15A-277V 2-Pole, 3-Wire | <b>14W34</b><br>NEMA 7-15P    | <b>15W34</b><br>NEMA 7-15R    |
| Yellow Rubber, 20A-125V 2-Pole, 3-Wire | <b>14W33</b><br>NEMA 5-20P    | <b>15W33</b><br>NEMA 5-20R    |
| Yellow Rubber, 20A-250V 2-Pole, 3-Wire | <b>14W48</b><br>NEMA 6-20P    | <b>15W48</b><br>NEMA 6-20R    |









## Replacement Closure Cap

| DESCRIPTION  | CAT. NO.     |
|--|--------------|
| Replacement Female Closure Cap for use with 15A & 20A 2-pole, 3-wire devices | <b>50W50</b> |



**Dustguard®** Dustguard® Devices Engineered to IP44 Splashproof and Dust-Tight Standards

## Dustguard Straight Blade Plugs and Connectors

| DESCRIPTION                                     | CAT. NO. PLUG   | CAT. NO. CONNECTOR  |
|---|---|---|
| High-Visibility Yellow, 15A-125V 2-Pole, 3-Wire | <b>1447</b><br>NEMA 5-15P  | <b>1547</b><br>NEMA 5-15R  |
| High-Visibility Yellow, 15A-250V 2-Pole, 3-Wire | <b>1449</b><br>NEMA 6-15P  | <b>1549</b><br>NEMA 6-15R  |
| High-Visibility Yellow, 20A-125V 2-Pole, 3-Wire | <b>1433</b><br>NEMA 5-20P  | <b>1533</b><br>NEMA 5-20R  |
| High-Visibility Yellow, 20A-250V 2-Pole, 3-Wire | <b>1448</b><br>NEMA 6-20P  | <b>1548</b><br>NEMA 6-20R  |

For 15 and 20 Amp corrosion resistant straight blade devices, see pages N20–N21.

### SPECIFICATIONS AND FEATURES

#### Wetguard

- IEC IP66 and IP 67 Rated, in accordance with IEC 529 as evaluated by UL and CSA
- NEMA Type 3, 3S, 4, 4X, 6 and 6P Ratings in accordance with UL 50 and CSA 94
- Outstanding resistance to wet and damp environments, extreme temperature variations, acids, alkalis, grease, oils and solvents
- Effective "tongue and groove" construction seals out water, moisture, dirt when plugs are mated with connectors
- Innovative strain-relief grips cables securely, keeps out water and moisture
- Cord clamp range: 18/3–10/3SO (.375"–.655")

- Non-magnetic stainless steel fast-threading assembly screws won't interfere with sensitive equipment
- Connector "hood" closure cap seals device when not in use

#### Dustguard

- IEC/IP44 Rated
- Developed to withstand dusty and dirty environments, cracking and fading, temperature extremes
- Rugged wiring modules have high performance 1-piece brass triple-wipe contacts, solid brass plug blades
- Self centering cord clamp accepts wide range of conductors, 18-3 SVT–12-3SO (.240"–.655")

### TESTING AND CODE COMPLIANCE

- Meet NEMA WD 1 & 6, ANSI requirements
- UL Listed & meets Fed. Spec. requirements: Wetguard (File #13393), Dustguard (File #E-13393)
- CSA Certified (File #LR-406)
- NOM Certified (#057)
- Backed by a Limited 10-Year Warranty

### MATERIAL CHARACTERISTICS

Environmental: Flammability, Rated V2  
Operating Temperature: -40°C to 65°C



Straight Blade Plugs and Connectors

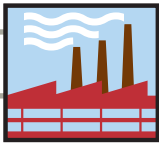

15 AMP 125 and 250V • 20 AMP 125 and 250V

## Industrial Grade Straight Blade Plugs and Connectors



5256-VA

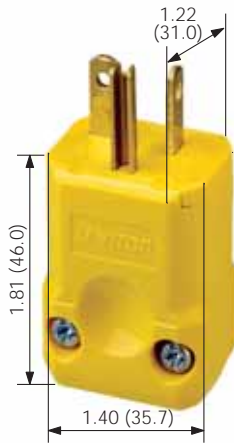

5456-VY

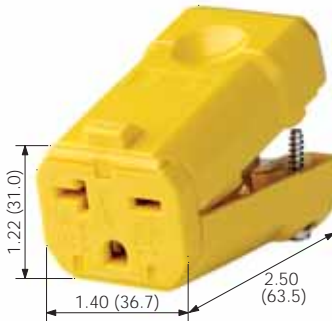

5459-VY

### **PYTHON™** Python™ Plugs and Connectors Feature a Hinged Design for Fast, Easy Installation and Assembly

#### Hospital Grade — 15 AMP 125V 2-Pole, 3-Wire Grounding

| DESCRIPTION      | CAT. NO. PLUG | CAT. NO. CONNECTOR |
|------------------|---------------|--------------------|
|                  | NEMA 5-15P    | NEMA 5-15R         |
| White Nylon Body | 8256-V        | 8259-V             |

#### Industrial Grade — 15 AMP 125V 2-Pole, 3-Wire Grounding

|  |         |         |
|--|---------|---------|
| Black Nylon Body                         | 5256-VB | 5259-VB |
| High-Visibility Yellow Nylon Body        | 5256-VY | 5259-VY |
| Gray Nylon Body                          | 5256-VG | 5259-VG |
| Angle, High-Visibility Yellow Nylon Body | 5256-VA | —       |

#### Hospital Grade — 15 AMP 250V 2-Pole, 3-Wire Grounding

| DESCRIPTION      | CAT. NO. PLUG | CAT. NO. CONNECTOR |
|------------------|---------------|--------------------|
|                  | NEMA 6-15P    | NEMA 6-15R         |
| White Nylon Body | 8656-V        | 8659-V             |

#### Industrial Grade — 15 AMP 250V 2-Pole, 3-Wire Grounding

|  |          |          |
|--|----------|----------|
| High-Visibility Yellow Nylon Body        | 15656-VY | 15659-VY |
| Angle, High-Visibility Yellow Nylon Body | 15656-VA | —        |

#### Hospital Grade — 20 AMP 125V 2-Pole, 3-Wire Grounding

| DESCRIPTION      | CAT. NO. PLUG | CAT. NO. CONNECTOR                              |
|------------------|---------------|---|
|                  | NEMA 5-20P    | NEMA 5-20R <small>CSA config. in Canada</small> |
| White Nylon Body | 8356-V        | 8359-V  |

#### Industrial Grade — 20 AMP 125V 2-Pole, 3-Wire Grounding

|  |         |         |
|--|---------|---------|
| Black Nylon Body                         | 5356-VB | 5359-VB |
| High-Visibility Yellow Nylon Body        | 5356-VY | 5359-VY |
| Angle, High-Visibility Yellow Nylon Body | 5356-VA | —       |

#### Hospital Grade — 20 AMP 250V 2-Pole, 3-Wire Grounding

| DESCRIPTION      | CAT. NO. PLUG | CAT. NO. CONNECTOR                              |
|------------------|---------------|---|
|                  | NEMA 6-20P    | NEMA 6-20R <small>CSA config. in Canada</small> |
| White Nylon Body | 8456-V        | 8459-V  |

#### Industrial Grade — 20 AMP 250V 2-Pole, 3-Wire Grounding

|  |         |         |
|--|---------|---------|
| High-Visibility Yellow Nylon Body        | 5456-VY | 5459-VY |
| Angle, High-Visibility Yellow Nylon Body | 5456-VA | —       |

#### SPECIFICATIONS AND FEATURES

##### Python

- Tough high-impact body
- Hinged design delivers fast, easy installation and assembly
- Triple-drive screws for easy wiring — Standard, Phillips, Robertson
- Wide Cord Clamp Range, 18-3 SVT–10-3 ST, (.245"–.700")

#### TESTING AND CODE COMPLIANCE

- Meet NEMA WD 1 & 6, ANSI requirements
- UL Listed & meets Fed. Spec. requirements: Industrial Plugs & Connectors (File #13393); Hospital Grade (UL 498, File #E-13393)
- CSA Certified (File #LR-406)
- NOM Certified (#057)
- Backed by a Limited 10-Year Warranty

#### MATERIAL CHARACTERISTICS

Environmental: Flammability, Rated V2  
Operating Temperature: -40°C to 65°C





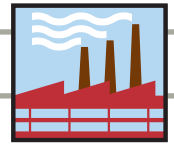









# 15 AMP 125 and 250V • 20 AMP 125 and 250V Industrial Grade Straight Blade Plugs and Connectors



## Integrated Power Inlets and Outlets with Weather-Resistant Covers

- Engineered to IP 64 and NEMA 3R Protection Ratings
- Suitable for Industrial Indoor and Outdoor Use

### Integrated Power Inlets and Outlets with Weather-Resistant Covers Gray, Glass-Filled Thermoplastic Cover and White, Nylon Device

| DESCRIPTION  | CAT. NO. FLANGED INLET   | CAT. NO. FLANGED OUTLET   |
|--|--|---|
| Standard Wire Wells,<br>15A-125V 2-Pole, 3-Wire      | <b>5278-CWP</b><br>NEMA 5-15P   | <b>5279-CWP</b><br>NEMA 5-15R    |
| Slots for Fork Terminals,<br>15A-125V 2-Pole, 3-Wire | <b>5278-FWP</b><br>NEMA 5-15P   | <b>5279-FWP</b><br>NEMA 5-15R    |
| Standard Wire Wells,<br>15A-250V 2-Pole, 3-Wire      | <b>15678-CWP</b><br>NEMA 6-15P  | <b>15679-CWP</b><br>NEMA 6-15R   |
| Standard Wire Wells,<br>20A-125V 2-Pole, 3-Wire      | <b>15378-CWP</b><br>NEMA 5-20P  | <b>15379-CWP</b><br>NEMA 5-20R  <small>CSA config. in Canada</small>  |
| Standard Wire Wells,<br>20A-250V 2-Pole, 3-Wire      | <b>5478-CWP</b><br>NEMA 6-20P   | <b>5479-CWP</b><br>NEMA 6-20R  <small>CSA config. in Canada</small>   |

**Note:** For locking configurations, please see Section N.



5278-CWP



5278-CWP Shown Open



5279-CWP Shown Open

#### SPECIFICATIONS AND FEATURES

- Glass-filled thermoplastic cover and plate provide outstanding impact resistance and durability
- UL 94 VO Flammability Rating
- IP 64 Suitability rating protects against dust particles and splashing water
- NEMA Type-3R enclosure Rating ensures protection against rain, sleet and damage from external ice formations
- Available with standard wire wells or with slots that accept fork terminals
- Dual gaskets, one under plate and one under lid, for weather-resistant fit
- Stainless steel external hardware resists corrosive effects of moisture
- Large thumb-tab makes it easy to open cover with gloved hand
- Mounts to panels or FS/FD boxes
- UL Listed and CSA Certified for wet locations with cover closed

#### TESTING AND CODE COMPLIANCE

- UL Listed (File #-13397)
- CSA Certified (File #LR-16347)
- NOM Certified (#057)
- IP 64 Suitability Rating (protected against dust and splashing water)
- NEMA Type-3R Enclosure Rating when properly installed (protected against rain, sleet and damage from external ice formations)
- Backed by a Limited 2-Year Warranty

#### MATERIAL CHARACTERISTICS

Environmental: VO Flammability Rating per UL 94  
Operating Temperature: -40°C to 75°C

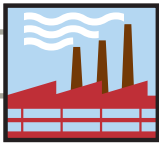

## Industrial Grade Straight Blade Plugs and Connectors

### 20 AMP Power Plugs

#### 20 AMP 125/250V Straight Blade Plugs 3-Pole 3-Wire Non-Grounding

| DESCRIPTION   | CAT. NO. | MATCHING RECEPTACLE | NEMA CONFIG.   |
|---------------|----------|---------------------|--|
| Straight Plug | 9151-N   | 5032<br>5032-1      | 10-20P  |

#### 20 AMP 120/208V 4-Pole, 4-Wire, 3ØY Non-Grounding

|               |        |         |  |
|---------------|--------|---------|--|
| Straight Plug | 7251-C | 7250-FR | 18-20P  |
|---------------|--------|---------|--|

### 30 AMP Nylon Angle Plugs

#### 30 AMP 125V 2-Pole 3-Wire Grounding

| DESCRIPTION | CAT. NO. | MATCHING RECEPTACLE | NEMA CONFIG.  |
|-------------|----------|---------------------|---|
| Angle Plug  | 9530-P   | 5371<br>5371-IG     | 5-30P  |

#### 30 AMP 250V 2-Pole 3-Wire Grounding

|            |        |                 |   |
|------------|--------|-----------------|---|
| Angle Plug | 9630-P | 5372<br>5372-IG | 6-30P  |
|------------|--------|-----------------|---|

#### 30 AMP 277V 2-Pole 3-Wire Grounding

|            |  |        |   |
|------------|--|--------|---|
| Angle Plug |  | 9730-A | 7-30P  |
|------------|--|--------|---|

#### 30 AMP 125/250V 3-Pole 3-Wire Non-Grounding

|            |        |      |  |
|------------|--------|------|--|
| Angle Plug | 9332-P | 5207 | 10-30P  |
|------------|--------|------|--|

#### 30 AMP 125/250V 3-Pole 4-Wire Grounding

|            |        |     |  |
|------------|--------|-----|--|
| Angle Plug | 9432-P | 278 | 14-30P  |
|------------|--------|-----|--|

#### 30 AMP 250V 3-Pole 4-Wire 3-Phase Grounding

|            |        |      |  |
|------------|--------|------|--|
| Angle Plug | 8432-P | 8430 | 15-30P  |
|------------|--------|------|--|

#### 30 AMP 120/208V 4-Pole 4-Wire 3ØY Non-Grounding

|            |        |      |  |
|------------|--------|------|--|
| Angle Plug | 8332-P | 8330 | 18-30P  |
|------------|--------|------|--|



9530-P



9432-P

For more information regarding matching receptacles, refer to Receptacles, Section G.

#### SPECIFICATIONS AND FEATURES

- Rugged cord clamp for secure cable grip accommodates cord diameters from .625" to 1.375" and does not tear conductor jacket
- Made of tough, heavy-duty nylon for long service life
- Devices feature heavy-sectioned dead-front right-angle
- Pressure-clamp terminal design
- Terminals accept up to #4AWG stranded conductors
- Four-way positioning front module
- Solid brass blades for maximum conductivity

#### TESTING AND CODE COMPLIANCE

- UL Listed (File #13393)
- UL Test 498 (CSA 42)
- CSA Certified (File #LR-406)
- NOM Certified (#057)
- Backed by a Limited Two-Year Warranty

#### MATERIAL CHARACTERISTICS

Environmental: Flammability, Rated V2  
Operating Temperature: -40°C to 65°C

# 50 AMP 125, 250, 277 125/250 and 120/208V Industrial Grade Straight Blade Plugs and Connectors

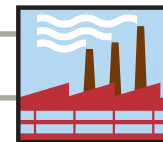

## 50 AMP Nylon Angle Plugs

### 50 AMP 125V 2-Pole 3-Wire Grounding

| DESCRIPTION | CAT. NO. | MATCHING RECEPTACLE | NEMA CONFIG.   |
|-------------|----------|---------------------|--|
| Angle Plug  | 9550-P   | 5373                | 5-50P  |

### 50 AMP 250V 2-Pole 3-Wire Grounding

|            |        |                 |  |
|------------|--------|-----------------|--|
| Angle Plug | 9650-P | 5374<br>5374-IG | 6-50P  |
|------------|--------|-----------------|--|

### 50 AMP 277V 2-Pole 3-Wire Grounding

|            |        |        |  |
|------------|--------|--------|--|
| Angle Plug | 9750-P | 9750-A | 7-50P  |
|------------|--------|--------|--|

### 50 AMP 125/250V 3-Pole 3-Wire Non-Grounding

|            |        |      |   |
|------------|--------|------|---|
| Angle Plug | 9450-P | 5206 | 10-50P  |
|------------|--------|------|---|

### 50 AMP 125/250V 3-Pole 4-Wire Grounding

|            |        |     |   |
|------------|--------|-----|---|
| Angle Plug | 9452-P | 279 | 14-50P  |
|------------|--------|-----|---|

### 50 AMP 250V 3-Pole 4-Wire 3-Phase Grounding

|            |        |                 |  |
|------------|--------|-----------------|--|
| Angle Plug | 8452-P | 8450<br>8450-IG | 15-50P  |
|------------|--------|-----------------|--|

### 50 AMP 120/208V 4-Pole 4-Wire 3ØY Non-Grounding

|            |        |      |   |
|------------|--------|------|---|
| Angle Plug | 8352-P | 8350 | 18-50P  |
|------------|--------|------|---|

For more information regarding matching receptacles, refer to Receptacles, Section G.



#### SPECIFICATIONS AND FEATURES

- Rugged cord clamp for secure cable grip accommodates cord diameters from .625" to 1.375" and does not tear conductor jacket
- Made of tough, heavy-duty nylon for long service life
- Devices feature heavy-sectioned dead-front right-angle
- Pressure-clamp terminal design
- Terminals accept up to #4AWG stranded conductors
- Four-way positioning front module
- Solid brass blades for maximum conductivity

#### TESTING AND CODE COMPLIANCE

- UL Listed (File #13393)
- UL Test 498 (CSA 42)
- CSA Certified (File #LR-406)
- NOM Certified (#057)
- Backed by a Limited Two-Year Warranty

#### MATERIAL CHARACTERISTICS

Environmental: Flammability, Rated V2  
Operating Temperature: -40°C to 65°C

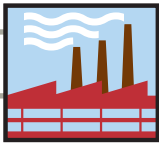

# 60 AMP 250, 125/250 and 120/208V

## Industrial Grade Straight Blade Plugs and Connectors

Straight Blade Plugs and Connectors

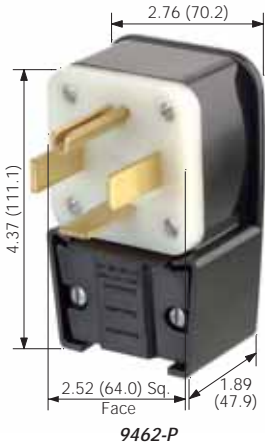

### 60 AMP Nylon Angle Plugs

#### 60 AMP 125/250V 3-Pole 4-Wire Grounding

| DESCRIPTION | CAT. NO. | MATCHING RECEPTACLE | NEMA CONFIG. |
|-------------|----------|---------------------|--------------|
| Angle Plug  | 9462-P   | 9460<br>9460-IG     | 14-60P       |

#### 60 AMP 250V 3-Pole 4-Wire 3-Phase Grounding

|            |        |      |        |
|------------|--------|------|--------|
| Angle Plug | 8462-P | 8460 | 15-60P |
|------------|--------|------|--------|

#### 60 AMP 120/208V 4-Pole 4-Wire 3ØY Non-Grounding

|            |        |      |        |
|------------|--------|------|--------|
| Angle Plug | 8362-P | 8360 | 18-60P |
|------------|--------|------|--------|

For more information regarding matching receptacles, refer to Receptacles, Section G.



#### SPECIFICATIONS AND FEATURES

- Rugged cord clamp for secure cable grip accommodates cord diameters from .625" to 1.375" and does not tear conductor jacket
- Made of tough, heavy-duty nylon for long service life
- Devices feature heavy-sectioned dead-front right-angle
- Pressure-clamp terminal design
- Terminals accept up to #4AWG stranded conductors
- Four-way positioning front module
- Solid brass blades for maximum conductivity

#### TESTING AND CODE COMPLIANCE

- UL Listed (File #13393)
- UL Test 498 (CSA 42)
- CSA Certified (File #LR-406)
- NOM Certified (#057)
- Backed by a Limited Two-Year Warranty

#### MATERIAL CHARACTERISTICS

Environmental: Flammability, Rated V2  
 Operating Temperature: -40°C to 65°C

# STRAIGHT BLADE PLUG AND CONNECTOR FEATURES

## Commercial Grade Straight Blade Plugs and Connectors

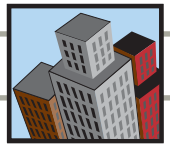

LEVITON OFFERS A LARGE SELECTION OF 15, 20, 30 AND 50 AMP COMMERCIAL GRADE STRAIGHT BLADE PLUGS AND CONNECTORS, AVAILABLE IN A WIDE VARIETY OF FEATURES.

*Leviton's Commercial Grade Straight Blade Plugs and Connectors are rugged performers. They are moisture, chemical and abuse-resistant. And they're ideal for indoor and outdoor use.*

- EPTR rubber-backed plugs and connectors stand up to rough use, protect against dirt and moisture
- Deep-slotted, backed-out terminal screws draw backwire clamps securely over stripped leads for maximum conductivity

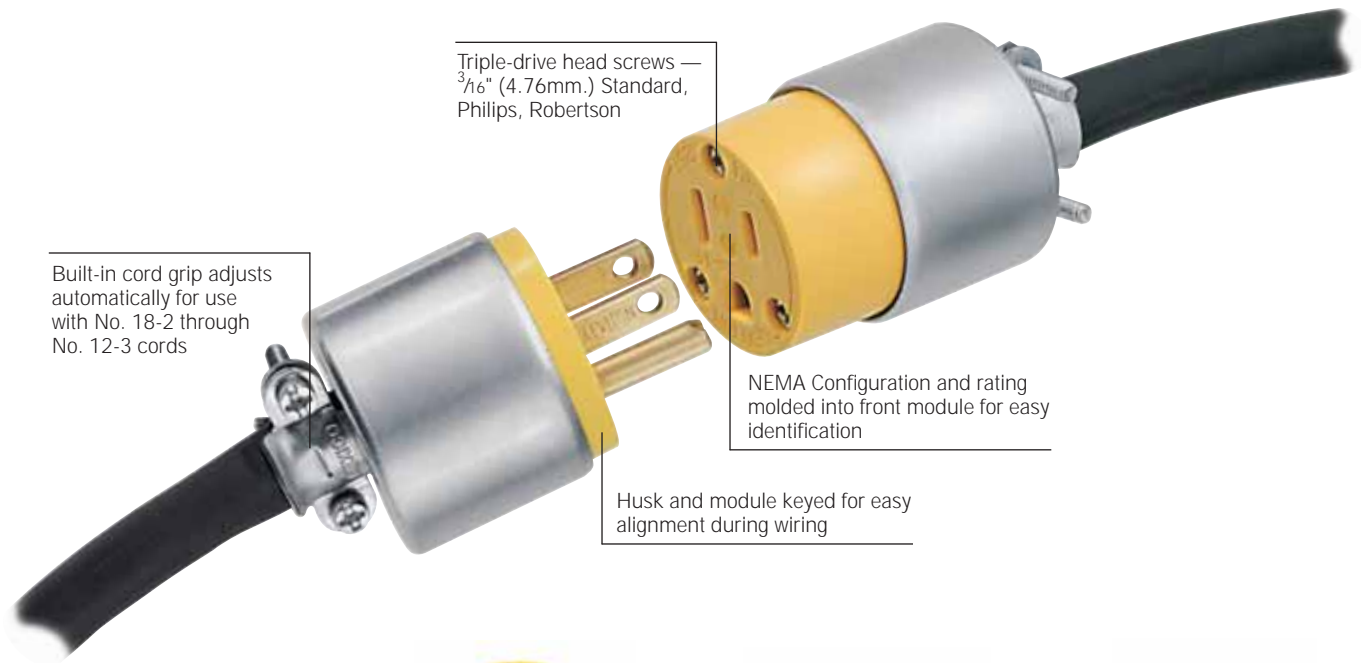

Built-in cord grip adjusts automatically for use with No. 18-2 through No. 12-3 cords

Triple-drive head screws —  $\frac{3}{16}$ " (4.76mm.) Standard, Phillips, Robertson

NEMA Configuration and rating molded into front module for easy identification

Husk and module keyed for easy alignment during wiring



**PVC Grounding Plug**  
Resists moisture and chemicals; suited for outdoor cords.  
*515PV shown*



**PVC Grounding Connector**  
Unique dimpled body design provides secure grip; resists abuse.  
*515CV shown*



**PVC Angle Grounding Plug**  
Speed-thread assembly screws tighten with just a few quick turns; impact-resistant.  
*515AN shown*



**Armored Grounding Plug**  
Ideal for shops, garages and rough-duty work with hard floors.  
*520PA shown*



**Armored Grounding Connector**  
Two-piece strain-relief clamp center cord for neat installation; able to take hard punishment.  
*615CA shown*



**Rubber Grounding Connector**  
Provides protection against rough use, dirt, moisture and temperature extremes.  
*515CR shown*



**Dual Power Vinyl Angle Plug**  
Thermoplastic body for long life; interchangeable blade configurations.  
*930 shown*



**Motor Base Inlet**  
Contains heavy gauge brass blades and thermoplastic housing.  
*5239 shown*

Straight Blade Plugs and Connectors

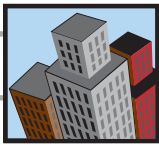

# 15 AMP 125 and 250V

## Commercial Grade Straight Blade Plugs and Connectors



515CV

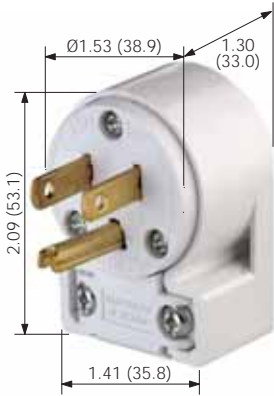

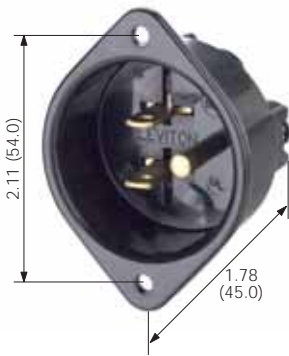

515AN





5239

### 15 AMP Plugs, Angle Plugs, Armored Plugs and Connectors

#### 15 AMP 125V 2-Pole 3-Wire Grounding

| DESCRIPTION                 | CAT. NO. | COLOR              | NEMA CONFIG.  |
|-----------------------------|----------|--------------------|---|
| PVC Grounding Plug          | 515PV    | Yellow             | 5-15P  5-15R  |
| Armored Grounding Plug      | 515PA    | Yellow/Steel Armor |   |
| Rubber Grounding Plug       | 515PR    | Black              |   |
| PVC Angle Grounding Plug    | 515AN    | White              |   |
| PVC Grounding Connector     | 515CV    | Yellow             |   |
| Armored Grounding Connector | 515CA    | Yellow/Steel Armor |   |
| Rubber Grounding Connector  | 515CR    | Black              |   |
| Motor Base Inlet            | 5239     | Black              |   |

#### 15 AMP 250V 2-Pole 3-Wire Grounding

| DESCRIPTION                 | CAT. NO. | COLOR              | NEMA CONFIG.  |
|-----------------------------|----------|--------------------|---|
| PVC Grounding Plug          | 615PV    | Yellow             | 6-15P  6-15R  |
| Armored Grounding Plug      | 615PA    | Yellow/Steel Armor |   |
| Armored Grounding Connector | 615CA    | Yellow/Steel Armor |   |
| Motor Base Inlet            | 5240     | Black              |   |

#### SPECIFICATIONS AND FEATURES

- Triple-drive head screws — Standard, Phillips, Robertson
- NEMA configuration number & rating molded on face of device for easy identification
- Rubber body is dirt and moisture resistant
- Deep-slotted, backed out terminal screws draw backwire clamps securely for maximum conductivity
- Husk & module keyed for easy alignment during wiring
- Built-in cord grip adjusts automatically for use with No. 18-3 through No. 12-3 cords (.245"-.655")
- Motor Base Inlet accepts No. 10 max. copper or copper clad wire

#### PVC Plugs & Connectors

- Rugged PVC body resists moisture and chemicals; suited for outdoor cords

- Unique dimpled body design provides a secure grip
- Speed-thread assembly screws tighten with just a few quick turns

#### Armored Plugs & Connectors

- Ideal for shops, garages and rough-duty work with hard floors
- Two piece strain-relief clamp center cord for neat installation

#### Rubber-Back Plugs & Connectors

- Designed to stand up to rough use
- No internal metal parts exposed
- Elastomeric husk provides added protection against dirt and moisture entry into the back wire port
- Designed to operate in the widest possible temperature range

#### TESTING AND CODE COMPLIANCE

- Meet NEMA requirements
- UL Listed (File #E-13393)
- CSA Certified (File #LR-406)
- NOM Certified (#057)
- Backed by a Limited 10-Year Warranty

#### MATERIAL CHARACTERISTICS



Environmental: Flammability, Rated V2 per UL 94  
Operating Temperature: -40°C to 65°C.





## Commercial Grade Straight Blade Plugs and Connectors

### 20 AMP Plugs, Angle Plugs, Armored Plugs and Connectors

#### 20 AMP 125V 2-Pole 3-Wire Grounding

| DESCRIPTION                 | CAT. NO. | COLOR              | NEMA CONFIG.  |
|-----------------------------|----------|--------------------|---|
| PVC Grounding Plug          | 520PV    | Yellow             |   |
| Armored Grounding Plug      | 520PA    | Yellow/Steel Armor |   |
| PVC Grounding Connector     | 520CV    | Yellow             | 5-20P  5-20R  |
| Armored Grounding Connector | 520CA    | Yellow/Steel Armor |   |

#### 20 AMP 250V 2-Pole 3-Wire Grounding

| DESCRIPTION                 | CAT. NO. | COLOR              | NEMA CONFIG.  |
|-----------------------------|----------|--------------------|---|
| PVC Grounding Plug          | 620PV    | Yellow             |   |
| Armored Grounding Plug      | 620PA    | Yellow/Steel Armor |   |
| PVC Grounding Connector     | 620CV    | Yellow             | 6-20P  6-20R  |
| Armored Grounding Connector | 620CA    | Yellow/Steel Armor |   |
| Rubber Back Grounding Plug  | 620PR    | Black              |   |



Straight Blade Plugs and Connectors

#### SPECIFICATIONS AND FEATURES

- Triple-drive head screws — Standard, Phillips, Robertson
- NEMA configuration number & rating molded on device for easy identification
- Dirt and moisture resistant
- Deep-slotted, backed out terminal screws draw backwire clamps securely for maximum conductivity
- Husk & module keyed for easy alignment during wiring
- Built-in cord grip adjusts automatically for use with No. 18-3 through No. 12-3 cords (.245"–.655")

#### PVC Plugs & Connectors

- Rugged PVC body resists moisture and chemicals; suited for outdoor cords
- Unique dimpled body design provides a secure grip
- Speed-thread assembly screws tighten with just a few quick turns

#### Armored Plugs & Connectors

- Ideal for shops, garages and rough-duty work with hard floors
- Two piece strain-relief clamp center cord for neat installation

#### TESTING AND CODE COMPLIANCE

- Meet NEMA requirements
- UL Listed (File #E-13393)
- CSA Certified (File #LR-406)
- NOM Certified (#057)
- Backed by a Limited 10-Year Warranty

#### MATERIAL CHARACTERISTICS

Environmental: Flammability, Rated V2 per UL 94  
Operating Temperature: -40°C to 65°C.



30 AMP—125V/50 AMP 125V, 250V/50 AMP 250V, 125/250V/50 AMP 125/250V, 125V

## Commercial Grade Straight Blade Plugs and Connectors



930

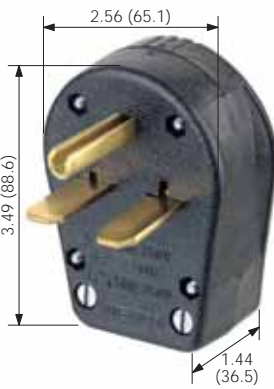

931

### 30 AMP/50 AMP Dual Power Attachment Plugs

#### 30 AMP 125V/50 AMP 125V Grounding

| DESCRIPTION   | CAT. NO. | COLOR | NEMA CONFIG. |
|---|----------|-------|--------------|
| Dual-Power Vinyl Angle Plug, Interchangeable Blades<br>Cord Dia. Range .630"–1.050" | 930      | Black | 5-30P  5-50P |

#### 30 AMP 250V/50 AMP 250V Grounding

| DESCRIPTION   | CAT. NO. | COLOR | NEMA CONFIG. |
|---|----------|-------|--------------|
| Dual-Power Vinyl Angle Plug, Interchangeable Blades<br>Cord Dia. Range .630"–1.050" | 931      | Black | 6-30P  6-50P |

#### 30 AMP 125/250V/50 AMP 125/250V Non-Grounding

| DESCRIPTION   | CAT. NO. | COLOR | NEMA CONFIG.   |
|---|----------|-------|----------------|
| Dual-Power Vinyl Angle Plug, Interchangeable Blades<br>Cord Dia. Range .687"–1.050" | 287-T    | Black | 10-30P  10-50P |

#### 30 AMP 125/250V/50 AMP 125/250V Grounding

| DESCRIPTION   | CAT. NO. | COLOR | NEMA CONFIG.   |
|---|----------|-------|----------------|
| Dual-Power Vinyl Angle Plug, Interchangeable Blades<br>Cord Dia. Range .750"–1.125" | 275-T    | Black | 14-30P  14-50P |

#### 30 AMP 125V 2-Pole 3-Wire Grounding

| DESCRIPTION  | CAT. NO. | COLOR | NEMA CONFIG.               |
|--|----------|-------|----------------------------|
| Travel Trailer Vinyl Angle Plug, for use with 7313 Receptacle<br>Cord Dia. Range .687"–.875" | 830-T    | Black | ANSI Std. C73.13<br>TT-30P |

#### SPECIFICATIONS AND FEATURES

- Tough thermoplastic shell for long life
- Shell and bottom are hinged in front for ease of assembly
- Solid brass blades with color-coded terminals simplify wiring
- Each dual combination plug supplied with 30A blades and flat 50A blade
- Dead front right angle construction
- Interchangeable blades eliminate need for stocking different devices
- Built-in rejection feature prevents closure if blades are incorrectly positioned
- Versatile cord clamp suitable for use with Nos. 14, 12, 10, 8 and 6 AWG round cord and Nos. 10/3 SRDT, 8/2-10/1 SRDT and 6/2-8/1 flat wire
- Wiring stripping gauge molded into plug cover

#### TESTING AND CODE COMPLIANCE

- Meet NEMA requirements
- UL Listed (File #13393)
- CSA Certified (File #LR-406)
- NOM Certified (File #057)
- Backed by a Limited 10-Year Warranty

#### MATERIAL CHARACTERISTICS

Environmental: Flammability, Rated V2 per UL 94  
Operating Temperature: -40°C to 65°C





## Residential Grade Straight Blade Plugs and Connectors

### 10 AMP and 15 AMP Parallel Plugs and Connectors

#### Easy Wire Plugs

| DESCRIPTION   | CAT. NO.                     | COLOR                   | CORD DIA. (inches) | WIRE GAUGE (stranded) Amperage (Watts)                         | NEMA CONFIG.        |
|---------------|------------------------------|-------------------------|--------------------|--|---------------------|
| Non-Polarized | 321<br>321-W                 | Brown<br>White          |                    | #16/2 HPN, 15A (1875 Watts)<br>#18/2 HPN, 10A (1250 Watts)     | 1-15P Non-Polarized |
| Polarized     | 321-P*<br>321-PW*            | Brown<br>White          |                    | #18/2 SPT-1, 10A (1250 Watts)<br>#18/2 SPT-2, 10A (1250 Watts) | 1-15P Polarized     |
| Non-Polarized | 123<br>123-I<br>123-W        | Brown<br>Ivory<br>White |                    | #18/2 SPT-1, 10A (1250 Watts)                                  | 1-15P Non-Polarized |
| Polarized     | 123-P*<br>123-PI*<br>123-PW* | Brown<br>Ivory<br>White |                    | #20/2 XT, 3A (375 Watts)                                       | 1-15P Polarized     |

\*Packed 500 Bulk

#### 15 AMP 125V 2-Pole, 2-Wire

| DESCRIPTION  | CAT. NO.                    | COLOR                   | CORD DIA. (inches) | WIRE GAUGE (stranded)          | NEMA CONFIG.    |
|--|-----------------------------|-------------------------|--------------------|--------------------------------|-----------------|
| Polarized Light Duty Clamptite Plug                                    | 101<br>101-W<br>101-E       | Brown<br>White<br>Black | Up to .250         | No. 20, 18, 16 Flat or Rounded |                 |
| <i>Note: Consult factory for availability of non-polarized version</i> |                             |                         |                    |                                |                 |
| Polarized Light Duty Clamptite Connector                               | 102<br>102-W<br>102-E       | Brown<br>White<br>Black | Up to .250         | No. 20, 18, 16 Flat or Rounded |                 |
| Non-Polarized Heavy-Duty PVC Plug                                      | 115PV                       | Yellow                  |                    |                                |                 |
| Non-Polarized Heavy-Duty TPE Rubber Plug                               | 115PR                       | Black                   | .245-.655"         | AWG 18-2 to 12-2 cable.        |                 |
| Non-Polarized Short Flat Vinyl Plug★                                   | 48643<br>48643-W<br>48643-E | Brown<br>White<br>Black | .375 max.          | 18-14                          | 1-15P Polarized |
| Polarized Angle Vinyl Plug★  | 638<br>638-B<br>638-W       | Black<br>Brown<br>White | .343 max.          | 16 max.                        | 1-15R Polarized |
| Non-Polarized Round Vinyl Handle Plug, w/Cord Clamp★                   | 48646                       | Black                   | .437 max.          | 18-14                          |                 |
| Non-Polarized Vinyl Connector, w/Cord Clamp★                           | 612†                        | Black                   | .437 max.          | 14 max.                        |                 |
| Non-Polarized Round Vinyl Handle Plug, w/Spring Blades★                | 48642                       | Black                   | .375 max.          | 18-14                          |                 |

†Not UL Listed. For replacement use only.  
CSA Certified except where indicated by ★

#### SPECIFICATIONS AND FEATURES

- Brass plug blades and connector contacts for maximum conductivity
- Armored devices have heavily plated steel shields and cord clamps
- Vinyl devices resist chipping, cracking, oils, grease and acids
- Rubber devices resist cold, abrasion, grease, oils, acids and impact
- Plastic devices resist grease, oils and acids

#### TESTING AND CODE COMPLIANCE

- Meet NEMA requirements (1-15P)
- UL Listed (File #E-13393)
- CSA Certified
- NOM Certified (#057)
- Backed by a Limited Two-Year Warranty

#### MATERIAL CHARACTERISTICS

Environmental: Flammability, Rated V2 per UL 94  
Operating Temperature: -40°C to 65°C

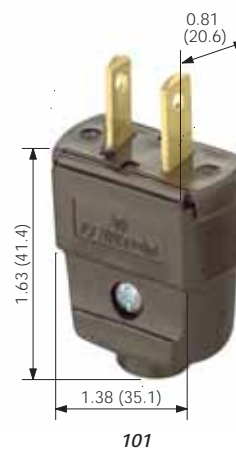
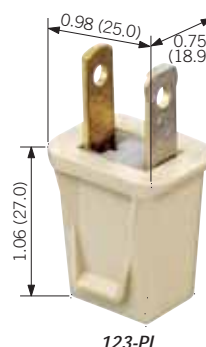
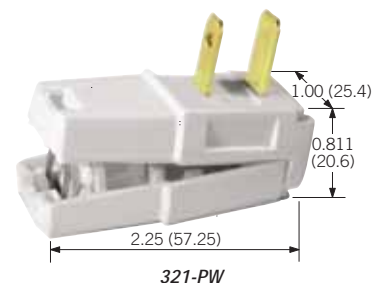



# 15 AMP 125V

## Residential Grade Straight Blade Plugs and Connectors



113





114



4937

### 15 AMP Plugs and Connectors

#### 15 AMP 125V 2-Pole, 3-Wire Grounding

| DESCRIPTION   | CAT. NO. | COLOR | CORD DIA. (inches) | WIRE GAUGE (stranded)             | NEMA CONFIG.  |
|---|----------|-------|--------------------|-----------------------------------|---|
| Vinyl Handle Plug, w/Cord Clamp★                                | 48648    | Black | .437 max.          | 18-14                             |  |
| Vinyl Connector, w/ Steel Cord Clamp                            | 617      | Black | .437 max.          | 16 max.                           |   |
| Rubber Plug w/Vinyl Inner Assembly                              | 113      | Black | .396-.562          | 18-14                             |  |
| Rubber Connector mates w/No. 113 above                          | 114      | Black | .396-.562          | 18-14                             |   |
| Weatherproof Inlet on Flush Mount Wallplate with Aluminum Cover | 4937     |       |                    | No. 10 max. copper or copper clad |   |

CSA Certified except where indicated by ★

Straight Blade Plugs and Connectors

#### SPECIFICATIONS AND FEATURES

- Double wipe brass contacts for maximum conductivity and blade retention

#### TESTING AND CODE COMPLIANCE

- Meet NEMA requirements
- UL Listed (File #E-13393)
- CSA Certified (File #LR-406)
- NOM Certified (#057)
- Backed by a Limited Two-Year Warranty

#### MATERIAL CHARACTERISTICS

Environmental: Flammability, Rated V2 per UL 94  
 Operating Temperature: -40°C to 65°C

# Locking and Corrosion Resistant Devices

## INDEX

### Industrial Specification Grade Locking Devices

|                |         |
|----------------|---------|
| Overview       | N2-N4   |
| 15 Amp Devices | N5, N6  |
| 20 Amp Devices | N7-N11  |
| 30 Amp Devices | N12-N16 |

### Wetguard® Devices

|        |          |
|--------|----------|
| 15 Amp | N17      |
| 20 Amp | N17, N18 |
| 30 Amp | N19      |

### Corrosion Resistant Devices

|        |     |
|--------|-----|
| 15 Amp | N20 |
| 20 Amp | N21 |
| 30 Amp | N22 |
| 50 Amp | N23 |

### Non-NEMA Devices

|                           |     |
|---------------------------|-----|
| 15 Amp                    | N24 |
| 20 Amp                    | N24 |
| 30 Amp                    | N25 |
| 50 Amp                    | N25 |
| 50 Amp "California Style" | N26 |

Weather Resistant Boots . . . . . N27

Power Interrupting Devices . . . . . N28

Midget Straight Blade and Locking Devices . . . . . N29

Combination Locking and  
Straight Blade Devices . . . . . N30

Integrated Inlets and Outlets with  
Weather Resistant Covers . . . . . N30



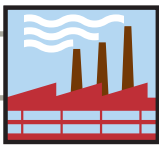

# LOCKING DEVICE FEATURES

## Industrial Grade Locking Devices

### LOCKING DEVICES FOR THE ENTIRE SPECTRUM OF INDUSTRIAL APPLICATIONS

Leviton's Industrial Grade Locking Devices are built to provide unparalleled quality and superior performance in the most severe industrial settings. The Locking Devices line represents a broad selection of plugs and connectors, locking receptacles, flanged inlets and outlets, California-style devices, midget locking devices, power interrupting devices, and non-NEMA devices. Leviton combines the best materials available with superior production standards to produce a broad selection of Locking Devices of unmatched flexibility and dependability.



Internal wiring chambers isolate individual conductors to prevent flashover, arcing, and stray strands of wire

Transparent wiring chambers provide a means of visual inspection of conductors and terminals

Color-coded terminal screws

External cord clamp utilizes deep triple drive steel screws that are backed out and positioned inside shrouded pockets. External clamp accepts wire mesh grips

Cleat on contacts cuts oxidation when plug blades enter contact surfaces

Cable gage identifies maximum cord size allowed with strain relief insert

One-piece, rivetless, .035" thick brass contacts offer enlarged contact surface areas, improved conductivity, low resistance, low heat and long life

Ergonomically designed fluted body with radial gripping ridge creates an ideal surface for gripping, turning and pulling

Combination #10-32 deep slotted/ Phillips brass screws easily torque to 10-14 in.-lbs.

- UL 498 Listed
- Federal Specification WC-596 Listed
- CSA Specification C22.2 No. 42 Certified

Color-coded terminal screws

Deep slotted/ Phillips/Robertson steel screws secure wiring module (12-14 in.-lbs) to body

Molded-in strip gage provides correct measurement for proper strip length of conductor

NEMA configuration, agency certifications and device rating are molded on front of device to assist with identification

Solid brass blades are fitted and held tightly and securely in place

Dead front construction prevents accidental contact with internal parts

Wiring module keyed to body for easy assembly

Super Tough Nylon resists damage from severe impact, abrasion and chemical attack

Speed drive screws for faster assembly

Terminal identification letters on back cover ensure quick and accurate termination



Positive crimp contact plate bundles stranded wire maximizing wire/clamp surface contact



Shrouded pockets in cord clamp prevents slippage of screwdriver blade when tightening clamp screws.



Wire clamps move within individual chambers to provide positive clamp lock without cutting wire strands.



Captive terminal screws eliminate nuisance dropping and searching for missing screws.



Deep-funnelled, large wire wells guide conductors into termination position.

Locking Devices

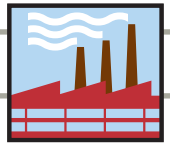

**Flanged Inlets and Outlets**  
Built to endure hard use with rugged nylon flanges that assure a smooth, flush fit and outstanding resistance to cracking and breaking.  
*2316 shown*



**Weather-Resistant Boots**  
Feature triple seal action to protect locking plugs and connectors from the harmful effects of dirt and moisture in harsh operations.  
*6034 shown*



**Midget Locking Devices**  
ML1, ML2 and ML3 Locking devices covering the entire spectrum of industrial applications where restrained space considerations are a factor.  
*ML1-C shown*



**Wetguard**  
Specifically developed for wet or damp locations. EPTR thermoplastic rubber body and rugged design resists water, acids, alkalis, grease, oils and solvents.  
*24W47 shown*

### V-MAX® LOCKING FLUSH RECEPTACLES

Engineered for maximum performance with a UL 94 V-0 Flammability Rating.



| Color-Coded Voltage Ratings |        |         |
|-----------------------------|--------|---------|
|                             |        |         |
| 125V                        | 250V   | 277V AC |
|                             |        |         |
| 125/250V                    | 3ø250V | 3ø480V  |

**LIFETIME WARRANTY**

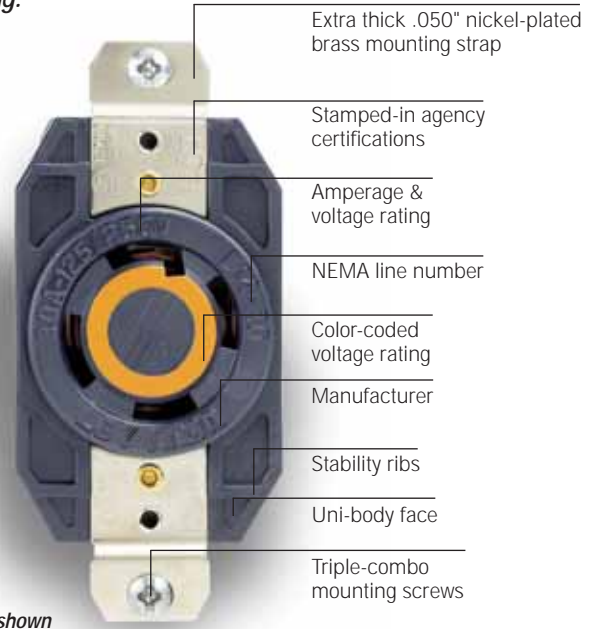

Seam between front cover and back cover is far from contact arcing

Oversized #10 brass Phillips/Robertson/Straight Slot drive terminal screw

Molded-in terminal identification letters

Multi-termination design

Accepts #8\*#14 solid or stranded conductors

Contacts deeply seated in thick walled faced



One-piece .040" thick brass, high-copper content contacts with nickel-plated clamp type terminals



Mechanically-secured all-brass ground path

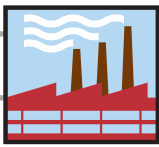

# WETGUARD® LOCKING AND CORROSION RESISTANT DEVICE FEATURES

## Industrial Grade Locking and Corrosion Resistant Devices



Clear back cover on wiring module for easy inspection of wired terminals

Rubber body is molded to bondable nylon substrate to maximize sealing capability

**LIFETIME WARRANTY**

27W47 shown

Innovative strain relief system and compression nut provide a watertight seal and prevent cord slippage

Heavy-duty, one-piece nickel-plated brass contacts for maximum conductivity

EPTB rubber parts resist water and most acids, alkalis, grease, oil, and solvents. Offers UV stability and resists fungal growth

Combination Phillips/standard assembly screws (Robertson/Slotted for Canada)

Nickel-plated brass blades, contacts, wiring screws and lugs resist corrosion

NEMA configuration number and rating molded onto device face

Cord Ranges  
.375" min., 1.125" max.

26W47 shown

Deep-fluted finger grips make for a firm grip when tightening nut

Extra large, deep wiring wells for quick, easy insertion of stranded conductors

Module and husk keyed for alignment

Non-magnetic stainless steel body assembly screws prevent electromagnetic interference



Wetguard Products are Engineered to Meet or Exceed UL and IEC Watertight Standards

- UL 498 Listed
- Federal Specification WC-596 Listed
- CSA Specification C22.2 No. 42 Certified
- Meets IP and NEMA Watertight Standards

*Leviton's Corrosion Resistant Devices are specifically designed for extremely damp and corrosive environments. They offer additional corrosive resistance because the metal parts (blades, contacts, terminals and screws) are nickel-plated. They have also passed the ASTM (B117.13) 500 hour Salt Spray (Fog) Test.*

Solid brass plug blades held tightly in individual module configurations

Non-magnetic stainless steel assembly screws will not interfere with sensitive navigational equipment

52CM-69C shown

All current-carrying metal parts (blades, contacts, terminals and screws) are electroless nickel-coated

Captive, brass #8 terminal screws are color coded for easy wiring identification

Plug blades avoid contaminants in interior chamber

Heavy-duty, impact-resistant, super tough ST801 all-nylon body construction, with sure grip fluted design

Nylon plug and connector body is distinguished by a bright yellow color for easy identification as corrosion resistant

### WEATHER RESISTANT BOOTS AND COVERS FOR CORROSION RESISTANT DEVICES

Weather-resistant boots and covers for plugs and connectors are available for 15A, 20A, 30A and 50A straight and locking plugs and connectors. The tough, rubber triple-seal design protects devices against the harmful effects of dirt and moisture. Thermoplastic covers for 15A, 20A and 30A flush receptacles have close-fitting, spring-loaded lids to protect outlets against the elements in harsh environments. Boots and covers are listed after their appropriate device.

52CM-66C shown

Wiring module keyed to body for easy assembly and tight fit

Wire clamp provides positive crimp lock without cutting wire strands



Mill-slotted, stainless steel cord clamp screws set in deep-funnelled wells

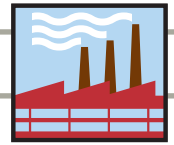



# Industrial Grade Locking Devices

## 15 AMP 125V 2-Pole 3-Wire Grounding

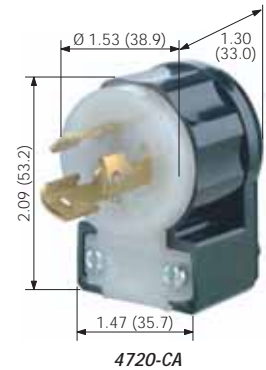
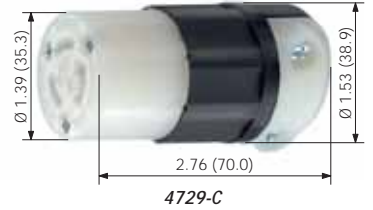

| DESCRIPTION   | CAT. NO. | NEMA CONFIG.  |
|---|----------|---|
| Dustguard™ Locking Plug, Yellow EPTR Body   | 2447     |   |
| Dustguard™ Locking Connector, Yellow EPTR Body  | 2547     |   |
| Duplex Flush Receptacle, Self Grounding, Back and Side Wired  | 4700     |   |
| Duplex Flush Receptacle w/2 Hot Feeds and 1 Neutral Return, Self Grounding, Back and Side Wired               | 4702-IIR |   |
| Duplex Flush Receptacle w/Split Feed — 2 Hot Feeds and 2 Neutral Returns, Self Grounding, Back and Side Wired | 4703-IIR |   |
| Duplex Flush Receptacle, Isolated Ground, Back and Side Wired   | 4700-IG  |   |
| Single Flush Receptacle   | 4710     |   |
| Single Flush Receptacle, w/Short Strap  | 4710-SS  |   |
| Single Flush Receptacle, Isolated Ground  | 4710-IG  |   |
| Locking Flanged Outlet  | 4715-C   |    |
| Locking Flanged Inlet   | 4716-C   |  |
| Locking Plug, Black & White Nylon Body  | 4720-C   |   |
| Power Indication™ Locking Plug, Black & White Nylon Body  | 4720-PLC |   |
| Angle Locking Plug, Black & White Nylon Body  | 4720-CA  |   |
| Locking Plug, All Black Nylon for Stage and Studio  | 4720-CB  |   |
| Locking Plug, Yellow Nylon Body   | 4720-CY  |   |
| Locking Connector, Black & White Nylon Body   | 4729-C   |   |
| Power Indication™ Locking Connector, Black Nylon Body   | 4729-PLC |   |
| Locking Connector, All Black Nylon for Stage and Studio   | 4729-CB  |   |
| Locking Connector, Yellow Nylon Body  | 4729-CY  |   |



Weather-Resistant Boots for 15A Locking Plugs and Connectors are listed on page N27

**Cord Clamp Range**—Black & White Plugs and Connectors: .240"–.700" #18–#10 AWG Dustguard Plugs and Connectors: .240"–.655" #18–#12 AWG

### Wallplates and Covers

| 302 STAINLESS STEEL SINGLE RECEPTACLE   | 302 STAINLESS STEEL DUPLEX RECEPTACLE   | WEATHER-RESISTANT FLIP LID COVER FOR INLETS AND OUTLETS                             |
|---|---|---|
| 1.41" Dia. Opening  |   | IP64 Rated—Includes Gasket and Screws   |
|  |  |  |
| 84004-40  | 84003-40  | WP1   |

For complete wallplate selection, see Section E.

### SPECIFICATIONS AND FEATURES

#### Locking Flush Receptacles

- Rugged nylon body and cover for outstanding resistance to impact and harsh chemicals
- Double-wipe phosphor-bronze power contacts

#### Locking Plugs and Connectors

- Super tough Nylon body resists damage from severe impact, abrasion and chemicals
- Ergonomic, fluted body design with radial grip ridge is ideal for gripping, turning and pulling
- Cord clamp does not have to be disassembled from body for wiring—accepts all wire mesh strain reliefs
- One-piece, rivetless .035" thick brass connector contacts and solid brass plug blades provide maximum conductivity and long service life
- Power Indication™ 15A Locking Plugs & Connectors equipped with green neon bulb rated at 30,000 hours (24/7) for 3.5 years

#### Flanged Inlets and Outlets

- Rugged nylon flange fits flush and won't crack in high-abuse applications
- Individual deep-funneled chamfered wire wells guide each wire into rectangular chambers
- Wire clamps provide positive crimp lock without cutting wire strands

#### Dustguard Plugs and Connectors

- IEC IP44 Rated
- Developed to withstand dusty and dirty environments, cracking and fading, temperature extremes
- Rugged wiring modules have high performance single-piece brass triple-wipe contacts, solid brass plug blades

### TESTING AND CODE COMPLIANCE

- All receptacles, plugs, connectors, inlets and outlets are designed to meet NEMA WD-6, and ANSI C-73, and to meet/exceed UL 498 standards
- UL Fed. Spec. Listed WC-596 – Plugs, Connectors and Flanged Inlets (File #E-13393), Receptacles and Flanged Outlets (File #E-13399)
- CSA Certified (File #LR-406)
- NOM Certified (#057)
- Backed by a Lifetime Warranty

### MATERIAL CHARACTERISTICS

Environmental: Flammability Rated V2 per UL94  
Operating Temperature: -40°C to 60°C

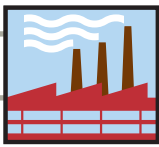

# 15 AMP 250V, 277V and 3Ø 250V

## Industrial Grade Locking Devices



4570-CA

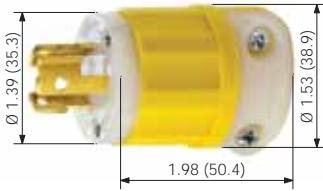

4570-CY

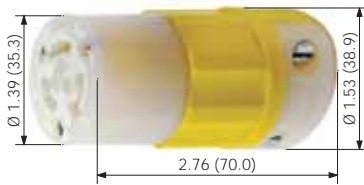

4579-CY

**Cord Clamp Range**—Black & White Plugs and Connectors: .240"–.700" #18–#10 AWG

### 15 AMP 250V 2-Pole 3-Wire Grounding

| DESCRIPTION   | CAT. NO. | NEMA CONFIG.   |
|---|----------|----------------|
| Duplex Flush Receptacle, Self Grounding, Back and Side Wired  | 4550     |                |
| Duplex Flush Receptacle, Isolated Ground, Back and Side Wired | 4550-IG  |                |
| Single Flush Receptacle                                       | 4560     |                |
| Single Flush Receptacle, Isolated Ground                      | 4560-IG  |                |
| Locking Plug, Black & White Nylon Body                        | 4570-C   |                |
| Power Indication™ Locking Plug, Black & White Nylon Body      | 4570-PLC |                |
| Angle Locking Plug, Black & White Nylon Body                  | 4570-CA  | L6-15P  L6-15R |
| Locking Plug, Yellow Nylon Body                               | 4570-CY  |                |
| Locking Connector, Black & White Nylon Body                   | 4579-C   |                |
| Power Indication™ Locking Connector, Black & White Nylon Body | 4579-PLC |                |
| Locking Connector, Yellow Nylon Body                          | 4579-CY  |                |
| Locking Flanged Outlet  | 4585-C   |                |
| Locking Flanged Inlet   | 4586-C   |                |

### 15 AMP 277V 2-Pole 3-Wire Grounding

| DESCRIPTION   | CAT. NO. | NEMA CONFIG.   |
|---|----------|----------------|
| Duplex Flush Receptacle, Self Grounding, Back and Side Wired  | 4750     |                |
| Duplex Flush Receptacle, Isolated Ground, Back and Side Wired | 4750-IG  |                |
| Single Flush Receptacle                                       | 4760     |                |
| Single Flush Receptacle, Isolated Ground                      | 4760-IG  |                |
| Locking Plug, Black & White Nylon Body                        | 4770-C   |                |
| Power Indication™ Locking Plug, Black & White Nylon Body      | 4770-PLC |                |
| Angle Locking Plug, Black & White Nylon Body                  | 4770-CA  | L7-15P  L7-15R |
| Locking Plug, Yellow Nylon Body                               | 4770-CY  |                |
| Locking Connector, Black & White Nylon Body                   | 4779-C   |                |
| Locking Connector, Yellow Nylon Body                          | 4779-CY  |                |
| Power Indication™ Locking Connector, Black & White Nylon Body | 4779-PLC |                |
| Locking Flanged Outlet  | 4785-C   |                |
| Locking Flanged Inlet   | 4786-C   |                |

### 15 AMP 3Ø 250V 3-Pole 3-Wire Non-Grounding

| DESCRIPTION                                 | CAT. NO. | NEMA CONFIG.     |
|---|----------|------------------|
| Single Flush Receptacle                     | 4870     |                  |
| Locking Plug, Black & White Nylon Body      | 4880-C   | L11-15P  L11-15R |
| Locking Connector, Black & White Nylon Body | 4889-C   |                  |

*Weather-Resistant Boots for 15A Locking Plugs and Connectors are listed on page N27*

### Wallplates and Covers

| 302 STAINLESS STEEL SINGLE RECEPTACLE | 302 STAINLESS STEEL DUPLEX RECEPTACLE | WEATHER-RESISTANT FLIP LID COVER FOR INLETS AND OUTLETS |
|---------------------------------------|---------------------------------------|---|
| 1.41" Dia. Opening                    |                                       | IP64 Rated—Includes Gasket and Screws                   |
|                                       |                                       |   |
| 84004-40                              | 84003-40                              | WP1   |

*For complete wallplate selection, see Section E.*

#### SPECIFICATIONS AND FEATURES

##### Locking Flush Receptacles

- Rugged nylon body and cover for outstanding resistance to impact and harsh chemicals
- Double-wipe phosphor-bronze power contacts

##### Locking Plugs and Connectors

- Super tough Nylon body resists damage from severe impact, abrasion and chemicals
- Ergonomic, fluted body design with radial grip ridge is ideal for gripping, turning and pulling
- Cord clamp does not have to be disassembled from body for wiring—accepts all wire mesh strain reliefs

- One-piece, rivetless .035" thick brass connector contacts and solid brass plug blades provide maximum conductivity and long service life
- Power Indication™ 15A Locking Plugs & Connectors equipped with green neon bulb rated at 30,000 hours (24/7) for 3.5 years

##### Flanged Inlets and Outlets

- Rugged nylon flange fits flush and won't crack in high-abuse applications
- Individual deep-funneled chamfered wire wells guide each wire into rectangular chambers
- Wire clamps provide positive crimp lock without cutting wire strands

#### TESTING AND CODE COMPLIANCE

- All receptacles, plugs, connectors, inlets and outlets are designed to meet NEMA WD-6, and ANSI C-73, and to meet/exceed UL 498 standards
- UL Fed Spec. Listed WC-596 – Plugs, Connectors and Flanged Inlets (File #E-13393), Receptacles and Flanged Outlets (File #E-13399)
- CSA Certified (File #LR-406)
- NOM Certified (#057)
- Backed by a Lifetime Warranty

#### MATERIAL CHARACTERISTICS

Environmental: Flammability Rated V2 per UL94  
Operating Temperature: -40°C to 60°C





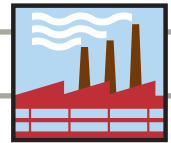

**20 AMP 125V 2-Pole 3-Wire Grounding**

| DESCRIPTION   | CAT. NO. | NEMA CONFIG. |
|---|----------|--------------|
| V-O-MAX® Single Flush Receptacle                              | 2310     |              |
| V-O-MAX® Single Flush Receptacle, Isolated Ground             | 2310-IG  |              |
| Locking Plug, Black & White Nylon Body                        | 2311     |              |
| Power Indication™ Locking Plug, Black & White Nylon Body      | 2311-PLC |              |
| Locking Plug, all Black for Stage and Studio                  | 2311-B   |              |
| Power Indication™ Locking Plug, All-Black Nylon Body          | 2311-PLB |              |
| Locking Plug, Yellow Nylon Body                               | 2311-CY  |              |
| Locking Connector, Black & White Nylon Body                   | 2313     |              |
| Power Indication™ Locking Connector, Black & White Nylon Body | 2313-PLC |              |
| Locking Connector, all Black for Stage and Studio             | 2313-B   |              |
| Power Indication™ Locking Connector, All-Black Nylon Body     | 2313-PLB |              |
| Locking Connector, Yellow Nylon Body                          | 2313-CY  |              |
| Locking Flanged Inlet   | 2315     |              |
| Locking Flanged Outlet  | 2316     |              |

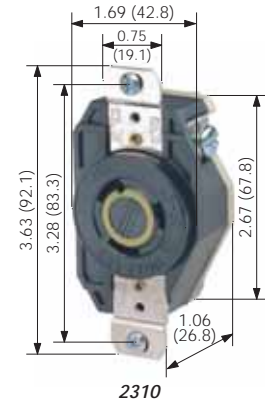

**20 AMP 250V 2-Pole 3-Wire Grounding**

| DESCRIPTION   | CAT. NO. | NEMA CONFIG. |
|---|----------|--------------|
| V-O-MAX® Single Flush Receptacle                              | 2320     |              |
| V-O-MAX® Single Flush Receptacle, Isolated Ground             | 2320-IG  |              |
| Locking Plug, Black & White Nylon Body                        | 2321     |              |
| Power Indication™ Locking Plug, Black & White Nylon Body      | 2321-PLC |              |
| Power Indication™ Locking Plug, All-Black Nylon Body          | 2321-PLB |              |
| Locking Plug, Yellow Nylon Body                               | 2321-CY  |              |
| Locking Connector, Black & White Nylon Body                   | 2323     |              |
| Power Indication™ Locking Connector, Black & White Nylon Body | 2323-PLC |              |
| Power Indication™ Locking Connector, All-Black Nylon Body     | 2323-PLB |              |
| Locking Connector, Yellow Nylon Body                          | 2323-CY  |              |
| Locking Flanged Inlet   | 2325     |              |
| Locking Flanged Outlet  | 2326     |              |



**20 AMP 277V 2-Pole 3-Wire Grounding**

| DESCRIPTION   | CAT. NO. | NEMA CONFIG. |
|---|----------|--------------|
| V-O-MAX® Single Flush Receptacle                              | 2330     |              |
| V-O-MAX® Single Flush Receptacle, Isolated Ground             | 2330-IG  |              |
| Locking Plug, Black & White Nylon Body                        | 2331     |              |
| Power Indication™ Locking Plug, Black & White Nylon Body      | 2331-PLC |              |
| Locking Connector, Black Nylon Body                           | 2333     |              |
| Power Indication™ Locking Connector, Black & White Nylon Body | 2333-PLC |              |
| Locking Flanged Inlet   | 2335     |              |
| Locking Flanged Outlet  | 2336     |              |



Weather-Resistant Boots for 20A Locking Plugs and Connectors are listed on page N27

For recommended Wallplates and Covers, see page N8.  
For complete wallplate selection, see Section E.

Cord Clamp Range—Black & White Plugs and Connectors: .385"–.780" #16–#10 AWG

**SPECIFICATIONS AND FEATURES**

**V-O-Max® Locking Flush Receptacles**

- UL 94 V-O Flammability Rating, the best rating of any material used in Industrial Locking Flush Receptacles available today
- Extra-thick .050" nickel-plated brass mounting strap for high-abuse applications
- Designed for maximum durability: One-piece .040" brass, high copper-content contacts with nickel-plated clamp-type terminals
- Color-coded voltage rating on face for easy identification

**Locking Plugs and Connectors**

- Super tough Nylon body resists damage from severe impact, abrasion and chemicals
- Ergonomic, fluted body design with radial grip ridge is ideal for gripping, turning and pulling

- Cord clamp does not have to be disassembled from body for wiring—accepts all wire mesh strain reliefs
- One-piece, rivetless .035" thick brass connector contacts and solid brass plug blades provide maximum conductivity and long service life
- Power Indication™ 20A Locking Plugs & Connectors equipped with green LED rated at 100,000 hours (24/7) for 11.5 years

**Flanged Inlets and Outlets**

- Rugged nylon flange fits flush and won't crack in high-abuse applications
- Individual deep-funneled chamfered wire wells guide each wire into rectangular chambers
- Wire clamps provide positive crimp lock without cutting wire strands

**TESTING AND CODE COMPLIANCE**

- All receptacles, plugs, connectors, inlets and outlets are designed to meet NEMA WD-6, and ANSI C-73, and to meet/exceed UL 498 standards
- UL Fed Spec. Listed WC-596 – Plugs, Connectors and Flanged Inlets (File #E-13393), Receptacles and Flanged Outlets (File #E-13399)
- CSA Certified (File #LR-406)
- NOM Certified (#057)
- Backed by a Lifetime Warranty

**MATERIAL CHARACTERISTICS**

Environmental: Flammability Rated V2 per UL94, V-O-MAX® Receptacles Rated V0  
Operating Temperature: -40°C to 60°C

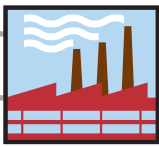

# 20 AMP 347V, 480V, 600V and 125/250V

## Industrial Grade Locking Devices

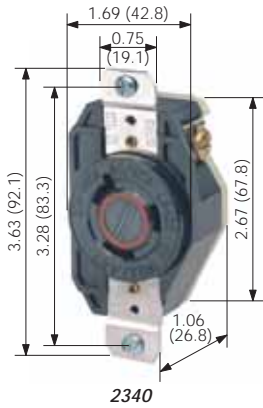

2340



2341



2343



2365

### 20 AMP 347V 2-Pole 3-Wire Grounding

| DESCRIPTION                                 | CAT. NO. | NEMA CONFIG.     |
|---|----------|------------------|
| V-O-MAX® Single Flush Receptacle            | 3720     |                  |
| Locking Plug, Black & White Nylon Body      | 3721     | L24-20P  L24-20R |
| Locking Connector, Black & White Nylon Body | 3723     |                  |
| Locking Flanged Inlet                       | 3755     |                  |
| Locking Flanged Outlet                      | 3756     |                  |

### 20 AMP 480V 2-Pole 3-Wire Grounding

| DESCRIPTION                                       | CAT. NO. | NEMA CONFIG.   |
|---|----------|----------------|
| V-O-MAX® Single Flush Receptacle                  | 2340     |                |
| V-O-MAX® Single Flush Receptacle, Isolated Ground | 2340-IG  |                |
| Locking Plug, Black & White Nylon Body            | 2341     | L8-20P  L8-20R |
| Locking Connector, Black & White Nylon Body       | 2343     |                |
| Locking Flanged Inlet                             | 2345     |                |
| Locking Flanged Outlet                            | 2346     |                |

### 20 AMP 600V 2-Pole 3-Wire Grounding

| DESCRIPTION                                       | CAT. NO. | NEMA CONFIG.   |
|---|----------|----------------|
| V-O-MAX® Single Flush Receptacle                  | 2350     |                |
| V-O-MAX® Single Flush Receptacle, Isolated Ground | 2350-IG  |                |
| Locking Plug, Black & White Nylon Body            | 2351     | L9-20P  L9-20R |
| Locking Connector, Black & White Nylon Body       | 2353     |                |
| Locking Flanged Inlet                             | 2355     |                |
| Locking Flanged Outlet                            | 2356     |                |

### 20 AMP 125/250V 3-Pole 3-Wire Non-Grounding

| DESCRIPTION                                 | CAT. NO. | NEMA CONFIG.     |
|---|----------|------------------|
| Single Flush Receptacle                     | 2360     |                  |
| Locking Plug, Black & White Nylon Body      | 2361     | L10-20P  L10-20R |
| Locking Connector, Black & White Nylon Body | 2363     |                  |
| Locking Flanged Inlet                       | 2365     |                  |
| Locking Flanged Outlet                      | 2366     |                  |

Weather-Resistant Boots for 20A Locking Plugs and Connectors are listed on page N27

Cord Clamp Range—Black & White Plugs and Connectors: .385"–.780" #16–#10 AWG

### Wallplates and Covers

| 302 STAINLESS STEEL SINGLE RECEPTACLE | WEATHER-RESISTANT FLIP LID COVER FOR 20A INLETS/OUTLETS AND 20A RECEPTACLES | WEATHER-RESISTANT THERMOPLASTIC COVER FOR RECEPTACLES |
|---------------------------------------|---|---|
| 1.60" Dia. Opening                    | IP64 Rated—Includes Gasket and Screws                                       | Self-Closing Lid—Includes Gasket and Screws           |
|                                       |   |   |
| 84020-40                              | WP2 for Inlets/Outlets 7420-CR for Receptacles                              | 4980-GY   |

For complete wallplate selection, see Section E.

#### SPECIFICATIONS AND FEATURES

##### V-O-Max® Locking Flush Receptacles

- UL 94 V-O Flammability Rating, the best rating of any material used in Industrial Locking Flush Receptacles available today
- Extra-thick .050" nickel-plated brass mounting strap for high-abuse applications
- Designed for maximum durability: One-piece .040" brass, high copper-content contacts with nickel-plated clamp-type terminals
- Color-coded voltage rating on face for easy identification

##### Locking Plugs and Connectors

- Super tough Nylon body resists damage from severe impact, abrasion and chemicals

- Ergonomic, fluted body design with radial grip ridge is ideal for gripping, turning and pulling
- Cord clamp does not have to be disassembled from body for wiring—accepts all wire mesh strain reliefs
- One-piece, rivetless .035" thick brass connector contacts and solid brass plug blades provide maximum conductivity and long service life

##### Flanged Inlets and Outlets

- Rugged nylon flange fits flush and won't crack in high-abuse applications
- Individual deep-funneled chamfered wire wells guide each wire into rectangular chambers
- Wire clamps provide positive crimp lock without cutting wire strands

#### TESTING AND CODE COMPLIANCE

- All receptacles, plugs, connectors, inlets and outlets are designed to meet NEMA WD-6, and ANSI C-73, and to meet/exceed UL 498 standards
- UL Fed Spec. Listed WC-596 – Plugs, Connectors and Flanged Inlets (File #E-13393), Receptacles and Flanged Outlets (File #E-13399)
- CSA Certified (File #LR-406)
- NOM Certified (#057)
- Backed by a Lifetime Warranty

#### MATERIAL CHARACTERISTICS

Environmental: Flammability Rated V2 per UL94, V-O-MAX® Receptacles Rated V0  
Operating Temperature: -40°C to 60°C

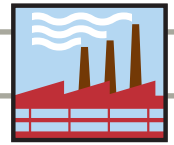

Industrial Grade Locking Devices

20 AMP 3Ø 250V 3-Pole 3-Wire Non-Grounding

| DESCRIPTION                                 | CAT. NO. | NEMA CONFIG.     |
|---|----------|------------------|
| Single Flush Receptacle                     | 2370     |                  |
| Locking Plug, Black & White Nylon Body      | 2371     |                  |
| Locking Connector, Black & White Nylon Body | 2373     | L11-20P  L11-20R |
| Locking Flanged Inlet                       | 2375     |                  |
| Locking Flanged Outlet                      | 2376     |                  |

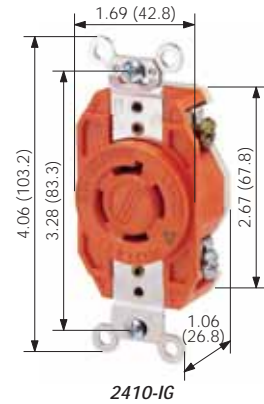

20 AMP 3Ø 480V 3-Pole 3-Wire Non-Grounding

| DESCRIPTION                                 | CAT. NO. | NEMA CONFIG.     |
|---|----------|------------------|
| Single Flush Receptacle                     | 2380     |                  |
| Locking Plug, Black & White Nylon Body      | 2381     |                  |
| Locking Connector, Black & White Nylon Body | 2383     | L12-20P  L12-20R |
| Locking Flanged Inlet                       | 2385     |                  |
| Locking Flanged Outlet                      | 2386     |                  |

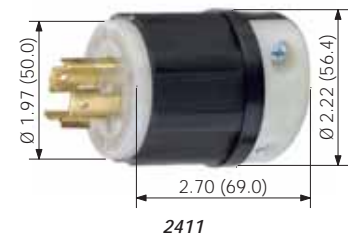

20 AMP 125/250V 3-Pole 4-Wire Grounding

| DESCRIPTION                                       | CAT. NO. | NEMA CONFIG.     |
|---|----------|------------------|
| V-O-MAX® Single Flush Receptacle                  | 2410     |                  |
| V-O-MAX® Single Flush Receptacle, Isolated Ground | 2410-IG  |                  |
| Locking Plug, Black & White Nylon Body            | 2411     |                  |
| Locking Connector, Black & White Nylon Body       | 2413     | L14-20P  L14-20R |
| Locking Flanged Inlet                             | 2415     |                  |
| Locking Flanged Outlet                            | 2416     |                  |



20 AMP 3Ø 250V 3-Pole 4-Wire Grounding

| DESCRIPTION                                       | CAT. NO. | NEMA CONFIG.     |
|---|----------|------------------|
| V-O-MAX® Single Flush Receptacle                  | 2420†    |                  |
| V-O-MAX® Single Flush Receptacle, Isolated Ground | 2420-IG† |                  |
| Locking Plug, Black & White Nylon Body            | 2421     |                  |
| Locking Connector, Black & White Nylon Body       | 2423     | L15-20P  L15-20R |
| Locking Flanged Inlet                             | 2425     |                  |
| Locking Flanged Outlet                            | 2426     |                  |

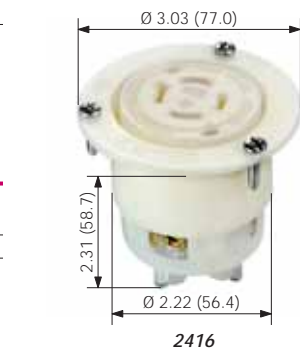

Weather-Resistant Boots for 20A Locking Plugs and Connectors are listed on page N27

**Cord Clamp Range**—Black & White Plugs and Connectors 3-Wire: .385"–.780" #16–#10 AWG  
4-Wire: .595"–.895" #14–#10 AWG

Wallplates and Covers

| 302 STAINLESS STEEL SINGLE RECEPTACLE | WEATHER-RESISTANT FLIP LID COVER FOR 20A INLETS/OUTLETS AND 20A RECEPTACLES | WEATHER-RESISTANT THERMOPLASTIC COVER FOR RECEPTACLES |
|---------------------------------------|---|---|
| 1.60" Dia. Opening                    | IP64 Rated—Includes Gasket and Screws                                       | Self-Closing Lid—Includes Gasket and Screws           |
|                                       |   |   |
| 84020-40                              | WP2 for Inlets/Outlets 7420-CR for Receptacles                              | 4980-GY   |

For complete wallplate selection, see Section E.

SPECIFICATIONS AND FEATURES

V-O-Max® Locking Flush Receptacles

- UL 94 V-O Flammability Rating, the best rating of any material used in Industrial Locking Flush Receptacles available today
- Extra-thick .050" nickel-plated brass mounting strap for high-abuse applications
- Designed for maximum durability: One-piece .040" brass, high copper-content contacts with nickel-plated clamp-type terminals
- Color-coded voltage rating on face for easy identification

Locking Plugs and Connectors

- Super tough Nylon body resists damage from severe impact, abrasion and chemicals

- Ergonomic, fluted body design with radial grip ridge is ideal for gripping, turning and pulling
- Cord clamp does not have to be disassembled from body for wiring—accepts all wire mesh strain reliefs
- One-piece, rivetless .035" thick brass connector contacts and solid brass plug blades provide maximum conductivity and long service life

Flanged Inlets and Outlets

- Rugged nylon flange fits flush and won't crack in high-abuse applications
- Individual deep-funneled chamfered wire wells guide each wire into rectangular chambers
- Wire clamps provide positive crimp lock without cutting wire strands

TESTING AND CODE COMPLIANCE

- All receptacles, plugs, connectors, inlets and outlets are designed to meet NEMA WD-6, and ANSI C-73, and to meet/exceed UL 498 standards
- UL Fed Spec. Listed WC-596 – Plugs, Connectors and Flanged Inlets (File #E-13393), Receptacles and Flanged Outlets (File #E-13399)
- CSA Certified (File #LR-406)
- NOM Certified (#057)
- Backed by a Lifetime Warranty

MATERIAL CHARACTERISTICS

Environmental: Flammability Rated V2 per UL94, V-O-MAX® Receptacles Rated V0  
Operating Temperature: -40°C to 60°C

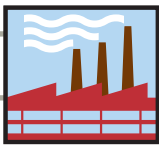

# 20 AMP 3Ø 480V; 3ØY 120/208V, 277/480V and 347/600V

## Industrial Grade Locking Devices

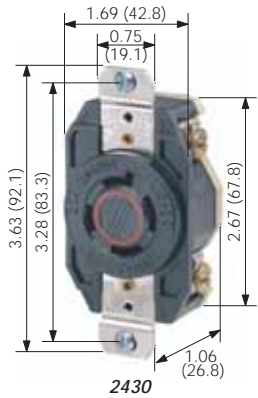

2430



2431



2433



2435

### 20 AMP 3Ø 480V 3-Pole 4-Wire Grounding

| DESCRIPTION                                       | CAT. NO. | NEMA CONFIG. |
|---|----------|--------------|
| V-O-MAX® Single Flush Receptacle                  | 2430     |              |
| V-O-MAX® Single Flush Receptacle, Isolated Ground | 2430-IG  |              |
| Locking Plug, Black & White Nylon Body            | 2431     | L16-20P      |
| Locking Connector, Black & White Nylon Body       | 2433     | L16-20R      |
| Locking Flanged Inlet                             | 2435     |              |
| Locking Flanged Outlet                            | 2436     |              |

### 20 AMP 3ØY 120/208V 4-Pole 4-Wire Non-Grounding

| DESCRIPTION                                 | CAT. NO. | NEMA CONFIG. |
|---|----------|--------------|
| Single Flush Receptacle                     | 2440     |              |
| Locking Plug, Black & White Nylon Body      | 2441     | L18-20P      |
| Locking Connector, Black & White Nylon Body | 2443     | L18-20R      |
| Locking Flanged Inlet                       | 2445     |              |
| Locking Flanged Outlet                      | 2446     |              |

### 20 AMP 3ØY 277/480V 4-Pole 4-Wire Non-Grounding

| DESCRIPTION                                 | CAT. NO. | NEMA CONFIG. |
|---|----------|--------------|
| Single Flush Receptacle                     | 2450     |              |
| Locking Plug, Black & White Nylon Body      | 2451     | L19-20P      |
| Locking Connector, Black & White Nylon Body | 2453     | L19-20R      |
| Locking Flanged Inlet                       | 2455     |              |
| Locking Flanged Outlet                      | 2456     |              |

### 20 AMP 3ØY 347/600V 4-Pole 4-Wire Non-Grounding

| DESCRIPTION                                 | CAT. NO. | NEMA CONFIG. |
|---|----------|--------------|
| Single Flush Receptacle                     | 2460     |              |
| Locking Plug, Black & White Nylon Body      | 2461     | L20-20P      |
| Locking Connector, Black & White Nylon Body | 2463     | L20-20R      |
| Locking Flanged Inlet                       | 2465     |              |
| Locking Flanged Outlet                      | 2466     |              |

Weather-Resistant Boots for 20A Locking Plugs and Connectors are listed on page N27

Cord Clamp Range—Black & White Plugs and Connectors: .595"–.895" #14–#10 AWG

### Wallplates and Covers

| 302 STAINLESS STEEL SINGLE RECEPTACLE<br>1.60" Dia. Opening | WEATHER-RESISTANT FLIP LID COVER FOR 20A INLETS/OUTLETS AND 20A RECEPTACLES<br>IP64 Rated—Includes Gasket and Screws | WEATHER-RESISTANT THERMOPLASTIC COVER FOR RECEPTACLES<br>Self-Closing Lid—Includes Gasket and Screws |
|---|--|--|
|   |  |  |
| 84020-40  | WP2 for Inlets/Outlets    7420-CR for Receptacles  | 4980-GY  |

For complete wallplate selection, see Section E.

### SPECIFICATIONS AND FEATURES

#### V-O-Max® Locking Flush Receptacles

- UL 94 V-O Flammability Rating, the best rating of any material used in Industrial Locking Flush Receptacles available today
- Extra-thick .050" nickel-plated brass mounting strap for high-abuse applications
- Designed for maximum durability: One-piece .040" brass, high copper-content contacts with nickel-plated clamp-type terminals
- Color-coded voltage rating on face for easy identification

#### Locking Plugs and Connectors

- Super tough Nylon body resists damage from severe impact, abrasion and chemicals

- Ergonomic, fluted body design with radial grip ridge is ideal for gripping, turning and pulling
- Cord clamp does not have to be disassembled from body for wiring—accepts all wire mesh strain reliefs
- One-piece, rivetless .035" thick brass connector contacts and solid brass plug blades provide maximum conductivity and long service life

#### Flanged Inlets and Outlets

- Rugged nylon flange fits flush and won't crack in high-abuse applications
- Individual deep-funneled chamfered wire wells guide each wire into rectangular chambers
- Wire clamps provide positive crimp lock without cutting wire strands

### TESTING AND CODE COMPLIANCE

- All receptacles, plugs, connectors, inlets and outlets are designed to meet NEMA WD-6, and ANSI C-73, and to meet/exceed UL 498 standards
- UL Fed Spec. Listed WC-596 – Plugs, Connectors and Flanged Inlets (File #E-13393), Receptacles and Flanged Outlets (File #E-13399)
- CSA Certified (File #LR-406)
- NOM Certified (#057)
- Backed by a Lifetime Warranty

### MATERIAL CHARACTERISTICS

Environmental: Flammability Rated V2 per UL94, V-O-MAX® Receptacles Rated V0  
Operating Temperature: -40°C to 60°C

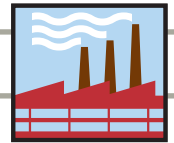

Industrial Grade Locking Devices

20 AMP 3ØY 120/208V 4-Pole 5-Wire Grounding

| DESCRIPTION                                       | CAT. NO. | NEMA CONFIG.     |
|---|----------|------------------|
| V-O-MAX® Single Flush Receptacle                  | 2510     |                  |
| V-O-MAX® Single Flush Receptacle, Isolated Ground | 2510-IG  |                  |
| Locking Plug, Black & White Nylon Body            | 2511     | L21-20P  L21-20R |
| Locking Connector, Black & White Nylon Body       | 2513     |                  |
| Locking Flanged Inlet                             | 2515     |                  |
| Locking Flanged Outlet                            | 2516     |                  |

20 AMP 3ØY 277/480V 4-Pole 5-Wire Grounding

| DESCRIPTION                                       | CAT. NO. | NEMA CONFIG.     |
|---|----------|------------------|
| V-O-MAX® Single Flush Receptacle                  | 2520     |                  |
| V-O-MAX® Single Flush Receptacle, Isolated Ground | 2520-IG  |                  |
| Locking Plug, Black & White Nylon Body            | 2521     | L22-20P  L22-20R |
| Locking Connector, Black & White Nylon Body       | 2523     |                  |
| Locking Flanged Inlet                             | 2525     |                  |
| Locking Flanged Outlet                            | 2526     |                  |

20 AMP 3ØY 347/600V 4-Pole 5-Wire Grounding

| DESCRIPTION                                 | CAT. NO. | NEMA CONFIG.     |
|---|----------|------------------|
| Single Flush Receptacle                     | 2530     |                  |
| Single Flush Receptacle, Isolated Ground    | 2530-IG  |                  |
| Locking Plug, Black & White Nylon Body      | 2531     | L23-20P  L23-20R |
| Locking Connector, Black & White Nylon Body | 2533     |                  |
| Locking Flanged Inlet                       | 2545     |                  |
| Locking Flanged Outlet                      | 2546     |                  |

Weather-Resistant Boots for 20A Locking Plugs and Connectors are listed on page N27

Cord Clamp Range—Black & White Plugs and Connectors: .595"–.895" #14–#10 AWG

Wallplates and Covers

| 302 STAINLESS STEEL SINGLE RECEPTACLE | WEATHER-RESISTANT FLIP LID COVER FOR 20A INLETS/OUTLETS AND 20A RECEPTACLES | WEATHER-RESISTANT THERMOPLASTIC COVER FOR RECEPTACLES |
|---------------------------------------|---|---|
| 1.60" Dia. Opening                    | IP64 Rated—Includes Gasket and Screws                                       | Self-Closing Lid—Includes Gasket and Screws           |
|                                       |   |   |
| 84020-40                              | WP2 for Inlets/Outlets 7420-CR for Receptacles                              | 4980-GY   |

For complete wallplate selection, see Section E.



Locking Devices

SPECIFICATIONS AND FEATURES

Locking Flush Receptacles

- UL 94 V-O Flammability Rating, the best rating of any material used in Industrial Locking Flush Receptacles available today
- Extra-thick .050" nickel-plated brass mounting strap for high-abuse applications
- Designed for maximum durability: One-piece .040" brass, high copper-content contacts with nickel-plated clamp-type terminals
- Color-coded voltage rating on face for easy identification

Locking Plugs and Connectors

- Super tough Nylon body resists damage from severe impact, abrasion and chemicals

- Ergonomic, fluted body design with radial grip ridge is ideal for gripping, turning and pulling
- Cord clamp does not have to be disassembled from body for wiring—accepts all wire mesh strain reliefs
- One-piece, rivetless .035" thick brass connector contacts and solid brass plug blades provide maximum conductivity and long service life

Flanged Inlets and Outlets

- Rugged nylon flange fits flush and won't crack in high-abuse applications
- Individual deep-funneled chamfered wire wells guide each wire into rectangular chambers
- Wire clamps provide positive crimp lock without cutting wire strands

TESTING AND CODE COMPLIANCE

- All receptacles, plugs, connectors, inlets and outlets are designed to meet NEMA WD-6, and ANSI C-73, and to meet/exceed UL 498 standards
- UL Fed Spec. Listed WC-596 – Plugs, Connectors and Flanged Inlets (File #E-13393), Receptacles and Flanged Outlets (File #E-13399)
- CSA Certified (File #LR-406)
- NOM Certified (#057)
- Backed by a Lifetime Warranty

MATERIAL CHARACTERISTICS

Environmental: Flammability Rated V2 per UL94, V-O-MAX® Receptacles Rated V0  
Operating Temperature: -40°C to 60°C

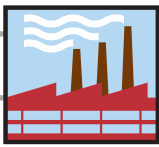

# 30 AMP 125V, 250V and 277V Industrial Grade Locking Devices

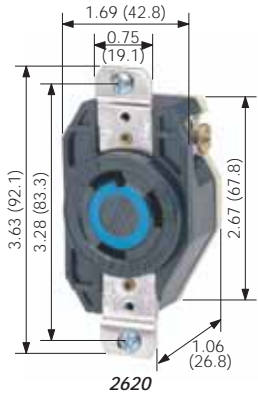

2620



2621-B



2625F

**Cord Clamp Range**—Black & White Plugs and Connectors: .385"–.860" #16–#8 AWG

## 30 AMP 125V 2-Pole 3-Wire Grounding

| DESCRIPTION   | CAT. NO. | NEMA CONFIG.   |
|---|----------|----------------|
| V-0-MAX® Single Flush Receptacle                              | 2610     |                |
| V-0-MAX® Single Flush Receptacle, Isolated Ground             | 2610-IG  |                |
| Locking Plug, Black & White Nylon Body                        | 2611     |                |
| Power Indication™ Locking Plug, Black & White Nylon Body      | 2611-PLC |                |
| Locking Plug, All Black for Stage and Studio                  | 2611-B   |                |
| Power Indication™ Locking Plug, All-Black Nylon Body          | 2611-PLB |                |
| Locking Plug, Yellow Nylon Body                               | 2611-CY  | L5-30P  L5-30R |
| Locking Connector, Black & White Nylon Body                   | 2613     |                |
| Power Indication™ Locking Connector, Black & White Nylon Body | 2613-PLC |                |
| Locking Connector, All Black for Stage and Studio             | 2613-B   |                |
| Power Indication™ Locking Connector, All-Black Nylon Body     | 2613-PLB |                |
| Locking Connector, Yellow Nylon Body                          | 2613-CY  |                |
| Locking Flanged Inlet   | 2615     |                |
| Locking Flanged Outlet  | 2616     |                |

## 30 AMP 250V 2-Pole 3-Wire Grounding

| DESCRIPTION   | CAT. NO. | NEMA CONFIG.   |
|---|----------|----------------|
| V-0-MAX® Single Flush Receptacle                              | 2620     |                |
| V-0-MAX® Single Flush Receptacle, Isolated Ground             | 2620-IG  |                |
| Locking Plug, Black & White Nylon Body                        | 2621     |                |
| Power Indication™ Locking Plug, Black & White Nylon Body      | 2621-PLC |                |
| Locking Plug, All Black for Stage and Studio                  | 2621-B   |                |
| Locking Plug, Yellow Nylon Body                               | 2621-CY  |                |
| Locking Connector, Black & White Nylon Body                   | C2623    | L6-30P  L6-30R |
| Power Indication™ Locking Connector, Black & White Nylon Body | 2623-PLC |                |
| Locking Connector, All Black for Stage and Studio             | C2623-B  |                |
| Locking Connector, Yellow Nylon Body                          | C2623-CY |                |
| Locking Flanged Inlet   | 2625F    |                |
| Locking Flanged Outlet  | 2626F    |                |

## 30 AMP 277V 2-Pole 3-Wire Grounding

| DESCRIPTION   | CAT. NO. | NEMA CONFIG.   |
|---|----------|----------------|
| V-0-MAX® Single Flush Receptacle                              | 2630     |                |
| V-0-MAX® Single Flush Receptacle, Isolated Ground             | 2630-IG  |                |
| Locking Plug, Black & White Nylon Body                        | 2631     |                |
| Power Indication™ Locking Plug, Black & White Nylon Body      | 2631-PLC |                |
| Locking Connector, Black & White Nylon Body                   | 2633     | L7-30P  L7-30R |
| Power Indication™ Locking Connector, Black & White Nylon Body | 2633-PLC |                |
| Locking Flanged Inlet   | 2635     |                |
| Locking Flanged Outlet  | 2636     |                |

*Weather-Resistant Boots for 30A Locking Plugs and Connectors are listed on page N27*

*For recommended Wallplates and Covers, see page N13.  
For complete wallplate selection, see Section E.*

### SPECIFICATIONS AND FEATURES

#### V-0-Max® Locking Flush Receptacles

- UL 94 V-0 Flammability Rating, the best rating of any material used in Industrial Locking Flush Receptacles available today
- Extra-thick .050" nickel-plated brass mounting strap for high-abuse applications
- Designed for maximum durability: One-piece .040" brass, high copper-content contacts with nickel-plated clamp-type terminals
- Color-coded voltage rating on face for easy identification

#### Locking Plugs and Connectors

- Super tough Nylon body resists damage from severe impact, abrasion and chemicals

- Ergonomic, fluted body design with radial grip ridge is ideal for gripping, turning and pulling
- Cord clamp does not have to be disassembled from body for wiring—accepts all wire mesh strain reliefs
- One-piece, rivetless .035" thick brass connector contacts and solid brass plug blades provide maximum conductivity and long service life
- Power Indication™ 30A Locking Plugs & Connectors equipped with green LED rated at 100,000 hours (24/7) for 11.5 years

#### Flanged Inlets and Outlets

- Rugged nylon flange fits flush and won't crack in high-abuse applications
- Individual deep-funneled chamfered wire wells guide each wire into rectangular chambers
- Wire clamps provide positive crimp lock without cutting wire strands

### TESTING AND CODE COMPLIANCE

- All receptacles, plugs, connectors, inlets and outlets are designed to meet NEMA WD-6, and ANSI C-73, and to meet/exceed UL 498 standards
- UL Fed Spec. Listed WC-596 – Plugs, Connectors and Flanged Inlets (File #E-13393), Receptacles and Flanged Outlets (File #E-13399)
- CSA Certified (File #LR-406)
- NOM Certified (#057)
- Backed by a Lifetime Warranty

### MATERIAL CHARACTERISTICS

Environmental: Flammability Rated V2 per UL94, V-0-MAX® Receptacles Rated V0  
Operating Temperature: -40°C to 60°C

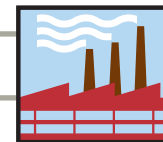

Industrial Grade Locking Devices

**30 AMP 480V 2-Pole 3-Wire Grounding**

| DESCRIPTION                                       | CAT. NO. | NEMA CONFIG.   |
|---|----------|----------------|
| V-O-MAX® Single Flush Receptacle                  | 2640     |                |
| V-O-MAX® Single Flush Receptacle, Isolated Ground | 2640-IG  |                |
| Locking Plug, Black & White Nylon Body            | 2641     | L8-30P  L8-30R |
| Locking Connector, Black & White Nylon Body       | 2643     |                |
| Locking Flanged Inlet                             | 2645     |                |
| Locking Flanged Outlet                            | 2646     |                |



**30 AMP 600V 2-Pole 3-Wire Grounding**

| DESCRIPTION                                       | CAT. NO. | NEMA CONFIG.   |
|---|----------|----------------|
| V-O-MAX® Single Flush Receptacle                  | 2650     |                |
| V-O-MAX® Single Flush Receptacle, Isolated Ground | 2650-IG  |                |
| Locking Plug, Black & White Nylon Body            | C2651    | L9-30P  L9-30R |
| Locking Connector, Black & White Nylon Body       | C2653    |                |
| Locking Flanged Inlet                             | 2655     |                |
| Locking Flanged Outlet                            | 2656     |                |



**30 AMP 125/250V 3-Pole 3-Wire Non-Grounding**

| DESCRIPTION                                 | CAT. NO. | NEMA CONFIG.     |
|---|----------|------------------|
| V-O-MAX® Single Flush Receptacle            | 2660     |                  |
| Locking Plug, Black & White Nylon Body      | 2661     |                  |
| Locking Connector, Black & White Nylon Body | 2663     | L10-30P  L10-30R |
| Locking Flanged Inlet                       | 2665     |                  |
| Locking Flanged Outlet                      | 2666     |                  |

**30 AMP 3Ø 250V 3-Pole 3-Wire Non-Grounding**

| DESCRIPTION                                 | CAT. NO. | NEMA CONFIG.     |
|---|----------|------------------|
| V-O-MAX® Single Flush Receptacle            | 2670     |                  |
| Locking Plug, Black & White Nylon Body      | 2671     |                  |
| Locking Connector, Black & White Nylon Body | 2673     | L11-30P  L11-30R |
| Locking Flanged Inlet                       | 2675     |                  |
| Locking Flanged Outlet                      | 2676     |                  |

Weather-Resistant Boots for 30A Locking Plugs and Connectors are listed on page N27

Cord Clamp Range—Black & White Plugs and Connectors: .385"–.860" #16–#8 AWG

Wallplates and Covers

| 302 STAINLESS STEEL SINGLE RECEPTACLE | WEATHER-RESISTANT FLIP LID COVER FOR 30A INLETS/OUTLETS AND 30A RECEPTACLES | WEATHER-RESISTANT THERMOPLASTIC COVER FOR RECEPTACLES |
|---------------------------------------|---|---|
| 1.60" Dia. Opening                    | IP64 Rated—Includes Gasket and Screws                                       | Self-Closing Lid—Includes Gasket and Screws           |
|                                       |   |   |
| 84020-40                              | WP2 for Inlets/Outlets 7420-CR for Receptacles                              | 4980-GY   |

For complete wallplate selection, see Section E.

SPECIFICATIONS AND FEATURES

Locking Flush Receptacles

- UL 94 V-O Flammability Rating, the best rating of any material used in Industrial Locking Flush Receptacles available today
- Extra-thick .050" nickel-plated brass mounting strap for high-abuse applications
- Designed for maximum durability: One-piece .040" brass, high copper-content contacts with nickel-plated clamp-type terminals
- Color-coded voltage rating on face for easy identification

Locking Plugs and Connectors

- Super tough Nylon body resists damage from severe impact, abrasion and chemicals

- Ergonomic, fluted body design with radial grip ridge is ideal for gripping, turning and pulling
- Cord clamp does not have to be disassembled from body for wiring—accepts all wire mesh strain reliefs
- One-piece, rivetless .035" thick brass connector contacts and solid brass plug blades provide maximum conductivity and long service life

Flanged Inlets and Outlets

- Rugged nylon flange fits flush and won't crack in high-abuse applications
- Individual deep-funneled chamfered wire wells guide each wire into rectangular chambers
- Wire clamps provide positive crimp lock without cutting wire strands

TESTING AND CODE COMPLIANCE

- All receptacles, plugs, connectors, inlets and outlets are designed to meet NEMA WD-6, and ANSI C-73, and to meet/exceed UL 498 standards
- UL Fed Spec. Listed WC-596 – Plugs, Connectors and Flanged Inlets (File #E-13393), Receptacles and Flanged Outlets (File #E-13399)
- CSA Certified (File #LR-406)
- NOM Certified (#057)
- Backed by a Lifetime Warranty

MATERIAL CHARACTERISTICS

Environmental: Flammability Rated V2 per UL94, V-O-MAX® Receptacles Rated V0  
Operating Temperature: -40°C to 60°C

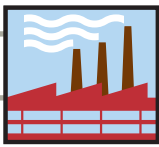

# 30 AMP 3Ø 480V, 3Ø 600V, 3Ø 250V and 125/250V

## Industrial Grade Locking Devices

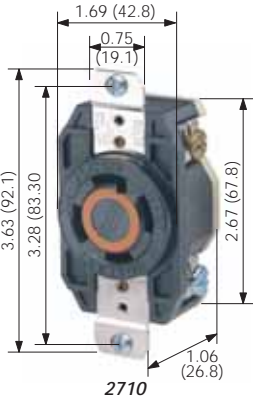

### 30 AMP 3Ø 480V 3-Pole 3-Wire Non-Grounding

| DESCRIPTION                                 | CAT. NO. | NEMA CONFIG.     |
|---|----------|------------------|
| Single Flush Receptacle                     | 2680     |                  |
| Locking Plug, Black & White Nylon Body      | 2681     |                  |
| Locking Connector, Black & White Nylon Body | 2683     | L12-30P  L12-30R |
| Locking Flanged Inlet                       | 2685     |                  |
| Locking Flanged Outlet                      | 2686     |                  |

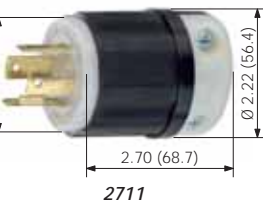

### 30 AMP 3Ø 600V 3-Pole 3-Wire Non-Grounding

| DESCRIPTION                                 | CAT. NO. | NEMA CONFIG.     |
|---|----------|------------------|
| Single Flush Receptacle                     | 2690     |                  |
| Locking Plug, Black & White Nylon Body      | 2691     |                  |
| Locking Connector, Black & White Nylon Body | 2693     | L13-30P  L13-30R |
| Locking Flanged Inlet                       | 2695     |                  |
| Locking Flanged Outlet                      | 2696     |                  |



### 30 AMP 125/250V 3-Pole 4-Wire Grounding

| DESCRIPTION                                       | CAT. NO. | NEMA CONFIG.     |
|---|----------|------------------|
| V-O-MAX® Single Flush Receptacle                  | 2710     |                  |
| V-O-MAX® Single Flush Receptacle, Isolated Ground | 2710-IG  |                  |
| Locking Plug, Black & White Nylon Body            | 2711     |                  |
| Locking Plug, Yellow Nylon Body                   | 2711-CY  |                  |
| Locking Connector, Black & White Nylon Body       | 2713     | L14-30P  L14-30R |
| Locking Connector, Yellow Nylon Body              | 2713-CY  |                  |
| Locking Flanged Inlet                             | 2715     |                  |
| Locking Flanged Outlet                            | 2716     |                  |



### 30 AMP 3Ø 250V 3-Pole 4-Wire Grounding

| DESCRIPTION                                       | CAT. NO. | NEMA CONFIG.     |
|---|----------|------------------|
| V-O-MAX® Single Flush Receptacle                  | 2720     |                  |
| V-O-MAX® Single Flush Receptacle, Isolated Ground | 2720-IG  |                  |
| Locking Plug, Black & White Nylon Body            | 2721     |                  |
| Locking Connector, Black & White Nylon Body       | 2723     | L15-30P  L15-30R |
| Locking Flanged Inlet                             | 2725     |                  |
| Locking Flanged Outlet                            | 2726     |                  |

Weather-Resistant Boots for 30A Locking Plugs and Connectors are listed on page N27

**Cord Clamp Range**—Black & White Plugs and Connectors 3-Wire: .385"–.860" #16–#8 AWG  
4-Wire: .595"–1.150" #14–#8 AWG

### Wallplates and Covers

| 302 STAINLESS STEEL SINGLE RECEPTACLE | WEATHER-RESISTANT FLIP LID COVER FOR 30A INLETS/OUTLETS AND 30A RECEPTACLES | WEATHER-RESISTANT THERMOPLASTIC COVER FOR RECEPTACLES |
|---------------------------------------|---|---|
| 1.60" Dia. Opening                    | IP64 Rated—Includes Gasket and Screws                                       | Self-Closing Lid—Includes Gasket and Screws           |
| 84020-40                              | WP2 for Inlets/Outlets 7420-CR for Receptacles                              | 4980-GY   |

For complete wallplate selection, see Section E.

#### SPECIFICATIONS AND FEATURES

##### V-O-Max® Locking Flush Receptacles

- UL 94 V-0 Flammability Rating, the best rating of any material used in Industrial Locking Flush Receptacles available today
- Extra-thick .050" nickel-plated brass mounting strap for high-abuse applications
- Designed for maximum durability: One-piece .040" brass, high copper-content contacts with nickel-plated clamp-type terminals
- Color-coded voltage rating on face for easy identification

##### Locking Plugs and Connectors

- Super tough Nylon body resists damage from severe impact, abrasion and chemicals

- Ergonomic, fluted body design with radial grip ridge is ideal for gripping, turning and pulling
- Cord clamp does not have to be disassembled from body for wiring—accepts all wire mesh strain reliefs
- One-piece, rivetless .035" thick brass connector contacts and solid brass plug blades provide maximum conductivity and long service life

##### Flanged Inlets and Outlets

- Rugged nylon flange fits flush and won't crack in high-abuse applications
- Individual deep-funneled chamfered wire wells guide each wire into rectangular chambers
- Wire clamps provide positive crimp lock without cutting wire strands

#### TESTING AND CODE COMPLIANCE

- All receptacles, plugs, connectors, inlets and outlets are designed to meet NEMA WD-6, and ANSI C-73, and to meet/exceed UL 498 standards
- UL Fed Spec. Listed WC-596 – Plugs, Connectors and Flanged Inlets (File #E-13393), Receptacles and Flanged Outlets (File #E-13399)
- CSA Certified (File #LR-406)
- NOM Certified (#057)
- Backed by a Lifetime Warranty

#### MATERIAL CHARACTERISTICS

Environmental: Flammability Rated V2 per UL94, V-O-MAX® Receptacles Rated V0  
Operating Temperature: -40°C to 60°C



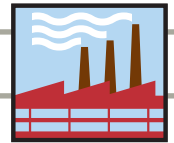

## Industrial Grade Locking Devices

### 30 AMP 3Ø 480V 3-Pole 4-Wire Grounding

| DESCRIPTION                                       | CAT. NO. | NEMA CONFIG.     |
|---|----------|------------------|
| V-O-MAX® Single Flush Receptacle                  | 2730     |                  |
| V-O-MAX® Single Flush Receptacle, Isolated Ground | 2730-IG  |                  |
| Locking Plug, Black & White Nylon Body            | 2731     | L16-30P  L16-30R |
| Locking Connector, Black & White Nylon Body       | 2733     |                  |
| Locking Flanged Inlet                             | 2735     |                  |
| Locking Flanged Outlet                            | 2736     |                  |

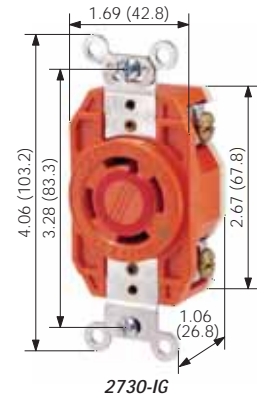

### 30 AMP 3Ø 600V 3-Pole 4-Wire Grounding

| DESCRIPTION                                 | CAT. NO. | NEMA CONFIG.     |
|---|----------|------------------|
| Single Flush Receptacle                     | 2740     |                  |
| Single Flush Receptacle, Isolated Ground    | 2740-IG  |                  |
| Locking Plug, Black & White Nylon Body      | 2741     | L17-30P  L17-30R |
| Locking Connector, Black & White Nylon Body | 2743     |                  |
| Locking Flanged Inlet                       | 2745     |                  |
| Locking Flanged Outlet                      | 2746     |                  |



### 30 AMP 3ØY 120/208V 4-Pole 4-Wire Non-Grounding

| DESCRIPTION                                 | CAT. NO. | NEMA CONFIG.     |
|---|----------|------------------|
| Single Flush Receptacle                     | 2750     |                  |
| Locking Plug, Black & White Nylon Body      | 2751     |                  |
| Locking Connector, Black & White Nylon Body | 2753     | L18-30P  L18-30R |
| Locking Flanged Inlet                       | 2755     |                  |
| Locking Flanged Outlet                      | 2756     |                  |



### 30 AMP 3ØY 277/480V 4-Pole 4-Wire Non-Grounding

| DESCRIPTION                                 | CAT. NO. | NEMA CONFIG.     |
|---|----------|------------------|
| Single Flush Receptacle                     | 2760     |                  |
| Locking Plug, Black & White Nylon Body      | 2761     |                  |
| Locking Connector, Black & White Nylon Body | 2763     | L19-30P  L19-30R |
| Locking Flanged Inlet                       | 2765     |                  |
| Locking Flanged Outlet                      | 2766     |                  |



Weather-Resistant Boots for 30A Locking Plugs and Connectors are listed on page N27

Cord Clamp Range—Black & White Plugs and Connectors: .595"–1.150" #14–#8 AWG

### Wallplates and Covers

| 302 STAINLESS STEEL SINGLE RECEPTACLE | WEATHER-RESISTANT FLIP LID COVER FOR 30A INLETS/OUTLETS AND 30A RECEPTACLES | WEATHER-RESISTANT THERMOPLASTIC COVER FOR RECEPTACLES |
|---------------------------------------|---|---|
| 1.60" Dia. Opening                    | IP64 Rated—Includes Gasket and Screws                                       | Self-Closing Lid—Includes Gasket and Screws           |
|                                       |   |   |
| 84020-40                              | WP2 for Inlets/Outlets 7420-CR for Receptacles                              | 4980-GY   |

For complete wallplate selection, see Section E.

#### SPECIFICATIONS AND FEATURES

##### V-O-Max® Locking Flush Receptacles

- UL 94 V-O Flammability Rating, the best rating of any material used in Industrial Locking Flush Receptacles available today
- Extra-thick .050" nickel-plated brass mounting strap for high-abuse applications
- Designed for maximum durability: One-piece .040" brass, high copper-content contacts with nickel-plated clamp-type terminals
- Color-coded voltage rating on face for easy identification

##### Locking Plugs and Connectors

- Super tough Nylon body resists damage from severe impact, abrasion and chemicals

- Ergonomic, fluted body design with radial grip ridge is ideal for gripping, turning and pulling
- Cord clamp does not have to be disassembled from body for wiring—accepts all wire mesh strain reliefs
- One-piece, rivetless .035" thick brass connector contacts and solid brass plug blades provide maximum conductivity and long service life

##### Flanged Inlets and Outlets

- Rugged nylon flange fits flush and won't crack in high-abuse applications
- Individual deep-funneled chamfered wire wells guide each wire into rectangular chambers
- Wire clamps provide positive crimp lock without cutting wire strands

#### TESTING AND CODE COMPLIANCE

- All receptacles, plugs, connectors, inlets and outlets are designed to meet NEMA WD-6, and ANSI C-73, and to meet/exceed UL 498 standards
- UL Fed Spec. Listed WC-596 – Plugs, Connectors and Flanged Inlets (File #E-13393), Receptacles and Flanged Outlets (File #E-13399)
- CSA Certified (File #LR-406)
- NOM Certified (#057)
- Backed by a Lifetime Warranty

#### MATERIAL CHARACTERISTICS

Environmental: Flammability Rated V2 per UL94, V-O-MAX® Receptacles Rated V0  
Operating Temperature: -40°C to 60°C

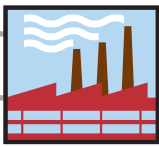

# 30 AMP 3ØY 347/600V, 3ØY 120/208V and 3ØY 277/480V

## Industrial Grade Locking Devices

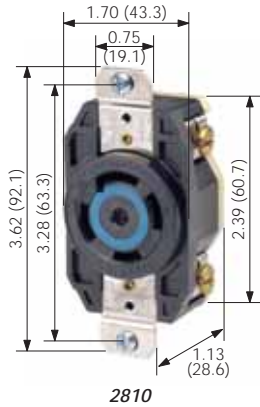

2810

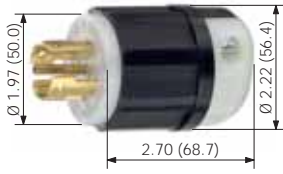

2811



2813



2816

**Cord Clamp Range**—Black & White Plugs and Connectors: .595"–1.150" #14–#8 AWG

### 30 AMP 3ØY 347/600V 4-Pole 4-Wire Non-Grounding

| DESCRIPTION                                 | CAT. NO. | NEMA CONFIG.     |
|---|----------|------------------|
| Single Flush Receptacle                     | 2770     |                  |
| Locking Plug, Black & White Nylon Body      | 2771     |                  |
| Locking Connector, Black & White Nylon Body | 2773     | L20-30P  L20-30R |
| Locking Flanged Inlet                       | 2775     |                  |
| Locking Flanged Outlet                      | 2776     |                  |

### 30 AMP 3ØY 120/208V 4-Pole 5-Wire Grounding

| DESCRIPTION                                       | CAT. NO. | NEMA CONFIG.     |
|---|----------|------------------|
| V-O-MAX® Single Flush Receptacle                  | 2810     |                  |
| V-O-MAX® Single Flush Receptacle, Isolated Ground | 2810-IG  |                  |
| Locking Plug, Black & White Nylon Body            | 2811     | L21-30P  L21-30R |
| Locking Connector, Black & White Nylon Body       | 2813     |                  |
| Locking Flanged Inlet                             | 2815     |                  |
| Locking Flanged Outlet                            | 2816     |                  |

### 30 AMP 3ØY 277/480V 4-Pole 5-Wire Grounding

| DESCRIPTION                                 | CAT. NO. | NEMA CONFIG.     |
|---|----------|------------------|
| Single Flush Receptacle                     | 2820     |                  |
| Single Flush Receptacle, Isolated Ground    | 2820-IG  |                  |
| Locking Plug, Black & White Nylon Body      | 2821     | L22-30P  L22-30R |
| Locking Connector, Black & White Nylon Body | 2823     |                  |
| Locking Flanged Inlet                       | 2825     |                  |
| Locking Flanged Outlet                      | 2826     |                  |

### 30 AMP 3ØY 347/600V 4-Pole 5-Wire Grounding

| DESCRIPTION                                 | CAT. NO. | NEMA CONFIG.     |
|---|----------|------------------|
| Single Flush Receptacle                     | 2830     |                  |
| Single Flush Receptacle, Isolated Ground    | 2830-IG  |                  |
| Locking Plug, Black & White Nylon Body      | 2831     | L23-30P  L23-30R |
| Locking Connector, Black & White Nylon Body | 2833     |                  |
| Locking Flanged Inlet                       | 2835     |                  |
| Locking Flanged Outlet                      | 2836     |                  |

*Weather-Resistant Boots for 30A Locking Plugs and Connectors are listed on page N27*

### Wallplates and Covers

| 302 STAINLESS STEEL SINGLE RECEPTACLE | WEATHER-RESISTANT FLIP LID COVER FOR 30A INLETS/OUTLETS AND 30A RECEPTACLES | WEATHER-RESISTANT THERMOPLASTIC COVER FOR RECEPTACLES |
|---------------------------------------|---|---|
| 1.60" Dia. Opening                    | IP64 Rated—Includes Gasket and Screws                                       | Self-Closing Lid—Includes Gasket and Screws           |
|                                       |   |   |
| 84020-40                              | WP2 for Inlets/Outlets 7420-CR for Receptacles                              | 4980-GY   |

*For complete wallplate selection, see Section E.*

### SPECIFICATIONS AND FEATURES

#### Locking Flush Receptacles

- UL 94 V-O Flammability Rating, the best rating of any material used in Industrial Locking Flush Receptacles available today
- Extra-thick .050" nickel-plated brass mounting strap for high-abuse applications
- Designed for maximum durability: One-piece .040" brass, high copper-content contacts with nickel-plated clamp-type terminals
- Color-coded voltage rating on face for easy identification

#### Locking Plugs and Connectors

- Super tough Nylon body resists damage from severe impact, abrasion and chemicals

- Ergonomic, fluted body design with radial grip ridge is ideal for gripping, turning and pulling
- Cord clamp does not have to be disassembled from body for wiring—accepts all wire mesh strain reliefs
- One-piece, rivetless .035" thick brass connector contacts and solid brass plug blades provide maximum conductivity and long service life

#### Flanged Inlets and Outlets

- Rugged nylon flange fits flush and won't crack in high-abuse applications
- Individual deep-funneled chamfered wire wells guide each wire into rectangular chambers
- Wire clamps provide positive crimp lock without cutting wire strands

### TESTING AND CODE COMPLIANCE

- All receptacles, plugs, connectors, inlets and outlets are designed to meet NEMA WD-6, and ANSI C-73, and to meet/exceed UL 498 standards
- UL Fed Spec. Listed WC-596 – Plugs, Connectors and Flanged Inlets (File #E-13393), Receptacles and Flanged Outlets (File #E-13399)
- CSA Certified (File #LR-406)
- NOM Certified (#057)
- Backed by a Lifetime Warranty

### MATERIAL CHARACTERISTICS





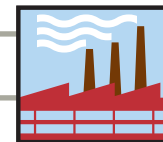







Environmental: Flammability Rated V2 per UL94, V-O-MAX® Receptacles Rated V0  
Operating Temperature: -40°C to 60°C

# 15 & 20 AMP 125V, 250V and 277V Industrial Grade Wetguard® Locking Devices



Wetguard® Devices Engineered to IP66 & IP67 Watertight Standards

## Wetguard Locking Plugs and Connectors

| DESCRIPTION   | CAT. NO. PLUG   | CAT. NO. CONNECTOR  |
|---|---|---|
| Yellow EPTR, 15A-125V<br>2-Pole, 3-Wire<br>Black EPTR | 24W47 <br>L5-15P | 25W47 <br>L5-15R |
| Yellow EPTR, 15A-250V<br>2-Pole, 3-Wire               | 24W49 <br>L6-15P | 25W49 <br>L6-15R |
| Yellow EPTR, 15A-277V<br>2-Pole, 3-Wire               | 24W34 <br>L7-15P | 25W34 <br>L7-15R |
| Yellow EPTR, 20A-125V<br>2-Pole, 3-Wire<br>Black EPTR | 26W47 <br>L5-20P | 27W47 <br>L5-20R |
| Yellow EPTR, 20A-250V<br>2-Pole, 3-Wire<br>Black EPTR | 26W48 <br>L6-20P | 27W48 <br>L6-20R |
| Yellow EPTR, 20A-277V<br>2-Pole, 3-Wire               | 26W49 <br>L7-20P | 27W49 <br>L7-20R |

## Replacement Closure Cap

| DESCRIPTION                   | CAT. NO. YELLOW | CAT. NO. BLACK |
|-------------------------------|-----------------|----------------|
| Connector Cap for 15A devices | 50W50           | 50W50-B        |
| Connector Cap for 20A devices | 50W52           | 50W52-B        |
| Plug Cap for 15A devices      | 14W             | 14W-B          |
| Plug Cap for 20A devices      | 26W             | 26W-B          |

**Cord Clamp Range**—Wetguard® Locking Plugs and Connectors  
15A: .375"–.655" #18–#10 AWG  
20A: .375"–.875" #18–#10 AWG



24W47



25W47



26W47

Locking Devices

### SPECIFICATIONS AND FEATURES

#### Wetguard

- IEC IP66 and IP 67 Rated, in accordance with IEC 529 as evaluated by UL and CSA
- NEMA Type 4, 4X, 6 and 6P Ratings in accordance with UL 50 and CSA 94
- EPTR rubber parts provide outstanding resistance to wet and damp environments, extreme temperature variations, acids, alkalis, grease, oils and solvents
- Interlocking "tongue and groove" construction seals out water, moisture, dirt when plugs are mated with connectors

- Multi-point sealing system utilizes nut, strain relief washer and rubber bushing to form a watertight cord grip seal
- Non-magnetic stainless steel fast-threading assembly screws won't interfere with sensitive equipment
- Connector "hood" closure cap seals device when not in use

### TESTING AND CODE COMPLIANCE

- Meet NEMA WD 1 & 6, ANSI requirements
- UL Listed & meets Fed. Spec. requirements: (File #13393)
- CSA Certified (File #LR-406)
- NOM Certified (#057)
- Backed by a Lifetime Warranty

### MATERIAL CHARACTERISTICS

Environmental: Flammability, Rated V2  
Operating Temperature: -40°C to 60°C

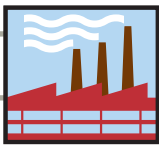

20 AMP 125/250V; 3Ø 250V, 480V, 3ØY 120/208V, 277/480V and 347/600V

## Industrial Grade Wetguard® Locking Devices



Wetguard® Devices Engineered to IP66 & IP67 Watertight Standards

### Wetguard Locking Plugs and Connectors















26W81







27W81



26W81-B

| DESCRIPTION   | CAT. NO. PLUG  | CAT. NO. CONNECTOR   |
|---|--|--|
| Yellow EPTR, 20A-125/250V<br>3-Pole, 4-Wire                   | 26W74<br>L14-20P  | 27W74<br>L14-20R  |
| Yellow EPTR, 20A-3Ø 250V<br>3-Pole, 4-Wire<br>Black EPTR      | 26W75<br>L15-20P  | 27W75<br>L15-20R  |
| Yellow EPTR, 20A-3Ø 480V<br>3-Pole, 4-Wire<br>Black EPTR      | 26W76<br>L16-20P  | 27W76<br>L16-20R  |
| Yellow EPTR, 20A-3ØY 120/208V<br>4-Pole, 5-Wire<br>Black EPTR | 26W81<br>L21-20P  | 27W81<br>L21-20R  |
| Yellow EPTR, 20A-3ØY 277/480V<br>4-Pole, 5-Wire               | 26W82<br>L22-20P  | 27W82<br>L22-20R  |
| Yellow EPTR, 20A-3ØY 347/600V<br>4-Pole, 5-Wire               | 26W83<br>L23-20P  | 27W83<br>L23-20R  |

### Wetguard Non-NEMA, Non-Grounding Devices (Not UL Listed—For Replacement Use Only)

| DESCRIPTION                                     | CAT. NO. PLUG  | CAT. NO. CONNECTOR   |
|---|--|--|
| Yellow EPTR, 20A-125/250V<br>3-Pole, 3-Wire     | 26W08<br>NON-NEMA   | 27W08<br>NON-NEMA   |
| Yellow EPTR, 20A-3ØY 120/208V<br>4-Pole, 4-Wire | 26W09<br>NON-NEMA  | 27W09<br>NON-NEMA  |

### Replacement Closure Cap

| DESCRIPTION                   | CAT. NO. YELLOW | CAT. NO. BLACK |
|-------------------------------|-----------------|----------------|
| Connector Cap for 20A devices | 50W52           | 50W52-B        |
| Plug Cap for 20A devices      | 26W             | 26W-B          |

Cord Clamp Range—Wetguard® 20A Locking Plugs and Connectors: .375"–.875" #18–#10 AWG

#### SPECIFICATIONS AND FEATURES

##### Wetguard

- IEC IP66 and IP 67 Rated, in accordance with IEC 529 as evaluated by UL and CSA
- NEMA Type 4, 4X, 6 and 6P Ratings in accordance with UL 50 and CSA 94
- EPTR rubber part provide outstanding resistance to wet and damp environments, extreme temperature variations, acids, alkalis, grease, oils and solvents
- Interlocking "tongue and groove" construction seals out water, moisture, dirt when plugs are mated with connectors

- Multi-point sealing system utilizes nut, strain relief washer and rubber bushing to form a watertight cord grip seal
- Non-magnetic stainless steel fast-threading assembly screws won't interfere with sensitive equipment
- Connector "hood" closure cap seals device when not in use

#### TESTING AND CODE COMPLIANCE

- Meet NEMA WD 1 & 6, ANSI requirements
- UL Listed & meets Fed. Spec. requirements: (File #13393)
- CSA Certified (File #LR-406)
- NOM Certified (#057)
- Backed by a Lifetime Warranty

#### MATERIAL CHARACTERISTICS

Environmental: Flammability, Rated V2  
Operating Temperature: -40°C to 60°C

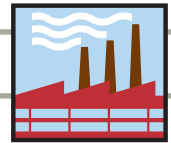





























## Industrial Grade Wetguard® Locking Devices







Wetguard® Devices Engineered to IP66 & IP67 Watertight Standards

### Wetguard Locking Plugs and Connectors

| DESCRIPTION  | CAT. NO. PLUG   | CAT. NO. CONNECTOR  |
|--|---|---|
| Yellow EPTR, 30A-125V<br>2-Pole, 3-Wire<br>Black EPTR    | <b>28W47</b><br>L5-30P     | <b>29W47</b><br>L5-30R     |
|  | <b>28W47-B</b>             | <b>29W47-B</b>             |
| Yellow EPTR, 30A-250V<br>2-Pole, 3-Wire                  | <b>28W48</b><br>L6-30P     | <b>29W48</b><br>L6-30R     |
| Yellow EPTR, 30A-277V<br>2-Pole, 3-Wire                  | <b>28W49</b><br>L7-30P     | <b>29W49</b><br>L7-30R     |
| Yellow EPTR, 30A-125/250V<br>3-Pole, 4-Wire              | <b>28W74</b><br>L14-30P    | <b>29W74</b><br>L14-30R    |
| Yellow EPTR, 30A-3Ø 250V<br>3-Pole, 4-Wire<br>Black EPTR | <b>28W75</b><br>L15-30P    | <b>29W75</b><br>L15-30R    |
|  | <b>28W75-B</b>             | <b>29W75-B</b>             |
| Yellow EPTR, 30A-3Ø 480V<br>3-Pole, 4-Wire<br>Black EPTR | <b>28W76</b><br>L16-30P    | <b>29W76</b><br>L16-30R    |
|  | <b>28W76-B</b>            | <b>29W76-B</b>            |
| Yellow EPTR, 30A-3Ø 600V<br>3-Pole, 4-Wire<br>Black EPTR | <b>28W77</b><br>L17-30P  | <b>29W77</b><br>L17-30R  |
|  | <b>28W77-B</b>           | <b>29W77-B</b>           |
| Yellow EPTR, 30A-3ØY 120/208V<br>4-Pole, 5-Wire          | <b>28W81</b><br>L21-30P  | <b>29W81</b><br>L21-30R  |
| Yellow EPTR, 30A-3ØY 277/480V<br>4-Pole, 5-Wire          | <b>28W82</b><br>L22-30P  | <b>29W82</b><br>L22-30R  |
| Yellow EPTR, 30A-3ØY 347/600V<br>4-Pole, 5-Wire          | <b>28W83</b><br>L23-30P  | <b>29W83</b><br>L23-30R  |

### Wetguard Non-NEMA, Non-Grounding Devices (Not UL Listed—For Replacement Use Only)

| DESCRIPTION                                     | CAT. NO. PLUG  | CAT. NO. CONNECTOR   |
|---|--|--|
| Yellow EPTR, 30A-125/250V<br>3-Pole, 3-Wire     | <b>28W08</b><br>NON-NEMA  | <b>29W08</b><br>NON-NEMA  |
| Yellow EPTR, 30A-3ØY 120/208V<br>4-Pole, 4-Wire | <b>28W09</b><br>NON-NEMA  | <b>29W09</b><br>NON-NEMA  |

### Replacement Closure Cap

| DESCRIPTION                   | CAT. NO. YELLOW | CAT. NO. BLACK |
|-------------------------------|-----------------|----------------|
| Connector Cap for 30A devices | <b>50W54</b>    | <b>50W54-B</b> |
| Plug Cap for 30A devices      | <b>28W</b>      | <b>28W-B</b>   |

**Cord Clamp Range**—Wetguard® 30A Locking Plugs and Connectors: .625"–1.125" #12–#8 AWG



28W47



29W47



29W47-B

Locking Devices

#### SPECIFICATIONS AND FEATURES

##### Wetguard

- IEC IP66 and IP 67 Rated, in accordance with IEC 529 as evaluated by UL and CSA
- NEMA Type 4, 4X, 6 and 6P Ratings in accordance with UL 50 and CSA 94
- EPTR rubber parts provide outstanding resistance to wet and damp environments, extreme temperature variations, acids, alkalis, grease, oils and solvents
- Interlocking "tongue and groove" construction seals out water, moisture, dirt when plugs are mated with connectors

- Multi-point sealing system utilizes nut, strain relief washer and rubber bushing to form a watertight cord grip seal
- Non-magnetic stainless steel fast-threading assembly screws won't interfere with sensitive equipment
- Connector "hood" closure cap seals device when not in use

#### TESTING AND CODE COMPLIANCE

- Meet NEMA WD 1 & 6, ANSI requirements
- UL Listed & meets Fed. Spec. requirements: (File #13393)
- CSA Certified (File #LR-406)
- NOM Certified (#057)
- Backed by a Lifetime Warranty

#### MATERIAL CHARACTERISTICS

Environmental: Flammability, Rated V2  
Operating Temperature: -40°C to 60°C

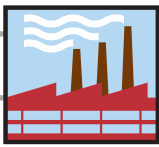

# 15 AMP 125V, 250V and 277V

## Industrial Grade Corrosion Resistant Devices

Corrosion Resistant Devices

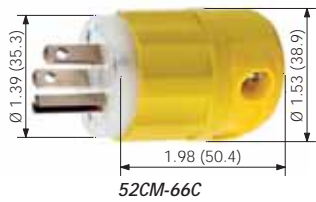

52CM-66C

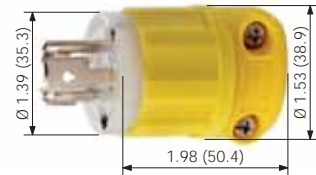

47CM-20C

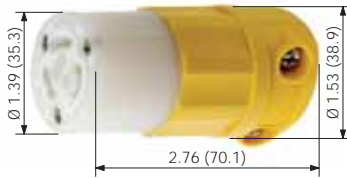

47CM-29C

**Cord Clamp Range—15A St.**  
Blade/Locking Plugs and Connectors:  
.240"-.700" #18-#10 AWG

### 15 AMP 125V 2-Pole 3-Wire Grounding

| DESCRIPTION  | CAT. NO. | NEMA CONFIG. |
|--|----------|--------------|
| Straight Blade Plug, Yellow Nylon Body and Cord Clamp                              | 52CM-66C | 5-15P        |
| Straight Blade Connector, Yellow Nylon Body and Cord Clamp                         | 52CM-69C | 5-15R        |
| Duplex Receptacle, Smooth Face.<br>One-Piece Electroless Nickel-Plated Brass Strap | 52CM-62  | 5-15R        |
| Single Receptacle, Smooth Face, Yellow Nylon Body                                  | 5261-CR  | 5-15R        |
| Locking Plug, Yellow Nylon Body and Cord Clamp                                     | 47CM-20C | L5-15P       |
| Locking Connector, Yellow Nylon Body and Cord Clamp                                | 47CM-29C | L5-15R       |
| Single Locking Flush Receptacle  | 47CM-10  | L5-15R       |

### 15 AMP 250V 2-Pole 3-Wire Grounding







| DESCRIPTION   | CAT. NO. | NEMA CONFIG. |
|---|----------|--------------|
| Single Receptacle, Smooth Face, Yellow Nylon Body   | 5661-CR  | 6-15R        |
| Locking Plug, Yellow Nylon Body and Cord Clamp      | 45CM-70C | L6-15P       |
| Locking Connector, Yellow Nylon Body and Cord Clamp | 45CM-79C | L6-15R       |
| Single Locking Flush Receptacle                     | 45CM-60  | L6-15R       |

### 15 AMP 277V AC 2-Pole 3-Wire Grounding

| DESCRIPTION                     | CAT. NO. | NEMA CONFIG. |
|---------------------------------|----------|--------------|
| Single Locking Flush Receptacle | 47CM-60  | L7-15R       |

*Weather-Resistant Boots for 15A Locking Plugs and Connectors are listed on page N27*

### Wallplates and Covers

| 302 STAINLESS STEEL FOR 15A/20A ST. BLADE/15A SINGLE LOCKING RECEPTACLE  | 302 STAINLESS STEEL FOR 15A/20A ST. BLADE DUPLEX RECEPTACLE   | WEATHER-RESISTANT FLIP LID COVER FOR 15A/20A ST. BLADE/15A LOCKING DEVICES   |
|--|---|--|
| 1.41" Dia. Opening   |   | IP64 Rated—Includes Gasket and Screws  |
| <br>84004-40                    | <br>84003-40     | <br>WP1   |
| WETGUARD COVER AND GASKET FOR 15A/20A ST. BLADE/15A LOCKING DEVICES  | BLANK PLATE W/GASKET  | FD BOX GLASS-FILLED POLYESTER (2 KO OPENINGS)  |
| IP66 Rated   |   |  |
| <br>60W03 Yellow, 60W03-B Black | <br>WP459 Yellow | <br>452CR Yellow 1/2", 453CR Yellow 3/4", 454CR Yellow 1" |

*For complete wallplate selection, see Section E.*

#### SPECIFICATIONS AND FEATURES

##### Plugs and Connectors

- All current-carrying metal parts (blades, contacts, terminals and screws) are electroless nickel-coated
- Captive, brass #8 terminal screws are color coded for easy wiring identification: green (ground), brass (hot) and silver (neutral)
- Super tough nylon plug and connector body is bright yellow for easy corrosion resistant identification
- Connector power contacts are heavy-duty, solid, one-piece brass, triple-wipe, set in deep pockets to resist rough use

- Heavy-duty, impact-resistant, super tough ST801 all-nylon body construction; fluted body design provides sure grip
- Wire clamp moves in individual chamber to provide positive crimp lock without cutting wire strands

#### TESTING AND CODE COMPLIANCE

- Plugs and connectors pass the ASTM B117-13 five-hundred hour Salt Spray (Fog) Test with no visible corrosion
- Designed to meet or exceed UL Fed Spec. Listing WC-596. UL Listed (File #E-13399 for Receptacles; File #E-13393 for Plugs and Connectors)
- CSA Certified (File #LR-406)
- NOM Certified (#057)
- Meets NEMA WD1 & WD6 requirements
- NEMA configuration and rating molded on front
- Backed by a Limited 10-Year Warranty

#### MATERIAL CHARACTERISTICS

Environmental: Flammability Rated V2 per UL 94  
Operating Temperature: -40°C (without impact) to 60°C maximum continuous

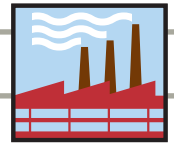

**20 AMP 125V 2-Pole 3-Wire Grounding**

| DESCRIPTION  | CAT. NO. | NEMA CONFIG. |
|--|----------|--------------|
| Straight Blade Plug, Yellow Nylon Body and Cord Clamp                              | 53CM-66C | 5-20P        |
| Straight Blade Connector, Yellow Nylon Body and Cord Clamp                         | 53CM-69C | 5-20R        |
| Duplex Receptacle, smooth face.<br>One Piece Electroless Nickel-Plated Brass Strap | 53CM-62  | 5-20R        |
| Single Receptacle, Smooth Face, Yellow Nylon Body                                  | 5361-CR  | 5-20R        |
| Locking Plug, Yellow Nylon Body and Cord Clamp                                     | 23CM-11  | L5-20P       |
| Locking Connector, Yellow Nylon Body and Cord Clamp                                | 23CM-13  | L5-20R       |
| V-0-MAX® Single Locking Flush Receptacle   | 23CM-10  | L5-20R       |

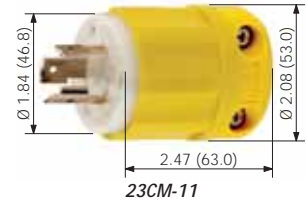

**20 AMP 250V 2-Pole 3-Wire Grounding**

| DESCRIPTION                                       | CAT. NO. | NEMA CONFIG. |
|---|----------|--------------|
| Single Receptacle, Smooth Face, Yellow Nylon Body | 5461-CR  | 6-20R        |
| V-0-MAX® Single Locking Flush Receptacle          | 23CM-20  | L6-20R       |

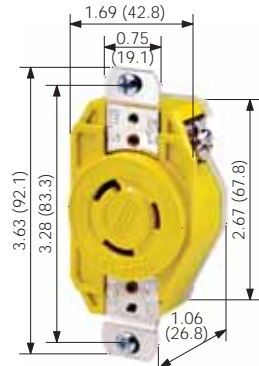

**20 AMP 277V AC 2-Pole 3-Wire Grounding**

| DESCRIPTION                              | CAT. NO. | NEMA CONFIG. |
|--|----------|--------------|
| V-0-MAX® Single Locking Flush Receptacle | 23CM-30  | L7-20R       |

**Cord Clamp Range—**  
 20A St. Blade/3-Wire Locking Plugs and Connectors: .240"–.700" #18–#10 AWG  
 20A 4-Wire Locking Plugs and Connectors: .595"–.895" #14–#10 AWG

**20 AMP 125/250V 3-Pole 4-Wire Grounding**

| DESCRIPTION                              | CAT. NO. | NEMA CONFIG. |
|--|----------|--------------|
| V-0-MAX® Single Locking Flush Receptacle | 24CM-10  | L14-20R      |

**20 AMP 3Ø 250V 3-Pole 4-Wire Grounding**

| DESCRIPTION                              | CAT. NO. | NEMA CONFIG. |
|--|----------|--------------|
| V-0-MAX® Single Locking Flush Receptacle | 24CM-20  | L15-20R      |

**20 AMP 3Ø 480V 3-Pole 4-Wire Grounding**

| DESCRIPTION                              | CAT. NO. | NEMA CONFIG. |
|--|----------|--------------|
| V-0-MAX® Single Locking Flush Receptacle | 24CM-30  | L16-20R      |

**SPECIFICATIONS AND FEATURES**

- Plugs and Connectors**
- All current-carrying metal parts (blades, contacts, terminals and screws) are electroless nickel-coated
  - Captive, brass #8 terminal screws are color coded for easy wiring identification: green (ground), brass (hot) and silver (neutral)
  - Super tough nylon plug and connector body is bright yellow for easy corrosion resistant identification
  - Connector power contacts are heavy-duty, solid, one-piece brass, triple-wipe, set in deep pockets to resist rough use
  - Heavy-duty, impact-resistant, all-nylon body construction; fluted body design provides sure grip
  - Wire clamp moves in individual chamber to provide positive crimp lock without cutting wire strands

**TESTING AND CODE COMPLIANCE**

- Plugs and connectors pass the ASTM B117-13 five-hundred hour Salt Spray (Fog) Test with no visible corrosion
- Designed to meet or exceed UL Fed Spec. Listing WC-596. UL Listed (File #E-13399 for Receptacles; File #E-13393 for Plugs and Connectors)
- CSA Certified (File #LR-406)
- NOM Certified (#057)
- Meets NEMA WD1 & WD6 requirements
- NEMA configuration and rating molded on front
- Backed by a Limited 10-Year Warranty

**MATERIAL CHARACTERISTICS**

Environmental: Flammability Rated V2 per UL94, V-0-MAX® Receptacles Rated V0  
 Operating Temperature: -40°C (without impact) to 60°C maximum continuous

Weather-Resistant Boots for 20A Locking Plugs and Connectors are listed on page N27

**Wallplates and Covers**

| 302 STAINLESS STEEL<br>20A SINGLE LOCKING RECEPTACLE | WEATHER-RESISTANT FLIP LID COVER<br>20A SINGLE LOCKING RECEPTACLE | WETGUARD COVER AND GASKET<br>20A SINGLE LOCKING RECEPTACLE |
|--|---|--|
| 1.60" Dia. Opening                                   | IP64 Rated—Includes Gasket and Screws                             | IP66 Rated   |
|  |   |  |
| 84020-40   | WP2 7420-CR   | 60W04 Yellow, 60W04-B Black                                |
| BLANK PLATE W/GASKET                                 | FD BOX GLASS-FILLED POLYESTER (2 KO OPENINGS)                     |  |
|  |   |  |
| WP459 Yellow   | 452CR Yellow 1/2", 453CR Yellow 3/4", 454CR Yellow 1"             |  |

For complete wallplate selection, see Section E.

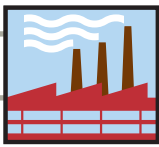

# 30 AMP 125V, 250V, 125/250V and 3Ø 250V

## Industrial Grade Corrosion Resistant Devices

Corrosion Resistant Devices

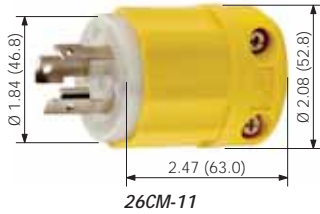

26CM-11

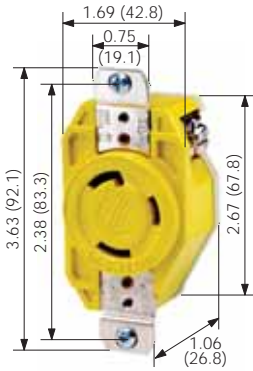

26CM-10

### 30 AMP 125V 2-Pole 3-Wire Grounding

| DESCRIPTION   | CAT. NO. | NEMA CONFIG. |
|---|----------|--------------|
| Locking Plug, Yellow Nylon Body and Cord Clamp      | 26CM-11  | L5-30P       |
| Locking Connector, Yellow Nylon Body and Cord Clamp | 26CM-13  | L5-30R       |
| V-O-MAX® Single Locking Flush Receptacle            | 26CM-10  | L5-30R       |

### 30 AMP 250V 2-Pole 3-Wire Grounding

| DESCRIPTION   | CAT. NO. | NEMA CONFIG. |
|---|----------|--------------|
| Locking Plug, Yellow Nylon Body and Cord Clamp      | 26CM-21  | L6-30P       |
| Locking Connector, Yellow Nylon Body and Cord Clamp | 26CM-23  | L6-30R       |
| Single Locking Flush Receptacle                     | 26CM-20  | L6-30R       |

### 30 AMP 125/250V 3-Pole 4-Wire Grounding

| DESCRIPTION                              | CAT. NO. | NEMA CONFIG. |
|--|----------|--------------|
| V-O-MAX® Single Locking Flush Receptacle | 27CM-10  | L14-30R      |

### 30 AMP 3Ø 250V 3-Pole 4-Wire Grounding

| DESCRIPTION                              | CAT. NO. | NEMA CONFIG. |
|--|----------|--------------|
| V-O-MAX® Single Locking Flush Receptacle | 27CM-20  | L15-30R      |

Weather-Resistant Boots for 30A Locking Plugs and Connectors are listed on page N27

**Cord Clamp Range**—30A 3-Wire Locking Plugs and Connectors: .385"–.860" #16–#8 AWG  
 30A 4-Wire Locking Plugs and Connectors: .595"–1.150" #14–#8 AWG

### Wallplates and Covers

| 302 STAINLESS STEEL<br>30A SINGLE LOCKING RECEPTACLE | WEATHER-RESISTANT FLIP LID COVER<br>30A SINGLE LOCKING RECEPTACLE | WETGUARD COVER AND GASKET<br>30A SINGLE LOCKING RECEPTACLE |
|--|---|--|
| 1.60" Dia. Opening                                   | IP64 Rated—Includes Gasket and Screws                             | IP66 Rated   |
|  |   |  |
| 84020-40   | WP2   | 7420-CR  |
| <b>BLANK PLATE W/GASKET</b>                          | <b>FD BOX GLASS-FILLED POLYESTER (2 KO OPENINGS)</b>              |  |
|  |   |  |
| WP459 Yellow   | 452CR Yellow 1/2", 453CR Yellow 3/4", 454CR Yellow 1"             |  |

For complete wallplate selection, see Section E.

#### SPECIFICATIONS AND FEATURES

##### Plugs and Connectors

- All current-carrying metal parts (blades, contacts, terminals and screws) are electroless nickel-coated
- Captive, brass #8 terminal screws are color coded for easy wiring identification: green (ground), brass (hot) and silver (neutral)
- Nylon plug and connector body is bright yellow for easy corrosion resistant identification

- Connector power contacts are heavy-duty, solid, one-piece brass, triple-wipe, set in deep pockets to resist rough use
- Heavy-duty, impact-resistant, all-nylon body construction; fluted body design provides sure grip
- Wire clamp moves in individual chamber to provide positive crimp lock without cutting wire strands

#### TESTING AND CODE COMPLIANCE

- Plugs and connectors pass the ASTM B117-13 five-hundred hour Salt Spray (Fog) Test with no visible corrosion
- Designed to meet or exceed UL Fed Spec. Listing WC-596. UL Listed (File #E-13399 for Receptacles; File #E-13393 for Plugs and Connectors)
- CSA Certified (File #LR-406)
- NOM Certified (#057)
- Meets NEMA WD1 & WD6 requirements
- NEMA configuration and rating molded on front
- Backed by a Limited 10-Year Warranty

#### MATERIAL CHARACTERISTICS

Environmental: Flammability Rated V2 per UL94, V-O-MAX® Receptacles Rated V0  
 Operating Temperature: -40°C (without impact) to 60°C maximum continuous



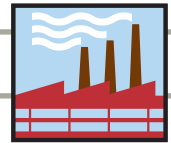

Industrial Grade Corrosion Resistant Devices

50 AMP 125V 2-Pole 3-Wire Grounding

| DESCRIPTION   | CAT. NO. | NEMA CONFIG. |
|---|----------|--------------|
| Locking Plug, Yellow Nylon Body and Cord Clamp      | 6361-CR  |              |
| Locking Connector, Yellow Nylon Body and Cord Clamp | 6360-CR  |              |
| Single Locking Flush Receptacle                     | 6370-CR  |              |
| Power Inlet, 316 Stainless Steel w/Threaded Cap     | 6372-CR  |              |



50 AMP 125/250V 3-Pole 4-Wire Grounding

| DESCRIPTION   | CAT. NO. | NEMA CONFIG. |
|---|----------|--------------|
| Locking Plug, Yellow Nylon Body and Cord Clamp      | 6365-CR  |              |
| Locking Connector, Yellow Nylon Body and Cord Clamp | 6364-CR  |              |
| Single Locking Flush Receptacle                     | 6369-CR  |              |
| Power Inlet, 316 Stainless Steel w/Threaded Cap     | 6374-CR  |              |



Boots and Covers for 50 AMP Corrosion Resistant Devices

| DESCRIPTION   | CAT. NO. |
|---|----------|
| 50A Locking Plug Boot, High Visibility Yellow                         | 7715-CRY |
| 50A Locking Plug Boot, Black  | 7715-CR  |
| 50A Locking Connector Boot, High Visibility Yellow                    | 7717-CRY |
| 50A Locking Connector Boot, High Visibility Yellow                    | 7717-CR  |
| Weather-Resistant Receptacle Flip Lid Cover, IP64 rated, Yellow Lexan | 7788-CR  |
| Cast Aluminum Grey Flip Lid Cover, IP64 rated                         | 7770     |

Cord Clamp Range—50A CR Locking Plugs and Connectors: .650"–1.125" #10–#4 AWG

SPECIFICATIONS AND FEATURES

- All current-carrying metal parts (blades, contacts, terminals and screws) are electroless nickel-coated
- Color coded wire entrance holes for simple and easy wiring
- Nylon plug and connector body are bright yellow for easy corrosion resistant identification
- Nylon housing for excellent impact resistance and secure gripping
- Boots are IP55 Rated
- Longer contacts inside connector assure stronger, tighter fitting contact points
- Backed by a lifetime warranty
- External cord clamp with cable insert accommodates from smallest to largest wire size
- Covers are IP64 rated for wet location with cover closed

TESTING AND CODE COMPLIANCE

- NOM Certified (#057)
  - CSA Certified (File# 152105)
- Receptacles**
- UL Listed (File #E-111198)
- Plugs & Connectors and Inlets**
- UL Listed (File #E-57672)

MATERIAL CHARACTERISTICS

Operating Temperature: -40°C to 75°C

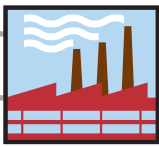

# 15 AMP 125V/10A-250; 20 AMP 250V, 125/250V and 3ØY 120/208V

## Industrial Grade Non-NEMA Locking Devices

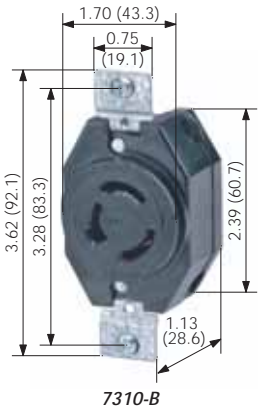

7310-B



7314-C



9965-C

**Cord Clamp Range**  
**Non-NEMA Locking Plugs and Connectors—**  
 15A: .240"–.700" #18–#10 AWG  
 20A 3-Wire: .385"–.780" #16–#10 AWG  
 20A 4- & 5-Wire: .595"–.895" #14–#10 AWG

### 15 AMP 125V/10A-250V 3-Pole 3-Wire Non-Grounding Non-NEMA†

| DESCRIPTION              | CAT. NO. | NON-NEMA CONFIG. |
|--------------------------|----------|------------------|
| Single Flush Receptacle† | 7582     |                  |
| Locking Plug             | 7567-C*  |                  |
| Locking Connector†       | 7565-C*  | NON-NEMA         |
| Locking Flanged Inlet    | 7556     |                  |
| Locking Flanged Outlet   | 7557     |                  |

†These devices are no longer UL Listed and are for replacement use only. Add (-G) for grounding version.

\*Grounding (-G) version not available. For grounding connector, use Cat. No. 7555-G

\*\*Uses stainless steel wallplate, Cat. No. 84004-40.

### 20 AMP 250V AC/DC / 10 AMP 600V AC 4-Pole 5-Wire Grounding Non-NEMA

| DESCRIPTION                         | CAT. NO. | NON-NEMA CONFIG. |
|-------------------------------------|----------|------------------|
| Single Flush Receptacle             | 3520     |                  |
| Locking Plug, Black Nylon Body      | 3521-C   |                  |
| Locking Connector, Black Nylon Body | 3523-C   | NON-NEMA         |
| Locking Flanged Inlet               | 3524-C   |                  |
| Locking Flanged Outlet              | 3525-C   |                  |

### 20 AMP 125V/250V 3-Pole 3-Wire Non-Grounding Non-NEMA††

| DESCRIPTION             | CAT. NO. | NON-NEMA CONFIG. |
|-------------------------|----------|------------------|
| Single Flush Receptacle | 7310-B   |                  |
| Locking Plug            | 9965-C   |                  |
| Locking Connector       | 7314-C   | NON-NEMA         |
| Locking Flanged Inlet   | 3325-C   |                  |
| Locking Flanged Outlet  | 3326-C   |                  |

### 20 AMP 3ØY 120V/208V 4-Pole 4-Wire Non-Grounding Non-NEMA††

| DESCRIPTION             | CAT. NO. | NON-NEMA CONFIG. |
|-------------------------|----------|------------------|
| Single Flush Receptacle | 7410-B   |                  |
| Locking Plug            | 7411-C   | NON-NEMA         |
| Locking Connector       | 7413-C   |                  |
| Locking Flanged Inlet   | 7408-C   | NON-NEMA         |
| Locking Flanged Outlet  | 7409-C   |                  |

†† Effective July 1, 1981, rating for non-grounding versions was changed from 20A-250V AC/DC, 10A-600V AC to comply with UL requirements. Add (-G) for grounding devices: (-G) devices are rated 20A-250V AC/DC, 10A-600V AC and are no longer UL Listed — for replacement use only.

**Weather-Resistant Boots for 15A and 20A Locking Plugs and Connectors are listed on page N27**

### Wallplates and Covers

| 302 STAINLESS STEEL<br>15A SINGLE RECEPTACLE | 302 STAINLESS STEEL<br>20A SINGLE RECEPTACLE | WEATHER-RESISTANT FLIP LID COVER<br>FOR 20A INLETS/OUTLETS AND 20A RECEPTACLES |
|--|--|--|
| 1.41" Dia. Opening                           | 1.60" Dia. Opening                           | IP64 Rated—Includes Gasket and Screws  |
|  |  |  |
| 84004-40                                     | 84020-40                                     | WP2 for Inlets/Outlets 7420-CR for Receptacles                                 |

For complete wallplate selection, see Section E.

### SPECIFICATIONS AND FEATURES

#### Locking Flush Receptacles

- Rugged nylon body and cover for outstanding resistance to impact and harsh chemicals
- Double-wipe phosphor-bronze power contacts

#### Locking Plugs and Connectors

- Super tough Nylon body resists damage from severe impact, abrasion and chemicals
- Ergonomic, fluted body design with radial grip ridge is ideal for gripping, turning and pulling
- Cord clamp does not have to be disassembled from body for wiring—accepts all wire mesh strain reliefs
- One-piece, rivetless .035" thick brass connector contacts and solid brass plug blades provide maximum conductivity and long service life

#### Flanged Inlets and Outlets

- Rugged nylon flange fits flush and won't crack in high-abuse applications
- Individual deep-funneled chamfered wire wells guide each wire into rectangular chambers
- Wire clamps provide positive crimp lock without cutting wire strands

### TESTING AND CODE COMPLIANCE

- All receptacles, plugs, connectors, inlets and outlets are designed to meet NEMA WD-6, and ANSI C-73, and to meet/exceed UL 498 standards
- Most non-NEMA locking devices are not UL Listed and are intended for replacement use only. Consult your Leviton representative for more information on UL Listing for Non-NEMA devices
- CSA Certified (File #LR-406)
- NOM Certified (#057)
- Backed by a Lifetime Warranty

### MATERIAL CHARACTERISTICS

Environmental: Flammability Rated V2 per UL94  
 Operating Temperature: -40°C to 60°C

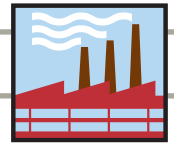

## Industrial Grade Non-NEMA Locking Devices

### 30 AMP 125V/250 3-Pole 3-Wire Non-Grounding Non-NEMA†

| DESCRIPTION             | CAT. NO. | NON-NEMA CONFIG. |
|-------------------------|----------|------------------|
| Single Flush Receptacle | 3330     |                  |
| Locking Plug            | 3331-C   |                  |
| Locking Connector       | 3333-C   |                  |
| Locking Flanged Inlet   | 3334-C   |                  |
| Locking Flanged Outlet  | 3335-C   |                  |

†Effective July 1, 1981, rating for non-grounding versions was changed from 30A-250V to comply with UL requirements. Add (-G) for grounding devices: (-G) devices are rated 30A-250V and are no longer UL Listed — for replacement use only.

### 30 AMP 3ØY 120V/208V 4-Pole 4-Wire Non-Grounding Non-NEMA††

| DESCRIPTION             | CAT. NO. | NON-NEMA CONFIG. |
|-------------------------|----------|------------------|
| Single Flush Receptacle | 3430     |                  |
| Locking Plug            | 3431-C   |                  |
| Locking Connector       | 3433-C   |                  |
| Locking Flanged Inlet   | 3434-C   |                  |
| Locking Flanged Outlet  | 3435-C   |                  |

††Effective July 1, 1981, rating for non-grounding versions was changed from 30A-250V AC/DC, 30A-600V AC to comply with UL requirements. Add (-G) for grounding devices: (-G) devices are rated 30A-250V AC/DC, 30A-600V AC and are no longer UL Listed—for replacement use only.

### 50 AMP 250V DC/600V AC 2-Pole 3-Wire Grounding Non-NEMA

| DESCRIPTION               | CAT. NO. | NON-NEMA CONFIG. |
|---------------------------|----------|------------------|
| Single Locking Receptacle | 3771     |                  |
| Locking Plug              | 3763-C   |                  |
| Locking Connector         | 3762-C   |                  |
| Locking Flanged Inlet     | 3777     |                  |

### 50 AMP 250V DC/600V AC 3-Pole 4-Wire Grounding Non-NEMA

| DESCRIPTION               | CAT. NO. | NON-NEMA CONFIG. |
|---------------------------|----------|------------------|
| Single Locking Receptacle | 7379*    |                  |
| Locking Plug              | 7765-C*  |                  |
| Locking Connector         | 7764-C*  |                  |
| Locking Flanged Inlet     | 7958*    |                  |

### 50 AMP 250V DC/600V AC 3-Pole 4-Wire Grounding Non-NEMA

| DESCRIPTION               | CAT. NO. | NON-NEMA CONFIG. |
|---------------------------|----------|------------------|
| Single Locking Receptacle | 3769     |                  |
| Locking Plug              | 3765-C   |                  |
| Locking Connector         | 3764-C   |                  |
| Locking Flanged Inlet     | 3775     |                  |

*Weather Resistant Boots for 30A Locking Plugs and Connectors are listed on page N27.  
Weather Resistant Boots for 50A Locking Plugs and Connectors are listed on page N23.*

### Wallplates and Covers

| WEATHER-RESISTANT FLIP LID COVER<br>FOR 30A INLETS AND OUTLETS AND 30A RECEPTACLES | WEATHER-RESISTANT FLIP LID COVER<br>FOR 50A RECEPTACLES |
|--|---|
| IP64 Rated—Includes Gasket and Screws  | IP64 Rated—Includes Gasket and Screws                   |
| WP2 for Inlets/Outlets   | 7788-CR Yellow Lexan                                    |
| 7420-CR for Receptacles  | 7770 Gray Metal   |

*For complete wallplate selection, see Section E.  
\*For replacement use in existing installations only.*

#### SPECIFICATIONS AND FEATURES

##### 30A Locking Flush Receptacles

- Rugged nylon body and cover for outstanding resistance to impact and harsh chemicals
- Double-wipe phosphor-bronze power contacts

##### 30A Locking Plugs and Connectors

- Super tough Nylon body resists damage from severe impact, abrasion and chemicals
- Ergonomic, fluted body design with radial grip ridge is ideal for gripping, turning and pulling
- Cord clamp does not have to be disassembled from body for wiring—accepts all wire mesh strain reliefs
- One-piece, rivetless .035" thick brass connector contacts and solid brass plug blades provide maximum conductivity and long service life

##### 30A Flanged Inlets and Outlets

- Rugged nylon flange fits flush and won't crack in high-abuse applications
- Individual deep-funneled chamfered wire wells guide each wire into rectangular chambers
- Wire clamps provide positive crimp lock without cutting wire strands

##### 50A Locking Plugs and Connectors

- Nylon housing for excellent impact and chemical resistance

##### 50A Locking Receptacles and Flanged Inlets

- Heavy-duty Nylon construction for excellent impact and chemical resistance
- Clamp-type wire terminals

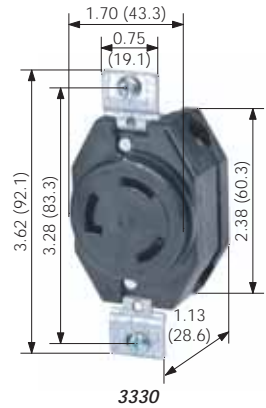

#### Cord Clamp Range Non-NEMA Locking Plugs and Connectors

- 30A 3-Wire: .385"–.860"  
#16–#8 AWG
- 30A 4-Wire: .595"–1.150"  
#14–#10 AWG
- 50A 4-Wire: .650"–1.20"  
#10–#4 AWG

#### TESTING AND CODE COMPLIANCE

- All receptacles, plugs, connectors, inlets and outlets are designed to meet NEMA WD-6, and ANSI C-73, and to meet/exceed UL 498 standards
- Most non-NEMA locking devices are not UL Listed and are intended for replacement use only. Consult your Leviton representative for more information on UL Listing for Non-NEMA devices

#### 50A Devices

- UL Listed Plugs, Connectors and Flanged Inlets (File #E-13393), Receptacles (File #E-13399)
- CSA Certified (File #LR-81290)
- NOM certified (#057)

#### MATERIAL CHARACTERISTICS

Environmental:  
Flammability Rated VO per UL94  
Operating Temperature:  
30A Devices: -40°C to 60°C  
50A Devices: -40°C to 75°C

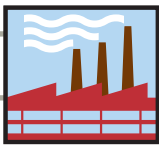

# 50 AMP 125V, 250V, 125/250V, 480V and 3Ø 480V

## Industrial Grade "California Style" CS Non-NEMA Locking Devices



CS63-60C



CS63-77

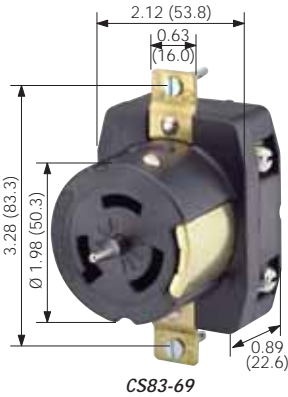

CS83-69

### 50 AMP 125V 2-Pole 3-Wire Grounding Non-NEMA

| DESCRIPTION               | CAT. NO. | NON-NEMA CONFIG. |
|---------------------------|----------|------------------|
| Single Locking Receptacle | CS63-70  |                  |
| Locking Plug              | CS63-61C |                  |
| Locking Connector         | CS63-60C |                  |
| Locking Flanged Inlet     | CS63-77  |                  |

### 50 AMP 250V 2-Pole 3-Wire Grounding Non-NEMA

| DESCRIPTION               | CAT. NO. | NON-NEMA CONFIG. |
|---------------------------|----------|------------------|
| Single Locking Receptacle | CS82-69  |                  |
| Locking Plug              | CS82-65C |                  |
| Locking Connector         | CS82-64C |                  |
| Locking Flanged Inlet     | CS82-75  |                  |

### 50 AMP 125/250V 3-Pole 4-Wire Grounding Non-NEMA

| DESCRIPTION               | CAT. NO. | NON-NEMA CONFIG. |
|---------------------------|----------|------------------|
| Single Locking Receptacle | CS63-69  |                  |
| Locking Plug              | CS63-65C |                  |
| Locking Connector         | CS63-64C |                  |
| Locking Flanged Inlet     | CS63-75  |                  |

### 50 AMP 3Ø 250V AC 3-Pole 4-Wire Grounding Non-NEMA

| DESCRIPTION               | CAT. NO. | NON-NEMA CONFIG. |
|---------------------------|----------|------------------|
| Single Locking Receptacle | CS83-69  |                  |
| Locking Plug              | CS83-65C |                  |
| Locking Connector         | CS83-64C |                  |
| Locking Flanged Inlet     | CS83-75  |                  |

### 50 AMP 480V 2-Pole 3-Wire Grounding Non-NEMA

| DESCRIPTION               | CAT. NO. | NON-NEMA CONFIG. |
|---------------------------|----------|------------------|
| Single Locking Receptacle | CS84-69  |                  |
| Locking Plug              | CS84-65C |                  |
| Locking Connector         | CS84-64C |                  |
| Locking Flanged Inlet     | CS84-75  |                  |

### 50 AMP 3Ø 480V AC 3-Pole 4-Wire Grounding Non-NEMA

| DESCRIPTION               | CAT. NO. | NON-NEMA CONFIG. |
|---------------------------|----------|------------------|
| Single Locking Receptacle | CS81-69  |                  |
| Locking Plug              | CS81-65C |                  |
| Locking Connector         | CS81-64C |                  |
| Locking Flanged Inlet     | CS8175   |                  |

Weather Resistant Boots for 50A Locking Plugs and Connectors are listed on page N23

Cord Clamp Range—50A CS Locking Plugs and Connectors: .680"–1.125" #10–#4 AWG

#### SPECIFICATIONS AND FEATURES

##### 50A CS Locking Plugs and Connectors

- Nylon housing for excellent impact resistance and secure gripping
- Color-coded wire entrance holes for simple, easy wiring

##### 50A CS Locking Receptacles and Flanged Inlets

- Heavy-duty nylon construction for excellent impact and chemical resistance
- Clamp-type wire terminals

#### TESTING AND CODE COMPLIANCE

- UL Listed Plugs, Connectors and Flanged Inlets (File #E-13393), Receptacles (File #E-13399)
- CSA Certified (File #LR-15105)
- NOM Certified (#057)

#### MATERIAL CHARACTERISTICS

Environmental: Flammability Rated VO per UL94  
Operating Temperature: -40°C to 75°C

#### Wallplates and Covers

##### WEATHER-RESISTANT FLIP LID COVER FOR 50A RECEPTACLES

IP64 Rated—Includes Gasket and Screws



7788-CR Yellow Lexan



7770 Gray Metal

For complete wallplate selection, see Section E.

# WEATHER-RESISTANT BOOTS

## Industrial Grade Locking Devices

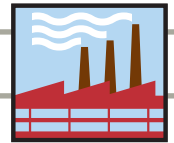

### Locking Plug and Connector Boots—Thermoplastic Elastomer Construction

#### Boots for 15 AMP Industrial Locking Plugs and Connectors

| DESCRIPTION                                    | CAT. NO. |
|--|----------|
| Locking Plug Boot, Black                       | 6017-L   |
| Locking Plug Boot, High-Visibility Yellow      | 6017-LY  |
| Locking Connector Boot, Black                  | 6018-L   |
| Locking Connector Boot, High Visibility Yellow | 6018-LY  |



6017-LY

#### Boots for 3-Wire 20 AMP & 30 AMP Industrial Locking Plugs and Connectors

| DESCRIPTION   | CAT. NO. |
|---|----------|
| 3-wire Locking Plug Boot, Black                       | 6031     |
| 3-wire Locking Plug Boot, High Visibility Yellow      | 6031-Y   |
| 3-wire Locking Connector Boot, Black                  | 6032     |
| 3-wire Locking Connector Boot, High Visibility Yellow | 6032-Y   |



6032

#### Boots for 4 and 5-Wire 20 AMP & 30 AMP Industrial Locking Plugs and Connectors

| DESCRIPTION   | CAT. NO. |
|---|----------|
| 4 & 5-wire Locking Plug Boot, black                       | 6033     |
| 4 & 5-wire Locking Plug Boot, High Visibility Yellow      | 6033-Y   |
| 4 & 5-wire Locking Connector Boot, black                  | 6034     |
| 4 & 5-wire Locking Connector Boot, High Visibility Yellow | 6034-Y   |



6033

For Weather-Resistant Boots for 50A Locking Plugs and Connectors see page N23



6034

#### SPECIFICATIONS AND FEATURES

- Feature a triple seal action to protect straight blade and locking plugs and connectors against dirt and moisture in harsh applications
- Plug and connector boots available in black and high-visibility yellow
- Fluted surface and grip-ring design provide a non-slip grip even in wet conditions

#### WARRANTY

- Backed by a Limited Lifetime Warranty

#### MATERIAL CHARACTERISTICS

Environmental: Flammability, Rated HB  
Operating Temperature: -40°C to 90°C

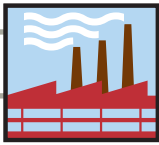

## 20 AMP 125V and 30A-600VAC / 20 AMP-250V DC

### Industrial Grade Locking Power Interrupting Devices—Non-NEMA

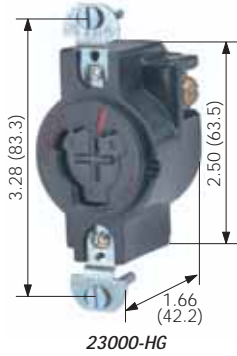

#### 20 AMP 125V 2-Pole 3-Wire Grounding

| DESCRIPTION                                   | CAT. NO.  | NON-NEMA CONFIG. |
|---|-----------|------------------|
| Single Flush Receptacle with a Thermoset body | 23000-HG* | <br>RECEPTACLE   |
| Locking Connector                             | 23001-HG* |                  |
| Locking Plug                                  | 23004-HG* |                  |

\*UL listed for "HOSPITAL USE ONLY" applications in non-hazardous locations

#### 20 AMP 125V 2-Pole 3-Wire Grounding

| DESCRIPTION             | CAT. NO. | NON-NEMA CONFIG. |
|-------------------------|----------|------------------|
| Single Flush Receptacle | 23030    | <br>RECEPTACLE   |
| Locking Connector       | 23031-A  |                  |
| Locking Plug            | 23034-A  |                  |

#### 30A-600VAC / 20AMP – 250V DC 3-Pole 4-Wire Grounding

| DESCRIPTION             | CAT. NO. | NON-NEMA CONFIG. |
|-------------------------|----------|------------------|
| Single Flush Receptacle | 20403    | <br>RECEPTACLE   |
| Locking Connector       | 21414-B  |                  |
| Locking Plug            | 21415-B  |                  |

#### 30A-600VAC / 20AMP – 250V DC 4-Pole 5-Wire Grounding

| DESCRIPTION   | CAT. NO. | NON-NEMA CONFIG. |
|---|----------|------------------|
| Single Receptacle with Fiberglass Reinforced Nylon Interior with Cast Iron and Steel Shell. Fits FS or FD boxes | 25403    | <br>RECEPTACLE   |
| Locking Connector   | 25414-B  |                  |
| Locking Plug  | 25415-B  |                  |

For complete wallplate selection, see Section E.

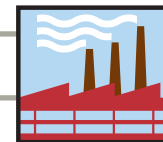

**15 AMP 125V 2-Pole 2-Wire Non-Grounding**

| DESCRIPTION                           | CAT. NO. | NEMA CONFIG.    |
|---------------------------------------|----------|-----------------|
| Midget Locking Plug                   | ML1-P    | <p>NEMA ML1</p> |
| Angle Plug                            | ML1-AP   |                 |
| Midget Locking Connector              | ML1-C    |                 |
| Angle Connector                       | ML1-AC   |                 |
| Plastic Midget Locking Flanged Inlet  | ML1-PB   |                 |
| Plastic Midget Locking Flanged Outlet | ML1-PER  |                 |



ML1-P

**15 AMP 125V 2-Pole 3-Wire Grounding**

| DESCRIPTION                           | CAT. NO. | NEMA CONFIG.    |
|---------------------------------------|----------|-----------------|
| Midget Locking Plug                   | ML2-P    | <p>NEMA ML2</p> |
| Angle Plug                            | ML2-AP   |                 |
| Midget Locking Connector              | ML2-C    |                 |
| Angle Connector                       | ML2-AC   |                 |
| Plastic Midget Locking Flanged Inlet  | ML2-PB   |                 |
| Plastic Midget Locking Flanged Outlet | ML2-PER  |                 |



ML1-AP

**15 AMP 125/250V 3-Pole 3-Wire Non-Grounding**

| DESCRIPTION                           | CAT. NO. | NEMA CONFIG.    |
|---------------------------------------|----------|-----------------|
| Midget Locking Plug                   | ML3-P    | <p>NEMA ML3</p> |
| Angle Plug                            | ML3-AP   |                 |
| Midget Locking Connector              | ML3-C    |                 |
| Angle Connector                       | ML3-AC   |                 |
| Plastic Midget Locking Flanged Inlet  | ML3-PB   |                 |
| Plastic Midget Locking Flanged Outlet | ML3-PER  |                 |

**Straight Blade 15 AMP 125V 2-Pole 2-Wire Non-Grounding**

| DESCRIPTION                                       | CAT. NO. PLUG | CAT. NO. ANGLE PLUG | NEMA CONFIG.      |
|---|---------------|---------------------|-------------------|
| Midget Straight Blade Plug<br>Black & White Nylon | MS2-P         | MS2-AP              | <p>NEMA 1-15P</p> |

Cord Clamp Range Midget Locking/St. Blade Plugs and Connectors—.218"-.430" #18-#14 AWG

**SPECIFICATIONS AND FEATURES**

- Offer a smaller form factor for limited-space applications
- Locking Plugs and Connectors feature heavy-duty construction for top performance in the environmental extremes of grueling industrial settings
- Flanged Inlets and Outlets are built to endure hard use with rugged nylon flanges that assure a smooth, flush fit and outstanding resistance to cracking and breaking

**TESTING AND CODE COMPLIANCE**

- All receptacles, plugs, connectors, inlets and outlets are designed to meet NEMA WD-6, and ANSI C-73, and to meet/exceed UL 498 standards
- UL Fed. Spec. Listed WC-596 – Plugs, Connectors and Flanged Inlets (File #E-13393), Receptacles and Flanged Outlets (File #E-13399)
- CSA Certified (File No. LR-406)
- NOM Certified (#057)
- Backed by a Lifetime Warranty

**MATERIAL CHARACTERISTICS**

Environmental: Flammability Rated V2 per UL94  
 Operating Temperature: -40°C to 60°C

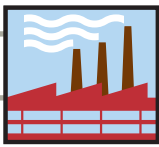

Industrial Grade Locking Devices

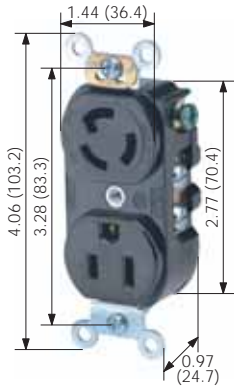

4792

Combination Locking and Straight Blade Duplex Receptacle

15 AMP 125V 2-Pole 3-Wire Grounding Back and Side Wired

| DESCRIPTION   | CAT. NO. | NEMA CONFIG. |
|---|----------|--------------|
| Duplex Combination Locking & Straight Blade Receptacle with Common Feed                                 | 4792     | L5-15R       |
| Duplex Combination Locking & Straight Blade Receptacle with 2 Hot Feeds, 1 Neutral Return               | 4794-1R  |              |
| Duplex Combination Locking & Straight Blade Receptacle with Split Feed — 2 Hot Feeds, 2 Neutral Returns | 4795-2R  | 5-15R        |

Integrated Power Inlets and Outlets with Weather-Resistant Covers

- Engineered to IP 64 and NEMA 3R Protection Ratings
- Suitable for Industrial Indoor and Outdoor Use

Integrated Power Inlets and Outlets with Weather-Resistant Covers

Gray, Glass-Filled Thermoplastic Cover and White, Nylon Device

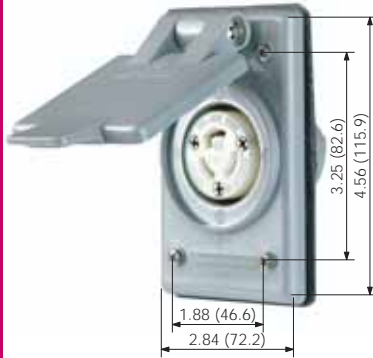

4715-FWP

| DESCRIPTION                                       | CAT. NO. FLANGED INLET                 | CAT. NO. FLANGED OUTLET                |
|---|--|--|
| Standard Wire Wells, 15A-125V 2-Pole, 3-Wire      | 4716-CWP<br><small>NEMA L5-15P</small> | 4715-CWP<br><small>NEMA L5-15R</small> |
| Slots for Fork Terminals, 15A-125V 2-Pole, 3-Wire | 4716-FWP<br><small>NEMA L5-15P</small> | 4715-FWP<br><small>NEMA L5-15R</small> |
| Standard Wire Wells, 15A-250V 2-Pole, 3-Wire      | 4586-CWP<br><small>NEMA L6-15P</small> | 4585-CWP<br><small>NEMA L6-15R</small> |

Note: For straight blade configurations, please see page M7.

Wallplates

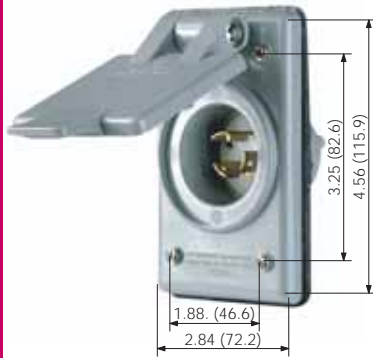

4716-FWP

| 302 STAINLESS STEEL DUPLEX RECEPTACLE | THERMOPLASTIC DUPLEX RECEPTACLE |
|---------------------------------------|---------------------------------|
| 84003-40                              | 80703-E                         |

For complete wallplate selection, see Section E.

SPECIFICATIONS AND FEATURES

Combination Devices

- Impact-resistant black thermoplastic nylon face and body
- Smooth face does not collect dirt
- Large, triple-wipe brass "T" contacts for superior contact and conductivity
- Triple-combination terminal screws
- Back and side wire options accept #10-#14 AWG stranded or solid wire

Integrated Devices

- Glass-filled thermoplastic cover and plate provide outstanding impact resistance and durability
- Dual gaskets, one under plate and one under lid, for weather-resistant fit
- Stainless steel external hardware resists corrosive effects of moisture
- Large thumb-tab makes it easy to open cover with gloved hand
- Mounts to panels or FS/FD boxes
- UL Listed and CSA Certified for wet locations with cover closed

TESTING AND CODE COMPLIANCE

Combination Devices

- UL Listed (File #E-13393)
- CSA Certified (File #LR-406)
- NOM Certified (#057)
- Backed by a Limited 10-Year Warranty

Integrated Devices

- UL Listed (File #E-13397)
- CSA Certified (File #LR-16347)
- NOM Certified (#057)
- IP 64 Suitability Rating (protected against dust and splashing water)
- NEMA Type 3R Enclosure Rating when properly installed (protected against rain, sleet and damage from external ice formations)
- Backed by a Limited 2-Year Warranty

MATERIAL CHARACTERISTICS

Combination Devices

Environmental: Flammability, Rated V2  
Operating Temperature: -40°C (without impact) to 60°C maximum continuous

Integrated Devices

Environmental: VO Flammability Rating per UL 94  
Operating Temperature: -40°C to 60°C



# Pin & Sleeve Devices

Series 309-1 and 309-2 IEC Configuration

## INDEX

**North American Watertight Pin & Sleeve Devices**  
 Overview . . . . .O2, O3  
 20 & 30 Amp Devices . . . . .O4  
 60 & 100 Amp Devices . . . . .O5  
 Dimensions . . . . .O6, O7  
 Specifications . . . . .O8, O9

**PowerSwitch® by Leviton**  
**North American Watertight Mechanical Interlocks**  
 Overview . . . . .O10, O11  
 20 & 30 Amp Devices . . . . .O12  
 60 & 100 Amp Devices . . . . .O13  
 Dimensions . . . . .O14  
 Specifications . . . . .O15

**International-Rated Pin & Sleeve Devices**  
 16, 32, 63 & 125 Amp Devices . . . . .O16  
 Specifications . . . . .O17  
 Dimensions . . . . .O18–O20

**Pin & Sleeve Products**  
 Back Boxes . . . . .O21  
 Accessories . . . . .O22

**Making the Right Connection:**  
 Color Code and Clock Position . . . . .O23  
 Leviton Catalog Numbering System . . . . .O23

**PowerSwitch® by Leviton**  
**Watertight Safety Disconnect Switches**  
 Overview . . . . .O24  
 30, 60 & 100 Amp Devices . . . . .O25  
 Specifications . . . . .O26  
 Dimensions . . . . .O27, O28  
 Accessories . . . . .O28

Pin & Sleeve Devices Index



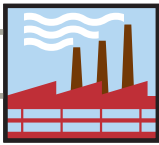

## PIN & SLEEVE DEVICE FEATURES

### Industrial Grade North American Watertight Pin & Sleeve Devices IEC 309-1 & 309-2

#### The Watertight Line: North American-Rated Devices

*Superior Connection...Superior Protection*

#### Features and Benefits

- Rugged housing, made of superior performance Valox 357, provides maximum corrosion protection and makes the device resistant to impact and abuse; greater resistance to temperature extremes, V-0 flame rated and superior UV stability.
- Contact carrier resists arcing and internal heat build-up; 60 and 100 amp contact/pin carriers are made of reinforced nylon for even greater strength and temperature resistance.
- Solid brass terminal screws on 20A, 30A & 60A devices provide maximum clamping pressure.
- Stainless steel terminal screws and terminals on 100A devices provide corrosion resistance in caustic environments.
- Dependable, clean brass construction for long life, reliable electrical contact, maximum conductivity, and corrosion resistance.
- Watertight Chloroprene onion skin grommet provides a precise, reliable seal at the cable entry point.
- Ground, neutral and phase terminals are clearly identified by color coding or letters and numbering on both front & back side.
- Multiple contact points assure a continuously reliable electrical connection.

#### UL Rated for both 50 and 60 Hz Applications.

2 YEAR LIMITED  
WARRANTY



Accepts liquid-tight conduit with adapter accessory—See page O21



Engineered to IP67  
Watertight Standards  
North American Rated Devices  
20, 30, 60 & 100 Amp

Heavy-Duty  
Valox 357 Exterior  
Cord Clamp

Reinforced Nylon  
Contact Carrier

Clean Brass Pins

Terminal Screws  
Stainless Steel (100A)  
Solid Brass (20-60A)

5100P7W

Super-Durable  
Valox 357 Housing

Watertight Chloroprene  
Onion Skin Grommet

5100C7W

Front Terminals,  
Raised Lettering,  
Identification

Rear Terminals, Raised  
Lettering, Identification

Calibrated, Self-Adjusting  
Contacts

Valox® is a registered trademark of GE.



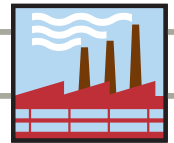

## Industrial Grade North American Watertight Pin & Sleeve Devices



### Super Tough Housing

- Provides maximum protection from abuse and environment
- Heavy-wall molding of Valox 357 resists impact, heat, flame and chemicals
- Superior performance in low-to-high ambient temperature extremes (-40°C to 60°C)
- Excellent UV stability for superior outdoor performance (UL1682)
- V-0 flammability rating
- Fully insulated
- Color-coded by voltage for easy identification



### Pin & Contact Carrier 60 & 100 Amp

- Protects pins & contacts, holding them firmly in place
- Pin Carrier and Contact Carrier constructed of glass fiber reinforced nylon for maximum impact resistance and maximum protection of pins and contacts
- Superior arc-tracking resistance
- Excellent heat-resistance and flame-resistance
- Chamfered wire entry makes wiring easier



### External Cord Clamp

- Protects terminals from strain
- Accommodates a wide variety of cord sizes
- Excellent impact strength
- Excellent UV stability for superior outdoor performance (UL1682)
- V-0 flammability rating



### Pin & Contact Carrier 20 & 30 Amp

- Pin Carrier and Contact Carrier constructed of nylon for maximum impact resistance and maximum protection of pins and contacts
- Terminal screws are aligned on a single plane for easier access
- Internal hinged cord clamp adds strain-relief and swings aside when wiring terminals
- Large diameter combination head terminal screws



### Internal Cord Clamp

- Secondary method for eliminating strain on terminals and conductors
- True IEC 309-1 & 309-2 acceptance
- Constructed of sturdy thermoplastic for tough environments
- Removes easily for user convenience



### Pins

- Designed for manageable insertion/withdrawal force
- Clean brass construction resists corrosion, provides superior contact and low electrical resistance
- Rounded tips reduce insertion force and decrease wear on the contact surface area



### Spring Loaded Cover, Cover Arm, & Locking Rings

- Rings lock plug to connector
- Spring loaded cover closes automatically
- "Performance grade" Stainless Steel cover spring for superior corrosion-resistance and long life
- Excellent UV stability for outdoor use
- V-0 flammability rating
- Interior arm design in 60 and 100 amp helps eliminate breakage



### Sleeves (Contacts)

- Designed for manageable insertion/withdrawal force
- Clean brass construction resists corrosion, provides superior contact and low electrical resistance
- Self-adjusting, machine-calibrated contacts for accurate contact pressure designed for superior wiping and cleaning action
- Made from high performance Swedish Industrial Standard (SIS) Brass 5170-04
- Positioned at sleeve entrance, stainless steel spring enables pin cleaning at earliest point of entry



### Gasket/Grommet

- Prevents moisture, dust, and contaminants from entering housing or pin/contact carrier
- Solid Chloroprene for positive seal and excellent chemical/corrosion-resistance
- Onion skin design on grommet provides precise watertight fit, eliminating the need to choose from multiple grommets that may not fit the cable jacket precisely



### Terminal Screws

- Engineered to provide maximum holding power and lowest electrical resistance
- Accepts a wide range of conductors
- Double screws ensure secure connection
- Direct bearing pressure terminals for 20, 30 and 60 Amp ratings; pressure clamp termination for 100 Amp devices
- Stainless steel terminal screws and terminals for top performance on 100 Amp



20 AMP • 30 AMP

# Industrial Grade North American Watertight Pin & Sleeve Devices

IEC 309-1 & 309-2

20 AMP and 30 AMP Watertight Pin & Sleeve Devices



Engineered to IP67  
Watertight Standards

2 YEAR LIMITED  
WARRANTY



PLUG — 320P4W



CONNECTOR — 320C4W



RECEPTACLE — 420R9W



INLET — 420B9W



BACK BOX — BX230-V

| AMPS | WIRING | VOLTAGE AC | CONNECTOR/RECEPTACLE | PLUG/INLET | PLUG    | CONNECTOR | RECEPTACLE | INLET   | BACK BOX |
|------|--------|------------|----------------------|------------|---------|-----------|------------|---------|----------|
| 20   | 2p3w   | 125        |                      |            | 320P4W  | 320C4W    | 320R4W     | 320B4W  | BX230-V  |
|      | 2p3w   | 250        |                      |            | 320P6W  | 320C6W    | 320R6W     | 320B6W  | BX230-V  |
|      | 2p3w   | 480        |                      |            | 320P7W  | 320C7W    | 320R7W     | 320B7W  | BX230-V  |
|      | 3p4w   | 125/250    |                      |            | 420P12W | 420C12W   | 420R12W    | 420B12W | BX230-V  |
|      | 3p4w   | 3Ø250      |                      |            | 420P9W  | 420C9W    | 420R9W     | 420B9W  | BX230-V  |
|      | 3p4w   | 3Ø480      |                      |            | 420P7W  | 420C7W    | 420R7W     | 420B7W  | BX230-V  |
|      | 3p4w   | 3Ø600      |                      |            | 420P5W  | 420C5W    | 420R5W     | 420B5W  | BX230-V  |
|      | 4p5w   | 3ØY120/208 |                      |            | 520P9W  | 520C9W    | 520R9W     | 520B9W  | BX230-V  |
|      | 4p5w   | 3ØY277/480 |                      |            | 520P7W  | 520C7W    | 520R7W     | 520B7W  | BX230-V  |
|      | 4p5w   | 3ØY347/600 |                      |            | 520P5W  | 520C5W    | 520R5W     | 520B5W  | BX230-V  |
| 30   | 2p3w   | 125        |                      |            | 330P4W  | 330C4W    | 330R4W     | 330B4W  | BX230-V  |
|      | 2p3w   | 250        |                      |            | 330P6W  | 330C6W    | 330R6W     | 330B6W  | BX230-V  |
|      | 2p3w   | 480        |                      |            | 330P7W  | 330C7W    | 330R7W     | 330B7W  | BX230-V  |
|      | 3p4w   | 125/250    |                      |            | 430P12W | 430C12W   | 430R12W    | 430B12W | BX230-V  |
|      | 3p4w   | 3Ø250      |                      |            | 430P9W  | 430C9W    | 430R9W     | 430B9W  | BX230-V  |
|      | 3p4w   | 3Ø480      |                      |            | 430P7W  | 430C7W    | 430R7W     | 430B7W  | BX230-V  |
|      | 3p4w   | 3Ø600      |                      |            | 430P5W  | 430C5W    | 430R5W     | 430B5W  | BX230-V  |
|      | 4p5w   | 3ØY120/208 |                      |            | 530P9W  | 530C9W    | 530R9W     | 530B9W  | BX230-V  |
|      | 4p5w   | 3ØY277/480 |                      |            | 530P7W  | 530C7W    | 530R7W     | 530B7W  | BX230-V  |
|      | 4p5w   | 3ØY347/600 |                      |            | 530P5W  | 530C5W    | 530R5W     | 530B5W  | BX230-V  |

Additional information for Back Boxes and Accessories can be found on pages O21 & O22.

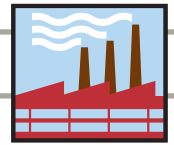

# Industrial Grade North American Watertight Pin & Sleeve Devices

IEC 309-1 & 309-2

## 60 AMP and 100 AMP Watertight Pin & Sleeve Devices



Engineered to IP67  
Watertight Standards

2 YEAR LIMITED  
WARRANTY



PLUG — 4100P12W

CONNECTOR — 4100C12W

RECEPTACLE — 360R6W

INLET — 360B7W

BACK BOX — BX100-V

| AMPS | WIRING | VOLTAGE AC | CONNECTOR/RECEPTACLE | PLUG/INLET | PLUG     | CONNECTOR | RECEPTACLE | INLET    | BACK BOX |
|------|--------|------------|----------------------|------------|----------|-----------|------------|----------|----------|
| 60   | 2p3w   | 125        |                      |            | 360P4W   | 360C4W    | 360R4W     | 360B4W   | BX60-V   |
|      | 2p3w   | 250        |                      |            | 360P6W   | 360C6W    | 360R6W     | 360B6W   | BX60-V   |
|      | 2p3w   | 480        |                      |            | 360P7W   | 360C7W    | 360R7W     | 360B7W   | BX60-V   |
|      | 3p4w   | 125/250    |                      |            | 460P12W  | 460C12W   | 460R12W    | 460B12W  | BX60-V   |
|      | 3p4w   | 3Ø250      |                      |            | 460P9W   | 460C9W    | 460R9W     | 460B9W   | BX60-V   |
|      | 3p4w   | 3Ø480      |                      |            | 460P7W   | 460C7W    | 460R7W     | 460B7W   | BX60-V   |
|      | 3p4w   | 3Ø600      |                      |            | 460P5W   | 460C5W    | 460R5W     | 460B5W   | BX60-V   |
|      | 4p5w   | 3ØY120/208 |                      |            | 560P9W   | 560C9W    | 560R9W     | 560B9W   | BX60-V   |
|      | 4p5w   | 3ØY277/480 |                      |            | 560P7W   | 560C7W    | 560R7W     | 560B7W   | BX60-V   |
|      | 4p5w   | 3ØY347/600 |                      |            | 560P5W   | 560C5W    | 560R5W     | 560B5W   | BX60-V   |
| 100  | 2p3w   | 125        |                      |            | 3100P4W  | 3100C4W   | 3100R4W    | 3100B4W  | BX100-V  |
|      | 2p3w   | 250        |                      |            | 3100P6W  | 3100C6W   | 3100R6W    | 3100B6W  | BX100-V  |
|      | 2p3w   | 480        |                      |            | 3100P7W  | 3100C7W   | 3100R7W    | 3100B7W  | BX100-V  |
|      | 3p4w   | 125/250    |                      |            | 4100P12W | 4100C12W  | 4100R12W   | 4100B12W | BX100-V  |
|      | 3p4w   | 3Ø250      |                      |            | 4100P9W  | 4100C9W   | 4100R9W    | 4100B9W  | BX100-V  |
|      | 3p4w   | 3Ø480      |                      |            | 4100P7W  | 4100C7W   | 4100R7W    | 4100B7W  | BX100-V  |
|      | 3p4w   | 3Ø600      |                      |            | 4100P5W  | 4100C5W   | 4100R5W    | 4100B5W  | BX100-V  |
|      | 4p5w   | 3ØY120/208 |                      |            | 5100P9W  | 5100C9W   | 5100R9W    | 5100B9W  | BX100-V  |
|      | 4p5w   | 3ØY277/480 |                      |            | 5100P7W  | 5100C7W   | 5100R7W    | 5100B7W  | BX100-V  |
|      | 4p5w   | 3ØY347/600 |                      |            | 5100P5W  | 5100C5W   | 5100R5W    | 5100B5W  | BX100-V  |

Additional information for Back Boxes and Accessories can be found on pages O21 & O22.

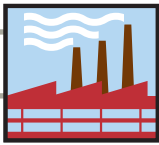

# PLUG & CONNECTOR DIMENSIONS

## Industrial Grade North American Watertight Pin & Sleeve Devices



Engineered to IP67  
Watertight Standards

2 YEAR LIMITED  
WARRANTY

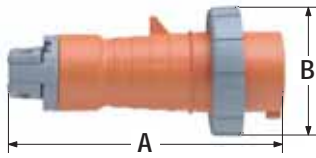

20A, 30A PLUG

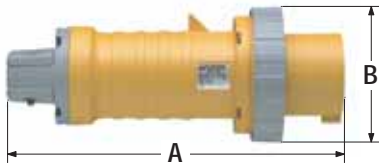

60A, 100A PLUG

### Plug Dimensions

| CATALOG NO. | AMPS | UNIT | A     | B    | CORD GRIP RANGE |
|-------------|------|------|-------|------|-----------------|
| 320P        | 20   | inch | 5.83  | 2.80 | .350 –.860      |
|             |      | mm   | 148   | 71   | 9 – 22          |
| 420P        | 20   | inch | 6.46  | 3.11 | .350 –.860      |
|             |      | mm   | 164   | 79   | 9 – 22          |
| 520P        | 20   | inch | 6.61  | 3.43 | .437 –1.187     |
|             |      | mm   | 168   | 87   | 11 – 30         |
| 330P        | 30   | inch | 6.85  | 3.70 | .437 –1.187     |
|             |      | mm   | 174   | 94   | 11 – 30         |
| 430P        | 30   | inch | 6.85  | 3.70 | .437 –1.187     |
|             |      | mm   | 174   | 94   | 11 – 30         |
| 530P        | 30   | inch | 7.40  | 3.98 | .437 –1.450     |
|             |      | mm   | 188   | 101  | 11 – 37         |
| 360P        | 60   | inch | 10.83 | 4.49 | .670 –1.625     |
|             |      | mm   | 275   | 114  | 17 – 41         |
| 460P        | 60   | inch | 10.83 | 4.49 | .670 –1.625     |
|             |      | mm   | 275   | 114  | 17 – 41         |
| 560P        | 60   | inch | 10.83 | 4.49 | .670 –1.625     |
|             |      | mm   | 275   | 114  | 17 – 41         |
| 3100P       | 100  | inch | 12.3  | 5    | .950 –1.875     |
|             |      | mm   | 312   | 127  | 24 – 48         |
| 4100P       | 100  | inch | 12.3  | 5    | .950 –1.875     |
|             |      | mm   | 312   | 127  | 24 – 48         |
| 5100P       | 100  | inch | 12.3  | 5    | .950 –1.875     |
|             |      | mm   | 312   | 127  | 24 – 48         |

### Connector Dimensions

| CATALOG NO. | AMPS | UNIT | A     | B    | CORD GRIP RANGE |
|-------------|------|------|-------|------|-----------------|
| 320C        | 20   | inch | 6.73  | 3.19 | .350 –.860      |
|             |      | mm   | 171   | 81   | 9 – 22          |
| 420C        | 20   | inch | 7.36  | 3.46 | .350 –.860      |
|             |      | mm   | 187   | 88   | 9 – 22          |
| 520C        | 20   | inch | 7.95  | 3.82 | .437 –1.187     |
|             |      | mm   | 202   | 97   | 11 – 30         |
| 330C        | 30   | inch | 7.95  | 4.02 | .437 –1.187     |
|             |      | mm   | 202   | 102  | 11 – 30         |
| 430C        | 30   | inch | 7.95  | 4.02 | .437 –1.187     |
|             |      | mm   | 202   | 102  | 11 – 30         |
| 530C        | 30   | inch | 8.27  | 4.29 | .437 –1.450     |
|             |      | mm   | 210   | 109  | 11 – 37         |
| 360C        | 60   | inch | 11.26 | 4.41 | .670 –1.625     |
|             |      | mm   | 286   | 112  | 17 – 41         |
| 460C        | 60   | inch | 11.26 | 4.41 | .670 –1.625     |
|             |      | mm   | 286   | 112  | 17 – 41         |
| 560C        | 60   | inch | 11.26 | 4.41 | .670 –1.625     |
|             |      | mm   | 286   | 112  | 17 – 41         |
| 3100C       | 100  | inch | 12.8  | 4.84 | .950 –1.875     |
|             |      | mm   | 325   | 123  | 24 – 48         |
| 4100C       | 100  | inch | 12.8  | 4.84 | .950 –1.875     |
|             |      | mm   | 325   | 123  | 24 – 48         |
| 5100C       | 100  | inch | 12.8  | 4.84 | .950 –1.875     |
|             |      | mm   | 325   | 123  | 24 – 48         |

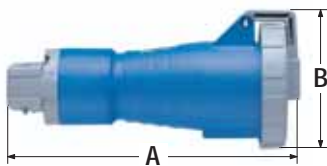

20A, 30A CONNECTOR

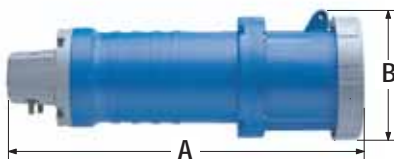

60A, 100A CONNECTOR

# INLET & RECEPTACLE DIMENSIONS

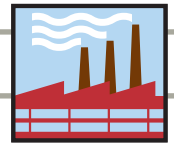

## Industrial Grade North American Watertight Pin & Sleeve Devices



Engineered to IP67  
Watertight Standards

2 YEAR LIMITED  
WARRANTY

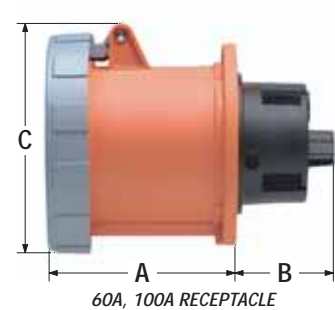
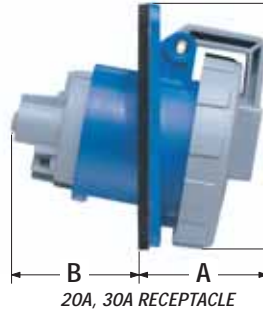
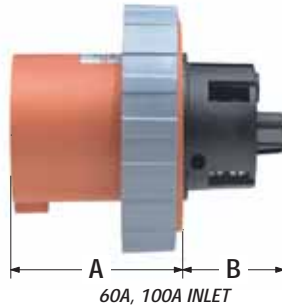
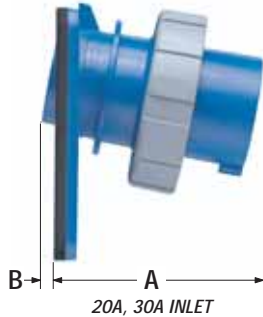

### Inlet Dimensions

| CATALOG NO. | AMPS | UNIT | A    | B    |
|-------------|------|------|------|------|
| 320B        | 20   | inch | 1.85 | 0.39 |
|             |      | mm   | 47   | 10   |
| 420B        | 20   | inch | 2.09 | 0.39 |
|             |      | mm   | 53   | 10   |
| 520B        | 20   | inch | 2.32 | 0.39 |
|             |      | mm   | 59   | 10   |
| 330B        | 30   | inch | 2.36 | 0.47 |
|             |      | mm   | 60   | 12   |
| 430B        | 30   | inch | 2.36 | 0.47 |
|             |      | mm   | 60   | 12   |
| 530B        | 30   | inch | 2.64 | .47  |
|             |      | mm   | 67   | 12   |
| 360B        | 60   | inch | 3.15 | 1.97 |
|             |      | mm   | 80   | 50   |
| 460B        | 60   | inch | 3.15 | 1.97 |
|             |      | mm   | 80   | 50   |
| 560B        | 60   | inch | 3.15 | 1.97 |
|             |      | mm   | 80   | 50   |
| 3100B       | 100  | inch | 3.50 | 2.21 |
|             |      | mm   | 89   | 56   |
| 4100B       | 100  | inch | 3.50 | 2.21 |
|             |      | mm   | 89   | 56   |
| 5100B       | 100  | inch | 3.50 | 2.21 |
|             |      | mm   | 89   | 56   |

### Receptacle Dimensions

| CATALOG NO. | AMPS | UNIT | A    | B    | C    |
|-------------|------|------|------|------|------|
| 320R        | 20   | inch | 1.77 | 2.24 | 3.74 |
|             |      | mm   | 45   | 57   | 95   |
| 420R        | 20   | inch | 1.77 | 2.24 | 3.74 |
|             |      | mm   | 45   | 57   | 95   |
| 520R        | 20   | inch | 1.85 | 2.24 | 3.90 |
|             |      | mm   | 47   | 57   | 99   |
| 330R        | 30   | inch | 2.20 | 2.40 | 4.10 |
|             |      | mm   | 56   | 61   | 104  |
| 430R        | 30   | inch | 2.20 | 2.40 | 4.10 |
|             |      | mm   | 56   | 61   | 104  |
| 530R        | 30   | inch | 2.20 | 2.44 | 4.37 |
|             |      | mm   | 56   | 62   | 111  |
| 360R        | 60   | inch | 3.50 | 1.89 | 4.37 |
|             |      | mm   | 89   | 48   | 111  |
| 460R        | 60   | inch | 3.50 | 1.89 | 4.37 |
|             |      | mm   | 89   | 48   | 111  |
| 560R        | 60   | inch | 3.50 | 1.89 | 4.37 |
|             |      | mm   | 89   | 48   | 111  |
| 3100R       | 100  | inch | 3.94 | 2.28 | 4.80 |
|             |      | mm   | 100  | 58   | 122  |
| 4100R       | 100  | inch | 3.94 | 2.28 | 4.80 |
|             |      | mm   | 100  | 58   | 122  |
| 5100R       | 100  | inch | 3.94 | 2.28 | 4.80 |
|             |      | mm   | 100  | 58   | 122  |

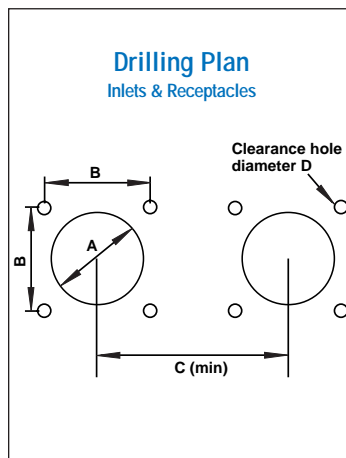

| DEVICE SIZE  |            | A      |    | B      |      | C (min) |     | D      |     |
|--------------|------------|--------|----|--------|------|---------|-----|--------|-----|
|              |            | inches | mm | inches | mm   | inches  | mm  | inches | mm  |
| 20A; 3-wire: | Receptacle | 3.26   | 83 | 3.12   | 79.5 | 3.94    | 100 | 0.185  | 4.7 |
|              | Inlet      | 3.26   | 83 | 3.12   | 79.5 | 3.94    | 100 | 0.185  | 4.7 |
| 20A; 4-wire: | Receptacle | 3.26   | 83 | 3.12   | 79.5 | 4.33    | 110 | 0.185  | 4.7 |
|              | Inlet      | 3.26   | 83 | 3.12   | 79.5 | 4.33    | 110 | 0.185  | 4.7 |
| 20A; 5-wire: | Receptacle | 3.26   | 83 | 3.12   | 79.5 | 4.92    | 125 | 0.236  | 6.0 |
|              | Inlet      | 3.26   | 83 | 3.12   | 79.5 | 4.92    | 125 | 0.185  | 4.7 |
| 30A; 3-wire: | Receptacle | 3.26   | 83 | 3.12   | 79.5 | 5.12    | 130 | 0.236  | 6.0 |
|              | Inlet      | 3.26   | 83 | 3.12   | 79.5 | 5.12    | 130 | 0.185  | 4.7 |
| 30A; 4-wire: | Receptacle | 3.26   | 83 | 3.12   | 79.5 | 5.12    | 130 | 0.236  | 6.0 |
|              | Inlet      | 3.26   | 83 | 3.12   | 79.5 | 5.12    | 130 | 0.185  | 4.7 |
| 30A; 5-wire: | Receptacle | 3.26   | 83 | 3.12   | 79.5 | 5.71    | 145 | 0.236  | 6.0 |
|              | Inlet      | 3.26   | 83 | 3.12   | 79.5 | 5.71    | 145 | 0.185  | 4.7 |
| 60A          | All        | 2.76   | 70 | 2.40   | 61   | 6.69    | 170 | 0.224  | 5.7 |
| 100A         | All        | 3.47   | 88 | 2.80   | 71   | 7.87    | 200 | 0.280  | 7.1 |

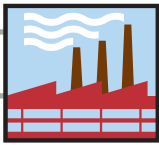

# TECHNICAL INFORMATION

## Industrial Grade North American Watertight Pin & Sleeve Devices



Engineered to IP67  
Watertight Standards

2 YEAR LIMITED  
**WARRANTY**



- Listed to UL 1682 and 1686
- Certified to CSA Standard C22.2 number 182.1
- Classified to IEC Standards 309-1 and 309-2 for both North American-rated and International-rated voltages and services
- CE marking per low-voltage directives 73/23/EEC, 93/68/EEC



4100P12W

4100C12W

### Material Specifications

#### Inlets

| PART                        | MATERIAL   |
|-----------------------------|--|
| Housing                     | Valox 357  |
| Locking Ring                | Valox 357  |
| Mounting Flange             | Valox 357  |
| Contact Carrier             | Nylon for 20 and 30 Amp devices; Reinforced nylon for 60 and 100 Amp devices |
| Phase, Ground Pins          | Brass  |
| 20, 30, 60A Terminal Screws | Brass  |
| 100A Terminal Screws        | Stainless Steel  |
| Sealing Gasket              | Solid Chloroprene  |

#### Connectors

| PART                        | MATERIAL   |
|-----------------------------|--|
| Housing                     | Valox 357  |
| Internal Cord Clamp Asmby   | Thermoplastic  |
| External Cord Clamp Asmby   | Valox 357  |
| Gland Cap                   | Valox 357  |
| Grommet                     | Chloroprene Onion Skin   |
| Cover with Arm              | Valox 357  |
| Arm Spring                  | "Performance Grade" Stainless Steel  |
| Cover Eyelet                | Nickel-Plated Brass  |
| Sealing Gasket              | Solid Chloroprene  |
| Contact Carrier             | Nylon for 20 and 30 Amp devices; Reinforced nylon for 60 and 100 Amp devices |
| Phase, Ground Sleeve        | Brass  |
| Sleeve Spring               | Stainless Steel  |
| 20, 30, 60A Terminal Screws | Brass  |
| 100A Terminal Screws        | Stainless Steel  |
| Internal Screws             | Zinc-plated Steel  |
| External Screws             | Acid-proof Stainless Steel   |

#### Plugs

| PART                        | MATERIAL   |
|-----------------------------|--|
| Housing                     | Valox 357  |
| Locking Ring                | Valox 357  |
| Sealing Gasket              | Solid Chloroprene  |
| Internal Cord Clamp Asmby   | Thermoplastic  |
| External Cord Clamp Asmby   | Valox 357  |
| Gland Cap                   | Valox 357  |
| Grommet                     | Chloroprene Onion Skin   |
| Contact Carrier             | Nylon for 20 and 30 Amp devices; Reinforced nylon for 60 and 100 Amp devices |
| Ground, Phase Pins          | Brass  |
| 20, 30, 60A Terminal Screws | Brass  |
| 100A Terminal Screws        | Stainless Steel  |
| Internal Screws             | Zinc-plated Steel  |
| External Screws             | Acid-proof Stainless Steel   |

#### Receptacles

| PART                        | MATERIAL                            |
|-----------------------------|-------------------------------------|
| Housing                     | Valox 357                           |
| Mounting Flange             | Valox 357                           |
| Cover with Arm              | Valox 357                           |
| Arm Spring                  | "Performance Grade" Stainless Steel |
| Cover Eyelet                | Nickel-Plated Brass                 |
| Sealing Gasket              | Solid Chloroprene                   |
| 20, 30, 60A Terminal Screws | Brass                               |
| 100A Terminal Screws        | Stainless Steel                     |
| Phase, Ground Sleeves       | Brass                               |
| Sleeve Spring               | Stainless Steel                     |

Valox® is a registered trademark of GE.

### STANDARDS & CERTIFICATIONS

#### Pin & Sleeve: Inlets, Connectors, Plugs, Receptacles

| UL<br>1682 & 1686 | CSA<br>C22.2 No. 182.1 | NOM | CE | IEC<br>309-1 & 309-2 |
|-------------------|------------------------|-----|----|----------------------|
| E164321 & E164322 | LR700925               | ✓   | ✓  | ✓                    |



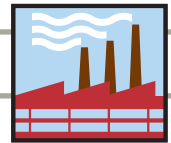

# Industrial Grade North American Watertight Pin & Sleeve Devices



Engineered to IP67  
Watertight Standards

2 YEAR LIMITED  
WARRANTY

## Performance Specifications – UL 1682 & 1686

### Electrical

| Dielectric Voltage    | Devices rated ≤ 300V: 2000V for 1 min. Devices rated >300V: 3000V for 1 min.  |        |                    |     |                             |          |                             |      |                            |
|-----------------------|---|--------|--------------------|-----|-----------------------------|----------|-----------------------------|------|----------------------------|
| Insulation Resistance | 500 V for 1 min. Insulation Resistance ≥ 5 megohms  |        |                    |     |                             |          |                             |      |                            |
| Ground Path Current   | Apply high current for short time (See Table 1) and maintain continuity   |        |                    |     |                             |          |                             |      |                            |
| Overload              | 150% of rated current and 100% of rated voltage for 50 cycles (Power factor 0.75–0.80)  |        |                    |     |                             |          |                             |      |                            |
| Current Interrupting  | Certified for current interrupting at full-rated current and voltage  |        |                    |     |                             |          |                             |      |                            |
| Temperature Rise      | Max 30°C rise at full rated current (after overload)  |        |                    |     |                             |          |                             |      |                            |
| Resistance to Arcing  | Continuation of overload for additional 200 cycles  |        |                    |     |                             |          |                             |      |                            |
| Endurance with Load   | <table border="1"> <thead> <tr> <th>Device</th> <th># Cycles with Load</th> </tr> </thead> <tbody> <tr> <td>20A</td> <td>5000 Rated Current, Voltage</td> </tr> <tr> <td>30A, 60A</td> <td>1000 Rated Current, Voltage</td> </tr> <tr> <td>100A</td> <td>250 Rated Current, Voltage</td> </tr> </tbody> </table> (Power Factor 0.75 – 0.80) | Device | # Cycles with Load | 20A | 5000 Rated Current, Voltage | 30A, 60A | 1000 Rated Current, Voltage | 100A | 250 Rated Current, Voltage |
| Device                | # Cycles with Load  |        |                    |     |                             |          |                             |      |                            |
| 20A                   | 5000 Rated Current, Voltage   |        |                    |     |                             |          |                             |      |                            |
| 30A, 60A              | 1000 Rated Current, Voltage   |        |                    |     |                             |          |                             |      |                            |
| 100A                  | 250 Rated Current, Voltage  |        |                    |     |                             |          |                             |      |                            |

### Mechanical

| Mold Stress Relief                      | 70°C for 7 hrs   |        |                                       |     |      |          |      |      |     |
|---|--|--------|---------------------------------------|-----|------|----------|------|------|-----|
| Humidity                                | 32°C, 93% humidity, 168 hrs  |        |                                       |     |      |          |      |      |     |
| Cable Secureness                        | Pull force and apply torque for 1 minute (See Table 2)   |        |                                       |     |      |          |      |      |     |
| Impact                                  | Drop from 30" 8 times after conditioning to -25°C, for 6 hrs   |        |                                       |     |      |          |      |      |     |
| Crush                                   | 250 lbs for 1 min after -25°C for 6 hrs  |        |                                       |     |      |          |      |      |     |
| Withdrawal Force                        | Pull for one minute (See Table 3)  |        |                                       |     |      |          |      |      |     |
| Strength of Insulating Base and Support | 110% of specified tightening torque on terminal screws   |        |                                       |     |      |          |      |      |     |
| Endurance                               | <table border="1"> <thead> <tr> <th>Device</th> <th>Total # Cycles (connect &amp; disconnect)</th> </tr> </thead> <tbody> <tr> <td>20A</td> <td>5000</td> </tr> <tr> <td>30A, 60A</td> <td>2000</td> </tr> <tr> <td>100A</td> <td>500</td> </tr> </tbody> </table> | Device | Total # Cycles (connect & disconnect) | 20A | 5000 | 30A, 60A | 2000 | 100A | 500 |
| Device                                  | Total # Cycles (connect & disconnect)  |        |                                       |     |      |          |      |      |     |
| 20A                                     | 5000   |        |                                       |     |      |          |      |      |     |
| 30A, 60A                                | 2000   |        |                                       |     |      |          |      |      |     |
| 100A                                    | 500  |        |                                       |     |      |          |      |      |     |
| Polarization Integrity                  | Matching devices will not mate so that ground is energized even when polarization feature is removed and 40-lb insertion force applied   |        |                                       |     |      |          |      |      |     |

### Environmental

|  |   |
|--|---|
| Flammability   | V2 or better on 20 and 30 amp devices per UL 94 or CSA 22.2 No 0.6 ; V-0 on 60 & 100 amp devices  |
| Resistance to Corrosion<br>Moisture Resistance per UL 1682 | Ferrous parts immersed in 10% ammonium chloride solution<br>Watertight: Device immersed for 24 hrs in 5 cm of 25°C water<br>Splashproof: 1" dia. water stream at 15 PSI from 10 ft. for 5 minutes |
| UV Resistance  | Exposed plastic materials are UV stabilized   |



460P7W

460C12W

### Short-Time Grounding Test Currents

| Device Rating, Amperes | Minimum Size Equipment Grounding Conductor (Copper) |                    | Time, Seconds | Test Current, Amperes |
|------------------------|---|--------------------|---------------|-----------------------|
|                        | AWG   | (mm <sup>2</sup> ) |               |                       |
| 20                     | 12  | (3.3)              | 4             | 470                   |
| 30                     | 10  | (5.3)              | 4             | 750                   |
| 60                     | 10  | (5.3)              | 4             | 750                   |
| 100                    | 8   | (8.4)              | 4             | 1180                  |

Ground-path integrity is of critical importance to safe operation of industrial equipment. Leviton pin and sleeve devices are tested by applying a test current through their ground path that far exceeds the device rating. All devices are properly wired and connected to line current at rated values. Then the ground path is subjected to a dramatic, sudden increase in current for 4 seconds. In all cases, the ground pin, sleeve, and terminals of the devices must sustain the test current, continue to function properly, and show no evidence of damage or deterioration in any electrical or mechanical elements of the ground path. Test current values and test parameters are displayed in the above chart.

### Cord Secureness Test Values

| Device Rating Amperes | Force |     | Torque |       | Maximum Displacement |      |
|-----------------------|-------|-----|--------|-------|----------------------|------|
|                       | lb    | N   | ft-lb  | N • M | inches               | mm   |
| 20                    | 30    | 133 | 0.4    | 0.54  | ≤3/32                | 2.38 |
| 30                    | 75    | 333 | 0.5    | 0.68  | ≤3/32                | 2.38 |
| 60                    | 150   | 667 | 1.0    | 1.4   | ≤3/32                | 2.38 |
| 100                   | 150   | 667 | 2.0    | 2.7   | ≤3/32                | 2.38 |

Heavy cord stress is typical of industrial applications. To assure you of top performance, Leviton pin and sleeve devices are subjected to a punishing series of tests to confirm they can absorb heavy cord pulls. The cord conductors wired to devices are simultaneously twisted and pulled. Values for the applied twisting torque and force of pull are shown above. In all cases, the cord displacement is less than 3/32 inches.

### Minimum Withdrawal Force

| Device Rating, Amperes | Minimum Withdrawal Force |    |
|------------------------|--------------------------|----|
|                        | lb                       | N  |
| 20                     | 5                        | 22 |
| 30                     | 6                        | 27 |
| 60                     | 15                       | 67 |
| 100                    | 20                       | 89 |

In industrial settings, inadvertent disconnection of power can be troublesome at best, dangerous at worst, and unacceptable in any case. To verify that Leviton pin and sleeve plugs and connectors remain securely connected, they are tested to establish the minimum force required for withdrawal. In establishing these minimum withdrawal forces, the plugs and connectors are properly mated, but not locked with locking rings or other mechanical means. The pins and sleeves provide the only resistance to the force of withdrawal. In all cases, the values in the table above show the minimum force required to separate the plugs and connectors.

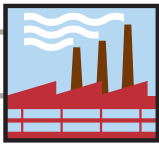

## MECHANICAL INTERLOCK FEATURES

### Industrial Grade North American Watertight Mechanical Interlocks IEC 309-1 & 309-2

Type 3R, 4X & 12K  
IP67



Engineered to IP67  
Watertight Standards

2 YEAR LIMITED  
WARRANTY



560MI7W  
60 Amp



420MI9W  
20 Amp



420MF9W  
20 Amp, Fused

Fused Models Accept  
"Class J" Time-Delay  
Fuses

## PowerSwitch® Mechanical Interlocks

- 20 Amp Non-Fused & Fused
- 30 Amp Non-Fused & Fused
- 60 Amp Non-Fused & Fused
- 100 Amp Non-Fused

PowerSwitch Mechanical Interlock devices incorporate a disconnect safety switch and IEC receptacle in a non-metallic watertight enclosure. The interlock mechanism prevents making and breaking of power under load. "The switch cannot be actuated to the *ON* position until an IEC compatible plug is fully inserted, and the plug cannot be removed until the switch is in the *OFF* position."

The complete IEC 309-1 and 309-2 system of plugs, connectors, inlets and mechanical interlock devices can be used for both retrofit and new installations enhancing safety and performance in critical power connections.

# MECHANICAL INTERLOCK FEATURES

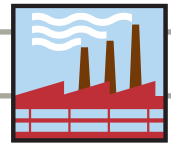

## Industrial Grade North American Watertight Mechanical Interlocks

2 YEAR LIMITED WARRANTY

Liquid-tight conduit fitting can be installed for top or bottom feed

- One fitting supplied:
- 20-30 Amp – 3/4"
  - 60 Amp – 1 1/4"
  - 100 Amp – 1 1/2"

Stainless steel screws are captive and will not fall out when cover is opened

Impact, UV and chemical-resistant Valox enclosure rated to UL and IEC watertight standards

- Type 3R, 4X & 12K
- IP67

Fused Models Accept "Class J" Time-Delay Fuses



420MF9W

Red "pistol grip" handle provides visual confirmation of switch's status

Integrated lockout handle meets OSHA safety regulations



Handle with padlock installed

Circuit identification pad for means of identifying specific equipment loads

Color-coded receptacle cover indicates voltage rating of device and seals against water and other contaminants when not in use

Pre-wired grounding plate connects to metal conduit grounding system

Brass threaded inserts will not strip, provide higher torque, and form tighter seal between back box and cover

Rugged hinge mechanism pivots 180° for easy access during installation and maintenance

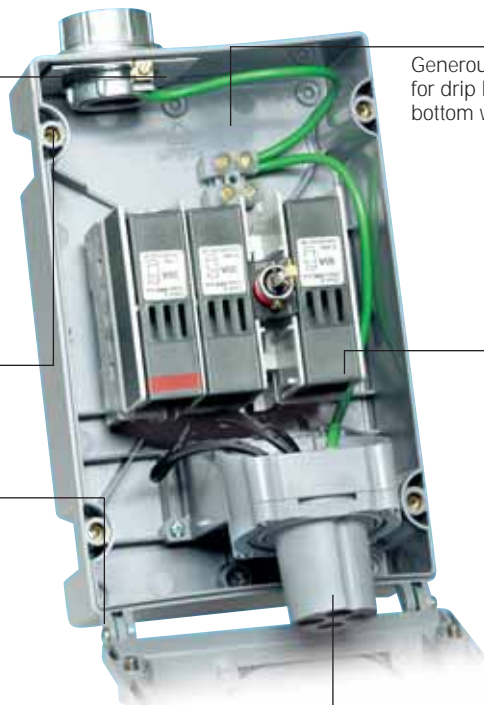

420MF9W

Generous wiring space for drip loop or top to bottom wiring

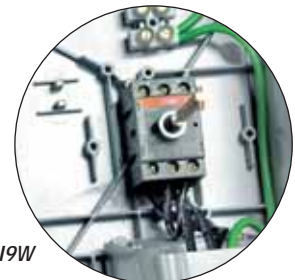

420MI9W

Compact non-fused mechanical interlocks are easy to wire

- Disconnect switch with integrated fuse holder offers proven performance in a compact package
- Fused cartridges accept "Class J" fuses (not included)
  - One factory installed auxiliary contact (normally opened – 10 Amp). Additional auxiliary contact available (normally closed — 10 Amp)
  - Easily accessible neutral and ground terminal blocks

Pre-wired IEC receptacle accepts all manufacturer's IEC 309-2 plugs



### STANDARDS & CERTIFICATIONS

#### Mechanical Interlocks

|                 |             |                  |                          |     |    |                   |
|-----------------|-------------|------------------|--------------------------|-----|----|-------------------|
| UL 231 & UL1686 | UL 98 Fused | UL 508 Non-Fused | CSA C22.2 No. 182.1 & 14 | NOM | CE | IEC 309-1 & 309-2 |
|                 | E171391     |                  | LR700925                 | ✓   | ✓  | ✓                 |



20 AMP • 30 AMP

# Industrial Grade North American Watertight Mechanical Interlocks

Non-Fused & Fused



420MF9W



2 YEAR LIMITED WARRANTY



Fused Models Accept "Class J" Time-Delay Fuses

Type 3R, 4X & 12K  
IP67

| AMPS | WIRING | VOLTAGE AC | RECEPTACLE CONFIG. | PLUG CONFIG. | NON-FUSED            |           | FUSED                |           | USE PLUG CAT. NO. |
|------|--------|------------|--------------------|--------------|----------------------|-----------|----------------------|-----------|-------------------|
|      |        |            |                    |              | MECHANICAL INTERLOCK | HP RATING | MECHANICAL INTERLOCK | HP RATING |                   |
| 20   | 2p3w   | 240        |                    |              | 320MI6W              | 3         | —                    | —         | 320P6W            |
|      | 2p3w   | 480        |                    |              | 320MI7W              | 5         | —                    | —         | 320P7W            |
|      | 3p4w   | 125/250    |                    |              | 420MI12W             | *         | 420MF12W             | *         | 420P12W           |
|      | 3p4w   | 3Ø240      |                    |              | 420MI9W              | 5         | 420MF9W              | 5         | 420P9W            |
|      | 3p4w   | 3Ø480      |                    |              | 420MI7W              | 10        | 420MF7W              | 10        | 420P7W            |
|      | 3p4w   | 3Ø600      |                    |              | 420MI5W              | 15        | 420MF5W              | 15        | 420P5W            |
|      | 4p5w   | 3ØY120/208 |                    |              | 520MI9W              | 5         | —                    | —         | 520P9W            |
|      | 4p5w   | 3ØY277/480 |                    |              | 520MI7W              | 10        | —                    | —         | 520P7W            |
|      | 4p5w   | 3ØY347/600 |                    |              | 520MI5W              | 15        | —                    | —         | 520P5W            |
| 30   | 2p3w   | 240        |                    |              | 330MI6W              | 5         | —                    | —         | 330P6W            |
|      | 2p3w   | 480        |                    |              | 330MI7W              | 10        | —                    | —         | 330P7W            |
|      | 3p4w   | 125/250    |                    |              | 430MI12W             | *         | 430MF12W             | *         | 430P12W           |
|      | 3p4w   | 3Ø240      |                    |              | 430MI9W              | 10        | 430MF9W              | 7.5       | 430P9W            |
|      | 3p4w   | 3Ø480      |                    |              | 430MI7W              | 20        | 430MF7W              | 15        | 430P7W            |
|      | 3p4w   | 3Ø600      |                    |              | 430MI5W              | 25        | 430MF5W              | 20        | 430P5W            |
|      | 4p5w   | 3ØY120/208 |                    |              | 530MI9W              | 10        | —                    | —         | 530P9W            |
|      | 4p5w   | 3ØY277/480 |                    |              | 530MI7W              | 20        | 530MF7W              | 15        | 530P7W            |
|      | 4p5w   | 3ØY347/600 |                    |              | 530MI5W              | 25        | 530MF5W              | 20        | 530P5W            |

\*Consult factory for your specific application.

Pin & Sleeve Devices

0  
12

60 AMP • 100 AMP

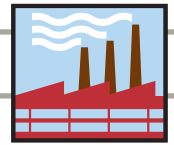

Industrial Grade North American Watertight Mechanical Interlocks  
Non-Fused & Fused



Fused Models Accept  
"Class J" Time-Delay Fuses



Engineered to IP67  
Watertight Standards

2 YEAR LIMITED  
WARRANTY

Type 3R, 4X & 12K  
IP67

560MI7W

| AMPS | WIRING | VOLTAGE AC | RECEPTACLE CONFIG. | PLUG CONFIG. | NON-FUSED            |           | FUSED                |           | USE PLUG CAT. NO. |
|------|--------|------------|--------------------|--------------|----------------------|-----------|----------------------|-----------|-------------------|
|      |        |            |                    |              | MECHANICAL INTERLOCK | HP RATING | MECHANICAL INTERLOCK | HP RATING |                   |
| 60   | 2p3w   | 240        |                    |              | 360MI6W              | 10        | 360MF6W              | *         | 360P6W            |
|      | 2p3w   | 480        |                    |              | 360MI7W              | 20        | —                    | —         | 360P7W            |
|      | 3p4w   | 125/250    |                    |              | 460MI12W             | *         | 460MF12W             | *         | 460P12W           |
|      | 3p4w   | 3Ø240      |                    |              | 460MI9W              | 20        | 460MF9W              | 15        | 460P9W            |
|      | 3p4w   | 3Ø480      |                    |              | 460MI7W              | 40        | 460MF7W              | 30        | 460P7W            |
|      | 3p4w   | 3Ø600      |                    |              | 460MI5W              | 40        | 460MF5W              | 50        | 460P5W            |
|      | 4p5w   | 3ØY120/208 |                    |              | 560MI9W              | 20        | 560MF9W              | 15        | 560P9W            |
|      | 4p5w   | 3ØY277/480 |                    |              | 560MI7W              | 40        | —                    | —         | 560P7W            |
|      | 4p5w   | 3ØY347/600 |                    |              | 560MI5W              | 40        | —                    | —         | 560P5W            |

Type 3R, 4X & 12K  
IP67

| AMPS | WIRING | VOLTAGE AC | RECEPTACLE CONFIG. | PLUG CONFIG. | NON-FUSED            |                   |                   |
|------|--------|------------|--------------------|--------------|----------------------|-------------------|-------------------|
|      |        |            |                    |              | MECHANICAL INTERLOCK | HORSEPOWER RATING | USE PLUG CAT. NO. |
| 100  | 2p3w   | 125        |                    |              | 3100MI4W             | 5                 | 3100P4W           |
|      | 2p3w   | 240        |                    |              | 3100MI6W             | 15                | 3100P6W           |
|      | 2p3w   | 480        |                    |              | 3100MI7W             | 25                | 3100P7W           |
|      | 3p4w   | 125/250    |                    |              | 4100MI12W            | *                 | 4100P12W          |
|      | 3p4w   | 3Ø240      |                    |              | 4100MI9W             | 30                | 4100P9W           |
|      | 3p4w   | 3Ø480      |                    |              | 4100MI7W             | 50                | 4100P7W           |
|      | 3p4w   | 3Ø600      |                    |              | 4100MI5W             | 50                | 4100P5W           |
|      | 4p5w   | 3ØY120/208 |                    |              | 5100MI9W             | 25                | 5100P9W           |
|      | 4p5w   | 3ØY277/480 |                    |              | 5100MI7W             | 50                | 5100P7W           |
|      | 4p5w   | 3ØY347/600 |                    |              | 5100MI5W             | 50                | 5100P5W           |

\*Consult factory for your specific application.

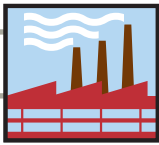

# MECHANICAL INTERLOCK DIMENSIONS

## Industrial Grade North American Watertight Mechanical Interlocks Non-Fused & Fused

2 YEAR LIMITED  
WARRANTY

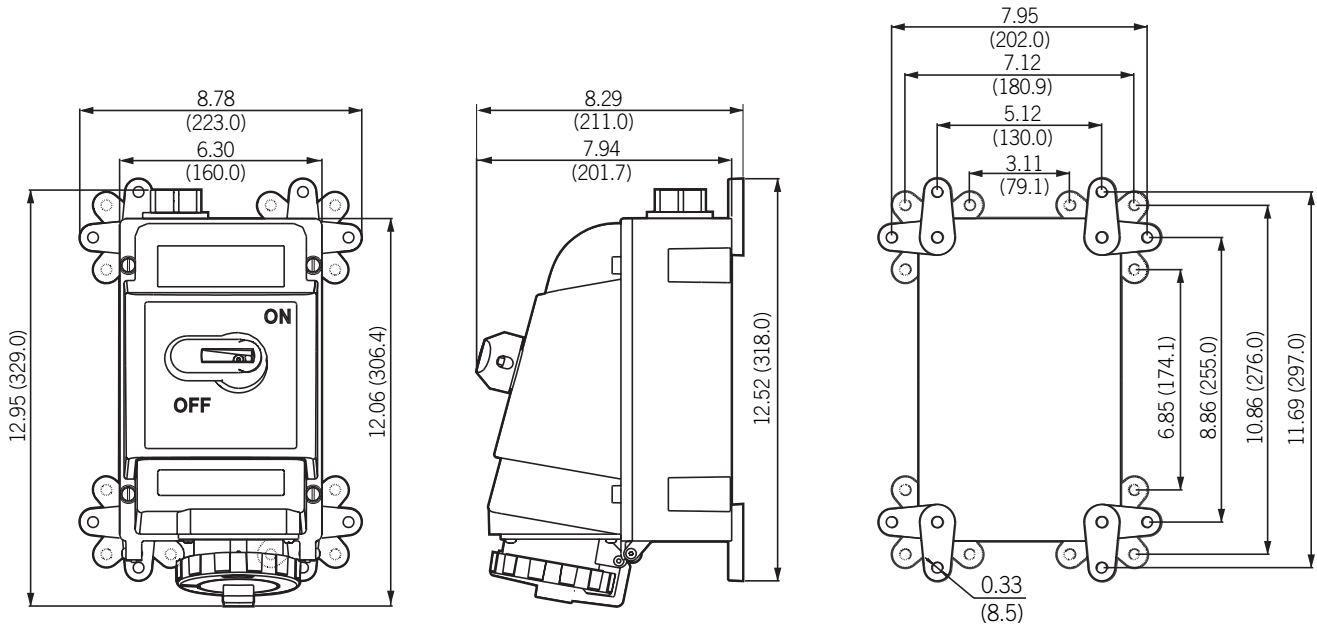

20 AMP & 30 AMP FUSED AND NON-FUSED

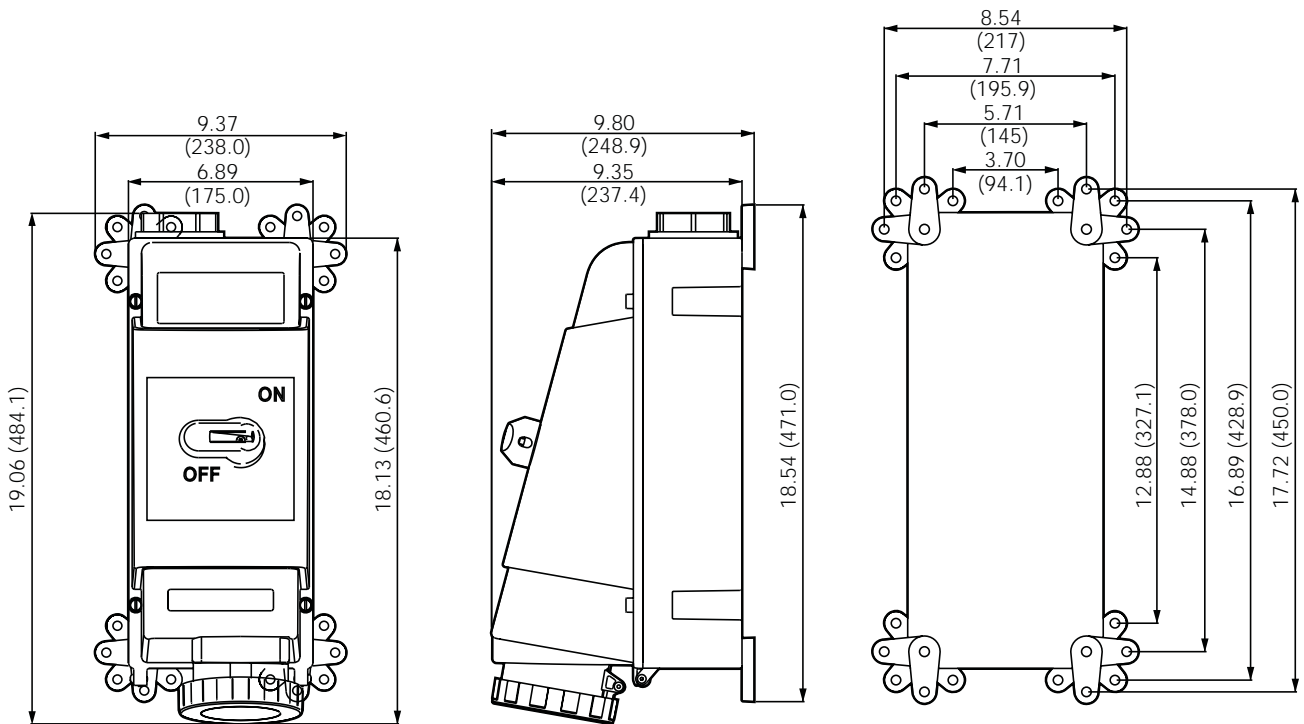

60 AMP FUSED & NON-FUSED & 100 AMP NON-FUSED

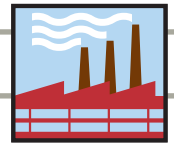

# Industrial Grade North American Watertight Mechanical Interlocks

20, 30, 60 and 100 AMP



Engineered to IP67  
Watertight Standards

2 YEAR LIMITED  
WARRANTY

- Enclosures are rated Type 3R, 4X & 12K, IP67
- Listed to UL 231 and 1686
- Certified to CSA Standard C22.2 number 182.1 & 14
- Classified to IEC Standards 309-1 and 309-2 for both North American-rated voltages and services
- CE marking per low-voltage directives 73/23/EEC, 93/68/EEC
- Switches are listed to UL 508 for Non-Fused and UL98 for Fused models (including 100 Amp Non-Fused)

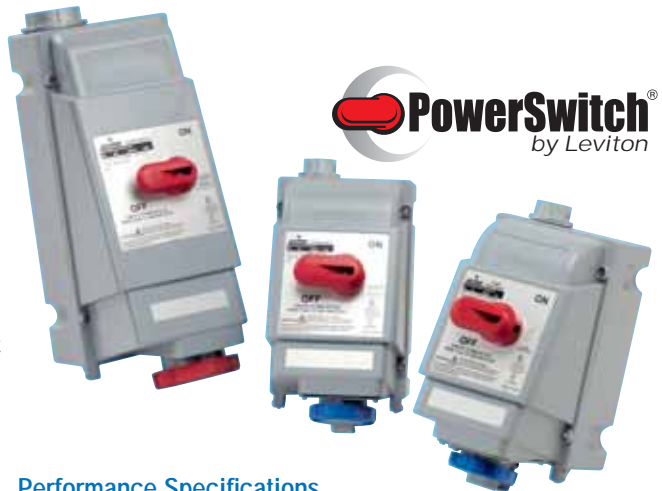

## Material Specifications

### 20 and 30 Amp Devices

| PART                     | MATERIAL            |
|--------------------------|---------------------|
| Housing Cover            | Valox 357           |
| Housing Base             | Valox 357           |
| Cover with Arm           | Valox 357           |
| Locking Ring             | Valox 357           |
| Cover Arm Eyelet         | Nickel-Plated Brass |
| Housing Gasket           | Solid Chloroprene   |
| Sealing Gasket           | Solid Chloroprene   |
| Handle                   | Valox 357           |
| Actuator Shaft           | Valox 357           |
| Locking Mechanism        | Zinc-Coated Steel   |
| Contact Carrier          | Nylon               |
| Phase and Ground Sleeves | Brass               |
| Ground Contact           | Brass               |
| Conduit Grounding Plate  | Zinc-Coated Steel   |
| Conduit Hub (1")         | Die-Cast Zinc       |
| Switch                   | Reinforced Nylon    |
| Switch Terminal Contacts | Brass               |
| Internal Screws          | Zinc-Coated Steel   |
| Housing Screws           | Stainless Steel     |

### Additional Components for 60 Amp Devices

| PART                 | MATERIAL          |
|----------------------|-------------------|
| Ground Bus           | Brass             |
| Neutral Bus          | Brass             |
| Actuator Shaft       | Zinc-Coated Steel |
| Contact Carrier      | Reinforced Nylon  |
| Conduit Hub (1 1/2") | Die-Cast Zinc     |
| Locking Mechanism    | Valox 357         |

### Additional Components for 100 Amp Devices

| PART                   | MATERIAL           |
|------------------------|--------------------|
| Ground Terminal        | Plated Brass/Steel |
| Ground Terminal Block  | Nylon              |
| Neutral Terminal       | Plated Brass/Steel |
| Neutral Terminal Block | Nylon              |
| Terminal Shaft Key     | Die-Cast Aluminum  |
| Actuator Shaft         | Zinc-Coated Steel  |
| Contact Carrier        | Reinforced Nylon   |
| Conduit Hub (2")       | Die-Cast Zinc      |
| Switch                 | Reinforced Nylon   |
| Locking Mechanism      | Valox 357          |

Valox® is a registered trademark of GE.

## Performance Specifications

| ELECTRICAL            |   |                                 |                            |
|-----------------------|---|---------------------------------|----------------------------|
| Ground Path Integrity | Device<br>20 A<br>30 A  | Current Applied<br>40 A<br>60 A | Duration<br>2 min<br>2 min |
|                       | 60 A<br>100 A   | 120 A<br>200 A                  | 4 min<br>6 min             |
| Current Interrupting  | Certified for current interrupting at full-rated current and voltage    |                                 |                            |
| Endurance             | 6000 operations at rated current and voltage (Power factor 0.75 – 0.80) |                                 |                            |
| Dielectric            | 1000 V plus twice rated voltage for 1 minute                            |                                 |                            |

| MECHANICAL                              |  |
|---|--|
| Mold Stress Relief                      | 70°C for 7 hours                                       |
| Knockout Test                           | Remains in place with 20 lb push                       |
| Crush                                   | 100 lb   |
| Impact                                  | 1.2 lb steel ball dropped from 5 ft                    |
| Cold Impact                             | Same as above, after conditioning to -35°C             |
| Strength of Insulating Base and Support | 110% of specified tightening torque on terminal screws |
| Pullout                                 | 18 lb pull on internal wires                           |

| ENVIRONMENTAL           |   |
|-------------------------|---|
| Flammability            | No 0.6; V-0 for watertight enclosure                  |
| Rain (3R) per UL 50     | Water spray @ 5 psi from all sides for 1 hr           |
| Hosedown (4X) per UL 50 | Water spray @ 65 gal/min for 5 min.                   |
| Dust (12K) per UL 50    | Cement Dust Circulated @ 1000 ft/minute for 5 minutes |
| Gasket Aging            | 70°C for 168 hours                                    |
| UV Resistance           | Exposed plastic materials are UV stabilized           |
| Operating Temperature   | -40°C to +60°C (-40°F to +140°F)                      |

| STANDARDS & CERTIFICATIONS |             |                  |           |     |    |                   |
|----------------------------|-------------|------------------|-----------|-----|----|-------------------|
| Mechanical Interlocks      |             |                  |           |     |    |                   |
| UL231 & UL1686             | UL 98 Fused | UL 508 Non-Fused | CSA C22.2 | NOM | CE | IEC 309-1 & 309-2 |
| ✓                          | ✓           | ✓                | ✓         | ✓   | ✓  | ✓                 |

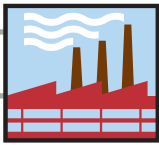

16 AMP • 32 AMP • 63 AMP • 125 AMP

## Industrial Grade International-Rated Pin & Sleeve Devices



2 YEAR LIMITED  
WARRANTY



SP516P6



SP516C6



SP516R6



SP516B6

### International-Rated Devices

Leviton offers international-rated pin and sleeve devices available in 16, 32, 63 and 125 Amps. These IEC 309-1 and 309-2 compliant devices are ideal for use overseas where voltage and amperage requirements differ from North American standards, but where rigorous performance, quality, and reliability criteria need to be met.

16, 32 and 63 Amp devices have an environmental classification of splashproof (IP44), and 125 Amp devices are classified as watertight (IP67).

### Ordering Information\*

| AMPS | WIRING | VOLTAGE AC        | CONNECTOR/RECEPTACLE | PLUG/INLET | PLUG     | CONNECTOR | RECEPTACLE | INLET   |
|------|--------|-------------------|----------------------|------------|----------|-----------|------------|---------|
| 16   | 2p3w   | 100 – 130         |                      |            | SP316P4  | SP316C4   | SP316R4    | SP316B4 |
|      | 2p3w   | 250               |                      |            | SP316P6  | SP316C6   | SP316R6    | SP316B6 |
|      | 3p4w   | 380 – 415         |                      |            | SP416P6  | SP416C6   | SP416R6    | SP416B6 |
|      | 4p5w   | 200/346 – 240/415 |                      |            | SP516P6  | SP516C6   | SP516R6    | SP516B6 |
| 32   | 2p3w   | 100 – 130         |                      |            | SP332P4  | SP332C4   | SP332R4    | SP332B4 |
|      | 2p3w   | 250               |                      |            | SP332P6  | SP332C6   | SP332R6    | SP332B6 |
|      | 3p4w   | 380 – 415         |                      |            | SP432P6  | SP432C6   | SP432R6    | SP432B6 |
|      | 3p4w   | 30380 – 30440     |                      |            | 432P3WL† | 432C3WL†  | —          | —       |
|      | 4p5w   | 200/346 – 240/415 |                      |            | SP532P6  | SP532C6   | SP532R6    | SP532B6 |
| 63   | 2p3w   | 250               |                      |            | SP363P6  | SP363C6   | SP363R6    | SP363B6 |
|      | 3p4w   | 380 – 415         |                      |            | SP463P6  | SP463C6   | SP463R6    | SP463B6 |
|      | 4p5w   | 200/346 – 240/415 |                      |            | SP563P6  | SP563C6   | SP563R6    | SP563B6 |
| 125  | 2p3w   | 250               |                      |            | 3125P6W  | 3125C6W   | 3125R6W    | 3125B6W |
|      | 3p4w   | 380 – 415         |                      |            | 4125P6W  | 4125C6W   | 4125R6W    | 4125B6W |
|      | 4p5w   | 200/346 – 240/415 |                      |            | 5125P6W  | 5125C6W   | 5125R6W    | 5125B6W |

\*Consult the factory for availability before placing your order. These are specialty order items and are not regularly stocked.

†This device has North American 30 Amp construction and is used in refrigerated container applications.



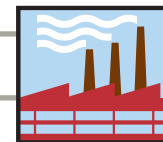

## Industrial Grade International-Rated Pin & Sleeve Devices

- Classified to IEC Standards 309-1 and 309-2
- CE marking per low-voltage directives 73/23/EEC, 93/68/EEC



432P3WL, 432C3WL & All 125A Devices listed on this page have North American Rated Construction

### Material Specifications

#### Inlets

| PART                                     | MATERIAL FOR 16A, 32A INLETS | MATERIAL FOR 63A, 125A INLETS |
|--|------------------------------|-------------------------------|
| Housing                                  | Nylon                        | Valox 357                     |
| Mounting Flange                          | Nylon                        | _____                         |
| Locking Ring (125A)                      | _____                        | Valox 357                     |
| Contact Carrier                          | Nylon                        | Reinforced Nylon              |
| Terminal Screws – Stainless Steel (125A) | Brass                        | Brass (63A)                   |
| Phase, Ground Pins                       | Brass                        | Brass                         |

#### Connectors

| PART                  | MATERIAL FOR 16A, 32A CONNECTORS | MATERIAL FOR 63A, 125A CONNECTORS                |
|-----------------------|----------------------------------|--|
| Housing               | Nylon                            | Valox 357  |
| Cover                 | Nylon                            | Valox 357  |
| Arm Spring            | Stainless Steel                  | Stainless Steel                                  |
| Contact Carrier       | Nylon                            | Reinforced Nylon                                 |
| Internal Cord Clamp   | Nylon                            | Nylon  |
| External Cord Clamp   | _____                            | Valox 357  |
| Grommet               | EPDM Rubber                      | EPDM Rubber (63A), Chloroprene Onion Skin (125A) |
| Sealing Gasket (125A) | _____                            | Solid Chloroprene                                |
| Cover Eyelet          | Nickel Plated Brass              | Nickel Plated Brass                              |
| External Screws       | _____                            | Acid-Proof Stainless Steel                       |
| Terminal Screws       | Brass                            | Brass (63A), Stainless Steel (125A)              |
| Phase, Ground Sleeve  | Brass                            | Brass  |
| Sleeve Spring         | Stainless Steel                  | Stainless Steel                                  |
| Internal Screws       | Zinc-Plated Steel                | Zinc-Plated Steel                                |

#### Plugs

| PART                  | MATERIAL FOR 16A, 32A PLUGS | MATERIAL FOR 63A, 125A PLUGS                 |
|-----------------------|-----------------------------|--|
| Housing               | Nylon                       | Valox 357                                    |
| Contact Carrier       | Nylon                       | Reinforced Nylon                             |
| Internal Cord Clamp   | Nylon                       | Nylon  |
| External Cord Clamp   | _____                       | Valox 357                                    |
| Grommet               | EPDM Rubber                 | EPDM Rubber (63A), Chloroprene Rubber (125A) |
| Sealing Gasket (125A) | _____                       | Solid Chloroprene                            |
| External Screws       | _____                       | Acid-Proof Stainless Steel                   |
| Terminal Screws       | Brass                       | Brass (63A), Stainless Steel (125A)          |
| Phase, Ground Pins    | Brass                       | Brass  |
| Sleeve Spring         | Stainless Steel             | Stainless Steel                              |
| Internal Screws       | Zinc-Plated Steel           | Zinc-Plated Steel                            |

#### Receptacles

| PART                  | MATERIAL FOR 16A, 32A PLUGS | MATERIAL FOR 63A, 125A PLUGS        |
|-----------------------|-----------------------------|-------------------------------------|
| Housing               | Nylon                       | Valox 357                           |
| Cover                 | Nylon                       | Valox 357                           |
| Mounting Flange       | Nylon                       | _____                               |
| Arm Spring            | _____                       | Stainless Steel                     |
| Contact Carrier       | Nylon                       | Reinforced Nylon                    |
| Sealing Gasket (125A) | _____                       | Solid Chloroprene                   |
| Cover Eyelet          | Nickel Plated Brass         | Nickel Plated Brass                 |
| Terminal Screws       | Brass                       | Brass (63A), Stainless Steel (125A) |
| Phase, Ground Sleeve  | Brass                       | Brass                               |
| Sleeve Spring         | Stainless Steel             | Stainless Steel                     |

Valox® is a registered trademark of GE.

| STANDARDS & CERTIFICATIONS                           |                        |
|--|------------------------|
| Pin & Sleeve: Inlets, Connectors, Plugs, Receptacles |                        |
| CE<br>✓  | IEC 309-1 & 309-2<br>✓ |

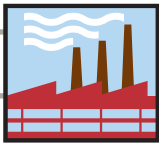

# PLUG & CONNECTOR DIMENSIONS

## Industrial Grade International-Rated Pin & Sleeve Devices

2 YEAR LIMITED  
WARRANTY

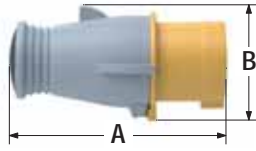

16A, 32A PLUG

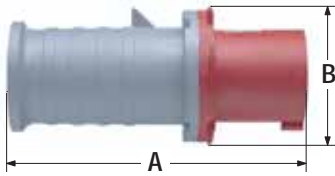

63A PLUG

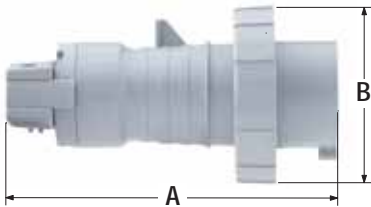

32A PLUG

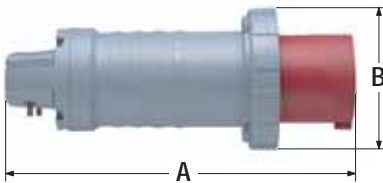

125A PLUG

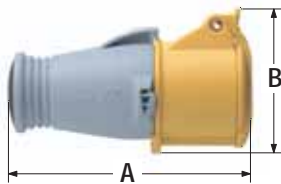

16A, 32A CONNECTOR

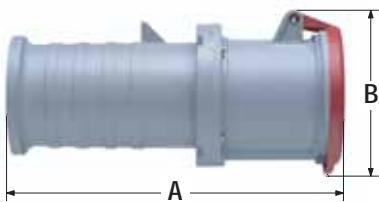

63A CONNECTOR

### Plug Dimensions

| CATALOG NO. | AMPS | UNIT | A    | B    | CORD GRIP RANGE (DIA.) |
|-------------|------|------|------|------|------------------------|
| SP316P      | 16   | inch | 4.53 | 2.48 | .350 – .860            |
|             |      | mm   | 115  | 63   | 9 – 22                 |
| SP416P      | 16   | inch | 5.51 | 2.83 | .350 – .860            |
|             |      | mm   | 140  | 72   | 9 – 22                 |
| SP516P      | 16   | inch | 5.51 | 2.99 | .437 – 1.187           |
|             |      | mm   | 140  | 76   | 11 – 30                |
| SP332P      | 32   | inch | 6.14 | 3.27 | .437 – 1.187           |
|             |      | mm   | 156  | 83   | 11 – 30                |
| SP432P      | 32   | inch | 6.14 | 3.27 | .437 – 1.187           |
|             |      | mm   | 156  | 83   | 11 – 30                |
| SP532P      | 32   | inch | 6.14 | 3.46 | .437 – 1.450           |
|             |      | mm   | 156  | 88   | 11 – 37                |
| SP363P      | 63   | inch | 8.46 | 4.06 | .670 – 1.625           |
|             |      | mm   | 215  | 103  | 17 – 41                |
| SP463P      | 63   | inch | 8.46 | 4.06 | .670 – 1.625           |
|             |      | mm   | 215  | 103  | 17 – 41                |
| SP563P      | 63   | inch | 8.46 | 4.06 | .670 – 1.625           |
|             |      | mm   | 215  | 103  | 17 – 41                |

### Plug Dimensions

| CATALOG NO. | AMPS | UNIT | A     | B    | CORD GRIP RANGE (DIA.) |
|-------------|------|------|-------|------|------------------------|
| 432P3WL     | 32   | inch | 5.79  | 3.70 | .437 – 1.450           |
|             |      | mm   | 147   | 94   | 11 – 37                |
| 3125P       | 125  | inch | 12.32 | 5.12 | .950 – 1.875           |
|             |      | mm   | 313   | 130  | 24 – 48                |
| 4125P       | 125  | inch | 12.32 | 5.12 | .950 – 1.875           |
|             |      | mm   | 313   | 130  | 24 – 48                |
| 5125P       | 125  | inch | 12.32 | 5.12 | .950 – 1.875           |
|             |      | mm   | 313   | 130  | 24 – 48                |

### Connector Dimensions

| CATALOG NO. | AMPS | UNIT | A    | B    | CORD GRIP RANGE (DIA.) |
|-------------|------|------|------|------|------------------------|
| SP316C      | 16   | inch | 4.88 | 2.95 | .350 – .860            |
|             |      | mm   | 124  | 75   | 9 – 22                 |
| SP416C      | 16   | inch | 5.91 | 3.45 | .350 – .860            |
|             |      | mm   | 150  | 85   | 9 – 22                 |
| SP516C      | 16   | inch | 5.98 | 3.50 | .437 – 1.187           |
|             |      | mm   | 152  | 89   | 11 – 30                |
| SP332C      | 32   | inch | 6.73 | 3.66 | .437 – 1.187           |
|             |      | mm   | 171  | 93   | 11 – 30                |
| SP432C      | 32   | inch | 6.73 | 3.66 | .437 – 1.187           |
|             |      | mm   | 171  | 93   | 11 – 30                |
| SP532C      | 32   | inch | 6.73 | 3.89 | .437 – 1.450           |
|             |      | mm   | 171  | 99   | 11 – 37                |
| SP363C      | 63   | inch | 8.82 | 4.41 | .670 – 1.625           |
|             |      | mm   | 224  | 112  | 17 – 41                |
| SP463C      | 63   | inch | 8.82 | 4.41 | .670 – 1.625           |
|             |      | mm   | 224  | 112  | 17 – 41                |
| SP563C      | 63   | inch | 8.82 | 4.41 | .670 – 1.625           |
|             |      | mm   | 224  | 112  | 17 – 41                |

# INLET & RECEPTACLE DIMENSIONS

## Industrial Grade International-Rated Pin & Sleeve Devices

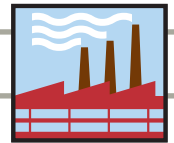

2 YEAR LIMITED  
WARRANTY

### Connector Dimensions

| CATALOG NO. | AMPS | UNIT | A     | B    | CORD GRIP RANGE (DIA.) |
|-------------|------|------|-------|------|------------------------|
| 432C3WL     | 32   | inch | 6.97  | 4.02 | .437 – 1.187           |
|             |      | mm   | 177   | 102  | 11 – 30                |
| 3125CW      | 125  | inch | 12.80 | 4.80 | .950 – 1.875           |
|             |      | mm   | 325   | 122  | 28 – 48                |
| 4125CW      | 125  | inch | 12.80 | 4.80 | .950 – 1.875           |
|             |      | mm   | 325   | 122  | 28 – 48                |
| 5125CW      | 125  | inch | 12.80 | 4.80 | .950 – 1.875           |
|             |      | mm   | 325   | 122  | 28 – 48                |

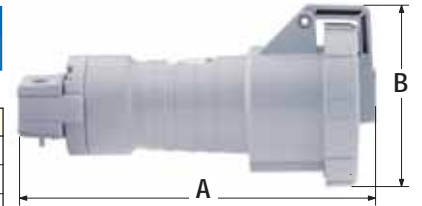

32A CONNECTOR

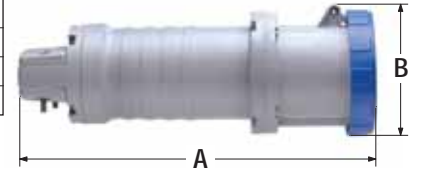

125A CONNECTOR

### Receptacle Dimensions

| CATALOG NO. | AMPS | UNIT | A    | B    | C    |
|-------------|------|------|------|------|------|
| SP316R      | 16   | inch | 2.20 | 1.14 | 2.87 |
|             |      | mm   | 56   | 29   | 73   |
| SP416R      | 16   | inch | 2.28 | 1.18 | 3.43 |
|             |      | mm   | 58   | 30   | 87   |
| SP516R      | 16   | inch | 2.36 | 1.22 | 3.50 |
|             |      | mm   | 60   | 31   | 89   |
| SP332R      | 32   | inch | 2.76 | 1.34 | 3.66 |
|             |      | mm   | 70   | 34   | 93   |
| SP432R      | 32   | inch | 2.76 | 1.34 | 3.66 |
|             |      | mm   | 70   | 34   | 93   |
| SP532R      | 32   | inch | 2.76 | 1.34 | 3.90 |
|             |      | mm   | 71   | 34   | 99   |
| SP363R      | 63   | inch | 3.43 | 1.89 | 4.41 |
|             |      | mm   | 87   | 48   | 112  |
| SP463R      | 63   | inch | 3.43 | 1.89 | 4.41 |
|             |      | mm   | 87   | 48   | 112  |
| SP563R      | 63   | inch | 3.43 | 1.89 | 4.41 |
|             |      | mm   | 87   | 48   | 112  |

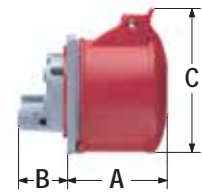

16A, 32A RECEPTACLE

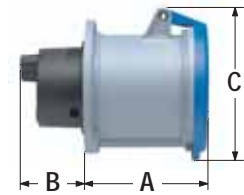

63A RECEPTACLE

### Receptacle Dimensions

| CATALOG NO. | AMPS | UNIT | A    | B    | C    |
|-------------|------|------|------|------|------|
| 3125R       | 125  | inch | 3.94 | 2.28 | 4.80 |
|             |      | mm   | 100  | 58   | 122  |
| 4125R       | 125  | inch | 3.94 | 2.28 | 4.80 |
|             |      | mm   | 100  | 58   | 122  |
| 5125R       | 125  | inch | 3.94 | 2.28 | 4.80 |
|             |      | mm   | 100  | 58   | 122  |

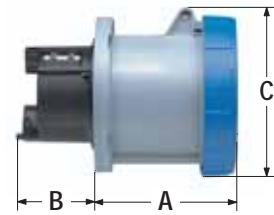

125A RECEPTACLE

### Inlet Dimensions for International-Rated Watertight devices

| CATALOG NO. | AMPS | UNIT | A    | B    |
|-------------|------|------|------|------|
| 3125B6W     | 125  | inch | 3.50 | 2.21 |
|             |      | mm   | 89   | 56   |
| 4125B6W     | 125  | inch | 3.50 | 2.21 |
|             |      | mm   | 89   | 56   |
| 5125B6W     | 125  | inch | 3.50 | 2.21 |
|             |      | mm   | 89   | 56   |



125A INLET

International-Rated Pin & Sleeve Devices



# INLET & RECEPTACLE DIMENSIONS

## Industrial Grade International-Rated Pin & Sleeve Devices

2 YEAR LIMITED  
WARRANTY

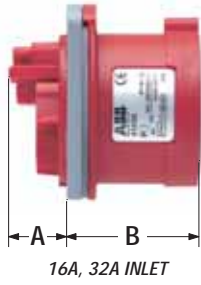

16A, 32A INLET



63A INLET

### Inlet Dimensions

| CATALOG NO. | AMPS | UNIT | A    | B    |
|-------------|------|------|------|------|
| SP316B      | 16   | inch | .85  | 1.83 |
|             |      | mm   | 21.5 | 46.5 |
| SP416B      | 16   | inch | .83  | 1.85 |
|             |      | mm   | 21   | 47   |
| SP516B      | 16   | inch | .83  | 1.83 |
|             |      | mm   | 21   | 46.5 |
| SP332B      | 32   | inch | .95  | 2.19 |
|             |      | mm   | 24.5 | 55.5 |
| SP432B      | 32   | inch | .95  | 2.19 |
|             |      | mm   | 24.5 | 55.5 |
| SP532B      | 32   | inch | .98  | 2.19 |
|             |      | mm   | 25   | 55.5 |
| SP363B      | 63   | inch | 1.97 | 3.0  |
|             |      | mm   | 50   | 78   |
| SP463B      | 63   | inch | 1.97 | 3.0  |
|             |      | mm   | 50   | 78   |
| SP563B      | 63   | inch | 1.97 | 3.0  |
|             |      | mm   | 50   | 78   |

### Inlet Panel Mounting Dimensions

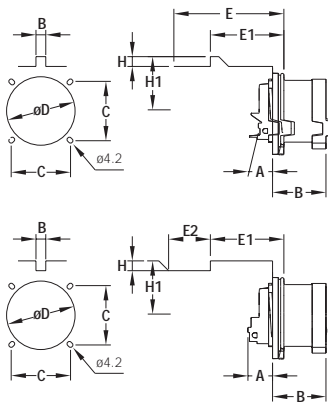

| DEVICE SIZE |    | C         | D    | E    | E1   | E2   | G    | H    | H1   |
|-------------|----|-----------|------|------|------|------|------|------|------|
| SP316B      | in | 1.73-1.85 | 1.93 | 2.95 | 1.59 | 0.31 | 0.35 | 0.16 | 1.18 |
|             | mm | 44-47     | 49   | 75   | 40.5 | 8    | 9    | 4    | 30   |
| SP416B      | in | 1.97-2.05 | 2.32 | 3.15 | 1.83 | 0.31 | 0.35 | 0.2  | 1.34 |
|             | mm | 50-52     | 59   | 80   | 46.5 | 8    | 9    | 5    | 34   |
| SP516B      | in | 1.97-2.05 | 2.32 | 3.54 | 2.07 | 0.31 | 0.35 | 0.27 | 1.5  |
|             | mm | 50-52     | 59   | 90   | 52.5 | 8    | 9    | 7    | 38   |
| SP332B      | in | 2.36-2.40 | 2.6  | 3.54 | 2.11 | 0.31 | 0.35 | 0.27 | 1.57 |
|             | mm | 60-61     | 66   | 90   | 53.5 | 8    | 9    | 7    | 40   |
| SP432B      | in | 2.36-2.40 | 2.6  | 3.54 | 2.11 | 0.31 | 0.35 | 0.27 | 1.57 |
|             | mm | 60-61     | 66   | 90   | 53.5 | 8    | 9    | 7    | 40   |
| SP532B      | in | 2.36-2.40 | 2.6  | 4.13 | 2.34 | 0.35 | 0.35 | 0.31 | 1.77 |
|             | mm | 60-61     | 66   | 105  | 59.5 | 9    | 9    | 8    | 45   |
| SP363B      | in | 2.40      | 2.76 | 4.13 | 2.32 | 0.39 | 0.43 | 0.35 | 1.95 |
|             | mm | 61        | 70   | 105  | 59   | 10   | 11   | 9    | 49.5 |
| SP463B      | in | 2.40      | 2.76 | 4.13 | 2.32 | 0.39 | 0.43 | 0.35 | 1.95 |
|             | mm | 61        | 70   | 105  | 59   | 10   | 11   | 9    | 49.5 |
| SP563B      | in | 2.40      | 2.76 | 4.13 | 2.32 | 0.39 | 0.43 | 0.35 | 1.95 |
|             | mm | 61        | 70   | 105  | 59   | 10   | 11   | 9    | 49.5 |

### Drilling Plan Inlets & Receptacles

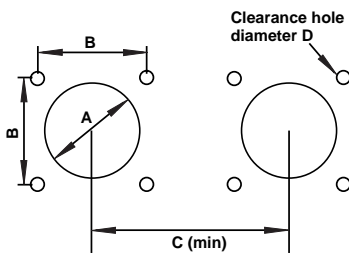

| DEVICE SIZE  |            | A      |    | B      |    | C (min) |     | D      |     |
|--------------|------------|--------|----|--------|----|---------|-----|--------|-----|
|              |            | inches | mm | inches | mm | inches  | mm  | inches | mm  |
| 16A; 3-wire: | Receptacle | 1.93   | 49 | 1.73   | 44 | 3.35    | 85  | .185   | 4.7 |
|              | Inlet      | 1.93   | 49 | 1.73   | 44 | 3.35    | 85  | .185   | 4.7 |
| 16A; 4-wire: | Receptacle | 2.32   | 59 | 2.05   | 52 | 3.94    | 100 | .185   | 4.7 |
|              | Inlet      | 2.32   | 59 | 2.05   | 52 | 3.94    | 100 | .185   | 4.7 |
| 16A; 5-wire: | Receptacle | 2.32   | 59 | 2.05   | 52 | 3.94    | 100 | .185   | 4.7 |
|              | Inlet      | 2.32   | 59 | 2.05   | 52 | 3.94    | 100 | .185   | 4.7 |
| 32A; 3-wire: | Receptacle | 2.60   | 66 | 2.40   | 61 | 4.53    | 115 | .185   | 4.7 |
|              | Inlet      | 2.60   | 66 | 2.40   | 61 | 4.53    | 115 | .185   | 4.7 |
| 32A; 4-wire: | Receptacle | 2.60   | 66 | 2.40   | 61 | 4.53    | 115 | .185   | 4.7 |
|              | Inlet      | 2.60   | 66 | 2.40   | 61 | 4.53    | 115 | .185   | 4.7 |
| 32A; 5-wire: | Receptacle | 2.60   | 66 | 2.40   | 61 | 4.53    | 115 | .185   | 4.7 |
|              | Inlet      | 2.60   | 66 | 2.40   | 61 | 4.53    | 115 | .185   | 4.7 |
| 63A          | All        | 2.76   | 70 | 2.40   | 61 | 6.69    | 170 | .185   | 4.7 |
| 125A         | All        | 3.47   | 88 | 2.80   | 71 | 7.87    | 200 | .280   | 7.1 |

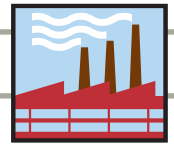

2 YEAR LIMITED WARRANTY

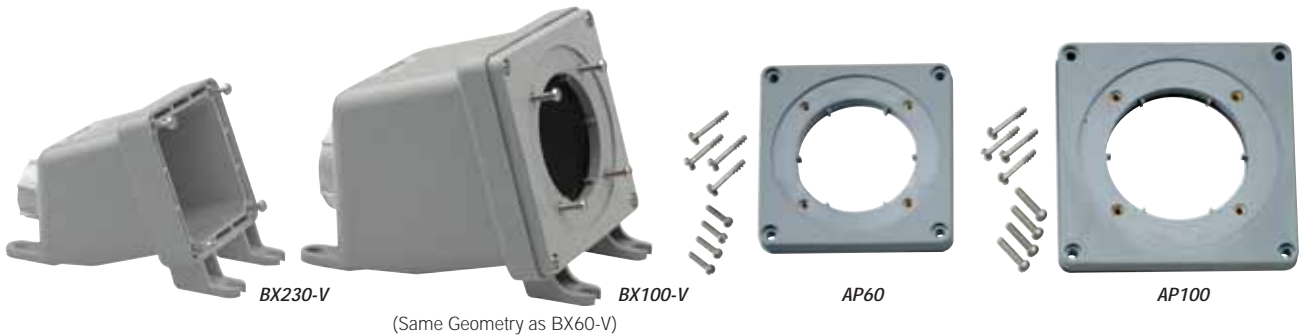

(Same Geometry as BX60-V)

**Valox® Back Boxes for Watertight Inlets & Receptacles**

| APPLICATION                              | CATALOG NO. |
|--|-------------|
| 20 & 30 Amp<br>No Adapter Plate Required | BX230-V     |
| 60 Amp<br>Adapter Plate Included         | BX60-V      |
| 100 Amp<br>Adapter Plate Included        | BX100-V     |

**Replacement Valox® Adapter Plates for Leviton & Hubbell Back Boxes**

| APPLICATION                                | CATALOG NO. |
|--|-------------|
| 60 Amp<br>Watertight Inlets & Receptacles  | AP60        |
| 100 Amp<br>Watertight Inlets & Receptacles | AP100       |

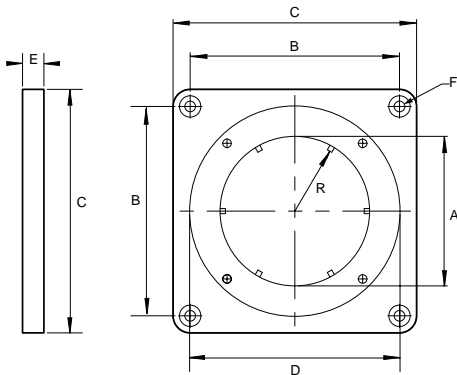

**Dimensions for Valox® Adapter Plates**

| UNIT           | A    | B    | C    | D    | E   | F   | R    |
|----------------|------|------|------|------|-----|-----|------|
| <b>60 Amp</b>  |      |      |      |      |     |     |      |
| inch           | 2.78 | 3.86 | 4.50 | 3.88 | .40 | .20 | 1.28 |
| mm             | 70   | 98   | 114  | 98.5 | 10  | 5   | 32.5 |
| <b>100 Amp</b> |      |      |      |      |     |     |      |
| inch           | 3.23 | 4.88 | 5.50 | 4.60 | .40 | .22 | 1.50 |
| mm             | 82   | 124  | 140  | 117  | 10  | 5.5 | 38   |

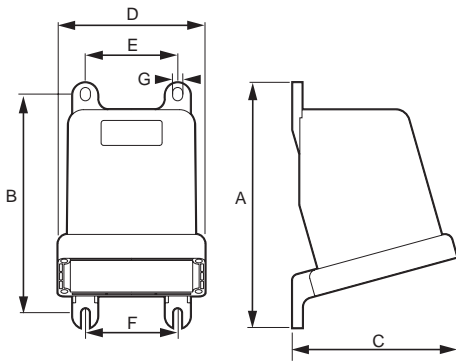

**Dimensions for Valox® Back Boxes**

| UNIT                                | A     | B     | C     | D     | E     | F    | G    |
|-------------------------------------|-------|-------|-------|-------|-------|------|------|
| <b>20 Amp &amp; 30 Amp – 1" Hub</b> |       |       |       |       |       |      |      |
| inch                                | 6.69  | 5.91  | 4.53  | 3.90  | 2.35  | 2.35 | 0.25 |
| mm                                  | 170.0 | 150.0 | 115.0 | 99.0  | 60.0  | 60.0 | 6.5  |
| <b>60 Amp – 1 1/2" Hub</b>          |       |       |       |       |       |      |      |
| inch                                | 7.68  | 6.92  | 5.20  | 4.65  | 2.99  | 2.99 | 0.31 |
| mm                                  | 195.0 | 176.0 | 132.0 | 118.0 | 76.0  | 76.0 | 8.0  |
| <b>100 Amp – 2" Hub</b>             |       |       |       |       |       |      |      |
| inch                                | 8.23  | 7.39  | 6.30  | 5.71  | 3.99  | 3.33 | 0.33 |
| mm                                  | 209.0 | 188.0 | 160.0 | 145.0 | 101.0 | 84.5 | 8.5  |

Valox® is a registered trademark of GE.

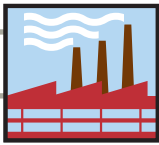

# PIN & SLEEVE ACCESSORIES

## Industrial Grade Pin & Sleeve Devices



PC420

PC60

PC100

PROTECTIVE CLOSURE CAPS

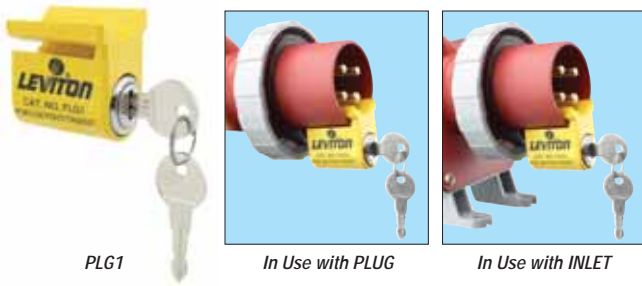

PLG1

In Use with PLUG

In Use with INLET

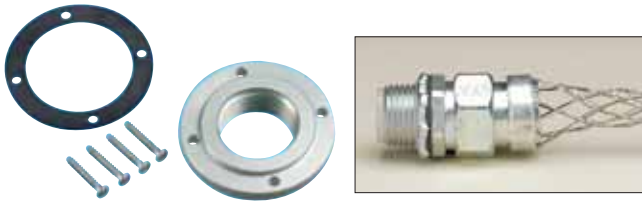

SAD125

L7902 STRAIGHT MALE  
LIQUID-TIGHT GRIP  
For use with flexible metal conduit.



CA520

CA100

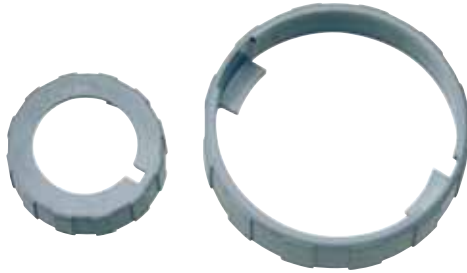

RA420

RA100



Mount-Kit

### Protective Closure Caps for Plugs and Inlets

| APPLICATION NORTH AMERICAN | APPLICATION INTERNATIONAL | WATERTIGHT CATALOG NO. |
|----------------------------|---------------------------|------------------------|
| 20 Amp, 3-Wire             | 16 Amp, 3-Wire            | PC320                  |
| 20 Amp, 4-Wire             | 16 Amp, 4-Wire            | PC420                  |
| 20 Amp, 5-Wire             | 16 Amp, 5-Wire            | PC520                  |
| 30 Amp, 3-, 4-Wire         | 32 Amp, 3-, 4-Wire        | PC3430                 |
| 30 Amp, 5-Wire             | 32 Amp, 5-Wire            | PC530                  |
| All 60 Amp                 | All 63 Amp                | PC60                   |
| All 100 Amp                | All 125 Amp               | PC100                  |

### Lockout / Tagout for Pin and Sleeve Devices

| APPLICATION  | CATALOG NUMBER WATERTIGHT & SPLASHPROOF |
|--|---|
| Can be used for any IEC 309-1 and 309-2 pin and sleeve plugs or inlets | PLG1                                    |

### Liquid-Tight Adapters

| APPLICATION        | NPT SIZE   | ADAPTER CATALOG NO. | STRAIGHT MALE FITTING CATALOG NO. |
|--------------------|------------|---------------------|-----------------------------------|
| 20 Amp, 3-, 4-Wire | 1/2" NPT   | SAA12               | L7902                             |
| 20 Amp, 5 Wire     | 1/2" NPT   | SAB12               | L7902                             |
| 30 Amp, 3-, 4-Wire | 3/4" NPT   | SAB34               | L7903                             |
| 30 Amp, 5 Wire     | 3/4" NPT   | SAC34               | L7903                             |
| 30 Amp, 5 Wire     | 1" NPT     | SAC100              | L7904                             |
| 60 Amp, All        | 1 1/4" NPT | SAC125              | L7905                             |
| 100 Amp, All       | 1 1/4" NPT | SAD125              | L7905                             |

### Replacement Watertight Closure Cover Kit for Connectors and Receptacles

| APPLICATION        | CATALOG NUMBER |
|--------------------|----------------|
| 20 Amp, 3-Wire     | CA320          |
| 20 Amp, 4-Wire     | CA420          |
| 20 Amp, 5-Wire     | CA520          |
| 30 Amp, 3-, 4-Wire | CA343          |
| 30 Amp, 5-Wire     | CA530          |
| All 60 Amp         | CA060          |
| All 100 Amp        | CA100          |

### Replacement Watertight Locking Ring for Plugs and Inlets

| APPLICATION        | CATALOG NUMBER |
|--------------------|----------------|
| 20 Amp, 3-wire     | RA320          |
| 20 Amp, 4-wire     | RA420          |
| 20 Amp, 5-wire     | RA520          |
| 30 Amp, 3-, 4-wire | RA343          |
| 30 Amp, 5-wire     | RA530          |
| All 60 Amp         | RA060          |
| All 100 Amp        | RA100          |

### Replacement Grommets for Plugs and Connectors

| APPLICATION             | CATALOG NUMBER |
|-------------------------|----------------|
| 20A 3,4-Wire            | GROMT-020      |
| 20A 5-Wire 30A 3,4-Wire | GROMT-023      |
| 30A 5-Wire              | GROMT-030      |
| All 60A                 | GROMT-060      |
| All 100A                | GROMT-100      |

### Replacement Mounting Feet

| APPLICATION  | CATALOG NUMBER |
|--|----------------|
| For all Disconnects and Mechanical Interlocks. Includes 4 feet and 4 mounting screws | MOUNT-KIT      |

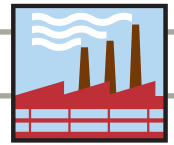

Industrial Grade Pin & Sleeve Devices

**Making the Right Connection is as Easy as Matching Colors and Telling Time!**

Leviton's pin and sleeve devices are easy to use. Matching amperage and voltage requirements is literally as easy as matching colors and telling time.

The amperage rating is related to the size of the device; devices of the same amperage are the same size.

The voltage rating is related to the location of the ground sleeve on the female device and the number of conductors. This location is based on a clock face with the key-way at the 6 o'clock position.

The ground sleeve is positioned at a specific hour location, depending on the device's voltage rating.

The clock position for plugs and inlets is a mirror image of the position for matching connectors and receptacles.

For quick visual identification, voltage ratings are also color-coded and the housings of interconnecting units are always the same color. All 125VAC devices are yellow; 250VAC are blue, etc. Matching up interconnecting devices is as easy as matching colors.

**North American**

Green Dot • Represents the Ground Sleeve of Female Devices (Connectors & Receptacles)

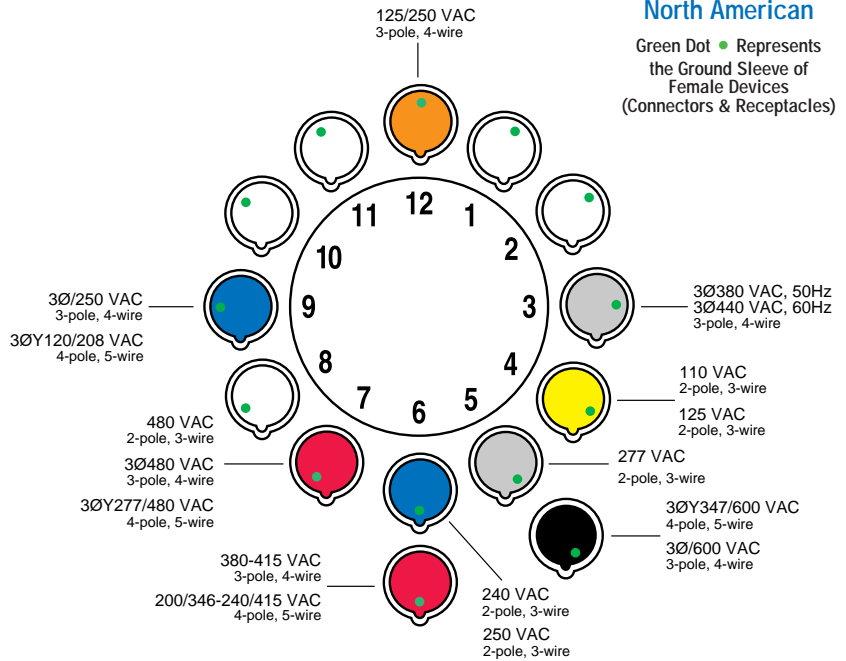

| Rated Voltage    | Color  |
|------------------|--------|
| 110V-130V        | Yellow |
| 125V-250V        | Orange |
| 200V-250V        | Blue   |
| 277V, 380V, 440V | Grey   |
| 346V-480V        | Red    |
| 500V and above   | Black  |

**Catalog Numbering System**

Leviton's catalog numbering system is easy to use. Each letter or number provides a description of the product. Simply follow the six-part code below, made up of letters and numbers. Each catalog number contains the number of conductors, amperage rating, device type, clock position of the ground sleeve, and environmental rating. For example, the catalog number below refers to a 3-wire, 20 amp receptacle with a grounding sleeve located at the 6 o'clock position and an environmental classification of watertight.

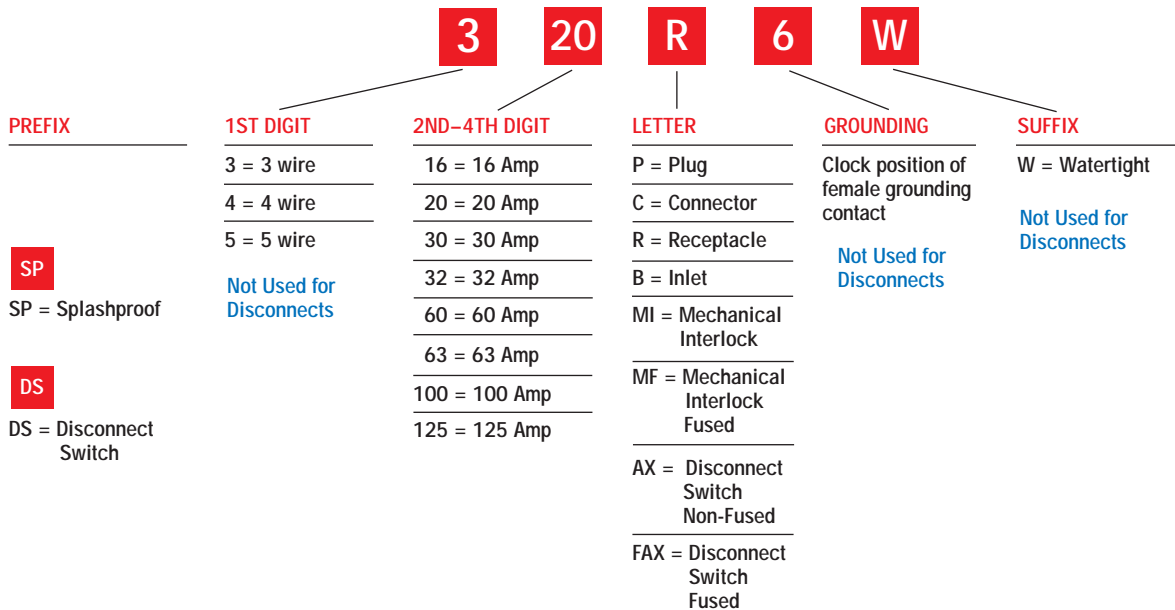

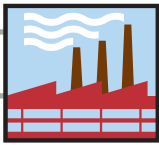

## SAFETY DISCONNECT SWITCH FEATURES

### Industrial Grade Watertight Safety Disconnect Switches UL 98 & UL 508 Listed, CUL per CSA Specification, C22.2 No. 14 Certified

2 YEAR LIMITED  
**WARRANTY**

Liquid-tight conduit fitting can be installed for top or bottom feed

- One fitting supplied:
- 30 Amp – 3/4"
  - 60 Amp – 1 1/4"
  - 100 Amp – 1 1/2"

Stainless steel screws are captive and will not fall out when cover is opened

- Impact UV and chemical-resistant Valox enclosure rated to UL and IEC watertight standards
- Type 3R, 4X & 12K
  - IP67

**Fused Models Accept  
"Class J" Time-Delay Fuses**

Pre-wired grounding plates (top and bottom of enclosure) connect to metal conduit grounding system

Brass threaded inserts will not strip, provide higher torque, and form tighter seal between back box and cover

Rugged hinge mechanism pivots 180° for easy access during installation and maintenance

Red "pistol grip" handle provides visual confirmation of switch's status

Integrated lockout handle meets OSHA safety regulations

**Watertight Safety Disconnect Switches Include —  
30 Amp Fused, 60 & 100 Amp (Fused & Non-Fused)**

**Meets 2002 NEC® Requirements  
430.102 (A) and 430.102 (B)**

Circuit identification pad for means of identifying specific equipment loads

DS60-FAX



Handle with padlock installed

Generous wiring space for top to bottom wiring

- Disconnect switch with integrated fuse holder offers proven performance in a compact package
- Fused cartridges accept "Class J" fuses (not included)
  - 1 Factory installed Auxiliary Contact (Normally Open – 10 Amp)
  - Additional Auxiliary Contact Available (Normally Closed – 10 Amp)
  - Easily accessible neutral and ground terminal blocks



DS60-FAX

| STANDARDS & CERTIFICATIONS                  |                  |                  |     |    |           |
|---|------------------|------------------|-----|----|-----------|
| Safety Disconnect Switches                  |                  |                  |     |    |           |
| UL 98 Fused (Including 100A Non-Fused - DS) | UL 508 Non-Fused | CSA C22.2 No. 14 | NOM | CE | IEC 947-3 |
| E63969                                      |                  | ✓                | ✓   | *  | ✓         |

\*Not available on DS30-AX



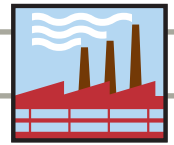

Industrial Grade Watertight Safety Disconnect Switches



Engineered to UL & IEC Watertight Standards



DS30-AX  
(Non-Fused)



DS60-FAX  
(Fused)



DS100-AX  
(Non-Fused)

2 YEAR LIMITED WARRANTY

Ordering Information

| AMPS | MAX VOLTAGE | CATALOG NO. |          |
|------|-------------|-------------|----------|
|      |             | NON-FUSED   | FUSED    |
| 30   | 600V AC     | DS30-AX     | DS30-FAX |
| 60   | 600V AC     | DS60-AX     | DS60-FAX |
| 100  | 600V AC     | DS100-AX    |          |

| ELECTRICAL            |  |   |          | MECHANICAL         |   | ENVIRONMENTAL  |   |   |
|-----------------------|--|---|----------|--------------------|---|--|---|---|
| Ground Path Integrity | Device   | Current Applied   | Duration | Mold Stress Relief | 70°C for 7 hours                        | Flammability   | V2 or better per UL 94 or CSA 22.2 No 0.6; V-0 for watertight enclosure |   |
|                       | 30 A   | 60 A  | 2 min    | Knockout Test      | Remains in place with 20 lb push        |  | Rain (3R) per UL 50   | Water spray @ 5 psi from all sides for 1 hr |
|                       | 60 A   | 120 A   | 4 min    | Crush              | 100 lb                                  |  | Hosedown (4X) per UL 50   | Water spray @ 65 gal/min for 5 minutes      |
| Current Interrupting  | Certified for current interrupting at full-rated current and voltage |   |          | Impact             | 1.2 lb steel ball dropped from 5 ft     | Dust (12K) per UL 50                                   | Cement Dust Circulated @ 1000 ft/minute for 5 minutes                   |   |
|                       | Endurance  | 6000 operations at rated current and voltage (Power factor 0.75 – 0.80) |          |                    | Cold Impact                             |  | Same as above, after conditioning to -35°C                              | Gasket Aging                                |
| Dielectric            |  | 1000 V plus twice rated voltage for 1 minute                            |          |                    | Strength of Insulating Base and Support | 110% of specified tightening torque on terminal screws | UV Resistance   | Exposed plastic materials are UV stabilized |
|                       |  |   |          |                    | Pullout                                 | 18 lb pull on internal wires                           | Operating Temperature   | -40°C to +60°C (-40°F to +140°F)            |

| VOLTS            | MAX. HP RATINGS PER UL508<br>NON-FUSED SAFETY DISCONNECT SWITCHES |         |          |
|------------------|---|---------|----------|
|                  | DS30-AX   | DS60-AX | DS100-AX |
| 120V AC          | 1   | 2       | 5        |
| 208V AC          | 5   | 20      | 25       |
| 240V AC          | 2.5   | 10      | 15       |
| 480V AC          | 5   | 20      | 25       |
| 600V AC          | NA  | 20      | 20       |
| 3Ø Y 120/208V AC | 5   | 20      | 25       |
| 3Ø 240V AC       | 5   | 20      | 30       |
| 3Ø 480V AC       | 15  | 40      | 50       |
| 3Ø 600V AC       | 15  | 40      | 50       |

| VOLTS            | MAX. HP RATINGS PER UL508<br>FUSED SAFETY DISCONNECT SWITCHES |          |
|------------------|---|----------|
|                  | DS30-FAX  | DS60-FAX |
| 120V AC          | 2   | NR       |
| 208V AC          | 7.5   | 15       |
| 240V AC          | 3   | NR       |
| 480V AC          | 15  | NR       |
| 600V AC          | 20  | NR       |
| 3Ø Y 120/208V AC | 7.5   | 15       |
| 3Ø 240V AC       | 7.5   | 15       |
| 3Ø 480V AC       | 15  | 30       |
| 3Ø 600V AC       | 20  | 50       |

NR = Not Rated

Watertight Safety Disconnect Switches

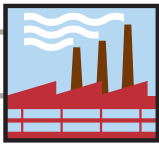

# TECHNICAL INFORMATION

## Industrial Grade Watertight Safety Disconnect Switches UL 98 & UL 508 Listed, CUL per CSA Specification, C22.2 No. 14 Certified



Engineered to IP67  
Watertight Standards

2 YEAR LIMITED  
WARRANTY



Watertight Safety Disconnect Switches

- Heavy Duty Safety Disconnects
- Enclosures are TYPE 3R, 4X & 12K, IP67
- Listed to UL 508 for Non-Fused and UL 98 for Fused
- Certified to CSA Standard C22.2 number 14
- Classified to IEC Standard 947-3
- CE marking per low-voltage directives 73/23/EEC, 93/68/EEC

### Material Specifications

#### 30 Amp Switch, Non-Fused

| PART                     | MATERIAL                  |
|--------------------------|---------------------------|
| Housing Cover            | Valox 357                 |
| Housing Base             | Valox 357                 |
| Housing Gasket           | Solid Chloroprene         |
| Handle                   | Valox 357                 |
| Screw handle             | Stainless Steel           |
| Conduit Grounding Plate  | Zinc-Coated Steel         |
| Conduit Hub              | Die-Cast Zinc             |
| Switch                   | Nylon                     |
| Switch Terminal Contacts | Brass                     |
| Switch Contacts          | Cadmium-Free Silver Alloy |
| Internal Screws          | Zinc-Coated Steel         |
| Housing Screws           | Stainless Steel           |
| Mounting Feet            | Valox 357                 |
| Ground Terminal          | Plated Brass/Steel        |
| Ground Terminal Block    | Nylon                     |
| Neutral Terminal         | Plated Brass/Steel        |
| Neutral Terminal Block   | Nylon                     |

#### 60 & 100 Amp Switch, Non-Fused

| PART                     | MATERIAL                  |
|--------------------------|---------------------------|
| Housing Cover            | Valox 357                 |
| Housing Base             | Valox 357                 |
| Housing Gasket           | Solid Chloroprene         |
| Handle                   | Valox 357                 |
| Screw handle             | Stainless Steel           |
| Conduit Grounding Plate  | Zinc-Coated Steel         |
| Conduit Hub              | Die-Cast Zinc             |
| Switch                   | Reinforced Nylon          |
| Switch Terminal Contacts | Brass                     |
| Switch Contacts          | Cadmium-Free Silver Alloy |
| Internal Screws          | Zinc-Coated Steel         |
| Housing Screws           | Stainless Steel           |
| Hinge Screws             | Stainless Steel           |
| Mounting Feet            | Valox 357                 |
| Ground Terminal          | Plated Brass/Steel        |
| Ground Terminal Block    | Nylon                     |
| Neutral Terminal         | Plated Brass/Steel        |
| Neutral Terminal Block   | Nylon                     |

#### 30 & 60 Amp Switch, Fused

| PART                     | MATERIAL           |
|--------------------------|--------------------|
| Housing Cover            | Valox 357          |
| Housing Base             | Valox 357          |
| Housing Gasket           | Solid Chloroprene  |
| Handle                   | Valox 357          |
| Screw handle             | Stainless Steel    |
| Conduit Grounding Plate  | Zinc-Coated Steel  |
| Conduit Hub              | Die-Cast Zinc      |
| Switch                   | Reinforced Nylon   |
| Switch Terminal Contacts | Brass              |
| Internal Screws          | Zinc-Coated Steel  |
| Housing Screws           | Stainless Steel    |
| Hinge Screws             | Stainless Steel    |
| Fuse Holder              | Reinforced Nylon   |
| Mounting Feet            | Valox 357          |
| Ground Terminal          | Plated Brass/Steel |
| Ground Terminal Block    | Nylon              |
| Neutral Terminal         | Plated Brass/Steel |
| Neutral Terminal Block   | Nylon              |

Valox® is a registered trademark of GE.

#### STANDARDS & CERTIFICATIONS

##### Safety Disconnect Switches

| UL 98 Fused | UL 508 Non-Fused | CSA C22.2 No.14 | NOM | CE | IEC 947-3 |
|-------------|------------------|-----------------|-----|----|-----------|
| ✓           | ✓                | ✓               | ✓   | *  | ✓         |

\*Not available on DS30-AX

#### IP Ratings & UL Standards

| CATALOG NO. | IP RATING | UL STANDARD |
|-------------|-----------|-------------|
| DS30-AX     | IP67      | UL508       |
| DS60-AX     | IP67      | UL508       |
| DS100-AX    | IP67      | UL98        |
| DS30-FAX    | IP67      | UL98        |
| DS60-FAX    | IP67      | UL98        |

#### SWITCHING MECHANISM TYPE

| NON-FUSED | SWITCHING | FUSED    | SWITCHING |
|-----------|-----------|----------|-----------|
| DS30-AX   | Rotary    | DS30-FAX | Knife     |
| DS60-AX   | Rotary    | DS60-FAX | Knife     |
| DS100-AX  | Knife     | —        | —         |

# SAFETY DISCONNECT SWITCH DIMENSIONS

## Industrial Grade Watertight Safety Disconnect Switches

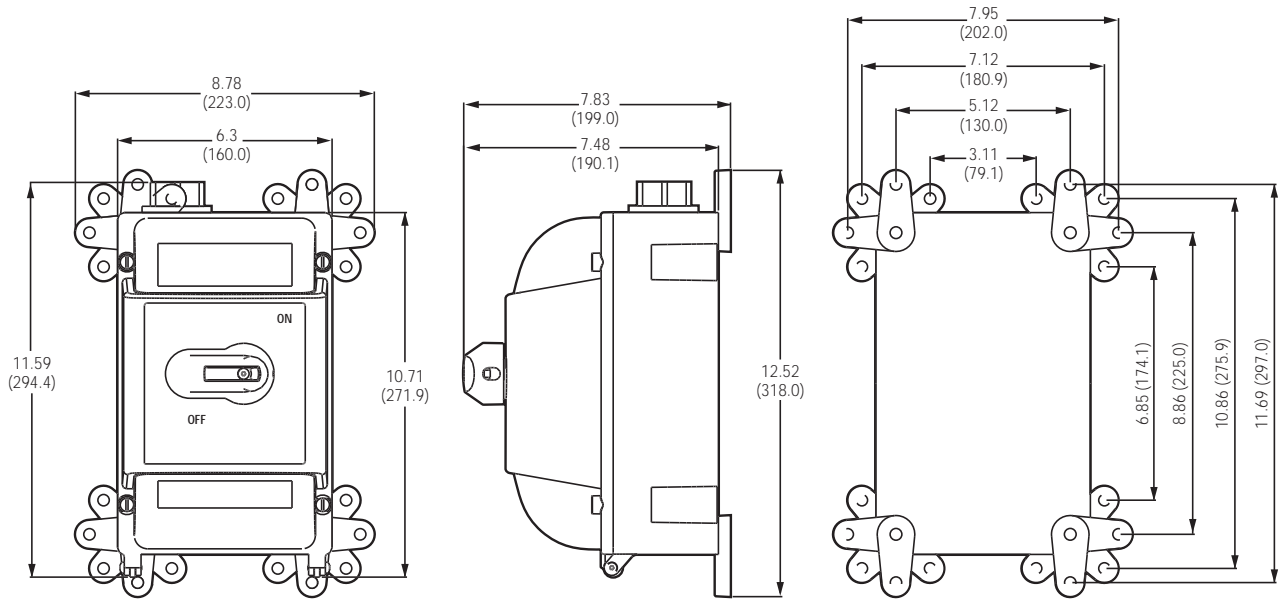
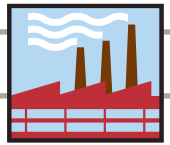

**30 AMP FUSED & 60 AMP NON-FUSED**

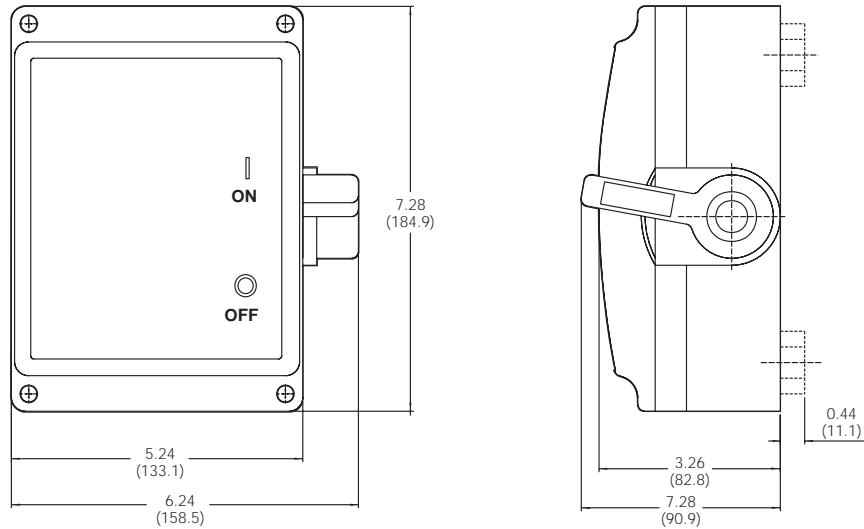

**30 AMP NON-FUSED**

Watertight Safety Disconnect Switches



# SAFETY DISCONNECT SWITCH DIMENSIONS

## Industrial Grade Watertight Safety Disconnect Switches

2 YEAR LIMITED  
WARRANTY

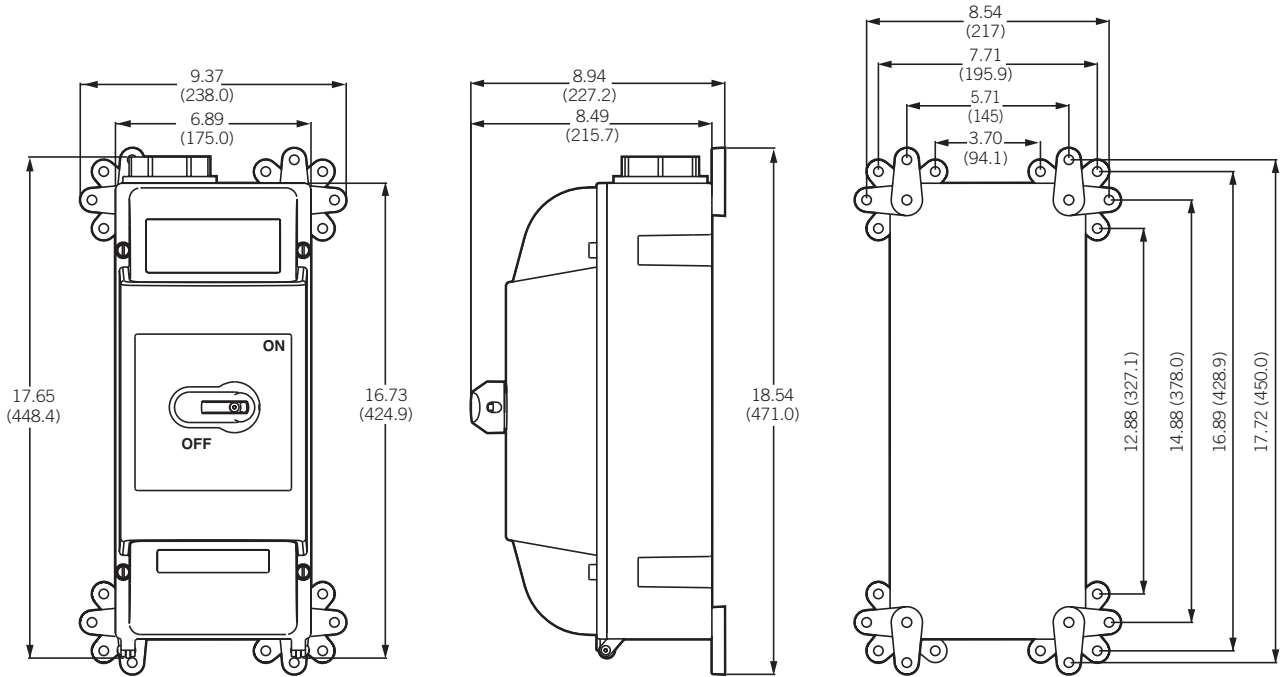

60 AMP FUSED & 100 AMP NON-FUSED

### Auxiliary Contacts for Safety Disconnect Switches

- Leviton Disconnect Switches automatically ship with one factory installed auxiliary contact, normally open.
- A second auxiliary contact may be added. Select from the table below.



| DEVICE  | CATALOG NO. | DESCRIPTION                                       |
|---|-------------|---|
| For ALL <b>non-fused</b> and <b>fused</b> disconnect switches | AUXNO       | Normally open contact, 10 Amp, early break type   |
|   | AUXNC-NF    | Normally closed contact, 10 Amp, early break type |
| For ALL <b>fused</b> disconnect switches                      | AUXNC-F     | Normally closed contact, 10 Amp, early break type |

# Single Pole Cam-Type Connectors and Stage Pin Devices

## INDEX

|  |         |
|--|---------|
| <b>Cam Connectors and Stage Pin Devices for Commercial and Industrial Applications</b> |         |
| Stage Pin Devices—Overview, and Benefits   | P2      |
| 20, 60 and 100 AMP Stage Pin Devices   | P3      |
| Cam Connectors—Overview, and Benefits  | P4, P5  |
| Ampacity Chart   | P6      |
| Up to 140 AMP  |         |
| 15 Series—Taper Nose   | P7      |
| Up to 300 AMP  |         |
| 16 Series—Taper Nose   | P8      |
| 18 Series—Ball Nose  | P11     |
| Up to 400 AMP  |         |
| 16 Series—Taper Nose   | P9, P10 |
| 18 Series—Ball Nose  | P12–P13 |
| Up to 690 AMP  |         |
| 17 Series—Taper Nose   | P14     |
| 19 Series—Ball Nose  | P15     |
| 22 Series—Latching Ball Nose   | P16     |
| 23 Series—Latching Taper Nose  | P17     |
| Product Accessories  | P18     |
| Stage Pin Dimensional Drawings   | P19–20  |
| Cam Connector Dimensional Drawings   | P21–26  |



# STAGE PIN DEVICE FEATURES

## Commercial Grade Stage Pin Devices

Stage Pin Devices — Conforms to USITT (United States Institute for Theater Technology) S3 Standard for Stage Pin Connectors



Male pins and female contacts have a one-piece solid brass design for superior current flow and resistance from abuse  
Male pins and female contacts float to ensure compatibility with all competitive products and improved electrical connections

Terminal identification letters on device ensure quick and accurate termination

100MP-E

Slit in male pin provides spring action to compensate for wear

60 and 100 Amp versions have rugged phenolic housings for superior high temperature performance

100FP-E

60 and 100 Amp plugs and connectors have **Sure Grip™** edge for easy handling

20MP-CL



20 Amp version is available with a clear cover to allow for visual inspection of proper termination of conductors. Other colors available include white, blue, green, yellow, red and orange. Consult factory for availability.

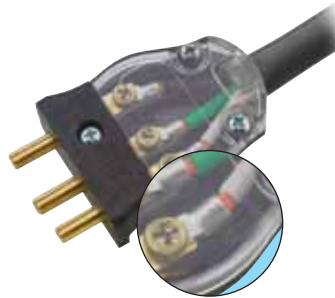

Male Plug, Crimp Terminal



Male Plug, Pressure Plate Terminal

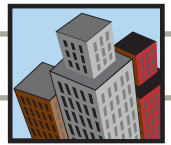

20, 60 and 100 AMP 125V Stage Pin Devices

20A 125V, 2-P 3-W, Grounding

| DESCRIPTION   | CATALOG NO. | COLOR*               |
|---|-------------|----------------------|
| Male Plug-Pressure Plate Terminal                               | 20MP-E      | Black                |
| Male Plug-Pressure Plate Terminal                               | 20MP-CL     | Black w/ Clear Cover |
| Male Plug-Crimp Terminal  | 20MC-E      | Black                |
| Male Plug-Crimp Terminal  | 20MC-CL     | Black w/ Clear Cover |
| Female Connector-Pressure Plate Terminal                        | 20FP-E      | Black                |
| Female Connector-Pressure Plate Terminal                        | 20FP-CL     | Black w/ Clear Cover |
| Female Connector-Crimp Terminal                                 | 20FC-E      | Black                |
| Female Connector-Crimp Terminal                                 | 20FC-CL     | Black w/ Clear Cover |
| Panel Mount Male Inlet-Set Screw Terminal, Snap-In Mounting†    | 20IS-E      | Black                |
| Panel Mount Female Receptacle-Screw Terminal, Snap-In Mounting† | 20RS-E      | Black                |



20MP-CL



20FP-CL

60A 125V, 2-P 3-W, Grounding

|   |        |       |
|---|--------|-------|
| Male Plug-Set Screw Terminal  | 60MP-E | Black |
| Female Connector-Set Screw Terminal                                 | 60FP-E | Black |
| Panel Mount Female Receptacle-Set Screw Terminal, Snap-In Mounting† | 60RS-E | Black |
| Panel Mount Female Receptacle-Set Screw Terminal, Bolt-On Mounting† | 60RB-E | Black |
| Panel Mount Male Inlet-Set Screw Terminal, Snap-In Mounting†        | 60IS-E | Black |
| Panel Mount Male Inlet-Set Screw Terminal, Bolt-On Mounting†        | 60IB-E | Black |



60MP-E



60FP-E

100A 125V, 2-P 3-W, Grounding

|   |         |       |
|---|---------|-------|
| Male Plug-Set Screw Terminal  | 100MP-E | Black |
| Female Connector-Set Screw Terminal                                 | 100FP-E | Black |
| Panel Mount Female Receptacle-Set Screw Terminal, Bolt-On Mounting† | 100RB-E | Black |
| Panel Mount Male Inlet-Set Screw Terminal, Bolt-On Mounting†        | 100IB-E | Black |

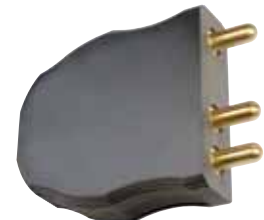

100MP-E



100FP-E

\*For 20 Amp male plugs and female connectors, other cover colors are available in white, blue, green, yellow, red and orange. Consult factory for availability.

†SEE PAGE P19 and P20 FOR DIMENSIONAL DRAWINGS



Male Panel Mount, Bolt-On



Female Panel Mount, Snap-In

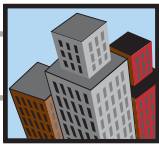

## SINGLE POLE CAM-TYPE CONNECTOR FEATURES

### Commercial & Industrial Grade Single Pole Cam-Type Connectors

#### Cam Connectors for Commercial and Industrial Use

Leviton offers a wide variety of single pin cam-type cable connectors and panel mount receptacles that supply temporary electrical power distribution for multiple indoor and outdoor applications. The heavy-duty connectors are the standard for the following markets:

- Entertainment and Movie Industry
- Concerts and Theme Parks
- Carnival Equipment
- Conventions.

Other applications include:

- Motor and Generator Splices
- Mining and Construction Sites
- Commercial and Navy Shipbuilding & Repair
- Other temporary power applications.

Leviton manufactures the highest quality single pin connectors available. Our connectors are completely compatible with competitive cam-type products and can be retrofitted to existing locations and power distribution systems. We offer a variety of quick connect/disconnect connectors for various amperage ratings in a multitude of cable sizes. Connectors are available in two styles:

- Field detachable
- Vulcanized

We also offer ball nose and taper nose configurations.

#### Quality Product and Diversification

In addition to high product quality comes diversity when doing business with Leviton. Leviton offers many varieties of entertainment cable and the ability to produce specialty cord sets for the entertainment/power distribution marketplace.

#### Leviton Cam-Type Connectors

##### Features and Benefits

- Intermateable and compatible with competitive cam-type products—can be retrofitted to existing locations and power distribution systems
- Locking and reinforcing ring won't melt, break or crack
- Shatter and crack proof—high durometer thermoplastic elastomer (TPE) or neoprene rubber
- Color-coded insulating sleeves—fast and easy phase identification
- Prevents arcing or burning—no movement of contact surfaces
- Self compensating for wear—slit and cam in male contact provides spring action for longer usage
- Quick connect/disconnect—twist and pull provided by double cam male and cam button in female
- High conductivity—positive, vibration-proof connection provided by double cam design
- Wide range of applications—usable with a wide range of cable and amperage ratings
- Meets NEC Code, UL Listed and CSA Certified. NEMA 3R-Rated for use in outside locations

##### Experience the Difference

*Our cam-type connectors are designed for easy assembly and disassembly without special tools. An insulated screw is used to tightly secure the contact inside the insulating sleeve, making assembly, disassembly and field repairs effortless. The connectors use plastic locking and reinforcement rings molded into insulating sleeves and receptacles. Under severe stress and load conditions, plastic locking and reinforcement rings will not melt, break or crack. Other quality differences include:*

- Reusable sleeves and contacts
- Preservation of cable length
- Snug fit due to Helox shape of connection as well as cable cutoffs that accommodate a wide range of cable sizes
- Hard thermoplastic elastomer screw head provides strength and durability
- Collar around port provides protection for insulated screw
- Quick check for cable-to-contact connection



# SINGLE POLE CAM-TYPE CONNECTOR FEATURES

## Commercial Grade Single Pole Cam-Type Connectors

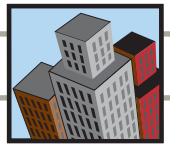

16/18 Series double-set screw with copper wire strain relief

High conductivity—positive, vibration-proof connection provided by double cam design

Collar around port provides protection for insulated screw

Shatter and crack proof—high durometer thermoplastic elastomer (TPE)

Self compensating for wear—slit and cam in male contact provides spring action for longer usage

Hard thermoplastic screw head provides strength and durability

Intermateable and compatible with competitive cam-type products—can be retrofitted to existing locations and power distribution systems

Color-coded insulating sleeves for easy phase identification

### 15, 16, 18 Series Connectors

| COMPONENT     | DESCRIPTION |
|---------------|-------------|
| Sleeve        | Santoprene  |
| Contact       | Brass       |
| Strain Relief | Copper Wire |

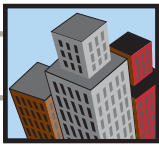

# SINGLE POLE CAM-TYPE AMPACITY CHART

## Commercial & Industrial Grade Single Pole Cam-Type Connectors

### Ampacity Chart

| CABLE SIZE | MAXIMUM ALLOWABLE AMPACITIES |                    |                    |
|------------|------------------------------|--------------------|--------------------|
|            | 60°C (140°F) CABLE           | 75°C (167°F) CABLE | 90°C (194°F) CABLE |
| #8         | 60                           | 70                 | 80                 |
| #6         | 80                           | 95                 | 105                |
| #4         | 105                          | 125                | 140                |
| #3         | 120                          | 145                | 165                |
| #2         | 140                          | 170                | 190                |
| #1         | 165                          | 195                | 220                |
| 1/0        | 195                          | 230                | 260                |
| 2/0        | 225                          | 265                | 300                |
| 3/0        | 260                          | 310                | 350                |
| 4/0        | 300                          | 360                | 400                |
| 250MCM     | 340                          | 405                | 455                |
| 300MCM     | 375                          | 445                | 505                |
| 350MCM     | 420                          | 505                | 570                |
| 400MCM     | 455                          | 545                | 615                |
| 500MCM     | 515                          | 620                | 690                |

# 15 SERIES—TAPER NOSE—UP TO 140 AMP

## Commercial Grade Single Pole Cam-Type Connectors



### 15 Series—Taper Nose—Up to 140 AMP, 600V

Refer to Ampacity Chart for all cable sizes on page P6

#### Male Detachable Plug

| CABLE SIZE | COMPLETE CAT NO. | CONTACT CAT NO. | INSULATOR CAT NO. | TERMINATION TYPE |
|------------|------------------|-----------------|-------------------|------------------|
| #6-#4      | 15D21*           | 15D21-C         | 15SDM*            | Single Set Screw |
| #6-#4      | 15D23*†          | 15D23-C         | 15SDM*            | Crimped★         |

#### Female Detachable Plug

| CABLE SIZE | COMPLETE CAT NO. | CONTACT CAT NO. | INSULATOR CAT NO. | TERMINATION TYPE |
|------------|------------------|-----------------|-------------------|------------------|
| #6-#4      | 15D22*           | 15D22-C         | 15SDF*            | Single Set Screw |
| #6-#4      | 15D24*†          | 15D24-C         | 15SDF*            | Crimped★         |

#### Male Detachable Plug

| CABLE SIZE | COMPLETE CAT NO. | CONTACT CAT NO. | INSULATOR CAT NO. | TERMINATION TYPE |
|------------|------------------|-----------------|-------------------|------------------|
| #8         | 15D25*           | 15D26-C         | 15SDM*            | Crimped          |

#### Female Detachable Plug

| CABLE SIZE | COMPLETE CAT NO. | CONTACT CAT NO. | INSULATOR CAT NO. | TERMINATION TYPE |
|------------|------------------|-----------------|-------------------|------------------|
| #8         | 15D26*           | 15D26-C         | 15SDF-*           | Crimped          |

#### Protective Caps for All 15 Series Insulators

| STYLE | CAT NO. | STYLE  | CAT NO. |
|-------|---------|--------|---------|
| Male  | 15P21-E | Female | 15P22-E |

#### Multi-Way Connectors★

| STYLE           | DESCRIPTION        | CAT NO. |
|-----------------|--------------------|---------|
| Paralleling Tee | Female-Male-Male   | 15A21†† |
| Tapping Tee     | Female-Female-Male | 15A22†† |
| Double Female   | Female-Female      | 15A23†† |

SEE PAGE P21 FOR DIMENSIONAL DRAWINGS



15D21



15D22



15R21-R



15P21-E



15A21-G

| COLOR      |            |          |           |            |             |             |            |
|------------|------------|----------|-----------|------------|-------------|-------------|------------|
|            |            |          |           |            |             |             |            |
| Black (-E) | White (-W) | Red (-R) | Blue (-B) | Green (-G) | Yellow (-Y) | Orange (-O) | Brown (-H) |

\* For color selections, add suffix to catalog number as follows: Black (-E), White (-W), Red (-R), Blue (-B), Green (-G), Yellow (-Y), Orange (-O) and Brown (-H).

† Available in Tour Grade (-T), Green (-G). Nickel Plated contact.

†† For color selections, add suffix to catalog number as follows: Black (-E), White (-W), Red (-R), Blue (-B) and Green (-G).

★ Contact Factory for Color Availability.

#### SPECIFICATIONS AND FEATURES

- The 15 Series Taper Nose mini-cam plugs, receptacles and connectors are tough and reliable. Primary applications include carnivals and theme parks, as well as the entertainment industry

#### TESTING AND CODE COMPLIANCE

- UL Listed E-13399
- NEMA 3R-Rated for use in outside locations
- CSA Certified 152105



# 16 SERIES—TAPER NOSE—UP TO 300 AMP

## Commercial Grade Single Pole Cam-Type Connectors

Single Pole Cam-Type Connectors



16D22-E



16D25-R

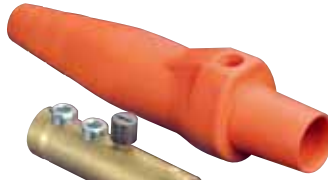

16D31-O

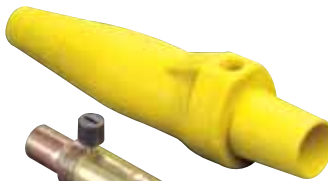

16D35-Y



16V22-B



16V27-G

### 16 Series—Taper Nose—Up to 300 AMP, 600V

Refer to Ampacity Chart for all cable sizes on page P6

#### Male Detachable Plug

| CABLE SIZE        | COMPLETE CAT NO. | CONTACT CAT NO. | INSULATOR CAT NO. | TERMINATION TYPE |
|-------------------|------------------|-----------------|-------------------|------------------|
| #2-2/0            | 16D21*           | -               | 16SDM-22*★        | Single Set Screw |
| #2-2/0            | 16D22*           | 16D22-C         | 16SDM-22*★        | Double Set Screw |
| #2-#1             | 16D25*           | -               | 16SDM-22*★        | Crimped★         |
| 1/0-2/0           | 16D26*           | -               | 16SDM-22*★        | Crimped★         |
| 1/0-2/0 HeavyDuty | 16D27*           | -               | -                 | Crimped★         |

#### Female Detachable Plug

| CABLE SIZE         | COMPLETE CAT NO. | CONTACT CAT NO. | INSULATOR CAT NO. | TERMINATION TYPE |
|--------------------|------------------|-----------------|-------------------|------------------|
| #2-2/0             | 16D29*           | -               | 16SDF-22*★        | Single Set Screw |
| #2-2/0             | 16D31*           | 16D31-C         | 16SDF-22*★        | Double Set Screw |
| #2-#1              | 16D34*           | -               | 16SDF-22*★        | Crimped★         |
| 1/0-2/0            | 16D35*           | -               | 16SDF-22*★        | Crimped★         |
| 1/0-2/0 Heavy Duty | 16D36*           | -               | -                 | Crimped★         |

#### Male Vulcanized Plug

| CABLE SIZE | COMPLETE CAT NO. | CONTACT CAT NO. | INSULATOR CAT NO. | TERMINATION TYPE |
|------------|------------------|-----------------|-------------------|------------------|
| 1/0-2/0    | 16V22*†          | -               | -                 | Crimped★         |

#### Female Vulcanized Plug

| CABLE SIZE | COMPLETE CAT NO. | CONTACT CAT NO. | INSULATOR CAT NO. | TERMINATION TYPE |
|------------|------------------|-----------------|-------------------|------------------|
| 1/0-2/0    | 16V26*†          | -               | -                 | Crimped★         |

SEE PAGE P21 and P22 FOR DIMENSIONAL DRAWINGS

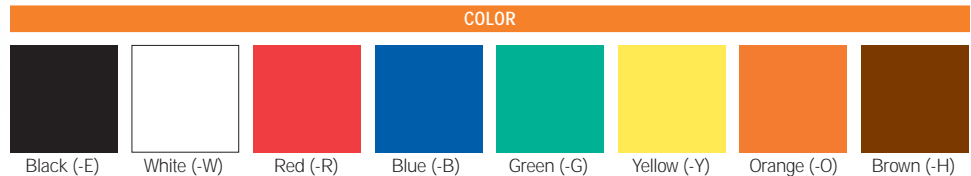

\*For color selections, add suffix to catalog number as follows: Black (-E), White (-W), Red (-R), Blue (-B), Green (-G), Yellow (-Y), Orange (-O) and Brown (-H).

†Available in Tour Grade (-T), Green (-G). Nickel Plated contact.

★Contact Factory for Color Availability.

#### SPECIFICATIONS AND FEATURES

- Leviton 16 Series Taper Nose products are the connectors of choice for concerts, sound stages, movie making, television production, sporting events and conventions.
- UL Listed E-13399
- CSA Certified 152105, all detachable plugs except single set screws.

# 16 SERIES—TAPER NOSE—UP TO 400 AMP

## Commercial Grade Single Pole Cam-Type Connectors



### 16 Series—Taper Nose—Up to 400 AMP, 600V

Refer to Ampacity Chart for all cable sizes on page P6

#### Male Detachable Plug

| CABLE SIZE | COMPLETE CAT NO. | CONTACT CAT NO. | INSULATOR CAT NO. | TERMINATION TYPE |
|------------|------------------|-----------------|-------------------|------------------|
| 1/0–4/0    | 16D23*           | -               | 16SDM-14**★       | Single Set Screw |
| 1/0–4/0    | 16D24*           | 16D24-C         | 16SDM-14**★       | Double Set Screw |
| 3/0–4/0    | 16D28*           | -               | 16SDM-14**★       | Crimped          |

#### Female Detachable Plug

| CABLE SIZE | COMPLETE CAT NO. | CONTACT CAT NO. | INSULATOR CAT NO. | TERMINATION TYPE |
|------------|------------------|-----------------|-------------------|------------------|
| 1/0–4/0    | 16D32*           | -               | 16SDF-14**★       | Single Set Screw |
| 1/0–4/0    | 16D33*           | 16D33-C         | 16SDF-14**★       | Double Set Screw |
| 3/0–4/0    | 16D37*           | 16D37-C         | 16SDF-14**★       | Crimped          |

#### Male Vulcanized Plug

| CABLE SIZE | COMPLETE CAT NO. | CONTACT CAT NO. | INSULATOR CAT NO. | TERMINATION TYPE |
|------------|------------------|-----------------|-------------------|------------------|
| 3/0–4/0    | 16V24*†          | -               | -                 | Crimped★         |

#### Female Vulcanized Plug

| CABLE SIZE | COMPLETE CAT NO. | CONTACT CAT NO. | INSULATOR CAT NO. | TERMINATION TYPE |
|------------|------------------|-----------------|-------------------|------------------|
| 3/0–4/0    | 16V28*†          | 16V28-C         | -                 | Crimped★         |

#### Protective Caps for All 16 Series Insulators

| STYLE | CAT NO. | STYLE  | CAT NO. |
|-------|---------|--------|---------|
| Male  | 16P21*  | Female | 16P22*  |

SEE PAGE P21 and P22 FOR DIMENSIONAL DRAWINGS



16D23-B



16D24-Y



16D32-W



16D33-O



16V24-Y



16V28-E



16P22-E

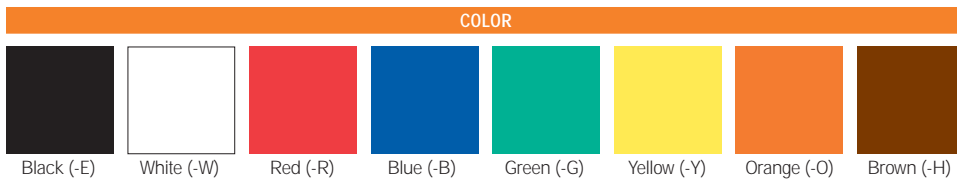

\*For color selections, add suffix to catalog number as follows: Black (-E), White (-W), Red (-R), Blue (-B), Green (-G), Yellow (-Y), Orange (-O) and Brown (-H).

†Available in Tour Grade (-T), Black (-E), White (-W), Red (-R) and Blue (-B). Nickel Plated contact.

★Contact factory for color availability

#### SPECIFICATIONS AND FEATURES

- Leviton 16 Series Taper Nose products are the connectors of choice for concerts, sound stages, movie making, television production, sporting events and conventions.
- UL Listed E-13399
- CSA Certified 152105, all detachable plugs except single set screws.



# 16 SERIES—TAPER NOSE—UP TO 400 AMP

## Commercial Grade Single Pole Cam-Type Connectors

### 16 Series—Taper Nose—Up to 400 AMP, 600V

Refer to Ampacity Chart for all cable sizes on page P6

#### Male Panel Receptacles

| CABLE SIZE | CAT NO. | TERMINATION TYPE |
|------------|---------|------------------|
| 1/0–4/0    | 16R21*  | Double Set Screw |
| #2–4/0     | 16R23*† | Threaded Stud**  |

#### Female Panel Receptacles

| CABLE SIZE | CAT NO. | TERMINATION TYPE |
|------------|---------|------------------|
| 1/0–4/0    | 16R22*  | Double Set Screw |
| #2–4/0     | 16R24*† | Threaded Stud**  |

#### Female Panel Receptacles – with Micro Switch

| CABLE SIZE | CAT NO. | TERMINATION TYPE |
|------------|---------|------------------|
| #2–4/0     | 16RSW†† | Threaded Stud★   |

#### Snap Back Cover for Male and Female Panel Receptacle

| CAT NO. |
|---------|
| 16S21*  |

#### Female Terminal Connector

| CABLE SIZE | CAT NO. | TERMINATION TYPE |
|------------|---------|------------------|
| #2–4/0     | 16F21*  | Angled           |
| #2–4/0     | 16F22*  | Offset           |

#### Multi-Way Connectors

| STYLE           | DESCRIPTION               | CAT NO. |
|-----------------|---------------------------|---------|
| Paralleling Tee | Female-Male-Male          | 16A21*★ |
| Tapping Tee     | Female-Female-Male        | 16A22*★ |
| 3-Fer           | Male-Female-Female-Female | 16A23*★ |
| Reverse 3-Fer   | Female-Male-Male-Male     | 16A26*★ |
| Double Female   | Female-Female             | 16A24*★ |
| Double Male     | Male-Male                 | 16A25*★ |

SEE PAGE P21 and P22 FOR DIMENSIONAL DRAWINGS

\*\*Threaded stud panel receptacles available in various lengths: Standard stud length is 3/4" – 1" stud length specify – 10 suffix; 1.125" stud length specify – 11 suffix; 1.25" stud length specify – 12 suffix; 1.50" stud length specify – 14 suffix; 2.00" stud length specify – 20 suffix (16R24 only). Other stud lengths available.

#### COLOR



Black (-E) White (-W) Red (-R) Blue (-B) Green (-G) Yellow (-Y) Orange (-O) Brown (-H)  
 \*For color selections, add suffix to catalog number as follows: Black (-E), White (-W), Red (-R), Blue (-B), Green (-G), Yellow (-Y), Orange (-O) and Brown (-H).

†Available in Tour Grade (-T), Black (-E), White (-W), Red (-R), Blue (-B) and Green (-G). Nickel Plated contact.

††For color selections, add suffix to catalog number as follows: Black (-E), White (-W), Red (-R), Blue (-B) and Green (-G).

★Contact factory for color availability

#### SPECIFICATIONS AND FEATURES

- Leviton 16 Series Taper Nose products are the connectors of choice for concerts, sound stages, movie making, television production, sporting events and conventions.

#### TESTING AND CODE COMPLIANCE

- UL Listed E-13399
- CSA Certified 152105
- NEMA 3R-Rated for use in outside locations

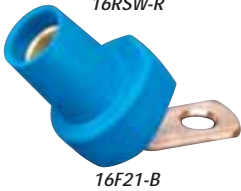
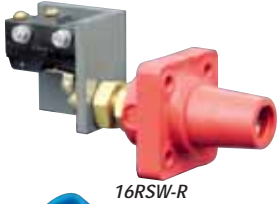
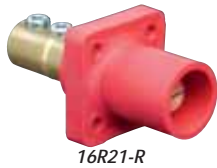

# 18 SERIES—BALL NOSE—UP TO 300 AMP

## Commercial Grade Single Pole Cam-Type Connectors



### 18 Series—Ball Nose—Up to 300 AMP, 600V

Refer to Ampacity Chart for all cable sizes on page P6

#### Male Detachable Plug

| CABLE SIZE | COMPLETE CAT NO. | CONTACT CAT NO. | INSULATOR CAT NO. | TERMINATION TYPE  |
|------------|------------------|-----------------|-------------------|-------------------|
| #2-2/0     | 18D21*           | -               | -                 | Single Set Screw★ |
| #2-2/0     | 18D22*           | -               | -                 | Double Set Screw★ |
| #2-#1      | 18D25*           | -               | -                 | Crimped★          |

#### Female Detachable Plug

| CABLE SIZE | COMPLETE CAT NO. | CONTACT CAT NO. | INSULATOR CAT NO. | TERMINATION TYPE  |
|------------|------------------|-----------------|-------------------|-------------------|
| #2-2/0     | 18D29*           | -               | -                 | Single Set Screw★ |
| #2-2/0     | 18D31*           | -               | -                 | Double Set Screw★ |

SEE PAGE P22 and P23 FOR DIMENSIONAL DRAWINGS



18D21-B



18D22-G

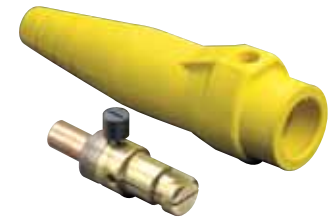

18D25-Y



18D29-O



18D31-W

#### COLOR



Black (-E) White (-W) Red (-R) Blue (-B) Green (-G) Yellow (-Y) Orange (-O) Brown (-H)

\* For color selections, add suffix to catalog number as follows: Black (-E), White (-W), Red (-R), Blue (-B), Green (-G), Yellow (-Y), Orange (-O) and Brown (-H).

★ Contact factory for color availability

#### SPECIFICATIONS AND FEATURES

- The 18 Series Ball Nose pin and sleeve type plugs, receptacles and connectors are used by the broadcast industry in Canada, as well as the welding industry in the United States

#### TESTING AND CODE COMPLIANCE

- UL Listed E-13399
- CSA Certified 152105, all detachable plugs except single set screws.



# 18 SERIES—BALL NOSE—UP TO 400 AMP

## Commercial Grade Single Pole Cam-Type Connectors

Single Pole Cam-Type Connectors

### 18 Series—Ball Nose—Up to 400 AMP, 600V

Refer to Ampacity Chart for all cable sizes on page P6

#### Male Detachable Plug

| CABLE SIZE | COMPLETE CAT NO. | CONTACT CAT NO. | INSULATOR CAT NO. | TERMINATION TYPE  |
|------------|------------------|-----------------|-------------------|-------------------|
| 1/0–4/0    | 18D23*           | -               | -                 | Single Set Screw★ |
| 1/0–4/0    | 18D24*           | -               | -                 | Double Set Screw  |

#### Female Detachable Plug

| CABLE SIZE | COMPLETE CAT NO. | CONTACT CAT NO. | INSULATOR CAT NO. | TERMINATION TYPE |
|------------|------------------|-----------------|-------------------|------------------|
| 1/0–4/0    | 18D33*           | -               | -                 | Double Set Screw |

#### Protective Caps for All 18 Series Insulators★

| STYLE | CAT NO. | STYLE  | CAT NO. |
|-------|---------|--------|---------|
| Male  | 18P21** | Female | 18P22** |

SEE PAGE P22 and P23 FOR DIMENSIONAL DRAWINGS



18D23-Y



18D24-E

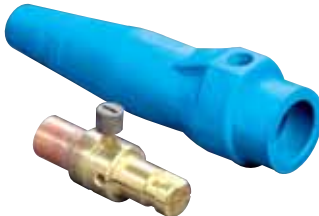

18D28-B



18D32-H



18D37-R



18V24-Y

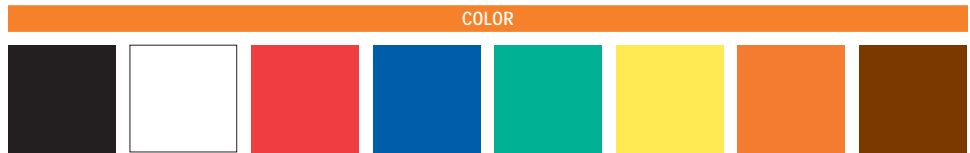

Black (-E) White (-W) Red (-R) Blue (-B) Green (-G) Yellow (-Y) Orange (-O) Brown (-H)  
 \* For color selections, add suffix to catalog number as follows: Black (-E), White (-W), Red (-R), Blue (-B), Green (-G), Yellow (-Y), Orange (-O) and Brown (-H).

★ Contact factory for color availability

#### SPECIFICATIONS AND FEATURES

- Leviton ECT 18 Series Taper Nose products are the connectors of choice for concerts, sound stages, movie making, television production, sporting events and conventions.

#### TESTING AND CODE COMPLIANCE

- UL Listed E-13399
- CSA Certified 152105, all detachable plugs except single set screws.



# 18 SERIES—BALL NOSE—UP TO 400 AMP

## Commercial Grade Single Pole Cam-Type Connectors



### 18 Series—Ball Nose—Up to 400 AMP, 600V

Refer to Ampacity Chart for all cable sizes on page P6

#### Male Panel Receptacles

| CABLE SIZE | CAT NO. | TERMINATION TYPE  |
|------------|---------|-------------------|
| #2–4/0     | 18R21*  | Threaded Stud**★  |
| 1/0–4/0    | 18R23*  | Double Set Screw★ |

#### Female Panel Receptacles

| CABLE SIZE | CAT NO. | TERMINATION TYPE |
|------------|---------|------------------|
| #2–4/0     | 18R22*  | Threaded Stud**★ |
| 1/0–4/0    | 18R24*  | Double Set Screw |

#### Female Terminal Connector

| CABLE SIZE | CAT NO. | TERMINATION TYPE |
|------------|---------|------------------|
| #2–4/0     | 18F21*  | Angled★          |

#### Multi-Way Connectors

| STYLE       | DESCRIPTION        | CAT NO. |
|-------------|--------------------|---------|
| Tapping Tee | Female-Female-Male | 18A22★  |
| Double Male | Male-Male          | 18A25★  |

SEE PAGE P22 and P23 FOR DIMENSIONAL DRAWINGS

\*\*Threaded stud panel receptacles available in various lengths: Standard stud length is 3/4" – 1.25" stud length specify – 12 suffix. Other stud lengths available.



18R22-G



18A22-E



18A25-E

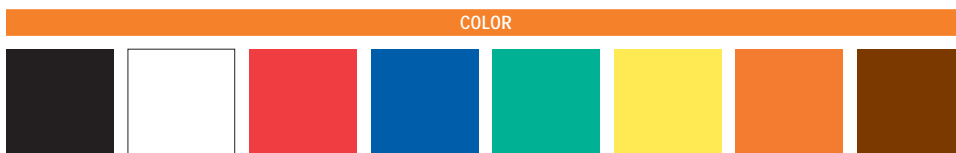

Black (-E) White (-W) Red (-R) Blue (-B) Green (-G) Yellow (-Y) Orange (-O) Brown (-H)  
 \* For color selections, add suffix to catalog number as follows: Black (-E), White (-W), Red (-R), Blue (-B), Green (-G), Yellow (-Y), Orange (-O) and Brown (-H).

★ Contact factory for color availability

#### SPECIFICATIONS AND FEATURES

- Leviton 18 Series Taper Nose products are the connectors of choice for concerts, sound stages, movie making, television production, sporting events and conventions.

#### TESTING AND CODE COMPLIANCE

- UL Listed E-13399
- CSA Certified 152105

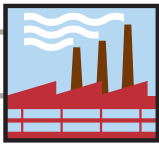

# 17 SERIES—TAPER NOSE—UP TO 690 AMP

## Industrial Grade Single Pole Cam-Type Connectors

### 17 Series—Taper Nose—Up to 690 AMP, 600V

Refer to Ampacity Chart for all cable sizes on page P6

#### Male Detachable Plug

| CABLE SIZE  | COMPLETE CAT NO. | CONTACT CAT NO. | INSULATOR CAT NO. | TERMINATION TYPE |
|-------------|------------------|-----------------|-------------------|------------------|
| 250–350 MCM | 17D21*           | -               | 17SDM*★           | Double Set Screw |
| 350–500 MCM | 17D22*           | -               | 17SDM*★           | Double Set Screw |

#### Female Detachable Plug

| CABLE SIZE  | COMPLETE CAT NO. | CONTACT CAT NO. | INSULATOR CAT NO. | TERMINATION TYPE |
|-------------|------------------|-----------------|-------------------|------------------|
| 250–350 MCM | 17D23*           | -               | -                 | Double Set Screw |
| 350–500 MCM | 17D24*           | -               | -                 | Double Set Screw |

#### Male Vulcanized Plug

| CABLE SIZE  | COMPLETE CAT NO. | CONTACT CAT NO. | INSULATOR CAT NO. | TERMINATION TYPE |
|-------------|------------------|-----------------|-------------------|------------------|
| 350–500 MCM | 17V22*           | -               | -                 | Crimped★         |
| 500–750 MCM | 17V23*           | -               | -                 | Crimped★         |

#### Female Vulcanized Plug

| CABLE SIZE  | COMPLETE CAT NO. | CONTACT CAT NO. | INSULATOR CAT NO. | TERMINATION TYPE |
|-------------|------------------|-----------------|-------------------|------------------|
| 500–750 MCM | 17V26-E          | -               | -                 | Crimped★         |

#### Protective Caps for All 17 Series Insulators

| STYLE | CAT NO. | STYLE  | CAT NO. |
|-------|---------|--------|---------|
| Male  | 17P21*  | Female | 17P22*  |

#### Male Panel Receptacles

| CABLE SIZE  | CAT NO. | TERMINATION TYPE | STYLE      |
|-------------|---------|------------------|------------|
| 250–750 MCM | 17R21*  | Threaded Stud    | 90 Degree  |
| 250–750 MCM | 17R23*  | Threaded Stud    | 30 Degree★ |

#### Female Panel Receptacles

| CABLE SIZE  | CAT NO. | TERMINATION TYPE | STYLE      |
|-------------|---------|------------------|------------|
| 250–750 MCM | 17R22*  | Threaded Stud    | 90 Degree  |
| 250–750 MCM | 17R24*  | Threaded Stud    | 30 Degree★ |

SEE PAGE P24 FOR DIMENSIONAL DRAWINGS



17D21-W



17D23-E



17V26-G



17R23-E



17P21-E

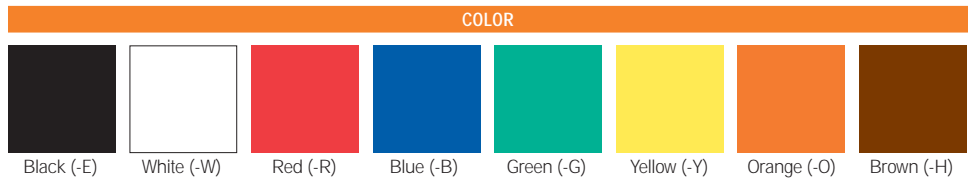

\* For color selections, add suffix to catalog number as follows: Black (-E), White (-W), Red (-R), Blue (-B), Green (-G), Yellow (-Y), Orange (-O) and Brown (-H).

★ Contact factory for color availability

#### SPECIFICATIONS AND FEATURES

- The 17 Series Taper Nose connectors withstand grueling, heavy-duty industrial use. Applications include generator test stations, water purification plants, electro-chemical machining equipment and other general industrial uses.

# 19 SERIES—BALL NOSE—UP TO 600 AMP

## Industrial Grade Single Pole Cam-Type Connectors

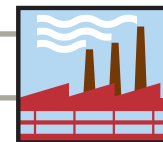

### 19 Series—Ball Nose—Up to 690 AMP, 600V

Refer to Ampacity Chart for all cable sizes on page P6

#### Male Detachable Plug

| CABLE SIZE  | COMPLETE CAT NO. | CONTACT CAT NO. | INSULATOR CAT NO. | TERMINATION TYPE  |
|-------------|------------------|-----------------|-------------------|-------------------|
| 250–350 MCM | 19D21*           | -               | -                 | Double Set Screw★ |
| 350–500 MCM | 19D22*           | -               | -                 | Double Set Screw  |

#### Female Detachable Plug

| CABLE SIZE  | COMPLETE CAT NO. | CONTACT CAT NO. | INSULATOR CAT NO. | TERMINATION TYPE  |
|-------------|------------------|-----------------|-------------------|-------------------|
| 250–350 MCM | 19D23*           | -               | -                 | Double Set Screw★ |
| 350–500 MCM | 19D24*           | -               | -                 | Double Set Screw★ |

#### Male Vulcanized Plug

| CABLE SIZE  | COMPLETE CAT NO. | CONTACT CAT NO. | INSULATOR CAT NO. | TERMINATION TYPE |
|-------------|------------------|-----------------|-------------------|------------------|
| 500–750 MCM | 19V23*           | -               | -                 | Crimped★         |

#### Protective Caps for All 19 Series Insulators

| STYLE | CAT NO. | STYLE  | CAT NO. |
|-------|---------|--------|---------|
| Male  | 19P21*★ | Female | 19P22   |

#### Male Panel Receptacles

| CABLE SIZE  | CAT NO. | TERMINATION TYPE | STYLE     |
|-------------|---------|------------------|-----------|
| 250–750 MCM | 19R21*  | Threaded Stud    | 90 Degree |

#### Female Panel Receptacles

| CABLE SIZE  | CAT NO. | TERMINATION TYPE | STYLE      |
|-------------|---------|------------------|------------|
| 250–750 MCM | 19R22*  | -                | 90 Degree  |
| 250–750 MCM | 19R24*  | Threaded Stud    | 30 Degree★ |

SEE PAGE P24 and P25 FOR DIMENSIONAL DRAWINGS



Single Pole Cam-Type Connectors

#### COLOR



Black (-E) White (-W) Red (-R) Blue (-B) Green (-G) Yellow (-Y) Orange (-O) Brown (-H)

\* For color selections, add suffix to catalog number as follows: Black (-E), White (-W), Red (-R), Blue (-B), Green (-G), Yellow (-Y), Orange (-O) and Brown (-H).

★ Contact factory for color availability

#### SPECIFICATIONS AND FEATURES

- The 19 Series Ball Nose connectors are designed for general industrial applications



## 22 SERIES—LATCHING BALL NOSE—UP TO 690 AMP

### Industrial Grade Single Pole Cam-Type Connectors

## 22 Series—Latching Ball Nose—Up to 690 Amp, 600V

Refer to Ampacity Chart for all cable sizes on page P6

### Male Latching Plug

| CABLE SIZE  | COMPLETE CAT NO.      | CONTACT CAT NO. | INSULATOR CAT NO.  | TERMINATION TYPE |
|-------------|-----------------------|-----------------|--------------------|------------------|
| 250–350 MCM | 22L21 <sup>1</sup>    | -               | 22SVM <sup>3</sup> | Crimped          |
| 350–500 MCM | 22L22 <sup>2</sup>    | 22L22-C         | 22SVM <sup>3</sup> | Crimped          |
| 350–500 MCM | 22L22-S <sup>3†</sup> | -               | -                  | -                |
| 500–750 MCM | 22L23 <sup>3</sup>    | 22L23-C         | 22SVM <sup>3</sup> | Crimped          |

### Female Latching Plug

| CABLE SIZE  | COMPLETE CAT NO.      | CONTACT CAT NO. | INSULATOR CAT NO.  | TERMINATION TYPE |
|-------------|-----------------------|-----------------|--------------------|------------------|
| 250–350 MCM | 22L24 <sup>1</sup>    | -               | 22SVF <sup>3</sup> | Crimped          |
| 350–500 MCM | 22L25 <sup>2</sup>    | 22L25-C         | 22SVF <sup>3</sup> | Crimped          |
| 350–500 MCM | 22L25-S <sup>3†</sup> | -               | -                  | -                |
| 500–750 MCM | 22L26 <sup>3</sup>    | -               | 22SVF <sup>3</sup> | Crimped          |

### Protective Caps for All 22 Series Insulators

| STYLE | CAT NO. | STYLE  | CAT NO. |
|-------|---------|--------|---------|
| Male  | 19P21★  | Female | 19P22★  |

### Male Panel Receptacles

| CABLE SIZE  | CAT NO.            | TERMINATION TYPE | STYLE     |
|-------------|--------------------|------------------|-----------|
| 250–750 MCM | 22R21 <sup>3</sup> | Threaded Stud    | 90 Degree |
| 250–750 MCM | 22R23 <sup>3</sup> | Threaded Stud    | 30 Degree |

### Female Panel Receptacles

| CABLE SIZE  | CAT NO.            | TERMINATION TYPE | STYLE     |
|-------------|--------------------|------------------|-----------|
| 250–750 MCM | 22R22 <sup>3</sup> | Threaded Stud    | 90 Degree |
| 250–750 MCM | 22R24 <sup>4</sup> | Threaded Stud    | 30 Degree |
| 250–750 MCM | 22R26 <sup>3</sup> | Threaded Stud    | 15 Degree |

### Female Panel Receptacles—with Micro Switch

| CABLE SIZE  | CAT NO.            | TERMINATION TYPE | STYLE     |
|-------------|--------------------|------------------|-----------|
| 250–750 MCM | 22R28 <sup>3</sup> | Threaded Stud    | 15 Degree |

SEE PAGE P25 and P26 FOR DIMENSIONAL DRAWINGS

†Detachable

★Contact factory for color availability

#### COLOR

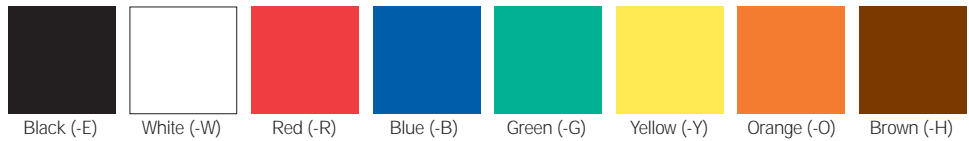

For color selections, add suffix to catalog number as follows:

<sup>1</sup> Black (-E), White (-W), Red (-R), Green (-G)

<sup>2</sup> Black (-E), White (-W), Red (-R), Yellow (-Y), Orange (-O), Brown (-H)

<sup>3</sup> Black (-E), White (-W), Red (-R)

<sup>4</sup> Black (-E), White (-W), Red (-R), Green (-G), Yellow (-Y), Orange (-O), Brown (-H)

#### SPECIFICATIONS AND FEATURES

- The Leviton 22 series Cam-Type connectors are specified in the United Facility Guide Specification (4FGS-16145).
- Leviton's Cam-Type positive latching connectors and receptacles are the standard used by Navy bases and shipyards in supplying 480 volts AC 3-phase power to ships at dockside. Our latching connector series has been thoroughly and successfully tested by ETL Laboratories to meet Navy specifications, including interchangeability with competition. Our latching connector series provides heavy duty, completely insulated connectors that are vibration-resistant and positively lock into place. Leviton latching connectors will not vibrate, twist or turn

loose, ensuring high conductivity and maximum efficiency. Leviton contacts can be retrofitted to existing locations and power distribution systems. Our male contacts are designed to provide 40% more surface contact with the female vs. competitive products. The additional efficiency will help ensure greater conductivity while preventing burnout.

- The connectors and all components are completely interchangeable with competitive cam-type products.

#### TESTING AND CODE COMPLIANCE

- ETL Tested, Report #521300
- Waterproof (when vulcanized) and fire-resistant for outside usage



22L21-R



22L22-E



22L25-E



22L22-S



22R23-E



22R24-E



22L25-E



22R28-W

# 23 SERIES—LATCHING TAPER NOSE—UP TO 690 AMP

## Industrial Grade Single Pole Cam-Type Connectors

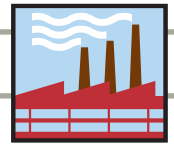

### 23 Series—Latching Taper Nose—Up to 690 Amp, 600V

Refer to Ampacity Chart for all cable sizes on page P6

#### Male Latching Plug

| CABLE SIZE  | COMPLETE CAT NO.   | CONTACT CAT NO. | INSULATOR CAT NO. | TERMINATION TYPE |
|-------------|--------------------|-----------------|-------------------|------------------|
| 350–500 MCM | 23L22 <sup>1</sup> | -               | -                 | Crimped          |
| 500–750 MCM | 23L23 <sup>2</sup> | -               | -                 | Crimped          |

#### Female Latching Plug

| CABLE SIZE  | COMPLETE CAT NO.   | CONTACT CAT NO. | INSULATOR CAT NO. | TERMINATION TYPE |
|-------------|--------------------|-----------------|-------------------|------------------|
| 350–500 MCM | 23L25 <sup>4</sup> | -               | -                 | Crimped          |
| 500–750 MCM | 23L26 <sup>5</sup> | -               | -                 | Crimped          |

#### Protective Caps for All 22 Series Insulators

| STYLE | CAT NO.            | STYLE  | CAT NO.            |
|-------|--------------------|--------|--------------------|
| Male  | 17P21 <sup>7</sup> | Female | 17P22 <sup>7</sup> |

#### Male Panel Receptacles

| CABLE SIZE  | CAT NO.            | TERMINATION TYPE | STYLE     |
|-------------|--------------------|------------------|-----------|
| 250–750 MCM | 23R21 <sup>6</sup> | Threaded Stud    | 90 Degree |
| 250–750 MCM | 23R23 <sup>4</sup> | Threaded Stud    | 30 Degree |

#### Female Panel Receptacles

| CABLE SIZE  | CAT NO.            | TERMINATION TYPE | STYLE     |
|-------------|--------------------|------------------|-----------|
| 250–750 MCM | 23R22 <sup>7</sup> | Threaded Stud    | 90 Degree |
| 250–750 MCM | 23R24 <sup>7</sup> | Threaded Stud    | 30 Degree |

SEE PAGES 25 AND 26 FOR DIMENSIONAL DRAWINGS



23L24-R



23L25-G



23R21-E

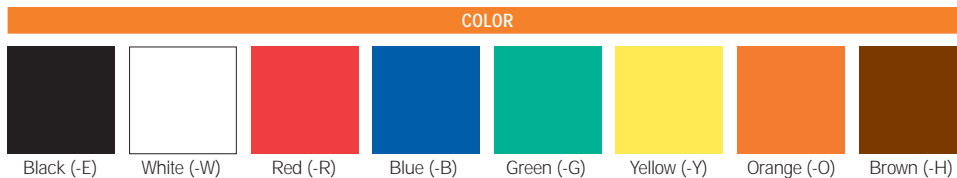

For color selections, add suffix to catalog number as follows:

- 1 White (-W), Blue (-B), Green (-G), Yellow (-Y), Orange (-O), Brown (-H)
- 2 Black (-E), White (-W), Red (-R), Blue (-B), Green (-G)
- 3 Black (-E), White (-W), Red (-R)
- 4 Black (-E), Blue (-B), Green (-G), Yellow (-Y), Orange (-O), Brown (-H)
- 5 Black (-E), White (-W), Red (-R)
- 6 Black (-E), Blue (-B), Green (-G)
- 7 Black (-E), White (-W), Red (-R), Blue (-B), Green (-G), Yellow (-Y), Orange (-O), Brown (-H)

★ Contact factory for color availability

#### SPECIFICATIONS AND FEATURES

- Leviton's Cam-Type positive latching connectors and receptacles are the standard used by Navy bases and shipyards in supplying 480 volts AC 3-phase power to ships at dockside. Our latching connector series has been thoroughly and successfully tested by ETL Laboratories to meet Navy specifications, including intermateability with competition. Our latching connector series provides heavy duty, completely insulated connectors that are vibration-resistant and positively lock into place. Leviton latching connectors will not vibrate, twist or turn loose, ensuring high conductivity and maximum efficiency. Leviton contacts can be retrofitted to existing

locations and power distribution systems. Our male contacts are designed to provide 40% more surface contact with the female vs. competitive products. The additional efficiency will help ensure greater conductivity while preventing burnout.

- The connectors and all components are completely interchangeable with competitive cam-type products.

#### TESTING AND CODE COMPLIANCE

- ETL Tested, Report #521300
- Waterproof (when vulcanized) and fire-resistant for outside usage



# SINGLE POLE CAM-TYPE CONNECTORS—PRODUCT ACCESSORIES

## Industrial Grade Single Pole Cam-Type Connectors

### “COM-A-LONG” Assembly Tool

#### 15 Series

| DESCRIPTION     | CAT. NO. |
|-----------------|----------|
| For Female Plug | 15CLM    |



|               |       |
|---------------|-------|
| For Male Plug | 15CLF |
|---------------|-------|



#### 16 Series & 18 Series

| DESCRIPTION     | CAT. NO. |
|-----------------|----------|
| For Female Plug | 16CLM    |



|               |       |
|---------------|-------|
| For Male Plug | 16CLF |
|---------------|-------|



#### 17 Series, 19 Series & 22/23 Series

| DESCRIPTION     | CAT. NO. |
|-----------------|----------|
| For Female Plug | 17CLM    |



|               |       |
|---------------|-------|
| For Male Plug | 17CLF |
|---------------|-------|



### Set Screws (10 per package)

| DESCRIPTION | CAT. NO. |
|-------------|----------|
| 15 Series   | A0001    |



|                       |       |
|-----------------------|-------|
| 16 Series & 18 Series | A0002 |
|-----------------------|-------|



### Copper Shims (10 per package)

| DESCRIPTION | CAT. NO. |
|-------------|----------|
| 15 Series   | A0006    |



|                       |       |
|-----------------------|-------|
| 16 Series & 18 Series | A0004 |
|-----------------------|-------|



### Strain Relief Wire (10 per package)

| DESCRIPTION | CAT. NO. |
|-------------|----------|
| 15 Series   | A0007    |



|                       |       |
|-----------------------|-------|
| 16 Series & 18 Series | A0003 |
|-----------------------|-------|



### Insulated Screw (10 per package)

| DESCRIPTION           | CAT. NO. |
|-----------------------|----------|
| 16 Series & 18 Series | A0005    |



### Lubricating Spray

| DESCRIPTION        | CAT. NO. |
|--------------------|----------|
| 16 Fluid Ounce Can | C0001    |



# STAGE PIN PANEL MOUNT—DIMENSIONAL DRAWINGS

## Commercial Grade Stage Pin Devices



### Stage Pin Panel Mount—20 AMP

20A Female Receptacle, Snap-In—page P3

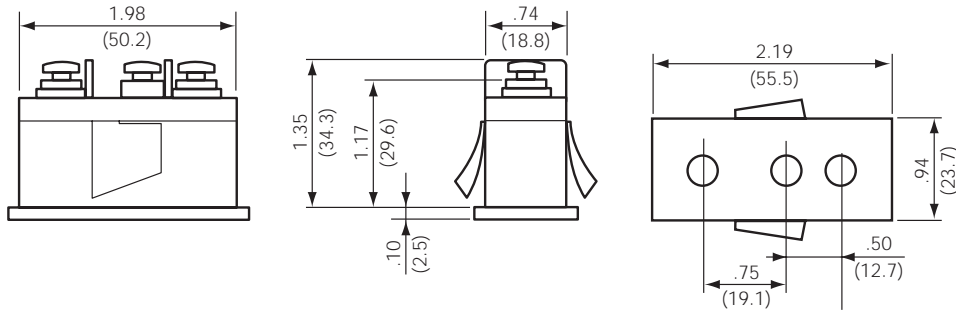

20A Male Inlet, Snap-In—page P3

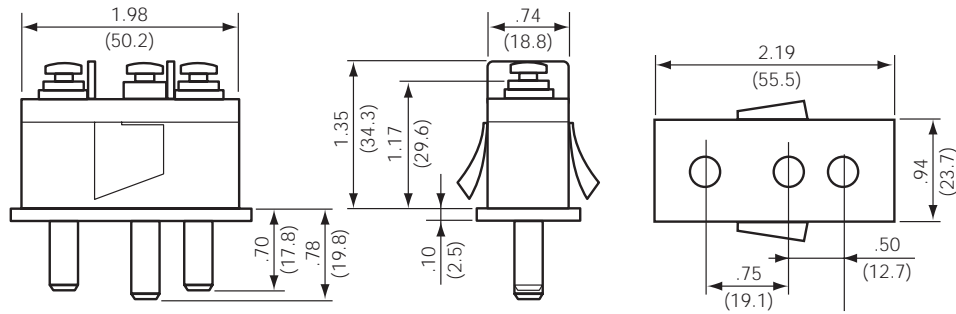

### Stage Pin Panel Mount—60 AMP

60A Female Receptacle, Bolt-On—page P3

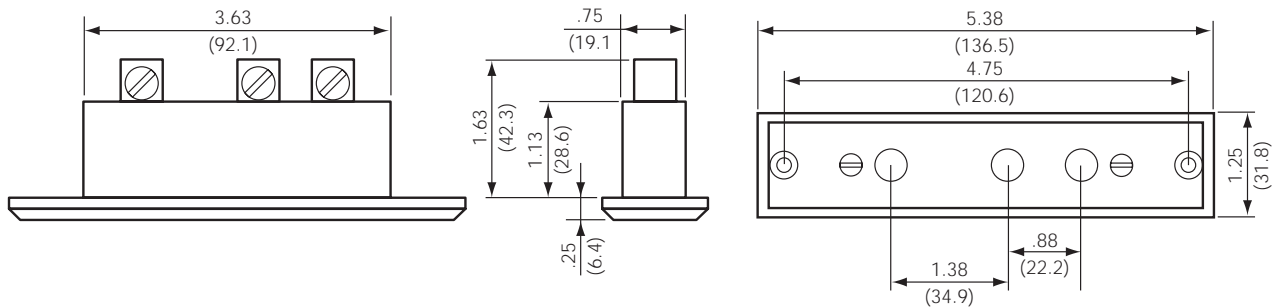

60A Male Inlet, Bolt-On—page P3

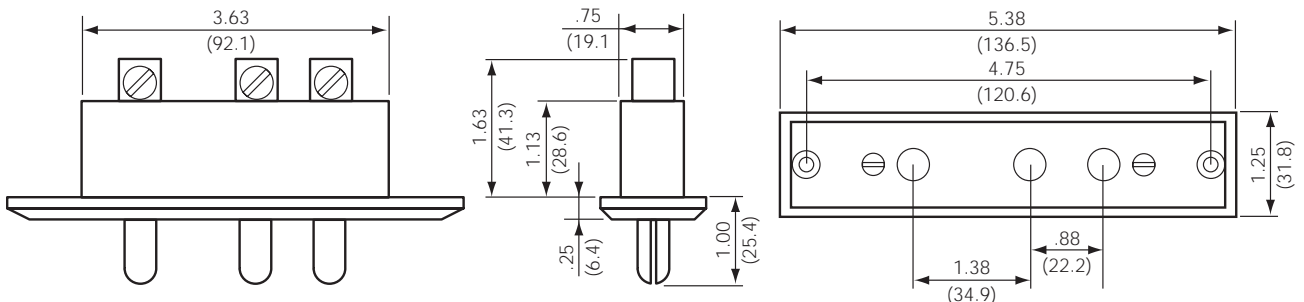



# STAGE PIN PANEL MOUNT—DIMENSIONAL DRAWINGS

## Commercial Grade Stage Pin Devices

### Stage Pin Panel Mount—60 AMP

60A Female Panel Receptacle, Snap-In—page P3

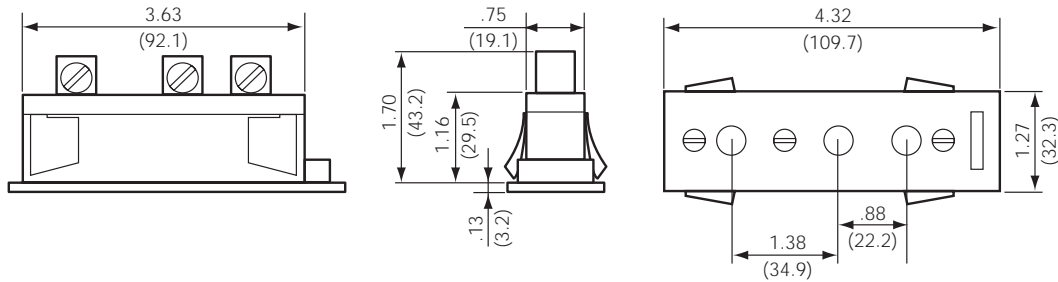

60A Male Panel Receptacle, Snap-In—page P3

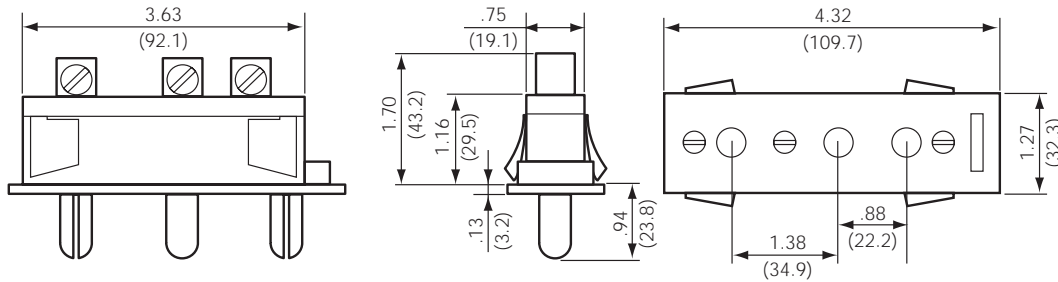

### Stage Pin Panel Mount—100 AMP

100A Female Receptacle, Bolt-On—page P3

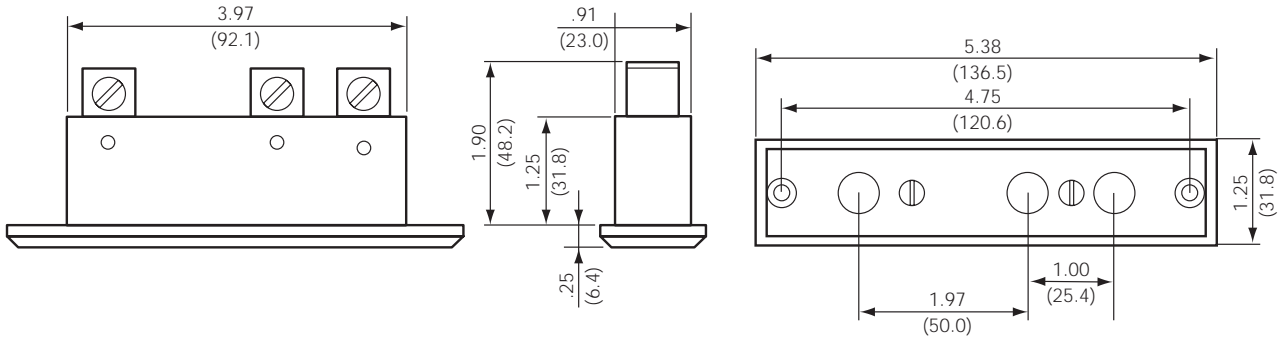

100A Male Inlet, Bolt-On—page P3

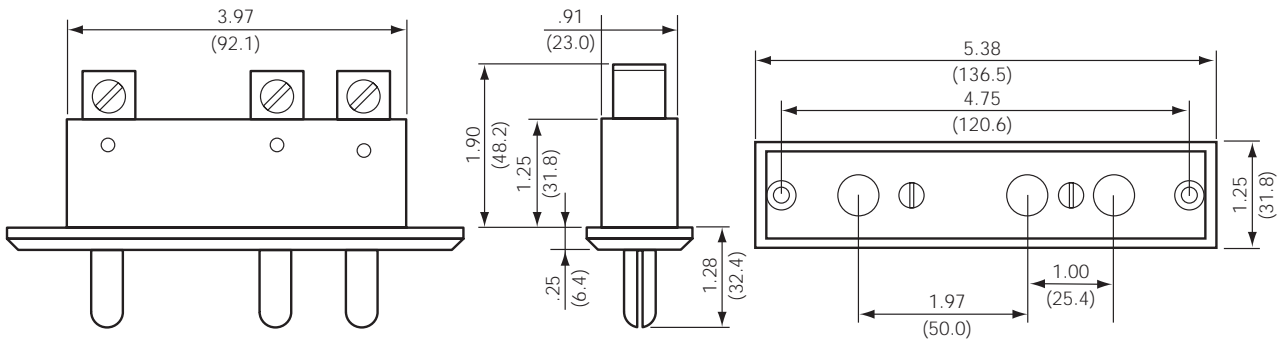



# SINGLE POLE CAM-TYPE CONNECTORS—DIMENSIONAL DRAWINGS

## Commercial Grade Single Pole Cam-Type Connectors



### 15 Series—Taper Nose

Male and Female Detachable Plugs—page P7

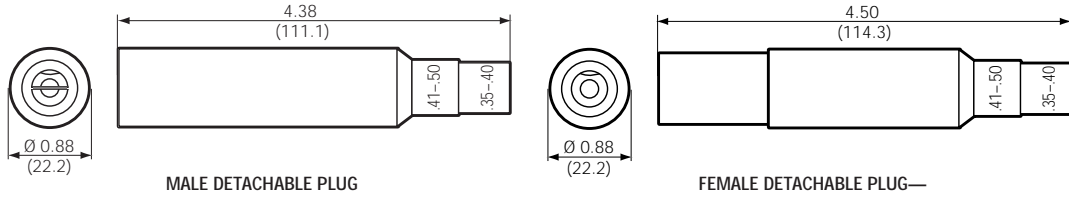

Panel Receptacle Threaded Studs—page P7

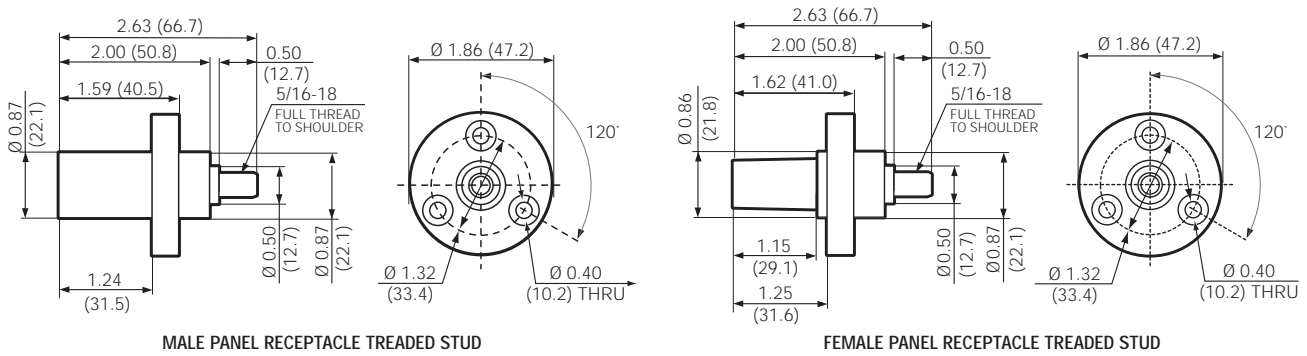

### 16 Series—Taper Nose

Male and Female Detachable Plugs—pages P8–P10

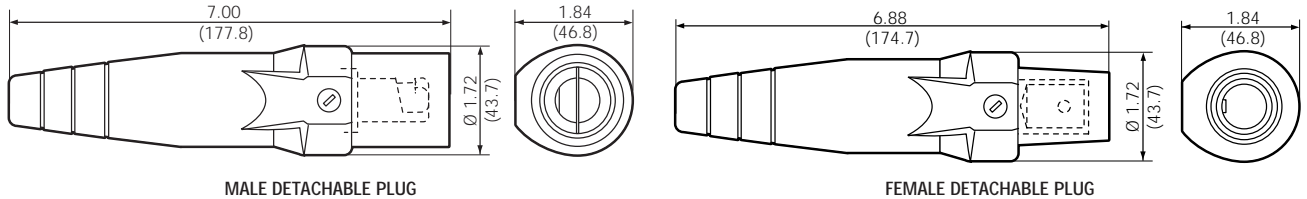

Male and Female Protective Caps—page P13

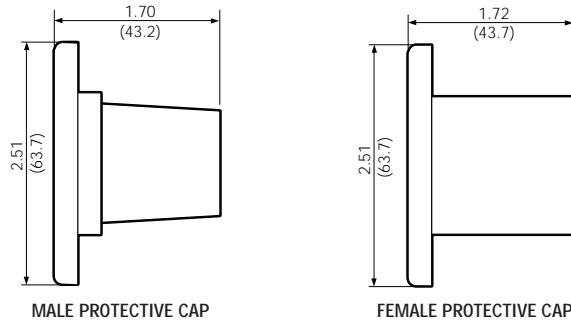

Male and Female Vulcanized Plugs—pages P14, P15

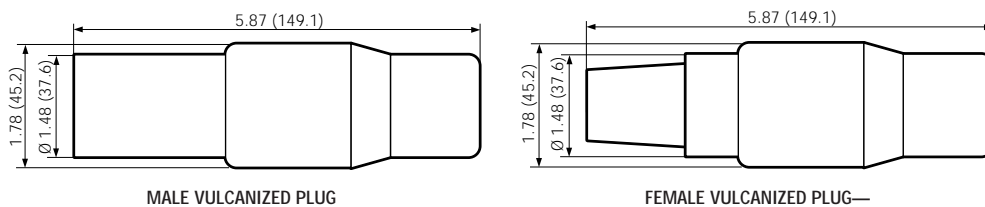

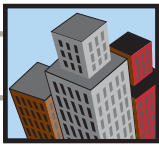

# SINGLE POLE CAM-TYPE CONNECTORS—DIMENSIONAL DRAWINGS

## Commercial Grade Single Pole Cam-Type Connectors

### 16 Series—Taper Nose

Double Set Screw and Threaded Panel Receptacle Studs—page P10

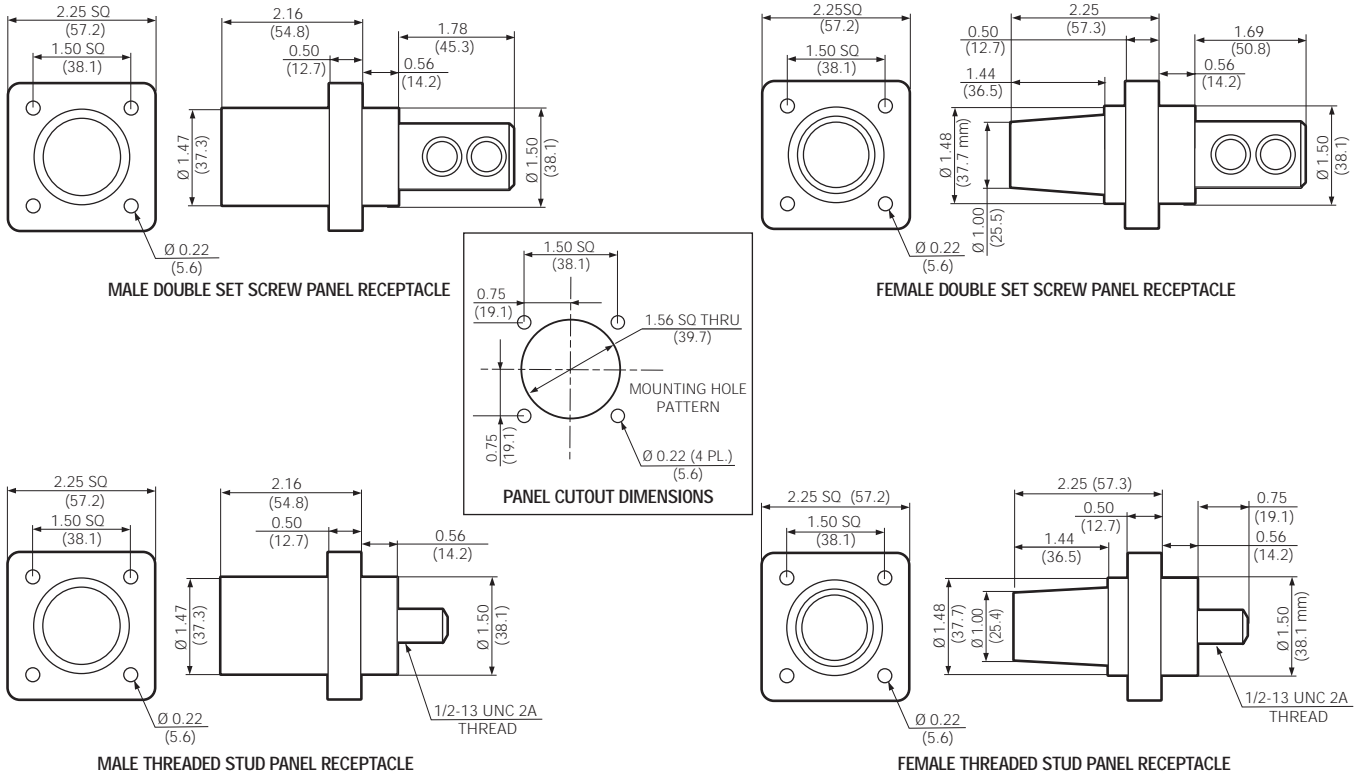

### Multi-Way Connectors—page P10

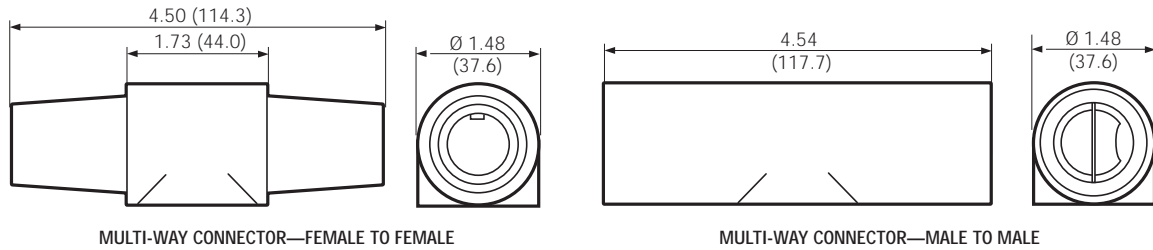

### 18 Series—Ball Nose

Male and Female Detachable Plugs—pages P11, P12

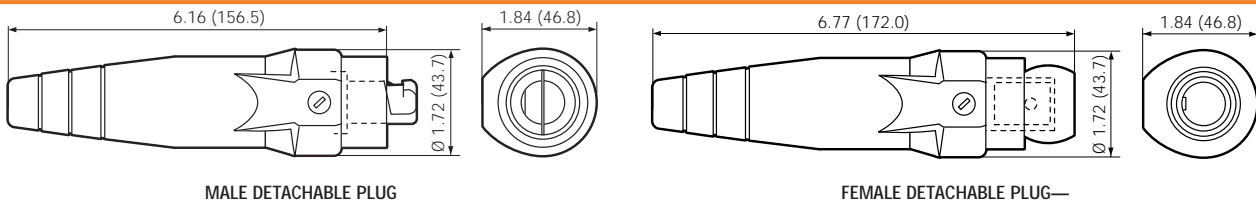

Male and Female Vulcanized Plugs—pages P11, P12

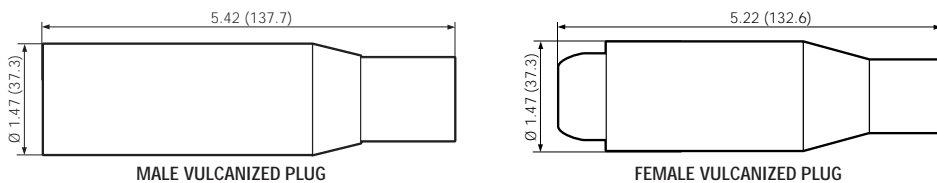

# SINGLE POLE CAM-TYPE CONNECTORS—DIMENSIONAL DRAWINGS

## Commercial Grade Single Pole Cam-Type Connectors

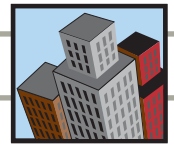

### 18 Series—Ball Nose

Male and Female Protective Caps—page P12

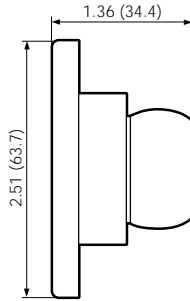

MALE PROTECTIVE CAP

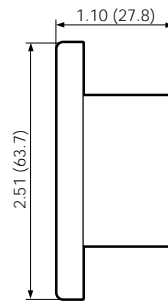

FEMALE PROTECTIVE CAP

### Double Set Screw and Threaded Panel Receptacle Studs—page P13

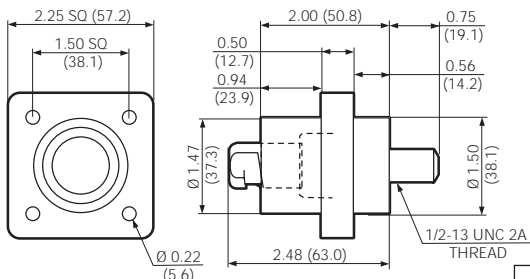

MALE THREADED STUD PANEL RECEPTACLE

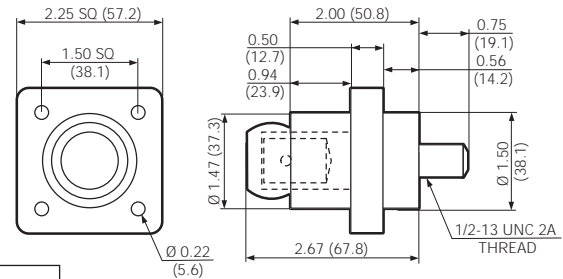

FEMALE THREADED STUD PANEL RECEPTACLE

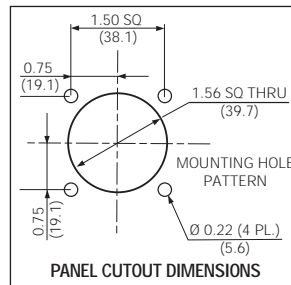

PANEL CUTOUT DIMENSIONS

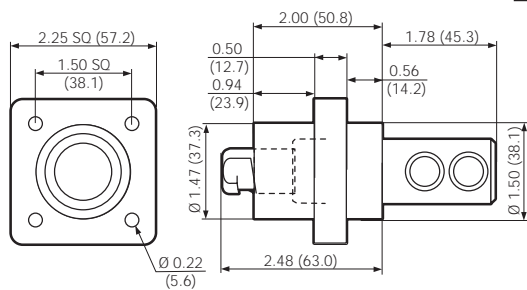

MALE DOUBLE SET SCREW PANEL RECEPTACLE

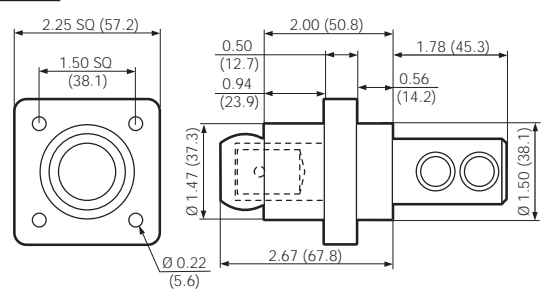

FEMALE DOUBLE SET SCREW PANEL RECEPTACLE

### Multi-Way Connectors—page P13

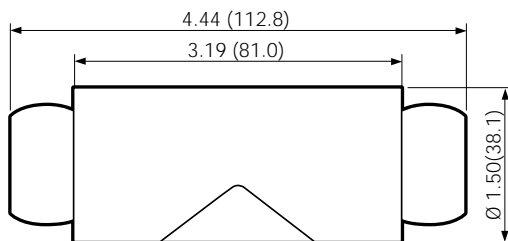

MULTI-WAY CONNECTOR—FEMALE TO FEMALE

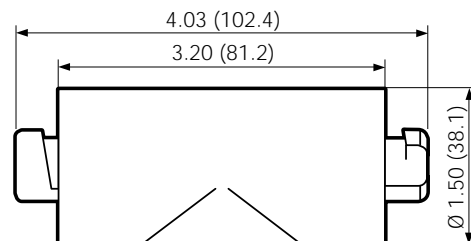

MULTI-WAY CONNECTOR—MALE TO MALE



# SINGLE POLE CAM-TYPE CONNECTORS—DIMENSIONAL DRAWINGS

## Industrial Grade Single Pole Cam-Type Connectors

### 17 Series—Taper Nose

Male and Female Vulcanized Plugs—pages P14



MALE VULCANIZED PLUG—CRIMPED

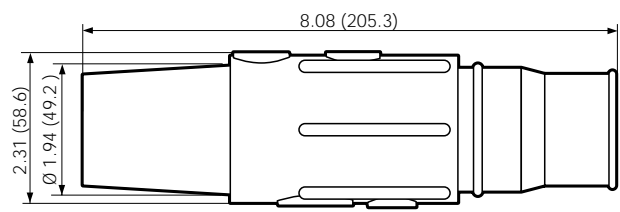

FEMALE VULCANIZED PLUG—CRIMPED

### Panel Receptacle Threaded Studs—page P14

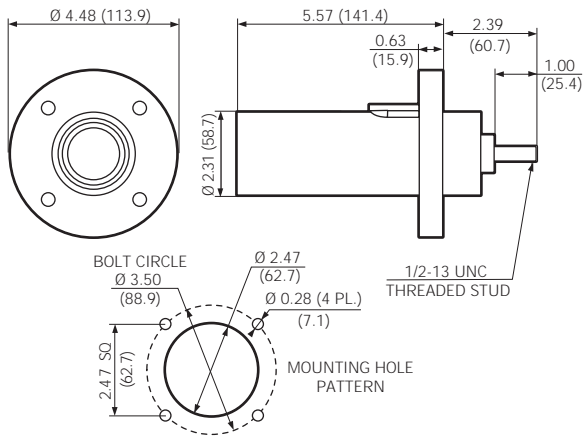

MALE PANEL RECEPTACLE THREADED STUD—90°

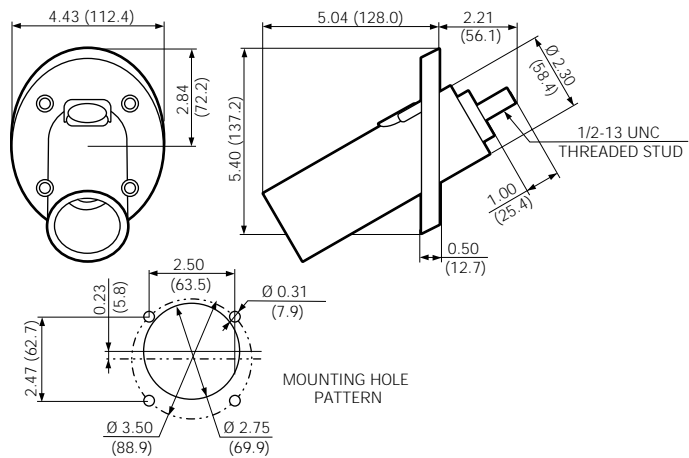

MALE PANEL RECEPTACLE THREADED STUD—30°

### 19 Series—Ball Nose

Male and Female Detachable Plugs—page P15

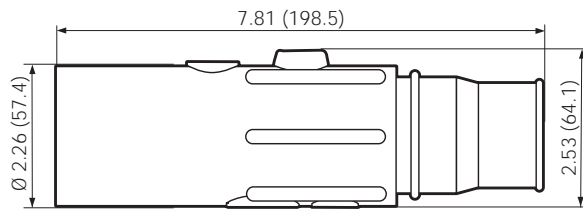

MALE DETACHABLE PLUG—DOUBLE SET SCREW

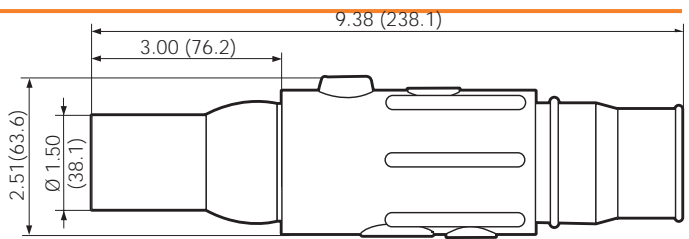

FEMALE DETACHABLE PLUG—DOUBLE SET SCREW

### 19 Series—Ball Nose

Male and Female Vulcanized Plugs—pages P15

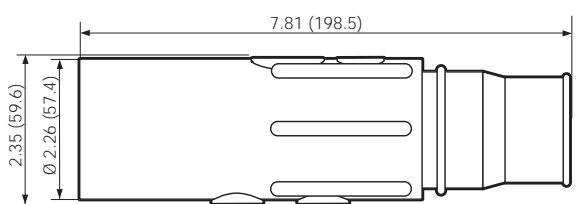

MALE VULCANIZED PLUG—CRIMPED

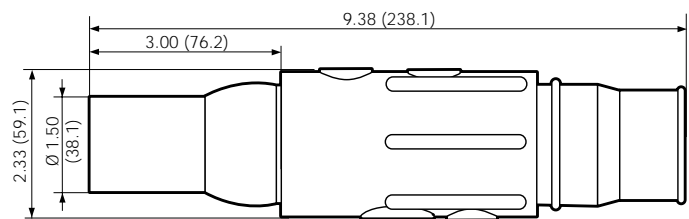

FEMALE VULCANIZED PLUG—CRIMPED

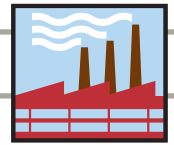

## Industrial Grade Single Pole Cam-Type Connectors

### 19 Series—Ball Nose

Panel Receptacle Threaded Studs—page P15

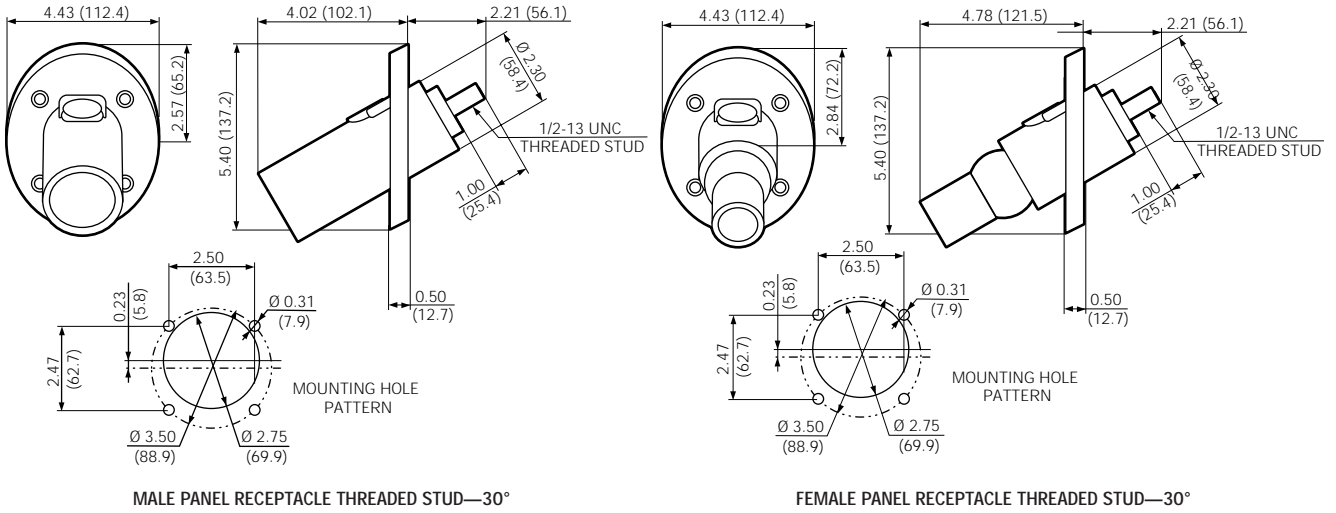

### 22 Series—Latching Ball Nose

Male and Female Ball Nose Latching Connectors—page P16

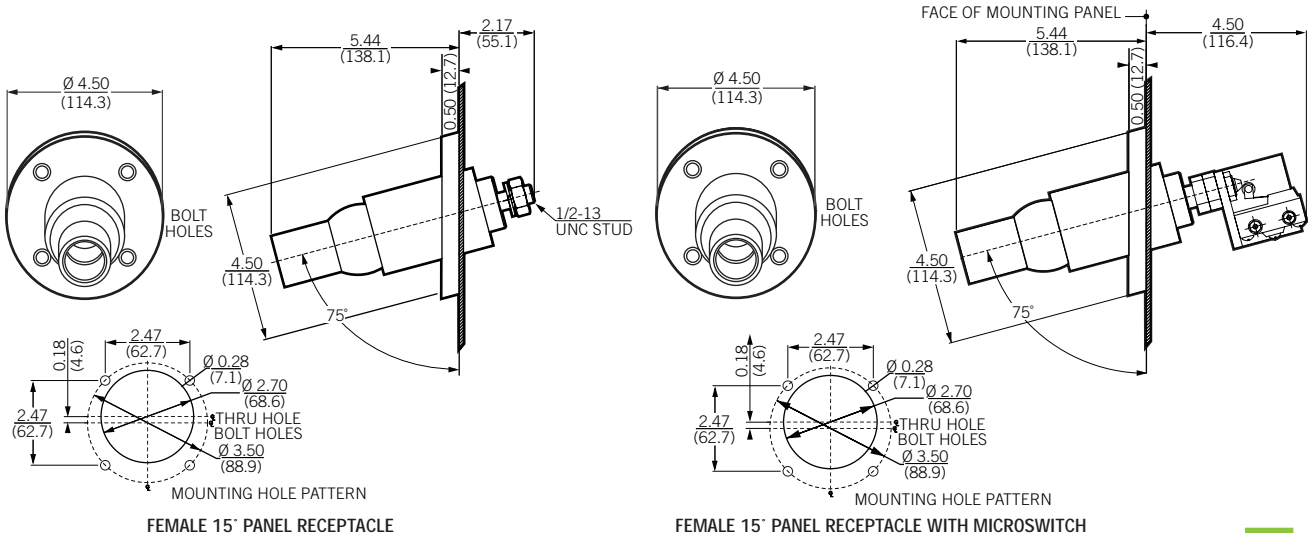
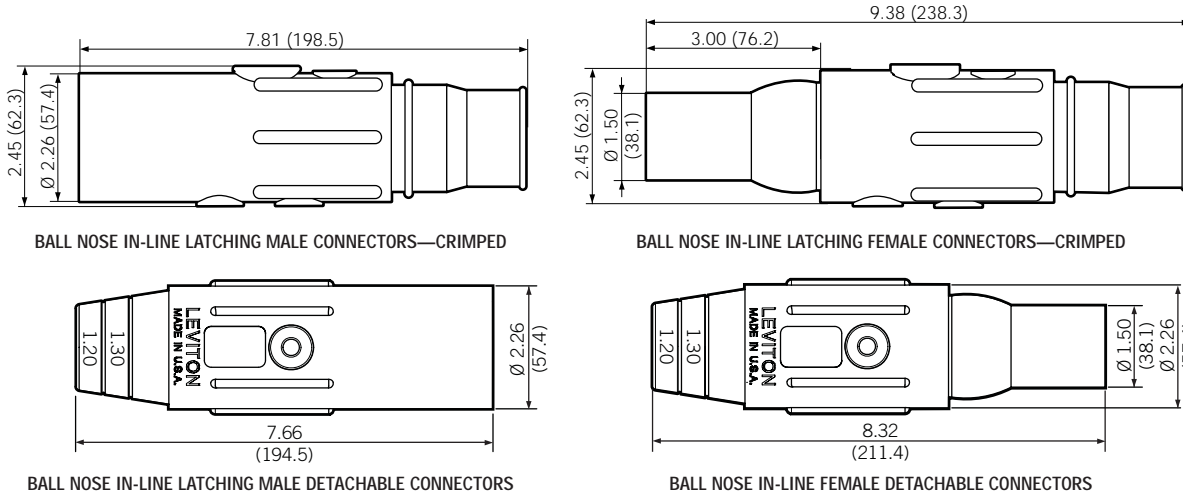

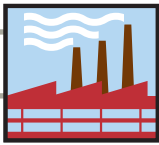

# SINGLE POLE CAM-TYPE CONNECTORS—DIMENSIONAL DRAWINGS

## Industrial Grade Single Pole Cam-Type Connectors

### 23 Series—Latching Taper Nose

Male and Female Taper Nose Latching Connectors—pages P17

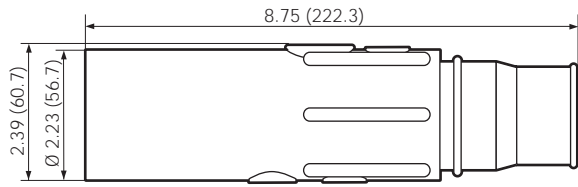

TAPER NOSE IN-LINE LATCHING MALE CONNECTORS—CRIMPED

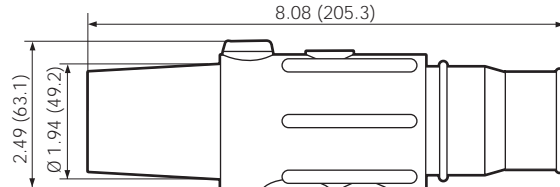

TAPER NOSE IN-LINE LATCHING FEMALE CONNECTORS—CRIMPED

### 23 Series—Latching Taper Nose

Panel Receptacle Threaded Studs—page P17

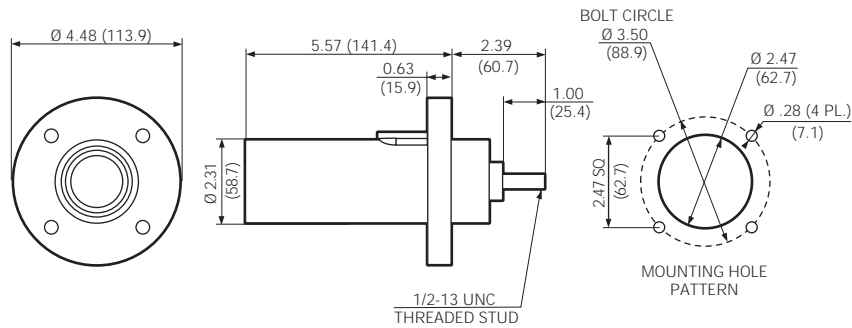

90° MALE PANEL RECEPTACLE THREADED STUD

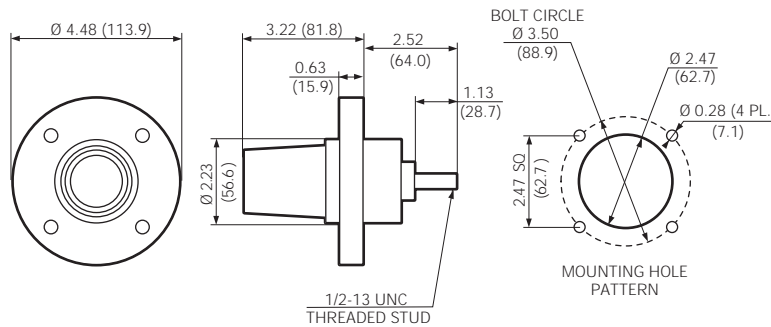

90° FEMALE PANEL RECEPTACLE THREADED STUD

Male and Female Protective Caps—page P17

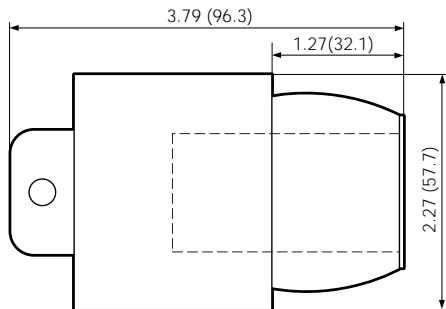

MALE PROTECTIVE CAP

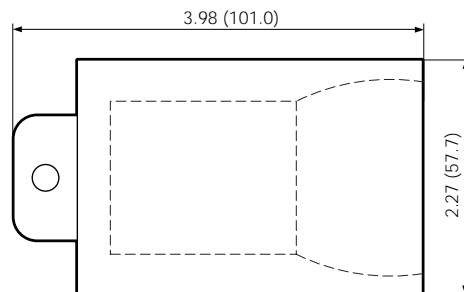

FEMALE PROTECTIVE CAP

# Wire Mesh Safety Grips

## INDEX

|                                     |          |
|-------------------------------------|----------|
| <b>Wire Mesh Safety Grips</b>       |          |
| Overview                            | .02      |
| Technical Reference                 | .03      |
| Selecting Pulling and Support Grips | .04–06   |
| Pulling Grips                       | .07–014  |
| Strain-Relief Grips                 | .015–018 |
| Support Grips                       | .019–026 |



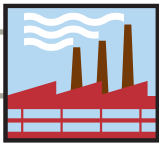

## WIRE MESH SAFETY GRIP FEATURES

### Industrial Grade Wire Mesh Safety Grips

#### A LARGE SELECTION OF WIRE MESH PULLING, STRAIN-RELIEF AND SUPPORT GRIPS

Leviton Wire Mesh Safety Grips are built tough to provide the strength, reliability and gripping force required for today's demanding wire management applications. They are designed to distribute stress over a large area so they can securely hold, pull or support the wire, rope, tubing or fiber optic cable to which they are applied.

Leviton Wire Mesh Safety Grip products offer a wide selection of style, weave, attachment and wire options designed to meet the highest standards for strength, flexibility, durability and longevity.

Leviton Wire Mesh Safety Grips are flexible holding devices used to pull cable, rope, or tubing into place; to support it after it has been installed, to prevent cable pullout; or to provide strain-relief that reduces the arc of bend at points of wire connections or terminations.

#### 1. Pulling Grips

Pulling Grips are reusable tools for pulling insulated conductors or bare wires, cable, nylon and wire rope, fiber optic cable etc. Both flexible eye and rotating eye attachments are available.

#### 2. Strain-Relief Grips

Strain-Relief Grips are used to connect cable or flexible conduit to electrical enclosures and equipment. This prevents pullout and bending due to tension at the inner conductors at the point of termination.

#### 3. Support Grips

Support Grips distribute the weight of the vertical or sloping runs of electrical and fiber optic cable, metal rods, tubing or hose over the entire length of the grip so that the cable is not subject to damage. A variety of hangers and bales are available. These grips are also available in stainless steel for additional corrosion-resistance. Consult factory for availability.

#### Agency Approvals

UL Listings and CSA Certifications are indicated on the appropriate product catalog pages. File numbers, are listed below.

| AGENCY                          | CONTROL NUMBER | FILE NUMBER          |
|---------------------------------|----------------|----------------------|
| Underwriters Laboratories, Inc. | 965U<br>16G5   | E-173944<br>E-176347 |
| Canadian Standards Association  | —              | LR-702185            |

#### Standards

Leviton Wire Mesh Safety Grips meet the following standards:

**NEC 300-19**—Supporting cables in vertical raceways.

**NEC 351-2**—Liquid-tight flexible metal conduit installations.

**NEC 400-7**—Flexible cord installations.

**NEC 400-10**—Strain-relief at joints and terminals.

**JIC H 13.11**—Prevention of flexible hose failure.



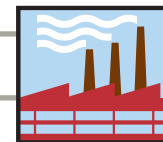

## Industrial Grade Wire Mesh Safety Grips

### Technical Reference

#### Hazardous Locations

The following product categories are suitable for use in hazardous locations per Class I, Div. 2; Class II, Div. 1 & 2; and Class III, Div. 1 & 2 requirements.

| PRODUCT CATEGORY  | TYPE  |
|-------------------|---|
| Deluxe Cord Grips | Aluminum fitting<br>Nylon fitting<br>Non-metallic |

#### Flammability

Non-metallic Deluxe Cord Grips will not support combustion. The ratings are listed below.

| COMPONENT      | RATING            |
|----------------|-------------------|
| Wire Mesh Grip | 94HB <sup>1</sup> |
| Fitting        | 94V <sup>2</sup>  |

<sup>1</sup>A test method used by U.L. to determine a rate of burning and/or extent and time of burning of self-supporting plastics in a horizontal position (ASTM D 635-88, IEC 707-1981, ISO/DIS 1210.2).

<sup>2</sup>A test method used by UL for measuring the comparative extinguishing characteristics of solid plastics in a vertical position (IEC 707-1981, ISO/DIS 1210.2).

#### Wet Locations

The strain-relief grips listed below are suitable for use in wet locations so long as a listed sealing ring is used between the box and the fitting.

| PRODUCT CATEGORY | TYPE  |
|------------------|---|
| Deluxe Cord Grip | Aluminum fitting<br>Nylon fitting<br>Non-metallic |

#### Types of Wire Mesh Safety Grips

| PRODUCT GROUP       | DESCRIPTION                          | MATERIAL                                      |
|---------------------|--------------------------------------|---|
| Pulling Grips       | Junior Duty                          | Galvanized steel wire                         |
|                     | Light Duty                           | Galvanized steel wire                         |
|                     | Medium Duty                          | Galvanized steel wire                         |
|                     | Heavy Duty                           | Galvanized steel wire                         |
|                     | Heavy Duty swivel                    | Galvanized steel wire                         |
|                     | MS Multi-Weave, Rotating Eye         | Galvanized steel wire                         |
|                     | MS Multi-Weave, Flexible Eye         | Galvanized steel wire                         |
|                     | High Strength                        | Galvanized steel wire                         |
|                     | Slack, Offset Eye                    | Galvanized steel wire                         |
|                     | Slack, Offset Eye                    | Galvanized steel wire                         |
| Strain-Relief Grips | Connection Wire                      | Galvanized steel                              |
|                     | Wide Range (with Gasket)             | Galvanized steel wire                         |
|                     | Deluxe Cord Grips                    | Stainless steel wire                          |
|                     | Liquid-Tight (metallic cond.)        | Stainless steel wire                          |
|                     | Liquid-tight (Non-Metallic Cond.)    | Stainless steel wire                          |
|                     | Nylon Cord Sealing Grips with Mesh   | Nylon   |
| Support Grips       | Support Closed                       | Tinned bronze or stainless steel <sup>1</sup> |
|                     | Support Split with Lace              | Tinned bronze or stainless steel <sup>1</sup> |
|                     | Support Split with Rod               | Tinned bronze or stainless steel <sup>1</sup> |
|                     | Support Closed, Heavy Duty, Long     | Tinned bronze or stainless steel <sup>1</sup> |
|                     | Support Split Lace, Heavy Duty, Long | Tinned bronze or stainless steel <sup>1</sup> |
|                     | Bus Drop Grips                       | Galvanized steel wire                         |
|                     | Safety Springs                       | Spring steel                                  |

<sup>1</sup>Stainless steel available on request. Contact your Leviton Representative.

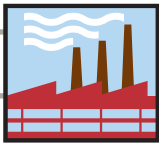

# WIRE MESH SAFETY GRIP SELECTION

## Industrial Grade Wire Mesh Safety Grips

### Selecting Proper Sized Pulling and Support Grips

#### How to Select Proper Grip Size

Example: For five cables bundled together, each with a diameter of 0.42":

- 1) Locate "5 Cables" column.
- 2) Read down column to range (0.38"-0.48").
- 3) Read across line to Grip Diameter Range (1.00-1.25).

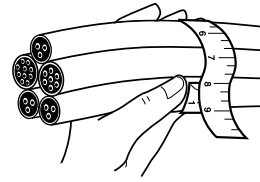

Grip size is based on the outside diameter or circumference of the cable(s). Use Selection Table 1 to determine the Grip Diameter Range for one or more cables of equal diameter. Use Selection Table 2 to determine the Grip Diameter Range for cables of different diameters bundled together. (Note: In this case, the bundle must be measured.) For your convenience, the Reference Tables provide approximate values for flexible cord and AWG or MCM wire.

#### Grip Selection Table for One or More Cables of Equal Diameter

- 1) Read across top line for number of cables in one grip.
- 2) Read down for diameter of each cable.
- 3) Read across line to Grip Diameter Range column

**TABLE 1**

**Decimal and Fractional Inch Cable Diameters—for One or More Cables of Equal Diameter**

| 1 CABLE               | 2 CABLES                | 3 CABLES                | 4 CABLES                | GRIP DIAMETER RANGE |
|-----------------------|-------------------------|-------------------------|-------------------------|---------------------|
| 0.25–0.37 1/4–3/8     | 0.16–0.25 1/64–1/4      | 0.15–0.22 5/32–7/32     | 0.12–0.20 1/8–13/64     | .250–.375           |
| 0.37–0.50 3/8–1/2     | 0.25–0.36 1/4–23/64     | 0.22–0.33 7/32–21/64    | 0.20–0.28 13/64–9/32    | .375–0.50           |
| 0.50–0.62 1/2–5/8     | 0.27–0.36 17/64–23/64   | 0.26–0.33 17/64–21/64   | 0.24–0.28 15/64–9/32    | 0.50–0.75           |
| 0.62–0.75 5/8–3/4     | 0.36–0.45 23/64–29/64   | 0.33–0.36 21/64–23/64   | 0.28–0.31 9/32–5/16     | 0.62–0.75           |
| 0.75–1.00 3/4–1       | 0.45–0.60 29/64–39/64   | 0.36–0.49 23/64–31/64   | 0.31–0.42 5/16–27/64    | 0.75–1.00           |
| 1.00–1.25 1–1 1/4     | 0.60–0.76 39/64–49/64   | 0.49–0.63 331/64–5/8    | 0.42–0.54 27/64–35/64   | 1.00–1.25           |
| 1.25–1.50 1 1/4–1 1/2 | 0.76–0.91 49/64–29/32   | 0.63–0.76 5/8–49/64     | 0.54–0.65 35/64–21/32   | 1.25–1.50           |
| 1.50–1.75 1 1/2–1 3/4 | 0.91–1.08 29/32–15/64   | 0.76–0.89 49/64–57/64   | 0.65–0.77 21/32–49/64   | 1.50–1.75           |
| 1.75–2.00 1 3/4–2     | 1.08–1.23 15/64–15/64   | 0.89–1.02 57/64–11/64   | 0.77–0.88 49/64–7/8     | 1.75–2.00           |
| 2.00–2.50 2–2 1/2     | 1.23–1.54 15/64–135/64  | 1.02–1.28 11/64–19/32   | 0.88–1.00 7/8–1         | 2.00–2.50           |
| 2.50–3.00 2 1/2–3     | 1.54–1.84 135/64–127/32 | 1.28–1.53 19/32–117/32  | 1.10–1.32 13/32–121/64  | 2.50–3.00           |
| 3.00–3.50 3–3 1/2     | 1.84–2.15 127/32–25/32  | 1.53–1.79 117/32–151/64 | 1.32–1.54 121/64–135/64 | 3.00–3.50           |
| 3.50–4.00 3 1/2–4     | 2.15–2.45 25/32–229/64  | 1.79–2.05 151/64–23/64  | 1.54–1.76 135/64–149/64 | 3.50–4.00           |

**Decimal and Fractional Inch Cable Diameters—for One or More Cables of Equal Diameter**

| 5 CABLES                | 6 & 7 CABLES           | 8 CABLES               | 9 CABLES              | GRIP DIAMETER RANGE |
|-------------------------|------------------------|------------------------|-----------------------|---------------------|
| 0.11–0.14 7/64–9/64     | 0.10–0.11 3/32–7/64    | 0.09–0.10 3/32–7/64    | 0.06–0.09 1/16–3/32   | .250–.375           |
| 0.14–0.25 9/64–1/4      | 0.11–0.25 7/64–1/4     | 0.10–0.20 7/64–13/64   | 0.09–0.19 3/32–3/16   | .375–0.50           |
| 0.21–0.25 7/32–1/4      | 0.19–0.22 3/16–7/32    | 0.17–0.20 11/64–13/64  | 0.15–0.19 5/32–3/16   | 0.50–0.75           |
| 0.25–0.29 1/4–19/64     | 0.22–0.26 7/32–17/64   | 0.20–0.23 13/64–15/64  | 0.19–0.22 3/16–7/32   | 0.62–0.75           |
| 0.29–0.38 19/64–3/8     | 0.26–0.34 17/64–11/32  | 0.23–0.31 15/64–5/16   | 0.22–0.31 7/32–5/16   | 0.75–1.00           |
| 0.38–0.48 3/8–31/64     | 0.34–0.43 11/32–7/16   | 0.31–0.39 5/16–25/64   | 0.29–0.36 19/64–23/64 | 1.00–1.25           |
| 0.48–0.58 31/64–37/64   | 0.43–0.52 7/16–33/64   | 0.39–0.46 25/64–15/32  | 0.36–0.43 23/64–7/16  | 1.25–1.50           |
| 0.58–0.67 37/64–43/64   | 0.52–0.60 33/64–39/64  | 0.46–0.54 15/32–35/64  | 0.43–0.49 7/16–31/64  | 1.50–1.75           |
| 0.67–0.77 43/64–49/64   | 0.60–0.69 39/64–11/16  | 0.54–0.62 35/64–5/8    | 0.49–0.57 31/64–37/64 | 1.75–2.00           |
| 0.77–0.96 49/64–31/32   | 0.69–0.86 11/16–55/64  | 0.62–0.77 5/8–49/64    | 0.57–0.72 37/64–23/32 | 2.00–2.50           |
| 0.96–1.16 31/32–15/32   | 0.86–1.03 55/64–11/32  | 0.77–0.93 49/64–15/16  | 0.72–0.86 23/32–55/64 | 2.50–3.00           |
| 1.16–1.35 15/32–123/64  | 1.03–1.20 11/32–113/64 | 0.93–1.08 15/16–15/64  | 0.86–1.00 55/64–1     | 3.00–3.50           |
| 1.35–1.54 123/64–135/64 | 1.20–1.37 113/64–13/8  | 1.08–1.24 15/64–115/64 | 1.00–1.14 1–19/64     | 3.50–4.00           |

# WIRE MESH SAFETY GRIP SELECTION

## Industrial Grade Wire Mesh Safety Grips

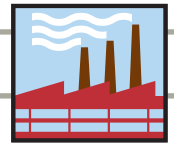

### Selecting Proper Sized Pulling and Support Grips

#### How to Select Proper Grip Size

Example:

For three different diameter cables bundled together with a measured circumference of 6.35".

- 1) Read down Inches (Decimal) column for 6.35" (6.29-7.86 in.).
- 2) Read across line to Grip Diameter Range (2.00-2.50).

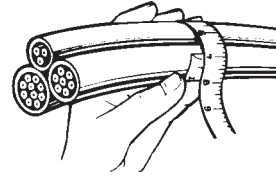

#### Grip Selection Table for Cables of Different Diameters

Grip Circumference Range refers to the circumference of all cables held together.

- 1) Determine Grip Circumference Range by measuring circumference of bundle of cables to be held (as shown in illustration).
- 2) Read down to locate correct range.
- 3) Read across line to Grip Diameter Range Column.

**TABLE 2**

**Grip Circumference Range—for Cables of Different Diameter**

| INCHES (FRACTIONAL)   | INCHES (DECIMAL) | GRIP DIAMETER RANGE |
|---|------------------|---------------------|
| 2 <sup>5</sup> / <sub>32</sub> –11 <sup>1</sup> / <sub>64</sub>   | 0.78–1.17        | .250–.375           |
| 1 <sup>11</sup> / <sub>64</sub> –1 <sup>37</sup> / <sub>64</sub>  | 1.17–1.57        | .375–0.50           |
| 1 <sup>37</sup> / <sub>64</sub> –1 <sup>15</sup> / <sub>16</sub>  | 1.57–1.94        | 0.50–.625           |
| 1 <sup>15</sup> / <sub>16</sub> –2 <sup>3</sup> / <sub>8</sub>    | 1.94–2.37        | 0.62–0.75           |
| 2 <sup>3</sup> / <sub>8</sub> –3 <sup>5</sup> / <sub>32</sub>     | 2.37–3.15        | 0.75–1.00           |
| 3 <sup>5</sup> / <sub>32</sub> –3 <sup>15</sup> / <sub>16</sub>   | 3.15–3.94        | 1.00–1.25           |
| 3 <sup>15</sup> / <sub>16</sub> –4 <sup>23</sup> / <sub>32</sub>  | 3.94–4.72        | 1.25–1.50           |
| 4 <sup>23</sup> / <sub>32</sub> –5 <sup>33</sup> / <sub>64</sub>  | 4.72–5.51        | 1.50–1.75           |
| 5 <sup>33</sup> / <sub>64</sub> –6 <sup>19</sup> / <sub>64</sub>  | 5.51–6.29        | 1.75–2.00           |
| 6 <sup>19</sup> / <sub>64</sub> –7 <sup>55</sup> / <sub>64</sub>  | 6.29–7.86        | 2.00–2.50           |
| 7 <sup>55</sup> / <sub>64</sub> –9 <sup>7</sup> / <sub>16</sub>   | 7.86–9.43        | 2.50–3.00           |
| 9 <sup>7</sup> / <sub>16</sub> –11 <sup>1</sup> / <sub>64</sub>   | 9.43–11.01       | 3.00–3.50           |
| 11 <sup>1</sup> / <sub>64</sub> –12 <sup>37</sup> / <sub>64</sub> | 11.01–12.58      | 3.50–4.00           |

#### Reference Table Cord Diameters

For your convenience, the following are nominal overall diameters (in inches) for flexible cord.

| DIAMETER | AT WIRE SIZE AND TYPE | CONDUCTORS |      |      |      |
|----------|-----------------------|------------|------|------|------|
|          |                       | 2          | 3    | 4    | 5    |
|          | 18 SO, STO            | .36        | .38  | .41  | .49  |
|          | 18 SJO, SJTO          | .30        | .32  | .35  | —    |
|          | 16 SO, STO            | .39        | .41  | .44  | .52  |
|          | 16 SJO, SJTO          | .32        | .34  | .37  | —    |
|          | 14 SO, STO            | .52        | .55  | .59  | .67  |
|          | 12 SO, STO            | .60        | .62  | .68  | .74  |
|          | 10 SO, STO            | .65        | .69  | .74  | .80  |
|          | 8 SO, STO             | .83        | .88  | .99  | 1.08 |
|          | 6 SO, STO             | .99        | 1.04 | 1.12 | 1.25 |

#### Reference Table AWG or MCM Diameters

This table is to be used as a guide only. Sizes may vary by manufacturer.

| DIAMETER | AWG OR MCM | APPROX. DIA. (INCHES) |      | AWG OR MCM | APPROX. DIA. (INCHES) |      |
|----------|------------|-----------------------|------|------------|-----------------------|------|
|          |            | THHN                  | THW  |            | THHN                  | THW  |
|          | 14         | .105                  | .162 | 3/0        | .588647               |      |
|          | 12         | .122                  | .179 | 4/0        | .646                  | .705 |
|          | 10         | .153                  | .199 | 250        | .716                  | .788 |
|          | 8          | .201                  | .259 | 300        | .771                  | .843 |
|          | 6          | .257                  | .323 | 350        | .822                  | .895 |
|          | 4          | .328                  | .372 | 400        | .869                  | .942 |
|          | 3          | .356                  | .401 | 500        | .955                  | 1.03 |
|          | 2          | .388                  | .433 | 600        | 1.06                  | 1.14 |
|          | 1          | .450                  | .508 | 700        | 1.13                  | 1.21 |
|          | 1/0        | .491                  | .549 | 750        | 1.16                  | 1.25 |
|          | 2/0        | .537                  | .595 | 1000       | 1.32                  | 1.40 |



## WIRE MESH SAFETY GRIP SELECTION

### Industrial Grade Wire Mesh Safety Grips

#### Selecting Proper Sized Pulling and Support Grips

##### Strength Information

The approximate breaking strength of any Leviton Wire Mesh Safety Grip is based on working load information established by our engineering laboratories. In making these determinations, it is not possible to cover all applications and operating conditions. Variables such as diameter, gripping surface, number of items gripped, tension, movement, attachments, abrasion, corrosion, prior use and abuse must be assessed by the user. Greater safety factors should be utilized when the conditions of application are vague or unknown.

For specific applications where strength and holding power are important, consult Leviton's Technical Services Department. To determine the recommended working load safety factor for listed cable grips, divide the approximate breaking strength by 5 for pulling grips and by 10 for support grips. Leviton maintains a 6 Sigma Safety Factor for this recommended working load (using average break strengths obtained on new grips under lab test conditions).

**Example:** For pulling grips— $33,000 \div 5 = 6,600$  lbs. which is the workload factor.

**Example:** For support grips— $10,080 \div 10 = 1,008$  lbs. which is the workload factor.

All warranties concerning product quality or performance are based on wire mesh safety grips that are properly stored and handled by the user, and grips that are maintained and inspected at a proper frequency in keeping with their use and condition.

##### Grip Cable Range—Fraction—Decimal—Millimeter Conversion

| INCHES (FRACTIONAL)     | INCHES (DECIMAL) | METRIC (mm)  |
|-------------------------|------------------|--------------|
| $1/4$ – $23/64$         | 0.25–0.36        | 6.35–9.13    |
| $3/8$ – $31/64$         | 0.37–0.49        | 9.52–12.30   |
| $1/2$ – $39/64$         | 0.50–0.61        | 12.70–15.48  |
| $5/8$ – $47/64$         | 0.62–0.74        | 15.88–18.65  |
| $3/4$ – $63/64$         | 0.75–0.99        | 19.05–25.00  |
| 1– $1^{15}/64$          | 1.00–1.24        | 25.40–31.35  |
| $1^{1/4}$ – $1^{31}/64$ | 1.25–1.49        | 31.75–37.70  |
| $1^{1/2}$ – $1^{63}/64$ | 1.50–1.99        | 38.10–50.40  |
| 2– $2^{31}/64$          | 2.00–2.49        | 50.80–63.10  |
| $2^{1/2}$ – $2^{63}/64$ | 2.50–2.99        | 63.50–75.80  |
| 3– $3^{31}/64$          | 3.00–3.49        | 76.20–88.50  |
| $3^{1/2}$ – $3^{63}/64$ | 3.50–3.99        | 88.90–101.20 |

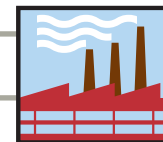

## Industrial Grade Wire Mesh Safety Grips





### PULLING GRIPS

Leviton Pulling Grips are reusable tools for pulling bare conductors, insulated wires, synthetic rope, wire rope, and fiber optic cable. These grips do not damage the cable, as the tension remains uniform throughout the length of the grip. The mesh responds to fit either a single cable or a bundle of cables.

Leviton Pulling Grips may be used for pulling cable on overhead or underground applications, for stringing service or communication lines into factories, for pulling wire through conduit, and for underground electrical pulls.

Leviton Pulling Grips are woven in galvanized steel for greater strength and longer life. Leviton also offers Pulling Kits that come in a vinyl mat with pockets that can be rolled and tied.

### Pulling Grip Eye Options

| DESCRIPTION   | PAGE NO. | ATTACHMENT INFORMATION   |
|---|----------|--|
| Bale Eye—Medium Duty, Single/Double Weave           | Q9       |         |
| Bale Eye—Medium and Heavy Duty, Single/Double Weave | Q10      | <b>Bale Eye</b><br>Attachment flexes to follow line of pull with plastic tubing on bale. |
| Flexible Eye—Junior Duty, Single Weave              | Q8       |  |
| Flexible Eye—Light Duty, Single Weave               | Q8       |         |
| Flexible Eye—for Fiber Optic, Multi-Weave           | Q9       | <b>Flexible Rope Eye</b><br>Bale has no plastic tubing for better flexibility.           |
| Flexible Eye—High Duty, Multi-Weave                 | Q13      |  |
| Slack Grips, Closed Mesh, Double Weave              | Q14      |         |
| Slack Grips, Split Lace Mesh, Double Weave          | Q14      | <b>Offset Flexible Eye</b><br>For easy attachment of the pulling line.                   |
| Slack Grips, Split Rod Mesh, Single Weave           | Q14      |  |
| Rotating Eye—Heavy Duty, Double Weave               | Q11      |       |
| Rotating Eye—Heavy Duty, Multi-Weave                | Q12      | <b>Rotating Eye</b><br>For use in changing wire rope in large cranes and derricks.       |

Note: To determine workload safety factor, divide approximate break strength by 5.  
See page Q6 for strength information

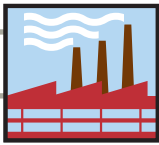

## WIRE MESH PULLING GRIPS

### Industrial Grade Wire Mesh Safety Grips

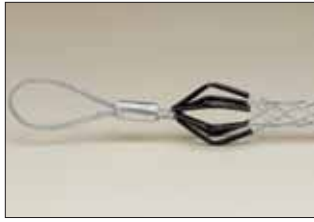

**L8503**

Junior Duty Series Grips are indispensable tools for electricians with small job requirements. They are used to connect insulated wire bundles to pulling tape or to pull wire rope through conduit.

#### Pulling Grips

##### Single Weave, Flexible Eye, Junior Duty

| CAT. NO. | CABLE DIA. RANGE (INCHES) | APPROXIMATE BREAK STRENGTH* | MESH LENGTH (INCHES) |
|----------|---------------------------|-----------------------------|----------------------|
| L8500    | 0.25–0.36                 | 1,700                       | 5                    |
| L8501    | 0.37–0.49                 | 1,700                       | 7                    |
| L8502    | 0.50–0.61                 | 1,700                       | 8                    |
| L8503    | 0.62–0.74                 | 2,800                       | 10                   |
| L8504    | 0.75–0.99                 | 4,100                       | 10                   |
| L8505    | 1.00–1.24                 | 4,100                       | 12                   |

##### Single Weave, Flexible Eye, Junior Duty—Kit

| KIT CAT. NO. | KIT INCLUDES ONE EACH OF CAT. NO. |
|--------------|-----------------------------------|
| L8510        | L8500                             |
|              | L8501                             |
|              | L8502                             |
|              | L8503                             |
|              | L8504                             |
|              | L8505                             |



**L8511**

Light Duty Grips are the most economical pulling grips for many applications, such as industrial plant wiring, rewiring, and underground electrical pulls.

#### Pulling Grips

##### Single Weave, Flexible Rope Eye, Light Duty, Short

| CAT. NO. | CABLE DIA. RANGE (INCHES) | APPROXIMATE BREAK STRENGTH* | MESH LENGTH (INCHES) |
|----------|---------------------------|-----------------------------|----------------------|
| L8511    | 0.50–0.61                 | 3,400                       | 12                   |
| L8512    | 0.62–0.74                 | 4,100                       | 14                   |
| L8513    | 0.75–0.99                 | 4,100                       | 14                   |
| L8514    | 1.00–1.24                 | 5,800                       | 16.5                 |
| L8515    | 1.25–1.49                 | 5,800                       | 17                   |
| L8516    | 1.50–1.74                 | 7,500                       | 20                   |
| L8517    | 1.75–1.99                 | 10,000                      | 23                   |
| L8518    | 2.00–2.49                 | 10,000                      | 23                   |
| L8519    | 2.50–2.99                 | 13,000                      | 23                   |

##### Single Weave, Flexible Rope Eye, Light Duty, Medium

| CAT. NO. | CABLE DIA. RANGE (INCHES) | APPROXIMATE BREAK STRENGTH* | MESH LENGTH (INCHES) |
|----------|---------------------------|-----------------------------|----------------------|
| L8523    | 0.50–0.61                 | 3,400                       | 16                   |
| L8524    | 0.62–0.74                 | 4,100                       | 16                   |
| L8525    | 0.75–0.99                 | 4,100                       | 20                   |
| L8526    | 1.00–1.24                 | 7,500                       | 20                   |
| L8527    | 1.25–1.49                 | 7,500                       | 22                   |
| L8528    | 1.50–1.99                 | 7,500                       | 25                   |
| L8529    | 2.00–2.49                 | 10,000                      | 26                   |
| L8530    | 2.50–2.9                  | 13,000                      | 28                   |
| L8531    | 3.00–3.49                 | 16,200                      | 30                   |
| L8532    | 3.50–3.99                 | 19,400                      | 32                   |

##### Single Weave, Flexible Rope Eye, Light Duty, Medium—Kit

| KIT CAT. NO. | KIT INCLUDES ONE EACH OF CAT. NO. |
|--------------|-----------------------------------|
| L8540        | L8525                             |
|              | L8526                             |
|              | L8528                             |
|              | L8529                             |

\*To determine workload safety factor, divide approximate break strength by 5. See page Q6 for strength information.

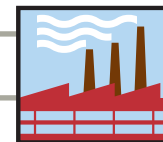

### Pulling Grips

#### Single/Double Weave, Bale Eye, Medium Duty

| CAT. NO. | CABLE DIA. RANGE (INCHES) | APPROXIMATE BREAK STRENGTH* | MESH LENGTH (INCHES) |
|----------|---------------------------|-----------------------------|----------------------|
| L8541    | 0.37-0.49                 | 2,500                       | 12                   |
| L8542    | 0.50-0.74                 | 3,400                       | 14                   |
| L8543    | 0.75-0.99                 | 5,500                       | 18                   |
| L8544    | 1.00-1.24                 | 8,100                       | 22                   |
| L8545    | 1.25-1.49                 | 8,100                       | 24                   |
| L8546    | 1.50-1.99                 | 8,100                       | 26                   |



**L8545**  
Single/Double Weave Pulling Grips are ideal for longer pull applications.

#### Single/Double Weave, Bale Eye, Medium Duty—Kit

| KIT CAT. NO. | KIT INCLUDES ONE EACH OF CAT. NO. |
|--------------|-----------------------------------|
| L8550        | L8541                             |
|              | L8542                             |
|              | L8543                             |
|              | L8544                             |
|              | L8545                             |
|              | L8546                             |

### Pulling Grips—Fiber Optic Series

Fiber Optic Pulling Grips are used for installation of fiber optic communication lines. They easily install on cables and are reusable. Applications include underground, overhead, through-conduit and/or enclosure type pulls.

Leviton fiber optic pulling grips are two-in-one reusable grips: the same tool features both a flexible eye and a swivel eye. The rounded, flexible eye attaches easily to pulling lines, and allows smoother passage through tight spaces than needle-eye designs.

#### Flexible/Swivel Eye Fiber Optic Grips Multi Weave

| CAT. NO. | CABLE DIA. RANGE (INCHES) | APPROX. BREAK STRENGTH* | LENGTH (INCHES) |               |           |
|----------|---------------------------|-------------------------|-----------------|---------------|-----------|
|          |                           |                         | BALE (DIM. A)   | MESH (DIM. M) | NOSE DIA. |
| L8801    | .10-.20                   | 1,000                   | 4.75            | 9             | .8        |
| L8802    | .21-.35                   | 1,500                   | 4.75            | 14            | .8        |
| L8803    | .35-.48                   | 2,200                   | 5.00            | 18            | .9        |
| L8804    | .42-.61                   | 2,800                   | 5.00            | 21            | .9        |
| L8805    | .53-.74                   | 3,300                   | 5.00            | 24            | 1.2       |
| L8806    | .64-.87                   | 4,700                   | 5.00            | 27            | 1.2       |

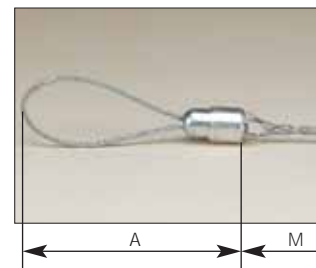

**L8801**  
Fiber Optic Grips are made to pull delicate communication and data lines that have a much smaller cable diameter.

\*To determine workload safety factor, divide approximate break strength by 5. See page Q6 for strength information.

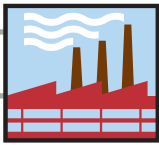

## WIRE MESH PULLING GRIPS

### Industrial Grade Wire Mesh Safety Grips

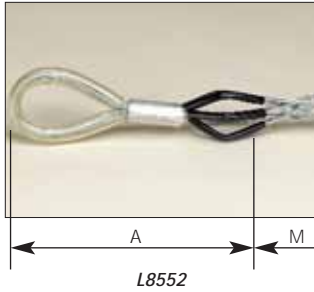

#### Pulling Grips

This series is recommended for heavy or rugged applications, and is ideally suited for overhead and underground installations. They are offered in short, standard or long mesh lengths.

#### Single/Double Weave, Bale Eye, Medium Duty, Short

| CAT. NO. | CABLE DIA. RANGE (INCHES) | NOMINAL GRIP SIZE | APPROX. BREAK STRENGTH* | LENGTH (INCHES) |               | EYE SIZE (INCHES) |
|----------|---------------------------|-------------------|-------------------------|-----------------|---------------|-------------------|
|          |                           |                   |                         | BALE (DIM. A)   | MESH (DIM. M) |                   |
| L8551    | 0.50–0.61                 | 0.55              | 4,500                   | 8               | 21            | 7/32              |
| L8552    | 0.62–0.74                 | 0.68              | 5,600                   | 8               | 24            | 1/4               |
| L8553    | 0.75–0.99                 | 0.87              | 6,800                   | 8               | 24            | 1/4               |
| L8554    | 1.00–1.49                 | 1.25              | 9,600                   | 9               | 24            | 5/16              |
| L8555    | 1.50–1.99                 | 1.75              | 16,400                  | 11              | 24            | 7/16              |
| L8556    | 2.00–2.49                 | 2.25              | 18,500                  | 12              | 24            | 7/16              |
| L8557    | 2.50–2.99                 | 2.75              | 24,500                  | 12              | 24            | 1/2               |
| L8558    | 3.00–3.49                 | 3.25              | 24,500                  | 14              | 24            | 1/2               |
| L8559    | 3.50–3.99                 | 3.75              | 31,000                  | 14              | 26            | 5/8               |

#### Single/Double Weave, Bale Eye, Medium Duty, Standard

| CAT. NO. | CABLE DIA. RANGE (INCHES) | NOMINAL GRIP SIZE | APPROX. BREAK STRENGTH* | LENGTH (INCHES) |               | EYE SIZE (INCHES) |
|----------|---------------------------|-------------------|-------------------------|-----------------|---------------|-------------------|
|          |                           |                   |                         | BALE (DIM. A)   | MESH (DIM. M) |                   |
| L8563    | 0.75–0.99                 | 0.87              | 6,800                   | 9               | 36            | 1/4               |
| L8564    | 1.00–1.49                 | 1.25              | 9,600                   | 9               | 36            | 5/16              |
| L8565    | 1.50–1.99                 | 1.75              | 16,400                  | 11              | 36            | 7/16              |
| L8566    | 2.00–2.49                 | 2.25              | 18,500                  | 12              | 36            | 7/16              |
| L8567    | 2.50–2.9                  | 2.75              | 24,500                  | 12              | 36            | 1/2               |
| L8568    | 3.00–3.49                 | 3.25              | 24,500                  | 14              | 36            | 1/2               |
| L8569    | 3.50–3.99                 | 3.75              | 31,000                  | 14              | 40            | 5/8               |

#### Single/Double Weave, Bale Eye, Medium Duty, Standard—Kit

| KIT CAT. NO. | KIT INCLUDES ONE EACH OF CAT. NO. |
|--------------|-----------------------------------|
| L8560        | L8563                             |
|              | L8564                             |
|              | L8565                             |
|              | L8566                             |

#### Single/Double Weave, Bale Eye, Heavy Duty, Long

| CAT. NO. | CABLE DIA. RANGE (INCHES) | NOMINAL GRIP SIZE | APPROX. BREAK STRENGTH* | MESH DIM. M (INCHES) |
|----------|---------------------------|-------------------|-------------------------|----------------------|
| L8572    | 0.75–0.99                 | 0.87              | 8,100                   | 48                   |
| L8573    | 1.00–1.49                 | 1.25              | 11,600                  | 48                   |
| L8574    | 1.50–1.99                 | 1.75              | 19,400                  | 48                   |
| L8575    | 2.00–2.49                 | 2.25              | 19,400                  | 48                   |
| L8576    | 2.50–2.99                 | 2.75              | 25,900                  | 48                   |
| L8577    | 3.00–3.49                 | 3.25              | 25,900                  | 48                   |
| L8578    | 3.50–3.99                 | 3.75              | 32,400                  | 48                   |

Note: See installation instructions supplied with grip for recommended swivels, links and clamps or accessories listing.  
\*To determine workload safety factor, divide approximate break strength by 5. See page Q6 for strength information.



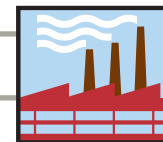

## Industrial Grade Wire Mesh Safety Grips

### Pulling Grips

These grips feature a double weave of galvanized steel strands for greater strength and added mesh contact with the cable. Leviton Double Weave Pulling Grips are designed to handle longer or heavier pulling jobs such as installation of underground cables, communication lines, and service lines.

Double Weave Pulling Grips have a forged steel compact rotating eye which can be attached to a swivel.

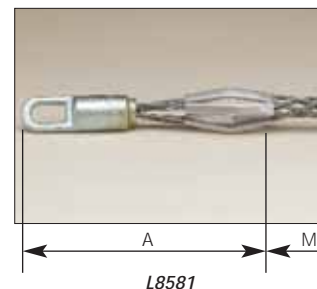

#### Double Weave, Rotating Eye, Heavy Duty, Short

| CAT. NO. | CABLE DIA. RANGE (INCHES) | NOMINAL GRIP SIZE | APPROX. BREAK STRENGTH* | LENGTH (INCHES) |               | EYE SIZE (INCHES) |
|----------|---------------------------|-------------------|-------------------------|-----------------|---------------|-------------------|
|          |                           |                   |                         | BALE (DIM. A)   | MESH (DIM. M) |                   |
| L8581    | 0.50-0.61                 | 0.55              | 5,600                   | 5               | 11            | 7/8               |
| L8582    | 0.62-0.74                 | 0.68              | 6,800                   | 5               | 11            | 7/8               |
| L8583    | 0.75-0.99                 | 0.87              | 9,600                   | 6               | 20            | 1                 |
| L8584    | 1.00-1.24                 | 1.12              | 16,400                  | 7               | 20            | 1 3/8             |
| L8585    | 1.25-1.49                 | 1.37              | 16,400                  | 7               | 21            | 1 3/8             |
| L8586    | 1.50-1.99                 | 1.74              | 27,200                  | 7               | 25            | 1 5/8             |
| L8587    | 2.00-2.49                 | 2.24              | 33,000                  | 8               | 26            | 1 7/8             |
| L8588    | 2.50-2.99                 | 2.74              | 41,000                  | 10              | 28            | 1 7/8             |
| L8589    | 3.00-3.49                 | 3.24              | 48,000                  | 10              | 30            | 1 7/8             |
| L8591    | 3.50-3.99                 | 3.74              | 48,000                  | 10              | 32            | 1 7/8             |
| L8592    | 4.00-4.49                 | 4.24              | 48,000                  | 10              | 33            | 1 7/8             |

#### Double Weave, Rotating Eye, Heavy Duty, Standard

| CAT. NO. | CABLE DIA. RANGE (INCHES) | NOMINAL GRIP SIZE | APPROX. BREAK STRENGTH* | LENGTH (INCHES) |               | EYE SIZE (INCHES) |
|----------|---------------------------|-------------------|-------------------------|-----------------|---------------|-------------------|
|          |                           |                   |                         | BALE (DIM. A)   | MESH (DIM. M) |                   |
| L8601    | 0.50-0.61                 | 0.55              | 5,600                   | 5               | 16            | 7/8               |
| L8602    | 0.62-0.74                 | 0.68              | 6,800                   | 5               | 16            | 7/8               |
| L8603    | 0.75-0.99                 | 0.87              | 9,600                   | 6               | 32            | 1                 |
| L8604    | 1.00-1.49                 | 1.12              | 16,400                  | 7               | 33            | 1 3/8             |
| L8605    | 1.50-1.99                 | 1.74              | 16,400                  | 7               | 34            | 1 3/8             |
| L8606    | 2.00-2.49                 | 2.24              | 27,200                  | 9               | 36            | 1 5/8             |
| L8607    | 2.50-2.99                 | 2.74              | 33,000                  | 10              | 38            | 1 7/8             |
| L8608    | 3.00-3.49                 | 3.24              | 41,000                  | 10              | 39            | 1 7/8             |
| L8609    | 3.50-3.99                 | 3.74              | 48,000                  | 10              | 41            | 1 7/8             |
| L8611    | 4.00-4.49                 | 4.24              | 48,000                  | 10              | 42            | 1 7/8             |
| L8612    | 4.50-4.99                 | 4.74              | 48,000                  | 10              | 58            | 1 7/8             |
| L8613    | 5.00-5.99                 | 5.49              | 48,000                  | 10              | 60            | 1 7/8             |
| L8614    | 6.00-6.99                 | 6.49              | 48,000                  | 10              | 66            | 1 7/8             |

#### Double Weave, Rotating Eye, Heavy Duty, Standard—Kit

| KIT CAT. NO. | KIT INCLUDES ONE EACH OF CAT. NO. |
|--------------|-----------------------------------|
| L8600        | L8603                             |
|              | L8604                             |
|              | L8605                             |
|              | L8606                             |

Note: See installation instructions supplied with grip for recommended swivels, links and clamps or accessories listing.

\*To determine workload safety factor, divide approximate break strength by 5. See page Q6 for strength information.

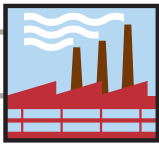

## WIRE MESH PULLING GRIPS

### Industrial Grade Wire Mesh Safety Grips

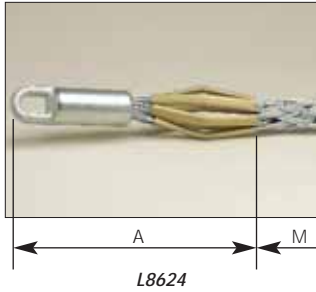

#### Pulling Grips—Multi-Weave Grips <sup>SE</sup>

Leviton Multi-Weave Pulling Grips are constructed of high strength galvanized steel strands and are designed for pulling aluminum or copper bare conductor, wire rope and insulated cables. These grips are used in applications such as distribution line stringing and overhead transmission.

Multi-Weave Pulling Grips are available with a flexible or rotating eye which can be attached to a swivel. The forged steel flexible eye will thread through sheaves and blocks without binding, but is not a swivel and will not turn under tension. The rotating eye can turn to relieve pulling torque when tension is relaxed.

#### Multi-Weave, Rotating Eye

| CAT. NO. | CABLE DIA. RANGE (INCHES) | NOMINAL GRIP SIZE | APPROX. BREAK STRENGTH* | LENGTH (INCHES) |               | COLOR CODE | EYE SIZE (INCHES) |
|----------|---------------------------|-------------------|-------------------------|-----------------|---------------|------------|-------------------|
|          |                           |                   |                         | BALE (DIM. A)   | MESH (DIM. M) |            |                   |
| L8621    | 0.25–0.49                 | 3/8               | 6,800                   | 5               | 26            | Dk. Green  | 7/8               |
| L8622    | 0.50–0.74                 | 5/8               | 10,000                  | 6               | 32            | Brown      | 1                 |
| L8623    | 0.75–0.99                 | 7/8               | 14,400                  | 6               | 41            | Lt. Blue   | 1                 |
| L8624    | 1.00–1.24                 | 1 1/8             | 24,600                  | 8               | 52            | Gold       | 1 3/8             |
| L8625    | 1.25–1.49                 | 1 3/8             | 30,600                  | 8               | 56            | Black      | 1 5/8             |
| L8626    | 1.50–1.74                 | 1 5/8             | 30,600                  | 9               | 60            | Red        | 1 7/8             |
| L8627    | 1.75–1.99                 | 2                 | 48,000                  | 10              | 70            | Dk. Blue   | 1 7/8             |
| L8628    | 2.00–2.49                 | 2 1/4             | 48,000                  | 10              | 50            | Yellow     | 1 7/8             |
| L8629    | 2.50–2.99                 | 2 3/4             | 48,000                  | 10              | 52            | Orange     | 1 7/8             |
| L8631    | 3.00–3.49                 | 3 1/4             | 48,000                  | 10              | 54            | Alum.      | 1 7/8             |
| L8632    | 3.50–3.99                 | 3 3/4             | 48,000                  | 10              | 56            | Lt. Green  | 1 7/8             |

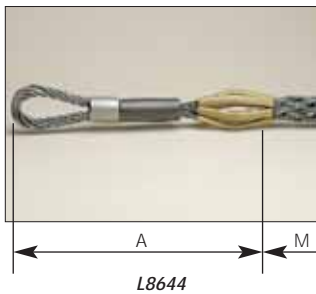

#### Multi-Weave, Flexible Eye

| CAT. NO. | CABLE DIA. RANGE (INCHES) | NOMINAL GRIP SIZE | APPROX. BREAK STRENGTH* | LENGTH (INCHES) |               | COLOR CODE | EYE SIZE (INCHES) |
|----------|---------------------------|-------------------|-------------------------|-----------------|---------------|------------|-------------------|
|          |                           |                   |                         | BALE (DIM. A)   | MESH (DIM. M) |            |                   |
| L8641    | 0.25–0.49                 | 3/8               | 6,800                   | 9               | 26            | Dk. Green  | 1/4               |
| L8642    | 0.50–0.74                 | 5/8               | 10,000                  | 9               | 32            | Brown      | 5/16              |
| L8643    | 0.75–0.99                 | 7/8               | 14,400                  | 11              | 41            | Lt. Blue   | 3/8               |
| L8644    | 1.00–1.24                 | 1 1/8             | 24,600                  | 12              | 52            | Gold       | 1/2               |
| L8645    | 1.25–1.49                 | 1 3/8             | 30,600                  | 12              | 56            | Black      | 1/2               |
| L8646    | 1.50–1.74                 | 1 5/8             | 30,600                  | 12              | 60            | Red        | 1/2               |
| L8647    | 1.75–1.99                 | 2                 | 48,000                  | 15              | 70            | Dk. Blue   | 5/8               |
| L8648    | 2.00–2.49                 | 2 1/4             | 48,000                  | 18              | 50            | Yellow     | 5/8               |
| L8649    | 2.50–2.99                 | 2 3/4             | 48,000                  | 18              | 52            | Orange     | 5/8               |
| L8651    | 3.00–3.49                 | 3 1/4             | 48,000                  | 18              | 54            | Alum.      | 5/8               |
| L8652    | 3.50–3.99                 | 3 3/4             | 48,000                  | 18              | 56            | Lt. Green  | 5/8               |

*Note: It is recommended that a swivel be used for release of torque during a pull. Use a connecting link when a swivel is not needed. Do not run grips or swivels over bullwheels while under tension. Do not use Multi-Weave for pulling rope. When higher loads are required, use Leviton's high strength-style pulling grips. See installation instructions supplied with grip for recommended swivels, links and clamps or accessories listing.*

*\*To determine workload safety factor, divide approximate break strength by 5. See page Q6 for strength information.*

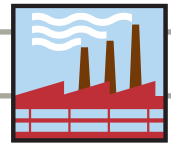

Industrial Grade Wire Mesh Safety Grips

**Pulling Grips—High Strength Grips**

High Strength Pulling Grips are designed for situations where load and safety considerations require an extra high strength grip. They are most commonly used for attaching pulling lines to conductors, conductors to running boards, and conductor-to-conductor connections. These grips can be used for pulling bare or insulated conductor, wire rope or synthetic rope

A feed tube is used when assembling synthetic rope<sup>1</sup> into the High Strength Pulling Grip and is required on the two largest grip sizes.



**Multi-weave Flexible Eye**

| CAT. NO. | GRIP RANGE O. D. (INCHES) |           | APPROX. BREAK STRENGTH* | LENGTH (INCHES) |               | COLOR CODE | FLEXIBLE EYE SIZE (INCHES) |
|----------|---------------------------|-----------|-------------------------|-----------------|---------------|------------|----------------------------|
|          | ROPE <sup>1</sup>         | CONDUCTOR |                         | BALE (DIM. A)   | MESH (DIM. M) |            |                            |
| L8660    | 0.25–0.65                 | 0.19–0.37 | 6,500                   | 10              | 24            | Black      | .218                       |
| L8661    | 0.50–0.90                 | 0.38–0.62 | 14,000                  | 13              | 26            | Dk. Green  | .375                       |
| L8662    | 0.75–1.10                 | 0.63–0.87 | 20,000                  | 14              | 48            | Red        | .437                       |
| L8663    | 1.00–1.50                 | 0.88–1.12 | 30,600                  | 15              | 60            | Dk. Blue   | .500                       |
| L8664    | 1.25–1.70                 | 1.13–1.37 | 46,800                  | 18              | 76            | Yellow     | .625                       |
| L8665    | 1.50–2.10                 | 1.38–1.90 | 66,500                  | 24              | 89            | Aluminum   | .750                       |

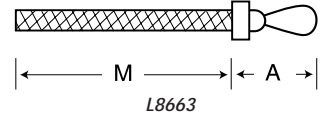

<sup>1</sup>For rope, select smallest size grip which meets required workload.

\*To determine workload safety factor, divide approximate break strength by 5. See page Q6 for strength information.

**Recommended Rope Assembly Using High Strength Feed Tube**

- 1) Insert feed tube into High Strength Pulling Grip.
- 2) Insert rope end fully into feed tube.
- 3) Hold rope in feed tube by pinning rope to the ground with end of tube. Pull mesh down onto feed so feed tube nose is protruding through shoulder protectors as shown.
- 4) Push mesh to end of feed tube and pull feed tube through mesh. When tube is pulled, the mesh gripping action will hold rope in place.
- 5) Position rope so that its end is inside the shoulder protectors. Remove slack from mesh by smoothing mesh tight to rope.
- 6) Apply clamps to mesh end.

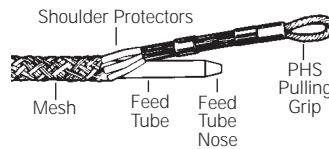

**Split-Lace/Split-Rod Attachments (for use where end of cable is not accessible—applies to slack grips only)**

Beginning at the end of the grip closest to the bale fitting, thread the lacing through the first two loops of the split, pulling the lace through until the ends are centered evenly. Cross the laces and thread them through the next two loops, and so on down the grip, being careful not to pull the lacing too tight.

Spacing of the laced closure should be approximately the same as the mesh weave. When the end of grip is reached, twist the lacing strands tightly together, wrapping the ends of the lace around the grip, and twisting again to secure. Excess length may be cut off.

Split grips with rod closing are economical, since they are quickly installed, and are reusable. Simply wrap the grip around the cable and thread the rod through the loops, using a corkscrew motion. To remove, pull the rod out, and the grip is ready for re-use.

**Split-Lace**

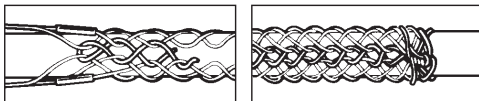

**Split-Rod**





## WIRE MESH PULLING GRIPS

### Industrial Grade Wire Mesh Safety Grips

#### PULLING GRIPS—SLACK GRIPS

*Slack Grips are reusable grips used for pulling slack in underground cable preparatory to final placement. They may also be used for cable removal. Slack Grips feature an offset eye for easy attachment to the pulling line. See attachment information for split lace and split rod on page Q13.*



L8671

#### Pulling Grips—Slack Grips Series

##### Closed Mesh, Double Weave, Offset Eye, Heavy Duty, Medium

| CAT. NO. | CABLE DIA. RANGE (INCHES) | APPROXIMATE BREAK STRENGTH* | MESH LENGTH (INCHES) |
|----------|---------------------------|-----------------------------|----------------------|
| L8671    | 0.75-0.99                 | 3,000                       | 13                   |
| L8672    | 1.00-1.24                 | 4,200                       | 16                   |
| L8673    | 1.25-1.49                 | 5,500                       | 17                   |
| L8674    | 1.50-1.74                 | 7,400                       | 18                   |
| L8675    | 1.75-1.99                 | 11,000                      | 19                   |
| L8676    | 2.00-2.49                 | 11,000                      | 20                   |
| L8677    | 2.50-2.99                 | 11,000                      | 21                   |
| L8678    | 3.00-3.49                 | 16,000                      | 22                   |
| L8679    | 3.50-3.99                 | 16,000                      | 23                   |

##### Closed Mesh, Double Weave, Offset Eye, Heavy Duty, Long

|       |           |        |    |
|-------|-----------|--------|----|
| L8681 | 0.75-0.99 | 3,000  | 21 |
| L8682 | 1.00-1.24 | 5,500  | 21 |
| L8683 | 1.25-1.49 | 5,500  | 24 |
| L8684 | 1.50-1.99 | 7,400  | 26 |
| L8685 | 2.00-2.49 | 11,000 | 27 |
| L8686 | 2.50-2.99 | 11,000 | 30 |
| L8687 | 3.00-3.49 | 16,000 | 33 |
| L8688 | 3.50-3.99 | 16,000 | 36 |

##### Split Lace, Double Weave, Offset Eye, Heavy Duty, Medium

| CAT. NO. | CABLE DIA. RANGE (INCHES) | APPROXIMATE BREAK STRENGTH* | MESH LENGTH (INCHES) |
|----------|---------------------------|-----------------------------|----------------------|
| L8691    | 0.75-0.99                 | 3,000                       | 13                   |
| L8692    | 1.00-1.24                 | 4,100                       | 16                   |
| L8693    | 1.25-1.49                 | 4,100                       | 17                   |
| L8694    | 1.50-1.74                 | 5,500                       | 18                   |
| L8695    | 1.75-1.99                 | 7,300                       | 19                   |
| L8696    | 2.00-2.49                 | 7,300                       | 20                   |
| L8697    | 2.50-2.99                 | 7,300                       | 21                   |
| L8698    | 3.00-3.49                 | 9,200                       | 22                   |
| L8699    | 3.50-3.99                 | 11,000                      | 23                   |

##### Split Lace, Double Weave, Offset Eye, Heavy Duty, Long

|       |           |        |    |
|-------|-----------|--------|----|
| L8701 | 0.75-0.99 | 3,000  | 21 |
| L8702 | 1.00-1.24 | 4,100  | 21 |
| L8703 | 1.25-1.49 | 4,100  | 24 |
| L8704 | 1.50-1.99 | 5,500  | 25 |
| L8705 | 2.00-2.49 | 7,300  | 27 |
| L8706 | 2.50-2.99 | 7,300  | 30 |
| L8707 | 3.00-3.49 | 9,200  | 33 |
| L8708 | 3.50-3.99 | 11,000 | 36 |

##### Split Rod, Single Weave, Offset Eye, Heavy Duty, Medium

|       |           |        |    |
|-------|-----------|--------|----|
| L8711 | 0.50-0.61 | 1,800  | 7  |
| L8712 | 0.62-0.74 | 1,900  | 9  |
| L8713 | 0.75-0.99 | 3,000  | 11 |
| L8714 | 1.00-1.24 | 4,100  | 12 |
| L8715 | 1.25-1.49 | 5,700  | 14 |
| L8716 | 1.50-1.74 | 5,800  | 16 |
| L8717 | 1.75-1.99 | 7,700  | 17 |
| L8718 | 2.00-2.49 | 9,300  | 20 |
| L8719 | 2.50-2.99 | 11,300 | 21 |
| L8721 | 3.00-3.49 | 15,100 | 22 |
| L8722 | 3.50-3.99 | 15,100 | 25 |

\*To determine workload safety factor, divide approximate break strength by 5. See page Q6 for strength information.



L8703



L8711

# WIRE MESH STRAIN-RELIEF GRIPS

## Industrial Grade Wire Mesh Safety Grips

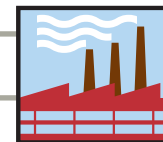

### STRAIN-RELIEF GRIPS

Strain-Relief Grips are used to connect cord or cable to electrical enclosures and equipment. These grips prevent pullout due to tension and limit the arc of bend at the point of entry; strain is distributed over the length of mesh rather than concentrated at one point or transferred to the internal termination.

### Wide-Range Grips

Wide-Range Grips are recommended for use in wiring of enclosures, power boxes, machine tools, and power centers. They include an insulated bushing (dust-tight).

#### Single Weave Galvanized Steel Mesh

| CAT. NO. | CABLE DIA. RANGE (INCHES) | NPT SIZE (INCHES) | MESH LENGTH @ NOMINAL DIA. (INCHES) | MINIMUM DISTANCE BETWEEN GRIPS (INCHES) |
|----------|---------------------------|-------------------|-------------------------------------|---|
| L7501    | 0.22–0.32                 | 1/2               | 4                                   | 1 1/4                                   |
| L7502    | 0.30–0.43                 | 1/2               | 4 1/2                               | 1 1/4                                   |
| L7503    | 0.40–0.54                 | 1/2               | 5 1/2                               | 1 1/4                                   |
| L7504    | 0.52–0.73                 | 3/4               | 5 1/2                               | 1 1/2                                   |
| L7505    | 0.70–0.97                 | 1                 | 8                                   | 1 7/8                                   |
| L7506    | 0.94–1.25                 | 1 1/4             | 9                                   | 2 3/8                                   |
| L7507    | 1.20–1.50                 | 1 1/2             | 11                                  | 2 5/8                                   |
| L7508    | 1.40–1.75                 | 2                 | 13                                  | 3 1/4                                   |
| L7509    | 1.62–2.00                 | 2 1/2             | 13 1/2                              | 3 5/8                                   |
| L7511    | 2.00–2.45                 | 2 1/2             | 13 1/2                              | 3 5/8                                   |



L7504  
Galva. Steel mesh

### Cord Sealing Grips

Cord Sealing Grips with Mesh are nylon devices used to connect electrical cables to boxes, cabinets, push-buttons, enclosures, etc. They are liquid-tight devices that are highly resistant to impact and corrosion. Non-metallic cord sealing grips will not support combustion. The ratings are: Wire Mesh Grip-94 HB and Fitting-94V-2. Cord Sealing Grip products are suitable for use in wet locations so long as a listed sealing ring is used between the box and the fitting.

#### Nylon Cord Sealing Grips with Mesh—Straight and 90°

| CAT. NOS.          | STAINLESS STEEL MESH |       | NON-METALLIC MESH |            | CABLE DIA. RANGE (INCHES) | NPT (FORM SIZE) |
|--------------------|----------------------|-------|-------------------|------------|---------------------------|-----------------|
|                    | STRAIGHT             | 90°   | STRAIGHT          | 90°        |                           |                 |
| L7521              | —                    | L7522 | L7524             | .187–.250  |                           |                 |
| —                  | L7527                | —     | L7528             | .250–.312  |                           |                 |
| —                  | L7532                | —     | L7533             | .312–.375  | 1/2"                      |                 |
| —                  | L7536                | —     | —                 | .375–.437  | (F2)                      |                 |
| L7538              | L7541                | L7539 | L7542             | .437–.500  |                           |                 |
| L7543 <sup>1</sup> | L7544 <sup>1</sup>   | —     | —                 | .500–.562  |                           |                 |
| L7545 <sup>1</sup> | L7546 <sup>1</sup>   | —     | —                 | .562–.625  |                           |                 |
| L7601              | —                    | L7602 | L7604             | .187–.250  |                           |                 |
| L7605              | —                    | —     | —                 | .250–.375  |                           |                 |
| —                  | L7612                | —     | —                 | .375–.437  |                           |                 |
| —                  | L7549                | —     | L7551             | .437–.562  | 3/4"                      |                 |
| L7552              | L7554                | L7553 | L7555             | .500–.625  | (F3)                      |                 |
| L7556              | L7558                | —     | L7559             | .562–.687  |                           |                 |
| L7561              | L7563                | L7562 | —                 | .625–.750  |                           |                 |
| L7565 <sup>1</sup> | L7566 <sup>1</sup>   | —     | —                 | .687–.812  |                           |                 |
| L7567              | —                    | L7568 | L7569             | .437–.562  |                           |                 |
| —                  | L7573                | —     | L7574             | .500–.625  |                           |                 |
| —                  | L7582                | —     | L7583             | .625–.750  | 1"                        |                 |
| L7584              | —                    | —     | L7587             | .687–.812  | (F4)                      |                 |
| L7588              | —                    | —     | L7592             | .750–.875  |                           |                 |
| L7597              | —                    | —     | —                 | .875–1.000 |                           |                 |



L7521  
Straight—SS mesh



L7527  
90°—SS mesh

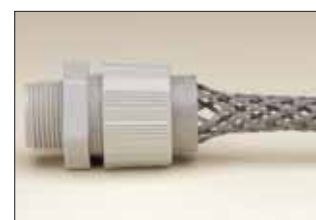

L7553  
Straight—nylon mesh

<sup>1</sup>Cable jacket may have to be stripped for clearance. NOTE: F2, F3 and F4 are fitting form sizes.

\*Cord Sealing Grips with non-metallic mesh are UL Listed and CSA Certified. Cord Sealing Grips with stainless steel mesh are CSA Certified only.

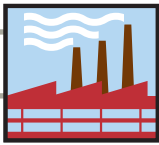

# WIRE MESH STRAIN-RELIEF GRIP DIMENSIONS

## Industrial Grade Wire Mesh Safety Grips

### Strain-Relief Grips—Dimensions

#### Dimensions for Nylon Cord-Sealing Fittings, Straight Body

| FORM | NPT    | A     | B     | C    | D    | E     | F     | G     | H (REF.) |
|------|--------|-------|-------|------|------|-------|-------|-------|----------|
| 0    | 1/4"   | .500  | .778  | .370 | .187 | .921  | .778  | .687  | 1.25     |
| 1    | 3/8"   | 1.000 | 1.150 | .500 | .250 | 1.250 | 1.115 | 1.000 | 1.85     |
| 2    | 1/2"   | 1.000 | 1.300 | .500 | .300 | 1.450 | 1.250 | 1.100 | 2.00     |
| 3    | 3/4"   | 1.000 | 1.500 | .550 | .375 | 1.700 | 1.578 | 1.375 | 2.00     |
| 4    | 1"     | 1.000 | 1.850 | .687 | .375 | 1.800 | 1.900 | 1.650 | 2.12     |
| 5    | 1 1/4" | 1.000 | 2.050 | .687 | .375 | 1.800 | 2.100 | 1.850 | 2.12     |

Form 0

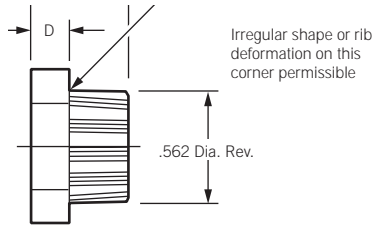

Forms 1-5

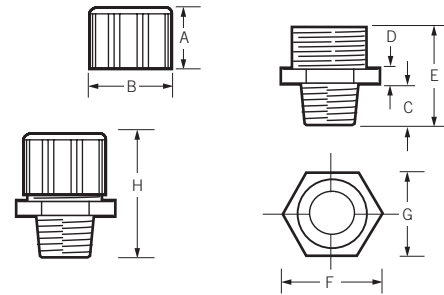

#### Dimensions for Nylon Cord-Sealing Fittings, 90° Body

| FORM | NPT    | A     | B     | C     | D    | E     | F    | G     | H (REF.) |
|------|--------|-------|-------|-------|------|-------|------|-------|----------|
| 1    | 3/8"   | 1.000 | 1.150 | 1.100 | .187 | 1.812 | .450 | 1.687 | 2.35     |
| 2    | 1/2"   | 1.000 | 1.300 | 1.165 | .187 | 1.900 | .578 | 1.820 | 2.40     |
| 3    | 3/4"   | 1.000 | 1.500 | 1.600 | .187 | 2.421 | .593 | 2.218 | 2.75     |
| 4    | 1"     | 1.000 | 1.850 | 1.850 | .187 | 2.656 | .800 | 2.700 | 3.00     |
| 5    | 1 1/4" | 1.000 | 2.050 | 1.965 | .187 | 2.859 | .750 | 2.812 | 3.25     |

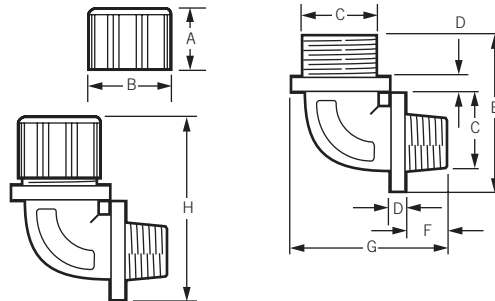

# WIRE MESH STRAIN-RELIEF GRIPS

## Industrial Grade Wire Mesh Safety Grips

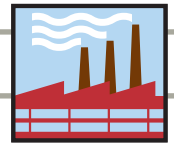

### Deluxe Cord Grips

Deluxe Cord Grips are woven of stainless steel mesh with an anodized aluminum body for corrosion resistance. They are offered in Single/Double Weave construction to help absorb direct pull, resist flexing and binding, and eliminate strain. Aluminum fittings are offered in a variety of NPT thread sizes. They are recommended for indoor or outdoor use where moisture may be present in the wiring of pendant stations, processing equipment, hand tools, and extension cord sets. They are UL Listed and CSA Certified. Deluxe Cord Grips are suitable for use in hazardous locations per Class I, Div. 2; Class II, Div. 1 and 2; and Class III, Div. 1 and 2. They are also suitable for use in wet locations as long as a listed sealing ring is used between the box and the fitting.

#### Single/Double Weave

| CAT. NOS.<br>STRAIGHT<br>MALE | 90° MALE | 45° MALE | STRAIGHT<br>FEMALE | CABLE. DIA.<br>RANGE<br>(INCHES) | NPT<br>SIZE |
|-------------------------------|----------|----------|--------------------|----------------------------------|-------------|
| L7701                         | —        | —        | —                  | .187-.250                        |             |
| L7702                         | —        | —        | —                  | .250-.312                        |             |
| L7703                         | —        | —        | L7822              | .312-.375                        | 3/8"        |
| L7704                         | —        | —        | —                  | .375-.437                        |             |
| L7705                         | L7761    | —        | —                  | .187-.250                        |             |
| L7706                         | —        | L7802    | —                  | .250-.375                        |             |
| L7707                         | L7763    | L7803    | L7826              | .375-.500                        | 1/2"        |
| L7708                         | L7764    | L7804    | L7827              | .500-.625                        |             |
| L7709                         | —        | —        | —                  | .625-.750                        |             |
| L7711                         | L7765    | L7805    | —                  | .250-.375                        |             |
| L7712                         | —        | L7806    | —                  | .375-.500                        |             |
| L7700                         | L7767    | L7807    | L7831              | .500-.625                        | 3/4"        |
| L7713                         | L7768    | L7808    | L7832              | .625-.750                        |             |
| L7714                         | —        | —        | —                  | .750-.875                        |             |
| L7715                         | L7769    | —        | —                  | .437-.562                        |             |
| L7716                         | —        | —        | L7833              | .562-.687                        |             |
| L7717                         | L7772    | —        | L7834              | .625-.750                        | 1"          |
| L7718                         | —        | —        | —                  | .750-.875                        |             |
| L7719                         | —        | —        | L7836              | .875-1.000                       |             |
| L7721                         | —        | —        | —                  | 1.000-1.125                      |             |
| L7722                         | —        | —        | —                  | 1.125-1.250                      |             |
| L7723                         | —        | —        | —                  | .750-.875                        |             |
| L7724                         | —        | —        | —                  | .875-1.000                       |             |
| L7725                         | —        | L7810    | —                  | 1.000-1.125                      | 1 1/4"      |
| L7726                         | L7778    | —        | —                  | 1.125-1.250                      |             |
| L7727                         | —        | L7820    | —                  | 1.250-1.375                      |             |
| L7728                         | L7781    | —        | —                  | .750-.875                        |             |
| L7729                         | L7782    | —        | —                  | .875-1.000                       |             |
| L7731                         | —        | —        | —                  | 1.000-1.125                      | 1 1/2"      |
| L7732                         | L7784    | —        | —                  | 1.125-1.250                      |             |
| L7733                         | L7785    | —        | —                  | 1.250-1.375                      |             |
| L8011                         | —        | —        | —                  | 1.312-1.437                      |             |
| L7770                         | —        | —        | —                  | 1.437-1.562                      |             |
| L7750                         | —        | —        | —                  | 1.562-1.687                      |             |
| L7760                         | —        | —        | —                  | 1.687-1.812                      |             |
| L7780                         | —        | —        | —                  | 1.750-1.875                      |             |
| L7734                         | —        | —        | —                  | 1.250-1.375                      |             |
| L7736                         | —        | —        | —                  | 1.500-1.625                      | 2"          |
| L7737                         | L7789    | —        | —                  | 1.625-1.750                      |             |
| —                             | L7791    | —        | —                  | 1.750-1.875                      |             |
| L8012                         | —        | —        | —                  | 1.812-1.937                      |             |
| L8013                         | —        | —        | —                  | 1.937-2.062                      |             |
| L7730                         | —        | —        | —                  | 2.187-2.312                      |             |
| L7739                         | —        | —        | —                  | 1.75-1.875                       |             |
| L7742                         | —        | —        | —                  | 1.937-2.062                      | 2-1/2"      |
| L7743                         | —        | —        | —                  | 2.062-2.187                      |             |
| L7744                         | —        | —        | —                  | 2.187-2.312                      |             |
| L7745                         | —        | —        | —                  | 1.688-1.812                      | 3"          |
| L7746                         | —        | —        | —                  | 1.812-1.937                      |             |
| L7747                         | —        | —        | —                  | 1.937-2.062                      |             |
| L7748                         | —        | —        | —                  | 2.062-2.187                      |             |
| L7751                         | —        | —        | —                  | 2.312-2.437                      |             |
| L7752                         | —        | —        | —                  | 2.437-2.625                      |             |
| L7754                         | —        | —        | —                  | 2.812-3.000                      |             |
| L7755                         | —        | —        | —                  | 3.000-3.250                      |             |



**L7701**  
Straight—Male



**L7761**  
90°—Male



**L7802**  
45°—Male



**L7822**  
Straight—Female

Wire Mesh Safety Grips

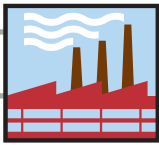

# WIRE MESH STRAIN-RELIEF GRIPS

## Industrial Grade Wire Mesh Safety Grips



**L7902**  
Straight—Male



**L7922**  
90°—Male



**L7951**  
Straight—Female



**L7990**  
90°—Male



**L7965**  
Straight—Male

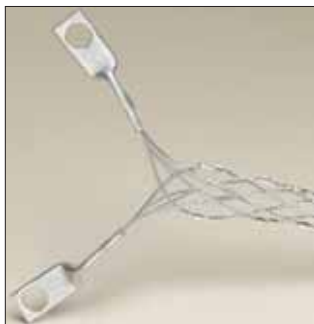

**L8003**

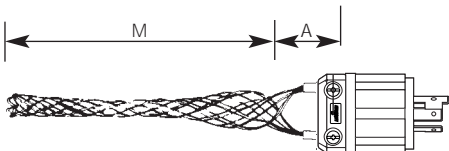

### Liquid-Tight Grips

Liquid-Tight Grips are woven stainless steel mesh with an anodized aluminum body for corrosion-resistance. They are used to connect liquid-tight flexible metal conduit to electrical enclosures to prevent conduit pullout. Each fitting is supplied with an insulated throat to ensure conductor insulation and protect against damage caused by flexing, heat expansion or contraction.

Liquid-Tight Grips are recommended in the wiring of motors and any electrical enclosure where liquid-tight conduit is subject to motion or strain. UL Listed and CSA Certified.

#### Liquid-Tight Grips

| CAT. NOS.<br>STRAIGHT<br>MALE | 90° MALE | 45° MALE | STRAIGHT<br>FEMALE | FITTING<br>SIZE<br>(INCHES)   | MESH<br>LENGTH<br>(INCHES)     |
|-------------------------------|----------|----------|--------------------|-------------------------------|--------------------------------|
| —                             | —        | L7931    | L7951              | 3/8                           | 2 <sup>5</sup> / <sub>8</sub>  |
| L7902                         | L7916    | L7932    | —                  | 1/2                           | 3 <sup>7</sup> / <sub>8</sub>  |
| L7903                         | L7917    | —        | L7953              | 3/4                           | 4 <sup>3</sup> / <sub>8</sub>  |
| L7904                         | L7918    | —        | L7954              | 1                             | 5 <sup>1</sup> / <sub>4</sub>  |
| L7905                         | L7919    | —        | —                  | 1 <sup>1</sup> / <sub>4</sub> | 5 <sup>5</sup> / <sub>8</sub>  |
| L7906                         | L7921    | —        | —                  | 1 <sup>1</sup> / <sub>2</sub> | 5 <sup>3</sup> / <sub>4</sub>  |
| L7907                         | L7922    | —        | —                  | 2                             | 7 <sup>1</sup> / <sub>2</sub>  |
| L7908                         | —        | —        | —                  | 2 <sup>1</sup> / <sub>2</sub> | 9 <sup>5</sup> / <sub>8</sub>  |
| L7911                         | L7924    | L7939    | —                  | 3                             | 10 <sup>5</sup> / <sub>8</sub> |
| L7912                         | —        | —        | —                  | 4                             | 12                             |

#### Liquid-Tight Grips for Non-Metallic Type "A" Flexible Conduit

| CAT. NOS.<br>STRAIGHT<br>MALE | 90° MALE | FITTING<br>SIZE<br>(INCHES)   | MESH<br>LENGTH<br>(INCHES)     |
|-------------------------------|----------|-------------------------------|--------------------------------|
| —                             | L7999    | 3/8                           | 9                              |
| L7962                         | L7990    | 1/2                           | 10                             |
| —                             | L7967    | 3/4                           | 10 <sup>1</sup> / <sub>2</sub> |
| —                             | L7968    | 1                             | 12                             |
| L7965                         | L7969    | 1 <sup>1</sup> / <sub>4</sub> | 17                             |
| —                             | L7971    | 1 <sup>1</sup> / <sub>2</sub> | 21 <sup>1</sup> / <sub>2</sub> |
| L7970                         | L7972    | 2                             | 24                             |

### Connection Wire Mesh Grips

Connection Wire Mesh Grips provide additional strain-relief for plugs and connectors used on portable equipment in commercial and institutional applications, and industrial plant and construction site areas which incur abnormally high abuse. Grips are made of galvanized steel.

#### Connection Wire Mesh Grips

| CAT NO. | CABLE DIA.<br>RANGE<br>(INCHES) | EYE<br>DIMENSIONS (A)<br>(INCHES) | MESH<br>LENGTH (M)<br>(INCHES) |
|---------|---------------------------------|-----------------------------------|--------------------------------|
| L8001   | .30-.43                         | 1 <sup>1</sup> / <sub>16</sub>    | 4 <sup>3</sup> / <sub>4</sub>  |
| L8002   | .40-.56                         | 1 <sup>1</sup> / <sub>16</sub>    | 6                              |
| L8003   | .52-.73                         | 1 <sup>1</sup> / <sub>16</sub>    | 7                              |
| L8004   | .70-.85                         | 1 <sup>5</sup> / <sub>16</sub>    | 8 <sup>1</sup> / <sub>2</sub>  |
| L8005   | .82-1.00                        | 1 <sup>5</sup> / <sub>16</sub>    | 8 <sup>1</sup> / <sub>2</sub>  |
| L8006   | .94-1.25                        | 1 <sup>5</sup> / <sub>16</sub>    | 10 <sup>1</sup> / <sub>2</sub> |



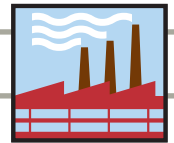

Industrial Grade Wire Mesh Safety Grips

**SUPPORT GRIPS**

Support Grips are designed to hold the weight of cable on vertical or sloping runs. They may be used indoors or outdoors to support electrical and fiber optic cable, metal rods and tubing.

Leviton Support Grips are woven with tinned bronze wire. For applications requiring a greater degree of corrosion resistance, stainless steel wire is available on special order. For information regarding selection of the proper-sized support grip, see pages Q4 and Q5.

**Style**

**SINGLE "U" EYE**

For use when cable is vertical and for applications where cable bends or where a single attachment is more advantageous for positioning.

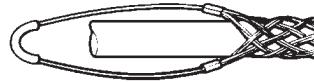

**DOUBLE "U" EYE**

For use when cable is vertical and extends through the grip without bending. Eyes may be fastened to open hooks, but should not be more than 15° from the axis of vertical cable. When eyes are supported equally, this attachment offers a fully balanced load.

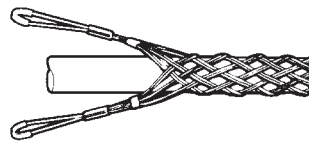

**OFFSET EYE**

Similar to single eye applications, but for use when offset positioning is required.

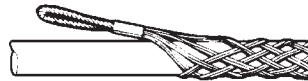

**LOCKING (UNIVERSAL) BALE**

Adjustable and self-locking, this attachment fits around a beam, pipe or other continuous structural object. The bale wraps around the object and is securely anchored in the bar.



**Split Lace/Split Rod**

**SPLIT LACE**

Beginning at the lead end of the grip, thread the lacing through the first two loops of the split, pulling the lace through until the ends are centered evenly. Cross laces and thread through the next two loops, and so on down the grip, being careful not to pull the lacing too tight. The spacing of the lace closure should be approximately the same as that of the mesh weave. When the end of grip is reached, twist the lacing strands tightly together; wrap the ends of the lace around the grip and twist again to secure. Excess length may be cut off.

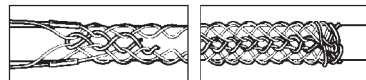

**SPLIT ROD**

Split grips with rod closing install quickly and they are economical and reusable. Simply wrap the grip around the cable and thread the rod through the loops, using a corkscrew motion. To remove, pull the rod out; and the grip is ready for re-use.

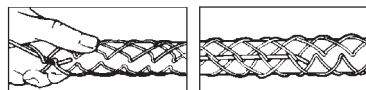

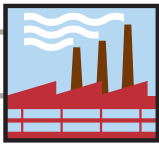

# WIRE MESH SUPPORT GRIPS

## Industrial Grade Wire Mesh Safety Grips

### Support Grips—Standard Closed Mesh

Standard Closed Mesh Support Grips are designed for loads up to 500 lbs. and vertical runs of no more than 100 feet. Heavy-duty closed mesh support grips are designed for loads in excess of 500 lbs. They are available in a variety of eye styles and cable ranges for supporting electrical cable, metal rods and tubing. Closed mesh support grips are used when the end of the cable is accessible. Mesh is made of tinned bronze material.

#### Single Eye, Closed Mesh, Single Weave

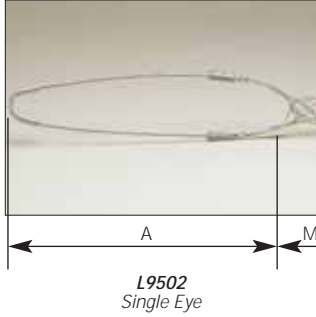

| CAT. NO. | CABLE DIA. RANGE (INCHES) | APPROX. BREAK STRENGTH* | LENGTH (INCHES) |               |
|----------|---------------------------|-------------------------|-----------------|---------------|
|          |                           |                         | BALE (DIM. A)   | MESH (DIM. M) |
| L9501    | 0.50-0.61                 | 770                     | 7               | 10            |
| L9502    | 0.62-0.74                 | 960                     | 8               | 10            |
| L9503    | 0.75-0.99                 | 1,300                   | 8               | 12            |
| L9504    | 1.00-1.24                 | 1,680                   | 9               | 12            |
| L9505    | 1.25-1.49                 | 1,680                   | 10              | 16            |
| L9506    | 1.50-1.74                 | 1,680                   | 12              | 17            |
| L9507    | 1.75-1.99                 | 2,640                   | 14              | 18            |
| L9508    | 2.00-2.49                 | 3,760                   | 16              | 18            |
| L9509    | 2.50-2.99                 | 3,760                   | 18              | 21            |
| L9511    | 3.00-3.49                 | 5,040                   | 21              | 26            |
| L9512    | 3.50-3.99                 | 5,040                   | 24              | 28            |

#### Double Eye, Closed Mesh, Single Weave

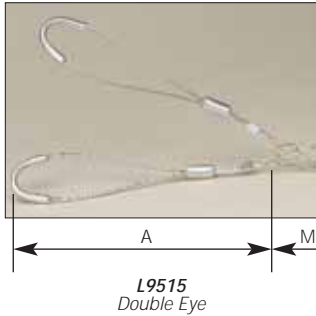

| CAT. NO. | CABLE DIA. RANGE (INCHES) | APPROX. BREAK STRENGTH* | LENGTH (INCHES) |               |
|----------|---------------------------|-------------------------|-----------------|---------------|
|          |                           |                         | BALE (DIM. A)   | MESH (DIM. M) |
| L9515    | 0.50-0.61                 | 770                     | 4               | 11            |
| L9516    | 0.62-0.74                 | 1,150                   | 4               | 11            |
| L9517    | 0.75-0.99                 | 1,320                   | 4               | 14            |
| L9518    | 1.00-1.24                 | 1,920                   | 5               | 15            |
| L9519    | 1.25-1.49                 | 1,920                   | 5               | 16            |
| L9521    | 1.50-1.74                 | 1,920                   | 6               | 18            |
| L9523    | 1.75-1.99                 | 3,360                   | 6               | 20            |
| L9524    | 2.00-2.49                 | 3,360                   | 6               | 22            |
| L9525    | 2.50-2.99                 | 3,360                   | 6               | 24            |
| L9526    | 3.00-3.49                 | 5,280                   | 8               | 26            |
| L9527    | 3.50-3.99                 | 5,280                   | 8               | 28            |

#### Offset Eye, Closed Mesh, Single Weave

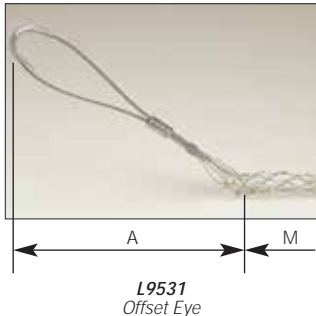

| CAT. NO. | CABLE DIA. RANGE (INCHES) | APPROX. BREAK STRENGTH* | LENGTH (INCHES) |               |
|----------|---------------------------|-------------------------|-----------------|---------------|
|          |                           |                         | BALE (DIM. A)   | MESH (DIM. M) |
| L9531    | 0.50-0.61                 | 770                     | 4               | 11            |
| L9532    | 0.62-0.74                 | 960                     | 4               | 11            |
| L9533    | 0.75-0.99                 | 960                     | 4               | 14            |
| L9534    | 1.00-1.24                 | 1,680                   | 5               | 15            |
| L9535    | 1.25-1.49                 | 1,680                   | 5               | 16            |
| L9536    | 1.50-1.74                 | 1,680                   | 5               | 18            |
| L9537    | 1.75-1.99                 | 2,640                   | 6               | 20            |
| L9538    | 2.00-2.49                 | 3,760                   | 6               | 21            |
| L9539    | 2.50-2.99                 | 3,760                   | 8               | 24            |
| L9541    | 3.00-3.49                 | 5,040                   | 9               | 26            |
| L9542    | 3.50-3.99                 | 5,040                   | 9               | 28            |

Note: Support grips are also available in stainless steel—contact your Leviton Representative.

\*To determine workload safety factor, divide approximate break strength by 10. See page Q6 for strength information.

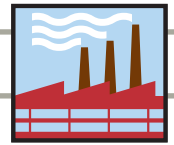

**Support Grips—Standard Closed Mesh**

**Locking Bale, Closed Mesh, Single Weave**

| CAT. NO. | CABLE DIA. RANGE (INCHES) | APPROX. BREAK STRENGTH* | LENGTH (INCHES) |               |
|----------|---------------------------|-------------------------|-----------------|---------------|
|          |                           |                         | BALE (DIM. A)   | MESH (DIM. M) |
| L9551    | 0.50–0.61                 | 770                     | 11              | 10            |
| L9552    | 0.62–0.74                 | 1,150                   | 11              | 10            |
| L9553    | 0.75–0.99                 | 1,320                   | 14              | 12            |
| L9554    | 1.00–1.24                 | 1,920                   | 15              | 12            |
| L9555    | 1.25–1.49                 | 1,920                   | 16              | 13            |
| L9556    | 1.50–1.74                 | 1,920                   | 18              | 17            |
| L9557    | 1.75–1.99                 | 3,150                   | 20              | 18            |
| L9558    | 2.00–2.49                 | 3,360                   | 21              | 18            |
| L9559    | 2.50–2.99                 | 3,360                   | 24              | 21            |
| L9561    | 3.00–3.49                 | 5,280                   | 26              | 23            |
| L9562    | 3.50–3.99                 | 5,280                   | 28              | 23.5          |

\*To determine workload safety factor, divide approximate break strength by 10. See page Q6 for strength information.

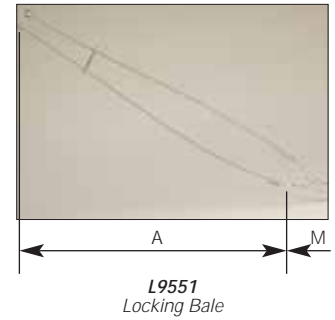

**Support Grips—Heavy Duty**

Heavy Duty Support Grips handle continuous loads of over 500 lbs. in vertical runs greater than 100 ft. for cable diameters from 3/4" to 4 1/2".

**Single Eye, Double Weave, Heavy Long, Closed Mesh**

| CAT. NO. | CABLE DIA. RANGE (INCHES) | APPROX. BREAK STRENGTH* | LENGTH (INCHES) |               |
|----------|---------------------------|-------------------------|-----------------|---------------|
|          |                           |                         | BALE (DIM. A)   | MESH (DIM. M) |
| L9701    | 0.75–0.99                 | 2,700                   | 10              | 26            |
| L9702    | 1.00–1.24                 | 4,720                   | 10              | 29            |
| L9703    | 1.25–1.49                 | 4,720                   | 10              | 31            |
| L9704    | 1.50–1.99                 | 4,720                   | 10              | 35            |

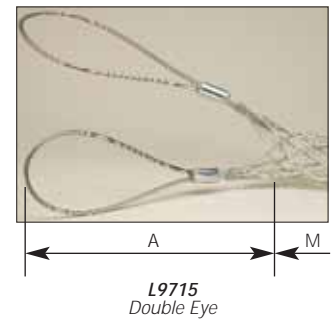

**Double Eye, Double Weave, Heavy Long, Closed Mesh**

| CAT. NO. | CABLE DIA. RANGE (INCHES) | APPROX. BREAK STRENGTH* | LENGTH (INCHES) |               |
|----------|---------------------------|-------------------------|-----------------|---------------|
|          |                           |                         | BALE (DIM. A)   | MESH (DIM. M) |
| L9711    | 0.75–0.99                 | 2,700                   | 10              | 26            |
| L9712    | 1.00–1.25                 | 4,720                   | 10              | 29            |
| L9713    | 1.25–1.49                 | 4,720                   | 10              | 31            |
| L9714    | 1.50–1.99                 | 4,720                   | 10              | 35            |
| L9715    | 2.00–2.49                 | 10,080                  | 10              | 37            |
| L9716    | 2.50–2.99                 | 10,080                  | 10              | 39            |
| L9717    | 3.00–3.49                 | 10,080                  | 10              | 41            |
| L9718    | 3.50–3.99                 | 13,120                  | 10              | 45            |
| L9719    | 4.00–4.49                 | 13,120                  | 10              | 47            |

\*To determine workload safety factor, divide approximate break strength by 10. See page Q6 for strength information.



# WIRE MESH SUPPORT GRIPS

## Industrial Grade Wire Mesh Safety Grips

### Support Grips—Standard Split Lace

Split Lace Support Grips are designed for loads up to 500 lbs. and vertical runs of no more than 100 feet. Heavy-duty split lace support grips are available on page Q23. They are available in a variety of eye styles and cable ranges for supporting electrical cable, metal rods and tubing. Split lace grips are utilized when the end of the cable cannot be feasibly accessed and the support grip is intended for permanent installation. Mesh is made of tinned bronze material. For attachment information see page Q19.

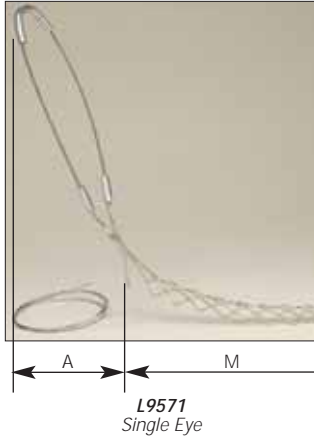

#### Single Eye, Split Lace, Single Weave

| CAT. NO. | CABLE DIA. RANGE (INCHES) | APPROX. BREAK STRENGTH* | LENGTH (INCHES) |               |
|----------|---------------------------|-------------------------|-----------------|---------------|
|          |                           |                         | BALE (DIM. A)   | MESH (DIM. M) |
| L9571    | 0.50-0.61                 | 770                     | 7               | 11            |
| L9572    | 0.62-0.74                 | 960                     | 8               | 11            |
| L9573    | 0.75-0.99                 | 1,320                   | 8               | 14            |
| L9574    | 1.00-1.24                 | 1,680                   | 9               | 15            |
| L9575    | 1.25-1.49                 | 1,680                   | 10              | 16            |
| L9576    | 1.50-1.74                 | 1,680                   | 12              | 18            |
| L9577    | 1.75-1.99                 | 2,640                   | 14              | 20            |
| L9578    | 2.00-2.49                 | 3,760                   | 16              | 22            |
| L9579    | 2.50-2.99                 | 3,760                   | 18              | 24            |
| L9581    | 3.00-3.49                 | 5,040                   | 21              | 26            |
| L9582    | 3.50-3.99                 | 5,040                   | 24              | 28            |

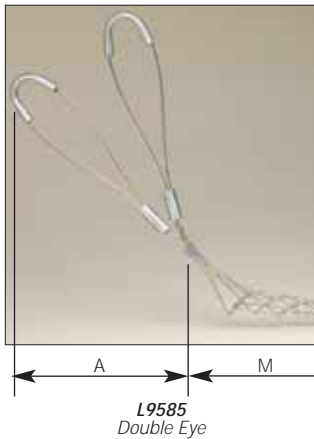

#### Double Eye, Split Lace, Single Weave

| CAT. NO. | CABLE DIA. RANGE (INCHES) | APPROX. BREAK STRENGTH* | LENGTH (INCHES) |               |
|----------|---------------------------|-------------------------|-----------------|---------------|
|          |                           |                         | BALE (DIM. A)   | MESH (DIM. M) |
| L9585    | 0.50-0.61                 | 770                     | 4               | 11            |
| L9586    | 0.62-0.74                 | 1,150                   | 4               | 11            |
| L9587    | 0.75-0.99                 | 1,320                   | 4               | 14            |
| L9588    | 1.00-1.24                 | 1,920                   | 5               | 15            |
| L9589    | 1.25-1.49                 | 1,920                   | 5               | 16            |
| L9591    | 1.50-1.74                 | 1,920                   | 5               | 18            |
| L9592    | 1.75-1.99                 | 3,150                   | 6               | 20            |
| L9593    | 2.00-2.49                 | 3,360                   | 6               | 22            |
| L9594    | 2.50-2.99                 | 3,360                   | 6               | 24            |
| L9595    | 3.00-3.49                 | 5,280                   | 8               | 26            |
| L9596    | 3.50-3.99                 | 5,280                   | 8               | 28            |

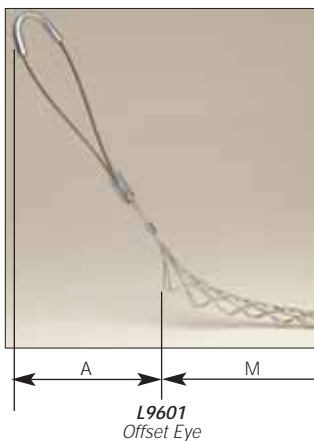

#### Offset Eye, Split Lace, Single Weave

| CAT. NO. | CABLE DIA. RANGE (INCHES) | APPROX. BREAK STRENGTH* | LENGTH (INCHES) |               |
|----------|---------------------------|-------------------------|-----------------|---------------|
|          |                           |                         | BALE (DIM. A)   | MESH (DIM. M) |
| L9601    | 0.50-0.61                 | 770                     | 4               | 11            |
| L9602    | 0.62-0.74                 | 960                     | 4               | 11            |
| L9603    | 0.75-0.99                 | 960                     | 4               | 14            |
| L9604    | 1.00-1.24                 | 1,680                   | 5               | 15            |
| L9605    | 1.25-1.49                 | 1,680                   | 5               | 16            |
| L9606    | 1.50-1.74                 | 1,680                   | 5               | 18            |
| L9607    | 1.75-1.99                 | 2,640                   | 8               | 20            |
| L9608    | 2.00-2.49                 | 3,760                   | 8               | 22            |
| L9609    | 2.50-2.99                 | 3,760                   | 8               | 24            |
| L9611    | 3.00-3.49                 | 5,040                   | 9               | 26            |
| L9612    | 3.50-3.99                 | 5,040                   | 9               | 28            |

Note: Support grips are also available in stainless steel—contact your Leviton Representative.

\*To determine workload safety factor, divide approximate break strength by 10. See page Q6 for strength information.

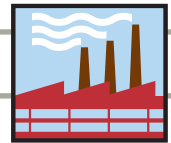

**Support Grips—Standard Split Lace** 

**Locking Bale, Split Lace, Single Weave**

| CAT. NO. | CABLE DIA. RANGE (INCHES) | APPROX. BREAK STRENGTH* | LENGTH (INCHES) |               |
|----------|---------------------------|-------------------------|-----------------|---------------|
|          |                           |                         | BALE (DIM. A)   | MESH (DIM. M) |
| L9621    | 0.50–0.61                 | 770                     | 18              | 11            |
| L9622    | 0.62–0.74                 | 1,150                   | 18              | 11            |
| L9623    | 0.75–0.99                 | 1,320                   | 18              | 14            |
| L9624    | 1.00–1.24                 | 1,920                   | 18              | 15            |
| L9625    | 1.25–1.49                 | 1,920                   | 18              | 16            |
| L9626    | 1.50–1.74                 | 1,920                   | 18              | 18            |
| L9627    | 1.75–1.99                 | 3,150                   | 18              | 20            |
| L9628    | 2.00–2.49                 | 3,360                   | 18              | 22            |
| L9629    | 2.50–2.99                 | 3,360                   | 18              | 24            |

\*To determine workload safety factor, divide approximate break strength by 10. See page Q6 for strength information.

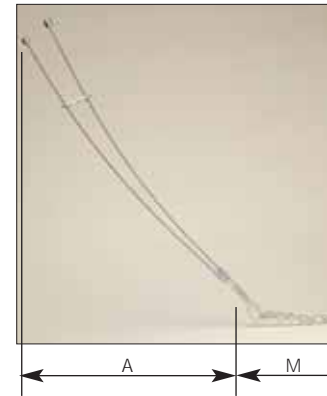

L9621 Locking Bale

**Support Grips—Heavy Duty Split Lace** 

Heavy Duty Support Grips handle continuous loads of over 500 lbs. in vertical runs greater than 100 ft. for cable diameters from 3/4" to 4 1/2".

**Single Eye, Double Weave, Heavy Long, Split Lace**

| CAT. NO. | CABLE DIA. RANGE (INCHES) | APPROX. BREAK STRENGTH* | LENGTH (INCHES) |               |
|----------|---------------------------|-------------------------|-----------------|---------------|
|          |                           |                         | BALE (DIM. A)   | MESH (DIM. M) |
| L9722    | 0.75–0.99                 | 2,700                   | 10              | 26            |
| L9723    | 1.00–1.24                 | 4,720                   | 10              | 29            |
| L9724    | 1.25–1.49                 | 4,720                   | 10              | 31            |
| L9725    | 1.50–1.99                 | 4,720                   | 10              | 35            |

**Double Eye, Double Weave, Heavy Long, Split Lace**

| CAT. NO. | CABLE DIA. RANGE (INCHES) | APPROX. BREAK STRENGTH* | LENGTH (INCHES) |               |
|----------|---------------------------|-------------------------|-----------------|---------------|
|          |                           |                         | BALE (DIM. A)   | MESH (DIM. M) |
| L9731    | 0.75–0.99                 | 2,700                   | 10              | 26            |
| L9732    | 1.00–1.24                 | 4,720                   | 10              | 29            |
| L9733    | 1.25–1.49                 | 4,720                   | 10              | 31            |
| L9734    | 1.50–1.99                 | 4,720                   | 10              | 35            |
| L9735    | 2.00–2.49                 | 10,080                  | 10              | 37            |
| L9736    | 2.50–2.99                 | 10,080                  | 10              | 39            |
| L9737    | 3.00–3.49                 | 10,080                  | 10              | 41            |
| L9738    | 3.50–3.99                 | 13,120                  | 10              | 45            |
| L9739    | 4.00–4.49                 | 13,120                  | 10              | 47            |

\*To determine workload safety factor, divide approximate break strength by 10. See page Q6 for strength information.



L9731 Double Eye

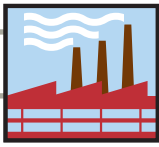

# WIRE MESH SUPPORT GRIPS

## Industrial Grade Wire Mesh Safety Grips

### Support Grips—Standard Split Rod <sup>SR</sup>

Split Rod Support Grips are designed for loads up to 500 lbs. and vertical runs of no more than 100 feet. They are available in a variety of eye styles and cable ranges for supporting electrical cable, metal rods and tubing. Split rod support grips are utilized when the end of the cable cannot be feasibly accessed and the installation is temporary. For attachment information see page Q19.

#### Single Eye, Split Rod, Single Weave

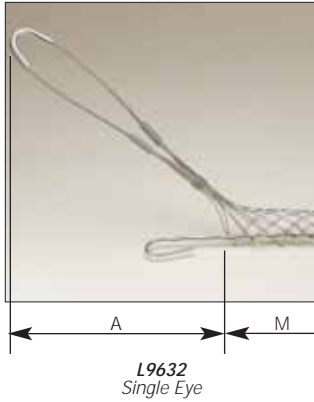

| CAT. NO. | CABLE DIA. RANGE (INCHES) | APPROX. BREAK STRENGTH* | LENGTH (INCHES) |               |
|----------|---------------------------|-------------------------|-----------------|---------------|
|          |                           |                         | BALE (DIM. A)   | MESH (DIM. M) |
| L9631    | 0.50-0.61                 | 770                     | 7               | 9             |
| L9632    | 0.62-0.74                 | 960                     | 8               | 9             |
| L9633    | 0.75-0.99                 | 1,320                   | 8               | 11            |
| L9634    | 1.00-1.24                 | 1,680                   | 9               | 13            |
| L9635    | 1.25-1.49                 | 1,680                   | 10              | 15            |
| L9636    | 1.50-1.74                 | 1,680                   | 12              | 16            |
| L9637    | 1.75-1.99                 | 2,640                   | 14              | 17            |
| L9638    | 2.00-2.49                 | 3,760                   | 16              | 20            |
| L9639    | 2.50-2.99                 | 3,760                   | 18              | 22            |
| L9641    | 3.00-3.49                 | 6,560                   | 21              | 24            |
| L9642    | 3.50-3.99                 | 6,560                   | 24              | 26            |

#### Double Eye, Split Rod, Single Weave

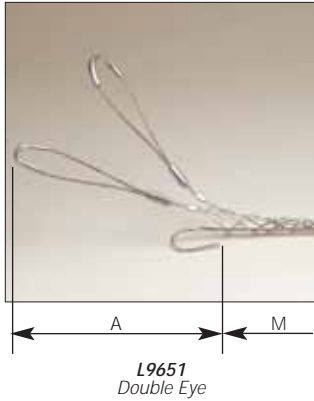

| CAT. NO. | CABLE DIA. RANGE (INCHES) | APPROX. BREAK STRENGTH* | LENGTH (INCHES) |               |
|----------|---------------------------|-------------------------|-----------------|---------------|
|          |                           |                         | BALE (DIM. A)   | MESH (DIM. M) |
| L9651    | 0.50-0.61                 | 770                     | 4               | 9             |
| L9652    | 0.62-0.74                 | 1,150                   | 4               | 9             |
| L9653    | 0.75-0.99                 | 1,320                   | 4               | 11            |
| L9654    | 1.00-1.24                 | 1,920                   | 5               | 13            |
| L9655    | 1.25-1.49                 | 1,920                   | 5               | 15            |
| L9656    | 1.50-1.74                 | 1,920                   | 5               | 16            |
| L9657    | 1.75-1.99                 | 3,150                   | 6               | 17            |
| L9658    | 2.00-2.49                 | 3,360                   | 6               | 20            |
| L9659    | 2.50-2.99                 | 3,360                   | 6               | 22            |
| L9661    | 3.00-3.49                 | 7,520                   | 8               | 24            |
| L9662    | 3.50-3.99                 | 7,520                   | 8               | 26            |

#### Offset Eye, Split Rod, Single Weave

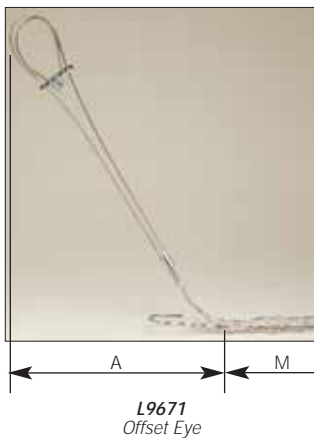

| CAT. NO. | CABLE DIA. RANGE (INCHES) | APPROX. BREAK STRENGTH* | LENGTH (INCHES) |               |
|----------|---------------------------|-------------------------|-----------------|---------------|
|          |                           |                         | BALE (DIM. A)   | MESH (DIM. M) |
| L9671    | 0.50-0.61                 | 770                     | 4               | 9             |
| L9672    | 0.62-0.74                 | 960                     | 4               | 9             |
| L9673    | 0.75-0.99                 | 960                     | 4               | 11            |
| L9674    | 1.00-1.24                 | 1,680                   | 5               | 13            |
| L9675    | 1.25-1.49                 | 1,680                   | 5               | 15            |
| L9676    | 1.50-1.74                 | 1,680                   | 5               | 16            |
| L9677    | 1.75-1.99                 | 2,640                   | 6               | 17            |
| L9678    | 2.00-2.49                 | 3,760                   | 6               | 20            |
| L9679    | 2.50-2.99                 | 3,760                   | 6               | 22            |
| L9681    | 3.00-3.49                 | 5,040                   | 8               | 24            |
| L9682    | 3.50-3.99                 | 5,040                   | 8               | 26            |

\*To determine workload safety factor, divide approximate break strength by 10. See page Q6 for strength information.

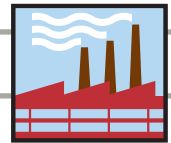

**Support Grips—Standard Split Rod**

**Locking Bale, Split Rod, Single Weave**

| CAT. NO. | CABLE DIA. RANGE (INCHES) | APPROX. BREAK STRENGTH* | LENGTH (INCHES) |               |
|----------|---------------------------|-------------------------|-----------------|---------------|
|          |                           |                         | BALE (DIM. A)   | MESH (DIM. M) |
| L9688    | 0.50-0.61                 | 770                     | 10              | 9             |
| L9689    | 0.62-0.74                 | 1,150                   | 10              | 9             |
| L9691    | 0.75-0.99                 | 1,320                   | 10              | 11            |
| L9692    | 1.00-1.24                 | 1,920                   | 14              | 13            |
| L9693    | 1.25-1.49                 | 1,920                   | 14              | 15            |
| L9694    | 1.50-1.74                 | 1,920                   | 14              | 16            |
| L9695    | 1.75-1.99                 | 3,150                   | 14              | 17            |
| L9696    | 2.00-2.49                 | 3,360                   | 18              | 20            |
| L9697    | 2.50-2.99                 | 3,360                   | 18              | 22            |
| L9698    | 3.00-3.49                 | 7,520                   | 18              | 24            |
| L9699    | 3.50-3.99                 | 7,520                   | 18              | 26            |

\*To determine workload safety factor, divide approximate break strength by 10. See page Q6 for strength information.



L9689 Locking Bale

**Support Grips—Bus-Drop**

Bus-Drop Grips are used as cable support. They relieve any direct tension from the critical connection and absorb vibration and flexing. Bus-Drop Grips are woven of galvanized steel wire. They are offered with either locking bale or single eye attachments.

**Locking Bale & Single Eye**

| CAT. NOS. | LOCKING BALE | CABLE DIA. RANGE (INCHES) | APPROX. BREAK STRENGTH* |
|-----------|--------------|---------------------------|-------------------------|
| L7981     | —            | .220-.320                 | 1,100                   |
| L7982     | —            | .300-.430                 | 1,100                   |
| L7983     | L7992        | .410-.560                 | 1,100                   |
| L7984     | L7993        | .530-.730                 | 1,100                   |
| L7985     | L7994        | .700-.850                 | 1,900                   |
| L7986     | L7995        | .820-1.00                 | 1,900                   |
| L7987     | —            | .960-1.25                 | 1,900                   |



L7984 Single "U" Eye



L7992 Locking Bale

**Support Grips—Bus-Drop Accessories**

Safety Springs are used with Bus-Drop Grips to relieve sudden strains on the cable system. To use with single eye-type grips, disassemble drawbar from coil, place through the eye and replace the drawbar.

**Safety Springs**

| DESCRIPTION                      | CAT. NO. | LENGTH (INCHES) |
|----------------------------------|----------|-----------------|
| Zinc Plated<br>Max. Load 40 Lbs. | L7997    | 7.50            |
| Zinc Plated<br>Max. Load 80 Lbs. | L7998    | 8.50            |

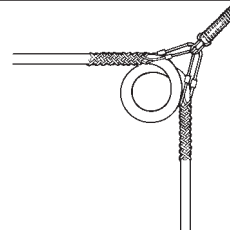

L7998 Safety Spring

**Support Hook**

| DESCRIPTION  | CAT. NO. |
|--|----------|
| 3/8" Right Hand Wood Screw,<br>Zinc Plated 4 1/2" Long | L7980    |

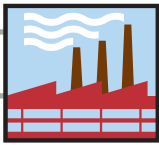

## WIRE MESH SUPPORT GRIPS

### Industrial Grade Wire Mesh Safety Grips

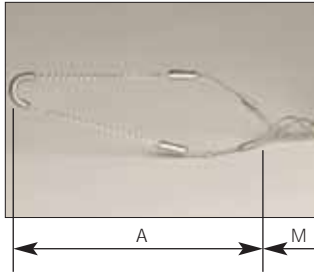

**L8807**  
Single Eye—closed mesh

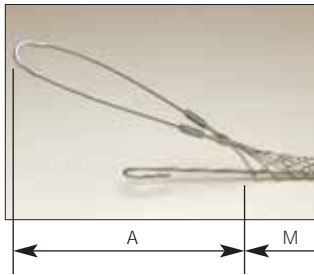

**L8821**  
Single Eye—split rod

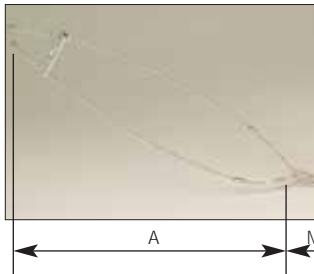

**L8823**  
Locking Bale

### Support Grips—Fiber Optic Grips

All Leviton Fiber Optic Support Grips are designed to wrap securely around fiber optic cable without damaging it. They are designed to reduce stress on cable in vertical, sloping, or horizontal positions. Single-eye or locking-bale style grips afford lasting support for a wide variety of applications where fiber optic cable is used.

#### Single Eye, Closed Mesh, Single Weave

| CAT. NO. | CABLE DIA. RANGE (INCHES) | APPROX. BREAK STRENGTH* | LENGTH (INCHES) |               |
|----------|---------------------------|-------------------------|-----------------|---------------|
|          |                           |                         | BALE (DIM. A)   | MESH (DIM. M) |
| L8807    | .18-.25                   | 300                     | 3               | 1.7           |
| L8808    | .23-.32                   | 300                     | 3               | 2.5           |
| L8809    | .30-.39                   | 300                     | 4               | 2.5           |
| L8811    | .37-.48                   | 300                     | 5               | 4             |
| L8812    | .46-.58                   | 400                     | 6               | 4             |
| L8813    | .56-.71                   | 600                     | 7               | 5.5           |
| L8814    | .69-.88                   | 800                     | 8               | 6             |

#### Single Eye, Split Rod, Single Weave

| CAT. NO. | CABLE DIA. RANGE (INCHES) | APPROX. BREAK STRENGTH* | LENGTH (INCHES) |               |
|----------|---------------------------|-------------------------|-----------------|---------------|
|          |                           |                         | BALE (DIM. A)   | MESH (DIM. M) |
| L8815    | .18-.25                   | 300                     | 3               | 2.5           |
| L8816    | .23-.32                   | 300                     | 3               | 2.5           |
| L8817    | .30-.39                   | 300                     | 4               | 2.5           |
| L8818    | .37-.48                   | 300                     | 5               | 4             |
| L8819    | .46-.58                   | 400                     | 6               | 5             |
| L8821    | .56-.71                   | 600                     | 7               | 5             |
| L8822    | .69-.88                   | 800                     | 8               | 6             |

#### Locking Bale, Closed Mesh, Single Weave

| CAT. NO. | CABLE DIA. RANGE (INCHES) | APPROX. BREAK STRENGTH* | LENGTH (INCHES) |               |
|----------|---------------------------|-------------------------|-----------------|---------------|
|          |                           |                         | BALE (DIM. A)   | MESH (DIM. M) |
| L8823    | .18-.25                   | 300                     | 9               | 2.5           |
| L8824    | .23-.36                   | 300                     | 9               | 2             |
| L8825    | .30-.39                   | 300                     | 9               | 2.5           |
| L8826    | .37-.48                   | 300                     | 10              | 4             |
| L8827    | .46-.58                   | 400                     | 10              | 4             |
| L8828    | .56-.71                   | 600                     | 10              | 5.5           |
| L8829    | .69-.88                   | 800                     | 10              | 6             |

\*To determine workload safety factor, divide approximate break strength by 10. See page Q6 for strength information.



# Surge Protection, Power Distribution and Uninterruptible Power Supply Devices

## INDEX

|  |          |
|--|----------|
| <b>Industrial Surge Protective Devices</b>       |          |
| Overview   | R2       |
| Four-Outlet Plug-Ins                             | R3       |
| 5100 Series                                      | R3       |
| Surge Strips                                     | R4       |
| Surge Protection Modules                         | R5       |
| Surge Protection Panels                          | R6, R7   |
| 74000 Series                                     | R6       |
| 57000 Series                                     | R7       |
| 52000 Series                                     | R8       |
| 47000 and 52000-7M3 Series                       | R9       |
| 42000 and 32000 Series                           | R10      |
| Low Voltage Communications SPD's                 |          |
| 3400 and 3800 Series                             | R11      |
| Surge Counter: 51000 SMC                         | R11      |
| Equipment Cabinet SPD's                          |          |
| 3800 Series                                      | R12      |
| Surge Protection Receptacles                     | R13      |
| Decora Series                                    |          |
| Four-In-One Series                               | R14      |
| <b>Commercial Surge Protection Devices</b>       |          |
| S1000 and S2000 Series Surge Strips              | R15      |
| 4950 Series Surge Strips                         | R15      |
| 5500 and 5505 Series PDU's with Surge Protection | R16      |
| <b>Rack-mounted Power Distribution Devices</b>   |          |
| 4505 Series 19" Rack Mount PDU's                 | R17      |
| P1000 Series PDU's                               | R17      |
| Metered Series PDU's                             | R18      |
| Switched Series PDU's                            | R19      |
| <b>Residential Surge Protection Devices</b>      |          |
| Meter Socket Surge Adapter                       | R20      |
| Secondary Surge Arrestors                        | R20      |
| General Purpose Plug-Ins                         | R21      |
| 51000 Series Surge Protection Panels             | R21      |
| 3950 Series Module Bracket                       | R22      |
| 5950 Series Surge Modules                        | R22      |
| <b>Uninterruptible Power Supplies</b>            |          |
| Sine and Online Series UPS Systems               | R23      |
| Pro, Slim and Strip Series UPS Systems           | R23, R24 |



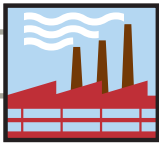

# SURGE PROTECTION DEVICE FEATURES

## Industrial Grade Surge Protection Devices

**LEVITON'S SURGE PROTECTIVE DEVICES (SPD'S) ARE DESIGNED TO REDUCE THE RANDOM ENERGY SURGES OF VOLTAGE TRANSIENTS AND ELECTRICAL NOISE ON THE POWER SUPPLY LINE.**

Volatile transients and noise are present in utility power lines, data networks, telephone lines, closed circuit and cable tv feeds, and any other power or control lines connected to electronic equipment.

Leviton's Surge Protection Devices can be used individually or as part of a coordinated application strategy, called Network Protection, to protect sensitive electronic equipment, in industrial, commercial and residential locations, from the stress and degradation inflicted by voltage transients. Leviton Surge Protection Devices are listed to UL 1449 Second Edition Standards.

*Leviton's outstanding Surge Protection Devices divert damaging voltage transients, or surges, away from electronic equipment. Transients are diverted away from sensitive microcircuitry, providing protection against catastrophic failure, costly downtime and data disruptions.*

### Features and Benefits

- Provides seven-mode protection
- User-replaceable modules
- Real-time diagnostics monitor power and suppression status for each mode
- Diagnostic display panel of 74000/75000 units indicates "Fault", "Alert" and "Protection" status
- Provides surge magnitude, time and date of each surge event
- Surge event history downloadable via RS-232 connection



74120-7M3



**Panel Mounted**  
Provides complete protection on all phases even if one module fails; modular design allows easy replacement of modules. NC, NO contacts for remote status indication.  
**57120-M3 shown**



**Receptacles**  
15-20 Amp single, duplex and four-in-one versions with 3-level MOV phase to neutral, phase to ground and neutral to ground protection.  
**8280-IGB shown**



**Stand-Alone Low-Voltage SPD**  
Provides surge protection for low-voltage data and communications lines.  
**5350-PT8 shown**



**Plug Strips**  
Available in a variety of grades, its real time diagnostics monitor power and suppression status.  
**5300-PS shown**



**PDU**  
Mounts on 19" equipment rack; available with or without rocker-style ON/OFF switch; Resettable circuit breaker protects against overloading and power supply failure.  
**5500-190 shown**



**UPS**  
New product line offers the latest technology and features available in Uninterruptible Power Supply devices.  
**U1000-AKP shown**



**Communication Modules**  
Provide surge protection for DC-powered low-voltage data network products.  
**3803-485 shown**



**Multi-Phase Panel Protector**  
Provides multiple-phase surge protection; 3-phase units are suitable for WYE and Delta AC systems. NC, NO contacts for remote status indication.  
**42120-D43 shown**

# WALL MOUNTED SURGE PROTECTION

## Industrial Grade Surge Protection Devices

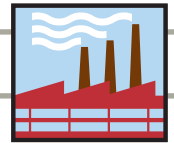

### Four-Outlet Plug-In Surge Protection Devices — 15 AMP 120V 50, 60 Hz AC

#### 5100 Series

| DESCRIPTION                    | CAT. NO. | COLOR | APPLICATION   |
|--------------------------------|----------|-------|---|
| 15A Four-Outlet Heavy-Duty DPI | 5100-P   | Beige | PC's and peripherals, electronic cash registers, digital sound systems, video equipment and microwave ovens |

#### Clamping Performance

| SPECIFICATION   | 5100         |
|---|--------------|
| Max. single-pulse transient current (8x20μs, Amps peak) | 26kA         |
| Rated single-pulse transient energy (10x1000μs, Joules) | 320 Joules   |
| EMI/RFI noise rejection @ 50 Ohms 5kHz-100MHz           | 10-20dB      |
| Cat. A ringwave (6kV, 200A, 100kHz)                     | 370V         |
| Cat. B ringwave (6kV, 500A, 100kHz)                     | 420V         |
| Cat B impulse (6kV, 3kA, 8x20μs)                        | 490          |
| UL 1449 ratings (8x20μs @ 500A) (L-N/L-G, N-G)          | 330/500/400V |
| Maximum continuous operating voltage                    | 135V         |



#### SPECIFICATIONS AND FEATURES

- Connect directly to standard NEMA 5-15 wall receptacles
- Diagnostic LED's indicate power & protection status
- Three mode protection for Normal & Common protection: L-N, L-G, N-G
- On-board thermal fusing & overcurrent protection via resettable 15A breaker
- Filtration reduces high frequency noise
- Maximum continuous operating voltage

#### 5100 Series

- Non-inductive design for compatibility with UPS & SPS or transformer systems
- Multi-component suppression circuitry

#### TESTING AND CODE COMPLIANCE

- UL 1449 Listed (File #E-146315)
- Meets ANSI/IEEE C62.41 standards for both Categories A & B
- CSA Certified (File #LR-94773)
- Lifetime Limited Downline Warranty for device & equipment plugged into it

#### MATERIAL CHARACTERISTICS

Operating Temperature: -10°C to 60°C  
Storage Temperature: -35°C to 60°C

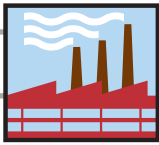

# SURGE PROTECTION PLUG STRIPS

## Industrial Grade Surge Protection Devices



5300-HTS



5300-PSC



5100-OPS

### Plug Strips

| DESCRIPTION   | CAT. NO. | RATING      | APPLICATION   |
|---|----------|-------------|---|
| 6-Outlet Plug Strip w/ON/OFF Switch                                 | 5300-PS  | 15A-120V AC | Data-sensitive operations                               |
| 6-Outlet Plug Strip w/ON/OFF Switch w/15 ft. Power Cord             | 5300-S15 | 15A-120V AC | Data-sensitive operations                               |
| 6-Outlet Plug Strip w/ON/OFF Switch                                 | 5300-PST | 15A-120V AC | Telephone line/modem line protection                    |
| 6-Outlet Plug Strip w/ON/OFF Switch                                 | 5300-PSC | 15A-120V AC | CATV line surge protection                              |
| 6-Outlet Plug Strip Hospital Grade Components                       | 5300-HTS | 15A-120V AC | Continues to supply power to load if protection is lost |
| 6-Outlet Plug Strip w/ON/OFF Switch                                 | 5300-IPS | 15A-120V AC | Rugged metal housing for use in rough environments      |
| Heavy-Duty 6-Outlet Plug Strip w/ON/OFF Switch                      | 5200-PS  | 15A-120V AC | For microprocessor-based equipment                      |
| Heavy-Duty 6-Outlet Plug Strip w/ON/OFF Switch, w/15 ft. Power Cord | 5200-S15 | 15A-120V AC | For microprocessor-based equipment                      |
| General-Duty 6-Outlet Plug Strip                                    | 5100-PS  | 15A-120V AC | Compatible with Decora Home Control                     |
| General-Duty 6-Outlet Plug Strip, w/15 ft. Power Cord               | 5100-S15 | 15A-120V AC | Compatible with UPS and SPS systems                     |
| General-Duty 6-Outlet Plug Strip                                    | 5100-IPS | 15A-120V AC | Rugged metal housing for use in rough environments      |
| General-Duty 6-Outlet Plug Strip                                    | 5100-IS2 | 20A-120V AC | Rugged metal housing for use in rough environments      |

### Clamping Performance

| DESCRIPTION   | 5100-PS     | 5200-PS     | 5300-PS GROUP                                |
|---|-------------|-------------|--|
| Max. single-pulse transient current (8x20µs, Amps peak) | 26kA        | 39kA        | 52kA   |
| Rated single-pulse transient energy (10x1000µs, Joules) | 720 Joules  | 940 Joules  | 1480 Joules                                  |
| EMI/RFI noise rejection @ 50 Ohms 5kHz-100MHz           | 10-30dB     | 40-50dB     | 50-60dB                                      |
| Cat. A ringwave (6kV, 200A, 100kHz)                     | 370V        | 230V        | 190V   |
| Cat. B ringwave (6kV, 500A, 100kHz)                     | 420V        | 270V        | 210V   |
| Cat B impulse (6kV, 3kA, 8x20µs)                        | 490         | 370         | 310  |
| UL 1449 ratings (8x20µs @ 3kA) (L-N/L-G, N-G)           | 400/400/400 | 330/400/330 | 330/330/330<br>400/400/400 for 5300-HTS only |

#### SPECIFICATIONS AND FEATURES

##### Plug Strips

- Available in Industrial Specification Grade, Commercial Specification Grade & General Purpose Classifications
- Clamping profile tightly tracks AC sine wave
- Real-time diagnostics monitor power & suppression status
- Six protected outlets
- Resettable circuit breaker & internal fusing
- May be wall-mounted
- Equipped with a 6-foot, 14-3AWG power cord

#### TESTING AND CODE COMPLIANCE

##### 5300-HPS

- UL Listed 544 (File #118936)
- UL Listed (File Nos. #1449, 1363, 1283)
- CSA Certified (File #LR-94773)
- Meets ANSI/IEEE C62.41 standards for both Categories A & B

##### Plug Strips

- Lifetime Limited Downline Warranty for device & equipment plugged into it

#### MATERIAL CHARACTERISTICS

##### 5100-PS, 5200-PS, 5300-PS

Operating Temperature: 0°C to 40°C  
Storage Temperature: -35°C to 60°C

##### 5300-HPS

Operating Temperature: 0°C to 60°C  
Storage Temperature: -35°C to 60°C

##### 5100-IPS, 5300-IPS, 5100-IS2

Operating Temperature: -10°C to 60°C  
Storage Temperature: -35°C to 60°C

# WIRED-IN SURGE PROTECTION MODULES

## Industrial Grade Surge Protection Devices

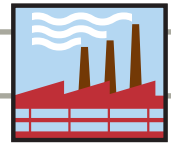

### Wired-In Surge Protection Modules NOM CULUS LISTED

| DESCRIPTION   | CAT. NO.  | RATING       |
|---|-----------|--------------|
| Single-Phase, 3-Wire                                  | 51005-WM  | 5A, 120V AC  |
| Single-Phase, 3-Wire                                  | 51010-WM  | 10A, 120V AC |
| Single-Phase, 3-Wire, DIN-Rail Mounting               | 51005-DIN | 5A, 120V AC  |
| Single-Phase, 3-Wire, DIN-Rail Mounting               | 51010-DIN | 10A, 120V AC |
| Single-Phase, 3-Wire                                  | 51015-WM  | 15A 120V AC  |
| Single-Phase, 3-Wire                                  | 51020-WM  | 20A 120V AC  |
| Single-Phase, 3-Wire, w/DIN-rail mounting             | 51020-DIN | 20A 120V AC  |
| Single-Phase, 3-wire (For use in parallel connection) | 51020-WMT | 20A 120V AC  |
| Single-Phase, 4-Wire                                  | 51240-WM  | 20A 240V AC  |
| Single-Phase, w/DIN-rail mounting                     | 51240-DIN | 20A 240V AC  |

### Performance Specifications

| SPECIFICATION                               | 51005-WM,<br>51010-WM,<br>51005-DIN,<br>51010-DIN | 51015-WM,<br>51020-WM,<br>51015-DIN,<br>51020-DIN,<br>51020-WMT | 51240-WM,<br>51240-DIN              |
|---|---|---|-------------------------------------|
| Max. Surge Current<br>(Test w. 8x20µs wave) | L-N: 26kA   | L-N: 52kA   | L-N: 52kA                           |
| Noise Rejection                             | 20-50dB<br>(@ 10K-100MHz)                         | 40-50dB<br>(@ 5kH-100MHz)                                       | 40-50dB<br>(@ 5kH-100MHz)           |
| Operating Frequency Range                   | 50, 60Hz  | 50, 60Hz  | 50, 60Hz                            |
| UL 1449 (2nd Ed.) Rating                    | L-N: 400V<br>L-G: 400V<br>N-G: 400V               | L-N: 330V<br>L-G: 330V<br>N-G: 400V                             | L-N: 600V<br>L-G: 330V<br>N-G: 600V |
| MCOV  | 150V AC   | 150V AC   | 270V AC                             |

*Note: See your Leviton representative for a complete listing of Low-Voltage Communication Protection modules for factory automation and industrial control applications.*



51020-DIN



51020-WMT

#### SPECIFICATIONS AND FEATURES

##### Wired-In Surge Protection Module —5100 Series

- For use by OEMs who wish to include 120/240V surge protection as an equipment feature
- Available with DIN-rail mounting
- Provides surge protection to branch circuits
- Staged multi-component surge suppression circuitry provides clamping envelope that follows AC sine-wave contour
- Primary and secondary suppression circuits are automatic resettable fuse protected
- Diagnostic circuitry, with LEDs, to indicate surge protection status & acoustic alert if surge protection is lost
- If surge protection is lost, power is still provided to load until SPD module is replaced

#### TESTING AND CODE COMPLIANCE

- Recognized to UL Standard 1449, Edition 2.5
- CSA Certified
- Backed by a Limited Five-Year Warranty

#### MATERIAL CHARACTERISTICS

Operating Temperature: -40°C to 70°C  
Storage Temperature: -20°C to 85°C

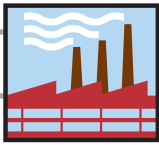

# SURGE PROTECTION PANELS

## Industrial Grade Surge Protection Devices



74120-7M3

### 74000 Series Panel Mount Devices NOM

| DESCRIPTION                     | CAT. NO.         | RATING      | MODULE NO.    |
|---------------------------------|------------------|-------------|---------------|
| 7-Mode, 3Ø WYE, 4-Wire + Ground | <b>74120-7M3</b> | 120/208V AC | (7) HC120-M40 |
| 7-Mode, 3Ø WYE, 4-Wire + Ground | <b>74277-7M3</b> | 277/480V AC | (7) HC277-M40 |

### Performance Specifications: 74000 Series

| CAT. NO.         | MCOV    | UL 1449 (2nd Ed)<br>IMPULSE (6kV/500A) |     |     | MAX. SURGE<br>CURRENT in KA<br>(Test w/8x20µs wave) |     |     | NOISE<br>REJECTION     |
|------------------|---------|--|-----|-----|---|-----|-----|------------------------|
|                  |         | L-N                                    | L-G | N-G | L-N + L-G = per phase                               |     |     |                        |
| <b>74120-7M3</b> | 150V AC | 400                                    | 400 | 400 | 200   | 200 | 400 | -40 dB<br>(@5K-100MHz) |
| <b>74277-7M3</b> | 320V AC | 800                                    | 800 | 800 | 200   | 200 | 400 | -40 dB<br>(@5K-100MHz) |

#### SPECIFICATIONS AND FEATURES

##### 74000 Series

- Provides seven mode protection
- Uses replaceable modules
- Real-time diagnostics monitor power and suppression status for each mode
- Surge magnitude, time and date is provided for each surge event
- Surge event history downloadable for storage via RS-232 connection
- AC sine wave tracking
- Optically isolated dry contacts

#### TESTING AND CODE COMPLIANCE

- UL 1449 Edition 2.5 Listed (#E146315)
- CSA Certified (#LR-94773)
- Meets ANSI/IEEE C62.41 & C62.45 Categories A, B & C

#### MATERIAL CHARACTERISTICS

Operating Temperature: -10°C to 60°C  
Storage Temperature: -20°C to 85°C

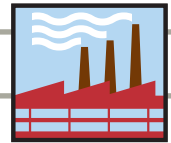

### 57000 Series Branch Panel Mounts

| DESCRIPTION   | CAT. NO. W/O SURGE COUNTER | CAT. NO. W/ SURGE COUNTER | VOLTAGE RATING | MODULE                      |
|---|----------------------------|---------------------------|----------------|-----------------------------|
| 3-Phase WYE, 4-Wire & Ground                              | 57120-M3                   | 57120-CM3                 | 120/208V AC    | (3) 120<br>(1) 8120-GN      |
| 3-Phase WYE, 7-Mode, Integral Disconnect, 4-Wire & Ground | 57120-M3S                  | 57120-C3S                 | 120/208V AC    | (3) 120-M3S<br>(1) 8120-GN  |
| 3-Phase WYE, 4-Wire & Ground                              | 57220-IM3                  | —                         | 220/380V AC    | (3) 220<br>(1) 8250-GN      |
| 3-Phase Delta, 3-Wire & Ground                            | 57240-DM3                  | —                         | 240V AC        | (3) 7240                    |
| 3-Phase WYE, 4-Wire & Ground                              | 57277-M3                   | 57277-CM3                 | 277/480V AC    | (3) 7277<br>(1) 8320-GN     |
| 3-Phase WYE, 7-Mode, Integral Disconnect, 4-Wire & Ground | 57277-M3S                  | 57277-C3S                 | 277/480V AC    | (3) 7277-M3S<br>(1) 8320-GN |
| 3-Phase WYE, 4-Wire & Ground                              | 57346-M3                   | —                         | 346/600V AC    | (3) 7346<br>(1) 8385-GN     |
| 3-Phase WYE, 4-Wire & Ground                              | 57347-M3S                  | —                         | 347/600V AC    | (3) 7347<br>(1) 8385-GN     |
| 3-Phase Delta, 3-Wire & Ground                            | 57480-DM3                  | —                         | 480V AC        | (3) 7480                    |
| 3-Phase Delta, 3-Wire & Ground                            | 57600-DM3                  | —                         | 600V AC        | (3) 7600                    |

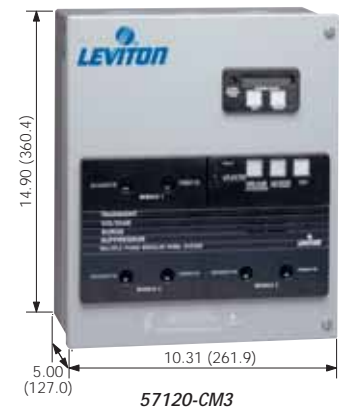

### Performance Specifications: 57000 Series

| CAT. NO.               | MCOV    | UL 1449 (2nd Ed) IMPULSE (6kV/500A) |      |      |      | MAX. SURGE CURRENT in KA (Test w/8x20µs wave) |     |     | NOISE REJECTION             |
|------------------------|---------|-------------------------------------|------|------|------|---|-----|-----|-----------------------------|
|                        |         | L-N                                 | L-G  | N-G  | L-L  | L-N + L-G = per phase                         |     |     |                             |
| 57120-M3<br>57120-CM3  | 150V AC | 400                                 | 800  | 400  | 800  | 150   | —   | 150 | -20 to -40 dB (@5K-10MHz)   |
| 57120-M3S<br>57120-C3S | 150V AC | 400                                 | 500  | 400  | 700  | 100   | 100 | 100 | -20 to -40 dB (@5K-10MHz)   |
| 57220-IM3              | 250V AC | 600                                 | 1200 | 600  | 1200 | 150   | —   | 150 | -20dB to -40 dB (@5K-10MHz) |
| 57240-DM3              | 250V AC | —                                   | —    | —    | 700  | L-L: 150                                      |     |     | -20dB to -40 dB (@5K-10MHz) |
| 57277-M3<br>57277-MC3  | 320V AC | 800                                 | 1800 | 800  | 1800 | 150   | —   | 150 | -20dB to -40 dB (@5K-10MHz) |
| 57277-M3S<br>57277-C3S | 320V AC | 900                                 | 1000 | 800  | 1500 | 100   | 100 | 200 | -20dB to -40 dB (@5K-10MHz) |
| 57346-M3               | 385V AC | 1000                                | 2000 | 1000 | 2000 | 150   | —   | 150 | -20dB to -40 dB (@5K-10MHz) |
| 57480-DM3              | 550V AC | —                                   | —    | —    | 1500 | L-L: 150                                      |     |     | -20dB to -40 dB (@5K-10MHz) |
| 57600-DM3              | 680V AC | —                                   | —    | —    | 1800 | L-L: 150                                      |     |     | -20dB to -40 dB (@5K-10MHz) |
| 57347-M3S              | 390V AC | 1000                                | 1000 | 1000 | 2000 | 100   | 100 | 200 | -20dB to -40 dB (@5K-10MHz) |

### Remote Supervisor

| DESCRIPTION       | CAT. NO. |
|-------------------|----------|
| Remote Supervisor | 52000-RS |

#### SPECIFICATIONS AND FEATURES

##### 57000 Series

- For installation at main distribution panels
- Hybrid suppression circuitry with built-in redundancy provides complete protection on all phases even if one module fails
- Modular design allows easy replacement of modules with the use of tools & without the need to shut down AC system power
- Provides Normal Mode (phase to neutral) & Common Mode (neutral to ground) protection for WYE-configured 3-phase AC systems
- Dry contacts for remote monitoring

##### 57000 Series

- "Series connection" parallel operated (Kelvin/feed-through) rated for 100 Amps maximum continuous line current using #3 AWG conductors
- Optically coupled remote-monitoring port allows use of the optional Remote Supervisor (Cat. No. 52000-RS)

- Dual-stage fuse protection for primary & secondary surge suppression circuits
- Housed in NEMA-12 case with hinged cover, surface or flush mountable
- Noise rejection -20 to -40dB

##### Remote Supervisor

- For use with any Cat. No. 57000 or 52000 panel-mounted SPD
- Monitors up to 6 (series alarm daisy-chained) panel-mounted SPDs
- Single key-hole surface mounting using just 2 screws
- Annunciator light shows steady GREEN when monitored panel-mounted SPDs are normal, & FLASHING RED in case of protection failure or power interruption
- 75dB acoustic beep tone draws attention to a potential failure
- Jack provided for simple connection to input port via #20 to #22 two-conductor twisted pair, with a wire run up to 5,000 ft. in length

#### TESTING AND CODE COMPLIANCE

##### 57000 Series

- UL 1449 Listed Edition 2.5 (File #E-146315)
- CSA Certified (File #LR-94773)
- 200 kA rated (M3S versions rated 100kA)
- Meets ANSI/IEEE C62.41 & C62.45 Categories A, B & C
- UL 945-V flame retardant thermoplastic (Front Bezel)
- Backed by a Limited 10-Year Warranty

#### MATERIAL CHARACTERISTICS

Operating Temperature: -10°C to 60°C  
Storage Temperature: -20°C to 85°C

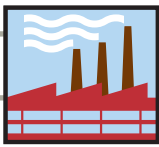

# SURGE PROTECTION PANELS

## Industrial Grade Surge Protection Devices



52120-M3



52120-CM3

### 52000 Series Branch Panel Mounts

| DESCRIPTION   | CAT. NO. W/O SURGE COUNTER | CAT. NO. W/ SURGE COUNTER | VOLTAGE RATING | MODULE                                 |
|---|----------------------------|---------------------------|----------------|--|
| Single-Phase, 2-Wire & Ground                         | 52120-M1                   | —                         | 120V AC        | (1) 2120<br>(1) 8120-GN                |
| Single-Phase, 3-Wire & Ground (Home Automation Model) | 52120-M2 (52120-M2H)       | 52120-CM2                 | 120/240V AC    | (2) 2120<br>(1) 8120-GN                |
| 3-Phase WYE, 4-Wire & Ground (Without Enclosure)      | 52120-M3 (52120-B3)        | 52120-CM3                 | 120/208V AC    | (3) 2120<br>(1) 8120-GN                |
| 3-Phase WYE (International), 4-Wire & Ground          | 52220-IM3                  | —                         | 220/380V AC    | (3) 2220<br>(1) 8250-GN                |
| 3-Phase Delta, 3-Wire & Ground                        | 52240-DM3                  | —                         | 240V AC        | (3) 2240                               |
| 3-Phase WYE, 4-Wire & Ground                          | 52277-M3                   | 52277-CM3                 | 277/480V AC    | (3) 2277<br>(1) 8320-GN                |
| 3-Phase WYE, 4-Wire & Ground                          | 52347-M3                   | —                         | 347/600V AC    | 3) 2347<br>(1) 8385-GN                 |
| 3-Phase Delta, 3-Wire & Ground                        | 52480-DM3                  | —                         | 480V AC        | (3) 2480                               |
| Split Phase Delta, 4-Wire & Ground                    | 52412-DS3                  | —                         | 120/240V AC    | (2) 2120 (120V) &<br>(1) 2412 (HI-LEG) |

### Performance Specifications: 52000 Series

| CAT. NO.                          | MCOV                | UL 1449 (2nd Ed) IMPULSE (6kV/500A) |      |     |      | MAX. SURGE CURRENT in KA (Test w/8x20µs wave) | NOISE REJECTION             |
|-----------------------------------|---------------------|-------------------------------------|------|-----|------|---|-----------------------------|
|                                   |                     | L-N                                 | L-G  | N-G | L-L  |   |                             |
| 52120-M1                          | 150V AC             | 400                                 | 800  | 400 | —    | 100   | -20 to -40 dB (@5K-10MHz)   |
| 52120-M3<br>52120-CM2             | 150V AC             | 400                                 | 800  | 400 | 800  | 100   | -20 to -40 dB (@5K-10MHz)   |
| 52120-M2H                         | 150V AC             | 400                                 | 800  | 400 | 800  | 100   | -20 to -40 dB (@5K-10MHz)   |
| 52120-M3<br>52120-B3<br>52120-CM3 | 150V AC             | 400                                 | 800  | 400 | 800  | 100   | -20 to -40 dB (@5K-10MHz)   |
| 52220-IM3                         | 250V AC             | 600                                 | 1200 | 600 | 1200 | 100   | -20 to -40 dB (@5K-10MHz)   |
| 52240-DM3                         | L-L: 250V AC        | —                                   | —    | —   | 600  | 100   | -20 to -40 dB (@5K-10MHz)   |
| 52277-M3<br>52277-CM3             | 320V AC             | 800                                 | 1800 | 800 | 1800 | 100   | -20dB to -40 dB (@5K-10MHz) |
| 52347-M3                          | 420V AC<br>L-L: 680 | 900                                 | —    | —   | 900  | 100   | -20 to -40 dB (@5K-10MHz)   |
| 52480-DM3                         | 550V AC             | —                                   | —    | —   | 1500 | 100   | -20 to -40 dB (@5K-10MHz)   |
| 52412-DS3                         | L-L: 250V AC        | 400                                 | 800  | 400 | 800  | 100   | -20 to -40 dB (@5K-10MHz)   |

### Remote Supervisor

| DESCRIPTION       | CAT. NO. |
|-------------------|----------|
| Remote Supervisor | 52000-RS |

### SPECIFICATIONS AND FEATURES

#### 52000 Series

- For installation at branch panels for protection in industrial & commercial facilities
- Hybrid suppression circuitry
- Features AC sine wave tracking and redundant protection
- Modular design allows easy replacement of modules without use of tools or the need to shut down the AC system
- Real-time diagnostics monitor power & suppression status for each phase & allow use of optional Remote Supervisor
- Dry contacts for remote monitoring
- Provides Normal Mode (phase to neutral) &

- Common Mode (neutral to ground) protection for WYE-configured 3-phase AC systems
- "Optional Series Connections" (Kelvin/feed-through) rated for 100 Amps maximum continuous line current using #3 AWG conductors
- Fuse protection for each module
- Housed in NEMA-12 case hinged cover, surface or flush mountable

### TESTING AND CODE COMPLIANCE

#### 52000 Series

- UL 1449 Listed Edition 2.5 (File #E-146315)
- CSA Certified (File #LR-94773)
- Meets ANSI/IEEE C62.41 and 62.45 requirements for Categories A, B, C
- Backed by a Limited 10-Year Warranty

### MATERIAL CHARACTERISTICS

Operating Temperature: -10°C to 60°C  
Storage Temperature: -20°C to 85°C



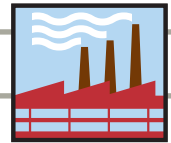

### 47000 & 52000-7M3 Series Branch Panel Mounts

| DESCRIPTION  | CAT. NO. W/O SURGE COUNTER | CAT. NO. W/ SURGE COUNTER | VOLTAGE RATING 3Ø WYE (4-Wire & Ground) | MODULE                     |
|--|----------------------------|---------------------------|---|----------------------------|
| 7-Mode Panel Mount (4-Wired + Ground)                    | 47120-007                  | —                         | 120/208V AC                             | —                          |
| 7-Mode Panel Mount w/NEMA 4X Enclosure (4-Wire + Ground) | 47120-4X7                  | —                         | 120/208V AC                             | —                          |
| 7-Mode Panel Mount (4-Wired + Ground)                    | 47277-007                  | —                         | 277/480V AC                             | —                          |
| 7-Mode Panel Mount w/NEMA 4X Enclosure (4-Wire + Ground) | 47277-4X7                  | —                         | 277/480V AC                             | —                          |
| 7-Mode Panel Mount (4-Wired + Ground)                    | 47347-007                  | —                         | 347/600V AC                             | —                          |
| 7-Mode Modular Panel Mount (4-Wired + Ground)            | 52120-7M3                  | 52120-7C3                 | 120/208V AC                             | (3) 120-7M3<br>(1) 8120-GN |
| 7-Mode Modular Panel Mount (4-Wired + Ground)            | 52277-7M3                  | 52277-7C3                 | 277/480V AC                             | (3) 220-7M3<br>(1) 8120-GN |



### Performance Specifications: 47000 and 52000-7M3 Series

| CAT. NO.               | MCOV    | UL 1449 (2nd Ed) IMPULSE (6kV/500A) |      |      |      | MAX. SURGE CURRENT in KA (Test w/8x20µs wave) |     |     | NOISE REJECTION           |
|------------------------|---------|-------------------------------------|------|------|------|---|-----|-----|---------------------------|
|                        |         | L-N                                 | L-G  | N-G  | L-L  | L-N + L-G = per phase                         |     |     |                           |
| 47120-007<br>47120-4X7 | 140V AC | 330                                 | 400  | 330  | 600  | 200   | 200 | 400 | -40 dB (@10K-10MHz)       |
| 47277-007<br>47277-4X7 | 320V AC | 700                                 | 800  | 700  | 1500 | 200   | 200 | 400 | -40 dB (@10K-10MHz)       |
| 47347-007              | 390V AC | 1200                                | 1300 | 1200 | 2200 | 200   | 200 | 400 | -40 dB (@10K-10MHz)       |
| 52120-7M3<br>52120-7C3 | 150V AC | 400                                 | 400  | 400  | 800  | 100   | 100 | 200 | -20 to -40 dB (@5K-10MHz) |
| 52277-7M3<br>52277-7C3 | 320V AC | 800                                 | 800  | 800  | 1500 | 100   | 100 | 200 | -20 to -40 dB (@5K-10MHz) |



### 37000, 47000 & 57000-7M3 Series Branch Panel Mounts

| DESCRIPTION  | CAT. NO. W/O SURGE COUNTER | CAT. NO. W/ SURGE COUNTER | VOLTAGE RATING 3Ø WYE (4-Wire & Ground) |
|--|----------------------------|---------------------------|---|
| 7-Mode Panel Mount Type 1 Enclosure (4-Wired + Ground)       | 37120-007                  | —                         | 120/208V AC                             |
| 7-Mode Panel Mount w/NEMA Type 1 Enclosure (4-Wire + Ground) | 37277-4X7                  | —                         | 277/480V AC                             |

#### SPECIFICATIONS AND FEATURES

##### 47000 & 52000-7M3 Series

- Provides low-clamping, high surge current capability
- Verifies fail-safe conditions for MOVs under steady-state overvoltage
- 200 kA rated per mode
- Parallel wired to facilitate connection to any service ampacity
- Provides Normal Mode (phase to neutral) & Common Mode (neutral to ground) protection for WYE-configured 3-phase AC systems
- Available with NEMA Type 4X enclosure for outdoor/uncontrolled environments

#### TESTING AND CODE COMPLIANCE

##### 47000 & 52000-7M3 Series

- UL 1449 Listed Edition 2.5 (File #E-146315)
- CSA Certified (File #LR-94773)
- Meets ANSI/IEEE C62.41 and 62.45 requirements for Categories A, B, C
- Backed by a Limited 10-Year Warranty

#### MATERIAL CHARACTERISTICS

Operating Temperature: -10°C to 60°C  
Storage Temperature: -20°C to 85°C

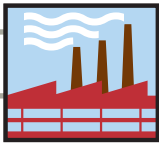

# MULTI-PHASE PANEL PROTECTORS

## Industrial Grade Surge Protection Devices



### 32000 and 42000 Series for Branch Panels

| DESCRIPTION                          | CAT. NO.               | VOLTAGE RATING           |
|--------------------------------------|------------------------|--------------------------|
| Single-Phase                         | 32120-1<br>42120-1     | 120/240V AC              |
| 3-Phase WYE or 220V AC, 3Ø Delta     | 32120-DY3<br>42120-DY3 | 120/208V AC              |
| 277/480V or 220/380V AC              | 32277-DY3              | 277/480V AC, 220/380V AC |
| 3-Phase WYE or 240, 480V AC 3Ø Delta | 42277-DY3              | 480V AC                  |
| 3-Phase WYE                          | 32347-DY3<br>42347-DY3 | 347/600V AC              |
| Hi-Leg Split Phase Delta             | 32412-DS3<br>42412-DS3 | 120/240V AC              |
| Flush Mount Collar                   | 42001-FMC              | —                        |

### Performance Specifications: 32000 and 42000 Series

| CAT. NO.               | MCOV                   | UL 1449 (2nd Ed)<br>IMPULSE (6kV/500A) |                |      | MAX. SURGE<br>CURRENT in KA<br>(Test w/8x20µs wave) | NOISE REJECTION                        |                                      |
|------------------------|------------------------|--|----------------|------|---|--|--------------------------------------|
|                        |                        | L-N                                    | N-G            | L-L  |   | 3200<br>Series                         | 4200<br>Series                       |
| 32120-1<br>42120-1     | 150V AC                | 500                                    | 500            | 700  | 80kA  | -20 to<br>-30 dB<br>(@1.5K-<br>1.2MHz) | -30 to<br>-40 dB<br>(@10K-<br>10MHz) |
| 32120-DY3<br>42120-DY3 | 150V AC                | 500                                    | 500            | 700  |   |  |                                      |
| 32277-DY3<br>42277-DY3 | 320V AC                | 900                                    | 800            | 1500 |   |  |                                      |
| 32347-DY3<br>42347-DY3 | 382V AC<br>L-L 660V AC | 1200                                   | 1000           | 2000 |   |  |                                      |
| 32412-DS3<br>42412-DS3 | 320V AC<br>L-L 264V AC | 400                                    | 700<br>(HiL-N) | 800  |   |  |                                      |

#### SPECIFICATIONS AND FEATURES

##### 32000 & 42000 Series

- 32000 Series compatible with Decora Home Automation devices
- Dry contacts for remote monitoring (NO-C-NC)
- Provide multiple-phase surge protection in commercial & industrial environments
- Compact design permits close installation to panel & provides a short parallel suppression path
- 3-phase units are suitable for WYE & Delta AC systems
- Easily surface-mounted or flush mountable with use of flush collar accessory 42001 FMC
- Real-time diagnostics monitor power & surge suppression status of each phase by means of indicator light & acoustic alarm
- Equipped with normally open/normally closed dry contacts rated 5 Amps 120/240V AC via 3 color-coded AWG leads rated 600V AC for remote monitoring

#### TESTING AND CODE COMPLIANCE

##### 32000 & 42000 Series

- UL 1449 Listed Edition 2.5 (File #E-146315)
- CSA Certified (File #LR-94773)
- Meets ANSI/IEEE C62.41 and 62.45 requirements for Categories A, B, C
- Backed by a Limited 10-Year Warranty

#### MATERIAL CHARACTERISTICS

##### 32000 & 42000 Series

Operating Temperature: -10°C to 60°C  
Storage Temperature: -20°C to 85°C

# LOW VOLTAGE COMMUNICATION MODULES

## Industrial Grade Surge Protection Devices

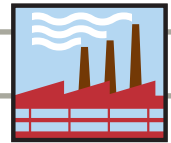

### 3400 and 3800 Series Low Voltage Communication

#### Surge Protection Modules



| DESCRIPTION   | CAT. NO.         | RATING   | APPLICATION   |
|---|------------------|----------|---|
| 3-Pin Header Connector, Surface Mount   | <b>3803-DHP*</b> | 9.6V DC  | For programmable logic devices and other computer-related data network products operating on "Blue Hose" networks               |
| 6-Pin Header Connector, Surface Mount   | <b>3803-485*</b> | 9.6C DC  | For programmable logic other devices and computer related data network products operating on Allen Bradley DH-485 data networks |
| 5-Pin Header Connector Surface & DIN-Rail Mount   | <b>3803-SPX</b>  | 13.6V DC | For products operating on SERIPLEX control bus networks   |
| DB-9 Connector, Surface & DIN-Rail Mount  | <b>3803-CAN</b>  | 25V DC   | For products operating on Honeywell control bus   |
| 3-Pin Header Connector, Surface Mount   | <b>3803-MOD</b>  | 9.6V DC  | For products operating on Modbus and Modbus Plus networks   |
| 3-Pin Header Connector, Surface Mount   | <b>3420-009*</b> | 9.6V DC  | For products operating on 4-20ma Signal Loop networks, 9V DC  |
| 3-PIN Header Connector, Surface Mount   | <b>3420-035*</b> | 38.5V DC | For products operating on 4-20ma Signal Loop networks, 38V DC   |
| 4-Position Terminal Block Surface & DIN-rail Mount  | <b>3860-GEF</b>  | 100V DC  | For products operating on GE Fanuc Control Bus networks   |
| RJ-45 Connector, Surface & DIN-Rail Mount   | <b>3861-ETH</b>  | 19.8V DC | For products operating on Ethernet PLC ports and CAT 3 networks   |
| BNC Connector, Surface & DIN-Rail Mount   | <b>3862-CON</b>  | 9.18V DC | For ControlNet networks   |
| 5-Pin Header Connector Surface & DIN-Rail Mount   | <b>3863-DEV</b>  | 19.8V DC | For DeviceNet networks  |
| Hospital Grade Din-Rail Mountable Surge Protected Duplex Receptacle w/LED & Audible Alarm | <b>3880-DIN</b>  | 120V     | For plug-in surge protection in equipment cabinets  |

#### Surge Counter: 51000-SMC

| DESCRIPTION           | CAT. NO.         |
|-----------------------|------------------|
| Plug-in Surge Counter | <b>51000-SMC</b> |

\*The Rockwell Automation Encompass Program references complementary products from third party manufacturers committed to providing quality products and services that enhance the Rockwell Automation Solution products and solve the industrial automation needs of mutual customers.



3803-485

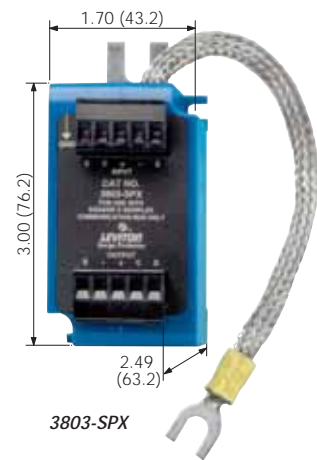

3803-SPX



3880-DIN



51000-SMC

#### SPECIFICATIONS AND FEATURES

##### 3400 & 3800 Series

- Designed for mounting in standard equipment cabinets
- For use on Allen Bradley & "Blue Hose" devices
- Two options for ground connection
- Low clamping voltage
- Withstands surges at programmable logic devices in harsh electromagnetic or geographic areas
- Provide transient voltage surge suppression for a selection of programmable logic devices & other computer-related data network products

##### 51000-SMC Surge Counter

- Plug-in design provides fast, simple way to determine if surges are present
- 3 settings indicate different sensitivity thresholds based on IEEE C62.41 impulse & ringwave waveforms
- Key operated to prevent tampering
- Excellent tool for determining if you need surge protection in an office environment.

#### TESTING AND CODE COMPLIANCE

##### 3400 & 3800 Series

- UL 497B Listed (#E175161)
- CSA Certified (#LR-94773)
- Meets ANSI/IEEE C-62.41 requirements
- Backed by a Limited 10-Year Warranty

##### 51000-SMC

- Meets UL Standard 1436

#### MATERIAL CHARACTERISTICS

Operating Temperature: -40°C to 60°C (3803-DHP, 3803-485, 3803-MOD, 3420-009, 3420-035); -10°C to 85°C (3803-SPX, 3803-CAN, 3860 Series)

Storage Temperature: -40°C to 90°C (3803-DHP, 3803-485, 3803-MOD, 3420-009, 3420-035); -20°C to 85°C (3803-SPX, 3803-CAN, 3860 Series)

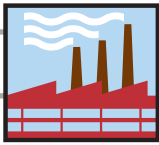

# EQUIPMENT CABINET SURGE PROTECTION

## Industrial Grade Surge Protection Devices

Surge Protection Devices



3800-DIN



3800-OEM



3840-DIN

### Equipment Cabinet Surge Protection Modules 3800 Series

| DESCRIPTION                                      | CAT. NO. | RATING         |
|--|----------|----------------|
| For DIN-Rail Mounting, w/Terminal Block; 120V AC | 3800-DIN | 120V AC (VRMS) |
| Terminal Block; 120V AC                          | 3800-OWM | 120V AC (VRMS) |
| Pigtail Wire Leads, 6" long; 120V AC             | 3800-OEM | 120V AC (VRMS) |
| For DIN-Rail Mounting, w/Terminal Block; 12V DC  | 3812-DIN | 12V DC         |
| Terminal Block; 12V DC                           | 3812-OWM | 12V DC         |
| Pigtail Wire Leads; 6" long; 12V DC              | 3812-OEM | 12V DC         |
| For DIN-Rail Mounting, w/Terminal Block; 24V DC  | 3824-DIN | 24V DC         |
| Terminal Block; 24V DC                           | 3824-OWM | 24V DC         |
| Pigtail Wire Leads; 6" long; 24V DC              | 3824-OEM | 24V DC         |
| For DIN-Rail Mounting, w/Terminal Block; 240V AC | 3840-DIN | 240V AC (VRMS) |
| Terminal Block; 240V AC                          | 3840-OWM | 240V AC (VRMS) |
| Pigtail Wire Leads; 6" long; 240V AC             | 3840-OEM | 240V AC (VRMS) |
| For DIN-Rail Mounting, w/Terminal Block; 48V DC  | 3848-DIN | 48V DC         |
| Terminal Block; 48V DC                           | 3848-OWM | 48V DC         |
| Pigtail Wire Leads; 6" long; 48V DC              | 3848-OEM | 48V DC         |

### Clamping Performance and Performance Specification

| CLAMPING PERFORMANCE                                    | CAT. NO. 3800                                      | CAT. NO. 3840                                      |
|---|--|--|
| UL Standard 1449 permanently-wired test (8x20μs, 3000A) | L-N: 500V Peak<br>L-G: 500V Peak<br>N-G: 500V Peak | L-N: 330V Peak<br>L-G: 400V Peak<br>N-G: 330V Peak |
| PERFORMANCE SPECIFICATION                               | CAT. NO. 3800                                      | CAT. NO. 3840                                      |
| Max. Single-Pulse                                       | L-N: 1300A   | L-N: 1300A   |
| Transient Current (8X20μs, Impulse)                     | L-G: 6500A<br>N-G: 6500A                           | L-G: 6500A<br>N-G: 6500A                           |

Consult factory for detailed performance data for other models.

### Equipment Cabinet Surge Protection Receptacles

| DESCRIPTION                           | CAT. NO. | RATING         |
|---------------------------------------|----------|----------------|
| Hospital Grade Duplex Receptacle 60Hz | 3880-DIN | 15A-120V @ 50, |
| Single Convenience Outlet 60Hz        | 3801-DIN | 15A-120V @ 50, |

### Performance Data (3880-DIN, 3801-DIN)

| CLAMPING VOLTAGE* | MCOV†   | MAX. SINGLE PULSE TRANSIENT CURRENT (8X20μs, Amps peak) | EMI-RFI NOISE REJECTION @50 ohms 5kHz-5MHz |
|-------------------|---------|---|--|
| 400/400/400V pk   | 150Vrms | 24kA(L-N), 12kA(L-G/N-G)                                | -35dB                                      |

\*UL 1449 Suppressed Voltage Ratings (SVR) Assigned at 6" length with 6k/500A per UL1449 (2nd Ed.)  
†Maximum Continuous Operating Voltage.

#### SPECIFICATIONS AND FEATURES

- 3800 Series**
- MOV-based suppression circuitry provides optimum clamping
  - Provides Normal Mode protection for line-to-neutral & common mode; line-to-ground & neutral-to-ground
  - Noise rejection @ 5kHz-5MHz: -35db
  - 3800: 135V (MCOV); 3840: 250V (MCOV)
  - 3800-DIN, 3800-OWM: Terminal block accepts 22 AWG to 12 AWG conductors
  - Consult factory on additional ratings on 3812, 3824 & 3848

- 3880-DIN & 3801-DIN**
- Ideal for mounting in equipment cabinets where convenient plugin surge protection is desired
  - Green LED indicates surge protection loss
  - Audible alarm w/integral disable (quiet) switch
  - Power continues to be provided to loads in the event of protection loss
  - Terminal Block accepts #22-#12 AWG conductors

#### TESTING AND CODE COMPLIANCE

- UL 1449 Listed Edition 2.5(E146315/DC-E175161)
- CSA Certified (#LR-94773)
- Meets ANSI/IEEE C-62.41 & C-62.45 Categories A, B & C (B & C ONLY for Cat Nos. 3880-DIN & 3801-DIN)
- Backed by a Limited 10-Year Warranty

#### MATERIAL CHARACTERISTICS

Operating Temperature: -10°C to 60°C  
Storage Temperature: -20°C to 85°C

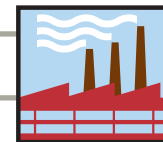

### Hospital Grade Surge Protection Receptacles—120V NOM cULUS LISTED

| DESCRIPTION                               | CAT. NO. | COLOR*  |
|---|----------|---|
| 15A Duplex—Indicator Light, Audible Alarm | 8280     | I, W, A, T, R, B<br><i>Basic Cat. No. Denotes Brown</i> |
| 20A Duplex—Indicator Light, Audible Alarm | 8380     | I, W, GY, B, R  |
| 20A Single—Indicator Light, Audible Alarm | 8381     | I, (No Brown)   |

### Hospital Grade Isolated Ground Surge Protection Receptacles—120V UL SF

| DESCRIPTION                               | CAT. NO. | COLOR*                                      |
|---|----------|---|
| 15A Duplex—Indicator Light, Audible Alarm | 8280-IG  | I, W, G, B, O<br><i>Brown Not Available</i> |
| 15A Single—Indicator Light, Audible Alarm | 8281-IG  | I, O  |
| 20A Duplex—Indicator Light, Audible Alarm | 8380-IG  | I, W, G, B, O                               |
| 20A Single—Indicator Light, Audible Alarm | 8381-IG  | I, W, B                                     |

### Industrial Grade Surge Protection Receptacles—120V UL SF

| DESCRIPTION                               | CAT. NO. | COLOR*   |
|---|----------|--|
| 15A Duplex—Indicator Light                | 5280     | I, W, A, T, GY, B<br><i>Basic Cat. No. Denotes Brown</i> |
| 15A Duplex—Indicator Light, Audible Alarm | 7280     | I, W, A, GY, B   |
| 20A Duplex—Indicator Light                | 5380     | I, W, GY, B  |
| 20A Duplex—Indicator Light, Audible Alarm | 7380     | I, W, GY, B  |

### Industrial Grade Isolated Ground Surge Protection Receptacles—120V UL SF

| DESCRIPTION                | CAT. NO. | COLOR*  |
|----------------------------|----------|---|
| 15A Duplex—Indicator Light | 5280-IG  | I, W, A, G, B, O<br><i>Basic Cat. No. Denotes Brown</i> |
| 20A Duplex—Indicator Light | 5380-IG  | I, W, G, B, O   |

### General Data

| SPECIFICATION  | DATA APPLICABLE TO ALL                       |
|--|--|
| Rated line voltage                                       | 120V (VRMS)                                  |
| Max. continuous operating voltage                        | 150V   |
| Max. single-pulse transient current (8x20µs, Amps peak)  | 24000A (L-N)<br>12000A (L-G)<br>12000A (N-G) |
| Rated single-pulse transient energy (10x1000µs, impulse) | 320 Joules                                   |
| Noise rejection @ 5kHz-5MHz                              | -35dB  |

### Clamping Performance

| SPECIFICATION  | DATA APPLICABLE TO ALL                                   |
|--|--|
| UL Standard 1449 (2nd Edition) permanently-wired test (8x20µs, 3000A); CSA and NOM Certified | (L-N): 400V Peak<br>(L-G): 400V Peak<br>(N-G): 400V Peak |

*Note: For Acenti Sixplex and Duplex Surge Protective Receptacles, see page A5*

#### SPECIFICATIONS AND FEATURES

- Provides hard-wired point-of use surge protection for electronic equipment in industrial, commercial and residential applications
- 3-Level surge protection for phase to neutral, phase to ground and neutral to ground
- All receptacles are back and side wired
- Hospital Grade versions (indicated by green dot on receptacle face) are suitable for high-abuse health care, industrial and commercial applications
- Isolated Ground versions (indicated by orange color or orange triangle on receptacle face) provide a pure ground path for use with isolated grounding systems
- Monitor/Indicator LED is ON continuously when protection is active and OFF when protection circuit is deactivated due to excessive transients
- All Hospital Grade devices and Cat. Nos. 7280 and 7380 Industrial devices also provide an audible tone alert that sounds if protection is lost
- EMI/RFI filtering
- Decora styling complements any interior and coordinates with Leviton's popular line of Decora devices

#### TESTING AND CODE COMPLIANCE

- UL Listed Standard 1449 (Edition 2.5)
- CSA certified
- Meets ANSI/IEEE C62.41 standards for both Categories A & B
- All SPD receptacles are backed by a Limited 10-Year Warranty

#### \*COLOR

Basic Cat. Nos. shown above denote Brown device, except Hospital Grade IG devices not available in Brown. Colors available as listed above, add suffix to basic catalog numbers as follows: Ivory (-I), White (-W), Almond (-A), Light Almond (-T), Gray (-G or -GY), Blue (-B), Orange (-O), Red (-R).

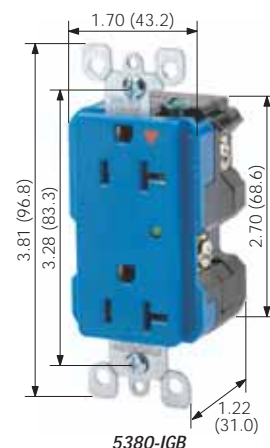
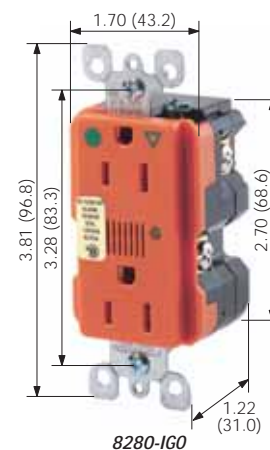

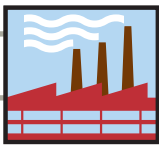

# FOUR-IN-ONE SURGE PROTECTION RECEPTACLES

## Industrial Grade Surge Protection Devices

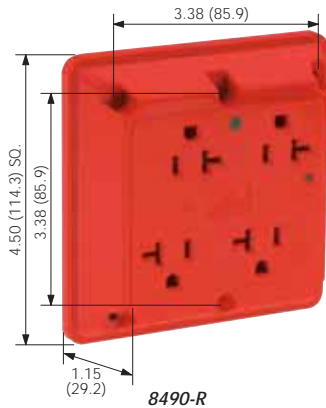

8490-R



3254-E



4254-Y

### Four-In-One Surge Protection Receptacles—120V

| DESCRIPTION   | CAT. NO. | COLOR*          |
|---|----------|-----------------|
| <i>Brown Not Available.<br/>For IG Devices, Basic Cat. No. Denotes Orange</i> |          |                 |
| 15A Hospital Grade Four-In-One  | 8480     | I, W, R         |
| 15A Hospital Grade Four-In-One Isolated Ground                                | 8480-IG  | I, W, B         |
| 20A Hospital Grade Four-In-One  | 8490     | I, W, R         |
| 20A Hospital Grade Four-In-One Isolated Ground                                | 8490-IG  | I, W, B         |
| 15A Industrial Grade Four-In-One  | 5480     | I, W, GY, BU, R |
| 15A Industrial Grade Four-In-One Isolated Ground                              | 5480-IG  | I, B            |
| 20A Industrial Grade Four-In-One  | 5490     | I, W, GY, BU    |
| 20A Industrial Grade Four-In-One Isolated Ground                              | 5490-IG  | I, B            |

### Four-In-One Adapter Plates

| CAT. NO.                            | COLOR*                  |
|-------------------------------------|-------------------------|
| <i>Basic Cat. No. Denotes Brown</i> |                         |
| 3254                                | I, W, GY, R, E, OR, BLU |

### Four-In-One Portable Boxes†

| CAT. NO.                   | COLOR*               |
|----------------------------|----------------------|
| <i>Brown Not Available</i> |                      |
| 4254                       | I, GY, E, OR, BLU, Y |

### General Data

| SPECIFICATION  | DATA FOR SURGE RECEPTACLES                   |
|--|--|
| Rated line voltage                                       | 120V (VRMS)                                  |
| Max. continuous operating voltage                        | 150V   |
| Max. single-pulse transient current (8x20µs, Amps peak)  | 24000A (L-N)<br>12000A (L-G)<br>12000A (N-G) |
| Rated single-pulse transient energy (10x1000µs, impulse) | 320 Joules                                   |
| Noise rejection @ 5kHz-5MHz                              | -35dB  |

### Clamping Performance

| SPECIFICATION  | DATA FOR SURGE RECEPTACLES                               |
|--|--|
| UL Standard 1449 (2nd Edition) permanently-wired test (8x20µs, 3000A); CSA and NOM Certified | (L-N): 330V Peak<br>(L-G): 400V Peak<br>(N-G): 400V Peak |

†Portable boxes are not UL Listed. UL Listing does not apply when Four-In-One receptacles are used with portable boxes for extension cord applications.

### SPECIFICATIONS AND FEATURES

#### Four-In-One Surge Protection Receptacles

- Replaces standard duplex receptacle with four surge-protected receptacles
- Ideal for locations where surge-protected receptacles are needed and plug-in devices can't be used
- 3-Level surge protection for phase to neutral, phase to ground and neutral to ground
- Hospital Grade versions (indicated by green dot on receptacle face) are suitable for high-abuse health care, industrial and commercial applications
- Isolated Ground versions (indicated by orange color or orange triangle on receptacle face) provide a pure ground path for use with isolated grounding systems

- Monitor/Indicator LED is ON continuously when protection is active and OFF when protection circuit is deactivated due to excessive transients

#### Four-In-One Adapter Plates & Portable Box

- Adapter plates not required with most standard wallboxes; provides popular "flush fit" look for any installation
- Portable Box designed for all Four-In-One Receptacles (not UL Listed for extension cord applications)
- Four-In-One Portable Box accepts #16/3 AWG Type SJ to #12/3 AWG Type SO COPPER Only

### TESTING AND CODE COMPLIANCE

- UL 1449 Edition 2.5
- Meets ANSI/IEEE C-62.41 & C-62.45 standards for both Categories A & B requirements
- CSA Certified (#152105)
- Backed by a Limited 10-Year Warranty

#### Four-In-One Adapter Plates

- UL Listed (File #E-13397 – Cat. No. 3254)

#### \*COLOR

Colors available as listed above. For IG devices, Basic Cat. No. denotes Orange device. Add suffix to basic catalog numbers as follows: Ivory (-I), White (-W), Gray (-GY), Blue (-B, -BU or -BLU), Black (-E), Orange (-OR), Red (-R), Yellow (-Y)

# PLUG-IN SURGE PROTECTION DEVICES

## Commercial Grade Surge Protection Devices



### S1000 & S2000 Series Plug Strips

| DESCRIPTION  | CAT. NO.  |
|--|-----------|
| S1000 Series Power Surge Strip (6 outlets)           | S1000-OPS |
| S1000 Series TELCO/ CATV/SAT Surge Strip (6 outlets) | S1000-PTC |
| S2000 Series Power Surge Strip (9 outlets)           | S2000-OPS |
| S2000 Series TELCO/ CATV/SAT Surge Strip (9 outlets) | S2000-PTC |

### Computer Grade Plug Strips

| DESCRIPTION  | CAT. NO. | RATING      | APPLICATION   |
|--|----------|-------------|---|
| 7-Outlet (6 switched, 1 continuously live) Strip; beige                              | 4950-PS  | 15A 125V AC | EMI/RFI noise attenuation for micro-processor-driven electronic equipment |
| 7-Outlet (6 switched, 1 continuously live) Strip w/Two RJ11 Phone Jacks; beige       | 4950-PST | 15A 125V AC | EMI/RFI noise attenuation for micro-processor-driven electronic equipment |
| 7-Outlet (6 switched, 1 continuously live) Strip w/Two F-type Coax Connectors; beige | 4950-PSC | 15A 125V AC | EMI/RFI noise attenuation for micro-processor-driven electronic equipment |

### Plug-In Surge Suppressors

| DESCRIPTION   | CAT. NO. | RATING      | APPLICATION   |
|---|----------|-------------|---|
| 6-Outlet (2 front, 4 side switched) Plug-in; beige                              | 4900-P   | 15A 125V AC | EMI/RFI noise attenuation for micro-processor-driven electronic equipment |
| 6-Outlet (2 front, 4 side switched) Plug-in w/Two RJ11 Phone Jacks; beige       | 4900-PT  | 15A 125V AC | EMI/RFI noise attenuation for micro-processor-driven electronic equipment |
| 6-Outlet (2 front, 4 side switched) Plug-in w/Two F-type Coax Connectors; beige | 4900-PC  | 15A 125V AC | EMI/RFI noise attenuation for micro-processor-driven electronic equipment |



S1000



S2000



4950-PSC



4900-P

### SPECIFICATIONS AND FEATURES

#### Plug Strips

- Ground pin to outside for more transformer configurations
- Diagnostic LEDs for surge protection, polarity and ground verification
- Resettable circuit breaker
- Power line carrier compatible
- Audible alarm indicates loss of protection
- Four non-skid rubber feet on the bottom

#### Computer Grade Plug Strips

- Provides excellent surge suppression & EMI/RFI noise attenuation for microprocessor-driven electronic equipment
- Three-stage protection: line-to-neutral, line-to-ground, neutral-to-ground
- Built-in overload circuit-breaker switch with reset button
- Indicator lights confirm unit is operating & properly grounded
- Clamping voltage: 330V all modes

#### Plug-Ins

- Provide excellent surge suppression & EMI/RFI noise attenuation for microprocessor-driven electronic equipment
- Indicator lights confirm unit is operating & properly grounded
- Audible alarm indicates protection is no longer active
- Clamping voltage: 330V all modes

### TESTING AND CODE COMPLIANCE

#### Plug Strips

- CSA Certified
- UL Listed 1449 Edition 2.5
- Meets ANSI/IEEE C62.41 Edition 2.5 and C62.45

#### Computer Grade Plug Strips

- UL Listed 1449
- Limited Lifetime Warranty

#### Plug-Ins

- UL Listed 1449
- Limited Lifetime Warranty



## RACK-MOUNT SURGE PROTECTION DEVICES

### Power Distribution Units with Surge Protection



#### 19" Rack-Mount PDU's with Surge Protection

| DESCRIPTION                                      | CAT. NO.        | RATING   |
|--|-----------------|----------|
| With ON/OFF Switch, NEMA 5-15P St. Blade Plug    | <b>5500-190</b> | 15A 125V |
| Without ON/OFF Switch, NEMA 5-15P St. Blade Plug | <b>5500-15N</b> | 15A 125V |
| With ON/OFF Switch, NEMA L5-15P Locking Plug     | <b>5500-15L</b> | 15A 125V |
| Without ON/OFF Switch, NEMA L5-15P Locking Plug  | <b>5500-NL</b>  | 15A 125V |
| With ON/OFF Switch, NEMA 5-20P St. Blade Plug    | <b>5500-192</b> | 20A 125V |
| With ON/OFF Switch, NEMA 5-15P St. Blade Plug    | <b>5505-190</b> | 15A 125V |
| Without ON/OFF Switch, NEMA 5-20P St. Blade Plug | <b>5500-20N</b> | 20A 125V |
| With ON/OFF Switch, NEMA L5-20P Locking Plug     | <b>5500-20L</b> | 20A 125V |
| Without ON/OFF Switch, NEMA L5-20P Locking Plug  | <b>5500-2NL</b> | 20A 125V |

#### General Data

| SPECIFICATION                     | 5500-190, 5505-190, 5500-15N,<br>5500-15L, 5500-NL | 5500-192, 5500-20N,<br>5500-20L, 5500-2NL |
|-----------------------------------|--|---|
| Rated line voltage (VRMS)         | 120V   | 120V                                      |
| Load current                      | 15A  | 20A                                       |
| Max. continuous operating voltage | 135V   | 135V                                      |
| Operating frequency range         | 50, 60Hz   | 50, 60 Hz                                 |

#### Performance Data

| SPECIFICATION  | 5500 SERIES | 5505 SERIES |
|--|-------------|-------------|
| Max. single-pulse transient current<br>(8x20μs, Amps peak) | 52kA        | 10kA        |
| Rated single-pulse transient energy<br>(10x1000μs, Joules) | 1440 Joules | 540 Joules  |
| Noise Rejection @ 100kHz – 30MHz                           | -5 to -40dB | -5 to -40dB |
| UL 1449 (2nd Ed) Impulse 6kV/500A                          | 330/330/330 | 400/400/400 |

#### SPECIFICATIONS AND FEATURES

##### 19" Rack Mount PDU's with Surge Protection

- Mounts on 19" equipment racks to provide point-of-use surge suppression for electronic equipment
- Clamping profile tightly tracks AC sine wave
- 6 protected duplex receptacles-5 in back, 1 in front
- Available with easy-access ON/OFF rocker-style switch, or without switch to avoid unnecessary equipment switching
- Resettable circuit breaker protects against over-loading & power supply failure
- Provided with 12-ft line cord with either NEMA 5-15P, L5-15P, 5-20P or L5-20P plug

#### TESTING AND CODE COMPLIANCE

##### 19" Rack Mount PDU's with Surge Protection

- UL Recognized Component tested to UL 1449 standards Edition 2.5
- Covered by a Lifetime Limited Downline Warranty

#### MATERIAL CHARACTERISTICS

Operating Temperature: -10°C to 60°C  
Storage Temperature: -35°C to 60°C



# VERTICAL (ZERO-U) AND RACK MOUNT DEVICES

## Commercial Grade Power Distribution Units



### 4505 Series 19" Rack Mount Power Distribution Units

| DESCRIPTION                          | CAT. NO. | RATING   | INPUT  | OUTPUT |
|--------------------------------------|----------|----------|--------|--------|
| [A] 10 Receptacle w/7 ft. power cord | 4505-20L | 120V 20A | L5-20P | 5-20R  |
| 10 Receptacle w/10 ft. power cord    | 4505-20T | 120V 20A | L5-20P | 5-20R  |
| 10 Receptacle w/15 ft. power cord    | 4505-20F | 120V 20A | L5-20P | 5-20R  |

### P1000 Series Vertical Power Distribution Units

| DESCRIPTION                           | CAT. NO.  | RATING   | INPUT  | OUTPUT |
|---------------------------------------|-----------|----------|--------|--------|
| 16 Receptacle w/10 ft. power cord     | P1040-10S | 120V 15A | 5-15P  | 5-15R  |
| [B] 16 Receptacle w/10 ft. power cord | P1041-10S | 120V 20A | 5-20P  | 5-20R  |
| 16 Receptacle w/10 ft. power cord     | P1042-10L | 120V 20A | L5-20P | 5-20R  |
| 24 Receptacle w/10 ft. power cord     | P1043-10S | 120V 20A | 5-20P  | 5-20R  |
| [C] 24 Receptacle w/10 ft. power cord | P1044-10L | 120V 20A | L5-20P | 5-20R  |
| 24 Receptacle w/10 ft. power cord     | P1045-10L | 120V 30A | L5-30P | 5-20R  |
| 24 Receptacle w/10 ft. power cord     | P1046-10L | 208V 20A | L6-20P | C13    |
| [D] 24 Receptacle w/10 ft. power cord | P1047-10L | 208V 30A | L6-30P | C13    |

### P1000 Series Horizontal Power Distribution Units

| DESCRIPTION                           | CAT. NO.  | RATING   | INPUT  | OUTPUT |
|---------------------------------------|-----------|----------|--------|--------|
| 10 Receptacle w/12 ft. power cord     | P1020-12S | 120V 15A | 5-15P  | 5-15R  |
| [E] 10 Receptacle w/12 ft. power cord | P1021-12S | 120V 20A | 5-20P  | 5-20R  |
| 10 Receptacle w/12 ft. power cord     | P1022-12L | 120V 20A | L5-20P | 5-20R  |
| 20 Receptacle w/12 ft. power cord     | P1023-12L | 120V 30A | L5-30P | 5-20R  |
| [F] 12 Receptacle w/12 ft. power cord | P1024-12L | 120V 20A | L6-20P | C13    |
| 12 Receptacle w/12 ft. power cord     | P1025-12L | 120V 30A | L6-30P | C13    |



A (30"L x 1.8"W x 1.75"D)



E (1.75"L x 17.5"W x 4.5"D)



F (30"L x 1.8"W x 1.75"D)

#### SPECIFICATIONS AND FEATURES

##### 4505 Series PDUs

- Mounts horizontally on 19" racks or cabinets
- 10 receptacles
- Resettable circuit breaker protects against overloading
- Most models available with locking plug
- 3-Year product warranty

##### P1000 Series

- Available in vertical zero-U or horizontal rack-mount styles
- Available in 120V or 208V options
- LED indicators for power and grounding/polarity
- All models feature circuit breaker protection to prevent current overloads

- 208V PDUs come with 2-pole circuit breakers for added safety
- 18AWG cold-rolled steel enclosure powder coated black
- Included mounting hardware allows attachment to most common cabinets and racks
- 120V/30A PDUs and all 208V PDUs come with DP-rated cords
- 3-Year product warranty

#### TESTING AND CODE COMPLIANCE

##### 4505 Series

- Meets UL Standard 1363

##### P1000 Series

- Certified to UL 1363 or UL 60950-1, RoHS compliant



B (30"L x 1.8"W x 1.75"D)

C (48"L x 1.8"W x 1.75"D)

D (48"L x 2.19"W x 2"D)

Surge Protection Devices

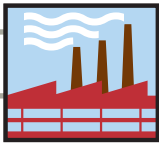

# VERTICAL (ZERO-U) AND RACK MOUNT DEVICES

## Commercial Grade Power Distribution Units



A

B

A (31.25"L x 1.75"W x 2.25"D  
54.0"L x 1.75"W x 2.25"D

B (31.25"L x 1.75"W x 2.25"D  
54.0"L x 1.75"W x 2.25"D  
45.75"L x 1.75"W x 2.25"D

### Metered Series Vertical Power Distribution Units

| DESCRIPTION                           | CAT. NO.  | INPUT RATING | INPUT  | OUTPUT RATING | OUTPUT |
|---------------------------------------|-----------|--------------|--------|---------------|--------|
| [A] 12 Receptacle w/modular cord*     | MV121-1D1 | 120V 20A     |        | 120V          | 5-20R  |
| 12 Receptacle w/10 ft. power cord     | MV121-1B1 | 120V 30A     | L5-30P | 120V          | 5-20R  |
| 24 Receptacle w/Modular cord*         | MV241-1D1 | 120V 20A     |        | 120V          | 5-20R  |
| [B] 24 Receptacle w/10 ft. power cord | MV241-1B1 | 120V 30A     | L5-30P | 120V          | 5-20R  |
| 12 Receptacle w/10 ft. power cord     | MV122-1C2 | 208V 30A     | L6-30P | 120V          | C13    |
| 24 Receptacle w/10 ft. power cord     | MV242-1C2 | 208V 30A     | L6-30P | 120V          | C13    |
| 21 Receptacle w/10 ft. power cord     | MV123-1E2 | 120/208V     |        |               |        |
| 3-Phase 20A                           | L21-20P   | 120V         | C13    |               |        |

\* 120V/20A PDUs need a Modular Power cord as shown in the "Accessories" below

### Metered Series Horizontal Power Distribution Units

| DESCRIPTION                           | CAT. NO.  | INPUT RATING | INPUT  | OUTPUT RATING | OUTPUT |
|---------------------------------------|-----------|--------------|--------|---------------|--------|
| [C] 10 Receptacle w/modular cord*     | MH101-1D1 | 120V 20A     |        | 120V          | 5-20R  |
| 10 Receptacle w/10 ft. power cord     | MH101-1B1 | 120V 30A     | L5-30P | 120V          | 5-20R  |
| [D] 12 Receptacle w/10 ft. power cord | MH122-1C2 | 208V 30A     | L6-30P | 208V          | C13    |

\* 120V/20A PDUs need a Modular Power cord as shown in the "Accessories" below

### Accessories

| DESCRIPTION                                 | CAT. NO.  |
|---|-----------|
| [E] Modular Power Cord, C19 to 5-15P, 10ft. | PCORD-G10 |
| Modular Power Cord, C19 to 5-20P, 10ft      | PCORD-A10 |
| Modular Power Cord, C19 to L5-20P, 10ft     | PCORD-H10 |



C

D

C & D (1.75"L x 17.25"W x 5"D)



E

### SPECIFICATIONS AND FEATURES

#### Metered Series PDUs

- LED display provides visible warning when current draw is close to maximum capacity thus avoiding circuit overload
- True RMS current monitoring prevents overloads in high-density computing environments
- Included mounting hardware allows attachment to most common cabinets and racks
- Available in vertical zero-u and horizontal rack-mount styles
- Available in 120V and 208V options
- A wide variety of input and output options ensures the flexibility to adapt to varying power requirements

### TESTING AND CODE COMPLIANCE

- Meets the UL 60950-1 requirements for branch circuit protection

# VERTICAL (ZERO-U) AND RACK MOUNT DEVICES

## Commercial Grade Power Distribution Units

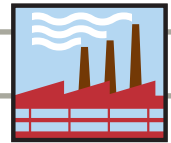

### Switched Series Vertical Power Distribution Units

| DESCRIPTION                           | CAT. NO.         | INPUT RATING | INPUT  | OUTPUT RATING | OUTPUT |
|---------------------------------------|------------------|--------------|--------|---------------|--------|
| [A] 16 Receptacle w/modular cord*     | <b>SV161-1D1</b> | 120V 20A     |        | 120V          | 5-20R  |
| 16 Receptacle w/10 ft. power cord     | <b>SV161-1B1</b> | 120V 30A     | L5-30P | 120V          | 5-20R  |
| [B] 16 Receptacle w/10 ft. power cord | <b>SV162-1C2</b> | 208V 30A     | L6-30P | 208V          | C13    |

\* 120V/20A PDUs need a Modular Power cord as shown in the "Accessories" below

### Switched Series Horizontal Power Distribution Units

| DESCRIPTION                          | CAT. NO.         | INPUT RATING | INPUT  | OUTPUT RATING | OUTPUT |
|--------------------------------------|------------------|--------------|--------|---------------|--------|
| [C] 8 Receptacle w/modular cord*     | <b>SH081-1D1</b> | 120V 20A     |        | 120V          | 5-20R  |
| 8 Receptacle w/10 ft. power cord     | <b>SH081-1B1</b> | 120V 30A     | L5-30P | 120V          | 5-20R  |
| [D] 8 Receptacle w/10 ft. power cord | <b>SH082-1C2</b> | 208V 30A     | L6-30P | 208V          | C13    |

\* 120V/20A PDUs need a Modular Power cord as shown in the "Accessories" below

### Accessories

| DESCRIPTION                                       | CAT. NO.         |
|---|------------------|
| [E] Modular Power Cord, C19 to 5-15P, 10ft.       | <b>PCORD-G10</b> |
| Modular Power Cord, C19 to 5-20P, 10ft            | <b>PCORD-A10</b> |
| Modular Power Cord, C19 to L5-20P, 10ft           | <b>PCORD-H10</b> |
| [F] Temperature & Relative Humidity Probe, 10 ft. | <b>TCORD-010</b> |



C & D (1.75"L x 17"W x 7"D)



E



F



A

B

A & B (63.5"L x 1.75"W x 2.25"D)

### SPECIFICATIONS AND FEATURES

#### Switched Series PDUs

- Remote individual outlet management allows shut down of unused outlets and remote rebooting of attached equipment
- Full featured network management provided via Web, SNMP, and Telnet allows remote access, configuration and management
- Power sequencing prevents in-rush current and avoids circuit overload
- Provides SNMP alerts when power or environmental conditions exceed thresholds
- Firmware is easily upgraded via network download to installed units for future product enhancements
- External probe available separately for environmental monitoring

Surge Protection Devices



# METER SOCKET SURGE ADAPTER and SECONDARY SURGE ARRESTER

## Residential Grade Surge Protection Devices

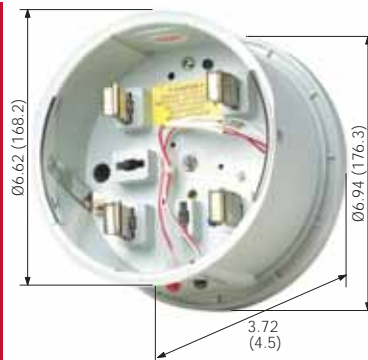

50240-MSA

### Meter Socket Surge Adapter

| DESCRIPTION  | CAT. NO.  | RATING               |
|--|-----------|----------------------|
| Meter Socket Surge Adapter w/LED's Only                                      | 50240-MSA | 120/240, 200A-4 Jaw  |
| Meter Socket Surge Adapter w/LED's and Audible Alarm (Switchable)            | 50240-ASA | 120/240, 200A-4 Jaw  |
| Meter Socket Surge Adapter w/LED's and 3Ø, 4-Wire Audible Alarm (Switchable) | 50208-ASA | 120/208, 200A-7 Jaw, |

### Secondary Surge Arresters

| DESCRIPTION   | CAT. NO.  | MCOV     | RATING   |
|---|-----------|----------|--|
| Secondary Surge Arrester                            | 54175-SSA | 150V AC* | 120/240, 200A                                      |
| Secondary Surge Arrester w/ LED's and Audible Alarm | 55175-ASA | 180V AC  | 120/240, 200A                                      |
| Secondary Surge Arrester                            | 55175-SSA | 180V AC  | 120/240, 200A                                      |
| Secondary Surge Arrester W/LEDs and Audible Alarm   | 55650-ASA | 480V AC  | 277/480V AC, 480V Delta<br>347/600V AC, 600V Delta |

\*MOV's rated at 150V. UL assigns a derated MCOV of 132V for surge arrester applications



54175-SSA



55175-ASA

### SPECIFICATIONS AND FEATURES

#### Meter Socket Surge Adapter

- Single 53mm MOV per line design (Line 1-Neutral, Line 2-Neutral) provides a higher energy capacity than smaller size (20mm) MOV's
- Superior to multiple small MOV configurations where the protection is only as good as the weakest MOV in the chain
- Rated for 65,000 peak amps maximum surge current
- Nominal clamping voltage per line: 800V
- Diagnostic LED's: Green indicates surge protection is active, Red indicates protection is no longer active

- Designed for 120/240 volt single-phase ringless or ring-type meters
- Rugged housing constructed of high-impact, non-conductive fiberglass-reinforced polycarbonate
- Available in popular jaw configurations, featuring spring-loaded, high-pressure copper-plated contacts for maximum conductivity

#### Secondary Surge Arresters

- Units come with 18" pigtail leads
- Constructed of high-impact, non-conductive, fiberglass-reinforced polycarbonate
- Compact design for easy installation

### TESTING AND CODE COMPLIANCE

- Surge arrester performance tested to IEEE C62.11 (10,000 amps/4 x 10 µs), IEEE C62.11, C62.41 & C62.45 Category C Standards
- UL Listed Surge Arrester (465V Discharge voltage @ 1500 amps) (#E146315)
- CSA Certified (#LR94773)
- Backed by a Limited 10-Year Warranty

### MATERIAL CHARACTERISTICS

Operating Temperature: -10°C to 60°C  
Storage Temperature: -20°C to 85°C



### General Purpose Plug-In's

| DESCRIPTION  | CAT. NO. | RATING   |
|--|----------|----------|
| 6-Outlet Plug-in w/Power & Circuit Monitor Lights<br>UL 1449 (All Modes) 400V  | 3500-P   | 15A 120V |
| 6-Outlet Plug-in w/two RJ11 Phone Jacks,<br>6 ft. Phone Cord, Power & Circuit Monitor Lights<br>UL 1449 (All Modes) 400V       | 3500-PT  | 15A 120V |
| 6-Outlet Plug-in w/two F Coax Cable Connectors,<br>4 ft. Coax Cable Power & Circuit Monitor Lights<br>UL 1449 (All Modes) 400V | 3500-PC  | 15A 120V |

### 51110 Series Residential Surge Protection Panels

| DESCRIPTION   | CAT. NO.  | RATING      |
|---|-----------|-------------|
| 1-Phase, 3-Wire & Ground  | 51110-1   | 120/240V AC |
| Multimedia Panel: 1-Phase, 3-Wire & Ground with<br>two pairs of phone/fax/modem terminals and<br>CATV/Satellite F-Connectors  | 51110-PTC | 120/240V AC |
| Multimedia Panel: 1-Phase, 3-Wire & Ground with<br>four pairs of phone/fax/modem terminals and<br>CATV/Satellite F-Connectors | 51110-CT8 | 120/240V AC |

### 51120 Series Surge Protection Panels

| DESCRIPTION   | CAT. NO.  | RATING      |
|---|-----------|-------------|
| 1-Phase, 3-Wire & Ground  | 51120-1   | 120/240V AC |
| 3-Phase WYE, 4-Wire & Ground  | 51120-3   | 120/208V AC |
| 1-Phase, 3-Wire & Ground;<br>NEMA 3R Outdoor Enclosure                                  | 51120-3R  | 120/240V AC |
| 1-Phase, 3-Wire & Ground; with RJ11 Telephone<br>and F-Connector CATV/Satellite Modules | 51120-PTC | 120/240V AC |

### Surge Protection Panel Performance Specifications

| CAT. NO.  | MCOV     | UL 1449 (2nd Ed)<br>IMPULSE (6kV/500A) |           | MAX. SURGE CURRENT<br>(Test w/8x20µs wave) |
|-----------|----------|--|-----------|--|
|           |          | L-N: 400V                              | L-L: 800V |  |
| 51110-1   | 150 V AC | L-N: 400V                              | L-L: 800V | L-N: 80kA                                  |
| 51110-PTC | 150V AC  | L-N: 400V                              | L-L: 800V | L-N: 80kA                                  |
| 51110-CT8 | 150V AC  | L-N: 400V                              | L-L: 800V | L-N: 80kA                                  |
| 51120-1   | 150V AC  | L-N: 500V                              | L-L: 800V | L-N: 50kA                                  |
| 51120-3   | 150V AC  | L-N: 500V                              | L-L: 800V | L-N: 50kA                                  |
| 51120-3R  | 180V AC  | L-N: 800V                              |           | L-N: 50kA                                  |
| 51120-PTC | 150V AC  | L-N: 500V                              | L-L: 800V | L-N: 80kA                                  |



3500-PT



51110-PTC



51120-1

#### SPECIFICATIONS AND FEATURES

##### General Purpose Plug-Ins

- RFI filtering
- 3-stage protection: hot-to-neutral, hot-to-ground, neutral-to-ground
- Built-in fuse protection
- Monitor lights ON indicates circuit is powered and protected

##### 51110 Series

- 51110-PTC provides protection for 2 telco lines and 2 coax feeds
- 51110-CT8 provides protection for 4 telco lines and 2 coax feeds
- Compatible with Decora Home Controls (see Section B)

##### 51120 Series

- Standard J-Box metal enclosures with pre-punched knockouts; 51120-3R features NEMA 3R enclosure
- Compatible with Decora Home Controls (see Section B)

#### TESTING AND CODE COMPLIANCE

- UL Listed 1449 Edition 2.5
- Meets ANSI/IEEE C62.41 & C62.45 requirements for Categories A, B & C
- Backed by a Limited 10-Year Warranty
- 51110 Series: CUL/US Certified
- 51120 Series: UL Listed and CSA Certified



# MODULAR SURGE PROTECTION STRIPS

## Residential Grade Surge Protection Devices



3950-BKT



Snap-In Surge Protection Modules

### Snap-In Modules for Structured Media Enclosure Surge Module Bracket

Leviton's snap-in surge protective modules provide customized surge protection for all low-voltage communication and data lines in the Structured Media Enclosure. All Series 5950 modules can snap-in to the Cat. No. 3950-BKT Surge Module Bracket. The bracket, allows you to add and change modules to fit specific protection needs. Choose from a selection of protection modules for Digital Satellite Systems, Ethernet systems, Cable TV, Telephone/Fax/Modem and DSL/ADSL equipment. All devices attached to the modules are covered under the Leviton \$50,000 Connected Equipment Warranty.

#### Snap-In Modules

| SPECIFICATION   | CAT. NO.  |
|---|---|
| Satellite System/Cable TV Protection Module—4 Standard F-connectors. 3-Amp fuse for over-current. Max. line voltage: 75V DC. Breakdown Voltage Range: 70.4-110 Volts/Sec  | Beige—5951-SA<br>Gray—5951-SAT<br>Ice—5951-SAC  |
| Ethernet Protection Module (10 Base-T Applications)—Two RJ45 connectors to protect two pair of transmit/receive lines. 10-Amp automatic Resettable PTC fuses. Max. operating voltage: 16.6V DC. Breakdown Voltage Range: 2.62-19.2 Volts/Sec  | Beige—5952-ET<br>Gray—5952-ETH<br>Ice—5952-ETC  |
| Cable TV System Protection Module—Two Standard F-type connectors. 3-Amp fuse for over-current. Max. line voltage: 75V DC. Breakdown Voltage Range: 70.4-110 Volts/Sec   | Beige—5953-PC<br>Gray—5953-PCG<br>Ice—5953-PCC  |
| Telephone/Fax/Modem Protection Module—Three RJ11, 4-wire/2-pair connectors. 3-Position splitter allows for connection to a common line. 3-Amp fuse for over-current protection. Max. operating voltage: 150V rms (including ring voltage). Breakdown Voltage Range: 162-331 Volts/Sec | Beige—5954-AT4<br>Gray—5954-PT4<br>Ice—5954-CT4 |
| DSL/ADSL Subscriber Equipment Protection Module—Three RJ11, 4-wire/2pair connectors. 3-Amp fuse for over-current protection. Max. operating voltage: 150V rms (including ring voltage). Breakdown Voltage Range: 162-331 Volts/Sec  | Beige—5955-DT<br>Gray—5955-DTG<br>Ice—5955-DTC  |
| Cat. 5 Ethernet Module<br>Two RJ45 Connectors with Ground Pin for Ethernet - Cat. 5   | Beige—5957-0CS<br>Grey—5957-C5G                 |
| Two Line Telephone Module<br>One Input, One Output RJ11 Connector for 4-Wire POTS   | Beige—5958-AT4<br>Grey—5958-PT4                 |
| Four Line Telephone Module<br>One Input, One Output RJ45 Connector for 8-Wire POTS  | Beige—5959-BT8<br>Grey—5959-GT8                 |
| Surge Module Bracket  | 3950-BKT  |

#### TESTING AND CODE COMPLIANCE

| CAT. NO. | MCOV (VDC) | CLAMPING VOLTAGE (VDC) | TESTED TO | MEET STANDARDS       |
|----------|------------|------------------------|-----------|----------------------|
| 5951     | 60         | 388                    | UL 452    | ANSI/IEEE<br>C-62.36 |
| 5952     | 16.6       | 23                     | UL497B    |                      |
| 5953     | 60         | 388                    | UL452     | CSA<br>(#LR-94773)   |
| 5954     | 288        | 715                    | UL497A    |                      |
| 5955     | 205        | 210                    | UL497A    |                      |
| 5957     | 16.6       | 23                     | UL497B    |                      |
| 5958     | 288        | 715                    | UL497A    |                      |
| 5959     | 288        | 715                    | UL497A    |                      |

#### SPECIFICATIONS AND FEATURES

- Interchangeable modules accommodate changing surge protection needs
- All modules easily snap in to the Cat. No. 3950 Surge Module Bracket
- User-friendly design—no wiring required
- Telephone/Fax/Modem Module acts as a splitter, allowing the connection of two devices



## Commercial Grade Uninterruptible Power Supplies (UPS's)

### Uninterruptible Power Supplies (UPS's)

Leviton's UPS product line offers the latest technology and features available to help prevent losses and costly downtime associated with outages, sags and blackouts for computers, data and telecom and other sensitive loads.

#### Sine Series Uninterruptible Power Supply (UPS's)

| DESCRIPTION                      | OUTPUT CAPACITY | FOOTPRINT      | OUTLET QTY & TYPE | TYPICAL BACK-UP TIME |           | CAT. NO.  |
|----------------------------------|-----------------|----------------|-------------------|----------------------|-----------|-----------|
|                                  |                 |                |                   | FULL LOAD            | HALF LOAD |           |
| Line-Interactive, True Sine Wave | 800VA/560W      | Tower          | (4) 5-15R         | 5 Min                | 14 Min    | U0800-SK  |
| Line-Interactive, True Sine Wave | 1000VA/700W     | Tower          | (4) 5-15R         | 5 Min                | 14 Min    | U1000-SK  |
| Line-Interactive, True Sine Wave | 1500VA/1050W    | Tower          | (6) 5-15R         | 5 Min                | 19 Min    | U1500-SK  |
| Line-Interactive, True Sine Wave | 2000VA/1400W    | Tower          | (6) 5-15R         | 10 Min               | 47 Min    | U2000-SK  |
| Line-Interactive, True Sine Wave | 3000VA/2100W    | Tower          | (6) 5-15R         | 10 Min               | 47 Min    | U3000-SK  |
| Line-Interactive, True Sine Wave | 800VA/560W      | Rack-mount, 2U | (4) 5-15R         | 10 Min               | 20 Min    | U0800-SRM |
| Line-Interactive, True Sine Wave | 1500VA/1050W    | Rack-mount, 2U | (4) 5-15R         | 5 Min                | 19 Min    | U1500-SRM |
| Line-Interactive, True Sine Wave | 3000VA/2100W    | Rack-mount, 2U | (6) 5-15R         | 10 Min               | 47 Min    | U3000-SRM |

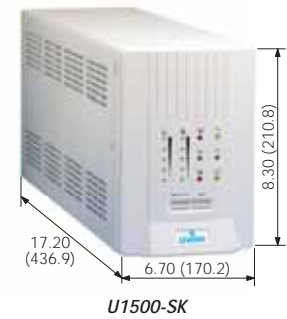

U1500-SK



U3000-VNL



U3000-VRM

#### On-Line Series Uninterruptible Power Supply (UPS's)

| DESCRIPTION             | OUTPUT CAPACITY | FOOTPRINT      | OUTLET QTY & TYPE | TYPICAL BACK-UP TIME |           | CAT. NO.  |
|-------------------------|-----------------|----------------|-------------------|----------------------|-----------|-----------|
|                         |                 |                |                   | FULL LOAD            | HALF LOAD |           |
| On-Line, Pure Sine Wave | 700VA / 490W    | Tower          | (6) 5-15R         | 7 Min                | 15 Min    | U0700-VNL |
| On-Line, Pure Sine Wave | 1000VA / 700W   | Tower          | (6) 5-15R         | 7 Min                | 15 Min    | U1000-VNL |
| On-Line, Pure Sine Wave | 1500VA / 1050W  | Tower          | (6) 5-15R         | 7 Min                | 11 Min    | U1500-VNL |
| On-Line, Pure Sine Wave | 2000VA / 1400W  | Tower          | (6) 5-15R         | 7 Min                | 15 Min    | U2000-VNL |
| On-Line, Pure Sine Wave | 3000VA / 2100W  | Tower          | (6) 5-15R         | 6 Min                | 15 Min    | U3000-VNL |
| On-Line, Pure Sine Wave | 700VA / 490W    | Rack-mount, 2U | (6) 5-15R         | 7 Min                | 15 Min    | U0700-VRM |
| On-Line, Pure Sine Wave | 1000VA / 700W   | Rack-mount, 2U | (6) 5-15R         | 7 Min                | 15 Min    | U1000-VRM |
| On-Line, Pure Sine Wave | 1500VA / 1050W  | Rack-mount, 2U | (6) 5-15R         | 7 Min                | 11 Min    | U1500-VRM |
| On-Line, Pure Sine Wave | 2000VA / 1400W  | Rack-mount, 2U | (6) 5-15R         | 7 Min                | 15 Min    | U2000-VRM |
| On-Line, Pure Sine Wave | 3000VA / 2100W  | Rack-mount, 2U | (6) 5-15R         | 6 Min                | 15 Min    | U3000-VRM |
| On-Line, Pure Sine Wave | 1000VA / 700W   | Rack-mount, 1U | (6) 5-15R         | 5 Min                | 11 Min    | U1000-DRM |

#### SPECIFICATIONS AND FEATURES

##### Sine Series Uninterruptible Power Supply

- Line-Interactive technology provides rapid transfer time (<4ms) and voltage regulation for minor sags and swells
- True sine-wave output less than 3% THD
- Selectable output voltage: 100V, 110V, 115V, 120V, or 127V
- Advanced Battery Management (ABM) extends battery life by up to 50%
- Included UPSMON software provides monitoring and control capability
- Energy-saving sleep mode reduces power consumption
- AC Surge Protection and Noise Filtering
- User-replaceable, sealed, maintenance-free lead acid batteries

##### On-Line Series Uninterruptible Power Supply

- On-Line Double Conversion technology with zero transfer time
- Provides true sine-wave output at less than 3% THD
- LED Display gives "Minutes Remaining" indicator based on actual load
- Selectable output voltage: 100V, 110V, 115V, 120V or 127V
- Advanced Battery Management (ABM) extends battery life by up to 50%
- Optional Extended Battery Packs provide additional back up time
- Included UPSMON software provides monitoring and control capability
- Energy-saving sleep mode reduces power consumption
- AC Surge Protection and Noise Filtering

- User-replaceable, sealed, maintenance-free lead acid batteries
- Includes interface for Emergency Power Off (EPO)

#### TESTING AND CODE COMPLIANCE

##### Sine Series Uninterruptible Power Supply

- UL 1778 & cUL Listed
- FCC compliant
- ISO 9001 Certified
- 2-Year Limited Product Warranty (covers parts, labor, and battery)
- 2-Year Limited Connected-Equipment Warranty

##### On-Line Series Uninterruptible Power Supply

- UL 1778 & cUL Listed
- 2-Year Limited Product Warranty (covers parts, labor, and battery)
- 2-Year Limited Connected-Equipment Warranty



# POWER QUALITY

## Commercial Grade Uninterruptible Power Supplies (UPS's)



U2200-AKP

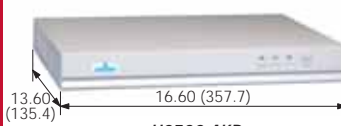

U0500-AKP



U0600-AKP Face



U0600-AKP Back



U0625-AKP Face



U0625-AKP Back

### Pro, Slim and Strip Series Uninterruptible Power Supplies (UPS's)

| DESCRIPTION                           | OUTPUT CAPACITY | FOOTPRINT      | OUTLET QTY & TYPE | TYPICAL BACK-UP TIME |           | CAT. NO.  |
|---------------------------------------|-----------------|----------------|-------------------|----------------------|-----------|-----------|
|                                       |                 |                |                   | FULL LOAD            | HALF LOAD |           |
| Line-Interactive, Simulated Sine Wave | 425VA / 297W    | Tower          | (6) 5-15R         | 4 Min                | 17 Min    | U0425-AKP |
| Line-Interactive, Simulated Sine Wave | 625VA / 437W    | Tower          | (6) 5-15R         | 4 Min                | 11 Min    | U0625-AKP |
| Line-Interactive, Simulated Sine Wave | 825VA / 578W    | Tower          | (6) 5-15R         | 6 Min                | 20 Min    | U0825-AKP |
| Line-Interactive, Simulated Sine Wave | 1000VA / 700W   | Tower          | (5) 5-15R         | 4 Min                | 13 Min    | U1000-AKP |
| Line-Interactive, Simulated Sine Wave | 1500VA / 1050W  | Tower          | (6) 5-15R         | 5 Min                | 18 Min    | U1500-AKP |
| Line-Interactive, Simulated Sine Wave | 2200VA / 1540W  | Tower          | (6) 5-15R         | 5 Min                | 22 Min    | U2200-AKP |
| Line-Interactive, Simulated Sine Wave | 500VA / 350W    | Desktop        | (5) 5-15R         | 5 Min                | 20 Min    | U0500-AKP |
| Line-Interactive, Simulated Sine Wave | 600VA / 420W    | Rack-mount, 1U | (5) 5-15R         | 7 Min                | 22 Min    | U0600-ARM |

#### SPECIFICATIONS AND FEATURES

- Line-Interactive technology provides rapid transfer time (<4ms) and voltage regulation for minor sags and swells
- Simulated sine-wave output
- Selectable output voltage: 100V, 110V, 115V, 120V or 127V
- Advanced Battery Management (ABM) extends battery life by up to 50%
- Included UPSMON software provides monitoring and control capability
- Energy-saving sleep mode reduces power consumption
- AC Surge Protection and Noise Filtering
- User-replaceable, sealed, maintenance-free lead acid batteries

#### TESTING AND CODE COMPLIANCE

- UL 1778 & cUL Listed
- FCC compliant
- ISO 9001 Certified
- 2-Year Limited Product Warranty (covers parts, labor, and battery)
- 2-Year Limited Connected-Equipment Warranty



# Lampholders

## INDEX

|   |          |
|---|----------|
| Overview  | S2       |
| <b>Incandescent Lampholders</b>                       |          |
| Outlet Box, Keyless and Pull Chain                    | S3, S4   |
| Metal Shell and Interiors                             | S5       |
| Phenolic Cap and Shell                                | S5       |
| Multi-Lampholder Clusters                             | S6       |
| Porcelain Par Connectors                              | S6       |
| Bayonet Socket-Single Contact                         | S6       |
| Porcelain Mogul Base                                  | S7       |
| Socket Extensions                                     | S8       |
| Appliance Heating Receptacle                          | S8       |
| Porcelain and Phenolic                                | S8       |
| Porcelain Snap-In                                     | S9       |
| Porcelain Keyless-Commercial Units                    | S9       |
| Porcelain Keyless Fixture                             |          |
| Single Circuit-Medium Base                            | S9       |
| Porcelain Keyless Medium Base-Side Angle Mounted      | S10      |
| Phenolic Keyless Fixture-Medium Base                  | S10      |
| Lampholders for Recessed Single Contact Lamps         | S10      |
| Lampholders for Metal Halide and Quartz Halogen Lamps | S10      |
| Candle Sockets  | S10-S12  |
| <b>Fluorescent Lampholders</b>                        |          |
| Compact Fluorescent Ceiling Lampholder                | S4       |
| Linear Fluorescent                                    | S13-S17  |
| Medium Bi-Pin   | S13-S15  |
| High Output   | S13, S14 |
| Slimline  | S13, S14 |
| Miniature   | S16      |
| T-8 to T-5 Adapter                                    | S16      |
| 4-Pin Long Twin Tube with 2G11 Base                   | S17      |
| Lamp Support Clips for Long Twin Tube                 | S18      |
| Compact Fluorescent Lampholders (CFL's)               | S19-S22  |

*For a complete listing of OEM products, see the OEM-100 Catalog.*



## LAMP HOLDERS

### A VARIETY OF INCANDESCENT AND FLUORESCENT STYLES IN A RANGE OF RATINGS AND MATERIALS

Leviton offers a complete selection of outlet box, incandescent, fluorescent and specialty lampholders, in various ratings and materials. The following pages offer a variety of types and styles.

#### PORCELAIN MEDIUM BASE LAMP HOLDER

With a choice of mounting and wiring options, these lampholders are ideal for a wide range of commercial and residential incandescent fixtures.

Cat. No. 8101 shown



#### OUTLET BOX LAMP HOLDER

Available in keyless, pull chain and outlet models, all featuring easy twist-lock mounting.

Cat. No. 8827-CW4 shown



#### LONG TWIN-TUBE 2G11 BASE LAMP HOLDERS

Choice of mounting and wiring options to reduce fixture assembly time.

Cat. No. 13453 shown



#### FLUORESCENT LAMP HOLDER FOR MEDIUM BI-PIN LAMPS

Features Lamp-Lock design for quick relamping. Models dedicated for energy-efficient T-8 lamps available.

Cat. No. 13653-WP shown



#### CANDELABRA BASE LAMP HOLDER

Keyless lampholders for chandeliers and other fixtures, featuring various hickeys or double snap-in spring clips.

Cat. No. 10014-800 shown



#### COMPACT FLUORESCENT LAMP HOLDERS

Available for all popular 2-pin and 4-pin lamp bases, with a variety of mounting options. Color-coded for easy wattage identification.

Cat. No. 26725-426 shown



#### PORCELAIN MOGUL BASE LAMP HOLDER

A complete selection of high-quality porcelain moguls with leads or screw terminals.

Pulse-rated models available. Cat. No. 8756 shown

#### METAL SHELL LAMP HOLDER

Medium base, electrolier lampholders available in a variety of attractive finishes. Cat. No. 9346-PG shown

## Medium Base Incandescent Lampholders



## Outlet Box Lampholders

660 WATT 600V One-Piece Keyless Top Wired  

| DESCRIPTION/<br>TERMINALS | WHITE UREA<br>CAT. NO. | OD     | FITS BOX SIZE |
|---------------------------|------------------------|--------|---------------|
| 2 Terminal Screws         | 8829-CW1               | 4 1/2" | 3 1/4" or 4"  |
| 6" Pigtail Leads          | 8829-CW2               | 4 1/2" | 3 1/4" or 4"  |
| 4 Terminal Screws         | 8829-CW4               | 4 1/2" | 3 1/4" or 4"  |

660 WATT 250V One-Piece Pull Chain Top Wired  

| DESCRIPTION/<br>TERMINALS                | WHITE UREA<br>CAT. NO. | OD     | FITS BOX SIZE |
|--|------------------------|--------|---------------|
| 2 Terminal Screws                        | 8827-CW1               | 4 1/2" | 3 1/4" or 4"  |
| 6" Pigtail Leads                         | 8827-CW2               | 4 1/2" | 3 1/4" or 4"  |
| 2 Terminal Screws<br>with Captive Clamps | 8827-CW4               | 4 1/2" | 3 1/4" or 4"  |

660 WATT 250V One-Piece Keyless Top Wired  

| DESCRIPTION/<br>TERMINALS     | PORCELAIN<br>CAT. NO. | OD     | FITS BOX SIZE |
|-------------------------------|-----------------------|--------|---------------|
| 2 Screws★                     | 9874                  | 3 3/4" | 3 1/4"        |
| 2 Screws, no cage lip         | 9875                  | 4 1/2" | 3 1/4" or 4"  |
| 6" Pigtail Leads, no cage lip | 9875-2                | 4 1/2" | 3 1/4" or 4"  |
| 4 Screws                      | 49875                 | 4 1/2" | 3 1/4" or 4"  |
| 4 Quickwire Push-In★          | 9883                  | 4 1/2" | 3 1/4" or 4"  |

660 WATT 250V One-Piece Pull Chain Top Wired  

| DESCRIPTION/<br>TERMINALS                                 | PORCELAIN<br>CAT. NO. | OD     | FITS BOX SIZE |
|---|-----------------------|--------|---------------|
| 2 Screws  | 29816-C               | 4 1/2" | 3 1/4" or 4"  |
| 6" Pigtail Leads  | 29816-C2              | 4 1/2" | 3 1/4" or 4"  |
| 2 Screws w/Captive Clamps<br>for 4-Wire Terminals         | 49816-C               | 4 1/2" | 3 1/4" or 4"  |
| Interior Mechanism for<br>2-Piece Outlet Box Lampholders★ | 29816-CM*             |        |               |

\*When existing stock is depleted, this item will be DISCONTINUED.

CSA Certified except where indicated by★



8827-CW2



9875-2



29816-C

## SPECIFICATIONS AND FEATURES

- Twist-lock mounting
- Pull chain models have bell at end of chain on 3 foot cord
- Medium base

## TESTING AND CODE COMPLIANCE

- UL Listed (File #E-3810)
- CSA Certified (File #LR-1863)



660W 125V — 15 AMP-125V • 120W 250V

## Medium Base Incandescent and GU24 Base Fluorescent Lampholders



9716-C

### Outlet Box Lampholders

#### 660 WATT 125V Lampholder Outlet 15 AMP-125V One-Piece Pull Chain Side Wired <sup>UL</sup>

| DESCRIPTION/<br>TERMINALS | PORCELAIN | OD     | FITS BOX SIZE | NEMA CONFIG.  |
|---------------------------|-----------|--------|---------------|---|
| 2 Screws★                 | 9716-C    | 4 1/2" | 3 1/4" or 4"  | 1-15R  |

#### 660 WATT 125V Lampholder Outlet 15 AMP-125V One-Piece Pull Chain Top Wired <sup>UL</sup> <sup>SB</sup>

| DESCRIPTION/<br>TERMINALS | PORCELAIN | OD     | FITS BOX SIZE | NEMA CONFIG.  |
|---------------------------|-----------|--------|---------------|---|
| 2 Screws                  | 9726-C    | 4 1/2" | 3 1/4" or 4"  | 5-15R  |



9726-C

### Ball and Chain Accessories

| DESCRIPTION                  | BRASS FINISH | NICKEL FINISH |
|------------------------------|--------------|---------------|
| No. 6 Chain; 1/8" Dia. Balls | 18302-1      | 18302-1N      |



18302-1N

| DESCRIPTION               | BRASS FINISH | NICKEL FINISH |
|---------------------------|--------------|---------------|
| Connector for No. 6 Chain | 9820         | 9820-N        |



9820

| DESCRIPTION   | BRASS FINISH | NICKEL FINISH |
|---|--------------|---------------|
| Chain, 3 feet long, End Bell and Connector; use as extension or replacement; 1/25" Dia. Balls | 6            | 6-N           |



6

| DESCRIPTION   | BROWN | WHITE  |
|---|-------|--------|
| Insulating Link; Thermoplastic<br>1 3/4" Total Length | 9839  | 9839-I |



9839-I

CSA Certified except where indicated by★

### GU24 Base Fluorescent Lampholder

#### Energy-Saving Keyless Bi-Pin Compact Fluorescent Ceiling Lampholder for Closets and Closed Spaces 120 WATT 250V AC <sup>cULus</sup>

| DESCRIPTION  | CAT. NO. |
|--|----------|
| Lampholder with pigtail leads and knockout holes for multiple configurations                               | 9860     |
| Lampholder with pigtail leads and knockout holes for multiple configurations; with 13W Bulb                | 9860-B   |
| Lampholder with pigtail leads and knockout holes for multiple configurations; with 13W Bulb and Lamp Guard | 9860-BL  |
| Lamp Guard   | 9860-L   |
| 13W Replacement Lamp   | 9865     |

Note: Not intended for use with incandescent lamps, dimmers or occupancy sensors.



9860

#### SPECIFICATIONS AND FEATURES

##### Outlet Box Incandescent Lampholders

- 2-Pole, 2-Wire Outlet; 2-Pole, 3-Wire Outlet
- Twist-lock mounting
- Pull chain models have bell at end of chain on 3 foot cord

##### Fluorescent Ceiling Lampholder\*

- Installs indoors in closets, garages, basements, utility rooms and attics
- Reduces risk of fire in closets and closed spaces
- Built of tough thermoplastic
- Use with a standard wall switch
- Pigtail leads provide easy installation

- Knockout holes on box enable multiple configurations
- \* Patent pending

#### TESTING AND CODE COMPLIANCE

##### Outlet Box Incandescent Lampholders

- UL Listed (File #E-3810; E-7516)
- CSA Certified (File #LR-1863)

##### Fluorescent Ceiling Lampholder

- cULus Listed
- Meets NFPA 70, NEC Section 410.8B Requirements and Canadian Electric Code Requirements for use in closets with lamp guard
- Backed by a Limited Two-Year Warranty



### Metal Shell Lampholders

Medium Base, Choice of Finishes\*

| DESCRIPTION   | CAT. NO. | RATING    |
|---|----------|-----------|
| Key—Electrolier; Single Circuit; 1/8 IPS Tapped Bushing w/Set Screw                           | 9346     | 250W 250V |
| Removable Turn Knob—Electrolier; Single Circuit; 1/8 IPS Tapped Bushing w/Set Screw           | 10083-16 | 250W 250V |
| Removable Turn Knob—Electrolier; 2-Circuit; 3 Terminal; 1/8 IPS Tapped Bushing less Set Screw | 7070     | 250W 250V |
| Removable Turn Knob—Electrolier; 2-Circuit; 1/8 IPS Tapped Bushing                            | 7090     | 250W 250V |
| Pull Chain—Electrolier; Single Circuit; 1/8 IPS Tapped Bushing w/Set Screws                   | 19980    | 660W 250V |
| Push Through—Electrolier; Single Circuit; 1/8 IPS Tapped Bushing w/Set Screw                  | 7080     | 660W 250V |
| Keyless—Electrolier; Single Circuit; 1/8 IPS Tapped Bushing w/Set Screw                       | 8004     | 660W 250V |
| Keyless—Short Electrolier; Single Circuit; 1/8 IPS Tapped Bushing w/Set Screw                 | 9347     | 660W 250V |

### Metal Shell Lampholders

Interiors — Medium Base, Phenolic Body, Aluminum Screw Shell†

| LAMPHOLDER | CAT. NO. INTERIOR |
|------------|-------------------|
| 19980      | 19980-M†          |
| 10083-16   | 10083-M†          |
| 7070       | 7070-M†           |
| 7090       | 7090-M†           |
| 9346       | 9346-M†           |
| 6098       | 7080-M†           |
| 8004       | 8004-M†           |

### Brown Phenolic Cap and Shell Lampholders

Two-Piece, Medium Base Electrolier Interiors

| DESCRIPTION  | CAT. NO. | RATING    | INTERIORS† |
|--|----------|-----------|------------|
| Pull Cord (nylon); 2-Circuit, 1/8 IPS Threaded Cap w/Set Screw | 97092    | 250W 250V | 7092-2M†   |
| Push-Through; 1/8 IPS Threaded Cap w/Set Screw                 | 95110    | 660W 250V | 7080-M†    |
| Keyless; 1/8 IPS Threaded Cap w/Set Screw                      | 95080    | 660W 250V | 8004-M†    |

†UL Recognized component.

NOM Certified except where indicated by†.

#### SPECIFICATIONS AND FEATURES

- Phenolic interior with aluminum screwshell
- 2-Circuit lampholders operate dual-filament lamps in sequence of Low-Medium-High-Off
- Cat. No. 7070 (2-Circuit, 3-Terminal) is wired in series with keyless lampholder

#### TESTING AND CODE COMPLIANCE

- UL Listed (File #E-3810)
- CSA Certified (File #LR-1863)
- NOM Certified (File #057), except interiors

#### \*FINISH

A suffix must be added to each basic catalog number to indicate the finish desired. For Polished Gilt/Brass finish, add -PG; for Unfinished Aluminum, add -AL; for Polished Aluminum, add -NI (finishes on aluminum). For bright dip/Brass, add -BR (finish on brass). CONSULT LEVITON REPRESENTATIVE FOR AVAILABILITY OF FINISHES.

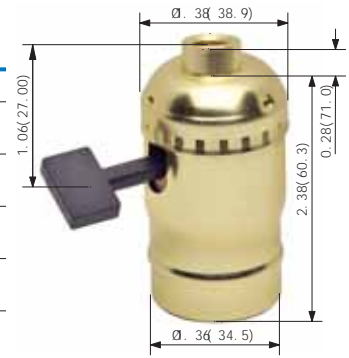

9346



7090

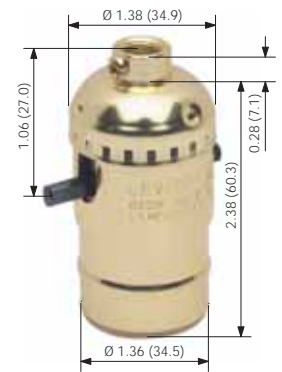

7080

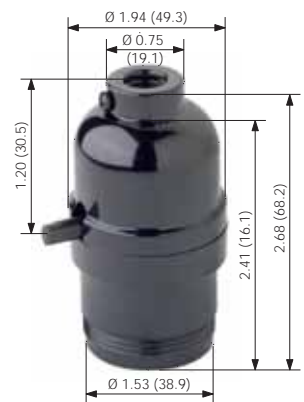

95110



660W 250V

## Medium, Candelabra Base, Par Connectors—Incandescent Lampholders

Incandescent Lampholders

### Medium Base Multi-Lampholder Clusters

Treated Aluminum Screw Shell

| DESCRIPTION  | CAT. NO. | RATING                 | T                               | TA                             | B                               | BA                             | OAH T+B                           |
|--|----------|------------------------|---------------------------------|--------------------------------|---------------------------------|--------------------------------|-----------------------------------|
| 2-Light Twin 1/8 IPS Male Top Bracket Only   | 4020-A3A | 660W 250V              | 1 <sup>5</sup> / <sub>16</sub>  | 5 <sup>1</sup> / <sub>16</sub> | —                               | —                              | —                                 |
| 2-Light Twin 1/8 IPS Male (top & bottom)   | 4015-D4F | 660W 250V              | 1 <sup>11</sup> / <sub>16</sub> | 5 <sup>1</sup> / <sub>16</sub> | 1 <sup>11</sup> / <sub>16</sub> | 7 <sup>1</sup> / <sub>16</sub> | 3 <sup>3</sup> / <sub>8</sub>     |
| 2-Light Offset 1/8 IPS Male (top & bottom)   | 4032-E5F | 660W 250V              | 1 <sup>3</sup> / <sub>4</sub>   | 5 <sup>1</sup> / <sub>16</sub> | 1 <sup>3</sup> / <sub>4</sub>   | 7 <sup>1</sup> / <sub>16</sub> | 3 <sup>11</sup> / <sub>16</sub>   |
| 3-Light 1/8 IPS Male (top & bottom)†   | 341-D4U  | 660W 250V              | 1 <sup>3</sup> / <sub>4</sub>   | 1 <sup>1</sup> / <sub>2</sub>  | 1 <sup>3</sup> / <sub>4</sub>   | 7 <sup>1</sup> / <sub>16</sub> | 3 <sup>1</sup> / <sub>2</sub>     |
| 2-Light Offset 1/8 IPS Male (top); Pullchain Switch (bottom) with 1/2" usable shank★ | 4034-F5A | 660W 250V<br>1A 125V T | 1 <sup>3</sup> / <sub>4</sub>   | 5 <sup>1</sup> / <sub>16</sub> | 1 <sup>15</sup> / <sub>16</sub> | 1 <sup>1</sup> / <sub>2</sub>  | 3 <sup>3</sup> / <sub>4</sub> †   |
| 2-Light Twin 1/8 IPS Male (top); Pullchain Switch (bottom) 3/8" usable shank★        | 4017-D2F | 660W 250V<br>1A 125V T | 1 <sup>1</sup> / <sub>16</sub>  | 5 <sup>1</sup> / <sub>16</sub> | 1 <sup>11</sup> / <sub>16</sub> | 3 <sup>3</sup> / <sub>8</sub>  | 2 <sup>13</sup> / <sub>16</sub> † |

+Includes nut.

Leads are No. 18 AWG 105°C plastic; 9" long, stripped 3/4"; untinned and pulled through top bracket.

### Porcelain Par Connectors

| DESCRIPTION  | CAT. NO. | RATING     |
|--|----------|------------|
| Medium Base for PAR #46 and #38 lamps. Leads are No. 14 AWG 200°C SEW-2 Silicone Rubber Insulated; 18" Long, Stripped 3/4". Others available on inquiry‡ | 368-1    | 660W 125V  |
| Mogul Base for PAR #56 and #64 lamps. Leads are No. 14 150°C SEWF-2; 18" Long, Stripped 3/4". Others available upon request                              | 357-8    | 1000W 125V |

### Bayonet Socket — Single Contact

#### Candelabra Base

| DESCRIPTION  | CAT. NO. | RATING      |
|--|----------|-------------|
| Flat Bracket. Leads are No. 18 AWG, 105°C Plastic; 6" Long, Stripped 3/4" (one black, one white)★‡ | 905      | Low Voltage |

All devices are UL Listed except Cat. No. 905. Also CSA Certified except where indicated by★, and NOM Certified except where indicated by‡.



4034-F5A



341-D4U



4032-E5F

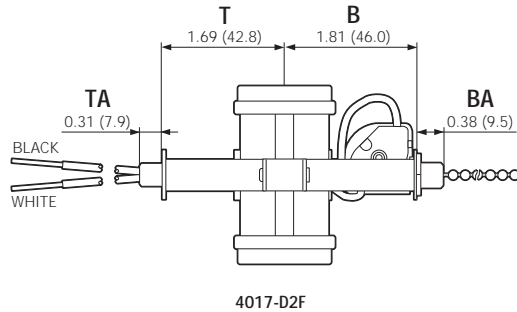

4017-D2F

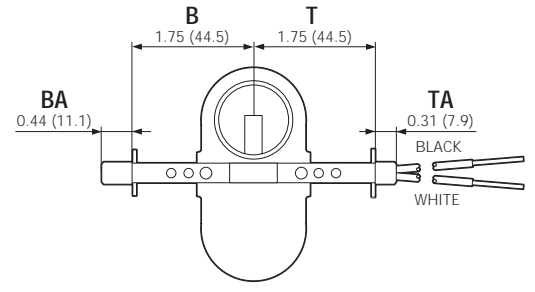

4032-E5F

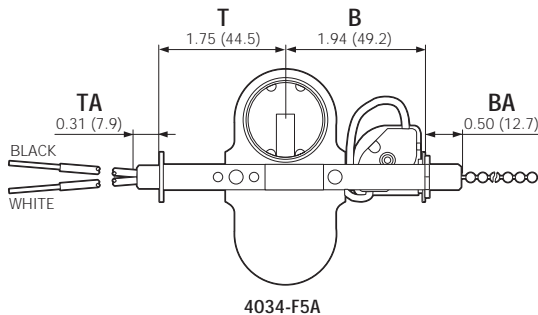

4034-F5A

#### SPECIFICATIONS AND FEATURES

- Pull chain models have bell at end of chain on 3 foot cord
- Medium and Candelabra bases
- Par connectors have white, unglazed porcelain body

#### TESTING AND CODE COMPLIANCE

- UL Listed (File #E-13405, E-3810)
- CSA Certified (File #LR-5863, LR-1863)
- NOM Certified (File #057)



Porcelain Mogul Base Lampholders

With Leads\*

| DESCRIPTION   | CAT. NO. | RATING                         | OD     | OH      |
|---|----------|--------------------------------|--------|---------|
| Keyless, Single Circuit. For high pressure sodium lamps up to 1000 watts.<br>8-32 Mounting Screws on 1 3/8" Centers                               | 8746     | 1500W 600V<br>5KV Pulse-rated  | 2 1/8  | 3 1/64  |
| Keyless, Single Circuit. Position-oriented.<br>For Super Metalarc HID lamps.<br>8-32 Mounting Screws on 1 3/8" Centers                            | 8750     | 1500W 600V                     | 2 5/32 | 2 39/64 |
| Keyless, Single Circuit. For high-pressure sodium lamps up to 400 watts.<br>8-32 Mounting Screws on 1 3/8" Centers                                | 8756     | 1500W 600V<br>4KV Pulse-rated  | 2 5/32 | 2 39/64 |
| Low Pressure Sodium. For use with all single-end bayonet base low pressure sodium lamps★‡   | 8806     | 660W 1000V                     | 1 3/8  | 1 5/8   |
| Designed for Open-Fixture Shielded Metal Halide Lamps. Complies with NFPA 70-2005 for Open-Rated Fixtures. 8-32 Mounting Screws on 1 3/8" Centers | 8751     | 1500W 600V,<br>4KV Pulse Rated | 2 5/32 | 2 39/64 |

\* Leads types, lengths and ratings vary with the end use applications. Standard leads as well as variations available on inquiry.

Screw Terminals

| DESCRIPTION  | CAT. NO. | RATING     | OD     | OH      |
|--|----------|------------|--------|---------|
| Keyless; 2-Piece; Single-Pole★   | 8765     | 1500W 600V | 2 5/16 | 2 23/64 |
| Keyless; Single Circuit with 8-32 Lock Nuts on 1 3/8" Centers.<br>Die-cast caps available upon request | 8694     | 1500W 600V | 2 5/32 | 2 39/64 |

CSA Certified except where indicated by★, and NOM Certified except where indicated by‡.



8746



8750



8694

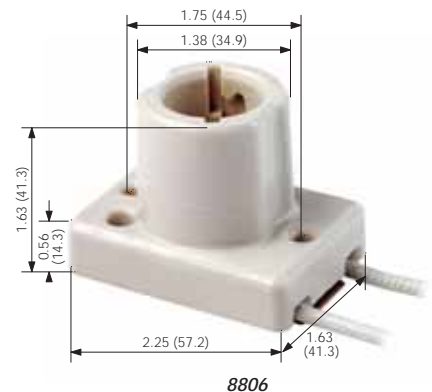

8806

SPECIFICATIONS AND FEATURES

- Cat. No. 8746 – Porcelain body gray glazed with ceramic arc shield; Cat. No. 8750 – Porcelain body yellow glazed; Cat. No. 8751 – Porcelain body pink glazed
- All other moguls listed have white glazed porcelain body
- Copper-alloy nickel-plated screw shell

TESTING AND CODE COMPLIANCE

- UL Listed (File #E-13402)
- CSA Certified (File #LR-1863)
- NOM Certified (File #057)
- Cat. No. 8751 complies with NFPA 70-2005 requirements for open-rated fixtures



660W 250V • 1500W 600V

## Medium, Mogul and Candelabra Base Incandescent Lampholders



2005



19062



9880

### Socket Extensions — Single Circuit

#### Medium-Medium

| DESCRIPTION   | CAT. NO. | RATING    |
|---|----------|-----------|
| 2-Piece Porcelain; Mounting Hole 1 <sup>3</sup> / <sub>8</sub> " Dia. Extension 1 <sup>1</sup> / <sub>4</sub> "**         | 2004     | 660W 250V |
| 1-Piece Porcelain; Slotted Mounting Hole 1 <sup>3</sup> / <sub>8</sub> " Dia. Extension 1 <sup>1</sup> / <sub>4</sub> "** | 2005     | 660W 250V |
| 1-Piece Phenolic. Extension 1 <sup>3</sup> / <sub>16</sub> "***   | 2006     | 660W 250V |

\*To be used with porcelain sockets only

\*\*To be used with phenolic sockets only

#### Mogul-Mogul

| DESCRIPTION   | CAT. NO. | RATING     |
|---|----------|------------|
| 1-Piece Porcelain. Extension 2 <sup>3</sup> / <sub>8</sub> "† | 8647     | 1500W 600V |

### Socket Adapter

#### Mogul-To-Porcelain Medium

| DESCRIPTION                             | CAT. NO. | RATING                        |
|---|----------|-------------------------------|
| 1-piece. Meets Fed. Spec. W-L-142a†     | 8681     | 660W 250V                     |
| Same as above, except 4 KV Pulse-Rated‡ | 8681-400 | 660W 250V<br>4 KV Pulse-Rated |

### Appliance Heating Receptacle

#### Porcelain Two-Piece

| DESCRIPTION                                   | CAT. NO. | RATING    |
|---|----------|-----------|
| 2-piece Heating Receptacle. Gasket Furnished‡ | 8110     | 660W 250V |

### Porcelain and Phenolic Lampholders

#### Pony Cleat Type

| DESCRIPTION                               | CAT. NO. | RATING    | OD                             | OH                            | C                               |
|---|----------|-----------|--------------------------------|-------------------------------|---------------------------------|
| Candelabra Base; Plastic. Not UL Listed★† | 10028    | 75W 125V  | 1 <sup>7</sup> / <sub>16</sub> | 7/8                           | 1 <sup>1</sup> / <sub>8</sub>   |
| Miniature Base, Plastic. Not UL Listed★†  | 10020    | 75W 125V  | 1 <sup>5</sup> / <sub>16</sub> | 7/8                           | 3 <sup>1</sup> / <sub>32</sub>  |
| Medium Base, Phenolic                     | 9063     | 660W 250V | 1 <sup>7</sup> / <sub>8</sub>  | 1 <sup>1</sup> / <sub>2</sub> | 1 <sup>15</sup> / <sub>16</sub> |
| Medium Base, Porcelain                    | 19062    | 660W 250V | 1 <sup>7</sup> / <sub>8</sub>  | 1 <sup>1</sup> / <sub>2</sub> | 1 <sup>15</sup> / <sub>16</sub> |

#### Surface Type

| DESCRIPTION                            | CAT. NO. | RATING    | OD                             | OH                            | C                             |
|--|----------|-----------|--------------------------------|-------------------------------|-------------------------------|
| Medium Base; Porcelain; Low 2-Piece    | 9880     | 660W 250V | 2 <sup>5</sup> / <sub>16</sub> | 1 <sup>1</sup> / <sub>2</sub> | 1 <sup>3</sup> / <sub>8</sub> |
| Medium Base; Porcelain; High 2-Piece★† | 9882     | 660W 250V | 2 <sup>5</sup> / <sub>16</sub> | 1 <sup>7</sup> / <sub>8</sub> | 1 <sup>3</sup> / <sub>8</sub> |

CSA Certified except where indicated by★, and NOM Certified except where indicated by†.

#### SPECIFICATIONS AND FEATURES

- Medium-to-Medium Extenders available in phenolic and porcelain
- Pony Cleat Receptacles have open wiring terminals
- Two-piece surface-type lampholders have concealed wiring terminals with wireways for top and continuous wiring

#### TESTING AND CODE COMPLIANCE

- UL Listed (File #E-3810; E-13396)
- CSA Certified (File #LR-1863)
- NOM Certified (File #057)





## Medium Base Incandescent Lampholders

### Porcelain Snap-In Lampholders — Medium Base

#### Screw Terminals

| DESCRIPTION   | CAT. NO.    | RATING    | OD      | OH      |
|---|-------------|-----------|---------|---------|
| 1-Piece, Front Mounted. 1/4" Shoulder.<br>Panel Thickness: .025 – .062" | <b>8880</b> | 660W 250V | 1 11/16 | 1 1/2   |
| 1-Piece, Front Mounted. Shallow Back.<br>Panel Thickness: .030 – .062"  | <b>8875</b> | 660W 250V | 1 11/16 | 1 11/16 |

### Porcelain Keyless Lampholders Commercial Units — Medium Base

#### Single Circuit Screw Terminals

| DESCRIPTION  | CAT. NO.     | RATING    | OD            | OH                  |
|--|--------------|-----------|---------------|---------------------|
| Straight Body with Cap. Screw Terminals.   | <b>10045</b> | 660W 250V | 1 1/2         | 2 1/8               |
| Beaded Body for 1 1/2" Clamp Style<br>Shadeholder with Cap.<br>Screw Terminals.                                | <b>10065</b> | 660W 250V | Body 1 1/2    | 2 1/8<br>Bead 1 5/8 |
| Adjustable Glass Retaining Ring with<br>Cap and Ring Nut. Screw Terminals.                                     | <b>20070</b> | 660W 250V | 2 1/4 ringnut | —                   |
| Straight Body with Leads. No. 18 AWG<br>105°C Plastic; 9" Long, Stripped 3/4"<br>with Two 6/32 Mounting Screws | <b>10085</b> | 660W 250V | 1 1/2         | 1 11/16             |

### Porcelain Keyless Fixture Single Circuit — Medium Base

#### Screw Terminals

| DESCRIPTION  | CAT. NO.      | RATING    | OD      | OH     |
|--|---------------|-----------|---------|--------|
| 1-Piece, Front Mounted for Fixture or<br>Sign Use. Tapped 8-32 Bushings,<br>Mounting Centers 1 13/16". | <b>9885</b>   | 660W 600V | 1 5/8   | 1 7/16 |
| 2-Piece, Ring Type   | <b>9350</b>   | 660W 250V | 1 3/4   | 1 3/8  |
| 1-Piece with Removable Strap★  | <b>8871</b>   | 660W 250V | 1 11/16 | 1 9/16 |
| Fixture Pan Lampholder with<br>1/8" IPS Hickey   | <b>3152-8</b> | 660W 250V | 1 3/8   | 1 7/16 |

#### Leads

| DESCRIPTION   | CAT. NO.         | RATING                        | OD      | OH     |
|---|------------------|-------------------------------|---------|--------|
| 2-Piece Ring Type with Leads: No. 18 AWG,<br>105°C Plastic; 9" Long, Stripped 3/4"  | <b>8101</b>      | 660W 250V                     | 1 3/4   | 1 3/8  |
| Angle Pan with Leads: No. 18 AWG Type AF<br>150°C Plastic; 9" Long, Stripped 3/4"   | <b>18315</b>     | 660W 250V                     | —       | —      |
| Removable Bracket with Leads  | <b>8052-1</b>    | 660W 250V                     | 1 3/8   | 1 7/16 |
| Screw-Mount Pulse-Rated Lampholder with<br>Leads for Open-Fixture Lamps; 18 AWG 200°C<br>600V SEW-2 (SF-2) wire; 9" Long, Stripped 1/2" | <b>70052-100</b> | 660W 600V,<br>4KV Pulse Rated | 1 45/64 | 2 9/32 |

#### Two-Piece Pull Chain

| DESCRIPTION                                       | CAT. NO.    | RATING    | OD      | OH      |
|---|-------------|-----------|---------|---------|
| Ring Type; Screw Terminals;<br>Gasket Furnished★† | <b>9814</b> | 250W 250V | 1 13/16 | 1 13/16 |

CSA Certified except where indicated by★, and NOM Certified except where indicated by†.

#### SPECIFICATIONS AND FEATURES

- Suitable for a wide variety of fixtures, signs and displays
- Unglazed base and ring on two-piece lampholders
- Gasket supplied with two-piece ring type rated at 90°C dry maximum

#### TESTING AND CODE COMPLIANCE

- UL Listed (File #E-3810)
- CSA Certified (File #LR-1863)
- NOM Certified (File #057)



8880

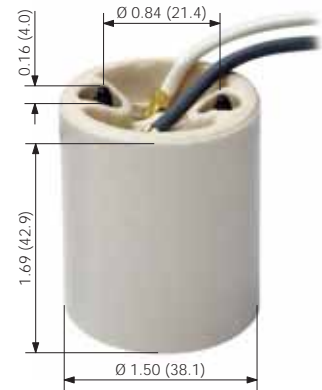

10085



3152



8101



660W 600V • 660W 250V • 250W 250V • 3000W 600V

## Medium Base, Metal Halide and Quartz Halogen Incandescent Lampholders

Incandescent Lampholders

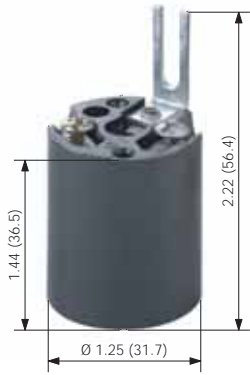

3352-1



4005

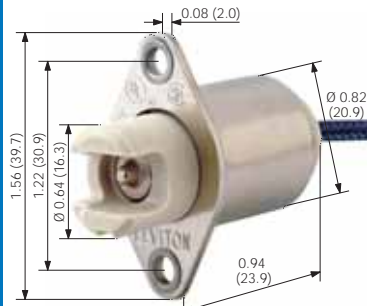

554

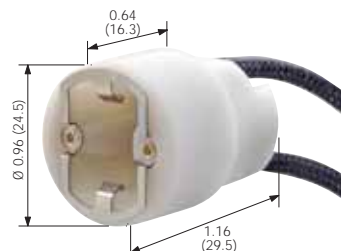

560

### Phenolic Keyless Fixture — Medium Base

Screw Terminals

| DESCRIPTION  | CAT. NO. | RATING    |
|--|----------|-----------|
| Permanent Bracket. Terminal Screws Backed Out and Staked | 3352-1   | 660W 250V |
| Same as 3352-1, with Shorter Bracket                     | 3352-F   | 660W 250V |
| Removable Hickey. Terminal Screws Backed Out and Staked  | 3352-8   | 660W 250V |

*Hickeys and brackets are available in various types and sizes. Consult a Leviton representative for more information.*

### Porcelain Keyless, Side-Mounted — Medium Base

Screw Terminals

| DESCRIPTION                                     | CAT. NO. | RATING    |
|---|----------|-----------|
| Single Lampholder w/Side Outlet Bushing—1/8 IPS | 10091    | 660W 250V |
| Twin Lampholder w/Bushed Flange—1/8 IPS         | 4010     | 660W 250V |
| Twin Lampholder w/Single Outlet Bushing—1/8 IPS | 4005     | 660W 250V |
| Same as 4005 with 3/8 IPS Bushing               | 4006     | 660W 250V |

*All bushings are tapped and have set screw*

### Candle Sockets, Bottom Turn Knob — Medium Base

Screw Terminals

| DESCRIPTION   | CAT. NO. | RATING    |
|---|----------|-----------|
| Three-light, two-piece phenolic husk. Lighting sequence: LO-MED-HI-OFF★ | 4063     | 250W 250V |

### Lampholders for Recessed Single Contact Lamps

| DESCRIPTION  | CAT. NO. | RATING     |
|--|----------|------------|
| Front Flange Mount. Standard Leads are No. 18 AWG, Type SEW-2, 200°C, 18" Long, Stripped 3/4"† | 554      | 3000W 600V |
| Rear Flange Mount. Same Leads and Specs as No. 554†  | 555      | 3000W 600V |

### Lampholders for Metal Halide and Quartz Halogen Lamps

| DESCRIPTION   | CAT. NO. | RATING                     |
|---|----------|----------------------------|
| Single-Ended Metal Halide for Lamps with a G8.5 Base. Lead-In Edge on Body Ensures Proper Lamping. Standard Leads (2) are Black No. 18 AWG, Type SEW-2, 200°C 600V Wire, 9" Long, Stripped .325"†   | 560      | 660W 600V, 5KV Pulse Rated |
| Single-Ended Metal Halide for Lamps with a GX8.5 Base, such as Philips CDM-R11, rated up to 150W. Standard Leads (2) are Black No. 18 AWG, SEW-2, 200°C 600V Wire, 12" Long, Stripped 1/2"†         | 565      | 660W 600V, 5KV Pulse Rated |
| Twist-In Single-Ended Quartz Halogen for Lamps with a GU10 Base, rated up to 150W. Fully Dimmable; Standard Leads (2) are White, No. 20 AWG Teflon® wire, rated 250°C 600V, 6" Long, Stripped 1/2"† | 570      | 660W 600V                  |

*CSA Certified except where indicated by ★, and NOM Certified except where indicated by †.*

#### SPECIFICATIONS AND FEATURES

- Cat. No. 3352 lampholder bodies have wireways
- Side-Mounted lampholders are white glazed porcelain with copper-alloy screwshell
- Recessed Single-Contact lampholders have porcelain body with nickel-plated steel housing
- Cat. No. 560 has a metal lamp-positioning clip (patent pending) that maintains lamp seating position
- Cat. No. 565 is designed for energy-efficient CDM lamps
- Cat. No. 570 twists in and is fully dimmable

#### TESTING AND CODE COMPLIANCE

- UL Listed (File #E-3810) Cat. Nos. 560, 565 and 570: cULus (File #E-13405)
- CSA Certified (File #LR-1863)
- NOM Certified (File #057)



To learn more about Leviton's outstanding offering of devices visit our Website at: [www.leviton.com](http://www.leviton.com)



## Candelabra and Medium Base Incandescent Lampholders

## Candle Sockets, Bottom Turn Knob — Medium Base

## Screw Terminals

| DESCRIPTION  | CAT. NO. | RATING    |
|--|----------|-----------|
| 1-Piece Phenolic Body; 2 Leg Bracket; Single Light; Removable Interior; Knurl Nut and Lock Nut | 4155     | 660W 250V |
| 2-Piece Phenolic Husk & Removable Interior Husk; Single Light; Knurl Nut                       | 4158     | 660W 250V |

## Candle Sockets, Keyless\* — Medium Base

## Fiber-Disc Body, Screw Terminals

| DESCRIPTION                              | CAT. NO. | RATING    |
|--|----------|-----------|
| Solid Hickey, 2" Overall Height†         | 8684     | 660W 250V |
| Adjustable Hickey, Overall Height: 4–5¾" | 9800     | 660W 250  |

\*Insulating paper liner pushes down against hickey projections.

NOTE: These items are designed for use with standard socket candle tubes (1<sup>5</sup>/<sub>16</sub>" dia.) and require a minimum of 1<sup>3</sup>/<sub>16</sub>" dia. flat bottom of candle cup for clearance.

## Candle Sockets, Phenolic — Medium Base

## With Removable Turn Knob, Screw Terminals

| DESCRIPTION  | CAT. NO. | RATING    |
|--|----------|-----------|
| Removable Knob (Short Type), Adjustable Hickey. Overall Height: 4–5½"                    | 9805*    | 250W 250V |
| Removable Knob, Removable 1-Leg Hickey. Overall Height: 2 <sup>7</sup> / <sub>16</sub> " | 9805-A*  | 250W 250V |

NOTE: These items are designed for use with standard socket candle tubes (1<sup>5</sup>/<sub>16</sub>" dia.) and require a minimum of 1<sup>3</sup>/<sub>16</sub>" dia. flat at bottom of candle for clearance.

## Candelabra Base, Keyless\* †

| DESCRIPTION   | CAT. NO.  | RATING   |
|---|-----------|----------|
| Screw Terminals; Solid Hickey. Overall Height: 2"   | 10025     | 75W 125V |
| Screw Terminals; Solid Hickey. Overall Height: 1½"  | 10027     | 75W 125V |
| Screw Terminals; Adjustable Hickey: 3¼–4¾"  | 10026     | 75W 125V |
| Double Snap-In Spring Clips. Height of socket from panel is 1". Leads are No. 18 AWG 105°C plastic, 24" long, stripped ½" | 10014-800 | 75W 125V |

\*7/8" candle tube. All hiccys tapped 1/8 IPS.

NOM Certified except where indicated by †

## SPECIFICATIONS AND FEATURES

- Candle sockets for single-light applications
- Fiber Disc Body for use with standard candle tubes
- Spring-tempered steel clip holds Cat. No. 10014-800 socket rigidly in place

## TESTING AND CODE COMPLIANCE

- UL Listed (File #E-3810; E-13400)
- CSA Certified (File #LR-1863)
- NOM Certified (File #057)



4155



9805



10025



10014-800



75W 125V • 660W 250V

## Candelabra and Medium Base Incandescent Lampholders



20025



267



167



55

### Candle Sockets — Porcelain

#### Candelabra Base Screw Terminals

| DESCRIPTION   | CAT. NO. | RATING   |
|---|----------|----------|
| Solid Hickey.* Overall Height: 2 <sup>3</sup> / <sub>32</sub> "★† | 20025    | 75W 125V |

\*Other hickey sizes available

### Keyless Heavy Duty Phenolic Single Circuit Lampholders

#### Two-Piece Pin Type

| DESCRIPTION  | CAT. NO. | RATING    |
|--|----------|-----------|
| Candelabra Base, Detachable Zinc-Plated Wire Hook. Accepts No. 20 – No. 18 Stranded Insulated Wire | 267**    | 75W 125V  |
| Medium Base, Detachable Zinc-Plated Wire Hook. Accepts No. 14 – No. 12 Stranded Insulated Wire     | 167**    | 660W 250V |

Note: Linings assembled.

\*\*For temporary lighting — not waterproof.

### Pigtail Type Medium Base with Leads

| DESCRIPTION   | CAT. NO. | RATING    |
|---|----------|-----------|
| Vinyl, Phenolic Interior & Screw Shell, Brass Shell Contact. Leads are No. 14 AWG, 6" Long, Stripped 3/4", Molded into Boots† | 55**     | 660W 250V |
| Phenolic with Brass Screw Shell. Leads Soldered and Hot Waxed in Deep Well are No. 14 AWG 6" Long                             | 157**    | 660W 250V |
| Same as 157 above, with Left-Hand Screw Shell   | 157-X**  | 660W 250V |
| Rubber, Aluminum Screwshell. Leads are No. 16 AWG, 6" Long, Soldered to Terminals and Sealed in Rubber Boot★                  | 124-D    | 660W 250V |

\*\*For temporary lighting—not waterproof.

All devices are UL Listed except Cat.No. 124-D. Also CSA Certified except where indicated by ★, and NOM Certified except where indicated by †

Note: The listed products may be used at construction sites provided that bulb cages are used and suitable splices are made. The listing for the products meets the OSHA requirement and is made for open wiring without a separate outlet box.

#### SPECIFICATIONS AND FEATURES

- Candle socket has white unglazed porcelain body with aluminum screw shell
- Choice of Pin-Type or Pigtail Type for temporary lighting applications
- Two-Piece Pin Type automatically pierces wire leads

#### TESTING AND CODE COMPLIANCE

- UL Listed (File #E-13400) 267\*\*
- UL Listed (File #E-3810) 55\*\*, 157\*\*, 157-X\*\* and 167\*\*
- CSA Certified (File #LR-1863)
- NOM Certified (File #057)



## Medium, High Output and Slimline—Linear Fluorescent Lampholders

Fluorescent Lampholders

### For High Output Lamps — Recessed Double Contact, Pedestal Type

| DESCRIPTION  | CAT. NO. PLUNGER | CAT. NO. FIXED | RATING    |
|--|------------------|----------------|-----------|
| Screw Mount, Push-in wiring.*  | 13464            | 13465          | 660W 600V |
| Same as 13464/13465 except with Internal Shunt Connection for Electronic Ballasts* | 23464            | 23465          | 660W 600V |
| Slide-on, Shallow Base, Quickwire Terminals*                                       | 13550            | 13551          | 660W 600V |
| Slide-on, Shallow Base for Power Groove and Jacketed Lamps, Quickwire Terminals*   | 13556            | 13557          | 660W 600V |



### For Slimline, Single Pin Lamps

| DESCRIPTION  | CAT. NO. PLUNGER | CAT. NO. FIXED | RATING                  |
|--|------------------|----------------|-------------------------|
| Butt-On Surface Mounting, 12" Leads†                             | 452              | 453            | 660W 1000V<br>660W 600V |
| Pedestal Base, Slide-On  | 466              | 467            | 660W 1000V<br>660W 600V |
| Shallow Base, Slide-On or Lock-On Mounting, Quickwire Terminals* | 2536             | 2537           | 660W 1000V<br>660W 600V |

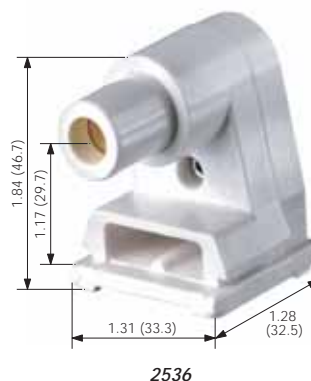

### For Medium Bi-Pin Lamps

| DESCRIPTION  | CAT. NO. WHITE | RATING    |
|--|----------------|-----------|
| Thin Body, Quickwire Terminals Accommodate Rapid-Start Circuits        | 431-W          | 660W 600V |
| Pedestal type, Straight-in Wiring Through Wireways or Screw Terminals‡ | 390-1W         | 660W 600V |
| Same as above, with Starter Base‡                                      | 391-1W         | 660W 600V |

### Starter Bases

#### For Medium Bi-Pin Lamps

| DESCRIPTION                           | CAT. NO. | RATING    |
|---------------------------------------|----------|-----------|
| Starter Base; Screw Terminals, Black‡ | 380      | 660W 250V |
| Starter Base; with Leads, Black‡      | 396      | 660W 250V |

NOM Certified except where indicated by†

\*Suitable for outdoor applications when properly enclosed

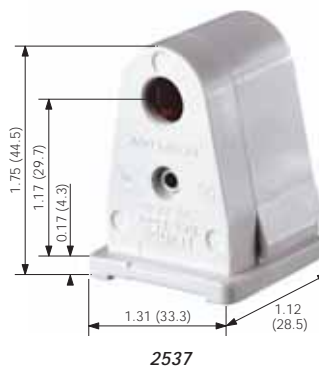

#### SPECIFICATIONS AND FEATURES

- Silver-plated copper alloy contacts
- Quickwire terminals accept No. 18 AWG twisted and tinned, solder-dipped or solid leads
- Lampholders are white, starter bases are black

#### TESTING AND CODE COMPLIANCE

- UL Listed (File #E-5833)
- CSA Certified (File #LR-1863; LR-5863; LR-2200)
- NOM Certified (#057)

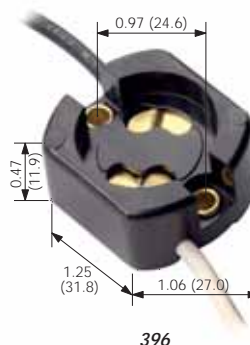



660W 600V • 660W 1000V • 75W 250V

## Medium and Miniature Bi-Pin Lamps—Linear Fluorescent Lampholders

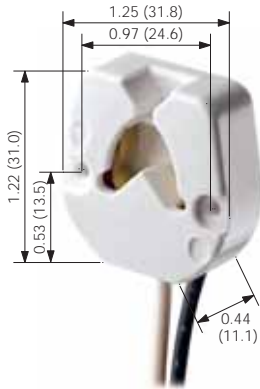

395-W

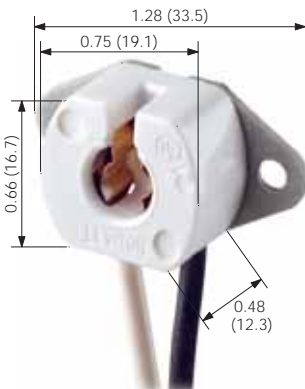

420-W



13518 — see diagram right

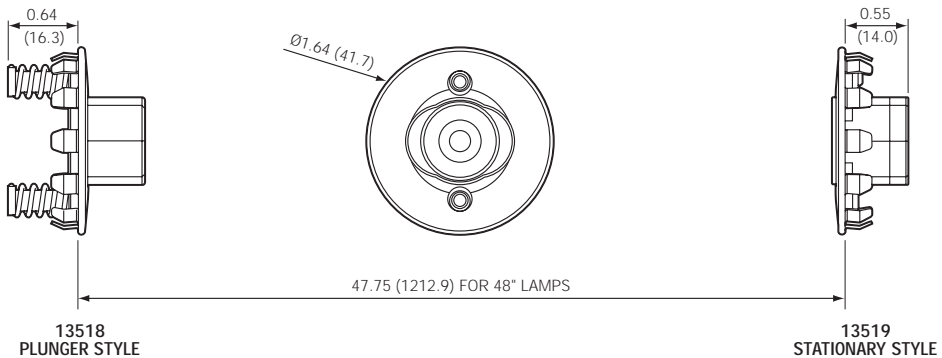

Medium Bi-Pin Spacing

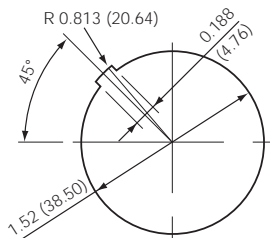

PANEL OPENING FOR 13518/13519  
PANEL THICKNESS 0.035-0.050 (0.89-1.27)

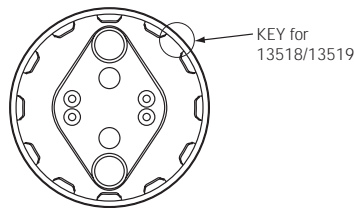

### For Medium and Miniature Bi-Pin Lamps — Surface Mount with Leads\*

| DESCRIPTION  | CAT. NO.<br>WHITE | RATING    |
|--|-------------------|-----------|
| Rapid-Start Medium Bi-Pin, 9" leads  | 395-W             | 660W 600V |
| Rapid-Start Medium Bi-Pin, Disconnect (paired with Cat. No. 395-W), 9" leads | 389-W             | 660W 600V |
| Miniature Bi-Pin for T5 Lamp, 6" leads                                       | 420-W             | 75W 250V  |

\*Leads are No. 18 AWG, 105°C plastic insulated wire

### For Slimline, Medium Bi-Pin, High Output Lamps — Snap-In with Quickwire

| DESCRIPTION  | CAT. NO.<br>PLUNGER | CAT. NO.<br>FIXED | RATING                  |
|--|---------------------|-------------------|-------------------------|
| Slimline†  | 516                 | 517               | 660W 1000V<br>660W 600V |
| Medium Bi-Pin, Stainless Steel Coverplate & Clip                                   | 13518               | 13519             | 660W 600V<br>660W 600V  |
| Medium Bi-Pin, Same as above, with Internal Shunt for Use with Electronic Ballasts | 23518               | 23519             | 660W 600V<br>660W 600V  |
| High Output 800mA and 1500mA ‡   | 523                 | 524               | 660W 600V<br>660W 600V  |

NOM Certified except where indicated by †

#### SPECIFICATIONS AND FEATURES

- Versatile snap-in mounting reduces fixture assembly time
- Quickwire terminals accept either No. 18 AWG (stranded, twisted or tinned), No. 18 AWG solid or No. 16 AWG solid.
- Internal Shunt versions stamped "S" on back for easy identification

#### TESTING AND CODE COMPLIANCE

- UL Listed (File #E-5833)
- CSA Certified (File #LR-5863; LR-1863)
- NOM Certified (#057)



## Medium Bi-Pin Lamps—Linear Fluorescent Lampholders

### For Medium Bi-Pin Lamps — Turn-Type

| DESCRIPTION   | CAT. NO. | RATING    |
|---|----------|-----------|
| Low Profile, Slide-On, with Captive Nut                       | 13353-N  | 660W 600V |
| Tall Profile, Slide-On, with Captive Nut                      | 13357-N  | 660W 600V |
| Tall Profile without Side Grooves, Slide-On, with Captive Nut | 13359-N  | 660W 600V |
| Low Profile Disconnect, Slide-On                              | 13351-D  | 660W 600V |
| Tall Profile Disconnect, Slide-On                             | 13354-D  | 660W 600V |
| Low-Profile; Shunted, Slide-On                                | 23351    | 660W 600V |

### For Medium Bi-Pin Lamps — Straight-In

| DESCRIPTION   | CAT. NO.  | RATING    |
|---|-----------|-----------|
| Low Profile, Slide-On   | 13150-UR5 | 660W 600V |
| Self-Locking; Slide-In, with Captive Nut.<br>For use with T-8 Lamps | 13451-N   | 660W 600V |

### For Medium Bi-Pin Lamps — Snap-In/Slide-On Design and Lamp-Lock

| DESCRIPTION  | CAT. NO.  | RATING    |
|--|-----------|-----------|
| Snap-In or Slide-On Mounting Featuring Lamp-Lock, with Panel Locator Post. For T-8 and T-12 Lamps                            | 13653-WP  | 660W 600V |
| Same as Above, Less Locator Post   | 13653-NP  | 660W 600V |
| Same as 13653-WP, Except with Internal Shunt Connection for Electronic Ballasts  | 23653-WP  | 660W 600V |
| Same as Above, Less Locator Post   | 23653-NP  | 660W 600V |
| Snap-In or Slide-On Mounting Featuring Lamp-Lock, Optional Panel Locator Post. Dedicated for Energy-Efficient T-8 Lamps Only | 13652-WP  | 660W 600V |
| Same as 13652, Except with Internal Shunt Connection for Electronic Ballasts   | 23652-WP  | 660W 600V |
| Snap-In or Slide-On Mounting Featuring Lamp-Lock, for Energy-Efficient T-8 Lamps Only. Wide-Wing Design                      | 13652-WWP | 600W 600V |
| Same as Above, Less Locator Post   | 13652-WNP | 600W 600V |
| Same as 13652-WWP, Except with Internal Shunt Connection for Electronic Ballasts   | 23652-WWP | 600W 600V |
| Same as Above, Less Locator Post   | 23652-WNP | 600W 600V |
| Snap-In or Slide-On Mounting Featuring Lamp-Lock, for T-8 and T-12 Lamps. Wide-Wing Design                                   | 13653-WWP | 600W 600V |
| Same as Above, Less Locator Post   | 13653-WNP | 600W 600V |
| Same as 13653-WWP, Except with Internal Shunt Connection for Electronic Ballasts   | 23653-WWP | 600W 600V |
| Same as Above, Less Locator Post   | 23653-WNP | 600W 600V |

NOTE: Also available with bottom push-in wiring. Contact your Leviton representative for further details.

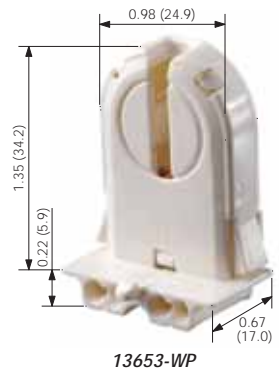
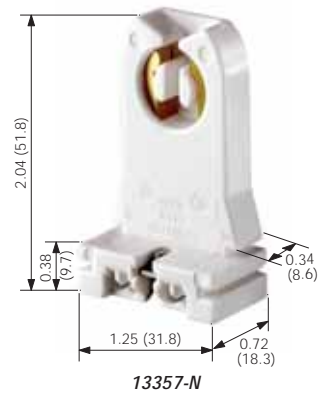
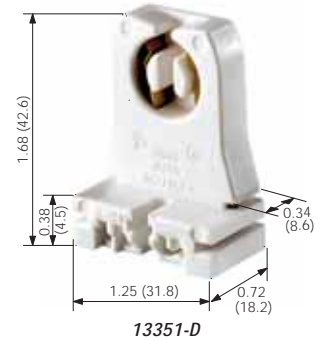

#### SPECIFICATIONS AND FEATURES

##### Lamp-Lock

- Four-position lamp-lock socket rotates 90°, forward and back, for quick relamping
- Lamp-Lock models have slim, low profile silhouette that fits 22 to 25 gauge panels
- Chemical-resistant white thermoplastic body

#### TESTING AND CODE COMPLIANCE

- UL Listed (File #E-5833)
- CSA Certified (File #LR-1863; LR-5863; LR-2200)
- NOM Certified (#057)
- Medium Bi-Pin lamps with Snap-In/Slide-On Design and Lamp-Lock are VDE Certified to IEC

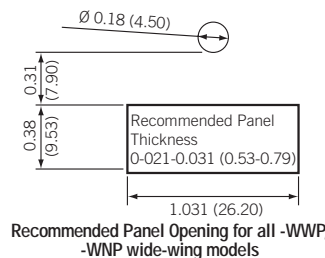
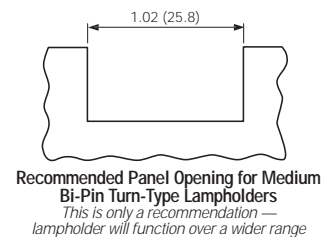
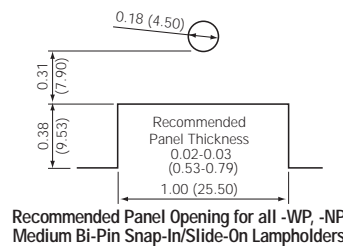



120W 600V • 660W 600V

## Medium and Miniature Bi-Pin Lamps—Linear Fluorescent Lampholders

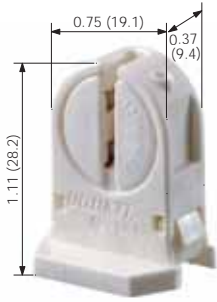

13654-SNP

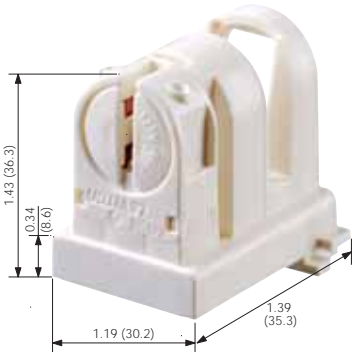

13654-EXL

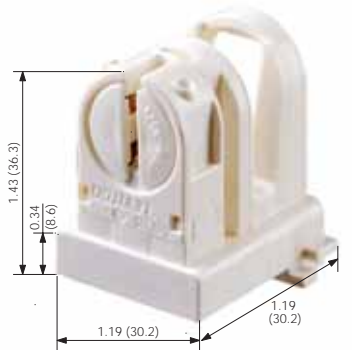

13654-EXS

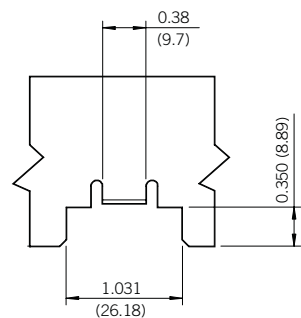

Recommended Panel Opening for Medium Bi-Pin Slide-On Lampholders

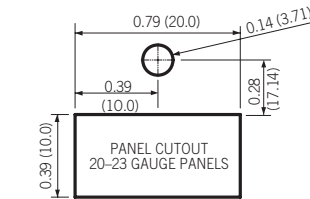

Recommended Panel Opening for Miniature Bi-Pin Snap-In/Slide-On Lampholders

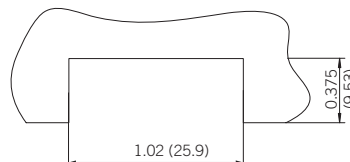

Recommended Panel Opening for T-8 to T-5 Adapter

### For Medium Bi-Pin Lamps — Slide-On Design and Lamp-Lock®

| DESCRIPTION   | CAT. NO. | RATING    |
|---|----------|-----------|
| Medium Profile 0.91 (23.0) Lamp Center. Slide-On Mounting Featuring Lamp Lock. For T-8 and T-12 Lamps | 13661    | 660W-600V |
| Same as 13661, Except with Internal Shunt Connection for Electronic Ballasts                          | 23661    | 660W-600V |
| Tall Profile 1.18 (30.0) Lamp Center. Slide-On Mounting Featuring Lamp Lock. For T-8 and T-12 Lamps   | 13660    | 660W-600V |
| Same as 13660, Except with Internal Shunt Connection for Electronic Ballasts                          | 23660    | 660W-600V |

### For Miniature Bi-Pin Lamps — Snap-In/Slide-On Design and Lamp-Lock®

| DESCRIPTION  | CAT. NO.  | RATING    |
|--|-----------|-----------|
| Low Profile 0.62 (15.7) Lamp Center, Snap-In or Slide-On Mounting Featuring Lamp-Lock, with Panel Locator Post. For T-5 Lamps  | 13654-SWP | 120W 600V |
| Same as Above, Less Locator Post   | 13654-SNP | 120W 600V |
| Tall Profile 0.98 (24.9) Lamp Center, Snap-In or Slide-On Mounting Featuring Lamp-Lock, with Panel Locator Post. For T-5 Lamps   | 13654-TWP | 120W 600V |
| Same as Above, Less Locator Post   | 13654-TNP | 120W 600V |
| Low Profile 0.62 (15.7) Lamp Center, Snap-In or Slide-On Mounting Featuring Lamp-Lock, with Panel Locator Post. For T-5 Lamps. Internal Shunt Connection for Electronic Ballasts   | 23654-SWP | 120W 600V |
| Same as Above, Less Locator Post   | 23654-SNP | 120W 600V |
| Tall Profile 0.98 (24.9) Lamp Center, Snap-In or Slide-On Mounting Featuring Lamp-Lock, with Panel Locator Post. For T-5 Lamps. Internal Shunt Connection for Electronic Ballasts. | 23654-TWP | 120W 600V |
| Same as above, Less Locator Post   | 23654-TNP | 120W 600V |

### T-8 to T-5 Adapter

|  |           |           |
|--|-----------|-----------|
| Long T-8 to T-5 Adapter, converts existing T-8 fixtures to accept energy-efficient T-5 lamps; with Lamp Lock.<br><i>Specify lamp length for proper ordering</i>  | 13654-EXL | 120W 600V |
| Short T-8 to T-5 Adapter, converts existing T-8 fixtures to accept energy-efficient T-5 lamps; with Lamp-Lock.<br><i>Specify lamp length for proper ordering</i> | 13654-EXS | 120W-600V |

#### SPECIFICATIONS AND FEATURES

##### Lamp-Lock

- Four-position lamp-lock socket rotates 90°, forward and back, for quick relamping
- Lamp-Lock models have slim, low profile silhouette that fits 22 to 25 gauge panels
- Chemical-resistant white thermoplastic body

##### T-8 to T-5 Adapter

- Cost-effective solution to incorporate miniature bi-pin T-5 lamps into existing T-8 configurations

#### TESTING AND CODE COMPLIANCE

- UL Listed (File #E-5833)
- CSA Certified (File #LR-1863; LR-5863; LR-2200)
- NOM Certified (#057)
- Medium Bi-Pin Lamps with Slide-On Design and Lamp-Lock are VDE Certified to IEC





# Long Twin Tube with 2G11 Base—Compact Fluorescent Lampholders

## 4-Pin Long Twin-Tube with 2G11 Base — Slide-In Mounting

| DESCRIPTION  | CAT. NO. | RATING    |
|--|----------|-----------|
| Slide-In for 18-20 Ga. Panels, Quickwire Terminals | 13452    | 660W 600V |

## 4-Pin Long Twin-Tube with 2G11 Base — Bottom or Back Mounting

| DESCRIPTION   | CAT. NO. | RATING    |
|---|----------|-----------|
| Vertical Snap-In Mounting, Side Push-In Wiring                        | 13453    | 660W 600V |
| Same as above, with Internal Shunt Connection for Electronic Ballasts | 23453    | 660W 600V |
| Horizontal Snap-In Mounting, Bottom Push-In Wiring                    | 13454    | 660W 600V |
| Same as above, with Internal Shunt Connection for Electronic Ballasts | 23454    | 660W 600V |
| Horizontal Screw-Mount, Bottom Push-In Wiring                         | 13455    | 660W 600V |
| Same as above, with Internal Shunt Connection for Electronic Ballasts | 23455    | 660W 600V |

Note: See page S18 for Lamp Support Clips



13453



13454

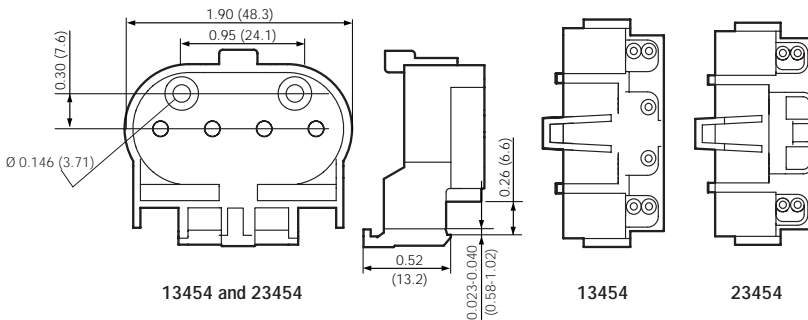
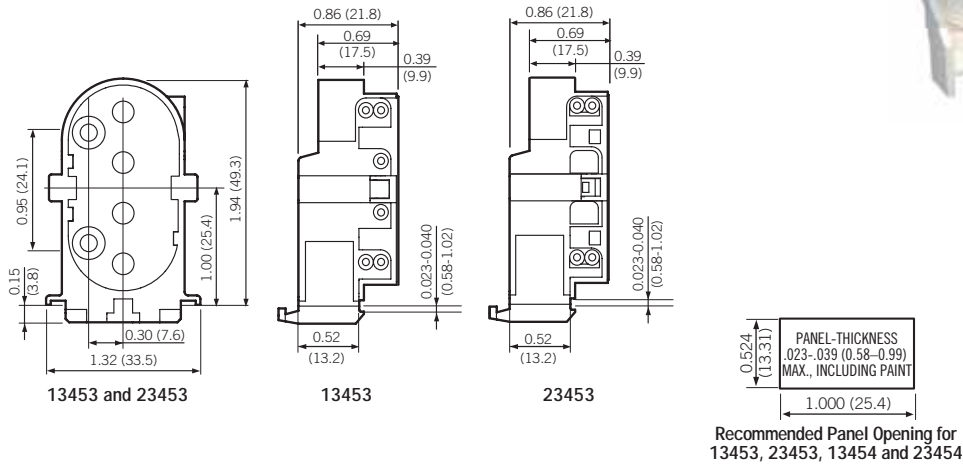

### SPECIFICATIONS AND FEATURES

- Vertical Snap-In model allows wires to be routed on either top or bottom of panel
- Two wiring ports per contact speed harness wiring
- Internal Shunt models eliminate need for extra jumper wire in fixtures designed for electronic ballasts
- Low-profile design for smaller, more compact fixtures
- Superior metal-spring lamp retainer clips

### TESTING AND CODE COMPLIANCE

- UL Listed (File #E-5833)
- CSA Certified (File #LR-1863)
- NOM Certified (File #057)

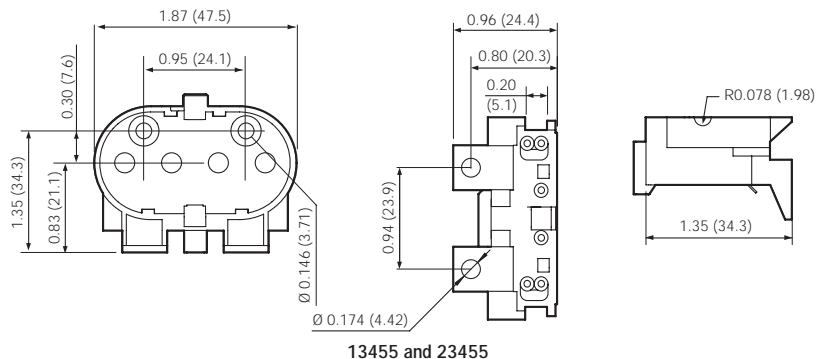



# LAMP SUPPORT CLIPS

## Lamp Support Clips for Long Twin Tube 2G11 Base Fluorescent Lampholders



23452-H



23452-V



23452-MTS



23452-MTL

### Plastic and Stainless Steel Lamp Support Clips

| DESCRIPTION  | CAT. NO.  |
|--|-----------|
| Plastic Lamp Support Clip, Slide-On  | 23452-A*  |
| Plastic Lamp Support Clip, Screw Mount   | 23452-B*  |
| Horizontal Snap-In Lamp Support Clip for 13454, 23454, 13455 and 23455. UV-Stable, Clear Polycarbonate | 23452-H*  |
| Vertical Snap-In Lamp Support Clip for 13453 and 23453. UV-Stable, Clear Polycarbonate                 | 23452-V*  |
| Stainless Steel Horizontal Lamp Support Clip, Short Version  | 23452-MTS |
| Stainless Steel Horizontal Lamp Support Clip, Tall Version   | 23452-MTL |

\*Note: Leviton strongly recommends replacing support clips 23452-A, 23452-B, 23452-V and 23452-H during lamp replacement.

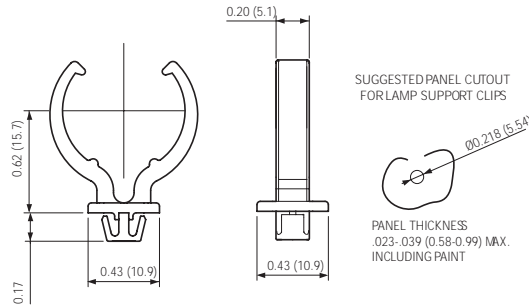

Vertical Lamp Support Clip—23452-V

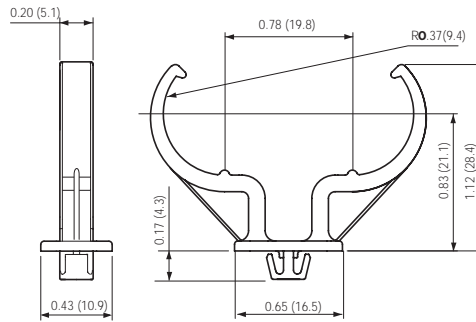

Horizontal Lamp Support Clip—23452-H

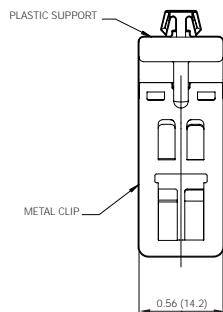

Horizontal Lamp Support Clips  
23452-MTS, 234452-MTL

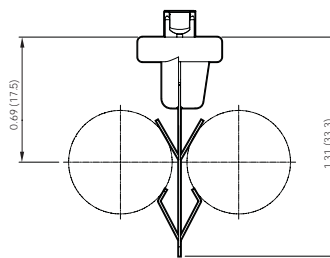

Horizontal Lamp Support Clip, Short  
23452-MTS

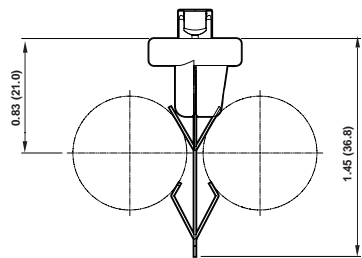

Horizontal Lamp Support Clip, Tall  
23452-MTL

### SPECIFICATIONS AND FEATURES

- Choice of quality lamp support clips in a variety of configurations for long twin tube lamps with 2G11 base
- UV stable clear polycarbonate clips for vertical or horizontal mounting
- Stainless steel clips with UV stable clear polycarbonate base for horizontal mounting only; short or tall versions
- Plastic clips for slide-on or screw-mount



# Compact Fluorescent Lampholders (CFLs)

## 10mm Compact Fluorescent Lampholders

For G23 and G23-2 Lamp Bases — Rating: 75 WATT 600V

| MOUNTING                   | CAT. NO.   | COLOR | LAMP BASE  | PHILIPS        | OSRAM SYLVANIA                   | GE LIGHTING                       |
|----------------------------|------------|-------|------------|----------------|----------------------------------|-----------------------------------|
| Horizontal Snap-In         | 26719-100  | White | G23, G23-2 |                |                                  |                                   |
| Horizontal Screw-Down      | 26719-200  | White | G23, G23-2 | PL-S 5W, 7W 9W | DULUX S 5W, 7W, 9W<br>DULUX D 9W | BIAX, 5W, 7W 9W<br>DOUBLE BIAX 9W |
| Vertical Top Snap-In       | 26719-300* | White | G23        |                |                                  |                                   |
| 4-Hole Vertical Screw-Down | 26719-400  | White | G23, G23-2 |                |                                  |                                   |
| Vertical Bottom Snap-In    | 26719-500  | White | G23, G23-2 |                |                                  |                                   |

\*Not compatible with 9-watt DTT lamps

For GX23 and GX23-2 Lamp Bases — Rating: 75 WATT 600V

| MOUNTING                   | CAT. NO.   | COLOR         | LAMP BASE    | PHILIPS              | OSRAM SYLVANIA             | GE LIGHTING                 |
|----------------------------|------------|---------------|--------------|----------------------|----------------------------|-----------------------------|
| Horizontal Snap-In         | 26720-100  | White w/Black | GX23, GX23-2 |                      |                            |                             |
| Horizontal Screw-Down      | 26720-200  | White w/Black | GX23, GX23-2 |                      |                            |                             |
| Vertical Top Snap-In       | 26720-300* | White w/Black | GX23         | PL-S 13W<br>PL-C 13W | DULUX S 13W<br>DULUX D 13W | BIAX 13W<br>DOUBLE BIAX 13W |
| 4-Hole Vertical Screw-Down | 26720-400  | White w/Black | GX23, GX23-2 |                      |                            |                             |
| Vertical Bottom Snap-In    | 26720-500  | White w/Black | GX23, GX23-2 |                      |                            |                             |

\*Not compatible with 13-watt DTT lamps



Fluorescent Lampholders

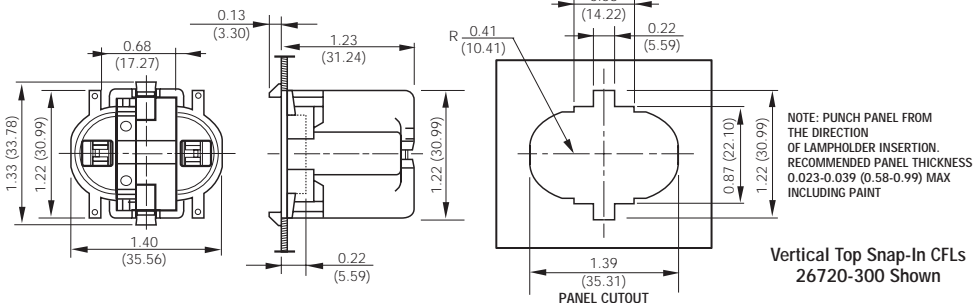
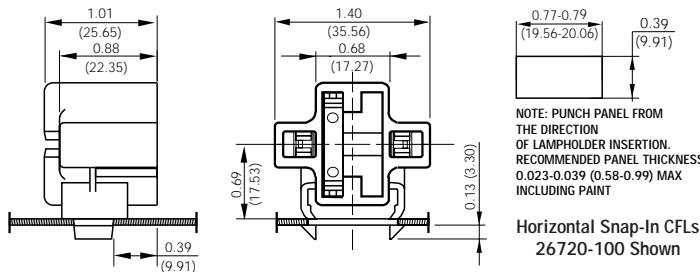

### SPECIFICATIONS AND FEATURES

- “Smart” CFL Lampholders are color-coded for easy wattage identification
- Bottom Snap-In versions for easier panel assembly
- Snap-In versions designed for 16 Ga. panels
- Metal-spring lamp-retainer clip provides positive lamp retention and is more durable than plastic clips
- Two wiring ports per contact speed harness wiring

- Four screw holes for greater mounting flexibility
- Wire-routing options for top or bottom side of mounting panel for easier assembly
- White thermoplastic body

### TESTING AND CODE COMPLIANCE

- UL Listed (File #E-5833)
- UL Listed for indoor and outdoor applications when properly enclosed
- CSA Certified (File #LR-1863)
- NOM Certified (File #057)

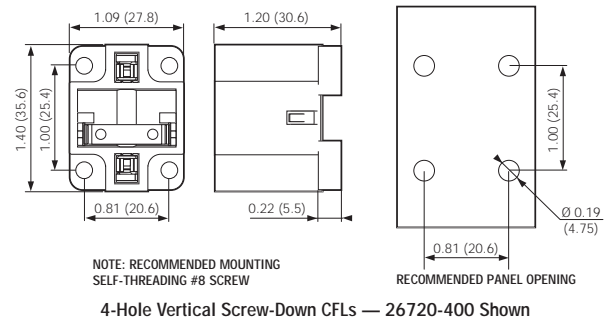



75W 600V

## Compact Fluorescent Lampholders (CFLs)



26725-213



26725-419

### 10mm Compact Fluorescent Lampholders

For G24d Lamp Bases 2-Pin — Rating: 75 WATT 600V

| MOUNTING                 | CAT. NO.  | COLOR         | LAMP BASE | PHILIPS       | OSRAM SYLVANIA             | GE LIGHTING          |
|--------------------------|-----------|---------------|-----------|---------------|----------------------------|----------------------|
| <b>Bottom Snap-In</b>    |           |               |           |               |                            |                      |
| For 16 Ga. Panels        | 26725-201 | White w/Black | G24d-1    | PL-C 10W, 13W | DULUX D 10W, 13W           | DOUBLE BIAX 10W, 13W |
| For 18-20 Ga. Panels     | 26725-221 |               |           |               |                            |                      |
| For 16 Ga. Panels        | 26725-202 | Green         | G24d-2    | PL-C 18-W     | DULUX D 18W                | DOUBLE BIAX 18W      |
| For 18-20 Ga. Panels     | 26725-222 |               |           |               |                            |                      |
| For 16 Ga. Panels        | 26725-203 | Orange        | G24d-3    | PL-C 26W      | DULUX D 26W                | DOUBLE BIAX 26W      |
| For 18-20 Ga. Panels     | 26725-223 |               |           |               |                            |                      |
| <b>Bottom Screw-Down</b> |           |               |           |               |                            |                      |
| 4-Hole                   | 26725-211 | White w/Black | G24d-1    | PL-C 10W, 13W | DULUX D 10W, 13W           | DOUBLE BIAX          |
| 4-Hole                   | 26725-212 | Green         | G24d-2    | PL-C 18W      | DULUX D 18W                | DOUBLE BIAX 18W      |
| 4-Hole                   | 26725-213 | Orange        | G24d-3    | PL-C 26W      | DULUX D 26W<br>DULUX T 26W | DOUBLE BIAX 26W      |

For G24q and GX24q Lamp Bases 4-Pin — Rating: 75 WATT 600V  
Suitable for Dimming or Electronic Ballasts

| MOUNTING                                     | CAT. NO.  | COLOR         | LAMP BASE         | PHILIPS                   | OSRAM SYLVANIA                           | GE LIGHTING               |
|--|-----------|---------------|-------------------|---------------------------|--|---------------------------|
| <b>Bottom Snap-In</b>                        |           |               |                   |                           |  |                           |
| For 16 Ga. Panels                            | 26725-401 | White w/Black | G24q-1            | PL-C 10W, 13W             | DULUX D/E 10W, 13W                       | DOUBLE BIAX 10W, 13W      |
| For 18-20 Ga. Panels                         | 26725-421 |               |                   |                           |  |                           |
| For 16 Ga. Panels                            | 26725-402 | Green         | G24q-2            | PL-C 18W                  | DULUX D/E 18W                            | DOUBLE BIAX 18W           |
| For 18-20 Ga. Panels                         | 26725-422 |               |                   |                           |  |                           |
| For 16 Ga. Panels                            | 26725-403 | Orange        | G24q-3, GX24q-3   | PL-C 26W<br>PL-T 26W, 32W | DULUX D/E 26W<br>DULUX T/E 26W           | DOUBLE BIAX               |
| For 18-20 Ga. Panels                         | 26725-423 |               |                   |                           |  |                           |
| For 16 Ga. Panels                            | 26725-404 | Yellow        | GX24q-4           | PL-T 42W                  | DULUX T/E 42W                            | PERFORMANCE BIAX 42W      |
| For 18-20 Ga. Panels                         | 26725-424 |               |                   |                           |  |                           |
| For Universal ballast only, 18-20 Ga. Panels | 26725-429 | White         | G24q-3<br>GX24q-4 | PL-T 26W, 32W, 42W        | DULUX T/E 26W, 32W, 42W                  | TRIPLE BIAX 26W, 32W, 42W |
| <b>Bottom Screw-Down</b>                     |           |               |                   |                           |  |                           |
| 4-Hole                                       | 26725-411 | White w/Black | G24q-1            | PL-C 10W, 13W             | DULUX D/E 10W, 13W                       | DOUBLE BIAX 10W, 13W      |
| 4-Hole                                       | 26725-412 | Green         | G24q-2            | PL-C 18W                  | DULUX D/E 18W                            | DOUBLE BIAX 18W           |
| 4-Hole                                       | 26725-413 | Orange        | G24q-3, GX24q-3   | PL-C 26W<br>PL-T 26W, 32W | DULUX D/E 26W, 32W<br>DULUX T/E 26W, 32W | DOUBLE BIAX 26W           |
| 4-Hole                                       | 26725-414 | Yellow        | GX24q-4           | PL-T 42W                  | DULUX T/E 42W                            | PERFORMANCE BIAX 42W      |
| 4-Hole for Universal ballast only            | 26725-419 | White         | G24q-3<br>GX24q-4 | PL-T 26W, 32W, 42W        | DULUX T/E 26W, 32W, 42W                  | TRIPLE BIAX 26W, 32W, 42W |

Note: Lamp names are trademarked by manufacturers

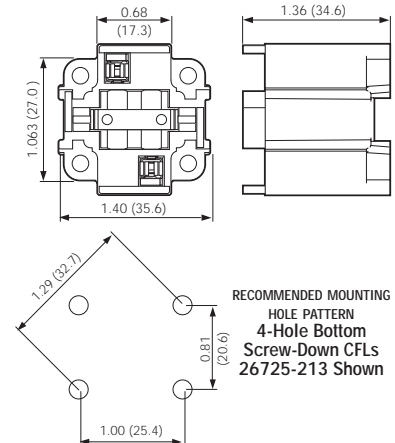
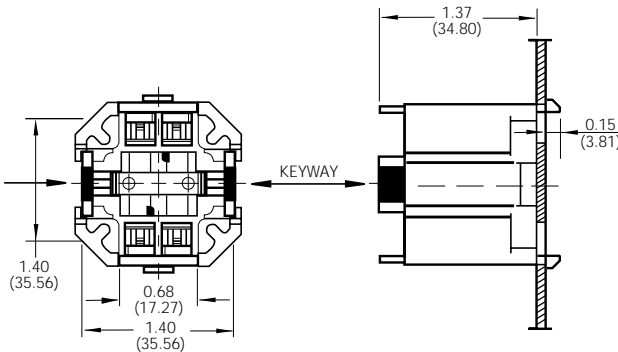
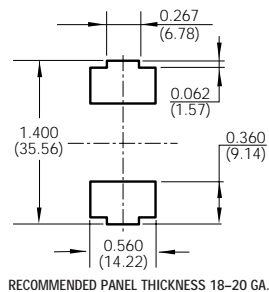

To learn more about Leviton's outstanding offering of devices visit our Website at: [www.leviton.com](http://www.leviton.com)



# Compact Fluorescent Lampholders (CFLs)

## 10mm Compact Fluorescent Lampholders for High-Wattage Lamps

For GX24q Lamp Bases, 4-Pin — Rating: 75 WATT 600V  
Suitable for Dimming or Electronic Ballasts

| MOUNTING                             | CAT. NO.  | COLOR | LAMP BASE | OSRAM SYLVANIA | GE LIGHTING  |
|--------------------------------------|-----------|-------|-----------|----------------|--------------|
| Bottom Snap-In for 16 Ga. Panels     | 26725-405 | Blue  | GX24q-5   | DULUX T/E 57W  | BIAX Q/E 57W |
| 4-Hole Bottom Screw-Down             | 26725-415 | Blue  | GX24q-5   | DULUX T/E 57W  | BIAX Q/E 57W |
| 2-Hole Bottom Screw-Down, Round Body | 26725-4A5 | Blue  | GX24q-5   | DULUX T/E 57W  | BIAX Q/E 57W |
| Bottom Snap-In for 18–20 Ga. Panels  | 26725-425 | Blue  | GX24q-5   | DULUX T/E 57W  | BIAX Q/E 57W |
| Bottom Snap-In for 16 Ga. Panels     | 26725-406 | Red   | GX24q-6   | —              | BIAX Q/E 70W |
| 4-Hole Bottom Screw-Down             | 26725-416 | Red   | GX24q-6   | —              | BIAX Q/E 70W |
| 2-Hole Bottom Screw-Down, Round Body | 26725-4A6 | Red   | GX24q-6   | —              | BIAX Q/E 70W |
| Bottom Snap-In for 18–20 Ga. Panels  | 26725-426 | Red   | GX24q-6   | —              | BIAX Q/E 70W |



26725-406



26725-425



26725-416

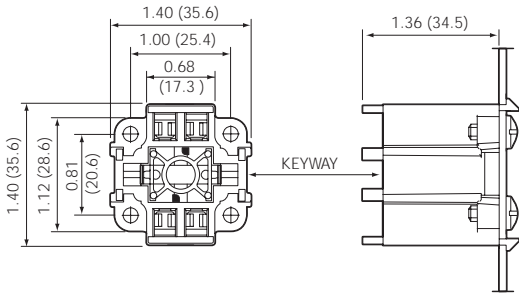

RECOMMENDED MOUNTING SCREW #8 SELF-CUTTING

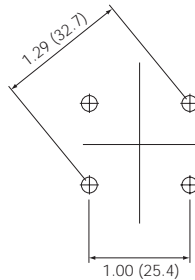

RECOMMENDED HOLE PATTERN

4-Hole Bottom Screw-Down CFLs  
26725-415 Shown

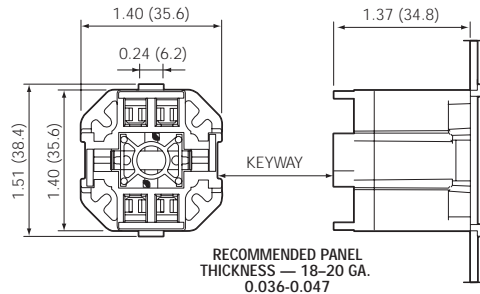

RECOMMENDED PANEL THICKNESS — 18–20 GA.  
0.036–0.047

Bottom Snap-In CFLs for 18–20 Ga Panels  
26725-426 Shown

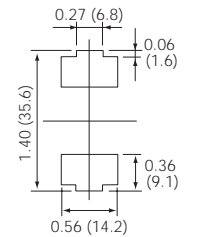

RECOMMENDED PANEL OPENING

### SPECIFICATIONS AND FEATURES

- “Smart” CFL Lampholders are color-coded for easy wattage identification
- Bottom Snap-In versions for easier panel assembly available for 16 Ga. and 18–20 Ga. panels
- All 4-pin lampholders have internal rejection feature that prevents insertion of 2-pin lamps
- Metal-spring lamp-retainer clip provides positive lamp retention
- Two wiring ports per contact speed harness wiring
- Wire-routing options for top or bottom side of mounting panel for easier assembly
- Bodies are white thermoplastic (with color-coding as indicated)
- Quick-connect push-in wiring terminals accept No. 18 AWG solid or twisted-and-overtinned leads, stripped 3/8 inch

### TESTING AND CODE COMPLIANCE

- UL Listed (File #E-5833)
- UL Listed for indoor and outdoor applications when properly enclosed
- CSA Certified (File #LR-1863)
- NOM Certified (#057)

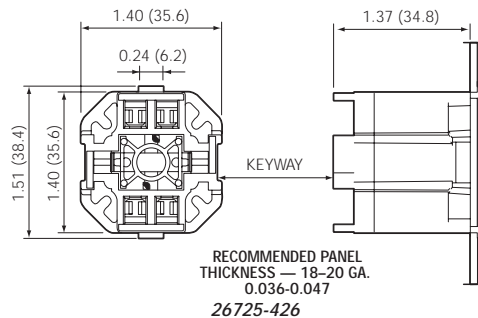

RECOMMENDED PANEL THICKNESS — 18–20 GA.  
0.036–0.047  
26725-426



75W 600V

## Compact Fluorescent Lampholders (CFLs)



26725-4A2

### 10mm Compact Fluorescent Lampholders with Round Bodies

For G24d Lamp Bases, 2-Pin — Rating: 75 WATT 600V  
Bottom Screw-Down Mounting

| CAT. NO.  | COLOR  | LAMP BASE | PHILIPS          | OSRAM SYLVANIA               | GE LIGHTING             |
|-----------|--------|-----------|------------------|------------------------------|-------------------------|
| 26725-2A1 | Black  | G24d-1    | PL-C<br>10W, 13W | DULUX D<br>10W, 13W          | DOUBLE BIAX<br>10W, 13W |
| 26725-2A2 | Green  | G24d-2    | PL-C, 18W        | DULUX D, 18W<br>DULUX T, 18W | DOUBLE BIAX 18W         |
| 26725-2A3 | Orange | G24d-3    | PL-C, 26W        | DULUX D, 26W<br>DULUX T, 26W | DOUBLE BIAX 26W         |



26725-4A3

For G24q and GX24q Lamp Bases, 4-Pin — Rating: 75 WATT 600V  
Bottom Screw-Down Mounting — Suitable for Dimming or Electronic Ballasts

| CAT. NO.                | COLOR                               | LAMP BASE         | PHILIPS                       | OSRAM SYLVANIA                        | GE LIGHTING                                 |
|-------------------------|-------------------------------------|-------------------|-------------------------------|---------------------------------------|---|
| 26725-4A1               | Black                               | G24q-1            | PL-C<br>10W, 13W              | DULUX-D<br>10W, 13W                   | DOUBLE BIAX<br>10W, 13W<br>TRIPLE BIAX 13W  |
| 26725-4A2               | Green<br>Green                      | G24q-2<br>GX24q-2 | PL-C, 18W<br>PL-C, 18W        | DULUX D, 18W<br>DULUX T/E, 18W        | DOUBLE BIAX, 18W<br>TRIPLE BIAX, 18W        |
| 26725-4A3               | Orange<br>Orange                    | G24q-3<br>GX24q-3 | PL-C, 26W<br>PL-T<br>26W, 32W | DULUX D, 26W<br>DULUX T/E<br>26W, 32W | DOUBLE BIAX, 26W<br>TRIPLE BIAX<br>26W, 32W |
| 26725-4A4               | Yellow                              | GX24q-4           | PL-T, 42W                     | DULUX T/E, 42W                        | PERFORMANCE<br>BIAX 42W                     |
| 26725-4A5               | Blue                                | GX24q-5           | —                             | DULUX T/E, 57W                        | BIAX Q/E, 57W                               |
| 26725-4A6               | Red                                 | GX24q-6           | —                             | —                                     | BIAX Q/E, 70W                               |
| 26725-4A9<br>Universal* | No color code<br>White body<br>only | G24q-3<br>GX24q-4 | PL-T<br>26W, 32W<br>42W       | DULUX T/E<br>26W, 32W,<br>42W         | TRIPLE BIAX<br>26W, 32W, 42W                |

\*For use with universal ballast only  
Note: Lamp names are trademarked by manufacturers

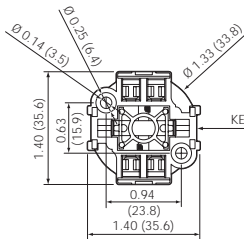

26725-4A5

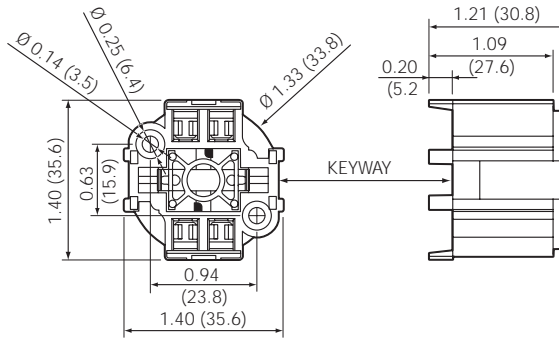

All Round-Body CFLs  
26725-4A5 Shown

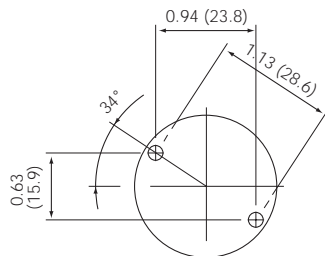

RECOMMENDED PANEL OPENING FOR ALL  
ROUND-BODY CFLs

#### SPECIFICATIONS AND FEATURES

- “Smart” CFL Lampholders are color-coded for easy wattage identification
- All 4-pin lampholders have internal rejection feature that prevents insertion of 2-pin lamps
- Metal-spring lamp-retainer clip provides positive lamp retention and is more durable than plastic clips
- Two wiring ports per contact speed harness wiring
- Wire-routing options for top or bottom side of mounting panel for easier assembly
- Bodies are white thermoplastic (with color-coding as indicated)
- Quick-connect push-in wiring terminals accept No. 18 AWG solid or twisted-and-overtinned leads, stripped 3/8 inch

#### TESTING AND CODE COMPLIANCE

- UL Listed (File #E-5833)
- UL Listed for indoor and outdoor applications when properly enclosed
- CSA Certified (File #LR-1863)
- NOM Certified (#057)

# Appliance Switches

## INDEX

**Appliance Switches**

- Single Pole Pull Chain .....T2
- Single Pole Rotary .....T2
- Two Circuit Rotary .....T3
- Single Pole Pushbutton .....T3
- Door Jamb Switch .....T3
- Fluorescent Starter Pushbutton .....T4
- Single Pole Toggle .....T4
- Feed-Through Cord Switch .....T5
- Miniature Feed-Through Cord Switch .....T5





3 AMP 125V • 6 AMP 125V

## Commercial Grade Appliance Switches

THE LEVITON WIRING DEVICES INCLUDED IN THIS SECTION CONSTITUTE ONLY A PARTIAL LISTING OF LEVITON'S COMPLETE APPLIANCE DEVICE LINE.

To learn more about the availability of appliance devices to meet your specialized needs, please contact your Leviton representative.

Appliance Switches



1689-75



10041-500



10097-8



90572

### Single Pole Pull Chain Switches

3 AMP 125V AC-L 6 AMP 125V AC 3 AMP 250V AC 1/4 HP 125/250V

| DESCRIPTION   | CAT. NO. | SEQUENCE                               |
|---|----------|--|
| Heavy Duty, Single Circuit, Black and Red Leads                 | 1689-75  | ON-OFF (L1, OFF)                       |
| Heavy Duty, Two Circuit, Four Positions, Black, Blue, Red Leads | 1689-50  | LOW-MED-HIGH-OFF (L1, L2, L1 & 2, OFF) |
| Heavy Duty, Two Speed, Four Positions, Black, Blue, Red Leads   | 1691-50  | ONE-OFF-TWO-OFF (L1, L2, L3, OFF)      |

3 AMP 125V 1 AMP 125VT 1 AMP 250V

| DESCRIPTION                          | CAT. NO. | SEQUENCE |
|--------------------------------------|----------|----------|
| Compact, Single Circuit, Black Leads | 10097-8  | ON-OFF   |

3 AMP 125V AC-L 6 AMP 125V AC 3 AMP 250V AC

| DESCRIPTION                          | CAT. NO.  | SEQUENCE |
|--------------------------------------|-----------|----------|
| Compact, Single Circuit, Black Leads | 10041-500 | ON-OFF   |

### Single Pole Rotary Switches

6 AMP 125V AC 3 AMP 250V AC

| DESCRIPTION   | CAT. NO.  | SEQUENCE |
|---|-----------|----------|
| Non-Removable Black Plastic Knob, Black Leads                 | 90572     | ON-OFF   |
| Non-Removable Metal Knob, Brass or Nickel Finish, Black Leads | 90577-010 | ON-OFF   |

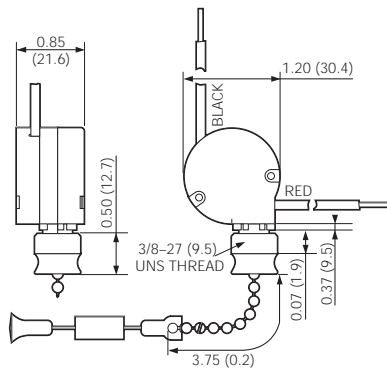

1689-75—HEAVY DUTY PULL CHAIN SWITCH

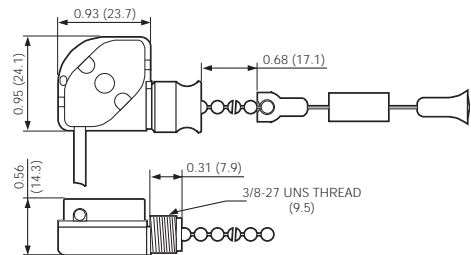

10097-8—COMPACT PULL CHAIN SWITCH

#### SPECIFICATIONS AND FEATURES

##### Single Pole Pull Chain Switches

- Standard finish of metal chain is nickel
- Standard leads are No. 18 AWG 105°C plastic 6" long, stripped 1/2"
- 3/4" chain connector, 3' braided cord, end bell
- Bushing 3/8-27 x 3/8" long
- Piercing 1 1/32" dia.

##### Single Pole Rotary Switches

- Standard leads are No. 18 AWG 105°C plastic 6" long, stripped 1/2"

Cat. No. 90572

- Bushing 3/8-27 x 1 1/32" long; panel opening 1 3/32" dia.

#### TESTING AND CODE COMPLIANCE

- UL Recognized Component (File #E-7458)—Cat. Nos. 1689-75, 1689-50, 1691-50, 10041-500, 90572, 90577-010
- UL Listed (File #E-7443)—Cat. No. 10097-8
- CSA Certified (File #LR-3413)
- NOM Certified (#057)

#### MATERIAL CHARACTERISTICS

Environmental: Flammability UL-94, V2 Rating  
Operating Temperature: -40°C to 120°C





## Two Circuit Rotary Switches

### 6 AMP 125VT 3 AMP 250V

| DESCRIPTION  | CAT. NO. | SEQUENCE                               |
|--|----------|--|
| Two Circuit, Four Position, Heavy Duty, Black, Blue, Red Leads | 663      | LOW-MED-HIGH-OFF (L1, L2, L1 & 2, OFF) |

### 3 AMP 125VT 1 AMP 250V

| DESCRIPTION  | CAT. NO. | SEQUENCE                               |
|--|----------|--|
| Two Circuit, Four Position, Black, Blue, Red Leads | 573      | LOW-MED-HIGH-OFF (L1, L2, L1 & 2, OFF) |

## Single Pole Pushbutton Switches

### 3 AMP 125V AC-L 1.5 AMP 250V AC

| DESCRIPTION  | CAT. NO. | SEQUENCE |
|--|----------|----------|
| Single Circuit, Black Leads, Molded Brown Pushbutton | 9575-250 | ON-OFF   |

### 3 AMP 125V AC

| DESCRIPTION   | CAT. NO. | SEQUENCE     |
|---|----------|--------------|
| Single Circuit, Momentary, for double-insulated applications. Black leads | 2591     | NORMALLY OFF |

|   |      |             |
|---|------|-------------|
| Single Circuit, Momentary, for double-insulated applications. Also rated 1.5 AMP 277V AC. Black leads | 2592 | NORMALLY ON |
|---|------|-------------|

### 3 AMP 125V — Door Jamb Switch

| DESCRIPTION  | CAT. NO. | SEQUENCE    |
|--|----------|-------------|
| Single Circuit, Momentary, Metal Pushbutton, No. 18AWG Leads, with Jamb Box, Mounting Screws and Cover Plate | 1865     | NORMALLY ON |

### 3 AMP 125V AC-L 1.5 AMP 250V AC

| DESCRIPTION   | CAT. NO.  | SEQUENCE |
|---|-----------|----------|
| Single Circuit, Compact Body, Black Leads, Metal Pushbutton | 90679-001 | ON-OFF   |

### 3 AMP 125VT 1 AMP 250V

| DESCRIPTION                                       | CAT. NO. | SEQUENCE    |
|---|----------|-------------|
| Two Speed, Three-Position, Black, Blue, Red Leads | 585      | L1, L2, OFF |



9575-250



2591



1865



90679-001

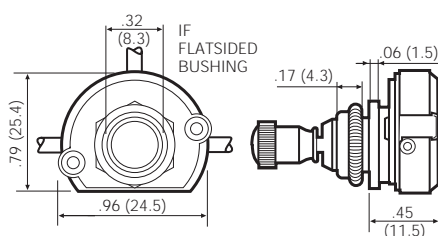

573—TWO CIRCUIT ROTARY SWITCH

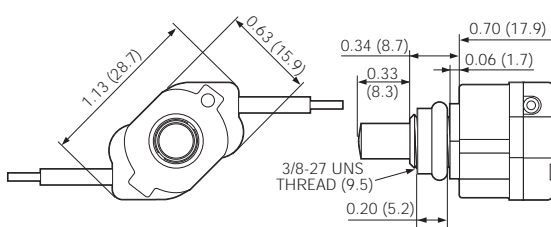

9575-250—SINGLE CIRCUIT PUSHBUTTON SWITCH

### SPECIFICATIONS AND FEATURES

#### Rotary Switches

- Standard leads are No. 18 AWG 105°C plastic 6" long, stripped 1/2"

#### Cat. Nos. 663, 573

- Bushing 3/8-27 x 3/8" long; panel opening 1 1/32" dia.; knob spindle 4-36 x 5/32"

#### Single Pole Pushbutton Switches

- Standard leads are No. 18 AWG 105°C plastic 6" long, stripped 1/2"
- Plastic actuators are brown molded plastic unless otherwise indicated

#### Cat. No. 9575-250

- Plastic button; bushing 3/8-27 x 1 1/32" long; panel opening 1 1/32" dia. Leads stripped 3/4"

#### Cat. Nos. 2591, 2592

- Plastic button; bushing 3/8-27 x 27/64" long
- 2591: One 12" lead and one 6" lead

#### Cat. No. 1865 – Door Jamb Switch

- Bushing 1 5/32-32 x 9/16" long

#### Cat. No. 90679-001

- Metal button; bushing 3/8-27 x 27/64" long. Leads stripped 3/4"

#### Cat. No. 585

- Metal button; bushing 3/8-27 x 27/64" long. Leads stripped 3/4"

### TESTING AND CODE COMPLIANCE

- UL Recognized Component (File #E-7458)—Cat. Nos. 9575-250, 2591, 2592, 90679-001, 585
- UL Listed (File #E-7443)—Cat. Nos. 663, 573, 1865
- CSA Certified (File #LR-3413)—All, except Cat. Nos. 2591 and 2592
- NOM Certified (#057)

### MATERIAL CHARACTERISTICS

Environmental: Flammability UL-94, V2 Rating  
Operating Temperature: -40°C to 120°C



40 WATT 125V • 6 AMP 125V • 8 AMP 125V • 15 AMP 125V

## Commercial Grade Appliance Switches

### Pushbutton Switches Fluorescent Starter

40 WATT 125V AC

| DESCRIPTION                           | CAT. NO. | SEQUENCE |
|---------------------------------------|----------|----------|
| Metal Button, 2 Black, 2 Blue Leads   | 388      | ON-OFF   |
| Plastic Button, 2 Black, 2 Blue Leads | 9382     | ON-OFF   |

### Single Pole Toggle Switches

6 AMP 125V 3 AMP 250V

| DESCRIPTION  | CAT. NO. | SEQUENCE |
|--|----------|----------|
| Single-Throw Ball Toggle. Nickel Finish ON-OFF Indicator Plate keyed to bushing. #6-32 Brass Terminal Screws | 735      | ON-OFF   |

6 AMP 125V 3 AMP 125VT 3 AMP 250V

| DESCRIPTION  | CAT. NO. | SEQUENCE |
|--|----------|----------|
| Single-Throw Metal Bat Toggle. ON-OFF Indicator Plate keyed to bushing. No. 18 AWG leads.            | 720-L5   | ON-OFF   |
| Same as above, with Molded Nylon Bat Toggle. Meets UL requirements for double insulated applications | 1720-T   | ON-OFF   |

8 AMP 125V

| DESCRIPTION   | CAT. NO. | SEQUENCE |
|---|----------|----------|
| Single-Throw Metal Bat Toggle. Nickel Finish ON-OFF Indicator Plate keyed to bushing with No. 16 AWG leads.     | 738      | ON-OFF   |
| Similar to Cat. No 738, with Black Molded Nylon Bat Toggle. No. 16 AWG leads. For double insulated applications | 1738     | ON-OFF   |

15 AMP 125V AC 10 AMP 250V AC 3/4 HP 125/250V AC

| DESCRIPTION  | CAT. NO. | SEQUENCE |
|--|----------|----------|
| Single-Throw Heavy-Duty Aluminum Bat Toggle. Stamped with ON-OFF marking. Screw terminals    | 5731     | ON-OFF   |
| Single-Throw Heavy-Duty Aluminum Bat Toggle. Stamped with ON-OFF marking. Quick connect tabs | 5721     | ON-OFF   |



388



735



1720-T



5731

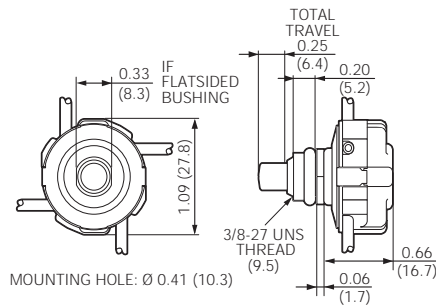

388—FLUORESCENT STARTER SWITCH

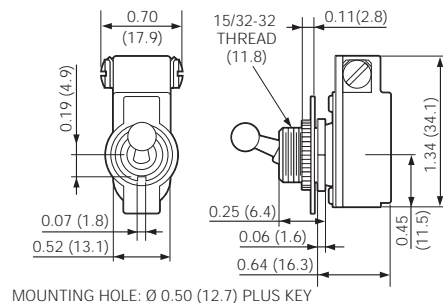

735—SINGLE POLE TOGGLE SWITCH

#### SPECIFICATIONS AND FEATURES

Cat. Nos. 388, 9382

- Bushing 3/8-27 x 1 1/32" long; panel opening 1 3/32" dia.

Cat. No. 735

- Bushing 15/32-32 x 1/4" long

Cat. No. 720-L5

- Bushing 15/32-32 x 1/4" long

Cat. No. 1720-T

- Bushing 15/32-32 x 1 1/32" long

Cat. Nos. 738, 738

- Bushing 15/32-32 x 1 1/32" long; panel opening 1/2" dia.

Cat. Nos. 5731, 5721

- Bushing 15/32-32 x 3 1/64" long. Bat-type toggle extends 1 1/16" from top of bushing

#### TESTING AND CODE COMPLIANCE

- UL Listed (File #E-18134)—Cat. Nos. 388, 9382
- UL Listed (File #E-7458)—Cat. Nos. 735, 720-L5, 1720-T, 738, 1738, 5731, 5721
- CSA Certified (File #LR-8255)—Cat. No. 388
- CSA Certified (File #LR-3413)—Cat. Nos. 9382, 735, 720-L5, 1720-T, 738, 1738, 5731, 5721
- NOM Certified (#057)

#### MATERIAL CHARACTERISTICS

Environmental: Flammability UL-94, V2 Rating  
Operating Temperature: -40°C to 120°C

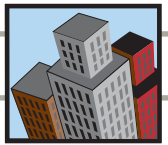

**Feed-Through Cord Switches**

**3 AMP 125V 1/2 H.P. 125V**

| DESCRIPTION   | CAT. NO. | SEQUENCE | COLOR*  |
|---|----------|----------|---|
| Heavy Duty, Single Pole, 18/2 – 16/2 Type SPT-1, SPT-2 or Round Cord 18/2, Type SVT and other cords up to 9/32" outer jacket. | 5410     | ON-OFF   | I, W<br><small>Basic Cat. No. denotes Brown</small> |

**Miniature Feed-Through Cord Switch**

**6 AMP 125V 3 AMP 125VT 3 AMP 250V**

| DESCRIPTION  | CAT. NO. | COLOR*  |
|--|----------|---|
| Miniature Single Pole, ON-OFF Sequence, Captive Screw. For use with #18 ga. SPT-1 conductors | 423-3    | I, W<br><small>Basic Cat. No. denotes Brown</small> |



5410-W



423-3I

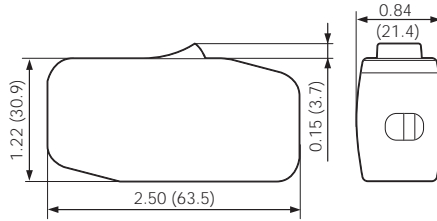

5410—FEED-THROUGH SWITCH

**TESTING AND CODE COMPLIANCE**

- UL Listed (File #E-7458)
- CSA Certified (File #LR-3413)
- NOM Certified (#057)

**\*COLOR**

Basic Cat. No. denotes Brown. Add the suffix to catalog number as follows for additional color selections: Ivory (-I), White (-W).

**MATERIAL CHARACTERISTICS**

Environmental: Flammability UL-94, V2 Rating  
Operating Temperature: -40°C to 120°C

# HOW TO USE THIS CATALOG

The L-101 Leviton Wiring Device Catalog is designed to help you find the device you're seeking in the quickest and easiest way possible. Most product sections are divided into three distinct categories in the following sequence—Industrial Grade, Commercial Grade and Residential Grade—and grouped according to amperage and voltage, lowest to highest. For example, if you need to order 15 Amp, 125 Volt Industrial Grade straight-blade duplex receptacles, begin your search with the main Table of Contents at the front of the book. Here you'll see that all straight blade receptacles are listed in Section G. Turn to Section G for a more detailed Table of Contents on the first page. Each section page contains product descriptions, ratings and catalog numbers. There are also helpful highlights including Specifications and Features, Testing and Code Compliance, Color listing, Material Characteristics and dimensioned color product photos. Any product page in the L-101 Catalog can be clearly copied or faxed to customers and prospects for use as a specifier sheet or as part of a presentation.

The Quick Reference Guide follows the main Table of Contents to help you pinpoint and locate specific products. Technical Section V provides general product and test data, industry standards, NEMA configuration charts, a glossary of wiring device terms, ANSI architectural symbols and other related information. Specific catalog numbers are listed in the exhaustive index at the back of the catalog.

## 15 AMP 125 and 250V ~ 20 AMP 125 and 250V

### Industrial Grade Straight Blade Receptacles

**Back and Side Wired** (Basic Cat. No. Denotes Brown Device\*)

| DESCRIPTION                             | CAT. NO./COLOR<br>15A/125V       | CAT. NO./COLOR<br>15A/250V | CAT. NO./COLOR<br>20A/125V | CAT. NO./COLOR<br>20A/250V |
|---|----------------------------------|----------------------------|----------------------------|----------------------------|
| LEVSPEC® Duplex Receptacle, Brass Strap | 5262<br>I, W, GY, R, E           | 5662<br>I                  | 5362<br>I, W, GY, R, E     | 5462<br>I, GY              |
| Single Receptacle                       | 5261<br>I, W, GY                 | 5661<br>I                  | 5361<br>I, W, A, T, GY     | 5461<br>I, A, T, GY        |
| Narrow Body Duplex Receptacle           | 5252<br>I, W, A, T, GY, R,<br>BU |                            | 5352<br>I, W, A, T, GY, R, |                            |

5362-IG

**For complete wallplate selection, see Section E.**

80703-IG

80703-I

80704-GY

80716-R

84003-40

84004-40

84016-40

**SPECIFICATIONS AND FEATURES**

**Back & Side Wired Duplex**

- Impact-resistant thermoplastic nylon cover and body
- Smooth face does not collect dirt
- Four corner latches securely fasten face
- Single-piece brass mounting strap on LEVSPEC devices, multi-piece steel strap on other devices
- Large, triple-wipe, brass "T" contacts for superior contact and conductivity
- Back and side-wiring options
- Brass terminal screws to reduce conductor oxidation
- Break-off tabs for easy two-circuit conversion
- Apron barrier to prevent accidental contact between terminal screw heads and metal box
- Exclusive V-shaped, serrated back-wiring clamp for superior contact and conductivity

**TESTING AND CODE COMPLIANCE**

- UL Listed 498 (UL File #13399); UL Federal Specification WC-596

**\*COLOR**

Basic Cat. Nos. shown above denote Brown device, except for Isolated Ground (-IG) devices Basic Cat. No. denotes Orange. Isolated Ground Receptacle is distinguished by an orange triangle on its face. For other color selections, add suffix to the catalog number as follows: Ivory (-I), White (-W), Brown (For IG devices only, add -B), Almond (-A), Light Almond (-T), Gray (-G or -GY), Black (-E), Red (-R) and Blue (-BU); for IG devices only, add -BIG)

**MATERIAL CHARACTERISTICS**

Environmental: Flammability, Rated V2  
Operating Temperature: From -40° C (without impact) to 60°C maximum continuous

- |                                       |  |                                      |
|---------------------------------------|--|--------------------------------------|
| <b>A</b> RATING                       | <b>E</b> CATALOG NUMBER                      | <b>I</b> SPECIFICATIONS & FEATURES   |
| <b>B</b> Choose GRADE, if appropriate | <b>F</b> DESCRIPTION                         | <b>J</b> TESTING AND CODE COMPLIANCE |
| <b>C</b> DIMENSIONED PHOTOGRAPH       | <b>G</b> Check for NEMA CONFIGURATION        | <b>K</b> COLOR LISTING               |
| <b>D</b> WIRING/CERTIFICATIONS        | <b>H</b> WALLPLATE REFERENCE, if appropriate | <b>L</b> MATERIAL CHARACTERISTICS    |

# Electrical Accessories and Decorative Devices

## INDEX

### Residential Grade Electrical Accessories and Decorative Devices

|                                  |    |
|----------------------------------|----|
| Taps and Adapters .....          | U2 |
| Night Lights .....               | U3 |
| Guide Lights .....               | U4 |
| Fluorescent Utility Lights ..... | U4 |
| Child Protection Devices .....   | U4 |
| Accessories .....                | U4 |
| Wallplates .....                 | U5 |





# ADAPTERS

## Residential Grade Devices

LEVITON OFFERS A VARIETY OF ELECTRICAL ACCESSORIES FOR RESIDENTIAL USE, INCLUDING TAPS, SURFACE OUTLETS, ADAPTERS, NIGHT LIGHTS AND SAFETY ITEMS USED FOR CHILD PROTECTION.

### Switch Tap

#### 13 AMP 125V 2-Pole 2-Wire Non-Grounding

| DESCRIPTION        | CAT. NO. | COLOR | NEMA CONFIG. |
|--------------------|----------|-------|--------------|
| Plug-In Switch Tap | 1469     | I, W  | 1-15R        |



1469-W



69-W



607-W



698-W



1403-W

### Plug-In Outlet Adapters

#### 15 AMP 125V 2-Pole 2-Wire Non-Grounding

| DESCRIPTION  | CAT. NO. | COLOR | NEMA CONFIG. |
|--|----------|-------|--------------|
| Single-to-Triple<br>3 round or flat plugs accepted               | 63       | I, W  | 1-15R        |
| Single-to-Triple Right Angle,<br>3 round or flat plugs accepted★ | 65       | I, W  |              |
| Single-to-Triple, Swivel,<br>3 flat plugs accepted               | 69       | I, W  |              |
| Cube Tap, Vinyl,<br>3 round or flat plugs accepted               | 531      | I, W  |              |

#### 15 AMP 125V 2-Pole 3-Wire Grounding

| DESCRIPTION  | CAT. NO. | COLOR         | NEMA CONFIG. |
|--|----------|---------------|--------------|
| 3-Wire, Grounding Duplex-to-Six,<br>6 small or 4 large plugs accepted            | 49686    | I, W          | 5-15R        |
| 3-Wire, Grounding Single-to-Triple,<br>3 straight or angle plugs acceptedH       | 697      | I, W          |              |
| 3-Wire, Grounding Single-to-Triple, Vinyl,<br>3 straight or angle plugs accepted | 699      | Orange only   |              |
| 3-Wire, Grounding Single-to-Triple,<br>3 straight plugs accepted                 | 694      | Orange, Green |              |
| Triple Cube Adapter  | 692      | I, W          |              |

#### 15 AMP 125V 2-Pole 2-Wire to 2-Pole 3-Wire Grounding

| DESCRIPTION   | CAT. NO. | COLOR | NEMA CONFIG. |
|---|----------|-------|--------------|
| Adapter, 2-Wire to Grounding,<br>1 straight or 1 angle plug accepted★ | 274      | Gray  | 5-15R        |
| 2-Wire to Grounding,<br>3 straight plugs accepted★                    | 698      | I, W  |              |

Note: All Leviton #274 and #698 adapters use the outlet wallplate screws for grounding.

### Medium Base Lampholder Outlet Adapters

#### 660 WATT 125V 2-Pole 2-Wire

| DESCRIPTION   | CAT. NO. | COLOR   | NEMA CONFIG. |
|---|----------|---------|--------------|
| Outlet-to-Lampholder★                               | 61       | I, W    | 1-15R        |
| Lampholder-to-Outlet                                | 125      | I, W    |              |
| Keyless Lampholder and 2 Outlets                    | 1403     | I, W, E |              |
| Single Lampholder-to-Twin Lampholder<br>(660W-250V) | 128      | I       |              |

#### 660 WATT 125V Max. Total 2-Pole 2-Wire

| DESCRIPTION  | CAT. NO. | COLOR   | NEMA CONFIG. |
|--|----------|---------|--------------|
| Pull Chain Lampholder and 2 Outlets.<br>Pull chain controls lamp socket ONLY.<br>Outlet continuously live. | 1406     | I, W, E | 1-15R        |

CSA Certified except where indicated by★

#### SPECIFICATIONS AND FEATURES

##### Plug-In Switch

- Provides ON/OFF switching at outlet location

##### Plug-In Outlet Adapters

- Convenient expansion of outlet capacity

#### TESTING AND CODE COMPLIANCE

- UL Listed (File #E13393 – Cat. No. 125; File #E13394 – Cat. Nos. 1469, 49686, 692, 694, 697, 698, 274, 128, 1403 and 1406; File #E-13399 – Cat. Nos. 63, 65, 69, 531)
- CSA Certified (File #LR-406 – Cat. No. 125; File #LR-1523 – Cat. No. 63; File #LR-2780 – Cat. No. 128; File #LR-61476 – Cat. Nos. 65, 69, 531 and 1469; File #LR-91345 – Cat. No. 49686)
- NOM Certified (#057)
- Backed by a Limited Two-Year Warranty

#### \*COLOR

Basic Cat. No. denotes Brown device. For other color selections, add suffix to catalog number as follows: Ivory (-I), White (-W), Almond (-A) and Black (-E).



Night Lights

**ON/OFF Night Light 4 WATT 125V**

| DESCRIPTION                                       | CAT.NO | COLOR* |
|---|--------|--------|
| ON/OFF switching with sleek, contemporary styling | 48566  | I, W   |

**Automatic Light Directing LED Night Light .25W 120V**

| DESCRIPTION  | CAT.NO | COLOR |
|--|--------|-------|
| Removable shade slides up and down to direct light | 48585  | W     |

**Automatic Rotating Spotlight 120V**

| DESCRIPTION   | CAT.NO    | COLOR |
|---|-----------|-------|
| Automatic ON/OFF with 360° rotating head directs light and varies intensity (2.4W)    | 49566     | W     |
| LED Automatic ON/OFF with 360° rotating head directs light and varies intensity (.5W) | 49566-LED | W     |

**Automatic Night Light 4 WATT 125V**

| DESCRIPTION  | CAT.NO | COLOR*<br>(Night Light Base) |
|--|--------|------------------------------|
| Automatic ON/OFF sensor with sleek, contemporary styling | 48568  | I, W                         |

**Automatic LED Night Light .25W 120V**

| DESCRIPTION   | CAT.NO | COLOR                                    |
|---|--------|--|
| Automatic ON/OFF with light-reflecting, crystal-faceted shade | 48580  | BLU (Blue)<br>GRN (Green)<br>WHT (White) |

**Automatic Sound-Activated Night Light 125V**

| DESCRIPTION   | CAT.NO    | COLOR |
|---|-----------|-------|
| Sound-Activated with adjustable sensitivity (4W)      | 51012     | W     |
| LED Sound-Activated with adjustable sensitivity (.5W) | 51012-LED | W     |

**Decorative Shade LED Night Lights .5W 120V**

| DESCRIPTION  | CAT.NO | COLOR |
|--|--------|-------|
| <b>49563 Series</b> —Consult your Leviton representative for available shade designs | 49563  | W     |



**Leviton's Energy Smart Living Program**

Leviton offers a broad range of energy-efficient lighting devices for homes and businesses. From dimmers, timers and motion sensors to night-lights and more, Leviton has the electrical products you need to save energy and conserve resources. Look for the Energy Smart Living logo, your assurance of an environmentally friendly lighting product. For more information, visit our website at [www.leviton.com](http://www.leviton.com).



48566-W



48580-WHT



51012



49563-SWL



49563-PLM

**SPECIFICATIONS AND FEATURES**

**Automatic Night Lights**

- Turn ON automatically at dusk and OFF automatically at dawn, by sound or by movement depending on model
- Long-life 4 watt bulb or LED included

**TESTING AND CODE COMPLIANCE**

- UL Listed (File #E-39445 – Cat. Nos. 16509, 48566, 48581, 49563, 49566 and 51012; File #E-121173 – Cat. No. 48568)
- CSA Certified (File #LR-1863 – Cat. Nos. 48566, 48568 and 49566)
- NOM Certified (#057)
- Backed by a Limited Two-Year Warranty

**\*COLOR**

Add suffix to catalog number as follows for color selections: Ivory (-I), White (-W).



Residential Grade Devices



49568



6511-6



6516



12540

**Guide Lights**

| DESCRIPTION                                      | CAT.NO | COLOR                           |
|--|--------|---------------------------------|
| Button-Style Neon Guide Light .25 Watt 120V AC   | 49567  | W                               |
| LED Guide Light with clear shade .5 Watt 120V AC | 49568  | W (Amber LED)<br>BLU (Blue LED) |

**Cool Glow Night Light**

| DESCRIPTION                                      | CAT.NO    | COLOR |
|--|-----------|-------|
| Electro-Luminescent Guide Light 1 pack .03W 115V | 16509-1PK | W     |
| Electro-Luminescent Guide Light 2 pack .03W 115V | 16509-2PK | W     |

**Utility Lights**

| DESCRIPTION   | CAT.NO   | COLOR             |
|---|----------|-------------------|
| <b>6" Battery-Operated Fluorescent Light</b> —With 4W replaceable bulb. Requires 4 AA batteries (not included). 6V DC Jack for use with AC/DC adapter (Sold separately) | 6511-6   | (White base only) |
| <b>6" Battery-Operated Closet Utility Light with ON/OFF switch (2 pack)</b> —Requires 3 AA batteries (not included)   | 6516-2PK | (White base only) |

**Child Protection Devices**

**Outlet Cover Night Light .25 WATT**

| DESCRIPTION   | CAT.NO | COLOR             |
|---|--------|-------------------|
| Cool neon light on top outlet, cover on bottom outlet | 48500  | (White base only) |

**Outlet Caps**

| DESCRIPTION         | CAT.NO | COLOR      |
|---------------------|--------|------------|
| Outlet Caps—12 Pack | 12777  | White only |

**Tamper Resistant Receptacles 15 AMP 125V 2-Pole 3-Wire Grounding**

| DESCRIPTION                 | CAT. NO. | COLOR | NEMA CONFIG. |
|-----------------------------|----------|-------|--------------|
| Tamper Resistant Receptacle | 5321     | I, W  | 5-15R        |

**Electrical Accessories**

| DESCRIPTION  | CAT.NO | COLOR                             |
|--|--------|-----------------------------------|
| <b>Insulated Staples</b> — <sup>5</sup> / <sub>8</sub> " long, for use with 18/2 or smaller cord (40 Pieces)               | 12533  | White                             |
| <b>Plastic Staples</b> —for 1/2" 14/2 & 12/2 NM Cable (50 Pieces)  | 12536  | White                             |
| <b>Wiring Fasteners</b> —Includes 1/2" Plastic Staples, Coax Cable Fasteners and 1/2" X 1" Metal Staples (47 Mixed Pieces) | 12537  | White/Black/<br>Metal Mix         |
| <b>NM Cable Fittings</b> — <sup>3</sup> / <sub>8</sub> " dia. for 14/2, 14/3 & 12/3 NM Cable (4 Pack)                      | 12538  | —                                 |
| <b>8" Cable Ties</b> —Holds wires, cables, bundles and hoses; comes in assorted lengths and colors                         | 12540  | White,<br>BL (Black)<br>NE (Neon) |

**SPECIFICATIONS AND FEATURES**

**Guide Lights**

- Energy-efficient with soft, comforting light
- Compact Neon model keeps second outlet free
- No bulb to replace in LED models

**Utility Lights**

- Battery operation adds light without wiring anywhere extra light is needed
- Includes adhesives for easy, anywhere mounting

**Outlet Caps**

- Insert into unused outlets to serve as a barrier
- Can be easily removed by adults when needed for lights and appliances

**Tamper Resistant Receptacle**

- Exclusive design helps prevent insertion of anything but a properly rated plug
- Floating shutters behind outlet faces block clear access to energized contacts

**TESTING AND CODE COMPLIANCE**

- UL Listed (File #E-84313 – Cat. Nos. 48500; File #E-7416 – Cat. No. 12777; File #E-13399 – Cat. No. 5321)
- CSA Certified (File #LR-64317 – Cat. No. 48500; File #LR-406 – Cat. No. 5321)
- NOM Certified (#057)
- Backed by a Limited Two-Year Warranty

**\*COLOR**

Add suffix to catalog number as follows for color selections: Ivory (-I), White (-W), Black (-E).





### The Finishing Touch® Wallplates

Available in warm wood tones and decorative metals, The Finishing Touch® wallplates are perfect for decorating, redecorating or adding an accent to any room. These wallplates feature elegant and stylish finishes with an oversize silhouette for complete coverage.

#### Decorative Wood — Straight Edge

| DESCRIPTION       | CAT. NO.  | COLOR      |
|-------------------|-----------|------------|
| 1-GANG, 1-Toggle  | 89201-OAK | Oak        |
|                   | 89201-CHR | Cherry     |
|                   | 89201-UNF | Unfinished |
|                   | 89201-WWP | Whitewash  |
| 2-GANG, 2-Toggles | 89209-OAK | Oak        |
|                   | 89209-CHR | Cherry     |
|                   | 89209-UNF | Unfinished |
|                   | 89209-WWP | Whitewash  |
| 1-GANG, 1-Duplex  | 89203-OAK | Oak        |
|                   | 89203-CHR | Cherry     |
|                   | 89203-UNF | Unfinished |
|                   | 89203-WWP | Whitewash  |

#### Wood — Scalloped Edge

| DESCRIPTION      | CAT. NO.  | COLOR |
|------------------|-----------|-------|
| 1-GANG, 1-Toggle | 89201-CVP | Pine  |
| 2-GANG, 2 Toggle | 89203-CVP | Pine  |
| 1-GANG, 1 Duplex | 89209-CVP | Pine  |

#### Wood — Beveled Edge

| DESCRIPTION      | CAT. NO.  | COLOR |
|------------------|-----------|-------|
| 1-GANG, 1-Toggle | 89201-POK | Oak   |
| 1-GANG, 1-Duplex | 89203-POK | Oak   |

#### Decorative Metal

| DESCRIPTION       | CAT. NO.  | COLOR         |
|-------------------|-----------|---------------|
| 1-GANG, 1-Toggle  | 89301-ATB | Antique Brass |
|                   | 89301-SSS | Satin Chrome  |
|                   | 89601-STB | Stepped Brass |
| 2-GANG, 2-Toggles | 89309-ATB | Antique Brass |
|                   | 89309-SSS | Satin Chrome  |
|                   | 89609-STB | Stepped Brass |
| 1-GANG, 1-Duplex  | 89303-ATB | Antique Brass |
|                   | 89303-SSS | Satin Chrome  |
|                   | 89603-STB | Stepped Brass |

For the full offering of Decorative Wallplates contact your Leviton representative.

#### SPECIFICATIONS AND FEATURES

##### Decorative Wood and Metal Wallplates

- Genuine wood available in Oak, Cherry, Whitewash and Unfinished
- Metal available in Antique Brass, Satin Chrome White Vinyl and Stepped Brass
- Sturdy impact-resistant construction for long-lasting performance
- Modern design with oversized silhouette for complete coverage
- Clean attractive appearance
- Smooth surface is easy to keep clean
- Mounting screws included—Metal plates feature matching-color screws



89201-OAK



89209-CHR



89203-CVP



89309-SSS



89601-STB

# TABLE OF CONTENTS with Quick Reference Index

The L-101 Leviton Wiring Device Catalog is designed to help you find the device you're seeking in the quickest and easiest way possible. Most product sections are divided into three distinct categories in the following sequence—Industrial Grade, Commercial Grade and Residential Grade—and grouped according to amperage and voltage, lowest to highest. For example, if you need to order 15 Amp, 125 Volt Industrial Grade straight-blade duplex receptacles, begin your search with the main Table of Contents at the front of the book. Here you'll see that all straight blade receptacles are listed in Section G. Turn to Section G for a more detailed Table of Contents on the first page. Each section page contains product descriptions, ratings and catalog numbers. There are also helpful highlights including Specifications and Features, Testing and Code Compliance, Color listing, Material Characteristics and dimensioned color product photos. Any product page in the L-101 Catalog can be clearly copied or faxed to customers and prospects for use as a specifier sheet or as part of a presentation.

The Quick Reference Guide follows the main Table of Contents to help you pinpoint and locate specific products. Technical Section V provides general product and test data, industry standards, NEMA configuration charts, a glossary of wiring device terms, ANSI architectural symbols and other related information. Specific catalog numbers are listed in the exhaustive index at the back of the catalog.

A
B
D

15 AMP 125 and 250V • 20 AMP 125 and 250V  
Industrial Grade Straight Blade Receptacles

1.53 (38.9)  
4.06 (103.2)  
3.28 (83.3)  
2.77 (70.4)  
0.87 (22.2)

Back and Side Wired

| DESCRIPTION                             | CAT. NO./COLOR<br>15A/125V          | CAT. NO./COLOR<br>15A/250V | CAT. NO./COLOR<br>20A/125V | CAT. NO./COLOR<br>20A/250V |
|---|-------------------------------------|----------------------------|----------------------------|----------------------------|
| LEVSPEC® Duplex Receptacle, Brass Strap | 5262<br>I, W, GY, R, E              | 5662<br>I                  | 5362<br>I, W, GY, R, E     | 5462<br>I, GY              |
| Single Receptacle                       | 5261<br>I, W, GY                    | 5661<br>I                  | 5361<br>I, W, A, T, GY     | 5461<br>I, A, T, GY        |
| Narrow Body Duplex Receptacle           | 5252<br>I, W, A, T, GY, R,<br>E, BU |                            | 5352<br>I, W, A, T, GY, R, |                            |

0.87 (22.2)

1.56 (39.6)  
4.06 (103.2)  
3.28 (83.3)  
2.80 (71.0)  
0.85 (21.6)

80703-IG 80703-I 80704-GY 80716-R

84003-40 84004-40 84016-40

0.85 (21.6)

**For complete wallplate selection, see Section E.**

SPECIFICATIONS AND FEATURES

**Back & Side Wired Duplex**

- Impact-resistant thermoplastic nylon cover and body
- Smooth face does not collect dirt
- Four corner latches securely fasten face
- Single-piece brass mounting strap on LEVSPEC devices, multi-piece steel strap on other devices
- Large, triple-wipe, brass "T" contacts for superior contact and conductivity
- Back and side-wiring options
- Brass terminal screws to reduce conductor oxidation
- Break-off tabs for easy two-circuit conversion
- Apron barrier to prevent accidental contact between terminal screw heads and metal box
- Exclusive V-shaped, serrated back-wiring clips for superior contact and conductivity

TESTING AND CODE COMPLIANCE

- UL Listed 498 (UL File #13399); UL Federal Specification WC-596

- Meets NEMA WD-1 & 6, and ANSI standards
- Backed by a Limited 10-Year Warranty
- SPECCLASS devices backed by a Limited 2-Year Warranty

\*COLOR

Basic Cat. Nos. shown above denote Brown device, except for Isolated Ground (-IG) devices. Basic Cat. No. denotes Orange. Isolated Ground Receptacle is distinguished by an orange triangle on its face. For other color selections, add suffix to the catalog number as follows: Ivory (-I), White (-W), Brown (For IG devices only, add -B), Almond (-A), Light Almond (-T), Gray (-G or -GY), Black (-E), Red (-R) and Blue (-BU; for IG devices only, add -BIG)

MATERIAL CHARACTERISTICS

Environmental: Flammability, Rated V2  
Operating Temperature: From -40° C (without impact) to 60° C maximum continuous

0.85 (21.6)

|  |   |  |
|--|---|--|
| <p><b>A</b> RATING</p> <p><b>B</b> Choose GRADE, if appropriate</p> <p><b>C</b> DIMENSIONED PHOTOGRAPH</p> <p><b>D</b> WIRING/CERTIFICATIONS</p> | <p><b>E</b> CATALOG NUMBER</p> <p><b>F</b> DESCRIPTION</p> <p><b>G</b> Check for NEMA CONFIGURATION</p> <p><b>H</b> WALLPLATE REFERENCE, if appropriate</p> | <p><b>I</b> SPECIFICATIONS &amp; FEATURES</p> <p><b>J</b> TESTING AND CODE COMPLIANCE</p> <p><b>K</b> COLOR LISTING</p> <p><b>L</b> MATERIAL CHARACTERISTICS</p> |
|--|---|--|

U  
6

# Technical Information

## INDEX

List of Abbreviations . . . . .V2  
 National Electrical Code (NEC) Requirements . . .V3  
 Associations, Organizations and Standards . .V4, V5  
 Certification Agencies and Markings . . . . .V5  
 UL, CSA and NEMA Standards  
 Pertaining to Leviton . . . . .V6  
 High-Abuse, UL Listed  
 Hospital Grade Wiring Devices . . . . .V7  
 Glossary of Electrical Wiring Device Terms . .V8-V10  
 Switches . . . . .V11  
 Dimmers . . . . .V11  
 Receptacles . . . . .V11, V12  
 Ground Fault Circuit Interrupters (GFCI's) . . .V12  
 Enclosure Classifications . . . . .V13-V15  
 Materials Used in Wiring Devices . . . . .V15, V16  
 ANSI Architectural Symbols . . . . .V17  
 NEMA Straight Blade Configurations . . . . .V18  
 NEMA Locking Configurations . . . . .V19  
 Horsepower Ratings for NEMA Configurations . .V20  
 Circuit Wiring Diagrams . . . . .V21-V23  
 Switch Wiring Diagrams . . . . .V24  
 Diameter Ranges of Jacketed Cord . . . . .V25  
 Wallplate Dimensions . . . . .V26  
 Telephone Wiring Devices —  
 Codes and Standards . . . . .V27  
 Wire Color Codes and Jack Pin Designations . . .V28

Technical Information Index

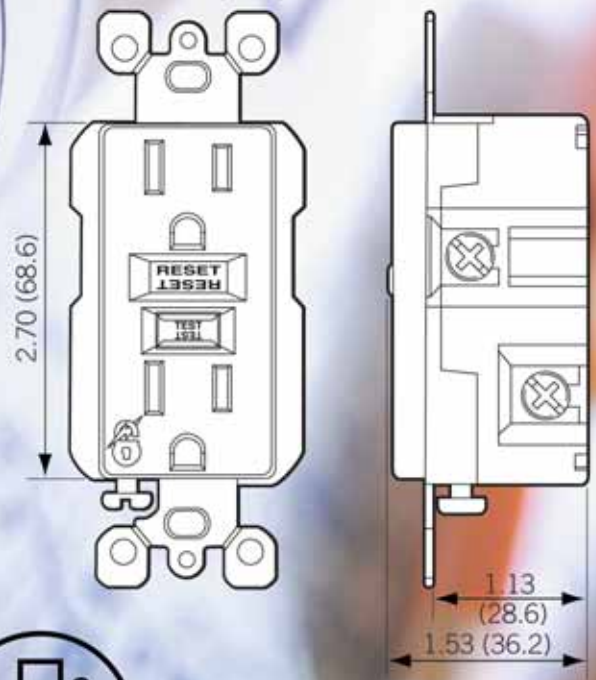
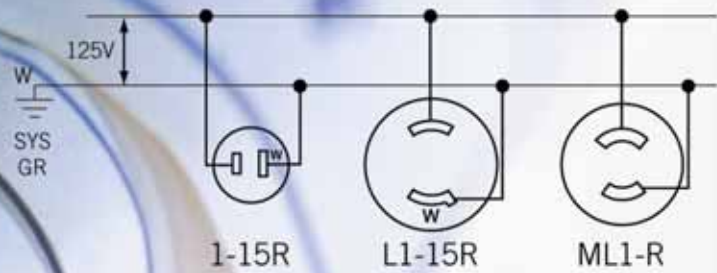

Add Light



● Hospital Grade

● Hospital Grade



INDUSTRY STANDARDS, RELEVANT DEFINITIONS, PERTINENT PRODUCT DATA, REPRESENTATIVE DIMENSIONAL DRAWINGS AND GENERAL PRODUCT REFERENCES ARE INCLUDED IN THIS SECTION.

### List of Abbreviations Used In Leviton Catalogs

#### ANSI

**American National Standards Institute, Inc.**  
11 West 42nd St., New York, NY 10036

An independent organization that identifies industrial and public requirements for national consensus standards and coordinates and manages their development, resolves national standards problems, and ensures effective participation in international standardization.

Various U.S. Government Agencies often adopt ANSI Standards. For example, the Department of Defense has made mandatory the use of ANSI Standard Y32.9-1972, "Graphic Symbols for Electrical Wiring and Layout Diagrams used in Architecture and Building Construction." Such Standards are often developed by specialized technical societies for ANSI. The Standard referred to above was prepared by the Institute of Electrical and Electronics Engineers (IEEE) and the American Society of Mechanical Engineers (ASME).

#### GSA

**General Services Administration Federal Supply Service**  
Crystal Mall Bldg. 4, Washington, D.C. 20406

The U.S. Government administration responsible for the approval of Federal Specifications used in the purchase of products by all Federal Agencies.

The two most relevant Federal Specifications for Electrical Wiring Devices are:

**W-C-596**, for Electrical Power Connector, Plug, Receptacle and Cable Outlet

**W-S-896**, for Toggle and Lock, Flush Mounted Switches

Leviton devices that comply with these specifications, as verified by Underwriters Laboratories Inc., are also listed in this catalog.

#### NEC

**National Electrical Code**  
Published by the NFPA (see listing)

The purpose of the Code is the practical safeguarding of persons and property from hazards arising from the use of electricity. This Code is sponsored by NFPA under the auspices of ANSI. It is revised every three years. OSHA (see listing) has adopted the NEC as the code to follow in order to comply with OSHA requirements.

#### NEMA

**National Electrical Manufacturers Association**  
2101 L St. NW, Washington, D.C. 20003

An organization of electrical manufacturers that establishes standards for manufacture and tests for performance and reliability of electrical products. NEMA tests are often the basis or prerequisite for approval by the Federal Government and/or by Underwriter's Laboratories, Inc.

#### NFPA

**National Fire Protection Association**  
Battery March Park, Quincy, MA 02269

An organization devoted to promoting the science and improving the methods of Fire Protection. Membership is open to anyone interested. Every three years, the NFPA produces a new edition of the NEC (see listing). The NFPA also provides many other useful publications dealing with fire prevention.

#### OSHA

**Occupational Safety and Health Administration**  
(U.S. Department of Labor), 200 Constitution Ave. NW,  
Washington D.C. 20210 (plus regional offices)

That part of the U.S. Department of Labor responsible for assuring that employers provide safe and healthful working conditions and equipment for employees, and that employees properly avail themselves of these conditions.

In addition to specific regulations published in the Federal Register, OSHA has also adopted the National Electrical Code in part for existing installations and equipment and completely for new construction.

**Note:** OSHA does not approve products. Compliance with OSHA regulations is contingent on two factors: The approval or listing of the product by an authorized testing laboratory, such as UL (see listing), and the proper installation and/or use of the product in accordance with OSHA guidelines.

#### UL

**Underwriters Laboratories Inc.**  
Northbrook, IL; Melville, NY; Santa Clara, CA

"An independent, not-for-profit organization testing for public safety." Tests by UL are the basis for acceptance by various government agencies. Listing by UL denotes initial testing and periodic retesting to assure continuing conformance to standards.

#### NOM

**Norma Oficial Mexicana**  
(Mexican Official Standard) SECOFI  
Avenida Puente de Tecamachalco #6  
Col. Lomas de Tecamachalco 53950  
Naucalpan, Edomex Mexico

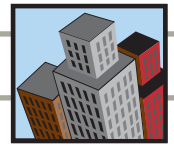

## Industry Standards for Electrical Wiring Devices

### National Electrical Code Requirements for Wiring Devices

National Electrical Code NFPA No. 70-1996 (Selected Articles)

**ARTICLE 90 — Introduction**

**ARTICLE 100 — Definitions**

**ARTICLE 110 — Requirements for Electrical Installations**

- 110-18 Arcing Parts
- 110-21 Marking

**ARTICLE 200 — Use and Identification of Grounded Conductors**

- 200-9 Means of Identification of Terminals
- 200-10 Identification of Terminals

**ARTICLE 210 — Branch Circuits**

- 210-4 Multiwire Branch Circuits
- 210-6 Branch Circuit Voltage Limitations
- 210-7 Receptacles and Cord Connectors
- 210-8 Ground Fault Protection for Personnel
- 210-21 Outlet Devices
- 210-24 Branch Circuit Requirements
- 210-50 Required Outlets, General
- 210-52 Dwelling Unit Receptacle Outlets
- 210-60 Guest Rooms
- 210-63 Rooftop Heating, Air Conditioning and Refrigeration Equipment Outlet
- 210-70 Lighting Outlets Required

**ARTICLE 220 — Branch Circuit, Feeder and Service Calculations**

- 220-4 Branch Circuits Required

**ARTICLE 250 — Grounding**

- 250-45 Equipment Connected by Cord and Plug
- 250-50 Equipment Grounding Conductor Connections
- 250-51 Effective Grounding Path
- 250-59 Cord and Plug Connected Equipment
- 250-74 Connecting Receptacle Grounding Terminal to Box

**ARTICLE 310 — Conductors for General Wiring**

- 310-15 Ampacities

**ARTICLE 380 — Switches**

- 380-1 Scope
- 380-2 Switch Connections
- 380-8 Accessibility and Grouping
- 380-9 Faceplates for Flush-Mounted Snap Switches
- 380-14 Rating and Use of Snap Switches
- 380-15 Marking

**ARTICLE 410 — Lighting Fixtures, Lampholders, Lamps, Receptacles**

- 410-29 Cord-Connected Showcases
- 410-56 Receptacles, Cord Connectors and Attachment Plugs
- 410-57 Receptacles in Damp or Wet Locations
- 410-58 Grounding-Type Receptacles, Adapters, Cord Connectors and Attachment Plugs

**ARTICLE 422 — Appliances**

- 422-22 Disconnection of Cord- and Plug-Connected Appliances

**ARTICLE 511 — Commercial Garages, Repair and Storage**

- 511-10 Ground Fault Circuit Interrupter Protection for Personnel

**ARTICLE 517 — Health Care Facilities**

- 517-3 Definitions
- 517-12 Wiring Methods
- 517-13 Grounding of Receptacles and Fixed Electric Equipment
- 517-16 Receptacles with Insulated Grounding Terminals
- 517-18 General Care Areas
- 517-19 Critical Care Areas
- 517-19(e) Additional Protective Techniques
- 517-20 Wet Locations
- 517-21 Ground Fault Circuit Interrupter Protection for Personnel
- 517-31 Emergency System
- 517-44 Sources of Power
- 517-61 Wiring and Equipment
  - (a) Within Hazardous (Classified) Anesthetizing Locations
  - (b) Above Hazardous (Classified) Anesthetizing Locations
  - (c) Other-Than-Hazardous (Classified) Anesthetizing Locations
- 517-62 Grounding
- 517-64 Low-Voltage Equipment and Instruments

**ARTICLE 518 — Places of Assembly**

- 518-3(b) Temporary Wiring Receptacles

**ARTICLE 550 — Mobile Homes and Mobile Home Parks**

- 550-5(c) Attachment Plug Cap
- 550-8 Receptacle Outlets

**ARTICLE 555 — Marinas and Boatyards**

- 555-3 Receptacles
- 555-7 Grounding

**ARTICLE 625 — Electrical Vehicle Charging System Equipment**

- 625-22 (New Article) GFCI Protection for Cord- and Plug-Connected Electric Vehicle Supply Equipment

**ARTICLE 680 — Swimming Pools, Fountains and Similar Installations**

- 680-4 Definitions
- 680-5 Transformers and Ground Fault Circuit Interrupters
- 680-6(a) Receptacles
- 680-6(b) Lighting Fixtures, Lighting Outlets, Switching Devices and Ceiling Fans
- 680-7 Cord- and Plug-Connected Equipment
- 680-40 Outdoor Installations
- 680-41 Indoor Installations
- 680-51 Lighting Fixtures, Submersible Pumps and Other Submersible Equipment
- 680-62 Cord- and Plug-Connected Equipment
- 680-62 Therapeutic Tubs (Hydrotherapeutic Tanks)
- 680-62(a) Ground Fault Circuit Interrupter
- 680-62(c) Methods of Bonding



## Associations, Organizations and Standards

The following listings define the common acronyms used for a variety of organizations.

### Standards Development Organizations

Primarily involved in the development and/or promulgation of standards

|               |   |
|---------------|---|
| <b>NFPA</b>   | National Fire Protection Agency   |
| <b>IEC</b>    | International Electrotechnical Commission   |
| <b>IEEE</b>   | Institute of Electrical and Electronics Engineers   |
| <b>ANSI</b>   | American National Standards Institute   |
| <b>CANENA</b> | Consejo de Armonizacion de Normas Electrotecnicas de Norte America (Council for Harmonization of Electrotechnical Standardization of North America) |
| <b>SAE</b>    | Society of Automotive Engineers   |
| <b>ISA</b>    | Instrument Society of America   |
| <b>SME</b>    | Society of Manufacturing Engineers  |
| <b>ISO</b>    | International Standards Organization  |
| <b>ASME</b>   | American Society of Mechanical Engineers  |

### Codes and Standards

Installation codes and product safety, performance and interchangeability standards.

|            |   |
|------------|---|
| <b>NEC</b> | National Electrical Code                                  |
| <b>NOM</b> | Normas Oficiales de Mexicanas (Official Mexican Standard) |
| <b>NMX</b> | Normas Mexicanas  |
| <b>CEC</b> | Canadian Electrical Code                                  |
| <b>CEE</b> | European Electrotechnical Committee                       |

### Industry Associations

For the purpose of standardization, trade, and professional development, etc.

|                |  |
|----------------|--|
| <b>NMDA</b>    | National Marine Distributor Association                                  |
| <b>NEMA</b>    | National Electrical Manufacturers Association                            |
| <b>ABYC</b>    | American Boat and Yacht Council  |
| <b>EIA/TIA</b> | Electronics Industry Association/Telecommunications Industry Association |
| <b>NAED</b>    | National Association of Electrical Distributors                          |
| <b>NAW</b>     | National Association of Wholesalers                                      |
| <b>BICISI</b>  | Building Industry Consulting Services International                      |
| <b>IBI</b>     | Intelligent Building Institute   |

|               |   |
|---------------|---|
| <b>EPRI</b>   | Electric Power Research Institute                             |
| <b>NEMRA</b>  | National Electrical Manufacturers Representative Association  |
| <b>IAEI</b>   | International Association of Electrical Inspectors            |
| <b>IFMA</b>   | International Facilities Management Association               |
| <b>BOMA</b>   | Building Owners Management Association                        |
| <b>SEMI</b>   | Semi-Conductor Equipment and Material International           |
| <b>CEMRA</b>  | Canadian Electrical Manufacturers Representatives Association |
| <b>NMRA</b>   | National Marine Representative Association                    |
| <b>EFI</b>    | Electro-Federation Incorporated                               |
| <b>NECA</b>   | National Electrical Contractors Association                   |
| <b>IECA</b>   | Independent Electrical Contractors Association                |
| <b>ECOC</b>   | Electrical Contractors of Canada                              |
| <b>CANAME</b> | Camara Nacional de Manufacturas Electricas (Mexico)           |

### Certification Agencies

Primarily involved in certification of products or manufacturers to standards developed by the certification agency or by others.

|             |  |
|-------------|--|
| <b>UL</b>   | Underwriters Laboratories Inc.   |
| <b>CSA</b>  | Canadian Standards Association   |
| <b>ANCE</b> | National Association of Normalization and Certification of the Electrical Sector (Mexico)        |
| <b>TUV</b>  | TUV Rheinland of N.A., Inc.  |
| <b>VDE</b>  | Verband Deutscher Elektrotechniker (Germany)   |
| <b>BSI</b>  | British Standards Institute  |
| <b>FM</b>   | Factory Mutual   |
| <b>NRTL</b> | National Recognized Testing Laboratories   |
| <b>OSHA</b> | Occupational Safety and Health Administration  |
| <b>FCC</b>  | Federal Communications Commission  |
| <b>DESC</b> | Defense Electronic Supply Center   |
| <b>IAPA</b> | Independent Accident and Protection Association (Canada)   |
| <b>CE</b>   | European Compliance (This is not a certification agency, but CE is the European Compliance Mark) |
| <b>ETL</b>  | ETL Testing Laboratories   |





## European Agencies: IEC and CEE

### The IEC

The IEC is the International Electrotechnical Commission. Formed in 1906, it is a worldwide organization primarily involved in the international standardization of electrical standards and equipment. As of 1994, 48 countries are represented in the IEC. IEC member countries produce and consume the majority of the world's electrical energy. They also manufacture and use the majority of the world's electrical products.

The IEC works towards standardization of the following areas:

- Universal technical language; including definitions, and electrical symbols
- Systems for ratings, testing requirements and methods of testing
- Electrical system characteristics; including voltages, frequencies and tolerances
- Dimensional requirements and tolerances
- Universal electrical safety requirements







### The CEE

The CEE is the European Electrotechnical Committee. The CEE works on safety standards, definitions for conformity and certifications for electrical equipment. Cooperation between the CEE and the IEC has led to worldwide publications for standards pertaining to electrical equipment.

## Certification and Markings

Certification marks indicate a product has been tested to the requirements of a specific certification agency. Manufacturers may choose a particular product identity (e.g. Specification Grade) even though no outside certification agency is involved. The following table illustrates the variety of certification markings typically used for 15A and 20A Straight Blade Receptacles.

**Typical Product Certification Marks** — 15 & 20 Amp Straight Blade Receptacles. Products with these markings must meet the specific testing standards indicated.

| Certification Mark   | UL498  | CSA, C22.2, No. 42M | UL 498 Hospital Grade | CSA, C22.2, No. 42M, Hosp. Grade | DESC W-C-596F | Certification Agency  |
|--|--|---------------------|-----------------------|----------------------------------|---------------|---|
| Spec Grade*  | No Product Testing Required — Manufacturer's Term Only |                     |                       |                                  |               | Manufacturer Only   |
|                             | X  |                     |                       |                                  |               | Underwriters Laboratories Inc. Recognized Component for OEM use.    |
|                             | X  |                     |                       |                                  |               | Underwriters Laboratories Inc.                                      |
|                             |  | X                   |                       |                                  |               | Canadian Standards Association                                      |
|  • Hospital Grade           | X  |                     | X                     |                                  |               | Underwriters Laboratories Inc.                                      |
|  • Hospital Grade           |  | X                   |                       | X                                |               | Canadian Standards Association                                      |
|  Fed. Spec                  | X  |                     |                       |                                  | X             | Underwriters Laboratories Inc. and Defense Electronic Supply Center |
|  Fed. Spec • Hospital Grade | X  |                     | X                     |                                  | X             | Underwriters Laboratories Inc. and Defense Electronic Supply Center |

\*Includes variations such as Industrial Spec. Grade, Premium Spec. Grade, etc.

NOTE: The C-UL listing mark is applied to products for the Canadian market evaluated by UL to Canadian safety standards. The C-UL US listing mark indicates compliance with both U. S. and Canadian safety standards.

### Cross References

The cross-reference guides supplied by manufacturers are convenient for determining compatible devices but they are not official confirmation of compliance to any standard or testing criteria. Similarly, common catalog numbers used by different manufacturers in no way imply compliance to any standard or testing criteria.



## UL, CSA and NEMA Standards Pertaining to Leviton Devices

### UL Standards Pertaining to Leviton Devices

|                          |  |
|--------------------------|--|
| <b>UL20</b>              | General-use switches   |
| <b>UL50</b>              | Enclosures for electrical equipment                                |
| <b>UL94</b>              | Flammability testing for materials                                 |
| <b>UL486E</b>            | Equipment and wiring terminals                                     |
| <b>UL498</b>             | Plugs, connectors, receptacles, inlets, outlets, taps and adapters |
| <b>UL508</b>             | Industrial equipment (including motor control switches)            |
| <b>UL514A</b>            | Metallic boxes/covers/wallplates                                   |
| <b>UL514C</b>            | Non-metallic boxes/covers/wallplates                               |
| <b>UL817</b>             | Cordsets   |
| <b>UL943</b>             | GFCI's   |
| <b>UL1363</b>            | Temporary power taps   |
| <b>UL1436</b>            | Outlet circuit testers   |
| <b>UL1449</b>            | Surge suppression devices  |
| <b>UL1567</b>            | Switches and receptacles used with AL wire                         |
| <b>UL1682 &amp; 1686</b> | Pin & Sleeve devices   |
| <b>UL1776</b>            | High-pressure cleaning equipment                                   |
| <b>FS</b>                | Federal Spec receptacles   |
| <b>WC596F</b>            |  |
| <b>FS</b>                | Federal Spec switches  |
| <b>WS896</b>             |  |

**Note:** Straight blade and locking NEMA configurations are defined by UL 1681 and NEMA WD 6.

Each UL standard consists of requirements that cover three characteristics of the product being reviewed:

|                        |  |
|------------------------|--|
| <b>1. Construction</b> | Material properties and general design                   |
| <b>2. Performance</b>  | Mechanical and electrical testing                        |
| <b>3. Markings</b>     | Identification of manufacturer, applicable ratings, etc. |

### CSA Standards Pertaining to Leviton Devices

|                         |   |
|-------------------------|---|
| <b>C22.2, No. 0.17</b>  | Polymeric materials   |
| <b>C22.2, No. 42</b>    | General-use receptacles, attachment plugs   |
| <b>C22.2, No. 55</b>    | Special-use switches  |
| <b>C22.2, No. 111</b>   | General-use switches  |
| <b>C22.2, No. 182.1</b> | Industrial-type, special-use attachment plugs, receptacles and connectors. Pin and sleeve devices |
| <b>C22.2, No. 182.2</b> | Industrial locking type   |

### NEMA Standards Pertaining To Leviton Devices — In Accordance With NEMA Standard WD-1

|                  |   |
|------------------|---|
| <b>WD 1-1.01</b> | <b>CORD CONNECTOR</b><br>A cord connector is a portable receptacle which is provided with means for attachment to a flexible cord and which is not intended for permanent mounting.<br><i>NEMA Standard 7-13-1967</i>   |
| <b>WD 1-1.02</b> | <b>GROUNDING CONDUCTOR (SYSTEM GROUND)</b><br>A grounded conductor is a circuit conductor (normally current carrying) which is intentionally connected to earth ground. (It is identified as the white conductor.)<br><i>NEMA Standard 7-13-1967</i>  |
| <b>WD 1-1.03</b> | <b>GROUNDING CONDUCTOR (EQUIPMENT GROUND)</b><br>A grounding conductor is a conductor which connects noncurrent-carrying metal parts of equipment to earth ground to provide an intentional path for fault current to ground (It is bare, or, when covered, is identified as the green or green with yellow stripes conductor.)<br><i>NEMA Standard 7-13-1967</i> |

|                  |   |
|------------------|---|
| <b>WD 1-1.04</b> | <b>LAMPHOLDER</b><br>A lampholder is a device which is intended to support an electric lamp mechanically and to connect it electrically to a circuit.<br><i>NEMA Standard 7-13-1967</i> |
|------------------|---|

|                  |  |
|------------------|--|
| <b>WD 1-1.05</b> | <b>MALE BASE (INLET)</b><br>A male base is a plug which is intended for flush or surface mounting on an appliance or equipment and which serves to connect utilization equipment to a connector.<br><i>NEMA Standard 7-13-1967</i> |
|------------------|--|

|                  |   |
|------------------|---|
| <b>WD 1-1.06</b> | <b>OUTLET</b><br>An outlet is a point on the wiring system at which current is taken to supply utilization equipment.<br><i>NEMA Standard 7-13-1967</i> |
|------------------|---|

|                  |   |
|------------------|---|
| <b>WD 1-1.07</b> | <b>PLUG</b><br>A plug is a device with male blades which, when inserted into a receptacle, establishes connection between the conductors of the attached flexible cord and the conductors connected to the receptacle.<br><i>NEMA Standard 7-1-1967</i> |
|------------------|---|

|                  |  |
|------------------|--|
| <b>WD 1-1.08</b> | <b>POLARIZATION (PLUGS AND RECEPTACLES)</b><br>Polarization is a means of assuring the mating of plugs and receptacles of the same rating in only the correct position.<br><i>NEMA Standard 7-1-1967</i> |
|------------------|--|

|                  |   |
|------------------|---|
| <b>WD 1-1.09</b> | <b>POLE</b><br>The term "pole" as used in designating plugs and receptacles refers to a terminal to which a circuit conductor (normally current carrying) is connected.<br>In switches, the number of poles indicates the number or conductors being controlled.<br><i>NEMA Standard 7-1-1967</i> |
|------------------|---|

|                  |   |
|------------------|---|
| <b>WD 1-1.10</b> | <b>RECEPTACLE</b><br>A receptacle is a device with female contacts which is primarily installed at an outlet or on equipment and which is intended to establish electrical connection with an inserted plug.<br><i>NEMA Standard 7-1-1967</i> |
|------------------|---|

|                  |  |
|------------------|--|
| <b>WD 1-1.11</b> | <b>SLANT SYMBOL (/)</b><br>The "slant" line (/) as used in wiring device ratings indicates that two or more voltage potentials are present simultaneously between different terminals of a wiring device.<br><i>NEMA Standard 7-1-1967</i> |
|------------------|--|

|                  |   |
|------------------|---|
| <b>WD 1-1.12</b> | <b>SWITCH</b><br>A switch is a device for making, breaking, or changing the connections in an electric circuit.<br><b>A. Single-pole Switch (Single-pole, Single-throw)</b><br>A switch which makes or breaks the connection of one conductor.<br><b>B. Double-pole Switch (Double-pole, Single-throw)</b><br>A switch which makes or breaks the connection of two conductors of a single branch circuit.<br><b>C. Three-way Switch (Single-pole, Double-throw)</b><br>A switch which changes the connection of one conductor and which is normally used in pairs to control one utilization equipment from two locations.<br><b>D. Four-way Switch (Double-pole, Double-throw Reversing)</b><br>A form of double-pole switch which is used in conjunction with two three-way switches to control one utilization equipment from three or more locations.<br><i>NEMA Standard 7-13-1967</i> |
|------------------|---|

|                  |  |
|------------------|--|
| <b>WD 1-1.13</b> | <b>TERMINAL (ON A WIRING DEVICE)</b><br>A terminal is a fixed location on a wiring device where a conductor is intended to be connected.<br><i>NEMA Standard 7-13-1967</i> |
|------------------|--|

|                  |   |
|------------------|---|
| <b>WD 1-1.14</b> | <b>WIRE (PLUGS AND RECEPTACLES)</b><br>The term "wire" as used in designating plugs and receptacles indicates the number or either normally current-carrying or equipment grounding connected conductors.<br><i>NEMA Standard 7-13-1967</i> |
|------------------|---|





## High-Abuse Wiring Devices — UL Listed Hospital Grade

### Why was it developed?

Hospital Grade Listed devices were developed to provide maximum safety in high-abuse applications where constant strenuous use of the device is common. These highest reliability devices are built to protect against possible human negligence and keep the devices safe and functional.

### What are the applications for Hospital Grade, High Abuse Devices?

Rough use occurs not just in hospitals, but every place where people can't or won't be cautious with devices...the cleaning person who yanks the floor waxer plug down the hall, the mechanic who pulls the drill plug from the wall, or the child who removes the electric lawn-mower plug from 40 feet away!

In addition, Leviton realized that devices in rough use situations are often exposed to many corrosive liquids, such as cleaning fluids, rug shampoos, chlorinated water, sprays, salt air and chemical fumes. Our corrosion resistant devices permit use in environments where these conditions are common.

### Demanding Tests for UL Hospital Grade Listing

Leviton has designed a line of wiring devices that withstand impact, wear, crushing, and corrosive environments that would destroy ordinary heavy-duty devices. Leviton's comprehensive line of Hospital Grade and Industrial Grade plugs, connectors and receptacles include devices that have passed a series of demanding UL Hospital Grade tests. This assures the end-user of top performance in the harshest industrial environments. Here are examples of how Leviton devices meet or exceed the requirements of the most rigorous testing!

### Receptacles

#### Abrupt Removal of Plug Test

A steel-bodied test plug with brass blades is inserted into the receptacle. A 10-pound weight dropped from at least 24 inches yanks the plug out of the receptacle. This test is done eight times with the receptacle rotated into different positions to create the greatest stress on its face and contact. After this, the grounding contact must retain a four ounce, 0.184" diameter grounding pin, with the receptacle face down, for one minute. "There shall be no breakage of the receptacle that interferes with the receptacle function or the integrity of the enclosure. The receptacle shall maintain the grounding path integrity through the receptacle."

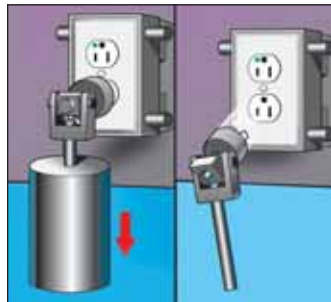

#### Ground Pin Test

The grounding contact of the receptacle is conditioned by 20 insertions with a 0.204" diameter oversized pin. "After conditioning, a 0.184" diameter pin shall be inserted in the grounding contact and shall be capable of supporting at least four ounces for one minute."

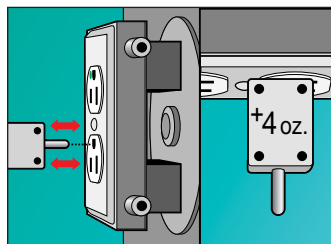

#### Power Blade Retention Test

A test plug with oversized blades of .075" is inserted into the current-carrying opening of the connector for 20 conditioning cycles. After the conditioning cycles, "the contact shall be capable of supporting for one minute 1 1/2 lbs, secured to a single .055" thick solid steel blade without holes."

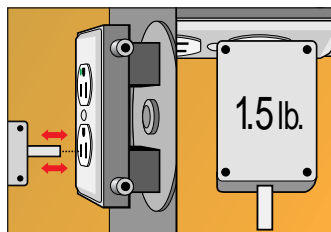

### Plugs and Connectors

#### 500 lb. Crush Test

A wired plug or connector is placed between two steel plates and subjected to a force which is steadily increased to 500 pounds. "There shall be no breakage, deformation or other effect that may interfere with the function of the device." Leviton knows that in real industrial environments, plugs and connectors are crushed by forces exceeding 500 lbs. Leviton performs the crush test with force of 2500 lbs to ensure that our devices withstand the really heavy hits on the job.

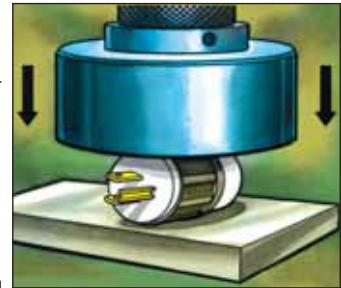

#### Impact Test

A wired plug or connector is subjected to impact from a 10 lb. weight dropped from a height of 18 inches. "There shall be no breakage, deformation or other effect that may interfere with the function of the device." Plugs and connectors are subjected to severe impacts in industrial settings. Therefore, Leviton exceed the UL requirement by dropping the weight from a height of 36 inches.



#### Cord Pull Test

The cord must remain securely fastened after straight pulls of 30 pounds, and rotating pulls (in a 3-inch circle) of 10 pounds for two hours. "Displacement of conductors, insulation, and outer jacket of the flexible cord AWG 18 SVT shall not exceed 1/32 inch. There shall be no cuts, rips, or tears in cord insulation."



Heavy-duty cord stress is typical abuse for industrial plugs and connectors. Leviton increases the weight in the straight cord pull test to 175 lbs. with AWG 14 ST and in the rotating pull test to 20 lbs, ensuring positive strain relief under industrial conditions.

#### Mechanical Drop Test

A sample wired plug or connector is suspended horizontally by its attached cord and released so that it impacts a hard wood surface 45 inches below the point of suspension — repeated for 1300 cycles. "There shall be no breakage, deformation or other damage which would interfere with the functioning of the device."





## Glossary of Electrical Wiring Device Terms

### General Terms

**Adapter** — An accessory used for interconnecting non-mating devices or converting an existing device for modified use.

**Ballast** — A transformer that steps down AC line voltage to voltage that can be used by fluorescent or other types of lighting. Ballasts may be electromagnetic or electronic.

**Cord Connector** — A portable receptacle designed for attachment to or provided with flexible cord, not intended for fixed mounting.

**Flanged Inlet** — A plug intended for flush mounting on appliances or equipment to provide a means for power connection via a cord connector.

**Flanged Outlet** — A receptacle intended for flush mounting on appliances or equipment to provide a means for power connection via an inserted plug.

**Fluorescent Starter** — A device with a voltage-sensitive switch and a capacitor that provides a high-voltage pulse to start a fluorescent lamp. Rated in watts.

**Lampholder** — A device with contacts that establishes mechanical and electrical connection to an inserted lamp.

**Plug** — A device with male contacts intended for insertion into a receptacle to establish electrical connection between the attached flexible cord and the conductors connected to the receptacle.

**Receptacle** — A device with female contacts designed for fixed installation in a structure or piece of equipment and which is intended to establish electrical connection with an inserted plug.

**Switch** — A device for making, breaking, or changing the connections in an electric circuit.

**Wallplate** — A plate designed to enclose an electrical box, with or without a device installed within the box.

### Adapter Variations

**Cube Tap** — An adapter that converts one receptacle opening into multiple openings.

**Current Tap** — An adapter designed for medium base lampholders which has one or two receptacle openings. Available with or without integral switch.

**Duplex** — An adapter that provides two female receptacle openings when plugged into a single receptacle opening.

**Grounding** — An adapter that converts a two-wire receptacle opening into a two-pole, three-wire grounding receptacle opening.

**Lampholder** — A threaded adapter that converts the thread size of the lampholder in which it is inserted so that the lampholder can accept an incandescent lamp bulb of a different size thread.

**Molded-On** — An adapter that is factory molded to a length of flexible cord.

**Series** — An adapter wired in series to a flexible cord containing an in-line switch used to control electrical equipment plugged into the adapter.

**“W” Type** — Same as “Y” type, except having three cord connectors arranged in the form of the letter “W”.

**“Y” Type** — An adapter in the form of a letter “Y”, having two cord connectors on one end and a male plug on the other end.

### Cord Connectors

**Angle** — A connector that allows the attached flexible cord to exit at right angles.

**Corrosion Resistant** — A connector constructed of special materials and/or suitably plated metal parts that is designed to withstand corrosive environments. Corrosion resistant devices must pass the ASTM B117-13 five-hundred hour Salt Spray (Fog) Test with no visible corrosion.

**Dust Proof** — A connector designed so that dust will not interfere with its operation. The IP Suitability Rating designates the degree of protection a device offers against the ingress of foreign objects (e.g. IP 20).

**Explosion Proof** — A connector constructed to meet the requirements of hazardous locations as defined by the National Electrical Code, NFPA-70.

**Hospital Grade** — A connector designed to meet the performance requirements of high-abuse areas typically found in health care facilities. These connectors are tested to the Hospital Grade requirements of Underwriters Laboratories Inc. Standard 498.

**Locking** — A connector designed to lock an inserted plug with a matching blade configuration when the plug is rotated in a clockwise direction. The plug can only be removed by first turning it in a counter-clockwise direction.

**Midget** — A connector designed with a smaller body diameter than standard connectors with a similar rating.

**Molded On** — A connector that is factory molded to a length of flexible cord.

**Pin and Sleeve** — A connector with hollow, cylindrical sleeve-type contacts.

**Straight Blade** — A non-locking connector into which mating plugs are inserted at a right angle to the plane of the connector face.

**Weatherproof** — A connector specially constructed so that exposure to weather will not interfere with its operation.

### Flanged Inlets

**Corrosion Resistant** — An inlet constructed of special materials and/or suitably plated metal parts that is designed to withstand corrosive environments. Corrosion resistant devices must pass the ASTM B117-13 five-hundred hour Salt Spray (Fog) Test with no visible corrosion.

**Flush-Mounted** — An inlet intended to be installed flush with the surface of a panel or a piece of equipment.

**Locking** — An inlet designed to lock an inserted matching connector when the connector is rotated in a clockwise direction. The connector can only be removed by first turning it in a counter-clockwise direction.

**Midget** — An inlet designed with a smaller body diameter than standard connectors with a similar rating.

**Pin and Sleeve** — An inlet with round pin-type contacts intended to mate with a connector having hollow cylindrical female contacts.

**Straight Blade** — A non-locking inlet into which mating connectors are inserted at a right angle to the plane of the connector face.

**Surface-Mounted** — An inlet designed to be surface mounted on a panel or piece of equipment.

**Watertight** — An inlet specially constructed so that water will not enter under specified test conditions. The IP Suitability Rating designates the degree of protection a device offers against the ingress of moisture and water (e.g. IP 55, IP 44).

**Weatherproof** — An inlet specially constructed to protect it from the effects of weather in outdoor locations.

### Flanged Outlets

**Corrosion Resistant** — An outlet constructed of special materials and/or suitably plated metal parts that is designed to withstand corrosive environments. Corrosion resistant devices must pass the ASTM B117-13 five-hundred hour Salt Spray (Fog) Test with no visible corrosion.

**Flush-Mounted** — An outlet intended to be installed flush with the surface of a panel or a piece of equipment.

**Locking** — An outlet designed to lock an inserted plug with a matching blade configuration when the plug is rotated in a clockwise direction. The plug can only be removed by first turning it in a counter-clockwise direction.

**Midget** — An outlet designed with a smaller body diameter than standard devices with a similar rating.

**Pin and Sleeve** — An outlet with hollow cylindrical female contacts intended to mate with a plug having round pin contacts.

**Straight Blade** — A non-locking outlet into which mating straight-blade plugs are inserted at a right angle to the plane of the outlet face.

**Surface-Mounted** — An outlet designed to be surface mounted on a panel or piece of equipment.

**Watertight** — An outlet specially constructed so that water will not enter under specified test conditions. The IP Suitability Rating designates the degree of protection a device offers against the ingress of moisture and water (e.g. IP 55, IP 44).

**Weatherproof** — An outlet specially constructed so that exposure to weather will not interfere with its operation.

### Fluorescent Starters

**Automatic Reset** — A starter that automatically restarts a new replacement fluorescent lamp after the circuit is energized.

**Direct Current** — A thermal-type starter designed for use on direct current (DC) circuits.

**Glow Discharge** — A starter that provides a rapid lamp start-up and will continue to try to start a failed fluorescent lamp, causing the lamp to flicker until it is replaced.

**Manual Reset** — A starter that automatically deactivates a failed fluorescent lamp to eliminate flickering. A reset button provides a means of activating the circuit after lamp replacement.

### Lampholders

**Bayonet** — Designed for incandescent lamps having an unthreaded metal shell with two diametrically opposite keyways that mate with the keyways on the lampholder. Pushing down on the bulb and turning it clockwise in the lampholder locks the bulb in place.

**Candelabra** — A small screw-base threaded lampholder designed for candelabra-base incandescent lamps commonly used in chandeliers, night lights, and ornamental lighting.

**Circline** — A four-contact, double-ended lampholder designed for use with tubular, circular fluorescent lamps.

**Compact Fluorescent** — A lampholder designed for the Compact Fluorescent Lamps (CFLs) that are increasingly being used to replace incandescent lamps for energy efficiency.

**Dimmer** — An electronic device with either a round knob, slide lever or finger-tip controlled buttons used to dim/brighten incandescent lighting. Available in a variety of wattages; fluorescent version also available.

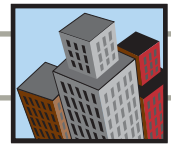

## Glossary of Electrical Wiring Device Terms

**Double-Contact Recessed** — Designed for high-output fluorescent lamps.

**Edison Base** — An internally-threaded lampholder, with the inner shell approx. 1" in diameter. Designed for widely-used standard medium base lamps.

**Electrolier** — Similar to the Edison Medium Base lampholder, but with a smaller outer diameter.

**Incandescent** — Designed for use with all manufactured incandescent lamps, most of which have threaded bases.

**Intermediate** — A lampholder with a threaded screw shell designed for intermediate base lamps that have a 1<sup>3</sup>/<sub>32</sub>" threaded base (smaller than the standard 1" dia. medium base). Mostly used in decorative lighting.

**Key** — A lampholder with a flat or round "key" knob that operates an internal switching mechanism ("Keyless" lampholders do not provide an internal switching mechanism).

**Lumiline** — A specially designed lampholder for tubular Lumiline-type incandescent lamps, typically used in bathrooms and retail display cases.

**Medium Base** — Same as the Edison base lampholder. An internally-threaded lampholder, with the inner shell approx. 1" in diameter. Designed for widely-used standard medium base lamps.

**Miniature** — Designed for the smallest available incandescent lamps with a screw-in base, approx. 3/8" dia. Widely used in flashlights and toys, etc.

**Mogul** — The largest screw-in type lampholder, designed for mogul incandescent lamps with a screw base of approx. 1 1/2" dia. Used in street lights and numerous commercial/industrial applications.

**Medium Bi-Pin** — A fluorescent lampholder with two contacts, used in pairs. For type T-8 tubular fluorescent lamps, approx. 1" in diameter.

**Miniature Bi-Pin** — Similar to medium bi-pin lampholders, but designed for type T-5 tubular fluorescent lamps, approx. 5/8" in diameter.

**Outlet Box** — Medium-base incandescent lampholder designed for mounting in 3 1/4" or 4" electrical boxes. Available with or without pull-chain mechanism, and with or without built-in receptacle.

**Pull-Chain** — An incandescent lampholder with an internal switching mechanism that is activated by pulling down on a beaded chain or cord.

**Push-Through** — An incandescent lampholder with an insulated lever that is pushed from either side to activate an internal ON/OFF switching mechanism.

**Slimline Single-Pin** — A fluorescent lampholder with a single contact designed for Slimline fluorescent lamps such as the T-12 (1 1/2" dia.), T-8 (1" dia.), and the smaller version T-6 (3/4" dia.).

**Snap-In** — An incandescent or compact fluorescent lampholder with factory-assembled spring clips that securely snap into a panel cutout without requiring additional fasteners.

**Surface-Mounted** — A lampholder of any type that mounts on a flat or plane surface.

### Plugs

**Angle** — A plug that allows the attached flexible cord to exit at right angles.

**Corrosion Resistant** — A plug constructed of special materials and/or suitably plated metal parts that is designed to withstand corrosive environments. Corrosion resistant devices must pass the ASTM B117-13 five-hundred hour Salt Spray (Fog) Test with no visible corrosion.

**Dust Proof** — A plug designed so that dust will not interfere with its operation. The IP Suitability Rating designates the degree of protection a device offers against the ingress of foreign objects (e.g. IP 20).

**Explosion Proof** — A plug constructed to meet the requirements of hazardous locations as defined by the National Electrical Code, NFPA-70.

**Hospital Grade** — A plug designed to meet the performance requirements of high-abuse areas typically found in health care facilities. These plugs are tested to the Hospital Grade requirements of Underwriter's Laboratories Inc. Standard 498.

**Locking** — A plug designed to lock into a matching connector or receptacle configuration when the plug is rotated in a clockwise direction. The plug can only be removed by turning it in a counter-clockwise direction.

**Midget** — A plug designed with a smaller body diameter than standard plugs with a similar rating.

**Molded On** — A plug that is factory molded to a length of flexible cord.

**Pin and Sleeve** — A plug with round pin contacts.

**Straight Blade** — A non-locking plug that is inserted at a right angle to the plane of the matching device face.

**Weatherproof** — A plug specially constructed so that exposure to weather will not interfere with its operation.

### Receptacles

**AL/CU** — 30A, 50A or 60A receptacles designated for use with aluminum or copper circuit conductors, identified by "AL/CU" stamped on the device. Receptacles without this designation must never be used with aluminum circuit conductors.

**Clock Hanger** — A single, recessed receptacle with a specialized cover plate that provides a hook or other means of supporting a wall clock.

**CO/ALR** — 15A or 20A receptacles designated for use with aluminum or copper circuit conductors, identified by "CO/ALR" stamped on the device. Receptacles without this designation must never be used with aluminum circuit conductors.

**Corrosion Resistant** — A receptacle constructed of special materials and/or suitably plated metal parts that is designed to withstand corrosive environments. Corrosion resistant devices must pass the ASTM B117-13 five-hundred hour Salt Spray (Fog) Test with no visible corrosion.

**Display** — Receptacle with a special cover plate intended for flush mounting on raised floors or walls.

**Duplex** — Two receptacles built with a common body and mounting means; accepts two plugs.

**Dust Proof** — A receptacle designed so that dust will not interfere with its operation. The IP Suitability Rating designates the degree of protection a device offers against the ingress of foreign objects (e.g. IP 20).

**Explosion Proof** — A receptacle constructed to meet the requirements of hazardous locations as defined by the National Electrical Code, NFPA-70.

**Fan Hanger** — A single receptacle with a specialized cover plate that provides a hook or other means of supporting a wall fan.

**Four-In-One or "Quad"** — A receptacle in a common housing that accepts up to four plugs. Four-In-One receptacles can be installed in place of duplex receptacles mounted in a single-gang box, providing a convenient means of adding receptacles without rewiring.

**GFCI (Ground Fault Circuit Interrupter)** — A receptacle with a built in circuit that will detect leakage current to ground on the load side of the device. When the GFCI detects leakage current to ground, it will interrupt power to the load side of the device, preventing a hazardous ground fault condition. GFCI receptacles must conform to UL Standard 943 Class A requirements, and their use is required by the National Electric Code NFPA-70 in a variety of indoor and outdoor locations.

**Hospital Grade** — A receptacle designed to meet the performance requirements of high-abuse areas typically found in health care facilities. These receptacles are tested to the Hospital Grade requirements of Underwriters Laboratories Inc. Standard 498.

**Interchangeable** — A receptacle or combination of receptacles with a common mounting dimension that may be installed on a single or multiple-opening mounting strap.

**Isolated Ground** — Receptacles intended for use in an Isolated Grounding system where the ground path is isolated from the facility grounding system. The grounding connection on these receptacles is isolated from the mounting strap.

**Lighted (Illuminated)** — A receptacle with a face that becomes illuminated when the device is connected to an energized electrical circuit.

**Locking** — A receptacle designed to lock an inserted plug with a matching blade configuration when the plug is rotated in a clockwise direction. The plug can only be removed by first turning it in a counter-clockwise direction.

**Pin and Sleeve** — A receptacle with cylindrical sleeve-type contacts.

**Safety or Tamper-Resistant** — A receptacle specially constructed so that access to its energized contacts is limited. Tamper-resistant receptacles are required by the National Electric Code NFPA-70 in specific pediatric care areas in health care facilities.

**Single** — A receptacle that accepts only one plug.

**Snap-In** — A receptacle with factory-assembled spring clips that securely snap into a panel cutout without requiring additional fasteners.

**Split-Circuit** — A duplex receptacle that allows each receptacle to be wired to separate circuits. Most duplex receptacles provide break-off tabs that allow them to be converted into split-circuit receptacles.

**Straight Blade** — A non-locking receptacle into which mating plugs are inserted at a right angle to the plane of the receptacle face.

**Surface-Mounted** — Any receptacle that mounts on a flat or plane surface.

**Surge-Suppression** — A receptacle with built-in circuitry designed to protect its load side from high-voltage transients and surges. The circuitry will limit transient voltage peaks to help protect sensitive electronic equipment such as PC's, modems, audio/video equipment, etc.

**Triplex** — A receptacle with a common mounting means which accepts three plugs.

**Weatherproof** — A receptacle specially constructed so that exposure to weather will not interfere with its operation.

### Switches

**AC/DC** — A switch designated for use with either Alternating Current (AC) or Direct Current (DC)

**AC Only** — A switch designated for use with Alternating Current (AC) only.

**Dimmer** — A switch with electronic circuitry that provides DIM/BRIGHT control of lighting loads.



## Glossary of Electrical Wiring Device Terms

**Door** — A momentary contact switch, usually installed on a doorjamb, that is activated when the door is opened or closed.

**Double-Pole, Single-Throw (DPST)** — A switch that makes or breaks the connection of two circuit conductors in a single branch circuit. This switch has four terminal screws and ON/OFF markings.

**Double-Pole, Double-Throw (DPDT)** — A switch that makes or breaks the connection of two conductors to two separate circuits. This switch has six terminal screws and is available in both momentary and maintained contact versions, and may also have a center OFF position.

**Feed-Through** — An in-line switch that can be attached at any point on a length of flexible cord to provide switching control of attached equipment.

**Flush-Mounted** — A switch designed for flush installation with the surface of a panel or equipment.

**Four-Way** — A switch used in conjunction with two 3-Way switches to control a single load (such as a light fixture) from three or more locations. This switch has four terminal screws and no ON/OFF marking.

**Horsepower Rated** — A switch with a marked horsepower rating, intended for use in switching motor loads.

**Interchangeable** — A switch or combination of switches with a common mounting dimension that may be installed on a single or multiple-opening mounting strap.

**Lighted Handle** — A switch with an integral lamp in its actuator (toggle, rocker or pushbutton) that illuminates when the switch is connected to an energized circuit and the actuator is in the OFF position.

**Locking** — A switch equipped with a locking mechanism that requires a key to operate the switching functions.

**Low-Voltage** — A switch rated for use on low-voltage circuits of 50 volts or less.

**L-Rated** — A switch specially designated with the letter "L" in its rating that is rated for controlling tungsten filament lamps on AC circuits only.

**Maintained Contact** — A switch where the actuator (toggle, rocker, pushbutton or key mechanism) makes and retains circuit contact when moved to the ON position. The contacts will only be opened when the actuator is manually moved to the OFF position. Ordinary light switches are maintained contact switches.

**Manual Motor Controller** — A switch designed for controlling small DC or AC motor loads, without overload protection.

**Mercury** — A type of switch that uses mercury as the contact means for making and breaking an electrical circuit.

**Momentary Contact** — A switch that makes circuit contact only as long as the actuator (toggle, rocker, pushbutton or key mechanism) is held in the ON position, after which it returns automatically to the OFF position. This is a "Normally Open" switch. A "Normally Closed" switch will break circuit contact as long as it is held in the OFF position, and then automatically return to the ON position. Available in "Center OFF" versions with both Momentary ON and Momentary OFF positions.

**Pendant** — A type of switch designed for installation at the end of a length of portable cord or cable.

**Pilot Light** — A switch with an integral lamp in its actuator (toggle, rocker or pushbutton) that illuminates when the switch is connected to an energized circuit and the actuator is in the ON position.

**Pull** — A switch where the making or breaking of contacts is controlled by pulling downward or outward on the actuator mechanism.

**Push Button** — A switch with an actuator mechanism that is operated by depressing a button.

**Rotary** — A switch where rotating the actuator in a clockwise direction makes the circuit connection, and then rotating the actuator in either the same or opposite direction breaks the connection.

**Single-Pole, Double-Throw (SPDT)** — A switch that makes or breaks the connection of a single conductor with either of two other single conductors. This switch has 3 terminal screws, and is commonly used in pairs and called a "Three-Way" switch.

**Single-Pole, Single-Throw (SPST)** — A switch that makes or breaks the connection of a single conductor in a single branch circuit. This switch has two screw terminals and ON/OFF designations. It is commonly referred to as a "Single-Pole" Switch.

**Slide** — A switch with a slide-action actuator for making or breaking circuit contact. Dimmer switches and fan speed controls are also available with slide-action mechanisms for lighting and fan speed control.

**Surface-Mounted** — Any switch that mounts on a flat or plane surface.

**Three-Position, Center OFF** — A two circuit switch, either maintained or momentary contact, where the OFF position is designated as the center position of the actuator.

**Three-Way** — A switch, always used in pairs, that controls a single load such as a light fixture from two locations. This switch has three terminal screws and has no ON/OFF marking.

**Time Delay** — A switch with an integral mechanism or electronic circuit that will automatically switch a load OFF at a predetermined time interval.

**Timer** — A switch with an integral mechanism or electronic circuit that can be set to switch an electrical load ON at a predetermined time.

**Toggle** — A switch with a lever-type actuator that makes or breaks switch contact as its position is changed.

**T-Rated** — A switch specially designated with the letter "T" in its rating that is rated for controlling tungsten filament lamps on direct current (DC) or alternating current (AC) circuits.

### Wallplates

**Combination** — A multiple-gang wallplate with openings in each gang to accommodate different devices.

**Decora®** — Wallplates with Decora-size openings for compatibility with Leviton's entire line of Decora devices. Available in a variety of multiple-gang configurations. Screwless-design snap-on versions also available.

**Flush** — A wallplate designed for flush-mounting with wall surfaces or the plane surfaces of electrical equipment.

**Gang** — A term that describes the number of devices a wallplate is sized to fit (i.e. "2-gang" designates two devices).

**Midway** — Wallplates that are approx. 3/8" higher and wider than the standard size that can be mounted onto larger volume outlet boxes and/or used to hide wall surface irregularities. These wallplates are approx. 1/4" deep to ensure a proper fit when used with protruding devices.

**Oversized** — Wallplates that are approx. 3/4" higher and wider than the standard size and are used to conceal greater wall irregularities than those hidden by Midway wallplates. These wallplates are approx. 1/4" deep to ensure a proper fit when used with protruding devices.

**Modular** — Individual-section wallplates with different openings that can be configured into a multi-gang plate.

**Multi-Gang** — A wallplate that has two or more gangs.

**Tandem** — A wallplate with individual gangs arranged vertically one above the other.

**Weatherproof (with Cover Closed)** — A UL Listed cover that meets specific test standards for use in wet and damp locations with the cover closed.

**Weatherproof (with Cover Open)** — A UL Listed cover that meets specific test standards for use in wet and damp locations with the cover open or closed.

### Surge Suppression

**Clamping Voltage** — The peak voltage that can be measured after a Surge Protective Device has limited or "clamped" a transient voltage surge.

Clamping voltage must be determined by using IEEE Standard C62 testing and evaluated by UL Standard 1449.

**Joule Rating** — The measurement of a Surge Protective Device's ability to absorb heat energy created by transient surges. Note that the Joule rating is not a part of IEEE or UL Standards. It is not as significant a specification as Clamping Voltage, Maximum Surge Current and other parameters recognized by these agencies.

**Transient Voltage Surges** — High-speed, high-energy electrical disturbances present on AC power lines and data and communication lines, generated by utility switching, motor-load switching and lightning strikes.

**Response Time** — The interval of time it takes for a surge protective device to react to a transient voltage surge. Note that this parameter is not a part of IEEE or UL Standards and is only based on estimations made by manufacturers.

**Surge Protective Device** — See "Transient Voltage Surge Suppressor (TVSS)" definition.

**Transient Voltage Surge Suppressor (TVSS)** — A device designed to protect sensitive electronic equipment such as computers and computer peripherals, logic controls, audio/video equipment and a wide range of microprocessor-based (computer chip) equipment from the harmful effects of transient voltage surges. Also referred to as a Surge Protective Device (SPD).

**Maximum (Peak) Surge Current** — The peak surge current a Surge Protective Device can withstand, based on IEEE Standard C62.45 test waveforms.

**MOV (Metal Oxide Varistor)** — The primary component used in most Surge Protective Devices to clamp down transient voltages.

**UL 1449 Listing** — The industry standard for Surge Protective Devices. A Surge Protective Device must have a UL 1449 Surge Suppression rating on its label in order to verify that the device has been tested with IEEE standardized waveforms. Devices without this identification should not be considered reliable surge protective devices.



## Switches

### Types of Switches

Switches used in branch circuit wiring are rated in two general categories: AC ONLY and AC/DC. Originally, the electrical power furnished to residences and businesses by utility companies was Direct Current or DC. Because DC current was always flowing at full value, the making or breaking of a circuit created a rather strong arc during switch operation. For this reason, the contacts had to be widely gapped and the operation had to be “quick make, quick break” to avoid excessive pitting or welding of the contact points.

Alternating current operates between zero and full power 120 times per second. Because of the oscillating characteristic of AC power, the arc from an AC circuit is self-extinguishing on the “break” of the current. This means a slower breaking action is possible on an AC switch, as opposed to the breaking action required of a switch made for use with continuous full-power DC. The pulsating nature of AC can, however, cause a “chattering” or very fast series of “makes” and “breaks” if the circuit is closed too quickly. For this reason an AC ONLY switch works with a somewhat slower “fast make” and “break” than an AC/DC switch.

Because the make and break actions of an AC/DC switch must be fast, it can be rather noisy, and must use contact metals capable of enduring such comparatively violent action while still offering acceptable electrical conductivity. An alloy of copper is most often used.

Silver and its oxides are better conductors than copper and its oxides. Silver is much softer than copper and therefore cannot be used in the AC/DC switch. However, silver can be used in the AC ONLY switch because of its gentler “fast make” characteristic, especially when silver is alloyed with cadmium oxide, a good conductor that’s quite hard.

### Switch Ratings

AC ONLY switches are often called AC Quiet switches because they can be made to operate very quietly, unlike AC/DC switches. AC ONLY switches are rated at their full current value for lighting, including tungsten filament, quartz metal-halide, and fluorescent; and 80% current value or full horsepower rating value for motor (inductive) loads.

AC/DC switches used for incandescent lighting should have a “T” rating (tungsten-filament rating). The “T” rating assures end-users of the longevity of the switch through the surge currents of a “make” action across a tungsten filament. Such capacity is already inherent in the design of AC Quiet switches.

AC/DC switches are rated at only 50% of their current capacity for motor loads. A 20 amp AC/DC switch could be used to control a 10 amp motor load, while a 20 amp AC Quiet switch can operate a 16 amp motor load.

In the past, MERCURY switches were available that operated by making and breaking contact within a hermetically sealed capsule containing a pool of mercury. MERCURY switches were actually silent in operation. However, due to health concerns about mercury, these switches are no longer manufactured and sold. MERCURY switches may still be in service in some installations

### Horsepower Ratings

Switches marked with Horsepower (HP) Ratings are suitable for controlling the motor loads of the HP ratings shown on the switch, as well as loads with a lower HP rating.

To qualify for an HP rating, a switch is tested at six times the full motor load current corresponding the HP rating marked on the switch. For DC motor load controllers, the test is made at 10 times the full motor load current corresponding to the DC HP rating marked on the switch. The test is conducted on six samples and consists of 50 On-Off operations at the load. For a 3/4 HP rating at 120/240 VAC, two sets of six samples each are tested in addition to the regular overload endurance, heating and insulation tests. The test circuit characteristics are:

|                      | For 3/4 HP Rating @ 120 VAC | For 3/4 HP @ 240 VAC |
|----------------------|-----------------------------|----------------------|
| Closed Circuit Volts | 120 VAC                     | 240 VAC              |
| Current              | 82.8 amps                   | 41.4 amps            |
| Power-Factor         | 0.40 – 0.50                 | 0.40 – 0.50          |

Note: The current at 240 VAC is 1/2 that at 120 VAC

All switches must be in good operating condition after the tests have been completed. There must be no excessive arcing, welding or burning of the contacts nor arc-over to ground (the switch frames are grounded during the Stalled Rotor Test).

## Dimmers

A common misconception about box-mounted dimmers is that they are simply variable resistors (rheostats) that absorb power to dim the lights. In fact, a rheostat would be too bulky, inefficient and heat producing to ever be practical as a wall-mounted dimmer. In the 1950’s, the advent of solid state technology and a type of semi-conductor called the TRIAC fostered the development of full-range dimmers and fan speed controls that were versatile, efficient and compact enough to fit in a standard wallbox.

Leviton has always taken an active role in the development lighting control technologies. Leviton introduced the Trimatron™ Rotary Dimmer that was only half as deep as conventional dimmers, allowing easier installation and wiring in a crowded wallbox. Today, Leviton offers innovative all-digital lighting controls that feature scene lighting and multi-location control capabilities for sophisticated residential and commercial installations. Leviton’s complete line of controls for incandescent, low-voltage and fluorescent lighting includes Decora-style and architectural specification grade devices, as well as traditional rotary devices. There is also a wide selection of Fan Speed Controls

See Section C for information on Leviton’s comprehensive line of Lighting and Fan Speed Controls.

## Receptacles

### Types of Receptacles

Receptacles generally are made to accommodate either of two types of plugs. *Straight-Blade* plugs are pushed in and pulled straight out. *Locking* plugs are pushed in and rotated slightly in a clockwise direction to a position where they cannot be pulled straight out. They must be rotated counterclockwise back to the insertion position in order to be withdrawn. This locking action is intended to prevent accidental disconnection of the circuit by pulling the plug straight out unintentionally.

### Grounding

Originally, residential electrical circuitry was “2-pole, 2-wire” and did not have an equipment grounding means at the receptacle. The only grounding point was at the service entrance, where the neutral (white) conductor was grounded. The receptacle slot for the neutral wire, according to NEMA configuration 1-15R, must be longer than the slot for the phase or hot wire (typically black or red). This enables certain items of equipment, like TV sets and home appliances, to have their external metal parts or casing grounded through the white neutral connection. Such equipment uses a polarized plug where the neutral plug blade is wider than the hot plug blade, ensuring that it mates properly with the NEMA 1-15R configuration receptacle. Receptacles designed for 2-pole, 2-wire circuits do not have mounting straps that are connected to a grounding terminal. Leviton still offers 2-pole, 2-wire receptacles for replacement use only in existing non-grounding systems.

Experience proved that a single grounding point through the neutral conductor was not sufficiently safe. Conditions could occur where fault currents and differences in potential lead to shocks, overheating, equipment burnout and fire. Therefore, the 2-pole, 3-wire circuit was developed. A third conductor, called the grounding conductor, does not carry current during normal circuit operation. It is connected to the neutral bus bar at the service entrance and runs along with the current-carrying neutral and hot conductors. The grounding conductor is connected only to outlet boxes, chassis and other non-current carrying components that may carry current in case of damage or defects in the wiring system. It is sometimes referred to as the “equipment grounding conductor.”

The grounding contacts on the 2-pole, 3-wire receptacles are most commonly shaped like a “U”, which is how the term “U-ground” evolved. The grounding contacts on these receptacles are securely fastened to the mounting strap. In Leviton receptacles, the grounding contacts are permanently riveted to the mounting strap, and in most Leviton Hospital Grade and Industrial Grade receptacles they are an integral part of the strap. Many Leviton receptacles offer dual ground connection options to help ensure that the receptacle is properly connected to the grounding system: An integral green grounding screw for direct connection to the green or bare grounding wire, and a patented Groundamatic® self-grounding clip riveted to the strap to provide automatic ground connection when the receptacle is mounted in a properly grounded metal wallbox.

### Isolated-Ground Receptacles

Although the conventional grounding system provides safety for personnel and equipment, it may be a source of electrical interference that can cause problems in modern electronic equipment. Because the conventional grounding network runs through an entire facility, it can unintentionally function as a pick-up of transient electrical signals or “noise.”



# TECHNICAL INFORMATION

These transient signals will then be introduced to equipment through the ground connection. Microprocessor-based equipment, including computers, cash registers, medical equipment and audio/video equipment, may malfunction as a result of this noise.

Isolated-Grounding Receptacles can help eliminate problems caused by electrical interference in a conventional ground system. The ground contacts on Isolated-Ground Receptacles are electrically isolated from the mounting strap and therefore they are isolated from the conventional ground system. The green ground screw is connected to a pure ground path that is separate from a facility's grounding network. The isolated ground network is relatively free of electrical noise because it is not a facility-wide grounding path and it's connected to ground at a single point.

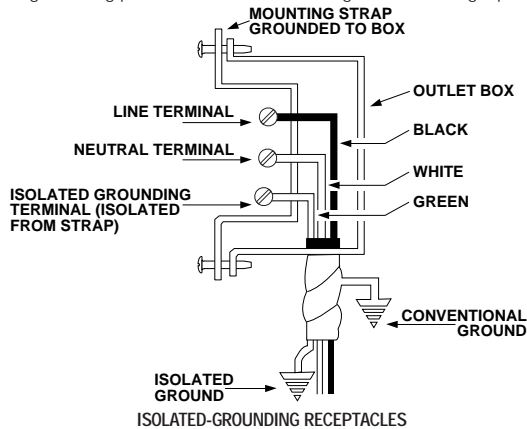

### Mounting Straps

There are basically two kinds of mounting straps for receptacles. The "through" type passes between the receptacle body and cover. The "wrap-around" type acts as a cradle for the receptacle, surrounding its side, ends and bottom surfaces.

### Power Contact Design

The "contact" does more than make contact with the plug blade — It must grip the plug blade for maximum electrical conductivity and mechanical strength. Leviton receptacles feature double-wipe contacts that grip both sides of each blade, including the U-ground contacts that are often single-wipe in receptacles made by other manufacturers. Leviton Hospital Grade and Industrial Grade receptacles feature triple-wipe contacts for added strength and durability in high-abuse applications. Leviton contacts are made of the copper alloys that offer maximum strength and electrical conductivity.

### Wiring of Leviton Receptacles



**Side Wiring**  
Loop wire around terminal screw. Screw head locks wire against terminal. For copper or copper/clad aluminum conductors.



**Quickwire™ Connection**  
Insert wire into wire well. Wire is automatically clamped by spring action, insuring good electrical connection. For copper conductors only.



**Quickwire™ and Screw**  
Option of (1) side wiring or (2) Quickwire connection. NOTE: For continuous wiring, both sets of terminals (screw and Quickwire) can be used together.



**Back & Side Wiring**  
Option of (1) side wiring or (2) back wiring: Insert wire into well. Tighten screw, thus clamping wire against terminal. Back wiring for copper or copper/clad aluminum conductors.



**Two-Circuit Conversion**  
To power each outlet of a duplex receptacle separately, simply break off the tab between the two terminals.

## Ground Fault Circuit Interrupters (GFCI's)

### The Need for Ground Fault Protection

Circuit breakers and fuses protect equipment and building structures from overheating and fire caused by short circuits and high-current overloads. However, the current level needed to trip a breaker is many times greater than the amount of current needed to deliver a powerful, and possibly lethal electrical shock. For example, the hot conductor in an electrical device can become exposed through a break in its insulation, and it may end up touching the device's metal enclosure. The leakage current that now flows through the metal enclosure will be conducted to ground through any available path — including the body of a human being that happens to touch the faulty device. This condition is called a Ground Fault, and the current flowing through the person to ground can be life threatening, though there is usually nowhere near enough current to trip a circuit breaker.

### How a GFCI Works

When there is a ground fault condition, all of the current flowing through the "hot" conductor is not returning through the neutral conductor. A Ground Fault Circuit Interrupter (GFCI) monitors the difference in current flow between hot and neutral conductors. If the GFCI senses even a very tiny difference in current flow between the conductors (a ground fault), it interrupts the flow of electrical current through the device by opening its internal double-pole contacts. According to UL Standard 943 Class A, the GFCI must trip when there is a ground fault of 5 milliamperes ( $\pm 1\text{mA}$ ). The GFCI must also trip within approximately 25 milliseconds.

GFCI receptacles are rated for 15 or 20 amp circuits. They are used in place of standard box-mounted duplex receptacles. GFCI receptacles can also be feed-through wired to provide ground fault protection to feed-through wired receptacles downstream.

See Section H for information on Leviton's comprehensive line of Ground Fault Circuit Interrupter Devices.

### UL 2006 Code Requirements (Effective July 28, 2006)

- If a miswiring (line-load reversal) occurs during installation, the GFCI must not be capable of supplying power to either the GFCI's face or to feed-through terminals
- GFCIs must provide a visual and/or audible indication OR be able to render themselves incapable of delivering power when they no longer offer ground fault protection based on a failure to pass their internal test

Note that the National Electrical Code strongly recommends monthly testing of all GFCIs.

### Leviton SmartLockPRO® GFCI with Lockout Action

The TEST and RESET functions on Leviton's SmartLock GFCI work together so that a tripped GFCI cannot be reset if the GFCI circuit is no longer providing ground fault protection. The RESET button is blocked if GFCI protection has been compromised, eliminating the possibility of end-users incorrectly assuming that a reset GFCI is providing ground fault protection when it actually is not.

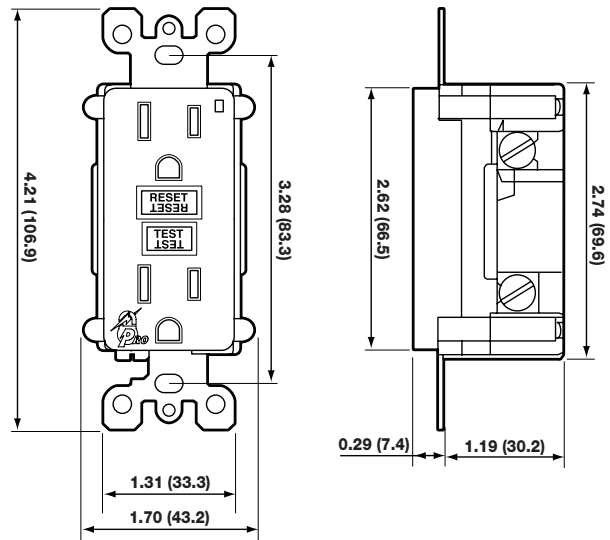

SmartLockPRO® GFCI RECEPTACLE  
7599 Series



### Enclosure Type Designations

Enclosures serve the dual purpose of protecting personnel from incidental contact with the enclosed electrical equipment and protecting the enclosed equipment against specified environmental conditions. Enclosures are rated for use in specific environmental conditions by NEMA, UL, CSA and the IEC. The major rating systems used are the NEMA Type Numbers and the IEC Enclosure Classification Designation.

#### The IEC Enclosure Classification Designation — IP Suitability Ratings

The IP Suitability Ratings are a system for classifying the degree of protection provided by enclosures of electrical equipment. The higher the number in the rating, the greater the degree of protection provided by the enclosure. Note that the rating will ONLY apply to properly installed equipment. The chart below defines the numerals in the IP Code.

1. The First Numeral indicates the degree of protection for persons against access to hazardous parts inside the enclosure and/or against the ingress of solid foreign objects
2. The Second Numeral indicates the degree of protection of equipment inside enclosures against damage from the ingress of water.

#### Elements of the IP Code

| Code Letters       | Meaning for the Protection of Equipment  |   |
|--------------------|--|---|
|                    | First Number                             | Second Number                                 |
| Ingress Protection | Against Ingress of Solid Foreign Objects | Against Ingress of Water with Harmful Effects |
| IP                 | 0 – Non protected                        | 0 – Non protected                             |
|                    | 1 – $\geq$ 50 mm diameter                | 1 – Vertically dripping                       |
|                    | 2 – $\geq$ 12.5 mm diameter              | 2 – Dripping (15 °tilted)                     |
|                    | 3 – $\geq$ 2.5 mm diameter               | 3 – Spraying                                  |
|                    | 4 – $\geq$ 1.0 mm                        | 4 – Splashing                                 |
|                    | 5 – Dust-protected                       | 5 – Jetting                                   |
|                    | 6 – Dust-tight                           | 6 – Power jetting                             |
|                    |  | 7 – Temporary immersion                       |
|                    | 8 – Continuous immersion                 |   |

Note: > denotes greater than or equal to.

Example: IP 54 Suitability Rating = Ingress Protection/Dust-protected/Splashing

### Enclosure Types for Non-Hazardous Locations

#### NATIONAL ELECTRICAL MANUFACTURERS ASSOCIATION

NEMA Standards Publication No. 250-1991  
Enclosures for Electrical Equipment (1000 Volts max.)

| Type Designation | Intended Use and Description   |
|------------------|--|
|                  | An enclosure is a surrounding case constructed to provide a degree of protection to personnel against incidental contact with the enclosed equipment and to provide a degree of protection to enclosed equipment against the specified environmental conditions. |
| Type 1           | Enclosures are intended for indoor use primarily to provide a degree of protection against limited amounts of falling dirt.  |
| Type 2           | Enclosures are intended for indoor use primarily to provide a degree of protection against limited amounts of falling water or dirt.   |
| Type 3           | Enclosures are intended for outdoor use primarily to provide a degree of protection against rain, sleet, windblown dust, and damage from external ice formation.   |

#### UNDERWRITERS LABORATORIES INC.

UL50  
Standard for Enclosures for Electrical Equipment (10th Edition)

| Type Designation | Intended Use and Description  |
|------------------|---|
|                  | Enclosure — A surrounding case constructed to provide a degree of protection against incidental contact with the enclosed equipment and to provide a degree of protection to the enclosed equipment against specified environmental conditions.<br><br>A complete enclosure shall be provided for all live parts that may be housed in it. The enclosure shall be tight and, unless designed for a specific installation, such as a cast metal junction or pull box intended to be installed in poured concrete, shall be provided with means for mounting. |
| Type 1           | Indoor use primarily to provide a degree of protection against limited amounts of falling dirt.   |
| Type 2           | Indoor use primarily to provide a degree of protection against limited amounts of falling water or dirt.  |
| Type 3           | Outdoor use primarily to provide a degree of protection against rain, sleet, windblown dust and damage from external ice formation.   |

#### CANADIAN STANDARDS ASSOCIATION

CAN/CSA C22.2 No. 94-M91  
Special Purposes Enclosures

| Type Designation | Intended Use and Description  |
|------------------|---|
|                  | Enclosures — provide a degree of protection against accidental contact with the enclosed equipment, and to the enclosed equipment against specified environmental conditions.           |
|                  | No CSA equivalent.  |
| Type 2           | An enclosure for indoor use, constructed so as to provide a degree of protection against dripping and light splashing of non-corrosive liquids, and falling dirt.                       |
| Type 3           | An enclosure for either indoor or outdoor use, constructed so as to provide a degree of protection against rain and snow, undamaged by the external formation of ice on the enclosures. |

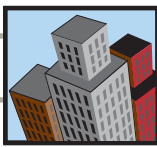

## Enclosure Types for Non-Hazardous Locations

### NATIONAL ELECTRICAL MANUFACTURERS ASSOCIATION

NEMA Standards Publication No. 250-1991  
Enclosures for Electrical Equipment (1000 Volts max.)

| Type Designation | Intended Use and Description   |
|------------------|--|
| Type 3R          | Enclosures are intended for outdoor use primarily to provide a degree of protection against rain, sleet, and damage from external ice formation.   |
| Type 3S          | Enclosures are intended for outdoor use primarily to provide a degree of protection against rain, sleet, windblown dust, and to provide for operation of external mechanisms when ice laden.   |
| Type 4           | Enclosures are intended for indoor or outdoor use primarily to provide a degree of protection against windblown dust and rain, splashing water, hose-directed water, and damage from external ice formation.                                     |
| Type 4X          | Enclosures are intended for indoor or outdoor use primarily to provide a degree of protection against corrosion, windblown dust and rain, splashing water, hose directed water, and damage from external ice formation.                          |
| Type 5           | Enclosures are intended for indoor use primarily to provide a degree of protection against settling airborne dust, falling dirt, and dripping noncorrosive liquids.  |
| Type 6           | Enclosures are intended for indoor or outdoor use primarily to provide a degree of protection against hose-directed water, the entry of water during occasional temporary submersion at a limited depth, and damage from external ice formation. |
| Type 6P          | Enclosures are intended for indoor or outdoor use primarily to provide a degree of protection against hose-directed water, the entry of water during prolonged submersion at a limited depth, and damage from external ice formation.            |
| Type 12          | Enclosures are intended for indoor use primarily to provide a degree of protection against circulating dust, falling dirt, and dripping noncorrosive liquids.  |
| Type 12K         | Enclosures with knockouts are intended for indoor use primarily to provide a degree of protection against circulating dust, falling dirt, and dripping noncorrosive liquids.   |
| Type 13          | Enclosures are intended for indoor use primarily to provide a degree of protection against dust, spraying of water, oil, and noncorrosive coolants.  |

### UNDERWRITERS LABORATORIES INC.

UL50  
Standard for Enclosures for Electrical Equipment  
(10th Edition)

| Type Designation | Intended Use and Description   |
|------------------|--|
| Type 3R          | Outdoor use primarily to provide a degree of protection against rain, sleet, and damage from external ice formation.   |
| Type 3S          | Outdoor use primarily to provide a degree of protection against rain, sleet, windblown dust, and to provide for operation of external mechanisms when ice laden.   |
| Type 4           | Indoor or outdoor use primarily to provide a degree of protection against windblown dust and rain, splashing water, hose-directed water, and damage from external ice formation.                                     |
| Type 4X          | Indoor or outdoor use primarily to provide a degree of protection against corrosion, windblown dust and rain, splashing water, hose-directed water and damage from external ice formation.                           |
| Type 5           | Indoor use primarily to provide a degree of protection against settling airborne dust, falling dirt, and dripping noncorrosive liquids.  |
| Type 6           | Indoor or outdoor use primarily to provide a degree of protection against hose-directed water, the entry of water during occasional temporary submersion at a limited depth, and damage from external ice formation. |
| Type 6P          | Indoor or outdoor use primarily to provide a degree of protection against hose-directed water, the entry of water during prolonged submersion at a limited depth, and damage from external ice formation.            |
| Type 12          | Indoor use primarily to provide a degree of protection against circulating dust, falling dirt, and dripping noncorrosive liquids.  |
| Type 12K         | Indoor use primarily to provide a degree of protection against circulating dust, falling dirt, and dripping noncorrosive liquids.  |
| Type 13          | Indoor use primarily to provide a degree of protection against dust, spraying of water, oil, and noncorrosive coolant.   |

### CANADIAN STANDARDS ASSOCIATION

CAN/ CSA C22.2 No. 94-M91  
Special Purposes Enclosures

| Type Designation | Intended Use and Description   |
|------------------|--|
| Type 3R          | An enclosure for either indoor or outdoor use, constructed so as to provide a degree of protection against rain and snow, undamaged by the external formation of ice on the enclosure.   |
| Type 3S          | An enclosure for either indoor or outdoor use, constructed so as to provide a degree of protection against rain, snow and windblown dust, the external mechanism(s) remain operable while ice covered.   |
| Type 4           | An enclosure for either indoor or outdoor use, constructed so as to provide a degree of protection against rain, snow, windblown dust, splashing and hose-directed water; undamaged by the external formation of ice on the enclosure.                                 |
| Type 4X          | An enclosure for either indoor or outdoor use, constructed so as to provide a degree of protection against rain, snow, windblown dust, splashing and hose-directed water; undamaged by the external formation of ice on the enclosure.                                 |
| Type 5           | An enclosure for indoor use, constructed so as to provide a degree of protection against dripping and light splashing of noncorrosive liquids and settling dust, lint, fibers, and flyings.  |
| Type 6           | An enclosure for either indoor or outdoor use, constructed so as to provide a degree of protection against the entry of water during occasional temporary submersion at a limited depth; undamaged by the external formation of ice on the enclosure.                  |
| Type 6P          | An enclosure for either indoor or outdoor use, constructed so as to provide a degree of protection against the entry of water during prolonged submersion at a limited depth; undamaged by the external formation of ice on the enclosure; resists extended corrosion. |
| Type 12          | An enclosure for indoor use, constructed so as to provide a degree of protection against circulating dust, lint, fibers, and flyings; dripping and light splashing of noncorrosive liquids; not provided with knockouts.   |
| Type 12K         | An enclosure for indoor use, constructed so as to provide a degree of protection against circulating dust, lint, fibers, and flyings; dripping and light splashing of noncorrosive liquids; and provided with knockouts.   |
| Type 13          | An enclosure for indoor use, constructed so as to provide a degree of protection against circulating dust, lint, fibers, and flyings; seepage and spraying of noncorrosive liquids including oils and coolants.  |



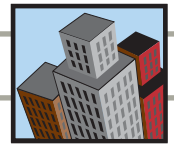

## NEMA and IEC Enclosure Classifications

### Comparing NEMA Enclosure Type Numbers and IEC Enclosure Classification Designations (IP Suitability Rating)

#### IEC

IEC Publication 529, "Classification of Degrees of Protection Provided by Enclosures", defines the IP (Ingress Protection) Suitability Rating. The IP Suitability Rating is a system for classifying the degree of protection provided by enclosures of electrical equipment. The higher the number in the rating, the greater the degree of protection provided by the enclosure. The first numeral of the code indicates the degree of protection for persons against access to hazardous parts inside the enclosure and/or against the ingress of solid foreign objects. The second numeral indicates the degree of protection of equipment inside enclosures against damage from the ingress of water. For a more detailed explanation of the IP Suitability Code, refer to page U-12.

The IP Suitability Rating defined by IEC 529 does not specify any degree of protection against mechanical damage of equipment, risk of explosions, or conditions such as moisture (i.e. condensation), corrosive vapors, fungus, or vermin.

#### NEMA

NEMA Standards Publication 250 defines the NEMA Enclosure Type Numbers. Unlike the IEC Enclosure Classification Designations, NEMA Standards Publication 250 does tests for environmental condition such as corrosion, rust, icing, oil and coolants. For this reason and because the tests and evaluations for other characteristics are not identical, the IEC Enclosure Classification Designations cannot be exactly equated with NEMA Enclosure Type Numbers.

The table below provides an equivalent conversion from NEMA Enclosure Type Numbers to IEC Enclosure Classification Designations. Note that the NEMA Types meet or exceed the test requirements for the associated IEC Classifications. Therefore, this table cannot be used to convert from IEC Classifications to NEMA Types.

### Converting NEMA Type Numbers to IEC Classification Designations

(Note: This table cannot be used to convert IEC classification designations to NEMA type numbers)

| NEMA Enclosure Type Number | Equivalent IEC Enclosure Classification Designation |
|----------------------------|---|
| 1                          | IP10  |
| 2                          | IP11  |
| 3                          | IP54  |
| 3R                         | IP14  |
| 3S                         | IP54  |
| 4 and 4X                   | IP56  |
| 5                          | IP52  |
| 6 and 6P                   | IP67  |
| 12 and 12K                 | IP52  |
| 13                         | IP54  |

### Materials Used in Wiring Devices

The following is an overview of the materials commonly used in wiring devices. Note that specific brand names of materials used in Leviton devices are subject to change due to a variety of factors. These changes will never compromise the quality, performance and durability features of our wiring devices. Leviton is committed to maintaining the positive qualities of the materials being replaced and choosing new materials with superior qualities as they become available.

#### Brass

The type of brass commonly used in wiring devices is referred to as standard or "70/30" brass. It is an alloy of 70% copper and 30% zinc that provides the strength and conductivity needed for power and ground contacts, wiring terminals and terminal screws. It is also used for some mounting straps and wallplates.

The Olin Corporation offers a series of alloys sometimes referred to as

High Performance Brass or "Olin Brass." Olin brass is a copper alloy consisting of more than 90% copper. It is more resilient than 70/30 brass and used by Leviton to form the power contacts in some Industrial Grade and Hospital Grade devices.

#### Phosphor Bronze

Phosphor Bronze, an alloy of copper and tin, is superior in strength to 70/30 brass. The advantage of using phosphor bronze parts is that they can be thinner than comparable parts made of standard brass without any loss in strength. For example, Leviton uses a phosphor bronze alloy of 95% copper and 5% tin to form power contacts in some Industrial Grade receptacles. Phosphor bronze power contacts at .031" outperform brass power contacts of a thicker gauge.

#### Beryllium Copper

An alloy of copper and .5% beryllium is used to form some of the components in Leviton Industrial Grade devices. Beryllium Copper provides excellent strength, durability, electrical conductivity. It also retains its resiliency at elevated temperatures. These properties make Beryllium Copper ideal for the contact arm in heavy-duty switches.

#### Silver-Cadmium Oxide

Although pure silver is an excellent conductor (superior to copper), it cannot be used for switch contacts. Over time, arcing caused by actuation would weld the silver contacts together. Silver-cadmium oxide, an alloy of 90% silver and 10% cadmium oxide, is widely used by Leviton to form switch contacts. Microscopic particles of cadmium oxide in the silver will decompose due to the heat buildup, preventing the contacts from welding together.

#### Zinc-Plated Steel

In addition to being strong and durable, zinc-plated steel provides a higher degree of corrosion resistance than standard cold-rolled steel. Leviton uses zinc-plated steel mounting straps in many of their devices. Leviton also offers zinc-plated steel wallplates for power receptacles, available with either a brass or aluminum finish.

#### Nickel-Plated Metals

Nickel-plating adds a high degree of corrosion resistance to either brass or steel. All the metal parts in Leviton Corrosion Resistant devices (blades, contacts, terminals, mounting straps and screws) are nickel-plated for maximum corrosion resistance. In some cases, cupronickel screws are used, which provide a high degree of corrosion resistance.

Leviton uses an electroless nickel-plating process. The standard plating process uses an electrical charge to coat the metal with nickel. This can produce uneven results, leaving some areas of the metal more coated than others. The more effective electroless process involves submerging the metal in a chemical bath where salts decompose and deposit nickel on the metal substrate. Every surface of the metal is evenly coated. Leviton uses this electroless process to ensure that their Corrosion Resistant wiring devices provide maximum performance in extremely damp and corrosive environments.

#### Stainless Steel

##### Type 430 Standard Stainless Steel

Type 430 stainless steel is resistant to the corrosive effects of moisture. Leviton offers a wide selection of wallplates made from this material. Leviton's Raintight-While-In-Use Covers are supplied with stainless-steel mounting screws to help ensure a long service life in wet applications. Note that Type 430 Stainless Steel does have magnetic properties that may interfere with magnetic-sensitive equipment.

##### Type 302/304 Non-Magnetic Stainless Steel

Type 302/304 Non-Magnetic Stainless Steel is suitable for applications where sensitive equipment may be affected by magnetic material. For example, navigational equipment in marine applications and MRI equipment in health care environments are susceptible to magnetic interference. In addition to being non-magnetic, Type 302/304 stainless Steel is more corrosion resistant than Type 430 stainless steel. Types 302 and 304 differ in composition, but there is virtually no difference between them in terms of non-magnetic and corrosion-resistant properties.



## TECHNICAL INFORMATION

Leviton offers a complete selection of wallplates made of Type 302/304 Non-Magnetic Stainless Steel. These wallplates are ideal for any application where magnetic interference must be avoided. Leviton's Corrosion Resistant wiring devices feature non-magnetic stainless steel assembly screws to ensure their suitability in marine applications. For health care applications where non-magnetic devices are desired, Leviton's Corrosion Resistant devices should also be used.

### CO/ALR Devices

Aluminum is used for residential wiring in Europe because it is a good conductor and considerably cheaper than copper. Houses with aluminum wiring were built in the United States, but the practice stopped at least twenty years ago. It was discovered that poor connections between aluminum wire and steel or brass terminal screws led to serious fires. There are still homes with aluminum wiring, and the National Electrical Code stipulates that only CO/ALR devices are to be used in these applications.

Aluminum wire tends to oxidize over time, and the oxide layer does not conduct electricity. This results in a poor connection with the wiring device terminal screws, particularly if they are steel. The connections gradually heat up to the point where fires are started inside the walls. For this reason, all standard wiring devices contain the warning, "For use with copper or copper-clad wire ONLY. Do not use with aluminum wire." The only exception to this are CO/ALR wiring devices.

Leviton offers a selection of CO/ALR devices for use with aluminum wire. In CO/ALR devices, the terminal screws are plating with the element Indium. Indium is an extremely soft metal that forms a gas-sealed connection with the aluminum wire, eliminating problems caused by oxidation.

### Thermoset and Thermoplastic Material

There are significant benefits in using thermoplastics in wiring devices instead of thermosets. Each type of thermoplastic also has particular characteristics that may make it ideally suited for a specific application.

### Thermosets

Thermoset components are manufactured by compression molding, where powdered material is molded by heat and pressure. Thermoset materials cannot be remolded. The major types of thermoset materials are Phenolic, Urea and Melamine. Phenolic is primarily used for dark colors, while Urea is used for lighter colors.

All thermoset materials provide dimensional stability when used in wiring devices. Phenolic is also a flame-resistant material. Thermosets do not provide a high degree of resistance to impacts, chemicals and solvents, and therefore they are not suitable for heavy-duty applications. Thermosets are not used in Leviton Industrial Grade devices. Urea is still widely used to manufacture wallplates.

### Thermoplastics

Thermoplastic components are manufactured by injection molding where pellets of the material are heated to a liquid which can flow into a mold. Unlike thermosets, thermoplastics can be remolded. These materials are the preferred choice for heavy-duty applications because they provide superior resistance to impacts, chemicals and solvents compared to thermosets. The following is a list of the major types of thermoplastic materials, along with some well-known brand names.

- Nylon: Zytel® 101 Type 66 and Zytel Supertough ST 801 Type66
- Polycarbonate: Lexan®, Calibre®, Makrolon®
- Polyester: Valox®, Rynite®
- ABS
- Acrylic
- Polypropylene

Zytel® and Rynite® are registered trademarks of the Dupont Co.  
Lexan® and Valox® are registered trademarks of the General Electric Co.  
Calibre® is a registered trademark of the Dow Chemical Co.  
Makrolon® is a registered trademark of Bayer, Inc.

### Chemical Resistance of Materials Commonly Used in Wiring Devices\*

| CHEMICALS     | Nylon | Melamine | Phenolic | Urea | Polyvinyl Chloride | Poly-carbonate | Rubber | Polyester | Poly-propylene |
|---------------|-------|----------|----------|------|--------------------|----------------|--------|-----------|----------------|
| Acids         | C     | B        | B        | B    | A                  | B              | B      | A         | A              |
| Alcohol       | A     | A        | A        | A    | A                  | A              | B      | A         | A              |
| Caustic Bases | A     | B        | B        | B    | A                  | C              | C      | B         | A              |
| Gasoline      | A     | B        | A        | C    | A                  | B              | B      | A         | A              |
| Grease        | A     | A        | A        | A    | A                  | B              | B      | A         | A              |
| Kerosene      | A     | A        | A        | A    | A                  | B              | A      | A         | A              |
| Oil           | A     | A        | A        | A    | A                  | B              | A      | A         | A              |
| Solvents      | A     | A        | A        | A    | C                  | C              | C      | B         | B              |
| Water         | A     | A        | A        | A    | A                  | A              | B      | A         | A              |

A – Completely resistant — Good to excellent for general use.  
B – Resistance is fair to good — Recommended for limited service.  
C – Slow attack. No recommended for use.

### Thermoplastic Enhancements

#### UV Stability

Thermoplastics provide varying degrees of UV (Ultraviolet Light) stability. For example, standard grade nylon will lose tensile strength and durability when exposed to sunlight and weathering. Discoloring will also occur. There are additives that will increase the UV stability of thermoplastics. UV Stabilized thermoplastics should be used when a device is intended for extensive outdoor use. For example, Leviton uses UV-stabilized Lexan in their Raintight-While-In-Use Cover, with excellent results.

#### Glass-Reinforced Thermoplastics

Several types of thermoplastics are available in glass-reinforced versions, including Rynite®, Lexan®, Valox® and nylon. Glass reinforcement increases the rigidity of the material and also raises the operating temperature. For example, Leviton Momentary and Maintained Contact Switches feature glass-reinforced thermoplastic construction, making these switches ideally suited for rugged applications.



## ANSI Architectural Symbols

### 1. LIGHTING OUTLETS

|   | Ceiling | Wall |
|---|---------|------|
| 1.1 Surface or Pendant Incandescent, Mercury-Vapor, or Similar Lamp Fixture           |         |      |
| 1.2 Recessed Incandescent, Mercury-Vapor, or Similar Lamp Fixture                     |         |      |
| 1.3 Surface or Pendant Individual Fluorescent Fixture                                 |         |      |
| 1.4 Recessed Individual Fluorescent Fixture   |         |      |
| 1.5 Surface or Pendant Continuous Row Fluorescent Fixture                             |         |      |
| 1.6 Recessed Continuous Row Fluorescent Fixture                                       |         |      |
| 1.7 Bare-Lamp Fluorescent Strip   |         |      |
| 1.8 Surface or Pendant Exit Light   |         |      |
| 1.9 Recessed Exit Light   |         |      |
| 1.10 Blanket Outlet   |         |      |
| 1.11 Junction Box   |         |      |
| 1.12 Outlet Controlled by Low-Voltage Switching when Relay is Installed in Outlet Box |         |      |

### 2. RECEPTACLE OUTLETS

|  | Grounded | Ungrounded |
|--|----------|------------|
| 2.1 Single Receptacle Outlet                 |          |            |
| 2.2 Duplex Receptacle Outlet                 |          |            |
| 2.3 Triplex Receptacle Outlet                |          |            |
| 2.4 Quadruplex Receptacle Outlet             |          |            |
| 2.5 Duplex Receptacle Outlet — Split Wired   |          |            |
| 2.6 Triplex Receptacle Outlet — Split Wired  |          |            |
| 2.7 Single Special-Purpose Receptacle Outlet |          |            |
| 2.8 Duplex Special-Purpose Receptacle Outlet |          |            |
| 2.9 Range Outlet (typical)                   |          |            |

|   | Grounded | Ungrounded |
|---|----------|------------|
| 2.10 Special Purpose Connection or Provision for Connection |          |            |
| 2.11 Multi-outlet assembly                                  |          |            |
| 2.12 Clock Hanger Receptacle                                |          |            |
| 2.13 Fan Hanger Receptacle                                  |          |            |
| 2.14 Floor Single Receptacle Outlet                         |          |            |
| 2.15 Floor Duplex Receptacle Outlet                         |          |            |
| 2.16 Floor Special-Purpose Outlet                           |          |            |

### 3. SWITCH OUTLETS

|   |            |
|---|------------|
| 3.1 Single-Pole Switch  | <b>S</b>   |
| 3.2 Double-Pole Switch  | <b>S2</b>  |
| 3.3 Three-Way Switch  | <b>S3</b>  |
| 3.4 Four-Way Switch   | <b>S4</b>  |
| 3.5 Key-Operated Switch   | <b>SK</b>  |
| 3.6 Switch and Pilot Lamp   | <b>SP</b>  |
| 3.7 Switch for Low-Voltage switching System                                 | <b>SL</b>  |
| 3.8 Maser Switch for Low-Voltage Switching System                           | <b>SLM</b> |
| 3.9 Switch and Single Receptacle  |            |
| 3.10 Switch and Double Receptacle   |            |
| 3.11 Door Switch  | <b>SD</b>  |
| 3.12 Time Switch  | <b>ST</b>  |
| 3.13 Circuit Breaker Switch   | <b>SCB</b> |
| 3.14 Momentary Contact Switch or Pushbutton for Other Than Signaling System | <b>SMC</b> |
| 3.15 Ceiling Pull Switch  |            |

### 4. RESIDENTIAL OCCUPANCIES

|                             |  |
|-----------------------------|--|
| 4.1 Pushbutton              |  |
| 4.2 Buzzer                  |  |
| 4.3 Bell                    |  |
| 4.4 Combination Bell-Buzzer |  |
| 4.5 Chime                   |  |
| 4.6 Annunciator             |  |



# TECHNICAL INFORMATION

## NEMA Straight Blade Configurations

### NEMA CONFIGURATIONS FOR GENERAL-PURPOSE NONLOCKING PLUGS AND RECEPTACLES

| WIRING / VOLTAGE        |              | 15 AMPERE  |        | 20 AMPERE  |        | 30 AMPERE  |        | 50 AMPERE  |        | 60 AMPERE  |        |        |
|-------------------------|--------------|------------|--------|------------|--------|------------|--------|------------|--------|------------|--------|--------|
|                         |              | RECEPTACLE | PLUG   | RECEPTACLE | PLUG   | RECEPTACLE | PLUG   | RECEPTACLE | PLUG   | RECEPTACLE | PLUG   |        |
| 2-POLE 2-WIRE           | 125V         | 1          | 1-15R  | 1-15P      |        |            |        |            |        |            |        |        |
|                         | 250V         | 2          |        | 2-15P      | 2-20R  | 2-20P      | 2-30R  | 2-30P      |        |            |        |        |
|                         | 277V AC      | 3          |        |            |        |            |        |            |        |            |        |        |
|                         | 600V         | 4          |        |            |        |            |        |            |        |            |        |        |
| 2-POLE 3-WIRE GROUNDING | 125V         | 5          | 5-15R  | 5-15P      | 5-20R  | 5-20P      | 5-30R  | 5-30P      | 5-50R  | 5-50P      |        |        |
|                         | 250V         | 6          | 6-15R  | 6-15P      | 6-20R  | 6-20P      | 6-30R  | 6-30P      | 6-50R  | 6-50P      |        |        |
|                         | 277V AC      | 7          | 7-15R  | 7-15P      | 7-20R  | 7-20P      | 7-30R  | 7-30P      | 7-50R  | 7-50P      |        |        |
|                         | 347V AC      | 24         | 24-15R | 24-15P     | 24-20R | 24-20P     | 24-30R | 24-30P     | 24-50R | 24-50P     |        |        |
|                         | 480V AC      | 8          |        |            |        |            |        |            |        |            |        |        |
|                         | 600V         | 9          |        |            |        |            |        |            |        |            |        |        |
| 3-POLE 3-WIRE           | 125/250V     | 10         |        |            | 10-20R | 10-20P     | 10-30R | 10-30P     | 10-50R | 10-50P     |        |        |
|                         | 3Ø 250V      | 11         | 11-15R | 11-15P     | 11-20R | 11-20P     | 11-30R | 11-30P     | 11-50R | 11-50P     |        |        |
|                         | 3Ø 480V      | 12         |        |            |        |            |        |            |        |            |        |        |
|                         | 3Ø 600V      | 13         |        |            |        |            |        |            |        |            |        |        |
| 3-POLE 4-WIRE GROUNDING | 125/250V     | 14         | 14-15R | 14-15P     | 14-20R | 14-20P     | 14-30R | 14-30P     | 14-50R | 14-50P     | 14-60R | 14-60P |
|                         | 3Ø 250V      | 15         | 15-15R | 15-15P     | 15-20R | 15-20P     | 15-30R | 15-30P     | 15-50R | 15-50P     | 15-60R | 15-60P |
|                         | 3Ø 480V      | 16         |        |            |        |            |        |            |        |            |        |        |
|                         | 3Ø 600V      | 17         |        |            |        |            |        |            |        |            |        |        |
| 4-POLE 4-WIRE           | 3ØY 120/208V | 18         | 18-15R | 18-15P     | 18-20R | 18-20P     | 18-30R | 18-30P     | 18-50R | 18-50P     | 18-60R | 18-60P |
|                         | 3ØY 277/480V | 19         |        |            |        |            |        |            |        |            |        |        |
|                         | 3ØY 347/600V | 20         |        |            |        |            |        |            |        |            |        |        |
| 4-POLE 5-WIRE GROUNDING | 3ØY 120/208V | 21         |        |            |        |            |        |            |        |            |        |        |
|                         | 3ØY 277/480V | 22         |        |            |        |            |        |            |        |            |        |        |
|                         | 3ØY 347/600V | 23         |        |            |        |            |        |            |        |            |        |        |



## NEMA Locking Configurations

### NEMA CONFIGURATIONS FOR LOCKING TYPE PLUGS AND RECEPTACLES

| WIRING / VOLTAGE        |              |     | 15 AMPERE  |         | 20 AMPERE                          |         | 30 AMPERE  |         |
|-------------------------|--------------|-----|------------|---------|------------------------------------|---------|------------|---------|
|                         |              |     | RECEPTACLE | PLUG    | RECEPTACLE                         | PLUG    | RECEPTACLE | PLUG    |
| 2-POLE 2-WIRE           | 125V         | L1  | L1-15R     | L1-15P  |                                    |         |            |         |
|                         | 250V         | L2  |            |         | L2-20R                             | L2-20P  |            |         |
|                         | 277V AC      | L3  |            |         | RESERVED FOR FUTURE CONFIGURATIONS |         |            |         |
|                         | 600V         | L4  |            |         | RESERVED FOR FUTURE CONFIGURATIONS |         |            |         |
| 2-POLE 3-WIRE GROUNDING | 125V         | L5  | L5-15R     | L5-15P  | L5-20R                             | L5-20P  | L5-30R     | L5-30P  |
|                         | 250V         | L6  | L6-15R     | L6-15P  | L6-20R                             | L6-20P  | L6-30R     | L6-30P  |
|                         | 277V AC      | L7  | L7-15R     | L7-15P  | L7-20R                             | L7-20P  | L7-30R     | L7-30P  |
|                         | 347V AC      | L24 |            |         | L24-20R                            | L24-20P |            |         |
|                         | 480V AC      | L8  |            |         | L8-20R                             | L8-20P  | L8-30R     | L8-30P  |
|                         | 600V AC      | L9  |            |         | L9-20R                             | L9-20P  | L9-30R     | L9-30P  |
| 3-POLE 3-WIRE           | 125/250V     | L10 |            |         | L10-20R                            | L10-20P | L10-30R    | L10-30P |
|                         | 3Ø 250V      | L11 | L11-15R    | L11-15P | L11-20R                            | L11-20P | L11-30R    | L11-30P |
|                         | 3Ø 480V      | L12 |            |         | L12-20R                            | L12-20P | L12-30R    | L12-30P |
|                         | 3Ø 600V      | L13 |            |         |                                    |         | L13-30R    | L13-30P |
| 3-POLE 4-WIRE GROUNDING | 125/250V     | L14 |            |         | L14-20R                            | L14-20P | L14-30R    | L14-30P |
|                         | 3Ø 250V      | L15 |            |         | L15-20R                            | L15-20P | L15-30R    | L15-30P |
|                         | 3Ø 480V      | L16 |            |         | L16-20R                            | L16-20P | L16-30R    | L16-30P |
|                         | 3Ø 600V      | L17 |            |         |                                    |         | L17-30R    | L17-30P |
| 4-POLE 4-WIRE           | 3ØY 120/208V | L18 |            |         | L18-20R                            | L18-20P | L18-30R    | L18-30P |
|                         | 3ØY 277/480V | L19 |            |         | L19-20R                            | L19-20P | L19-30R    | L19-30P |
|                         | 3ØY 347/600V | L20 |            |         | L20-20R                            | L20-20P | L20-30R    | L20-30P |
| 4-POLE 5-WIRE GROUNDING | 3ØY 120/208V | L21 |            |         | L21-20R                            | L21-20P | L21-30R    | L21-30P |
|                         | 3ØY 277/480V | L22 |            |         | L22-20R                            | L22-20P | L22-30R    | L22-30P |
|                         | 3ØY 347/600V | L23 |            |         | L23-20R                            | L23-20P | L23-30R    | L23-30P |



# TECHNICAL INFORMATION

## Horsepower Ratings for NEMA Configurations — for Plugs and Receptacles Only

### STRAIGHT BLADE CONFIGURATIONS

| NEMA  | AC HP Rating     | Rating            |
|-------|------------------|-------------------|
| 1-15  | 0.5              | 15A-125V          |
| 2-15  | 1.5*             | 15A-250V          |
| 2-20  | 2*               | 20A-250V          |
| 2-30  | 2*               | 30A-250V          |
| 5-15  | 0.5              | 15A-125V          |
| 5-20  | 1                | 20A-125V          |
| 5-30  | 2                | 30A-125V          |
| 5-50  | 2                | 50A-125V          |
| 6-15  | 1.5*             | 15A-250V          |
| 6-20  | 2*               | 20A-250V          |
| 6-30  | 2*               | 30A-250V          |
| 6-50  | 3*               | 50A-250V          |
| 7-15  | 2                | 15A-277V AC Only  |
| 7-20  | 2                | 20A-277V AC Only  |
| 7-30  | 3                | 30A-277 V AC Only |
| 7-50  | 5                | 50A-277V AC Only  |
| 10-20 | 2 L-L*/1 L-N     | 20A-125/250V      |
| 10-30 | 2 L-L*/2 L-N     | 30A-125/250V      |
| 10-50 | 3 L-L*/2 L-N     | 50A-125/250V      |
| 11-15 | 2                | 15A-250V 3Ø       |
| 11-20 | 3                | 20A-250V 3Ø       |
| 11-30 | 3                | 30A-250V 3Ø       |
| 11-50 | 7.5              | 50A-250V 3Ø       |
| 14-15 | 1.5 L-L*/0.5 L-N | 15A-125/250V      |
| 14-20 | 2 L-L*/1 L-N     | 20A-125/250V      |
| 14-30 | 2 L-L*/2 L-N     | 30A-125/250V      |
| 14-50 | 3 L-L*/2 L-N     | 50A-125/250V      |
| 14-60 | 3 L-L*/2 L-N     | 60A-125/250V      |
| 15-15 | 2                | 15A-250V 3Ø       |
| 15-20 | 3                | 20A-250V 3Ø       |
| 15-30 | 3                | 30A-250V 3Ø       |
| 15-50 | 7.5              | 50A-250V 3Ø       |
| 15-60 | 10               | 60A-250V 3Ø       |
| 18-15 | 2                | 15A-120/208V 3ØY  |
| 18-20 | 2                | 20A-120/208V 3ØY  |
| 18-30 | 3                | 30A-120/208V 3ØY  |
| 18-50 | 7.5              | 50A-120/208V 3ØY  |
| 18-60 | 7.5              | 60A-120/208V 3ØY  |

L-L Denotes phase-to-phase HP rating

L-N Denotes phase-to-neutral HP rating

\*Suitable for 208V motor applications at HP rating

### LOCKING CONFIGURATIONS

| NEMA   | AC HP Rating | Rating           |
|--------|--------------|------------------|
| L1-15  | 0.5          | 15A-125V         |
| L2-20  | 2*           | 20A-250V         |
| L5-15  | 0.5          | 15A-125V         |
| L5-20  | 1            | 20A-125V         |
| L5-30  | 2            | 30A-125V         |
| L6-15  | 1.5*         | 15A-250V         |
| L6-20  | 2*           | 20A-250V         |
| L6-30  | 2*           | 30A-250V         |
| L7-15  | 2            | 15A-277V AC Only |
| L7-20  | 2            | 20A-277V AC Only |
| L7-30  | 3            | 30A-277V AC Only |
| L8-20  | 3            | 20A-480V AC Only |
| L8-30  | 5            | 30A-480V AC Only |
| L9-20  | NA           | 20A-600V AC Only |
| L9-30  | NA           | 30A-600V AC Only |
| L10-20 | 2 L-L*/1 L-N | 20A-125/250V     |
| L10-30 | 2 L-L*/2 L-N | 30A-125/250V     |
| L11-15 | 2            | 15A-250V 3Ø      |
| L11-20 | 3            | 20A-250V 3Ø      |
| L11-30 | 3            | 30A-250V 3Ø      |
| L12-20 | 5            | 20A-480V 3Ø      |
| L12-30 | 10           | 30A-480V 3Ø      |
| L13-30 | NA           | 30A-600V 3Ø      |
| L14-20 | 2 L-L*/1 L-N | 20A-125/250V     |
| L14-30 | 2 L-L*/2 L-N | 30A-125/250V     |
| L15-20 | 3            | 20A-250V 3Ø      |
| L15-30 | 3            | 30A-250V 3Ø      |
| L16-20 | 5            | 20A-480V 3Ø      |
| L16-30 | 10           | 30A-480V 3Ø      |
| L17-30 | NA           | 30A-600V 3Ø      |
| L18-20 | 2            | 20A-120/208V 3ØY |
| L18-30 | 3            | 30A-120/208V 3ØY |
| L19-20 | 5            | 20A-277/480V 3ØY |
| L19-30 | 10           | 30A-277/480V 3ØY |
| L20-20 | NA           | 20A-347/600V 3ØY |
| L20-30 | NA           | 30A-347/600V 3ØY |
| L21-20 | 2            | 20A-120/208V 3ØY |
| L21-30 | 3            | 30A-120/208V 3ØY |
| L22-20 | 5            | 20A-277/480V 3ØY |
| L22-30 | 10           | 30A-277/480V 3ØY |
| L23-20 | NA           | 20A-347/600V 3ØY |

L-L Denotes phase-to-phase HP rating

L-N Denotes phase-to-neutral HP rating

\*Suitable for 208V motor applications at HP rating



Circuit Wiring Diagrams

WIRING DIAGRAMS FOR NEMA CONFIGURATIONS

125V — 2-POLE, 2-WIRE

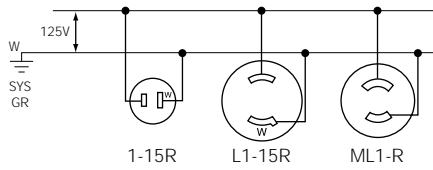

250V — 2-POLE, 2-WIRE

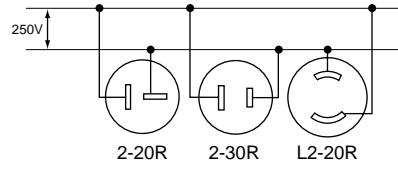

125V — 2-POLE, 3-WIRE GROUNDING

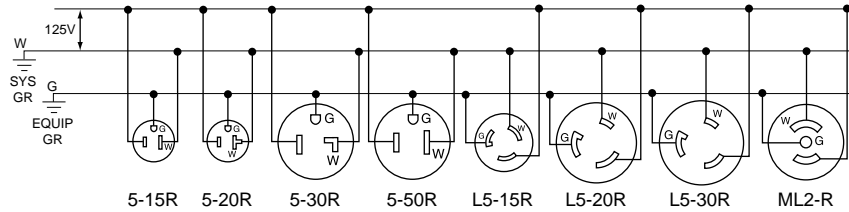

250V — 2-POLE, 3-WIRE GROUNDING

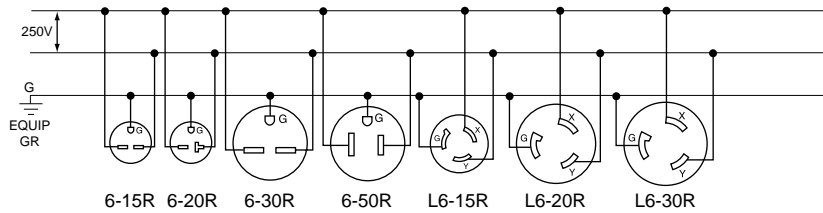

277V AC — 2-POLE, 3-WIRE GROUNDING

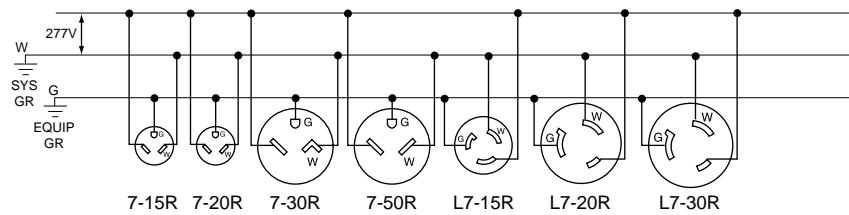

480V AC — 2-POLE, 3-WIRE GROUNDING

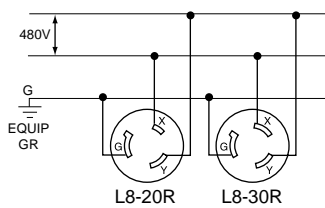

600V AC — 2-POLE, 3-WIRE GROUNDING

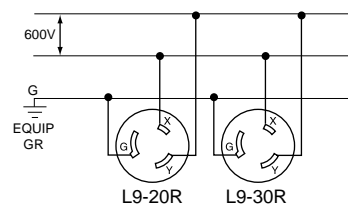

125/250V — 3-POLE, 3-WIRE

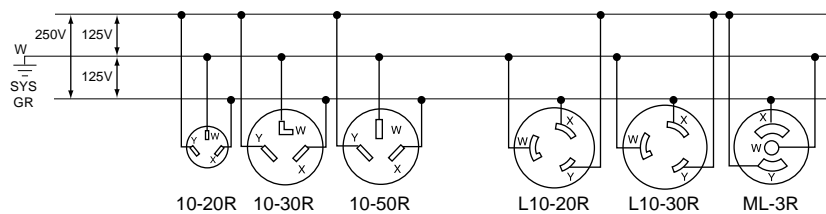

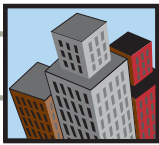

# TECHNICAL INFORMATION

## Circuit Wiring Diagrams

### WIRING DIAGRAMS FOR NEMA CONFIGURATIONS

#### 3Ø 250V — 3-POLE, 3-WIRE

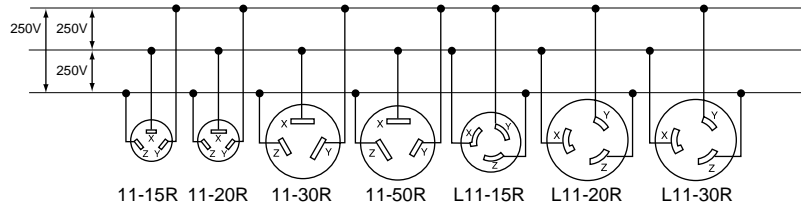

#### 3Ø 480V — 3-POLE, 3-WIRE

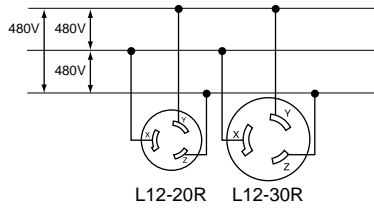

#### 3Ø 600V — 3-POLE, 3-WIRE

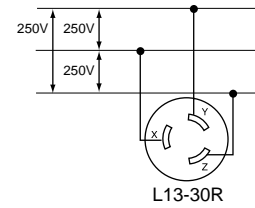

#### 125/250V — 3-POLE, 4-WIRE GROUNDING

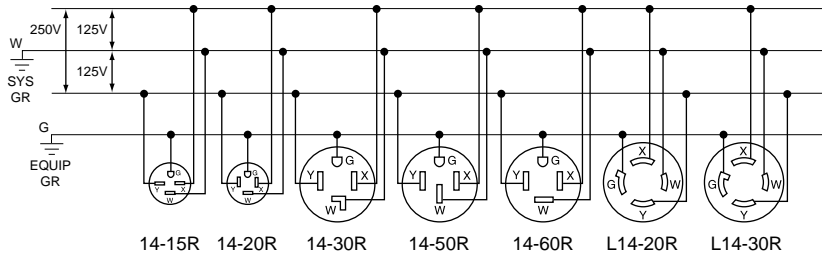

#### 3Ø 250V — 3-POLE, 4-WIRE GROUNDING

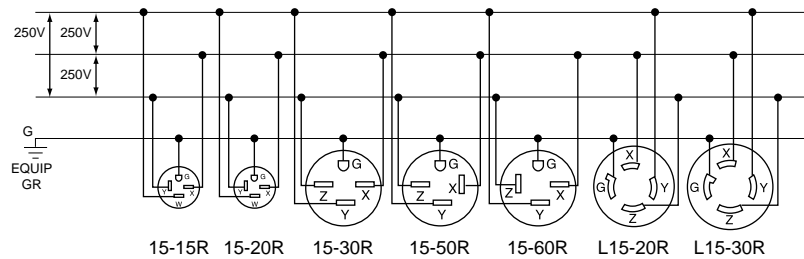

#### 3Ø 480V — 3-POLE, 4-WIRE GROUNDING

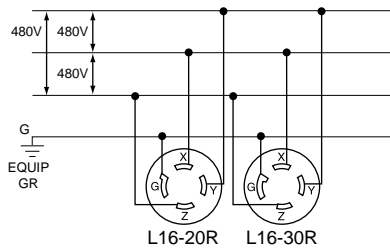

#### 3Ø 600V — 3-POLE, 4-WIRE GROUNDING

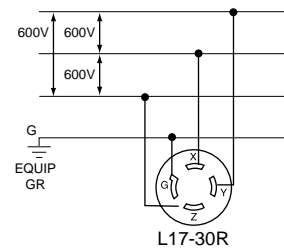



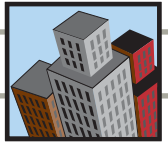

Circuit Wiring Diagrams

WIRING DIAGRAMS FOR NEMA CONFIGURATIONS

3ØY 120/208V — 4-POLE, 4-WIRE

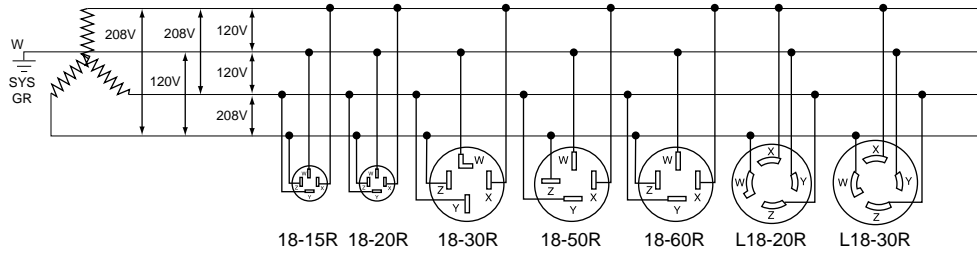

3ØY 277/480V — 4-POLE, 4-WIRE

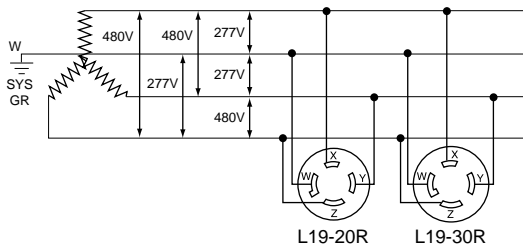

3ØY 347/600V — 4-POLE, 4-WIRE

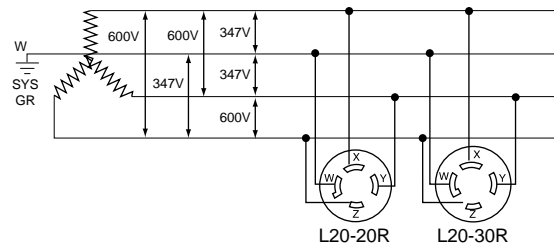

3ØY 120/208V — 4-POLE, 5-WIRE GROUNDING

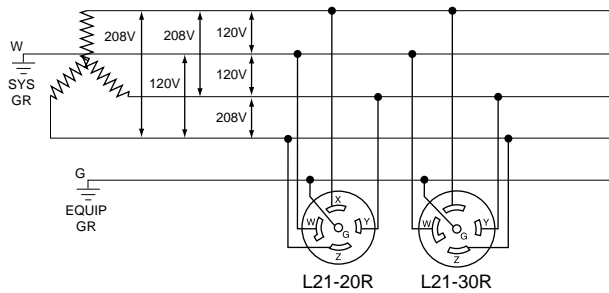

3ØY 277/480V — 4-POLE, 5-WIRE GROUNDING

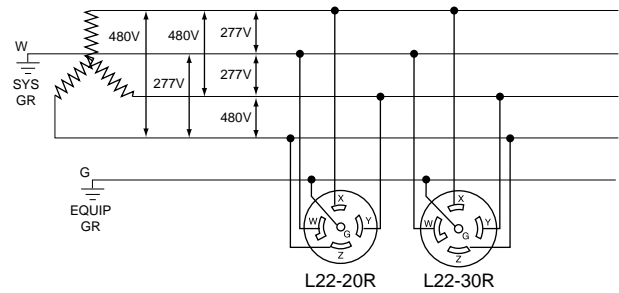

3ØY 347/600V — 4-POLE, 5-WIRE GROUNDING

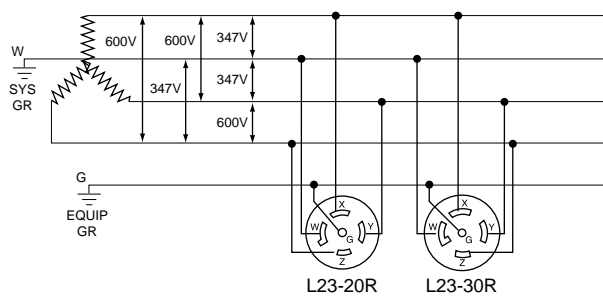



## Switch Wiring Diagrams

### STANDARD TOGGLE TYPE SWITCHES

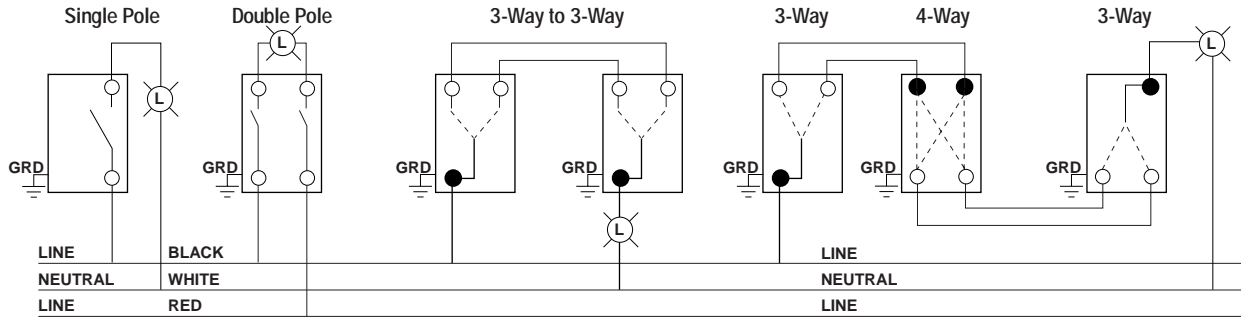

### LIGHTED HANDLE SWITCHES

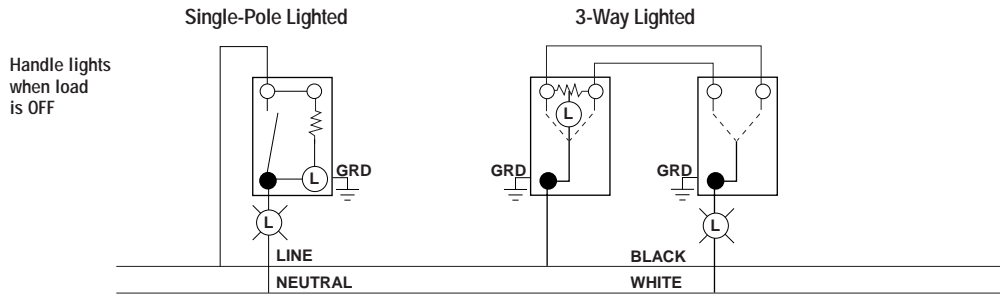

### PILOT LIGHT SWITCHES

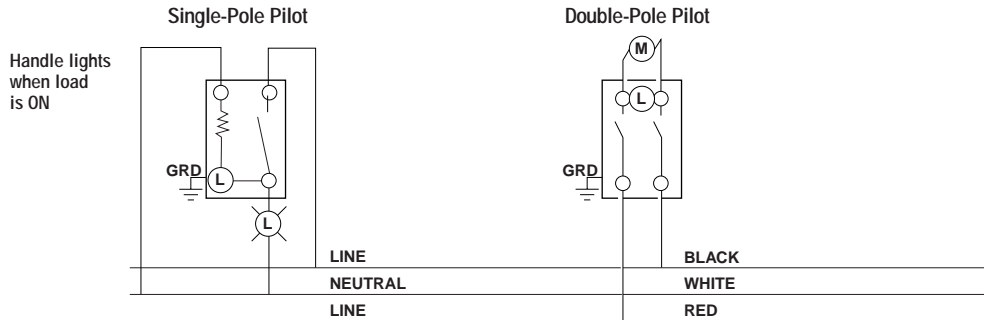

### 3-WAY PILOT SWITCHES

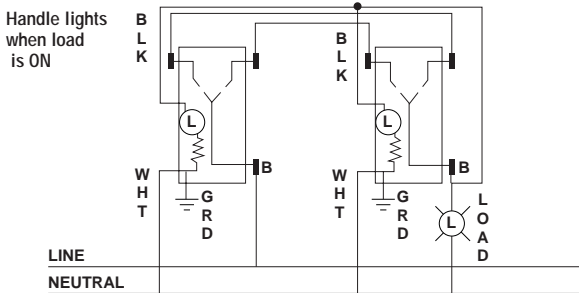

### 3-POSITION SWITCHES MOMENTARY AND MAINTAINED

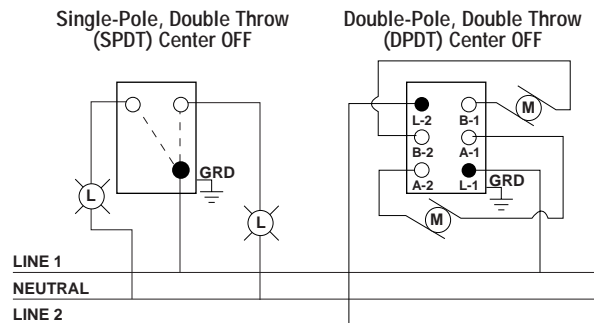



## Diameter Ranges of Jacketed Cord in Accordance with Standard UL62

Acceptable range for overall diameter of jacketed cord indicated in inches and millimeters (in parentheses)

| TYPE OF CORD       | AWG SIZE                 | 2-CONDUCTOR              | 3-CONDUCTOR              | 4-CONDUCTOR              | 5-CONDUCTOR                           |                        |
|--------------------|--------------------------|--------------------------|--------------------------|--------------------------|---------------------------------------|------------------------|
| SV, SVO, SVT, SVTO | 18                       | .22-.26<br>(5.6-6.6)     | .23-.27<br>(5.8-6.9)     | —                        | —                                     |                        |
|                    | SJ, SJ0, SJT, SJTO       | 18                       | .28-.32<br>(7.1-8.1)     | .30-.34<br>(7.6-8.6)     | .33-.37<br>(8.4-9.4)                  | —                      |
| SJ, SJ0, SJT, SJTO | 16                       | .31-.34<br>(7.9-8.6)     | .33-.36<br>(8.4-9.1)     | 35-.40<br>(8.9-10.2)     | —                                     |                        |
|                    | 14                       | .34-.38<br>(8.6-9.7)     | .36-.40<br>(9.1-10.2)    | .39-.44<br>(9.9-11.2)    | —                                     |                        |
|                    | 12                       | .41-.46<br>(10.4-11.7)   | .43-.48<br>(10.9-12.2)   | .47-.52<br>(11.9-13.2)   | —                                     |                        |
|                    | 10                       | .54-.61<br>(13.7-15.5)   | .57-.64<br>(14.5-16.3)   | .63-.70<br>(16.0-17.8)   | —                                     |                        |
|                    | S, S0, ST, ST0           | 18                       | .34-.39<br>(8.6-9.9)     | .36-.40<br>(9.1-10.2)    | .39-.43<br>(9.9-10.9)                 | .46-.51<br>(11.7-13.0) |
|                    |                          | 16                       | .37-.41 )<br>(9.4-10.4)  | .39-.43<br>(9.9-10.9)    | .41-.46<br>(10.4-11.7)                | .49-.55<br>(12.4-14.0) |
| 14                 |                          | .50-.55                  | .52-.58<br>(12.7-14.0)   | .56-.62<br>(13.2-14.7)   | .63-.71<br>(14.2-15.7)<br>(16.0-18.0) |                        |
| 12                 |                          | .57-.63<br>(14.5-16.0)   | .59-.66<br>(15.0-16.8)   | .64-.71<br>(16.3-18.0)   | .70-.77<br>(17.8-19.6)                |                        |
| 10                 |                          | .62-.69<br>(15.7-17.5)   | .65-.72<br>(16.5-18.3)   | .70-.78<br>(17.8-19.8)   | .76-.84<br>(19.3-21.3)                |                        |
| 8                  |                          | .78-.88<br>(19.8-22.4)   | .83-.93<br>(21.1-23.6)   | .93-1.05<br>(23.6-26.7)  | 1.00-1.15<br>(25.4-29.2)              |                        |
| 6                  |                          | .92-1.05<br>(23.4-26.7)  | .97-1.10<br>(24.6-27.9)  | 1.05-1.20<br>(26.7-30.5) | 1.18-1.33<br>(30.0-33.8)              |                        |
| 4                  |                          | 1.06-1.21<br>(26.9-30.7) | 1.13-1.28<br>(28.7-32.5) | 1.25-1.45<br>(31.8-36.8) | —                                     |                        |
| 2                  | 1.21-1.40<br>(30.7-35.6) | 1.30-1.50<br>(33.0-38.1) | 1.45-1.65<br>(36.8-41.9) | —                        |                                       |                        |



# TECHNICAL INFORMATION

## Wallplates

### WALLPLATE DIMENSIONS

| Gangs | Standard<br>4.50 H x D*<br>(114.3 H x D*) | Midway<br>4.88 H x .260 D<br>(123.8 H x 6.5 D)  | Oversizes<br>5.25 H x .260 D<br>(133.4 H x 6.5 D) |
|-------|---|---|---|
| 1     | 2.75 (69.9)W                              | 3.13 (79.4)W  | 3.50 (88.9)W                                      |
| 2     | 4.56 (115.9)W                             | 4.94 (125.4)W   | 5.31 (134.9)W                                     |
| 3     | 6.38 (161.9)W                             | 6.75 (171.5)W   | —   |
| 4     | 8.19 (208.0)W                             | <i>NOTE: This chart is based on the standard calculation of adding 1.81" (46.0) width for each gang in multi-gang wallplates.</i> |   |
| 5     | 10 (254.0)W                               |   |   |
| 6     | 11.81 (300.0)W                            |   |   |

\*DEPTHS OF STANDARD WALLPLATES: Plastic — .22 (5.6)  
Metal — .19 (4.7)

### WALLPLATE SIZE COMPARISON

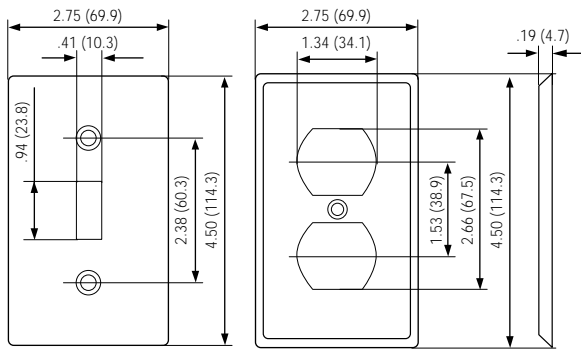
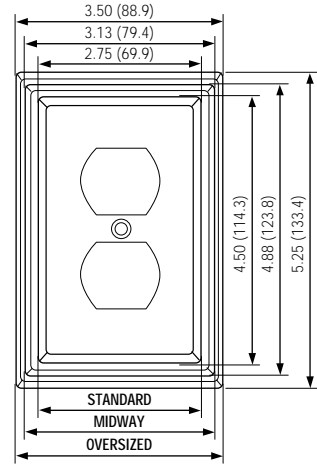

STANDARD SIZE WALLPLATE  
81001 Series and 81003 Series

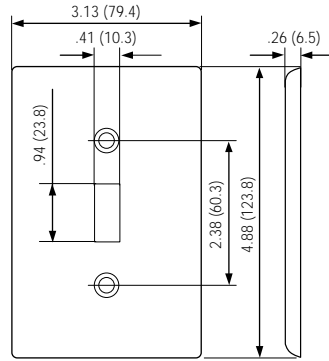

MIDWAY SIZE WALLPLATE  
80501 Series

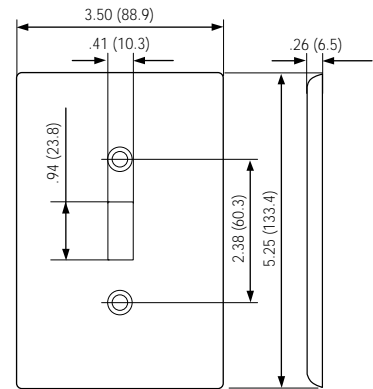

OVERSIZED WALLPLATE  
85101 Series

### POWER RECEPTACLE WALLPLATES

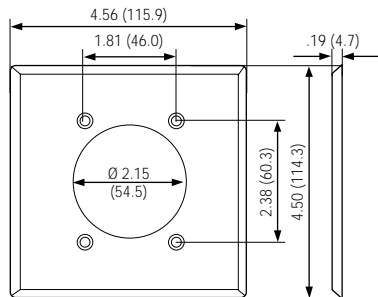

4934 Series

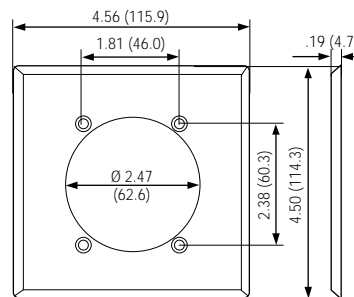

S701

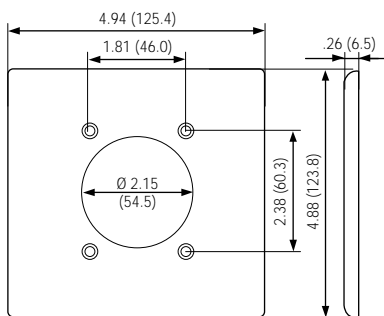

80526 Series

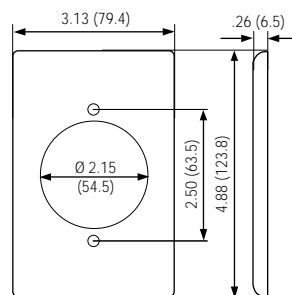

80528 Series

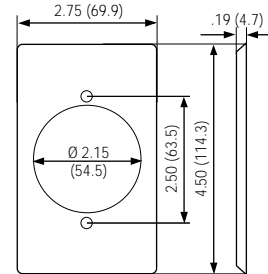

4927 Series

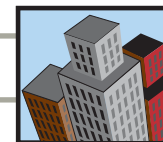

## Telephone Wiring Devices Codes and Standards

### Industry Standards

At Leviton, our concern since deregulation has been the proliferation of poor quality devices and equipment being attached to the network. These devices meet few of the customary standards for mechanical integrity and combustibility and have caused a number of problems for those who have installed them.

The responsibility for ensuring that no sub-standard devices are connected to the network rests on everyone's shoulders. In fact, the FCC recently issued a Public Notice strongly reminding manufacturers, carriers and customers that the manufacture and installation of sub-standard devices and equipment will not be tolerated — and that a substantial fine is the penalty for noncompliance. Recently, organizations such as the Federal Communications Commission (FCC), Underwriter's Laboratories (UL), the Canadian Standards Association (CSA), and the Telecommunications Industry Association (TIA) have been developing standards for premise wiring systems. Additionally, Article 800 of the National Electrical Code (NEC), published by the National Fire Protection Association (NFPA), mandated "listing" of equipment connected to telecommunications networks. Leviton has always played a role in the standards-making process and will continue to do so. We wholeheartedly support this new standards environment.



### Industry Basics: Drawing the Line

The dividing line between public network and customer premises is called the demarcation point. Equipment, including wiring, on the network side of the demarcation point is the property and responsibility of the local telephone company (telco). Equipment and wiring on the customer side is the responsibility of the customer, who may procure equipment, materials, and service from the provider of their choice. A subscriber network interface (SNI) often called a "demarcation jack", is recommended to be installed at the demarcation point. A standard registered jack is often used at this point so that the network and the premise wiring system can be quickly separated from each other. The location of the SNI depends on local rules and on such factors as the number of units in the facility, access, and the type and age of connecting hardware. The SNI may be inside the building or outside.

### FCC Part 68 Requirements

The equipment standards outlined in FCC Part 68 were developed long before divestiture to assure consumers, manufacturers and carriers that terminal equipment and wiring could be connected without degrading the network. Part 68 describes minimum requirements for the mechanical or physical properties of wiring devices such as the amount of gold on jack contacts, electrical performance, dimensional integrity, material properties, and spring characteristics of contacts. Only equipment meeting FCC Part 68 standards may be manufactured and connected to the network. The vast changes that have occurred in the industry because of evolving deregulation have made it necessary to modify Part 68. To this end, FCC Wiring Docket 88-57 was issued in 1990. There have been numerous attempts to change this docket; however, as of this writing, the following guidelines are true:

- Since 1984, Part 68 specified that all connections to the network be made through the standard plugs and standard telephone company-provided jacks described in Subpart F or Part 68. Now, Docket 88-57 permits customers to connect to the carrier's jack or wiring.
- The demarcation point has been redefined to be not more than 12 inches from the protector, or when no protector is present, 12 inches from the point of entry to the premises. In the past, the demarcation point could extend into the customer premise hundreds of feet, if necessary, depending on the wiring application. The new 12-inch ruling limits the carrier's access to the customer premise.
- The carriers are not responsible for customer wiring unless they have an agreement for such responsibility. Because the customer can now install a jack at the network interface, the customer is responsible for any wiring errors and malfunctions that occur.

- The "extraordinary procedures," acceptance testing, and carrier notification for wiring clause has been eliminated. The carrier is no longer required to take steps to protect the network from harm when there is a violation of Part 68 a failure during testing of newly installed wiring, or when harm has actually occurred. Once again, because the carriers now have less access to the customer premise, they will also have less responsibility in maintaining the network.
- Customer-provided, as well as carrier-provided plugs and jacks must meet Subpart F of Part 68 when newly installed on or after January 1, 1991. Prior to this ruling, Part 68 could be interpreted to require that only the jack at the network interface conform to Part 68.

### Beware of the Number Game

FCC Part 68, Subpart F, specifies that contacts in the telephone jacks must have 50 micro-inches of gold over 100 micro-inches of nickel. Some manufacturers claim .5 microns of gold plating on their jack contacts. At 39.37 micro-inches per micron, that's only 19.7 micro-inches — less than half of what is required to meet FCC Part 68 specifications. If jack contacts have not been plated with the right thickness or quality of gold, corrosion at these critical points can cause signal degradation, equipment failure, and even damage to the public telephone network. Data networks are more at risk because even slight imperfections result in transmission error or data loss.

### Reduce Risks — Specify Leviton

There are no two ways about it. The risk to your operation and equipment is so great that it only makes sense to insist on top-quality station products. When you specify Leviton jacks, you're assured maximum contact life with minimum resistance. We start with durable phosphor-bronze contacts and plate them with a full 50 micro-inches of lubricated hard gold over 100 micro-inches of nickel (or the electrical performance equivalent as specified in FCC Part 68 requirements). Jack openings are built within precise tolerances. High-quality thermoplastic rated UL 94V-0 resists distortion from changes in temperature and humidity, physical stress, and aging. Spring contacts are engineered to maintain positive contact pressure over the life of the device.

### Telecommunications Industry Association Standards

If FCC regulations protect the telephone network from harm and UL requirements protect the consumer from harm, who is responsible for providing performance standards for the telecommunications industry? Recently, the FCC asked the Telecommunications Industry Association (TIA), a sister organization of the Electronic Industries Association (EIA), to take on this task, and they accepted the challenge. The TIA was asked to define minimum standards for such things as how to wire a building, what kind of wire to use, and so on. The following standards went into effect in 1991.

- **Pathway Standard (EIA/TIA 569-A):** This standard for installing pipe and conduit in commercial buildings is now available through TIA and the American National Standards Institute (ANSI).
- **Residential/Light Commercial Wiring (EIA/TIA 570):** A draft of this standard, which applies to premises with up to four telephone lines, has been reviewed by ANSI and TIA committees and released.
- **Commercial Wiring Standard (EIA/TIA 568-A):** The Commercial Wiring Standard applies to premises with more than four telephone lines. This draft has also been reviewed and released by ANSI and TIA committees. At time of printing, the standards are undergoing major revisions and are currently up for ballot.

### We're the "Standards" People

Because Leviton is an active participant in the formation of North American codes and standards, you can be assured that our product development activities fully support this emerging standards environment. In fact, we have prepared several publications which describe standard practices and provide installation guidelines for contractors. Many Leviton distributors also sponsor training programs dealing with telecom wiring. And, of course, Leviton's Applications Engineering Group is always ready to assist you with any questions you may have about standards and codes, standard practices, or any installation problem.

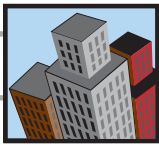

## Wire Color Codes and Jack Pin Designations

### Electrical Network Connection

From 1 to 25 single or multiple-pair circuits bridged to the network or other connected equipment.

### Mechanical Arrangement

Circuits are provided on numbered tip and ring positions on a miniature 50-pin ribbon connector (Amphenol-type). Pins 1 (ring) and 26 (tip) are considered position 1. Pins 2 (ring) and 27 (tip) of the ribbon connector are position 2. This pairing continues through twenty-five pairs.

### Typical Usage

Many key and PBX systems specify the RJ21X, or 'Amphenol-type' as the network interface device. Many of these systems also use the RJ21X as a connector for stations or telephone sets, wired from the KSU or PBX Main Distribution Frame.

**Note:** Sometimes an RJ11 or RJ14C can be installed in place of an RJ21X. While many smaller systems that require only a few lines may show the RJ21X as the 'official' jack required under registration, less complex jacks such as the RJ11 or RJ14C can often be specified (perhaps in multiples). If the system requires only a few lines but the RJ21X is specified on the registration label, under FCC Part 68 you may specify the RJ11C, RJ14C, RJ25C, or RJ61X instead.

Many Leviton jacks can be used for the RJ21X configuration where 'intermixing' is permitted. Substitution of these special jacks is often both economical and practical. Contact Leviton Telcom Applications Engineering for information about versions to meet your requirements.

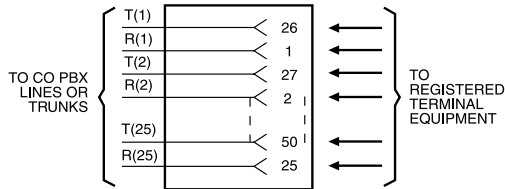

### 25-PAIR COLOR CODING/ISDN CONTACT ASSIGNMENTS

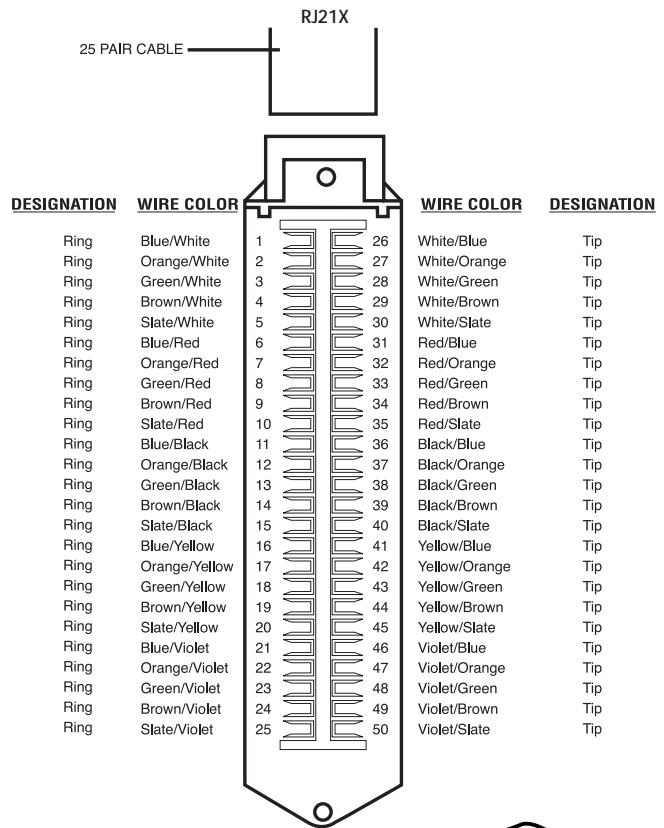

### ISDN Assignment of Contact Numbers as specified by ISO Document 8877: 1987 (E)

Contact assignments for plugs and jacks:

| CONTACT NUMBER | TE             | NT             | POLARITY |
|----------------|----------------|----------------|----------|
| 1              | Power source 3 | Power sink 3   | +        |
| 2              | Power source 3 | Power sink 3   | -        |
| 3              | Transmit       | Receive        | +        |
| 4              | Receive        | Transmit       | +        |
| 5              | Receive        | Transmit       | -        |
| 6              | Transmit       | Receive        | -        |
| 7              | Power sink 2   | Power source 2 | -        |
| 8              | Power sink 2   | Power source 2 | +        |

**Note:** For use in TE to TE interconnections, power source/sink 3 shall conform to the requirements specified in CCITT Recommendation 1.430, section 9.2 for power source/sink 2.

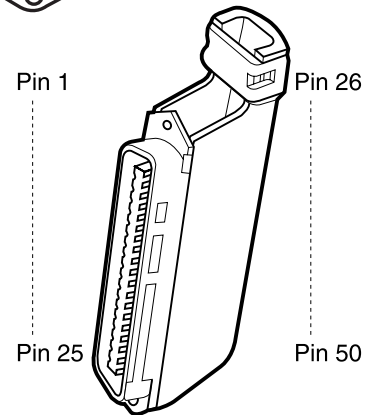
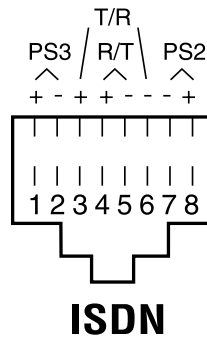

### WIRE COLOR CODES

| Standard 4-Pair Wiring Color Codes |   |              |
|------------------------------------|---|--------------|
| PAIR 1                             | T | White/Blue   |
|                                    | R | Blue/White   |
| PAIR 2                             | T | White/Orange |
|                                    | R | Orange/White |
| PAIR 3                             | T | White/Green  |
|                                    | R | Green/White  |
| PAIR 4                             | T | White/Brown  |
|                                    | R | Brown/White  |

*Note: For 6-wire jacks use pair 1, 2 and 3 color codes. For 4-wire jacks use pair 1 and 2 color codes.*

#### A. Band-Striped Twisted-Pair Wire

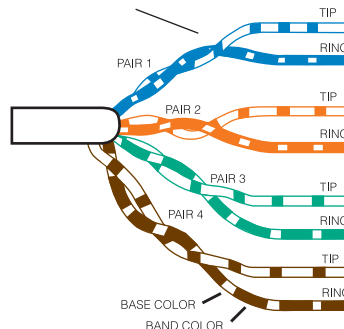

#### B. Solid-Color Twisted-Pair Wire



#### C. Quad Wire\* (Solid-Color, Non-Twisted Wire)

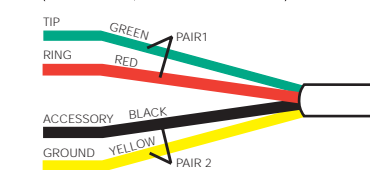

#### \*CAUTION

Quad wire is no longer acceptable for installation in multi-line environments. If encountered during a retrofit, quad wire should be replaced with 100Ω UTP. Connecting new quad to installed quad will only amplify existing problems and limitations associated with quad wire; leaving existing quad in place and connecting 100Ω UTP to it may also be ineffective, as the quad wire may negate the desired effect of the UTP.

# CATALOG NUMBER ALPHANUMERIC INDEX

**Important:** Dash-numbers, indicating different product colors or other variations, are listed on the same page as the basic catalog numbers shown below, unless otherwise indicated.

**THIS PAGE A0001-IPF01**

| CAT. NO.  | PAGE NO. | CAT. NO.  | PAGE NO. | CAT. NO.     | PAGE NO. |            |           |
|-----------|----------|-----------|----------|--------------|----------|------------|-----------|
| A0001     | P18      | ACWM4-ST5 | .A6      | CS63-60C     | .N26     | D42P9      | .C6       |
| A0002     | P18      | ACWM5-ST5 | .A6      | CS63-61C     | .N26     | D42RL      | .C6       |
| A0003     | P18      | ACWM6-ST5 | .A6      | CS63-64C     | .N26     | D42SQ      | .C6       |
| A0004     | P18      | ACWP1-W   | .A6, L17 | CS63-65C     | .N26     | D670K      | .L31      |
| A0005     | P18      | ACWP2     | .A6, L17 | CS63-69      | .N26     | D675E      | .L31      |
| A0006     | P18      | ACWP3     | .A6, L17 | CS63-70      | .N26     | D6701      | .L31      |
| A0007     | P18      | ACWP4     | .A6, L17 | CS63-75      | .N26     | D6706      | .L31      |
| AC00R-10  | .A3      | ACWP5     | .A6, L17 | CS63-77      | .N26     | D6710      | .L31      |
| AC00R-1L  | .A3      | ACWP6     | .A6, L17 | CS81-64C     | .N26     | D6720      | .L31      |
| AC00R-7B  | .A3      | ACX10-1L  | .A3      | CS81-65C     | .N26     | D6721      | .L31      |
| AC084     | .A7, L17 | ACX12-7B  | .A3      | CS81-69      | .N26     | D8000      | .C5       |
| AC0SR-10  | .A4      | AE6MA     | .J27     | CS81-75      | .N26     | DCK05-OC   | .C4       |
| AC0SR-1L  | .A4      | AE6MC     | .J27     | CS82-64C     | .N26     | DCK3D      | .K5       |
| AC108-R*5 | .A7, L17 | AEC65     | .J23     | CS82-65C     | .N26     | DCK4A      | .K5       |
| AC201-1L  | .A4      | AEC80     | .J23     | CS82-69      | .N26     | DCK4D      | .K5       |
| AC201-7L  | .A4      | AECCS     | .J24     | CS82-75      | .N26     | DCKS7      | .C25      |
| AC203-1L  | .A4      | AEH50     | .J25     | CS83-64C     | .N26     | DRKOD-1LX  | .K9       |
| AC204-1L  | .A4      | AEHTK     | .J34     | CS83-65C     | .N26     | DRKOR-00   | .K12, C23 |
| AC204-7L  | .A4      | AEI55     | .J24     | CS83-69      | .N26     | DRKDD-1L   | .C23-C24  |
| AC215     | .A5      | AEI65     | .J23     | CS83-75      | .N26     | DRKOS-OLX  | .K4, K9   |
| AC220     | .A5      | AEI80     | .J23     | CS84-64C     | .N26     | DRK1D-00X  | .K4       |
| AC315     | .A2, A5  | AEM65     | .J23     | CS84-65C     | .N26     | DRKOS-OLX  | .K9       |
| AC320     | .A5      | AEMRK     | .J34     | CS84-69      | .N26     | DS30-AX    | .F9       |
| AC642     | .A7, L17 | AEN24     | .J24     | CS84-75      | .N26     | DS60-AX    | .F9       |
| AC643     | .A7, L17 | AEPC8     | .J24     | CS115-2      | .F12     | DS100-AX   | .F9       |
| AC644     | .A7, L17 | AEPHK     | .J25     | CS120-2      | .F12     | DS30-FAX   | .F9       |
| AC646     | .A7, L17 | AEPI6     | .J24     | CS215-2      | .F12     | DS60-FAX   | .F9       |
| AC734     | .A7, L17 | AEPI8     | .J24     | CS220-2      | .F12     | HCA02-10E  | .K16      |
| AC735     | .A7, L17 | AEPIS     | .J24     | CS315-2      | .F12     | HCCPRF-1TW | .K6       |
| AC830     | .A7, L17 | AES36     | .J24     | CS320-2      | .F12     | HCCKR-E    | .K6       |
| AC831     | .A7, L17 | AESS5     | .J25     | CS415-2      | .F12     | HCCUR      | .K6       |
| AC832     | .A7, L17 | AESUB     | .J25     | CS420-2      | .F12     | HCM06-1DW  | .K8       |
| AC833     | .A7, L17 | BR15      | .G13     | CSB1-15      | .F12     | HCM10-1DW  | .K8       |
| AC837     | .A7, L17 | BR20      | .G13     | CSB1-20      | .F12     | HCM06-1SW  | .K9       |
| ACE04-1L  | .A3      | BX60-V    | .O5      | CSB2-15      | .F12     | HCM10-1SW  | .K9       |
| ACE06-1L  | .A3      | BX100-V   | .O5      | CSB2-20      | .F12     | HCP03-10W  | .K10      |
| ACE06-1LW | .A3      | BX230-V   | .O4      | CSB3-15      | .F12     | HCS10-1SW  | .K9       |
| ACF01-1L  | .A3      | C0001     | .P18     | CSB3-20      | .F12     | HKABH      | .J26      |
| ACGF1     | .A5      | C2623     | .N12     | CSB4-15      | .F12     | HKABV      | .J26      |
| ACGF2     | .A5      | C2623-B   | .N12     | CSB4-20      | .F12     | HKAVR      | .J26      |
| ACH06-7B  | .A3      | C2623-CY  | .N12     | D32CK        | .C3      | HKCDC      | .J26      |
| ACH08-1L  | .A3      | C2651     | .N13     | D3204-1LW    | .C3      | HKDVD      | .J26      |
| ACI06-1L  | .A3      | C2653     | .N13     | D3204-2LW    | .C3      | HKPOD      | .J26      |
| ACI06-1LW | .A3      | CA060     | .O22     | D3206-1LW    | .C3      | HKRMS      | .J26      |
| ACM06-1L  | .A3      | CA320     | .O22     | D3206-2LW    | .C3      | HXC3D-1TW  | .K5       |
| ACM10-1L  | .A3      | CA343     | .O22     | D3208-1LW    | .C3      | HXC4A-1TW  | .K5       |
| ACP0R-CB  | .A4      | CA420     | .O22     | D4000 Series | .C6      | HXC4D-1TW  | .K5       |
| ACP15-CB  | .A4      | CA520     | .O22     | D4200        | .C5      | HXC7S-1TW  | .K5       |
| ACS15-1L  | .A2, A4  | CA530     | .O22     | D4200-OW     | .C6      | HXC10-1TW  | .K4       |
| AC SIS-1L | .A4      | CN100-OD0 | .D18     | D42CS        | .C6      | HXC1A-1TW  | .K4       |
| ACSR6     | .A2, A5  | CN200-00C | .D18     | D42ET        | .C6      | HXC1D-1TW  | .K4       |
| ACSSR     | .A5      | CN220-00C | .D18     | D42IR        | .C6      | HXC2D-1TW  | .K4       |
| ACT60-L   | .A4      | CN221-00C | .D18     | D42LI        | .C6      | HXM06-1TW  | .K8       |
| ACW14     | .A6      | CR015     | .G14     | D42LO        | .C6      | HXM10-1TW  | .K8       |
| ACWM1-ST5 | .A6      | CR15      | .G14     | D42M0        | .C6      | HXS08-1TW  | .K8       |
| ACWM2-ST5 | .A6      | CR15S-G   | .G14     | D42P1        | .C6      | HXP15-1TW  | .K10      |
| ACWM3-ST5 | .A6      | CR020     | .G14     | D42P4        | .C6      | IPE04      | .C30      |
|           |          | CR20      | .G14     | D42P8        | .C6      | IPF01      | .C30      |

# CATALOG NUMBER ALPHANUMERIC INDEX

**Important:** Dash-numbers, indicating different product colors or other variations, are listed on the same page as the basic catalog numbers shown below, unless otherwise indicated.

| THIS PAGE IPF05-RA520 |           |
|-----------------------|-----------|
| CAT. NO.              | PAGE NO.  |
| IPF05                 | .C30      |
| IPI06                 | .C30      |
| IPI10-1L              | .C30      |
| IPIM10                | .C30      |
| IPKIT                 | .C30      |
| IPM06                 | .C30      |
| IPP15-IL              | .D6       |
| IPPOR-1L              | .D6       |
| IPOFK                 | .C30      |
| IP710                 | .C30      |
| IPX10                 | .C30      |
| KRS-A9519             | .H7       |
| KUS-A9519             | .H7       |
| L21-20P               | .R18      |
| L7500 Series          | .Q15      |
| L7600 Series          | .Q15      |
| L7700 Series          | .Q17      |
| L7900 Series          | .Q18, Q25 |
| L7902                 | .Q22      |
| L7903                 | .Q22      |
| L7904                 | .Q22      |
| L7905                 | .Q22      |
| L7918                 | .Q18      |
| L8000 Series          | .Q18      |
| L8500 Series          | .Q8-Q11   |
| L8600 Series          | .Q11-Q14  |
| L8700 Series          | .Q14      |
| L8800 Series          | .Q9, Q26  |
| L9500 Series          | .Q20-Q21  |
| L9600 Series          | .Q23, Q25 |
| L9700 Series          | .Q21, Q23 |
| LVS-XXX               | .D26      |
| MCM06-1L              | .C23, C24 |
| MCM10                 | .C24      |
| MCX10                 | .C24      |
| MDE03                 | .C23      |
| MDF01                 | .C23      |
| MDI06                 | .C23      |
| MDI10                 | .C23      |
| MDM06                 | .C23      |
| MH101                 | .R18      |
| MH122                 | .R18      |
| ML1-AC                | .N29      |
| ML1-AP                | .N29      |
| ML1-C                 | .N29      |
| ML1-P                 | .N29      |
| ML1-PB                | .N29      |
| ML1-PER               | .N29      |
| ML2-AC                | .N29      |
| ML2-AP                | .N29      |
| ML2-C                 | .N29      |
| ML2-P                 | .N29      |
| ML2-PB                | .N29      |
| ML2-PER               | .N29      |
| ML3-AC                | .N29      |
| ML3-AP                | .N29      |
| ML3-C                 | .N29      |

| CAT. NO.  | PAGE NO. |
|-----------|----------|
| ML3-P     | .N29     |
| ML3-PB    | .N29     |
| ML3-PER   | .N29     |
| MNE04     | .C11     |
| MNF07     | .C11     |
| MNF10     | .C11     |
| MNI06     | .C11     |
| MNI10     | .C11     |
| MNI15     | .C11     |
| MNK0R     | .C11     |
| MNKIT     | .C11     |
| MNM06     | .C11     |
| MNM10     | .C11     |
| MNM15     | .C11     |
| MNS20-1L  | .C12     |
| MNS20-D3  | .C12     |
| MNS20-D4  | .C12     |
| MNX10     | .C11     |
| MNX15     | .C11     |
| MNX20     | .C11     |
| MNX30     | .C11     |
| MN00C-1LW | .C25     |
| MN00R-DOW | .C11     |
| MNOLA     | .C11     |
| MNOSA     | .C11     |
| MSE0R-10  | .C23     |
| MS00R-10  | .C23     |
| MS2-P     | .N29     |
| MS2-AP    | .N29     |
| MS302     | .F7      |
| MS302-S   | .F7      |
| MS303     | .F7      |
| MS303-S   | .F7      |
| MS402     | .F7      |
| MS403     | .F7      |
| MS602-BW  | .F7      |
| MS602-FW  | .F7      |
| MS603-BW  | .F7      |
| MS603-FW  | .F7      |
| MV121     | .R18     |
| MV122     | .R18     |
| MV123     | .R18     |
| MV241     | .R18     |
| MV242     | .R18     |
| NE100-00C | .C4, D18 |
| NE200-00E | .D18     |
| NE210     | .C4      |
| NE505     | .C4      |
| NE515     | .C4      |
| NE600     | .C4      |
| N13NC     | .F7, E34 |
| N138      | .E27     |
| N751      | .E29     |
| N1302     | .F7      |
| N1303     | .F7      |
| N3302     | .F7      |
| N3303     | .F7      |
| N3602     | .F7      |

| CAT. NO.  | PAGE NO.       |
|-----------|----------------|
| N3603     | .F7            |
| ODCCG     | .D9            |
| ODCCG-000 | .D10, D11, D12 |
| ODCOP     | .D18           |
| ODCOS-I1W | .D9            |
| ODCOS-I2W | .D9            |
| ODCOS-I7W | .D9            |
| ODSIOD-ID | .D4            |
| ODSOD-TD  | .D4            |
| ODS10-ID  | .D3            |
| ODS15-ID  | .D3            |
| OPB15-ODW | .D8            |
| OSA20-R00 | .D15           |
| OSCO4-IOW | .D12, D17      |
| OSCO5-M0W | .D10, D17      |
| OSCO5-U0W | .D11, D17      |
| OSC10-M0W | .D10, D17      |
| OSC10-U0W | .D11, D17      |
| OSC15-I0W | .D12, D17      |
| OSC20-M0W | .D10, D17      |
| OSC20-U0W | .D11           |
| OSFHU-ITW | .D7            |
| OSFOA-00W | .D7            |
| OSP15-R30 | .D15           |
| OSP20-0D0 | .D15           |
| OSP20-RD0 | .D15           |
| OSPNA-000 | .D15           |
| OSSMT-MD  | .D4            |
| OSSNL-ID  | .D3            |
| OSS10-ID  | .D3            |
| OSW12-M0W | .D13, D17      |
| OSWHB-I0W | .D14           |
| OSWWW-I0W | .D14, D17      |
| OSWLR-I0W | .D14, D17      |
| P22       | .E15           |
| P32       | .E15           |
| P38       | .E24           |
| P48       | .E24           |
| P326      | .E25           |
| P1020-12S | .R17           |
| P1021-12S | .R17           |
| P1022-12L | .R17           |
| P1023-12L | .R17           |
| P1024-12L | .R17           |
| P1025-12L | .R17           |
| P1040-10S | .R17           |
| P1041-10S | .R17           |
| P1042-10L | .R17           |
| P1043-10S | .R17           |
| P1044-10L | .R17           |
| P1045-10L | .R17           |
| P1046-10L | .R17           |
| P1047-10L | .R17           |
| P1426     | .E28           |
| P2262     | .E25           |
| PB101-SGF | .H7            |
| PB103-SGF | .H7            |
| PCC55     | .J33           |

| CAT. NO.  | PAGE NO.  |
|-----------|-----------|
| PCC55-KIT | .J24      |
| PCI65     | .J33      |
| PCI80     | .J33      |
| PCORD     | .R18, R19 |
| PC60      | .Q22      |
| PC100     | .Q22      |
| PC320     | .Q22      |
| PC420     | .Q22      |
| PC520     | .Q22      |
| PC530     | .Q22      |
| PC3430    | .Q22      |
| PEAUX     | .C7       |
| PEAU7     | .C7       |
| PE100     | .C7       |
| PE200     | .C7       |
| PE300     | .C7       |
| PE400     | .C7       |
| PJ1       | .E7       |
| PJ2       | .E7       |
| PJ3       | .E7       |
| PJ4       | .E8       |
| PJ7       | .E12      |
| PJ8       | .E10, E29 |
| PJ11      | .E13      |
| PJ13      | .E16      |
| PJ18      | .E23      |
| PJ23      | .E16      |
| PJ26      | .B22, E4  |
| PJ82      | .E10, E29 |
| PJ126     | .E25      |
| PJ226     | .E25      |
| PJ262     | .B22, E4  |
| PJ263     | .B22, E4  |
| PJ264     | .E5       |
| PJ826     | .E27      |
| PLG1      | .Q22      |
| PR150-1L  | .D5       |
| PR180-1L  | .D5       |
| PSC1      | .E29      |
| PSC7      | .E29      |
| PSC8      | .E29      |
| PSC14     | .E29      |
| PSC26     | .E29      |
| PSE1      | .E29      |
| PSE7      | .E29      |
| PSE8      | .E29      |
| PSE14     | .E29      |
| PSE26     | .E29      |
| PS110-10  | .D16      |
| PS110-1F  | .D16      |
| PS200-10  | .D16      |
| PS200-1F  | .D16      |
| RA060     | .Q22      |
| RA100     | .Q22      |
| RA320     | .Q22      |
| RA343     | .Q22      |
| RA420     | .Q22      |
| RA520     | .Q22      |





## CATALOG NUMBER ALPHANUMERIC INDEX

**Important:** Dash-numbers, indicating different product colors or other variations, are listed on the same page as the basic catalog numbers shown below, unless otherwise indicated.

### THIS PAGE 5G34A-27CM-20

| CAT. NO. | PAGE NO.           | CAT. NO. | PAGE NO. | CAT. NO. | PAGE NO.  |
|----------|--------------------|----------|----------|----------|-----------|
| 5G34A    | .L37               | 15D22    | .P7      | 17D21    | .P14      |
| 5G34B    | .L37               | 15D23    | .P7      | 17D22    | .P14      |
| 5G460    | .L32               | 15D24    | .P7      | 17D23    | .P14      |
| 5G596    | .L26               | 15D25    | .P7      | 17D24    | .P14      |
| 5G597    | .L27               | 15P21-E  | .P7      | 17P21    | .P14, P17 |
| 5L000    | .J4, L42, L43, L44 | 15P22-E  | .P7      | 17P22    | .P17      |
| 5P030    | .L41               | 15SDF-S  | .P7      | 17R21    | .P14, P17 |
| 5P130    | .L41               | 15SDM    | .P7      | 17R22    | .P14      |
| 5P230    | .L41               | 15W33    | .M5      | 17R23    | .P14      |
| 5P330    | .L41               | 15W47    | .M5      | 17R24    | .P14      |
| 5R030    | .L41               | 15W48    | .M5      | 17SDM    | .P14      |
| 5R1UA    | .L45               | 15W49    | .M5      | 17V22    | .P14      |
| 5R1UE    | .L45               | 16A21    | .P10     | 17V23    | .P14      |
| 5R100    | .L42, L50          | 16A22    | .P10     | 17V26-E  | .P14      |
| 5R130    | .L41, L42          | 16A23    | .P10     | 18A22    | .P13      |
| 5R2UA    | .L45               | 16A24    | .P10     | 18A25    | .P13      |
| 5R230    | .L41, L42          | 16A25    | .P10     | 18D21    | .P11      |
| 5R3UA    | .L45               | 16A26    | .P10     | 18D22    | .P11      |
| 5R330    | .L41               | 16CLF    | .P18     | 18D23    | .P12      |
| 5R430    | .L42               | 16CLM    | .P18     | 18D24    | .P12      |
| 5R440    | .L42               | 16D21    | .P8      | 18D25    | .P11      |
| 5R460    | .L42               | 16D22    | .P8      | 18D25-C  | .P11      |
| 5R730    | .L43               | 16D23    | .P9      | 18D29    | .P11      |
| 5R740    | .L43               | 16D24    | .P9      | 18D31    | .P11      |
| 5R760    | .L43               | 16D24-C  | .P9      | 18D33    | .P12      |
| 5R930    | .L43               | 16D25    | .P8      | 18D34    | .P11      |
| 5R940    | .L43               | 16D26    | .P8      | 18D37    | .P12      |
| 5R960    | .L43               | 16D27    | .P8      | 18F21    | .P13      |
| 5S100    | .L42, L43          | 16D28    | .P9      | 18P21    | .P12      |
| 5S180    | .L3                | 16D31    | .P8      | 18P22    | .P12      |
| 5T000    | .L42, L43, L50     | 16D31-C  | .P8      | 18R21    | .P13      |
| 6D460    | .L32               | 16D32    | .P9      | 18R22    | .P13      |
| 6S460    | .L32               | 16D33    | .P9      | 18R23    | .P13      |
| 6S180    | .L3                | 16D33-C  | .P9      | 18R24    | .P13      |
| 5W110    | .L44               | 16D34    | .P8      | 19D21    | .P15      |
| 5W120    | .L44               | 16D35    | .P8      | 19D22    | .P15      |
| 5W170    | .L44               | 16D36    | .P8      | 19D23    | .P15      |
| 5W310    | .L44               | 16D37    | .P9      | 19D24    | .P15      |
| 5W320    | .L44               | 16D37-C  | .P9      | 19P21    | .P15      |
| 5W370    | .L44               | 16F21    | .P10     | 19R21    | .P15      |
| 5W710    | .L44               | 16F22    | .P10     | 19R22    | .P15      |
| 5W720    | .L44               | 16P21    | .P9      | 19R24    | .P15      |
| 5W770    | .L44               | 16P22    | .P9      | 19V23    | .P15      |
| 6        | .S4                | 16R21    | .P10     | 20FC-CL  | .P3       |
| 14W      | .N17               | 16R22    | .P10     | 20FC-E   | .P3       |
| 14W33    | .M5                | 16R23    | .P10     | 20FP-CL  | .P3       |
| 14W34    | .M5                | 16R24    | .P10     | 20FP-E   | .P3       |
| 14W47    | .M5                | 16RSW    | .P10     | 20IS-E   | .P3       |
| 14W48    | .M5                | 16SDF-14 | .P9      | 20MC-CL  | .P3       |
| 14W49    | .M5                | 16SDF-22 | .P8, P9  | 20MC-E   | .P3       |
| 15A21    | .P7                | 16SDM-14 | .P9      | 20MP-CL  | .P3       |
| 15A22    | .P7                | 16SDM-22 | .P8      | 20MP-E   | .P3       |
| 15A23    | .P7                | 16V22    | .P8      | 20RS-E   | .P3       |
| 15CLF    | .P18               | 16V24    | .P9      | 22L21    | .P16      |
| 15CLM    | .P18               | 16V26    | .P8      | 22L21-C  | .P16      |
| 15D21    | .P7                | 16V28    | .P9      | 22L22    | .P16      |
| 15D22-SC | .P7                | 17CLF    | .P18     | 22L22-C  | .P16      |
|          |                    | 17CLM    | .P18     | 22L22-S  | .P16      |
|          |                    |          |          | 22L23    | .P16      |
|          |                    |          |          | 22L24    | .P16      |
|          |                    |          |          | 22L25    | .P16      |
|          |                    |          |          | 22L25-C  | .P16      |
|          |                    |          |          | 22L25-S  | .P16      |
|          |                    |          |          | 22L26    | .P16      |
|          |                    |          |          | 22R21    | .P16      |
|          |                    |          |          | 22R22    | .P16      |
|          |                    |          |          | 22R23    | .P16      |
|          |                    |          |          | 22R24    | .P16      |
|          |                    |          |          | 22R26    | .P16      |
|          |                    |          |          | 22R28    | .P16      |
|          |                    |          |          | 22SVF    | .P16      |
|          |                    |          |          | 22SVM    | .P16      |
|          |                    |          |          | 23CM-10  | .N21      |
|          |                    |          |          | 23CM-11  | .N21      |
|          |                    |          |          | 23CM-13  | .N21      |
|          |                    |          |          | 23CM-20  | .N21      |
|          |                    |          |          | 23CM-30  | .N21      |
|          |                    |          |          | 23L22    | .P17      |
|          |                    |          |          | 23L23    | .P17      |
|          |                    |          |          | 23L25    | .P17      |
|          |                    |          |          | 23L26    | .P17      |
|          |                    |          |          | 23R21    | .P17      |
|          |                    |          |          | 23R22    | .P17      |
|          |                    |          |          | 23R23    | .P17      |
|          |                    |          |          | 23R24    | .P17      |
|          |                    |          |          | 24CM-10  | .N21      |
|          |                    |          |          | 24CM-20  | .N21      |
|          |                    |          |          | 24CM-30  | .N21      |
|          |                    |          |          | 24W34    | .N17      |
|          |                    |          |          | 24W47    | .N17      |
|          |                    |          |          | 24W49    | .N17      |
|          |                    |          |          | 25W34    | .N17      |
|          |                    |          |          | 25W47    | .N17      |
|          |                    |          |          | 25W49    | .N17      |
|          |                    |          |          | 26W      | .N17, N18 |
|          |                    |          |          | 26CM-10  | .N22      |
|          |                    |          |          | 26CM-11  | .N22      |
|          |                    |          |          | 26CM-13  | .N22      |
|          |                    |          |          | 26CM-20  | .N22      |
|          |                    |          |          | 26CM-21  | .N22      |
|          |                    |          |          | 26CM-23  | .N22      |
|          |                    |          |          | 26W08    | .N18      |
|          |                    |          |          | 26W09    | .N18      |
|          |                    |          |          | 26W47    | .N17      |
|          |                    |          |          | 26W47-B  | .N17      |
|          |                    |          |          | 26W48    | .N17      |
|          |                    |          |          | 26W49    | .N17      |
|          |                    |          |          | 26W74    | .N18      |
|          |                    |          |          | 26W75    | .N18      |
|          |                    |          |          | 26W76    | .N18      |
|          |                    |          |          | 26W81    | .N18      |
|          |                    |          |          | 26W81-B  | .N18      |
|          |                    |          |          | 26W82    | .N18      |
|          |                    |          |          | 26W83    | .N18      |
|          |                    |          |          | 27CM-10  | .N22      |
|          |                    |          |          | 27CM-20  | .N22      |

# CATALOG NUMBER ALPHANUMERIC INDEX

**Important:** Dash-numbers, indicating different product colors or other variations, are listed on the same page as the basic catalog numbers shown below, unless otherwise indicated.

| THIS PAGE 26W08-430MI12W |           | CAT. NO. | PAGE NO. | CAT. NO. | PAGE NO. | CAT. NO. | PAGE NO. |
|--------------------------|-----------|----------|----------|----------|----------|----------|----------|
| CAT. NO.                 | PAGE NO.  | 41880    | .L38     | 306      | .G17     | 389W     | .S14     |
| 27W08                    | .N18      | 45CM-60  | .N20     | 321      | .M5      | 390-1W   | .S13     |
| 27W09                    | .N18      | 45CM-70C | .N20     | 320B     | .07      | 391-1W   | .S13     |
| 27W47                    | .N17      | 45CM-79C | .N20     | 320C     | .06      | 395-W    | .S14     |
| 27W47-B                  | .N17      | 47CM-10  | .N20     | 320C4W   | .04      | 396      | .S13     |
| 27W48                    | .N17      | 47CM-20C | .N20     | 320C6W   | .04      | 403      | .E36     |
| 27W49                    | .N17      | 47CM-29C | .N20     | 320C7W   | .04      | 404      | .E36     |
| 27W74                    | .N18      | 47CM-60  | .N20     | 320MI6W  | .012     | 405      | .E36     |
| 27W75                    | .N18      | 50W50    | .N17     | 320MI7W  | .012     | 406      | .E36     |
| 27W76                    | .N18      | 50W52    | .N17-N18 | 320P     | .06      | 41LBL    | .L60     |
| 27W81                    | .N18      | 50W54    | .N19     | 320P4W   | .04      | 420B     | .07      |
| 27W81-B                  | .N18      | 52CM-62  | .N20     | 320P6W   | .04, 012 | 420B5W   | .04      |
| 27W82                    | .N18      | 52CM-66C | .N20     | 320P7W   | .04, 012 | 420B7W   | .04      |
| 27W83                    | .N18      | 52CM-69C | .N20     | 320R     | .07      | 420B9W   | .04      |
| 28W                      | .N19      | 53CM-62  | .N21     | 320R4W   | .04      | 420B12W  | .04      |
| 28W08                    | .N19      | 53CM-66C | .N21     | 320R6W   | .04      | 420C     | .06      |
| 28W09                    | .N19      | 53CM-69C | .N21     | 320R7W   | .04      | 420C5W   | .04      |
| 28W47                    | .N19      | 55       | .S12     | 330B     | .07      | 420C7W   | .04      |
| 28W47-B                  | .N19      | 60FP-E   | .P3      | 330B4W   | .04      | 420C9W   | .04      |
| 28W48                    | .N19      | 60IB-E   | .P3      | 330B6W   | .04      | 420C12W  | .04      |
| 28W49                    | .N19      | 60IS-E   | .P3      | 330B7W   | .04      | 420MF5W  | .012     |
| 28W74                    | .N19      | 60MP-E   | .P3      | 330C     | .06      | 420MF7W  | .012     |
| 28W75                    | .N19      | 60RB-E   | .P3      | 330C4W   | .04      | 420MF9W  | .012     |
| 28W76                    | .N19      | 60RS-E   | .P3      | 330C6W   | .04      | 420MF12W | .012     |
| 28W77                    | .N19      | 61       | .U2      | 330C7W   | .04      | 420MI5W  | .012     |
| 28W81                    | .N19      | 61C05    | .L3      | 330MI6W  | .012     | 420MI7W  | .012     |
| 28W82                    | .N19      | 63       | .U2      | 330MI7W  | .012     | 420MI9W  | .012     |
| 28W83                    | .N19      | 65       | .U2      | 330P     | .06      | 420MI12W | .012     |
| 29W08                    | .N19      | 69       | .U2      | 330P4W   | .04      | 420P     | .06      |
| 29W09                    | .N19      | 100FP-E  | .P3      | 330P6W   | .04, 012 | 420P5W   | .04, 012 |
| 29W47                    | .N19      | 100IB-E  | .P3      | 330P7W   | .04, 012 | 420P7W   | .04, 012 |
| 29W47-B                  | .N19      | 100MP-E  | .P3      | 330R     | .07      | 420P9W   | .04, 012 |
| 29W48                    | .N19      | 100RB-E  | .P3      | 330R4W   | .04      | 420P12W  | .04, 012 |
| 29W49                    | .N19      | 101      | .M15     | 330R6W   | .04      | 420R     | .07      |
| 29W74                    | .N19      | 102      | .M15     | 330R7W   | .04      | 420R5W   | .04      |
| 29W75                    | .N19      | 113      | .M16     | 341-D4U  | .S6      | 420R7W   | .04      |
| 29W76                    | .N19      | 114      | .M16     | 357-8    | .S6      | 420R9W   | .04      |
| 29W77                    | .N19      | 115PR    | .M15     | 360B     | .07      | 420R12W  | .04      |
| 29W81                    | .N19      | 115PV    | .M15     | 360B4W   | .05      | 420-W    | .S14     |
| 29W82                    | .N19      | 123      | .M15     | 360B6W   | .05      | 423-3    | .T5      |
| 29W83                    | .N19      | 124-D    | .S12     | 360B7W   | .05      | 430B     | .07      |
| 41AB2                    | .L35      | 125      | .U2      | 360C     | .06      | 430B5W   | .04      |
| 41AB6                    | .L33      | 128      | .U2      | 360C4W   | .05      | 430B7W   | .04      |
| 41AW1                    | .L35      | 157      | .S12     | 360C6W   | .05      | 430B9W   | .04      |
| 41AW2                    | .L35      | 157-X    | .S12     | 360C7W   | .05      | 430B12W  | .04      |
| 41A10                    | .L35      | 167      | .S12     | 360MF6W  | .013     | 430C     | .06      |
| 41CMS                    | .L38, L57 | 177BI    | .C25     | 360MI6W  | .013     | 430C5W   | .04      |
| 41DW1                    | .L35      | 177IR    | .C25     | 360MI7W  | .013     | 430C7W   | .04      |
| 41DW2                    | .L35      | 177RC    | .C25     | 360P4W   | .05      | 430C9W   | .04      |
| 41D10                    | .L35      | 223      | .G17     | 360P6W   | .05, 013 | 430C12W  | .04      |
| 410L2                    | .L35      | 267      | .S12     | 360P7W   | .05, 013 | 430MF5W  | .012     |
| 41DR2                    | .L36, L38 | 274      | .U2      | 360R     | .07      | 430MF7W  | .012     |
| 41D1R                    | .L34      | 275-T    | .M14     | 360R4W   | .05      | 430MF9W  | .012     |
| 41DBR                    | .L36      | 278      | .G8, M8  | 360R6W   | .05      | 430MF12W | .012     |
| 41DR6                    | .L35      | 278-PM   | .G8      | 360R7W   | .05      | 430MI5W  | .012     |
| 41MB2                    | .L38      | 279      | .G10, M9 | 368-1    | .S6      | 430MI7W  | .012     |
| 41NB2                    | .L35      | 279-PM   | .G10     | 380      | .S13     | 430MI9W  | .012     |
| 41NB6                    | .L33      | 287-T    | .M14     | 388      | .T4      | 430MI12W | .012     |

## CATALOG NUMBER ALPHANUMERIC INDEX

**Important:** Dash-numbers, indicating different product colors or other variations, are listed on the same page as the basic catalog numbers shown below, unless otherwise indicated.

### THIS PAGE 430P-1281

| CAT. NO. | PAGE NO.  | CAT. NO. | PAGE NO. | CAT. NO. | PAGE NO.  |
|----------|-----------|----------|----------|----------|-----------|
| 430P     | .06       | 520B     | .07      | 560MI5W  | .012, 013 |
| 430P5W   | .04, 012  | 520B5W   | .04      | 560MI7W  | .012, 013 |
| 430P7W   | .04, 012  | 520B7W   | .04      | 560MI9W  | .013      |
| 430P9W   | .04, 012  | 520B9W   | .04      | 560P     | .06       |
| 430P12W  | .04, 012  | 520C     | .06      | 560P5W   | .05, 013  |
| 430R     | .07       | 520C5W   | .04      | 560P7W   | .05, 013  |
| 430R5W   | .04       | 520C7W   | .04      | 560P9W   | .05, 013  |
| 430R7W   | .04       | 520C9W   | .04      | 560R     | .07       |
| 430R9W   | .04       | 520CA    | .M13     | 560R5W   | .05       |
| 430R12W  | .04       | 520CV    | .M13     | 560R7W   | .05       |
| 431W     | .S13      | 520MI5W  | .012     | 560R9W   | .05       |
| 432C3WL  | .019      | 520MI7W  | .012     | 565      | .S10      |
| 432P3WL  | .016, 018 | 520MI9W  | .012     | 570      | .S10      |
| 452      | .S13      | 520P     | .06      | 573      | .T3       |
| 453      | .S13      | 520P5W   | .04, 012 | 585      | .T3       |
| 460B     | .07       | 520P7W   | .04, 012 | 612      | .M15      |
| 460B5W   | .05       | 520P9W   | .04, 012 | 615CA    | .M12      |
| 460B7W   | .05       | 520PA    | .M13     | 615PA    | .M12      |
| 460B9W   | .05       | 520PV    | .M13     | 615PV    | .M12      |
| 460B12W  | .05       | 520R     | .07      | 617      | .M16      |
| 460C     | .06       | 520R5W   | .04      | 620CA    | .M13      |
| 460C5W   | .05       | 520R7W   | .04      | 620CV    | .M13      |
| 460C7W   | .05       | 520R9W   | .04      | 620PA    | .M13      |
| 460C9W   | .05       | 523      | .S14     | 620PR    | .M13      |
| 460C12W  | .05       | 524      | .S14     | 620PV    | .M13      |
| 460MF5W  | .013      | 530B     | .07      | 638      | .M15      |
| 460MF7W  | .013      | 530B5W   | .04      | 663      | .T3       |
| 460MF9W  | .013      | 530B7W   | .04      | 688      | .G17, J35 |
| 460MF12W | .013      | 530B9W   | .04      | 689      | .B26, J35 |
| 460MI5W  | .013      | 530C     | .06      | 690      | .B26, J35 |
| 460MI7W  | .013      | 530C5W   | .04      | 692      | .U2       |
| 460MI9W  | .013      | 530C7W   | .04      | 694      | .U2       |
| 460MI12W | .013      | 530C9W   | .04      | 697      | .U2       |
| 460P     | .06       | 530MF5W  | .012     | 698      | .U2       |
| 460P5W   | .05, 013  | 530MF7W  | .012     | 699      | .U2       |
| 460P7W   | .05, 013  | 530MI5W  | .012     | 720-L5   | .T4       |
| 460P9W   | .05, 013  | 530MI7W  | .012     | 735      | .T4       |
| 460P12W  | .05, 013  | 530MI9W  | .012     | 738      | .T4       |
| 460R     | .07       | 530P     | .06      | 830-T    | .G6, M14  |
| 460R5W   | .05       | 530P5W   | .04, 012 | 905      | .S6       |
| 460R7W   | .05       | 530P7W   | .04, 012 | 911      | .B8, C34  |
| 460R9W   | .05       | 530P9W   | .04, 012 | 930      | .M14      |
| 460R12W  | .05       | 530R     | .07      | 931      | .M14      |
| 466      | .S13      | 530R5W   | .04      | 1101-2   | .F6       |
| 467      | .S13      | 530R7W   | .04      | 1101-2L  | .F6       |
| 491RU    | .L53      | 530R9W   | .04      | 1101-C   | .F12      |
| 492RU    | .L53      | 531      | .U2      | 1102-2   | .F6       |
| 510-R    | .N23      | 554      | .S10     | 1102-2L  | .F6       |
| 515AN    | .M12      | 560      | .S10     | 1102-C   | .F12      |
| 515CA    | .M12      | 560B     | .07      | 1103-2   | .F6       |
| 515CR    | .M12      | 560B5W   | .05      | 1103-2L  | .F6       |
| 515CV    | .M12      | 560B7W   | .05      | 1103-C   | .F12      |
| 515PA    | .M12      | 560B9W   | .05      | 1104-2   | .F6       |
| 515PR    | .M12      | 560C     | .06      | 1104-2L  | .F6       |
| 515PV    | .M12      | 560C5W   | .05      | 1104-C   | .F12      |
| 516      | .S14      | 560C7W   | .05      | 1121-2   | .F6       |
| 517      | .S14      | 560C9W   | .05      | 1121-2L  | .F6       |
|          |           | 560MF9W  | .013     | 1122-2   | .F6       |
|          |           |          |          | 1122-2L  | .F6       |
|          |           |          |          | 1123-2   | .F6       |
|          |           |          |          | 1123-2L  | .F6       |
|          |           |          |          | 1124-2   | .F6       |
|          |           |          |          | 1124-2L  | .F6       |
|          |           |          |          | 1201-2   | .F3       |
|          |           |          |          | 1201-2L  | .F3       |
|          |           |          |          | 1201-LH  | .F4       |
|          |           |          |          | 1201-PL  | .F4       |
|          |           |          |          | 1202-2   | .F3       |
|          |           |          |          | 1202-2L  | .F3       |
|          |           |          |          | 1202-PL  | .F4       |
|          |           |          |          | 1203-2   | .F3       |
|          |           |          |          | 1203-2L  | .F3       |
|          |           |          |          | 1203-LH  | .F4       |
|          |           |          |          | 1203-PL  | .F4       |
|          |           |          |          | 1204-2   | .F3       |
|          |           |          |          | 1204-2L  | .F3       |
|          |           |          |          | 1221-2   | .F3       |
|          |           |          |          | 1221-2L  | .F3       |
|          |           |          |          | 1221-2KL | .F10      |
|          |           |          |          | 1221-7P  | .F4       |
|          |           |          |          | 1221-LH  | .F4       |
|          |           |          |          | 1221-PL  | .F4       |
|          |           |          |          | 1221-S   | .F3       |
|          |           |          |          | 1222-2   | .F3       |
|          |           |          |          | 1222-2L  | .F3       |
|          |           |          |          | 1222 2KL | .F10      |
|          |           |          |          | 1222-7P  | .F4       |
|          |           |          |          | 1222-S   | .F3       |
|          |           |          |          | 1221-7L  | .F4       |
|          |           |          |          | 1222-PL  | .F4       |
|          |           |          |          | 1223-2   | .F3       |
|          |           |          |          | 1223-2L  | .F3       |
|          |           |          |          | 1223-2KL | .F10      |
|          |           |          |          | 1223-7L  | .F4       |
|          |           |          |          | 1223-7P  | .F4       |
|          |           |          |          | 1223-LH  | .F4       |
|          |           |          |          | 1223-PL  | .F4       |
|          |           |          |          | 1223-S   | .F3       |
|          |           |          |          | 1224-2   | .F3       |
|          |           |          |          | 1224-2L  | .F3       |
|          |           |          |          | 1224-2KL | .F10      |
|          |           |          |          | 1224-S   | .F3       |
|          |           |          |          | 1228     | .G16      |
|          |           |          |          | 1241     | .F3       |
|          |           |          |          | 1242     | .F3       |
|          |           |          |          | 1243     | .F3       |
|          |           |          |          | 1244     | .F3       |
|          |           |          |          | 1254     | .G5       |
|          |           |          |          | 1254-H   | .G5       |
|          |           |          |          | 1254-IG  | .G5       |
|          |           |          |          | 1256     | .F5       |
|          |           |          |          | 1257     | .F5       |
|          |           |          |          | 1257-L   | .F5       |
|          |           |          |          | 1260     | .F5       |
|          |           |          |          | 1262     | .F5       |
|          |           |          |          | 1281     | .F5       |

# CATALOG NUMBER ALPHANUMERIC INDEX

**Important:** Dash-numbers, indicating different product colors or other variations, are listed on the same page as the basic catalog numbers shown below, unless otherwise indicated.

**THIS PAGE 1281-L-2695**

| THIS PAGE 1281-L-2695 |          | CAT. NO. | PAGE NO. | CAT. NO. | PAGE NO. | CAT. NO. | PAGE NO. |
|-----------------------|----------|----------|----------|----------|----------|----------|----------|
| CAT. NO.              | PAGE NO. | 2311-PLB | .N7      | 2413     | .N9      | 2611-CY  | .N12     |
| 1281-L                | .F5      | 2311-PLC | .N7      | 2415     | .N9      | 2611-PLB | .N12     |
| 1282                  | .F5      | 2313     | .N7      | 2416     | .N9      | 2611-PLC | .N12     |
| 1285                  | .F5      | 2313-B   | .N7      | 2420     | .N9      | 2613     | .N12     |
| 1285-L                | .F5      | 2313-CY  | .N7      | 2420-IG  | .N9      | 2613-B   | .N12     |
| 1286                  | .F5      | 2313-PLB | .N7      | 2421     | .N9      | 2613-CY  | .N12     |
| 1287                  | .F5      | 2313-PLC | .N7      | 2423     | .N9      | 2613-PLB | .N12     |
| 1287-L                | .F5      | 2315     | .N7      | 2425     | .N9      | 2613-PLC | .N12     |
| 1288                  | .F5      | 2316     | .N7      | 2426     | .N9      | 2615     | .N12     |
| 1288-L                | .F5      | 2320     | .N7      | 2430     | .N10     | 2616     | .N12     |
| 1306                  | .G17     | 2320-IG  | .N7      | 2430-IG  | .N10     | 2620     | .N12     |
| 1373                  | .G17     | 2321     | .N7      | 2431     | .N10     | 2620-IG  | .N12     |
| 1374                  | .G17     | 2321-PLB | .N7      | 2433     | .N10     | 2621     | .N12     |
| 1403                  | .U2      | 2321-PLC | .N7      | 2435     | .N10     | 2621-B   | .N12     |
| 1406                  | .U2      | 2321-CY  | .N7      | 2436     | .N10     | 2621-CY  | .N12     |
| 1420                  | .C35     | 2323     | .N7      | 2440     | .N10     | 2621-PLC | .N12     |
| 1432                  | .E34     | 2323-CY  | .N7      | 2441     | .N10     | 2625F    | .N12     |
| 1433                  | .M5      | 2323-PLC | .N7      | 2443     | .N10     | 2623-PLC | .N12     |
| 1447                  | .M5      | 2325     | .N7      | 2445     | .N10     | 2626F    | .N12     |
| 1448                  | .M5      | 2326     | .N7      | 2446     | .N10     | 2630     | .N12     |
| 1449                  | .M5      | 2330     | .N7      | 2447     | .N5      | 2630-IG  | .N12     |
| 1451                  | .F14     | 2330-IG  | .N7      | 2450     | .N10     | 2631     | .N12     |
| 1451-2                | .F14     | 2331     | .N7      | 2451     | .N10     | 2631-PLC | .N12     |
| 1451-4                | .F14     | 2331-PLC | .N7      | 2453     | .N10     | 2633     | .N12     |
| 1453                  | .F14     | 2333     | .N7      | 2455     | .N10     | 2633-PLC | .N12     |
| 1453-2                | .F14     | 2333-PLC | .N7      | 2456     | .N10     | 2635     | .N12     |
| 1453-4                | .F14     | 2335     | .N7      | 2460     | .N10     | 2636     | .N12     |
| 1461-XXX              | .F14     | 2336     | .N7      | 2461     | .N10     | 2640     | .N13     |
| 1463-XXX              | .F14     | 2340     | .N8      | 2463     | .N10     | 2640-IG  | .N13     |
| 1469                  | .U2      | 2340-IG  | .N8      | 2465     | .N10     | 2641     | .N13     |
| 1533                  | .M5      | 2341     | .N8      | 2466     | .N10     | 2643     | .N13     |
| 1547                  | .M5      | 2343     | .N8      | 2510     | .N11     | 2645     | .N13     |
| 1548                  | .M5      | 2345     | .N8      | 2510-IG  | .N11     | 2646     | .N13     |
| 1549                  | .M5      | 2346     | .N8      | 2511     | .N11     | 2650     | .N13     |
| 1689-50               | .T2      | 2350     | .N8      | 2513     | .N11     | 2650-IG  | .N13     |
| 1689-75               | .T2      | 2350-IG  | .N8      | 2515     | .N11     | 2651-2   | .F14     |
| 1691-50               | .T2      | 2351     | .N8      | 2516     | .N11     | 2653-2   | .F14     |
| 1720-T                | .T4      | 2353     | .N8      | 2520     | .N11     | 2655     | .N13     |
| 1738                  | .T4      | 2355     | .N8      | 2520-IG  | .N11     | 2656     | .N13     |
| 1754                  | .B17, I4 | 2356     | .N8      | 2521     | .N11     | 2660     | .N13     |
| 1754-IL               | .B17, I4 | 2360     | .N8      | 2523     | .N11     | 2661     | .N13     |
| 1754-2                | .B17, I4 | 2361     | .N8      | 2525     | .N11     | 2663     | .N13     |
| 1755                  | .B17, I4 | 2363     | .N8      | 2526     | .N11     | 2665     | .N13     |
| 1755-2                | .B17, I4 | 2365     | .N8      | 2530     | .N11     | 2666     | .N13     |
| 1759                  | .B17, I4 | 2366     | .N8      | 2530-IG  | .N11     | 2670     | .N13     |
| 1865                  | .T3      | 2370     | .N8      | 2531     | .N11     | 2671     | .N13     |
| 1901                  | .E7      | 2371     | .N8      | 2533     | .N11     | 2673     | .N13     |
| 1903                  | .E10     | 2373     | .N8      | 2536     | .S13     | 2675     | .N13     |
| 1909                  | .E7      | 2375     | .N8      | 2537     | .S13     | 2676     | .N13     |
| 2004                  | .S8      | 2376     | .N8      | 2545     | .N11     | 2680     | .N14     |
| 2005                  | .S8      | 2380     | .N8      | 2546     | .N11     | 2681     | .N14     |
| 2006                  | .S8      | 2381     | .N8      | 2547     | .N5      | 2683     | .N14     |
| 2152                  | .E36     | 2383     | .N8      | 2591     | .T3      | 2685     | .N14     |
| 2310                  | .N7      | 2385     | .N8      | 2592     | .T3      | 2686     | .N14     |
| 2310-IG               | .N7      | 2386     | .N8      | 2610     | .N12     | 2690     | .N14     |
| 2311                  | .N7      | 2410     | .N9      | 2610-IG  | .N12     | 2691     | .N14     |
| 2311-B                | .N7      | 2410-IG  | .N9      | 2611     | .N12     | 2693     | .N14     |
| 2311-CY               | .N7      | 2411     | .N9      | 2611-B   | .N12     | 2695     | .N14     |

# CATALOG NUMBER ALPHANUMERIC INDEX

**Important:** Dash-numbers, indicating different product colors or other variations, are listed on the same page as the basic catalog numbers shown below, unless otherwise indicated.

**THIS PAGE 2696-4710**

| CAT. NO. | PAGE NO. | CAT. NO. | PAGE NO.  | CAT. NO.    | PAGE NO.  |
|----------|----------|----------|-----------|-------------|-----------|
| 2696     | .N14     | 2833     | .N16      | 3500-PC     | .R21      |
| 2710     | .N14     | 2835     | .N16      | 3500-PT     | .R21      |
| 2710-IG  | .N14     | 2836     | .N16      | 3520        | .N24      |
| 2711     | .N14     | 3031-2   | .F3       | 3521-C      | .N24      |
| 2711-CY  | .N14     | 3031-2L  | .F3       | 3523-C      | .N24      |
| 2713     | .N14     | 3031-LH  | .F4       | 3524-C      | .N24      |
| 2713-CY  | .N14     | 3031-PL  | .F4       | 3525-C      | .N24      |
| 2715     | .N14     | 3032-2   | .F3       | 3720        | .N8       |
| 2716     | .N14     | 3032-2L  | .F3       | 3721        | .N8       |
| 2720     | .N14     | 3033-2   | .F3       | 3723        | .N8       |
| 2720-IG  | .N14     | 3033-2L  | .F3       | 3755        | .N8, N25  |
| 2721     | .N14     | 3032-PL  | .F4       | 3756        | .N8       |
| 2723     | .N14     | 3100B    | .07       | 3762-C      | .N25      |
| 2725     | .N14     | 3100B4W  | .05       | 3763-C      | .N25      |
| 2726     | .N14     | 3100B6W  | .05       | 3764-C      | .N25      |
| 2730     | .N15     | 3100B7W  | .05       | 3765-C      | .N25      |
| 2730-IG  | .N15     | 3100C    | .06       | 3769        | .N25      |
| 2731     | .N15     | 3100C4W  | .05       | 3771        | .N25      |
| 2733     | .N15     | 3100C6W  | .05       | 3775        | .N25      |
| 2735     | .N15     | 3100C7W  | .05       | 3777        | .N25      |
| 2736     | .N15     | 3100MI4W | .013      | 3800-DIN    | .R12      |
| 2740     | .N15     | 3100MI6W | .013      | 3800-OEM    | .R12      |
| 2740-IG  | .N15     | 3100MI7W | .013      | 3800-OWM    | .R12      |
| 2741     | .N15     | 3100P    | .06       | 3801-DIN    | .R12      |
| 2743     | .N15     | 3100P4W  | .05, 013  | 3803-485    | .R11      |
| 2745     | .N15     | 3100P6W  | .05, 013  | 3803-CAN    | .R11      |
| 2746     | .N15     | 3100P7W  | .05, 013  | 3803-MOD    | .R11      |
| 2750     | .N15     | 3100R    | .07       | 3803-SPX    | .R11      |
| 2751     | .N15     | 3100R4W  | .05       | 3803-DHP    | .R11      |
| 2753     | .N15     | 3100R6W  | .05       | 3812-DIN    | .R12      |
| 2755     | .N15     | 3100R7W  | .05       | 3812-OEM    | .R12      |
| 2756     | .N15     | 3125B6W  | .016, 019 | 3812-OWM    | .R12      |
| 2760     | .N15     | 3125C6W  | .016      | 3824-DIN    | .R12      |
| 2761     | .N15     | 3125CW   | .019      | 3824-OEM    | .R12      |
| 2763     | .N15     | 3125P6W  | .016      | 3824-OWM    | .R12      |
| 2765     | .N15     | 3125P    | .018      | 3840-DIN    | .R12      |
| 2766     | .N15     | 3125R    | .019      | 3840-OEM    | .R12      |
| 2770     | .N16     | 3125R6W  | .016      | 3840-OWM    | .R12      |
| 2771     | .N16     | 3152-8   | .S9       | 3848-DIN    | .R12      |
| 2773     | .N16     | 3254     | .G5, R14  | 3848-OEM    | .R12      |
| 2775     | .N16     | 3325-C   | .N24      | 3848-OWM    | .R12      |
| 2776     | .N16     | 3326-C   | .N24      | 3860-GEF    | .R11      |
| 2810     | .N16     | 3330     | .N25      | 3861-ETH    | .R11      |
| 2810-IG  | .N16     | 3331-C   | .N25      | 3862-CON    | .R11      |
| 2811     | .N16     | 3333-C   | .N25      | 3863-DEV    | .R11      |
| 2813     | .N16     | 3334-C   | .N25      | 3880-DIN    | .R11, R12 |
| 2815     | .N16     | 3335-C   | .N25      | 3950-BKT    | .R22      |
| 2816     | .N16     | 3352-1   | .S10      | 4005        | .S10      |
| 2820     | .N16     | 3352-8   | .S10      | 4006        | .S10      |
| 2820-IG  | .N16     | 3352-F   | .S10      | 4010        | .S10      |
| 2821     | .N16     | 3420-009 | .R11      | 4015-D4F    | .S6       |
| 2823     | .N16     | 3420-035 | .R11      | 4017-D2F    | .S6       |
| 2825     | .N16     | 3430     | .N25      | 4020-A3A    | .S6       |
| 2826     | .N16     | 3431-C   | .N25      | 4032-E5F    | .S6       |
| 2830     | .N16     | 3433-C   | .N25      | 4034-F5A    | .S6       |
| 2830-IG  | .N16     | 3434-C   | .N25      | 4063        | .S10      |
| 2831     | .N16     | 3435-C   | .N25      | 4090-24W    | .J30      |
|          |          | 3500-P   | .R21      | 4100B       | .07       |
|          |          |          |           | 4100B5W     | .05       |
|          |          |          |           | 4100B7W     | .05       |
|          |          |          |           | 4100B9W     | .05       |
|          |          |          |           | 4100B12W    | .013      |
|          |          |          |           | 4100C       | .06       |
|          |          |          |           | 4100C5W     | .05       |
|          |          |          |           | 4100C7W     | .05       |
|          |          |          |           | 4100C9W     | .05       |
|          |          |          |           | 4100C12W    | .05       |
|          |          |          |           | 4100MI5W    | .013      |
|          |          |          |           | 4100MI7W    | .013      |
|          |          |          |           | 4100MI9W    | .013      |
|          |          |          |           | 4100MI12W   | .013      |
|          |          |          |           | 4100P       | .06       |
|          |          |          |           | 4100P5W     | .05, 013  |
|          |          |          |           | 4100P7W     | .05, 013  |
|          |          |          |           | 4100P9W     | .05, 013  |
|          |          |          |           | 4100P12W    | .05, 013  |
|          |          |          |           | 4100R       | .07       |
|          |          |          |           | 4100R5W     | .05       |
|          |          |          |           | 4100R7W     | .05       |
|          |          |          |           | 4100R9W     | .05       |
|          |          |          |           | 4100R12W    | .05       |
|          |          |          |           | 4108W       | .L11      |
|          |          |          |           | 4125B6W     | .016, 019 |
|          |          |          |           | 4125CW      | .019      |
|          |          |          |           | 4125C6W     | .016      |
|          |          |          |           | 4125P       | .018      |
|          |          |          |           | 4125P6W     | .016      |
|          |          |          |           | 4125R       | .019      |
|          |          |          |           | 4125R6W     | .016      |
|          |          |          |           | 4155        | .S11      |
|          |          |          |           | 4158        | .S11      |
|          |          |          |           | 4254        | .G5, R14  |
|          |          |          |           | 4505 Series | .R17      |
|          |          |          |           | 4550        | .N6       |
|          |          |          |           | 4550-IG     | .N6       |
|          |          |          |           | 4560        | .N6       |
|          |          |          |           | 4560-IG     | .N6       |
|          |          |          |           | 4570-C      | .N6       |
|          |          |          |           | 4570-CA     | .N6       |
|          |          |          |           | 4570-CY     | .N6       |
|          |          |          |           | 4570-IG     | .N6       |
|          |          |          |           | 4570-PLC    | .N6       |
|          |          |          |           | 4579-C      | .N6       |
|          |          |          |           | 4579-CY     | .N6       |
|          |          |          |           | 4579-PLC    | .N6       |
|          |          |          |           | 4585-C      | .N6       |
|          |          |          |           | 4585-CWP    | .N30      |
|          |          |          |           | 4586-C      | .N6       |
|          |          |          |           | 4586-CWP    | .N30      |
|          |          |          |           | 4625A       | .L22      |
|          |          |          |           | 4625B       | .L18      |
|          |          |          |           | 4700        | .N5       |
|          |          |          |           | 4700-IG     | .N5       |
|          |          |          |           | 4702-IIR    | .N5       |
|          |          |          |           | 4703-IIR    | .N5       |
|          |          |          |           | 4710        | .N5       |

# CATALOG NUMBER ALPHANUMERIC INDEX

**Important:** Dash-numbers, indicating different product colors or other variations, are listed on the same page as the basic catalog numbers shown below, unless otherwise indicated.

**THIS PAGE 4710-IG-5458-SS**

| CAT. NO. | PAGE NO. | CAT. NO. | PAGE NO.  | CAT. NO. | PAGE NO.  |
|----------|----------|----------|-----------|----------|-----------|
| 4710-IG  | .N5      | 4990     | .E34, H7  | 5226     | .I2       |
| 4710-SS  | .N5      | 4992     | .E34, H7  | 5239     | .M12      |
| 4715-C   | .N5      | 4996     | .E35, H7  | 5240     | .M12      |
| 4715-CWP | .N30     | 4998     | .E35, H7  | 5241     | .I2       |
| 4715-FWP | .N30     | 5000     | .G17      | 5242     | .G4       |
| 4716-C   | .N5      | 5015     | .G14      | 5243     | .I2       |
| 4716-CWP | .N30     | 5028     | .G14      | 5245     | .I2       |
| 4716-FWP | .N30     | 5029     | .G14      | 5246     | .I2       |
| 4720-C   | .N5      | 5031     | .G13      | 5248-4   | .G16      |
| 4720-CA  | .N5      | 5032     | .G15, M8  | 5248-CP  | .G16      |
| 4720-CB  | .N5      | 5032-I   | .M8       | 5249-CAP | .G14      |
| 4720-CY  | .N5      | 5040     | .G14      | 5249-FBA | .G14      |
| 4720-PLC | .N5      | 5042     | .G14      | 5250     | .G14      |
| 4729-C   | .N5      | 5050     | .G10      | 5251     | .G4       |
| 4729-CB  | .N5      | 5054     | .G7       | 5252     | .G4       |
| 4729-CY  | .N5      | 5059     | .G14      | 5256-VA  | .M6       |
| 4729-PLC | .N5      | 5088     | .G13      | 5256-VB  | .M6       |
| 4750     | .N6      | 5089     | .G13      | 5256-VG  | .M6       |
| 4760     | .N6      | 5098     | .G13      | 5256-VY  | .M6       |
| 4760-IG  | .N6      | 50W50    | .M5, N17  | 5258-SS  | .G14      |
| 4770-C   | .N6      | 5100     | .R3       | 5259-VB  | .M6       |
| 4770-CA  | .N6      | 5100B    | .O7       | 5259-VG  | .M6       |
| 4770-CY  | .N6      | 5100B5W  | .O5       | 5259-VY  | .M6       |
| 4770-PLC | .N6      | 5100B7W  | .O5       | 5261     | .G4       |
| 4779-C   | .N6      | 5100B9W  | .O5       | 5261-CH  | .G4, J35  |
| 4779-CY  | .N6      | 5100C    | .O6       | 5261-CR  | .N20      |
| 4779-PLC | .N6      | 5100C5W  | .O5       | 5262     | .G4       |
| 4785-C   | .N6      | 5100C7W  | .O5       | 5262-IG  | .G4       |
| 4786-C   | .N6      | 5100C9W  | .O5       | 5262-S   | .G4       |
| 4792     | .N30     | 5100-IPS | .R4       | 5266-C   | .M3       |
| 4794-1R  | .N30     | 5100IS2  | .R4       | 5266-CA  | .M3       |
| 4795-2R  | .N30     | 5100MI5W | .O13      | 5266-CB  | .M3       |
| 4870     | .N6      | 5100MI7W | .O13      | 5266-CG  | .M3       |
| 4880-C   | .N6      | 5100MI9W | .O13      | 5266-CO  | .M3       |
| 4889-C   | .N6      | 5100P    | .R3, O6   | 5266-CY  | .M3       |
| 4900-P   | .R15     | 5100-PS  | .R4       | 5266-N   | .M3       |
| 4900-PC  | .R15     | 5100P5W  | .O5, O13  | 5266-PLB | .M3       |
| 4900-PT  | .R15     | 5100P7W  | .O5, O13  | 5266-PLC | .M3       |
| 4925-2   | .E34     | 5100P9W  | .O5, O13  | 5269-C   | .M3       |
| 4925C    | .L54     | 5100R    | .O7       | 5269-CA  | .M3       |
| 4926     | .E34     | 5100R5W  | .O5       | 5269-CB  | .M3       |
| 4927     | .E19     | 5100R7W  | .O5       | 5269-CG  | .M3       |
| 4928     | .E19     | 5100R9W  | .O5       | 5269-CO  | .M3       |
| 4934     | .E19     | 5100-S15 | .R4       | 5269-CY  | .M3       |
| 4935L    | .L53     | 5125B6W  | .O16, O19 | 5269-N   | .M3       |
| 4937     | .M16     | 5125C6W  | .O16      | 5269-PLB | .M3       |
| 4950-PS  | .R15     | 5125CW   | .O19      | 5269-PLC | .M3       |
| 4950-PSC | .R15     | 5125P    | .O18      | 5278-C   | .M3       |
| 4950-PST | .R15     | 5125P6W  | .O16      | 5278-CWP | .M7       |
| 4970     | .E34     | 5125R    | .O19      | 5278-FWP | .M7       |
| 4976     | .E35     | 5125R6W  | .O16      | 5279-C   | .M3       |
| 4976-FS  | .E35     | 5200-PS  | .R4       | 5279-CWP | .M7       |
| 4978     | .E35     | 5200-S15 | .R4       | 5279-FWP | .M7       |
| 4979     | .E35     | 5206     | .G10, M9  | 5280     | .B13, R13 |
| 4980     | .E35     | 5207     | .G7, M8   | 5280-IG  | .B13, R13 |
| 4980L    | .L53     | 5224     | .I2       | 5292     | .G4       |
| 4986     | .E35     | 5224-2   | .I2       | 5300-HTS | .R4       |
|          |          | 5225     | .I2       | 5300-IPS | .R4       |
|          |          |          |           | 5300-PS  | .R4       |
|          |          |          |           | 5300-PSC | .R4       |
|          |          |          |           | 5300-PST | .R4       |
|          |          |          |           | 5300-S15 | .R4       |
|          |          |          |           | 5320-CP  | .G16      |
|          |          |          |           | 5320-S   | .G16      |
|          |          |          |           | 5320-4   | .G16      |
|          |          |          |           | 5321     | .U4       |
|          |          |          |           | 5325     | .B12      |
|          |          |          |           | 5325-I   | .B9       |
|          |          |          |           | 5325-S   | .B12      |
|          |          |          |           | 5328     | .B12      |
|          |          |          |           | 5334     | .I2       |
|          |          |          |           | 5335     | .I2       |
|          |          |          |           | 5336     | .I2       |
|          |          |          |           | 5340     | .G14      |
|          |          |          |           | 5342     | .G14      |
|          |          |          |           | 5349-FBA | .G14      |
|          |          |          |           | 5351     | .G4       |
|          |          |          |           | 5352     | .G4       |
|          |          |          |           | 5356-VA  | .M6       |
|          |          |          |           | 5356-VB  | .M6       |
|          |          |          |           | 5356-VY  | .M6       |
|          |          |          |           | 5359-VB  | .M6       |
|          |          |          |           | 5359-VY  | .M6       |
|          |          |          |           | 5361     | .G4       |
|          |          |          |           | 5361-CH  | .G4, J35  |
|          |          |          |           | 5361-CR  | .N21      |
|          |          |          |           | 5362     | .G4       |
|          |          |          |           | 5362-S   | .G4       |
|          |          |          |           | 5362-IG  | .G4       |
|          |          |          |           | 5366-C   | .M4       |
|          |          |          |           | 5366-CA  | .M4       |
|          |          |          |           | 5366-CG  | .M4       |
|          |          |          |           | 5366-CY  | .M4       |
|          |          |          |           | 5366-PLB | .M4       |
|          |          |          |           | 5366-PLC | .M4       |
|          |          |          |           | 5369-C   | .M4       |
|          |          |          |           | 5369-CA  | .M4       |
|          |          |          |           | 5369-CG  | .M4       |
|          |          |          |           | 5369-CY  | .M4       |
|          |          |          |           | 5369-PLB | .M4       |
|          |          |          |           | 5369-PLC | .M4       |
|          |          |          |           | 5371     | .G6, M8   |
|          |          |          |           | 5371-IG  | .G7, M8   |
|          |          |          |           | 5372     | .G7, M8   |
|          |          |          |           | 5372-IG  | .G7, M8   |
|          |          |          |           | 5373     | .G9, M9   |
|          |          |          |           | 5374     | .G9, M9   |
|          |          |          |           | 5374-IG  | .G9, M9   |
|          |          |          |           | 5376     | .G7       |
|          |          |          |           | 5378     | .G9       |
|          |          |          |           | 5380     | .B13, R13 |
|          |          |          |           | 5380-IG  | .B13, R13 |
|          |          |          |           | 5410     | .T5       |
|          |          |          |           | 5456-VA  | .M6       |
|          |          |          |           | 5456-VY  | .M6       |
|          |          |          |           | 5458-SS  | .G14      |

## CATALOG NUMBER ALPHANUMERIC INDEX

**Important:** Dash-numbers, indicating different product colors or other variations, are listed on the same page as the basic catalog numbers shown below, unless otherwise indicated.

**THIS PAGE 5459-VY-7899-XXX**

| CAT. NO.      | PAGE NO. |
|---------------|----------|
| 5459-VY       | .M6      |
| 5461          | .G4      |
| 5461-CR       | .N21     |
| 5462          | .G4      |
| 5462-IG       | .G4      |
| 5466-C        | .M4      |
| 5466-CY       | .M4      |
| 5469-C        | .M4      |
| 5469-CY       | .M4      |
| 5478-C        | .M4      |
| 5478-CWP      | .M7      |
| 5479-C        | .M4      |
| 5479-CWP      | .M7      |
| 5480          | .G5, R14 |
| 5480-IG       | .G5, R14 |
| 5490          | .G5, R14 |
| 5490-IG       | .G5, R14 |
| 5500-NL       | .R16     |
| 5500-2NL      | .R16     |
| 5500-15L      | .R16     |
| 5500-15N      | .R16     |
| 5500-20L      | .R16     |
| 5500-20N      | .R16     |
| 5500-190      | .R16     |
| 5500-192      | .R16     |
| 5501-8        | .F12     |
| 5501-LH       | .F13     |
| 5502-8        | .F12     |
| 5503-LH       | .F13     |
| 5505-190      | .R16     |
| 5585          | .G15     |
| 5601 Series   | .B7      |
| 5601-Z2       | .B8      |
| 5601-X2       | .B8      |
| 5602-2 Series | .B7      |
| 5603 Series   | .B7      |
| 5604-2 Series | .B7      |
| 5611 Series   | .B8      |
| 5613 Series   | .B8      |
| 5614-2 Series | .B8      |
| 5618-2        | .B8      |
| 5621-2        | .B4      |
| 5621-C        | .B19     |
| 5623-2        | .B4      |
| 5623-C        | .B19     |
| 5624-2        | .B4      |
| 5624-C        | .B19     |
| 5625          | .B16, I3 |
| 5626          | .B16, I3 |
| 5627          | .B16, I3 |
| 5628-2        | .B6      |
| 5631-2        | .B6      |
| 5633-2        | .B6      |
| 5634          | .B16, I3 |
| 5636          | .B16, I3 |
| 5637          | .B16, I3 |
| 5638-2        | .B6      |

| CAT. NO. | PAGE NO.    |
|----------|-------------|
| 5639-2   | .B6         |
| 5640     | .B16, I3    |
| 5641     | .B16, I3    |
| 5643     | .B16, I3    |
| 5645     | .B16, I3    |
| 5646     | .B16, I3    |
| 5649-2   | .B6         |
| 5651     | .G4         |
| 5657-2   | .B5         |
| 5658-SS  | .G14        |
| 5659-2   | .B6         |
| 5661     | .G4         |
| 5661-CR  | .N20        |
| 5662     | .G4         |
| 5662-IG  | .G4         |
| 5666-C   | .M3         |
| 5666-CA  | .M3         |
| 5666-CY  | .M3         |
| 5669-C   | .M3         |
| 5669-CY  | .M3         |
| 5685-2   | .B5         |
| 5686-2   | .B5         |
| 5691-2   | .B4         |
| 5691-C   | .B19        |
| 5693-2   | .B4         |
| 5693-C   | .B19        |
| 5694-C   | .B19        |
| 5721     | .T4         |
| 5731     | .T4         |
| 5801     | .G14        |
| 5821     | .G14        |
| 5822     | .G14        |
| 5823     | .G13        |
| 5824     | .G13        |
| 5842     | .G13        |
| 5844     | .G13        |
| 5891     | .G13        |
| 5951     | .J14        |
| 5952     | .J14        |
| 5953     | .J14        |
| 5954     | .J14        |
| 5955     | .J14        |
| 5957     | .J14        |
| 5958     | .J14        |
| 5959     | .J14        |
| 5976     | .E32        |
| 5977     | .H7, E32,   |
| 5978     | .E32        |
| 5996     | .E32        |
| 5997     | .H7, E32    |
| 5998     | .E32        |
| 6017     | .M4         |
| 6017-L   | .N27        |
| 6017-Y   | .M4         |
| 6018     | .M4, K2, K3 |
| 6018-L   | .N27        |
| 6018-Y   | .M4         |
| 6031     | .N27        |

| CAT. NO. | PAGE NO.      |
|----------|---------------|
| 6032     | .N27          |
| 6033     | .N27          |
| 6034     | .N27          |
| 6124H    | .D20          |
| 6151     | .M12, C35     |
| 6161     | .C35          |
| 6185     | .F5           |
| 6196     | .H7           |
| 6196-FS  | .H7, E34      |
| 6196-V   | .H7           |
| 6196-VFS | .H7, E34      |
| 6197     | .B24, H4, E36 |
| 6210G    | .L32          |
| 6212H    | .D19          |
| 6215M    | .D19          |
| 6227     | .K13          |
| 6230M    | .D19          |
| 6250-3   | .C35          |
| 6260M    | .D19          |
| 6280     | .K13          |
| 6284     | .K16          |
| 6285     | .K16          |
| 6287     | .K17          |
| 6288     | .K17          |
| 6289     | .K17          |
| 6291-WI  | .K11          |
| 6293-WI  | .K11          |
| 6294     | .K12          |
| 6296     | .K13          |
| 6298     | .K13          |
| 6299     | .K16          |
| 6312     | .K7           |
| 6315     | .K7           |
| 6316     | .K7           |
| 6320     | .K7           |
| 6337     | .K14          |
| 6360-CR  | .N23          |
| 6361-CR  | .N23          |
| 6364-CR  | .N23          |
| 6365-CR  | .N23          |
| 6369-CR  | .N23          |
| 6370-CR  | .N23          |
| 6371-I   | .K12          |
| 6375     | .K14          |
| 6375-CR  | .N23          |
| 6376     | .K14          |
| 6377-CR  | .N23          |
| 6386     | .K17          |
| 6512H    | .D19          |
| 6515M    | .D19          |
| 6516-2PK | .U4           |
| 6560M    | .D15          |
| 6593     | .H5           |
| 6594     | .H5           |
| 6602     | .C33          |
| 6602-220 | .C33          |
| 6613     | .C32          |
| 6615     | .C32          |

| CAT. NO. | PAGE NO.      |
|----------|---------------|
| 6627     | .C32          |
| 6628     | .C32          |
| 6629     | .C32          |
| 6630     | .C32          |
| 6631     | .C32          |
| 6633-P   | .C32          |
| 6637-P   | .C32          |
| 6639     | .C33          |
| 6641     | .C34          |
| 6643     | .C34          |
| 6651     | .D20          |
| 6652     | .D20          |
| 6668     | .C32          |
| 6681     | .C33          |
| 6683     | .C33          |
| 6691     | .C34          |
| 6693     | .C34          |
| 6893     | .H5           |
| 6894     | .H5           |
| 7070     | .S5           |
| 7070-M   | .S5           |
| 7080     | .S5           |
| 7080-M   | .S5           |
| 7090     | .S5           |
| 7090-M   | .S5           |
| 7092-2M  | .S5           |
| 7250-FR  | .G6, M8       |
| 7251-C   | .G6, M8       |
| 7280     | .B13, R13     |
| 7299     | .B15, B17, H4 |
| 7310-B   | .N24          |
| 7313     | .G6           |
| 7314-C   | .N24          |
| 7379     | .N25          |
| 7380     | .B13, R13     |
| 7408-C   | .N24          |
| 7409-C   | .N24          |
| 7410-B   | .N24          |
| 7411-C   | .N24          |
| 7413-C   | .N24          |
| 7420-CR  | .E33          |
| 7556     | .N24          |
| 7557     | .N24          |
| 7565-C   | .N24          |
| 7567-C   | .N24          |
| 7582     | .N24          |
| 7599     | .B15, H4      |
| 7599-DIN | .B15, H4      |
| 7599-HG  | .B15, H4      |
| 7599-L   | .H4           |
| 7599-W   | .B9           |
| 7715-CR  | .N23          |
| 7717-CR  | .N23          |
| 7764-C   | .N25          |
| 7765-C   | .N25          |
| 7770     | .N23          |
| 7788-CR  | .N23          |
| 7899-XXX | .B15, H4      |



# CATALOG NUMBER ALPHANUMERIC INDEX

**Important:** Dash-numbers, indicating different product colors or other variations, are listed on the same page as the basic catalog numbers shown below, unless otherwise indicated.

| THIS PAGE 7958-17100-2WY |               | CAT. NO. | PAGE NO.  | CAT. NO.    | PAGE NO. | CAT. NO.  | PAGE NO. |
|--------------------------|---------------|----------|-----------|-------------|----------|-----------|----------|
| CAT. NO.                 | PAGE NO.      | 8400     | .G3       | 9716-C      | .S4      | 13550     | .S13     |
| 7958                     | .N25          | 8430     | .G8, M8   | 9726-C      | .S4      | 13551     | .S13     |
| 8004                     | .S5           | 8432-P   | .G8, M8   | 9730-A      | .G7, M8  | 13556     | .S13     |
| 8004-M                   | .S5           | 8450     | .G10, M9  | 9730-P      | .M8      | 13557     | .S13     |
| 8052-1                   | .S9           | 8450-IG  | .G10, M9  | 9750-A      | .G9, M9  | 13652     | .S15     |
| 8101                     | .S9           | 8452-P   | .G10, M9  | 9750-P      | .G9, M9  | 13653     | .S15     |
| 8110                     | .S8           | 8456-V   | .M6       | 9800        | .S11     | 13654-EXL | .S16     |
| 8200                     | .G3           | 8459-V   | .M6       | 9805        | .S11     | 13654-EXS | .S16     |
| 8200-H                   | .G3           | 8460     | .G11, M10 | 9805-A      | .S11     | 13654-SNP | .S16     |
| 8200-L                   | .G3           | 8462-P   | .G11, M10 | 9814        | .S9      | 13654-SWP | .S15     |
| 8200-IG                  | .G3           | 8480     | .G5, R14  | 9820        | .S4      | 13654-TNP | .S16     |
| 8200-LIG                 | .G3           | 8480-IG  | .G5, R14  | 9839        | .S4      | 13654-TWP | .S16     |
| 8200-SG                  | .G3           | 8490     | .G5, R14  | 9860 Series | .S4      | 13660     | .S16     |
| 8200-HL                  | .G3           | 8490-IG  | .G5, R14  | 9865        | .S4      | 13661     | .S16     |
| 8200-PL                  | .G3           | 8590     | .B15, H4  | 9874        | .S3      | 15378-C   | .M4      |
| 8210                     | .G3           | 8600     | .G3       | 9875        | .S3      | 15378-CWP | .M7      |
| 8210-IG                  | .G3           | 8647     | .S8       | 9875-2      | .S3      | 15379-C   | .M4      |
| 8215-C                   | .M3           | 8656-V   | .M6       | 9880        | .S8      | 15379-CWP | .M7      |
| 8215-CT                  | .M3           | 8659-V   | .M6       | 9882        | .S8      | 15656-VA  | .M6      |
| 8215-CAT                 | .M3           | 8681     | .S8       | 9883        | .S3      | 15656-VY  | .M6      |
| 8215-PLC                 | .M3           | 8681-400 | .S8       | 9885        | .S9      | 15659-VY  | .M6      |
| 8219-C                   | .M3           | 8684     | .S11      | 9965-C      | .N24     | 15678-C   | .M7      |
| 8219-CT                  | .M3           | 8694     | .S7       | 10014-800   | .S11     | 15678-CWP | .M3      |
| 8219-PLC                 | .M3           | 8746     | .S7       | 10020       | .S8      | 15679-C   | .M3      |
| 8256-V                   | .M6           | 8750     | .S7       | 10025       | .S11     | 15679-CWP | .M7      |
| 8259-V                   | .M6           | 8751     | .S7       | 10026       | .S11     | 16241     | .B11     |
| 8280                     | .B13, R13     | 8756     | .S7       | 10027       | .S11     | 16242     | .B11     |
| 8280-IGB                 | .B9, B13, R13 | 8765     | .S7       | 10028       | .S8      | 16251     | .B11     |
| 8281-IG                  | .B13, R13     | 8806     | .S7       | 10041-500   | .T2      | 16252     | .B11     |
| 8300                     | .G3           | 8827-CW1 | .S3       | 10045       | .S9      | 16262     | .B10     |
| 8300-H                   | .G3           | 8827-CW2 | .S3       | 10065       | .S9      | 16262-HG  | .B10     |
| 8300-IG                  | .G3           | 8827-CW4 | .S3       | 10083-16    | .S5      | 16262-IG  | .B10     |
| 8300-L                   | .G3           | 8829-CW1 | .S3       | 10083-M     | .S5      | 16262-PL  | .B10     |
| 8300-LIG                 | .G3           | 8829-CW2 | .S3       | 10085       | .S9      | 16262-SGI | .B9, B10 |
| 8300-SG                  | .G3           | 8829-CW4 | .S3       | 10091       | .S10     | 16292-I   | .B9, B11 |
| 8300-HL                  | .G3           | 8871     | .S9       | 10097-8     | .T2      | 16341     | .B11     |
| 8300-PL                  | .G3           | 8875     | .S9       | 12533       | .U4      | 16342     | .B11     |
| 8310                     | .G3           | 8880     | .S9       | 12536       | .U4      | 16351     | .B11     |
| 8310-IG                  | .G3           | 8895     | .H5       | 12537       | .U4      | 16352     | .B11     |
| 8315-C                   | .M4           | 9063     | .S8       | 12538       | .U4      | 16362-PLR | .B9      |
| 8315-CAT                 | .M4           | 9151-N   | .M8       | 12540       | .U4      | 16362-XX  | .B10     |
| 8315-CT                  | .M4           | 9332-P   | .G7, M8   | 12650       | .G16     | 16441     | .B11     |
| 8315-PLC                 | .M4           | 9346     | .S5       | 12777       | .U4      | 16451     | .B11     |
| 8319-C                   | .M4           | 9346-M   | .S5       | 13150-UR5   | .S15     | 16462     | .B11     |
| 8319-CT                  | .M4           | 9347     | .S5       | 13351-D     | .S15     | 16462-HG  | .B10     |
| 8319-PLC                 | .M4           | 9350     | .S9       | 13353-N     | .S15     | 16509-1PK | .U4      |
| 8330                     | .G8, M8       | 9382     | .T4       | 13354-D     | .S15     | 16509-2PK | .U4      |
| 8332-P                   | .G8, M8       | 9432-P   | .G8, M8   | 13357-N     | .S15     | 16592     | .H5      |
| 8350                     | .G11, M9      | 9450-P   | .G10, M9  | 13359-N     | .S15     | 16593     | .H5      |
| 8352-P                   | .G11, M9      | 9452-P   | .G10, M9  | 13451-N     | .S15     | 16641     | .B11     |
| 8356-V                   | .M6           | 9460     | .G11, M10 | 13452       | .S17     | 16651     | .B11     |
| 8359-V                   | .M6           | 9460-IG  | .G11, M10 | 13453       | .S17     | 16662     | .B11     |
| 8360                     | .G11, M10     | 9462-P   | .G11, M10 | 13454       | .S17     | 16893     | .H5      |
| 8362-P                   | .G11, M10     | 9530-P   | .G6, M8   | 13455       | .S17     | 1689-50   | .T2      |
| 8380                     | .B13, R12     | 9550-P   | .G9, M9   | 13464       | .S13     | 1689-75   | .T2      |
| 8380-IG                  | .B13, R13     | 9575-250 | .T3       | 13465       | .S13     | 1691-50   | .T2      |
| 8381                     | .B13, R13     | 9630-P   | .G7, M8   | 13518       | .S14     | 17100-1WY | .C25     |
| 8381-IG                  | .B13, R13     | 9650-P   | .G9, M9   | 13519       | .S14     | 17100-2WY | .C25     |

# CATALOG NUMBER ALPHANUMERIC INDEX

**Important:** Dash-numbers, indicating different product colors or other variations, are listed on the same page as the basic catalog numbers shown below, unless otherwise indicated.

**THIS PAGE 18201-48500**

| CAT. NO.        | PAGE NO.  | CAT. NO.  | PAGE NO.  | CAT. NO.  | PAGE NO.              |
|-----------------|-----------|-----------|-----------|-----------|-----------------------|
| 18201           | .F3       | 29816-C   | .S3       | 40888     | .J30                  |
| 18201-C         | .F13      | 29816-C2  | .S3       | 40905     | .J30                  |
| 18202           | .F3       | 29816-CM  | .S3       | 40914     | .L20                  |
| 18202-C         | .F13      | 32120-1   | .R10      | 40944     | .L19                  |
| 18203           | .F3       | 32120-DY3 | .R10      | 40949     | .L19                  |
| 18203-C         | .F13      | 32277-DY3 | .R10      | 40951     | .J32                  |
| 18204           | .F3       | 32347-DY3 | .R10      | 40952     | .J32                  |
| 18204-C         | .F13      | 32412-DS3 | .R10      | 40959     | .L19                  |
| 18221           | .F3       | 36592-E   | .H6       | 40985     | .L4, L5               |
| 18222           | .F3       | 37120-007 | .R9       | 40988     | .L65                  |
| 18223           | .F3       | 37277-4X7 | .R9       | 40989     | .L61                  |
| 18224           | .F3       | 40050     | .L40      | 41010     | .L58                  |
| 18302-1         | .S4       | 40054     | .L40, L57 | 41020     | .L58                  |
| 18315           | .S9       | 40066     | .L39      | 41030     | .L23, L58             |
| 19062           | .S8       | 40067     | .L41      | 41034     | .L22                  |
| 19980           | .S5       | 40070     | .L66      | 41036     | .L22                  |
| 19980-M         | .S5       | 40072     | .L40      | 41038     | .L22                  |
| 20025           | .S12      | 40089     | .L28      | 41044     | .L22                  |
| 20070           | .S9       | 40201     | .L21      | 41046     | .L22                  |
| 20403           | .N28      | 40214     | .L20      | 41048     | .L22                  |
| 21254           | .G5       | 40215     | .S13      | 41054     | .L21                  |
| 21254-H         | .G5       | 40216     | .L20      | 41058     | .L21                  |
| 21254-IG        | .G5       | 40223     | .L20      | 41080     | .L10, L60             |
| 21414-B         | .N28      | 40226     | .L20      | 41084     | .L4, L7               |
| 21415-B         | .N28      | 40238     | .L18      | 41085     | .L7                   |
| 23000-HG        | .N28      | 40244     | .L20      | 41086     | .L22                  |
| 23001-HG        | .N28      | 40249     | .L18      | 41087     | .L11                  |
| 23004-HG        | .N28      | 40253     | .L20      | 41088     | .L22                  |
| 23030           | .N28      | 40257     | .L20      | 41089     | .L16                  |
| 23031-A         | .N28      | 40258     | .L18      | 41091     | .L10                  |
| 23034-A         | .N28      | 40259     | .L18      | 41100     | .L60                  |
| 23452           | .S18      | 40263     | .L20      | 41106-    | .R6, L3               |
| 23453           | .S17      | 40266     | .L20      | 41108-R3  | .L3                   |
| 23454           | .S17      | 40274     | .L22      | 41108-R5  | .L3                   |
| 23455           | .S17      | 40278     | .L22      | 41108-R8  | .L3                   |
| 23464           | .S13      | 40280     | .L18      | 41150     | .L55                  |
| 23465           | .S13      | 40280     | .L18      | 41188     | .L54                  |
| 23518           | .S14      | 40539     | .L19      | 41225     | .L58                  |
| 23519           | .S14      | 40544     | .L19      | 41290     | .L14                  |
| 23652 Series    | .S15      | 40549     | .L18      | 41291     | .L14                  |
| 23653 Series    | .S15      | 40566     | .L19      | 41292     | .L14                  |
| 23654 Series    | .S16      | 40580     | .L18      | 41293     | .L14                  |
| 23660           | .S16      | 40588     | .L19      | 41294     | .L14                  |
| 23661           | .S16      | 40638     | .B18, L19 | 41295     | .L14                  |
| 25403           | .N28      | 40649     | .B18, L19 | 41296     | .L14                  |
| 25414-B         | .N28      | 40680     | .B18, L19 | 41360     | .L21                  |
| 25415-B         | .N28      | 40681     | .B18, B24 | 41361     | .L22                  |
| 26115           | .C33      | 40682     | .B18      | 41364     | .L21                  |
| 26591-37C       | .H6       | 40734     | .L4       | 41365     | .L21                  |
| 26592-E         | .H6       | 40735     | .L4       | 41366     | .L21                  |
| 26666-31        | .C14      | 40740     | .L60      | 41367     | .L21                  |
| 26666-37        | .C14      | 40782     | .L4       | 41368     | .L21                  |
| 26719 Series    | .S19      | 40830     | .L4       | 41600     | .L40                  |
| 26720 Series    | .S19      | 40831     | .L4       | 41610     | .L40                  |
| 26725 Series    | .S20, S21 | 40832     | .L4       | 41620     | .L40                  |
| 26725-2A Series | .S22      | 40833     | .L5       | 41642     | .B18, L9              |
| 26725-4A Series | .S22      | 40837     | .L5       | 41643     | .L9                   |
|                 |           | 40839     | .L5       | 41644     | .L9                   |
|                 |           | 40841     | .J29      |           |                       |
|                 |           |           |           | 41646     | .L9                   |
|                 |           |           |           | 41647     | .L15                  |
|                 |           |           |           | 41649     | .L14                  |
|                 |           |           |           | 41650     | .L11                  |
|                 |           |           |           | 41650-6   | .G15                  |
|                 |           |           |           | 41650-F   | .G15                  |
|                 |           |           |           | 41652-000 | .G15, L11             |
|                 |           |           |           | 41652-006 | .L11                  |
|                 |           |           |           | 41652-06F | .L11                  |
|                 |           |           |           | 41652-6   | .G15                  |
|                 |           |           |           | 41652-6F  | .G15                  |
|                 |           |           |           | 41658     | .B18, L9              |
|                 |           |           |           | 41666     | .B18, L9              |
|                 |           |           |           | 41668     | .B18, L9              |
|                 |           |           |           | 41688     | .B18, L9              |
|                 |           |           |           | 42001-FMC | .R10                  |
|                 |           |           |           | 42080     | .L10                  |
|                 |           |           |           | 42120-1   | .R10                  |
|                 |           |           |           | 42120-DY3 | .R10                  |
|                 |           |           |           | 42277-DY3 | .R10                  |
|                 |           |           |           | 42347-DY3 | .R10                  |
|                 |           |           |           | 42400     | .J11                  |
|                 |           |           |           | 42412-DS3 | .R10                  |
|                 |           |           |           | 42777     | .L23                  |
|                 |           |           |           | 43080     | .L11                  |
|                 |           |           |           | 43105     | .L58                  |
|                 |           |           |           | 43108     | .L58                  |
|                 |           |           |           | 43112     | .L58                  |
|                 |           |           |           | 43115     | .L58                  |
|                 |           |           |           | 45224     | .L58                  |
|                 |           |           |           | 46666     | .L66                  |
|                 |           |           |           | 46700     | .L58                  |
|                 |           |           |           | 47000     | .J22                  |
|                 |           |           |           | 47120-007 | .R9                   |
|                 |           |           |           | 47120-4X7 | .R9                   |
|                 |           |           |           | 47277-007 | .R9                   |
|                 |           |           |           | 47277-4X7 | .R9                   |
|                 |           |           |           | 47347-007 | .R9                   |
|                 |           |           |           | 47602     | .J5                   |
|                 |           |           |           | 47603     | .J9, J10, J11, J35    |
|                 |           |           |           | 47604     | .J6                   |
|                 |           |           |           | 47605     | .J3, J4, J6, J10, J13 |
|                 |           |           |           | 47606     | .J9                   |
|                 |           |           |           | 47609     | .J10, J11             |
|                 |           |           |           | 47611     | .J10, J15             |
|                 |           |           |           | 47612     | .J11, J12             |
|                 |           |           |           | 47616     | .J10, J11             |
|                 |           |           |           | 47617-XXX | .B26, J35             |
|                 |           |           |           | 47621     | .J35                  |
|                 |           |           |           | 47689     | .L28                  |
|                 |           |           |           | 47690     | .J18, J21             |
|                 |           |           |           | 47691     | .J18                  |
|                 |           |           |           | 47693     | .J16                  |
|                 |           |           |           | 48210     | .J17, J34             |
|                 |           |           |           | 48211     | .J29, J31             |
|                 |           |           |           | 48212     | .J14                  |
|                 |           |           |           | 48213     | .J20, J21             |
|                 |           |           |           | 48500     | .U4                   |

# CATALOG NUMBER ALPHANUMERIC INDEX



**Important:** Dash-numbers, indicating different product colors or other variations, are listed on the same page as the basic catalog numbers shown below, unless otherwise indicated.

## THIS PAGE 48566–80414

| CAT. NO. | PAGE NO.       | CAT. NO.  | PAGE NO.  | CAT. NO.  | PAGE NO.          |
|----------|----------------|-----------|-----------|-----------|-------------------|
| 48566    | .U3            | 49889     | .L7, L49  | 51715-ASA | .R20              |
| 48568    | .U3            | 49910     | .L12      | 51715-SSA | .R20              |
| 48580    | .U3            | 49990     | .L7       | 55650-ASA | .R20              |
| 48585    | .U3            | 49991     | .L6       | 57120-CM3 | .R7               |
| 48642    | .M15           | 50208-ASA | .R20      | 57120-C3S | .R7               |
| 48643    | .M15           | 50240-ASA | .R20      | 57120-M3  | .R7               |
| 48646    | .M15           | 50240-MSA | .R20      | 57120-M3S | .R7               |
| 48648    | .M16           | 51000-SMC | .R11      | 57220-IM3 | .R7               |
| 48900    | .L58           | 51005-DIN | .R5       | 57240-DM3 | .R7               |
| 49005    | .L29, L54      | 51005-WM  | .R5       | 57277-CM3 | .R7               |
| 49006    | .L27, L56      | 51010-DIN | .R5       | 57277-C3S | .R7               |
| 49012    | .L30           | 51010-WM  | .R5       | 57277-M3  | .R7               |
| 49013    | .L30           | 51012     | .U3       | 57277-M3S | .R7               |
| 49014    | .L30           | 51015-WM  | .R5       | 57277-MC3 | .R7               |
| 49018    | .L30           | 51020-DIN | .R5       | 57346-M3  | .R7               |
| 49103    | .L37           | 51020-WM  | .R5       | 57347-M3S | .R7               |
| 49104    | .L37           | 51020-WMT | .R5       | 57480-DM3 | .R7               |
| 49105    | .L37           | 51084     | .L60      | 57600-DM3 | .R7               |
| 49200    | .L40           | 51110-1   | .R21      | 59256     | .L59              |
| 49222    | .L23           | 51110-CT8 | .R21      | 59257     | .L59              |
| 49252    | .L55           | 51110-PTC | .K15, R21 | 59258     | .L59              |
| 49251    | .L57           | 51120-1   | .K15, R21 | 59259     | .L59              |
| 49253    | .L54           | 51120-3   | .K15, R21 | 59260     | .L59              |
| 49254    | .L57           | 51120-3R  | .K15, R21 | 59596     | .L26              |
| 49255    | .L29           | 51120-PTC | .R19      | 60001     | .C16              |
| 49256    | .L27, L30      | 51240-DIN | .R5       | 60002     | .C16              |
| 49257    | .L28           | 51240-WM  | .R5       | 60800     | .C16              |
| 49258    | .L55           | 52000-RS  | .R8       | 60800-3   | .C16              |
| 49260    | .L55           | 52120-7C3 | .R9       | 61000     | .C16              |
| 49261    | .L55           | 52120-7M3 | .R9       | 61000-3   | .C16              |
| 49262    | .L27, L56      | 52120-B3  | .R8       | 61027     | .C16              |
| 49265    | .L53           | 52120-CM2 | .R8       | 6110G-R*6 | .L3               |
| 49280    | .L29           | 52120-CM3 | .R8       | 61110-B*6 | .L3               |
| 49400    | .L54           | 52120-CM3 | .R8       | 61110-R*6 | .L3               |
| 49553    | .L61           | 52120-M1  | .R8       | 61500     | .C16              |
| 49560    | .L65           | 52120-M2  | .R8       | 62000     | .C16              |
| 49561    | .L65           | 52120-M2H | .K15, R8  | 62240     | .L34              |
| 49562    | .L65           | 52120-M3  | .R8       | 6234A     | .L34              |
| 49563    | .U3            | 52220-IM3 | .R8       | 6234B     | .L34              |
| 49566    | .U3            | 52240-DM3 | .R8       | 62460     | .L32              |
| 49567    | .U4            | 52277-7C3 | .R9       | 6616-X    | .C33              |
| 49568    | .U4            | 52277-7M3 | .R9       | 66591-2C  | .H6               |
| 49575    | .L66           | 52277-CM3 | .R8       | 66591-6C  | .H6               |
| 49660    | .L65           | 52277-M3  | .R8       | 66591-25C | .H6               |
| 49666    | .L66           | 52347-M3  | .R8       | 66591-WL  | .H6               |
| 49686    | .U2            | 52412-DS3 | .R8       | 66593-3   | .H6               |
| 49800    | .L49, L62, L63 | 52455     | .L32      | 66597-3   | .H6               |
| 49816-C  | .S3            | 52480-DM3 | .R8       | 66891-3   | .H6               |
| 49855    | .L6            | 54175-SSA | .R20      | 66897-3   | .H6               |
| 49875    | .S3            | 54501-2   | .F12      | 6910G     | .L24, L29         |
| 49882    | .L6, L49       | 54502-2   | .F12      | 69104     | .L34              |
| 49883    | .L6, L49       | 54503-2   | .F12      | 69270     | .L25, L29         |
| 49884    | .L6, L49       | 54504-2   | .F12      | 69271     | .L27              |
| 49885    | .L6, S49       | 54521-2   | .F12      | 69586     | .L25              |
| 49886    | .L7, L63, L64  | 54522-2   | .F12      | 69587     | .L27              |
| 49887    | .L49           | 54523-2   | .F12      | 69591-3   | .H6               |
| 49888    | .L6            | 54524-2   | .F12      | 69591-25  | .H6               |
|          |                | 55050     | .G10      | 69591-W3  | .H6               |
|          |                | 55054     | .G8       |           |                   |
|          |                |           |           | 69591-W25 | .H6               |
|          |                |           |           | 69593-3   | .H6               |
|          |                |           |           | 69891-3   | .H6               |
|          |                |           |           | 69891-W3  | .H6               |
|          |                |           |           | 70052-100 | .S9               |
|          |                |           |           | 71111     | .C14              |
|          |                |           |           | 71113     | .C14              |
|          |                |           |           | 71511     | .C14              |
|          |                |           |           | 71513     | .C14              |
|          |                |           |           | 7299      | .L4               |
|          |                |           |           | 74120-7M3 | .R6               |
|          |                |           |           | 74277-7M3 | .R6               |
|          |                |           |           | 78001     | .E7               |
|          |                |           |           | 78003     | .E10              |
|          |                |           |           | 78004     | .E13              |
|          |                |           |           | 78005     | .E23              |
|          |                |           |           | 78009     | .E7               |
|          |                |           |           | 78011     | .E7               |
|          |                |           |           | 78012     | .E8               |
|          |                |           |           | 78013     | .E13              |
|          |                |           |           | 78014     | .E16              |
|          |                |           |           | 78016     | .E10              |
|          |                |           |           | 78021     | .E24              |
|          |                |           |           | 78023     | .E8               |
|          |                |           |           | 78025     | .E16              |
|          |                |           |           | 78030     | .E10              |
|          |                |           |           | 78036     | .E8               |
|          |                |           |           | 80301-OS  | .L10              |
|          |                |           |           | 80301-S   | .B20, B22, E2, E4 |
|          |                |           |           | 80309-OS  | .L10              |
|          |                |           |           | 80309-S   | .B20, B22, E2, E4 |
|          |                |           |           | 80311-OS  | .L10              |
|          |                |           |           | 80311-S   | .B20, B22, E2, E4 |
|          |                |           |           | 80312-OS  | .L10              |
|          |                |           |           | 80312-S   | .B20, B23, E2, E5 |
|          |                |           |           | 80314     | .B24, E36         |
|          |                |           |           | 80321-S   | .B20, B23, E2, E5 |
|          |                |           |           | 80326-S   | .B20, B23, E2, E5 |
|          |                |           |           | 80381     | .B18, B24, E36    |
|          |                |           |           | 80400     | .B24, C32, E36    |
|          |                |           |           | 80401     | .B22, E4, L9      |
|          |                |           |           | 80401-CN  | .B19              |
|          |                |           |           | 80401-XXX | .E30              |
|          |                |           |           | 80401-IG  | .B10, E30         |
|          |                |           |           | 80401-N   | .B22, E4          |
|          |                |           |           | 80405     | .E25              |
|          |                |           |           | 80407     | .B23, E5          |
|          |                |           |           | 80408     | .B23, E5          |
|          |                |           |           | 80409     | .B22, E4, L9      |
|          |                |           |           | 80409-CN  | .B19              |
|          |                |           |           | 80409     | .B22, E4          |
|          |                |           |           | 80411     | .B22, E4, L9      |
|          |                |           |           | 80411-CN  | .B19              |
|          |                |           |           | 80411-N   | .B22, E4          |
|          |                |           |           | 80412     | .B23, L9, E5      |
|          |                |           |           | 80412-CN  | .B19              |
|          |                |           |           | 80412-N   | .B23, E5          |
|          |                |           |           | 80414     | .B24, E36, L9     |

## CATALOG NUMBER ALPHANUMERIC INDEX

**Important:** Dash-numbers, indicating different product colors or other variations, are listed on the same page as the basic catalog numbers shown below, unless otherwise indicated.

| THIS PAGE 80421-84085-40 |          |
|--------------------------|----------|
| CAT. NO.                 | PAGE NO. |
| 80421                    | E25      |
| 80423                    | B23, E5  |
| 80431                    | E25      |
| 80436                    | B23, E5  |
| 80455                    | E27      |
| 80479                    | E27      |
| 80501                    | E7       |
| 80503                    | E10      |
| 80504                    | E12      |
| 80505                    | E23      |
| 80506                    | E26      |
| 80508                    | E27      |
| 80509                    | E7       |
| 80511                    | E7       |
| 80512                    | E8       |
| 80513                    | E13      |
| 80514                    | E16      |
| 80516                    | E10      |
| 80521                    | E24      |
| 80525                    | E16      |
| 80526                    | E19      |
| 80528                    | E19      |
| 80530                    | E20      |
| 80532                    | E19      |
| 80533                    | E16      |
| 80601                    | B22, E4  |
| 80605                    | E25      |
| 80608                    | E28      |
| 80609                    | B22, E4  |
| 80611                    | B22, E4  |
| 80612                    | B23, E5  |
| 80700                    | E36      |
| 80701                    | E7       |
| 80701-RE                 | E30      |
| 80703                    | E10      |
| 80703-XXX                | E30      |
| 80703-IG                 | E29      |
| 80703-RE                 | E29      |
| 80704                    | E12, L21 |
| 80704-IG                 | E29      |
| 80705                    | E23      |
| 80706                    | E26      |
| 80707                    | E25      |
| 80708                    | E28      |
| 80709                    | E7       |
| 80711                    | E7       |
| 80712                    | E8       |
| 80714                    | E16      |
| 80716                    | E10, E29 |
| 80718                    | E14      |
| 80719                    | E17      |
| 80720                    | E19, E30 |
| 80721                    | E24      |
| 80723                    | E8       |
| 80726                    | E19      |
| 80730                    | E10      |
| 80731                    | E25      |

| CAT. NO. | PAGE NO. |
|----------|----------|
| 80732    | E25      |
| 80734    | E17      |
| 80735    | E16      |
| 80736    | E8       |
| 80743    | E24      |
| 80745    | E25      |
| 80746    | E27      |
| 80747    | E28      |
| 80781    | E31, L18 |
| 80782    | E31, L18 |
| 80800    | C14      |
| 80827    | C15      |
| 81000    | C14      |
| 81000-3  | C14      |
| 81000-L  | C14      |
| 81000-L3 | C14      |
| 81001    | E7       |
| 81001-PB | E7       |
| 81003    | E10      |
| 81003-PB | E10      |
| 81004    | E12      |
| 81005    | E23      |
| 81009    | E7       |
| 81009-PB | E7       |
| 81011    | E7       |
| 81011-PB | E7       |
| 81012    | E8       |
| 81012-PB | E8       |
| 81013    | E13      |
| 81014    | E16      |
| 81017    | E13      |
| 81021    | E24      |
| 81023    | E8       |
| 81023-PB | E8       |
| 81025    | E16      |
| 81036    | E8       |
| 81040    | E21      |
| 81045    | E28      |
| 81079    | E22      |
| 81080    | E22      |
| 81127    | C15      |
| 81401    | B22, E4  |
| 81401-PB | B22, E4  |
| 81409    | B22, E4  |
| 81409-PB | B22      |
| 81411    | E4       |
| 81411-PB | E4       |
| 81412    | E5       |
| 81423    | E5       |
| 81500    | C14      |
| 81500-3  | C14      |
| 81527    | C15      |
| 82000    | C14      |
| 82000-L  | C14      |
| 82000-3  | C14      |
| 82000-L3 | C14      |
| 82001    | E7       |
| 82003    | E10      |

| CAT. NO.  | PAGE NO. |
|-----------|----------|
| 82004     | E12      |
| 82005     | E23      |
| 82009     | E7       |
| 82011     | E7       |
| 82012     | E8       |
| 82013     | E13      |
| 82014     | E16      |
| 82016     | E10      |
| 82021     | E24      |
| 82023     | E8       |
| 82025     | E16      |
| 82036     | E8       |
| 82080     | E22      |
| 82400     | B24      |
| 82400-PRT | E36      |
| 82601     | E4       |
| 82602     | E4       |
| 82605     | E25      |
| 83000-PRT | E36      |
| 83001     | E7       |
| 83003     | E10      |
| 83004     | E12      |
| 83005     | E23      |
| 83009     | E7       |
| 83011     | E7       |
| 83012     | E8       |
| 83013     | E13      |
| 83014     | E16      |
| 83014-EXT | E35      |
| 83016     | E10      |
| 83025     | E16      |
| 83025-EXT | E35      |
| 83026     | E19      |
| 83028     | E19      |
| 83401     | E4       |
| 83409     | E4       |
| 83411     | E4       |
| 84000-PRT | E36      |
| 84001     | E7       |
| 84001-40  | E7       |
| 84001-E40 | E30      |
| 84001-LOK | E34      |
| 84003     | E10      |
| 84003-40  | E10      |
| 84003-E40 | E29      |
| 84003-IG  | E29      |
| 84004     | E12      |
| 84004-40  | E12      |
| 84005     | E23      |
| 84005-40  | E23      |
| 84006-40  | E26      |
| 84007     | E23      |
| 84007-40  | E23      |
| 84008-40  | E27      |
| 84009     | E7       |
| 84009-40  | E7       |
| 84011     | E7       |
| 84011-40  | E7       |

| CAT. NO.  | PAGE NO. |
|-----------|----------|
| 84012     | E8       |
| 84012-40  | E8       |
| 84013     | E13      |
| 84013-40  | E13      |
| 84014     | E16      |
| 84014-40  | E16      |
| 84016     | E10      |
| 84016-40  | E10      |
| 84016-E40 | E29      |
| 84017-40  | E13      |
| 84018-40  | E14      |
| 84019     | E17      |
| 84019-40  | E17      |
| 84020-40  | E19      |
| 84021-40  | E24      |
| 84022     | E20      |
| 84023-40  | E8       |
| 84025     | E16      |
| 84025-40  | E16      |
| 84026     | E19      |
| 84028     | E19      |
| 84030-40  | E10      |
| 84033-40  | E16      |
| 84034-40  | E17      |
| 84035-40  | E17      |
| 84036-40  | E8       |
| 84037-40  | E14      |
| 84039-40  | E21      |
| 84040-40  | E21      |
| 84041     | E11      |
| 84042-40  | E23      |
| 84043     | E24      |
| 84045-40  | E28      |
| 84046-40  | E26      |
| 84047-40  | E28      |
| 84048-40  | E9       |
| 84049-40  | E9       |
| 84050-40  | E9       |
| 84052-40  | E12      |
| 84055-40  | E11      |
| 84056-40  | E11      |
| 84057-40  | E18      |
| 84061-40  | E13      |
| 84062-40  | E13      |
| 84064     | E16      |
| 84064-40  | E16      |
| 84065-40  | E16      |
| 84066-40  | E17      |
| 84067-40  | E17      |
| 84068-40  | E17      |
| 84070-40  | E9       |
| 84071-40  | E35      |
| 84077-40  | E26      |
| 84078-40  | E27      |
| 84079-40  | E22      |
| 84080-40  | E22      |
| 84081-40  | E22      |
| 84085-40  | E28      |

# CATALOG NUMBER ALPHANUMERIC INDEX

**Important:** Dash-numbers, indicating different product colors or other variations, are listed on the same page as the basic catalog numbers shown below, unless otherwise indicated.

## THIS PAGE 84087-40-97092

| CAT. NO.  | PAGE NO. | CAT. NO.  | PAGE NO. | CAT. NO.  | PAGE NO. |           |          |
|-----------|----------|-----------|----------|-----------|----------|-----------|----------|
| 84087-40  | E28      | 85025     | E16      | 86107     | E13      | 88057     | E18      |
| 84088-40  | E23      | 85030     | E10      | 86108     | E27      | 88062     | E13      |
| 84092-40  | E21      | 85033     | E16      | 86109     | E7       | 88064     | E16      |
| 84101     | E7       | 85036     | E8       | 86111     | E7       | 88078     | E27      |
| 84101-40  | E7       | 85041     | E11      | 86113     | E14      | 88079     | E22      |
| 84103     | E10      | 85047     | E28      | 86114     | E16      | 88080     | E22      |
| 84103-40  | E10      | 85052     | E12      | 86116     | E10      | 88085     | E28      |
| 84105-40  | E23      | 85064     | E16      | 86400     | B24      | 88087     | E28      |
| 84109-40  | E7       | 85101     | E7       | 86400-PRT | E36      | 88101     | E7       |
| 84111-40  | E7       | 85103     | E10      | 86593     | H5       | 88103     | E10      |
| 84112-40  | E8       | 85111     | E7       | 86601     | E4       | 88105     | E23      |
| 84114     | E16      | 85114     | E16      | 86602     | E4       | 88106     | E10, E26 |
| 84114-40  | E16      | 85116     | E10      | 86605     | E25      | 88111     | E7       |
| 84116-40  | E10      | 85400     | B24      | 86500-PRT | E36      | 88113     | E14      |
| 84119-40  | E17      | 85400-PRT | E36      | 86593     | H5       | 88114     | E16      |
| 84121-40  | E24      | 85500-PRT | E36      | 87000-PRT | E36      | 88116     | E10      |
| 84125-40  | E16      | 86000-PRT | E36      | 87001     | E7       | 88400-PRT | E36      |
| 84130-40  | E10      | 86001     | E7       | 87003     | E10      | 88500-PRT | E36      |
| 84133-40  | E16      | 86003     | E10      | 87005     | E23      | 88605     | E25      |
| 84134-40  | E17      | 86004     | L22, E12 | 87009     | E7       | 89201     | U5       |
| 84137     | E14      | 86005     | E23      | 87011     | E7       | 89203     | U5       |
| 84137-40  | E14      | 86006     | E26      | 87012     | E8       | 89209     | U5       |
| 84146-40  | E26      | 86007     | E23      | 87014     | E16      | 89301     | U5       |
| 84147-40  | E28      | 86008     | E27      | 87016     | E10      | 89303     | U5       |
| 84400     | B24      | 86009     | E7       | 87025     | E16      | 89309     | U5       |
| 84400-PRT | E36      | 86011     | E7       | 87400     | B24      | 89500-PRT | E36      |
| 84401-40  | B22, E4  | 86012     | E8       | 87400-PRT | E36      | 90572     | T2       |
| 84409-40  | B22, E4  | 86013     | E13      | 88000-PRT | E36      | 90577-010 | T2       |
| 84411-40  | E4       | 86014     | E16      | 88101     | E7       | 90679-001 | T3       |
| 84412-40  | B23, E5  | 86016     | E10      | 88001     | E7       | 95080     | S5       |
| 84421-40  | E25      | 86017     | E13      | 88003     | E10      | 95110     | S5       |
| 84423-40  | B23, E5  | 86018     | E14      | 88004     | E12      | 97092     | S5       |
| 84436-40  | B23, E5  | 86019     | E17      | 88005     | E23      |           |          |
| 84440     | E36      | 86021     | E24      | 88006     | E26      |           |          |
| 84441-40  | E31      | 86023     | E8       | 88007     | E23      |           |          |
| 84442-40  | E31      | 86025     | E16      | 88008     | E27      |           |          |
| 84444-40  | E31      | 86030     | E10      | 88009     | E7       |           |          |
| 84455-40  | E27      | 86033     | E16      | 88011     | E7       |           |          |
| 84500-PRT | E36      | 86034     | E17      | 88012     | E8       |           |          |
| 85000-PRT | E36      | 86035     | E17      | 88013     | E13      |           |          |
| 85001     | E7       | 86036     | E8       | 88014     | E16      |           |          |
| 85003     | E10      | 86041     | E11      | 88016     | E10      |           |          |
| 85004     | E12      | 86046     | E26      | 88017     | E13      |           |          |
| 85005     | E23      | 86047     | E28      | 88018     | E14      |           |          |
| 85006     | E26      | 86052     | E12      | 88019     | E17      |           |          |
| 85007     | E23      | 86057     | E18      | 88021     | E24      |           |          |
| 85008     | E27      | 86062     | E13      | 88023     | E8       |           |          |
| 85009     | E7       | 86064     | E16      | 88025     | E16      |           |          |
| 85011     | E7       | 86077     | E27      | 88030     | E10      |           |          |
| 85012     | E8       | 86078     | E27      | 88033     | E16      |           |          |
| 85013     | E13      | 86079     | E22      | 88034     | E17      |           |          |
| 85014     | E16      | 86080     | E22      | 88035     | E17      |           |          |
| 85016     | E10      | 86085     | E28      | 88036     | E8       |           |          |
| 85018     | E14      | 86087     | E28      | 88037     | E14      |           |          |
| 85019     | E17      | 86101     | E7, E8   | 88041     | E11      |           |          |
| 85021     | E24      | 86103     | E10      | 88046     | E26      |           |          |
| 85023     | E8       | 86105     | E23      | 88047     | E28      |           |          |
|           |          | 86106     | E26      | 88052     | E12      |           |          |











# Access Everything Leviton on One, Easy-to-Use Website

**Clean, modern and easy to navigate, our redesigned website consolidates all Leviton product group sites into a single domain—leviton.com. Whether you're an electrical professional or consumer, you'll find everything Leviton has to offer at your fingertips, from our database-driven product catalog to company news, services and customer support.**

## leviton.com at a glance:

- Pull-down menus link to our complete catalog for all Leviton products
- Powerful, user-friendly search capability
- New Distribution, OEM and Retail sections target your market
- Clean, modern and easy to navigate design
- One comprehensive website where you can browse between product families without having to go to multiple websites
- And much more...

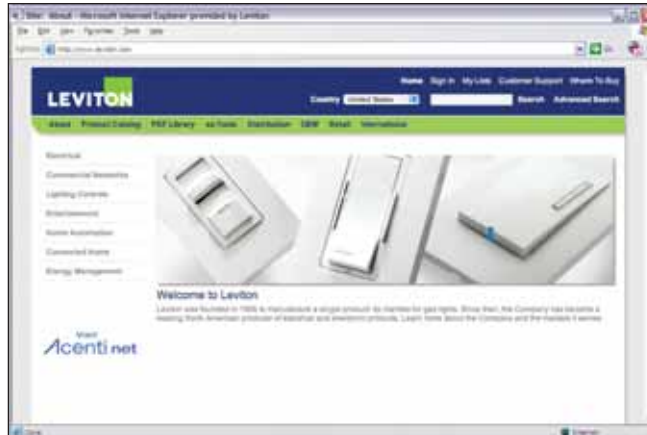

*Start at the Leviton Home Page, your portal to the wide world of leviton.com*



*Select your area of interest*

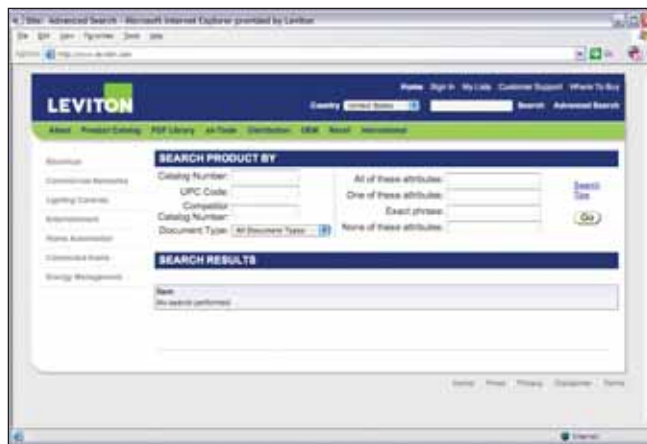

*Find what you're looking for with our powerful search engine*

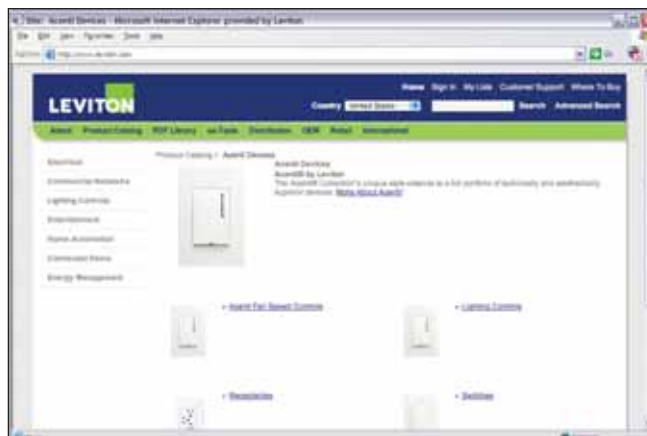

*Explore the Product Catalog and create lists for your next project*

**100,000,000+ homes,  
20,000+ products,  
100+ years,  
1 brand...**

**LEVITON**  <sup>®</sup>

Leviton Manufacturing proudly presents our new look. A concise visual expression to help better communicate the qualities that make us the unique, one-of-a-kind industry leader customers and distributors have come to know and trust over the past one hundred years. This trust is at the core of our success, and we pledge our continued devotion to the pursuit of excellence every day, in everything we do.

**THE FUTURE IS ON**



**Leviton Manufacturing Co., Inc.**

59-25 Little Neck Parkway, Little Neck, NY 11362-2591

Telephone: 1-800-323-8920 • FAX: 1-800-832-9538

Tech Line (8:30AM–7:30PM E.S.T. Monday–Friday): 1-800-824-3005

**Leviton Manufacturing of Canada, Ltd.**

165 Hymus Boulevard, Pointe Claire, Quebec H9R 1E9

Telephone: 1-800-469-7890 • FAX: 1-800-563-1853

**Leviton S. de R.L. de C.V.**

Lago Tana 43, Mexico DF, Mexico CP 11290

Tel. (+52) 55-5082-1040 • [www.leviton.com.mx](http://www.leviton.com.mx)