



Catalog | 2014

Pilot devices

The complete offering

Modular range

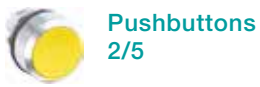

Pushbuttons
2/5



Double pushbuttons
2/6



Mushroom pushbuttons
2/9



Pilot lights
2/9



Emergency stop pushbuttons
2/10



Machine stop pushbuttons
2/10



Selector switches
2/11



Key-operated Selector switches
2/14



Potentiometers
2/15



Reset pushbuttons
2/16



Joysticks
2/17



Toggle switches
2/18



Heavy duty pushbuttons
2/19



Accessories
2/20

Compact range



Pushbuttons
3/3



Mushroom pushbuttons
3/3



Illuminated pushbuttons
3/4



Pilot lights
3/5



Selector switches
3/6



Emergency stop pushbuttons
3/7



Machine stop pushbuttons
3/7



Buzzer
3/8



Heavy duty pushbuttons
3/8



Accessories
3/9

Other products



Enclosures and stations
4/3



Legend plates
5/3



Signal towers and signal beacons
6/3

Contents Overview

Introduction	1
Modular range	2
Compact range	3
Enclosures and stations	4
Legend plates	5
Signal towers and signal beacons	6
Dimensions and general information	7



Introduction Overview

Introduction	
ABB's pilot devices	1/4
Emergency stop	1/6
L-mark	1/7

ABB's pilot devices

1

Worldwide availability Over 130 countries

Global network

ABB's pilot devices are a part of the comprehensive range of high quality Low Voltage Products and Systems for industrial control applications. ABB has a wide network of external channel partners, such as distributors, system integrators and panel builders all around the world.

Made for tough industrial environments IP67 and IP69K

Heavy duty design

Our pilot device ranges feature a heavy duty design, suitable for tough environments, and meet most major global industrial standards and approvals. Our entire compact range and selected parts of the modular range features IP69K degree protection demanded in many industries such as cement, food and beverage. Whatever the application, you can feel confident that ABB's pilot devices will do the job.

Pilot devices offering Compact and modular range

ABB's pilot devices

ABB offers a complete range of 22 mm pushbuttons, emergency stops, selector switches and signaling units. These are complemented with enclosures and a wide range of accessories. ABB offers high performing, robust and easy to install products, providing cost efficient solutions for our customers. ABB's pilot devices are suitable for a wide variety of industrial environments, indoor as well as outdoor.

High standard

Our products also meet all essential national and international product standards making us your perfect global business partner.

In combination of our wide range of pilot devices, ABB also offers a broad product portfolio of Low Voltage Products such as contactors, softstarters, DOL & Y/D starters, electronic relays, breakers, switches, UMC etc.



IP67 and IP69K

ABB's entire compact range, and selected devices from the modular range, are approved IP67 and IP69K. This means that the products are designed to withstand periodic submersion, as well as high pressure, high temperature spraydown.

Wiping action

The contact blocks for both compact and modular devices feature self-cleaning contacts per a built-in wiping action. Upon operation, the moving contact rolls over and slides sideways when touching the fixed contact. This feature ensures a good, clean contact even in applications of seldom or periodic use.



Pilot devices offering

ABB's pilot devices offer both a modular and compact range of pushbuttons. Both feature the same front-of-panel design and appear consistent when combined.

- The modular range features a wide range of operators that can be combined with high flexibility. The unique snap-on design promotes simple and fast assembly.
- The compact range features an all-in-one construction and rugged design for added simplicity and ease of installation.



Emergency stop

Award winning design

1



Emergency stops

Choosing the right emergency stop device is vital in order to increase the safety for your personnel and equipment. ABB has a very wide range of emergency stops which all fulfill the IEC 60947-5-5 standard For emergency stop devices.

Best product award

Our emergency stop series was awarded "Best product" by the well-known magazine P&A, in the category "Ex-shutz & sicherheit" voted by the magazine's readers.

Modular range

Includes operators, holder, contact blocks, LED blocks and accessories that can be combined with high flexibility.

Compact range

Features an all-in-one design.

Accessories

- Emergency stop shroud
- Enclosures
- Legend plates



L-mark

Customer specific marking online



L-mark makes customer specific marking easy

A new system for custom marking our pilot devices is now available. In addition to engraving legend plates, ABB can now laser-engage our entire pilot device offering as well.

The customer will receive a reference number for their specified marking from the L-mark web page, where it also will be saved, making reordering simple and ensuring that our customers receive their preferred marking every time they order.

Text only available in black.

It's now possible to create a customer specific marking online using our five step marking tool:

Visit: <http://bol.services.it.abb.com/pilot-devices>

- Step 1 Find your product by typing the type or order code
- Step 2 Choose between text or symbol marking.
- Step 3 Choose your preferred marking layout.
- Step 4 Type marking or choose any of our 3000 symbols including the ISO 7000 library.
- Step 5 Order the product by the order code + ref. code provided on the site. Example:
order code: 1SFA611130L1101
(order code always with a L instead of a R)
type code: MPD1-11R-L
reference number: MUE979

Modular range

2



The modular range is our widest range of operators with solutions for almost every need and with market leading electrical ratings

General construction

- Unique snap on contact blocks
- Simple mounting without tools
- One of the widest range of integrated LED bulbs
- Same front design as compact range
- Up to 6 contact blocks (8 joystick)

Operators

- Pushbuttons (illuminated & non-illuminated)
- Emergency stops (twist, pull & key release)
- Machine stops (twist, pull & key release)
- Selector switches (2,3 & 4-position)
- Key switches
- Mushrooms
- Joysticks
- Toggle switches
- Heavy duty pushbuttons
- Double pushbuttons
- Potentiometers
- Reset pushbuttons

Pilot lights

- Integrated LED (wide range of voltages)
- BA9s base for filament bulb or LED

Product features

- Suitable in the toughest environments IP 66, (67 & 69K)
- Wiping action gives high performance with low energies
- UL/NEMA Type 1,3R,4,4X,12,13
- Unique wide range of integrated LED bulbs

Modular range

Overview

Introduction

Mounting	2/3
Contact block combinations	2/4

Ordering data

Pushbuttons	2/5
Double pushbuttons	2/6
Mushroom pushbuttons	2/9
Pilot lights	2/9
Emergency stop pushbuttons	2/10
Machine stop pushbuttons	2/10
Selector switches	2/11
Key-operated selector switches	2/14
Potentiometers	2/15
Reset pushbuttons	2/16
Joysticks	2/17
Toggle switches	2/18
Heavy duty pushbuttons	2/19

Accessories

Accessories	2/20
-------------	------

Technical data

Technical data	2/27
----------------	------

Modular range Mounting

2

Contact block

Single pole with making or breaking contact

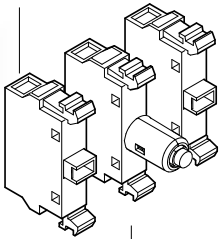

Holder

Available either for three or five blocks in one single row. Additional blocks can be stacked on holder for three blocks

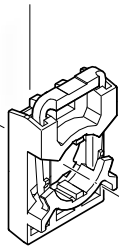

Locking nut



Legend plates

Aluminum construction with guided slots for proper alignment of the legend plate and operator.

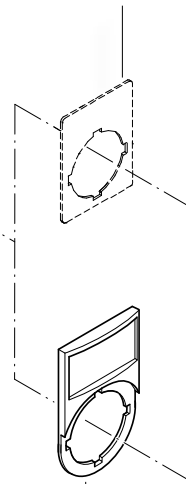

Operator

Buttons, lenses and handles in several colors. Illuminated or non-illuminated

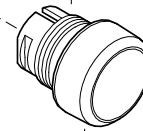

LED/lamp block

Illuminated pushbuttons, illuminated selector switches and pilot lights have a lamp block in the center position of the holder

Round or notched holes

Same actuator can be used in notched holes as well as in round holes

Legend plate holder

Of black plastic. Insert of brushed aluminum.

Bezels

Pushbuttons, selector switches and toggle switches with bezel in black plastic, chrome plastic or chrome metal available

Easy to install

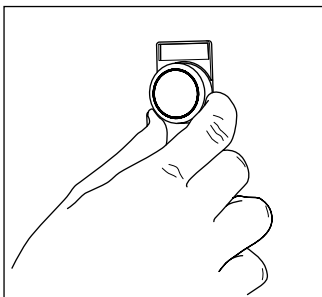

The operator is to be inserted from the front...

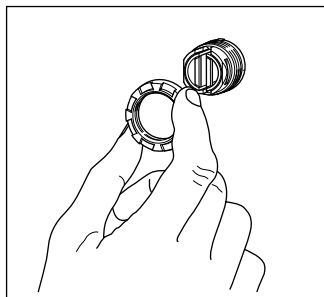

...and secured at the back with the nut.

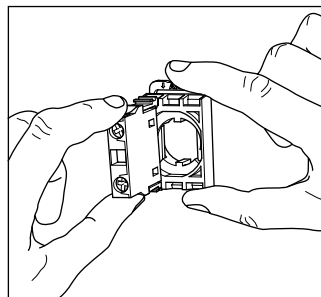

The contact blocks/Lamp block are then snapped on to the holder...

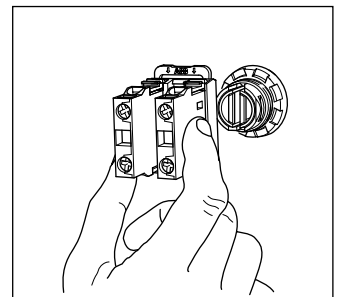

...and the holder snaps on to the operator.

...and to remove

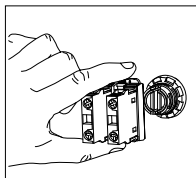
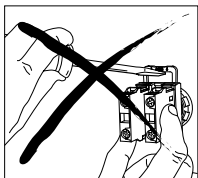

Press down the spring on the holder and pull the holder from the actuator.

Modular range

Contact block combinations

Pushbuttons and mushrooms



Double pushbuttons



Emergency stops



Selector switches



Toggles



Pilot lights



Joysticks



Pushbuttons

2



Description

Colors	Red	Green	Yellow	Blue	White	Black	Grey	Clear
Replace ■ in type with	R	G	Y	L	W	B	U	C
Replace □ in order code with	1	2	3	4	5	6	7	8

Ordering details	Type	Order code	Pkg qty	Weight (1pce) Kg
------------------	------	------------	---------	------------------

How to order non-illuminated pushbutton:
 see page 2/3-4 for more information
Alt.1 operator (with locking nut) + holder + contact block(s)
Alt.2 operator (with locking nut) + holder with contact block(s)

Flush pushbutton

Available in: red, green, yellow, blue, white, black, clear

Momentary	MP1-10■	1SFA611100R100□	1x10	0.016
Maintained	MP2-10■	1SFA611101R100□	1x10	0.016

Extended pushbutton

Available in: red, green, yellow, blue, white, black, clear

Momentary	MP3-10■	1SFA611102R100□	1x10	0.016
Maintained	MP4-10■	1SFA611103R100□	1x10	0.016

How to order illuminated pushbutton:

see page 2/3-4 for more information
Alt.1 operator (with locking nut) + holder + contact block(s) + LED/lamp block
Alt.2 operator (with locking nut) + holder with contact block(s) and lamp block

Illuminated flush pushbutton

Available in: red, green, yellow, blue, white, clear

Momentary	MP1-11■	1SFA611100R110□	1x10	0.016
Maintained	MP2-11■	1SFA611101R110□	1x10	0.016

Note: Light bulb max 2 W, not included

Illuminated extended pushbutton

Available in: red, green, yellow, blue, white, clear

Momentary	MP3-11■	1SFA611102R110□	1x10	0.016
Maintained	MP4-11■	1SFA611103R110□	1x10	0.016

Note: Light bulb max 2 W, not included

Accessories

Bezel options - how to order

Black plastic - standard	MPX-10X	1SFA61110XR1XXX	1x10	0.002
Chrome plastic - replace '1' with '2' in Type and Order codes	MPX-20X	1SFA61110XR2XXX	1x10	0.002
Chrome metal	MPX-30X	1SFA61110XR3XXX	1x10	0.015

Contact blocks and holder

Holder for 3 blocks	MCBH-00	1SFA611605R1100	1x10	0.006
Contact block 1NO	MCB-10	1SFA611610R1001	1x10	0.013
Contact block 1NC	MCB-01	1SFA611610R1010	1x10	0.013
Lamp block, BA 9s base	MLB-1	1SFA611620R1001	1x10	0.015
Mounting tool	MA1-8015	1SFA611920R8015	1	0.021



Double pushbuttons



MPD2-11B

MPD3-11B



MPD12-11B

MPD16-11B

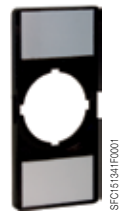

MA1-8138

Description

How to order:

see page 2/3-4 for more information

Alt.1 operator + holder + contact blocks

Alt.2 operator + holder with contact blocks

Upper button	Lower button	Type	Order code	Pkg qty	Weight (1pce) Kg
--------------	--------------	------	------------	---------	------------------

Flush pushbutton

Upper button	Lower button	Type	Order code	Pkg qty	Weight (1pce) Kg
● Green	● Red				
No text	No text	MPD1-11B	1SFA611130R1106	1x10	0.025
I	O	MPD2-11B	1SFA611131R1106	1x10	0.025
ON	OFF	MPD3-11B	1SFA611132R1106	1x10	0.025
START	STOP	MPD4-11B	1SFA611133R1106	1x10	0.025
○ White	● Black				
No text	No text	MPD5-11B	1SFA611134R1106	1x10	0.025
Customer specific marking		MPD5-11B-L	1SFA611134L1106	1x10	0.025

Extended lower Pushbutton

Upper button	Lower button	Type	Order code	Pkg qty	Weight (1pce) Kg
● Green	● Red				
No text	No text	MPD12-11B	1SFA611141R1106	1x10	0.025
I	O	MPD13-11B	1SFA611142R1106	1x10	0.025
ON	OFF	MPD14-11B	1SFA611143R1106	1x10	0.025
START	STOP	MPD15-11B	1SFA611144R1106	1x10	0.025
○ White	● Black				
No text	No text	MPD16-11B	1SFA611145R1106	1x10	0.025
Customer specific marking		MPD16-11B-L	1SFA611145L1106	1x10	0.025

Accessories

Legend plate holder

Type	Type	Order code	Pkg qty	Weight (1pce) Kg
2-position	MA1-8138	1SFA611920R8138	1	0.003

Double pushbuttons Illuminated

2



MPD2-11R

1SFC151079W001



MPD3-11G

1SFC151083W001



MPD1-11Y

1SFC151077W001



MPD5-11C

1SFC151009W001



MA1-8138

1SFC151344F001

Description

How to order:

see page 2/3-4 for more information

Alt.1 operator + holder + contact blocks + LED/lamp block

Alt.2 operator + holder with contact blocks and lamp block

Upper button	Lower button	Type	Order code	Pkg qty	Weight (1pce) Kg
--------------	--------------	------	------------	---------	------------------

Red indicator light

Green	Red				
No text	No text	MPD1-11R	1SFA611130R1101	1x10	0.025
	O	MPD2-11R	1SFA611131R1101	1x10	0.025
ON	OFF	MPD3-11R	1SFA611132R1101	1x10	0.025
START	STOP	MPD4-11R	1SFA611133R1101	1x10	0.025
White	Black				
No text	No text	MPD5-11R	1SFA611134R1101	1x10	0.025
Customer specific marking		MPD5-11R-L	1SFA611134L1101	1x10	0.025

Green indicator light

Green	Red				
No text	No text	MPD1-11G	1SFA611130R1102	1x10	0.025
	O	MPD2-11G	1SFA611131R1102	1x10	0.025
ON	OFF	MPD3-11G	1SFA611132R1102	1x10	0.025
START	STOP	MPD4-11G	1SFA611133R1102	1x10	0.025
White	Black				
No text	No text	MPD5-11G	1SFA611134R1102	1x10	0.025
Customer specific marking		MPD5-11G-L	1SFA611134L1102	1x10	0.025

Yellow indicator light

Green	Red				
No text	No text	MPD1-11Y	1SFA611130R1103	1x10	0.025
	O	MPD2-11Y	1SFA611131R1103	1x10	0.025
ON	OFF	MPD3-11Y	1SFA611132R1103	1x10	0.025
START	STOP	MPD4-11Y	1SFA611133R1103	1x10	0.025
White	Black				
No text	No text	MPD5-11Y	1SFA611134R1103	1x10	0.025
Customer specific marking		MPD5-11Y-L	1SFA611134L1103	1x10	0.025

Clear indicator light

Green	Red				
No text	No text	MPD1-11C	1SFA611130R1108	1x10	0.025
	O	MPD2-11C	1SFA611131R1108	1x10	0.025
ON	OFF	MPD3-11C	1SFA611132R1108	1x10	0.025
START	STOP	MPD4-11C	1SFA611133R1108	1x10	0.025
White	Black				
No text	No text	MPD5-11C	1SFA611134R1108	1x10	0.025
Customer specific marking		MPD5-11C-L	1SFA611134L1108	1x10	0.025

Accessories

Legend plate holder

2-position	MA1-8138	1SFA611920R8138	1	0.003
------------	----------	-----------------	---	-------

Double pushbuttons Illuminated, extended lower button



MPD13-11R

1SFC15113W0001



MPD14-11G

1SFC15117W0001



MPD12-11Y

1SFC15119W0001



MPD15-11C

1SFC15117W0001



MA1-8138

1SFC15144F0001

Description

How to order:

see page 2/3-4 for more information

Alt.1 operator + holder + contact blocks + LED/lamp block

Alt.2 operator + holder with contact blocks and lamp block

Upper button	Lower button	Type	Order code	Pkg qty	Weight (1pce) Kg
Red indicator light					
● Green	● Red				
No text	No text	MPD12-11R	1SFA611141R1101	1x10	0.025
I	O	MPD13-11R	1SFA611142R1101	1x10	0.025
ON	OFF	MPD14-11R	1SFA611143R1101	1x10	0.025
START	STOP	MPD15-11R	1SFA611144R1101	1x10	0.025
○ White	● Black				
No text	No text	MPD16-11R	1SFA611145R1101	1x10	0.025
Customer specific marking		MPD16-11R-L	1SFA611145L1101	1x10	0.025
Green indicator light					
● Green	● Red				
No text	No text	MPD12-11G	1SFA611141R1102	1x10	0.025
I	O	MPD13-11G	1SFA611142R1102	1x10	0.025
ON	OFF	MPD14-11G	1SFA611143R1102	1x10	0.025
START	STOP	MPD15-11G	1SFA611144R1102	1x10	0.025
○ White	● Black				
No text	No text	MPD16-11G	1SFA611145R1102	1x10	0.025
Customer specific marking		MPD16-11G-L	1SFA611145L1102	1x10	0.025
Yellow indicator light					
● Green	● Red				
No text	No text	MPD12-11Y	1SFA611141R1103	1x10	0.025
I	O	MPD13-11Y	1SFA611142R1103	1x10	0.025
ON	OFF	MPD14-11Y	1SFA611143R1103	1x10	0.025
START	STOP	MPD15-11Y	1SFA611144R1103	1x10	0.025
○ White	● Black				
No text	No text	MPD16-11Y	1SFA611145R1103	1x10	0.025
Customer specific marking		MPD16-11Y-L	1SFA611145L1103	1x10	0.025
Clear indicator light					
● Green	● Red				
No text	No text	MPD12-11C	1SFA611141R1108	1x10	0.025
I	O	MPD13-11C	1SFA611142R1108	1x10	0.025
ON	OFF	MPD14-11C	1SFA611143R1108	1x10	0.025
START	STOP	MPD15-11C	1SFA611144R1108	1x10	0.025
○ White	● Black				
No text	No text	MPD16-11C	1SFA611145R1108	1x10	0.025
Customer specific marking		MPD16-11C-L	1SFA611145L1108	1x10	0.025
Accessories					
Legend plate holder					
2-position		MA1-8138	1SFA611920R8138	1	0.003

Mushroom pushbuttons

Non-illuminated and illuminated

2



MPM1-10B

1SFC151010W001



MPM2-10Y

1SFC151074W001



MPM1-11G

1SFC151173W001



MPM2-11R

1SFC151459W001

Description

Colors	Red	Green	Yellow	Black
Replace <input type="checkbox"/> in type with	R	G	Y	B
Replace <input type="checkbox"/> in order code with	1	2	3	6

Description	Type	Order code	Pkg qty	Weight (1pce) Kg
-------------	------	------------	---------	------------------

How to order non-illuminated:

see page 2/3-4 for more information

Alt.1 operator (with locking nut) + holder + contact block(s)

Alt.2 operator (with locking nut) + holder with contact block(s)

Non-illuminated

Ø 40 mm available in: red, green, yellow, black	MPM1-10	1SFA611124R100	1x10	0.018
Ø 60 mm available in: red, yellow, black	MPM2-10	1SFA611125R100	1x10	0.020

How to order illuminated:

see page 2/3-4 for more information

Alt.1 operator (with locking nut) + holder + contact block(s) + LED/lamp block

Alt.2 operator (with locking nut) + holder with contact block(s) and lamp block

Illuminated

Ø 40 mm available in: red, green, yellow	MPM1-11	1SFA611124R110	1x10	0.018
Ø 60 mm available in: red, yellow	MPM2-11	1SFA611125R110	1x10	0.020

Note: Light bulb max 2 W, not included

Pilot lights



ML1-100R

1SFC151134W001



ML1-100G

1SFC151134W001



ML1-100Y

1SFC151136W001



ML1-100L

1SFC151137W001



ML1-100C

1SFC151138W001

Description

Colors	Red	Green	Yellow	Blue	White	Clear
Replace <input type="checkbox"/> in type with	R	G	Y	L	W	C
Replace <input type="checkbox"/> in order code with	1	2	3	4	5	8

Description	Type	Order code	Pkg qty	Weight (1pce) Kg
-------------	------	------------	---------	------------------

How to order:

see page 2/3-4 for more information

Alt.1 Indicator + holder + LED/lamp block

Alt.2 Indicator + holder + LED/lamp block + lens: used together with LED to improve light diffusion (Cannot be used together with text cap)

Pilot light

Pilot light	ML1-100	1SFA611400R100	1x10	0.018
-------------	---------	----------------	------	-------

Note: Light source not included. Bulbs and lamp blocks or LED blocks - See Accessories.

Accessories

Lens

Light diffusing lens	KA1-8005	1SFA616920R8005	1x10	0.001
----------------------	----------	-----------------	------	-------

Note: Light diffusing lens is used to improve illumination of LED bulbs. Cannot be used together with text cap.

Emergency stop pushbuttons

Non-illuminated, illuminated

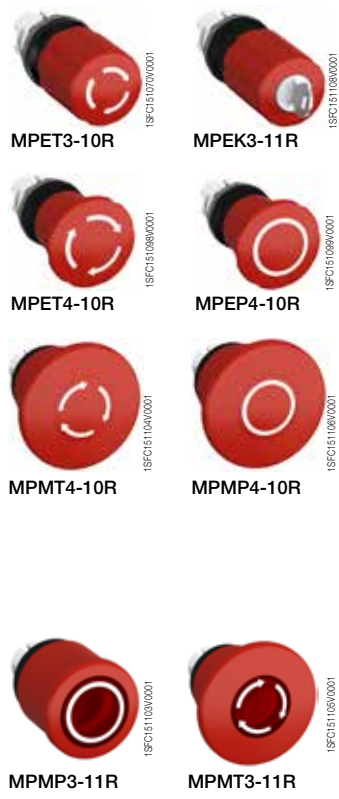

Description	Type	Order code	Pkg qty	Weight (1pce) Kg
How to order non-illuminated: see page 2/3-4 for more information Alt.1 operator + holder + contact block(s) Alt.2 operator + holder with contact block(s)				
Non-illuminated				
Ø 30 mm				
● Red	Twist release	MPET3-10R	1SFA611520R1001	1 0.036
● Red	Pull release	MPEP3-10R	1SFA611521R1001	1 0.036
● Red	Key release code 71/ronis 455	MPEK3-11R	1SFA611522R1101	1 0.065
● Red	Key release code 72/ronis 421	MPEK3-12R	1SFA611522R1201	1 0.065
● Red	Key release code 73/ronis 3433-E	MPEK3-13R	1SFA611522R1301	1 0.065
Ø 40 mm				
● Red	Twist release	MPET4-10R	1SFA611523R1001	1 0.036
● Red	Pull release	MPEP4-10R	1SFA611524R1001	1 0.036
● Red	Key release code 71/ronis 455	MPEK4-11R	1SFA611525R1101	1 0.065
● Red	Key release code 72/ronis 421	MPEK4-12R	1SFA611525R1201	1 0.065
● Red	Key release code 73/ronis 3433-E	MPEK4-13R	1SFA611525R1301	1 0.065
Ø 60 mm				
● Red	Twist release	MPMT4-10R	1SFA611513R1001	1 0.048
● Red	Pull release	MPMP4-10R	1SFA611514R1001	1 0.048
How to order illuminated: see page 2/3-4 for more information Alt.1 operator + holder + contact block(s) + LED/lamp block Alt.2 operator + holder with contact block(s) and LED/lamp block				
Illuminated				
Ø 40 mm				
● Red	Twist release	MPMT3-11R	1SFA611510R1101	1 0.041
● Red	Pull release	MPMP3-11R	1SFA611511R1101	1 0.041
Ø 60 mm				
● Red	Twist release	MPMT4-11R	1SFA611513R1101	1 0.048
● Red	Pull release	MPMP4-11R	1SFA611514R1101	1 0.048
Note: Light bulb max 2 W, not included				

Machine stop pushbuttons

Non-illuminated

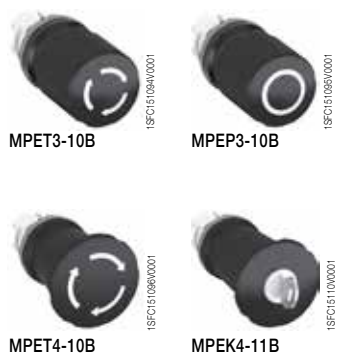

Description	Type	Order code	Pkg qty	Weight (1pce) Kg
How to order: see page 2/3-4 for more information Alt.1 operator + holder + contact block(s) Alt.2 operator + holder with contact block(s)				
Non-illuminated				
Ø 30 mm				
● Black	Twist release	MPET3-10B	1SFA611520R1006	1 0.036
● Black	Pull release	MPEP3-10B	1SFA611521R1006	1 0.036
● Black	Key release code 71/ronis 455	MPEK3-11B	1SFA611522R1106	1 0.065
Ø 40 mm				
● Black	Twist release	MPET4-10B	1SFA611523R1006	1 0.036
● Black	Pull release	MPEP4-10B	1SFA611524R1006	1 0.036
● Black	Key release code 71/ronis 455	MPEK4-11B	1SFA611525R1106	1 0.065

Selector switches

2-position

2



M2SS1-10B 1SFC1511300/0001 M2SS1-10R 1SFC1511280/0001



M2SS4-30B 1SFC1511260/0001 M2SS4-30U 1SFC1511280/0001



M2SS1-31L 1SFC1511440/0001 M2SS1-11C 1SFC1511430/0001



M2SS4-31R 1SFC1512380/0001 M2SS4-11G 1SFC1512100/0001



Bezel 1SFC1512100/0001 MCBH-00 1SFC1512700/0001 MA1-8015 1SFC1512790/0001



MCB-01 1SFC1512700/0001 MCB-10 1SFC1512380/0001 MLB-1 1SFC1511680/0001

Description

Colors	Red	Green	Yellow	Blue	Black	Grey	Clear
Replace ■ in type with	R	G	Y	L	B	U	C
Replace □ in order code with	1	2	3	4	6	7	8

Description	Type	Order code	Pkg qty	Weight (1pce) Kg
-------------	------	------------	---------	------------------

How to order non-illuminated:

see page 2/3-4 for more information
Alt.1 operator + holder + contact block(s)
Alt.2 operator + holder with contact block(s)

Non-illuminated

Short handle available in: red, black, grey

	Maintained	M2SS1-10■	1SFA611200R100□	1x10	0.015
	Maintained	M2SS2-10■	1SFA611201R100□	1x10	0.015
	Momentary, spring return from C to B	M2SS3-10■	1SFA611202R100□	1x10	0.015
Long handle available in: red, black, grey					
	Maintained	M2SS4-10■	1SFA611203R100□	1x10	0.018
	Maintained	M2SS5-10■	1SFA611204R100□	1x10	0.018
	Momentary, spring return from C to B	M2SS6-10■	1SFA611205R100□	1x10	0.018

How to order illuminated:

see page 2/3-4 for more information
Alt.1 operator + holder + contact block(s) + LED/lamp block
Alt.2 operator + holder with contact block(s) and LED/lamp block

Illuminated

Short handle available in: red, green, yellow, blue, clear

	Maintained	M2SS1-11■	1SFA611200R110□	1x10	0.015
	Maintained	M2SS2-11■	1SFA611201R110□	1x10	0.015
	Momentary, spring return from C to B	M2SS3-11■	1SFA611202R110□	1x10	0.015
Long handle available in: red, green, yellow, blue, clear					
	Maintained	M2SS4-11■	1SFA611203R110□	1x10	0.018
	Maintained	M2SS5-11■	1SFA611204R110□	1x10	0.018
	Momentary, spring return from C to B	M2SS6-11■	1SFA611205R110□	1x10	0.018

Note: Light bulb max 2 W, not included

Accessories

Bezel options, how to order

Black plastic - standard	M2SS(X)-10X	1SFA61120XR10XX	1x10	0.001
Chrome plastic - replace '1' with '2' in type and order codes	M2SS(X)-20X	1SFA61120XR20XX	1x10	0.001
Chrome metal - replace '1' with '3' in type and order codes	M2SS(X)-30X	1SFA61120XR30XX	1x10	0.010

Contact blocks and holder

Holder for 3 blocks	MCBH-00	1SFA611605R1100	1x10	0.006
Contact block 1NO	MCB-10	1SFA611610R1001	1x10	0.013
Contact block 1NC	MCB-01	1SFA611610R1010	1x10	0.013
Lamp block, BA 9s base	MLB-1	1SFA611620R1001	1x10	0.015
Mounting tool	MA1-8015	1SFA611920R8015	1	0.021

Selector switches

3-position



M3SS1-10B

M3SS1-10R



M3SS4-30B

M3SS4-30U



M3SS1-31L

M3SS1-11C



M3SS4-31R

M3SS4-11G

Description

Colors	Red	Green	Yellow	Blue	Black	Grey	Clear
Replace ■ in type with	R	G	Y	L	B	U	C
Replace □ in order code with	1	2	3	4	6	7	8

Description	Type	Order code	Pkg qty	Weight (1pce) Kg
-------------	------	------------	---------	------------------

How to order non-illuminated:

see page 2/3-4 for more information

Alt.1 operator + holder + contact block(s)

Alt.2 operator + holder with contact block(s)

Non-illuminated

Short handle available in: red, black, grey

Maintained	M3SS1-10■	1SFA611210R100□	1x10	0.015
Momentary, spring return from A to B and from C to B	M3SS2-10■	1SFA611211R100□	1x10	0.015
Momentary, spring return from C to B	M3SS3-10■	1SFA611212R100□	1x10	0.015
Momentary, spring return from A to B	M3SS7-10■	1SFA611216R100□	1x10	0.015

Long handle available in: red, black, grey

Maintained	M3SS4-10■	1SFA611213R100□	1x10	0.018
Momentary, spring return from A to B and from C to B	M3SS5-10■	1SFA611214R100□	1x10	0.018
Momentary, spring return from C to B	M3SS6-10■	1SFA611215R100□	1x10	0.018
Momentary, spring return from A to B	M3SS8-10■	1SFA611217R100□	1x10	0.018

How to order illuminated:

see page 2/3-4 for more information

Alt.1 operator + holder + contact block(s) + LED/lamp block

Alt.2 operator + holder with contact block(s) and LED/lamp block

Illuminated

Short handle available in: red, green, yellow, blue, clear

Maintained	M3SS1-11■	1SFA611210R110□	1x10	0.015
Momentary, spring return from A to B and from C to B	M3SS2-11■	1SFA611211R110□	1x10	0.015
Momentary, spring return from C to B	M3SS3-11■	1SFA611212R110□	1x10	0.015
Momentary, spring return from A to B	M3SS7-11■	1SFA611216R110□	1x10	0.015

Long handle available in: red, green, yellow, blue, clear

Maintained	M3SS4-11■	1SFA611213R110□	1x10	0.018
Momentary, spring return from A to B and from C to B	M3SS5-11■	1SFA611214R110□	1x10	0.018
Momentary, spring return from C to B	M3SS6-11■	1SFA611215R110□	1x10	0.018
Momentary, spring return from A to B	M3SS8-11■	1SFA611217R110□	1x10	0.018

Note: Light bulb max 2 W, not included

Accessories

Bezel options, how to order

Black plastic - standard	M3SS(X)-10X	1SFA6112XXR10XX	1x10	0.001
Chrome plastic - replace '1' with '2' in type and order codes	M3SS(X)-20X	1SFA6112XXR20XX	1x10	0.001
Chrome metal - replace '1' with '3' in type and order codes	M3SS(X)-30X	1SFA6112XXR30XX	1x10	0.010

Contact blocks and holder

Holder for 3 blocks	MCBH-00	1SFA611605R1100	1x10	0.006
Contact block 1NO	MCB-10	1SFA611610R1001	1x10	0.013
Contact block 1NC	MCB-01	1SFA611610R1010	1x10	0.013
Lamp block, BA 9s base	MLB-1	1SFA611620R1001	1x10	0.015
Mounting tool	MA1-8015	1SFA611920R8015	1	0.021



Bezel

MCBH-00

MA1-8015



MCB-01

MCB-10

MLB-1

Selector switches 3 and 4-position

2



Description	Type	Order code	Pkg qty	Weight (1pce) Kg
-------------	------	------------	---------	------------------

How to order 3-position:
see page 2/3-4 for more information
Alt.1 operator + holder + contact block(s)
Alt.2 operator + holder with contact block(s)

Short handle				
Maintained	M3SSC1-10B	1SFA611250R1006	1x10	0.015
Momentary, spring return from A to B and from C to B	M3SSC2-10B	1SFA611251R1006	1x10	0.015
Momentary, spring return from C to B	M3SSC3-10B	1SFA611252R1006	1x10	0.015
Momentary, spring return from A to B	M3SSC7-10B	1SFA611256R1006	1x10	0.015

Long handle				
Maintained	M3SSC4-10B	1SFA611253R1006	1x10	0.018
Momentary, spring return from A to B and from C to B	M3SSC5-10B	1SFA611254R1006	1x10	0.018
Momentary, spring return from C to B	M3SSC6-10B	1SFA611255R1006	1x10	0.018
Momentary, spring return from A to B	M3SSC8-10B	1SFA611257R1006	1x10	0.018

How to order 4-position:
see page 2/3-4 for more information
Alt.1 operator + holder + contact block(s)
Alt.2 operator + holder with contact block(s)

Short handle				
Maintained	M4SS1-10	1SFA611290R400	1x10	

Long handle				
Maintained	M4SS2-10	1SFA611291R400	1x10	

Accessories

Bezel options, how to order				
Black plastic - standard	M3SSC(X)-10B	1SFA61125XR1006	1x10	0.001
Chrome metal - replace '1' with '3' in type and order codes	M3SSC(X)-30B	1SFA61125XR3006	1x10	0.010

Contact blocks and holder

Holder for 3 blocks	MCBH-00	1SFA611605R1100	1x10	0.006
Contact block 1NO	MCB-10	1SFA611610R1001	1x10	0.013
Contact block 1NC	MCB-01	1SFA611610R1010	1x10	0.013
Lamp block, BA 9s base	MLB-1	1SFA611620R1001	1x10	0.015
Mounting tool	MA1-8015	1SFA611920R8015	1	0.021



Contacts actuated

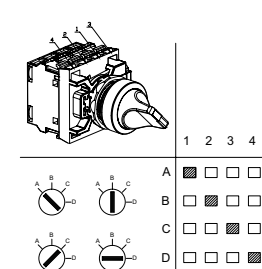

Contacts actuated

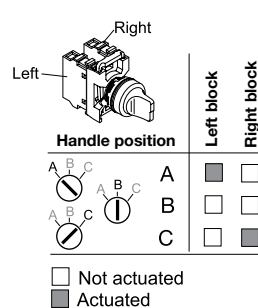

Key-operated selector switches 2 and 3-positions



Description	Type	Order code	Pkg qty	Weight (1pce) Kg
How to order 2-positions: see page 2/3-4 for more information Alt.1 operator + holder + contact block(s) Alt.2 operator + holder with contact block(s)				
2-positions				
Maintained (The key can be removed in both positions)				
	Key release code 71/ronis 455	M2SSK1-101	1SFA611280R1001	1 0.045
	Key release code 72/ronis 421	M2SSK1-102	1SFA611280R1002	1 0.045
	Key release code 73/ronis 3433-E	M2SSK1-103	1SFA611280R1003	1 0.045
	Random selection *)	M2SSK1-104	1SFA611280R1004	1 0.045
Maintained (The key can be removed in position B only)				
	Key release code 71/ronis 455	M2SSK2-101	1SFA611281R1001	1 0.045
	Key release code 72/ronis 421	M2SSK2-102	1SFA611281R1002	1 0.045
	Key release code 73/ronis 3433-E	M2SSK2-103	1SFA611281R1003	1 0.045
	Random selection *)	M2SSK2-104	1SFA611281R1004	1 0.045
Momentary, spring return from C to B (The key can be removed in position B only)				
	Key release code 71/ronis 455	M2SSK3-101	1SFA611282R1001	1 0.045
	Key release code 72/ronis 421	M2SSK3-102	1SFA611282R1002	1 0.045
	Key release code 73/ronis 3433-E	M2SSK3-103	1SFA611282R1003	1 0.045
	Random selection *)	M2SSK3-104	1SFA611282R1004	1 0.045

How to order 3-positions:
see page 2/3-4 for more information
Alt.1 operator + holder + contact block(s)
Alt.2 operator + holder with contact block(s)

3-positions				
Maintained (The key can be removed in all positions)				
	Key release code 71/ronis 455	M3SSK1-101	1SFA611283R1001	1 0.045
	Key release code 72/ronis 421	M3SSK1-102	1SFA611283R1002	1 0.045
	Key release code 73/ronis 3433-E	M3SSK1-103	1SFA611283R1003	1 0.045
	Random selection *)	M3SSK1-104	1SFA611283R1004	1 0.045
Maintained (The key can be removed in position B only)				
	Key release code 71/ronis 455	M3SSK2-101	1SFA611284R1001	1 0.045
	Key release code 72/ronis 421	M3SSK2-102	1SFA611284R1002	1 0.045
	Key release code 73/ronis 3433-E	M3SSK2-103	1SFA611284R1003	1 0.045
	Random selection *)	M3SSK2-104	1SFA611284R1004	1 0.045
Momentary, spring return from A to B and from C to B (The key can be removed in position B only)				
	Key release code 71/ronis 455	M3SSK3-101	1SFA611285R1001	1 0.045
	Key release code 72/ronis 421	M3SSK3-102	1SFA611285R1002	1 0.045
	Key release code 73/ronis 3433-E	M3SSK3-103	1SFA611285R1003	1 0.045
	Random selection *)	M3SSK3-104	1SFA611285R1004	1 0.045

*) 25 randomly picked unique key codes. (Key codes 71,72 and 73 not included)

Accessories

Bezel options, how to order

Black plastic - standard	M3SSK(X)-10X	1SFA61128X R100X	1x10	0.001
Chrome metal - replace '1' with '3' in type and order codes	M3SSK(X)-30X	1SFA61128X R300X	1x10	0.010

Contact blocks and holder

Holder for 3 blocks	MCBH-00	1SFA611605R1100	1x10	0.006
Contact block 1NO	MCB-10	1SFA611610R1001	1x10	0.013
Contact block 1NC	MCB-01	1SFA611610R1010	1x10	0.013
Lamp block, BA 9s base	MLB-1	1SFA611620R1001	1x10	0.015
Mounting tool	MA1-8015	1SFA611920R8015	1	0.021



Contacts actuated

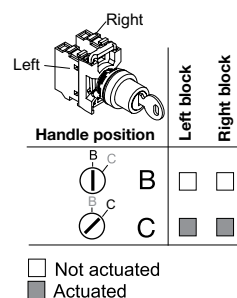

Contacts actuated

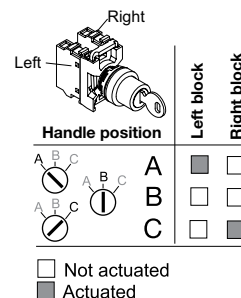

Potentiometers



1SFC151139/0001

2

MT-105B

Description	Type	Order code	Pkg qty	Weight (1pce) Kg
Complete potentiometers				
Black knob with integrated position indication and marking in white				
With resistor 5 kohm				
Black plastic bezel	MT-105B	1SFA611410R1056	1	0.040
Chrome metal bezel	MT-305B	1SFA611410R3056	1	0.048
With resistor 10 kohm				
Black plastic bezel	MT-110B	1SFA611410R1106	1	0.040
Chrome metal bezel	MT-310B	1SFA611410R3106	1	0.048
With resistor 50 kohm				
Black plastic bezel	MT-150B	1SFA611410R1506	1	0.040
Chrome metal bezel	MT-350B	1SFA611410R3506	1	0.048
Knob without resistor				
Black knob with integrated position indication and marking in white. For shaft diameter 6 -6.35 mm. Min. shaft length 20 mm.				
Black plastic bezel	KT-100B	1SFA616410R1006	10	0.034
Chrome metal bezel	KT-300B	1SFA616410R3006	10	0.042
Legend plates aluminium				
Symbol: see fig. (29.6 x 44.5 mm)	-	SK615562-87	10	0.002
Scale: 0-10 (48.5 x 44.5 mm)	-	SK615562-88	10	0.002
Scale: 0-50 (48.5 x 44.5 mm)	-	1SFA611930R1252	10	0.002

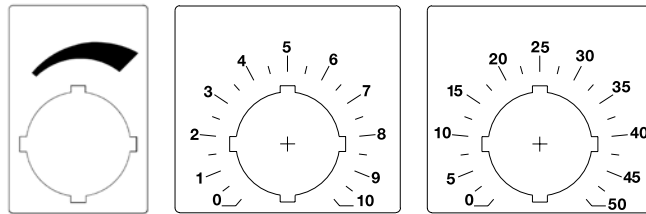

Reset pushbuttons

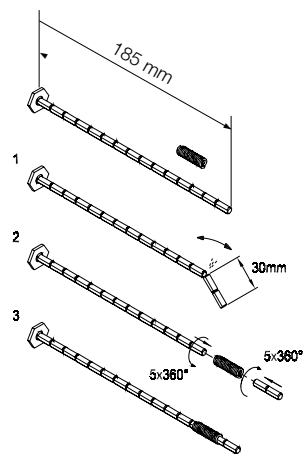

Description	Text	Type	Order code	Pkg qty	Weight (1pce) Kg
Flush button					
● Red	No text	KPR1-100R	1SFA616160R1001	1x10	0.020
● Green	No text	KPR1-100G	1SFA616160R1002	1x10	0.020
	II	KPR1-103G	1SFA616160R1032	1x10	0.020
● Yellow	No text	KPR1-100Y	1SFA616160R1003	1x10	0.020
● Blue	No text	KPR1-100L	1SFA616160R1004	1x10	0.020
	R	KPR1-101L	1SFA616160R1014	1x10	0.020
○ White	No text	KPR1-100W	1SFA616160R1005	1x10	0.020
	R	KPR1-101W	1SFA616160R1015	1x10	0.020
	I	KPR1-102W	1SFA616160R1025	1x10	0.020
	II	KPR1-103W	1SFA616160R1035	1x10	0.020
● Black	No text	KPR1-100B	1SFA616160R1006	1x10	0.020
	RESET	KPR1-104B	1SFA616160R1046	1x10	0.020

Extended button					
● Red	No text	KPR2-100R	1SFA616161R1001	1x10	0.021
	O	KPR2-105R	1SFA616161R1051	1x10	0.021
○ White	No text	KPR2-100W	1SFA616161R1005	1x10	0.021
● Black	No text	KPR2-100B	1SFA616161R1006	1x10	0.021
	O	KPR2-105B	1SFA616161R1056	1x10	0.021

How to order reset pushbuttons with shaft:

Alt.1 operator
+ shaft
+ flexible joint

Flush button					
● Red	No text	KPR3-100R	1SFA616162R1001	1x10	0.027
● Green	No text	KPR3-100G	1SFA616162R1002	1x10	0.027
	II	KPR3-103G	1SFA616162R1032	1x10	0.027
● Yellow	No text	KPR3-100Y	1SFA616162R1003	1x10	0.027
● Blue	No text	KPR3-100L	1SFA616162R1004	1x10	0.027
	R	KPR3-101L	1SFA616162R1014	1x10	0.027
○ White	No text	KPR3-100W	1SFA616162R1005	1x10	0.027
	R	KPR3-101W	1SFA616162R1015	1x10	0.027
	I	KPR3-102W	1SFA616162R1025	1x10	0.027
● Black	No text	KPR3-100B	1SFA616162R1006	1x10	0.027
	RESET	KPR3-104B	1SFA616162R1046	1x10	0.027

Extended button					
● Red	No text	KPR4-100R	1SFA616163R1001	1x10	0.028
	O	KPR4-105R	1SFA616163R1051	1x10	0.028
○ White	No text	KPR4-100W	1SFA616163R1005	1x10	0.028
● Black	No text	KPR4-100B	1SFA616163R1006	1x10	0.028
	O	KPR4-105B	1SFA616163R1056	1x10	0.028

Accessories

Shaft					
Shaft		KA1-8046	1SFA616920R8046	1x10	0.007
Flexible joint		KA1-8047	1SFA616920R8047	1x10	0.005

Bezel options, how to order

Black plastic - standard	KPRX-10XX	1SFA61616XR100X	1x10	0.001
Chrome metal - replace '1' with '3' in type and order codes	KPRX-30XX	1SFA61616XR300X	1x10	0.010

Joysticks IP67 and IP69K

2



MJS7-60B

1SFC1511270001

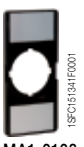

MA1-3138

1SFC151341F0001



MA1-8137

1SFC151341F0001

Description	Type	Order code	Pkg qty	Weight (1pce) Kg
-------------	------	------------	---------	------------------

How to order:
see page 2/3-4 for more information
Alt.1 operator (holder included) + contact blocks

Joystick				
2-position maintained	MJS1-60B	1SFA611701R6006	1	0.062
2-position momentary	MJS2-60B	1SFA611702R6006	1	0.062
4-position maintained	MJS5-60B	1SFA611705R6006	1	0.088
4-position momentary	MJS6-60B	1SFA611706R6006	1	0.088

Joystick with latching function				
2-position maintained	MJS7-60B	1SFA611707R6006	1	0.062
2-position momentary	MJS8-60B	1SFA611708R6006	1	0.062
4-position maintained	MJS11-60B	1SFA611711R6006	1	0.088
4-position momentary	MJS12-60B	1SFA611712R6006	1	0.088

Accessories

Legend plates				
2-position (1) (up - down)	MA6-1240	1SFA611930R1240	1	0.004
2-position (2) (right - left)	MA6-1241	1SFA611930R1241	1	0.004
4-position (3) (up - down - right - left)	MA6-1242	1SFA611930R1242	1	0.004

Legend plates holder				
4-position	MA1-8137	1SFA611920R8137	1	0.004
2-position	MA1-3138	1SFA611920R3138	1	0.003

Insert with symbol				
↑	MA6-1065	1SFA611930R1065	1x10	0.001

Toggle switches 2 and 3-positions



MTS2-10B

1SFC151132R0001



Bezel

1SFC151212V0001



MCBH-00

1SFC151027V0001



MA1-8015

1SFC151275V0001



MCB-01

1SFC151237V0001



MCB-10

1SFC151238V0001



MLB-1

1SFC151163F0001

Description	Bezel	Type	Order code	Pkg qty	Weight (1pce) Kg
How to order: see page 2/3-4 for more information Alt.1 operator + holder + contact block(s) Alt.2 operator + holder with contact block(s)					
2-positions					
Maintained					
	Black plastic	MTS1-10B	1SFA611300R1006	1x10	0.021
	Chrome plastic	MTS1-20B	1SFA611300R2006	1x10	0.021
	Chrome metal	MTS1-30B	1SFA611300R3006	1x10	0.021
3-positions					
Momentary, spring return from A to B and from C to B					
	Black plastic	MTS2-10B	1SFA611301R1006	1x10	0.021
	Chrome plastic	MTS2-20B	1SFA611301R2006	1x10	0.021
	Chrome metal	MTS2-30B	1SFA611301R3006	1x10	0.021
Maintained					
	Black plastic	MTS3-10B	1SFA611302R1006	1x10	0.021
	Chrome plastic	MTS3-20B	1SFA611302R2006	1x10	0.021
	Chrome metal	MTS3-30B	1SFA611302R3006	1x10	0.021
Accessories					
Contact blocks and holder					
Holder for 3 blocks		MCBH-00	1SFA611605R1100	1x10	0.006
Contact block 1NO		MCB-10	1SFA611610R1001	1x10	0.013
Contact block 1NC		MCB-01	1SFA611610R1010	1x10	0.013
Lamp block, BA 9s base		MLB-1	1SFA611620R1001	1x10	0.015
Mounting tool		MA1-8015	1SFA611920R8015	1	0.021

Contacts actuated

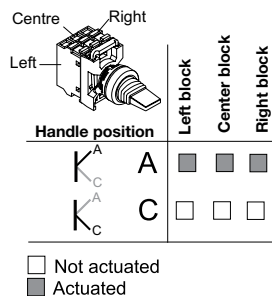

Contacts actuated

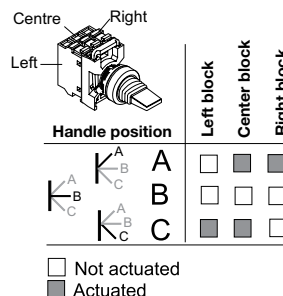

Heavy duty pushbuttons

For 30 mm mounting hole

2



KP6-40R

1SFC1510890001



KP6-40G

1SFC1510890001



KP6-40B

1SFC1510370001

Description

The heavy duty pushbutton for 30 mm hole, is a robust and compact pushbutton for use in cold, hot, damp, oily and other tough environments. Suitable especially for hydraulic lifts, compact pendant controllers and pushbutton stations.

How to order:

see page 2/3-4 for more information

Alt.1 Operator + contact block(s)

Description	Included Contact blocks	Type	Order code	Pkg qty	Weight (1pce) Kg
● Red	-	KP6-40R	1SFA616105R4001	1	0.022
● Green	-	KP6-40G	1SFA616105R4002	1	0.022
● Black	-	KP6-40B	1SFA616105R4006	1	0.022
● Black	1 NO + 1 NC	KP6-40B-11	1SFA616105R4076	1	0.048
● Black	1 NO	KP6-40B-10	1SFA616105R4016	1	0.035
● Black	1 NC	KP6-40B-01	1SFA616105R4046	1	0.035
● Black	2 NO	KP6-40B-20	1SFA616105R4026	1	0.048
● Black	2 NC	KP6-40B-02	1SFA616105R4056	1	0.048

Accessories

Contact blocks

1 NO	MCB-10	1SFA611610R1001	1x10	0.013
1 NC	MCB-01	1SFA611610R1010	1x10	0.013

Accessories for modular range LED blocks, front mounting



MLBL-00W

1SFC1512520001

Description	Rated current mA	Wavelength nm	Luminance mcd	Type	Order code	Pkg qty	Weight (1pce) Kg
Rated voltage 12 V DC							
● Red	12.0	620	320	MLBL-00R	1SFA611621R1001	1x10	0.012
● Green	12.0	520	1500	MLBL-00G	1SFA611621R1002	1x10	0.012
● Yellow	12.0	588	380	MLBL-00Y	1SFA611621R1003	1x10	0.012
● Blue	12.0	468	450	MLBL-00L	1SFA611621R1004	1x10	0.012
○ White	12.0	2) ¹⁾	600	MLBL-00W	1SFA611621R1005	1x10	0.012
Rated voltage 24 V AC/DC							
● Red	10.0	620	250	MLBL-01R	1SFA611621R1011	1x10	0.012
● Green	10.0	520	1500	MLBL-01G	1SFA611621R1012	1x10	0.012
● Yellow	10.0	588	250	MLBL-01Y	1SFA611621R1013	1x10	0.012
● Blue	10.0	468	450	MLBL-01L	1SFA611621R1014	1x10	0.012
○ White	10.0	2) ¹⁾	600	MLBL-01W	1SFA611621R1015	1x10	0.012
Rated voltage 48 V AC/DC							
● Red	10.0	620	260	MLBL-02R	1SFA611621R1021	1x10	0.012
● Green	13.0	520	1500	MLBL-02G	1SFA611621R1022	1x10	0.012
● Yellow	10.0	588	300	MLBL-02Y	1SFA611621R1023	1x10	0.012
● Blue	13.0	468	450	MLBL-02L	1SFA611621R1024	1x10	0.012
○ White	13.0	1) ¹⁾	600	MLBL-02W	1SFA611621R1025	1x10	0.012
Rated voltage 60 V AC/DC							
● Red	13.0	620	350	MLBL-03R	1SFA611621R1031	1x10	0.012
● Green	13.0	520	2000	MLBL-03G	1SFA611621R1032	1x10	0.012
● Yellow	13.0	588	400	MLBL-03Y	1SFA611621R1033	1x10	0.012
● Blue	13.0	468	550	MLBL-03L	1SFA611621R1034	1x10	0.012
○ White	13.0	1) ¹⁾	750	MLBL-03W	1SFA611621R1035	1x10	0.012
Rated voltage 110-130 V AC							
● Red	10.0	620	200	MLBL-04R	1SFA611621R1041	1x10	0.012
● Green	10.0	520	1200	MLBL-04G	1SFA611621R1042	1x10	0.012
● Yellow	10.0	588	250	MLBL-04Y	1SFA611621R1043	1x10	0.012
● Blue	10.0	468	400	MLBL-04L	1SFA611621R1044	1x10	0.012
○ White	10.0	1) ¹⁾	500	MLBL-04W	1SFA611621R1045	1x10	0.012
Rated voltage 110-130 V DC							
● Red	10.0	620	250	MLBL-05R	1SFA611621R1051	1x10	0.012
● Green	10.0	520	1500	MLBL-05G	1SFA611621R1052	1x10	0.012
● Yellow	10.0	588	300	MLBL-05Y	1SFA611621R1053	1x10	0.012
● Blue	10.0	468	450	MLBL-05L	1SFA611621R1054	1x10	0.012
○ White	10.0	1) ¹⁾	600	MLBL-05W	1SFA611621R1055	1x10	0.012
Rated voltage 220 V DC							
● Red	8.0	620	180	MLBL-06R	1SFA611621R1061	1x10	0.012
● Green	8.0	520	110	MLBL-06G	1SFA611621R1062	1x10	0.012
● Yellow	8.0	588	200	MLBL-06Y	1SFA611621R1063	1x10	0.012
● Blue	8.0	468	450	MLBL-06L	1SFA611621R1064	1x10	0.012
○ White	8.0	1) ¹⁾	600	MLBL-06W	1SFA611621R1065	1x10	0.012
Rated voltage 230 V AC							
● Red	10.0	620	250	MLBL-07R	1SFA611621R1071	1x10	0.012
● Green	10.0	520	1500	MLBL-07G	1SFA611621R1072	1x10	0.012
● Yellow	10.0	588	300	MLBL-07Y	1SFA611621R1073	1x10	0.012
● Blue	10.0	468	450	MLBL-07L	1SFA611621R1074	1x10	0.012
○ White	10.0	1) ¹⁾	600	MLBL-07W	1SFA611621R1075	1x10	0.012
Rated voltage 380 V AC							
● Red	10.0	620	250	MLBL-08R	1SFA611621R1081	1x10	0.012
● Green	10.0	520	1500	MLBL-08G	1SFA611621R1082	1x10	0.012
● Yellow	10.0	582	300	MLBL-08Y	1SFA611621R1083	1x10	0.012
● Blue	10.0	468	450	MLBL-08L	1SFA611621R1084	1x10	0.012
○ White	10.0	1) ¹⁾	600	MLBL-08W	1SFA611621R1085	1x10	0.012
Rated voltage 415 V AC							
● Red	11	620	280	MLBL-09R	1SFA611621R1091	1x10	0.012
● Green	11	520	1800	MLBL-09G	1SFA611621R1092	1x10	0.012
● Yellow	11	588	350	MLBL-09Y	1SFA611621R1093	1x10	0.012
● Blue	11	468	500	MLBL-09L	1SFA611621R1094	1x10	0.012
○ White	11	1) ¹⁾	650	MLBL-09W	1SFA611621R1095	1x10	0.012

Note: Care should be taken for DC supply where + and - must be correctly connected. This is marked X1 (+) and X2 (-) on the product.

¹⁾ X=0.31, Y=0.32 according to the ICI Chromaticity diagram.

Accessories for modular range

Contact blocks and holder

2



MCBH-00

1SFC151027V0001



MCBH5-00

1SFC151277V0001



MCB-01

1SFC151237V0001



MCB-10

1SFC151238V0001



MCBL-01

1SFC151239V0001



MCBL-10

1SFC151239V0001



MCB-02

1SFC151279V0001



MCB-20

1SFC151278V0001

Description	Type	Order code	Pkg qty	Weight (1pce) Kg
Holder				
3-positions	MCBH-00	1SFA611605R1100	1x10	0.006
5-positions*	MCBH5-00	1SFA611601R1100	1x10	0.008
* Note: Double contact blocks are required on side positions				
Single contact blocks for front mounting				
1 NO	MCB-10	1SFA611610R1001	1x10	0.013
1 NO	MCB-10	1SFA611610H1001	100	0.013
1 NC	MCB-01	1SFA611610R1010	1x10	0.013
1 NC	MCB-01	1SFA611610H1010	100	0.013
1 NO with gold plated contacts	MCB-10G	1SFA611610R1101	1x10	0.013
1 NC with gold plated contacts	MCB-01G	1SFA611610R1110	1x10	0.013
Micro switch blocks				
1 NO	MCBL-10	1SFA611612R1010	1x10	0.010
1 NC	MCBL-01	1SFA611612R1001	1x10	0.010
Double contact block for front mounting				
2 NO	MCB-20	1SFA611610R1002	1x10	0.026
2 NC	MCB-02	1SFA611610R1020	1x10	0.026
1 NO + 1 NC	MCB-11	1SFA611610R1011	1x10	0.026
Note: To be used together with MCBH5-00 when contact blocks in position 4- and 5- are needed. Also when using MCBH-00 together with selector switch and contact block in position 3 is needed				
Contact blocks with holder for front mounting, for non-illuminated operators				
1 NC	MCBH-01	1SFA611605R1110	1x10	0.019
1 NO	MCBH-10	1SFA611605R1101	1x10	0.019
2 NC	MCBH-02	1SFA611605R1120	1x10	0.032
2 NO	MCBH-20	1SFA611605R1102	1x10	0.032
1 NO + 1 NC	MCBH-11	1SFA611605R1111	1x10	0.032

Accessories for modular range

Transformer and lamp blocks



KTR1-1001

1SFC151889F0001



KTR1-2001

1SFC151881F0001



MLB-1

1SFC151620R0001

Description	Type	Order code	Pkg qty	Weight (1pce) Kg
-------------	------	------------	---------	------------------

Transformer blocks

For non-illuminated operators

Primary voltage	Secondary voltage				
110-127 V AC	6 V AC	KTR1-1001	1SFA616950R1001	1	0.095
220-250 V AC	6 V AC	KTR1-1002	1SFA616950R1002	1	0.095
380-420 V AC	6 V AC	KTR1-1003	1SFA616950R1003	1	0.095
440-480 V AC	6 V AC	KTR1-1004	1SFA616950R1004	1	0.095
500-600 V AC	6 V AC	KTR1-1005	1SFA616950R1005	1	0.095
110-127 V AC	24 V AC ¹⁾	KTR1-1011	1SFA616950R1011	1	0.095
220-250 V AC	24 V AC ¹⁾	KTR1-1012	1SFA616950R1012	1	0.095
380-420 V AC	24 V AC ¹⁾	KTR1-1013	1SFA616950R1013	1	0.095
440-480 V AC	24 V AC ¹⁾	KTR1-1014	1SFA616950R1014	1	0.095

Note: ¹⁾ Can be used with LED bulb

For illuminated operators

110-127 V AC	6 V AC	KTR1-2001	1SFA616950R2001	1	0.095
220-250 V AC	6 V AC	KTR1-2002	1SFA616950R2002	1	0.095
380-420 V AC	6 V AC	KTR1-2003	1SFA616950R2003	1	0.095
440-480 V AC	6 V AC	KTR1-2004	1SFA616950R2004	1	0.095
500-600 V AC	6 V AC	KTR1-2005	1SFA616950R2005	1	0.095
110-127 V AC	24 V AC ¹⁾	KTR1-2011	1SFA616950R2011	1	0.095
220-250 V AC	24 V AC ¹⁾	KTR1-2012	1SFA616950R2012	1	0.095
380-420 V AC	24 V AC ¹⁾	KTR1-2013	1SFA616950R2013	1	0.095
440-480 V AC	24 V AC ¹⁾	KTR1-2014	1SFA616950R2014	1	0.095

Note: For 6 or 24 V Filament bulb and 24 V LED. Max 1.2 W Filament bulb. Lamp block included in the transformer, BA 9s base

Diode block

Diode block	MDB-1001	1SFA611630R1001	1x10	0.015
-------------	----------	-----------------	------	-------

Note: To be used if several lamps are to be connected to a common lamp test pushbutton. A diode must be connected in series with each lamp. The Diode block snaps onto the lamp block or is placed at the side

Single lamp blocks for front mounting, BA 9s base

<p>230 V, 2 W X1 X2</p>	For max. 2 W, 230 V AC and DC filament bulb or LED	MLB-1	1SFA611620R1001	1x10	0.015
<p>115 V X1 X2 60 V 1.2 W</p>	115 V AC supply voltage. For 60 V filament bulb 1.2 W	MLB-2	1SFA611620R1002	1x10	0.017
<p>230 V X1 X2 130 V 2 W</p>	230 V AC supply voltage. For 130 V filament bulb 2 W	MLB-3	1SFA611620R1003	1x10	0.020
<p>115 V X1 X2 24 V LED</p>	115 V AC and DC supply voltage For 24 V LED only	MLB-4	1SFA611620R1004	1x10	0.017
<p>LED X1 X2 24-230V AC</p>	LED block designed to prevent glowing from leakage current	MLB-8	1SFA611620R1008	1x10	0.015

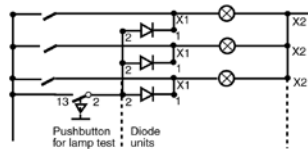

Diagram for lamp test with three diode blocks (not intended for integrated LED bulbs)

Accessories for modular range

2



MA1-8131

1SFC151278V0001



MDB-2

1SFC151455F0001



KA1

1SFC151253R0001



KA1-8072

1SFC151484R0001



MA1-8015

1SFC151278V0001



MA1-8149

1SFC151004R0001

Description	Type	Order code	Pkg qty	Weight (1pce) Kg
DIN-rail adaptor				
DIN-rail adaptor	MA1-8131	1SFA611920R8131	1	0.020
DIN-rail (adaptor) kit with one dummy block	MA1-8001	1SFA611920R8001	1	0.028
Note: DIN-rail adaptor should be used with back mounted contactblocks				
Dummy block				
Dummy block	MDB-2	1SFA611630R1002	1x10	0.003
Note: Dummy blocks are used when only one contact block or a compact device is used together with the DIN-rail adaptor				
30 mm adaptors for 22 mm operator (1.5-4 mm panels)				
For emergency stop pushbutton				
Black plastic	KA1-8027	1SFA616920R8027	1	0.007
Chrome metal	KA1-8028	1SFA616920R8028	1	0.021
For pushbuttons, selector switches, pilot lights, potentiometers and buzzers				
Black plastic	KA1-8029	1SFA616920R8029	1	0.010
Chrome metal	KA1-8030	1SFA616920R8030	1	0.035
Flush mounted adaptors (metal)				
For pushbuttons	KA1-8073	1SFA616920R8073	1	0.050
For selector switches	MA1-8074	1SFA611920R8074	1	0.050
Lamp changing tool				
For LED and filament bulbs	KA1-8072	1SFA616920R8072	1	0.002
Mounting tool for operator				
Mounting tool for tightening the locking nut	MA1-8015	1SFA611920R8015	1	0.021
Mounting tool for power tool	MA1-8149	1SFA611920R8149	1	0.155
Extra key				
Ronis 455 (key code 71)	-	SK616021-71	1x10	0.007
Ronis 421 (key code 72)	-	SK616021-72	1x10	0.007
Ronis 3433-E (key code 73)	-	SK616021-73	1x10	0.007
Locking nut				
Locking nut	MA1-8019	1SFA611920R8019	1x10	0.001
Note: The locking nut can also be used with compact devices				

Accessories for modular range



MA1-8126

1SFC151408F0001



KA1-8010

1SFC151379F0001



Bezel

1SFC151212K0001



MA1-81..

1SFC151488F0001



MA1-8124

1SFC151487F0001



MA1-8153

1SFC151470F0001



MA1-8152

1SFC151472F0001



MA1-8053

1SFC151282F0001



MA1-8128

1SFC151281F0001

Description	Type	Order code	Pkg qty	Weight (1pce) Kg
Protective membrane				
For flush button	MA1-8052	1SFA611920R8052	1x10	0.002
For extended button	MA1-8002	1SFA616920R8002	1x10	0.002
For double pushbutton	MA1-8126	1SFA611920R8126	1x10	0.002
Protective ring				
Operator for protective ring	-	SK615512-1	1x10	0.002
Note: For flush and extended pushbuttons. To prevent accidental operation. Cannot be used together with Legend plate holder				
Protective cover				
Protective cover	KA1-8010	1SFA616920R8010	1x10	0.008
Note: For flush pushbutton. To prevent accidental operation. Cannot be used together with Legend plate holder				
Bezel				
For pushbuttons				
Grey plastic	KA1-8079	1SFA616920R8079	1x10	0.002
Black plastic	KA1-8022	1SFA616920R8022	1x10	0.002
Chrome metal	KA1-8021	1SFA616920R8021	1x10	0.015
For selector switches				
Grey plastic	KA1-8077	1SFA616920R8077	1x10	0.001
Black plastic	KA1-8080	1SFA616920R8080	1x10	0.001
Chrome metal	KA1-8024	1SFA616920R8024	1x10	0.010
Locking nut				
Locking nut	MA1-8019	1SFA611920R8019	1x10	0.001
Note: The locking nut can also be used with compact devices.				
Blanking plug				
Grey	MA1-8129	1SFA611920R8129	1x10	0.005
Black	MA1-8130	1SFA611920R8130	1x10	0.005
Light grey	MA1-8136	1SFA611920R8136	1x10	0.005
Square bezel				
Black plastic	-	SK616016-2	1x10	0.001
Grey plastic	MA1-8124	1SFA611920R8124	1x10	0.001
Shroud for pushbuttons				
Lockable shroud	MA1-8153	1SFC611920R8153	1x10	0.023
Touch guard	MA1-8152	1SFC611920R8152	1x10	0.009
Note: Touch guard for modular and compact pushbutton Lockable shroud for modular and compact pushbuttons and selector switches				
Shroud for emergency stop and machine stop				
● Yellow	MA1-8053	1SFA611920R8053	1x10	0.020
● Grey	MA1-8128	1SFA611920R8128	1x10	0.020
Note: For 40 mm emergency stop pushbuttons and machine stop pushbuttons. To prevent accidental operation. With anti rotation tabs and slot for pad-lock and with water drainage.				

Accessories for modular range

LED bulbs



1SFC15178P001

KA2...

2

Description	Wavelength nm	Luminance mcd	Type	Order code	Pkg qty	Weight (1pce) Kg
Rated voltage 12 V DC rated current 15 mA, service life >50 000h						
● Red	630	250	KA2-2011	1SFA616921R2011	1x20	0.005
● Green	525	1000	KA2-2012	1SFA616921R2012	1x20	0.005
● Yellow	592	250	KA2-2013	1SFA616921R2013	1x20	0.005
● Blue	470	450	KA2-2014	1SFA616921R2014	1x20	0.005
○ White	¹⁾	600	KA2-2015	1SFA616921R2015	1x20	0.005
Rated voltage 24 V (AC)/DC rated current 15 mA, service life >50 000h						
● Red	630	250	KA2-2021	1SFA616921R2021	1x20	0.005
● Green	525	800	KA2-2022	1SFA616921R2022	1x20	0.005
● Yellow	592	250	KA2-2023	1SFA616921R2023	1x20	0.005
● Blue	470	400	KA2-2024	1SFA616921R2024	1x20	0.005
○ White	¹⁾	500	KA2-2025	1SFA616921R2025	1x20	0.005
Rated voltage 36 V (AC)/DC rated current 12 mA, service life >50 000h						
● Red	630	200	KA2-2031	1SFA616921R2031	1x20	0.005
● Green	525	2000	KA2-2032	1SFA616921R2032	1x20	0.005
● Yellow	592	200	KA2-2033	1SFA616921R2033	1x20	0.005
● Blue	470	750	KA2-2034	1SFA616921R2034	1x20	0.005
○ White	¹⁾	1400	KA2-2035	1SFA616921R2035	1x20	0.005
Rated voltage 48 V (AC)/DC rated current 12 mA, service life >50 000h						
● Red	630	200	KA2-2041	1SFA616921R2041	1x20	0.005
● Green	525	1700	KA2-2042	1SFA616921R2042	1x20	0.005
● Yellow	592	240	KA2-2043	1SFA616921R2043	1x20	0.005
● Blue	470	720	KA2-2044	1SFA616921R2044	1x20	0.005
○ White	¹⁾	1200	KA2-2045	1SFA616921R2045	1x20	0.005
Rated voltage 60 V (AC)/DC rated current 10 mA, service life >50 000h						
● Red	630	160	KA2-2051	1SFA616921R2051	1x20	0.005
● Green	525	1400	KA2-2052	1SFA616921R2052	1x20	0.005
● Yellow	592	200	KA2-2053	1SFA616921R2053	1x20	0.005
● Blue	470	600	KA2-2054	1SFA616921R2054	1x20	0.005
○ White	¹⁾	1000	KA2-2055	1SFA616921R2055	1x20	0.005
Rated voltage 110-130 V AC rated current 4-6 mA, service life 25 000h						
● Red	630	60-100	KA2-2131	1SFA616921R2131	1x20	0.005
● Green	525	500-850	KA2-2132	1SFA616921R2132	1x20	0.005
● Yellow	592	70-120	KA2-2133	1SFA616921R2133	1x20	0.005
● Blue	470	220-350	KA2-2134	1SFA616921R2134	1x20	0.005
○ White	¹⁾	350-600	KA2-2135	1SFA616921R2135	1x20	0.005
Rated voltage 110-130 V AC/DC rated current 4-6 mA, service life 25 000h						
● Red	630	60	KA2-2141	1SFA616921R2141	1x20	0.005
● Green	525	500	KA2-2142	1SFA616921R2142	1x20	0.005
● Yellow	592	70	KA2-2143	1SFA616921R2143	1x20	0.005
● Blue	470	220	KA2-2144	1SFA616921R2144	1x20	0.005
○ White	¹⁾	350	KA2-2145	1SFA616921R2145	1x20	0.005
Rated voltage 230 V AC rated current 4 mA, service life 25 000h						
● Red	630	60	KA2-2221	1SFA616921R2221	1x20	0.005
● Green	525	500	KA2-2222	1SFA616921R2222	1x20	0.005
● Yellow	592	70	KA2-2223	1SFA616921R2223	1x20	0.005
● Blue	470	220	KA2-2224	1SFA616921R2224	1x20	0.005
○ White	¹⁾	350	KA2-2225	1SFA616921R2225	1x20	0.005
Rated voltage 230 V AC/DC rated current 4 mA, service life 25 000h						
● Red	630	60	KA2-2231	1SFA616921R2231	1x20	0.005
● Green	525	500	KA2-2232	1SFA616921R2232	1x20	0.005
● Yellow	592	70	KA2-2233	1SFA616921R2233	1x20	0.005
● Blue	470	220	KA2-2234	1SFA616921R2234	1x20	0.005
○ White	¹⁾	350	KA2-2235	1SFA616921R2235	1x20	0.005

Note: Care should be taken for DC supply where + and - must be correctly connected. This is marked X1 (+) and X2 (-) on the product. Choose the same color on the LED as on the lamp cap. ¹⁾ X=0.31, Y=0.32 according to the ICI chromaticity diagram

Accessories for modular range

LED bulbs, lamp changing tool and lenses



Filament bulbs

1SFC151179F0001



KA1-8072

1SFC151468F0001



KA1-8083

1SFC151249W0001



KA1-8084

1SFC151248V0001



KA1-8091

1SFC151240V0001



KA1-8092

1SFC151241V0001



KA1-8102

1SFC151250V0001



KA1-8108

1SFC151251V0001



KA1-8111

1SFC151247V0001



KA1-8114

1SFC151246V0001

Description	Wavelength nm	Service life hours	Type	Order code	Pkg qty	Weight (1pce) Kg
-------------	---------------	--------------------	------	------------	---------	------------------

Flashing LED bulbs

Rated voltage 24 V rated current 25 mA, DC

● Red	630	50 000	-	4950512-1	1x20	0.005
● Green	565	50 000	-	4950512-2	1x20	0.005
● Yellow	585	50 000	-	4950512-3	1x20	0.005

Note: Care should be taken for DC supply where + and - must be correctly connected. This is marked X1 (+) and X2 (-) on the product. Choose the same color on the LED as on the lamp cap

Filament bulbs BA 9s base

Rated voltage V m AC/DC	Rated current A	Rated Output W	Service life h	Luminance mcd	Type	Order code	Pkg qty	Weight (1pce) Kg
6	200	1.2	10 000	350	-	5911086-11	1x20	0.002
12	100	1.2	10 000	203	-	5911086-12	1x20	0.002
24	50	1.2	10 000	280	-	5911086-13	1x20	0.002
30	40	1.2	10 000	250	-	5911086-4	1x20	0.002
48	42	2	6 000	500	-	5911086-5	1x20	0.002
60	20	1.2	5 000	190	-	5911086-14	1x20	0.002
110	18	2	7 500	250	-	5911086-7	1x20	0.002
130	15	2	7 500	120	-	5911086-15	1x20	0.002

Note: A lamp changing tool is required for changing bulb

Lamp changing tool

For LED bulbs and for bulbs	KA1-8072	1SFA616920R8072	1	0.002
-----------------------------	----------	-----------------	---	-------

Note: A lamp changing tool is required for changing bulb

Lenses

Colors	● Red	● Green	● Yellow	● Blue	○ White	● Black	● Grey	○ Clear
Replace <input type="checkbox"/>	1	2	3	4	5	6	7	8

Description	Type	Order code	Pkg qty	Weight (1pce) Kg
-------------	------	------------	---------	------------------

Lenses for pilot lights

Available in: red, green, yellow, blue, white, clear

Lenses for pilot lights	KA1-803 <input type="checkbox"/>	1SFA616920R803 <input type="checkbox"/>	1x10	0.02
-------------------------	----------------------------------	---	------	------

Lenses for non-illuminated pushbuttons

Available in: red, green, yellow, blue, white, black, grey, clear

Flush	KA1-808 <input type="checkbox"/>	1SFA616920R808 <input type="checkbox"/>	1x10	0.015
Extended	KA1-809 <input type="checkbox"/>	1SFA616920R809 <input type="checkbox"/>	1x10	0.025

Lenses for illuminated pushbuttons

Available in: red, green, yellow, blue, white, clear

Flush	KA1-810 <input type="checkbox"/>	1SFA616920R810 <input type="checkbox"/>	1x10	0.015
Extended	KA1-811 <input type="checkbox"/>	1SFA616920R811 <input type="checkbox"/>	1x10	0.025

Technical data

2

Standards and approvals

IEC / EN 60947-1	Low Voltage switchgear and controlgear - Part 1: General rules
IEC / EN 60947-5-1	Low Voltage switchgear and controlgear - part 5-1: control circuit devices and switching elements - electromechanical control circuit devices
IEC / EN 60947-5-5	Low Voltage switchgear and controlgear - part 5-5: control circuit devices and switching elements - electrical emergency stop device with mechanical latching function
IEC / EN 60073	Basic and safety principles for man-machine interface, marking and identification coding principles for indicators and actuators
IEC / EN 60529	Degrees of protection provided by enclosures (IP code)
EN 50013	Low Voltage switchgear and controlgear for industrial use - terminal marking and distinctive number for particular control switches
DIN 40050-9	Road vehicles; Degrees of protection (IP-code); protection against foreign objects; water and contact; electrical equipment
UL 508	Industrial control equipment
CSA C22.2 No 14	Industrial control equipment

Environmental data

Degrees of protection

Operators	IEC/EN DIN	UL/CSA
Pushbutton: MP *	IP66	Type 1, 3R, 4, 4X, 12, 13
Double pushbutton: MPD *	IP66	Type 1, 3R, 4, 4X, 12, 13
Mushroom pushbutton: MPM *	IP66	Type 1, 3R, 4, 4X, 12, 13
Emergency stop: MPMT/P *	IP66	Type 1, 3R, 4, 4X, 12, 13
Selector switch: M2SS/M3SS *	IP66	Type 1, 3R, 4, 4X, 12, 13
Key-operated selector switch: M2SSK/M3SSK *	IP66	Type 1, 3R, 4, 4X, 12
Toggle switch: MTS2/MTS3 *	IP66	Type 1, 3R, 4, 4X, 12, 13
Heavy duty pushbutton: KP6	-	Type 1, 3R, 4, 4X
Reset pushbutton: KPR *	IP 66	Type 1, 3R, 4, 4X, 12, 13
Joystick: MJS	IP66, 67, 69K	Type 1, 4X (indoor), 12, 13
Pilot lights: ML	IP66	Type 1, 3R, 4, 4X, 12, 13
Potentiometer: KT MT*	IP66	Type 1, 3R, 4, 4X, 12, 13
Contact block and transformer block	IP20	-
Plastic enclosures	IP66	Type 1, 3R, 4, 4X, 12, 13
Metallic enclosures	IP66, 67, 69K	-

Temperature

Ambient temperature during operation	-25 to +70 °C
Storage temperature	-40 to +85 °C

* With chrome plastic bezel IP66 Type 1, 12, 13

Note: specified degree of protection is for operator mounted on panel. If other items are mounted in between, please make sure that they are correctly sealed.

Technical data

Terminals

Plus-minus pozidriv No.2 screw with DIN-washer.	
Connectable area	min. 1 x 0.5 mm ² /AWG 20 max. 2 x 2.5 mm ² /2 x AWG14

Tightening torque

Operators locking nut	Min. 2 Nm / Max. 2.3 Nm
Cable terminals	0.9 Nm

Material

No ozone depleting substances in the products. All front of panel plastic components are made of polycarbonate	
PC polycarbonate	High impact strength, good outdoor resistance. Chemical resistance (see table below)
PSU polysulphone	Can withstand high temperatures, acids, basic solutions, alkaline compounds, oils, alcohols
PA polyamide	Can withstand high temperatures, aliphatic, aromatic and chlorinated hydrocarbons, esters, ketone-aldehydes, alcohols and basic solutions
PBT	Can withstand high temperature, aliphatic and aromatic hydrocarbons, acids, basic solutions, alcohols, grease and oils
Zinc	Good corrosion resistance in inland-, sea and industrial atmosphere
Light-alloy	Good corrosion resistance in inland-, sea and industrial atmosphere

Chemical resistance for polycarbonate

Chemical class	Effects
Acids	No significant effect under most typical conditions of concentration and temperature
Alcohols and alkalis	Generally compatible at low concentration and room temperature. Higher concentrations and elevated temperatures can result in etching and attack evidenced by decomposition
Aliphatic hydrocarbons	Generally compatible
Amines	Surface crystallization and chemical attack. Avoid
Aromatic hydrocarbons	Partial solvents and severe stress cracking agents (i.e., xylene, toluene). Avoid
Detergents and cleaners	Mild soap solutions are generally compatible. Strong alkaline materials should be avoided
Esters	Cause severe crystallization. Partial solvents. Avoid
Greases and oils	Pure petroleum types generally compatible. Many additives used with them are not
Halogenated, hydrocarbons	Solvents. Avoid
Ketones	Cause severe crystallization and stress cracking. Partial solvents. Avoid
Silicone oil and greases	Generally compatible up to 85 °C

Technical data

Electrical data

Standard contact blocks

Self cleaning silver contacts, NC contact with positive opening. At voltages and currents below 24 V and 5.6 mA we recommend our micro switch blocks.

Ratings as per IEC 60947-5-1

Rated insulation voltage, U _i		690 V	
Rated thermal current, I _t		10 A	
Rated operational current, I _e	at: 120 V	8 A	
Utilization category AC 15,	at: 230 V	6 A	
	at: 400 V	4 A	
	at: 690 V	2 A	
Rated operational current, I _e utilisation category DC 13,	at: 24 V	5 A	
	at: 125 V	1.1 A	
	at: 250 V	0.55 A	

Ratings as per UL, CSA, NEMA

		A600 AC	Q600 DC
Rated insulation voltage		600 V	600 V
Rated thermal current		10 A	2.5 A
Rated operational current	at: 120 V	6 A	at: 125 V 0.55 A
	at: 240 V	3 A	at: 250 V 0.27 A
	at: 480 V	1.5 A	at: 480 V 0.10 A
	at: 600 V	1.2 A	at: 600 V 0.10 A

Contact resistance

< 25 mΩ

Compulsory function test

at: 5V, 16 mA

Max. number of contact blocks per operator

The contact blocks can be stacked in max two levels on the 3-block holder. Only one level is accepted on the 5-block holder.

Pushbutton, toggle switch, mushroom pushbutton, double pushbutton, selector switch, key-operated selector switch and emergency stop operator 6

Joystick 8

Short circuit protection

Max. fuse at 1 kA gG 16A

Diagram for make and break contact

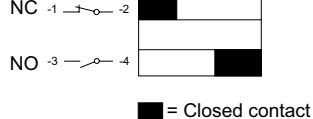

Micro switch block / Ratings as per IEC 60947-5-1

Rated insulation voltage, U _i		125 V
Rated thermal current, I _t		3 A
Rated operational current, I _e utilisation category AC 14,	at: 125 V	0.5 A
Rated operational current, I _e utilization category DC 13,	at: 24 V	0.3 A
Rated operational current, I _e utilization category DC 12,	at: 24 V	0.1 A

Minimum switching capacity

Standard contact blocks	24 V DC	5.6 mA
Gold plated contact blocks	5 V DC	12 mA
	12 V DC	1 mA
Micro switch blocks	3 V DC	1 mA

Ratings as per UL 508

	125 V AC	3 A
	60 V DC	0.2 A
	48 V DC	0.1 A

Mechanical data

Mechanical life

Standard contact blocks		10 million operations
Pushbuttons, momentary mushroom pushbutton		2 million operations
Selector switches		
Present standard (no operation of center contact)		500 000 operations
With operation of center contact		250 000 operations
		150 000 operations
Maintained mushroom pushbutton, key-operated selector switch and double pushbutton		500 000 operations
Emergency stop		100 000 operations
Toggle switch		1 million operations
Joystick		500 000 operations
		400 000 operations
		300 000 operations

Lamp block ratings as per IEC 60 947-5-1

Rated insulation voltage	230 V
Base	BA 9s
Permissible power, up to	2 W

Transformer block

Suitable for filament bulb 6 or 24 V AC, 1.2 W and LED 24 V	
Rated power	1.5 W
Rated insulation voltage acc. to IEC 70 °C (DT)	Class E

LED bulbs

Service life for LED bulbs means number of service hours until the brightness has been reduced down 50 %. Service life 50 000 h	
Color of white LED	x=0.31 Y=0.32 means the position of color in the ICI Chromaticity diagram
Voltage tolerance on LED bulbs	-30 to +10 % voltage is acceptable without affecting the Service life
Voltage peaks on LED bulbs	Voltage peaks up to 1000 V Current peaks up to 500 mA during a few msec
Glowing light	All integrated LED bulbs have a function built in to cut leakage currents

Compact range



The compact range is designed to be our most efficient solution when it comes to assembly and cost, suitable for the most demanding environments. It can also be combined with the modular range to cover the needs of additional flexibility.

General construction

- "All-in-one" design
- Same front as modular range
- 42 mm built in depth
- Up to 2 electrical contacts
- Metal or black plastic look

Product features

- Suitable in the toughest environments IP 66, 67 & 69K
- Wiping action gives high performance with low energies
- UL/NEMA Type 1,3R,4,4X,12,13

Operators

- Pushbuttons (illuminated & non-illuminated)
- Emergency stops (twist, pull & key release)
- Machine stops (twist, pull & key release)
- Selector switches (2 & 3 position)
- Mushrooms

Pilot lights

- Integrated LED (wide range of voltages)
- BA9s base for filament bulb or LED

Compact range

Overview

Ordering data

Pushbuttons	3/3
Mushroom pushbuttons	3/3
Illuminated pushbuttons	3/4
Pilot lights	3/5
Selector switches	3/6
Emergency stops	3/7
Machine stops	3/7
Buzzer	3/8
Heavy duty pushbuttons	3/8

Accessories

Accessories	3/9
-------------	-----

Technical data

Technical data	3/12
----------------	------

Pushbuttons

Flush and extended



CP1-10R-10

CP1-30W-10



CP1-10U-10

CP1-30L-10



CP3-10Y-10

CP3-30G-10

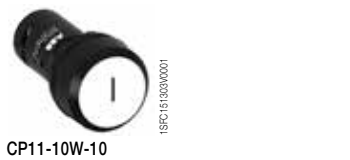

CP11-10W-10



Bezel

Description

Colors	Red	Green	Yellow	Blue	White	Black	Grey
Replace ■ in type with	R	G	Y	L	W	B	U
Replace □ in order code with	1	2	3	4	5	6	7

Description	Type	Order code	Pkg qty	Weight (1pce) Kg
-------------	------	------------	---------	------------------

Flush pushbutton

Momentary

1 NO	CP1-10■-10	1SFA619100R10□	1x10	0.018
2 NO	CP1-10■-20	1SFA619100R102□	1x10	0.022
1 NC	CP1-10■-01	1SFA619100R104□	1x10	0.018
2 NC	CP1-10■-02	1SFA619100R105□	1x10	0.022
1 NO +1 NC	CP1-10■-11	1SFA619100R107□	1x10	0.022

Maintained

1 NO	CP2-10■-10	1SFA619101R10□	1x10	0.018
2 NO	CP2-10■-20	1SFA619101R102□	1x10	0.022
1 NC	CP2-10■-01	1SFA619101R104□	1x10	0.018
2 NC	CP2-10■-02	1SFA619101R105□	1x10	0.022
1 NO +1 NC	CP2-10■-11	1SFA619101R107□	1x10	0.022

Extended pushbutton

Momentary

1 NO	CP3-10■-10	1SFA619102R10□	1x10	0.019
2 NO	CP3-10■-20	1SFA619102R102□	1x10	0.022
1 NC	CP3-10■-01	1SFA619102R104□	1x10	0.019
2 NC	CP3-10■-02	1SFA619102R105□	1x10	0.022
1 NO +1 NC	CP3-10■-11	1SFA619102R107□	1x10	0.022

Maintained

1 NO	CP4-10■-10	1SFA619103R10□	1x10	0.019
2 NO	CP4-10■-20	1SFA619103R102□	1x10	0.022
1 NC	CP4-10■-01	1SFA619103R104□	1x10	0.019
2 NC	CP4-10■-02	1SFA619103R105□	1x10	0.022
1 NO +1 NC	CP4-10■-11	1SFA619103R107□	1x10	0.022

Flush pushbutton

Momentary, white button marked with I (black)

1 NO	CP11-10W-10	1SFA619110R1015	1x10	0.018
------	-------------	-----------------	------	-------

Momentary, white button with II (black)

1 NO	CP12-10W-10	1SFA619120R1015	1x10	0.018
------	-------------	-----------------	------	-------

Extended pushbutton

Momentary, black button with O (white)

1 NC	CP33-10B-01	1SFA619132R1046	1x10	0.018
------	-------------	-----------------	------	-------

Accessories

Bezel options, how to order

Black plastic - standard	CP(X)-10X-XX	1SFA61910XR10XX	1x10	0.001
Chrome metal - replace '1' with '3' in type and order codes	CP(X)-30X-XX	1SFA61910XR30XX	1x10	0.010

Mushroom pushbuttons



CPM3-10R-11

CPM3-10L-11

Description	Type	Order code	Pkg qty	Weight (1pce) Kg
● Red	1 NO + 1 NC	CPM3-10R-11	1	0.036
● Green	1 NO + 1 NC	CPM3-10G-11	1	0.036
● Yellow	1 NO + 1 NC	CPM3-10Y-11	1	0.036
● Blue	1 NO + 1 NC	CPM3-10L-11	1	0.036
● Black	1 NO + 1 NC	CPM3-10B-11	1	0.036

Note: All mushroom pushbuttons are momentary. For maintained functions see machine stops or emergency stops

Illuminated pushbuttons

Flush and extended



CP1-31R-10

1SFC151191V0001



CP3-11G-01

1SFC15123V0001



CP1-31Y-10

1SFC151189V0001



CP1-11L-10

1SFC151149V0001



CP1-31C-10

1SFC151179V0001



CP3-31Y-01

1SFC151209V0001



Bezel

1SFC15122V0001

Description

Colors

Replace ■ in type with	● Red R	● Green G	● Yellow Y	● Blue L	○ Clear C
Replace □ in order code with	1	2	3	4	8

Description

Description	Type	Order code	Pkg qty	Weight (1pce) Kg
-------------	------	------------	---------	------------------

Flush pushbutton

Rated voltage 24 V AC/DC

Momentary

1 NC	CP1-11■-01	1SFA619100R114□	1x10	0.025
1 NO	CP1-11■-10	1SFA619100R111□	1x10	0.025

Maintained

1 NC	CP2-11■-01	1SFA619101R114□	1x10	0.025
1 NO	CP2-11■-10	1SFA619101R111□	1x10	0.025

Rated voltage 110-130 V AC/DC

Momentary

1 NC	CP1-12■-01	1SFA619100R124□	1x10	0.025
1 NO	CP1-12■-10	1SFA619100R121□	1x10	0.025

Maintained

1 NC	CP2-12■-01	1SFA619101R124□	1x10	0.025
1 NO	CP2-12■-10	1SFA619101R121□	1x10	0.025

Rated voltage 220 V AC/DC

Momentary

1 NC	CP1-13■-01	1SFA619100R134□	1x10	0.025
1 NO	CP1-13■-10	1SFA619100R131□	1x10	0.025

Maintained

1 NC	CP2-13■-01	1SFA619101R134□	1x10	0.025
1 NO	CP2-13■-10	1SFA619101R131□	1x10	0.025

Extended pushbutton

Rated voltage 24 V AC/DC

Momentary

1 NC	CP3-11■-01	1SFA619102R114□	1x10	0.025
1 NO	CP3-11■-10	1SFA619102R111□	1x10	0.025

Maintained

1 NC	CP4-11■-01	1SFA619103R114□	1x10	0.025
1 NO	CP4-11■-10	1SFA619103R111□	1x10	0.025

Rated voltage 110-130 V AC/DC

Momentary

1 NC	CP3-12■-01	1SFA619102R124□	1x10	0.025
1 NO	CP3-12■-10	1SFA619102R121□	1x10	0.025

Maintained

1 NC	CP4-12■-01	1SFA619103R124□	1x10	0.025
1 NO	CP4-12■-10	1SFA619103R121□	1x10	0.025

Rated voltage 220 V AC/DC

Momentary

1 NC	CP3-13■-01	1SFA619102R134□	1x10	0.025
1 NO	CP3-13■-10	1SFA619102R131□	1x10	0.025

Maintained

1 NC	CP4-13■-01	1SFA619103R134□	1x10	0.025
1 NO	CP4-13■-10	1SFA619103R131□	1x10	0.025

Accessories

Bezel options, how to order

Black plastic - standard	CP(X)-10X-XX	1SFA61910XR10XX	1x10	0.001
Chrome metal - replace '1' with '3' in type and order codes	CP(X)-30X-XX	1SFA61910XR30XX	1x10	0.010

Pilot lights with integrated LED



CL-501R

1SFC1512650001



CL-501L

1SFC1512670001

3

Description	Rated current mA	Wavelength nm	Luminance mcd	Type	Order code		Pkg qty	Weight (1pce) Kg
Rated voltage 12 V DC ¹⁾								
● Red	30	625	60	CL-501R	1SFA619402R5011		1x10	0.023
● Green	15	520	126	CL-501G	1SFA619402R5012		1x10	0.023
● Yellow	30	590	60	CL-501Y	1SFA619402R5013		1x10	0.023
● Blue	30	470	22	CL-501L	1SFA619402R5014		1x10	0.023
○ White	30	²⁾	88	CL-501W	1SFA619402R5015		1x10	0.023
Rated voltage 24 V AC/DC								
● Red	15	625	60	CL-502R	1SFA619402R5021		1x10	0.023
● Green	15	520	126	CL-502G	1SFA619402R5022		1x10	0.023
● Yellow	15	590	60	CL-502Y	1SFA619402R5023		1x10	0.023
● Blue	15	470	22	CL-502L	1SFA619402R5024		1x10	0.023
○ White	15	²⁾	88	CL-502W	1SFA619402R5025		1x10	0.023
Rated voltage 48 V AC/DC								
● Red	15	625	60	CL-504R	1SFA619402R5041		1x10	0.023
● Green	15	520	126	CL-504G	1SFA619402R5042		1x10	0.023
● Yellow	15	590	60	CL-504Y	1SFA619402R5043		1x10	0.023
● Blue	15	470	22	CL-504L	1SFA619402R5044		1x10	0.023
○ White	15	²⁾	88	CL-504W	1SFA619402R5045		1x10	0.023
Rated voltage 60 V AC/DC								
● Red	15	625	60	CL-505R	1SFA619402R5051		1x10	0.023
● Green	15	520	126	CL-505G	1SFA619402R5052		1x10	0.023
● Yellow	15	590	60	CL-505Y	1SFA619402R5053		1x10	0.023
● Blue	15	470	22	CL-505L	1SFA619402R5054		1x10	0.023
○ White	15	²⁾	88	CL-505W	1SFA619402R5055		1x10	0.023
Rated voltage 110-130 V AC								
● Red	15	625	60	CL-513R	1SFA619402R5131		1x10	0.023
● Green	15	520	126	CL-513G	1SFA619402R5132		1x10	0.023
● Yellow	15	590	60	CL-513Y	1SFA619402R5133		1x10	0.023
● Blue	15	470	22	CL-513L	1SFA619402R5134		1x10	0.023
○ White	15	²⁾	88	CL-513W	1SFA619402R5135		1x10	0.023
Rated voltage 110-130 V DC ¹⁾								
● Red	15	625	60	CL-515R	1SFA619402R5151		1x10	0.023
● Green	15	520	126	CL-515G	1SFA619402R5152		1x10	0.023
● Yellow	15	590	60	CL-515Y	1SFA619402R5153		1x10	0.023
● Blue	15	470	22	CL-515L	1SFA619402R5154		1x10	0.023
○ White	15	²⁾	88	CL-515W	1SFA619402R5155		1x10	0.023
Rated voltage 220 V DC ¹⁾								
● Red	15	625	60	CL-520R	1SFA619402R5201		1x10	0.023
● Green	15	520	126	CL-520G	1SFA619402R5202		1x10	0.023
● Yellow	15	590	60	CL-520Y	1SFA619402R5203		1x10	0.023
● Blue	15	470	22	CL-520L	1SFA619402R5204		1x10	0.023
○ White	15	²⁾	88	CL-520W	1SFA619402R5205		1x10	0.023
Rated voltage 230 V AC								
● Red	15	625	60	CL-523R	1SFA619402R5231		1x10	0.023
● Green	15	520	126	CL-523G	1SFA619402R5232		1x10	0.023
● Yellow	15	590	60	CL-523Y	1SFA619402R5233		1x10	0.023
● Blue	15	470	22	CL-523L	1SFA619402R5234		1x10	0.023
○ White	15	²⁾	88	CL-523W	1SFA619402R5235		1x10	0.023
Rated voltage 380 V AC								
● Red	15	625	60	CL-530R	1SFA619402R5301		1x10	0.023
● Green	15	520	126	CL-530G	1SFA619402R5302		1x10	0.023
● Yellow	15	590	60	CL-530Y	1SFA619402R5303		1x10	0.023
● Blue	15	470	22	CL-530L	1SFA619402R5304		1x10	0.023
○ White	15	²⁾	88	CL-530W	1SFA619402R5305		1x10	0.023
Rated voltage 415 V AC								
● Red	15	625	60	CL-541R	1SFA619402R5411		1x10	0.023
● Green	15	520	126	CL-541G	1SFA619402R5412		1x10	0.023
● Yellow	15	590	60	CL-541Y	1SFA619402R5413		1x10	0.023
● Blue	15	470	22	CL-541L	1SFA619402R5414		1x10	0.023
○ White	15	²⁾	88	CL-541W	1SFA619402R5415		1x10	0.023

Note: ¹⁾ Care should be taken for DC supply where + and - must be correctly connected. This is marked X1 (+) and X2 (-) on the product.

²⁾ X=0.31, Y=0.32 according to the ICI chromaticity diagram.

Pilot lights



CL-100R

1SFC151265W0001

Description						
Colors	Red	Green	Yellow	Blue	White	Clear
Replace <input checked="" type="checkbox"/> in type with	R	G	Y	L	W	C
Replace <input type="checkbox"/> in order code with	1	2	3	4	5	8
Description	Type	Order code	Pkg qty	Weight (1pce)	Kg	
Pilot light BA 9s base, bulb not included						
Pilot light	CL-100	1SFA619402R100	1x10	0.018		

Selector switches

2- and 3-position, non-illuminated



C2SS1-10R-10

1SFC151254W0001



C2SS1-10B-10

1SFC151255W0001



C2SS1-30U-10

1SFC151253W0001

Description						
Colors	Red	Black	Grey			
Replace <input checked="" type="checkbox"/> in type with	R	B	U			
Replace <input type="checkbox"/> in order code with	1	6	7			
Description	Type	Order code	Pkg qty	Weight (1pce)	Kg	
2-position						
Maintained						
	1 NO	C2SS1-10-10	1SFA619200R101	1x10	0.020	
	2 NO	C2SS1-10-20	1SFA619200R102	1x10	0.024	
	1 NC	C2SS1-10-01	1SFA619200R104	1x10	0.020	
	2 NC	C2SS1-10-02	1SFA619200R105	1x10	0.024	
	1 NO +1 NC	C2SS1-10-11	1SFA619200R107	1x10	0.024	
Maintained						
	1 NO	C2SS2-10-10	1SFA619201R101	1x10	0.020	
	2 NO	C2SS2-10-20	1SFA619201R102	1x10	0.024	
	1 NC	C2SS2-10-01	1SFA619201R104	1x10	0.020	
	2 NC	C2SS2-10-02	1SFA619201R105	1x10	0.024	
	1 NO +1 NC	C2SS2-10-11	1SFA619201R107	1x10	0.024	
Momentary						
	1 NO	C2SS3-10-10	1SFA619202R101	1x10	0.020	
	2 NO	C2SS3-10-20	1SFA619202R102	1x10	0.024	
	1 NC	C2SS3-10-01	1SFA619202R104	1x10	0.020	
	2 NC	C2SS3-10-02	1SFA619202R105	1x10	0.024	
	1 NO +1 NC	C2SS3-10-11	1SFA619202R107	1x10	0.024	
3-position						
Maintained						
	2 NO	C3SS1-10-20	1SFA619210R102	1x10	0.024	
	2 NC	C3SS1-10-02	1SFA619210R105	1x10	0.024	
	1 NO +1 NC	C3SS1-10-11	1SFA619210R107	1x10	0.024	
Momentary						
	2 NO	C3SS2-10-20	1SFA619211R102	1x10	0.024	
	2 NC	C3SS2-10-02	1SFA619211R105	1x10	0.024	
	1 NO +1 NC	C3SS2-10-11	1SFA619211R107	1x10	0.024	
Momentary						
	2 NO	C3SS3-10-20	1SFA619212R102	1x10	0.024	
	2 NC	C3SS3-10-02	1SFA619212R105	1x10	0.024	
	1 NO +1 NC	C3SS3-10-11	1SFA619212R107	1x10	0.024	
Momentary						
	2 NO	C3SS7-10-20	1SFA619216R102	1x10	0.024	
	2 NC	C3SS7-10-02	1SFA619216R105	1x10	0.024	
	1 NO +1 NC	C3SS7-10-11	1SFA619216R107	1x10	0.024	
Accessories						
Bezel options, how to order						
Black plastic - standard	C(X)SS(X)-10X-XX	1SFA619XXXR10XX	1x10	0.001		
Chrome metal - replace '1' with '3' in type and order codes	C(X)SS(X)-30X-XX	1SFA619XXXR30XX	1x10	0.010		



Bezel

1SFC151212W0001

Emergency stops Non-illuminated



Description	Type	Order code	Pkg qty	Weight (1pce) Kg
Ø 30 mm				
Twist release				
1 NC	CE3T-10R-01	1SFA619500R1041	1	0.032
2 NC	CE3T-10R-02	1SFA619500R1051	1	0.032
1 NO + 1 NC	CE3T-10R-11	1SFA619500R1071	1	0.032
Pull release				
2 NC	CE3P-10R-02	1SFA619501R1051	1	0.032
1 NO + 1 NC	CE3P-10R-11	1SFA619501R1071	1	0.032
Key release, ronis 455, key code 71				
2 NC	CE3K1-10R-02	1SFA619502R1051	1	0.060
1 NO + 1 NC	CE3K1-10R-11	1SFA619502R1071	1	0.060
Ø 40 mm				
Twist release				
1 NC	CE4T-10R-01	1SFA619550R1041	1	0.036
2 NC	CE4T-10R-02	1SFA619550R1051	1	0.036
1 NO + NC	CE4T-10R-11	1SFA619550R1071	1	0.036
Pull release				
2 NC	CE4P-10R-02	1SFA619551R1051	1	0.036
1 NO + 1 NC	CE4P-10R-11	1SFA619551R1071	1	0.036
Key release, ronis 455, key code 71				
2 NC	CE4K1-10R-02	1SFA619552R1051	1	0.064
1 NO + 1 NC	CE4K1-10R-11	1SFA619552R1071	1	0.064

Machine stops Non-illuminated



Description	Type	Order code	Pkg qty	Weight (1pce) Kg
Ø 30 mm				
Twist release				
1 NO + 1 NC	CE3T-10B-11	1SFA619500R1076	1	0.032
Pull release				
1 NO + 1 NC	CE3P-10B-11	1SFA619501R1076	1	0.032
Key release, ronis 455, key code 71				
1 NO + 1 NC	CE3K1-10B-11	1SFA619502R1076	1	0.060
Ø 40 mm				
Twist release				
1 NO + 1 NC	CE4T-10B-11	1SFA619550R1076	1	0.032
Pull release				
1 NO + 1 NC	CE4P-10B-11	1SFA619551R1076	1	0.032
Key release, ronis 455, key code 71				
1 NO + 1 NC	CE4K1-10B-11	1SFA619552R1076	1	0.064

Buzzers



CB1-600G

1SFC1511570/0001



CB1-610R

1SFC151159/0001



CB1-610Y

1SFC151159/0001



CB1-620B

1SFC151160/0001

Description	Lights and sound output	Rated current mA	Luminance mcd	Type	Order Code	Pkg qty	Weight (1pce) Kg
Illuminated							
Rated voltage 24 V AC/DC							
● Green	Continuous	48	126	CB1-600G	1SFA619600R6002	1x10	0.021
● Red	Pulsation	53	60	CB1-610R	1SFA619600R6101	1x10	0.021
● Yellow	Pulsation	53	60	CB1-610Y	1SFA619600R6103	1x10	0.021
Rated voltage 110-130 V AC							
● Green	Continuous	55	126	CB1-601G	1SFA619600R6012	1x10	0.021
● Red	Pulsation	70	60	CB1-611R	1SFA619600R6111	1x10	0.021
● Yellow	Pulsation	70	60	CB1-611Y	1SFA619600R6113	1x10	0.021
Rated voltage 110-130 V DC							
● Green	Continuous	15	126	CB1-602G	1SFA619600R6022	1x10	0.021
● Red	Pulsation	15	60	CB1-612R	1SFA619600R6121	1x10	0.021
● Yellow	Pulsation	15	60	CB1-612Y	1SFA619600R6123	1x10	0.021
Rated voltage 230 V AC							
● Green	Continuous	55	126	CB1-603G	1SFA619600R6032	1x10	0.021
● Red	Pulsation	70	60	CB1-613R	1SFA619600R6131	1x10	0.021
● Yellow	Pulsation	70	60	CB1-613Y	1SFA619600R6133	1x10	0.021
Non-illuminated							
Rated voltage 24 V AC/DC							
● Black	Continuous	40	-	CB1-620B	1SFA619600R6206	1x10	0.021
● Black	Pulsation	48	-	CB1-630B	1SFA619600R6306	1x10	0.021
Rated voltage 110-130 V AC							
● Black	Continuous	40	-	CB1-621B	1SFA619600R6216	1x10	0.021
● Black	Pulsation	48	-	CB1-631B	1SFA619600R6316	1x10	0.021
Rated voltage 110-130 V DC							
● Black	Continuous	15	-	CB1-622B	1SFA619600R6226	1x10	0.021
● Black	Pulsation	15	-	CB1-632B	1SFA619600R6326	1x10	0.021
Rated voltage 230 V AC							
● Black	Continuous	40	-	CB1-623B	1SFA619600R6236	1x10	0.021
● Black	Pulsation	40	-	CB1-633B	1SFA619600R6336	1x10	0.021

3

Heavy duty pushbuttons



CP6-10R

1SFC151029/0001



CP6-10G

1SFC151029/0001



CP6-10B

1SFC151029/0001

Description							
Colors							
Replace ■ in type with	● Red	● Green	● Black				
Replace □ in order code with	R	G	B				
	1	2	6				
Description	Type	Order code	Pkg qty	Weight (1pce) Kg			
Heavy duty pushbutton							
2NO	CP6-10■-20	1SFA619105R102□	1x10	0.031			
2NC	CP6-10■-02	1SFA619105R105□	1x10	0.031			
1NO+1NO	CP6-10■-11	1SFA619105R107□	1x10	0.031			

Accessories for compact range LED bulbs



KA2...

1SFC15178P001

3

Description	Wavelength nm	Luminance mcd	Type	Order code	Pkg qty	Weight (1pce) Kg
Rated voltage 12 V DC, rated current 15 mA, service life >50 000h						
● Red	630	250	KA2-2011	1SFA616921R2011	1x20	0.005
● Green	525	1000	KA2-2012	1SFA616921R2012	1x20	0.005
● Yellow	592	250	KA2-2013	1SFA616921R2013	1x20	0.005
● Blue	470	450	KA2-2014	1SFA616921R2014	1x20	0.005
○ White	¹⁾	600	KA2-2015	1SFA616921R2015	1x20	0.005
Rated voltage 24 V (AC)/DC, rated current 15 mA, service life >50 000h						
● Red	630	250	KA2-2021	1SFA616921R2021	1x20	0.005
● Green	525	800	KA2-2022	1SFA616921R2022	1x20	0.005
● Yellow	592	250	KA2-2023	1SFA616921R2023	1x20	0.005
● Blue	470	400	KA2-2024	1SFA616921R2024	1x20	0.005
○ White	¹⁾	500	KA2-2025	1SFA616921R2025	1x20	0.005
Rated voltage 36 V (AC)/DC, rated current 12 mA, service life >50 000h						
● Red	630	200	KA2-2031	1SFA616921R2031	1x20	0.005
● Green	525	2000	KA2-2032	1SFA616921R2032	1x20	0.005
● Yellow	592	200	KA2-2033	1SFA616921R2033	1x20	0.005
● Blue	470	750	KA2-2034	1SFA616921R2034	1x20	0.005
○ White	¹⁾	1400	KA2-2035	1SFA616921R2035	1x20	0.005
Rated voltage 48 V (AC)/DC, rated current 12 mA, service life >50 000h						
● Red	630	200	KA2-2041	1SFA616921R2041	1x20	0.005
● Green	525	1700	KA2-2042	1SFA616921R2042	1x20	0.005
● Yellow	592	240	KA2-2043	1SFA616921R2043	1x20	0.005
● Blue	470	720	KA2-2044	1SFA616921R2044	1x20	0.005
○ White	¹⁾	1200	KA2-2045	1SFA616921R2045	1x20	0.005
Rated voltage 60 V (AC)/DC, rated current 10 mA, service life >50 000h						
● Red	630	160	KA2-2051	1SFA616921R2051	1x20	0.005
● Green	525	1400	KA2-2052	1SFA616921R2052	1x20	0.005
● Yellow	592	200	KA2-2053	1SFA616921R2053	1x20	0.005
● Blue	470	600	KA2-2054	1SFA616921R2054	1x20	0.005
○ White	¹⁾	1000	KA2-2055	1SFA616921R2055	1x20	0.005
Rated voltage 110-130 V AC, rated current 4-6 mA, service life 25 000h						
● Red	630	60-100	KA2-2131	1SFA616921R2131	1x20	0.005
● Green	525	500-850	KA2-2132	1SFA616921R2132	1x20	0.005
● Yellow	592	70-120	KA2-2133	1SFA616921R2133	1x20	0.005
● Blue	470	220-350	KA2-2134	1SFA616921R2134	1x20	0.005
○ White	¹⁾	350-600	KA2-2135	1SFA616921R2135	1x20	0.005
Rated voltage 110-130 V AC/DC, rated current 4-6 mA, service life 25 000h						
● Red	630	60	KA2-2141	1SFA616921R2141	1x20	0.005
● Green	525	500	KA2-2142	1SFA616921R2142	1x20	0.005
● Yellow	592	70	KA2-2143	1SFA616921R2143	1x20	0.005
● Blue	470	220	KA2-2144	1SFA616921R2144	1x20	0.005
○ White	¹⁾	350	KA2-2145	1SFA616921R2145	1x20	0.005
Rated voltage 230 V AC, rated current 4mA, service life 25 000h						
● Red	630	60	KA2-2221	1SFA616921R2221	1x20	0.005
● Green	525	500	KA2-2222	1SFA616921R2222	1x20	0.005
● Yellow	592	70	KA2-2223	1SFA616921R2223	1x20	0.005
● Blue	470	220	KA2-2224	1SFA616921R2224	1x20	0.005
○ White	¹⁾	350	KA2-2225	1SFA616921R2225	1x20	0.005
Rated voltage 230 V AC/DC, rated current 4 mA, service life 25 000h						
● Red	630	60	KA2-2231	1SFA616921R2231	1x20	0.005
● Green	525	500	KA2-2232	1SFA616921R2232	1x20	0.005
● Yellow	592	70	KA2-2233	1SFA616921R2233	1x20	0.005
● Blue	470	220	KA2-2234	1SFA616921R2234	1x20	0.005
○ White	¹⁾	350	KA2-2235	1SFA616921R2235	1x20	0.005

Note: Care should be taken for DC supply where + and - must be correctly connected. This is marked X1 (+) and X2 (-) on the product. Choose the same color on the LED as on the lamp cap.

¹⁾ X=0.31, Y=0.32 according to the ICI chromaticity diagram.

Accessories for compact range



5911086-11

1SFC151179F001



KA1-8072

1SFC151484F001



MA1-8015

1SFC151279W001



MA1-8149

1SFC151004F001



CA1-8080

1SFC151279W001



KA1-80..

1SFC151253F001

Rated voltage V AC/DC	Rated current A	Rated Output W	Service life h	Lumi- nance mcd	Type	Order code	Pkg qty	Weight (1pce) Kg
Filament bulbs BA 9s base								
6	200	1.2	10 000	350	-	5911086-11	1x20	0.002
12	100	1.2	10 000	203	-	5911086-12	1x20	0.002
24	50	1.2	10 000	280	-	5911086-13	1x20	0.002
30	40	1.2	10 000	250	-	5911086-4	1x20	0.002
48	42	2	6 000	500	-	5911086-5	1x20	0.002
60	20	1.2	5 000	190	-	5911086-14	1x20	0.002
110	18	2	7 500	250	-	5911086-7	1x20	0.002
130	15	2	7 500	120	-	5911086-15	1x20	0.002

Note: A lamp changing tool is required for changing bulb

Description	Type	Order code	Pkg qty	Weight (1pce) Kg
-------------	------	------------	------------	------------------------

Lamp changing tool

For LED bulbs and for bulbs

KA1-8072

1SFA616920R8072

1

0.002

Note: A Lamp changing tool is required for changing bulb

Light diffusing lens

Light diffusing lens

KA1-8005

1SFA616920R8005

1x10

0.001

Note: To improve illumination. Cannot be used with Text cap. The lens is used instead of Text cap

Mounting tool

Used for tightening the Locking nut

MA1-8015

1SFA611920R8015

1

0.021

Mounting tool for power tool

MA1-8149

1SFA611920R8149

1

0.155

DIN-rail adaptor

DIN-rail adaptor

CA1-8080

1SFA619920R8080

1x10

0.028

Dummy block

MDB-2

1SFA611630R1002

1x10

0.003

Note: Two dummy blocks are included with the DIN-rail adaptor to make it possible to mount any compact device

Adaptors 30 mm

Black plastic

KA1-8029

1SFA616920R8029

1

0.010

Metal

KA1-8030

1SFA616920R8030

1

0.035

Note: For use when fitting the 22 mm pilot devices in 30 mm mounting holes (1.5 - 4 mm panels)

For use with pushbuttons, selector switches, emergency stop pushbutton and pilot lights

Adaptors

For flush mounted pushbutton

KA1-8073

1SFA616920R8073

1

0.050

For flush mounted selector switches

CA1-8075

1SFA619920R8075

1

0.046

Accessories for compact range



Description	Type	Order code	Pkg qty	Weight (1pce) Kg
Membrane				
Flush button	MA1-8052	1SFA611920R8052	1x10	0.002
Extended button	MA1-8002	1SFA616920R8002	1x10	0.002
Note: Made of transparent, heat and cold resistant silicon rubber. Does not harden at low temperature. Remove the gasket when using membrane.				
Protective ring				
Protective ring	-	SK615512-1	1x10	0.002
Note: For flush and extended pushbutton to prevent inadvertent operation. Cannot be used together with Legend plate holder.				
Protective cover				
Protective cover	KA1-8010	1SFA616920R8010	1x10	0.008
Note: For flush pushbutton. To prevent accidental operation. Cannot be used together with Legend plate holder.				
Button				
Grey flush	KA1-8087	1SFA616920R8087	1x10	0.001
Grey extended	KA1-8097	1SFA616920R8097	1x10	0.001
Bezel				
For pushbuttons				
Black plastic	KA1-8022	1SFA616920R8022	1x10	0.002
Chrome metal	KA1-8021	1SFA616920R8021	1x10	0.015
For selector switches				
Black plastic	CA1-8077	1SFA619920R8077	1x10	0.001
Chrome metal	CA1-8078	1SFA619920R8078	1x10	0.010
Square bezel				
Black plastic	-	SK616016-2	1x10	0.001
Grey plastic	MA1-8124	1SFA611920R8124	1x10	0.001
Blanking plug				
Light grey	MA1-8136	1SFA611920R8136	1x10	0.005
Grey	MA1-8129	1SFA611920R8129	1x10	0.005
Black	MA1-8130	1SFA611920R8130	1x10	0.005
Shroud for pushbuttons				
Lockable shroud	MA1-8153	1SFC611920R8153	1x10	0.023
Touch guard	MA1-8152	1SFC611920R8152	1x10	0.009
Note: Touch guard for modular and compact pushbutton				
Lockable shroud for modular and compact pushbuttons and selector switches				
Extra key				
Key code 71 = ronis 455	-	SK616021-71	1x10	0.007

Technical data

Standards and Approvals

IEC / EN 60947-1	Low Voltage switchgear and controlgear - Part 1: General rules
IEC / EN 60947-5-1	Low Voltage switchgear and controlgear - Part 5-1: Control circuit devices and switching elements - Electromechanical control circuit devices
IEC / EN 60947-5-5	Low Voltage switchgear and controlgear - Part 5-5: Control circuit devices and switching elements - Electrical emergency stop device with mechanical latching function
IEC / EN 60073	Basic and safety principles for man-machine interface, marking and identification, coding principles for indicators and actuators
IEC / EN 60529	Degrees of protection provided by enclosures (IP code)
EN 50013	Low Voltage switchgear and controlgear for industrial use, terminal marking and distinctive number for particular control switches
DIN 40050-9	Road vehicles; degrees of protection (IP-code); protection against foreign objects; water and contact; electrical equipment
UL 508	Industrial control equipment
CSA C22.2 No 14	Industrial control equipment

Environmental data

Degrees of protection

Pilot device:	IEC/EN DIN	UL/CSA
Pushbuttons	IP66, IP67 and IP69K	Type 1, 3R, 4, 4X, 12, 13
Selector switches	IP66, IP67 and IP69K	Type 1, 3R, 4, 4X, 12, 13
Buzzer	IP66, IP67 and IP69K	Type 1, 3R, 4, 4X, 12, 13
Heavy duty	IP66, IP67 and IP69K	Type 1, 3R, 4, 4X, 12, 13
Pilot lights	IP66, IP67 and IP69K	Type 1, 3R, 4, 4X, 12, 13
Emergency stops	IP66, IP67 and IP69K	Type 1, 3R, 4, 4X, 12, 13
Terminals	IP20	
Temperature		
Ambient temperature during operation		-25 to +70 °C
Storage temperature		-40 to +85 °C

Technical data

Cable connections

Operator	Cable terminal
Pushbutton	Plus-minus Pozidriv No. 2
Selector switch	Connectable area: min. 1 x 0.5 mm ² / 1 x AWG22 max. 2 x 1.5 mm ² / 2 x AWG14
Emergency stop	
Pilot light	Connectable area: min. 1 x 0.5 mm ² / 1 x AWG20 max. 2 x 2.5 mm ² / 2 x AWG14

Tightening torque

Operators locking nut	Min. 2 Nm / Max. 2.3 Nm
Cable terminals M3	0.8 Nm
Cable terminals M3.5	0.9 Nm

Short circuit protection

Max. fuse at 1 kA	gG 10A
-------------------	--------

Mechanical life

Pushbuttons, selector switches, heavy duty	500 000 operations
Emergency stop pushbutton	50 000 operations

LED bulbs

Service life for LED bulbs means number of service hours until the brightness has been reduced down 50 %. Service life 50 000 h

Color of white LED	x=0.31 Y=0.32 means the position of color in the ICI chromaticity diagram
Voltage tolerance on LED bulbs	-30 to +10 % voltage is acceptable without affecting the service life
Voltage peaks on LED bulbs	Voltage peaks up to 1000 V current peaks up to 500 mA during a few msec
Glowing light	All integrated LED bulbs have a function built in to cut leakage currents

Make-and-break contacts

Pushbutton	Emergency stop pushbutton
<p>NC -1 - 2</p> <p>NO -3 - 4</p>	<p>NC -1 - 2</p> <p>NO -3 - 4</p>
■ = Closed contact	■ = Closed contact

Material

No ozone depleting substances in the products.	
All front of panel plastic components are made of polycarbonate	
PC polycarbonate	High impact strength, good outdoor resistance. Chemical resistance (see table below)
PSU polysulphone	Can withstand high temperatures, acids, basic solutions, alkaline compounds, oils, alcohols
PA polyamide	Can withstand high temperatures, aliphatic, aromatic and chlorinated hydrocarbons, esters, ketone-aldehydes, alcohols and basic solutions
PBT	Can withstand high temperature, aliphatic and aromatic hydrocarbons, acids, basic solutions, alcohols, grease and oils
Zinc	Good corrosion resistance in inland-, sea and industrial atmosphere
Light-alloy	Good corrosion resistance in inland-, sea and industrial atmosphere

Chemical resistance for polycarbonate

Chemical class	Effects
Acids	No significant effect under most typical conditions of concentration and temperature
Alcohols and alkalis	Generally compatible at low concentration and room temperature. Higher concentrations and elevated temperatures can result in etching and attack evidenced by decomposition
Aliphatic hydrocarbons	Generally compatible
Amines	Surface crystallization and chemical attack. Avoid
Aromatic hydrocarbons	Partial solvents and severe stress cracking agents (i.e., xylene, toluene). Avoid
Detergents and cleaners	Mild soap solutions are generally compatible. Strong alkaline materials should be avoided
Esters	Cause severe crystallization. Partial solvents. Avoid
Greases and oils	Pure petroleum types generally compatible. Many additives used with them are not
Halogenated, hydrocarbons	Solvents. Avoid.
Ketones	Cause severe crystallization and stress cracking. Partial solvents. Avoid
Silicone oil and greases	Generally compatible up to 85 °C

Note: Specified degree of protection is for operator mounted on panel. If other items are mounted in between, please make sure that they are correctly sealed.

Electrical data

Contacts

Ratings as per IEC 60947-5-1

Rated insulation voltage, U _i		300 V
Rated thermal current, I _t		5 A
Rated operational current, I _o		
Utilization category AC-15	at: 240 V	1 A
Rated operational current, I _o	at: 24 V	0.3 A
Utilization category DC-13	at: 125 V	0.2 A

Ratings as per UL, CSA, NEMA

	C300 AC	R300 DC
Rated insulation voltage	250 V	250 V
Rated thermal current	2.5 A	1 A
Rated operational current		
	at: 120 V	1.5 A
	at: 125 V	0.22 A
	at: 240 V	0.75 A
	at: 250 V	0.11 A

Short circuit protection

Max. fuse at 1 kA	gG 10A
-------------------	--------

Minimum switching capacity

5 V DC	1 mA
--------	------

Buzzer

Short circuit protection

Max. fuse at 1 kA	gG 10A
-------------------	--------

Ratings as per IEC 60947-5-1

Rated insulation voltage, U _i	300 V
Rated impulse withstand voltage u _{imp}	4kV
Rated frequency	50-60 Hz
Sound level db	≥90 db / 10 cm
Product service life	>5000 hours

Enclosures and assembled stations

4



Large plastic enclosure (modular & compact)

This enclosure can fit both modular and compact operators with the unique possibility to mount up to 5 contact blocks assigned to one operator.

Degree of protection: IP66 UL/NEMA type 1, 3R, 4, 4X, 12, 13

Compact plastic enclosure

The compact enclosure is one of the smallest on the market intended for compact operators.

Degree of protection: IP66, 67, 69K UL/NEMA type 1, 3R, 4, 4X, 12, 13

Metallic enclosure

Our metallic line is made in addition to our plastic lines when plastic is not accepted. Featuring a high protection degree and large installation space.

Degree of protection: IP66, 67, 69K

Assembled stations

We can also offer some of the most common assembled stations as a standard in combination with both modular and compact range.

Enclosures and assembled stations

Overview

Ordering data

Plastic enclosures for modular and compact range	4/3
Selector switches for vertically mounted enclosures	4/4
LED blocks for rear mounting	4/5
Accessories for plastic enclosures	4/6
Metallic enclosures and accessories	4/7
Assembled stations	4/8

Plastic enclosures

For modular and compact range



MEPY1-0

1SFC151270V0001



MEP2-0

1SFC151272R0001



MEP3-0

1SFC151274V0001



CEPY1-0

1SFC151285V0001



CEP1-0

1SFC151284V0001



CA1-8053

1SFC151286V0001



CA1-8054

1SFC151287V0001

Description

When ordering

- Select operators
- Select contact blocks and lamp blocks for rear mounting
- For accessories, please note that one spacer per operator has to be ordered if legend plate is not used (for rear mounted pilot devices)
- Holes for cable glands 1-seat to 3-seat enclosures: M20 and Pg 13.5/Pg16 and (M20) 4-seat and 6-seat enclosures: M25/Pg 16 and (M20)

UL-listed applications: For end of line use only

Description	Type	Order code	Pkg qty	Weight (1pce) Kg
Empty plastic enclosures with stainless steel screws				
1-seat	Dark grey / light grey	MEP1-0	1SFA611811R1000	1x10 0.15
1-seat	Yellow / light grey	MEPY1-0	1SFA611821R1000	1x10 0.15
2-seat	Dark grey / light grey	MEP2-0	1SFA611812R1000	1x10 0.17
3-seat	Dark grey / light grey	MEP3-0	1SFA611813R1000	1x10 0.20
4-seat	Dark grey / light grey	MEP4-0	1SFA611814R1000	1x10 0.23
6-seat	Dark grey / light grey	MEP6-0	1SFA611816R1000	1x10 0.30
Compact enclosure for emergency stop pushbutton				
Yellow / light grey		CEPY1-0	1SFA619821R1000	1 0.072
Shroud				
Yellow		CA1-8053	1SFA619920R8053	1 0.016
Compact enclosure for machine stop pushbutton				
Dark grey / light grey		CEP1-0	1SFA619811R1000	1 0.072
Shroud				
Grey		CA1-8054	1SFA619920R8054	1 0.016

Selector switches

For vertically mounted enclosures



Description

Colors

Replace ■ in type with	● Red R	● Green G	● Yellow Y	● Black B
Replace □ in order code with	1	2	3	6

Description	Type	Order code	Pkg qty	Weight (1pce) Kg
-------------	------	------------	---------	------------------

2-position selector switch, short handle, non-illuminated

Available in: red, black

	Maintained	M2SSV1-10■	1SFA611220R100□	1x10	0.015
	Maintained	M2SSV2-10■	1SFA611221R100□	1x10	0.015
	Momentary, spring return from C to B	M2SSV3-10■	1SFA611222R100□	1x10	0.015

2-position selector switch, short handle, illuminated

Available in: red, green, yellow

	Maintained	M2SSV1-11■	1SFA611220R110□	1x10	0.015
	Maintained	M2SSV2-11■	1SFA611221R110□	1x10	0.015
	Momentary, spring return from C to B	M2SSV3-11■	1SFA611222R110□	1x10	0.015

3-position selector switch, short handle, non-illuminated

Available in: red, black

	Maintained	M3SSV1-10■	1SFA611230R100□	1x10	0.015
	Momentary, spring return from A to B and from C to B	M3SSV2-10■	1SFA611231R100□	1x10	0.015
	Momentary, spring return from C to B	M3SSV3-10■	1SFA611232R100□	1x10	0.015

3-position selector switch, short handle, illuminated

Available in: red, green, yellow

	Maintained	M3SSV1-11■	1SFA611230R110□	1x10	0.015
	Momentary, spring return from A to B and from C to B	M3SSV2-11■	1SFA611231R110□	1x10	0.015
	Momentary, spring return from C to B	M3SSV3-11■	1SFA611232R110□	1x10	0.015

Accessories

Bezel options, how to order

Black plastic - standard	M3SSVX-1XX	1SFA61123XR1X0X	1x10	0.001
Chrome metal - replace '1' with '3' in type and order codes	M3SSVX-3XX	1SFA61123XR3X0X	1x10	0.010

LED blocks

For rear mounting



MLBL-00BW

1SFC151281W0001

4

Description	Rated current mA	Wavelength nm	Luminance mcd	Type	Order code	Pkg qty	Weight (1pce) Kg
Rated voltage 12 V DC ¹⁾							
● Red	12.0	620	320	MLBL-00BR	1SFA611621R2001	1x10	0.012
● Green	9.3	520	1500	MLBL-00BG	1SFA611621R2002	1x10	0.012
● Yellow	12.0	588	380	MLBL-00BY	1SFA611621R2003	1x10	0.012
● Blue	9.5	468	450	MLBL-00BL	1SFA611621R2004	1x10	0.012
○ White	9.3	2)	600	MLBL-00BW	1SFA611621R2005	1x10	0.012
Rated voltage 24 V AC/DC ¹⁾							
● Red	9.9	620	250	MLBL-01BR	1SFA611621R2011	1x10	0.012
● Green	9.2	520	1500	MLBL-01BG	1SFA611621R2012	1x10	0.012
● Yellow	9.9	588	250	MLBL-01BY	1SFA611621R2013	1x10	0.012
● Blue	9.3	468	450	MLBL-01BL	1SFA611621R2014	1x10	0.012
○ White	9.2	2)	600	MLBL-01BW	1SFA611621R2015	1x10	0.012
Rated voltage 48 V AC/DC ¹⁾							
● Red	10.0	620	260	MLBL-02BR	1SFA611621R2021	1x10	0.012
● Green	9.7	520	1500	MLBL-02BG	1SFA611621R2022	1x10	0.012
● Yellow	10.0	588	300	MLBL-02BY	1SFA611621R2023	1x10	0.012
● Blue	9.7	468	450	MLBL-02BL	1SFA611621R2024	1x10	0.012
○ White	9.7	2)	600	MLBL-02BW	1SFA611621R2025	1x10	0.012
Rated voltage 60 V AC/DC ¹⁾							
● Red	13.0	620	350	MLBL-03BR	1SFA611621R2031	1x10	0.012
● Green	12.7	520	2000	MLBL-03BG	1SFA611621R2032	1x10	0.012
● Yellow	13.0	588	400	MLBL-03BY	1SFA611621R2033	1x10	0.012
● Blue	12.7	468	550	MLBL-03BL	1SFA611621R2034	1x10	0.012
○ White	12.7	2)	750	MLBL-03BW	1SFA611621R2035	1x10	0.012
Rated voltage 110-130 V AC							
● Red	8.6	620	200	MLBL-04BR	1SFA611621R2041	1x10	0.012
● Green	8.5	520	1200	MLBL-04BG	1SFA611621R2042	1x10	0.012
● Yellow	8.6	588	250	MLBL-04BY	1SFA611621R2043	1x10	0.012
● Blue	7.0	468	400	MLBL-04BL	1SFA611621R2044	1x10	0.012
○ White	7.0	2)	500	MLBL-04BW	1SFA611621R2045	1x10	0.012
Rated voltage 110-130 V DC ¹⁾							
● Red	9.9	620	250	MLBL-05BR	1SFA611621R2051	1x10	0.012
● Green	9.8	520	1500	MLBL-05BG	1SFA611621R2052	1x10	0.012
● Yellow	9.9	588	300	MLBL-05BY	1SFA611621R2053	1x10	0.012
● Blue	9.8	468	450	MLBL-05BL	1SFA611621R2054	1x10	0.012
○ White	9.8	2)	600	MLBL-05BW	1SFA611621R2055	1x10	0.012
Rated voltage 220 V DC ¹⁾							
● Red	8.0	620	180	MLBL-06BR	1SFA611621R2061	1x10	0.012
● Green	8.0	520	110	MLBL-06BG	1SFA611621R2062	1x10	0.012
● Yellow	8.0	588	200	MLBL-06BY	1SFA611621R2063	1x10	0.012
● Blue	8.0	468	450	MLBL-06BL	1SFA611621R2064	1x10	0.012
○ White	8.0	2)	600	MLBL-06BW	1SFA611621R2065	1x10	0.012
Rated voltage 230 V AC							
● Red	9.5	620	250	MLBL-07BR	1SFA611621R2071	1x10	0.012
● Green	9.4	520	1500	MLBL-07BG	1SFA611621R2072	1x10	0.012
● Yellow	9.5	588	300	MLBL-07BY	1SFA611621R2073	1x10	0.012
● Blue	8.2	468	450	MLBL-07BL	1SFA611621R2074	1x10	0.012
○ White	8.2	2)	600	MLBL-07BW	1SFA611621R2075	1x10	0.012
Rated voltage 380 V AC							
● Red	10.2	620	250	MLBL-08BR	1SFA611621R2081	1x10	0.012
● Green	10.2	520	1500	MLBL-08BG	1SFA611621R2082	1x10	0.012
● Yellow	10.2	582	300	MLBL-08BY	1SFA611621R2083	1x10	0.012
● Blue	9.1	468	450	MLBL-08BL	1SFA611621R2084	1x10	0.012
○ White	9.1	2)	600	MLBL-08BW	1SFA611621R2085	1x10	0.012
Rated voltage 415 V AC							
● Red	11.2	620	280	MLBL-09BR	1SFA611621R2091	1x10	0.012
● Green	11.2	520	1800	MLBL-09BG	1SFA611621R2092	1x10	0.012
● Yellow	11.2	588	350	MLBL-09BY	1SFA611621R2093	1x10	0.012
● Blue	9.9	468	500	MLBL-09BL	1SFA611621R2094	1x10	0.012
○ White	9.9	2)	650	MLBL-09BW	1SFA611621R2095	1x10	0.012

Note: ¹⁾ Care should be taken for DC supply where + and - must be correctly connected. This is marked X1 (+) and X2 (-) on the product.

²⁾ X=0.31, Y=0.32 according to the ICI Chromaticity diagram.

Accessories for plastic enclosures



MCB-01B



MCB-11B

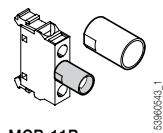

MCB-11B

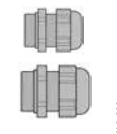

MA5-300



MA1...



MA1-8150

Description	Type	Order code	Pkg qty	Weight (1pce) Kg
Contact block for rear mounting				
1NO	MCB-10B	1SFA611610R2001	1x10	0.013
1NC	MCB-01B	1SFA611610R2010	1x10	0.013
Double contact block				
2NO	MCB-20B	1SFA611610R2002	1x10	0.026
2NC	MCB-02B	1SFA611610R2020	1x10	0.026
1NO+1NC	MCB-11B	1SFA611610R2011	1x10	0.026
Contact block with gold plated contacts				
1NO	MCB-10BG	1SFA611610R2101	1x10	0.013
1NC	MCB-01BG	1SFA611610R2110	1x10	0.013
Lamp block for rear mounting				
For max. 2 W, 230 V AC and DC filament bulb or LED	MLB-1B	1SFA611620R2001	1x10	0.015
115 V AC supply voltage. For 60 V filament bulb 1.2 W	MLB-2B	1SFA611620R2002	1x10	0.017
230 V AC supply voltage. For 130 V filament bulb 2 W	MLB-3B	1SFA611620R2003	1x10	0.020
Protective sleeve				
Protective sleeve	-	53960543-1	1x10	0.002
Note: To make a rear mounted lamp block screen protected. IP20 (Not together with illuminated selector switch)				
Cable gland				
M25	MA5-3001	1SFA611925R3001	1x10	0.015
M20	MA5-3002	1SFA611925R3002	1x10	0.015
PG 13.5	MA5-3006	1SFA611925R3006	1x10	0.010
PG 16	MA5-3007	1SFA611925R3007	1x10	0.015
Note: Grey plastic, threaded outer sleeve sealing ring included.				
Nut				
Grey plastic, for cable gland above				
M25	MA5-3003	1SFA611925R3003	1x10	0.005
M20	MA5-3004	1SFA611925R3004	1x10	0.005
PG 13.5	MA5-3008	1SFA611925R3008	1x10	0.001
PG 16	MA5-3009	1SFA611925R3009	1x10	0.001
Earthing terminal				
For plastic enclosure	MA5-3005	1SFA611925R3005	1x10	0.005
Sealing ring				
For plastic enclosure	MA1-8150	1SFA611920H8150	1x100	0.001
Spacer				
Spacer	-	SK615516-1	1x10	0.002
Spacer for modular emergency stop	KA1-8045	1SFA616920R8045	1x10	0.004
Note: 1 mm thick. Needed when legend plates are not used in plastic enclosures.				
Blanking plug				
Grey	MA1-8129	1SFA611920R8129	1x10	0.005
Black	MA1-8130	1SFA611920R8130	1x10	0.005
Light grey	MA1-8136	1SFA611920R8136	1x10	0.005
Adaptor				
PG 16/M20	MA5-3010	1SFA611925R3010	1x10	0.010

Lamp blocks

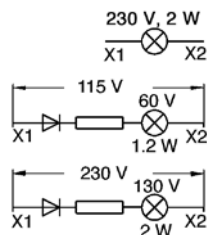

Metallic enclosures and accessories

Degree of protection IP66, IP67 and IP69K



KEM...

1SFC151005C0201



Cable gland

1SFC151488F0001



Hexagon nut

1SFC151488F0001



Blanking plate

1SFC151488F0001



MA1-81...

1SFC151488F0001

Description	Type	Order code	Pkg qty	Weight (1pce) Kg
Empty metallic enclosures for front mounted pilot devices				
1-seat Grey	KEM1-0	SK616701-AA	1	0.40
2-seat Grey	KEM2-0	SK616702-AA	1	0.70
3-seat Grey	KEM3-0	SK616703-AA	1	0.80
4-seat Grey	KEM4-0	SK616704-AA	1	1.20
6-seat Grey	KEM6-0	SK616706-AA	1	1.40
Note: Blanking plates not included				
Accessories for metallic enclosures				
Cable gland, metal, threaded outer sleeve				
Pr	Pg	diameter, mm		
22.5	16	8.5-11.5	-	SK1707685
22.5	16	10.5-13.5	-	SK1707686
22.5	16	12.5-15.0	-	SK1707687
Hexagon nut				
Metal, Pr 22.5, Pg 16			-	SK1750152
Blanking plates without holes, metal, black, for 4- and 6-seat enclosures				
For flange opening		Suitable flange gasket		
FL 13		SK 170 4536	-	SK172105-AA
Blanking plates with holes, metal, black for 4- and 6-seat enclosures				
For flange opening		Suitable flange gasket		
Two holes		Pr 22.5 (Pg 16)	-	SK172105-AD
Hole centre distance 50 mm				
FL 13		SK 170 4536	-	
Three holes		Pr 22.5 (Pg 16)	-	SK172105-AE
Hole centre distance 38 mm				
FL 13		SK 170 4536	-	
Four holes		Pr 22.5 (Pg 16)	-	SK172105-AF
Hole centre distance 30 mm				
FL 13		SK 170 4536	-	
Note: Gasket not included				
Flange gasket				
FL 13			-	SK1704536
Blanking plug				
Grey		MA1-8129	1SFA611920R8129	1x10
Black		MA1-8130	1SFA611920R8130	1x10
Light grey		MA1-8136	1SFA611920R8136	1x10
Note: Applicable to cover a 22 mm-hole in an enclosure instead of an operator. Gasket and nut included				
Sealing plug, black plastic				
Pr 22.5 Pg 16			-	SK175919-3

Assembled stations



CEPY1-2002

1SFC151239F001



MEP2-1001

1SFC151239G001

Description	Type	Order code	Pkg qty	Weight (1pce) Kg
1-seat plastic enclosures				
Emergency stop pushbutton, 40 mm. Twist release. No legend plate. Yellow top / light grey bottom				
● Red	2 NC	MEPY1-1005	1SFA611821R1005	1 0.234
● Red	1 NO + 2 NC	MEPY1-1024	1SFA611821R1024	1 0.250
1-seat plastic enclosures				
Emergency stop, 40 mm. Twist release. Legend plate: "Emergency stop" Yellow top / light grey bottom				
● Red	2 NC	MEPY1-1026	1SFA611821R1026	1 -
1-seat plastic enclosure				
Yellow / light grey				
Twist release, emergency stop 2 NC		CEPY1-1001	1SFA619821R1001	1 0.108
Yellow / light grey				
Pull release, emergency stop 2 NC		CEPY1-1002	1SFA619821R1002	1 0.108
Yellow / light grey				
Key release, emergency stop 1NC + 1NO		CEPY1-1006	1SFA619821R1006	1 0.105
1-seat plastic enclosure with shroud				
Yellow / light grey				
Twist release, emergency stop 2 NC		CEPY1-2001	1SFA619821R2001	1 0.124
Yellow / light grey				
Pull release, emergency stop 2 NC		CEPY1-2002	1SFA619821R2002	1 0.124
1-seat plastic enclosure with black mushroom pushbutton				
Dark grey / light grey				
Twist release, machine stop 1 NO + 1 NC		CEP1-1001	1SFA619811R1001	1 0.108
Dark grey / light grey				
Pull release, machine stop 1 NO + 1 NC		CEP1-1002	1SFA619811R1002	1 0.108
1-seat plastic enclosure with black mushroom pushbutton and shroud				
Dark grey / light grey				
Twist release, machine stop 1 NO + 1 NC		CEP1-2001	1SFA619811R2001	1 0.124
Dark grey / light grey				
Pull release, machine stop 1 NO + 1 NC		CEP1-2002	1SFA619811R2002	1 0.124
2-seat plastic enclosure				
Dark grey top / light grey bottom				
Two flush pushbuttons, momentary				
● Green	● Red			
1 NO	1 NC	MEP2-1001	1SFA611812R1001	1 0.220
I	O			

Legend plates and caps

5



ABB offers a wide range of alternatives to label our products. It's also possible in a large number of markets to get these engraved from the factory with our L-mark system: <http://bolsservices.it.abb.com/pilot-devices>

Legend plates and caps

Overview

Ordering data

Legend plate holder with insert	5/3
Legend plates for emergency stops	5/5
Legend plates for pushbuttons	5/6
Special legend plates for plastic enclosures	5/7
Text caps for pushbuttons and pilot lights	5/7

Legend plate holder With inserts



Legend plate holder and inserts

1SFC151482F001

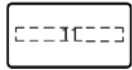

Insert

1SFC151482F001

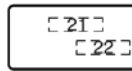

2-position insert

1SFC151482F001

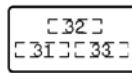

3-position insert

1SFC151484F001

5

Description	Type	Order code	Pkg qty	Weight (1pce) Kg
Legend plate holder with Inserts				
- Holder of black plastic				
- Insert of brushed aluminum look on black plastic				
Legend plate holder				
Black	KA1-8120	1SFA616920R8120	1x100	0.002
Inserts				
Without text or symbol	KA1-8121	1SFA616920R8121	1x10	0.001
Inserts with text/symbol engraved with L-mark				
O	MA6-1032	1SFA611930R1032	1x10	0.001
I	MA6-1033	1SFA611930R1033	1x10	0.001
→	MA6-1034	1SFA611930R1034	1x10	0.001
Close	MA6-1036	1SFA611930R1036	1x10	0.001
Open	MA6-1037	1SFA611930R1037	1x10	0.001
On	MA6-1038	1SFA611930R1038	1x10	0.001
Off	MA6-1039	1SFA611930R1039	1x10	0.001
Fast	MA6-1040	1SFA611930R1040	1x10	0.001
Slow	MA6-1041	1SFA611930R1041	1x10	0.001
Down	MA6-1042	1SFA611930R1042	1x10	0.001
Up	MA6-1043	1SFA611930R1043	1x10	0.001
Start	MA6-1044	1SFA611930R1044	1x10	0.001
Stop	MA6-1045	1SFA611930R1045	1x10	0.001
Inserts for 2-position selector switches				
With text or symbol:				
Pos. 21	Pos. 22			
O	I	MA6-1070	1SFA611930R1070	1x10 0.001
I	II	MA6-1071	1SFA611930R1071	1x10 0.001
→	→→	MA6-1072	1SFA611930R1072	1x10 0.001
Off	On	MA6-1073	1SFA611930R1073	1x10 0.001
Stop	Start	MA6-1074	1SFA611930R1074	1x10 0.001
Low	High	MA6-1075	1SFA611930R1075	1x10 0.001
Slow	Fast	MA6-1076	1SFA611930R1076	1x10 0.001
Close	Open	MA6-1077	1SFA611930R1077	1x10 0.001
Jog	Run	MA6-1078	1SFA611930R1078	1x10 0.001
Hand	Auto	MA6-1079	1SFA611930R1079	1x10 0.001
Inserts for 3-position selector switches				
With text or symbol:				
Pos. 31	Pos. 32	Pos. 33		
←	O	→	MA6-1080	1SFA611930R1080 1x10 0.001
→	O	→→	MA6-1081	1SFA611930R1081 1x10 0.001
I	O	II	MA6-1082	1SFA611930R1082 1x10 0.001
Hand	O	Auto	MA6-1083	1SFA611930R1083 1x10 0.001
Slow	Off	Fast	MA6-1084	1SFA611930R1084 1x10 0.001

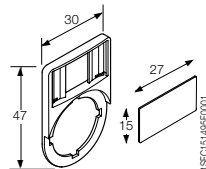

Dimensions

Legend plate holder

With inserts for plastic enclosures



Legend plate holder and inserts

1SFC151485F0001

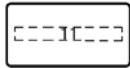

Insert

1SFC151482F0001

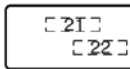

2-position insert

1SFC151483F0001

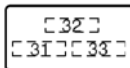

3-position insert

1SFC151484F0001

Description	Type	Order code	Pkg qty	Weight (1pce) Kg
Legend plate holder for plastic enclosures				
Grey	MA6-1060	1SFA611930R1060	1x10	0.002
Inserts: Packing				
Without text or symbol	MA6-1061	1SFA611930R1061	1x10	0.001
Inserts with text/symbol engraved with L-mark				
O	MA6-1062	1SFA611930R1062	1x10	0.001
I	MA6-1063	1SFA611930R1063	1x10	0.001
II	MA6-1064	1SFA611930R1064	1x10	0.001
→	MA6-1130	1SFA611930R1130	1x10	0.001
→→	MA6-1131	1SFA611930R1131	1x10	0.001
Close	MA6-1132	1SFA611930R1132	1x10	0.001
Open	MA6-1133	1SFA611930R1133	1x10	0.001
On	MA6-1134	1SFA611930R1134	1x10	0.001
Off	MA6-1135	1SFA611930R1135	1x10	0.001
Fast	MA6-1136	1SFA611930R1136	1x10	0.001
Slow	MA6-1137	1SFA611930R1137	1x10	0.001
Down	MA6-1138	1SFA611930R1138	1x10	0.001
Up	MA6-1139	1SFA611930R1139	1x10	0.001
Start	MA6-1140	1SFA611930R1140	1x10	0.001
Stop	MA6-1141	1SFA611930R1141	1x10	0.001

Inserts for 2-position selector switches				
With text or symbol:				
Pos. 21	Pos. 22			
O	I	MA6-1170	1SFA611930R1170	1x10 0.001
I	II	MA6-1171	1SFA611930R1171	1x10 0.001
→	→→	MA6-1172	1SFA611930R1172	1x10 0.001
Off	On	MA6-1173	1SFA611930R1173	1x10 0.001
Stop	Start	MA6-1174	1SFA611930R1174	1x10 0.001
Low	High	MA6-1175	1SFA611930R1175	1x10 0.001
Slow	Fast	MA6-1176	1SFA611930R1176	1x10 0.001
Close	Open	MA6-1177	1SFA611930R1177	1x10 0.001
Jog	Run	MA6-1178	1SFA611930R1178	1x10 0.001
Hand	Auto	MA6-1179	1SFA611930R1179	1x10 0.001

Inserts for 3-position selector switches				
With text or symbol				
Pos. 31	Pos. 32	Pos. 33		
←	O	→	MA6-1190	1SFA611930R1190 1x10 0.001
→	O	→→	MA6-1191	1SFA611930R1191 1x10 0.001
I	O	II	MA6-1192	1SFA611930R1192 1x10 0.001
Hand	O	Auto	MA6-1193	1SFA611930R1193 1x10 0.001
Slow	Off	Fast	MA6-1194	1SFA611930R1194 1x10 0.001

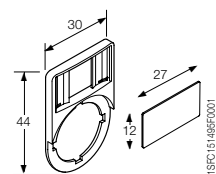

Dimensions

1SFC151485F0001

Legend plates For emergency stop



CA6-1026

1SFC151260/0001

5

Description/Text	Type	Order code	Pkg qty	Weight (1pce) Kg
Emergency stop legend plates 70mm				
Black text on a yellow plastic plate. Can be used as yellow background				
Emergency stop	-	1SFA616915R1005	1x10	0.003
Not Aus	-	1SFA616915R6005	1x10	0.003
Without text	-	1SFA616915R1038	1x10	0.003
With customer marking	-	1SFA616915L1038	1x10	0.003
Black text on a yellow aluminum plate				
Nöd Stopp	-	SK615546-1	1x10	0.010
Emergency stop	-	SK615546-2	1x10	0.010
Not Aus	-	SK615546-3	1x10	0.010
ARRET D'URGENCE	-	SK615546-4	1x10	0.010
HÄTASEIS	-	SK615546-5	1x10	0.010
PARADA DE EMERGENCIA	-	SK615546-6	1x10	0.010
Emergency stop NOT AUS ARRET D'URGENCE	-	SK615546-13	1x10	0.010
Without text	-	SK615546-8	1x10	0.010
Emergency stop legend plates for plastic enclosures				
For horizontally mounted enclosures. Yellow plastic with black text				
Nöd Stopp	MA6-1025	1SFA611930R1025	1	0.004
Emergency stop	MA6-1026	1SFA611930R1026	1	0.004
Not Aus	MA6-1027	1SFA611930R1027	1	0.004
ARRET D'URGENCE	MA6-1028	1SFA611930R1028	1	0.004
Hätäseis	MA6-1029	1SFA611930R1029	1	0.004
For vertically mounted enclosures. Yellow plastic with black text				
Nöd Stopp	MA6-1100	1SFA611930R1100	1	0.004
Emergency stop	MA6-1101	1SFA611930R1101	1	0.004
Not Aus	MA6-1102	1SFA611930R1102	1	0.004
ARRET D'URGENCE	MA6-1103	1SFA611930R1103	1	0.004
Hätäseis	MA6-1104	1SFA611930R1104	1	0.004
Yellow plastic				
Without text	MA6-1024	1SFA611930R1024	1	0.004
With customer marking	MA6-1024-L	1SFA611930L1024	1x10	0.004
Emergency stop legend plates for compact enclosure				
Black text on yellow aluminum plate 59mm				
Emergency stop	CA6-1026	1SFA619930R1026	1x10	0.004
Not Aus	CA6-1027	1SFA619930R1027	1x10	0.004

Legend plates For pushbuttons



1SFC151488F0001

Text / symbol	Type	Order code	Pkg qty	Weight (1 pce) Kg
Fixed legend plates without text				
For pushbuttons, mushroom pushbuttons and pilot lights, made of silver-grey aluminum				
H = 39 mm	MA16-1000	1SFA611940R1000	1x10	0.002
H = 44 mm	MA16-1001	1SFA611940R1001	1x10	0.002
Engraved fixed legend plates				
For pushbuttons – with symbols, Text height 3 mm				
O	-	SK615550-61	1x10	0.002
I	-	SK615550-62	1x10	0.002
II	-	SK615550-63	1x10	0.002
→	-	SK615562-12	1x10	0.002
←	-	SK615562-18	1x10	0.002
→ →	-	SK615562-27	1x10	0.002
Close	-	SK615552-13	1x10	0.002
Down	-	SK615552-14	1x10	0.002
Emergency stop	-	SK615552-15	1x10	0.002
Fast	-	SK615552-16	1x10	0.002
Forward	-	SK615552-17	1x10	0.002
In	-	SK615550-29	1x10	0.002
Inching	-	SK615552-18	1x10	0.002
Left	-	SK615552-39	1x10	0.002
Lower	-	SK615552-20	1x10	0.002
Off	-	SK615552-21	1x10	0.002
On	-	SK615552-22	1x10	0.002
Open	-	SK615552-23	1x10	0.002
Out	-	SK615552-24	1x10	0.002
Raise	-	SK615552-25	1x10	0.002
Reset	-	SK615552-27	1x10	0.002
Reverse	-	SK615552-28	1x10	0.002
Right	-	SK615552-40	1x10	0.002
Run	-	SK615552-29	1x10	0.002
Slow	-	SK615552-30	1x10	0.002
Start	-	SK615550-44	1x10	0.002
Stop	-	SK615552-31	1x10	0.002
Up	-	SK615552-32	1x10	0.002
For 2-position selector switches – with symbols (description/symbol/text pos 21 pos 22)				
I O II	-	SK615550-81	1x10	0.002
← O →	-	SK615562-82	1x10	0.002
→ O → →	-	SK615562-83	1x10	0.002
Hand O Auto	-	SK615550-80	1x10	0.002
Slow Off Fast	-	SK615552-60	1x10	0.002
Legend plates with customer specific marking				
H = 39 mm	MA16-1000-L	1SFA611940L1000	1x10	0.002
H = 44 mm	MA16-1001-L	1SFA611940L1001	1x10	0.002

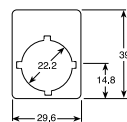

1SFC151488F0001

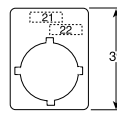

1SFC151487F0001

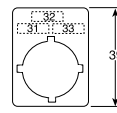

1SFC151485F0001

Special legend plates

For plastic enclosures

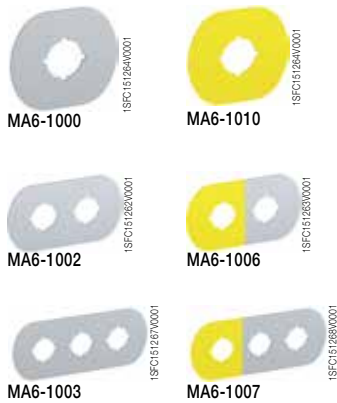

Description	Type	Order code	Pkg qty	Weight (1pce) Kg
Silver-grey aluminum on plastic				
1-seat without text	MA6-1000	1SFA611930R1000	1	0.004
2-seat without text	MA6-1002	1SFA611930R1002	1	0.006
3-seat without text	MA6-1003	1SFA611930R1003	1	0.008
4-seat without text	MA6-1004	1SFA611930R1004	1	0.010
6-seat without text	MA6-1005	1SFA611930R1005	1	0.012
1-seat O	MA6-1012	1SFA611930R1012	1	0.004
1-seat I	MA6-1013	1SFA611930R1013	1	0.004
2-seat O I	MA6-1014	1SFA611930R1014	1	0.006
3-seat O I I	MA6-1015	1SFA611930R1015	1	0.008
3-seat I O II	MA6-1016	1SFA611930R1016	1	0.008
Pos. 1 yellow				
2-seat without text	MA6-1006	1SFA611930R1006	1	0.006
3-seat without text	MA6-1007	1SFA611930R1007	1	0.008
4-seat without text	MA6-1008	1SFA611930R1008	1	0.010
6-seat without text	MA6-1009	1SFA611930R1009	1	0.012
Emergency stop legend plate				
Black text on an yellow aluminum plate				
Without text	MA6-1010	1SFA611930R1010	1	0.005
Nöd stopp	MA6-1017	1SFA611930R1017	1	0.005
Not Aus	MA6-1018	1SFA611930R1018	1	0.005
Emergency stop	MA6-1019	1SFA611930R1019	1	0.005
ARRÊT D'URGENCE	MA6-1020	1SFA611930R1020	1	0.005
Hätäseis	MA6-1021	1SFA611930R1021	1	0.005
PARADA DE EMERGENCIA	MA6-1022	1SFA611930R1022	1	0.005
Black text on an yellow plastic plate				
Without text	MA6-1011	1SFA611930R1011	1	0.002
Emergency stop	MA6-1023	1SFA611930R1023	1	0.002

Text caps

For illuminated pushbuttons and pilot lights



Text / symbol	Cap color ¹⁾	Type	Order code	Pkg qty	Weight (1pce) Kg
Text caps for illuminated pushbuttons and pilot lights					
Flush pushbutton					
START	White	KTC6-1042	1SFA616906R1042	1x10	0.001
R	White	KTC1-9009	1SFA616901R9009	1x10	0.001
On	White	KTC1-1020	1SFA616901R1020	1x10	0.001
ON	White	KTC1-1039	1SFA616901R1039	1x10	0.001
	Green	KTC6-1039	1SFA616906R1039	1x10	0.001
	Black	KTC8-1039	1SFA616908R1039	1x10	0.001
Off	White	KTC1-1019	1SFA616901R1019	1x10	0.001
Stop	White	KTC1-1031	1SFA616901R1031	1x10	0.001
STOP	Red	KTC4-1047	1SFA616904R1047	1x10	0.001
Reset	White	KTC1-1025	1SFA616901R1025	1x10	0.001
(Without text)	White	KTC1-9000	1SFA616901R9000	1x10	0.001
Extended pushbutton					
R	White	KTC2-9009	1SFA616902R9009	1x10	0.001
On	White	KTC2-1020	1SFA616902R1020	1x10	0.001
OFF	White	KTC2-1040	1SFA616902R1040	1x10	0.001
	Red	KTC5-1040	1SFA616905R1040	1x10	0.001
Stop	White	KTC2-1031	1SFA616902R1031	1x10	0.001
STOP	Red	KTC5-1047	1SFA616905R1047	1x10	0.001
Reset	White	KTC2-1025	1SFA616902R1025	1x10	0.001
(Without text)	White	KTC2-9000	1SFA616902R9000	1x10	0.001
Pilot light					
On	White	KTC3-1020	1SFA616903R1020	1x10	0.001
ON	White	KTC3-1039	1SFA616903R1039	1x10	0.001
Off	White	KTC3-1019	1SFA616903R1019	1x10	0.001
Stop	White	KTC3-1031	1SFA616903R1031	1x10	0.001
(Without text)	White	KTC3-9000	1SFA616903R9000	1x10	0.001

¹⁾ Use only white caps for illuminated pushbutton and pilot lights. Note: Can be turned 90° or 180°

Text caps

For illuminated pushbuttons and pilot lights



KTC1-9004

1SFC151288V0001



KTC2-9004

1SFC151288V0001



KTC3-9004

1SFC151292V0001



KTC1-9024

1SFC151289V0001



KTC2-9024

1SFC151291V0001



Pilot light

1SFC151312V0001

Text / symbol	Cap Color ¹⁾	Type	Order code	Pkg qty	Weight (1pce) Kg
Text caps for illuminated pushbuttons and pilot lights					
Flush pushbutton					
0	White	KTC1-9004	1SFA616901R9004	1x10	0.001
	Red	KTC4-9004	1SFA616904R9004	1x10	0.001
	Black	KTC8-9004	1SFA616908R9004	1x10	0.001
I	White	KTC1-9002	1SFA616901R9002	1x10	0.001
	Green	KTC6-9002	1SFA616906R9002	1x10	0.001
	Black	KTC8-9002	1SFA616908R9002	1x10	0.001
II	White	KTC1-9003	1SFA616901R9003	1x10	0.001
	Green	KTC6-9003	1SFA616906R9003	1x10	0.001
	Black	KTC8-9003	1SFA616908R9003	1x10	0.001
III	White	KTC1-9028	1SFA616901R9028	1x10	0.001
+	White	KTC1-9011	1SFA616901R9011	1x10	0.001
	Black	KTC8-9011	1SFA616908R9011	1x10	0.001
-	White	KTC1-9012	1SFA616901R9012	1x10	0.001
	Black	KTC8-9012	1SFA616908R9012	1x10	0.001
↑	White	KTC1-9005	1SFA616901R9005	1x10	0.001
	Black	KTC8-9005	1SFA616908R9005	1x10	0.001
↔	White	KTC1-9015	1SFA616901R9015	1x10	0.001
	Black	KTC8-9015	1SFA616908R9015	1x10	0.001
↔↔↔	White	KTC1-9016	1SFA616901R9016	1x10	0.001
	Black	KTC8-9016	1SFA616908R9016	1x10	0.001
→	White	KTC1-9017	1SFA616901R9017	1x10	0.001
	Black	KTC8-9017	1SFA616908R9017	1x10	0.001
→↔	White	KTC1-9006	1SFA616901R9006	1x10	0.001
⊕	White	KTC1-9018	1SFA616901R9018	1x10	0.001
	Black	KTC8-9018	1SFA616908R9018	1x10	0.001
●	White	KTC1-9019	1SFA616901R9019	1x10	0.001
⊙	White	KTC1-9020	1SFA616901R9020	1x10	0.001
	Black	KTC8-9020	1SFA616908R9020	1x10	0.001
☞	White	KTC1-9021	1SFA616901R9021	1x10	0.001
	Black	KTC8-9021	1SFA616908R9021	1x10	0.001
⚡	White	KTC1-9023	1SFA616901R9023	1x10	0.001
☞	White	KTC1-9024	1SFA616901R9024	1x10	0.001
↑	White	KTC1-9025	1SFA616901R9025	1x10	0.001
	Black	KTC8-9025	1SFA616908R9025	1x10	0.001
↓	White	KTC1-9026	1SFA616901R9026	1x10	0.001
	Black	KTC8-9026	1SFA616908R9026	1x10	0.001
☞	White	KTC1-9027	1SFA616901R9027	1x10	0.001
	Black	KTC8-9027	1SFA616908R9027	1x10	0.001
(Customer specific marking)	White	KTC1-9000-L	1SFA616901L9000	1x10	0.001
Extended pushbutton					
0	White	KTC2-9004	1SFA616902R9004	1x10	0.001
	Red	KTC5-9004	1SFA616905R9004	1x10	0.001
I	White	KTC2-9002	1SFA616902R9002	1x10	0.001
II	White	KTC2-9003	1SFA616902R9003	1x10	0.001
III	White	KTC2-9028	1SFA616902R9028	1x10	0.001
+	White	KTC2-9011	1SFA616902R9011	1x10	0.001
↑	White	KTC2-9005	1SFA616902R9005	1x10	0.001
↔	White	KTC2-9015	1SFA616902R9015	1x10	0.001
↔↔↔	White	KTC2-9016	1SFA616902R9016	1x10	0.001
→	White	KTC2-9006	1SFA616902R9006	1x10	0.001
↓	White	KTC2-9026	1SFA616902R9026	1x10	0.001
(Customer specific marking)	White	KTC2-9000-L	1SFA616902L9000	1x10	0.001
Pilot light					
0	White	KTC3-9004	1SFA616903R9004	1x10	0.001
I	White	KTC3-9002	1SFA616903R9002	1x10	0.001
II	White	KTC3-9003	1SFA616903R9003	1x10	0.001
↑	White	KTC3-9005	1SFA616903R9005	1x10	0.001
→	White	KTC3-9006	1SFA616903R9006	1x10	0.001
(Customer specific marking)	White	KTC3-9000-L	1SFA616903L9000	1x10	0.001

¹⁾Use only white caps for illuminated pushbutton and Pilot lights. Cont. next page. Note: Can be turned 90° or 180°

Signal towers and signal beacons



Signal towers and signal beacons offer customers a wide range of signal elements in all voltages and a solution for every signalling field

Signal towers

- Fast mounting of signal elements using bayonet fixing
- Easy changing of bulbs for each module without tools
- Flexibility of signal element combination
- Up to 5 elements possible/up to 10 elements with bracket for 2-sided mounting
- High protection rating optical and audible signal elements with IP54
- LED elements for long life

Signal beacons

- Design withstands every mechanical and natural challenge both indoors and outdoors.
- High protection rating IP65
- Cap consists of high impact polycarbonate (up to 20 J)
- Bulb change via inside of control box

Simple fitting with quick fix system

Each signal tower module is equipped with a bayonet fixing with integral contact system. The modules are fastened together by aligning the corresponding white marks then with a gentle twist they are locked into place (see the figures).

Signal towers and beacons

- Permanent light
- Blinking light
- Flashing light
- Audible
- LED permanent light
- LED blinking light
- LED rotating light

Combination possibilities

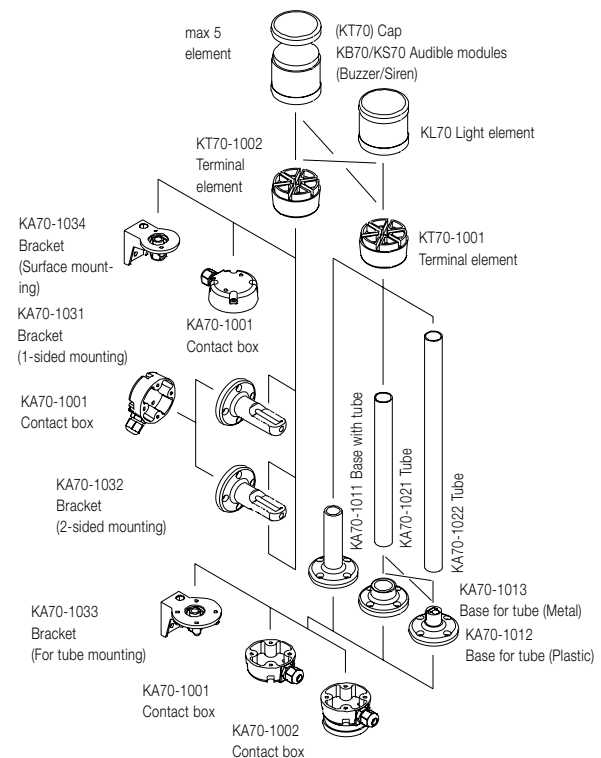

Signal towers and signal beacons

Overview

Ordering data

Signal towers	6/3
Signal beacons	6/5

Technical data

Signal towers and signal beacons	6/6
----------------------------------	-----

Signal towers



KL70-401B

1SFC151609F001



KL70-401Y

1SFC151609F001



KA4-102...

1SFC151609F001

6

Description

Colors	Red	Green	Yellow	Blue	Clear
Replace <input checked="" type="checkbox"/> in type with	R	G	Y	L	C
Replace <input type="checkbox"/> in order code with	1	2	3	4	8

Description	Type	Order code	Pkg qty	Weight (1pce) Kg
-------------	------	------------	---------	------------------

Light element

Available in red, green, yellow, blue and clear

Permanent light, 12-240 V AC/DC For bulb BA 15d. Bulb not included	KL70-401■	1SFA616070R401□	1	0.09
Blinking light, 24 V AC/DC with integrated LED	KL70-306■	1SFA616070R306□	1	0.10
Flashing light, 24 V AC/DC with integrated xenon tube	KL70-203■	1SFA616070R203□	1	0.12
Blinking light, 115 V AC with integrated LED	KL70-342■	1SFA616070R342□	1	0.10
Flashing light, 115 V AC with integrated xenon tube	KL70-113■	1SFA616070R113□	1	0.11
Blinking light, 230 V AC with integrated LED	KL70-352■	1SFA616070R352□	1	0.10
Flashing light, 230 V AC with integrated xenon tube	KL70-123■	1SFA616070R123□	1	0.11
LED permanent light, 24 V AC/DC with integrated LED	KL70-305■	1SFA616070R305□	1	0.10
LED rotating light, 24 V AC/DC with integrated LED	KL70-307■	1SFA616070R307□	1	0.10

Bulbs: Bulb Ba 15d, 42mm, max 7 W for permanent or blinking light

24 V, 5 W, AC/DC	KA4-1021	1SFA616923R1028	1x10	0.009
115 V, 5 W, AC/DC	KA4-1118	1SFA616923R1118	1x10	0.009
230 V, 5 W, AC/DC	KA4-1148	1SFA616923R1148	1x10	0.009

LED bulbs Ba 15d, 40mA

Available in red, green, yellow, blue and white

24 V AC/DC	KA4-102■	1SFA616924R102□	1	0.009
------------	----------	-----------------	---	-------

Audible modules buzzer element. 85 dB, continuous or pulsating tone, adjustable

24 V AC/DC	KB70-3001	1SFA616071R3001	1	0.11
115 V AC	KB70-3101	1SFA616071R3101	1	0.11
230 V AC	KB70-1201	1SFA616071R1201	1	0.12



Signal towers



KT70-10...

1SFC151510F001



KA70-1001

1SFC151511F001



KA70-1031

1SFC151512F001

Description	Type	Order code	Pkg qty	Weight (1 pce) Kg
Siren element				
Multi function, 8 diff. Tones adjustable, volume adjustable 100 dB, 115 V AC	KS70-1104	1SFA616073R1104	1	0.13
Multi function, 8 diff. Tones adjustable, volume adjustable 100 dB, 230 V AC	KS70-1204	1SFA616073R1204	1	0.12
Multi function, 7 diff. Tones adjustable, volume adjustable, 100 dB, 24 V DC	KS70-2004	1SFA616073R2004	1	0.12
Multi function, 8 diff. Tones adjustable, volume adjustable 100 dB, 24 V AC/DC	KS70-3004	1SFA616073R3004	1	0.12
Continuous tone alternating 108 dB, 24 V DC	KS70-2002	1SFA616073R2002	1	0.15
Terminal elements				
For tube mounting, including cap	KT70-1001	1SFA616075R1001	1	0.15
For bracket or base, including cap	KT70-1002	1SFA616075R1002	1	0.15
Special parts				
Contact box				
Cable exit at side	KA70-1001	1SFA616077R1001	1	0.07
Magnetic base	KA70-1002	1SFA616077R1002	1	0.07
Base with tube				
D=25 mm L=110 mm	KA70-1011	1SFA616077R1011	1	0.06
Base for tube				
D=25 mm, plastic	KA70-1012	1SFA616077R1012	1	0.03
D=25 mm, metal	KA70-1013	1SFA616077R1013	1	0.32
Tube, anodized aluminum				
D=25 mm L=250 mm	KA70-1021	1SFA616077R1021	1	0.08
D=25 mm L=400 mm	KA70-1022	1SFA616077R1022	1	0.12
D=25 mm L=800 mm	KA70-1023	1SFA616077R1023	1	0.24
Bracket				
1-sided mounting	KA70-1031	1SFA616077R1031	1	0.07
2-sided mounting	KA70-1032	1SFA616077R1032	1	0.07
For tube mounting	KA70-1033	1SFA616077R1033	1	0.07
For surface mounting	KA70-1034	1SFA616077R1034	1	0.07

Signal beacons



KSB-401G

1SFC151519P001



KASB-100

1SFC151514R001

Description

Colors	● Red	● Green	● Yellow	● Blue	○ Clear
Replace ■ in type with	R	G	Y	L	C
Replace □ in order code with	1	2	3	4	8

Description	Type	Order code	Pkg qty	Weight (1pce) Kg
-------------	------	------------	---------	------------------

Light element: Available in red, green, yellow, blue and clear

Permanent light, 12-240 V AC/DC. For Bulb BA 15d Bulb not included	KSB-401■	1SFA616080R401□	1	0.13
Flashing light, 24 V DC. With integrated xenon tube	KSB-203■	1SFA616080R203□	1	0.14
Flashing light, 115 V AC. With integrated xenon tube	KSB-113■	1SFA616080R113□	1	0.14
Flashing light, 230 V AC. With integrated xenon tube	KSB-123■	1SFA616080R123□	1	0.14

Light element LED: Available in red, green and yellow

LED permanent light, 24 V AC/DC. With integrated LED	KSB-305■	1SFA616080R305□	1	0.14
LED blinking light, 24 V AC/DC. With integrated LED	KSB-306■	1SFA616080R306□	1	0.14
LED rotation light, 24 V AC/DC. With integrated LED	KSB-307■	1SFA616080R307□	1	0.14

Special parts

Anti-twist device	KASB-100	1SFA616087R1000	1	0.005
-------------------	----------	-----------------	---	-------

Bulbs for signal beacons max 10 W. For permanent light Bulb

Ba 15d, 52mm				
12 V, 7 W, AC/DC	KA3-1018	1SFA616922R1018	1x10	0.011
24 V, 7 W, AC/DC	KA3-1028	1SFA616922R1028	1x10	0.011
115 V, 7 W, AC/DC	KA3-1118	1SFA616922R1118	1x10	0.011
220-260 V, 7-10 W, AC/DC	KA3-1148	1SFA616922R1148	1x10	0.011

Technical data

Signal towers and signal beacons

Signal towers K70

Technical specifications			
Housing and accessories	Polyamide, high impact, black		
Dome	Polycarbonate, transparent		
Fixing	Base mounting, tube Ø 25mm, bracket mounting		
Socket	B 15 d, for bulb max. 7W		
Connection	Screw connection up to 2.5 mm ²		
Number of modules possible 2-sided bracket	max. 5	max. 10 elements	
Degrees of protection			
Light elements	IP 54	UL type 5	
Audible elements	IP 54	UL type 5	
Electrical data			
Permanent light element	12-240 V AC/DC		
Bulb socket B 15 d, max 7 W	Bulb not included		
	24 V DC	115 V AC	230 V AC
Flashing light element			
Flash frequency	1 Hz	1 Hz	1 Hz
Flash energy	2 Ws	2 Ws	2 Ws
Life duration	4 x 10 ⁶ flashes		
Current consumption reduced for AS-Interface	125 mA 80 mA	20mA	35 mA
Starting current	< 0.5 A at 24 V		
	24 V AC/DC	115 V AC	230 V AC
LED permanent light element			
Life duration	100 000 hours		
Current consumption	45 mA	25mA	25mA
Starting current	< 0.5 A at 24 V		
	24 V AC/DC	115 V AC	230 V AC
LED blinking light element			
Life duration	100 000 hours		
Current consumption	25 mA	25mA	25mA
Starting current	< 0.5 A at 24 V		
Blink frequency	c. 1 Hz	c. 1 Hz	c. 1 Hz
	24 V AC/DC		
LED rotation light element			
Life duration	100 000 hours		
Current consumption	70 mA		
Starting current	< 0.5 A at 24 V		
Rotation frequency	c. 120 r.p.m.		
Temperature			
Ambient temperature during operations	-20 to +50 °C		

Signal beacons KSB

Technical specifications			
Housing and accessories	PC/ABS-blend, high impact, black		
Dome	Polycarbonate, transparent		
Fixing	Installation mounting for Ø 37mm, (PG 29)		
Bulb socket	B 15 d, for bulb max. 10W		
Bulb change	Via rear access with bayonet mechanism (Bulb not included)		
Connection	Screw connection max 2.5 mm ²		
Degrees of protection			
	IP 65, UL type 5		
Electrical data			
Permanent light element			
Operating voltage	max. 250 V		
Life duration	100 000 hours		
Bulb socket B 15 d, max 10 W	Bulb not included		
LED version: Permanent light	24 V, AC/DC		
Life duration	100 000 hours		
Current consumption	45 mA		
Blinking light element	24 V, AC/DC		
Life duration	100 000 hours		
Current consumption	25 mA		
Rotation light element	24 V, AC/DC		
Life duration	100 000 hours		
Current consumption	70 mA		
Starting current	< 0.5 A		
	24 V AC/DC	115 V AC	230 V AC
Flashing light element			
Operating voltage	24 V AC/DC	115 V AC	230 V AC
Flash frequency	1 Hz	1 Hz	1 Hz
Flash energy	2 Ws	2 Ws	2 Ws
Life duration	4 x 10 ⁶ flashes		
Current consumption	125 mA	20mA	35 mA
Starting current	< 0.5 A	< 0.5 A	< 0.5 A
Temperature			
Ambient temperature during operations	-20 to +50 °C		

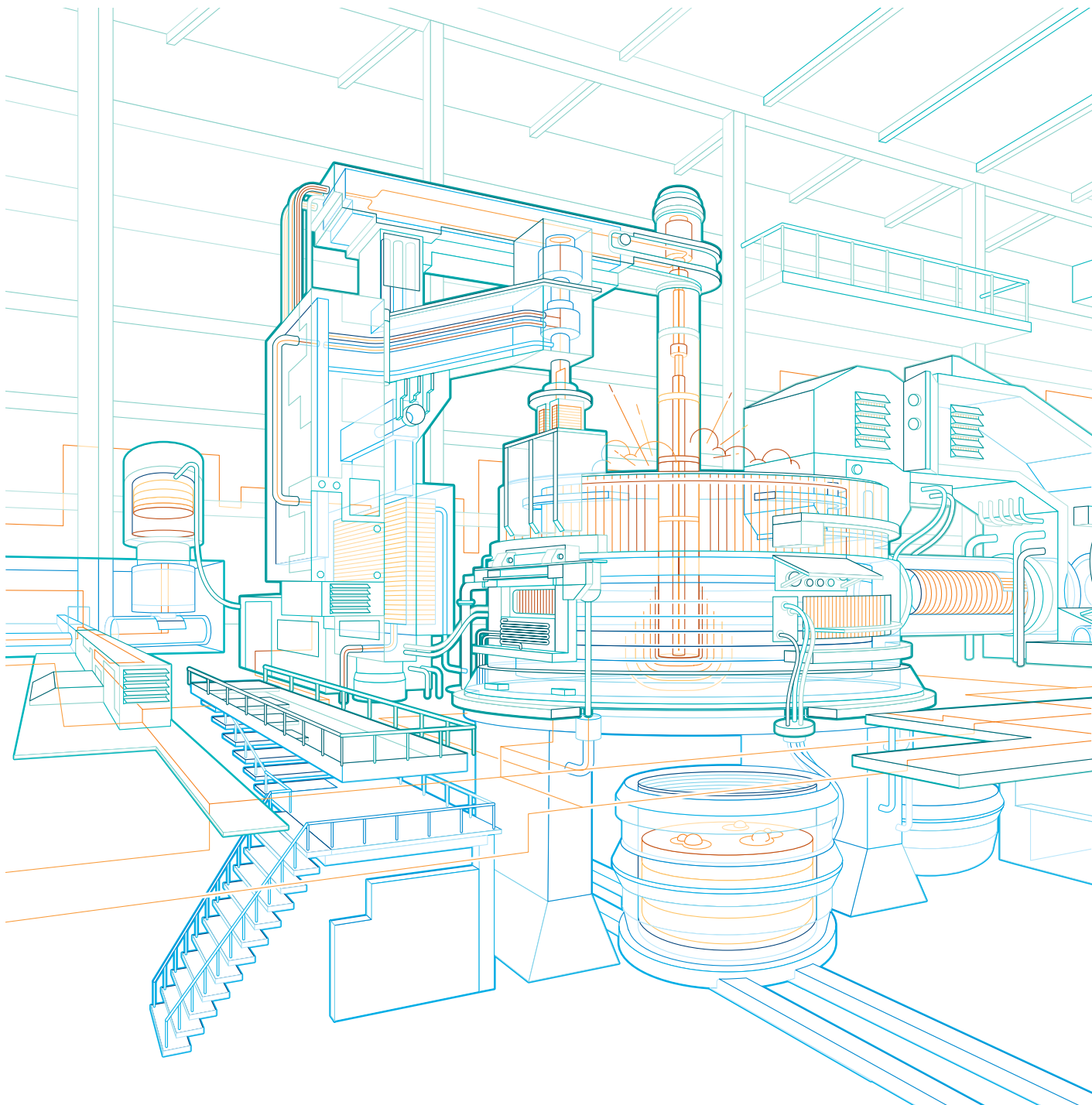

Dimensions and general information

Overview

Dimensions

Modular range	7/3
Miscellaneous	7/4
Compact range	7/5
Signal towers	7/6
Enclosures	7/7

General information

Color selection	7/8
Mounting kit for DIN-rail	7/8
Degrees of protection	7/9
Explanation of type codes	7/10
Index	7/11

Dimensions

Modular range

3D drawings can be found in ABB Library.

Pushbutton

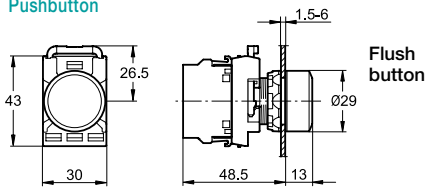

Double pushbutton

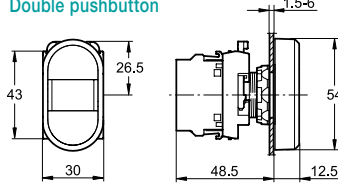

Mushroom pushbutton

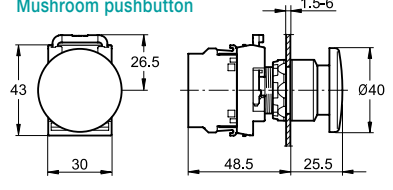

Flush button

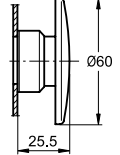
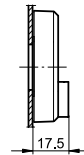
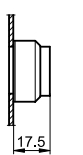

Emergency stop type MPM

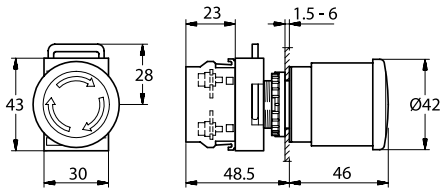

Emergency stop type MPE

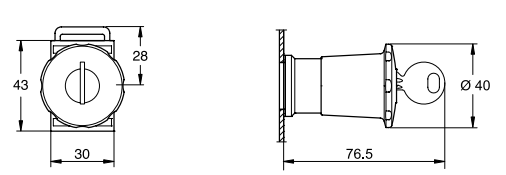
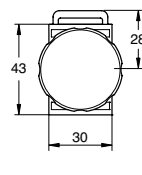
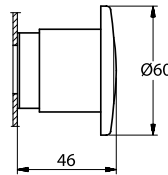
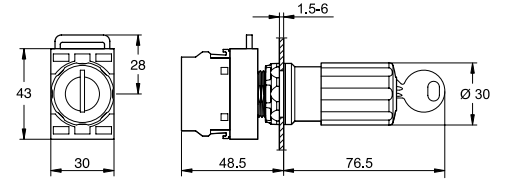
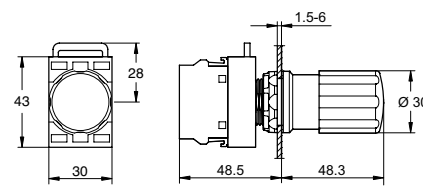

Selector switch

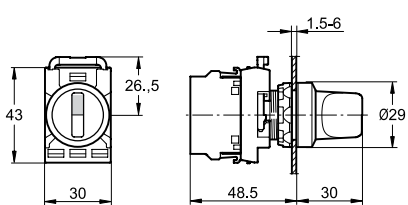

Joystick

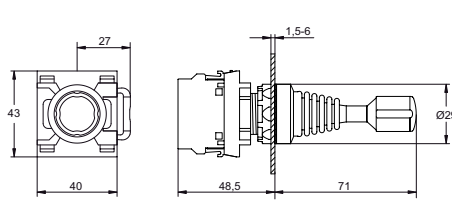

Toggle switch

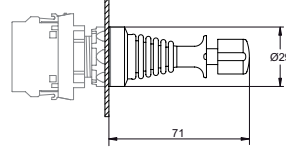
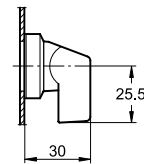
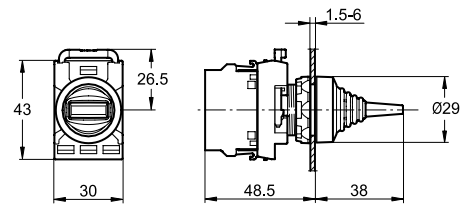

Pilot light

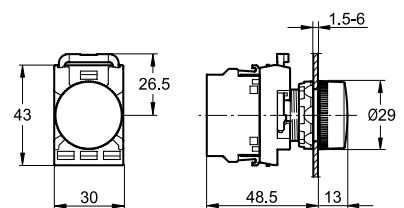

Key-operated selector switch

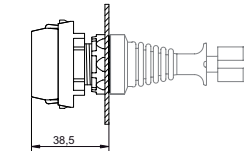
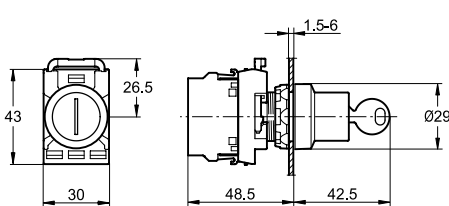

Pilot light with transformer

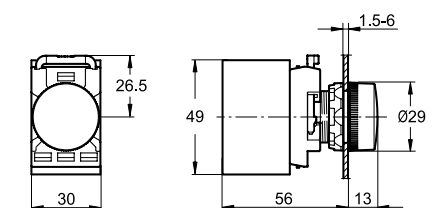

Dimensions and drilling plans

Miscellaneous

Heavy duty pushbutton

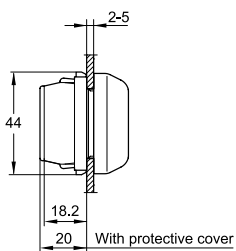
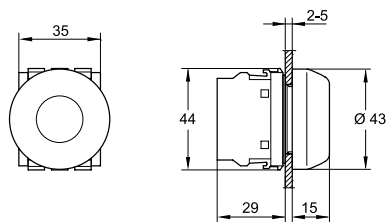

Reset pushbutton

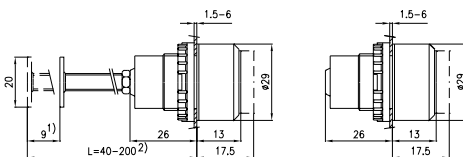

- 1) Length of stroke
- 2) Can be cut to desired length

Potentiometer

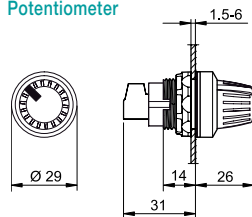

Drilling plans for pushbuttons, switches and pilot lights

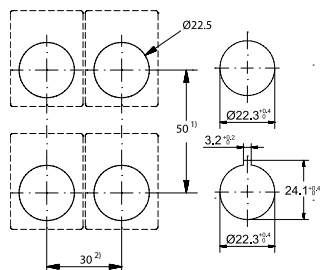

- 1) 55 mm when legend plate H= 44.5 mm is used.
- 61 mm for mushroom pushbutton with D=60 mm
- 2) 37 mm when legend plate with insert is used

Drilling plan for double pushbutton

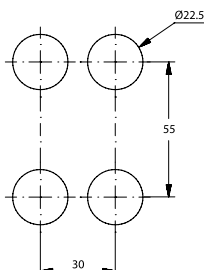

Drilling plan for 30 mm adaptor

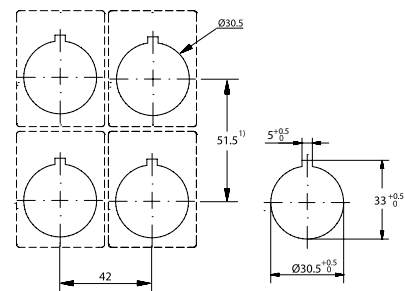

Contact block (for front mounting)

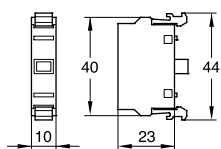

Micro contact block (for front mounting)

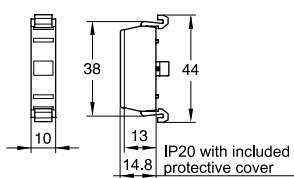

Lamp block (for front mounting)

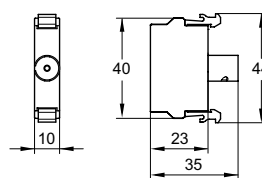

Transformer block

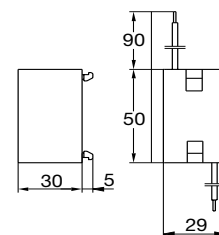

Emergency stop shroud Modular range

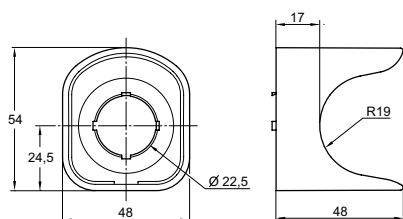

Emergency stop shroud Compact range

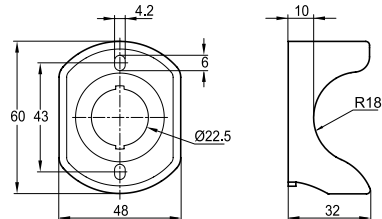

Dimensions

Compact range

Pushbutton

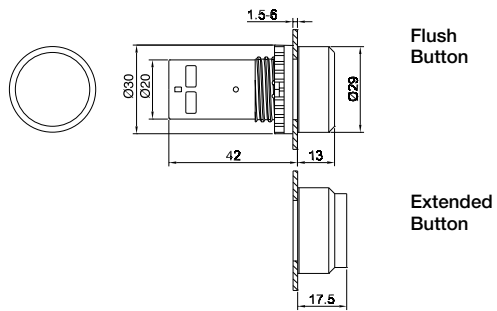

Selector switch

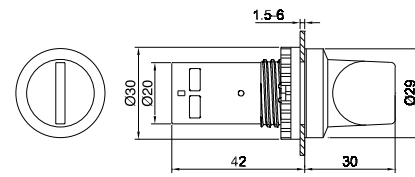

Pilot light

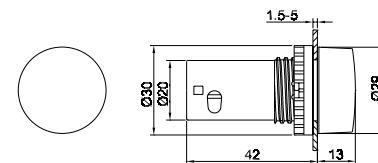

Heavy duty

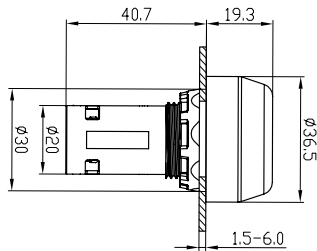

7

Emergency stop CE3P/CE4P (Pull release)

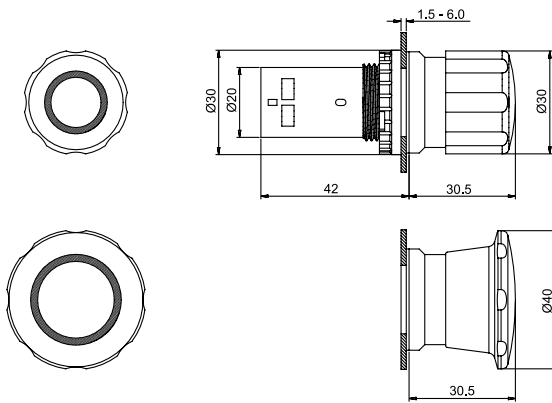

CE3T/CE4T (Twist release)

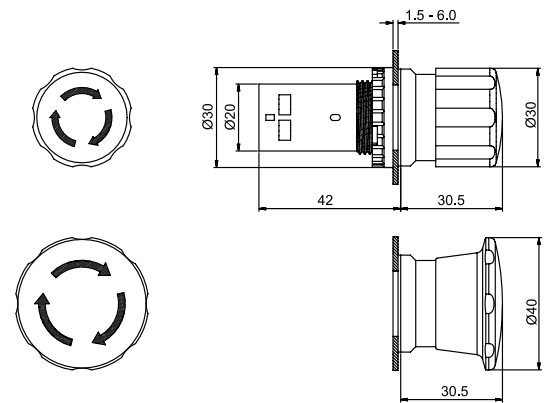

CE3K1/CE4K1

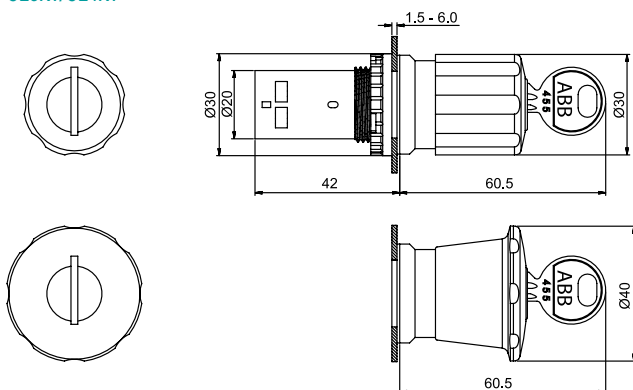

Buzzer

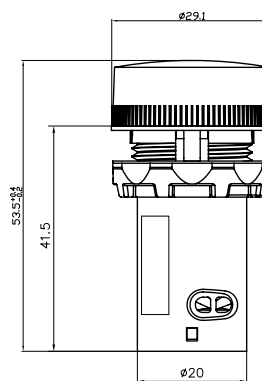

Mushroom

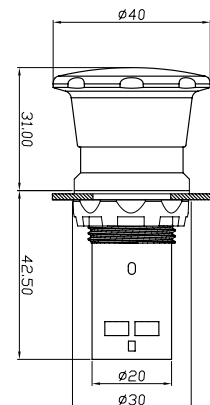

Dimensions Enclosures

Plastic enclosures

1-seat

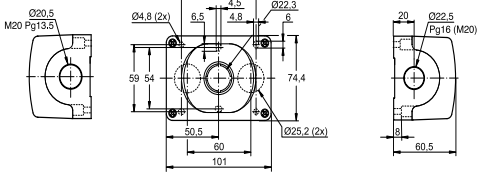

2 seats

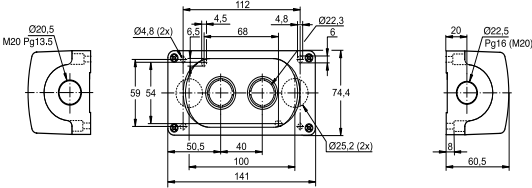

3-seats

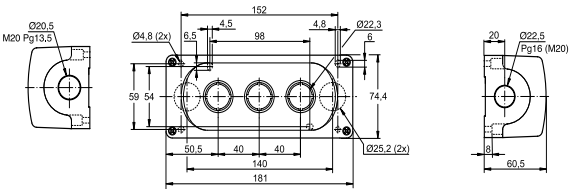

4-seats

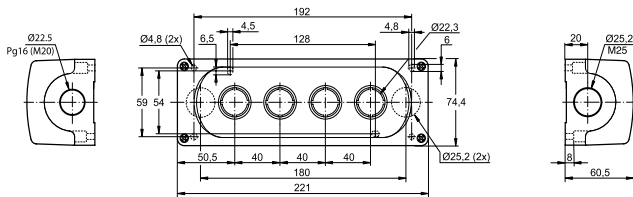

6-seats

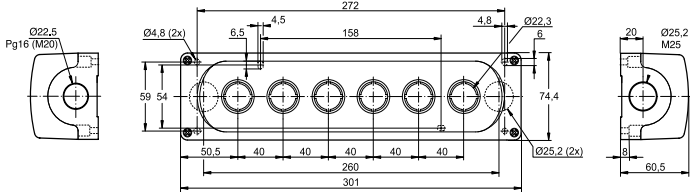

Metallic enclosures

1-seat

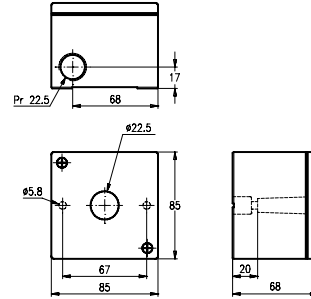

2 or 3-seats

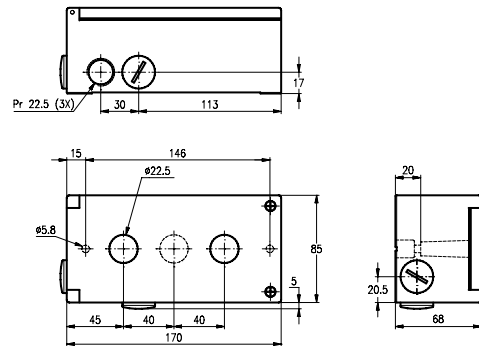

4 or 6-seats

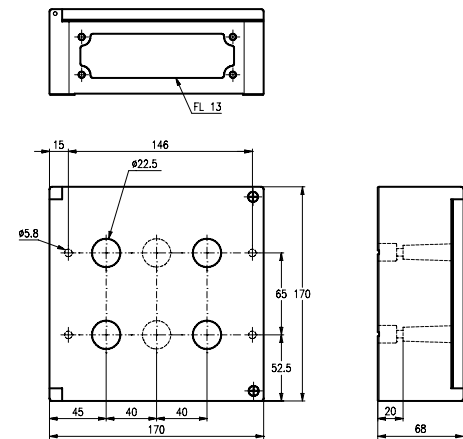

7

Plastic enclosure for compact range

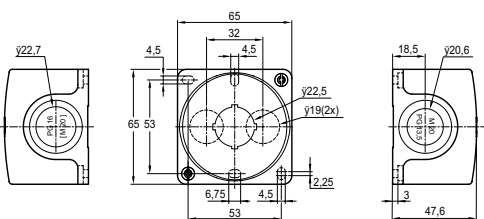

Mounting kit for DIN-rail

MA1-8001, MA1-8131

Mounting kit for DIN-rail

Operating instructions

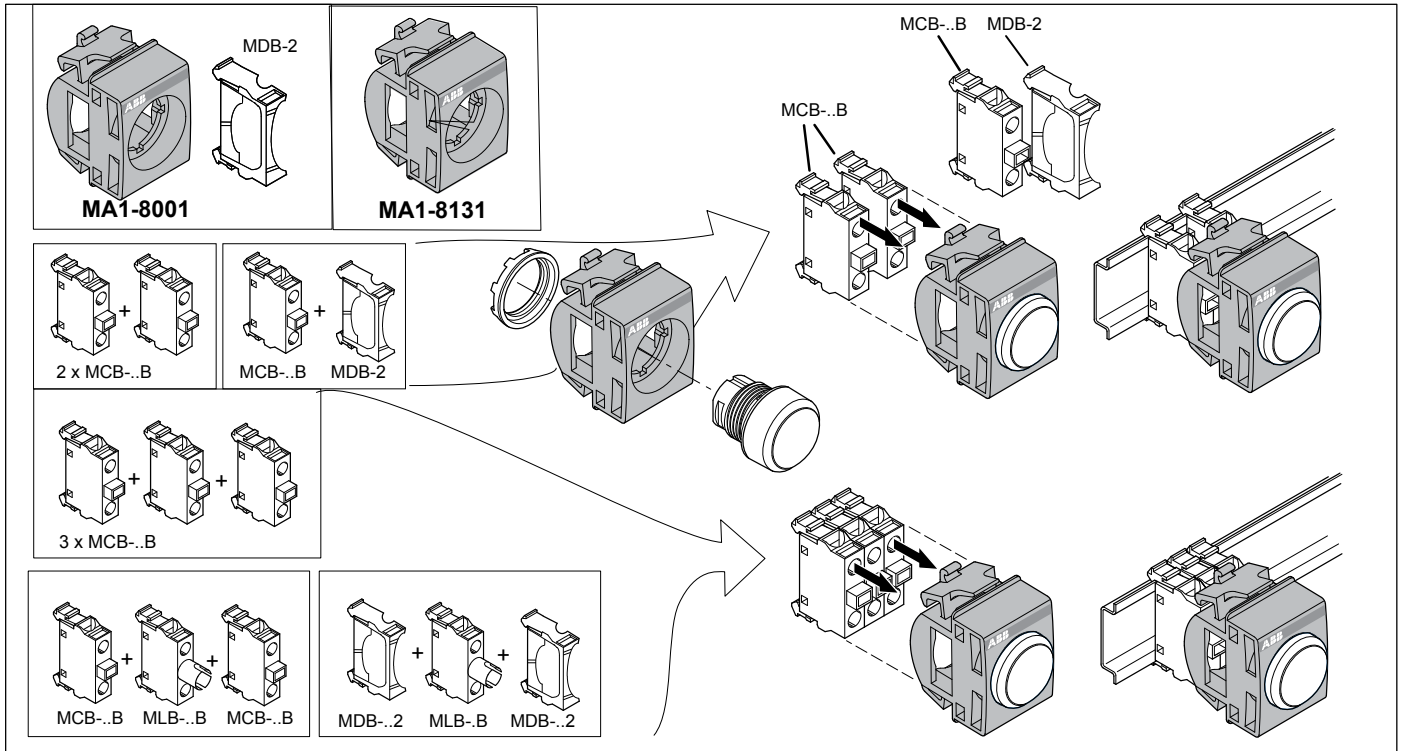

Color selection

Color selection according to IEC 60 073

IEC 60 073 specifies coding principles for indicators and actuators and gives recommendation regarding the use of colors. An excerpt from the standard is given below. For detailed information, see the standard.

Meaning of colors - General principles

Color	Safety of persons or environment	Condition of process	State of equipment
● Red	Danger	Emergency	Faulty
● Yellow	Warning/caution	Abnormal	Abnormal
● Green	Safe	Normal	Normal
● Blue	Mandatory significance		
○● White, grey, black	No specific meaning assigned		

Non-illuminated actuators

Emergency Actuators
EMERGENCY-STOP / OFF actuators shall be identified by the color RED

STOP / OFF actuators

WHITE, GREY and BLACK are the preferred colors for STOP / OFF actuators, with the main preference being for BLACK. RED is also permitted. GREEN shall not be used.

START / ON actuators

WHITE, GREY and BLACK are the preferred colors for START / ON actuators, which cause the closing of switching devices and the equipment to start, with the main preference being for WHITE. GREEN is also permitted. RED shall not be used.

Use of WHITE and BLACK for specific meanings

Where the colors WHITE and BLACK are used to distinguish between START / ON and STOP / OFF actuators, then the color WHITE shall be used for START / ON actuators and the color BLACK shall be used for STOP / OFF actuators.

The same actuators serving for START / STOP or ON / OFF

WHITE, GREY and BLACK are the preferred colors for actuators which, when actuated several times, act alternately as a START / ON and STOP / OFF actuator.

The colors YELLOW and GREEN shall not be used. The color RED shall be used only in cases where the same actuator, other than a push-button, is used for both EMERGENCYSTOP / OFF and normal operation.

WHITE, GREY and BLACK are preferred colors for actuators which cause a movement while they are actuated and stop the movement when they are released (such as inching or jogging actuators). GREEN is also permitted. RED shall not be used.

RESET actuators

RESET Actuators (used, for example, with protective relays) shall be BLUE, WHITE, GREY or BLACK, except RESET actuators which also act as STOP / OFF actuators. The color of such STOP / OFF actuators shall be in accordance with STOP / OFF actuators above.

Degrees of protection

In an installation, the degree of protection required for electrical equipment depends on the environmental characteristics. The degree of protection, ensured by the enclosure of equipment or by the cubicle containing the equipment is expressed by the IP code which gives the level of protection against access to hazardous parts, the ingress of foreign bodies and/or the ingress of water, in compliance with IEC 60529, IEC 60947-1. Besides the IP symbol, the complete code has two figures followed (optionally) by two additional letters. A short description of the elements used in IP coding is given below.

IP... code	Figures or Letters	Specifications for installation protection	Protection of persons
First figure		Against ingress of foreign bodies	Against access to hazardous parts with:
	0	No protection	No protection
	1	Diameter > 50 mm	Back of hand
	2	Diameter > 12.5 mm	Finger
	3	Diameter > 2.5 mm	Tool
	4	Diameter > 1 mm	Wire
	5	Limited protection against dust	Wire
	6	Total protection against dust	Wire
Second figure		Against entrance of water having a harmful effect	
	0	No protection	
	1	Vertical dripping	
	2	Dripping at a vertical angle of < 15°	
	3	Rain at a vertical angle of < 60°	
	4	Splashing	
	5	Low pressure water jet	
	6	Powerful water jets	
	7	Temporary immersion	
	8	Permanent immersion	
	9K*	High pressure, high temperature washdown	

Note: The type of enclosure or cubicle in which the equipment must be installed prevails with respect to the degree of protection.

*According to DIN 400 50-9

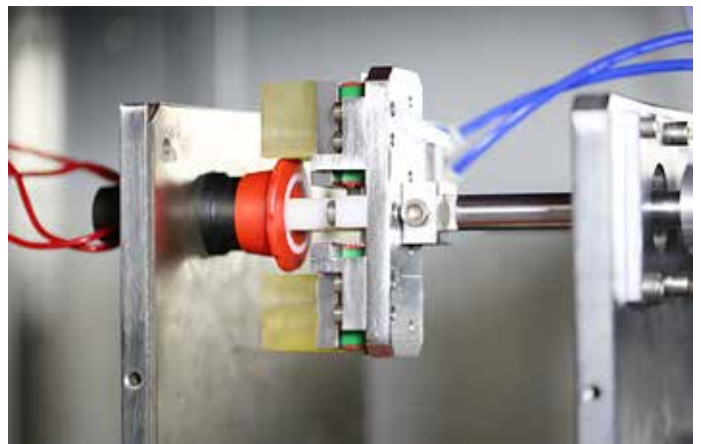

Explanation of type codes

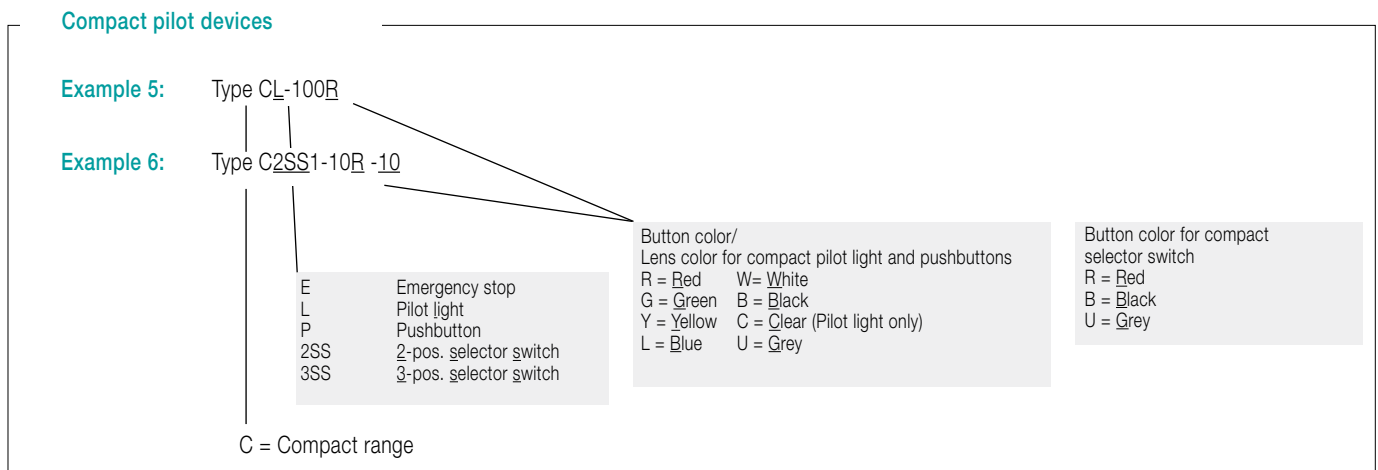
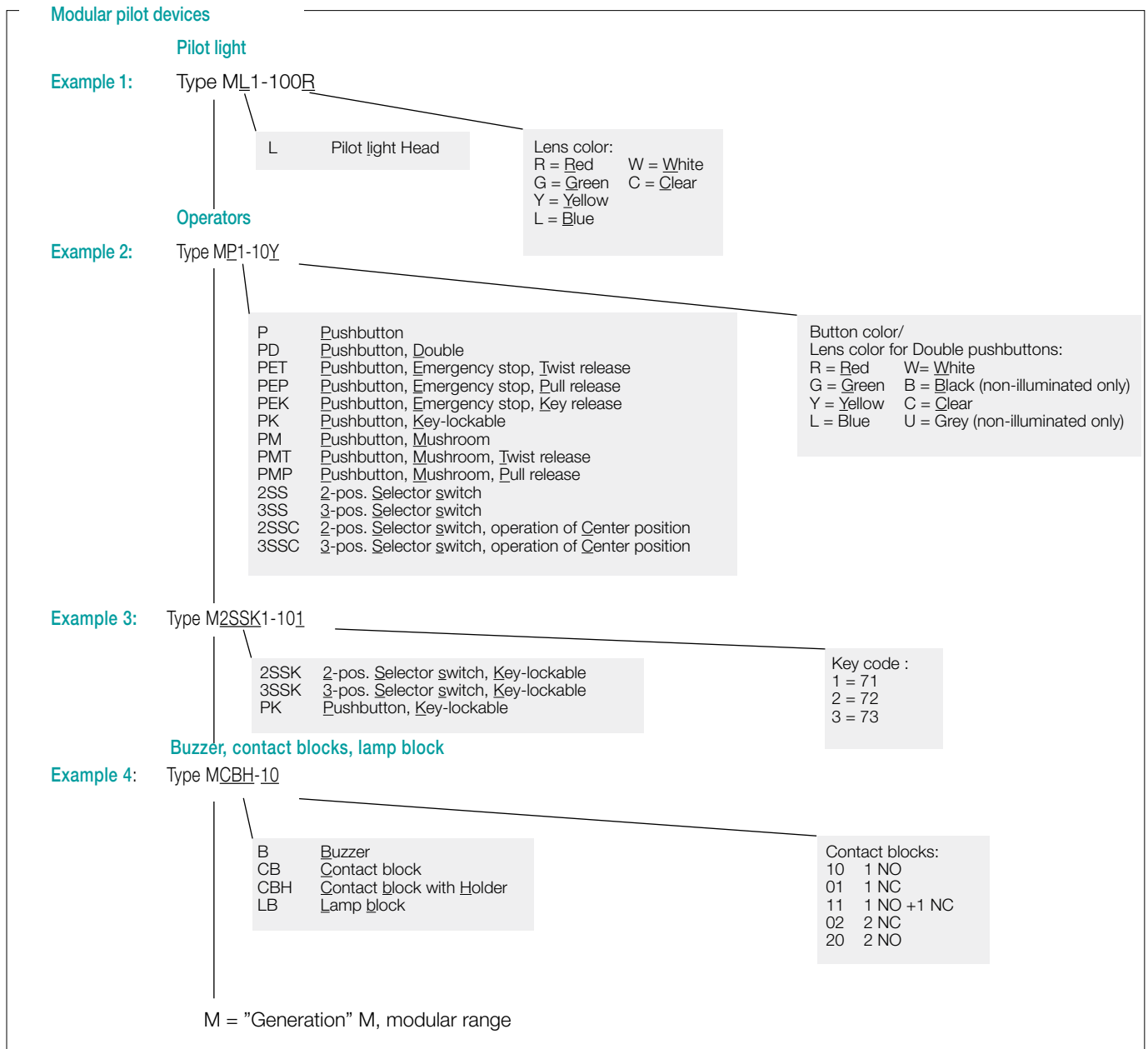

Index

Type - order code

Type	Order code	Page	Type	Order code	Page	Type	Order code	Page
-	1SFA611930R1252	2 / 15	-	SK615552-29	5 / 6	CE3T-10R-11	1SFA619500R1071	3 / 7
-	SK615552-87	2 / 15	-	SK615552-30	5 / 6	CE4K1-10B-11	1SFA619552R1076	3 / 7
-	SK615552-88	2 / 15	-	SK615552-31	5 / 6	CE4K1-10R-02	1SFA619552R1051	3 / 7
-	SK616016-2	2 / 24	-	SK615552-32	5 / 6	CE4K1-10R-11	1SFA619552R1071	3 / 7
-	SK616021-71	2 / 23	-	SK615552-39	5 / 6	CE4P-10B-11	1SFA619551R1076	3 / 7
-	SK616021-72	2 / 23	-	SK615552-40	5 / 6	CE4P-10R-02	1SFA619551R1051	3 / 7
-	SK616021-73	2 / 23	-	SK615552-60	5 / 6	CE4P-10R-11	1SFA619551R1071	3 / 7
-	SK615512-1	2 / 24	-	SK615562-12	5 / 6	CE4T-10B-11	1SFA619550R1076	3 / 7
-	SK616016-2	2 / 24	-	SK615562-18	5 / 6	CE4T-10R-01	1SFA619550R1041	3 / 7
-	4950512-1	2 / 26	-	SK615562-27	5 / 6	CE4T-10R-02	1SFA619550R1051	3 / 7
-	4950512-2	2 / 26	-	SK615562-82	5 / 6	CE4T-10R-11	1SFA619550R1071	3 / 7
-	4950512-3	2 / 26	-	SK615562-83	5 / 6	CEP1-0	1SFA619811R1000	4 / 3
-	5911086-11	2 / 26	C2SS1-10-01	1SFA619200R104	3 / 6	CEP1-1001	1SFA619811R1001	4 / 8
-	5911086-12	2 / 26	C2SS1-10-02	1SFA619200R105	3 / 6	CEP1-1002	1SFA619811R1002	4 / 8
-	5911086-13	2 / 26	C2SS1-10-10	1SFA619200R101	3 / 6	CEP1-2001	1SFA619811R2001	4 / 8
-	5911086-14	2 / 26	C2SS1-10-11	1SFA619200R107	3 / 6	CEP1-2002	1SFA619811R2002	4 / 8
-	5911086-15	2 / 26	C2SS1-10-20	1SFA619200R102	3 / 6	CEPY1-0	1SFA619821R1000	4 / 3
-	5911086-4	2 / 26	C2SS2-10-01	1SFA619201R104	3 / 6	CEPY1-1001	1SFA619821R1001	4 / 8
-	5911086-5	2 / 26	C2SS2-10-02	1SFA619201R105	3 / 6	CEPY1-1002	1SFA619821R1002	4 / 8
-	5911086-7	2 / 26	C2SS2-10-10	1SFA619201R101	3 / 6	CEPY1-1006	1SFA619821R1006	4 / 8
-	5911086-11	3 / 10	C2SS2-10-11	1SFA619201R107	3 / 6	CEPY1-2001	1SFA619821R2001	4 / 8
-	5911086-12	3 / 10	C2SS2-10-20	1SFA619201R102	3 / 6	CEPY1-2002	1SFA619821R2002	4 / 8
-	5911086-13	3 / 10	C2SS3-10-01	1SFA619202R104	3 / 6	CL-100	1SFA619402R100	3 / 6
-	5911086-14	3 / 10	C2SS3-10-02	1SFA619202R105	3 / 6	CL-501G	1SFA619402R5012	3 / 5
-	5911086-15	3 / 10	C2SS3-10-10	1SFA619202R101	3 / 6	CL-501L	1SFA619402R5014	3 / 5
-	5911086-4	3 / 10	C2SS3-10-11	1SFA619202R107	3 / 6	CL-501R	1SFA619402R5011	3 / 5
-	5911086-5	3 / 10	C2SS3-10-20	1SFA619202R102	3 / 6	CL-501W	1SFA619402R5015	3 / 5
-	5911086-7	3 / 10	C3SS1-10-02	1SFA619210R105	3 / 6	CL-501Y	1SFA619402R5013	3 / 5
-	SK615512-1	3 / 11	C3SS1-10-11	1SFA619210R107	3 / 6	CL-502G	1SFA619402R5022	3 / 5
-	SK616016-2	3 / 11	C3SS1-10-20	1SFA619210R102	3 / 6	CL-502L	1SFA619402R5024	3 / 5
-	SK616021-71	3 / 11	C3SS2-10-02	1SFA619211R105	3 / 6	CL-502R	1SFA619402R5021	3 / 5
-	53960543-1	4 / 6	C3SS2-10-11	1SFA619211R107	3 / 6	CL-502W	1SFA619402R5025	3 / 5
-	SK615516-1	4 / 6	C3SS2-10-20	1SFA619211R102	3 / 6	CL-502Y	1SFA619402R5023	3 / 5
-	SK1704536	4 / 7	C3SS3-10-02	1SFA619212R105	3 / 6	CL-504G	1SFA619402R5042	3 / 5
-	SK1707685	4 / 7	C3SS3-10-11	1SFA619212R107	3 / 6	CL-504L	1SFA619402R5044	3 / 5
-	SK1707686	4 / 7	C3SS3-10-20	1SFA619212R102	3 / 6	CL-504R	1SFA619402R5041	3 / 5
-	SK1707687	4 / 7	C3SS7-10-02	1SFA619216R105	3 / 6	CL-504W	1SFA619402R5045	3 / 5
-	SK172105-AA	4 / 7	C3SS7-10-11	1SFA619216R107	3 / 6	CL-504Y	1SFA619402R5043	3 / 5
-	SK172105-AD	4 / 7	C3SS7-10-20	1SFA619216R102	3 / 6	CL-505G	1SFA619402R5052	3 / 5
-	SK172105-AE	4 / 7	CA1-8053	1SFA619920R8053	4 / 3	CL-505L	1SFA619402R5054	3 / 5
-	SK172105-AF	4 / 7	CA1-8054	1SFA619920R8054	4 / 3	CL-505R	1SFA619402R5051	3 / 5
-	SK1750152	4 / 7	CA1-8075	1SFA619920R8075	3 / 10	CL-505W	1SFA619402R5055	3 / 5
-	SK175919-3	4 / 7	CA1-8077	1SFA619920R8077	3 / 11	CL-505Y	1SFA619402R5053	3 / 5
-	1SFA616915L1038	5 / 5	CA1-8078	1SFA619920R8078	3 / 11	CL-513G	1SFA619402R5132	3 / 5
-	1SFA616915R1005	5 / 5	CA1-8080	1SFA619920R8080	3 / 10	CL-513L	1SFA619402R5134	3 / 5
-	1SFA616915R1038	5 / 5	CA6-1026	1SFA619930R1026	5 / 5	CL-513R	1SFA619402R5131	3 / 5
-	1SFA616915R6005	5 / 5	CA6-1027	1SFA619930R1027	5 / 5	CL-513W	1SFA619402R5135	3 / 5
-	SK615546-1	5 / 5	CB1-600G	1SFA619600R6002	3 / 8	CL-513Y	1SFA619402R5133	3 / 5
-	SK615546-13	5 / 5	CB1-601G	1SFA619600R6012	3 / 8	CL-515G	1SFA619402R5152	3 / 5
-	SK615546-2	5 / 5	CB1-602G	1SFA619600R6022	3 / 8	CL-515L	1SFA619402R5154	3 / 5
-	SK615546-3	5 / 5	CB1-603G	1SFA619600R6032	3 / 8	CL-515R	1SFA619402R5151	3 / 5
-	SK615546-4	5 / 5	CB1-610R	1SFA619600R6101	3 / 8	CL-515W	1SFA619402R5155	3 / 5
-	SK615546-5	5 / 5	CB1-610Y	1SFA619600R6103	3 / 8	CL-515Y	1SFA619402R5153	3 / 5
-	SK615546-6	5 / 5	CB1-611R	1SFA619600R6111	3 / 8	CL-520G	1SFA619402R5202	3 / 5
-	SK615546-8	5 / 5	CB1-611Y	1SFA619600R6113	3 / 8	CL-520L	1SFA619402R5204	3 / 5
-	SK615550-29	5 / 6	CB1-612R	1SFA619600R6121	3 / 8	CL-520R	1SFA619402R5201	3 / 5
-	SK615550-44	5 / 6	CB1-612Y	1SFA619600R6123	3 / 8	CL-520W	1SFA619402R5205	3 / 5
-	SK615550-61	5 / 6	CB1-613R	1SFA619600R6131	3 / 8	CL-520Y	1SFA619402R5203	3 / 5
-	SK615550-62	5 / 6	CB1-613Y	1SFA619600R6133	3 / 8	CL-523G	1SFA619402R5232	3 / 5
-	SK615550-63	5 / 6	CB1-620B	1SFA619600R6206	3 / 8	CL-523L	1SFA619402R5234	3 / 5
-	SK615550-80	5 / 6	CB1-621B	1SFA619600R6216	3 / 8	CL-523R	1SFA619402R5231	3 / 5
-	SK615550-81	5 / 6	CB1-622B	1SFA619600R6226	3 / 8	CL-523W	1SFA619402R5235	3 / 5
-	SK615552-13	5 / 6	CB1-623B	1SFA619600R6236	3 / 8	CL-523Y	1SFA619402R5233	3 / 5
-	SK615552-14	5 / 6	CB1-630B	1SFA619600R6306	3 / 8	CL-530G	1SFA619402R5302	3 / 5
-	SK615552-15	5 / 6	CB1-631B	1SFA619600R6316	3 / 8	CL-530L	1SFA619402R5304	3 / 5
-	SK615552-16	5 / 6	CB1-632B	1SFA619600R6326	3 / 8	CL-530R	1SFA619402R5301	3 / 5
-	SK615552-17	5 / 6	CB1-633B	1SFA619600R6336	3 / 8	CL-530W	1SFA619402R5305	3 / 5
-	SK615552-18	5 / 6	CE3K1-10B-11	1SFA619502R1076	3 / 7	CL-530Y	1SFA619402R5303	3 / 5
-	SK615552-20	5 / 6	CE3K1-10R-02	1SFA619502R1051	3 / 7	CL-541G	1SFA619402R5412	3 / 5
-	SK615552-21	5 / 6	CE3K1-10R-11	1SFA619502R1071	3 / 7	CL-541L	1SFA619402R5414	3 / 5
-	SK615552-22	5 / 6	CE3P-10B-11	1SFA619501R1076	3 / 7	CL-541R	1SFA619402R5411	3 / 5
-	SK615552-23	5 / 6	CE3P-10R-02	1SFA619501R1051	3 / 7	CL-541W	1SFA619402R5415	3 / 5
-	SK615552-24	5 / 6	CE3P-10R-11	1SFA619501R1071	3 / 7	CL-541Y	1SFA619402R5413	3 / 5
-	SK615552-25	5 / 6	CE3T-10B-11	1SFA619500R1076	3 / 7	CP1-10-01	1SFA619100R104	3 / 3
-	SK615552-27	5 / 6	CE3T-10R-01	1SFA619500R1041	3 / 7	CP1-10-02	1SFA619100R105	3 / 3
-	SK615552-28	5 / 6	CE3T-10R-02	1SFA619500R1051	3 / 7	CP1-10-10	1SFA619100R101	3 / 3

Index

Type - order code

Type	Order code	Page
CP1-10-11	1SFA619100R107	3 / 3
CP1-10-20	1SFA619100R102	3 / 3
CP1-11-01	1SFA619100R114	3 / 4
CP1-11-10	1SFA619100R111	3 / 4
CP11-10W-10	1SFA619110R1015	3 / 3
CP1-12-01	1SFA619100R124	3 / 4
CP1-12-10	1SFA619100R121	3 / 4
CP1-13-01	1SFA619100R134	3 / 4
CP1-13-10	1SFA619100R131	3 / 4
CP12-10W-10	1SFA619120R1015	3 / 3
CP2-10-01	1SFA619101R104	3 / 3
CP2-10-02	1SFA619101R105	3 / 3
CP2-10-10	1SFA619101R101	3 / 3
CP2-10-11	1SFA619101R107	3 / 3
CP2-10-20	1SFA619101R102	3 / 3
CP2-11-01	1SFA619101R114	3 / 4
CP2-11-10	1SFA619101R111	3 / 4
CP2-12-01	1SFA619101R124	3 / 4
CP2-12-10	1SFA619101R121	3 / 4
CP2-13-01	1SFA619101R134	3 / 4
CP2-13-10	1SFA619101R131	3 / 4
CP3-10-01	1SFA619102R104	3 / 3
CP3-10-02	1SFA619102R105	3 / 3
CP3-10-10	1SFA619102R101	3 / 3
CP3-10-11	1SFA619102R107	3 / 3
CP3-10-20	1SFA619102R102	3 / 3
CP3-11-01	1SFA619102R114	3 / 4
CP3-11-10	1SFA619102R111	3 / 4
CP3-12-01	1SFA619102R124	3 / 4
CP3-12-10	1SFA619102R121	3 / 4
CP3-13-01	1SFA619102R134	3 / 4
CP3-13-10	1SFA619102R131	3 / 4
CP33-10B-01	1SFA619132R1046	3 / 3
CP4-10-01	1SFA619103R104	3 / 3
CP4-10-02	1SFA619103R105	3 / 3
CP4-10-10	1SFA619103R101	3 / 3
CP4-10-11	1SFA619103R107	3 / 3
CP4-10-20	1SFA619103R102	3 / 3
CP4-11-01	1SFA619103R114	3 / 4
CP4-11-10	1SFA619103R111	3 / 4
CP4-12-01	1SFA619103R124	3 / 4
CP4-12-10	1SFA619103R121	3 / 4
CP4-13-01	1SFA619103R134	3 / 4
CP4-13-10	1SFA619103R131	3 / 4
CP6-10-02	1SFA619105R105	3 / 8
CP6-10-11	1SFA619105R107	3 / 8
CP6-10-20	1SFA619105R102	3 / 8
CPM3-10B-11	1SFA619126R1076	3 / 3
CPM3-10G-11	1SFA619126R1072	3 / 3
CPM3-10L-11	1SFA619126R1074	3 / 3
CPM3-10R-11	1SFA619126R1071	3 / 3
CPM3-10Y-11	1SFA619126R1073	3 / 3
MA1-8002	1SFA616920R8002	2 / 24
MA1-8002	1SFA616920R8002	3 / 11
KA1-8005	1SFA616920R8005	3 / 10
KA1-8010	1SFA616920R8010	2 / 24
KA1-8010	1SFA616920R8010	3 / 11
KA1-8021	1SFA616920R8021	2 / 24
KA1-8021	1SFA616920R8021	3 / 11
KA1-8022	1SFA616920R8022	2 / 24
KA1-8022	1SFA616920R8022	3 / 11
KA1-8024	1SFA616920R8024	2 / 24
KA1-8027	1SFA616920R8027	2 / 23
KA1-8028	1SFA616920R8028	2 / 23
KA1-8029	1SFA616920R8029	2 / 23
KA1-8029	1SFA616920R8029	3 / 10
KA1-803	1SFA616920R803	2 / 26
KA1-8030	1SFA616920R8030	2 / 23
KA1-8030	1SFA616920R8030	3 / 10
KA1-8045	1SFA616920R8045	4 / 6
KA1-8046	1SFA616920R8046	2 / 16
KA1-8047	1SFA616920R8047	2 / 16
MA1-8052	1SFA611920R8052	2 / 24
MA1-8052	1SFA611920R8052	3 / 11
KA1-8072	1SFA616920R8072	2 / 23
KA1-8072	1SFA616920R8072	2 / 26

Type	Order code	Page
KA1-8072	1SFA616920R8072	3 / 10
KA1-8073	1SFA616920R8073	2 / 23
KA1-8073	1SFA616920R8073	3 / 10
KA1-8077	1SFA616920R8077	2 / 24
KA1-8079	1SFA616920R8079	2 / 24
KA1-808	1SFA616920R808	2 / 26
KA1-8080	1SFA616920R8080	2 / 24
KA1-8087	1SFA616920R8087	3 / 11
KA1-809	1SFA616920R809	2 / 26
KA1-8097	1SFA616920R8097	3 / 11
KA1-810	1SFA616920R810	2 / 26
KA1-811	1SFA616920R811	2 / 26
KA1-8120	1SFA616920R8120	5 / 3
KA1-8121	1SFA616920R8121	5 / 3
KA2-2011	1SFA616921R2011	2 / 25
KA2-2011	1SFA616921R2011	3 / 9
KA2-2012	1SFA616921R2012	2 / 25
KA2-2012	1SFA616921R2012	3 / 9
KA2-2013	1SFA616921R2013	2 / 25
KA2-2013	1SFA616921R2013	3 / 9
KA2-2014	1SFA616921R2014	2 / 25
KA2-2014	1SFA616921R2014	3 / 9
KA2-2015	1SFA616921R2015	2 / 25
KA2-2015	1SFA616921R2015	3 / 9
KA2-2021	1SFA616921R2021	2 / 25
KA2-2021	1SFA616921R2021	3 / 9
KA2-2022	1SFA616921R2022	2 / 25
KA2-2022	1SFA616921R2022	3 / 9
KA2-2023	1SFA616921R2023	2 / 25
KA2-2023	1SFA616921R2023	3 / 9
KA2-2024	1SFA616921R2024	2 / 25
KA2-2024	1SFA616921R2024	3 / 9
KA2-2025	1SFA616921R2025	2 / 25
KA2-2025	1SFA616921R2025	3 / 9
KA2-2031	1SFA616921R2031	2 / 25
KA2-2031	1SFA616921R2031	3 / 9
KA2-2032	1SFA616921R2032	2 / 25
KA2-2032	1SFA616921R2032	3 / 9
KA2-2033	1SFA616921R2033	2 / 25
KA2-2033	1SFA616921R2033	3 / 9
KA2-2034	1SFA616921R2034	2 / 25
KA2-2034	1SFA616921R2034	3 / 9
KA2-2035	1SFA616921R2035	2 / 25
KA2-2035	1SFA616921R2035	3 / 9
KA2-2041	1SFA616921R2041	2 / 25
KA2-2041	1SFA616921R2041	3 / 9
KA2-2042	1SFA616921R2042	2 / 25
KA2-2042	1SFA616921R2042	3 / 9
KA2-2043	1SFA616921R2043	2 / 25
KA2-2043	1SFA616921R2043	3 / 9
KA2-2044	1SFA616921R2044	2 / 25
KA2-2044	1SFA616921R2044	3 / 9
KA2-2045	1SFA616921R2045	2 / 25
KA2-2045	1SFA616921R2045	3 / 9
KA2-2051	1SFA616921R2051	2 / 25
KA2-2051	1SFA616921R2051	3 / 9
KA2-2052	1SFA616921R2052	2 / 25
KA2-2052	1SFA616921R2052	3 / 9
KA2-2053	1SFA616921R2053	2 / 25
KA2-2053	1SFA616921R2053	3 / 9
KA2-2054	1SFA616921R2054	2 / 25
KA2-2054	1SFA616921R2054	3 / 9
KA2-2055	1SFA616921R2055	2 / 25
KA2-2055	1SFA616921R2055	3 / 9
KA2-2131	1SFA616921R2131	2 / 25
KA2-2131	1SFA616921R2131	3 / 9
KA2-2132	1SFA616921R2132	2 / 25
KA2-2132	1SFA616921R2132	3 / 9
KA2-2133	1SFA616921R2133	2 / 25
KA2-2133	1SFA616921R2133	3 / 9
KA2-2134	1SFA616921R2134	2 / 25
KA2-2134	1SFA616921R2134	3 / 9
KA2-2135	1SFA616921R2135	2 / 25
KA2-2135	1SFA616921R2135	3 / 9
KA2-2141	1SFA616921R2141	2 / 25
KA2-2141	1SFA616921R2141	3 / 9

Type	Order code	Page
KA2-2142	1SFA616921R2142	2 / 25
KA2-2142	1SFA616921R2142	3 / 9
KA2-2143	1SFA616921R2143	2 / 25
KA2-2143	1SFA616921R2143	3 / 9
KA2-2144	1SFA616921R2144	2 / 25
KA2-2144	1SFA616921R2144	3 / 9
KA2-2145	1SFA616921R2145	2 / 25
KA2-2145	1SFA616921R2145	3 / 9
KA2-2221	1SFA616921R2221	2 / 25
KA2-2221	1SFA616921R2221	3 / 9
KA2-2222	1SFA616921R2222	2 / 25
KA2-2222	1SFA616921R2222	3 / 9
KA2-2223	1SFA616921R2223	2 / 25
KA2-2223	1SFA616921R2223	3 / 9
KA2-2224	1SFA616921R2224	2 / 25
KA2-2224	1SFA616921R2224	3 / 9
KA2-2225	1SFA616921R2225	2 / 25
KA2-2225	1SFA616921R2225	3 / 9
KA2-2231	1SFA616921R2231	2 / 25
KA2-2231	1SFA616921R2231	3 / 9
KA2-2232	1SFA616921R2232	2 / 25
KA2-2232	1SFA616921R2232	3 / 9
KA2-2233	1SFA616921R2233	2 / 25
KA2-2233	1SFA616921R2233	3 / 9
KA2-2234	1SFA616921R2234	2 / 25
KA2-2234	1SFA616921R2234	3 / 9
KA2-2235	1SFA616921R2235	2 / 25
KA2-2235	1SFA616921R2235	3 / 9
KA3-1018	1SFA616922R1018	6 / 5
KA3-1028	1SFA616922R1028	6 / 5
KA3-1118	1SFA616922R1118	6 / 5
KA3-1148	1SFA616922R1148	6 / 5
KA4-102	1SFA616924R102	6 / 3
KA4-1021	1SFA616923R1028	6 / 3
KA4-1118	1SFA616923R1118	6 / 3
KA4-1148	1SFA616923R1148	6 / 3
KA70-1001	1SFA616077R1001	6 / 4
KA70-1002	1SFA616077R1002	6 / 4
KA70-1011	1SFA616077R1011	6 / 4
KA70-1012	1SFA616077R1012	6 / 4
KA70-1013	1SFA616077R1013	6 / 4
KA70-1021	1SFA616077R1021	6 / 4
KA70-1022	1SFA616077R1022	6 / 4
KA70-1023	1SFA616077R1023	6 / 4
KA70-1031	1SFA616077R1031	6 / 4
KA70-1032	1SFA616077R1032	6 / 4
KA70-1033	1SFA616077R1033	6 / 4
KA70-1034	1SFA616077R1034	6 / 4
KASB-100	1SFA616087R1000	6 / 5
KB70-1201	1SFA616071R1201	6 / 3
KB70-3001	1SFA616071R3001	6 / 3
KB70-3101	1SFA616071R3101	6 / 3
KEM1-0	SK616701-AA	4 / 7
KEM2-0	SK616702-AA	4 / 7
KEM3-0	SK616703-AA	4 / 7
KEM4-0	SK616704-AA	4 / 7
KEM6-0	SK616706-AA	4 / 7
KL70-113	1SFA616070R113	6 / 3
KL70-123	1SFA616070R123	6 / 3
KL70-203	1SFA616070R203	6 / 3
KL70-305	1SFA616070R305	6 / 3
KL70-306	1SFA616070R306	6 / 3
KL70-307	1SFA616070R307	6 / 3
KL70-342	1SFA616070R342	6 / 3
KL70-352	1SFA616070R352	6 / 3
KL70-401	1SFA616070R401	6 / 3
KP6-40B	1SFA616105R4006	2 / 19
KP6-40B-01	1SFA616105R4046	2 / 19
KP6-40B-02	1SFA616105R4056	2 / 19
KP6-40B-10	1SFA616105R4016	2 / 19
KP6-40B-11	1SFA616105R4076	2 / 19
KP6-40B-20	1SFA616105R4026	2 / 19
KP6-40G	1SFA616105R4002	2 / 19
KP6-40R	1SFA616105R4001	2 / 19
KPR1-100B	1SFA616160R1006	2 / 16
KPR1-100G	1SFA616160R1002	2 / 16

Index

Type - order code

Type	Order code	Page
KPR1-100L	1SFA616160R1004	2 / 16
KPR1-100R	1SFA616160R1001	2 / 16
KPR1-100W	1SFA616160R1005	2 / 16
KPR1-100Y	1SFA616160R1003	2 / 16
KPR1-101L	1SFA616160R1014	2 / 16
KPR1-101W	1SFA616160R1015	2 / 16
KPR1-102W	1SFA616160R1025	2 / 16
KPR1-103G	1SFA616160R1032	2 / 16
KPR1-104B	1SFA616160R1046	2 / 16
KPR2-100B	1SFA616161R1006	2 / 16
KPR2-100R	1SFA616161R1001	2 / 16
KPR2-100W	1SFA616161R1005	2 / 16
KPR2-105B	1SFA616161R1056	2 / 16
KPR2-105R	1SFA616161R1051	2 / 16
KPR3-100B	1SFA616162R1006	2 / 16
KPR3-100G	1SFA616162R1002	2 / 16
KPR3-100L	1SFA616162R1004	2 / 16
KPR3-100R	1SFA616162R1001	2 / 16
KPR3-100W	1SFA616162R1005	2 / 16
KPR3-100Y	1SFA616162R1003	2 / 16
KPR3-101L	1SFA616162R1014	2 / 16
KPR3-101W	1SFA616162R1015	2 / 16
KPR3-102W	1SFA616162R1025	2 / 16
KPR3-103G	1SFA616162R1032	2 / 16
KPR3-103W	1SFA616162R1035	2 / 16
KPR3-104B	1SFA616162R1046	2 / 16
KPR4-100B	1SFA616163R1006	2 / 16
KPR4-100R	1SFA616163R1001	2 / 16
KPR4-100W	1SFA616163R1005	2 / 16
KPR4-105B	1SFA616163R1056	2 / 16
KPR4-105R	1SFA616163R1051	2 / 16
KS70-1104	1SFA616073R1104	6 / 4
KS70-1204	1SFA616073R1204	6 / 4
KS70-2002	1SFA616073R2002	6 / 4
KS70-2004	1SFA616073R2004	6 / 4
KS70-3004	1SFA616073R3004	6 / 4
KSB-113	1SFA616080R113	6 / 5
KSB-123	1SFA616080R123	6 / 5
KSB-203	1SFA616080R203	6 / 5
KSB-305	1SFA616080R305	6 / 5
KSB-306	1SFA616080R306	6 / 5
KSB-307	1SFA616080R307	6 / 5
KSB-401	1SFA616080R401	6 / 5
KT-100B	1SFA616410R1006	2 / 15
KT-300B	1SFA616410R3006	2 / 15
KT70-1001	1SFA616075R1001	6 / 4
KT70-1002	1SFA616075R1002	6 / 4
KTC1-1019	1SFA616901R1019	5 / 7
KTC1-1020	1SFA616901R1020	5 / 7
KTC1-1025	1SFA616901R1025	5 / 7
KTC1-1031	1SFA616901R1031	5 / 7
KTC1-1039	1SFA616901R1039	5 / 7
KTC1-9000	1SFA616901R9000	5 / 7
KTC1-9000-L	1SFA616901L9000	5 / 8
KTC1-9002	1SFA616901R9002	5 / 8
KTC1-9003	1SFA616901R9003	5 / 8
KTC1-9004	1SFA616901R9004	5 / 8
KTC1-9005	1SFA616901R9005	5 / 8
KTC1-9006	1SFA616901R9006	5 / 8
KTC1-9009	1SFA616901R9009	5 / 7
KTC1-9011	1SFA616901R9011	5 / 8
KTC1-9012	1SFA616901R9012	5 / 8
KTC1-9015	1SFA616901R9015	5 / 8
KTC1-9016	1SFA616901R9016	5 / 8
KTC1-9017	1SFA616901R9017	5 / 8
KTC1-9018	1SFA616901R9018	5 / 8
KTC1-9019	1SFA616901R9019	5 / 8
KTC1-9020	1SFA616901R9020	5 / 8
KTC1-9021	1SFA616901R9021	5 / 8
KTC1-9023	1SFA616901R9023	5 / 8
KTC1-9024	1SFA616901R9024	5 / 8
KTC1-9025	1SFA616901R9025	5 / 8
KTC1-9026	1SFA616901R9026	5 / 8
KTC1-9027	1SFA616901R9027	5 / 8
KTC1-9028	1SFA616901R9028	5 / 8
KTC2-1020	1SFA616902R1020	5 / 7

Type	Order code	Page
KTC2-1025	1SFA616902R1025	5 / 7
KTC2-1031	1SFA616902R1031	5 / 7
KTC2-1040	1SFA616902R1040	5 / 7
KTC2-9000	1SFA616902R9000	5 / 7
KTC2-9000-L	1SFA616902L9000	5 / 8
KTC2-9002	1SFA616902R9002	5 / 8
KTC2-9003	1SFA616902R9003	5 / 8
KTC2-9004	1SFA616902R9004	5 / 8
KTC2-9005	1SFA616902R9005	5 / 8
KTC2-9006	1SFA616902R9006	5 / 8
KTC2-9009	1SFA616902R9009	5 / 7
KTC2-9011	1SFA616902R9011	5 / 8
KTC2-9015	1SFA616902R9015	5 / 8
KTC2-9016	1SFA616902R9016	5 / 8
KTC2-9026	1SFA616902R9026	5 / 8
KTC2-9028	1SFA616902R9028	5 / 8
KTC3-1019	1SFA616903R1019	5 / 7
KTC3-1020	1SFA616903R1020	5 / 7
KTC3-1031	1SFA616903R1031	5 / 7
KTC3-1039	1SFA616903R1039	5 / 7
KTC3-9000	1SFA616903R9000	5 / 7
KTC3-9000-L	1SFA616903L9000	5 / 8
KTC3-9002	1SFA616903R9002	5 / 8
KTC3-9003	1SFA616903R9003	5 / 8
KTC3-9004	1SFA616903R9004	5 / 8
KTC3-9005	1SFA616903R9005	5 / 8
KTC3-9006	1SFA616903R9006	5 / 8
KTC4-1047	1SFA616904R1047	5 / 7
KTC4-9004	1SFA616904R9004	5 / 8
KTC5-1040	1SFA616905R1040	5 / 7
KTC5-1047	1SFA616905R1047	5 / 7
KTC5-9004	1SFA616905R9004	5 / 8
KTC6-1039	1SFA616906R1039	5 / 7
KTC6-1042	1SFA616906R1042	5 / 7
KTC6-9002	1SFA616906R9002	5 / 8
KTC6-9003	1SFA616906R9003	5 / 8
KTC8-1039	1SFA616908R1039	5 / 7
KTC8-9002	1SFA616908R9002	5 / 8
KTC8-9003	1SFA616908R9003	5 / 8
KTC8-9004	1SFA616908R9004	5 / 8
KTC8-9005	1SFA616908R9005	5 / 8
KTC8-9011	1SFA616908R9011	5 / 8
KTC8-9012	1SFA616908R9012	5 / 8
KTC8-9015	1SFA616908R9015	5 / 8
KTC8-9016	1SFA616908R9016	5 / 8
KTC8-9017	1SFA616908R9017	5 / 8
KTC8-9018	1SFA616908R9018	5 / 8
KTC8-9020	1SFA616908R9020	5 / 8
KTC8-9021	1SFA616908R9021	5 / 8
KTC8-9025	1SFA616908R9025	5 / 8
KTC8-9026	1SFA616908R9026	5 / 8
KTC8-9027	1SFA616908R9027	5 / 8
KTR1-1001	1SFA616950R1001	2 / 22
KTR1-1002	1SFA616950R1002	2 / 22
KTR1-1003	1SFA616950R1003	2 / 22
KTR1-1004	1SFA616950R1004	2 / 22
KTR1-1005	1SFA616950R1005	2 / 22
KTR1-1011	1SFA616950R1011	2 / 22
KTR1-1012	1SFA616950R1012	2 / 22
KTR1-1013	1SFA616950R1013	2 / 22
KTR1-1014	1SFA616950R1014	2 / 22
KTR1-2001	1SFA616950R2001	2 / 22
KTR1-2002	1SFA616950R2002	2 / 22
KTR1-2003	1SFA616950R2003	2 / 22
KTR1-2004	1SFA616950R2004	2 / 22
KTR1-2005	1SFA616950R2005	2 / 22
KTR1-2011	1SFA616950R2011	2 / 22
KTR1-2012	1SFA616950R2012	2 / 22
KTR1-2013	1SFA616950R2013	2 / 22
KTR1-2014	1SFA616950R2014	2 / 22
M2SS1-10	1SFA611200R100	2 / 11
M2SS1-11	1SFA611200R110	2 / 11
M2SS2-10	1SFA611201R100	2 / 11
M2SS2-11	1SFA611201R110	2 / 11
M2SS3-10	1SFA611202R100	2 / 11
M2SS3-11	1SFA611202R110	2 / 11

Type	Order code	Page
M2SS4-10	1SFA611203R100	2 / 11
M2SS4-11	1SFA611203R110	2 / 11
M2SS5-10	1SFA611204R100	2 / 11
M2SS5-11	1SFA611204R110	2 / 11
M2SS6-10	1SFA611205R100	2 / 11
M2SS6-11	1SFA611205R110	2 / 11
M2SSK1-101	1SFA611280R1001	2 / 14
M2SSK1-102	1SFA611280R1002	2 / 14
M2SSK1-103	1SFA611280R1003	2 / 14
M2SSK1-104	1SFA611280R1004	2 / 14
M2SSK2-101	1SFA611281R1001	2 / 14
M2SSK2-102	1SFA611281R1002	2 / 14
M2SSK2-103	1SFA611281R1003	2 / 14
M2SSK2-104	1SFA611281R1004	2 / 14
M2SSV1-10	1SFA611220R100	4 / 4
M2SSV1-11	1SFA611220R110	4 / 4
M2SSV2-10	1SFA611221R100	4 / 4
M2SSV2-11	1SFA611221R110	4 / 4
M2SSV3-10	1SFA611222R100	4 / 4
M2SSV3-11	1SFA611222R110	4 / 4
M3SS1-10	1SFA611210R100	2 / 12
M3SS1-11	1SFA611210R110	2 / 12
M3SS2-10	1SFA611211R100	2 / 12
M3SS2-11	1SFA611211R110	2 / 12
M3SS3-10	1SFA611212R100	2 / 12
M3SS3-11	1SFA611212R110	2 / 12
M3SS4-10	1SFA611213R100	2 / 12
M3SS4-11	1SFA611213R110	2 / 12
M3SS5-10	1SFA611214R100	2 / 12
M3SS5-11	1SFA611214R110	2 / 12
M3SS6-10	1SFA611215R100	2 / 12
M3SS6-11	1SFA611215R110	2 / 12
M3SS7-10	1SFA611216R100	2 / 12
M3SS7-11	1SFA611216R110	2 / 12
M3SS8-10	1SFA611217R100	2 / 12
M3SS8-11	1SFA611217R110	2 / 12
M3SSC1-10B	1SFA611250R1006	2 / 13
M3SSC2-10B	1SFA611251R1006	2 / 13
M3SSC3-10B	1SFA611252R1006	2 / 13
M3SSC4-10B	1SFA611253R1006	2 / 13
M3SSC5-10B	1SFA611254R1006	2 / 13
M3SSC6-10B	1SFA611255R1006	2 / 13
M3SSC7-10B	1SFA611256R1006	2 / 13
M3SSC8-10B	1SFA611257R1006	2 / 13
M3SSK1-101	1SFA611283R1001	2 / 14
M3SSK1-102	1SFA611283R1002	2 / 14
M3SSK1-103	1SFA611283R1003	2 / 14
M3SSK1-104	1SFA611283R1004	2 / 14
M3SSK2-101	1SFA611284R1001	2 / 14
M3SSK2-102	1SFA611284R1002	2 / 14
M3SSK2-103	1SFA611284R1003	2 / 14
M3SSK2-104	1SFA611284R1004	2 / 14
M3SSK3-101	1SFA611285R1001	2 / 14
M3SSK3-102	1SFA611285R1002	2 / 14
M3SSK3-103	1SFA611285R1003	2 / 14
M3SSK3-104	1SFA611285R1004	2 / 14
M3SSV1-10	1SFA611230R100	4 / 4
M3SSV1-11	1SFA611230R110	4 / 4
M3SSV2-10	1SFA611231R100	4 / 4
M3SSV2-11	1SFA611231R110	4 / 4
M3SSV3-10	1SFA611232R100	4 / 4
M3SSV3-11	1SFA611232R110	4 / 4
M4SS1-10	1SFA611290R400	2 / 13
M4SS2-10	1SFA611291R400	2 / 13
MA16-1000	1SFA611940R1000	5 / 6
MA16-1000-L	1SFA611940L1000	5 / 6
MA16-1001	1SFA611940R1001	5 / 6
MA16-1001-L	1SFA611940L1001	5 / 6
MA1-8001	1SFA611920R8001	2 / 23
MA1-8015	1SFA611920R8015	2 / 23
MA1-8015	1SFA611920R8015	3 / 10
MA1-8019	1SFA611920R8019	2 / 23
MA1-8019	1SFA611920R8019	2 / 24
MA1-8053	1SFA611920R8053	2 / 24
MA1-8074	1SFA611920R8074	2 / 23
MA1-8124	1SFA611920R8124	2 / 24

Index

Type - order code

Type	Order code	Page
MA1-8124	1SFA611920R8124	2 / 24
MA1-8124	1SFA611920R8124	3 / 11
MA1-8126	1SFA611920R8126	2 / 24
MA1-8128	1SFA611920R8128	2 / 24
MA1-8129	1SFA611920R8129	2 / 24
MA1-8129	1SFA611920R8129	2 / 24
MA1-8129	1SFA611920R8129	3 / 11
MA1-8129	1SFA611920R8129	4 / 6
MA1-8129	1SFA611920R8129	4 / 7
MA1-8130	1SFA611920R8130	2 / 24
MA1-8130	1SFA611920R8130	2 / 24
MA1-8130	1SFA611920R8130	3 / 11
MA1-8130	1SFA611920R8130	4 / 6
MA1-8130	1SFA611920R8130	4 / 7
MA1-8131	1SFA611920R8131	2 / 23
MA1-8136	1SFA611920R8136	2 / 24
MA1-8136	1SFA611920R8136	2 / 24
MA1-8136	1SFA611920R8136	3 / 11
MA1-8136	1SFA611920R8136	4 / 6
MA1-8136	1SFA611920R8136	4 / 7
MA1-8149	1SFA611920R8149	2 / 23
MA1-8149	1SFA611920R8149	3 / 10
MA1-8150	1SFA611920H8150	4 / 6
MA5-3001	1SFA611925R3001	4 / 6
MA5-3002	1SFA611925R3002	4 / 6
MA5-3003	1SFA611925R3003	4 / 6
MA5-3004	1SFA611925R3004	4 / 6
MA5-3005	1SFA611925R3005	4 / 6
MA5-3006	1SFA611925R3006	4 / 6
MA5-3007	1SFA611925R3007	4 / 6
MA5-3008	1SFA611925R3008	4 / 6
MA5-3009	1SFA611925R3009	4 / 6
MA5-3010	1SFA611925R3010	4 / 6
MA6-1000	1SFA611930R1000	5 / 7
MA6-1002	1SFA611930R1002	5 / 7
MA6-1003	1SFA611930R1003	5 / 7
MA6-1004	1SFA611930R1004	5 / 7
MA6-1005	1SFA611930R1005	5 / 7
MA6-1006	1SFA611930R1006	5 / 7
MA6-1007	1SFA611930R1007	5 / 7
MA6-1008	1SFA611930R1008	5 / 7
MA6-1009	1SFA611930R1009	5 / 7
MA6-1010	1SFA611930R1010	5 / 7
MA6-1011	1SFA611930R1011	5 / 7
MA6-1012	1SFA611930R1012	5 / 7
MA6-1013	1SFA611930R1013	5 / 7
MA6-1014	1SFA611930R1014	5 / 7
MA6-1015	1SFA611930R1015	5 / 7
MA6-1016	1SFA611930R1016	5 / 7
MA6-1017	1SFA611930R1017	5 / 7
MA6-1018	1SFA611930R1018	5 / 7
MA6-1019	1SFA611930R1019	5 / 7
MA6-1020	1SFA611930R1020	5 / 7
MA6-1021	1SFA611930R1021	5 / 7
MA6-1022	1SFA611930R1022	5 / 7
MA6-1023	1SFA611930R1023	5 / 7
MA6-1024	1SFA611930R1024	5 / 5
MA6-1024-L	1SFA611930L1024	5 / 5
MA6-1025	1SFA611930R1025	5 / 5
MA6-1026	1SFA611930R1026	5 / 5
MA6-1027	1SFA611930R1027	5 / 5
MA6-1028	1SFA611930R1028	5 / 5
MA6-1029	1SFA611930R1029	5 / 5
MA6-1032	1SFA611930R1032	5 / 3
MA6-1033	1SFA611930R1033	5 / 3
MA6-1034	1SFA611930R1034	5 / 3
MA6-1036	1SFA611930R1036	5 / 3
MA6-1037	1SFA611930R1037	5 / 3
MA6-1038	1SFA611930R1038	5 / 3
MA6-1039	1SFA611930R1039	5 / 3
MA6-1040	1SFA611930R1040	5 / 3
MA6-1041	1SFA611930R1041	5 / 3
MA6-1042	1SFA611930R1042	5 / 3
MA6-1043	1SFA611930R1043	5 / 3
MA6-1044	1SFA611930R1044	5 / 3
MA6-1045	1SFA611930R1045	5 / 3

Type	Order code	Page
MA6-1060	1SFA611930R1060	5 / 4
MA6-1061	1SFA611930R1061	5 / 4
MA6-1062	1SFA611930R1062	5 / 4
MA6-1063	1SFA611930R1063	5 / 4
MA6-1064	1SFA611930R1064	5 / 4
MA6-1070	1SFA611930R1070	5 / 3
MA6-1071	1SFA611930R1071	5 / 3
MA6-1072	1SFA611930R1072	5 / 3
MA6-1073	1SFA611930R1073	5 / 3
MA6-1074	1SFA611930R1074	5 / 3
MA6-1075	1SFA611930R1075	5 / 3
MA6-1076	1SFA611930R1076	5 / 3
MA6-1077	1SFA611930R1077	5 / 3
MA6-1078	1SFA611930R1078	5 / 3
MA6-1079	1SFA611930R1079	5 / 3
MA6-1080	1SFA611930R1080	5 / 3
MA6-1081	1SFA611930R1081	5 / 3
MA6-1082	1SFA611930R1082	5 / 3
MA6-1083	1SFA611930R1083	5 / 3
MA6-1084	1SFA611930R1084	5 / 3
MA6-1100	1SFA611930R1100	5 / 5
MA6-1101	1SFA611930R1101	5 / 5
MA6-1102	1SFA611930R1102	5 / 5
MA6-1103	1SFA611930R1103	5 / 5
MA6-1104	1SFA611930R1104	5 / 5
MA6-1130	1SFA611930R1130	5 / 4
MA6-1131	1SFA611930R1131	5 / 4
MA6-1132	1SFA611930R1132	5 / 4
MA6-1133	1SFA611930R1133	5 / 4
MA6-1134	1SFA611930R1134	5 / 4
MA6-1135	1SFA611930R1135	5 / 4
MA6-1136	1SFA611930R1136	5 / 4
MA6-1137	1SFA611930R1137	5 / 4
MA6-1138	1SFA611930R1138	5 / 4
MA6-1139	1SFA611930R1139	5 / 4
MA6-1140	1SFA611930R1140	5 / 4
MA6-1141	1SFA611930R1141	5 / 4
MA6-1170	1SFA611930R1170	5 / 4
MA6-1171	1SFA611930R1171	5 / 4
MA6-1172	1SFA611930R1172	5 / 4
MA6-1173	1SFA611930R1173	5 / 4
MA6-1174	1SFA611930R1174	5 / 4
MA6-1175	1SFA611930R1175	5 / 4
MA6-1176	1SFA611930R1176	5 / 4
MA6-1177	1SFA611930R1177	5 / 4
MA6-1178	1SFA611930R1178	5 / 4
MA6-1179	1SFA611930R1179	5 / 4
MA6-1190	1SFA611930R1190	5 / 4
MA6-1191	1SFA611930R1191	5 / 4
MA6-1192	1SFA611930R1192	5 / 4
MA6-1193	1SFA611930R1193	5 / 4
MA6-1194	1SFA611930R1194	5 / 4
MCB-01	1SFA611610H1010	2 / 21
MCB-01	1SFA611610R1010	2 / 21
MCB-01B	1SFA611610R2010	4 / 6
MCB-01BG	1SFA611610R2110	4 / 6
MCB-01G	1SFA611610R1110	2 / 21
MCB-02	1SFA611610R1020	2 / 21
MCB-02B	1SFA611610R2020	4 / 6
MCB-10	1SFA611610H1001	2 / 21
MCB-10	1SFA611610R1001	2 / 21
MCB-10B	1SFA611610R2001	4 / 6
MCB-10BG	1SFA611610R2101	4 / 6
MCB-10G	1SFA611610R1101	2 / 21
MCB-11	1SFA611610R1011	2 / 21
MCB-11B	1SFA611610R2011	4 / 6
MCB-20	1SFA611610R1002	2 / 21
MCB-20B	1SFA611610R2002	4 / 6
MCBH-00	1SFA611605R1100	2 / 21
MCBH-01	1SFA611605R1110	2 / 21
MCBH-02	1SFA611605R1120	2 / 21
MCBH-10	1SFA611605R1101	2 / 21
MCBH-11	1SFA611605R1111	2 / 21
MCBH-20	1SFA611605R1102	2 / 21
MCBH5-00	1SFA611601R1100	2 / 21
MCBL-01	1SFA611612R1001	2 / 21

Type	Order code	Page
MCBL-10	1SFA611612R1010	2 / 21
MDB-1001	1SFA611630R1001	2 / 22
MDB-2	1SFA611630R1002	2 / 23
MDB-2	1SFA611630R1002	3 / 10
MEP1-0	1SFA611811R1000	4 / 3
MEP2-0	1SFA611812R1000	4 / 3
MEP2-1001	1SFA611812R1001	4 / 8
MEP3-0	1SFA611813R1000	4 / 3
MEP4-0	1SFA611814R1000	4 / 3
MEP6-0	1SFA611816R1000	4 / 3
MEPY1-0	1SFA611821R1000	4 / 3
MEPY1-1005	1SFA611821R1005	4 / 8
MEPY1-1024	1SFA611821R1024	4 / 8
MEPY1-1026	1SFA611821R1026	4 / 8
MJS11-60B	1SFA611711R6006	2 / 17
MJS12-60B	1SFA611712R6006	2 / 17
MJS1-60B	1SFA611701R6006	2 / 17
MJS2-60B	1SFA611702R6006	2 / 17
MJS5-60B	1SFA611705R6006	2 / 17
MJS6-60B	1SFA611706R6006	2 / 17
MJS7-60B	1SFA611707R6006	2 / 17
MJS8-60B	1SFA611708R6006	2 / 17
ML1-100	1SFA611400R100	2 / 9
MLB-1	1SFA611620R1001	2 / 22
MLB-1B	1SFA611620R2001	4 / 6
MLB-2	1SFA611620R1002	2 / 22
MLB-2B	1SFA611620R2002	4 / 6
MLB-3	1SFA611620R1003	2 / 22
MLB-3B	1SFA611620R2003	4 / 6
MLB-4	1SFA611620R1004	2 / 22
MLB-8	1SFA611620R1008	2 / 22
MLBL-00BG	1SFA611621R2002	4 / 5
MLBL-00BL	1SFA611621R2004	4 / 5
MLBL-00BR	1SFA611621R2001	4 / 5
MLBL-00BW	1SFA611621R2005	4 / 5
MLBL-00BY	1SFA611621R2003	4 / 5
MLBL-00G	1SFA611621R1002	2 / 20
MLBL-00L	1SFA611621R1004	2 / 20
MLBL-00R	1SFA611621R1001	2 / 20
MLBL-00W	1SFA611621R1005	2 / 20
MLBL-00Y	1SFA611621R1003	2 / 20
MLBL-01BG	1SFA611621R2012	4 / 5
MLBL-01BL	1SFA611621R2014	4 / 5
MLBL-01BR	1SFA611621R2011	4 / 5
MLBL-01BW	1SFA611621R2015	4 / 5
MLBL-01BY	1SFA611621R2013	4 / 5
MLBL-01G	1SFA611621R1012	2 / 20
MLBL-01L	1SFA611621R1014	2 / 20
MLBL-01R	1SFA611621R1011	2 / 20
MLBL-01W	1SFA611621R1015	2 / 20
MLBL-01Y	1SFA611621R1013	2 / 20
MLBL-02BG	1SFA611621R2022	4 / 5
MLBL-02BL	1SFA611621R2024	4 / 5
MLBL-02BR	1SFA611621R2021	4 / 5
MLBL-02BW	1SFA611621R2025	4 / 5
MLBL-02BY	1SFA611621R2023	4 / 5
MLBL-02G	1SFA611621R1022	2 / 20
MLBL-02L	1SFA611621R1024	2 / 20
MLBL-02R	1SFA611621R1021	2 / 20
MLBL-02W	1SFA611621R1025	2 / 20
MLBL-02Y	1SFA611621R1023	2 / 20
MLBL-03BG	1SFA611621R2032	4 / 5
MLBL-03BL	1SFA611621R2034	4 / 5
MLBL-03BR	1SFA611621R2031	4 / 5
MLBL-03BW	1SFA611621R2035	4 / 5
MLBL-03BY	1SFA611621R2033	4 / 5
MLBL-03G	1SFA611621R1032	2 / 20
MLBL-03L	1SFA611621R1034	2 / 20
MLBL-03R	1SFA611621R1031	2 / 20
MLBL-03W	1SFA611621R1035	2 / 20
MLBL-03Y	1SFA611621R1033	2 / 20
MLBL-04BG	1SFA611621R2042	4 / 5
MLBL-04BL	1SFA611621R2044	4 / 5
MLBL-04BR	1SFA611621R2041	4 / 5
MLBL-04BW	1SFA611621R2045	4 / 5
MLBL-04BY	1SFA611621R2043	4 / 5

Index

Order code - type

Order code	Type	Page
1SFA611100R100	MP1-10	2 / 5
1SFA611100R110	MP1-11	2 / 5
1SFA611101R100	MP2-10	2 / 5
1SFA611101R110	MP2-11	2 / 5
1SFA611102R100	MP3-10	2 / 5
1SFA611102R110	MP3-11	2 / 5
1SFA611103R100	MP4-10	2 / 5
1SFA611103R110	MP4-11	2 / 5
1SFA611124R100	MPM1-10	2 / 9
1SFA611124R110	MPM1-11	2 / 9
1SFA611125R100	MPM2-10	2 / 9
1SFA611125R110	MPM2-11	2 / 9
1SFA611130R1101	MPD1-11R	2 / 7
1SFA611130R1102	MPD1-11G	2 / 7
1SFA611130R1103	MPD1-11Y	2 / 7
1SFA611130R1106	MPD1-11B	2 / 6
1SFA611130R1108	MPD1-11C	2 / 7
1SFA611131R1101	MPD2-11R	2 / 7
1SFA611131R1102	MPD2-11G	2 / 7
1SFA611131R1103	MPD2-11Y	2 / 7
1SFA611131R1106	MPD2-11B	2 / 6
1SFA611131R1108	MPD2-11C	2 / 7
1SFA611132R1101	MPD3-11R	2 / 7
1SFA611132R1102	MPD3-11G	2 / 7
1SFA611132R1103	MPD3-11Y	2 / 7
1SFA611132R1106	MPD3-11B	2 / 6
1SFA611132R1108	MPD3-11C	2 / 7
1SFA611133R1101	MPD4-11R	2 / 7
1SFA611133R1102	MPD4-11G	2 / 7
1SFA611133R1103	MPD4-11Y	2 / 7
1SFA611133R1106	MPD4-11B	2 / 6
1SFA611133R1108	MPD4-11C	2 / 7
1SFA611134L1101	MPD5-11R-L	2 / 7
1SFA611134L1102	MPD5-11G-L	2 / 7
1SFA611134L1103	MPD5-11Y-L	2 / 7
1SFA611134L1106	MPD5-11B-L	2 / 6
1SFA611134L1108	MPD5-11C-L	2 / 7
1SFA611134R1101	MPD5-11R	2 / 7
1SFA611134R1102	MPD5-11G	2 / 7
1SFA611134R1103	MPD5-11Y	2 / 7
1SFA611134R1106	MPD5-11B	2 / 6
1SFA611134R1108	MPD5-11C	2 / 7
1SFA611141R1101	MPD12-11R	2 / 8
1SFA611141R1102	MPD12-11G	2 / 8
1SFA611141R1103	MPD12-11Y	2 / 8
1SFA611141R1106	MPD12-11B	2 / 6
1SFA611141R1108	MPD12-11C	2 / 8
1SFA611142R1101	MPD13-11R	2 / 8
1SFA611142R1102	MPD13-11G	2 / 8
1SFA611142R1103	MPD13-11Y	2 / 8
1SFA611142R1106	MPD13-11B	2 / 6
1SFA611142R1108	MPD13-11C	2 / 8
1SFA611143R1101	MPD14-11R	2 / 8
1SFA611143R1102	MPD14-11G	2 / 8
1SFA611143R1103	MPD14-11Y	2 / 8
1SFA611143R1106	MPD14-11B	2 / 6
1SFA611143R1108	MPD14-11C	2 / 8
1SFA611144R1101	MPD15-11R	2 / 8
1SFA611144R1102	MPD15-11G	2 / 8
1SFA611144R1103	MPD15-11Y	2 / 8
1SFA611144R1106	MPD15-11B	2 / 6
1SFA611144R1108	MPD15-11C	2 / 8
1SFA611145L1101	MPD16-11R-L	2 / 8
1SFA611145L1102	MPD16-11G-L	2 / 8
1SFA611145L1103	MPD16-11Y-L	2 / 8
1SFA611145L1106	MPD16-11B-L	2 / 6
1SFA611145L1108	MPD16-11C-L	2 / 8
1SFA611145R1101	MPD16-11R	2 / 8
1SFA611145R1102	MPD16-11G	2 / 8
1SFA611145R1103	MPD16-11Y	2 / 8
1SFA611145R1106	MPD16-11B	2 / 6
1SFA611145R1108	MPD16-11C	2 / 8
1SFA611200R100	M2SS1-10	2 / 11
1SFA611200R110	M2SS1-11	2 / 11
1SFA611201R100	M2SS2-10	2 / 11
1SFA611201R110	M2SS2-11	2 / 11
1SFA611202R100	M2SS3-10	2 / 11
1SFA611202R110	M2SS3-11	2 / 11
1SFA611203R100	M2SS4-10	2 / 11
1SFA611203R110	M2SS4-11	2 / 11
1SFA611204R100	M2SS5-10	2 / 11
1SFA611204R110	M2SS5-11	2 / 11
1SFA611205R100	M2SS6-10	2 / 11
1SFA611205R110	M2SS6-11	2 / 11
1SFA611210R100	M3SS1-10	2 / 12
1SFA611210R110	M3SS1-11	2 / 12
1SFA611211R100	M3SS2-10	2 / 12
1SFA611211R110	M3SS2-11	2 / 12
1SFA611212R100	M3SS3-10	2 / 12
1SFA611212R110	M3SS3-11	2 / 12
1SFA611213R100	M3SS4-10	2 / 12
1SFA611213R110	M3SS4-11	2 / 12
1SFA611214R100	M3SS5-10	2 / 12
1SFA611214R110	M3SS5-11	2 / 12
1SFA611215R100	M3SS6-10	2 / 12
1SFA611215R110	M3SS6-11	2 / 12
1SFA611216R100	M3SS7-10	2 / 12
1SFA611216R110	M3SS7-11	2 / 12
1SFA611217R100	M3SS8-10	2 / 12
1SFA611217R110	M3SS8-11	2 / 12
1SFA611218R100	M2SSV1-10	4 / 4
1SFA611220R110	M2SSV1-11	4 / 4
1SFA611221R100	M2SSV2-10	4 / 4
1SFA611221R110	M2SSV2-11	4 / 4
1SFA611222R100	M2SSV3-10	4 / 4
1SFA611222R110	M2SSV3-11	4 / 4
1SFA611230R100	M3SSV1-10	4 / 4
1SFA611230R110	M3SSV1-11	4 / 4
1SFA611231R100	M3SSV2-10	4 / 4
1SFA611231R110	M3SSV2-11	4 / 4
1SFA611232R100	M3SSV3-10	4 / 4
1SFA611232R110	M3SSV3-11	4 / 4
1SFA611250R1006	M3SSC1-10B	2 / 13
1SFA611251R1006	M3SSC2-10B	2 / 13
1SFA611252R1006	M3SSC3-10B	2 / 13
1SFA611253R1006	M3SSC4-10B	2 / 13
1SFA611254R1006	M3SSC5-10B	2 / 13
1SFA611255R1006	M3SSC6-10B	2 / 13
1SFA611256R1006	M3SSC7-10B	2 / 13
1SFA611257R1006	M3SSC8-10B	2 / 13
1SFA611280R1001	M2SSK1-101	2 / 14
1SFA611280R1002	M2SSK1-102	2 / 14
1SFA611280R1003	M2SSK1-103	2 / 14
1SFA611280R1004	M2SSK1-104	2 / 14
1SFA611281R1001	M2SSK2-101	2 / 14
1SFA611281R1002	M2SSK2-102	2 / 14
1SFA611281R1003	M2SSK2-103	2 / 14
1SFA611281R1004	M2SSK2-104	2 / 14
1SFA611283R1001	M3SSK1-101	2 / 14
1SFA611283R1002	M3SSK1-102	2 / 14
1SFA611283R1003	M3SSK1-103	2 / 14
1SFA611283R1004	M3SSK1-104	2 / 14
1SFA611284R1001	M3SSK2-101	2 / 14
1SFA611284R1002	M3SSK2-102	2 / 14
1SFA611284R1003	M3SSK2-103	2 / 14
1SFA611284R1004	M3SSK2-104	2 / 14
1SFA611285R1001	M3SSK3-101	2 / 14
1SFA611285R1002	M3SSK3-102	2 / 14
1SFA611285R1003	M3SSK3-103	2 / 14
1SFA611285R1004	M3SSK3-104	2 / 14
1SFA611290R400	M4SS1-10	2 / 13
1SFA611291R400	M4SS2-10	2 / 13
1SFA611300R1006	MTS1-10B	2 / 18
1SFA611300R2006	MTS1-20B	2 / 18
1SFA611300R3006	MTS1-30B	2 / 18
1SFA611301R1006	MTS2-10B	2 / 18
1SFA611301R2006	MTS2-20B	2 / 18
1SFA611301R3006	MTS2-30B	2 / 18
1SFA611302R1006	MTS3-10B	2 / 18
1SFA611302R2006	MTS3-20B	2 / 18
1SFA611302R3006	MTS3-30B	2 / 18
1SFA611400R100	ML1-100	2 / 9

Order code	Type	Page
1SFA611410R1056	MT-105B	2 / 15
1SFA611410R1106	MT-110B	2 / 15
1SFA611410R3056	MT-305B	2 / 15
1SFA611410R3106	MT-310B	2 / 15
1SFA611510R1101	MPMT3-11R	2 / 10
1SFA611511R1101	MPMP3-11R	2 / 10
1SFA611513R1001	MPMT4-10R	2 / 10
1SFA611513R1101	MPMT4-11R	2 / 10
1SFA611514R1001	MPMP4-10R	2 / 10
1SFA611514R1101	MPMP4-11R	2 / 10
1SFA611520R1001	MPET3-10R	2 / 10
1SFA611520R1006	MPET3-10B	2 / 10
1SFA611521R1001	MPEP3-10R	2 / 10
1SFA611521R1006	MPEP3-10B	2 / 10
1SFA611522R1101	MPEK3-11R	2 / 10
1SFA611522R1106	MPEK3-11B	2 / 10
1SFA611522R1201	MPEK3-12R	2 / 10
1SFA611522R1301	MPEK3-13R	2 / 10
1SFA611523R1001	MPET4-10R	2 / 10
1SFA611523R1006	MPET4-10B	2 / 10
1SFA611524R1001	MPEP4-10R	2 / 10
1SFA611524R1006	MPEP4-10B	2 / 10
1SFA611525R1101	MPEK4-11R	2 / 10
1SFA611525R1106	MPEK4-11B	2 / 10
1SFA611525R1201	MPEK4-12R	2 / 10
1SFA611525R1301	MPEK4-13R	2 / 10
1SFA611601R1100	MCBH5-00	2 / 21
1SFA611605R1100	MCBH-00	2 / 21
1SFA611605R1101	MCBH-10	2 / 21
1SFA611605R1102	MCBH-20	2 / 21
1SFA611605R1110	MCBH-01	2 / 21
1SFA611605R1111	MCBH-11	2 / 21
1SFA611605R1120	MCBH-02	2 / 21
1SFA611610H1001	MCB-10	2 / 21
1SFA611610H1010	MCB-01	2 / 21
1SFA611610R1001	MCB-10	2 / 21
1SFA611610R1002	MCB-20	2 / 21
1SFA611610R1010	MCB-01	2 / 21
1SFA611610R1011	MCB-11	2 / 21
1SFA611610R1020	MCB-02	2 / 21
1SFA611610R1101	MCB-10G	2 / 21
1SFA611610R1110	MCB-01G	2 / 21
1SFA611610R2001	MCB-10B	4 / 6
1SFA611610R2002	MCB-20B	4 / 6
1SFA611610R2010	MCB-01B	4 / 6
1SFA611610R2011	MCB-11B	4 / 6
1SFA611610R2020	MCB-02B	4 / 6
1SFA611610R2101	MCB-10BG	4 / 6
1SFA611610R2110	MCB-01BG	4 / 6
1SFA611612R1001	MCBL-01	2 / 21
1SFA611612R1010	MCBL-10	2 / 21
1SFA611620R1001	MLB-1	2 / 22
1SFA611620R1002	MLB-2	2 / 22
1SFA611620R1003	MLB-3	2 / 22
1SFA611620R1004	MLB-4	2 / 22
1SFA611620R1008	MLB-8	2 / 22
1SFA611620R2001	MLB-1B	4 / 6
1SFA611620R2002	MLB-2B	4 / 6
1SFA611620R2003	MLB-3B	4 / 6
1SFA611621R1001	MLBL-00R	2 / 20
1SFA611621R1002	MLBL-00G	2 / 20
1SFA611621R1003	MLBL-00Y	2 / 20
1SFA611621R1004	MLBL-00L	2 / 20
1SFA611621R1005	MLBL-00W	2 / 20
1SFA611621R1011	MLBL-01R	2 / 20
1SFA611621R1012	MLBL-01G	2 / 20
1SFA611621R1013	MLBL-01Y	2 / 20
1SFA611621R1014	MLBL-01L	2 / 20
1SFA611621R1015	MLBL-01W	2 / 20
1SFA611621R1021	MLBL-02R	2 / 20
1SFA611621R1022	MLBL-02G	2 / 20
1SFA611621R1023	MLBL-02Y	2 / 20
1SFA611621R1024	MLBL-02L	2 / 20
1SFA611621R1025	MLBL-02W	2 / 20
1SFA611621R1031	MLBL-03R	2 / 20
1SFA611621R1032	MLBL-03G	2 / 20

Order code	Type	Page
1SFA611410R1056	MT-105B	2 / 15
1SFA611410R1106	MT-110B	2 / 15
1SFA611410R3056	MT-305B	2 / 15
1SFA611410R3106	MT-310B	2 / 15
1SFA611510R1101	MPMT3-11R	2 / 10
1SFA611511R1101	MPMP3-11R	2 / 10
1SFA611513R1001	MPMT4-10R	2 / 10
1SFA611513R1101	MPMT4-11R	2 / 10
1SFA611514R1001	MPMP4-10R	2 / 10
1SFA611514R1101	MPMP4-11R	2 / 10
1SFA611520R1001	MPET3-10R	2 / 10
1SFA611520R1006	MPET3-10B	2 / 10
1SFA611521R1001	MPEP3-10R	2 / 10
1SFA611521R1006	MPEP3-10B	2 / 10
1SFA611522R1101	MPEK3-11R	2 / 10
1SFA611522R1106	MPEK3-11B	2 / 10
1SFA611522R1201	MPEK3-12R	2 / 10
1SFA611522R1301	MPEK3-13R	2 / 10
1SFA611523R1001	MPET4-10R	2 / 10
1SFA611523R1006	MPET4-10B	2 / 10
1SFA611524R1001	MPEP4-10R	2 / 10
1SFA611524R1006	MPEP4-10B	2 / 10
1SFA611525R1101	MPEK4-11R	2 / 10
1SFA611525R1106	MPEK4-11B	2 / 10
1SFA611525R1201	MPEK4-12R	2 / 10
1SFA611525R1301	MPEK4-13R	2 / 10
1SFA611601R1100	MCBH5-00	2 / 21
1SFA611605R1100	MCBH-00	2 / 21
1SFA611605R1101	MCBH-10	2 / 21
1SFA611605R1102	MCBH-20	2 / 21
1SFA611605R1110	MCBH-01	2 / 21
1SFA611605R1111	MCBH-11	2 / 21
1SFA611605R1120	MCBH-02	2 / 21
1SFA611610H1001	MCB-10	2 / 21
1SFA611610H1010	MCB-01	2 / 21
1SFA611610R1001	MCB-10	2 / 21
1SFA611610R1002	MCB-20	2 / 21
1SFA611610R1010	MCB-01	2 / 21
1SFA611610R1011	MCB-11	2 / 21
1SFA611610R1020	MCB-02	2 / 21
1SFA611		

Index

Order code - type

Order code	Type	Page
1SFA611621R1033	MLBL-03Y	2 / 20
1SFA611621R1034	MLBL-03L	2 / 20
1SFA611621R1035	MLBL-03W	2 / 20
1SFA611621R1041	MLBL-04R	2 / 20
1SFA611621R1042	MLBL-04G	2 / 20
1SFA611621R1043	MLBL-04Y	2 / 20
1SFA611621R1044	MLBL-04L	2 / 20
1SFA611621R1051	MLBL-05R	2 / 20
1SFA611621R1052	MLBL-05G	2 / 20
1SFA611621R1053	MLBL-05Y	2 / 20
1SFA611621R1054	MLBL-05L	2 / 20
1SFA611621R1055	MLBL-05W	2 / 20
1SFA611621R1061	MLBL-06R	2 / 20
1SFA611621R1062	MLBL-06G	2 / 20
1SFA611621R1063	MLBL-06Y	2 / 20
1SFA611621R1064	MLBL-06L	2 / 20
1SFA611621R1065	MLBL-06W	2 / 20
1SFA611621R1071	MLBL-07R	2 / 20
1SFA611621R1072	MLBL-07G	2 / 20
1SFA611621R1073	MLBL-07Y	2 / 20
1SFA611621R1074	MLBL-07L	2 / 20
1SFA611621R1075	MLBL-07W	2 / 20
1SFA611621R1081	MLBL-08R	2 / 20
1SFA611621R1082	MLBL-08G	2 / 20
1SFA611621R1083	MLBL-08Y	2 / 20
1SFA611621R1084	MLBL-08L	2 / 20
1SFA611621R1085	MLBL-08W	2 / 20
1SFA611621R1091	MLBL-09R	2 / 20
1SFA611621R1092	MLBL-09G	2 / 20
1SFA611621R1093	MLBL-09Y	2 / 20
1SFA611621R1094	MLBL-09L	2 / 20
1SFA611621R1095	MLBL-09W	2 / 20
1SFA611621R2001	MLBL-00BR	4 / 5
1SFA611621R2002	MLBL-00BG	4 / 5
1SFA611621R2003	MLBL-00BY	4 / 5
1SFA611621R2004	MLBL-00BL	4 / 5
1SFA611621R2005	MLBL-00BW	4 / 5
1SFA611621R2011	MLBL-01BR	4 / 5
1SFA611621R2012	MLBL-01BG	4 / 5
1SFA611621R2013	MLBL-01BY	4 / 5
1SFA611621R2014	MLBL-01BL	4 / 5
1SFA611621R2015	MLBL-01BW	4 / 5
1SFA611621R2021	MLBL-02BR	4 / 5
1SFA611621R2022	MLBL-02BG	4 / 5
1SFA611621R2023	MLBL-02BY	4 / 5
1SFA611621R2024	MLBL-02BL	4 / 5
1SFA611621R2025	MLBL-02BW	4 / 5
1SFA611621R2031	MLBL-03BR	4 / 5
1SFA611621R2032	MLBL-03BG	4 / 5
1SFA611621R2033	MLBL-03BY	4 / 5
1SFA611621R2034	MLBL-03BL	4 / 5
1SFA611621R2035	MLBL-03BW	4 / 5
1SFA611621R2041	MLBL-04BR	4 / 5
1SFA611621R2042	MLBL-04BG	4 / 5
1SFA611621R2043	MLBL-04BY	4 / 5
1SFA611621R2044	MLBL-04BL	4 / 5
1SFA611621R2045	MLBL-04BW	4 / 5
1SFA611621R2051	MLBL-05BR	4 / 5
1SFA611621R2052	MLBL-05BG	4 / 5
1SFA611621R2053	MLBL-05BY	4 / 5
1SFA611621R2054	MLBL-05BL	4 / 5
1SFA611621R2055	MLBL-05BW	4 / 5
1SFA611621R2061	MLBL-06BR	4 / 5
1SFA611621R2062	MLBL-06BG	4 / 5
1SFA611621R2063	MLBL-06BY	4 / 5
1SFA611621R2064	MLBL-06BL	4 / 5
1SFA611621R2065	MLBL-06BW	4 / 5
1SFA611621R2071	MLBL-07BR	4 / 5
1SFA611621R2072	MLBL-07BG	4 / 5
1SFA611621R2073	MLBL-07BY	4 / 5
1SFA611621R2074	MLBL-07BL	4 / 5
1SFA611621R2075	MLBL-07BW	4 / 5
1SFA611621R2081	MLBL-08BR	4 / 5
1SFA611621R2082	MLBL-08BG	4 / 5
1SFA611621R2083	MLBL-08BY	4 / 5
1SFA611621R2084	MLBL-08BL	4 / 5

Order code	Type	Page
1SFA611621R2085	MLBL-08BW	4 / 5
1SFA611621R2091	MLBL-09BR	4 / 5
1SFA611621R2092	MLBL-09BG	4 / 5
1SFA611621R2093	MLBL-09BY	4 / 5
1SFA611621R2094	MLBL-09BL	4 / 5
1SFA611621R2095	MLBL-09BW	4 / 5
1SFA611630R1001	MDB-1001	2 / 22
1SFA611630R1002	MDB-2	2 / 23
1SFA611630R1002	MDB-2	3 / 10
1SFA611701R6006	MJS1-60B	2 / 17
1SFA611702R6006	MJS2-60B	2 / 17
1SFA611705R6006	MJS5-60B	2 / 17
1SFA611706R6006	MJS6-60B	2 / 17
1SFA611707R6006	MJS7-60B	2 / 17
1SFA611708R6006	MJS8-60B	2 / 17
1SFA611711R6006	MJS11-60B	2 / 17
1SFA611712R6006	MJS12-60B	2 / 17
1SFA611811R1000	MEP1-0	4 / 3
1SFA611812R1000	MEP2-0	4 / 3
1SFA611812R1001	MEP2-1001	4 / 8
1SFA611813R1000	MEP3-0	4 / 3
1SFA611814R1000	MEP4-0	4 / 3
1SFA611816R1000	MEP6-0	4 / 3
1SFA611821R1000	MEPY1-0	4 / 3
1SFA611821R1005	MEPY1-1005	4 / 8
1SFA611821R1024	MEPY1-1024	4 / 8
1SFA611821R1026	MEPY1-1026	4 / 8
1SFA611920H8150	MA1-8150	4 / 6
1SFA611920R8001	MA1-8001	2 / 23
1SFA611920R8015	MA1-8015	2 / 23
1SFA611920R8015	MA1-8015	3 / 10
1SFA611920R8019	MA1-8019	2 / 23
1SFA611920R8019	MA1-8019	2 / 24
1SFA611920R8053	MA1-8053	2 / 24
1SFA611920R8074	MA1-8074	2 / 23
1SFA611920R8124	MA1-8124	2 / 24
1SFA611920R8124	MA1-8124	2 / 24
1SFA611920R8124	MA1-8124	3 / 11
1SFA611920R8126	MA1-8126	2 / 24
1SFA611920R8128	MA1-8128	2 / 24
1SFA611920R8129	MA1-8129	2 / 24
1SFA611920R8129	MA1-8129	2 / 24
1SFA611920R8129	MA1-8129	3 / 11
1SFA611920R8129	MA1-8129	4 / 6
1SFA611920R8129	MA1-8129	4 / 7
1SFA611920R8130	MA1-8130	2 / 24
1SFA611920R8130	MA1-8130	2 / 24
1SFA611920R8130	MA1-8130	3 / 11
1SFA611920R8130	MA1-8130	4 / 6
1SFA611920R8130	MA1-8130	4 / 7
1SFA611920R8131	MA1-8131	2 / 23
1SFA611920R8136	MA1-8136	2 / 24
1SFA611920R8136	MA1-8136	2 / 24
1SFA611920R8136	MA1-8136	3 / 11
1SFA611920R8136	MA1-8136	4 / 6
1SFA611920R8136	MA1-8136	4 / 7
1SFA611920R8149	MA1-8149	2 / 23
1SFA611920R8149	MA1-8149	3 / 10
1SFA611925R3001	MA5-3001	4 / 6
1SFA611925R3002	MA5-3002	4 / 6
1SFA611925R3003	MA5-3003	4 / 6
1SFA611925R3004	MA5-3004	4 / 6
1SFA611925R3005	MA5-3005	4 / 6
1SFA611925R3006	MA5-3006	4 / 6
1SFA611925R3007	MA5-3007	4 / 6
1SFA611925R3008	MA5-3008	4 / 6
1SFA611925R3009	MA5-3009	4 / 6
1SFA611925R3010	MA5-3010	4 / 6
1SFA611930L1024	MA6-1024-L	5 / 5
1SFA611930R1000	MA6-1000	5 / 7
1SFA611930R1002	MA6-1002	5 / 7
1SFA611930R1003	MA6-1003	5 / 7
1SFA611930R1004	MA6-1004	5 / 7
1SFA611930R1005	MA6-1005	5 / 7
1SFA611930R1006	MA6-1006	5 / 7
1SFA611930R1007	MA6-1007	5 / 7

Order code	Type	Page
1SFA611930R1008	MA6-1008	5 / 7
1SFA611930R1009	MA6-1009	5 / 7
1SFA611930R1010	MA6-1010	5 / 7
1SFA611930R1011	MA6-1011	5 / 7
1SFA611930R1012	MA6-1012	5 / 7
1SFA611930R1013	MA6-1013	5 / 7
1SFA611930R1014	MA6-1014	5 / 7
1SFA611930R1015	MA6-1015	5 / 7
1SFA611930R1016	MA6-1016	5 / 7
1SFA611930R1017	MA6-1017	5 / 7
1SFA611930R1018	MA6-1018	5 / 7
1SFA611930R1019	MA6-1019	5 / 7
1SFA611930R1020	MA6-1020	5 / 7
1SFA611930R1021	MA6-1021	5 / 7
1SFA611930R1022	MA6-1022	5 / 7
1SFA611930R1023	MA6-1023	5 / 7
1SFA611930R1024	MA6-1024	5 / 5
1SFA611930R1025	MA6-1025	5 / 5
1SFA611930R1026	MA6-1026	5 / 5
1SFA611930R1027	MA6-1027	5 / 5
1SFA611930R1028	MA6-1028	5 / 5
1SFA611930R1029	MA6-1029	5 / 5
1SFA611930R1032	MA6-1032	5 / 3
1SFA611930R1033	MA6-1033	5 / 3
1SFA611930R1034	MA6-1034	5 / 3
1SFA611930R1036	MA6-1036	5 / 3
1SFA611930R1037	MA6-1037	5 / 3
1SFA611930R1038	MA6-1038	5 / 3
1SFA611930R1039	MA6-1039	5 / 3
1SFA611930R1040	MA6-1040	5 / 3
1SFA611930R1041	MA6-1041	5 / 3
1SFA611930R1042	MA6-1042	5 / 3
1SFA611930R1043	MA6-1043	5 / 3
1SFA611930R1044	MA6-1044	5 / 3
1SFA611930R1045	MA6-1045	5 / 3
1SFA611930R1060	MA6-1060	5 / 4
1SFA611930R1061	MA6-1061	5 / 4
1SFA611930R1062	MA6-1062	5 / 4
1SFA611930R1063	MA6-1063	5 / 4
1SFA611930R1064	MA6-1064	5 / 4
1SFA611930R1070	MA6-1070	5 / 3
1SFA611930R1071	MA6-1071	5 / 3
1SFA611930R1072	MA6-1072	5 / 3
1SFA611930R1073	MA6-1073	5 / 3
1SFA611930R1074	MA6-1074	5 / 3
1SFA611930R1075	MA6-1075	5 / 3
1SFA611930R1076	MA6-1076	5 / 3
1SFA611930R1077	MA6-1077	5 / 3
1SFA611930R1078	MA6-1078	5 / 3
1SFA611930R1079	MA6-1079	5 / 3
1SFA611930R1080	MA6-1080	5 / 3
1SFA611930R1081	MA6-1081	5 / 3
1SFA611930R1082	MA6-1082	5 / 3
1SFA611930R1083	MA6-1083	5 / 3
1SFA611930R1084	MA6-1084	5 / 3
1SFA611930R1100	MA6-1100	5 / 5
1SFA611930R1101	MA6-1101	5 / 5
1SFA611930R1102	MA6-1102	5 / 5
1SFA611930R1103	MA6-1103	5 / 5
1SFA611930R1104	MA6-1104	5 / 5
1SFA611930R1130	MA6-1130	5 / 4
1SFA611930R1131	MA6-1131	5 / 4
1SFA611930R1132	MA6-1132	5 / 4
1SFA611930R1133	MA6-1133	5 / 4
1SFA611930R1134	MA6-1134	5 / 4
1SFA611930R1135	MA6-1135	5 / 4
1SFA611930R1136	MA6-1136	5 / 4
1SFA611930R1137	MA6-1137	5 / 4
1SFA611930R1138	MA6-1138	5 / 4
1SFA611930R1139	MA6-1139	5 / 4
1SFA611930R1140	MA6-1140	5 / 4
1SFA611930R1141	MA6-1141	5 / 4
1SFA611930R1170	MA6-1170	5 / 4
1SFA611930R1171	MA6-1171	5 / 4
1SFA611930R1172	MA6-1172	5 / 4
1SFA611930R1173	MA6-1173	5 / 4

Index

Order code - type

Order code	Type	Page
1SFA611930R1174	MA6-1174	5 / 4
1SFA611930R1175	MA6-1175	5 / 4
1SFA611930R1176	MA6-1176	5 / 4
1SFA611930R1177	MA6-1177	5 / 4
1SFA611930R1178	MA6-1178	5 / 4
1SFA611930R1179	MA6-1179	5 / 4
1SFA611930R1190	MA6-1190	5 / 4
1SFA611930R1191	MA6-1191	5 / 4
1SFA611930R1192	MA6-1192	5 / 4
1SFA611930R1193	MA6-1193	5 / 4
1SFA611930R1194	MA6-1194	5 / 4
1SFA611930R1252	-	2 / 15
1SFA611940L1000	MA16-1000-L	5 / 6
1SFA611940L1001	MA16-1001-L	5 / 6
1SFA611940R1000	MA16-1000	5 / 6
1SFA611940R1001	MA16-1001	5 / 6
1SFA616070R113	KL70-113	6 / 3
1SFA616070R123	KL70-123	6 / 3
1SFA616070R203	KL70-203	6 / 3
1SFA616070R305	KL70-305	6 / 3
1SFA616070R306	KL70-306	6 / 3
1SFA616070R307	KL70-307	6 / 3
1SFA616070R342	KL70-342	6 / 3
1SFA616070R352	KL70-352	6 / 3
1SFA616070R401	KL70-401	6 / 3
1SFA616071R1201	KB70-1201	6 / 3
1SFA616071R3001	KB70-3001	6 / 3
1SFA616071R3101	KB70-3101	6 / 3
1SFA616073R1104	KS70-1104	6 / 4
1SFA616073R1204	KS70-1204	6 / 4
1SFA616073R2002	KS70-2002	6 / 4
1SFA616073R2004	KS70-2004	6 / 4
1SFA616073R3004	KS70-3004	6 / 4
1SFA616075R1001	KT70-1001	6 / 4
1SFA616075R1002	KT70-1002	6 / 4
1SFA616077R1001	KA70-1001	6 / 4
1SFA616077R1002	KA70-1002	6 / 4
1SFA616077R1011	KA70-1011	6 / 4
1SFA616077R1012	KA70-1012	6 / 4
1SFA616077R1013	KA70-1013	6 / 4
1SFA616077R1021	KA70-1021	6 / 4
1SFA616077R1022	KA70-1022	6 / 4
1SFA616077R1023	KA70-1023	6 / 4
1SFA616077R1031	KA70-1031	6 / 4
1SFA616077R1032	KA70-1032	6 / 4
1SFA616077R1033	KA70-1033	6 / 4
1SFA616077R1034	KA70-1034	6 / 4
1SFA616080R113	KSB-113	6 / 5
1SFA616080R123	KSB-123	6 / 5
1SFA616080R203	KSB-203	6 / 5
1SFA616080R305	KSB-305	6 / 5
1SFA616080R306	KSB-306	6 / 5
1SFA616080R307	KSB-307	6 / 5
1SFA616080R401	KSB-401	6 / 5
1SFA616105R1000	KASB-100	6 / 5
1SFA616105R4001	KP6-40R	2 / 19
1SFA616105R4002	KP6-40G	2 / 19
1SFA616105R4006	KP6-40B	2 / 19
1SFA616105R4016	KP6-40B-10	2 / 19
1SFA616105R4026	KP6-40B-20	2 / 19
1SFA616105R4046	KP6-40B-01	2 / 19
1SFA616105R4056	KP6-40B-02	2 / 19
1SFA616105R4076	KP6-40B-11	2 / 19
1SFA616160R1001	KPR1-100R	2 / 16
1SFA616160R1002	KPR1-100G	2 / 16
1SFA616160R1003	KPR1-100Y	2 / 16
1SFA616160R1004	KPR1-100L	2 / 16
1SFA616160R1005	KPR1-100W	2 / 16
1SFA616160R1006	KPR1-100B	2 / 16
1SFA616160R1014	KPR1-101L	2 / 16
1SFA616160R1015	KPR1-101W	2 / 16
1SFA616160R1025	KPR1-102W	2 / 16
1SFA616160R1032	KPR1-103G	2 / 16
1SFA616160R1046	KPR1-104B	2 / 16
1SFA616161R1001	KPR2-100R	2 / 16
1SFA616161R1005	KPR2-100W	2 / 16

Order code	Type	Page
1SFA616161R1006	KPR2-100B	2 / 16
1SFA616161R1051	KPR2-105R	2 / 16
1SFA616161R1056	KPR2-105B	2 / 16
1SFA616162R1001	KPR3-100R	2 / 16
1SFA616162R1002	KPR3-100G	2 / 16
1SFA616162R1003	KPR3-100Y	2 / 16
1SFA616162R1004	KPR3-100L	2 / 16
1SFA616162R1005	KPR3-100W	2 / 16
1SFA616162R1006	KPR3-100B	2 / 16
1SFA616162R1014	KPR3-101L	2 / 16
1SFA616162R1015	KPR3-101W	2 / 16
1SFA616162R1025	KPR3-102W	2 / 16
1SFA616162R1032	KPR3-103G	2 / 16
1SFA616162R1035	KPR3-103W	2 / 16
1SFA616162R1046	KPR3-104B	2 / 16
1SFA616163R1001	KPR4-100R	2 / 16
1SFA616163R1005	KPR4-100W	2 / 16
1SFA616163R1006	KPR4-100B	2 / 16
1SFA616163R1051	KPR4-105R	2 / 16
1SFA616163R1056	KPR4-105B	2 / 16
1SFA616410R1006	KT-100B	2 / 15
1SFA616410R3006	KT-300B	2 / 15
1SFA616901L9000	KTC1-9000-L	5 / 8
1SFA616901R1019	KTC1-1019	5 / 7
1SFA616901R1020	KTC1-1020	5 / 7
1SFA616901R1025	KTC1-1025	5 / 7
1SFA616901R1031	KTC1-1031	5 / 7
1SFA616901R1039	KTC1-1039	5 / 7
1SFA616901R9000	KTC1-9000	5 / 7
1SFA616901R9002	KTC1-9002	5 / 8
1SFA616901R9003	KTC1-9003	5 / 8
1SFA616901R9004	KTC1-9004	5 / 8
1SFA616901R9005	KTC1-9005	5 / 8
1SFA616901R9006	KTC1-9006	5 / 8
1SFA616901R9009	KTC1-9009	5 / 7
1SFA616901R9011	KTC1-9011	5 / 8
1SFA616901R9012	KTC1-9012	5 / 8
1SFA616901R9015	KTC1-9015	5 / 8
1SFA616901R9016	KTC1-9016	5 / 8
1SFA616901R9017	KTC1-9017	5 / 8
1SFA616901R9018	KTC1-9018	5 / 8
1SFA616901R9019	KTC1-9019	5 / 8
1SFA616901R9020	KTC1-9020	5 / 8
1SFA616901R9021	KTC1-9021	5 / 8
1SFA616901R9023	KTC1-9023	5 / 8
1SFA616901R9024	KTC1-9024	5 / 8
1SFA616901R9025	KTC1-9025	5 / 8
1SFA616901R9026	KTC1-9026	5 / 8
1SFA616901R9027	KTC1-9027	5 / 8
1SFA616901R9028	KTC1-9028	5 / 8
1SFA616902L9000	KTC2-9000-L	5 / 8
1SFA616902R1020	KTC2-1020	5 / 7
1SFA616902R1025	KTC2-1025	5 / 7
1SFA616902R1031	KTC2-1031	5 / 7
1SFA616902R1040	KTC2-1040	5 / 7
1SFA616902R9000	KTC2-9000	5 / 7
1SFA616902R9002	KTC2-9002	5 / 8
1SFA616902R9003	KTC2-9003	5 / 8
1SFA616902R9004	KTC2-9004	5 / 8
1SFA616902R9005	KTC2-9005	5 / 8
1SFA616902R9006	KTC2-9006	5 / 8
1SFA616902R9009	KTC2-9009	5 / 7
1SFA616902R9011	KTC2-9011	5 / 8
1SFA616902R9015	KTC2-9015	5 / 8
1SFA616902R9016	KTC2-9016	5 / 8
1SFA616902R9026	KTC2-9026	5 / 8
1SFA616902R9028	KTC2-9028	5 / 8
1SFA616903L9000	KTC3-9000-L	5 / 8
1SFA616903R1019	KTC3-1019	5 / 7
1SFA616903R1020	KTC3-1020	5 / 7
1SFA616903R1031	KTC3-1031	5 / 7
1SFA616903R1039	KTC3-1039	5 / 7
1SFA616903R9000	KTC3-9000	5 / 7
1SFA616903R9002	KTC3-9002	5 / 8
1SFA616903R9003	KTC3-9003	5 / 8
1SFA616903R9004	KTC3-9004	5 / 8

Order code	Type	Page
1SFA616903R9005	KTC3-9005	5 / 8
1SFA616903R9006	KTC3-9006	5 / 8
1SFA616904R1047	KTC4-1047	5 / 7
1SFA616904R9004	KTC4-9004	5 / 8
1SFA616905R1040	KTC5-1040	5 / 7
1SFA616905R1047	KTC5-1047	5 / 7
1SFA616905R9004	KTC5-9004	5 / 8
1SFA616906R1039	KTC6-1039	5 / 7
1SFA616906R1042	KTC6-1042	5 / 7
1SFA616906R9002	KTC6-9002	5 / 8
1SFA616906R9003	KTC6-9003	5 / 8
1SFA616908R1039	KTC8-1039	5 / 7
1SFA616908R9002	KTC8-9002	5 / 8
1SFA616908R9003	KTC8-9003	5 / 8
1SFA616908R9004	KTC8-9004	5 / 8
1SFA616908R9005	KTC8-9005	5 / 8
1SFA616908R9011	KTC8-9011	5 / 8
1SFA616908R9012	KTC8-9012	5 / 8
1SFA616908R9016	KTC8-9016	5 / 8
1SFA616908R9017	KTC8-9017	5 / 8
1SFA616908R9018	KTC8-9018	5 / 8
1SFA616908R9020	KTC8-9020	5 / 8
1SFA616908R9021	KTC8-9021	5 / 8
1SFA616908R9025	KTC8-9025	5 / 8
1SFA616908R9026	KTC8-9026	5 / 8
1SFA616908R9027	KTC8-9027	5 / 8
1SFA616915L1038	-	5 / 5
1SFA616915R1005	-	5 / 5
1SFA616915R1038	-	5 / 5
1SFA616915R6005	-	5 / 5
1SFA616920R8002	MA1-8002	2 / 24
1SFA616920R8002	MA1-8002	3 / 11
1SFA616920R8005	KA1-8005	3 / 10
1SFA616920R8010	KA1-8010	2 / 24
1SFA616920R8010	KA1-8010	3 / 11
1SFA616920R8021	KA1-8021	2 / 24
1SFA616920R8021	KA1-8021	3 / 11
1SFA616920R8022	KA1-8022	2 / 24
1SFA616920R8022	KA1-8022	3 / 11
1SFA616920R8024	KA1-8024	2 / 24
1SFA616920R8027	KA1-8027	2 / 23
1SFA616920R8028	KA1-8028	2 / 23
1SFA616920R8029	KA1-8029	2 / 23
1SFA616920R8029	KA1-8029	3 / 10
1SFA616920R803	KA1-803	2 / 26
1SFA616920R8030	KA1-8030	2 / 23
1SFA616920R8030	KA1-8030	3 / 10
1SFA616920R8045	KA1-8045	4 / 6
1SFA616920R8046	KA1-8046	2 / 16
1SFA616920R8047	KA1-8047	2 / 16
1SFA611920R8052	MA1-8052	2 / 24
1SFA611920R8052	MA1-8052	3 / 11
1SFA616920R8072	KA1-8072	2 / 23
1SFA616920R8072	KA1-8072	2 / 26
1SFA616920R8072	KA1-8072	3 / 10
1SFA616920R8073	KA1-8073	2 / 23
1SFA616920R8073	KA1-8073	3 / 10
1SFA616920R8077	KA1-8077	2 / 24
1SFA616920R8079	KA1-8079	2 / 24
1SFA616920R808	KA1-808	2 / 26
1SFA616920R8080	KA1-8080	2 / 24
1SFA616920R8087	KA1-8087	3 / 11
1SFA616920R809	KA1-809	2 / 26
1SFA616920R8097	KA1-8097	3 / 11
1SFA616920R810	KA1-810	2 / 26
1SFA616920R811	KA1-811	2 / 26
1SFA616920R8120	KA1-8120	5 / 3
1SFA616920R8121	KA1-8121	5 / 3
1SFA616921R2011	KA2-2011	2 / 25
1SFA616921R2011	KA2-2011	3 / 9
1SFA616921R2012	KA2-2012	2 / 25
1SFA616921R2012	KA2-2012	3 / 9
1SFA616921R2013	KA2-2013	2 / 25
1SFA616921R2013	KA2-2013	3 / 9
1SFA616921R2014	KA2-2014	2 / 25

Index

Order code - type

Order code	Type	Page
1SFA616921R2014	KA2-2014	3 / 9
1SFA616921R2015	KA2-2015	2 / 25
1SFA616921R2015	KA2-2015	3 / 9
1SFA616921R2021	KA2-2021	2 / 25
1SFA616921R2021	KA2-2021	3 / 9
1SFA616921R2022	KA2-2022	2 / 25
1SFA616921R2022	KA2-2022	3 / 9
1SFA616921R2023	KA2-2023	2 / 25
1SFA616921R2023	KA2-2023	3 / 9
1SFA616921R2024	KA2-2024	2 / 25
1SFA616921R2024	KA2-2024	3 / 9
1SFA616921R2025	KA2-2025	2 / 25
1SFA616921R2025	KA2-2025	3 / 9
1SFA616921R2031	KA2-2031	2 / 25
1SFA616921R2031	KA2-2031	3 / 9
1SFA616921R2032	KA2-2032	2 / 25
1SFA616921R2032	KA2-2032	3 / 9
1SFA616921R2033	KA2-2033	2 / 25
1SFA616921R2033	KA2-2033	3 / 9
1SFA616921R2034	KA2-2034	2 / 25
1SFA616921R2034	KA2-2034	3 / 9
1SFA616921R2035	KA2-2035	2 / 25
1SFA616921R2035	KA2-2035	3 / 9
1SFA616921R2041	KA2-2041	2 / 25
1SFA616921R2041	KA2-2041	3 / 9
1SFA616921R2042	KA2-2042	2 / 25
1SFA616921R2042	KA2-2042	3 / 9
1SFA616921R2043	KA2-2043	2 / 25
1SFA616921R2043	KA2-2043	3 / 9
1SFA616921R2044	KA2-2044	2 / 25
1SFA616921R2044	KA2-2044	3 / 9
1SFA616921R2045	KA2-2045	2 / 25
1SFA616921R2045	KA2-2045	3 / 9
1SFA616921R2051	KA2-2051	2 / 25
1SFA616921R2051	KA2-2051	3 / 9
1SFA616921R2052	KA2-2052	2 / 25
1SFA616921R2052	KA2-2052	3 / 9
1SFA616921R2053	KA2-2053	2 / 25
1SFA616921R2053	KA2-2053	3 / 9
1SFA616921R2054	KA2-2054	2 / 25
1SFA616921R2054	KA2-2054	3 / 9
1SFA616921R2055	KA2-2055	2 / 25
1SFA616921R2055	KA2-2055	3 / 9
1SFA616921R2131	KA2-2131	2 / 25
1SFA616921R2131	KA2-2131	3 / 9
1SFA616921R2132	KA2-2132	2 / 25
1SFA616921R2132	KA2-2132	3 / 9
1SFA616921R2133	KA2-2133	2 / 25
1SFA616921R2133	KA2-2133	3 / 9
1SFA616921R2134	KA2-2134	2 / 25
1SFA616921R2134	KA2-2134	3 / 9
1SFA616921R2135	KA2-2135	2 / 25
1SFA616921R2135	KA2-2135	3 / 9
1SFA616921R2141	KA2-2141	2 / 25
1SFA616921R2141	KA2-2141	3 / 9
1SFA616921R2142	KA2-2142	2 / 25
1SFA616921R2142	KA2-2142	3 / 9
1SFA616921R2143	KA2-2143	2 / 25
1SFA616921R2143	KA2-2143	3 / 9
1SFA616921R2144	KA2-2144	2 / 25
1SFA616921R2144	KA2-2144	3 / 9
1SFA616921R2145	KA2-2145	2 / 25
1SFA616921R2145	KA2-2145	3 / 9
1SFA616921R2221	KA2-2221	2 / 25
1SFA616921R2221	KA2-2221	3 / 9
1SFA616921R2222	KA2-2222	2 / 25
1SFA616921R2222	KA2-2222	3 / 9
1SFA616921R2223	KA2-2223	2 / 25
1SFA616921R2223	KA2-2223	3 / 9
1SFA616921R2224	KA2-2224	2 / 25
1SFA616921R2224	KA2-2224	3 / 9
1SFA616921R2225	KA2-2225	2 / 25
1SFA616921R2225	KA2-2225	3 / 9
1SFA616921R2231	KA2-2231	2 / 25
1SFA616921R2231	KA2-2231	3 / 9
1SFA616921R2232	KA2-2232	2 / 25

Order code	Type	Page
1SFA616921R2232	KA2-2232	3 / 9
1SFA616921R2233	KA2-2233	2 / 25
1SFA616921R2233	KA2-2233	3 / 9
1SFA616921R2234	KA2-2234	2 / 25
1SFA616921R2234	KA2-2234	3 / 9
1SFA616921R2235	KA2-2235	2 / 25
1SFA616921R2235	KA2-2235	3 / 9
1SFA616922R1018	KA3-1018	6 / 5
1SFA616922R1028	KA3-1028	6 / 5
1SFA616922R1118	KA3-1118	6 / 5
1SFA616922R1148	KA3-1148	6 / 5
1SFA616923R1028	KA4-1021	6 / 3
1SFA616923R1118	KA4-1118	6 / 3
1SFA616923R1148	KA4-1148	6 / 3
1SFA616924R102	KA4-102	6 / 3
1SFA616950R1001	KTR1-1001	2 / 22
1SFA616950R1002	KTR1-1002	2 / 22
1SFA616950R1003	KTR1-1003	2 / 22
1SFA616950R1004	KTR1-1004	2 / 22
1SFA616950R1005	KTR1-1005	2 / 22
1SFA616950R1011	KTR1-1011	2 / 22
1SFA616950R1012	KTR1-1012	2 / 22
1SFA616950R1013	KTR1-1013	2 / 22
1SFA616950R1014	KTR1-1014	2 / 22
1SFA616950R2001	KTR1-2001	2 / 22
1SFA616950R2002	KTR1-2002	2 / 22
1SFA616950R2003	KTR1-2003	2 / 22
1SFA616950R2004	KTR1-2004	2 / 22
1SFA616950R2005	KTR1-2005	2 / 22
1SFA616950R2011	KTR1-2011	2 / 22
1SFA616950R2012	KTR1-2012	2 / 22
1SFA616950R2013	KTR1-2013	2 / 22
1SFA616950R2014	KTR1-2014	2 / 22
1SFA619100R101	CP1-10-10	3 / 3
1SFA619100R102	CP1-10-20	3 / 3
1SFA619100R104	CP1-10-01	3 / 3
1SFA619100R105	CP1-10-02	3 / 3
1SFA619100R107	CP1-10-11	3 / 3
1SFA619100R111	CP1-11-10	3 / 4
1SFA619100R114	CP1-11-01	3 / 4
1SFA619100R121	CP1-12-10	3 / 4
1SFA619100R124	CP1-12-01	3 / 4
1SFA619100R131	CP1-13-10	3 / 4
1SFA619100R134	CP1-13-01	3 / 4
1SFA619101R101	CP2-10-10	3 / 3
1SFA619101R102	CP2-10-20	3 / 3
1SFA619101R104	CP2-10-01	3 / 3
1SFA619101R105	CP2-10-02	3 / 3
1SFA619101R107	CP2-10-11	3 / 3
1SFA619101R111	CP2-11-10	3 / 4
1SFA619101R114	CP2-11-01	3 / 4
1SFA619101R121	CP2-12-10	3 / 4
1SFA619101R124	CP2-12-01	3 / 4
1SFA619101R131	CP2-13-10	3 / 4
1SFA619101R134	CP2-13-01	3 / 4
1SFA619102R101	CP3-10-10	3 / 3
1SFA619102R102	CP3-10-20	3 / 3
1SFA619102R104	CP3-10-01	3 / 3
1SFA619102R105	CP3-10-02	3 / 3
1SFA619102R107	CP3-10-11	3 / 3
1SFA619102R111	CP3-11-10	3 / 4
1SFA619102R114	CP3-11-01	3 / 4
1SFA619102R121	CP3-12-10	3 / 4
1SFA619102R124	CP3-12-01	3 / 4
1SFA619102R131	CP3-13-10	3 / 4
1SFA619102R134	CP3-13-01	3 / 4
1SFA619103R101	CP4-10-10	3 / 3
1SFA619103R102	CP4-10-20	3 / 3
1SFA619103R104	CP4-10-01	3 / 3
1SFA619103R105	CP4-10-02	3 / 3
1SFA619103R107	CP4-10-11	3 / 3
1SFA619103R111	CP4-11-10	3 / 4
1SFA619103R114	CP4-11-01	3 / 4
1SFA619103R121	CP4-12-10	3 / 4
1SFA619103R124	CP4-12-01	3 / 4
1SFA619103R131	CP4-13-10	3 / 4

Order code	Type	Page
1SFA619103R134	CP4-13-01	3 / 4
1SFA619105R102	CP6-10-20	3 / 8
1SFA619105R105	CP6-10-02	3 / 8
1SFA619105R107	CP6-10-11	3 / 8
1SFA619110R1015	CP11-10W-10	3 / 3
1SFA619120R1015	CP12-10W-10	3 / 3
1SFA619126R1071	CPM3-10R-11	3 / 3
1SFA619126R1072	CPM3-10G-11	3 / 3
1SFA619126R1073	CPM3-10Y-11	3 / 3
1SFA619126R1074	CPM3-10L-11	3 / 3
1SFA619126R1076	CPM3-10B-11	3 / 3
1SFA619132R1046	CP33-10B-01	3 / 3
1SFA619200R101	C2SS1-10-10	3 / 6
1SFA619200R102	C2SS1-10-20	3 / 6
1SFA619200R104	C2SS1-10-01	3 / 6
1SFA619200R105	C2SS1-10-02	3 / 6
1SFA619200R107	C2SS1-10-11	3 / 6
1SFA619200R101	C2SS2-10-10	3 / 6
1SFA619201R102	C2SS2-10-20	3 / 6
1SFA619201R104	C2SS2-10-01	3 / 6
1SFA619201R105	C2SS2-10-02	3 / 6
1SFA619201R107	C2SS2-10-11	3 / 6
1SFA619202R101	C2SS3-10-10	3 / 6
1SFA619202R102	C2SS3-10-20	3 / 6
1SFA619202R104	C2SS3-10-01	3 / 6
1SFA619202R105	C2SS3-10-02	3 / 6
1SFA619202R107	C2SS3-10-11	3 / 6
1SFA619210R102	C3SS1-10-20	3 / 6
1SFA619210R105	C3SS1-10-02	3 / 6
1SFA619210R107	C3SS1-10-11	3 / 6
1SFA619211R102	C3SS2-10-20	3 / 6
1SFA619211R105	C3SS2-10-02	3 / 6
1SFA619211R107	C3SS2-10-11	3 / 6
1SFA619212R102	C3SS3-10-20	3 / 6
1SFA619212R105	C3SS3-10-02	3 / 6
1SFA619212R107	C3SS3-10-11	3 / 6
1SFA619216R102	C3SS7-10-20	3 / 6
1SFA619216R105	C3SS7-10-02	3 / 6
1SFA619216R107	C3SS7-10-11	3 / 6
1SFA619402R100	CL-100	3 / 6
1SFA619402R5011	CL-501R	3 / 5
1SFA619402R5012	CL-501G	3 / 5
1SFA619402R5013	CL-501Y	3 / 5
1SFA619402R5014	CL-501L	3 / 5
1SFA619402R5015	CL-501W	3 / 5
1SFA619402R5021	CL-502R	3 / 5
1SFA619402R5022	CL-502G	3 / 5
1SFA619402R5023	CL-502Y	3 / 5
1SFA619402R5024	CL-502L	3 / 5
1SFA619402R5025	CL-502W	3 / 5
1SFA619402R5041	CL-504R	3 / 5
1SFA619402R5042	CL-504G	3 / 5
1SFA619402R5043	CL-504Y	3 / 5
1SFA619402R5044	CL-504L	3 / 5
1SFA619402R5045	CL-504W	3 / 5
1SFA619402R5051	CL-505R	3 / 5
1SFA619402R5052	CL-505G	3 / 5
1SFA619402R5053	CL-505Y	3 / 5
1SFA619402R5054	CL-505L	3 / 5
1SFA619402R5055	CL-505W	3 / 5
1SFA619402R5131	CL-513R	3 / 5
1SFA619402R5132	CL-513G	3 / 5
1SFA619402R5133	CL-513Y	3 / 5
1SFA619402R5134	CL-513L	3 / 5
1SFA619402R5135	CL-513W	3 / 5
1SFA619402R5151	CL-515R	3 / 5
1SFA619402R5152	CL-515G	3 / 5
1SFA619402R5153	CL-515Y	3 / 5
1SFA619402R5154	CL-515L	3 / 5
1SFA619402R5155	CL-515W	3 / 5
1SFA619402R5201	CL-520R	3 / 5
1SFA619402R5202	CL-520G	3 / 5
1SFA619402R5203	CL-520Y	3 / 5
1SFA619402R5204	CL-520L	3 / 5
1SFA619402R5205	CL-520W	3 / 5
1SFA619402R5231	CL-523R	3 / 5

Contact us

ABB AB
Low Voltage Products
Motorgränd 20
S-72161 Västerås / Sweden

www.abb.com/lowvoltage

Note: We reserve the right to make technical changes or modify the contents of this document without prior notice. With regard to purchase orders, the agreed particulars shall prevail. ABB AG does not accept any responsibility whatsoever for potential errors or possible lack of information in this document.

We reserve all rights in this document and in the subject matter and illustrations contained therein. Any reproduction, disclosure to third parties or utilization of its contents – in whole or in parts – is forbidden without prior written consent of ABB AG.

Copyright © 2014 ABB
All rights reserved

