

AC Drives and Soft Starters

Pricing Guide
8800PL9701R01/14

2014

Class 8800



CONTENTS

Description	Page
AC Drives for Centrifugal Pumps and Fans (Variable Torque Applications)	
Altivar™ 212 drives	3
Altivar 61 drives	4
S-Flex™ 212 enclosed drives with keypad	10
E-Flex™ enclosed drives	11
M-Flex™ enclosed drives	12
PowerGard™ Type CPD drives	26
AC Drives for Conveyors, Mixers, Extruders and Material Handling (Constant Torque Applications)	
Altivar 12 drives	35
Altivar 312 drives	36
Altivar 32 drives	39
Altivar 71 drives	42
M-Flex™ enclosed drive controllers	12
PowerGard™ Type CPD	26
AC Soft Starter for Reduced Voltage Control (Variable Torque or Constant Torque Applications)	
Altistart™ 01 soft starter	47
Altistart 22 soft starter	49
Enclosed Altistart 22 soft starter	51
Altistart 48 soft starter	53
Enclosed Altistart 48 soft starter	54
Line Reactors and Motor Protection Output Filters	64
Braking Resistors and Modules	65
Spare Parts	
Altivar 61/71 drives	70
Altistart 48 soft starter	83
Auxiliary Services	84



ATV212HU15N4



ATV212W075N4



ATV212HU30M3X with Type 1 Conduit Kit



ATV212HD37N4 with Type 1 Conduit Kit



VW3A1101



VW3A1101

VW3A1102

VW3A1103

VW3A1104R10



VW3A8121



LonWorks Option Card VW3A21212

The Altivar 212 drive is for use with three-phase asynchronous motors for variable torque pump and fan applications. Select the Altivar 212 drive from Table 1 using the motor nameplate voltage and full load ampere ratings. The Altivar 212 drive includes 3 logic inputs, 2 analog inputs, 1 analog output, and 2 relay outputs (with 1 NO and 1 NO/NC contacts). The Altivar 212 drive includes an integrated 4 digit, 7 segment LED display with a 7 button keypad and includes an RJ45 Modbus port plus a four-screw terminal block for BACnet, Modbus, Metasys N2, and Apogee P1 communication protocols. LonWorks® is available in an option card.

Table 1: Altivar™ 212 Selection and Pricing

AC Input Line Voltage	Three-Phase Motor Power ▲		Continuous Output Current	Enclosure Rating					
	HP	kW		IP 20 ■ Open Style Product		Type 1 Conduit Kit Purchase ATV212 and Conduit Kit for Type 1 Installation		Type 12 / IP54 ◆	
				Catalog Number	\$ Price	Catalog Number	\$ Price	Catalog Number	\$ Price
200/240 Vac -15%, +10% Three-Phase	1	0.75	4.6	ATV212H075M3X	447.00	VW3A31814★	45.00	—	—
	2	1.5	7.5	ATV212HU15M3X	510.00	VW3A31814★	45.00	—	—
	3	2.2	10.6	ATV212HU22M3X	618.00	VW3A31814★	45.00	—	—
	4	3	13.7	ATV212HU30M3X	700.00	VW3A31815★	45.00	—	—
	5	4	18.7	ATV212HU40M3X	725.00	VW3A31815★	45.00	—	—
	7.5	5.5	24.2	ATV212HU55M3X	815.00	VW3A31816★	45.00	—	—
	10	7.5	32	ATV212HU75M3X	963.00	VW3A31816★	45.00	—	—
	15	11	46.2	ATV212HD11M3X	1398.00	VW3A31817★	45.00	—	—
	20	15	61	ATV212HD15M3X	1805.00	VW3A31817★	45.00	—	—
	25	18.5	74.8	ATV212HD18M3X	2314.00	VW3A31817★	45.00	—	—
	30	22	88	ATV212HD22M3X	3125.00	VW3A9206★	65.00	—	—
	40	30	117	ATV212HD30M3X	4013.00	VW3A9208★	135.00	—	—
380/480 Vac -15%, +10% Three-Phase	1	0.75	2.2	ATV212H075N4	498.00	VW3A31814★	45.00	ATV212W075N4	617.00
	2	1.5	3.7	ATV212HU15N4	552.00	VW3A31814★	45.00	ATV212WU15N4	694.00
	3	2.2	5.1	ATV212HU22N4	605.00	VW3A31814★	45.00	ATV212WU22N4	747.00
	4	3	7.2	ATV212HU30N4	675.00	VW3A31815★	45.00	ATV212WU30N4	792.00
	5	4	9.1	ATV212HU40N4	685.00	VW3A31815★	45.00	ATV212WU40N4	829.00
	7.5	5.5	12	ATV212HU55N4	795.00	VW3A31815★	45.00	ATV212WU55N4	1070.00
	10	7.5	16	ATV212HU75N4	875.00	VW3A31816★	45.00	ATV212WU75N4	1208.00
	15	11	22.5	ATV212HD11N4	1187.00	VW3A31816★	45.00	ATV212WD11N4	1456.00
	20	15	30.5	ATV212HD15N4	1425.00	VW3A31817★	45.00	ATV212WD15N4	1668.00
	25	18.5	37	ATV212HD18N4	1856.00	VW3A31817★	45.00	ATV212WD18N4	2219.00
	30	22	43.5	ATV212HD22N4S	2289.00	VW3A31817★	45.00	—	—
	30	22	43.5	ATV212HD22N4	2856.00	VW3A9206★	65.00	ATV212WD22N4	2709.00
	40	30	58.5	ATV212HD30N4	3091.00	VW3A9206★	65.00	ATV212WD30N4	3204.00
	50	37	79	ATV212HD37N4	3479.00	VW3A9207★	65.00	ATV212WD37N4	3623.00
	60	45	94	ATV212HD45N4	3998.00	VW3A9207★	65.00	ATV212WD45N4	4448.00
	75	55	116	ATV212HD55N4	4705.00	VW3A9208★	135.00	ATV212WD55N4	5038.00
	100	75	160	ATV212HD75N4	5743.00	VW3A9208★	135.00	ATV212WD75N4	6115.00

UL File E116875, CSA 2278406, Plenum rated per UL 508C for UL 1995 installations. NOM, CE

- ▲ These horsepower, wattage and continuous ampere ratings apply to the default switching frequency and maximum 40 °C ambient. Refer to the installation manual for derating curves as a function of switching frequency, ambient temperature, and mounting conditions.
- IP20 Altivar 212 drives can be installed as UL Type 1 with an optional conduit box by following the instructions in the Installation Manual.
- ◆ For ATV212W... drives with Class B EMC filter, add the letter "C" to the end of the standard catalog number and multiply \$ Price by 1.3.
- ★ Discount Schedule for this product is PC4B.

Table 2: Altivar 212 Options and Accessories

	Description	For Use on Drives	Catalog Number	\$ Price
User Interface Options				
Remote LCD Display Keypad	8 line, 24 characters per line, plain text, 8 keys, rotary wheel, 60 °C IP54 rated	Altivar 212, 312, 32 Altivar 61 & 71	VW3A1101■	115.00
Remote LCD Keypad Mounting Accessories	IP54 rated kit for remote mounting LCD keypad on enclosure door. Clear plastic door for use with VW3A1102 for IP65 rating and tamper resistant. Female / Female right angle RJ45 adaptor, to connect cable and keypad.▲	VW3A1101	VW3A1102■	55.00
		VW3A1102	VW3A1103■	45.00
		VW3A1101	VW3A1105■	35.00
Multi-loader	Remote LCD Keypad Mounting Cables —Equipped with two RJ45 connectors 1 meter length 3 meter length 5 meter length 10 meter length	VW3A1101	VW3A1104R10◆	35.00
		VW3A1101	VW3A1104R30◆	35.00
		VW3A1101	VW3A1104R50◆	35.00
		VW3A1101	VW3A1104R100◆	35.00
Potentiometer	Use to copy configurations between like drives, PC Soft, or SoMove PC Software	Altivar 12, 212, 312, 32, 61, 71, & Altistart 22	VW3A8121▼	350.00
Potentiometer	Operator, mounting collar, 2.5 kilohm, ½ watt potentiometer	Altivar 212	ATVPOT25K▼	69.00
Software				
SoMove™ Lite This software enables the user to configure, set, debug and organize maintenance task for the Altivar 12 drive. It can also be used to customize the integrated display terminal menus. It can be used with a direct connection or a Bluetooth® wireless connection. Free download at http://products.schneider-electric.us/products-services/products/ac-drives-and-soft-starts/				
USB to RJ45 adaptor	For use in connecting to a PC with a USB port	Advantys™ OTB, Altistart™ motor starters, Altivar series including HMI, Altivar controller	TCSMCNAM3M002P	52.00
PCSoft	PC software configuring, monitoring and trouble shooting Altivar 212 drives. Requires one of two cables (noted below) to connect a PC to the RJ45 Modbus port on the drive	Altivar 212	Download at http://products.schneider-electric.us/products-services/products/ac-drives-and-soft-starts/	
	USB/RS485 cable: equipped with USB connector and RJ45 connector	Altivar & Altistart	TCSMCNAM3M002P◆	52.00
Universal Bluetooth Interface	RS 232-RS485 converter with SUB-D & RJ45 port, cable with two RJ45 connectors	Altivar 212	VW3A8106■	75.00
	Bluetooth connectivity to devices through serial RS-485, RJ45 Modbus port. For permanent installation, to be used during commissioning, maintenance and troubleshooting of equipment.	Altivar 12, 212, 312, 61, 71, Altistart 22	TCSWAAC13FB★	180.00
Communication Option				
LonWorks Communication Card Option	Provides a four-screw terminal block for connection to LonWorks network. Install in place of standard control board that comes mounted in the Altivar 212 drive. The I/O count is reduced to 3LI, 1 AI and 1 NO/NC relay	Altivar 212	VW3A21212▼	375.00
Mounting Kit				
DIN Rail Mounting Kit	For installation on 35 mm wide DIN rail	Altivar 212H075M3X...U22M3X Altivar 212H075N4...U22N4	VW3A31852▼	375.00

- ▲ Not required if using VW3A1102.
- Discount Schedule for this product is CP4C.
- ◆ Discount Schedule for this product is CP1G.
- ★ Discount Schedule for this product is PC41.
- ▼ Discount Schedule for this product is PC4B.



Altivar™ 61 Single-Phase Drives

In an application where it is necessary to use a 240 V single-phase input for a 3-phase motor, the drive must be derated; therefore, the power listed on the drive nameplate will be higher than the power rating on the motor nameplate.

See page 64 for line reactor selection and pricing.



Table 3: Altivar 61 Selection and Pricing

Input Line Voltage	With a 5% Line Reactor			Without a Line Reactor			 Catalog Number with LCD Keypad	List Price \$	 Catalog Number for ATV61 drive and Type 1 conduit entry kit shipped as one line item. Field installation required (packaged as kit at warehouse).	List Price \$	 Catalog Number with LED Keypad (Non-stocked)	List Price \$
	Motor Power		Continuous Output Current	Motor Power		Continuous Output Current						
	HP	kW	A	HP	kW	A						
208/ 240 Vac Single Phase	—	—	—	0.5	0.37	3	ATV61H075M3▲	639.00	ATV61H075M3T1	684.00	ATV61H075M3Z▲	544.00
	—	—	—	1	0.75	4.8	ATV61HU15M3▲	663.00	ATV61HU15M3T1	708.00	ATV61HU15M3Z▲	568.00
	—	—	—	2	1.5	8	ATV61HU22M3▲	764.00	ATV61HU22M3T1	809.00	ATV61HU22M3Z▲	669.00
	—	—	—	3	2.2	11	ATV61HU30M3▲	925.00	ATV61HU30M3T1	970.00	ATV61HU30M3Z▲	830.00
	—	3	13.7	—	—	—	ATV61HU40M3▲	1035.00	ATV61HU40M3T1	1080.00	ATV61HU40M3Z▲	940.00
	5	4	17.5	—	—	—	ATV61HU55M3▲	1292.00	ATV61HU55M3T1	1337.00	ATV61HU55M3Z▲	1197.00
	7.5	5.5	27.5	5	4	17.5	ATV61HU75M3▲	1586.00	ATV61HU75M3T1	1631.00	ATV61HU75M3Z▲	1491.00
	10	7.5	33	7.5	5.5	27.5	ATV61HD15M3X▲◆	2525.00	ATV61HD15M3XT1◆	2570.00	ATV61HD15M3XZ▲◆	2430.00
	—	—	—	10	7.5	33	ATV61HD18M3X▲◆	2943.00	ATV61HD18M3XT1◆	3008.00	—	—
	15	11	54	—	—	—	ATV61HD22M3X▲◆	3586.00	ATV61HD22M3XT1◆	3651.00	—	—
	20	15	66	15	11	54	ATV61HD30M3X▲◆	4599.00	ATV61HD30M3XT1◆	4684.00	—	—
	25	18	75	20	15	66	ATV61HD37M3X▲◆	5342.00	ATV61HD37M3XT1◆	5427.00	—	—
	30	22	88	25	18	75	ATV61HD45M3X▲◆	6326.00	ATV61HD45M3XT1◆	6411.00	—	—

- ▲ Option to have product treated for increased protection for dusty and corrosive environments. This product is not stocked. On 0.5 hp to 5 hp at 230 Vac single phase, add "S337" to the end of the catalog number. On 7.5 hp to 25 hp at 230 Vac single phase, add "337" to the end of the catalog number. In both cases multiply price by 1.2 to obtain the new price. With this option, exposed copper is tinned, circuit boards are conformal coated in critical areas and plastics are treated to better withstand the corrosive nature of certain oils.
- ◆ Product does not contain an EMC filter.
- ◆ Product contains an internal DC choke inductance is 2–3%.

Altivar™ 61 Three-Phase Drives

Refer to document S1B8698100 for short circuit current ratings and branch circuit protection selection.

Table 4: Altivar 61 Selection and Pricing

Input Line Voltage	Variable Torque			Catalog Number with LCD Keypad (Stocked) ^Δ	\$ Price	Catalog Number to have ATV61 and Type 1 conduit lentry kit shipped as one line item. Field installation required (Packaged as kit at warehouse).	\$ Price	Catalog Number with LED Keypad (Non-stocked)	\$ Price
	Three-Phase Motor Power		Continuous Output Current						
	HP	kW							
208/240 Vac Three Phase	1	0.75	4.8	ATV61H075M3▲★	639.00	ATV61H075M3T1★	684.00	ATV61H075M3Z	544.00
	2	1.5	8	ATV61HU15M3▲★	663.00	ATV61HU15M3T1★	708.00	ATV61HU15M3Z	568.00
	3	2.2	11	ATV61HU22M3▲★	764.00	ATV61HU22M3T1★	809.00	ATV61HU22M3Z	669.00
	4	3	13.7	ATV61HU30M3▲★	925.00	ATV61HU30M3T1★	970.00	ATV61HU30M3Z	830.00
	5	4	17.5	ATV61HU40M3▲★	1035.00	ATV61HU40M3T1★	1080.00	ATV61HU40M3Z	940.00
	7.5	5.5	27.5	ATV61HU55M3▲★	1292.00	ATV61HU55M3T1★	1337.00	ATV61HU55M3Z	1197.00
	10	7.5	33	ATV61HU75M3▲★	1586.00	ATV61HU75M3T1★	1631.00	ATV61HU75M3Z	1491.00
	15	11	54	ATV61HD11M3X▲★□	2011.00	ATV61HD11M3XT1■□	2056.00	ATV61HD11M3XZ■□	1916.00
	20	15	66	ATV61HD15M3X▲★□	2525.00	ATV61HD15M3XT1■□	2570.00	ATV61HD15M3XZ■□	2430.00
	25	18	75	ATV61HD18M3X▲★□	2943.00	ATV61HD18M3XT1■□	3008.00	—	—
	30	22	88	ATV61HD22M3X▲★□	3586.00	ATV61HD22M3XT1■□	3651.00	—	—
	40	30	120	ATV61HD30M3X▲★□	4599.00	ATV61HD30M3XT1■□	4684.00	—	—
	50	37	144	ATV61HD37M3X▲★□	5342.00	ATV61HD37M3XT1■□	5427.00	—	—
	60	45	176	ATV61HD45M3X▲★□	6326.00	ATV61HD45M3XT1■□	6411.00	—	—
	75	55	221	ATV61HD55M3X▲★□	7806.00	ATV61HD55M3XT1■□	8266.00	—	—
100	75	285	ATV61HD75M3X▲★□	9379.00	ATV61HD75M3XT1■□	9839.00	—	—	
125	90	359	ATV61HD90M3X▲★□	11954.00	ATV61HD90M3XT1■□	12507.00	—	—	
400/480 Vac Three Phase	1	0.75	2.3	ATV61H075N4▲★	754.00	ATV61H075N4T1★	799.00	ATV61H075N4Z	659.00
	2	1.5	4.1	ATV61HU15N4▲★	857.00	ATV61HU15N4T1★	902.00	ATV61HU15N4Z	762.00
	3	2.2	5.8	ATV61HU22N4▲★	999.00	ATV61HU22N4T1★	1044.00	ATV61HU22N4Z	904.00
	4	3	7.8	ATV61HU30N4▲★	1125.00	ATV61HU30N4T1★	1170.00	ATV61HU30N4Z	1030.00
	5	4	10.8	ATV61HU40N4▲★	1158.00	ATV61HU40N4T1★	1203.00	ATV61HU40N4Z	1063.00
	7.5	5.5	14.3	ATV61HU55N4▲★	1299.00	ATV61HU55N4T1★	1344.00	ATV61HU55N4Z	1204.00
	10	7.5	17.6	ATV61HU75N4▲★	1578.00	ATV61HU75N4T1★	1623.00	ATV61HU75N4Z	1483.00
	15	11	27.7	ATV61HD11N4▲★	1868.00	ATV61HD11N4T1★	1913.00	ATV61HD11N4Z	1773.00
	20	15	33	ATV61HD15N4▲★	2322.00	ATV61HD15N4T1★	2367.00	ATV61HD15N4Z	2227.00
	25	18	41	ATV61HD18N4▲★	2795.00	ATV61HD18N4T1★	2840.00	ATV61HD18N4Z	2700.00
	30	22	48	ATV61HD22N4▲★	3042.00	ATV61HD22N4T1★	3107.00	ATV61HD22N4Z	2947.00
	40	30	66	ATV61HD30N4▲★	3744.00	ATV61HD30N4T1★	3809.00	ATV61HD30N4Z	3649.00
	50	37	79	ATV61HD37N4▲★	4403.00	ATV61HD37N4T1★	4468.00	ATV61HD37N4Z	4308.00
	60	45	94	ATV61HD45N4▲★	5528.00	ATV61HD45N4T1★	5563.00	ATV61HD45N4Z	5433.00
	75	55	116	ATV61HD55N4▲★	6365.00	ATV61HD55N4T1★	6500.00	ATV61HD55N4Z	6270.00
	100	75	160	ATV61HD75N4▲★	7267.00	ATV61HD75N4T1★	7402.00	ATV61HD75N4Z	7172.00
	125	90	179	ATV61HD90N4▲★	7988.00	ATV61HD90N4T1★	8448.00	—	—
	150	110	215	ATV61HC11N4◆★	10105.00	ATV61HC11N4T1★	10620.00	—	—
	200	130	259	ATV61HC13N4◆★	11610.00	ATV61HC13N4T1★	12229.00	—	—
	250	160	314	ATV61HC16N4◆★	13116.00	ATV61HC16N4T1★	13758.00	—	—
350	220	427	ATV61HC22N4◆★	15672.00	ATV61HC22N4T1★	16331.00	—	—	
400	250	481	ATV61HC25N4◆★	18946.00	ATV61HC25N4T1★	19550.00	—	—	
500	315	616	ATV61HC31N4◆	27294.00	—	—	—	—	
600	400	759	ATV61HC40N4◆	38140.00	—	—	—	—	
700	500	941	ATV61HC50N4◆	53082.00	—	—	—	—	
900	630	1188	ATV61HC63N4◆	76722.00	—	—	—	—	

- ▲ Option to have product treated for increased protection for dusty and corrosive environments. This product is not stocked. On 1 hp to 10 hp at 230 Vac 3 phase and up to 100 hp at 460 V, add "S337" to the end of the catalog number. On 15 hp to 60 hp at 230 Vac 3 phase, add "337" to the end of the catalog number. In both cases multiply price by 1.2 to obtain new price. With this option, exposed copper is tinned, circuit boards are conformal coated in critical areas and plastics are treated to better withstand the corrosive nature of certain oils. This option is standard on 55 kW/75 hp @ 230 Vac 3 phase and higher and 90 kW/125 hp @ 460 Vac and higher.
- ◆ Product does not contain an EMC filter.
- ◆ Product ships with a DC choke that must be field mounted inductance 2–3%. A 5% line reactor may be purchased and installed in place of the DC choke. Add "D" to the end of the catalog number to receive just the AC drive and multiply the listed price by 0.96 to obtain new price.
- ★ These products can be ordered with LonWorks® or BACnet communication option card shipped as one line item. Field installation required. Add "LW" to the end of the part number to receive a LonWorks option card. Add \$550 to the price. Add "BN" to the end of the part number to receive a BACnet option card. Add \$225 to the price.
- ▼ These products do not contain a dynamic braking transistor. A separate transistor must be added for applications requiring dynamic braking.
- Δ When ordering replacements for Square D™ brand E-Flex™, MCC and M-Flex™ enclosed drive controllers containing the Altivar 61 drive, identify the replacement catalog number by referring to the applicable instruction manual, the side nameplate on power converter, or using the graphic keypad (menu 1.11 identification).
- Product contains an internal DC choke inductance is 2–3%.



Altivar™ 61 Selection and Pricing (continued)

Input Line Voltage	Variable Torque			 Catalog Number with LCD Keypad (Stocked)	\$ Price
	Three-Phase Motor Power		Continuous Output Current		
	HP	kW	A		
500/600 Vac Three Phase	3	2.2	3.9	ATV61HU22S6X★	1889.00
	4	3	5.8	ATV61HU30S6X★	1989.00
	5	4	6.1	ATV61HU40S6X★	2099.00
	7.5	5.5	9	ATV61HU55S6X★	2380.00
	10	7.5	11	ATV61HU75S6X★	2799.00
575/690 Vac Three Phase	15	15	17	ATV61HD15Y▲	4790.00
	20	18.5	22	ATV61HD18Y▲	4790.00
	25	22	27	ATV61HD22Y▲	4790.00
	30	30	32	ATV61HD30Y▲	5780.00
	40	37	41	ATV61HD37Y▲	6999.00
	50	45	52	ATV61HD45Y▲	8579.00
	60	55	62	ATV61HD55Y▲	10379.00
	75	75	77	ATV61HD75Y▲	12199.00
	100	90	99	ATV61HD90Y▲	14399.00
	125	110	125	ATV61HC11Y▲■	18917.00
	150	132	150	ATV61HC13Y▲■	21480.00
	—	160	180	ATV61HC16Y▲■	23290.00
	200	200	220	ATV61HC20Y▲■	27205.00
	250	250	290	ATV61HC25Y▲■◆	32424.00
	350	315	355	ATV61HC31Y▲■◆	41343.00
	450	400	420	ATV61HC40Y▲■◆	56100.00
	550	500	543	ATV61HC50Y▲■◆	71508.00
700	630	675	ATV61HC63Y▲■◆	94188.00	
800	800	840	ATV61HC80Y▲■◆	124068.00	

- ▲ Conformal coating is standard.
- An AC 5% line reactor which must be ordered separately is mandatory.
- ◆ These products do not contain a dynamic braking transistor. A separate transistor must be added for applications requiring dynamic braking.
- ★ Product does not contain EMC filter. All boards are conformal coated.

Table 5: Altivar 61 UL Type 12 / IP54 Selection and Pricing



	Three-Phase Motor Power		Continuous Output Current	Catalog Number	\$ Price
	Horsepower	kW	A		
400/480 Vac Three-Phase UL Type 12/IP54	1	0.75	2.3	ATV61W075N4U	943.00
	2	1.5	4.1	ATV61WU15N4U	1072.00
	3	2.2	5.1	ATV61WU22N4U	1249.00
	—	3	7.2	ATV61WU30N4U	1406.00
	5	4	9.1	ATV61WU40N4U	1448.00
	7.5	5.5	12	ATV61WU55N4U	1624.00
	10	7.5	16	ATV61WU75N4U	1972.00
	15	11	22.5	ATV61WD11N4U	2335.00
	20	15	30.5	ATV61WD15N4U	2903.00
	25	18.5	37	ATV61WD18N4U	3493.00
	30	22	43.5	ATV61WD22N4U	3803.00
	40	30	58.5	ATV61WD30N4U	4680.00
	50	37	71.5	ATV61WD37N4U	5504.00
	60	45	85	ATV61WD45N4U	6911.00
	75	55	103	ATV61WD55N4U	7956.00
100	75	137	ATV61WD75N4U	9084.00	
125	90	163	ATV61WD90N4U	9986.00	

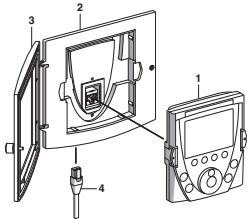

LCD Keypad Mounting Kits

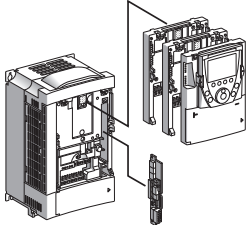

Option Card Assembly

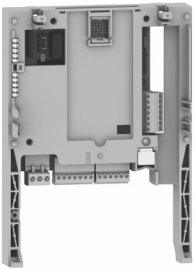

I/O Option Card

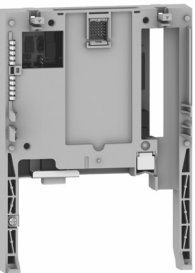

Communication Option Card

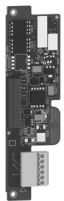

Incremental Encoder Interface Option Card

Table 6: Options—Field Installed

Description		For Use on Drives	Catalog No.	\$ Price	
Operator Interface	LCD graphic keypad: IP54 rating	any ATV61 any ATV71	VW3A1101	115.00	
	Remote mounting kit: includes bezel and mounting hardware		VW3A1102	55.00	
	Door for use with remote mount kit for IP65 rating		VW3A1103	45.00	
	Cable for remote mounting LCD graphic keypad RJ-45 connector on each end		1 meter	VW3A1104R10	35.00
			3 meters	VW3A1104R30	35.00
			5 meters	VW3A1104R50	35.00
			10 meters	VW3A1104R100	45.00
RJ-45 female—female adaptor to connect LCD keypad and cable. Not required if using VW3A1102.	VW3A1105	35.00			
Operator, mounting collar, 2.5 kilohm, 1/2 watt potentiometer	Altivar 61	ATVPOT25K	69.00		
Software					
SoMove™ This software enables the user to configure, set, debug and organize maintenance task for the Altivar 12 drive. It can also be used to customize the integrated display terminal menus. It can be used with a direct connection or a Bluetooth® wireless connection. Free download at http://products.schneider-electric.us/products-services/products/ac-drives-and-soft-starts/					
USB to RJ45 adaptor	For use in connecting to a PC with a USB port	Advantys™ OTB, Altistar™ motor starters, Altivar series including HMI, Altivar controller	TCSMCNAM3M002P	52.00	
Universal Bluetooth Interface	Bluetooth connectivity to devices through serial RS-485, RJ45 Modbus port. For permanent installation, to be used during commissioning, maintenance and troubleshooting of equipment.	Altivar 12, 212, 312, 61, 71, and Altistar 22	TCSWAAC13FB★	180.00	
I/O Adaptor	115 Vac logic input adaptor adapts 7 logic inputs for use with user supplied 115 Vac signals	any ATV61 any ATV71	VW3A3101	195.00	
I/O Extension Option Cards	Basic I/O option card—4 logic inputs, 2 logic outputs, 1 Form C relay output, an input for PTC motor probes, a 24 Vdc output, and a 10 Vdc output	any ATV61 any ATV71	VW3A3201	165.00	
	Extended I/O option card—contains all the I/O on the Basic I/O option card plus 2 analog inputs, 2 analog outputs, 1 pulse input		VW3A3202	195.00	
CANopen Adaptor	This adaptor connects to the RJ-45 port and provides a 9-pin male SUB-D connector conforming to the CANopen standard (CIA DRP 303-1)	any ATV61 any ATV71	VW3CANA71	45.00	
CANopen Connector	9-pin female SUB-D with line terminator (can be disabled), 180° cable outlet CAN-H, CAN-L, CAN-GND connection	any ATV61 any ATV71	VW3CANKCDF180T	45.00	
Incremental Encoder Interface Option Cards	with RS-422 outputs, 5 Vdc	any ATV71	VW3A3401	85.00	
	with RS-422 outputs, 15 Vdc		VW3A3402	85.00	
	with open collector outputs, 12 Vdc		VW3A3403	85.00	
	with open collector outputs, 15 Vdc		VW3A3404	85.00	
	with push-pull outputs, 12 Vdc		VW3A3405	85.00	
	with push-pull outputs, 15 Vdc		VW3A3406	85.00	
	with push-pull outputs, 24 Vdc		VW3A3407	85.00	
	Resolver		VW3A3408▲	85.00	
	Universal with SinCos, SinCos Hiperface®, SinCos EnDat® or SSI output		VW3A3409▲	85.00	
	Incremental with RS422 outputs and encoder emulation		VW3A3411▲	85.00	
Communication Option Cards	Modbus / Uni-Telway™ card	any ATV61 any ATV71	VW3A3303	225.00	
	Modbus TCP/IP daisy chain		VW3A3310D	275.00	
	Interbus® S card		VW3A3304	550.00	
	Profibus DP card		VW3A3307	550.00	
	Profibus DPv1 card		VW3A3307S371	550.00	
	DeviceNet™ card		VW3A3309	225.00	
	Ethernet/IP™ card	VW3A3316	275.00		
	LonWorks® card	VW3A3312	550.00		
	Metasys® N2 card with removable 4 position screw connector	VW3A3318	225.00		
	Apogee® FLN P1 card	VW3A3314	225.00		
	BACnet card with removable 4 position screw connector	VW3A3319	225.00		
	IMC Option Card	ATV IMC drive controller card♦		VW3A3521S0★	755.00
Controller Inside Option Card	Programmable option card, conforms with IEC61131-3 programming standard. (Software for this option card is available after completing training class offered by Schneider Electric Services.)	any ATV61 any ATV71	VW3A3501■	550.00	
Water Solutions Control Card	This option card contains a variety of pre-programmed functions and features to manage multi-pump installations.	any ATV61 any ATV71	VW3A3503■	650.00	
Simple Loader	Using RJ45 port connections, the configurations of a drive can be downloaded then uploaded to compatible drive.	ATV31, ATV61, and ATV71	VW3A8120	175.00	

- ▲ For use with the ATV71H...383 drive ONLY.
- The drive cannot support the VW3A3503 water solutions card and the VW3A3501 controller inside option card simultaneously.
- ♦ SoMachine is required to use this product.
- ★ Discount Schedule for this product is PC41.

Table 6: Options—Field Installed (continued)

Description		For Use on Drives	Fan Kit Catalog No.	\$ Price		
Fan Kit	Installation of the fan kit enables the drive to operate in higher ambient temperatures. The fan mounts on the drive. Consult the product catalog for more information.	ATV61/71HD18M3X...HD22M3X, ATV61/71HD22N4	VW3A9404	135.00		
		ATV61/71HD30N4...HD37N4	VW3A9405	145.00		
		ATV61/71HD30M3X...HD45M3X	VW3A9406	165.00		
		ATV61/71HD45N4...HD75N4	VW3A9407	195.00		
ATV61: Options and Accessories — Variable Torque Applications						
Description		ATV58 Drive	Replaced by	Mounting Plate Catalog No. \$ Price		
Single-phase supply voltage: 200...240 V 50/60 Hz						
Mounting Plate Kit	Kit includes: Mechanical adaptors required for mounting an Altivar™ 61/71 drive in the place of an Altivar 58 or Altivar 58F drive using the same holes.	ATV58HU09M2ZU	ATV61H075M3	VW3A9301	83.00	
		ATV58HU18M2ZU	ATV61HU15M3	VW3A9301	83.00	
		ATV58HU29M2ZU	ATV61HU22M3	VW3A9303	83.00	
		ATV58HU41M2ZU	ATV61HU30M3	VW3A9303	83.00	
		ATV58HU72M2ZU	ATV61HU40M3	VW3A9304	93.00	
		ATV58HU90M2ZU	ATV61HU55M3	VW3A9306	133.00	
		ATV58HD12M2ZU	ATV61HU75M3	VW3A9307	133.00	
		Three-phase supply voltage: 200...240 V 50/60 Hz				
		ATV58HU29M2ZU	ATV61HU15M3	VW3A9302	83.00	
		ATV58HU41M2ZU	ATV61HU22M3	VW3A9303	83.00	
		ATV58HU54M2ZU	ATV61HU30M3	VW3A9304	93.00	
		ATV58HU72M2ZU	ATV61HU40M3	VW3A9304	93.00	
		ATV58HU90M2ZU	ATV61HU55M3	VW3A9306	133.00	
		ATV58HD12M2ZU	ATV61HU75M3	VW3A9307	133.00	
		ATV58HD16M2XZU	ATV61HD11M3X	VW3A9309	170.00	
		ATV58HD16M2XZU	ATV61HD15M3X	VW3A9309	170.00	
		ATV58HD23M2XZU	ATV61HD18M3X	VW3A9310	170.00	
		ATV58HD28M2XZU	ATV61HD22M3X	VW3A9312	337.00	
		ATV58HD33M2XZU	ATV61HD30M3X	VW3A9312	337.00	
		ATV58HD46M2XZU	ATV61HD37M3X	VW3A9312	337.00	
		Three-phase supply voltage: 380...480 V 50/60 Hz				
		ATV58HU18N4ZU	ATV61H075N4	VW3A9302	83.00	
		ATV58HU29N4ZU	ATV61HU15N4	VW3A9302	83.00	
		ATV58HU41N4ZU	ATV61HU22N4	VW3A9302	83.00	
ATV58HU54N4XZU	ATV61HU40N4	VW3A9304	93.00			
ATV58HU72N4XZU	ATV61HU55N4	VW3A9305	93.00			
ATV58HU90N4XZU	ATV61HU75N4	VW3A9305	93.00			
ATV58HD12N4XZU	ATV61HD11N4	VW3A9307	133.00			
ATV58HD16N4XZU	ATV61HD15N4	not available	—			
ATV58HD23N4XZU	ATV61HD18N4	VW3A9308	138.00			
ATV58HD28N4XZU	ATV61HD22N4	VW3A9310	170.00			
ATV58HD33N4XZU	ATV61HD30N4	VW3A9310	170.00			
ATV58HD46N4XZU	ATV61HD37N4	VW3A9310	170.00			
ATV58HD54N4XZU	ATV61HD45N4	VW3A9312	337.00			
ATV58HD64N4XZU	ATV61HD55N4	VW3A9312	337.00			
ATV58HD79N4XZU	ATV61HD75N4	VW3A9312	337.00			
ATV71: Options and Accessories—Constant Torque Applications						
Description		ATV58 Drive	Replaced by	Mounting Plate Catalog No. \$ Price		
Single-phase supply voltage: 200...240 V 50/60 Hz						
Mounting Plate Kit	Kit includes: Mechanical adaptors required for mounting an Altivar™ 61/71 drive in the place of an Altivar 58 or Altivar 58F drive using the same holes.	ATV58HU09M2ZU	ATV71H075M3	VW3A9301	83.00	
		ATV58HU18M2ZU	ATV71HU15M3	VW3A9301	83.00	
		ATV58HU29M2ZU	ATV71HU22M3	VW3A9303	83.00	
		ATV58HU41M2ZU	ATV71HU30M3	VW3A9303	83.00	
		ATV58HU72M2ZU	ATV71HU40M3	VW3A9304	93.00	
		ATV58HU90M2ZU	ATV71HU55M3	VW3A9306	133.00	
		ATV58HD12M2ZU	ATV71HU75M3	VW3A9307	133.00	
		Three-phase supply voltage: 200...240 V 50/60 Hz				
		ATV58HU29M2ZU	ATV71HU15M3	VW3A9302	83.00	
		ATV58HU41M2ZU	ATV71HU22M3	VW3A9303	83.00	
		ATV58HU54M2ZU	ATV71HU30M3	VW3A9304	93.00	
		ATV58HU72M2ZU	ATV71HU40M3	VW3A9304	93.00	
		ATV58HU90M2ZU	ATV71HU55M3	VW3A9306	133.00	
		ATV58HD12M2ZU	ATV71HU75M3	VW3A9307	133.00	
		ATV58HD16M2XZU	ATV71HD11M3X	VW3A9309	170.00	
		ATV58HD23M2XZU	ATV71HD15M3X	VW3A9309	170.00	
		ATV58HD28M2XZU	ATV71HD18M3X	VW3A9310	170.00	
		ATV58HD33M2XZU	ATV71HD22M3X	VW3A9312	337.00	
		ATV58HD46M2XZU	ATV71HD30M3X	VW3A9312	337.00	
		Three-phase supply voltage: 380...480 V 50/60 Hz				
		ATV58HU18N4ZU	ATV71H075N4	VW3A9302	83.00	
		ATV58HU29N4ZU	ATV71HU15N4	VW3A9302	83.00	
		ATV58HU41N4ZU	ATV71HU22N4	VW3A9302	83.00	
		ATV58HU54N4ZU	ATV71HU30N4	VW3A9304	93.00	
ATV58HU72N4ZU	ATV71HU40N4	VW3A9304	93.00			
ATV58HU90N4ZU	ATV71HU55N4	VW3A9305	93.00			
ATV58HD12N4ZU	ATV71HU75N4	VW3A9306	133.00			
ATV58HD16N4ZU	ATV71HD11N4	VW3A9307	133.00			
ATV58HD23N4ZU	ATV71HD15N4	VW3A9308	138.00			
ATV58HD28N4ZU	ATV71HD18N4	VW3A9309	170.00			
ATV58HD33N4ZU	ATV71HD22N4	VW3A9310	170.00			
ATV58HD46N4ZU	ATV71HD30N4	VW3A9310	170.00			
ATV58HD54N4ZU	ATV71HD37N4	VW3A9312	337.00			
ATV58HD64N4ZU	ATV71HD45N4	VW3A9312	337.00			
ATV58HD79N4ZU	ATV71HD55N4	VW3A9312	337.00			

Table 6: Options—Field Installed (continued)

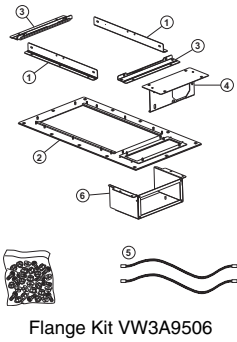

Flange Kit VW3A9506

Description		For Use on Drives	Catalog No.	\$ Price																																																																		
Flange Kit	Kit includes: a metal frame, seals, mounting hardware, and a bracket to mount the fan kit so the fan can be accessed from the front of the drive template. Kit used to mount the heatsink of the drive outside of an enclosure.	ATV61/71H037M3...HU15M3	VW3A9501	255.00																																																																		
		ATV61/71H075N4...HU22N4																																																																				
		ATV61/71HU22M3...HU40M3	VW3A9502	279.00																																																																		
		ATV61/71HU30N4...HU40N4																																																																				
		ATV61/71HU55M3	VW3A9503	325.00																																																																		
		ATV61/71HU55N4, HU75N4																																																																				
		ATV61/71HU75M3	VW3A9504	358.00																																																																		
		ATV61/71HD11N4, ATV61/71...S6X																																																																				
		ATV61/71HD11M3X..HD15M3X	VW3A9505	419.00																																																																		
		ATV61/71HD15N4, HD18N4																																																																				
		ATV61/71HD18M3X..HD22M3X	VW3A9506	438.00																																																																		
		ATV61/71HD22N4, ATV61/71HU30Y...HD30Y																																																																				
		ATV61/71HD30N4, HD37N4	VW3A9507	469.00																																																																		
		ATV61/71HD30M3X..HD45M3X	VW3A9508	469.00																																																																		
		ATV61/71HD45N4...HD75N4, ATV61/71HD37Y...HD90Y	VW3A9509	477.00																																																																		
		ATV61HD55M3X...HD75M3X																																																																				
		ATV61HD90N4...HC11N4	VW3A9510	500.00																																																																		
		ATV71HD55M3X, ATV71HD90N4																																																																				
		ATV61HD90M3X, ATV61HC13N4	VW3A9511	667.00																																																																		
		ATV71HD75M3X, ATV71HC11N4																																																																				
		ATV61HC16N4, ATV61HC20Y, ATV61/71HC11Y...HC16Y, ATV71HC13N4	VW3A9512	1053.00																																																																		
		ATV61HC22N4, ATV71HC16N4	VW3A9513	1053.00																																																																		
		ATV61HC25N4...HC31N4																																																																				
		ATV61HC40Y	VW3A9514	1053.00																																																																		
		ATV61/71HC25Y, HC31Y																																																																				
		ATV71HC20N4...HC28N4																																																																				
		ATV71HC20Y																																																																				
		ATV61HC25N4...HC31N4 with VW3A7101 braking transistor																																																																				
		ATV61HC40Y	VW3A9515	1062.00																																																																		
		ATV61/71HC25Y, HC31Y																																																																				
ATV71HC20N4...HC28N4 with VW3A7101 braking transistor																																																																						
ATV71HC20Y																																																																						
Type 1 Conduit Kit	Kit includes: a metal box with conduit knockouts. The kit provides conduit landing when wall mounting the drive.	ATV61/71H037M3...HU15M3	VW3A9201	45.00																																																																		
		ATV61/71H075N4...HU22N4																																																																				
		ATV61/71HU22M3...HU40M3	VW3A9202	45.00																																																																		
		ATV61/71HU30N4...HU40N4																																																																				
		ATV61/71HU55M3	VW3A9203	45.00																																																																		
		ATV61/71HU55N4, HU75N4																																																																				
		ATV61/71HU75M3	VW3A9204	45.00																																																																		
		ATV61/71HD11N4, ATV61/71...S6X																																																																				
		ATV61/71HD11M3X..HD15M3X	VW3A9205	45.00																																																																		
		ATV61/71HD15N4, HD18N4																																																																				
		ATV61/71HD18M3X..HD22M3X																																																																				
		ATV61/71HD22N4	VW3A9206	65.00																																																																		
		ATV61/71HU30Y...HD30Y																																																																				
		ATV61/71HD30N4, HD37N4	VW3A9207	65.00																																																																		
		ATV61/71HD30M3X..HD45M3X	VW3A9217	85.00																																																																		
		ATV61/71HD45N4..HD75N4	VW3A9208	135.00																																																																		
		ATV61/71HD37Y...HD90Y																																																																				
		ATV61HD55M3X...HD75M3X																																																																				
		ATV61HD90N4...HC11N4	VW3A9209	460.00																																																																		
		ATV71HD55M3X, ATV71HD90N4, ATV61HC11N4																																																																				
		ATV61HD90M3X, ATV61HC13N4	VW3A9210	553.00																																																																		
		ATV71HD75M3X, ATV71HC11N4																																																																				
		ATV61HC16N4, ATV71HC13N4																																																																				
		ATV61/71HC11Y...HC16Y	VW3A9211	573.00																																																																		
		ATV61HC20Y																																																																				
		ATV61HC22N4, ATV71HC16N4	VW3A9212	588.00																																																																		
		ATV61HC25N4...HC31N4																																																																				
		ATV71HC20N4...HC28N4																																																																				
		ATV71HC20Y	VW3A9213	604.00																																																																		
		ATV61/71HC25Y, HC31Y																																																																				
ATV61HC40Y																																																																						
ATV61HC25N4...HC31N4 with VW3A7101 braking transistor																																																																						
ATV71HC20N4...HC28N4 with VW3A7101 braking transistor	VW3A9214	604.00																																																																				
ATV71HC20Y																																																																						
ATV61/71HC25Y, HC31Y																																																																						
ATV61HC40Y																																																																						
Profibus Option Card Cover	Type 1 cover for Profibus Option Card	<table border="1"> <thead> <tr> <th colspan="2">230 V Drive controllers</th> <th colspan="2">480 V Drive controllers</th> <th></th> <th></th> </tr> <tr> <th>ATV61H***▲</th> <th>ATV71H***▲</th> <th>ATV61H***▲</th> <th>ATV71H***▲</th> <th></th> <th></th> </tr> </thead> <tbody> <tr> <td>075M3</td> <td>037M3</td> <td>075N4</td> <td>075N4</td> <td rowspan="4">VW3A9201PF</td> <td rowspan="4">101.00</td> </tr> <tr> <td>U15M3</td> <td>075M3</td> <td>U15N4</td> <td>U15N4</td> </tr> <tr> <td>—</td> <td>U15M3</td> <td>U22N4</td> <td>U22N4</td> </tr> <tr> <td>U22M3</td> <td>U22M3</td> <td>U30N4</td> <td>U30N4</td> </tr> <tr> <td>U30M3</td> <td>U30M3</td> <td>U40N4</td> <td>U40N4</td> <td rowspan="2">VW3A9292PF</td> <td rowspan="2">102.00</td> </tr> <tr> <td>U40M3</td> <td>U40M3</td> <td>—</td> <td>—</td> </tr> <tr> <td>U55M3</td> <td>U55M3</td> <td>U55N4</td> <td>U55N4</td> <td rowspan="2">VW3A9203PF</td> <td rowspan="2">104.00</td> </tr> <tr> <td>—</td> <td>—</td> <td>U75N4</td> <td>U75N4</td> </tr> <tr> <td>U75M3</td> <td>U75M3</td> <td>D11N4</td> <td>D11N4</td> <td>VW3A9204PF</td> <td>107.00</td> </tr> <tr> <td>D11M3X</td> <td>D11M3X</td> <td>D15N4</td> <td>D15N4</td> <td rowspan="2">VW3A9205PF</td> <td rowspan="2">112.00</td> </tr> <tr> <td>D15M3X</td> <td>D15M3X</td> <td>D18N4</td> <td>D18N4</td> </tr> </tbody> </table>	230 V Drive controllers		480 V Drive controllers				ATV61H***▲	ATV71H***▲	ATV61H***▲	ATV71H***▲			075M3	037M3	075N4	075N4	VW3A9201PF	101.00	U15M3	075M3	U15N4	U15N4	—	U15M3	U22N4	U22N4	U22M3	U22M3	U30N4	U30N4	U30M3	U30M3	U40N4	U40N4	VW3A9292PF	102.00	U40M3	U40M3	—	—	U55M3	U55M3	U55N4	U55N4	VW3A9203PF	104.00	—	—	U75N4	U75N4	U75M3	U75M3	D11N4	D11N4	VW3A9204PF	107.00	D11M3X	D11M3X	D15N4	D15N4	VW3A9205PF	112.00	D15M3X	D15M3X	D18N4	D18N4		
		230 V Drive controllers		480 V Drive controllers																																																																		
		ATV61H***▲	ATV71H***▲	ATV61H***▲	ATV71H***▲																																																																	
		075M3	037M3	075N4	075N4	VW3A9201PF	101.00																																																															
		U15M3	075M3	U15N4	U15N4																																																																	
		—	U15M3	U22N4	U22N4																																																																	
		U22M3	U22M3	U30N4	U30N4																																																																	
		U30M3	U30M3	U40N4	U40N4	VW3A9292PF	102.00																																																															
		U40M3	U40M3	—	—																																																																	
		U55M3	U55M3	U55N4	U55N4	VW3A9203PF	104.00																																																															
		—	—	U75N4	U75N4																																																																	
		U75M3	U75M3	D11N4	D11N4	VW3A9204PF	107.00																																																															
		D11M3X	D11M3X	D15N4	D15N4	VW3A9205PF	112.00																																																															
		D15M3X	D15M3X	D18N4	D18N4																																																																	

▲ The symbol "▲" indicates the part of the number that varies with controller size or rating.

Variable Torque AC Drive—208 V, 230 V, and 460 V Ratings

Table 7: S-Flex™ 212 Enclosed Drive Controller Selection and Pricing

Input Line Voltage	HP	kW	Output Current A	Catalog Number	Standard Product List \$ Price	Options				
						Without Bypass	Disc Switch	Line Contactor	1.5% AC Line Reactor	
						MOD W Price \$▲	MOD A07 Price \$■	MOD B07 Price \$■	MOD X07 List Price \$	
208 Vac Three-phase	1	0.75	4.8	SFD212CG2Y	1227.00	902.00	1338.00	1288.00	118.00	
	2	1.5	7.8	SFD212DG2Y	1338.00	983.00	1459.00	1404.00	136.00	
	3	2.2	11	SFD212EG2Y	1617.00	1188.00	1763.00	1697.00	157.00	
	5	4	17.5	SFD212FG2Y	1768.00	1299.00	1927.00	1855.00	213.00	
	7.5	5.5	25.3	SFD212GG2Y	1983.00	1457.00	2162.00	2081.00	248.00	
	10	7.5	32.2	SFD212HG2Y	2197.00	1614.00	2395.00	2305.00	248.00	
	15	11	48.3	SFD212JG2Y	2540.00	1866.00	2769.00	2665.00	325.00	
	20	15	62.1	SFD212KG2Y	3106.00	2281.00	3386.00	3259.00	416.00	
	25	18.5	78.2	SFD212LG2Y	3862.00	2836.00	4210.00	4052.00	499.00	
	30	22	92	SFD212MG2Y	5248.00	3855.00	5722.00	5507.00	499.00	
	40	30	120	SFD212NG2Y	6012.00	4416.00	6555.00	6309.00	566.00	
	230 Vac Three-phase	1	0.75	4.2	SFD212CG3Y	1227.00	902.00	1338.00	1288.00	118.00
		2	1.5	6.8	SFD212DG3Y	1338.00	983.00	1459.00	1404.00	136.00
		3	2.2	9.6	SFD212EG3Y	1617.00	1188.00	1763.00	1697.00	136.00
5		4	15.2	SFD212FG3Y	1768.00	1299.00	1927.00	1855.00	169.00	
7.5		5.5	22	SFD212GG3Y	1983.00	1457.00	2162.00	2081.00	213.00	
10		7.5	28	SFD212HG3Y	2197.00	1614.00	2395.00	2305.00	248.00	
15		11	42	SFD212JG3Y	2540.00	1866.00	2769.00	2665.00	325.00	
20		15	54	SFD212KG3Y	3106.00	2281.00	3386.00	3259.00	416.00	
25		18.5	68	SFD212LG3Y	3862.00	2836.00	4210.00	4052.00	469.00	
30		22	80	SFD212MG3Y	5248.00	3855.00	5722.00	5507.00	499.00	
40		30	104	SFD212NG3Y	6012.00	4416.00	6555.00	6309.00	566.00	
460 Vac Three-phase		1	0.75	2.1	SFD212CG4Y	1310.00	963.00	1429.00	1375.00	109.00
		2	1.5	3.4	SFD212DG4Y	1375.00	1010.00	1499.00	1443.00	118.00
		3	2.2	4.8	SFD212EG4Y	1501.00	1103.00	1636.00	1575.00	136.00
	5	4	7.6	SFD212FG4Y	1606.00	1180.00	1751.00	1685.00	136.00	
	7.5	5.5	11	SFD212GG4Y	1674.00	1230.00	1826.00	1757.00	157.00	
	10	7.5	14	SFD212HG4Y	1873.00	1376.00	2042.00	1965.00	169.00	
	15	11	21	SFD212JG4Y	2202.00	1618.00	2401.00	2311.00	213.00	
	20	15	27	SFD212KG4Y	2744.00	2015.00	2991.00	2879.00	248.00	
	25	18.5	34	SFD212LG4Y	3263.00	2397.00	3558.00	3424.00	248.00	
	30	22	40	SFD212MG4Y	3734.00	2743.00	4071.00	3918.00	325.00	
	40	30	52	SFD212NG4Y	4339.00	3187.00	4731.00	4553.00	325.00	
	50	37	65	SFD212PG4Y	5413.00	3967.00	5902.00	5680.00	416.00	
	60	45	77	SFD212QG4Y	6660.00	4892.00	7261.00	6988.00	499.00	
	75	55	96	SFD212RG4Y	7921.00	5818.00	8636.00	8312.00	566.00	
100	75	124	SFD212SG4Y	9547.00	7013.00	10409.00	10018.00	566.00		

S-Flex 212 Enclosed Drive Controller Type 1
Rated +14 to +140 °F
(-10 to +40 °C)

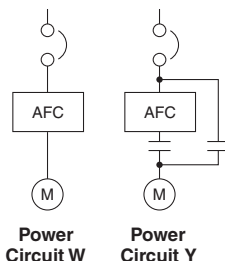

- ▲ When ordering a unit without bypass, insert a "W" in place of the "Y" in the Catalog Number.
- Options A07 Disconnect Switch and B07 Line Contactor are available only when a full voltage bypass standard "Y" product is selected. Options A07 and B07 are mutually exclusive.

Table 8: Miscellaneous Options▲

Description	Option Number	\$ Price
BACnet Factory Set Up	A06	55.00
LonWorks® Communication Card	B06	394.00
Metasys® N2 Factory Set Up	C06	55.00
Apogee® FLN P1 Factory Set Up	D06	55.00
LCD Text Keypad	D07	250.00
Seismic Qualification	S07	226.00

- ▲ Miscellaneous Options A06, B06, C06, and D06 are mutually exclusive. Add Misc. Option number to S-Flex 212 catalog number when ordering communications factory installed.
 - For Modbus control, see the Instruction Manual.
- Note: See the Instruction Bulletin for set up instructions.

Table 9: Accessories

Description	Catalog Number	\$ Price
Allivar 212 PCSoft Test and Commissioning Software. For use with Microsoft Windows™ 95, 98, NT, XP, and Vista operating systems for PCs only. (Cable not included.) Download from www.schneider-electric.us.	VW3A2104♦	N/C
PC Cable for Test and Commissioning Software. Includes 3-meter (9.8 ft.) cable, RS-485/RS-232C adaptor, and connectors	VW3A8106	75.00
USB to RJ45 Adaptor Kit For use in connecting to a PC with a USB port	TCSCMNCAM3M002P	52.00
EZ-M Mounting Channel, 72 in. length	EZM72MC	42.00

- ♦ Can be downloaded from the internet at <http://products.schneider-electric.us/products-services/products/ac-drives-and-soft-starts/>.

All S-Flex 212 Enclosed Drives are supplied with:

- Altivar™ 212 power converter
- Square D™ circuit breaker disconnect (Power Fuses for 460 V version only)
- UL 508C coordinated short circuit rating for 100,000 A
- Adjustable Frequency Controller-Off-Bypass selector switch
- Local/Remote configurable on controller
- Power On red LED
- Bypass Run green LED
- Fire/Freezestat interlock for Adjustable Frequency Drive and Bypass mode
- Form C Adjustable Frequency Controller fault auxiliary contact
- Modbus RJ-45 communication port
- Smoke Purge Function
- Bypass Run Auxiliary Contact
- Drive Run Auxiliary Contact
- Full Voltage Bypass Power Circuit with overload relay
- 120 Vac fused control power transformer

Variable Torque AC Drive—208, 230 V, and 460 V Ratings

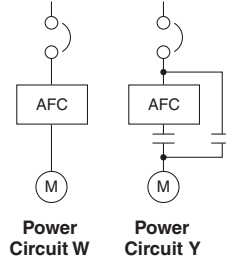

HP	Output Amperes		
	208 V	230 V	460 V
1	4.6	4.2	2.1
2	7.5	6.8	3.4
3	10.6	9.6	4.8
5	16.7	15.2	7.6
7.5	24.2	22	11
10	30.8	28	14
15	46.2	42	21
20	59.4	54	27
25	74.8	68	34
30	88	80	40
40	114	104	52
50	143	130	65
60	—	—	77
75	—	—	96
100	—	—	124

Class	Type	Modifications		
		Control	Lights	Misc
8839	EFD			
		V		
		1	2	3
		4	5	6
		7	8	9

Note: Standard packages are rated 100 k AIC

Table 10: E-Flex™ Selection and Pricing

2 HP Code	3 Enclosure Type						4 Voltage Code	5 Application Type (Applied Rating Code)	6 Device Type				9 Miscellaneous Options					
	208/230 V			460 V					W—Without Bypass Package		Y—Bypass Package		Mod X09 3% Line Reactor		Mod A09 5% Line Reactor		Mod B09 Line Contactor	
	G= Type 1	A= Type 12K	H= Type 3R	G= Type 1	A= Type 12K	H= Type 3R			208/230 V	460 V	208/230 V	460 V	208/230 V	460 V	208/230 V	460 V	208/230 V	460 V
	\$ Price			\$ Price					\$ Price		\$ Price		\$ Price		\$ Price		\$ Price	
C = 1	164.00	1584.00	164.00	1584.00	164.00	1584.00	173.00	173.00	1773.00	1695.00	173.00	173.00	216.00	216.00	50.00	50.00		
D = 2	164.00	1584.00	164.00	1584.00	164.00	1584.00	1648.00	1653.00	1773.00	1920.00	188.00	188.00	235.00	235.00	50.00	50.00		
E = 3	164.00	1584.00	164.00	1584.00	164.00	1584.00	1648.00	1791.00	1773.00	2061.00	188.00	188.00	235.00	235.00	60.00	50.00		
F = 5	164.00	1584.00	164.00	1584.00	164.00	1584.00	1865.00	1928.00	2007.00	2195.00	202.00	202.00	253.00	253.00	70.00	50.00		
G = 7.5	164.00	1795.00	164.00	1795.00	164.00	1795.00	1993.00	2044.00	2144.00	2460.00	238.00	238.00	298.00	298.00	70.00	60.00		
H = 10	164.00	1795.00	164.00	1795.00	164.00	1795.00	2305.00	2226.00	2480.00	2555.00	306.00	306.00	382.00	382.00	90.00	70.00		
J = 15	382.00	2772.00	382.00	2772.00	382.00	2772.00	2997.00	2479.00	3225.00	2746.00	315.00	315.00	394.00	394.00	120.00	78.00		
K = 20	382.00	2772.00	382.00	2772.00	382.00	2772.00	3824.00	2892.00	4115.00	3195.00	382.00	382.00	478.00	478.00	168.00	90.00		
L = 25	382.00	2772.00	382.00	2772.00	382.00	2772.00	3901.00	3083.00	4198.00	3650.00	382.00	382.00	478.00	478.00	195.00	120.00		
M = 30	382.00	3960.00	382.00	3960.00	382.00	3960.00	4895.00	3686.00	5267.00	4225.00	398.00	398.00	497.00	497.00	195.00	120.00		
N = 40	382.00	3960.00	382.00	3960.00	382.00	3960.00	6178.00	4424.00	6647.00	4647.00	448.00	448.00	560.00	560.00	252.00	168.00		
P = 50	382.00	3960.00	382.00	3960.00	382.00	3960.00	7726.00	5222.00	8314.00	6000.00	583.00	583.00	729.00	729.00	364.00	195.00		
Q = 60	—	—	—	—	—	—	—	6604.00	—	7360.00	—	583.00	—	729.00	—	195.00		
R = 75	—	—	—	—	—	—	—	7372.00	—	8233.00	—	649.00	—	811.00	—	252.00		
S = 100	—	—	—	—	—	—	—	8908.00	—	9861.00	—	777.00	—	971.00	—	364.00		

7 Control Options

A07△	Hand-Off—Auto, Speed Pot.	Included
B07△	Hand-Off—Auto, Start-Stop, Speed Pot.	100.00
C07▲	Start-Stop, Speed Pot.	75.00
D07△	Hand-Off—Comm, Speed Pot.	N/C
E07△	Hand-Off—Comm, Start-Stop, Speed Pot.	100.00
N07	No operators; wired for remote operation	-100.00

- ▲ Control Option C07 (Start-Stop, Speed Potentiometer) is not compatible with Power Circuit Y Bypass or Light Option A08 or B08.
- Light Options A08, B08 and C08 cannot be selected together. Select only one.
- ◆ Light Option B08 (Power On, Run, Fault, Bypass) is not compatible with Power Circuit W Without Bypass.
- ★ Misc. Option B09 Line Contactor is not compatible with Power Circuit W (Without Bypass).
- ▼ Misc. Option E09 Smoke Purge (Fireman's Override) permits motor to run at full speed.
- △ Hand-Off—Auto switch must be placed in off position for AFC fault reset.
- When Power Circuit Y Bypass selected, AFC—Off—Bypass switch and Test—Normal switch is supplied.
- ◇ When communication options are selected, Control Option D07 or E07 must be selected for control.
- ☆ Misc. Option C09 3–15 PSI Transducer is not compatible with Control Options C07, D07 or E07, J09 0–10 Vdc Auto Speed Reference Option, H09 I/O Extension Card, F09, L09, M09, O09, P09, Q09, R09 Serial Communication Cards.
- ▽ Misc. Option H09 I/O Extension Card is not compatible with C09 3–15 PSI Transducer.

8 Light Options

A08■	Power On, Run, Fault, Auto Lights	80.00
B08◆	Power On, Run, Fault, Bypass Lights	80.00
C08■	Power On, Run, Fault Lights	65.00

- Misc. Option J09 input programmed for 0–10 Vdc is not compatible with Control Options C07, D07 or E07 Control Options or Misc. Option C09 3–15 PSI Transducer.
- * Omit the Keypad Option D09 from Enclosure Door. User must buy a separate device to program the controller inside.
- ◇ Serial Communication Options F09, L09, M09, O09, P09, Q09, R09 cannot be selected together. Select only one. Control Option D07 or E07 must be selected for monitoring and control with Serial Communication Options.
- Light Option A08 is compatible with Control Options A07, B07, D07 and E07.
- Misc. Option S09 End Damper Control is not compatible with Control Options D07 Hand-Off—Comm, Speed Pot. Or E07 Hand-Off—Comm, Start-Stop, Speed Pot.
- Misc. Option B09 Line Contactor is not compatible with Type 3R Enclosure.
- ◇ Option T09 service entrance rating and K09 (cUL) are mutually exclusive. T09 only available in Type 3R enclosures.
- ‡ T09 not available on 460 V (1–7.5 hp) and 208/230 V (1–5 hp).

NOTE: Order part numbers by using the Product Selectors.

9 Miscellaneous Options

A09	5% Line Reactor option	See Above
B09★	Line Contactor	See Above
C09☆	3–15 PSI Transducer	180.00
D09*	Omit Keypad	-40.00
E09▼	Smoke Purge (Fireman's Override)	80.00
F09◇	Profibus DP	400.00
H09▽	I/O Extension Card, 0–20 mA Output	150.00
J09○	input programmed for 0–10 Vdc	N/C
K09	cUL Listing Certification	140.00
L09◇	LonWorks® Card	400.00
M09◇	Modbus™ / Uni-Telway™ Card	165.00
O09◇	Apogee® P1 Card	165.00
P09◇	Metasys® N2 Card	165.00
Q09◇	Ethernet TCP/IP	165.00
R09◇	BACnet Card	165.00
S09○	End Damper Control	115.00
T09‡	Service entrance rating	185.00
U09	Seismic Qualification	215.00
V09	Ethernet/IP™ Card	275.00
X09	3% Line Reactor option	See Above
Y09	OSHPD Adder—All Enclosed	400.00

E-Flex devices are supplied with:

- Circuit breaker as the overcurrent protective device (OCPD) and have a coordinated short circuit current rating of 100,000 A symmetrical.
- Equivalent 3% DC choke is standard. Option A09 replaces DC choke with 5% line reactor.
- Fire/Freezestats interlock locations wired to customer terminal strip
- One Form C AFC run mode contact
- One Form C AFC fault contact
- Circuit Breaker Disconnect
- Analog Output terminals on terminal strip (A01 and COM)
- Modbus and CANopen communications built into Drive. Modbus Uni-Telway card option provides Modbus ASCII and 4 wire RS485 functions.
- Speed Potentiometer as part of keypad or separately mounted on the enclosure door.

General Information

M-Flex™ enclosed adjustable frequency AC drive controllers are designed for industrial, commercial and municipal process applications, where high functionality of features is required. Each M-Flex enclosed drive offers a platform of standard, engineered and special features to meet the most demanding application and specification requirements. M-Flex enclosed drive controllers are low voltage products in the following ratings:

Constant torque (Heavy duty ratings—150% current limit)

- Altivar™ 71 power converter
- 1 to 450 hp, 460 V
- 1 to 40 hp, 208/230 V

Variable torque (Light duty ratings—110% current limit)

- Altivar 61 power converter
- 1 to 500 hp, 460 V
- 1 to 50 hp, 208/230 V

Application Data

The table below outlines typical application characteristics with load requirements and should be used as a guideline only. This information should be confirmed by the responsible system designer for a designated installation.

Application	Speed-Torque Relationship	Breakaway Torque
Agitators Liquid Slurry	Variable Torque▲ Variable Torque▲	Moderate◆ Moderate◆
Blowers Centrifugal Positive Displacement	Variable Torque Constant Torque	Low★ Low (Unloaded)★
Calendars	Constant Torque	Low★
Card Machines	Constant Torque	Moderate◆
Centrifuges	Constant Torque	Moderate◆
Chippers	Constant Torque▲	High■
Compressors Axial-Centrifugal Reciprocating Rotary	Variable Torque Constant Torque▲ Constant Torque	Low★ Moderate◆ Moderate◆
Conveyors Belt Screw Shaker	Constant Torque Constant Torque▲ Constant Torque▲	Moderate◆ High■ Moderate◆
Cranes Bridge Trolley Hoist	Constant Torque Constant Torque Constant Torque	Moderate◆ Moderate◆ Moderate◆
Crushers	Constant Torque▲	High■
Drill Presses	Constant Horsepower	Moderate◆
Elevators	Constant Torque	Moderate◆
Extruders	Constant Torque	Moderate◆
Fans-Centrifugal	Variable Torque	Low★
Frames-Spinning	Constant Horsepower	Low★
Grinders	Constant Horsepower	Moderate◆
Kiln	Constant Torque	High■
Looms	Constant Torque	Moderate◆
Lathes	Constant Horsepower▲	Moderate◆

- ▲ Potential impact load.
- > 150% torque.
- ◆ 100 to 150% torque.
- ★ < 100% torque.

Application	Speed-Torque Relationship	Breakaway Torque
Machines Boring Bottling Milling	Constant Torque Constant Torque Constant Horsepower▲	Moderate◆ Moderate◆ Moderate◆
Mills Rolling Rubber	Constant Torque▲ Constant Torque▲	Moderate◆ Moderate◆
Mixers Chemical Dough Slurry	Constant Torque Constant Torque Constant Torque	High■ High■ High■
Planers	Constant Torque	Moderate◆
Plows-Conveyor	Constant Torque	Moderate◆
Presses Printing Punch	Constant Torque Constant Torque▲	Moderate◆ Moderate◆
Pullers-Car	Constant Torque	Moderate◆
Pumps Centrifugal Positive Displacement Slurry	Variable Torque Constant Torque Constant Torque	Low★ Moderate◆ High■
Roll Benders	Constant Torque	Moderate◆
Sanders	Constant Torque	Low★
Saws	Constant Torque▲	Moderate◆
Shakers	Constant Torque▲	High■
Shears	Constant Torque▲	Low★
Tension Drives	Constant Horsepower	Moderate◆
Tool Machines	Constant Horsepower	Moderate◆
Walkways	Constant Torque	Low★
Winches	Constant Torque	Moderate◆
Winders	Constant Horsepower	Moderate◆
Washers	Constant Torque	Moderate◆

Product Selection

To select an M-Flex™ enclosed drive controller, identify the basic drive and optional devices by Class, Type, Modifications (MODS, E-MODS) and Special Features as required to create the catalog number shown below. In all cases, Q2C/Product Selectors are preferred to price enclosed drives.

Contact Seneca TAG for pricing assistance with special features if required. Features highlighted in gray within this selection are ENGINEERED and require special handling by factory personnel in lieu of system supported features.

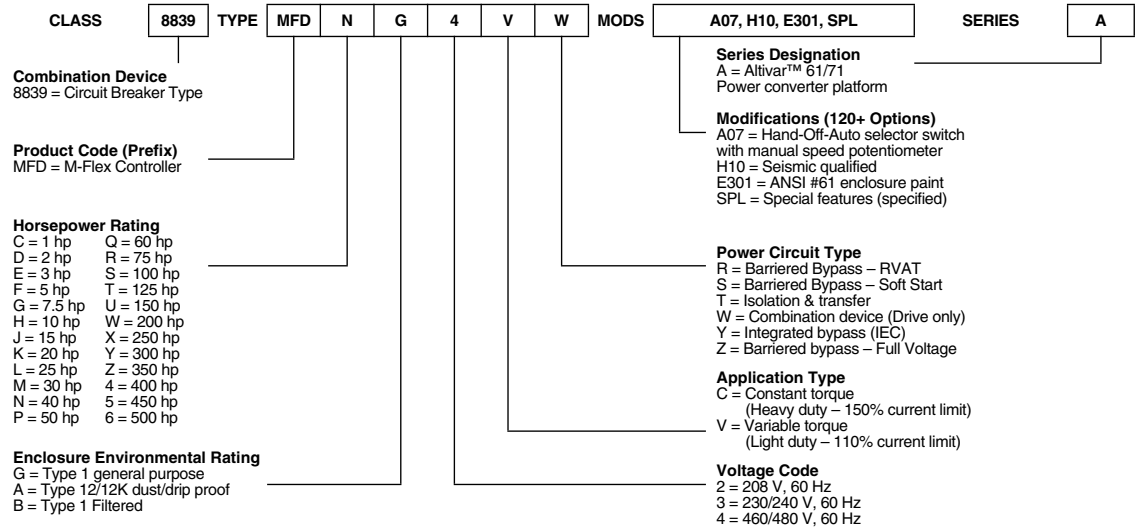

NOTE: Type 12/12K pending UL approval of new UL 508C Section 9.6 testing requirements for insulation materials and is subject to availability and Q2C/Product Selector support.

Standard M-Flex Features

- Type 12/12K dust/drip proof enclosure ratings
- Circuit Breaker Disconnect
- 3% AC line reactor
- UL listed to UL 508C Power Conversion Equipment
- 100,000 A symmetrical short circuit rating
- Heavy duty industrial disconnect handle with lockout/tag-out provisions
- Hand-Off-Auto selector switch and manual speed potentiometer
- 0–10 Vdc and 4–20 mAdc speed reference input
- 0–10 Vdc or x-y mAdc programmable output
- Door mounted graphic display terminal
- Auto Start Relay (120 Vac control)
- One Form 'C' AFC Run mode contact
- One Form 'C' AFC Fault contact
- Remote fault condition reset in AUTO mode with transition of auto start contact
- Manual fault condition reset in OFF position of H-O-A selector switch
- Safety interlock/Run permissive wired to customer terminal strip
- Permanent wire markings
- White component mounting plate

- Conduit knockouts on top and bottom for wall mounted enclosures
- Removable conduit entry plates on top and bottom for floor mount enclosures
- ANSI #49 gray enclosure
- Class 10 electronic overload protection
- Custom wiring diagrams

Isolation/Bypass Standard Features

- Class 20 overload protection with door mounted reset
- AFC-Off-Bypass selector switch
- Test-Normal selector switch
- AC3 duty rated isolation and bypass contactors (with mechanical and electrical interlocking)
- Bypass and isolation contactor sequencing provides true motor isolation
- Remote automatic bypass operation using Auto Start Relay
- Custom wiring diagrams

Table 11: Pricing – Constant Torque

HP Reference Code	HP Ratings	Controller Output Current	Enclosure Frame Size	Price—Power Circuits (Type 1 General Purpose Enclosures)					
				Constant Torque—Heavy Duty Rating (150% Current Limit)					
				Power Circuit W: Combination Disconnect (Drive Only) \$ Price	Power Circuit Y: IEC Integrated Isolation/Bypass \$ Price	Power Circuit S: Soft Start Isolation/Bypass▲ \$ Price	Power Circuit Z: Full Voltage Barriered Isolation/Bypass \$ Price	Power Circuit T: Separate Starter Isolation/Transfer▲ \$ Price	Power Circuit R: RVAT Isolation/Bypass▲ \$ Price
208/230 V									
C	1	4.6 A	C	2485.00	2824.00	N/A	3439.00	2824.00	N/A
D	2	7.5 A		2501.00	2842.00	N/A	3457.00	2842.00	N/A
E	3	10.6 A		2685.00	3051.00	N/A	3666.00	3051.00	N/A
F	5	16.7 A		2920.00	3115.00	N/A	3730.00	3115.00	N/A
G	7.5	24.2 A	D	3342.00	3729.00	N/A	4344.00	3729.00	N/A
H	10	30.8 A		3629.00	4123.00	N/A	4738.00	4123.00	N/A
J	15	46.2 A	E	4059.00	4612.00	N/A	5352.00	4612.00	N/A
K	20	59.4 A		4937.00	6074.00	N/A	6815.00	6074.00	N/A
L	25	74.8 A		5577.00	7720.00	N/A	8765.00	7720.00	N/A
M	30	88 A	F	6644.00	8892.00	N/A	9937.00	8892.00	N/A
N	40	114 A		8584.00	9754.00	N/A	11223.00	9754.00	N/A
460 V									
C	1	2.1 A	C	2241.00	2931.00	N/A	3546.00	2931.00	N/A
D	2	3.4 A		2379.00	3057.00	N/A	3672.00	3057.00	N/A
E	3	4.8 A		2593.00	3318.00	N/A	3932.00	3318.00	N/A
F	5	7.6 A		2883.00	3604.00	N/A	4219.00	3604.00	N/A
G	7.5	11 A		3449.00	4040.00	N/A	4655.00	4040.00	N/A
H	10	14 A		3860.00	4378.00	N/A	4993.00	4378.00	N/A
J	15	21 A		4211.00	5024.00	N/A	5765.00	5024.00	N/A
K	20	27 A		4860.00	5522.00	N/A	6263.00	5522.00	N/A
L	25	34 A		5728.00	6830.00	N/A	7875.00	6830.00	N/A
M	30	40 A		E	6703.00	7971.00	N/A	9015.00	7971.00
N	40	52 A	7803.00		8868.00	12295.00	10336.00	8868.00	12653.00
P	50	65 A	9150.00		10397.00	14666.00	13185.00	10397.00	15317.00
Q	60	77 A	F	10354.00	11766.00	16512.00	14554.00	11766.00	19109.00
R	75	96 A		12018.00	13656.00	18701.00	16444.00	13656.00	20999.00
S	100	124 A		14447.00	18829.00	24202.00	20405.00	18829.00	26172.00
T	125	156 A	H	16955.00	21522.00	27761.00	23128.00	21522.00	33581.00
U	150	180 A	I	20298.00	25068.00	32113.00	26710.00	25068.00	37127.00
W	200	240 A		23402.00	31933.00	39844.00	33689.00	31933.00	44053.00
X	250	302 A		27462.00	N/A	45450.00	38321.00	36554.00	48614.00
Y	300	361 A	J	31044.00	N/A	50029.00	42721.00	40865.00	63372.00
Z	350	414 A		35342.00	N/A	56667.00	48047.00	46070.00	68577.00
4	400	477 A		40357.00	N/A	64554.00	54751.00	52554.00	75061.00
5	450	515 A		45605.00	N/A	72762.00	60900.00	58554.00	81061.00

▲ Factory engineered products—dimensions subject to design modifications.

Table 12: Pricing – Variable Torque

HP Reference Code	HP Ratings	Controller Output Current	Enclosure Frame Size	Price—Power Circuits (Type 1 General Purpose Enclosures)					
				Variable Torque—Light Duty Ratings (110% Current Limit)					
				Power Circuit W: Combination Disconnect (Drive Only) \$ Price	Power Circuit Y: IEC Integrated Isolation/Bypass \$ Price	Power Circuit S: Soft Start Isolation/Bypass▲ \$ Price	Power Circuit Z: Full Voltage Barrierc Isolation/Bypass \$ Price	Power Circuit T: Separate Starter Isolation/Transfer▲ \$ Price	Power Circuit R: RVAT Isolation/Bypass▲ \$ Price
208/230 V									
C	1	4.6 A	C	2429.00	2760.00	N/A	3375.00	2760.00	N/A
D	2	7.5 A		2485.00	2824.00	N/A	3439.00	2824.00	N/A
E	3	10.6 A		2501.00	2842.00	N/A	3457.00	2842.00	N/A
F	5	16.7 A		2685.00	3051.00	N/A	3666.00	3051.00	N/A
G	7.5	24.2 A	D	2920.00	3115.00	N/A	3730.00	3115.00	N/A
H	10	30.8 A		3342.00	3729.00	N/A	4344.00	3729.00	N/A
J	15	46.2 A	E	3629.00	4123.00	N/A	4738.00	4123.00	N/A
K	20	59.4 A		4059.00	4612.00	N/A	5352.00	4612.00	N/A
L	25	74.8 A		4937.00	6074.00	N/A	6815.00	6074.00	N/A
M	30	88 A	F	5577.00	7720.00	N/A	8765.00	7720.00	N/A
N	40	114 A		6644.00	8892.00	N/A	9937.00	8892.00	N/A
460 V									
C	1	2.1 A	C	2106.00	2774.00	N/A	3389.00	2774.00	N/A
D	2	3.4 A		2241.00	2931.00	N/A	3546.00	2931.00	N/A
E	3	4.8 A		2379.00	3057.00	N/A	3672.00	3057.00	N/A
F	5	7.6 A		2593.00	3318.00	N/A	3932.00	3318.00	N/A
G	7.5	11 A		2863.00	3604.00	N/A	4219.00	3604.00	N/A
H	10	14 A		3449.00	4040.00	N/A	4655.00	4040.00	N/A
J	15	21 A		3860.00	4378.00	N/A	4993.00	4378.00	N/A
K	20	27 A		4211.00	5024.00	N/A	5765.00	5024.00	N/A
L	25	34 A	4860.00	5522.00	N/A	6263.00	5522.00	N/A	
M	30	40 A	E	5728.00	6830.00	N/A	7875.00	6830.00	N/A
N	40	52 A		6703.00	7971.00	11397.00	9015.00	7971.00	11809.00
P	50	65 A		7803.00	8868.00	13136.00	10366.00	8868.00	13787.00
Q	60	77 A	F	9150.00	10397.00	15144.00	13185.00	10397.00	17740.00
R	75	96 A		10354.00	11766.00	16811.00	14554.00	11766.00	19109.00
S	100	124 A		12018.00	13656.00	19029.00	16444.00	13656.00	20999.00
T	125	156 A	H	14447.00	18829.00	25068.00	20405.00	18829.00	30889.00
U	150	180 A	I	16955.00	21522.00	28566.00	23128.00	21522.00	33581.00
W	200	240 A		20298.00	25068.00	32919.00	26710.00	25068.00	37127.00
X	250	302 A		23402.00	N/A	40889.00	33689.00	31993.00	54500.00
Y	300	361 A	J	27462.00	N/A	45718.00	38321.00	36554.00	59061.00
Z	350	414 A		31044.00	N/A	51461.00	42721.00	40865.00	63372.00
4	400	477 A		35342.00	N/A	58070.00	48047.00	46070.00	68577.00
5	450	515 A		40357.00	N/A	66763.00	54751.00	52554.00	75061.00
6	500	590 A		45605.00	N/A	72762.00	60900.00	58554.00	97060.00

▲ Factory engineered products – dimensions subject to design modifications.

Table 13: Type 12 & 1G Environment Adders

Constant Torque	Variable Torque	A = Type 12 (Dust/Drip) \$ Price	B = Type 1 G (Gasket) \$ Price
HP @ 208/230 V			
1–10 hp	1–10 hp	208.00	N/A
15–40 hp	15–50 hp	447.00	N/A
HP @ 460 V			
1–20 hp	1–25 hp	208.00	N/A
25–40 hp	30–50 hp	447.00	N/A
50–75 hp	60–100 hp	567.00	N/A
100–450 hp	125–500 hp	N/A	333.00

Table 14: Dimensions

M-Flex™ Enclosed AC Drives Class 8839 Type MFD – With or Without Options				Dimensions			Weights	Construction Data							
HP/Voltage (VT)	HP/Voltage (CT)	Power Circuit Configuration	Enclosure Size	Height (In)	Width (In)	Depth (In)	lbs.	Wall or Floor Mount	Environment Rating	Operating Handle					
1–25 hp @ 460 V	1–20 hp @ 460 V	Power Circuit W Combination Device or Power Circuit & Integrated Bypass	C	49.00	20	14.81	175	Wall	Type 1 or Type 12/12K	3" Metal Rotary					
1–5 hp @ 208/230 V	1–5 hp @ 208/230 V														
7.5–10 hp @ 208/230 V	7.5–10 hp @ 208/230 V		D	63.00	25	14.81	243	Wall		6" Metal Rotary					
30–50 hp @ 460 V	25–40 hp @ 460 V														
15–25 hp @ 208/230 V	15–20 hp @ 208/230 V														
60–100 hp @ 460 V	50–75 hp @ 460 V														
30–50 hp @ 208/230 V	25–40 hp @ 208/230 V	E	93.87	20	20.38	170.5	Floor Mount	3" Metal Rotary							
1–25 hp @ 460 V	1–20 hp @ 460 V														
1–10 hp @ 208/230 V	1–10 hp @ 208/230 V	Power Circuits Z, S, T or R Barrired Designs with 2 Disconnects	Barrired C/D	93.87	20	20.38	379	Floor Mount	Type 1 or Type 1G Filtered	6" Metal Rotary					
30–50 hp @ 460 V	25–40 hp @ 460 V														
15–25 hp @ 208/230 V	15–20 hp @ 208/230 V		Barrired E	93.87	25	20.38	512			6" Metal Rotary					
60–100 hp @ 460 V	50–75 hp @ 460 V														
30–50 hp @ 208/230 V	25–40 hp @ 208/230 V										Barrired F	93.87	30	20.38	684
125 hp @ 460 V	100 hp @ 460 V														
150–250 hp @ 460 V	125–200 hp @ 460 V	Power Circuit W▲	25" Wide Relay Section	94.58	25	20	489	Type 1 or Type 1G Filtered	Flange						
300–500 hp @ 460 V	250–450 hp @ 460 V	Power Circuit W◆	30" Wide Relay Section	94.58	30	20	657								
		Power Circuit W★▼	35" Wide Relay Section	94.58	35	20	969								

- ▲ Integrated bypass for 125 hp offered in 20" wide section adder (45" total width). Barrired bypass offered in 25" wide section adder (50" total width)—standard product configuration
- Integrated bypass for 150–200 hp offered in 20" wide section adder (50" total width). Barrired bypass offered in 25" wide section adder (55" total width)—standard configuration
- ◆ Integrated bypass for 250 hp offered in 20" wide section adder (50" total width). Barrired bypass offered in 30" wide section adder (60" total width)—factory engineered configuration
- ★ Integrated bypass for 300–400 hp not available. Barrired bypass offered in 30" wide section adder (65" total width)—factory engineered configuration
- ▼ Integrated bypass for 450–500 hp not available. Barrired bypass offered in 35" wide section adder (70" total width)—factory engineered configuration

Operator Control Device Options

Door mounted operator controls provide dedicated control for commanding operation of the power converter functions. Select only one.

MOD	Description	\$ Price
Hand-Off-Auto selector switch with manual speed potentiometer▲		
A07	Provides a three position selector switch and manual speed potentiometer door mounted. The Hand-Off-Auto selector switch is used to select between the AI1 and AI2 analog inputs. In the Auto position the motor may be started and stopped by a user supplied remote contact. The speed may be adjusted by a 4–20 mAdc signal to analog input reference AI2 or the door mounted manual speed potentiometer. The Off position will stop the motor. The Off position is also used to reset drive controller faults.	—
Hand-Off-Auto selector switch, Start/Stop push-buttons with manual speed potentiometer		
B07	Provides a three-position selector switch and manual speed potentiometer door mounted. The Hand-Off-Auto selector switch is used to select between the AI1 and AI2 analog inputs. In the Auto position the motor may be started and stopped by a user supplied remote contact. The speed may be adjusted by a 4–20 mAdc signal to analog input reference AI2 or the door mounted manual speed potentiometer. In the Hand position, Start/Stop push-buttons are used to start and stop the motor using a "three-wire" control strategy. The Off position will also stop the motor. The Off position is also used to reset drive controller faults.	60.00
Start/Stop push-buttons with manual speed potentiometer■		
C07	Provides Start/Stop pushbuttons to start and stop the motor using a "three-wire" control strategy. The speed is adjusted by a door mounted manual speed potentiometer. The drive disconnect is used to reset drive controller faults unless "Fault Reset" (P10) is ordered.	45.00
Start/Stop push-buttons, Forward-Reverse selector switch with manual speed potentiometer■		
D07	Provides Start/Stop push-buttons to start and stop the motor using a "three-wire" control strategy. The speed is adjusted by a door mounted manual speed potentiometer. Motor direction is controlled with a forward–reverse selector switch. The drive disconnect is used to reset drive controller faults unless "Fault Reset" (P10) is ordered.	119.00
Hand-Off-Auto selector, Local-Remote selector switch with manual speed potentiometer		
E07	Provides a three-position selector switch and manual speed potentiometer door mounted. The Hand-Off-Auto selector switch is used to select between the AI1 and AI2 analog inputs. In the Auto position the motor may be started and stopped by a user supplied remote contact. The speed may be adjusted by a 4–20 mAdc signal to analog input reference AI2 or the door mounted manual speed potentiometer. The Off position will stop the motor. The Off position is also used to reset drive controller faults.	60.00
Communication-Hand-Off-Auto selector switch with manual speed potentiometer◆		
F07	Provides a four-position selector switch and manual speed potentiometer door mounted. The Communication-Hand-Off-Auto selector switch is used to select between the AI1 and AI2 analog inputs. In the Auto position the motor may be started and stopped by a user supplied remote contact. The speed may be adjusted by a 4–20 mAdc signal to analog input reference AI2 or the door mounted manual speed potentiometer. The Off position will stop the motor. The Off position is also used to reset drive controller faults.	149.00
No Door Mounted Operators (wired for remote operation)		
N07	No operators are provided on the enclosure door. The customer must provide remote mounted operator controls. Drive controllers are factory programmed and configured for remote mounted Hand-Off-Auto operation.	Deduct 100.00

- ▲ Control option defined by default.
- Available only with Power Circuit W.
- ◆ Provides control and monitoring capabilities when supplied with any communication card.

Pilot Light Combination Options

Pilot lights are ordered in light groups and door mounted. Pilot light groups are selected with compatible control options. Pilot lights are all 22 mm long life LED type. Select only one.

MOD	Description	\$ Price
Power On, Fault, AFC Run, Auto pilot lights▲		
A08	Provides a combination of (4) pilot lights for visual indication of protective functions and circuit status; power on (red), fault (yellow), AFC run (green) and auto (yellow).	146.00
Power On, Fault, AFC Run, Bypass pilot lights■		
B08	Provides a combination of (4) pilot lights for visual indication of protective functions and circuit status; power on (red), fault (yellow), AFC run (green) and bypass (yellow).	146.00
Power On, Fault, AFC Run pilot lights		
C08	Provides a combination of (3) pilot lights for visual indication of protective functions and circuit status; power on (red), fault (yellow) and AFC run (green).	110.00
Power On, Fault, AFC Forward, AFC Reverse pilot lights◆★		
D08	Provides a combination of (4) pilot lights for visual indication of protective functions and circuit status; power on (red), fault (yellow), forward (green) and reverse (green).	146.00
Power On, Fault, AFC Run, Hand, Auto pilot lights▼△		
E08	Provides a combination of (5) pilot lights for visual indication of protective functions and circuit status; power on (red), fault (yellow), AFC run (green), hand (blue) and auto (yellow).	182.00
Power On, Fault, AFC Run, Communication pilot lights□		
F08	Provides a combination of (4) pilot lights for visual indication of protective functions and circuit status; power on (red), fault (yellow), AFC run (green) and communication (yellow).	146.00

- ▲ Not available with C07 or D07.
- Not available with Power Circuit W.
- ◆ Available only with D07 or N07.
- ★ Available only with Power Circuit W.
- ▼ Available only with A07, B07, E07 or N07.
- △ Supplied with AMR relay.
- Available only with F07 or N07.

Option Cards

All communication cards are provided without factory programming. Select only one.

MOD	Description	\$ Price
Modbus/Uni-Telway™ communication card		
B09	Provides a factory installed plug-in Modbus/Uni-Telway card, VW3A3303.	284.00
Johnson Controls Metasys® N2 communication card		
C09	Provides a factory installed plug-in Johnson Controls Metasys N2 card, VW3A3313. VW3A3313: Obsolete. Direct replacement = VW3A3318. Has 4 position network connector instead of 9 pin D-shell.	284.00
Ethernet TCP/IP communication card		
D09	Provides a factory installed plug-in Ethernet TCP/IP card, VW3A3310, with user termination to RJ45 plug-in interface connector.	284.00
LonWorks® communication card		
E09	Provides a factory installed LonWorks card, VW3A3312.	475.00
DeviceNet™ communication card		
F09	Provides a factory installed DeviceNet card, VW3A3309.	284.00
Profibus DP communication card		
G09	Provides a factory installed Profibus DP card, VW3A3307.	475.00
I/O Extension card		
H09	Provides a factory installed I/O Extension card, VW3A3202. Adds (2) analog outputs, 4 logic inputs, 2 logic outputs and 1 differential analog input.	164.00
Siemens Apogee® FLN / P1 communication card		
J09	Provides a factory installed Siemens Building Automation Apogee FLN / P1 card, VW3A3314.	284.00
BACnet communication card		
K09	Provides a factory installed BACnet card, VW3A3315. VW3A3315: Obsolete soon. Direct replacement = VW3A3319. Has 4 position network connector instead of 5 position connector.	284.00
Interbus® S communication card		
L09	Provides a factory installed Interbus S card, VW3A3304.	475.00

Miscellaneous Options

Additional system supported features that provide miscellaneous product modifications.

MOD	Description	\$ Price		
		208/230 V	460 V	
5% AC line reactor ▲				
A10	Provides an integrally mounted, 5% AC line reactor factory-installed and wired between the circuit breaker disconnect means and the power converter for harmonic mitigation.	1–3 hp	491.00	491.00
		5–7.5 hp	567.00	567.00
		10–15 hp	629.00	597.00
		20 hp	884.00	597.00
		25 hp	884.00	906.00
		30–40 hp	1051.00	906.00
		50 hp	1157.00	1023.00
		60 hp	—	1023.00
		75 hp	—	1098.00
		100 hp	—	1194.00
		125 hp	—	1241.00
		150 hp	—	1368.00
		200 hp	—	1972.00
		250 hp	—	2207.00
300 hp	—	2272.00		
350–400 hp	—	2978.00		
450–500 hp	—	3141.00		
Line contactor ■ ◆				
B10	A line contactor is added between the circuit breaker disconnect (or line reactor or harmonic filter when provided) and the power converter for bypass configured Power Circuits. With the line contactor, the AFC Fault light illuminates when the AFC-Off-Bypass selector switch is in the Off or Bypass position to indicate that the power converter is not running. When the line contactor is open, serial communication is disabled.	1–5 hp	72.00	72.00
		7.5–10 hp	118.00	94.00
		15 hp	171.00	112.00
		20 hp	240.00	127.00
		25–30 hp	278.00	171.00
		40 hp	359.00	240.00
		50 hp	518.00	278.00
		60 hp	—	278.00
		75 hp	—	359.00
		100 hp	—	518.00
		125 hp	—	636.00
		150 hp	—	761.00
		200 hp	—	1045.00
		250 hp	—	1284.00
		300 hp	—	1642.00
		350 hp	—	1940.00
400 hp	—	2197.00		
450 hp	—	2498.00		
500 hp	—	2803.00		

- ▲ All M-Flex™ enclosed drive controllers include a 3% AC line reactor as standard. The selection of A10 substitutes a 5% line reactor in place of the 3% AC line reactor.
- Available only with Power Circuit Y, unless factory engineered.
- ◆ Factory engineered for 125–500 hp ratings.

Miscellaneous Options (continued)

MOD	Description	\$ Price
3–15 PSI transducer▲■◆		
C10	Allows the controller to follow a user supplied 3–15 PSI input.	269.00
Omit door mounted graphic display terminal		
D10	The graphic display terminal is not supplied. To alter the programming of the power converter, the user must buy a graphic display terminal or SoMove™ software to program the drive controller.	Deduct 100.00
Smoke purge relay		
E10	Provides a smoke purge operating mode controlled by a user-supplied 120 Vac signal wired to terminal block TB1. Smoke purge operation is full speed bypass (when provided) or High Speed in the drive controller. This operation is designed run the motor from any operator control setting except emergency stop or open safety interlocks	134.00
Additional control power VA◆		
F10	Provides additional control power VA using a larger control transformer (120 Vac) connected to terminal block TB1 for customer use. 1–50 hp @ 208/230 V / 1–100 hp @ 460 V—50 VA 125–500 hp @ 460 V—50 VA	173.00 227.00
CSA / cUL certification		
G10	Provides a Canadian cUL (or CSA) certification when required by local code requirements.	200.00
Seismic qualified		
H10	Supplies a certification label and hardware qualified to seismic rating ICC ES AC156 acceptance criteria test protocol with an importance factor of 1.5.	254.00
Permanent wire markers (sleeve type)★		
I10	Provides permanent wire sleeve type markers on control wiring.	1045.00
0–10 Vdc Auto speed reference (programming)▼		
J10	Provides a controller interface for 0–10 Vdc user supplied auto speed reference signal to the AI2 input, on terminal block TB2. The 0–10 V analog input is not isolated, but it does contain noise suppression circuitry and a programmable electronic filter.	N/C
1 Additional N.O. auxiliary drive run contact◆		
K10	Provides 1 additional N.O. contact for drive run indication wired to TB1.	110.00
1 Additional N.C. auxiliary drive fault contact★		
L10	Provides 1 additional N.C. contact for drive fault indication wired to TB1.	110.00
1 N.O. Auxiliary bypass run contact◆△		
M10	Provides 1 additional N.O. contact for bypass run indication wired to TB1.	110.00
N10	OSHPD Adder—All Enclosed	400.00
1 N.O. Auxiliary auto mode contact▲◆		
O10	Provides 1 additional N.O. contact for auto mode indication wired to TB1.	110.00
AFC Fault reset push-button ▲◆□		
P10	Provides factory installed door-mounted push button to fault reset LI4 on the power converter at terminal TB2 when Hand-Off-Auto is not supplied.	100.00
Push-to-Test pilot lights◇		
Q10	Provides push-to-test function on all pilot lights except Power On.	125.00
Auto transfer to bypass△★		
R10	Provides an automatic transfer (time adjustable 0.1–10 s) to bypass in the event that the drive controller faults. A selector switch is provided inside the enclosure to enable or disable this function. Longer transfer time requirements are available by replacing the plug-in adjustable timer.	161.00
Motor elapsed time meter◆		
S10	Provides a dedicated non-resettable elapsed time meter to record the motor run time. Runs whenever the motor is running.	161.00
Emergency stop mushroom head push-button ▲◆		
T10	Provides door mounted maintained off emergency stop red mushroom pushbutton with turn-to-reset feature.	76.00
Motor space heater sequencing circuit (light duty)▽○		
U10	Provides 50 VA/120 V to terminal block TB1 for motor space heater whenever the motor is not running.	240.00
Seal water solenoid◆★		
V10	Provides 50 VA/120 V to terminal block TB1 for seal water solenoid whenever the motor is running.	240.00
Check valve sequencing circuit (gravity type)◆		
W10	Provides an automatic shutdown of the drive controller when the user supplied N.C. contact from the check valve limit switch does not open within 5 seconds after the motor starts. The user limit switch contact connects to terminal block TB1. Circuit provides reset function with an illuminated (blue) push-button.	310.00
ID engraved nameplates		
X10	Provides an engraved laminated nameplate attached to the front door of the enclosure (engraved per user request at time of order).	60.00

- ▲ Not available with C07 or D07.
- Mutually exclusive with J09.
- ◆ Factory engineered for 125–500 hp ratings.
- ★ Permanent wire marking is provided as standard.
- ▼ Not available with C07, D07 or C10.
- △ Available only with Power Circuits Y, S, Z, R and T.
- Available only with Power Circuit W.
- ◇ Not available on Fault pilot light if P10 is selected.
- ☆ Not available with B07, C07 or D07.
- ▽ Mutually exclusive with V10 unless F10 is also selected.
- For 125–500 hp, select E217.
- * Exclusive with U10 unless F10 is also selected.

Miscellaneous Options (continued)

MOD	Description	\$ Price				
Harmonic filter provisions▲■◆						
Y10	Provides fused output terminals with return terminals for connection of an externally mounted harmonic filter (provided separately). Class J fuses are provided. For 125–500 hp VT units, the standard 3% line reactor is removed due to the line impedance of the harmonic filter.					
		CT	VT			
		5–10 hp	5–10 hp	208/230 V	460 V	
		15–20 hp	15–25 hp	442.00	442.00	
		25–40 hp	30–50 hp	508.00	508.00	
		50–200 hp	60–250 hp	573.00	573.00	
		250–450 hp	300–500 hp	N/A	640.00	910.00

- ▲ Not available with 1–3 hp controllers.
- Mutually exclusive with A10
- ◆ Factory engineered for 125–500 hp

MOD	Description	\$ Price
24 Vdc power supply		
Z10	Provides a 24 Vdc, 300 mA power supply at terminal block TB2.	222.00
RFI/EMI suppressor		
410	Provides radio frequency interference suppression with ferrite cores which are factory supplied on the power wires ahead of the power converter.	150.00

MOD	Description	\$ Price
610	100k Circuit Breaker Rating▲	1195.00

- ▲ Only available: 460 V—Constant Torque 300–450 hp. 460 V—Variable Torque 300–500 hp.

Engineered Features

Factory orders with engineered features (E-MOD, SPL, etc.) are subject to review by factory personnel and have longer lead-time availability. Standard M-Flex™ enclosure dimensions may no longer apply to orders containing any combination of engineered features. In addition, factory orders containing engineered features may carry a UL 508A (Industrial Control Equipment) label in lieu of a UL 508C (Power Conversion Equipment) label depending on configuration.

Control Options

The E200 series features cover control circuit option configurations for M-Flex enclosed drive controllers.

E-MOD	Description	\$ Price
Door mounted meters (dedicated displays)▲■		
Provides a dedicated door mounted meter display, analog or digital		
E201	Analog percent speed meter scaled 0 to 120% base speed.	322.00
E202	Analog percent current scaled 0 to 100% of rated output current.	322.00
E203	Digital ammeter (amperes) scaled 0 to 2 times rated output amperes.	376.00
E204	Digital speed meter (frequency) scaled 0 to 72 Hz output frequency.	376.00
E205	Digital percent speed meter scaled 0 to 120% base speed.	376.00
E206	Digital percent current scaled 0 to 100% of rated output current.	376.00
Door mounted RJ45 port		
E211	Provides (1) Sixnet RJ45 door mounted 30 mm bulk head connector and internal CAT5 cabling for access via PC with SoMove™ software. The RJ45 (Modbus/CANopen) drive port provides customer access through the enclosure door.	194.00
Auxiliary drive run contacts◆★▼		
E212	Provides (3) Form 'C' contacts rated 5 A @ 120 Vac wired to terminal blocks for customer use.	185.00
Auxiliary bypass run contacts△□◇		
E213	Provides (3) Form 'C' contacts rated 5 A @ 120 Vac wired to terminal blocks for customer use.	185.00
Auxiliary drive fault contacts◆★		
E214	Provides (3) Form 'C' contacts rated 5 A @ 120 Vac wired to terminal blocks for customer use.	185.00
Auxiliary auto mode contacts▽◆		
E215	Provides (3) Form 'C' contacts rated 5 A @ 120 Vac wired to terminal blocks for customer use.	185.00
Adjustable restart delay timer		
E216	Provides an adjustable On Time Delay Relay for power up restart function, mounted and wired for AFC mode (hand or auto) mode and/or in the bypass mode (hand/auto).	143.00
Motor space heater (heavy duty)		
E217	Provides control circuit contacts, 120 Vac, 500 VA supply and fusing wired to terminals for customer use.	597.00
Signal loss follower alarm relay★		
E218	Provides (1) Form 'C' contact rated 5 A @ 120 Vac wired to terminal blocks for customer use. Intended for 4–20 mAdc control loop applications where upon the loss of input signal it is desired to retain the output signal at the last input signal level. The relay provides an alarm relay contact for signal loss alert.	215.00
Inhibit/shutdown sequence (timed operation)		
E219	Provides a relay circuit operating in the fail safe mode where a remote initiating contact opens the relay, de-energizes and after a specified time shuts the drive controller down in the AFC mode (hand or auto) and/or in the bypass mode (hand or auto).	346.00
Check valve sequence (motorized type)		
E220	Provides relay circuitry sequenced from a check valve limit switch. A valve closed position limit switch will energize relays that will initiate a remote valve operating solenoid limited to 50 VA and give a run permissive to the drive controller in the AFC mode (hand or auto) and/or in the bypass mode (hand or auto). A valve closed position limit switch will de-energize a timer relay such that if this relay is not de-energized within a specified time period, the drive controller will shut down in the AFC mode (hand or auto) and/or in the bypass mode (hand or auto).	424.00
Seal water solenoid—with pressure switch feedback		
E221	Provides relay, which will energize a remote seal water solenoid limited to 50 VA during drive controller operation. Additionally, the remote initiating contact will open the relay, de-energizing and after a specified time shuts the drive controller down in the AFC mode (hand or auto) and/or in the bypass mode (hand or auto).	728.00
Moisture detection relay circuit (without relay)◆		
E222	Provides 24 V or 120 V control power to a customer supplied moisture detection relay device, either electronic or electro-mechanical. Factory provides pre-wired socket or mounting space only.	209.00
Moisture detection relay circuit (with relay options)◆		
E223A	Relay option: Provides 24 V or 120 V control power to a moisture detection relay device, either electronic or electro-mechanical. The moisture detection relay is mounted and wired by the factory.	728.00
E223B	Relay and Pilot Light indication option: Provides 24 V or 120 V control power to a customer supplied moisture detection relay device, either electronic or electro-mechanical. Includes a pilot light for discrete input(s). The customer supplied moisture detection relay is mounted and wired by the factory.	833.00

- ▲ Limited to one meter selection unless H09 is selected.
- If H09 is selected, (1) additional meter can be selected.
- ◆ One (1) Form 'C' contact for drive run indication is supplied as standard.
- ★ Available only if K10 is selected.
- ▼ Available without K10 for 125–500 hp.
- △ One (1) N.O. contact for bypass run indication is supplied as standard when bypass is provided.
- Available only if M10 is selected.
- ◇ Available without M10 for 125–500 hp.
- ◆ Available only if L10 is selected.
- ▽ One (1) N.O. contact for auto mode indication is supplied as standard when auto mod operation is provided.
- Available only if O10 is selected.
- * Requires use of logic output LO1.
- ◆ Customer supplies relay. Details concerning type must also be provided at time of order entry in "Engineering Notes" within Q2C.
- Details concerning type must be provided at time of order entry in "Engineering Notes" within Q2C.

E-MOD	Description	\$ Price
Substitute Type K operators		
E224	Provides Class 9001 Type K 30 mm heavy duty multi-function operators in lieu of standard 22 mm pilot devices.	245.00
Spare control relays (for customer use)		
E225	Provides control relays mounted and unwired for customer use. Up to (3) are available.	90.00 each
Substitute pilot light lens color(s)▲		
E226	Provides the flexibility to configure lens cap colors to contract equipment designations.	—
Blown fuse indicators on control fuses		
E227	Provides blown circuit fuse indicators on control circuit fuses in lieu of standard fuses.	448.00
Motor over temperature logic input		
E228	Provides dedicated terminals using an external motor over temperature input (N.C. contact) factory wired and programmed.	111.00
RTD inputs (motor protection alarm)■		
E229	Provides capability for accepting RTD inputs using an RTD limit alarm, factory mounted and wired. Limited to three (3) RTD inputs.	2461.00
Motor management relay option◆		
Provides motor protection and metering functions using a selection of motor management relays. This relay provides protection for motor and load conditions: overload, differential, stator temperature, high inertia loads, undercurrent, under power, jam and bearing over temperature. The motor management relay is factory mounted and wired. Includes PT's and CT's.		
E230A	Schneider Electric Sepam™ Series 20 motor protective relay	1701.00
E230B	Schneider Electric Sepam Series 41 motor protective relay	2373.00
E230C	GE Multilin® 269+ motor management relay	8355.00
E230D	GE Multilin 469 motor management relay	8806.00
PowerLogic™ power meter display option		
Provides a Class 3020 PM800 series power module true rms meter display with basic instrumentation, demand, THD, date/time stamping, neutral current, min/max, alarms, event and data storage factory mounted and wired.		
E231A	PM820 power module	836.00
E231B	PM850 power module	925.00
E231C	PM870 power module	1191.00
PowerLogic circuit monitor option		
Provides a Class 3020 CM3000 or CM4000 series circuit monitor display with instrumentation, 0.2% accuracy, data logging and waveform capture, factory mounted and wired. Includes PT's and CT's.		
E232A	CM3250 circuit monitor	1442.00
E232B	CM3350 circuit monitor	1442.00
E232C	CM4000T circuit monitor	2552.00
E232D	CM4250 circuit monitor	2552.00
Spare terminal blocks (unwired)		
E234	Provides (10) spare terminal blocks 'unwired' for customer use using the Class 9080 Type G series terminals.	72.00
End damper control circuit		
E235	Provides a damper control circuit to coordinate starting of the drive controller or the bypass with the position of the damper. Requires connection to customer damper limit switch.	143.00
Emergency power off push-button		
E236	Provides a shunt trip modified molded case switch or circuit breaker where a push-pull maintained mushroom head push-button energizes the shunt trip coil and instantaneously opens to shut down power supplied to the drive controller in the AFC mode and/or bypass mode, coasting to an uncontrolled stop.	322.00
Audible alarm horn with silencer		
E238	Provides an audible alarm horn, timer to annunciate a user defined conditions with a silencer push-button, factory assembled and wired for customer use.	373.00
Three-phase ammeter with selector switch		
Provides 3 CT's with 3-position selector switch to indicate Phase A, B or C connected on the motor leads to monitor full load amps.		
E239A	Monitor input full load amps	940.00
E239B	Monitor output full load amps	940.00
Basin high level alarm indication option		
E240A	Alarm with pilot light: Provides relay circuit and pilot light indicator alarm for high level alarm limit switch via contact closure. Includes master reset push-button and (1) Form 'C' contact for customer use.	475.00
E240B	Command to run and alarm with pilot light indication: Provides relay circuit, timer and pilot light indicator sequenced for high level alarm limit switch via contact closure, energizing the drive controller and/or bypass to run full speed. Includes master reset push-button and (1) Form 'C' contact for customer use	534.00

- ▲ Specify lens cap colors desired at time of order in "Engineering Notes" field within Q2C.
- Specify RTD values at time of order entry in "Engineering Notes" within Q2C.
- ◆ Available for 125–500 hp only.

E-MOD	Description	\$ Price
Basin low-level stop with pilot light indication		
E241	Provides relay circuit and pilot light indicator sequenced for low level alarm limit switch via N.O./N.C. contact closure, causing the drive controller to stop. Includes master reset push-button and (1) Form 'C' contact for customer use.	475.00
Enclosure ventilation fan shutdown		
E242	Provides interlocking and timer functions of enclosure ventilation fans to shutdown during drive controller idle conditions.	475.00
High discharge pressure with pilot light indication		
E243	Provides relay circuitry with pilot light indicator sequenced from a pressure switch input, causing the drive controller to stop. Includes master reset push-button and (1) Form 'C' contact for customer use.	475.00
Low discharge pressure with pilot light indication		
E244	Provides relay circuit, timer with pilot light sequenced from a pressure switch input when low discharge condition. Includes master reset push-button and (1) Form 'C' contact for customer use.	475.00
Low seal water shutdown with pilot light indication ▲		
E245	Provides relay circuitry, timer with pilot light sequenced from a pressure switch input when not enough seal water is supplied. Includes master reset push-button and (1) Form 'C' contact for customer use.	475.00
Motor over temperature shutdown with pilot light ■		
E246	Provides dedicated terminals using an external motor over temperature input (Form 'C' contact) and a pilot light indicator factory wired and programmed.	277.00
Phase failure relay ♦		
E247	Provides a phase failure relay (Tele RM4T series) mounted and wired to indicate phase reversal, phase loss and imbalance operating conditions.	433.00
Single test pilot light push-button ★		
E248	Provides a dedicated 30 mm push-to-test button for indication of operable pilot lights.	78.00
Substitute TeSys™ 600 V relay(s)		
E249	Substitutes TeSys Type NEMA® rated relays rated 600 V, 10A.	588.00

- ▲ Mutually exclusive to E221.
- Mutually exclusive to E228.
- ♦ Available with Power Circuits Y, Z, S, T, or R only.
- ★ Must also select E224.

Enclosure & Miscellaneous Modifications

The E300 series features cover enclosure and miscellaneous option configurations for the M-Flex™ enclosed drive controller.

E-MOD	Description	\$ Price
ANSI #61 enclosure paint		
E301	Provides option to configure enclosure paint to industry standard ANSI #61 light gray paint in lieu of ANSI #49 gray.	314.00
Free standing enclosure ▲		
E302	Converts all standard wall mounted enclosure configurations to a floor mounted 90" high enclosure.	552.00
Enclosure expansion ■		
E303	Converts all standard wall and floor mounted enclosures up one enclosure size.	552.00
Barriered enclosure expansion ♦		
E304	Uses Barriered enclosure for non-bypass drives controllers. Bypass space is configured with circuit breaker disconnect and handle only.	866.00
Enclosure space heater option		
E305A	Space heater only; provides a Hoffman type enclosure strip heater and thermostat to maintain internal low temperature ambient ratings.	896.00
E305B	Space heater with storage operation provision; provides a Hoffman type enclosure strip heater and thermostat to maintain internal low temperature ambient ratings. Includes 120 V remote source input terminals for operation during storage conditions.	1075.00

- ▲ Available on configurations 1–20 hp CT or 1–25 hp VT only.
- Available on configurations 1–50 hp CT or 1–60 hp VT only.
- ♦ Available on configurations 1–75 hp CT or 1–100 hp VT only.

Power Options

The E400 series features cover engineered power option configurations for M-Flex™ enclosed drive controllers.

E-MOD	Description	208/230V Rating	\$ Price	460 V Rating	\$ Price
Dynamic braking resistors					
E401	Provides dynamic braking resistor top mounted on the enclosure. Resistors are 10% duty cycle constant torque (CT) applications. Overload protection for externally mounted dynamic braking resistor is mounted inside the drive controller enclosure.	1 hp	618.00	1–3 hp	845.00
		2–5 hp	743.00	5 hp	952.00
		7.5 hp	952.00	7.5 hp	1060.00
		10–15 hp	1205.00	10–20 hp	1519.00
		20–25 hp	1507.00	25–40 hp	1627.00
		30–40 hp	2100.00	50 hp	2397.00
		—	—	60–75 hp	3185.00
Motor protection filter					
E402	Provides a factory mounted and wired dV/dt filter on the drive output for long motor lead lengths considerations in excess of published guidelines.	1 hp	669.00		
		2 hp	669.00		
		3 hp	684.00		
		5 hp	696.00		
		7.5 hp	725.00		
		10 hp	730.00		
		15 hp	913.00		
		20 hp	1012.00		
		25 hp	1057.00		
		30 hp	1098.00		
		40 hp	1131.00		
		50–60 hp	1597.00		
		75 hp	1878.00		
		100 hp	2194.00		
125 hp	3000.00				
150 hp	3122.00				
200 hp	3182.00				
250 hp	3203.00				
300 hp	3370.00				
350 hp	3904.00				
400 hp	4167.00				
450–500 hp	4364.00				
NEMA® rated contactors ▲					
E403	Provides NEMA rated contactors for isolation and bypass configuration in lieu of the IEC rated contactors.	1–3 hp	1030.00	1–3 hp	688.00
		5–7.5 hp	1205.00	5–10 hp	752.00
		10–15 hp	1442.00	15–20 hp	1202.00
		20–25 hp	1717.00	25–30 hp	1442.00
		30 hp	2060.00	40–50 hp	1716.00
		40–50 hp	2884.00	60 hp	2060.00
		—	—	75–100 hp	2884.00
		—	—	125 hp	3158.00
		—	—	150 hp	3725.00
		—	—	200 hp	4543.00
		—	—	250 hp	5295.00
		—	—	300 hp	5361.00
		—	—	350 hp	5642.00
—	—	400 hp	6734.00		
—	—	450 hp	7319.00		
—	—	500 hp	7510.00		

▲ Available for Barrired design configurations only; requires selection of Power Circuit S, Z, T, or R.

E-MOD	Description	\$ Price
Transient voltage surge suppressor		
E405	Provides supplementary surge protection using a Class 1310 TVSS XWF Series Transient Voltage Surge Suppressor hard-wired and factory mounted. 100,000 peak volts of surge protection.	1125.00
Note: Service connection type (Delta or Wye) must be specified in "Engineering Notes" within Q2C.		
Dual motor overloads and branch short circuit protection▲		
E406	Provides short circuit and overload protection for (2) motors connected to the output of the drive controller. Includes thermal overload modules for each motor.	1-10 hp 430.00
		15-25 hp 472.00
		30-50 hp 525.00
		60-100 hp 746.00
		125-200 hp 2179.00
Motor A or B contactor alternation scheme■		
E407	Provides a contactor interlocked for the selection of one motor for load share via a selector switch or rotation timer scheme.	1-10 hp 782.00
		15-25 hp 1164.00
		30-50 hp 1463.00
		60-100 hp 3295.00
		125-200 hp 6836.00
250-500 hp 14895.00		
Line contactor (without bypass)		
E409	Provides a line contactor between the circuit breaker disconnect (or line reactor or harmonic filter where provided) and the power converter. When the line contactor is open, serial communications is disabled.	1-10 hp 698.00
		15-25 hp 1000.00
		30-50 hp 1299.00
		60-100 hp 2920.00
125-200 hp 6485.00		
Secondary surge arrester		
E413	Provides a secondary surge arrester Class 6671 SDSA3650 mounted and wired.	290.00
3% output reactor◆		
E414	Provides a 3% rated output reactor to address long lead considerations, mounted and wired.	1-5 hp 448.00
		7.5-25 hp 507.00
		30-40 hp 866.00
		50-60 hp 985.00
		75-100 hp 1045.00
		125 hp 1104.00
		150 hp 1224.00
		200 hp 1881.00
		250 hp 2060.00
		300-350 hp 2597.00
400-450 hp CT / 400-500 hp VT 2895.00		

- ▲ The sum of the total connected motors must not exceed the drive controller FLA rating. Specify motor FLA values at time of order entry in "Engineering Notes" within Q2C.
- Specify mode of operation via "Motor A-Off-Motor B" selector switch, remote contact closure or rotation timer scheme at time of order entry in "Engineering Notes" within Q2C.
- ◆ Available for 460/480 V rated devices only.

PowerGard™ Series CPD—18-Pulse Drives

Class 8839 Type CPD family of drive controllers now features the Altivar™ 61/71 platform in an integrated 18-Pulse AC drive solution designed for the construction and industrial markets. An 18-Pulse converter design provides near linear load performance for adjustable frequency controller rated 40 hp and above. This product is strategically designed to help the user comply with IEEE 519 guidelines.

Each PowerGard 18-Pulse enclosed drive offers a feature-rich platform of standard, engineered and user-configurable options to meet the most demanding application and specification requirements with availability in the following ratings:

- | | |
|------------------------------------------------------------------------------------------------------------------------|------------------------------------------------------------------------------------------------------------------------|
| Constant torque (Heavy duty ratings—150% current limit) | Variable torque (Normal duty ratings—110% current limit) |
| <ul style="list-style-type: none"> • Altivar 71 power converter platform • 40 to 450 hp, 460 V | <ul style="list-style-type: none"> • Altivar 61 power converter platform • 50 to 500 hp, 460 V |

Selection

To select a PowerGard 18-Pulse enclosed drive controller, identify the basic drive and optional devices by Class, Type, Options (MODS, E-MODS,) and Special Features (if required) to create the catalog number as shown below. This catalog number is used to identify the features of the product. In all cases, Q2C/Product Selectors must be used to price enclosed drives.

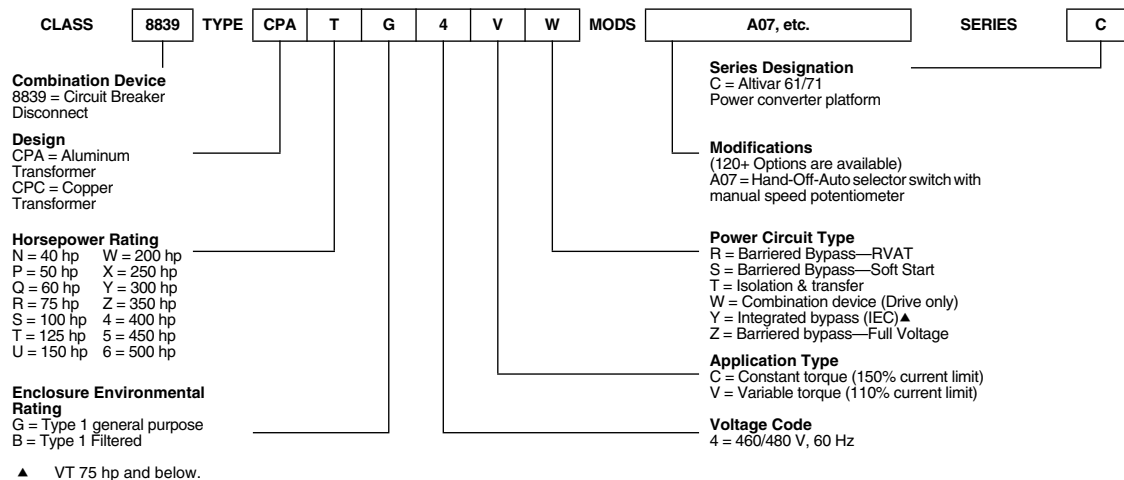

Table 15: PowerGard Copper Price Adder

18 Pulse Frame Size	HP Range	Torque	Copper Transformer	Copper \$ Price Adder
36" X 24"	40 HP	Constant	80444-189-05	850.00
	50 HP	Variable	80444-189-05	
		Constant		
	60 HP	Variable	80444-189-05	
		Constant		
	75 HP	Variable	80444-189-05	
42" X 24"	125 HP	Constant	80444-189-01	
		Variable		
	150 HP	Constant	80444-189-02	
		Variable		
	200 HP	Constant	80444-189-01	
	250 HP	Variable		
46" X 24"	250 HP	Constant	80444-189-03	1900.00
	300 HP	Variable	80444-189-03	
		Constant		
	350 HP	Variable	80444-189-03	
		Constant		
	400 HP	Variable	80444-189-03	
		Constant		
	450 HP	Variable	80444-189-04	
		Constant		
	500 HP	Variable	80444-189-04	1900.00

Standard PowerGard Features

- Circuit Breaker Disconnect
- UL listed to UL 508
- 100,000 A symmetrical short circuit rating
- Heavy duty industrial disconnect handle with lockout/tag-out provisions
- 18-Pulse transformer/reactor assembly
- 18-Pulse bridge rectifier assembly
- Altivar 61/71 power converter
- 120 V fused control transformer
- Hand-Off-Auto selector switch and manual speed potentiometer
- Door mounted graphic display terminal
- Auto Start Relay (120 V control)
- One Form "C" AFC Run mode contact
- One Form "C" AFC Fault contact
- Remote fault condition reset in AUTO mode with transition of auto start contact
- Manual fault condition reset in OFF position of H-O-A selector switch
- Safety interlock (e.g., run permissive) wired to user terminal block TB1
- Permanent wire markings
- White component mounting plate
- Top and bottom conduit access
- ANSI #49 gray enclosure
- Class 10 electronic overload protection
- Optional equipment as specified
- Customized wiring diagrams

Typical Isolation/Bypass Features (when provided)

- Class 20 overload protection with door mounted reset
- 120 V fused control transformer
- AFC-Off-Bypass selector switch
- Test-Normal selector switch
- AC3 duty rated isolation and bypass contactors (with mechanical and electrical interlocking)
- Bypass and isolation contactor sequencing provides true motor isolation
- Overload relay reset push button
- Customized wiring diagrams

Table 16: Selection and Pricing

Horsepower HP @ 480 V	HP Code	Output Current (A)	Power Circuit Configurations (Type 1 General Purpose Enclosures)					
			Combination Drive Only W \$ Price	Integrated Bypass Full Voltage Y \$ Price	Barriered Bypass Full Voltage Z \$ Price	Barriered Bypass Soft Start S \$ Price	Isolation & Transfer Separate Starter T \$ Price	Barriered Bypass RVAT R \$ Price
Constant Torque—Heavy Duty Ratings (150% Current Limit)								
40	N	52	30164.00	32681.00	32936.00	37356.00	32485.00	37985.00
50	P	65	30717.00	34130.00	35137.00	39327.00	33934.00	41975.00
60	Q	77	30896.00	34806.00	35499.00	40330.00	34610.00	42651.00
75	R	96	31657.00	35848.00	36508.00	41732.00	35652.00	43693.00
100	S	124	37312.00	—	44320.00	49426.00	42398.00	55604.00
125	T	156	40352.00	—	48989.00	54944.00	47099.00	60305.00
150	U	180	43053.00	—	53781.00	60580.00	51787.00	64996.00
200	W	240	45409.00	—	56673.00	64558.00	53967.00	72730.00
250	X	302	55907.00	—	67800.00	75900.00	65669.00	87701.00
300	Y	361	68748.00	—	81535.00	91107.00	79306.00	103954.00
350	Z	414	73480.00	—	87393.00	98370.00	85033.00	110988.00
400	4	477	77796.00	—	93559.00	106713.00	90957.00	120835.00
450	5	515	78750.00	—	95500.00	108491.00	92735.00	134903.00
450	5	515	78750.00	—	95500.00	108491.00	92735.00	134903.00
Variable Torque—Light Duty Ratings (110% Current Limit)								
50	P	65	30164.00	32681.00	32936.00	37356.00	32485.00	37872.00
60	Q	77	30717.00	34130.00	35137.00	39327.00	33934.00	41975.00
75	R	96	30896.00	34806.00	35499.00	40330.00	34610.00	42651.00
100	S	124	31657.00	—	36508.00	41732.00	35652.00	43693.00
125	T	156	37312.00	—	44320.00	49426.00	42398.00	55604.00
150	U	180	40352.00	—	48989.00	54944.00	47099.00	60305.00
200	W	240	43053.00	—	53781.00	60580.00	51787.00	64996.00
250	X	302	45409.00	—	56673.00	64558.00	53967.00	72730.00
300	Y	361	55907.00	—	67800.00	75900.00	65669.00	87701.00
350	Z	414	68748.00	—	81535.00	91107.00	79306.00	103954.00
400	4	477	73480.00	—	87393.00	98370.00	85033.00	110988.00
450	5	515	77796.00	—	93559.00	106713.00	90957.00	120835.00
500	6	590	78750.00	—	95500.00	108491.00	92735.00	134903.00

Notes:

For Type 1B enclosures with fan filter option, add \$550.
 The listings define the available factory modifications. Modifications in gray shaded areas require order engineering support. All modifications follow specific interoperability rules for selection and configuration. Modification selection can be validated at the time of quotation or order entry by the Q2C/Product Selector process. Contact your nearest Schneider Electric sales office for details.
 When options with an "E" and/or "SPL" prefix appear on the name plate, engineered-to-order options are provided.

Table 17: Dimensions

HP @ 480 V	PowerGuard™ Series C enclosure width dimensions								
	Combination Drive only W	Integrated Bypass Full Voltage Y		Barriered Bypass Full Voltage / Separate Starter Z or T		Barriered Bypass Soft Start S		Barriered Bypass RVAT R	
	Total	Extender	Total	Extender	Total	Extender	Total	Extender	Total
50 to 75	36"	—	36"	20"	56"	20"	56"	42"	78"
100	36"	—	36"	20"	56"	36"	72"	42"	78"
125	36"	20"	56"	20"	56"	36"	72"	42"	78"
150	42"	20"	62"	20"	62"	36"	78"	48"	90"
200	42"	20"	62"	20"	62"	36"	78"	48"	90"
250	42"	20"	62"	20"	62"	42"	84"	54"	90"
300	48"	25"	73"	25"	73"	42"	90"	54"	102"
350	48"	25"	73"	25"	73"	42"	90"	54"	102"
400	48"	25"	73"	25"	73"	42"	90"	54"	102"
450	48" or 54"	36"	84"	36"	84"	48"	96"	54"	102"
500	48" or 54"	36"	84"	36"	84"	48"	96"	54"	102"

Note:

All enclosures are 94.65" height and 24" depth standard switchboard enclosures.

Table 18: Weights and Heat Loss Data

PowerGuard Series C—Power Circuit W							
HP @ CT rating	Weight lbs.	Estimated Heat Loss		HP @ VT rating	Weight	Estimated Heat Loss	
		Watts Loss	BTU/Hour			Watts Loss	BTU/Hour
40	1603	2478	8457	—	—	—	—
50	1603	2674	9126	50	1603	2674	9126
60	1603	2838	9686	60	1603	2838	9686
75	1603	3027	10331	75	1603	3027	10331
100	1703	4776	16300	100	1703	3756	12819
125	2070	6333	21615	125	1703	4843	16529
150	2070	6637	22652	150	2070	6637	22652
200	2086	7074	24144	200	2086	7074	24144
250	2682	9582	32703	250	2086	9582	32703
300	2682	11216	38280	300	1682	11216	38280
350	2682	11684	39877	350	2682	11684	39877
400	2682	12894	44007	400	2682	12894	44007
450	3148	13793	47076	450	3148	13793	47076
—	—	—	—	500	3148	14691	50140

Operator Control Device Options

Door mounted operator controls provide dedicated control for commanding power converter speed and start/stop functions. Select only one.

MOD	Description	\$ Price
Hand-Off-Auto selector switch with manual speed potentiometer		
A07	Provides a three position selector switch and manual speed potentiometer door mounted. The Hand-Off-Auto selector switch is used to select between the AI1 and AI2 analog inputs. In the Auto position the motor may be started and stopped by a user supplied remote contact. The speed may be adjusted by a 4–20 mAdc signal to analog input reference AI2 or the door mounted manual speed potentiometer. The Off position will stop the motor. The Off position is also used to reset drive controller faults.	—
Rules: Control option defined by default.		
Hand-Off-Auto selector switch, Start/Stop push-buttons with manual speed potentiometer		
B07	Provides a three-position selector switch and manual speed potentiometer door mounted. The Hand-Off-Auto selector switch is used to select between the AI1 and AI2 analog inputs. In the Auto position the motor may be started and stopped by a user supplied remote contact. The speed may be adjusted by a 4–20 mAdc signal to analog input reference AI2 or the door mounted manual speed potentiometer. In the Hand position, Start/Stop push-buttons are used to start and stop the motor using a "three-wire" control strategy. The Off position will also stop the motor. The Off position is also used to reset drive controller faults.	57.00
Start/Stop push-buttons with manual speed potentiometer		
C07	Provides Start/Stop pushbuttons to start and stop the motor using a "three-wire" control strategy. The speed is adjusted by a door mounted manual speed potentiometer. The drive disconnect is used to reset drive controller faults unless "Fault Reset" (MOD P10) is ordered.	44.00
Rules: Available only with Power Circuit W.		
Start/Stop push-buttons, Forward-Reverse selector switch with manual speed potentiometer		
D07	Provides Start/Stop push-buttons to start and stop the motor using a "three-wire" control strategy. The speed is adjusted by a door mounted manual speed potentiometer. Motor direction is controlled with a forward -reverse selector switch. The drive disconnect is used to reset drive controller faults unless "Fault Reset" (Option P10) is ordered.	115.00
Rules: Available only with Power Circuit W.		
Hand-Off-Auto selector, Local-Remote selector switch with manual speed potentiometer		
E07	Provides a three-position selector switch and manual speed potentiometer door mounted. The Hand-Off-Auto selector switch is used to select between the AI1 and AI2 analog inputs. In the Auto position the motor may be started and stopped by a user supplied remote contact. The speed may be adjusted by a 4–20 mAdc signal to analog input reference AI2 or the door mounted manual speed potentiometer. The Off position will stop the motor. The Off position is also used to reset drive controller faults. The Local-Remote switch selects whether speed control is sent by a signal into terminal AI1 (local) or AI2 (remote) on terminal block TB2, when the Hand-Off-Auto switch is in Auto mode.	57.00
Communication-Hand-Off-Auto selector switch with manual speed potentiometer		
F07	Provides a four-position selector switch and manual speed potentiometer door mounted. The Communication-Hand-Off-Auto selector switch is used to select between the AI1 and AI2 analog inputs. The communication position is for communication option card control of the drive controller. In the Auto position the motor may be started and stopped by a user supplied remote contact. The speed may be adjusted by a 4–20 mAdc signal to analog input reference AI2 or the door mounted manual speed potentiometer. The Off position will stop the motor. The Off position is also used to reset drive controller faults.	142.00
Rules: Provides control and monitoring capabilities when supplied with any communication card.		
No Door Mounted Operators (wired for remote operation)		
N07	No operators are provided on the enclosure door. The customer must provide remote mounted operator controls. Drive controllers are factory programmed and configured for remote mounted Hand-Off-Auto operation.	Deduct \$100.00

Pilot Light Options

Pilot lights are ordered in light groups and door mounted. Pilot light groups are selected with compatible control options. Pilot lights are all 22 mm, long-life LED type. Select only one.

MOD	Description	\$ Price
Power On, Fault, AFC Run, Auto pilot lights		
A08	Provides a combination of (4) pilot lights for visual indication of protective functions and circuit status; power on (red), fault (yellow), AFC run (green) and auto (yellow).	140.00
Rules: Not available with C07 or D07.		
Power On, Fault, AFC Run, Bypass pilot lights		
B08	Provides a combination of (4) pilot lights for visual indication of protective functions and circuit status; power on (red), fault (yellow), AFC run (green) and bypass (yellow).	140.00
Rules: Not available with Power Circuit W.		
Power On, Fault, AFC Run pilot lights		
C08	Provides a combination of (3) pilot lights for visual indication of protective functions and circuit status; power on (red), fault (yellow) and AFC run (green).	105.00
Power On, Fault, AFC Forward, AFC Reverse pilot lights		
D08	Provides a combination of (4) pilot lights for visual indication of protective functions and circuit status; power on (red), fault (yellow), forward (green) and reverse (green).	140.00
Rules: 1. Available only with D07 or N07. 2. Available only with Power Circuit W.		
Power On, Fault, AFC Run, Hand, Auto pilot lights		
E08	Provides a combination of (5) pilot lights for visual indication of protective functions and circuit status; power on (red), fault (yellow), AFC run (green), hand (blue) and auto (yellow).	175.00
Rules: 1. Available only with A07, B07, E07 or N07. 2. Supplied with AMR relay.		
Power On, Fault, AFC Run, Communication pilot lights		
F08	Provides a combination of (4) pilot lights for visual indication of protective functions and circuit status; power on (red), fault (yellow), AFC run (green) and communication (yellow).	140.00
Rules: Available only with F07 or N07.		

Option Cards

All communication cards are provided without factory programming. Select only one.

MOD	Description	\$ Price
Modbus/Uni-Telway™ communication card		
B09	Provides a factory installed plug-in Modbus/Uni-Telway card, VW3A3303.	272.00
Johnson Controls Metasys® N2 communication card		
C09	Provides a factory installed plug-in Metasys N2 card, VW3A3313. VW3A3313: Obsolete. Direct replacement = VW3A3318. Has 4 position network connector instead of 9 pin D-shell.	272.00
Ethernet TCP/IP communication card		
D09	Provides a factory installed plug-in Ethernet TCP/IP card, VW3A3310, with user termination to RJ45 plug-in interface connector.	272.00
LonWorks® communication card		
E09	Provides a factory installed LonWorks card, VW3A3312.	452.00
DeviceNet™ communication card		
F09	Provides a factory installed DeviceNet card, VW3A3309.	272.00
Profibus DP communication card		
G09	Provides a factory installed Profibus DP card, VW3A3307.	452.00
I/O Extension card		
H09	Provides a factory installed I/O extension card, VW3A3202. Adds (2) analog outputs, 4 logic inputs, 2 logic outputs and 1 differential analog input.	156.00
Siemens Apogee® FLN / P1 communication card		
J09	Provides a factory installed Apogee P1 card, VW3A3314.	272.00
BACnet communication card		
K09	Provides a factory installed BACnet card, VW3A3315. VW3A3315: Obsolete soon. Direct replacement = VW3A3319. Has 4 position network connector instead of 5 position connector.	272.00
Interbus® S communication card		
L09	Provides a factory installed Interbus card, VW3A3304.	452.00
Bluetooth® Modbus		
P09	Provides a Bluetooth Modbus adapter, TCSWAAC13FB.	71.00

Miscellaneous Options

Pre-engineered and system supported options to provide miscellaneous product modifications.

MOD	Description	\$ Price
3–15 PSI Transducer		
C10	Allows the controller to follow a user supplied 3–15 PSI input. Rules: 1. Not available with C07 or D07. 2. Mutually exclusive with J09.	256.00
Omit Door mounted graphic display terminal		
D10	The graphic display terminal is not supplied. To alter the programming of the power converter, the user must buy a graphic display terminal or SoMove™ software to program the drive controller.	Deduct 100.00
Smoke Purge Relay		
E10	Provides a smoke purge operating mode controlled by a user-supplied 120 Vac signal wired to terminal block TB1. Smoke purge operation is full speed bypass (when provided) or High Speed in the drive controller. This operation is designed run the motor from any operator control setting except emergency stop or open safety interlocks.	128.00
Additional 200 VA Control Power		
F10	Provides additional control power 200 VA using a larger 120 V control transformer connected to terminal block TB1 for customer use.	216.00
cUL Certification		
G10	Provides a Canadian cUL certification when required by local code requirements.	190.00
Seismic Qualified		
H10	Supplies a certification label and hardware qualified to seismic rating ICC ES AC156 acceptance criteria test protocol with an importance factor of 1.5.	242.00
Permanent Wire Marker (Sleeve Type)		
I10	Provides permanent wire sleeve type markers on control wiring. Note: Permanent wire markings are provided as standard.	995.00
Input programmed for 0–10 Vdc AI2 input		
J10	Provides programming for 0–10 Vdc user supplied auto speed reference signal to the AI2 input, on terminal block TB2. The 0–10 Vdc analog input is not isolated, but it does contain noise suppression circuitry and a programmable electronic filter. using a 0–10 V / 4–20 mA converter (P/n# 31158-297-50). Source impedance: Z=40kΩ . Rules: Not available with C07, D07 or C10.	—
1 Additional N.O. Auxiliary Drive Run Contact		
K10	Provides 1 additional N.O. contact for drive run indication wired to TB1.	105.00
1 Additional N.C. Auxiliary Drive Fault Contact		
L10	Provides 1 additional N.C. contact for drive fault indication wired to TB1.	105.00
1 N.O. Auxiliary Bypass Run Contact		
M10	Provides 1 additional N.O. contact for bypass run indication wired to TB1. Rules: Available only with Power Circuits Y, S, Z, R and T.	105.00
1 N.O. Auxiliary Auto Mode Contact		
O10	Provides 1 additional N.O. contact for auto mode indication wired to TB1. Rules: Not available with C07 or D07.	105.00
AFC Fault Reset Push-button		
P10	Provides factory installed door-mounted push button to fault reset LI4 on the power converter at terminal TB1 when Hand-Off-Auto is not supplied. Rules: 1. Available only with C07 or D07. 2. Available only with Power Circuit W.	57.00
Push-to-Test Pilot Lights		
Q10	Provides push-to-test function on all pilot lights except Power On pilot light. Rules: Not available on Fault pilot light if P10 is selected.	120.00
Auto Transfer to Bypass		
R10	Provides an automatic transfer (time adjustable 0.1–10 s) to bypass in the event that the drive controller faults. A selector switch is provided inside the enclosure to enable or disable this function. Longer transfer time requirements are available by replacing the plug-in adjustable timer. Rules: 1. Available only with Power Circuits Y, S, Z, T or R. 2. Not available with B07, C07 or D07.	153.00
Motor Elapsed Time Meter		
S10	Provides a dedicated elapsed time meter to record the motor run time. Runs whenever the motor is running. The motor elapsed time meter is non-resettable.	153.00
Emergency Stop Mushroom Head Push-button		
T10	Provides door mounted maintained off emergency stop red mushroom pushbutton with turn-to-reset feature. Rules: Not available with C07 or D07.	72.00
Motor Space Heater Sequencing Circuit—Light Duty		
U10	Provides 50 VA/120 V to terminal block TB1 for motor space heater whenever the motor is not running. Rules: Mutually exclusive with V10 unless F10 is also selected.	227.00

MOD	Description	\$ Price
Seal Water Solenoid		
V10	Provides 50 VA/120 V to terminal block TB1 for seal water solenoid whenever the motor is running.	227.00
Rules: Exclusive with U10 unless F10 is also selected.		
Check Valve Sequencing Circuit (Gravity Type)		
W10	Provides an automatic shutdown of the drive controller when the user supplied N.C. contact from the check valve limit switch does not open within 5 seconds after the motor starts. The user limit switch contact connects to terminal block TB1. Circuit provides reset function with an illuminated (blue) push-button.	296.00
54 inch wide enclosure		
Y10	Provides a 54 inch wide switchboard enclosure for bottom conduit entry space provisions.	156.00
Rules: Available for 450–500 hp ratings only.		
24 Vdc Power Supply		
Z10	Provides a 24 Vdc, 300 mA power supply at terminal block TB1.	210.00
ID Engraved Nameplates		
610	Provides an engraved laminated nameplate attached to the front door of the enclosure (engraved per user request at time of order).	57.00

Engineered Features

Factory orders with engineered features (E-MOD, SPL, etc.) are subject to review by factory personnel and have longer lead-time availability. Standard PowerGard™ enclosure dimensions may no longer apply to orders containing any combination of engineered features. In addition, factory orders containing engineered features may carry a UL 508A (Industrial Control Equipment) label in lieu of a UL 508C (Power Conversion Equipment) label depending on configuration.

Control Options

The E200 series features cover control circuit option configurations for PowerGard enclosed drive controllers.

E-MOD	Description	\$ Price
Door mounted meters (dedicated displays)		
Provides a dedicated door mounted meter display, analog or digital.		
E201	Analog percent speed meter scaled 0 to 120% base speed.	307.00
E202	Analog percent current scaled 0 to 100% of rated output current.	307.00
E203	Digital ammeter (amperes) scaled 0 to 2 times rated output amperes.	358.00
E204	Digital speed meter (frequency) scaled 0 to 72 Hz output frequency.	358.00
E205	Digital percent speed meter scaled 0 to 120% base speed.	358.00
E206	Digital percent current scaled 0 to 100% of rated output current.	358.00
Rules: 1. Limited to one meter selection unless H09 is selected. 2. If H09 is selected, (1) additional meter can be selected.		
Door mounted RJ45 port		
E211	Provides (1) Sixnet RJ45 door mounted 30 mm bulk head connector and internal CAT5 cabling for access via PC with SoMove™ software. The RJ45 (Modbus™/CANopen) drive port provides customer access through the enclosure door.	185.00
Auxiliary drive run contacts		
E212	Provides (3) Form 'C' contacts rated 5 A @ 120 V wired to terminal blocks for customer use.	176.00
Note: One (1) Form 'C' contact for drive run indication is supplied as standard. Rules: 1. Available only if K10 is selected. 2. Available without K10 for 100–450 hp CT / 125–500 hp VT.		
Auxiliary bypass run contacts		
E213	Provides (3) Form 'C' contacts rated 5 A @ 120 V wired to terminal blocks for customer use.	176.00
Note: One (1) N.O. contact for bypass run indication is supplied as standard when bypass is provided. Rules: 1. Available only if M10 is selected. 2. Available without M10 for 100–450 hp CT / 125–500 hp VT.		
Auxiliary drive fault contacts		
E214	Provides (3) Form 'C' contacts rated 5 A @ 120 V wired to terminal blocks for customer use.	176.00
Note: One (1) Form 'C' contact for drive fault indication is supplied as standard. Rules: Available only if L10 is selected.		
Auxiliary auto mode contacts		
E215	Provides (3) Form 'C' contacts rated 5 A @ 120 V wired to terminal blocks for customer use.	176.00
Note: One (1) N.O. contact for auto mode indication is supplied as standard when auto mod operation is provided. Rules: Available only if O10 is selected.		
Adjustable restart delay timer		
E216	Provides an adjustable On Time Delay Relay for power up restart function, mounted and wired for AFC mode (hand or auto) mode and/or in the bypass mode (hand/auto).	136.00

E-MOD	Description	\$ Price
Motor space heater (heavy duty)		
E217	Provides control circuit contacts, 120 V, 500 VA supply and fusing wired to terminals for customer use.	569.00
Signal loss follower alarm relay		
E218	Provides (1) Form 'C' contact rated 5 A @ 120 V wired to terminal blocks for customer use. Intended for 4–20 mA dc control loop applications where upon the loss of input signal it is desired to retain the output signal at the last input signal level. The relay provides an alarm relay contact for signal loss alert.	205.00
Note: Requires use of logic output LO1.		
Inhibit/shutdown sequence (timed operation)		
E219	Provides a relay circuit operating in the fail safe mode where a remote initiating contact opens the relay, de-energizes and after a specified time shuts the drive controller down in the AFC mode (hand or auto) and/or in the bypass mode (hand or auto).	330.00
Check valve sequence (motorized type)		
E220	Provides relay circuitry sequenced from a check valve limit switch. A valve closed position limit switch will energize relays that will initiate a remote valve operating solenoid limited to 50 VA and give a run permissive to the drive controller in the AFC mode (hand or auto) and/or in the bypass mode (hand or auto). A valve closed position limit switch will de-energize a timer relay such that if this relay is not de-energized within a specified time period, the drive controller will shut down in the AFC mode (hand or auto) and/or in the bypass mode (hand or auto).	404.00
Seal water solenoid—with pressure switch feedback		
E221	Provides relay, which will energize a remote seal water solenoid limited to 50 VA during drive controller operation. Additionally, the remote initiating contact will open the relay, de-energizing and after a specified time shuts the drive controller down in the AFC mode (hand or auto) and/or in the bypass mode (hand or auto).	694.00
Moisture detection relay circuit (without relay)		
E222	Provides 24 V or 120 V control power to a customer supplied moisture detection relay device, either electronic or electro-mechanical. Factory provides pre-wired socket or mounting space only.	200.00
Note: Customer supplies relay. Details concerning type must also be provided at time of order entry in "Engineering Notes" within Q2C.		
Moisture detection relay circuit (with relay options)		
E223A	Relay option: Provides 24 V or 120 V control power to a moisture detection relay device, either electronic or electro-mechanical. The moisture detection relay is mounted and wired by the factory.	694.00
E223B	Relay and Pilot Light indication option: Provides 24 V or 120 V control power to a customer supplied moisture detection relay device, either electronic or electro-mechanical. Includes a pilot light for discrete input(s). The customer supplied moisture detection relay is mounted and wired by the factory.	793.00
Note: Details concerning type must be provided at time of order entry in "Engineering Notes" within Q2C.		
Substitute Type K operators		
E224	Provides Class 9001 Type K 30 mm heavy duty multi-function operators in lieu of standard 22 mm pilot devices.	233.00
Spare control relays (for customer use)		
E225	Provides control relays mounted and unwired for customer use. Up to (3) are available.	85.00 each
Substitute pilot light lens color(s)		
E226	Provides the flexibility to configure lens cap colors to contract equipment designations.	—
Notes: Specify lens cap colors desired at time of order entry in "Engineering Notes" field within Q2C.		
Blown fuse indicators on control fuses		
E227	Provides blown circuit fuse indicators on control circuit fuses in lieu of standard fuses.	426.00
Motor over temperature logic input		
E228	Provides dedicated terminals using an external motor over temperature input (N.C. contact) factory wired and programmed.	106.00
RTD inputs (motor protection alarm)		
E229	Provides capability for accepting RTD inputs using an RTD limit alarm, factory mounted and wired. Limited to three (3) RTD inputs.	2343.00
Note: Specify RTD values at time of order entry in 'Engineering Notes' within Q2C.		
Motor management relay option		
Provides motor protection and metering functions using a selection of motor management relays. This relay provides protection for motor and load conditions: overload, differential, stator temperature, high inertia loads, undercurrent, under power, jam and bearing over temperature. The motor management relay is factory mounted and wired. Includes PT's and CT's.		
E230A	Schneider Electric Sepam™ Series 20 motor protective relay	1620.00
E230B	Schneider Electric Sepam Series 41 motor protective relay	2260.00
E230C	GE Multilin® 269+ motor management relay	7956.00
E230D	GE Multilin 469 motor management relay	8385.00
PowerLogic™ power meter display option		
Provides a Class 3020 PM800 series power module true rms meter display with basic instrumentation, demand, THD, date/time stamping, neutral current, min/max, alarms, event and data storage factory mounted and wired.		
E231A	PM820 power module	796.00
E231B	PM850 power module	881.00
E231C	PM870 power module	1134.00

E-MOD	Description	\$ Price
PowerLogic™ circuit monitor option		
Provides a Class 3020 CM3000/CM4000 series circuit monitor display with instrumentation, 0.2% accuracy, data logging and waveform capture, factory mounted and wired. Includes PT's and CT's.		
E232A	CM3250 circuit monitor	1373.00
E232B	CM3350 circuit monitor	1373.00
E232C	CM4000T circuit monitor	2430.00
E232D	CM4250 circuit monitor	2430.00
Spare terminal blocks (unwired)		
E234	Provides (10) spare terminal blocks 'unwired' for customer use using the Class 9080 Type G series terminals.	68.00
End damper control circuit		
E235	Provides a damper control circuit to coordinate starting of the drive controller or the bypass with the position of the damper. Requires connection to customer damper limit switch.	136.00
Emergency power off push-button		
E236	Provides a shunt trip modified molded case switch or circuit breaker where a push-pull maintained mushroom head push-button energizes the shunt trip coil and instantaneously opens to shut down power supplied to the drive controller in the AFC mode and/or bypass mode, coasting to an uncontrolled stop.	307.00
Audible alarm horn with silence		
E238	Provides an audible alarm horn, timer to annunciate a user defined conditions with a silencer push-button, factory assembled and wired for customer use.	355.00
Three-phase ammeter with selector switch		
Provides 3 CT's with 3-position selector switch to indicate Phase A, B or C connected on the motor leads to monitor full load amps.		
E239A	Monitor input full load amps	895.00
E239B	Monitor output full load amps	895.00
Basin high level alarm indication option		
E240A	Alarm with pilot light: Provides relay circuit and pilot light indicator alarm for high level alarm limit switch via contact closure. Includes master reset push-button and (1) Form 'C' contact for customer use.	452.00
E240B	Command to run and alarm with pilot light indication: Provides relay circuit, timer and pilot light indicator sequenced for high level alarm limit switch via contact closure, energizing the drive controller and/or bypass to run full speed. Includes master reset push-button and (1) Form 'C' contact for customer use.	509.00
Basin low level stop with pilot light indication		
E241	Provides relay circuit and pilot light indicator sequenced for low level alarm limit switch via N.O./N.C. contact closure, causing the drive controller to stop. Includes master reset push-button and (1) Form 'C' contact for customer use.	452.00
Enclosure ventilation fan shutdown		
E242	Provides interlocking and timer functions of enclosure ventilation fans to shutdown during drive controller idle conditions.	452.00
High discharge pressure with pilot light indication		
E243	Provides relay circuitry with pilot light indicator sequenced from a pressure switch input, causing the drive controller to stop. Includes master reset push-button and (1) Form 'C' contact for customer use.	452.00
Low discharge pressure with pilot light indication		
E244	Provides relay circuit, timer with pilot light sequenced from a pressure switch input when low discharge condition. Includes master reset push-button and (1) Form 'C' contact for customer use.	452.00
Low seal water shutdown with pilot light indication		
E245	Provides relay circuitry, timer with pilot light sequenced from a pressure switch input when not enough seal water is supplied. Includes master reset push-button and (1) Form 'C' contact for customer use.	452.00
Rules: Mutually exclusive to E221.		
Motor over temperature shutdown with pilot light		
E246	Provides dedicated terminals using an external motor over temperature input (Form 'C' contact) and a pilot light indicator factory wired and programmed.	216.00
Rules: Mutually exclusive to E228.		
Phase failure relay		
E247	Provides a phase failure relay (Tele RM4T series) mounted and wired to indicate phase reversal, phase loss and imbalance operating conditions.	412.00
Rules: Available with Power Circuits Y, Z, S, T, or R only.		
Single test pilot light push-button		
E248	Provides a dedicated 30 mm push-to-test button for indication of operable pilot lights.	74.00
Rules: Must also select E224.		
Substitute TeSys™ 600 V relay(s)		
E249	Substitutes TeSys Type NEMA® rated relays rated 600 V, 10 A.	560.00

Enclosure & Miscellaneous Modifications

The E300 series features cover enclosure and miscellaneous option configurations for the PowerGard™ enclosed drive controller.

E-MOD	Description	\$ Price
ANSI #61 enclosure paint		
E301	Provides option to configure enclosure paint to industry standard ANSI #61 light gray paint in lieu of ANSI #49 gray.	300.00
Enclosure space heater option		
E305A	Space heater only: Provides a Hoffman type enclosure strip heater and thermostat to maintain internal low temperature ambient ratings.	853.00
E305B	Space heater with storage operation provision: Provides a Hoffman type enclosure strip heater and thermostat to maintain internal low temperature ambient ratings. Includes 120 V remote source input terminals for operation during storage conditions.	1023.00

Power Options

The E400 series features cover engineered power option configurations for PowerGard enclosed drive controllers.

E-MOD	Description	\$ Price
Motor protection filter		
Provides a factory mounted and wired dV/dt filter on the drive output for long motor lead lengths considerations in excess of our published guidelines, up to 1000 feet.		
E402	40 hp CT	1077.00
	50–60 hp	1520.00
	75 hp	1788.00
	100 hp	2089.00
	125 hp	2857.00
	150 hp	2973.00
	200 hp	3030.00
	250 hp	3050.00
	300 hp	3209.00
	350 hp	3718.00
	400hp	3968.00
	450–500 hp	4156.00
Transient voltage surge suppressor		
E405	Provides supplementary surge protection using a Class 1310 TVSS XWF Series Transient Voltage Surge Suppressor hard-wired and factory mounted. 100,000 peak volts of surge protection.	1072.00
Note: Service connection type (Delta or Wye) must be specified in "Engineering Notes" within Q2C.		
Secondary surge arrester		
E413	Provides a secondary surge arrester Class 6671 SDSA3650 mounted and wired.	276.00
3% output reactor		
Provides a 3% rated output reactor to address long lead considerations, mounted and wired.		
E414	40 hp CT	824.00
	50–60 hp	938.00
	75–100 hp	995.00
	125 hp	1052.00
	150 hp	1165.00
	200 hp	1791.00
	250 hp	1961.00
	300–350 hp	2473.00
	400–450 hp CT / 400–500 hp VT	2757.00



Table 19: Selection and Pricing

Voltage + 10% -15% 50/60 Hz		Motor Power▲		Nominal Current Rating A	Catalog Number■	\$ Price
Input	Output	Horsepower	kW			
115 V single-phase	230 V three-phase	0.25	0.18	1.4	ATV12H018F1	185.00
		0.5	0.37	2.4	ATV12*037F1	192.00
		1	0.75	4.2	ATV12HU075F1	224.00
230 V single-phase	230 V three-phase	0.25	0.18	1.4	ATV12H018M2◆	185.00
		0.5	0.37	2.4	ATV12*037M2◆	192.00
		0.75	0.55	3.5	ATV12*055M2◆	205.00
		1	0.75	4.2	ATV12*075M2◆	224.00
		2	1.5	7.5	ATV12HU15M2★	291.00
		3	2.2	10	ATV12HU22M2★	348.00
230 V three-phase	230 V three-phase	0.25	0.18	1.4	ATV12H018M3	169.00
		0.5	0.37	2.4	ATV12*037M3	176.00
		1	0.75	4.2	ATV12*075M3	206.00
		2	1.5	7.5	ATV12*U15M3	267.00
		3	2.2	10	ATV12*U22M3	320.00
		—	3	12.2	ATV12*U30M3	371.00
		5	3.7	16.7	ATV12*U40M3	436.00

- ▲ These power ratings are for use as switching frequency of 4 kHz, in continuous operation.
- The ATV12 part numbers with the * are available as H or P version (reference installation manual BBV28587 for heatsink version). Replace the * with H for drives with standard heatsink on the back of the drive. Example: ATV12H037M2 has a heatsink. Replace the * with P for drives without a heatsink. These drives do not have a heatsink but have a smooth back that can be mounted to a thermally conductive machined surface. Example: ATV12P037M2 does not have a heatsink.
- ◆ Available in lots of 14 by adding TQ to the end of the reference number.
- ★ Available in lots of 7 by adding TQ to the end of the reference number.

Table 20: Options and Accessories

Description	Part Number	For Use on Drives	\$ Price
Software			
SoMove™ This software enables the user to configure, set, debug and organize maintenance task for the Altivar drives and soft starts. It can also be used to customize the integrated display terminal menus. It can be used with a direct connection or a Bluetooth® wireless connection. Free download at http://products.schneider-electric.us/products-services/products/ac-drives-and-soft-starts/			
USB to RJ45 adaptor; for use in connecting to a PC with a USB port	TCSMCNAM3M002P	Compatible device families: Advantys™ OTB, Altistart™ motor starters, Altivar series including HMI, Altivar controller	52.00
User Interface Options			
Remote Keypad Display for ATV12 (IP54)	VW3A1006	ATV12 and ATV312	56.00
Remote Keypad Display for ATV12 (IP65)	VW3A1007	ATV12 and ATV312	56.00
Cable for remote mounting LCD graphic keypad RJ-45 connector on each end			
1 meter	VW3A1104R10	any Altivar drive	35.00
3 meters	VW3A1104R30		35.00
5 meters	VW3A1104R50		35.00
10 meters	VW3A1104R100		45.00
Operator, mounting collar, 2.5 kilohm, 1/2 watt potentiometer	ATVPOT25K	any Altivar drive	69.00
Conformity Kits			
EMC Conformity Kit	VW3A9523	ATV12H018F1, H037F1, ATV12H018M2...H075M2, ATV12H018M3...H075M3, ATV12P037F1, ATV12P037M2...P075M2, ATV12P037M3...P075M3	25.00
EMC Conformity Kit	VW3A9524	ATV12H075F1, ATV12HU15M2, HU22M2, ATV12HU15M3, HU22M3, ATV12PU15M3, PU22M3	25.00
EMC Conformity Kit	VW3A9525	ATV12HU30M3, ATV12HU40M3	25.00
Filters			
EMC Filters for C1, C2, C3	VW3A4416	ATV12H018F1, H037F1, ATV12H018M2...H075M2, ATV12P037F1, ATV12P037M2...P075M2	105.00
EMC Filters for C1, C2, C3	VW3A4417	ATV12H075F1, ATV12HU15M2, HU22M2	125.00
EMC Filters for C1, C2, C3	VW3A4418	ATV12H018M3...H075M3, ATV12P037M3...P075M3	120.00
EMC Filters for C1, C2, C3	VW3A4419	ATV12HU15M3, HU22M3, ATV12PU15M3, PU22M3	180.00
Converters			
15 / 24 voltage converter	VW3A9317	All ATV12 ranges	88.00
Mounting Kits			
Mounting Plate for 35 mm DIN rail	VW3A9804	ATV12H018F1, H037F1, ATV12H018M2...H075M2, ATV12H018M3...H075M3	64.00
Mounting Plate for 35 mm DIN rail	VW3A9805	ATV12H075F1, ATV12HU15M2, HU22M2, ATV12HU15M3, HU22M3	72.00

Table 21: Configuration Tools

Description	Part Number	For Use on Drives	\$ Price
Universal Bluetooth Interface: Bluetooth connectivity to devices through serial RS-485, RJ45 Modbus port. For permanent installation, to be used during commissioning, maintenance and troubleshooting of equipment.	TCSWAAC13FB▼	Altivar 12, 212, 312, 61, 71, and Altistart 22	180.00
Simple Loader: to transfer configuration between like drives. For use with the Altivar product line.	VW3A8120	ATV12, ATV312, ATV32, ATV61, ATV71	175.00
Multi-loader: to copy a configuration from a drive or from SoMove via an SD card, and transferring to another drive or to a PC	VW3A8121	ATV12, ATV312, ATV212, ATV32, ATV61, ATV71, ATS22	350.00
Guiding tool cable: for connection between the MultiLoader and an ATV12 that is in its packaging	VW3A8126	ATV12, ATV32, Lexium 32	30.00

- ▼ Discount Schedule for this product is PC41.

Selection and Pricing

Table 22: Altivar™ 312 Selection and Pricing

Input Line Voltage	With a 5% Line Reactor			Without a Line Reactor			Open Drives■	
	Three-Phase Motor Power▲		Continuous Output Current	Three-Phase Motor Power▲		Continuous Output Current	Catalog Number	\$ Price
	HP	kW	A	HP	kW	A		
208/230 Vac Single-Phase	—	—	—	0.25	0.18	1.5	ATV312H018M2	268.00
	—	—	—	0.5	0.37	3.3	ATV312H037M2	287.00
	—	—	—	0.75	0.55	3.7	ATV312H055M2	306.00
	—	—	—	1	0.75	4.6	ATV312H075M2	335.00
	—	—	—	1.5	1.1	6.9	ATV312HU11M2	363.00
	—	—	—	2	1.5	8	ATV312HU15M2	402.00
208/230 Vac Three-Phase	—	—	—	3	2.2	11	ATV312HU22M2	468.00
	0.25	0.18	—	0.25	0.18	1.5	ATV312H018M3	258.00
	0.5	0.37	—	0.5	0.37	3.3	ATV312H037M3	287.00
	0.75	0.55	—	0.75	0.55	3.7	ATV312H055M3	306.00
	1	0.75	—	1	0.75	4.8	ATV312H075M3	325.00
	1.5	1.1	—	1.5	1.1	6.9	ATV312HU11M3	363.00
	2	1.5	—	2	1.5	8	ATV312HU15M3	421.00
	3	2.2	—	3	2.2	11	ATV312HU22M3	478.00
	—	3	—	4	3	13.7	ATV312HU30M3	554.00
	5	4	—	5	—	17.5	ATV312HU40M3	650.00
	7.5	5.5	—	7.5	5.5	27.5	ATV312HU55M3	841.00
10	7.5	—	10	7.5	33	ATV312HU75M3	1013.00	
15	11	—	15	11	54	ATV312HD11M3	1338.00	
20	15	—	20	15	66	ATV312HD15M3	1721.00	
400/480 Vac Three-Phase	0.5	0.37	—	0.5	0.37	1.5	ATV312H037N4	363.00
	0.75	0.55	—	0.75	0.55	1.9	ATV312H055N4	392.00
	1	0.75	—	1	0.75	2.3	ATV312H075N4	421.00
	1.5	1.1	—	1.5	1.1	3	ATV312HU11N4	449.00
	2	1.5	—	2	1.5	4.1	ATV312HU15N4	497.00
	3	2.2	—	3	2.2	5.5	ATV312HU22N4	574.00
	—	3	—	4	3	7.1	ATV312HU30N4	650.00
	5	4	—	5	—	9.5	ATV312HU40N4	688.00
	7.5	5.5	—	7.5	5.5	14.3	ATV312HU55N4	860.00
	10	7.5	—	10	7.5	17	ATV312HU75N4	1052.00
	15	11	—	15	11	27.7	ATV312HD11N4	1386.00
20	15	—	20	15	33	ATV312HD15N4	1721.00	
575/600 Vac Three-Phase♦	1	0.75	1.7				ATV312H075S6	484.00
	2	1.5	2.7				ATV312HU15S6	572.00
	3	2.2	3.9				ATV312HU22S6	660.00
	5	3.7/4.0	6.1				ATV312HU40S6	792.00
	7.5	5.5	9				ATV312HU55S6	989.00
	10	7.5	11				ATV312HU75S6	1209.00
	15	11	17				ATV312HD11S6	1594.00
20	15	22				ATV312HD15S6	1979.00	

- ▲ These horsepower, wattage, and continuous ampere ratings apply to 4 kHz switching frequency and maximum 50 °C ambient. Refer to the installation manual for derating curves as a function of switching frequency, ambient temperature, and mounting conditions.
- Open type Altivar 312 Drives can be installed as UL Type 1 with optional conduit box when following instructions in the installation manual.
- ♦ A minimum 3% line reactor is required on all 575 V drive installations.

Selection and Pricing

Table 23: Altivar 31 UL Type 12 / IP54 Selection and Pricing

Input Line Voltage	Three-Phase Motor Power▲		Open Drives■	IP54 / UL Type 12 Enclosed	
	kW	HP	A▲	Catalog Number	Standard \$ Price
208/230 Vac Single-Phase	0.18	0.25	1.5	ATV31C018M2	362.00
	0.37	0.5	3.3	ATV31C037M2	387.00
	0.55	0.75	3.7	ATV31C055M2	413.00
	0.75	1	4.6	ATV31C075M2	452.00
	1.1	1.5	6.9	ATV31CU11M2	490.00
	1.5	2	8	ATV31CU15M2	543.00
400/480 Vac Three-Phase	2.2	3	11	ATV31CU22M2	632.00
	0.37	0.5	1.5	ATV31C037N4	490.00
	0.55	0.75	1.9	ATV31C055N4	529.00
	0.75	1	2.3	ATV31C075N4	568.00
	1.1	1.5	3	ATV31CU11N4	606.00
	1.5	2	4.1	ATV31CU15N4	671.00
	2.2	3	5.5	ATV31CU22N4	774.00
	3	4	7.1	ATV31CU30N4	878.00
	—	5	9.5	ATV31CU40N4	929.00
	5.5	7.5	14.3	ATV31CU55N4	1162.00
	7.5	10	17	ATV31CU75N4	1420.00
11	15	27.7	ATV31CD11N4	1733.00	
15	20	33	ATV31CD15N4	2151.00	

- ▲ These horsepower, wattage, and continuous ampere ratings apply to 4 kHz switching frequency and maximum 50 °C ambient. Refer to the installation manual for derating curves as a function of switching frequency, ambient temperature, and mounting conditions.



ATV31C
IP54 / UL Type 12

Table 24: Altivar™ 312 Options and Accessories

Description	For Use on Drives	Catalog Number	\$ Price
Software			
SoMove™ This software enables the user to configure, set, debug and organize maintenance task for the Altivar 312 drive. It can also be used to customize the integrated display terminal menus. It can be used with a direct connection or a Bluetooth® wireless connection. Free download at http://products.schneider-electric.us/products-services/products/ac-drives-and-soft-starts/			
User Interface Kits			
USB to RJ45 Adaptor Kit	For use in connecting to a PC with a USB port	Advantys™ OTB, Altistart™ motor starters, Altivar series incl. HMI, Altivar controller	TCSMCNAM3M002P 52.00
Remote Keypad Options and Accessories	Remote Keypad Display (IP54)	ATV312, ATV12	VW3A1006 56.00
	Remote Keypad Display (IP65)	ATV312, ATV12	VW3A1007 56.00
	Remote Keypad Display and Mounting Kit	ATV312	VW3A31101 175.00
	Remote Keypad Display	ATV312, ATV61, ATV71	VW3A1101 115.00
Cable for remote mounting LCD graphic keypad. RJ-45 connector on each end.	1 meter	Any ATV61, Any ATV71	VW3A1104R10 35.00
	3 meters	Any ATV61, Any ATV71	VW3A1104R30 35.00
	5 meters	Any ATV61, Any ATV71	VW3A1104R50 35.00
	10 meters	Any ATV61, Any ATV71	VW3A1104R100 45.00
Communication Options	Profibus	ATV312	VW3A31207 185.00
	CANopen Daisy Chain	ATV312	VW3A31208 185.00
	DeviceNet	ATV312	VW3A31209 185.00
Potentiometer	Operator, mounting collar, 2.5 kilohm, ½ watt potentiometer	Altivar 312	ATVPOT25K 69.00
Braking Resistors	Non-Protected (IP00)	ATV312H018M2 to H075M2, ATV312HU11M2, HU15M2, ATV312H018M3 to H075M3, ATV312HU11M3, HU15M3, ATV312H037N4 to H075N4, ATV312HU11N4 to HU22N4, ATV312H075S6, HU22S6, ATV312HU30N4, ATV312HU40N4, ATV312HU40S6	VW3A7723 195.00
		ATV312HU30N4, ATV312HU40N4, ATV312HU40S6	VW3A7725 215.00
		ATV312HU22M2, ATV312HU22M3, ATV312HU30M3	VW3A7724 205.00
Ferrite Suppressors	For downstream contactor opening	ATV312H018M2	VW3A31451 45.00
		ATV312H037M2, ATV312H018M3, H037M3	VW3A31452 45.00
		ATV312H055M2 to HU22M2, ATV312H055M3 to HU22M3	VW3A31453 45.00
Replacement Parts			
Control I/O Card	ATV312 Replacement Control I/O Card	ATV312 all ranges	VW3A31201 95.00
Fan Kit	ATV312 Replacement Fan Kit	ATV312HU11M3, ATV312HU15M3, ATV312HU11M2, ATV312HU15M2, ATV312HU22M3, ATV312H037N4, ATV312H055N4, ATV312H075N4, ATV312HU11N4, ATV312HU15N4, ATV312H075S6, ATV312HU15S6	VZ3V3101 44.00
Fan Kit	ATV312 Replacement Fan Kit	ATV312HU22M2, ATV312HU30M3, ATV312HU40M3, ATV312HU22N4, ATV312HU30N4, ATV312HU40N4, ATV312HU22S6, ATV312HU40S6	VZ3V3102 44.00
Fan Kit	ATV312 Replacement Fan Kit	ATV312HU55M3, ATV312HU75M3, ATV312HU55N4, ATV312HU75N4, ATV312HU55S6, ATV312HU75S6	VZ3V3103 61.00
Fan Kit	ATV312 Replacement Fan Kit	ATV312HD11M3, ATV312HD15M3	VZ3V3104 61.00

NOTE: Reference Catalog #8800CT0401 for communication cables.

Table 25: Configuration Tools

Description	Part Number	For Use on Drives	\$ Price
Universal Bluetooth Interface: Bluetooth connectivity to devices through serial RS-485, RJ45 Modbus port. For permanent installation, to be used during commissioning, maintenance and troubleshooting of equipment.	TCSWAAC13FB	Altivar 12, 212, 312, 61, 71, and Altistart 22	180.00
Simple Loader: to transfer configuration between like drives. For use with the Altivar product line.	VW3A8120	ATV12, ATV312, ATV32, ATV61 and ATV71	175.00
Multi-loader: to copy a configuration from a drive or from SoMove via an SD card, and transferring to another drive or to a PC	VW3A8121	ATV12, ATV312, ATV212, ATV32, ATV61, ATV71 and ATS22	350.00

■ Discount Schedule for this product is PC41.

Table 26: Options—Field Installed Kits

Description	For Use on Drives	Catalog Number	\$ Price
DIN Rail Mount Kit	ATV312H018M2, ATV312H037M2, ATV312H055M2, ATV312H075M2, ATV312H018M3, ATV312H037M3, ATV312H055M3, ATV312H075M3	VW3A9804	72.00
	ATV312HU11M2, ATV312HU15M2, ATV312HU11M3, ATV312HU15M3, ATV312HU22M3, ATV312H037N4, ATV312H055N4, ATV312H075N4, ATV312HU11N4, ATV312HU15N4, ATV312H075S6, ATV312HU15S6	VW3A9805	72.00
Conduit Entrance Kit	ATV312H018M2, ATV312H037M2, ATV312H055M2, ATV312H075M2, ATV312H055M3, ATV312H075M3	VW3A31812	45.00
	ATV312H018M3, ATV312H037M3, ATV312H055M3, ATV312H075M3	VW3A31811	45.00
	ATV312HU11M3, ATV312HU15M3	VW3A31813	45.00
	ATV312HU11M2, ATV312HU15M2, ATV312HU22M3, ATV312H037N4, ATV312H055N4, ATV312H075N4, ATV312HU11N4, ATV312HU15N4, ATV312H075S6, ATV312HU15S6	VW3A31814	45.00
	ATV312HU22M2, ATV312HU30M3, ATV312HU40M3, ATV312HU22N4, ATV312HU30N4, ATV312HU40N4, ATV312HU22S6, ATV312HU40S6	VW3A31815	45.00
	ATV312HU55M3, ATV312HU75M3, ATV312HU55N4, ATV312HU75N4, ATV312HU55S6, ATV312HU75S6	VW3A31816	45.00
	ATV312HD11M3, ATV312HD15M3, ATV312HD11N4, ATV312HD15N4, ATV312HD11S6, ATV312HD15S6	VW3A31817	45.00

Options—Field Installed Kits (continued)

Description		For Use on Drives	Catalog Number	\$ Price			
ATV28 Replacement Kit	This kit contains brackets that adapt the spacing of the ATV312 mounting holes to be equivalent to that of an ATV28 with the same rating. This will permit the ATV312 to be secured to the panel holes and mounting hardware already in place for the ATV28.	ATV312H018M2, ATV312H037M2, ATV312H055M2, ATV312H075M2, ATV312H018M3, ATV312H037M3, ATV312H055M3, ATV312H075M3	VW3A31821	25.00			
		ATV312HU11M2, ATV312HU15M2, ATV312HU11M3, ATV312HU15M3, ATV312HU22M3, ATV312H075S6, ATV312HU15S6	VW3A31822	25.00			
		ATV312HU55M3, ATV312HU75M3, ATV312HU55N4, ATV312HU75N4, ATV312HU55S6, ATV312HU75S6	VW3A31823	25.00			
Dynamic Braking Resistor Kit	DB resistors are provided in a Type 1 enclosure and are thermally protected.	ATV312H018M2-037M2, ATV312H018M3-037M3, ATV312H037N4-U40N4	VW3A66711	422.00			
		ATV312H055M2-U22M2, ATV312H055M3-U22M3, ATV312HU55N4-U75N4	VW3A66712	633.00			
		ATV312HU30M3-U40M3, ATV312HD11N4-D15N4	VW3A66713	950.00			
		ATV312HU55M3-U75M3	VW3A66714	1266.00			
		ATV312HD11M3-D15M3	VW3A66715	1846.00			
Line Reactors	230/460 V	See page 56 of this Price Guide.					
	575 V	Open Style	ATV312H075S6	RL00202▲	158.00		
			ATV312HU15S6, ATV312HU22S6	RL00403▲	163.00		
			ATV312HU40S6, ATV312HU55S6, ATV312HU75S6, ATV312HD11S6, ATV312HD15S6	RL00803▲, RL00802▲, RL01202▲, RL01802▲, RL02502▲	245.00, 179.00, 200.00, 253.00, 291.00		
			ATV312H075S6	RL00212▲	289.00		
			ATV312HU15S6, ATV312HU22S6	RL00413▲	294.00		
		Enclosed (Type 1)	ATV312HU40S6, ATV312HU55S6, ATV312HU75S6, ATV312HD11S6, ATV312HD15S6	RL00813▲, RL00812▲, RL01212▲, RL01812▲, RL02512▲	379.00, 310.00, 332.00, 388.00, 507.00		
			RFI Input Filter	Single-phase supply voltage: 200–240 V 50/60 Hz	ATV312H037M2, ATV312H055M2, ATV312H075M2	VW3A31401	58.00
					ATV312HU11M2, ATV312HU15M2	VW3A31403	79.00
					ATV312HU22M2	VW3A31405	108.00
3 phase supply voltage: 200–240 V 50/60 Hz				ATV312H018M3, ATV312H037M3, ATV312H055M3, ATV312H075M3	VW3A31402	72.00	
	ATV312HU11M3, ATV312HU15M3, ATV312HU22M3	VW3A31404		90.00			
	ATV312HU30M3, ATV312HU40M3	VW3A31406		133.00			
	ATV312HU55M3, ATV312HU75M3	VW3A31407		189.00			
	ATV312HD11M3, ATV312HD15M3	VW3A31408		297.00			
	ATV312HD11N4, ATV312HD15N4	VW3A31409		243.00			
3 phase supply voltage: 380–500 V 50/60 Hz	ATV312H037N4, ATV312H055N4, ATV312H075N4, ATV312HU11N4, ATV312HU15N4	VW3A31404	90.00				
	ATV312HU22N4, ATV312HU30N4, ATV312HU40N4	VW3A31406	133.00				
	ATV312HU55N4, ATV312HU75N4	VW3A31407	189.00				
ATV312HD11N4, ATV312HD15N4	VW3A31409	243.00					

▲ Discount schedule for line reactors is CP4C.

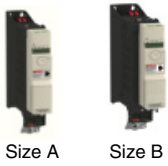

Size A Size B



Size C



Size D

Selection and Pricing

The Altivar™ 32 is intended for use with three-phase asynchronous and synchronous motors.

Select the Altivar 32 using the nameplate voltage and full load ampere rating of the motor and the table below. The horsepower ratings are for reference only.

Table 27: Altivar 32 Selection and Pricing

Input Line Voltage	Three-Phase Motor Power		Continuous Output Current	Catalog Number	Dimensions						Frame Size	\$ Price
	HP	kW			A	W		H		D		
			IN			mm	IN	mm	IN	mm		
200–240 Vac Single-Phase Input	0.25	0.18	1.5	ATV32H018M2	1.77	45	12.8	325	9.65	245	A	335.00
	0.50	0.37	3.3	ATV32H037M2	1.77	45	12.8	325	9.65	245	A	365.00
	0.75	0.55	3.7	ATV32H055M2	1.77	45	12.8	325	9.65	245	A	395.00
	1	0.75	4.8	ATV32H075M2	1.77	45	12.8	325	9.65	245	A	420.00
	1.5	1.10	6.9	ATV32HU11M2	2.36	60	12.8	325	9.65	245	B	475.00
	2	1.50	8	ATV32HU15M2	2.36	60	12.8	325	9.65	245	B	525.00
380–480 Vac Three-Phase Input	2	2.20	11	ATV32HU22M2	2.36	60	12.8	325	9.65	245	B	620.00
	0.50	0.37	1.5	ATV32H037N4	1.77	45	12.8	325	9.65	245	A	490.00
	0.75	0.55	1.9	ATV32H055N4	1.77	45	12.8	325	9.65	245	A	525.00
	1	0.75	2.3	ATV32H075N4	1.77	45	12.8	325	9.65	245	A	550.00
	1.5	1.1	3	ATV32HU11N4	1.77	45	12.8	325	9.65	245	A	602.00
	2	1.5	4.1	ATV32HU15N4	1.77	45	12.8	325	9.65	245	A	665.00
	3	2.2	5.5	ATV32HU22N4	2.36	60	12.8	325	9.65	245	B	751.00
	4	3	7.1	ATV32HU30N4	2.36	60	12.8	325	9.65	245	B	852.00
	5	4	9.5	ATV32HU40N4	2.36	60	12.8	325	9.65	245	B	980.00
	7.5	5.5	14.3	ATV32HU55N4	5.90	150	9.25	235	9.13	232	C	1191.00
	10	7.5	17	ATV32HU75N4	5.90	150	9.25	235	9.13	232	C	1455.00
	15	11	27.7	ATV32HD11N4	7.08	180	13	330	9.13	232	D	1825.00
20	15	33	ATV32HD15N4	7.08	180	13	330	9.13	232	D	2325.00	

Network Communication Option Cards

The Altivar 32 can accept one of the following network communication option cards. The card slides into the Altivar 32 without taking up addition panel space, CANopen from the embedded port is disabled when an option card is installed.



VW3 A3 608



VW3 A3 628



VW3 A3 616



Mounting using VW3A9920



GV mounted using VW3A9921 and GV 2AF4



Mounting using VW3M7101R01

Table 28: Network Communication Option Card Selection and Pricing

Description	Catalog Number	Qty.	\$ Price
CANopen daisy chain option card, two RJ45 ports	VW3A3608▲		130.00
0.3 meter CANopen cable with two RJ45 connectors	VW3CANCARR03		25.00
1 meter CANopen cable with two RJ45 connectors	VW3CANCARR1		25.00
CANopen end of line terminator with RJ45 connector	TCSCAR013M120▲	2	20.00
IP20 CANopen junction box with: 2 screw terminal blocks for trunk cable tap connection 2 RJ45 connectors for connection to drives 1 RJ45 connector for connecting a PC	VW3CANTAP2		130.00
CANopen single port option card, 9 pin male SUB-D connector	VW3A3618▲		149.00
CANopen single port option card, removable 5 position screw connector	VW3A3628		130.00
Profibus DP V1 single port option card, 9 pin male SUB-D connector Supports CiA 402 drive profile and Profidrive profile, Offers several message handling modes based on DP V1	VW3A3607▲		281.00
DeviceNet™ single port option card, removable 5 position screw connector Supports CIP AC drive profile and CiA 402 drive profile.	VW3A3609		185.00
Ethernet IP—Modbus™ TCP/IP daisy chain option card, two RJ45 ports 10/100 Mbps, half duplex and full duplex, embedded web server,	VW3A3616▲		250.00
EtherCAT daisy chain option card, two RJ45 ports	VW3A3601▲		300.00

▲ Discount Schedule for this product is PC51.

Table 29: Mounting Accessories

Description	For Use On	Catalog Number	Qty.	\$ Price
Adaptor to mount the ATV32 control module rotated 90° Use this adaptor to mount the ATV32 control module rotated 90°, allowing the ATV32 to be mounted in a shallow enclosure.	ATV32H...M2 to ATV32H037N4...U40N4	VW3A9920	1	45.00
Bracket for mounting GV2 manual protector on an ATV 32 Metal bracket mounts to the ATV32 and holds a GV2. Requires a GV2AF4 adaptor for electrical connections. Must order in sets of 10.	ATV32H...M2 to ATV32H037N4...U40N4	VW3A9921	1	4.50
Adaptor for use with mounting a GV2 on an ATV 32 Provides electrical power connections between GV2 and ATV32. Requires a VW39921 bracket to mount the GV2. Must order in sets of 10.	ATV32H...M2 to ATV32H037N4...U40N4	GV2AF4▲	1	3.20

▲ Discount Schedule for this product is I11.

DC Bus Connectors

Use these connectors to daisy chain multiple Altivar 32 drives together to balance acceleration and decelerating loads. (Use in addition to dynamic braking resistors in this type of application.) Or use these connectors when the drives are powered at the DC bus only.

Table 30: Mounting Accessories

Description	Use To Connect	Catalog Number	Qty.	\$ Price
Daisy chain DC bus cord with two connectors	ATV32H...M2 ATV32H037N4...U40N4	VW3M7101R01■	5	83.00
Daisy chain DC bus cord with one connector and flying leads at one end	ATV32H037N4...U40N4 to ATV32HU55N4...D15N4	VW3M7102R150■		115.00
Daisy chain DC bus cord with two connectors	ATV32H037N4...U40N4 to ATV32HU55N4...D15N4	VW3M2207■	10	115.00

■ Discount Schedule for this product is PC51.

Options and Accessories

IP 65 Rated Dynamic Braking Resistors for the Altivar™ 32

For use with high inertia motor loads, generating motor mode loads and machines with fast cycle times. See Altivar 32 Installation Manual for sizing information

Table 31: Altivar 32 Options and Accessories

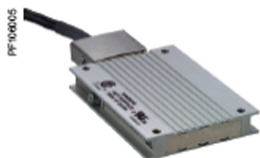

VW3 A7 608 R**

For Use On	Minimum Resistor Value to Connect to the Drive: ohms	Resistor Description Ohmic Value: Average Power Available at 50 °C		Catalog Number	Cable Length: m	\$ Price
		ohms	watts			
ATV32H018M2...H075M2 ATV32H037N4...H075N4	40 80	100	100	VW3A7608R07▲	0.75	305.00
ATV32HU11N4...HU22N4	54			VW3A7608R30▲	3	413.00
ATV32HU11M2...HU15M2	27	72	100	VW3A7605R07▲ VW3A7605R30▲	0.75 3	180.00 243.00
ATV32HU22M2	25	27	200	VW3A7603R07▲ VW3A7603R30▲	0.75 3	203.00 261.00
ATV32HU30N4 ATV32HU40N4	54 36	72	200	VW3A7606R07▲ VW3A7606R30▲	0.75 3	203.00 261.00
ATV32HU55N4...HU75N4	27	27	400	VW3A7604R07▲ VW3A7604R30▲	0.75 3	270.00 333.00

▲ Discount Schedule for this product is PC51.



VW3 A7 701

IP 20 Rated Dynamic Braking Resistors for the Altivar 32

For use with high inertia motor loads, generating motor mode loads and machines with fast cycle times. See Altivar 32 Installation Manual for sizing information

Table 32: Altivar 32 IP 20 Rated Dynamic Braking Resistors

For Use On	Minimum Resistor Value to Connect to the Drive: ohms	Resistor Description Ohmic Value: Average Power Available at 50 °C		Catalog Number	\$ Price
		ohms	watts		
ATV32H018M2...H075M2 ATV32HU11M2...HU15M2 ATV32H037N4...H075N4 ATV32HU11N4...HU30N4 ATV32HU40N4	40 27 80 54 36	100	50	VW3A7701	575.00
ATV32HU22M2 ATV32HU55N4...HU75N4	25 27				
ATV32HD11N4...HD15N4	18	28	200	VW3A7703	1165.00

EMC Input Filters for the Altivar 32

Maximum length in meter of shielded cable between drive and motor in reference to IEC 61800-3. Category 1 (C1) is for residential limits Category 2 (C2) is for industrial limit

Table 33: Altivar 32 EMC Input Filters

For Use On	Filter Mounts	Heat Loss Watts	Nominal Current Amps	Category C1 m	Category C2 m	Catalog Number	\$ Price
ATV32H018M2 ATV32H037M2 ATV32H055M2 ATV32H075M2	on side of drive	3.7	10.1	20	50	VW3A4420	79.00
ATV32HU11M2 ATV32HU15M2	on side of drive	6.9	17.6	20	50	VW3A4421	95.00
ATV32HU22M2	on side of drive	7.5	23.9	20	50	VW3A4426	120.00
ATV32H037N4 ATV32H055N4 ATV32H075N4 ATV32HU11N4 ATV32HU15N4	on side of drive	9.5	15	20	50	VW3A4422	79.00
ATV32HU22N4 ATV32HU30N4 ATV32HU40N4	on side of drive	15.8	25	20	50	VW3A4423	120.00
ATV32HU55N4 ATV32HU75N4	underneath drive	19.3	47	20	50	VW3A4424	145.00
ATV32HD11N4 ATV32HD15N4	underneath drive	27.4	49	20	50	VW3A4425	175.00

Output Motor Filters for the Altivar 32

Motor filters can be installed between the Altivar 32 and the motor to: • limit the dV/dt at the motor terminals • filter interference • reduce leakage current • filter the current wave form to create a smoother wave form to reduce motor noise. This listing is a global offer. See page 64 of this document for additional filters available in the USA.

Table 34: Altivar 32 Output Motor Filters

For Use On	Heat Loss Watts	Nominal Current Amps	Cable Length		Catalog Number	\$ Price
			Shielded m	Unshielded m		
ATV32HU22M2	75	16	<100	<200	VW3A4553▲	1489.00
ATV32HU22N4...HU40N4	65	10			VW3A4552▲	1379.00
ATV32HU55N4	75	16			VW3A4553▲	1489.00
ATV32HU75N4...HD11N4	90	30			VW3A4554▲	1720.00
ATV32HD15N4	80	60			VW3A4555▲	2085.00

▲ Discount Schedule for this product is PC51.

Table 35: Altivar™ 32 Options and Accessories

Description	For Use On	Catalog Number	\$ Price	
Software				
SoMove™ PC software enables the user to configure, set, diagnose and maintain the Altivar 32 drive. The ATV Logic and Safety functions embedded in the Altivar 32 drive must be configured with this software. The software can also be used to customize the integrated display terminal menus. It can be used with a direct connection or a Bluetooth® wireless connection. Free download www.schneider-electric.us				
Cable to connect PC to Altivar 32				
USB/RS485 cord set (equipped with RJ45 socket)		TCSMCNAM3M002P	52.00	
Remote Display Keypad and cables				
Remote LED Display Keypad Description: 4 digit, 8 keys, 50 °C rated				
IP54 keypad, also select remote keypad cable below IP65 keypad, also select remote keypad cable below	Altivar 12 & Altivar 32	VW3A1006■ VW3A1007■	65.00 65.00	
Remote LCD Graphic Display Keypad, cables and accessories				
Remote LCD Graphical Display Keypad Description:				
8 line, 24 characters per line, plain text, 8 keys, rotary wheel, 600 °C IP54 rated, Type 12	Altivar 212, 312, 32, 61, & 71	VW3A1101	115.00	
Remote LCD Graphical Keypad Mounting accessories				
IP54, Type 12 rated kit for remote mounting LCD Graphical keypad on enclosure door	VW3A1101	VW3A1102	55.00	
Clear plastic door for use with kit V■W3A1102 for IP65 rating and tamper resistance	VW3A1102	VW3A1103	45.00	
Female / Female right angle RJ45 adaptor, to connect cable and keypad.▲	VW3A1101	VW3A1105	35.00	
Remote Keypad Cables—Equipped with 2 RJ45 Connectors				
1 meter length	VW3A1101	VW3A1104R10	35.00	
3 meter length	VW3A1101	VW3A1104R30	35.00	
5 meter length	VW3A1101	VW3A1104R50	35.00	
10 meter length	VW3A1101	VW3A1104R100	35.00	
Modbus™ Serial Link—Connection via splitter box and RJ45 connectors				
	Length			
Modbus splitter box (with 10 RJ45 Connectors)	—	LU9GC3▲	312.00	
Cordsets for Modbus serial link (with 2 RJ45 connectors)	.3 m	LU9GC3	VW3A8306R03■	20.00
	1 m	LU9GC3	VW3A8306R10■	25.00
	3 m	LU9GC3	VW3A8306R30■	30.00
Modbus T-junction boxes (with integrated cables)	.3 m	LU9GC3	VW3A8306TF03■	75.00
	1 m	LU9GC3	VW3A8306TF10■	85.00
RJ45 Line Terminators (Sold in lots of 2)	—	LU9GC3	VW3A8306RC■	6.00
Configuration Loaders—Use to Upload Download and store drive configuration settings				
Simple Loader —Using RJ45 port on product, one product configuration can be downloaded from a product, stored & uploaded to similar products. Cable included.	Altivar 12, 312, 32, 61, 71	VW3A8120	175.00	
Multi-Loader —Multiple product configurations can be downloaded from a PC or drive, stored on an SD card and uploaded to similar products.	Altivar 12, 212, 312, 32, 61, 71 Altistart 22	VW3A8121	350.00	
Multi-loader Cable . Fitted with non-locking RJ45 connector and handle to reach into Altivar 12 & Altivar 32 packaging.	VW3A8121	VW3A8126	30.00	
Operator Interface				
Operator, mounting collar, 2.5 kilohm, ½ watt potentiometer	Altivar 32	ATVPOT25K	69.00	



VW3A1006



VW3A1101



Using the graphic terminal on enclosure door:

VW3A1102
VW3A1103
VW3A1101
VW3A1104R10



Multi-loader

Table 36: Altivar 32 Replacement Cooling Fans

These replacement cooling fans have a quick connect connector and snap into the Altivar 32.

Description	For Use On	Reference Number	\$ Price
Replacement Cooling Fans ♦	ATV32H018M2...075M2 ATV32H037N4...HU15N4	VZ3V32A100	75.00
	ATV32HU11M2...U22M2 ATV32HU22N4...HU40N4	VZ3V32B100	85.00
	ATV32HU55N4...ATV32U75N4	VZ3V32C100	105.00
	ATV32HD11N4...HD15N4	VZ3V32D100	135.00

♦ Available 2nd Quarter 2012.

Altivar™ 71 Single-Phase

In an application where it is necessary to use a 240 V single-phase input for a 3-phase motor, the drive must be derated; therefore, the power listed on the drive nameplate will be higher than the power rating on the motor nameplate.

See page 64 for line reactor selection and pricing.



Table 37: Altivar 71 Selection and Pricing

Input Line Voltage	With a 5% Line Reactor			Without a Line Reactor			Catalog Number with LCD Keypad	Price \$	Catalog Number to have ATV71 and Type 1 conduit entry kit shipped as one line item. Field installation required (Packaged as kit at warehouse).	Price \$	Catalog Number with LED Keypad (Non-stocked)	Price \$
	Motor Power		Continuous Output Current	Motor Power		Continuous Output Current						
	HP	kW	A	HP	kW	A						
208/240 Vac Single Phase	—	—	—	0.5	0.37	3	ATV71H075M3▲◆	717.00	ATV71H075M3T1◆	767.00	ATV71H075M3Z▲◆	613.00
	—	—	—	1	0.75	4.8	ATV71HU15M3▲◆	752.00	ATV71HU15M3T1◆	802.00	ATV71HU15M3Z▲◆	648.00
	—	—	—	2	1.5	8	ATV71HU22M3▲◆	876.00	ATV71HU22M3T1◆	925.00	ATV71HU22M3Z▲◆	771.00
	—	—	—	3	2.2	11	ATV71HU30M3▲◆	1082.00	ATV71HU30M3T1◆	1132.00	ATV71HU30M3Z▲◆	978.00
	—	3	13.7	—	—	—	ATV71HU40M3▲◆	1265.00	ATV71HU40M3T1◆	1315.00	ATV71HU40M3Z▲◆	1161.00
	5	4	17.5	—	—	—	ATV71HU55M3▲◆	1604.00	ATV71HU55M3T1◆	1653.00	ATV71HU55M3Z▲◆	1499.00
	7.5	5.5	27.5	5	4	17.5	ATV71HU75M3▲◆	1969.00	ATV71HU75M3T1◆	2019.00	ATV71HU75M3Z▲◆	1865.00
	10	7.5	33	7.5	5.5	27.5	ATV71HD15M3X▲◆◆	2850.00	ATV71HD15M3XT1◆◆	2895.00	ATV71HD15M3XZ▲◆◆	2755.00
	—	—	—	10	7.5	33	ATV71HD18M3X▲◆◆	3422.00	ATV71HD18M3XT1◆◆	3487.00	—	—
	15	11	54	—	—	—	ATV71HD22M3X▲◆◆	4170.00	ATV71HD22M3XT1◆◆	4253.00	—	—
	20	15	66	15	11	54	ATV71HD30M3X▲◆◆	5348.00	ATV71HD30M3XT1◆◆	5433.00	—	—
	25	18	75	20	15	66	ATV71HD37M3X▲◆◆	6212.00	ATV71HD37M3XT1◆◆	6297.00	—	—
	30	22	88	25	18	75	ATV71HD45M3X▲◆◆	7356.00	ATV71HD45M3XT1◆◆	7491.00	—	—

- ▲ Option to have product treated for increased protection for dusty and corrosive environments. This product is not stocked. On 0.5 hp to 5 hp at 230 Vac single-phase, add "S337" to the end of the catalog number. On 7.5 hp to 25 hp at 230 Vac single-phase, add "337" to the end of the catalog number. In both cases multiply price by 1.2 to obtain new price. With this option, exposed copper is tinned, circuit boards are conformal coated in critical areas and plastics are treated to better withstand the corrosive nature of certain oils.
- ◆ Product does not contain an EMC filter.
- ◆ Does not have a DC choke, has minimal inductance provided by the common mode choke and filtering on the input to drive. Inductance 1–2%.
- ★ Product contains an internal DC choke. Inductance is 2–3%.

Altivar 71 Three-Phase

Table 38: Altivar 71 Selection and Pricing

Input Line Voltage	Constant Torque			Catalog Number	\$ Price	Catalog Number ATV71 drive and Type 1 conduit entry kit	\$ Price	Catalog Number with LED Keypad (Non-stocked)	\$ Price
	Three-Phase Motor Power		Continuous Output Current						
	HP	kW	A						
208/240 Vac Three Phase	0.5	0.37	3	ATV71H037M3▲▼	678.00	ATV71H037M3T1▼	727.00	ATV71H037M3Z▲▼	573.00
	1	0.75	4.8	ATV71H075M3▲▼	717.00	ATV71H075M3T1▼	767.00	ATV71H075M3Z▲▼	613.00
	2	1.5	8	ATV71HU15M3▲▼	752.00	ATV71HU15M3T1▼	802.00	ATV71HU15M3Z▲▼	648.00
	3	2.2	11	ATV71HU22M3▲▼	876.00	ATV71HU22M3T1▼	925.00	ATV71HU22M3Z▲▼	771.00
	4	3	13.7	ATV71HU30M3▲▼	1082.00	ATV71HU30M3T1▼	1132.00	ATV71HU30M3Z▲▼	978.00
	5	4	17.5	ATV71HU40M3▲▼	1265.00	ATV71HU40M3T1▼	1314.00	ATV71HU40M3Z▲▼	1161.00
	7.5	5.5	27.5	ATV71HU55M3▲▼	1604.00	ATV71HU55M3T1▼	1653.00	ATV71HU55M3Z▲▼	1499.00
	10	7.5	33	ATV71HU75M3▲▼	1969.00	ATV71HU75M3T1▼	2019.00	ATV71HU75M3Z▲▼	1865.00
	15	11	54	ATV71HD11M3X▲◆△	2497.00	ATV71HD11M3XT1◆◆△	2547.00	ATV71HD11M3XZ▲◆△	2393.00
	20	15	66	ATV71HD15M3X▲◆△	2850.00	ATV71HD15M3XT1◆◆△	2895.00	ATV71HD15M3XZ▲◆△	2755.00
	25	18	75	ATV71HD18M3X▲◆△	3422.00	ATV71HD18M3XT1◆◆△	3487.00	—	—
	30	22	88	ATV71HD22M3X▲◆△	4170.00	ATV71HD22M3XT1◆◆△	4235.00	—	—
	40	30	120	ATV71HD30M3X▲◆△	5348.00	ATV71HD30M3XT1◆◆△	5433.00	—	—
	50	37	144	ATV71HD37M3X▲◆△	6212.00	ATV71HD37M3XT1◆◆△	6297.00	—	—
	60	45	176	ATV71HD45M3X▲◆△	7356.00	ATV71HD45M3XT1◆◆	7491.00	—	—
	75	55	221	ATV71HD55M3X▲◆◆★	8870.00	ATV71HD55M3XT1◆◆	9330.00	—	—
	100	75	285	ATV71HD75M3X▲◆◆★	10658.00	ATV71HD75M3XT1◆◆	11211.00	—	—

- ▲ Option to have product treated for increased protection for dusty and corrosive environments. This product is not stocked. On 0.5 hp to 10 hp at 230 Vac 3 phase and up to 100 hp at 460 V, add "S337" to the end of the catalog number. On 15 hp to 60 hp at 230 Vac 3 phase, add "337" to the end of the catalog number. In both cases multiply price by 1.2 to obtain new price. With this option, exposed copper is tinned, circuit boards are conformal coated in critical areas and plastics are treated to better withstand the corrosive nature of certain oils. This option is standard on 55 kW/75 hp @ 230 Vac 3 phase and higher & 90 kW/125 hp @ 460 Vac and higher.
- ◆ Product does not contain an EMC filter.
- ◆ Product ships with a DC choke that must be field mounted. A 5% line reactor may be purchased and installed in place of the DC choke. Add "D" to the end of the catalog number to receive just the AC drive and multiply the listed price by .96 to obtain new price.
- ★ Conformal coating is standard.
- ▼ Does not have a DC choke, has minimal inductance provided by the common mode choke and filtering on the input to drive. Inductance 1–2%.
- △ Product contains an internal DC choke. Inductance is 2–3%.



LCD Keypad



LED Keypad





ATV71HC28N4



ATV71HC31Y

Altivar™ 71 Selection and Pricing (continued)

Input Line Voltage	Constant Torque			 Catalog Number with LCD Keypad (Stocked)	\$ Price	 Catalog Number to have ATV71 drive and Type 1 conduit entry kit shipped as one line item. Field installation required (Packaged as kit at warehouse).	\$ Price	 Catalog Number with LED Keypad (Non-stocked)	\$ Price
	Three-Phase Motor Power		Continuous Output Current						
	HP	KW	A						
400/480 Vac Three Phase	1	0.75	2.3	ATV71H075N4◆◆□	873.00	ATV71H075N4T1□	923.00	ATV71H075N4Z▲□	769.00
	2	1.5	4.1	ATV71HU15N4◆◆□	1003.00	ATV71HU15N4T1□	1053.00	ATV71HU15N4Z▲□	899.00
	3	2.2	5.8	ATV71HU22N4◆◆□	1221.00	ATV71HU22N4T1□	1271.00	ATV71HU22N4Z▲□	1117.00
	4	3	7.8	ATV71HU30N4◆◆□	1375.00	ATV71HU30N4T1□	1425.00	ATV71HU30N4Z▲□	1271.00
	5	4	10.5	ATV71HU40N4◆◆□	1448.00	ATV71HU40N4T1□	1497.00	ATV71HU40N4Z▲□	1343.00
	7.5	5.5	14.3	ATV71HU55N4◆◆□	1742.00	ATV71HU55N4T1□	1792.00	ATV71HU55N4Z▲□	1638.00
	10	7.5	17.6	ATV71HU75N4◆◆□	2116.00	ATV71HU75N4T1□	2166.00	ATV71HU75N4Z▲□	2012.00
	15	11	27.7	ATV71HD11N4◆◆□	2506.00	ATV71HD11N4T1□	2555.00	ATV71HD11N4Z▲□	2401.00
	20	15	33	ATV71HD15N4◆◆□	3059.00	ATV71HD15N4T1□	3107.00	ATV71HD15N4Z▲□	2956.00
	25	18	41	ATV71HD18N4◆◆□	3408.00	ATV71HD18N4T1□	3453.00	ATV71HD18N4Z▲□	3313.00
	30	22	48	ATV71HD22N4◆◆□	3710.00	ATV71HD22N4T1□	3775.00	ATV71HD22N4Z▲□	3615.00
	40	30	66	ATV71HD30N4◆◆□	4566.00	ATV71HD30N4T1□	4631.00	ATV71HD30N4Z▲□	4471.00
	50	37	79	ATV71HD37N4◆◆□	5370.00	ATV71HD37N4T1□	5435.00	ATV71HD37N4Z▲□	5275.00
	60	45	94	ATV71HD45N4◆◆□	6742.00	ATV71HD45N4T1□	6877.00	ATV71HD45N4Z▲□	6647.00
	75	55	116	ATV71HD55N4◆◆□	7762.00	ATV71HD55N4T1□	7897.00	ATV71HD55N4Z▲□	7667.00
	100	75	160	ATV71HD75N4◆◆□	8862.00	ATV71HD75N4T1□	8997.00	ATV71HD75N4Z▲□	8767.00
	125	90	179	ATV71HD90N4◆◆□	10716.00	ATV71HD90N4T1□	11222.00	—	—
	150	110	215	ATV71HC11N4◆◆◆	12652.00	—	—	—	—
	200	130	259	ATV71HC13N4◆◆◆	15170.00	—	—	—	—
	250	160	314	ATV71HC16N4◆◆◆	17138.00	—	—	—	—
	300	200	387	ATV71HC20N4◆◆◆	20084.00	—	—	—	—
400	250	481	ATV71HC25N4◆◆◆	23646.00	—	—	—	—	
450	280	550	ATV71HC28N4◆◆◆	28062.00	—	—	—	—	
500	310	616	ATV71HC31N4◆◆◆	33506.00	—	—	—	—	
600	400	759	ATV71HC40N4◆◆◆	44870.00	—	—	—	—	
700	500	941	ATV71HC50N4◆◆◆	62449.00	—	—	—	—	
500/600 Vac Three Phase	2	1.5	3.2	ATV71HU15S6X★	1889.00	—	—	—	—
	3	2.2	4.5	ATV71HU22S6X★	1990.00	—	—	—	—
	4	3	5.8	ATV71HU30S6X★	2175.00	—	—	—	—
	5	4	7.5	ATV71HU40S6X★	2380.00	—	—	—	—
	7.5	5.5	10	ATV71HU55S6X★	2799.00	—	—	—	—
	10	7.5	13.5	ATV71HU75S6X★	3380.00	—	—	—	—
575/690 Vac Three Phase	15	15	17	ATV71HD15Y★	5780.00	—	—	—	—
	20	18.5	22	ATV71HD18Y★	5780.00	—	—	—	—
	25	22	27	ATV71HD22Y★	5780.00	—	—	—	—
	30	30	32	ATV71HD30Y★	6999.00	—	—	—	—
	40	37	41	ATV71HD37Y★	8579.00	—	—	—	—
	50	45	52	ATV71HD45Y★	10379.00	—	—	—	—
	60	55	62	ATV71HD55Y★	12199.00	—	—	—	—
	75	75	77	ATV71HD75Y★	14399.00	—	—	—	—
	100	90	99	ATV71HD90Y★	16899.00	—	—	—	—
	125	110	125	ATV71HC11Y★▼	22056.00	—	—	—	—
	150	132	150	ATV71HC13Y★▼	28554.00	—	—	—	—
	175	160	180	ATV71HC16Y★▼	29148.00	—	—	—	—
	200	200	220	ATV71HC20Y★▼△	35319.00	—	—	—	—
	250	250	290	ATV71HC25Y★▼△	43859.00	—	—	—	—
	350	315	355	ATV71HC31Y★▼△	56100.00	—	—	—	—
	450	400	420	ATV71HC40Y★▼△	71508.00	—	—	—	—
	550	500	543	ATV71HC50Y★▼△	94188.00	—	—	—	—
700	630	675	ATV71HC63Y★▼△	124068.00	—	—	—	—	

- ▲ Option to have product treated for increased protection for dusty and corrosive environments. This product is not stocked. Up to 100 hp at 460 V, add "S337" to the end of the catalog number and multiply price by 1.2 to obtain new price. With this option, exposed copper is tinned, circuit boards are conformal coated in critical areas and plastics are treated to better withstand the corrosive nature of certain oils. This option is standard on 90 kW/125 hp @ 460 Vac and higher.
- Product ships with a DC choke that must be field mounted. A 5% line reactor may be purchased and installed in place of the DC choke. Add "D" to the end of the catalog number to receive just the AC drive and multiply the listed price by .96 to obtain new price.
- ◆ Also possible for use with a synchronous motor. Add "383" to the end of the catalog number and multiply the listed price by 1.2 to obtain new price.
- ★ Conformal coating is standard.
- ▼ An AC 5% line reactor which must be ordered separately is mandatory.
- △ These products do not contain a dynamic braking transistor. A separate transistor must be added for applications requiring dynamic braking.
- Does not have a DC choke, has minimal inductance provided by the common mode choke and filtering on the input drive. Inductance 1–2%.
- ◇ Product contains an internal DC choke, inductance 2–3%.
- ☆ Product does not contain EMC filter. All boards are conformal coated.

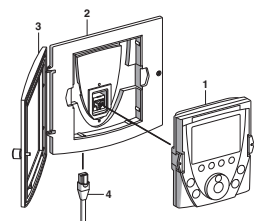

LCD Keypad Mounting Kits

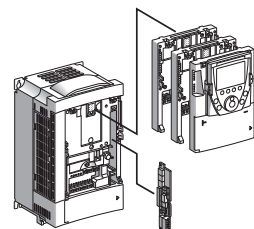

Option Card Assembly

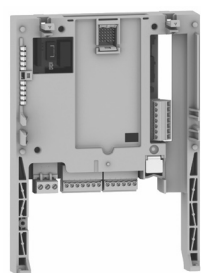

I/O Option Card

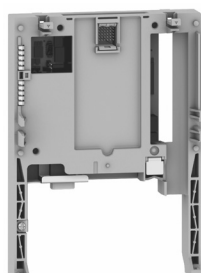

Communication Option Card



Incremental Encoder Interface Option Card

Table 39: Options—Field Installed

Description		For Use on Drives	Catalog No.	\$ Price	
Operator Interface	LCD graphic keypad: IP54 rating	any ATV61 any ATV71	VW3A1101	115.00	
	Remote mounting kit: includes bezel and mounting hardware		VW3A1102	55.00	
	Door for use with remote mount kit for IP65 rating		VW3A1103	45.00	
	Cable for remote mounting LCD graphic keypad RJ-45 connector on each end		1 meter	VW3A1104R10	35.00
			3 meters	VW3A1104R30	35.00
			5 meter	VW3A1104R50	35.00
			10 meters	VW3A1104R100	45.00
RJ-45 female—female adaptor to connect LCD keypad and cable. Not required if using VW3A1102.	VW3A1105	35.00			
Operator, mounting collar, 2.5 kilohm, 1/2 watt potentiometer	Altivar 71	ATVPOT25K	69.00		
Software					
SoMove™ Lite This software enables the user to configure, set, debug and organize maintenance task for the Altivar drive. It can also be used to customize the integrated display terminal menus. It can be used with a direct connection or a Bluetooth® wireless connection. Free download at http://products.schneider-electric.us/products-services/products/ac-drives-and-soft-starts/					
USB to RJ45 adaptor	For use in connecting to a PC with a USB port	Advantys™ OTB, Allstart™ motor starters, Altivar series including HMI, Altivar controller	TCSMCNAM3M002P	52.00	
Universal Bluetooth Interface ♦	Bluetooth connectivity to devices through serial RS-485, RJ45 Modbus port. For permanent installation, to be used during commissioning, maintenance and troubleshooting of equipment.	Altivar 12, 212, 312, 61, 71 Allstart 22	TCSWAAC13FB	180.00	
I/O Adaptor	115 Vac logic input adaptor adapts 7 logic inputs for use with user supplied 115 Vac signals	any ATV61 any ATV71	VW3A3101	195.00	
I/O Extension Option Cards	Basic I/O option card—4 logic inputs, 2 logic outputs, 1 Form C relay output, an input for PTC motor probes, a 24 Vdc output, a—10 Vdc output	any ATV61 any ATV71	VW3A3201	165.00	
	Extended I/O option card—contains all the I/O on the Basic I/O option card plus 2 analog inputs, 2 analog outputs, 1 pulse input		VW3A3202	195.00	
CANopen Adapter	This adaptor connects to the RJ-45 port and provides a 9-pin male SUB-D connector conforming to the CANopen standard (CIA DRP 303-1)	any ATV61 any ATV71	VW3CANA71	45.00	
CANopen Connector	9-pin female SUB-D with line terminator (can be disabled). 180° cable outlet CAN-H, CAN-L, CAN-GND connection	any ATV61 any ATV71	VW3CANKCDF180T	45.00	
Incremental Encoder Interface Option Cards	with RS-422 outputs, 5 Vdc	any ATV71	VW3A3401	85.00	
	with RS-422 outputs, 15 Vdc		VW3A3402	85.00	
	with open collector outputs, 12 Vdc		VW3A3403	85.00	
	with open collector outputs, 15 Vdc		VW3A3404	85.00	
	with push-pull outputs, 12 Vdc		VW3A3405	85.00	
	with push-pull outputs, 15 Vdc		VW3A3406	85.00	
	with push-pull outputs, 24 Vdc		VW3A3407	85.00	
	Resolver		VW3A3408▲	85.00	
	Universal with SinCos, SinCos Hiperface®, SinCos EnDat® or SSI output		VW3A3409▲	85.00	
	incremental with RS422 outputs and encoder emulation		VW3A3411▲	85.00	
Communication Option Cards	Modbus / Uni-Telway™ card	any ATV61 any ATV71	VW3A3303	225.00	
	Modbus TCP/IP Daisy Chain		VW3A3310D	275.00	
	Interbus® S card		VW3A3304	550.00	
	Profibus DP card		VW3A3307	550.00	
	Profibus DPv1 card		VW3A3307S371	550.00	
	DeviceNet™ card		VW3A3309	225.00	
	Ethernet/IP™ card		VW3A3316	275.00	
	LonWorks® card		VW3A3312	550.00	
	Metasys® N2 card with removable 4 position screw connector		VW3A3318	225.00	
	Apogee® FLN P1 card		VW3A3314	225.00	
BACnet card with removable 4 position screw connector	VW3A3319	225.00			
IMC Option Card	ATV IMC drive controller card ♦		VW3A3521S0★	755.00	
Controller Inside Option Card	Programmable option card, conforms with IEC61131-3 programming standard. (Software for this option card is available after completing training class offered by Schneider Electric Services.)	any ATV61 any ATV71	VW3A3501■	550.00	
Water Solutions Control Card	This option card contains a variety of pre-programmed functions and features to manage multi-pump installations.	any ATV61 any ATV71	VW3A3503■	650.00	
Simple Loader	Using RJ45 port connections, the configurations of a drive can be downloaded then uploaded to compatible drive.	ATV312, ATV32, ATV61 and ATV71	VW3A8120	175.00	

- ▲ For use with the ATV71H...383 drive ONLY.
- The drive cannot support the VW3A3503 water solutions card and the VW3A3501 controller inside option card simultaneously.
- ♦ SoMachine is required to use this product.
- ★ Discount Schedule for this product is PC41.

Table 39: Options—Field Installed (continued)

Description		For Use on Drives	Catalog No.	\$ Price	
Fan Kit	Installation of kit enables the drive to operate in higher ambient temperatures. Fan mounts on drive. Consult the product catalog for more information.	ATV61/71HD18M3X...HD22M3X, ATV61/71HD22N4	VW3A9404	135.00	
		ATV61/71HD30N4...HD37N4	VW3A9405	145.00	
		ATV61/71HD30M3X...HD45M3X	VW3A9406	165.00	
		ATV61/71HD45N4...HD75N4	VW3A9407	195.00	
ATV61: Options and Accessories—Variable Torque Applications					
Description		ATV58 Drive	Replaced by	Reference Mounting Plate	\$ Price
Single-phase supply voltage: 200...240 V 50/60 Hz					
		ATV58HU09M2ZU	ATV61H075M3	VW3A9301	83.00
		ATV58HU18M2ZU	ATV61HU15M3	VW3A9301	83.00
		ATV58HU29M2ZU	ATV61HU22M3	VW3A9303	83.00
		ATV58HU41M2ZU	ATV61HU30M3	VW3A9303	83.00
		ATV58HU72M2ZU	ATV61HU40M3	VW3A9304	93.00
		ATV58HU90M2ZU	ATV61HU55M3	VW3A9306	133.00
		ATV58HD12M2ZU	ATV61HU75M3	VW3A9307	133.00
Three-phase supply voltage: 200...240 V 50/60 Hz					
		ATV58HU29M2ZU	ATV61HU15M3	VW3A9302	83.00
		ATV58HU41M2ZU	ATV61HU22M3	VW3A9303	83.00
		ATV58HU54M2ZU	ATV61HU30M3	VW3A9304	93.00
		ATV58HU72M2ZU	ATV61HU40M3	VW3A9304	93.00
		ATV58HU90M2ZU	ATV61HU55M3	VW3A9306	133.00
		ATV58HD12M2ZU	ATV61HU75M3	VW3A9307	133.00
		ATV58HD16M2XZU	ATV61HD11M3X	VW3A9309	170.00
		ATV58HD16M2XZU	ATV61HD15M3X	VW3A9309	170.00
		ATV58HD23M2XZU	ATV61HD18M3X	VW3A9310	170.00
		ATV58HD28M2XZU	ATV61HD22M3X	VW3A9312	337.00
		ATV58HD33M2XZU	ATV61HD30M3X	VW3A9312	337.00
		ATV58HD46M2XZU	ATV61HD37M3X	VW3A9312	337.00
Three-phase supply voltage: 380...480 V 50/60 Hz					
		ATV58HU18N4ZU	ATV61H075N4	VW3A9302	83.00
		ATV58HU29N4ZU	ATV61HU15N4	VW3A9302	83.00
		ATV58HU41N4ZU	ATV61HU22N4	VW3A9302	83.00
		ATV58HU54N4XZU	ATV61HU40N4	VW3A9304	93.00
		ATV58HU72N4XZU	ATV61HU55N4	VW3A9305	93.00
		ATV58HU90N4XZU	ATV61HU75N4	VW3A9305	93.00
		ATV58HD12N4XZU	ATV61HD11N4	VW3A9307	133.00
		ATV58HD16N4XZU	ATV61HD15N4	not available	—
		ATV58HD23N4XZU	ATV61HD18N4	VW3A9308	138.00
		ATV58HD28N4XZU	ATV61HD22N4	VW3A9310	170.00
		ATV58HD33N4XZU	ATV61HD30N4	VW3A9310	170.00
		ATV58HD46N4XZU	ATV61HD37N4	VW3A9310	170.00
		ATV58HD54N4XZU	ATV61HD45N4	VW3A9312	337.00
		ATV58HD64N4XZU	ATV61HD55N4	VW3A9312	337.00
		ATV58HD79N4XZU	ATV61HD75N4	VW3A9312	337.00
ATV71: Options and Accessories—Constant Torque Applications					
Description		ATV58 Drive	Replaced by	Reference Mounting Plate	\$ Price
Single-phase supply voltage: 200...240 V 50/60 Hz					
		ATV58HU09M2ZU	ATV71H075M3	VW3A9301	83.00
		ATV58HU18M2ZU	ATV71HU15M3	VW3A9301	83.00
		ATV58HU29M2ZU	ATV71HU22M3	VW3A9303	83.00
		ATV58HU41M2ZU	ATV71HU30M3	VW3A9303	83.00
		ATV58HU72M2ZU	ATV71HU40M3	VW3A9304	93.00
		ATV58HU90M2ZU	ATV71HU55M3	VW3A9306	133.00
		ATV58HD12M2ZU	ATV71HU75M3	VW3A9307	133.00
Three-phase supply voltage: 200...240 V 50/60 Hz					
		ATV58HU29M2ZU	ATV71HU15M3	VW3A9302	83.00
		ATV58HU41M2ZU	ATV71HU22M3	VW3A9303	83.00
		ATV58HU54M2ZU	ATV71HU30M3	VW3A9304	93.00
		ATV58HU72M2ZU	ATV71HU40M3	VW3A9304	93.00
		ATV58HU90M2ZU	ATV71HU55M3	VW3A9306	133.00
		ATV58HD12M2ZU	ATV71HU75M3	VW3A9307	133.00
		ATV58HD16M2XZU	ATV71HD11M3X	VW3A9309	170.00
		ATV58HD23M2XZU	ATV71HD15M3X	VW3A9309	170.00
		ATV58HD28M2XZU	ATV71HD18M3X	VW3A9312	337.00
		ATV58HD33M2XZU	ATV71HD22M3X	VW3A9312	337.00
		ATV58HD46M2XZU	ATV71HD30M3X	VW3A9312	337.00
Three-phase supply voltage 380...480 V 50/60 Hz					
		ATV58HU18N4ZU	ATV71H075N4	VW3A9302	83.00
		ATV58HU29N4ZU	ATV71HU15N4	VW3A9302	83.00
		ATV58HU41N4ZU	ATV71HU22N4	VW3A9302	83.00
		ATV58HU54N4ZU	ATV71HU30N4	VW3A9304	93.00
		ATV58HU72N4ZU	ATV71HU40N4	VW3A9304	93.00
		ATV58HU90N4ZU	ATV71HU55N4	VW3A9305	93.00
		ATV58HD12N4ZU	ATV71HU75N4	VW3A9306	133.00
		ATV58HD16N4ZU	ATV71HD11N4	VW3A9307	133.00
		ATV58HD23N4ZU	ATV71HD15N4	VW3A9308	138.00
		ATV58HD28N4ZU	ATV71HD18N4	VW3A9309	170.00
		ATV58HD33N4ZU	ATV71HD22N4	VW3A9310	170.00
		ATV58HD46N4ZU	ATV71HD30N4	VW3A9310	170.00
		ATV58HD54N4ZU	ATV71HD37N4	VW3A9312	337.00
		ATV58HD64N4ZU	ATV71HD45N4	VW3A9312	337.00
		ATV58HD79N4ZU	ATV71HD55N4	VW3A9312	337.00

Mounting Plate Kit
Kit includes: Mechanical adaptors required for mounting and Altivar™ 61/71 drive in the place of an Altivar 58 or Altivar 58F drive using same holes.

▲ Verify motor/drive ratings and application for proper replacement selections.
■ Catalog number may or may not contain an "X" in this position.

Table 39: Options—Field Installed (continued)

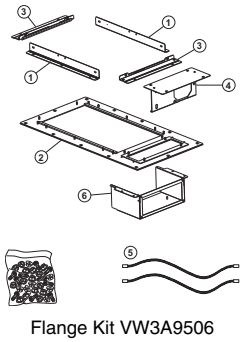

Description	For Use on Drives		Catalog No.	\$ Price
Flange Kit Kit includes: a metal frame, seals, mounting hardware, and bracket to mount fan kit so fan can be accessed from the front of the drive template. Kit used to mount the heatsink of the drive outside of an enclosure. To provide Type 12 rating.	ATV61/71H037M3...HU15M3		VW3A9501	255.00
	ATV61/71H075N4...HU22N4			
	ATV61/71HU22M3...HU40M3			
	ATV61/71HU30N4...HU40N4		VW3A9502	279.00
	ATV61/71HU55M3			
	ATV61/71HU55N4, HU75N4			
	ATV61/71HU75M3		VW3A9504	358.00
	ATV61/71HD11N4, ATV61/71...S6X			
	ATV61/71HD11M3X..HD15M3X			
	ATV61/71HD15N4, HD18N4		VW3A9505	419.00
	ATV61/71HD18M3X..HD22M3X			
	ATV61/71HD22N4, ATV61/71HU30Y...HD30Y			
	ATV61/71HD30N4, HD37N4		VW3A9507	469.00
	ATV61/71HD30M3X..HD45M3X			
	ATV61/71HD45N4...HD75N4, ATV61/71HD37Y...HD90Y			
	ATV61/71HD37Y...HD90Y		VW3A9509	477.00
	ATV61HD55M3X...HD75M3X			
	ATV61HD90N4...HC11N4			
	ATV71HD55M3X, ATV71HD90N4		VW3A9510	500.00
	ATV61HD90M3X, ATV61HC13N4			
	ATV71HD75M3X, ATV71HC11N4			
	ATV61HC16N4, ATV61HC20Y, ATV61/71HC11Y...HC16Y, ATV71HC13N4		VW3A9511	667.00
	ATV61HC22N4, ATV71HC16N4			
	ATV61HC25N4...HC31N4			
	ATV61HC40Y		VW3A9514	1053.00
	ATV61/71HC25Y, HC31Y			
	ATV71HC20N4...HC28N4			
	ATV61HC20Y		VW3A9515	1062.00
	ATV61HC25N4...HC31N4 with VW3A7101 braking transistor			
	ATV61HC40Y			
ATV61/71HC25Y, HC31Y		VW3A7101	1062.00	
ATV71HC20N4...HC28N4 with VW3A7101 braking transistor				
ATV71HC20Y				
Type 1 Conduit Kit Kit includes: a metal box, with conduit knockouts Kit provides conduit landing when wall mounting the drive	ATV61/71H037M3...HU15M3		VW3A9201	45.00
	ATV61/71H075N4...HU22N4			
	ATV61/71HU22M3...HU40M3			
	ATV61/71HU30N4...HU40N4		VW3A9202	45.00
	ATV61/71HU55M3			
	ATV61/71HU55N4, HU75N4			
	ATV61/71HU75M3		VW3A9203	45.00
	ATV61/71HD11N4, ATV61/71...S6X			
	ATV61/71HD11M3X..HD15M3X			
	ATV61/71HD15N4, HD18N4		VW3A9205	45.00
	ATV61/71HD18M3X..HD22M3X			
	ATV61/71HD22N4			
	ATV61/71HU30Y...HD30Y		VW3A9206	65.00
	ATV61/71HD30N4, HD37N4			
	ATV61/71HD30M3X..HD45M3X			
	ATV61/71HD45N4...HD75N4		VW3A9208	135.00
	ATV61/71HD37Y...HD90Y			
	ATV61/71HD37Y...HD90Y			
	ATV61HD55M3X...HD75M3X		VW3A9209	460.00
	ATV61HD90N4...HC11N4			
	ATV71HD55M3X, ATV71HD90N4, ATV61HC11N4			
	ATV61HD90M3X, ATV61HC13N4		VW3A9210	553.00
	ATV71HD75M3X, ATV71HC11N4			
	ATV61HC16N4, ATV71HC13N4			
	ATV61/71HC11Y...HC16Y		VW3A9211	573.00
	ATV61HC20Y			
	ATV61HC20Y			
	ATV61HC22N4, ATV71HC16N4		VW3A9212	588.00
	ATV61HC25N4...ATV61HC31N4			
	ATV71HC20N4...HC28N4			
ATV71HC20Y		VW3A9213	604.00	
ATV61/71HC25Y, HC31Y				
ATV61HC40Y				
ATV61HC25N4...HC31N4 with VW3A7101 braking transistor		VW3A7101	604.00	
ATV71HC20N4...HC28N4 with VW3A7101 braking transistor				
ATV71HC20Y				
ATV61/71HC25Y, HC31Y		VW3A7101	604.00	
ATV61HC40Y				
ATV61HC40Y				
Profibus Option Card Cover Type 1 cover for Profibus Option Card	230V Drive controllers		480V Drive controllers	
	ATV61H***▲	ATV71H***	ATV61H***	ATV71H***
	075M3	037M3	075N4	075N4
	U15M3	075M3	U15N4	U15N4
	—	U15M3	U22N4	U22N4
	U22M3	U22M3	U30N4	U30N4
	U30M3	U30M3	U40N4	U40N4
	U40M3	U40M3	—	—
	U55M3	U55M3	U55N4	U55N4
	—	—	U75N4	U75N4
	U75M3	U75M3	D11N4	D11N4
	D11M3X	D11M3X	D15N4	D15N4
	D15M3X	D15M3X	D18N4	D18N4

▲ The symbol "*" indicates the part of the number that varies with controller size or rating.



Altistart™ ATS•01N2 Soft Starts

Three-phase motors rated for 6 to 32 A at 230, 400, and 460 volts.

- TeSys™ U-line compatible** Full motor control solution
- Soft start and soft stop** 1–10 second ramp
- Motor voltage** 230, 400, 460
- Three-phase motor** 1 to 20 hp, 0.75–15 kW
- Internal shorting contactor** Cool, reliable operation
- Application** Derate for high duty cycle, temperature > 40 °C, altitude > 1000 m (see ATS01 Catalog 8637CT0401 for more detail)
- Adjustments** Start and stop times (1–10 s) and initial (starting) voltage (30–80%)
- Voltage boost (Kickstart)** Activated by BOOST logic input—full voltage for first 12 cycles of motor starting (200 ms)
- LED display** Two: “Power ON” and “Full Voltage” (up to speed)
- Control inputs and outputs** 2 or 3 wire control, fault relay (also for isolation contactor control), “up to speed” logic output
- Plug-in control terminals** Ease of wiring

Table 40: ATSU01N2 Family Selection and Pricing
For use with TeSys U-line motor starter (24 Vdc control power)

A	Catalog Number	Three-Phase Motor Power				\$ Price
		230 V		400 V	460 V	
6	ATSU01N206LT	0.75–1.1 kW	1–1.5 hp	1.5–2.2 kW	2–3 hp	133.00
9	ATSU01N209LT	1.5 kW	2 hp	3–4 kW	5 hp	152.00
12	ATSU01N212LT	2.2–3 kW	3 hp	5.5 kW	7.5 hp	175.00
22	ATSU01N222LT	4–5.5 kW	5–7.5 hp	7.5–11 kW	10–15 hp	219.00
32	ATSU01N232LT	7.5 kW	10 hp	15 kW	20 hp	300.00

NOTE: The ATSU01N2 soft start must be externally supplied with 24 Vdc control power. If this is not available, select from the ATS01N2 table below.

The ATSU01N2 soft start is shipped with a custom ATSU01N2 to TeSys U-line power connector.

Table 41: ATS01N2 Family Selection and Pricing
For use with TeSys U-line▲, GV2, GV3, and other motor starters

A	Catalog Number	Three-Phase Motor Power				\$ Price
		230 V		400 V	460 V	
6	ATS01N206LU	0.75 / 1.1 kW	1 / 1.5 hp	—	—	133.00
9	ATS01N209LU	1.5 kW	2 hp	—	—	152.00
12	ATS01N212LU	2.2 / 3 kW	3 hp	—	—	175.00
22	ATS01N222LU	4 / 5.5 kW	5 / 7.5 hp	—	—	219.00
32	ATS01N232LU	7.5 kW	10 hp	—	—	300.00
6	ATS01N206QN	—	—	1.5 / 2.2 kW	—	133.00
9	ATS01N209QN	—	—	3 / 4 kW	—	152.00
12	ATS01N212QN	—	—	5.5 kW	—	175.00
22	ATS01N222QN	—	—	7.5 / 11 kW	—	219.00
32	ATS01N232QN	—	—	15 kW	—	300.00
6	ATS01N206RT	—	—	—	2 / 3 hp	133.00
9	ATS01N209RT	—	—	—	5 hp	152.00
12	ATS01N212RT	—	—	—	7.5 hp	175.00
22	ATS01N222RT	—	—	—	10 / 15 hp	219.00
32	ATS01N232RT	—	—	—	20 hp	300.00

▲ No separate control voltage is needed.

Table 42: Accessory

Description	Catalog No.	\$ Price
Custom power connector (between ATS01N2 and TeSys U-line motor starter)	VW3G4104	10.00





Altistart™ ATS01N1 Soft Starts

Single or three-phase motors rated for 3 to 12 A at 110, 208, 230, 400 and 460 volts

- Soft Start (no soft stop)** 1–5 second ramp
- Motor voltage** 110, 208, 230, 400, 460
- Three-phase motor** 1/2 to 7.5 hp
- Single-phase motor** 1/4 to 2 hp
- External control power** 24 Vac/dc or 110–230 Vac
- Internal shorting contactor** 9 and 12 A models—cool, reliable operation
- Application** Derate for temperature > 40 °C, altitude > 1000 m (see ATS01 Catalog 8637CT0401 for more detail)
- Adjustments** Start time (1–5 s) and initial (starting) voltage (30–80%)
- LED display** Two: “Power ON” and “Full Voltage” (up to speed)
- Plug-in control terminals** 9 and 12 A models—ease of wiring

Table 43: ATS01N1 Selection and Pricing

A	Catalog Number	Motor Power								\$ Price
		Single-Phase				Three-Phase				
		110 V	208 V	230 V		230 V		400 kW	460 V	
3	ATS01N103FT	—	1/4 hp	0.37 kW	1/4 hp	0.37–0.55 kW	1/2 hp	1.1 kW	1–1.5 hp	100.00
6	ATS01N106FT	1/4 hp	1/2 hp	0.75 kW	1/2 hp	0.75–1.1 kW	1–1.5 hp	2.2 kW	2–3 hp	115.00
9	ATS01N109FT	1/3 hp	1 hp	1.1 kW	1 hp	1.5 kW	2 hp	4 kW	5 hp	130.00
12	ATS01N112FT	1/2 hp	1.5 hp	1.5 kW	2 hp	2.2 kW	3 hp	5.5 kW	7.5 hp	145.00
25	ATS01N125FT	—	—	—	—	3, 4, 5.5 kW	3, 4, 5.5 kW	7.5, 9, 11 kW	10–15 hp	240.00

Table 44: Accessory

Description	Catalog No.	\$ Price
DZ5 MB DIN rail (□) adaptor for 3 and 6 A models (sold only in packages of 10)	RHZ66▲	3.60

▲ Discount Schedule I.



Altistart™ 22 Open Style Soft Starter

The Altistart 22 unit uses both voltage and torque control to provide a soft start and soft stop for three-phase asynchronous motors between 17 and 590 amps.

Table 45: ATS22 Selection and Pricing*

Select the Altistart 22 soft start using the nameplate full-load ampere rating of the motor and the table below. The horsepower ratings are for reference only.

208 V HP	230 V HP	400 kW	460 V HP	575 V HP	Rated A	Soft Start Reference ■ or ◆	Dimensions (inches)			Frame Size	\$ Price
							W	H	D		
3	5	7.5	10	15	17	ATS22D17S6,S6U	5.1	9.8	6.6	A	613.00
7.5	10	15	20	25	32	ATS22D32S6,S6U	5.1	9.8	6.6	A	654.00
—▲	15	22	30	40	47	ATS22D47S6,S6U	5.1	9.8	6.6	A	786.00
15	20	30	40	50	63	ATS22D62S6,S6U	5.7	10.9	8.1	B	945.00
20	25	37	50	60	75	ATS22D75S6,S6U	5.7	10.9	8.1	B	1083.00
25	30	45	60	75	88	ATS22D88S6,S6U	5.7	10.9	8.1	B	1266.00
30	40	55	75	100	110	ATS22C11S6,S6U	5.9	13	9	C	1468.00
40	50	75	100	125	140	ATS22C14S6,S6U	5.9	13	9	C	1792.00
50	60	90	125	150	170	ATS22C17S6,S6U	5.9	13	9	C	2056.00
60	75	110	150	200	210	ATS22C21S6,S6U	8.1	15.6	11.8	D	2383.00
75	100	132	200	250	250	ATS22C25S6,S6U	8.1	15.6	11.8	D	2714.00
100	125	160	250	300	320	ATS22C32S6,S6U	8.1	15.6	11.8	D	3083.00
125	150	220	300	350	410	ATS22C41S6,S6U	8.1	15.6	11.8	D	3573.00
150	—	250	350	400	480	ATS22C48S6,S6U	11.9	16.8	13.4	E	4263.00
—	200	315	400	500	590	ATS22C59S6,S6U	11.9	16.8	13.4	E	4862.00

- ▲ Value not indicated when there is no corresponding standardized motor.
- S6 = 208–600 line voltage, 220 V control voltage
- ◆ S6U = 208–600 line voltage, 110 V control voltage
- ★ Motor full load amperate (FLA) must not exceed the ampere ratings of the soft starter.

Table 46: Maximum Number of Starts/Stops per Hour

Catalog Number	Number of Starts/Stops per Hour
ATS22D17S6U...D88S6U	6 (up to 10 with optional fan)
ATS22C11S6U...C17S6U	4 (up to 10 with optional fan)
ATS22C21S6U...C59S6U	4 (comes with fan)

Altistart™ Options: Fans and Accessories

Table 47: Accessories Selection and Pricing

	Description	Length	Catalog Number	\$ Price
Software	SoMove™ This software enables the user to configure, set, debug and organize maintenance task for the Altistart 22 soft starter. It can also be used to customize the integrated display terminal menus. It can be used with a direct connection or a Bluetooth® wireless connection. Free download www.schneider-electric.us			
Cable	USB/RS485 cord set (equipped with RJ45 socket)		TCSMCNAM3M002P■	52.00
Remote Keypad▲	IP54/NEMA® 12 keypad		VW3G22101■	65.00
	IP65 keypad		VW3G22102■	65.00
Remote Keypad Cords Equipped with 2 RJ45 Connectors	3 FT length		VW3A1104R10■	35.00
	9 FT length		VW3A1104R30■	35.00
Modbus Serial Link Connection via splitter box and RJ45 connectors	Modbus™ splitter box (with 10 RJ45 Connectors)		LU9GC3◆	312.00
	Cordsets for Modbus serial link (with 2 RJ45 connectors)	.3 m	VW3A8306R03■	20.00
		1 m	VW3A8306R10■	25.00
		3 m	VW3A8306R30■	30.00
	Modbus T-junction boxes (with integrated cables)	.3 m	VW3A8306TF03■	75.00
		1 m	VW3A8306TF10■	85.00
RJ45 Line Terminators (Sold in lots of 2)			VW3A8306RC■	6.00

- ▲ A remote keypad cord set is required.
- Discount Schedule for this product is CP1C.
- ◆ Discount Schedule for this product is I11.

Table 48: Fans Selection and Pricing

Power Supply Voltage For Control	For Use On Altistart	Catalog Number	\$ Price
The ATS22C21S6,S6U..C59S6,S6U units come with an integrated fan. The ATS22D17S6,S6U..C17S6,S6U units are ventilated by means of natural ventilation. For more demanding applications, such as those with a greater number of starts, the Altistart 22 range offers fans as an option. The fans are powered by the Altistart 22 unit and attach to the back of the device. The fan's noise level is less than 60 dBA.			
220 V	ATS22D17..D47S6	VW3G22400	65.00
	ATS22D62..D88S6	VW3G22401	65.00
	ATS22C11..C17S6	VW3G22402	75.00
110 V	ATS22D17..D47S6U	VW3G22U400	65.00
	ATS22D62..D88S6U	VW3G22U401	65.00
	ATS22C11..C17S6U	VW3G22U402	75.00

Table 49: Protection Shrouds for Power Terminals

Description	For Use On Altistart	Catalog Number	\$ Price
Set of 6 power terminal protection shrouds	ATS22C11S6,S6U ..C17S6,S6U	LA9F702★	61.00
	ATS22C21S6,S6U ..C59S6,S6U	LA9F703★	82.00

- ★ Discount Schedule for this product is I12.

Table 50: Replacement Parts

	Description	For Use On Altistart	Catalog Number	\$ Price
220 V	Control Block	ATS22™S6, ATS22™Q	VX4A221220V	295.00
110 V	Control Block	ATS22™S6U	VX4A221220V	295.00



Enclosed Altistart™ 22 Motor Controllers

Enclosed Altistart 22 (ATS22) solid-state combination motor controllers are a pre-engineered, integrated solution for reduced voltage starting and soft stopping of standard three-phase asynchronous induction (squirrel cage) motors. The Enclosed 22 controllers consist of a disconnect means and an ATS22 soft starter in a stand-alone enclosure. Enclosed 22 controllers integrate the ATS22 soft start technology into a combination package for application requirements up to 125 hp at 480 V.

- 3–50 hp, 208 V
- 5–60 hp, 230 V
- 10–125 hp, 460 V



Table 51: Catalog Number Description

Field	Digit	Characteristic	Description
—	—	Controller Class	8638 = Fused Disconnect ♦ 8639 = Circuit Breaker Disconnect
01	1–3	Controller Style	22F = Altistart 22 with Class J Fuse Clips and Molded Case Switch ♦ 22T = Altistart 22 with PowerPact Motor Circuit Protector 22U = Altistart 22 with PowerPact Thermal-
02	4	Horsepower	A = 3 hp B = 5 hp C = 7.5 hp D = 10 hp E = 15 hp F = 20 hp G = 25 hp H = 30 hp J = 40 hp K = 50 hp L = 60 hp M = 75 hp N = 100 hp P = 125 hp Q = 150 hp R = 200 hp S = 250 hp T = 300 hp U = 350 hp W = 400 hp X = 500 hp
03	5	Enclosure Type	G = UL Type 1 General Purpose A = UL Type 12K Industrial Use, Dust-Tight/Drip-Tight H = UL Type 3R Outdoor Use
04	6	Voltage	2 = 208 Vac 3 = 230 Vac 4 = 460 Vac 5 = 575 Vac
05	7	Power Circuit	B = Basic Shunt Trip S = Full-Featured Shunt Trip N = Non-Reversing Isolation R = Reversing Isolation Y = Integral Full-Voltage Bypass
06	8–10	Control Options★▼	A06 = Start-Stop Pushbuttons B06 = Forward-Off-Reverse C06 = Hand-Off-Auto (HOA) Selector Switch D06 = Stop-Run Selector Switch E06 = Hand-Auto Selector Switch/Start-Stop Pushbuttons
07	11–13	Pilot Device Options★▼	A07 = Run Light (Red), Off Light (Green) B07 = Push-to-Test Run Light (Red), Push-to-Test Off Light (Green) C07 = Run Light (Red), Off Light (Green), Tripped Light/Reset (Yellow) D07 = PTT Run Light (Red), PTT Off Light (Green), Tripped Light/Reset (Yellow)
08	14–16	Metering Options	B08 = Elapsed Run Time Meter▼
09	17–19	Miscellaneous Options	A10 = Floor Mounting Kit△ B10 = Additional 150 VA□ C10 = Power-Up On Delay Relay◇ D10 = Emergency Stop Pushbutton□ E10 = cUL Label▲ F10 = Auxiliary Run Mode Contacts G10 = Auxiliary FB Bypass Contacts★ H10 = Auxiliary Auto Mode Contacts▽ J10 = Auxiliary Trip Indication Contacts L10 = ID Engraved Nameplate□ M10 = 10 Spare Terminal Blocks□ P10 = Permanent Wire Markers□ R10 = MOV-Surge Arrestor□ U10 = Omit Door-Mounted Keypad Display■ V10 = OSHPD Seismic Certification X10 = 50 °C Operation Z10 = Service Entrance Rating▲● Y10 = Seismic qualification label

- ▲ Options E10 and Z10 cannot be used together.
- If you select option U10, you must separately order the remote keypad (VW3G22101) and cable (VW3A1104R30) to commission the soft starter. Refer to the *ATS22 User Manual*, BBV51330, for serial communication programming and control capabilities.
- ♦ This option is not selectable with power circuit option B05.
- ★ Select only one option.
- ▼ To omit, do not include a selection in the catalog number.
- △ This option is available only for enclosure size D.
- This option is not selectable with power circuit option B05
- ◇ This option is not selectable with power circuit option B05. This option is valid only with the following control options: C06, D06, or E06.
- ★ This option is not selectable with power circuit option B05. The contacts are available only when power circuit option Y05 is selected.
- ▽ The contacts are not available when power circuit option R05 is selected. This option is valid only with the following control options: C06, D06, or E06.
- Options E10 and Z10 cannot be ordered together.

Table 52: Catalog Number Example: 863922UCG4BA06A07

Field							
—	1	2	3	4	5	6	7
8639	22U	C	G	4	B	A06	A07
Controller Class	PowerPact™ Thermal-Magnetic Circuit Breaker	7.5 hp	Type 1 General Purpose	460 Vac	Basic Shunt Trip	Start-Stop Pushbutton	Run Light (Red), Off Light (Green)

Option Pricing—
Phase 2 Options highlighted in green

Control Options (pick one)

Mod	Start/Stop push buttons	\$ Price
A06	Provides black start and red stop push buttons (3-wire control scheme).	132.00
B06	Forward-Off-Reverse selector switch Provides three-position selector switch to select between forward, off and reverse. Uses 2-wire control.	240.00
C06	Hand-Off-Auto selector switch Provides a three-position selector switch, 2-wire control scheme.	132.00
D06	Stop-Run selector switch Provides a two-position selector switch.	132.00
E06	Hand-Auto selector switch and Start/Stop push buttons Provides a two-position selector switch and start/stop push buttons (3-wire control).	264.00

Pilot Light Cluster Options (pick one)

Mod	Pilot light cluster #1	\$ Price
A07	Consists of red "RUN" and green "OFF" pilot lights. Provides standard red "RUN (ON)" and green "OFF" pilot lights for status annunciation.	180.00
B07	Pilot light cluster #2 Consists of red "RUN" (push-to-test) and green "OFF" (push-to-test) pilot lights. Provides push-to-test type red "RUN (ON)" and standard green "OFF" pilot lights for status annunciation.	360.00
C07	Pilot light cluster #3 Consists of red "RUN", green "OFF" and yellow "FAULT" pilot lights. Provides standard red "RUN (ON)", green "OFF" and yellow "FAULT" pilot lights for status annunciation.	270.00
D07	Pilot light cluster #4 Consists of red "RUN (ON)" (push-to-test), green "OFF" (push-to-test) and yellow "FAULT" (push-to-reset) pilot lights. Provides push-to-test type red "RUN (ON)", standard green "OFF", and push-to-reset type yellow "FAULT" for status annunciation.	540.00

Meter Display Options (pick one)

Mod	Elapsed time meter	\$ Price
B08	Provides a seven-digit analog, non-resettable elapsed run time meter. Not available on Type 3R Enclosures	348.00

Miscellaneous Options (multiple compatible options may be selected)

Mod	Floor mounting kit	\$ Price
A10	Only available for size D enclosures.	105.00

Rules: Available for power options S05, N05, R05, Y05.

Mod	150 VA additional control power capacity	\$ Price
B10	Provides 150 VA additional control VA capacity for customer use.	150.00

Mod C10	Power up on delay (start relay) Provides an electronic time delay relay adjustable from 0.1 to 60 seconds. Relay is pre-wired to inhibit start for users set delay time upon power-up of control.	\$ Price 150.00
Mod D10	Emergency stop push button Provides a push-button for immediate removal of all power.	\$ Price 140.00
Mod E10	"cUL" label Provides a Canadian Underwriters Laboratories label when required by local code requirements.	\$ Price 200.00
Mod F10	Auxiliary contacts for run mode Provides one Form A, normally open (N.O.) contact rated 5 A at 120 Vac to the terminal blocks for customer use. The contact closes when the controller is applying power to the motor.	\$ Price 550.00
Mod G10	Auxiliary contacts for full voltage bypass run mode Provides 1 Form C contact rated 5 A @ 120 Vac (8501 Type R relay or equivalent) wired to terminal blocks for customer use. Contacts change state when motor is operated across the line with full voltage by bypass starter.	\$ Price 550.00
Rules: Must use Power Circuit N or R (line isolation) contactor combination.		
Mod H10	Auxiliary contacts for auto mode Provides one Form A, normally open (N.O.) contact rated 5 A @ 120 Vac to the terminal blocks for user use. The contact closes when the controller is placed in Auto (remote) mode.	\$ Price 550.00
Rules: MOD C06 (Hand-Off-Auto selector switch) or E06 (Hand-Auto selector switch) must be specified.		
Mod J10	Auxiliary contacts for trip status Provides one Form A, normally open (N.O.) contact rated 5 A @ 120 Vac to the terminal blocks for user use. The contact closes when the controller has tripped.	\$ Price 650.00
Mod L10	ID engraved nameplates Provides a lamacold nameplate, engraved with equipment designation.	\$ Price 50.00
Mod M10	Spare terminal blocks Provides up to 10 spare terminal blocks unwired for customer use. Since Phoenix style terminal blocks will be used, extra terminal points will be provided as standard 20 terminal points are available as standard for all control wiring (including any additional customer spare terminal points).	\$ Price 340.00

Mod P10	Permanent wire markers Provides a permanent sleeve type wire marker on control wiring assemblies	\$ Price 1400.00
Mod R10	MOV/Surge arrester (custom engineered option) Provides supplementary MOV protection using a Class 6671 SD3A3650 Surgebreaker Secondary Surge Arrester hard-wired and factory mounted.	\$ Price 450.00
Mod U10	Omit door mounted keypad display Omits the door-mounted keypad display. A keypad closing plate and gasket are provided on the door.	\$ Price (50.00)
Rules: To program or control the ATS22 soft starter with Modbus communication, refer to the ATS22 User Manual, BBV51330.		
Mod X10	50 Degrees C operation Provides extended range high ambient equipment rating above 40 °C (104 °F) to a maximum of 50 °C (122 °F) without de-rating.	\$ Price 125.00
Rules: Standard on Type 3R enclosures.		
Mod Y10	Seismic qualification label Provides a self-certified identification label with compliance to 2000 IBC, NFPA 5000, 2001 CBC, 1997 UBC, 1999 NBC, 1999SBC, ASCE-7 02 seismic qualification certification. The label criteria will be uniform for all enclosed products. Enclosures shall contain additional bracing as defined by the seismic qualification certification criteria.	\$ Price 450.00
Mod V10	OSHPD Seismic Certification This option provides special labels and documents to comply with the seismic requirements of the California Office of Statewide Planning and Development (OSHPD). Refer to 30072-454-87, <i>Seismic Qualification of Enclosed Drives and Soft Starters</i> , for additional information.	\$ Price 400.00
Rules: Not available for wall mounted enclosures.		
Mod Z10	Service Entrance Rating Provides a UL869A approved insulated ground neutral lug assembly, mounting bracket with bonded enclosure ground wire suitable for use as service entrance equipment.	\$ Price 185.00
Rules: Service Entrance Rating is not available with the Mod E10 (cUL Label).		

Table 53: Enclosed Altistart 22 Motor Controllers with Circuit Breaker—60 Hz, Three-Phase, 208/230/460/575 Volts—Standard Duty (40 °C)

Maximum Horsepower				Circuit Breaker Power Option—Type 1 Enclosure					Enclosure Rating Modifiers		
				Shunt Trip B	Shunt Trip S	Non-Rev N	Reversing Isolation R	Emergency Bypass Y	40 °C Rated Type 12	50 °C Rated Type 1/12	Type 3R
208 V	230 V	460 V	575 V						add	add	add
3	5	10	15	1400.00	1628.00	1822.00	2100.00	2190.00	160.00	450.00	650.00
5	7.5	15	20	1600.00	1870.00	2102.00	2400.00	2490.00	160.00	450.00	650.00
7.5	10	20	25	1800.00	2090.00	2336.00	2677.00	2780.00	160.00	450.00	650.00
10	—	25	30	1962.00	2286.00	2563.00	2930.00	3030.00	160.00	450.00	650.00
—	15	30	40	2124.00	2464.00	2753.00	3130.00	3280.00	160.00	550.00	750.00
15	20	40	50	2450.00	2832.00	3154.00	3640.00	3750.00	240.00	550.00	750.00
20	25	50	60	3226.00	3683.00	4061.00	4624.00	4825.00	240.00	550.00	750.00
25	30	60	75	3645.00	4146.00	4557.00	5189.00	5400.00	240.00	1000.00	1200.00
30	40	75	100	3944.00	4489.00	4938.00	5623.00	5888.00	360.00	1000.00	1200.00
40	50	100	125	4815.00	5438.00	5942.00	6710.00	7000.00	360.00	1000.00	1200.00
50	60	125	150	5673.00	6400.00	6990.00	7895.00	8150.00	360.00	1000.00	1200.00
60	75	150	200	6530.00	7391.00	7937.00	8933.00	9203.00	510.00	1450.00	1650.00
75	100	200	250	7387.00	8361.00	8927.00	10047.00	10337.00	510.00	1450.00	1650.00
100	125	250	300	8336.00	9310.00	10192.00	11470.00	11775.00	510.00	1450.00	1650.00
125	150	300	350	8878.00	10030.00	11181.00	12563.00	12880.00	735.00	1900.00	2350.00
150*	—	350	400	9498.00	10751.00	12170.00	13656.00	13986.00	735.00	1900.00	2350.00
—	200	400	500	10740.00	12157.00	13863.00	15602.00	15947.00	735.00	—	—

* 50 °C Operation and Type 3R Enclosure not available.

Table 54: Enclosed Altistart 22 Motor Controllers with Fusible Disconnect—60 Hz, Three-Phase, 208/230/460/575 Volts—Standard Duty (40 °C)

Maximum Horsepower				Fusible Power Option—Type 1 Enclosure				Enclosure Rating Modifiers		
				Shunt Trip S	Non-Rev N	Reversing Isolation R	Emergency Bypass Y	40 °C Rated Type 12	50 °C Rated Type 1/12	Type 3R
208 V	230 V	460 V	575 V					add	add	add
3	5	10	15	1705.00	1899.00	2177.00	2267.00	160.00	450.00	650.00
5	7.5	15	20	1950.00	2182.00	2480.00	2570.00	160.00	450.00	650.00
7.5	10	20	25	2178.00	2424.00	2765.00	2868.00	160.00	450.00	650.00
10	—	25	30	2380.00	2657.00	3024.00	3124.00	160.00	450.00	650.00
—	15	30	40	2558.00	2847.00	3224.00	3374.00	160.00	550.00	750.00
15	20	40	50	2940.00	3262.00	3748.00	3858.00	240.00	550.00	750.00
20	25	50	60	3826.00	4204.00	4767.00	4968.00	240.00	550.00	750.00
25	30	60	75	4307.00	4718.00	5350.00	5561.00	240.00	1000.00	1200.00
30	40	75	100	4663.00	5112.00	5797.00	6062.00	360.00	1000.00	1200.00
40	50	100	125	5624.00	6128.00	6896.00	7186.00	360.00	1000.00	1200.00
50	60	125	150	6619.00	7209.00	8114.00	8369.00	360.00	1000.00	1200.00
60	75	150	200	7620.00	8183.00	9210.00	9480.00	510.00	1450.00	1650.00
75	100	200	250	8620.00	9203.00	10358.00	10628.00	510.00	1450.00	1650.00
100	125	250	300	9598.00	10507.00	11825.00	12095.00	510.00	1450.00	1650.00
125	150	300	350	10340.00	11508.00	12952.00	13222.00	735.00	1900.00	2350.00
150♦	—	350	400	10833.00	12509.00	14078.00	14348.00	735.00	1900.00	2350.00
—	200	400	500	12532.00	14292.00	16085.00	16355.00	735.00	—	—

♦ 50 °C Operation and Type 3R Enclosure not available.



Altistart™ 48 Soft Starts

The Altistart 48 soft start combines ease of selection with simple installation and high motor control performance. With its exclusive motor Torque Control System, the Altistart 48 helps eliminate uncontrolled motor acceleration and deceleration, a problem inherent with standard voltage—ramp soft starts. The Altistart 48 includes features to help with motor and machine protection and is available for motors ranging from 208 to 575 volts. In addition to a built-in display and programming terminal, a remote keypad option and programming software is available to ease integration

and commissioning. The Altistart 48 has a built-in Modbus™ port and is offered with serial communication gateways to such popular networks as Ethernet and DeviceNet™.

Open Style Soft Starts 50–60 Hz, Three-Phase, 690 V Maximum—AC3 Duty

The Altistart 48 soft start must be selected using the table below, based on nameplate full load ampere rating of the motor. The horsepower ratings shown in table are for reference only.

Table 55: Altistart 48 Selection and Pricing▲

Standard Duty (Low Inertia Loads)■ Maximum Horsepower					Altistart Soft Starts		
208 V HP	230 V HP	400 kW	460 V HP	575 V HP	Rated A	Catalog Number	\$ Price
3	5	7.5	10	15	17	ATS48D17Y	819.00
5	7.5	11	15	20	22	ATS48D22Y	850.50
7.5	10	15	20	25	32	ATS48D32Y	882.00
10	—	18.5	25	30	38	ATS48D38Y	945.00
—	15	22	30	40	47	ATS48D47Y	997.50
15	20	30	40	50	62	ATS48D62Y	1260.00
20	25	37	50	60	75	ATS48D75Y	1344.00
25	30	45	60	75	88	ATS48D88Y	1575.00
30	40	55	75	100	110	ATS48C11Y	1785.00
40	50	75	100	125	140	ATS48C14Y	2205.00
50	60	90	125	150	170	ATS48C17Y	2415.00
60	75	110	150	200	210	ATS48C21Y	2730.00
75	100	132	200	250	250	ATS48C25Y	3045.00
100	125	160	250	300	320	ATS48C32Y	3630.00
125	150	220	300	350	410	ATS48C41Y	4290.00
150	—	250	350	400	480	ATS48C48Y	5405.00
—	200	315	400	500	590	ATS48C59Y	6210.00
200	250	355	500	600	660	ATS48C66Y	7440.00
250	300	400	600	800	790	ATS48C79Y	8640.00
350	350	500	800	1000	1000	ATS48M10Y	10320.00
400	450	630	1000	1200	1200	ATS48M12Y	12720.00

- ▲ Motor full load amperage (FLA) must not exceed the ampere rating of the soft start.
- Low Inertia—Connected motor load inertia equal or less than 10 times motor rotor inertia.
High Inertia—Connected motor load inertia greater than 10 times motor rotor inertia.

NOTE: For severe duty or high inertia loads, derate by 1 hp size.

Table 56: Altistart 48 Options

Description	Catalog Number	\$ Price
Remote Keypad Display Mounting Kit, including: Keypad with 3-character 7-segment display IP65 cover and seal, mounting screws, and 3 meter cable to connect keypad display to Altistart 48	VW3G48101	165.00
Cover for power terminals—Set of 6 for ATS48C14Y and ATS48C17Y	LA9F702★	61.00
Cover for power terminals—Set of 6 for ATS48C21Y, ATS48C25Y, and ATS48C32Y	LA9F703★	82.00
Modbus Ethernet Gateway	TSXETG100▼	1027.00
DeviceNet Gateway	LUFPP9△	495.00
Profibus DP Gateway	LUFPP7△	495.00
1/3 meter connection cable (RJ-45 to RJ-45)	VW3A8306R03	20.00
1 meter connection cable (RJ-45 to RJ-45)	VW3A8306R10	25.00
3 meter connection cable (RJ-45 to RJ-45)	VW3A8306R30	30.00
1/3 meter splitter cable (For RJ-45 daisy chain connection)	VW3A8306TF03	75.00
1 meter splitter cable (For RJ-45 daisy chain connection)	VW3A8306TF10	85.00
RJ45 terminator (2 per package)	VW3A8306RC	6.00
Modbus hub (Eight RJ-45 ports)	LU9GC3△	208.00
Software		
SoMove™ This software enables the user to configure, set, debug and organize maintenance task for the Altivar drives and soft starts. It can also be used to customize the integrated display terminal menus. It can be used with a direct connection or a Bluetooth® wireless connection. Free download at http://products.schneider-electric.us/products-services/products/ac-drives-and-soft-starts/		
USB to RJ45 adaptor: for use in connecting to a PC with a USB port. Compatible device families: Advantys™ OTB, Altistart™ motor starters, Altivar series including HMI, Altivar controller.	TCSMCNAM3M002P	52.00
Pocket PC connection kit. To connect JORNADA™ or iPAQ™ PPC to Altistart soft start◆	VW3A8111□	95.00
Size M10 Bolt Kit	W808780210111	8.00
Size M12 Bolt Kit	W808780220111	10.00

- ◆ For more information, see Data Bulletin 8806DB0001.
- ★ Discount Schedule for this product is I12.
- ▼ Discount Schedule for this product is PC41.
- △ Discount Schedule for this product is I11.
- Discount Schedule for this product is CP4C.

For additional information on Altistart 48, reference Catalog #8636CT0201.



General Information

Enclosed Altistart™ 48 Soft Starts (Enclosed 48) are available from 11 to 604 amperes in Type 1, 12 and 3R enclosures. The Enclosed 48 soft startsoft start can provide soft startsoft starting (reduced voltage) and stopping with deceleration control with machine and motor protection of standard NEMA® Design B squirrel cage asynchronous motors in the following ranges:

- 3–200 hp, 208 V
- 5–250 hp, 230 V
- 10–500 hp, 460 V
- 15–600 hp, 575 V

Selection

The Enclosed 48 controller must be selected based on three main criteria:

- AC mains voltage supply (distribution voltage):
Three-phase AC voltage: 208, 240, 480 or 600 V.
- The power and the nominal motor current (FLA) indicated on the motor nameplate.
- The type of application and the operating cycle. To simplify selection, applications are categorized as either standard duty or severe duty applications. Standard or severe duty applications define the limiting values of the current and the duty cycle ratings. **If severe duty is required, select the next higher horsepower device.**

Depending on the type of machine, the applications are categorized as standard or severe duty based on the starting characteristics, which are given by example are illustrated within the table below.

Type of Machine	Application	Functions performed by the ATS48	Starting Current (% In)	Starting Time (secs)
Centrifugal pump	Standard	Deceleration (reduction in pressure surges) Protection against underloads or inversion of the phase rotation direction	300	5 to 15
Piston pump	Standard	Control of running dry and direction of rotation of the pump	350	5 to 10
Fan	Standard Severe if > 30 s	Detection of overloads caused by clogging or underloads (motor fan transmission broken) Braking torque on stopping	300	10 to 40
Cold compressor	Standard	Protection, even for special motors	300	5 to 10
Screw compressor	Standard	Protection against inversion of direction of phase rotation Contact for automatic draining on stopping	300	3 to 20
Centrifugal compressor	Standard Severe if > 30 s	Protection against inversion of direction of phase rotation Contact for automatic emptying on stopping	350	10 to 40
Piston compressor	Standard	Protection against inversion of direction of phase rotation Contact for automatic emptying on stopping	350	5 to 10
Conveyor, transporter	Standard	Overload control for detecting faults or underload control for detecting breaks	300	3 to 10
Lifting screw	Standard	Overload control for detecting hard spots or underload control for detecting breaks	300	3 to 10
Drag lift	Standard	Overload control for detecting jamming or underload control for detecting breaks	400	2 to 10
Lift	Standard	Overload control for detecting jamming or underload control for detecting breaks Constant starting with variable load	350	5 to 10
Circular saw, band saw	Standard Severe if > 30 s	Braking for fast stop	300	10 to 60
Pulper, butchery knife	Severe	Torque control on starting	400	3 to 10
Agitator	Standard	The current display indicates the density of the product	350	5 to 20
Mixer	Standard	The current display indicates the density of the product	350	5 to 10
Grinder	Severe	Braking to limit vibrations during stopping, overload control to detect jamming	450	5 to 60
Crusher	Severe	Braking to limit vibrations during stopping, overload control to detect jamming	400	10 to 40
Refiner	Standard	Torque control on starting and stopping	300	5 to 30
Press	Severe	Braking to increase the number of cycles	400	20 to 60

Special Applications

Contact Seneca Enclosed Drives TAG for additional application information and pricing for those applications requiring:

- Two-speed or delta-wye motors. The ATS48 soft start can operate with a 2-speed motor. A motor demagnetizing period must elapse before changing from low speed to high speed in order to avoid anti-phase between the line supply and the motor, which would generate very high currents.
- Motors other than NEMA® Design B.
- High efficiency motors.
- Low slip motors.
- Power factor correction capacitors. Do not connect power factor correction capacitors to the terminals of a motor controlled by an ATS48 soft start. The power factor capacitors must be controlled and connected to a line side contactor sequenced by the ATS48 at end of starting.
- Controller oversizing of more than 50%.
- Non-standard trip characteristics.
- Modifications not listed in this pricing guide.
- Horsepower greater than those listed in this pricing guide.
- Long motor cable lengths. Very long motor cables cause voltage drops due to the resistance of the cable. If the voltage drop is significant, it could affect the current consumption and the torque available. This criterion must be taken into account when selecting the motor and the starter.
- Miscellaneous application precautions. Do not use the ATS48 controller upstream of loads other than motors (i.e., transformers and resistance type loads)

Pricing and Special Feature Assistance

Schneider Electric personnel are to use the Q2C computer-based pricing system to determine Enclosed 48 controller pricing. For pricing and delivery assistance on equipment and options not listed in Q2C or this pricing guide, contact the Seneca Enclosed Drives Technical Applications Group (TAG) located in the Seneca plant for further assistance.

Enclosed 48 Catalog Number Identification

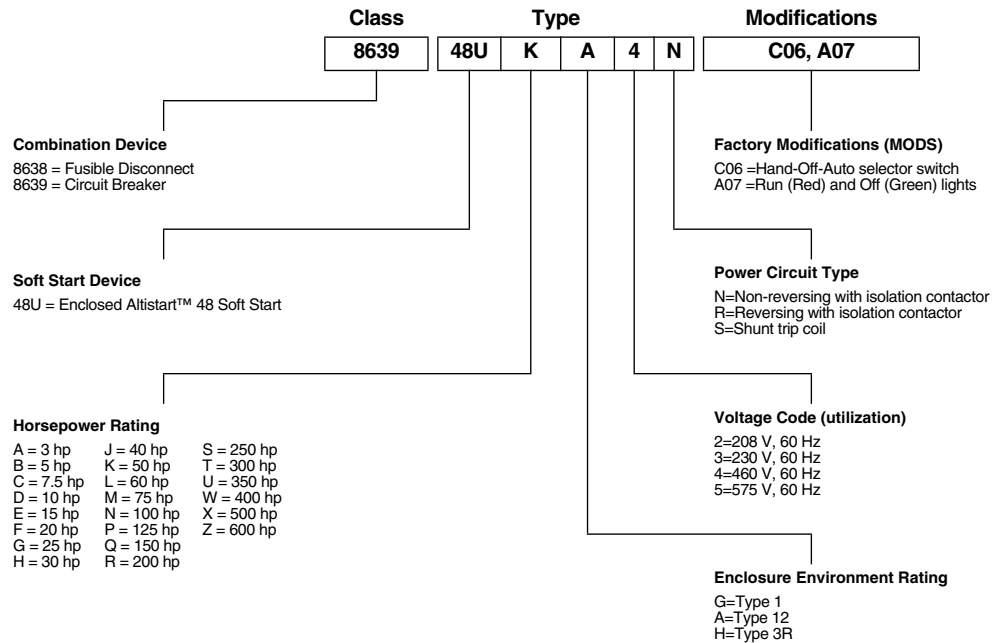

**Table 57: Combination Controller—Enclosed 48 Soft Starts (Fusible Disconnect)
60Hz, Three-Phase, 208/230/460/575 Volts—AC3 Duty**

Class 8638 Enclosed 48—FUSIBLE Disconnect						8638 Power Circuit Type (Type 1 Enclosure) (See page 58 for description)			Enclosure Type Adders	
Size	ATS48_YU	208 V	230 V	460 V	575 V	Power Circuit N \$ Price	Power Circuit R \$ Price	Power Circuit S \$ Price	Type 12 \$ Price	Type 3R \$ Price
A	D17	3	5	10	15	2944.00	3327.00	2576.00	200.00	750.00
	D22	5	7.5	15	20	3128.00	3535.00	2668.00	200.00	750.00
	D32	7.5	10	20	25	3404.00	3847.00	2944.00	200.00	750.00
	D38	10	—	25	30	3662.00	4138.00	3128.00	200.00	750.00
	D47	—	15	30	40	3662.00	4138.00	3128.00	200.00	750.00
B	D62	15	20	40	50	4180.00	4723.00	3608.00	300.00	1200.00
	D75	20	25	50	60	5315.00	6006.00	4752.00	300.00	1200.00
	D88	25	30	60	75	5940.00	6712.00	5368.00	300.00	1200.00
	C11	30	40	75	100	6442.00	7279.00	5808.00	300.00	1200.00
C	C14	40	50	100	125	6800.00	7684.00	6205.00	450.00	1750.00
	C17	50	60	125	150	7990.00	9029.00	7310.00	450.00	1750.00
D	C21	60	75	150	200	9070.00	10249.00	8415.00	600.00	2200.00
	C25	75	100	200	250	10200.00	11526.00	9520.00	600.00	2200.00
	C32	100	125	250	300	11645.00	13159.00	10600.00	600.00	2200.00
E	C41	125	150	300	350	11880.00	13424.00	10925.00	825.00	2900.00
	C48	150	—	350	400	13864.00	15666.00	12240.00	825.00	2900.00
	C59	—	200	400	500	15840.00	17899.00	13840.00	825.00	2900.00
	C66	200	250	500	600	18920.00	21380.00	16480.00	825.00	2900.00

**Table 58: Combination Controller—Enclosed 48 Soft Starts (Circuit Breaker Disconnect)
60Hz, Three-Phase, 208/230/460 Volts—AC3 Duty**

Class 8639 Enclosed 48—CIRCUIT BREAKER Disconnect						8639 Power Circuit Type (Type 1 Enclosure) (See page 58 for description)			Enclosure Type Adders	
Size	ATS48_YU	208 V	230 V	460 V	575 V	Power Circuit N \$ Price	Power Circuit R \$ Price	Power Circuit S \$ Price	Type 12 \$ Price	Type 3R \$ Price
A	D17	3	5	10	▲	2856.00	3227.00	2499.00	200.00	750.00
	D22	5	7.5	15		3034.00	3429.00	2588.00	200.00	750.00
	D32	7.5	10	20		3302.00	3731.00	2856.00	200.00	750.00
	D38	10	—	25		3552.00	4013.00	3034.00	200.00	750.00
	D47	—	15	30		3552.00	4013.00	3034.00	200.00	750.00
B	D62	15	20	40		4055.00	4582.00	3500.00	300.00	1200.00
	D75	20	25	50		5156.00	5826.00	4609.00	300.00	1200.00
	D88	25	30	60		5762.00	6511.00	5207.00	300.00	1200.00
	C11	30	40	75		6248.00	7061.00	5634.00	300.00	1200.00
C	C14	40	50	100		6596.00	7453.00	6019.00	450.00	1750.00
	C17	50	60	125		7750.00	8758.00	7091.00	450.00	1750.00
D	C21	60	75	150	8797.00	9941.00	8163.00	600.00	2200.00	
	C25	75	100	200	9894.00	11180.00	9234.00	600.00	2200.00	
	C32	100	125	250	11296.00	12764.00	10282.00	600.00	2200.00	
E	C41	125	150	300	11524.00	13022.00	10597.00	825.00	2900.00	
	C48	150	—	350	13448.00	15196.00	11873.00	825.00	2900.00	
	C59	—	200	400	15365.00	17362.00	13425.00	825.00	2900.00	
	C66	200	250	500	18352.00	20738.00	15986.00	825.00	2900.00	

▲ Not available in 575 V ratings.

Configuration & Factory Modifications

The Enclosed 48 combination controllers can be configured with pre-engineered features and functions identified below. Factory modifications (MODS) identified by “custom engineered option” has extended lead times and will be handled by a factory order engineer for processing.

Enclosed 48 Features

- Class 8638 fusible disconnect version with provisions for Class J or L fuses are provided. Fuses are not installed at the factory.
- Class 8639 circuit breaker version provided with MAG-GARD or thermal-magnetic circuit breaker as OCPD.
- Three power circuit configurations—shunt trip, non-reversing and reversing options.
- Industrial rated flange disconnect operating handle and mechanism.
- Shorting contactors (AC1 duty) provided on all Enclosed 48 soft starts.
- Input isolation contactor option.
- Full voltage bypass (AC3 duty) option.
- Transient suppression modules on all contactors.
- Agency listing to UL 508 Industrial Control Equipment. cUL and/or CSA label available as an option.
- Coordinated short circuit ratings:

Enclosure Size	Horsepower Rating				8638 Fusible Disconnect	8639 Circuit Breaker
	@ 208 V	@ 230 V	@ 460 V	@ 575 V		
A-C	3-50	5-60	10-125	15-150	100k	65k
D	60-100	75-125	150-250	200-300	100k	30k
E	125-200	150-250	300-500	350-600	65k	65k or 100k▲

▲ Must select 610 option for 100k.

- Type 1, 12 or 3R enclosure environmental ratings.
- 22 mm LED long life pilot light clusters with option for push-to-test configurations.
- 120 Vac control power transformers, with or without an additional 150 VA for customer use.
- Top and bottom conduit knockouts on wall-mounted enclosures
- Removable conduit entry plates on floor mounted enclosures.
- Cabinet component identification.
- ANSI #49 gray enclosure paint.
- Door mounted keypad on Type 1 and 12 units.
- Wire marking identification.
- Factory specific drawings.

Altistart™ 48 Soft Start Device Features

TCS™ Torque Control System

The Altistart 48 soft start uses TCS ramping to accelerate the motor to full voltage. Basing the acceleration ramp on the motor torque rather than current or voltage, as used in traditional soft starts, provides a linear speed ramp independent of the motor loading without tachometer feedback. The TCS ramp is also used for improved control of deceleration independent of motor loading. When used in pumping applications, TCS ramping can eliminate water hammer problems and provide an alternative to expensive motorized control valves.

Starting and Stopping

Four types of starting are available:

- TCS soft start—adjustable from 1 to 60 seconds
- TCS with “boost”—adjustable 50 to 100% of mains voltage
- Current limit—adjustable from 150 to 500% of controller rating
- Voltage ramping

Modes of stopping

- Freewheel or coast to stop
- TCS soft stop—adjustable from 1 to 60 seconds

Device Protective Features

- Solid State motor thermal overload protection—programmable from Class 10 through 30
- Soft start thermal protection
- Motor phase loss protection
- Line supply failure
- Overcurrent fault
- Locked rotor fault
- Line frequency outside limits $\pm 5\%$ or $\pm 20\%$ —EGSA compliance with Class 3 application (droop operation) generators.
- Selectable protection, including:
 - Phase reversal
 - Stall and jam
 - Thermal overload pre-alarm
 - Current threshold alarm
 - Underload fault

Device Monitoring and Indication

Door mounted keypad:

- Displays setup parameters and fault codes.
- Factory presets for most common adjustments.
- Security to avoid accidental controller modifications is provided by dialswitches on the back of the keypad, which must be adjusted to provide access to three programming levels.

Real time indication via the digital keypad of:

- Motor current
- Load Torque
- Motor thermal state
- Power factor
- Fault status

Two logic outputs:

- Motor thermal overload or indication of motor current present
- Current threshold alarm
- Motor underload alarm

One analog output for 4 to 20 or 0 to 20 mA indication of motor current, torque, thermal state, active power or power factor.

Two logic inputs, which are configurable for force to freewheel, thermal overload reset or indication of external fault.

Refer to the Altistart™ 48 product catalog (8636CT0201) for additional information.

Power Circuit Descriptions (pick one)

Power Circuit N—

Non-Reversing with Isolation Contactor

A contactor ahead of the soft start is coordinated to automatically disconnect the motor from the ac line in the conditions of a fault. In addition, the isolation contactor is coordinated to open when the motor is not running. This provides protection from voltage transients when the electronics are most susceptible to damage. The isolation contactor operation shall be coordinated via the R1 relay in isolation contactor control mode. The control scheme and contactor sequencing shall maintain the control power and remove the main power to the soft start after a fault or normal stop. Not available with shunt trip option, and is required with full voltage bypass option.

Power Circuit R—

Reversing with Isolation Contactor

The reversing combination starter is configured for forward and reverse operation through a reversing contactor and appropriate logic control. The reversing contactor also provides isolation for the motor from the line supply power following a stop command (and deceleration period, if selected) or in the condition of a fault. Control of the forward and reverse contactors shall use time delay relays (time set for 2 seconds) and the R1 fault relay in fault configuration. Not available with NEMA® contactors or full voltage bypass.

Power Circuit S—

Shunt Trip Coil

If a fault is detected, a shunt trip coil on the disconnect means removes all power on the load side of the disconnect. The disconnect must be reset before restarting is permitted after all fault conditions. The shunt trip function shall be coordinated via a time delay relay (time set for 2 seconds) signaled from the R1 relay in fault configuration. Shunt trip coils shall be standard for MCC & option S for enclosed, and available on both circuit breaker & molded case switch versions. Not available with input isolation contactor option (Power Circuit N).

Control Options (pick one)

Mod	Start/Stop push buttons	\$ Price
A06	Provides black start and red stop push buttons (3 wire control scheme).	132.00

Rules: Not available on Power Circuit R (Reversing).

Mod	Forward-Off-Reverse selector switch	\$ Price
B06	Provides three-position selector switch to select between forward, off and reverse. Uses 2-wire control.	240.00

Rules: Available for Power Circuit R (Reversing) configurations only.

Mod	Hand-Off-Auto selector switch	\$ Price
C06	Provides a three-position selector switch, 2-wire control scheme.	132.00

Rules: Not available on Power Circuit R (Reversing).

Mod	Stop-Run selector switch	\$ Price
D06	Provides a two-position selector switch.	132.00

Rules: Not available on Power Circuit R (Reversing).

Mod	Hand-Auto selector switch and Start/Stop push buttons	\$ Price
E06	Provides a two-position selector switch and start/stop push buttons (3-wire control).	264.00

Rules: Not available on Power Circuit R (Reversing).

Pilot Light Cluster Options (pick one)

Mod	Pilot light cluster #1	\$ Price
A07	Consists of red "RUN" and green "OFF" pilot lights. Provides standard red "RUN (ON)" and green "OFF" pilot lights for status annunciation.	180.00

Mod	Pilot light cluster #2	\$ Price
B07	Consists of red "RUN" (push-to-test) and green "OFF" (push-to-test) pilot lights. Provides push-to-test type red "RUN (ON)" and standard green "OFF" pilot lights for status annunciation.	360.00

Mod	Pilot Light Cluster #3	\$ Price
C07	Consists of red "RUN", green "OFF" and yellow "FAULT" pilot lights. Provides standard red "RUN (ON)", green "OFF", and yellow "FAULT" pilot lights for status annunciation.	270.

Rules: Not available with Power Circuit S (Shunt Trip).

Mod	Pilot light cluster #4	\$ Price
D07	Consists of red "RUN (ON)" (push-to-test), green "OFF" (push-to-test) and yellow "FAULT" (push-to-reset) pilot lights. Provides push-to-test type red "RUN (ON)", standard green "OFF", and push-to-reset type yellow "FAULT" for status annunciation.	540.00

Rules: Not available on Power Circuit S (Shunt Trip).

Meter Display Options (pick one)

Mod	Ammeter	\$ Price
A08	Provides a single-phase ammeter fed from the ATS48 analog output. Dial is in percent of device rated current.	1188.00

Rules: Not available on Type 3R Enclosed.

Mod	Elapsed Time Meter	\$ Price
B08	Provides a seven-digit analog, non-resettable elapsed run time meter.	348.00

Rules: Not available on Type 3R Enclosed.

Communications/Gateway Options (pick one)

Factory installed communication features shall be available as a custom engineered option utilizing the RJ45 communications port for control and annunciation of the soft start in "link" mode.

Mod	Modbus™	\$ Price
A09	Provides Modbus communications (native protocol)	1500.00

Mod	Ethernet	\$ Price
C09	Provides Ethernet gateway communications protocol.	1500.00

Mod	DeviceNet™	\$ Price
D09	Provides DeviceNet gateway communications protocol.	1500.00

Mod	Ethernet IP	\$ Price
E09	Provides Ethernet IP gateway communications protocol.	2000.00

Miscellaneous Options (multiple compatible options may be selected)

Mod A10	Full voltage bypass	\$ Price
	Provides an AC3 duty rated bypass/shorting contactor, normal/bypass selector switch, Class 20 bi-metal motor OL relay, door mounted OL reset push-button for across the line starting capability. Enclosure Size A adder: 500.00 Enclosure Size B adder: 600.00 Enclosure Size C adder: 700.00 Enclosure Size D adder: 750.00 Enclosure Size E adder: 900.00	
Rules: Only available for Power Circuit N (Non-Reversing). Not available with Power Circuit S (Shunt Trip) SCR fault isolation scheme.		
Mod B10	150 VA additional control power capacity	\$ Price
	Provides 150 VA additional control VA capacity for customer use.	150.00
Mod C10	Power Up ON delay (start relay)	\$ Price
	Provides an electronic time delay relay adjustable from 0.1 to 60 seconds. Relay is pre-wired to inhibit start for users set delay time upon power-up of control power circuit.	150.00
Rules: Only available on 2-wire control circuits.		
Mod D10	Emergency Stop push button	\$ Price
	Provides a push-button for immediate removal of all power.	140.00
Rules: Requires Power Circuit S (Shunt Trip).		
Mod E10	"cUL" Label	\$ Price
	Provides a Canadian Underwriters Laboratories label when required by local code requirements.	200.00
Mod F10	Auxiliary contacts for run mode	\$ Price
	Provides 1 Form 'C' contact rated 5 A @ 120 Vac (8501 Type R relay or equivalent) wired to terminal blocks for customer use. Contacts change state when soft start is sending current to the motor. Controlled by the R3 relay programmed for "m".	550.00
Mod G10	Auxiliary contacts for full voltage bypass run mode	\$ Price
	Provides 1 Form 'C' contact rated 5 A @ 120 Vac (8501 Type R relay or equivalent) wired to terminal blocks for customer use. Contacts change state when motor is operated across the line with full voltage bypass starter.	550.00
Rules: MOD A10 (Full Voltage Bypass) must be selected. Must use Power Circuit N or R (line isolation contactor combination). Not compatible with Power Circuit S (Shunt Trip).		
Mod H10	Auxiliary contacts for auto mode	\$ Price
	Provides an auxiliary starter mode (auto) contact that will energize a relay with 1 Form 'C' contact rated 5 A @ 120 Vac (8501 Type R relay or equivalent) wired to terminal blocks for customer use.	550.00
Rules: MOD C06 (Hand-Off-Auto selector switch) or E06 (Hand-Auto selector switch) must be specified.		
Mod J10	Auxiliary contacts for fault mode	\$ Price
	Provides an auxiliary starter mode (auto) contact that will energize a relay with 1 Form 'C' contact rated 5 A @ 120 Vac (8501 Type R relay or equivalent) wired to terminal blocks for customer use.	650.00
Mod K10	Motor space heater provisions (custom engineered option)	\$ Price
	Provides control circuit contacts, 120 V, 150–500 kW supply and fusing, wired to terminals (9080 GM6) for customer use.	640.00
Mod L10	ID engraved nameplates	\$ Price
	Provides a lamacoid nameplate, engraved with equipment designation.	50.00
Mod M10	Spare terminal blocks	\$ Price
	Provides up to (10) spare terminal blocks 'unwired' for customer use. Since Phoenix style terminal blocks will be used, extra terminal points will be provided as standard. 20 terminal points are available as standard for all control wiring (including any additional customer spare terminal points).	340.00

Mod P10	Permanent wire markers	\$ Price
	Provides permanent sleeve type wire markers on control wiring assemblies.	1400.00

Mod Q10	ANSI #61 painted enclosure (custom engineered option)	\$ Price
	Provides the option to configure the enclosure paint scheme to standard ANSI #61 paint instead of ANSI #49 paint.	375.00

Mod R10	MOV / Surge arrestor (custom engineered option)	\$ Price
	Provides supplementary MOV protection using a Class 6671 SDSA3650 Surgebreaker™ secondary surge arrester hard-wired and factory mounted.	450.00

Mod S10	Dual motor overloads and branch circuit protection (custom engineered option)	\$ Price
	Provides dual-rated motor OLs rated equally, one-half the hp of the selected starter. Motor branch short circuit protection is provided per NEC™. Maximum total current rating of the combined motors not to exceed the continuous current rating of the starter package. Enclosure Size A adder: 820.00 Enclosure Size B adder: 1874.00 Enclosure Size C adder: 2645.00 Enclosure Size D adder: 3160.00 Enclosure Size E adder: 6570.00	

Rules: Available on Class 8639 circuit breaker disconnect configurations only.

Mod U10	Omit door mounted keypad display	\$ Price
	Removes the keypad display from outside the enclosure door. The keypad on the ATS48 soft start can be used for programming and commissioning.	(50.00)

Rules: Only for Type 3R size D and E enclosures.

Mod V10	OSHPD Seismic Certification	\$ Price
	This option provides special labels and documents to comply with the seismic requirements of the California Office of Statewide Planning and Development (OSHPD). Refer to 30072-454-87, <i>Seismic Qualification of Enclosed Drives and Soft Starters</i> , for additional information.	400.00

Mod W10	NEMA® style contactors (custom engineered option)	\$ Price
	Provides horsepower rated NEMA rated contactors instead of AC3 rated IEC TeSys™ or F-line contactors. Enclosure Size A adder: 400.00 Enclosure Size B adder: 600.00 Enclosure Size C adder: 700.00 Enclosure Size D adder: 2000.00 Enclosure Size E adder: 4500.00	

Rules: Not available with Power Circuit R (Reversing) or MOD A10 (Full voltage bypass).

Mod X10	50 Degrees C operation	\$ Price
	Provides extended range high ambient equipment rating above 40 °C (104 °F) to a maximum of 50 °C (122 °F) without de-rating.	125.00

Rules: Standard on Type 3R enclosures.

Mod Y10	Seismic Qualification label	\$ Price
	Provides a self-certified identification label with compliance to 2000 IBC, NFPA™ 5000, 2001 CBC, 1997 UBC, 1999 NBC, 1999SBC, ASCE-7 02 seismic qualification/certification. The label criteria will be uniform for all enclosed products. Enclosures shall contain additional bracing as defined by the seismic qualification/certification criteria.	450.00

Rules: Not available for Enclosure Sizes A–C (wall mounted enclosures).

Mod Z10	Service Entrance Rating	\$ Price
	Provides a UL869A approved insulated ground neutral lug assembly, mounting bracket with bonded enclosure ground wire suitable for use as service entrance equipment.	185.00

Rules: Service Entrance Rating is only available for Type 3R enclosures and is not available with the Model E10 (cUL Label).

Mod 610	100 k Circuit Breaker Rating	\$ Price
	Only available: 208 V, 125–200 hp 230 V, 150–250 hp 460 V, 300–500 hp	2000.00

Table 59: Renewal Parts

Description	Line Voltage	Class 8636 Controllers		Class 8638/8639 Combination Controllers				Catalog Number	\$ Price	
		Type 1 No Shorting	Type 1 and 12 W/Shorting	Standard Duty	Heavy Duty	Standard W/Bypass	Heavy W/Bypass			
Control Power Primary Fuse FU8 Standard VA	460 V		10–20 hp ▲	10–20 hp	7.5–15 hp			2543020020	11.00	
	208 V		3–7.5 hp ▲	3–7.5 hp	2–5 hp			2543020050	11.00	
	230 V		5–10 hp ▲	5–10 hp	3–7.5 hp					
	460 V	30–60 hp	30–75 hp	30–75 hp	20–60 hp			2543020100	11.00	
	230 V	15–30 hp	15–40 hp	15–40 hp	10–30 hp					
	460 V	75–100 hp	100–125 hp	100–125 hp	75–100 hp	75 hp		2543020112	11.00	
	208 V	10–25 hp	10–30 hp	10–30 hp	7.5–25 hp					
	460 V	125 hp	150 hp	150 hp	125 hp			2543020125	14.76	
	460 V	250–400 hp	300–500 hp	300–500 hp	150–400 hp			2543020150	11.00	
	460 V	150–200 hp	200–250 hp	200–250 hp	150–200 hp	150 hp	125 hp	2543020180	11.00	
	230 V	40–50 hp	50–60 hp	50–60 hp	40–50 hp	40 hp		2543020200	11.00	
	208 V	30–40 hp	40–50 hp	40–50 hp	30–40 hp	30 hp		2543020250	13.68	
	230 V	60 hp	75 hp	75 hp	60 hp					
	208 V	50 hp	60 hp	60 hp	50 hp			2543020300	11.00	
	230 V	125–200 hp	150–250 hp	150–250 hp	125–200 hp			2543020350	11.00	
	208 V	100–150 hp	125–200 hp	125–200 hp	100–150 hp					
	230 V	75–100 hp	100–125 hp	100–125 hp	75–100 hp	75 hp	60 hp	2543020400	11.00	
	208 V	60–75 hp	75–100 hp	75–100 hp	60–75 hp	60 hp	50 hp	2543020400	11.00	
	Control Power Primary Fuse FU8 Form T41 100 Additional VA	460 V		10–20 hp ▲	10–20 hp	7.5–15 hp			2543020060	11.00
		460 V	30–60 hp	30–75 hp	30–75 hp	20–60 hp			2543020100	11.00
230 V			5–10 hp ▲	5–10 hp	3–7.5 hp			2543020150	11.00	
460 V		75–100 hp	100–125 hp	100–125 hp	75–100 hp	75 hp				
208 V			3–7.5 hp ▲	3–7.5 hp	2–5 hp			2543020160	14.76	
460 V		125 hp	150 hp	150 hp	125 hp			2543020180	11.00	
230 V		15–30 hp	15–40 hp	15–40 hp	10–30 hp			2543020200	11.00	
208 V		10–25 hp	10–30 hp	10–30 hp	7.5–25 hp			2543020250	13.68	
460 V		150–400 hp	200–500 hp	200–500 hp	150–400 hp	150 hp	125 hp			
230 V		40–50 hp	50–60 hp	50–60 hp	40–50 hp	40 hp		2543020300	11.00	
230 V		75–200 hp	100–250 hp	100–250 hp	75–200 hp	75 hp	60 hp	2543020320	11.00	
208 V		30–40 hp	40–50 hp	40–50 hp	30–40 hp	30 hp		2543020350	11.00	
230 V		60 hp	75 hp	75 hp	60 hp					
208 V		50–150 hp	60–200 hp	60–200 hp	50–150 hp	60 hp	50 hp	2543020400	11.00	
Control Power Primary Fuse FU8 Form T42 200 Additional VA	460 V		10–20 hp ▲	10–20 hp	7.5–15 hp			2543020125	14.67	
	460 V	30–60 hp	30–75 hp	30–75 hp	20–60 hp			2543020150	11.00	
	230 V		5–10 hp ▲	5–10 hp	3–7.5 hp			2543020250	13.68	
	460 V	75–125 hp	100–150 hp	100–150 hp	75–125 hp	75 hp				
	460 V	250–400 hp	300–500 hp	300–500 hp	250–400 hp			2543020300	11.00	
	208 V		3–7.5 hp ▲	3–7.5 hp	2–5 hp					
	230 V	15–30 hp	15–40 hp	15–40 hp	10–30 hp			2543020320	11.00	
	230 V	40–60 hp	50–75 hp	50–75 hp	40–60 hp	40 hp				
	230 V	125–200 hp	150–250 hp	150–250 hp	125–200 hp			2543020350	11.00	
	208 V	10–25 hp	10–30 hp	10–30 hp	7.5–25 hp					
	460 V	150–200 hp	200–250 hp	200–250 hp	150–200 hp	150 hp	125 hp	2543020400	11.00	
	208 V	30–50 hp	40–60 hp	40–60 hp	30–50 hp	30 hp				
	208 V	100–150 hp	125–200 hp	125–200 hp	100–150 hp			2543020500	11.00	
	230 V	75–100 hp	100–125 hp	100–125 hp	75–100 hp	75 hp	60 hp			
208 V	60–75 hp	75–100 hp	75–100 hp	60–75 hp	60 hp	50 hp	2543020600	11.00		

▲ These Type 1 and 12 units are not shipped with a shorting contactor installed.

Table 60: Renewal Parts

Description	Line Voltage	Class 8636 Controllers		Class 8638/8639 Combination Controllers				Catalog Number	\$ Price				
		Type 1 No Shorting	Type 1 & 12 W/Shorting	Standard Duty	Heavy Duty	Standard W/Bypass	Heavy W/Bypass						
Control Power Secondary Fuse FU6 & 7 Standard VA	208 V		3–7.5 hp ▲	3–7.5 hp	2–5 hp			2543020060	11.00				
	230 V		5–10 hp ▲	5–10 hp	3–7.5 hp								
	460 V		10–20 hp▲	10–20 hp	7.5–15 hp								
	208 V	10–25 hp	10–30 hp	10–30 hp	7.5–25 hp			2543020125■	14.76				
	230 V	15–30 hp	15–40 hp	15–40 hp	10–30 hp								
	460 V	30–60 hp	30–75 hp	30–75 hp	20–60 hp								
	208 V	30–40 hp	40–50 hp	40–50 hp	30–40 hp					30 hp			
	230 V	40–50 hp	50–60 hp	50–60 hp	40–50 hp					40 hp			
	460 V	75–100 hp	100–125 hp	100–125 hp	75–100 hp					75 hp			
	208 V	50 hp	60 hp	60 hp	50 hp			2543020300	11.00				
	230 V	60 hp	75 hp	75 hp	60 hp								
	460 V	125 hp	150 hp	150 hp	125 hp								
	208 V	100–150 hp	125–200 hp	125–200 hp	100–150 hp								
	230 V	125–200 hp	150–250 hp	150–250 hp	125–200 hp								
	460 V	250–400 hp	300–500 hp	300–500 hp	250–400 hp								
	208 V	60–75 hp	75–100 hp	75–100 hp	60–75 hp	60 hp	50 hp	2543020500	11.00				
	230 V	75–100 hp	100–125 hp	100–125 hp	75–100 hp	75 hp	60 hp						
	460 V	150–200 hp	200–250 hp	200–250 hp	150–200 hp	150 hp	125 hp						
Control Power Secondary Fuse FU6 & 7 Form T41 100 Additional VA	208 V		3–7.5 hp ▲	3–7.5 hp	2–5 hp			2543020200	11.00				
	230 V		5–10 hp ▲	5–10 hp	3–7.5 hp								
	460 V		10–20 hp ▲	10–20 hp	7.5–15 hp								
	208 V	10–25 hp	10–30 hp	10–30 hp	7.5–25 hp			2543020250■	13.68				
	230 V	15–30 hp	15–40 hp	15–40 hp	10–30 hp								
	460 V	30–60 hp	30–75 hp	30–75 hp	20–60 hp								
	208 V	30–40 hp	40–50 hp	40–50 hp	30–40 hp					30 hp			
	230 V	40–50 hp	50–60 hp	50–60 hp	40–50 hp					40 hp			
	460 V	75–100 hp	100–125 hp	100–125 hp	75–100 hp					75 hp			
	208 V	50 hp	60 hp	60 hp	50 hp			2543020500	11.00				
	230 V	60 hp	75 hp	75 hp	60 hp								
	460 V	125 hp	150 hp	150 hp	125 hp								
	208 V	60–150 hp	75–200 hp	75–200 hp	60–150 hp					60 hp	50 hp		
	230 V	75–200 hp	100–250 hp	100–250 hp	75–200 hp					75 hp	60 hp		
	460 V	150–400 hp	200–500 hp	200–500 hp	150–400 hp					150 hp	125 hp		
	Control Power Secondary Fuse FU6 & 7 Form T42 200 Additional VA	208 V		3–7.5 hp ▲	3–7.5 hp	2–5 hp			2543020300	11.00			
		230 V		5–10 hp ▲	5–10 hp	3–7.5 hp							
		460 V		10–20 hp ▲	10–20 hp	7.5–15 hp							
208 V		10–25 hp	10–30 hp	10–30 hp	7.5–25 hp			2543020400	11.00				
230 V		15–30 hp	15–40 hp	15–40 hp	10–30 hp								
460 V		30–60 hp	30–75 hp	30–75 hp	20–60 hp								
208 V		30–50 hp	40–60 hp	40–60 hp	30–50 hp					30 hp			
208 V		100–150 hp	125–200 hp	125–200 hp	100–150 hp							2543020700	11.00
230 V		40–60 hp	50–75 hp	50–75 hp	40–60 hp								
230 V		125–200 hp	150–250 hp	150–250 hp	125–200 hp								
460 V		75–125 hp	100–150 hp	100–150 hp	75–125 hp	75 hp							
460 V		250–400 hp	300–500 hp	300–500 hp	250–400 hp								
208 V		60–75 hp	75–100 hp	75–100 hp	60–75 hp	60 hp	50 hp						
230 V		75–100 hp	100–125 hp	100–125 hp	75–100 hp	75 hp	60 hp	2543021000	11.00				
460 V		150–200 hp	200–250 hp	200–250 hp	150–200 hp	150 hp	125 hp						

▲ These Type 1 & 12 units are not shipped with a shorting contactor installed.
■ Discount Schedule for this product is PE4.

Description	Line Voltage	Class 8636 Controllers		8638/8639 Combination Controllers		Catalog Number	\$ Price
		Type 1 No Shorting	Type 1 & 12 W/Shorting	Standard Duty	Heavy Duty		
Altistart™ CL1-CL2 Control Power Fuse FU4 & 5	208 V	3–7.5 hp	3–10 hp ▲	3–10 hp	2–7.5 hp	2543020025	11.00
	230 V	5–10 hp	5–15 hp ▲	5–15 hp	3–10 hp		
	460 V	10–75 hp	10–100 hp ▲	10–100 hp	7.5–75 hp		
	208 V	10–30 hp	15–40 hp	15–40 hp	10–30 hp	2543020050	11.00
	230 V	15–40 hp	20–50 hp	20–50 hp	15–40 hp		
	460 V	100–200 hp	125–250 hp	125–250 hp	100–200 hp	2543020080	11.00
	460 V	250–400 hp	300–500 hp	300–500 hp	250–400 hp	2543020100	11.00
	208 V	40–75 hp	50–100 hp	50–100 hp	40–75 hp	2543020160■	14.76
	230 V	50–100 hp	60–125 hp	60–125 hp	50–100 hp		
	208 V	100–150 hp	125–200 hp	125–200 hp	100–150 hp	2543020200	11.00
230 V	125–200 hp	150–250 hp	150–250 hp	125–200 hp			
Auxiliary CPT Primary Fuses FU9 & 10	208 V	10–150 hp	10–200 hp	10–200 hp	7.5–150 hp	2543021500	11.00
	230 V	15–200 hp	15–250 hp	15–250 hp	10–200 hp		
	460 V	30–400 hp	30–500 hp	30–500 hp	20–500 hp		
1.2 VA / 6 V Bulb for Pilot Lights	208 V	ALL	ALL	ALL	ALL	DL1CB006■	5.30
	230 V	ALL	ALL	ALL	ALL		
	460 V	ALL	ALL	ALL	ALL		

▲ Units with the following hp ratings are not shipped with shorting contactors: 3–7.5 hp (208 V), 5–10 hp (230 V) and 10–20 hp (460 V)
 ■ Discount Schedule for this product is PE4.

Options—Field Installed

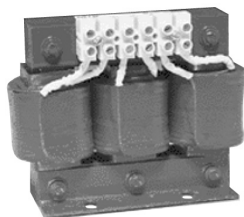

Table 61: Line Reactors—480 V Rated Three-Phase

460 V Drive Rating		Open Style Part Number	\$ Price	Enclosed Part Number (Type 1)	Approx. Wt. (Lbs.)	Enclosure Dimensions HxWxD (In.)	\$ Price
Horsepower	kW						
1	—	RL00202▲	169.00	RL00212▲	11	8x8x6	310.00
2-3	—	RL00403▲	174.00	RL00413▲	12	8x8x6	315.00
5	—	RL00803▲	262.00	RL00813▲	18	15x13x13	405.00
7.5	—	RL01203	308.00	RL01213	25	15x13x13	455.00
10	—	RL01803	357.00	RL01813	49	15x13x13	590.00
15	—	RL02503	368.00	RL02513	49	15x13x13	602.00
20-25	—	RL03503	487.00	RL03513	61	15x13x13	727.00
30	—	RL04503	571.00	RL04513	70	15x13x13	816.00
40	—	RL05503	578.00	RL05513	72	15x13x13	822.00
50-60	—	RL08003	939.00	RL08013	86	15x13x13	1200.00
75	—	RL10003	1096.00	RL10013	105	15x13x13	1366.00
100	—	RL13003	1120.00	RL13013	105	15x13x13	1392.00
125	—	RL16003	1260.00	RL16013	105	15x13x13	1539.00
150	—	RL20003	1539.00	RL20013	131	15x13x13	1831.00
200	—	RL25003	2727.00	RL25013	185	24x17x17	3447.00
250	—	RL32003	2915.00	RL32013	235	24x17x17	3646.00
300	—	RL40003	3576.00	RL40013	245	24x17x17	4338.00
350-400	—	RL50003	4150.00	RL50013	335	24x17x17	5761.00
450-500	—	RL60003	5740.00	RL60013	335	24x17x17	7431.00

Table 62: Line Reactors—208/230 V Rated Three-Phase

208 V Drive Rating		230 V Drive Rating		Open Style Part Number	\$ Price	Enclosed Part Number (Type 1)	Approx. Wt. (Lbs.)	Enclosure Dimensions HxWxD (In.)	\$ Price
Horsepower	kW	Horsepower	kW						
1	—	1	—	RL00402	168.00	RL00412	11	8x8x6	308.00
1.5-2	—	1.5-2	—	RL00802▲	192.00	RL00812▲	15	8x8x6	332.00
3	—	3	—	RL01202▲	214.00	RL01212▲	17	8x8x6	356.00
5	—	5	—	RL01802▲	270.00	RL01812▲	19	8x8x6	416.00
7.5	—	7.5	—	RL02502▲	311.00	RL02512▲	45	15x13x13	542.00
10	—	10	—	RL03502	327.00	RL03512	47	15x13x13	559.00
15	—	15	—	RL04502	431.00	RL04512	59	15x13x13	669.00
20	—	20	—	RL05502	455.00	RL05512	59	15x13x13	693.00
25	—	25-30	—	RL08002	534.00	RL08012	82	15x13x13	776.00
30	—	40	—	RL10002	746.00	RL10012	82	15x13x13	999.00
40	—	50	—	RL13002	848.00	RL13012	88	15x13x13	1106.00
50	—	—	—	RL16002	1048.00	RL16012	88	15x13x13	1317.00

Table 63: Motor Protecting Output Filters—480 V Rated Type 1 Enclosed Motor Protection Output Filters (UL 508A)



Horsepower	Amperes	KLCUL Filter Enclosed Part Number	\$ Price	Approximate Weight (lbs)	Enclosure Dimensions					
					H		W		D	
					IN	mm	IN	mm	IN	mm
1-2	4	KLCUL4A1	1126.00	15	12.25	311	12.50	318	6.75	171
3	6	KLCUL6A1	1148.00	15	12.25	311	12.50	318	6.75	171
5	8	KLCUL8A1	1171.00	15	12.25	311	12.50	318	6.75	171
7.5	12	KLCUL12A1	1224.00	15	12.25	311	12.50	318	6.75	171
10	16	KLCUL16A1	1249.00	17	12.25	311	12.50	318	6.75	171
15	25	KLCUL25A1	1355.00	20	12.25	311	12.50	318	6.75	171
20-25	35	KLCUL35A1	1485.00	20	12.25	311	12.50	318	6.75	171
30	45	KLCUL45A1	1535.00	20	12.25	311	12.50	318	6.75	171
40	55	KLCUL55A1	1672.00	20	12.25	311	12.50	318	6.75	171
50-60	80	KLCUL80A2	2178.00	56	19.13	486	15.50	394	15.50	394
75	110	KLCUL110A2	3005.00	60	19.13	486	15.50	394	15.50	394
100	130	KLCUL130A2	3368.00	66	19.13	486	15.50	394	15.50	394
125	160	KLCUL160A2	3617.00	80	19.13	486	15.50	394	15.50	394
150	200	KLCUL200A3	3766.00	102	22.13	562	20.50	521	24.37	619
200	250	KLCUL250A3	3841.00	110	22.13	562	20.50	521	24.37	619
250	300	KLCUL300A3	3863.00	115	22.13	562	20.50	521	24.37	619
300	360	KLCUL360A3	4300.00	125	22.13	562	20.50	521	24.37	619
350	420	KLCUL420A3	4659.00	145	22.13	562	20.50	521	24.37	619
400	480	KLCUL480A3	5221.00	150	22.13	562	20.50	521	24.37	619
450-500	600	KLCUL600A3	5393.00	167	22.13	562	20.50	521	24.37	619

NOTE: Line reactors and filters are intended for separate mounting and wiring by the user. Based on NEC™ (NFPA™ 70) 430–150 current ratings. If drive has higher FLA rating, use the “amperes” rating to select the appropriate filter.



Table 64: Standard NEMA 1 Style

Part Number	Ohms	Watts	Encl Type	Dimensions (inches)			Weight (lbs)	Price
				L	W	H		
P184441	100	400	GCE1	12	5	5	7	139.00
P184442	100	800	GCE2	12	7	5	9	224.00
P184443	100	1200	GCE3	12	10	5	13	295.00
P184444	100	1600	GCE4	12	13	5	16	367.00
P184445	100	2400	GCE6	19	10	5	20	508.00
P184446	72	400	GCE1	12	5	5	7	139.00
P184447	72	800	GCE2	12	7	5	9	224.00
P184448	72	1200	GCE3	12	10	5	13	295.00
P184449	72	1600	GCE4	12	13	5	16	367.00
P1844410	60	400	GCE1	12	5	5	7	139.00
P1844411	60	800	GCE2	12	7	5	9	224.00
P1844412	60	1200	GCE3	12	10	5	13	295.00
P1844413	60	1600	GCE4	12	13	5	16	367.00
P1844414	60	2000	GCE5	12	16	5	18	437.00
P1844415	60	2400	GCE6	19	10	5	20	508.00
P1844416	60	2800	GCE8	19	13	5	24	580.00
P1844417	40	400	GCE1	12	5	5	7	139.00
P1844418	40	800	GCE2	12	7	5	9	224.00
P1844419	40	1200	GCE3	12	10	5	13	295.00
P1844420	40	1600	GCE4	12	13	5	16	367.00
P1844421	40	2000	GCE5	12	16	5	18	437.00
P1844422	40	2400	GCE6	19	10	5	20	508.00
P1844423	40	2800	GCE8	19	13	5	24	580.00
P1844424	40	4000	GCE10	19	16	5	30	765.00
P1844425	40	4400	GCE12	26.5	13	5	32	836.00
P1844426	40	5600	GCE15	26.5	16	5	38	995.00
P1844427	25	400	GCE1	12	5	5	7	139.00
P1844428	25	800	GCE2	12	7	5	9	224.00
P1844429	25	1200	GCE3	12	10	5	13	295.00
P1844430	25	1600	GCE4	12	13	5	16	367.00
P1844431	25	5625	GCE12	26.5	13	5	28	822.00
P1844432	25	2000	GCE5	12	16	5	18	437.00
P1844433	25	8100	GCE15	26.5	16	5	36	1044.00
P1844434	25	2400	GCE6	19	10	5	20	508.00
P1844435	25	2800	GCE8	19	13	5	24	580.00
P1844436	25	3600	GCE9	26.5	10	5	27	694.00
P1844437	16	400	GCE1	12	5	5	7	139.00
P1844438	16	800	GCE2	12	7	5	9	224.00
P1844439	16	1200	GCE3	12	10	5	13	295.00
P1844440	16	3600	GCE6	19	10	5	19	559.00
P1844441	16	4096	GCE9	26.5	10	5	24	651.00
P1844442	16	1600	GCE4	12	13	5	16	367.00
P1844443	16	5184	GCE12	26.5	13	5	28	822.00
P1844444	16	6400	GCE12	26.5	13	5	31	884.00
P1844445	16	2000	GCE5	12	16	5	18	437.00
P1844446	16	8464	GCE15	26.5	16	5	36	1044.00
P1844447	16	2400	GCE6	19	10	5	20	508.00
P1844448	16	10816	GCE18	28	10	10	39	1230.00
P1844449	14	1200	GCE3	12	10	5	13	295.00
P1844450	14	3150	GCE6	19	10	5	19	559.00
P1844451	14	4536	GCE9	26.5	10	5	25	698.00
P1844452	14	1600	GCE4	12	13	5	16	367.00
P1844453	14	5600	GCE12	26.5	13	5	28	822.00
P1844454	14	2000	GCE5	12	16	5	18	437.00
P1844455	14	7406	GCE15	26.5	16	5	33	965.00
P1844456	14	9464	GCE18	28	10	10	37	1099.00
P1844457	14	2400	GCE6	19	10	5	20	508.00
P1844458	14	11774	GCE24	28	13	10	51	1535.00
P1844459	10	400	GCE1	12	5	5	7	139
P1844460	10	800	GCE2	12	7	5	9	224
P1844461	10	2250	GCE6	19	10	5	17	455.00
P1844462	10	1200	GCE3	12	10	5	13	295.00
P1844463	10	3240	GCE6	19	10	5	19	559.00
P1844464	10	4000	GCE9	26.5	10	5	24	651.00



Standard NEMA 1 Style (continued)

Part Number	Ohms	Watts	Encl Type	Dimensions (inches)			Weight (lbs)	Price
				L	W	H		
P1844465	10	5290	GCE9	26.5	10	5	25	698 .00
P1844466	10	1600	GCE4	12	13	5	16	367 .00
P1844467	10	6760	GCE12	26.5	13	5	28	884 .00
P1844468	10	2000	GCE5	12	16	5	18	437 .00
P1844469	10	10240	GCE18	28	10	10	44	1230.00
P1844470	10	12960	GCE24	28	13	10	55	1690.00
P1844471	10	16000	GCE30	28	16	10	70	2034.00
P1844472	8	1800	GCE6	19	10	5	16	438.00
P1844473	8	3200	GCE6	19	10	5	19	559.00
P1844474	8	4232	GCE18	28	10	10	32	788 .00
P1844475	8	5408	GCE18	28	10	10	32	835 .00
P1844476	8	8192	GCE15	26.5	16	5	37	1044.00
P1844477	8	10368	GCE18	28	10	10	44	1347.00
P1844478	8	12800	GCE24	28	13	10	59	1690.00
P1844479	8	16200	GCE30	28	16	10	70	1883.00
P1844480	8	20000	ED2	30	18	16	99	2463.00
P1844481	8	28800	ED3	30	18	24	142	3151.00
P1844482	6	800	GCE2	12	7	5	9	224 .00
P1844483	6	1944	GCE6	19	10	5	17	455.00
P1844484	6	2400	GCE6	19	10	5	17	455 .00
P1844485	6	1200	GCE3	12	10	5	13	295 .00
P1844486	6	1600	GCE4	12	13	5	16	367 .00
P1844487	6	3174	GCE6	19	10	5	19	559 .00
P1844488	6	4056	GCE9	26.5	10	5	24	651 .00
P1844489	6	1600	GCE4	12	13	5	16	367.00
P1844490	6	5046	GCE12	26.5	13	5	30	822.00
P1844491	6	6144	GCE12	26.5	13	5	32	884 .00
P1844492	6	7776	GCE15	26.5	16	5	37	1141.00
P1844493	6	9600	GCE18	28	10	10	47	1347.00
P1844494	6	12150	GCE24	28	13	10	57	1539.00
P1844495	6	15000	GCE24	28	13	10	67	1690.00
P1844496	6	21600	GCE30	28	16	10	89	2034.00
P1844497	4.5	1800	GCE6	19	10	5	16	438 .00
P1844498	4.5	1200	GCE3	12	10	5	13	295.00
P1844499	4.5	4608	GCE9	26.5	10	5	26	698 .00
P18444100	4.5	1600	GCE4	12	13	5	16	367.00
P18444101	4.5	5832	GCE12	26.5	13	5	32	894 .00
P18444102	4.5	7200	GCE15	26.5	16	5	39	1141.00
P18444103	4.5	9112	GCE15	26.5	16	5	41	1141.00
P18444104	4.5	11250	GCE18	28	10	10	53	1347.00
P18444105	4.5	16200	GCE24	28	13	10	74	1690.00
P18444106	4.5	22050	GCE30	28	16	10	99	2445.00
P18444107	4.5	32512	ED2	30	18	16	151	3875.00
P18444108	4.5	28800	ED2	30	18	16	105	3327.00
P18444109	4.5	45000	ED3	30	18	24	204	4675.00
P18444110	3.3	1745	GCE6	19	10	5	16	438 .00
P18444111	3.3	2230	GCE6	19	10	5	17	455.00
P18444112	3.3	1200	GCE3	12	10	5	13	295 .00
P18444113	3.3	2775	GCE6	19	10	5	19	559 .00
P18444114	3.3	3379	GCE6	19	10	5	21	559 .00
P18444115	3.3	4276	GCE9	26.5	10	5	26	705 .00
P18444116	3.3	5280	GCE12	26.5	13	5	33	894 .00
P18444117	3.3	6682	GCE12	26.5	13	5	34	962 .00
P18444118	3.3	8250	GCE15	26.5	16	5	44	1141.00
P18444119	3.3	8923	GCE18	28	10	10	40	1136.00
P18444120	3.3	11880	GCE18	28	10	10	58	1347.00
P18444121	3.3	16170	GCE24	28	13	10	75	1827.00
P18444122	3.3	13516	GCE24	28	13	10	55	1535.00
P18444123	3.3	23842	ED2	30	18	16	127	3032.00
P18444124	3.3	33000	ED3	30	18	24	176	3826.00
P18444125	2.2	5500	GCE9	26.5	10	5	30	756 .00
P18444126	2.2	7920	GCE12	26.5	13	5	41	962 .00
P18444127	2.2	10780	GCE15	26.5	16	5	54	1347
P18444128	2.2	11404	GCE24	28	13	10	56	1555
P18444129	2.2	15895	GCE24	28	13	10	82	2019.00



Standard NEMA 1 Style (continued)

Part Number	Ohms	Watts	Encl Type	Dimensions (inches)			Weight (lbs)	Price
				L	W	H		
P18444130	2.2	14080	GCE30	28	16	10	70	1864.00
P18444131	2.2	17820	GCE30	28	16	10	73	2034.00
P18444132	2.2	22000	GCE30	28	16	10	108	2445.00
P18444133	2.2	31680	ED3	30	18	24	151	3383.00
P18444134	2.2	40095	ED4	30	18	32	168	4473.00
P18444135	2.2	49500	ED5	30	18	40	232	5628.00
P18444136	2.2	97020	ED5	30	18	40	368	9370.00
P18444137	2.2	71280	ED6	30	18	48	310	6785.00
P18444138	1.8	1843	GCE6	19	10	5	16	438.00
P18444139	1.8	2332	GCE6	19	10	5	18	479.00
P18444140	1.8	2880	GCE6	19	10	5	22	595.00
P18444141	1.8	3645	GCE6	19	10	5	22	595.00
P18444142	1.8	4500	GCE9	26.5	10	5	30	705.00
P18444143	1.8	6480	GCE9	26.5	10	5	33	756.00
P18444144	1.8	8820	GCE12	26.5	13	5	45	1126.00
P18444145	1.8	9331	GCE18	28	10	10	44	1347.00
P18444146	1.8	13005	GCE24	28	13	10	75	1827.00
P18444147	1.8	11520	GCE24	28	13	10	59	1690.00
P18444148	1.8	18000	GCE24	28	13	10	89	2019.00
P18444149	1.8	20995	ED2	30	18	16	89	2696.00
P18444130	2.2	14080	GCE30	28	16	10	70	1864.00
P18444131	2.2	17820	GCE30	28	16	10	73	2034.00
P18444132	2.2	22000	GCE30	28	16	10	108	2445.00
P18444133	2.2	31680	ED3	30	18	24	151	3383.00
P18444134	2.2	40095	ED4	30	18	32	168	4473.00
P18444135	2.2	49500	ED5	30	18	40	232	5628.00
P18444136	2.2	97020	ED5	30	18	40	368	9370.00
P18444137	2.2	71280	ED6	30	18	48	310	6785.00
P18444138	1.8	1843	GCE6	19	10	5	16	438.00
P18444139	1.8	2332	GCE6	19	10	5	18	479.00
P18444140	1.8	2880	GCE6	19	10	5	22	595.00
P18444141	1.8	3645	GCE6	19	10	5	22	595.00
P18444142	1.8	4500	GCE9	26.5	10	5	30	705.00
P18444143	1.8	6480	GCE9	26.5	10	5	33	756.00
P18444144	1.8	8820	GCE12	26.5	13	5	45	1126.00
P18444145	1.8	9331	GCE18	28	10	10	44	1347.00
P18444146	1.8	13005	GCE24	28	13	10	75	1827.00
P18444147	1.8	11520	GCE24	28	13	10	59	1690.00
P18444148	1.8	18000	GCE24	28	13	10	89	2019.00
P18444149	1.8	20995	ED2	30	18	16	89	2696.00
P18444170	1.1	48510	ED4	30	18	32	225	5271.00
P18444171	1.1	71527	ED6	30	18	48	364	8491.00
P18444172	1.1	99000	ED7	30	18	56	462	9899.00
P18444173	0.7	15750	GCE30	28	16	10	76	1883.00
P18444174	0.7	22680	ED2	30	18	16	105	2347.00
P18444175	0.7	28000	ED2	30	18	16	143	3175.00
P18444176	0.7	30870	ED2	30	18	16	132	3175.00
P18444177	0.7	45517	ED4	30	18	32	240	5700.00
P18444178	0.7	63000	ED5	30	18	40	310	6666.00



Table 65: Case Resistor Style

Part Number	Ohms	Watts	Encl Type	Dimensions (inches)			Weight (lbs)	Price
				L	W	H		
P18444CR1	100	100	CR100	6	1.5	0.75	0.5	65.00
P18444CR2	100	150	CR150	9	1.5	0.75	1	77.00
P18444CR3	100	200	CR200	6	3	1.5	2	91.00
P18444CR4	100	250	CR250	7.5	3	1.5	2.5	97.00
P18444CR5	100	300	CR300	9	3	1.5	3	104.00
P18444CR6	100	400	CR400	12	3	1.5	4	129.00
P18444CR7	100	500	CR500	15	3	1.5	5	151.00
P18444CR8	72	150	CR150	9	1.5	0.75	1	77.00
P18444CR9	72	200	CR200	6	3	1.5	2	91.00
P18444CR10	72	250	CR250	7.5	3	1.5	2.5	97.00
P18444CR11	72	300	CR300	9	3	1.5	3	104.00
P18444CR12	72	400	CR400	12	3	1.5	4	129.00
P18444CR13	72	500	CR500	15	3	1.5	5	151.00
P18444CR14	60	300	CR300	9	3	1.5	3	104.00
P18444CR15	60	400	CR400	12	3	1.5	4	129.00
P18444CR16	60	500	CR500	15	3	1.5	5	151.00
P18444CR17	40	100	CR100	6	1.5	0.75	0.5	65.00
P18444CR18	40	150	CR150	9	1.5	0.75	1	77.00
P18444CR19	40	200	CR200	6	3	1.5	2	91.00
P18444CR20	40	250	CR250	7.5	3	1.5	2.5	97.00
P18444CR21	40	300	CR300	9	3	1.5	3	104.00
P18444CR22	40	400	CR400	12	3	1.5	4	129.00
P18444CR23	40	500	CR500	15	3	1.5	5	151.00
P18444CR24	25	200	CR200	6	3	1.5	2	91.00
P18444CR25	25	250	CR250	7.5	3	1.5	2.5	97.00
P18444CR26	25	300	CR300	9	3	1.5	3	104.00
P18444CR27	25	400	CR400	12	3	1.5	4	129.00
P18444CR28	25	150	CR150	9	1.5	0.75	1	77.00
P18444CR29	25	500	CR500	15	3	1.5	5	151.00
P18444CR30	16	200	CR200	6	3	1.5	2	91.00
P18444CR31	16	300	CR300	9	3	1.5	3	104.00
P18444CR32	16	400	CR400	12	3	1.5	4	129.00
P18444CR33	16	500	CR500	15	3	1.5	5	151.00



Table 66: Braking Modules

Part Number	Minimum Ohms	Continuous Amps	Peak Amps	Dimensions (inches)			Weight (lbs)	Price
				L	W	H		
ATVBM250	1.95	50	200	6.5	5.25	11	8	1653.00
ATVBM2115	1.95	115	200	6.5	5.25	13	11	1833.00
ATVBM2150	1.3	150	300	6.5	5.25	13	11	2001.00
ATVBM240450	0.65	450	600	7	10	20	30	6823.00
ATVBM240600	0.43	600	900	7	10	20	30	8902.00
ATVBM240900	0.29	900	1350	10	10	24	55	11943.00
ATVBM2401200	0.22	1200	1800	10	10	24	55	15758.00
ATVBM450	3.88	50	200	6.5	5.25	11	8	1653.00
ATVBM4115	3.88	115	200	6.5	5.25	13	11	1833.00
ATVBM4150	2.58	150	300	6.5	5.25	13	11	2001.00
ATVBM480450	1.29	450	600	7	10	20	30	6823.00
ATVBM480600	0.86	600	900	7	10	20	30	8902.00
ATVBM480900	0.57	900	1350	10	10	24	55	11943.00
ATVBM4801200	0.43	1200	1800	10	10	24	55	15758.00
ATVBM650	4.85	50	200	6.5	5.25	11	8	1653.00
ATVBM6115	4.85	115	200	6.5	5.25	13	11	1833.00
ATVBM6150	3.23	150	300	6.5	5.25	13	11	2001.00
ATVBM600450	1.62	450	600	7	10	20	30	6823.00
ATVBM600600	1.08	600	900	7	10	20	30	8902.00
ATVBM600900	0.72	900	1350	10	10	24	55	11943.00
ATVBM6001200	0.54	1200	1800	10	10	24	55	15758.00

Table 67: Kit Contents and Required Documentation

1—Identify Your Spare Parts Kit:			2—Identify Your Drive:		3—\$ Price	
Kit Catalog Number	Description	Qty	Kit Contents	Frame Size	Catalog Number	
VX4A1103	Control front cover with 4x7 Segments	1	Front cover assembly	All ATV61/ATV71	All ATV61/ATV71	144.00
VX4A1104	Control terminal board kit	1 2 1 1	Terminal PCBA Insulated jumpers Terminal PCBA lower cap Terminal PCBA upper cap	All ATV61/ATV71	All ATV61/ATV71	142.00
VX4A1106	Filter board	1	Filter board	6	ATV61HD18M3X ATV61HD22M3X ATV71HD18M3X ATV71HD22M3X	46.00
VX4A1107	Filter board	1	Filter board	6	ATV61HD22N4 ATV71HD22N4	260.00
VX4A1108	Filter board	1	Filter board	7A	ATV61HD30N4 ATV61HD37N4 ATV71HD30N4 ATV71HD37N4	149.00
VX4A1109	Filter board	1	Filter board	7B	ATV61HD30M3X ATV61HD37M3X ATV61HD45M3X ATV71HD30M3X ATV71HD37M3X ATV71HD45M3X	84.00
VX4A1110	Filter board	1	Filter board	8	ATV61HD45N4 ATV61HD55N4 ATV61HD75N4 ATV71HD45N4 ATV71HD55N4 ATV71HD75N4	130.00
VX4A1113	Filter board	1	Filter board	11	ATV61HC16N4 ATV71HC13N4	294.00
VX4A1114	Filter board	1	Filter board	12	ATV71HC16N4 ATV61HC22N4	382.00
VX4A1115	Filter board	1	Filter board	13	ATV61HC25N4 ATV61HC31N4 ATV71HC20N4 ATV71HC25N4 ATV71HC28N4	412.00
VX4A1116	Filter board	1	Filter board	9	ATV61HD75M3X ATV61HD90N4 ATV61HD55M3X ATV61HC11N4 ATV71HD90N4 ATV71HD55M3X	151.00
		1	Filter board	10	ATV61HC13N4 ATV61HD90M3X ATV71HC11N4 ATV71HD75M3X	244.00
VX4A1117	Filter board	1	Filter board	14B	ATV61HC50N4 ATV71HC40N4	333.00
				15	ATV61HC63N4 ATV71HC50N4	294.00
VX4A1118	Filter board	1	Filter board	14A	ATV61HC40N4 ATV71HC31N4	144.00
VX4A1200	SCR▲ Snubber Board	1	SCR snubber board	11	ATV61HC16N4 ATV71HC13N4	142.00
				12	ATV71HC16N4 ATV61HC22N4	46.00
				13	ATV61HC25N4 ATV61HC31N4 ATV71HC20N4 ATV71HC25N4 ATV71HC28N4	260.00
				14A	ATV61HC40N4 ATV71HC31N4	149.00
				14B	ATV61HC50N4 ATV71HC40N4	84.00
				15	ATV61HC63N4 ATV71HC50N4	130.00

▲ SCR: Silicon controlled rectifier.

Kit Contents and Required Documentation (Continued)

1—Identify Your Spare Parts Kit:			2—Identify Your Drive:		3—\$ Price	
Kit Catalog Number	Description	Qty	Kit Contents	Frame Size	Catalog Number	
VX4A61100Y	ATV61 Control board kit, <90 kW	1	Screw, captive washer, M4 x 8	2, 3, 4, 5A, 5B, 6, 7A, 7B, 8	ATV61H075M3 H075N4, HU15N4 HU22N4, HU22M3 HU15M3, HU30M3 HU30N4, HU40M3 HU40N4, HU55M3 HU55N4, HU75N4 HD11N4, HU75M3 HD11M3X, HD15M3X, HD15N4 HD18N4, HD18M3X HD22M3X, HD22N4 HU30Y, HU40Y HU55Y, HU75Y HD11Y, HD15Y HD18Y, HD22Y HD30Y, HD30N4 HD37N4, HD30M3X HD37M3X HD45M3X, HD45N4 HD55N4, HD75N4 HD37Y, HD45Y HD55Y, HD75Y HD90Y,	325.00
		1	Screw, captive washer, M4 x 10			
		4	Screws with washers, M3 x 8			
		1	Spring, 5 mm x 14 mm			
		9	Screws, M3 x 8, thread forming			
		1	Application PCBA insulate sheet			
		1	Flat washer, M4			
		1	Screw, M4 x 20			
		1	Control ground bar			
		1	Terminal PCBA lower cap			
		1	Control support			
		1	Display support			
		1	Terminal PCBA upper cap			
		1	Keyboard			
		1	Application PCBA			
		1	Motor control PCBA			
		1	Display PCBA			
		1	Terminal PCBA			
		1	Application PCBA / motor control			
		1	Option LED label			
		1	Brand marking label			
		1	Relay label			
		1	AI label			
		1	LI label			
		1	Control switch label			
		1	Modbus™ label			
		1	Motor control insulate sheet			
VX4A61101Y	ATV61 Control board kit, ≥ 90 kW	1	Spring, 5 mm x 14 mm	9, 10, 11, 12, 13, 14, 15	ATV61HD75M3X HD90N4, HD55M3X HC11N4, HC13N4 HD90M3X HC16N4 HC22N4, HC25N4 HC31N4, HC40N4 HC50N4, HC63N4 HC11Y, HC13Y HC16Y, HC20Y HC25Y, HC31Y HC40Y, HC50Y HC63Y HC80Y	375.00
		9	Screws, M3 x 8, thread forming			
		1	Motor control PCBA			
		1	Interface PCBA			
		1	Application/interface PCBA cable			
		1	Application PCBA insulate sheet			
		1	Flat washer, M4			
		1	Screw, captive washer, M4 x 20			
		1	Control ground bar			
		1	Terminal PCBA lower cap			
		1	Control support			
		1	Display support			
		1	Control trap			
		1	Terminal PCBA upper cap			
		1	Keyboard			
		1	Application PCBA			
		1	Display PCBA			
		1	Terminal PCBA			
		1	Application PCBA / motor control			
		1	Spacing assembly			
		1	Control trap label kit			
		1	Option LED label			
		1	Brand marking label			
		1	Relay label			
		1	AI label			
		1	LI label			
		1	Control switch label			
		1	Modbus label			
		1	Motor control insulate sheet			
VX4A71100Y	ATV71 control board kit, <90 kW	1	Screw, captive washer, M4 x 8	2, 3, 4, 5A, 5B, 6, 7A, 7B, 8	ATV71H037M3, H075M3, H075N4 HU15M3, HU15N4 HU22N4, HU22M3 HU30M3, HU30N4 HU40M3, HU40N4 HU55M3, HU55N4 HU75N4, HD11N4 HU75M3, HD11M3X HD15M3X HD15N4 HD18N4, HD18M3X HD22M3X, HD22N4 HU22Y, HU30Y HU40Y, HU55Y HU75Y, HD11Y HD15Y, HD18Y HD22Y, HD30Y HD30N4, HD37N4 HD30M3X HD37M3X HD45M3X HD45N4 HD55N4, HD75N4 HD37Y, HD45Y HD55Y, HD75Y HD90Y	325.00
		1	Screw, captive washer, M4 x 10			
		4	Screws with washers, M3 x 8			
		1	Spring, 5 mm x 14 mm			
		9	Screws, M3 x 8, thread forming			
		1	Application PCBA insulate sheet			
		1	Flat washer, M4			
		1	Screw, M4 x 20			
		1	Control ground bar			
		1	Terminal PCBA lower cap			
		1	Control support			
		1	Display support			
		1	Terminal PCBA upper cap			
		1	Keyboard			
		1	Application PCBA			
		1	Motor control PCBA			
		1	Display PCBA			
		1	Terminal PCBA			
		1	Application PCBA / motor control			
		1	Option LED label			
		1	Brand marking label			
		1	Relay label			
		1	AI label			
		1	LI label			
		1	Control switch label			
		1	Modbus label			
		1	Motor control insulate sheet			

Kit Contents and Required Documentation (Continued)

1—Identify Your Spare Parts Kit:			2—Identify Your Drive:		3—\$ Price	
Kit Catalog Number	Description	Qty	Kit Contents	Frame Size	Catalog Number	
VX4A71101Y	ATV71 control board kit, >=90 kW	1	Spring, 5 mm x 14 mm	9, 10, 11, 12, 13, 14, 15	ATV71HC11N4, HD75M3X, HD55M3X, HD90N4, HC13N4, HC16N4 HC11Y, HC13Y HC16Y, HC20Y, HC20N4, HC28N4, HC25N4, HC25Y HC31Y, HC40Y HC50N4, HC31N4, HC40N4, HC50Y HC63Y	375.00
		9	Screws, M3 x 8, thread forming			
		1	Motor control PCBA			
		1	Interface PCBA			
		1	Application/Interface PCBA cable			
		1	Application PCBA insulate sheet			
		1	Flat washer, M4			
		1	Screw, captive washer, M4 x 20			
		1	Control ground bar			
		1	Terminal PCBA lower cap			
		1	Control support			
		1	Display support			
		1	Control trap			
		1	Terminal PCBA upper cap			
		1	Keyboard			
		1	Application PCBA			
		1	Display PCBA			
1	Terminal PCBA					
1	Application PCBA / motor control					
1	Spacing assembly					
1	Control trap label kit					
1	Option LED label					
1	Brand marking label					
1	Relay Label					
1	AI label					
1	LI label					
1	Control switch label					
1	Modbus™ label					
VX5A1200	Gate driver board	1	Gate driver PCBA	11	ATV61HC16N4	1294.00
VX5A1201	Gate driver board	6	Plastic supports	12	ATV71HC13N4	647.00
		2	Gate driver PCBA	13	ATV61HC25N4	
VX5A1202	Gate driver board	2	Cable clamps	14A	ATV71HC20N4	647.00
		1	Gate driver PCBA	14B	ATV71HC28N4	
VX5A1203	Gate driver board	7	Cable clamps	15	ATV61HC31N4	1084.00
		1	Gate driver PCBA	14B	ATV71HC31N4	
VX5A1204	Gate driver board	7	Cable clamps	15	ATV61HC50N4	1220.00
		1	Gate driver PCBA	15	ATV71HC50N4	
VX5A1300	Soft charge board	1	Soft charge board	9	ATV61HD75M3X	126.00
		4	Mounting standoffs, 8/18/BM4/SNAP4	10	ATV61HD90N4	
		4	Mounting standoffs, 8/22.2/BM4/SNAP4	11	ATV61HD55M3X	
		4	Mounting standoffs	12	ATV61HC11N4	
				13	ATV71HD90N4	
				14A	ATV71HD55M3X	
				14B	ATV61HC16N4	
				15	ATV71HC13N4	
VX5A1400	Fan control board	1	Fan control board	10	ATV61HC13N4	160.00
				11	ATV61HD90M3X	
				12	ATV71HC11N4	
				13	ATV71HD75M3X	
				14A	ATV61HC16N4	
				14B	ATV71HC13N4	
				15	ATV71HC22N4	

Kit Contents and Required Documentation (Continued)

1—Identify Your Spare Parts Kit:			2—Identify Your Drive:		3—\$ Price	
Kit Catalog Number	Description	Qty	Kit Contents	Frame Size	Catalog Number	
VX5A1HC1113	Power board	1	Power board	10	ATV61HC13N4 ATV71HC11N4	737.00
VX5A1HC1316	Power board	1 5 4	Power board PCBA mounting standoffs Cable clamps	11	ATV61HC16N4 ATV71HC13N4	1235.00
VX5A1HC1622	Power board	1 5 4	Power board PCBA mounting standoffs Cable clamps	12	ATV71HC16N4 ATV61HC22N4	1824.00
VX5A1HC2025	Power board	1 5 5	Power board PCBA mounting standoffs Cable clamps	13	ATV61HC25N4 ATV71HC20N4	1824.00
VX5A1HC2531	Power board	1 5 5	Power board PCBA mounting standoffs Cable clamps	13	ATV71HC25N4 ATV61HC31N4	1824.00
VX5A1HC3140	Power board	1 7 1	Power board PCBA mounting standoffs Cable clamp	14A	ATV61HC40N4 ATV71HC31N4	2792.00
VX5A1HC4050	Power board	1 8 1	Power board PCBA mounting standoffs Cable clamp	14B	ATV61HC50N4 ATV71HC40N4	2846.00
VX5A1HC5063	Power board	1 8 1	Power board PCBA mounting standoffs Cable clamp	15	ATV61HC63N4 ATV71HC50N4	2846.00
VX5A1HD18M3X	Power board	5 4 1 1 1	Lock spacers Screws, M4 x 10 Power board Fan control cable Power supply cable	6	ATV61HD18M3X ATV71HD18M3X	486.00
VX5A1HD22M3X	Power board	5 4 1 1 1 1	Lock spacers Screws, M4 x 10 Power board Fan control cable Power supply cable Power insulate sheet	6	ATV61HD22M3X ATV71HD22M3X	486.00
VX5A1HD22N4	Power board	5 4 1 1 1 1	Lock spacers Screws, M4 x 10 Power board Fan control cable Power supply cable Power insulate sheet	6	ATV61HD22N4 ATV71HD22N4	475.00
VX5A1HD30M3X	Power board	6 3 1 1 1	Lock spacers Screws, M4 x 10 Power board Fan control cable Power insulate sheet	7B	ATV61HD30M3X ATV71HD30M3X	459.00
VX5A1HD37M3X	Power board	6 3 1 1 1	Lock spacers Screws, M4 x 10 Power board Fan control cable Power insulate sheet	7B	ATV61HD37M3X ATV71HD37M3X	459.00
VX5A1HD45M3X	Power board	6 3 1 1 1	Lock spacers Screws, M4 x 10 Power board Fan control cable Power insulate sheet	7B	ATV61HD45M3X ATV71HD45M3X	459.00
VX5A1HD5575	Power board	1	Power board	9	ATV61HD55M3X ATV71HD55M3X	459.00
VX5A1HD7590	Power board	1	Power board	9 10	ATV61HD75M3X ATV61HD90M3X ATV71HD75M3X	956.00 956.00
VX5A1HD9011	Power board	1	Power board	9	ATV61HD90N4 ATV61HC11N4 ATV71HD90N4	737.00
VX5A71HC13N4	Measuring board	1 5 7	Measuring board PCBA mounting standoffs Cable clamps	11	ATV61HC16N4 ATV71HC13N4	1147.00
VX5A71HC28N4	Power board	1 5 5	Power board PCBA mounting standoffs Cable clamps	13	ATV71HC28N4	1904.00
VX5IM2145M1271	Power board and power IGBT▲ modules	3 1 1	IGBT 1200 V, 220 A modules Power board 30 kW, 480 V Thermal compound	7A	ATV61HD30N4 ATV71HD30N4	1139.00
VX5IM2195M1271	Power board and power IGBT modules	3 1 1	IGBT 1200 V, 220 A modules Power board 37 kW, 480 V Thermal compound	7A	ATV61HD37N4 ATV71HD37N4	1139.00
VX5IM2200M1271	Power board and power IGBT modules	3 1 1	IGBT 1200 V, 300 A modules Power board 45 kW, 480 V Thermal compound	8	ATV61HD45N4 ATV71HD45N4	1379.00
VX5IM2300M1271	Power board and power IGBT modules	3 1 1	IGBT 1200 V, 300 A modules Power board Thermal compound	8	ATV61HD55N4 ATV71HD55N4	1252.00
VX5IM2400M1271	Power board and power IGBT modules	3 1 1	IGBT 1200 V, 400 A modules Power board 75 kW, 480 V Thermal compound	8	ATV61HD75N4 ATV71HD75N4	992.00

▲ IGBT: Insulated-gate bipolar transistor

Kit Contents and Required Documentation (Continued)

1—Identify Your Spare Parts Kit:				2—Identify Your Drive:		3—\$ Price
Kit Catalog Number	Description	Qty	Kit Contents	Frame Size	Catalog Number	
VY1A1105	Current sensor	3	Motor current sensors, 314 A	9	ATV61HD75M3X ATV61HD90N4 ATV61HD55M3X ATV61HC11N4 ATV71HD90N4 ATV71HD55M3X	106.00
				10	ATV61HC13N4 ATV61HD90M3X ATV71HC11N4 ATV71HD75M3X	
VY1A1107	Current sensor	1	Motor current sensor, 366 A	11	ATV61HC16N4 ATV71HC13N4	118.00
VY1A1108	Current sensor	1	Motor current sensor, 622 A	12	ATV71HC16N4 ATV61HC22N4	176.00
				13	ATV61HC25N4 ATV61HC31N4 ATV71HC20N4 ATV71HC25N4 ATV71HC28N4	
VY1A1109	Current sensor	1	Motor current sensor, 1188 A	14A	ATV61HC40N4 ATV71HC31N4	190.00
				14B	ATV61HC50N4 ATV71HC40N4	
				15	ATV61HC63N4 ATV71HC50N4	
VY1A1202	Plastic parts	1 1 1 2 1 1 1	IP4X top cover Wiring trap cover Power trap cover Side caps Top cap Danger label	2	ATV61H075M3 ATV61HU15M3 ATV61H075N4 ATV61HU15N4 ATV61HU22N4 ATV71H075M3 ATV71HU15M3 ATV71H037M3 ATV71H075N4 ATV71HU15N4 ATV71HU22N4	33.00
VY1A1203	Plastic parts	1 1 1 2 1 1 1	Front cap Wiring trap cover Power trap cover Side caps Top cap IP4X top cover Danger label	3	ATV61HU22M3 ATV61HU30M3 ATV61HU40M3 ATV61HU30N4 ATV61HU40N4 ATV71HU22M3 ATV71HU30M3 ATV71HU40M3 ATV71HU30N4 ATV71HU40N4	33.00
VY1A1204	Plastic parts	1 1 1 1 1 1 2 1	Top cap IP4X top cover Front cap Wiring trap cover Power trap cover Side caps Danger label	4	ATV61HU55M3 ATV61HU55N4 ATV61HU75N4 ATV71HU55M3 ATV71HU55N4 ATV71HU75N4	52.00
VY1A1205	Plastic parts	1 1 1 1 1 2 1	Top cap IP4X top cover Front cap Wiring trap cover Power trap cover Side caps Danger label	5B	ATV61HD11M3X ATV61HD15M3X ATV61HD15N4 ATV61HD18N4 ATV71HD11M3X ATV71HD15M3X ATV71HD15N4 ATV71HD18N4	56.00
VY1A1210	Front cover and I/O terminal cover	1	Front cover assembly	9	ATV61HD75M3X ATV61HD90N4 ATV61HD55M3X ATV61HC11N4 ATV71HD90N4 ATV71HD55M3X	283.00
VY1A1211	Front cover and I/O terminal cover	1	Front cover assembly	10	ATV61HC13N4 ATV61HD90M3X ATV71HC11N4 ATV71HD75M3X	283.00
VY1A1212	Front cover assembly	1	Front cover assembly	11	ATV61HC16N4 ATV71HC13N4	441.00
VY1A1213	Front cover assembly	1	Front cover assembly	12	ATV71HC16N4 ATV61HC22N4	500.00
VY1A1214	Front cover assembly	1	Front cover assembly	13	ATV61HC25N4 ATV61HC31N4 ATV71HC20N4 ATV71HC25N4 ATV71HC28N4	529.00
VY1A1215	Plastic parts kit	1 1 2 1 1 1 1	IP4X top cover Front cap Power trap cover Side caps Top cap Wiring trap cover Danger label	5A	ATV61HU75M3 ATV61HD11N4 ATV71HU75M3 ATV71HD11N4	58.00
VY1A1216	Front cover assembly	1	Front cover assembly	14A	ATV61HC40N4 ATV71HC31N4	813.00
				14B	ATV61HC50N4 ATV71HC40N4	

Kit Contents and Required Documentation (Continued)

1—Identify Your Spare Parts Kit:			2—Identify Your Drive:		3—\$ Price	
Kit Catalog Number	Description	Qty	Kit Contents	Frame Size	Catalog Number	
VY1A1217	Front cover assembly	1	Front cover assembly	15	ATV61HC63N4 ATV71HC50N4	1111.00
VY1A1401	Plastic parts kit	1 1 1 1 1 1 1 1 1	EMC tray Conduit tray Power terminal shield Soft charge board tray Fan control board plate DC reactor terminal shield Filter board shield Labels size 11 Danger label	11	ATV61HC16N4 ATV71HC13N4	882.00
VY1A1402	Plastic parts kit	1 1 1 1 1 1 1	EMC tray Conduit tray Power terminal shield SCR snubber board shield Filter board shield IT jumper warning label Danger label	12	ATV61HC22N4 ATV71HC16N4	618.00
VY1A1403	Plastic parts kit	1 1 1 1 1 1 1	EMC tray Conduit tray Power terminal shield SCR assembly shield Filter board shield IT jumper warning label Danger label	13	ATV61HC25N4 ATV61HC31N4 ATV71HC20N4 ATV71HC25N4 ATV71HC28N4	706.00
VY1A1404	EMC tray and power terminal shield	1 1	Control channel box Terminal cover with lid	9	ATV61HD75M3X ATV61HD90N4 ATV61HD55M3X ATV61HC11N4 ATV71HD90N4 ATV71HD55M3X	131.00
VY1A1405	EMC tray and power terminal shield	1 1	Control channel box Terminal cover with lid	10	ATV61HC13N4 ATV61HD90M3X ATV71HC11N4 ATV71HD75M3X	134.00
VY1A1406	Plastic parts kit	4 6 1 1 1 1 1 1 1 1 1 1 1 1	Bus bar brackets Insulation tubes for bus bar brackets Rectifier shield Conduit tray Right terminal shield Left terminal shield EMC tray Motor control board insulator Brake board insulator Power board insulator Bus plate shield IT jumper warning label Danger label	14A 14B	ATV61HC40N4 ATV71HC31N4 ATV61HC50N4 ATV71HC40N4	1111.00
VY1A1407	Plastic parts kit	4 6 1 1 1 1 1 1 1 1 1 1 1 1	Bus bar brackets Insulation tubes for bus bar brackets Rectifier shield Conduit tray Right terminal shield Left terminal shield EMC tray Motor control board insulator Brake board insulator Power board insulator Bus plate shield IT jumper warning label Danger label	15	ATV61HC63N4 ATV71HC50N4	1274.00
VY1ADC1110	Capacitor assembly	1	4-capacitor assembly	9	ATV61HD90N4 ATV61HC11N4 ATV71HD90N4	628.00
VY1ADC1111	Capacitor assembly	1	6-capacitor assembly	10	ATV61HC13N4 ATV71HC11N4	910.00
VY1ADC1112	Capacitors	6 6	Capacitors Gaskets	11 13 14B 15	ATV61HC16N4 ATV71HC13N4 ATV61HC31N4 ATV71HC25N4 ATV71HC28N4 ATV61HC50N4 ATV71HC40N4 ATV61HC63N4 ATV71HC50N4	1088.00
VY1ADC1113	Capacitors	8 8	Capacitors, 5200 µF / 400 V Gaskets	12	ATV71HC16N4 ATV61HC22N4	1441.00
VY1ADC1114	Capacitors	6 6	Capacitors, 3600 µF / 400 V Gaskets	13 14A	ATV61HC25N4 ATV71HC20N4 ATV61HC40N4 ATV71HC31N4	794.00
VY1ADC1115	Capacitor assembly	1	3-capacitor assembly	9	ATV61HD75M3X ATV61HD55M3X ATV71HD55M3X	693.00
VY1ADC1116	Capacitor assembly	1	4-capacitor assembly	10	ATV61HD90M3X ATV71HD75M3X	453.00

Kit Contents and Required Documentation (Continued)

1—Identify Your Spare Parts Kit:				2—Identify Your Drive:		3—\$ Price
Kit Catalog Number	Description	Qty	Kit Contents	Frame Size	Catalog Number	
VY1ADV1105	Screw kit	1	Set of screws, bolts, and nuts used in the drive	9	ATV61HD75M3X ATV61HD90N4 ATV61HD55M3X ATV61HC11N4 ATV71HD90N4 ATV71HD55M3X	107.00
VY1ADV1106	Screw kit	1	Set of screws, bolts, and nuts used in the drive	10	ATV61HC13N4 ATV61HD90M3X ATV71HC11N4 ATV71HD75M3X	109.00
VY1ADV1107	Screw kit	1	Set of screws, bolts, and nuts used in the drive	11	ATV61HC16N4 ATV71HC13N4	76.00
VY1ADV1108	Screw kit	1	Set of screws, bolts, and nuts used in the drive	12	ATV71HC16N4 ATV61HC22N4	76.00
VY1ADV1109	Screw kit	1	Set of screws, bolts, and nuts used in the drive	13	ATV61HC25N4 ATV61HC31N4 ATV71HC20N4 ATV71HC25N4 ATV71HC28N4	76.00
VY1ADV1110	Screw kit	1	Set of screws, bolts, and nuts used in the drive	14A 14B	ATV61HC40N4 ATV71HC31N4 ATV61HC50N4 ATV71HC40N4	70.00
VY1ADV1111	Screw kit	1	Set of screws, bolts, and nuts used in the drive	15	ATV61HC63N4 ATV71HC50N4	70.00
VZ3DM1600M1671	Diode module	1 1	Diode module, 600A, 1600V Thermal compound	13 14A 14B 15	ATV61HC25N4 ATV61HC31N4 ATV71HC20N4 ATV71HC25N4 ATV71HC28N4 ATV61HC40N4 ATV71HC31N4 ATV61HC50N4 ATV71HC40N4 ATV61HC63N4 ATV71HC50N4	412.00
VZ3F1110	Dynamic braking kit	1 1 2 2 1 1 1 1	Braking control PCBA Diode module, 75 A, 1200 V Brackets Bus bars Input PA bus bar Input PB bus bar IGBT module, 600 A, 1200 V Thermal compound	11 12	ATV61HC16N4 ATV71HC13N4 ATV71HC16N4 ATV61HC22N4	1030.00
VZ3F1113	Dynamic braking kit	1 6	Brake board PCB standoff	14A 14B 15	ATV61HC40N4 ATV71HC31N4 ATV61HC50N4 ATV71HC40N4 ATV61HC63N4 ATV71HC50N4	413.00
VZ3G1102	Temperature sensor wire	1	Temperature sensor	9 10	ATV61HD75M3X ATV61HD90N4 ATV61HD55M3X ATV61HC11N4 ATV71HD90N4 ATV71HD55M3X ATV61HC13N4 ATV61HD90M3X ATV71HC11N4 ATV71HD75M3X	41.00
VZ3G1104	Temperature sensor wire	2	Temperature sensors	11 12 13 14A 14B 15	ATV61HC16N4 ATV71HC13N4 ATV71HC16N4 ATV61HC22N4 ATV61HC25N4 ATV61HC31N4 ATV71HC20N4 ATV71HC25N4 ATV71HC28N4 ATV61HC40N4 ATV71HC31N4 ATV61HC50N4 ATV71HC40N4 ATV61HC63N4 ATV71HC50N4	71.00
VZ3IM1145M1271	Braking IGBT module	1 1	IGBT module, 1200 V, 175 A Thermal compound	7A	ATV61HD30N4 ATV61HD37N4 ATV71HD30N4 ATV71HD37N4	160.00
VZ3IM1195M0671	Braking IGBT module	1 1	IGBT module, 600 V, 250 A Thermal compound	7B	ATV61HD30M3X ATV71HD30M3X	154.00
VZ3IM1300M0671	Braking IGBT module	1 1	IGBT module, 600 V, 400 A Thermal compound	7B	ATV61HD37M3X ATV61HD45M3X ATV71HD37M3X ATV71HD45M3X	211.00

Kit Contents and Required Documentation (Continued)

1—Identify Your Spare Parts Kit:				2—Identify Your Drive:		3—\$ Price
Kit Catalog Number	Description	Qty	Kit Contents	Frame Size	Catalog Number	
VZ3IM1300M1271	Braking IGBT module	1 1	IGBT module, 1200 V, 345 A Thermal compound	8	ATV61HD45N4 ATV61HD55N4 ATV61HD75N4 ATV71HD45N4 ATV71HD55N4 ATV71HD75N4	212.00
VZ3IM1400M1271	Power IGBT module	1 1	IGBT module, 1200 V, 400 A Thermal compound	9	ATV61HD90N4 ATV61HC11N4 ATV71HD90N4	606.00
				10	ATV61HC13N4 ATV61HC11N4	
VZ3IM1402M1271	Power IGBT module	1 1	IGBT module, 1200 V, 400 A Thermal compound	12	ATV71HC16N4 ATV61HC22N4	794.00
				13	ATV61HC25N4 ATV71HC20N4	
VZ3IM1600M1271	Power IGBT module	1 1	IGBT module, 1200 V, 600 A Thermal compound	11	ATV61HC16N4 ATV71HC13N4	529.00
VZ3IM1602M1271	Power IGBT module	2 1	IGBT modules, 1200 V, 600 A Thermal compound	13	ATV61HC31N4 ATV71HC25N4 ATV71HC28N4	1059.00
VZ3IM1603M1271	Power IGBT module	3 2	IGBT modules, 1200 V, 600 A Thermal compound	14A	ATV61HC40N4 ATV71HC31N4	1491.00
				14B	ATV61HC50N4 ATV71HC40N4	
VZ3IM1604M1271	Power IGBT module	4 2	IGBT modules, 1200 V, 600 A Thermal compound	15	ATV61HC63N4 ATV71HC50N4	1952.00
VZ3IM2195M1271	Power IGBT modules	3 1	IGBT modules, 1200 V, 220 A Thermal compound	7A	ATV61HD37N4 ATV71HD37N4	223.00
VZ3IM2201M1271	Power IGBT modules	3 1	IGBT modules, 600 V, 200 A Thermal compound	7B	ATV61HD30M3X ATV71HD30M3X	487.00
VZ3IM2301M1271	Power IGBT modules	3 1	IGBT modules, 600 V, 300 A Thermal compound	7B	ATV61HD37M3X ATV71HD37M3X	625.00
VZ3IM2401M1271	Power IGBT modules	3 1	IGBT modules, 600 V, 400 A Thermal compound	7B	ATV61HD45M3X ATV71HD45M3X	798.00
VZ3N1205	Power terminal block	1 1 1 1 1	Power terminal DC warning label Motor warning label Input warning label (240 V) Input warning label (480 V)	5B	ATV61HD11M3X ATV61HD15M3X ATV61HD15N4 ATV61HD18N4 ATV71HD11M3X ATV71HD15M3X ATV71HD15N4 ATV71HD18N4	65.00
VZ3N1206	Power terminal block	1 1 1 1 1 1 1	Bottom power terminal block Top power terminal block DC warning label A#1 DC warning label A#2 Motor warning label Input warning label (240 V) Input warning label (480 V)	6	ATV61HD18M3X ATV61HD22M3X ATV71HD18M3X ATV71HD22M3X ATV61HD22N4 ATV71HD22N4	229.00
VZ3N1207	Power terminal block	1 1 1 1 1	Bottom power terminal block Top power terminal block DC warning label A#1 DC warning label A#2 Motor warning label Input warning label	7A	ATV61HD30N4 ATV61HD37N4 ATV71HD30N4 ATV71HD37N4	229.00
VZ3N1301	Wire kit▲	1 1 1 1 1 1 1 1 1 1	Brake cable DCCT cable LR cable Charge LED Fan control cable DR cable Fan supply cable PSU cable SCR cable	6	ATV61HD18M3X ATV61HD22M3X ATV71HD18M3X ATV71HD22M3X	89.00
VZ3N1302	Wire kit▲	1 1 1 1 1 1 1 1 1	Brake cable DCCT cable LR cable Charge LED Fan control cable DR cable Fan supply cable PSU cable SCR cable	6	ATV61HD22N4 ATV71HD22N4	86.00
VZ3N1307	Wire kit▲	1 3 1 1 1 1 1 1 1 1	Fan supply cable IGBT cables PSU cable SCR cable LR cable Charge LED DCCT cable Brake cable Fan control cable DR cable	7A	ATV61HD30N4 ATV61HD37N4 ATV71HD30N4 ATV71HD37N4	179.00

▲ Letter designations in the wire kit contents correspond to component and terminal designations on the wiring diagrams in the associated document.

Kit Contents and Required Documentation (Continued)

1—Identify Your Spare Parts Kit:			2—Identify Your Drive:		3— \$ Price	
Kit Catalog Number	Description	Qty	Kit Contents	Frame Size	Catalog Number	
VZ3N1323	Wire kit▲	4	Relay connectors Charge LED cable w/ LED Wire power for motor control board (CNX2) IGBT U gate cable (CNU) IGBT X gate cable (CNX) IGBT V gate cable (CNV) IGBT Y gate cable (CNY) IGBT W gate cable (CNW) IGBT Z gate cable (CNZ) Thyristor R gate cable (blue wire with 2 connectors) Braking IGBT (CNPB) SCR1 gate cable (CNL1G) SCR2 gate cable (CNL2G) SCR3 gate cable (CNL3G) Cable red sleeve (CN7) Line sense (CN5) SCR control cable (CN2) Jumper (CNX5-CNX6) Bus sense (CN6) Current sense (red) Current sense (white) Current sense (blue) Internal fan cable (CN12) Heatsink fan cable (CN25) Control module cable, 10 position (CNX2) Control module cable, 26 position (CNX1) PA power cable (red) PB power cable (white) Braking IGBT cable white (TAB1) Snubber cap cable, 400 V	9	ATV61HD75M3X ATV61HD90N4 ATV61HD55M3X ATV61HC11N4 ATV71HD90N4 ATV71HD55M3X	244.00
VZ3N1324	Wire kit▲	1	Relay connector Charge LED cable w/ LED Wire power for motor control board (CNX2) IGBT U gate cable (CNU) IGBT X gate cable (CNX) IGBT V gate cable (CNV) IGBT Y gate cable (CNY) IGBT W gate cable (CNW) IGBT Z gate cable (CNZ) Thyristor R gate cable (blue wire with 2 connectors) Braking IGBT (CNPB) SCR1 gate cable (CNL1G) SCR2 gate cable (CNL2G) SCR3 gate cable (CNL3G) Cable red sleeve (CN7) Line sense (CN5) SCR control cable (CN2) Jumper (CNX5-CNX6) Bus sense (CN6) Current sense (red) Current sense (white) Current sense (blue) Internal fan cable (CN12) Internal fan cable (INT) Internal fan cable (EXT) Control module cable, 26 position (CNX1) PA power cable (red) PB power cable (white) Braking IGBT cable (white) (TAB1) Snubber cap cable, 400 V CN13 X2 cable	10	ATV61HC13N4 ATV61HD90M3X ATV71HC11N4 ATV71HD75M3X	242.00
VZ3N1333	Wire kit▲	1	Cable A30-A70-A1 Cable SCB-V31/33/35 Cable L1,L2,L3-A31 Cable A30-A70-A71 Cable A70-A71-X3 Cable A1:X7-A30/A40 Cable SCB-V31/33/35 Cable L1,L2,L3-A31,A32 Cable UD(+)-A31:X4 Cable UD(+)-A32:X11 Cable UD(-)-A31:X5 Cable A5:X62-A41:X10 Cable A70/A71-X11,X12,X13 Flat Cable A10:X3-A3:X3 Flat Cable A1:X4-A10:X4 Flat Cable A4:X82-A5:X81 Flat Cable A1:X8-A4:X81-A3:X82 Flat Cable A4:X31-A3:X32 Flat Cable A1:X3-A5:X31 Cable UD0 connectors Cable UD0-A1:UD0 Cable UD0-A4:X52 Cable gate drive UD0 connectors Cable A5:X53-test connector Cable motor voltage measurement A1:X5 Cable A1:X30-A6:CN2A Cable A1:X31-A6:CN7A Cable A1:X30-A6:CN2A Cable A1:X31-A6:CN7A Cable A1:X21/X22-X30,31,32 Flat Cable A1:X2-A2:X2	14A	ATV61HC40N4 ATV71HC31N4	1135.00

▲ Letter designations in the wire kit contents correspond to component and terminal designations on the wiring diagrams in the associated document.

Kit Contents and Required Documentation (Continued)

1—Identify Your Spare Parts Kit:			2—Identify Your Drive:		3—\$ Price	
Kit Catalog Number	Description	Qty	Kit Contents	Frame Size	Catalog Number	
VZ3N1334	Wire kit▲	1	Cable A30-A70-A71 1 Cable A70-A71-X3 1 Cable A1:X7-A30/A40 1 Cable SCB-V31/33/35 1 Cable L1,L2,L3-A31,A32 3 Cable UD(+)-A31/A32:X4-A32:X11 2 Cable UD(-)-A31:X5 1 Cable A5:X62-A41:X10 1 Cable A70/A71-X11-X14 1 Flat cable A10:X3-A3:X3 1 Flat cable A1:X4-A10:X4 1 Flat cable A4:X82-A5:X81 1 Flat cable A4:X81-A1:X8-A3:X82 2 Flat cable A4:X31-A3:X32 1 Flat cable A1:X3-A5:X31 2 Cable UD0 connectors 1 Cable UD0-A1:UD0 1 Cable UD0-A4:X52 2 Cable gate drive UD0 connectors 1 Cable A5:X53-test connector 1 Cable motor voltage measurement 1 Cable A1:X30-A60:CN2A 1 Cable A1:X31-A6:CN7A 1 Cable A1:X30-A6:CN2A 1 Cable A1:X31-A6:CN7A 1 Cable A1:X21/X22-X30-33 1 Flat cable A1:X2-A2:X2 2 Cable A7:X2-A1:X14 1 Cable A1:X6 1 Cable T1/T2/T3-A1:X11	15	ATV61HC63N4 ATV71HC50N4	894.00
VZ3S1910	Snubber capacitor kit	1	Snubber board 1 Negative DC link bus bar 1 Positive DC link bus bar 3 Snubber capacitors (1200 V-0.47 μF) 2 Hexagonal metal supports, M4, 20 mm length 2 Torx™ screws w/ captive washers, M4 x 10 1 Wire	9	ATV61HD90N4 ATV61HC11N4 ATV71HD90N4	407.00
VZ3S1911	Snubber capacitor kit	1	Snubber board 3 Capacitors 1 Snubber capacitor (1200 V-0.47 μF) 1 Plastic nylon tie	9 10	ATV61HD75M3X ATV61HD55M3X ATV71HD55M3X ATV61HD90M3X ATV71HD75M3X	68.00
VZ3S1912	Snubber capacitor kit	1	Snubber board 1 Link N thyristor 1 Link P thyristor 3 Snubber capacitors (1200 V-0.47 μF) 2 Hexagonal metal supports, M4, 20 mm length 2 Torx screws w/ captive washers, M4 x 10 1 Wire	10	ATV61HC13N4 ATV71HC11N4	102.00
VZ3TD1057M1671	SCR modules	3	Thyristor/diode modules, 1600 V, 55 A 1 Thermal compound	7A	ATV61HD30N4 ATV71HD30N4	44.00
VZ3TD1072M1671	SCR modules	3	Thyristor/diode modules, 1600 V, 72 A 1 Thermal compound	7A 8	ATV61HD37N4 ATV71HD37N4 ATV61HD45N4 ATV71HD45N4	156.
VZ3TD1092M1671	SCR modules	3	Thyristor/diode modules, 1600 V, 92 A 1 Thermal compound	7B 8	ATV61HD30M3X ATV71HD30M3X ATV61HD55N4 ATV71HD55N4	155.00
VZ3TD1132M1671	SCR modules	3	Thyristor/diode modules, 1600 V, 132 A 1 Thermal compound	7B 8	ATV61HD37M3X ATV71HD37M3X ATV61HD75N4 ATV71HD75N4	290.00
VZ3TD1162M1671	SCR modules	3	Thyristor/diode modules, 1600 V, 162 A 1 Thermal compound	7B	ATV61HD45M3X ATV71HD45M3X	309.00
VZ3TD1250M1671	SCR module	1	Thyristor/diode module,1600 V, 250 A 1 Thermal compound	9	ATV61HD90N4 ATV61HC11N4 ATV71HD90N4	310.00
VZ3TD1285M1671	SCR module	1	Thyristor/diode module,1600 V, 285 A 1 Thermal compound	10 11	ATV61HC13N4 ATV71HC11N4 ATV61HC16N4 ATV71HC13N4	353.00

▲ Letter designations in the wire kit contents correspond to component and terminal designations on the wiring diagrams in the associated document.

Kit Contents and Required Documentation (Continued)

1—Identify Your Spare Parts Kit:				2—Identify Your Drive:		3—\$ Price
Kit Catalog Number	Description	Qty	Kit Contents	Frame Size	Catalog Number	
VZ3TD1330M1601	SCR module	1	Thyristor/diode module, 1200 V, 330 A Thermal compound	9	ATV61HD75M3X ATV61HD55M3X ATV71HD55M3X	412.00
				10	ATV61HC13N4 ATV61HD90M3X ATV71HC11N4 ATV71HD75M3X	
				12	ATV71HC16N4 ATV61HC22N4	
VZ3TM1400M0671	Braking IGBT module	1 1	IGBT module, 600 V, 400 A Thermal compound	9	ATV61HD75M3X ATV61HD55M3X ATV71HD55M3X	370.00
VZ3TM1400M1271	Braking IGBT module	1 1	IGBT module, 1200 V, 400 A Thermal compound	9	ATV61HD90N4 ATV61HC11N4 ATV71HD90N4	407.00
				10	ATV61HC13N4 ATV71HC11N4	
VZ3TM1425M1671	SCR module	1 1	SCR module, 425 A, 1600 V Thermal compound	13	ATV61HC25N4 ATV71HC20N4	382.00
				14B	ATV61HC50N4 ATV71HC40N4	
VZ3TM1600M1671	SCR module	1 1	SCR module, 600 A, 1200 V Thermal compound	13	ATV61HC31N4 ATV71HC25N4 ATV71HC28N4	407.00
				14A	ATV61HC40N4 ATV71HC31N4	
				15	ATV61HC63N4 ATV71HC50N4	
VZ3V1203	Fan kit	1 1	Fan support Fan, 50x50x10 mm, 24 Vdc, IP21	2	ATV61H075M3 ATV61HU15M3 ATV61H075N4 ATV61HU15N4 ATV61HU22N4 ATV71H075M3 ATV71HU15M3 ATV71H037M3 ATV71H075N4 ATV71HU15N4 ATV71HU22N4	44.00
VZ3V1204	Fan kit	1 1	Fan support Fan, 60x60x25 mm, 24 Vdc, IP55	4	ATV61HU55M3 ATV61HU55N4 ATV61HU75N4 ATV71HU55M3 ATV71HU55N4 ATV71HU75N4	61.00
VZ3V1205	Fan kit	1 1	Fan support Fan assembled, 80x38 mm	5B	ATV61HD11M3X ATV61HD15M3X ATV61HD15N4 ATV61HD18N4 ATV71HD11M3X ATV71HD15M3X ATV71HD15N4 ATV71HD18N4	98.00
VZ3V1206	Fan kit	2 2 4	Fans, 92x92x38 mm, 24 Vdc IP55 Fan supports Screws with washers, M4x16	7A	ATV61HD30N4 ATV61HD37N4 ATV71HD30N4 ATV71HD37N4	104.00
VZ3V1207	Fan kit	4 1 2	Screws with washers, M4x16 Fan support Fans, 92x92x38 mm, 24 Vdc, IP55	7B	ATV61HD30M3X ATV61HD37M3X ATV61HD45M3X ATV71HD30M3X ATV71HD37M3X ATV71HD45M3X	137.00
VZ3V1208	Fan kit	4 1 2	Screws with washers, M4x16 Fan support Fans, IP55	8	ATV61HD45N4 ATV61HD55N4 ATV61HD75N4 ATV71HD45N4 ATV71HD55N4 ATV71HD75N4	137.00
VZ3V1209	Fan kit	1 2	Fan Support Fans, 60x60x25 mm, 24 Vdc, IP55	3	ATV61HU22M3 ATV61HU30M3 ATV61HU40M3 ATV61HU30N4 ATV61HU40N4 ATV71HU22M3 ATV71HU30M3 ATV71HU40M3 ATV71HU30N4 ATV71HU40N4	55.00
VZ3V1210	Fan kit	1 1 1	Fan support Fan, 60x25 mm Fan, 80x38 mm	5A	ATV61HU75M3 ATV61HD11N4 ATV71HU75M3 ATV71HD11N4	78.00
VZ3V1211	Fan kit	2 1 1	Screws with washers, M4X16 Fan support Fan, 92x92x38 mm, 24 Vdc, IP55	6	ATV61HD18M3X ATV61HD22M3X ATV61HD22N4 ATV71HD18M3X ATV71HD22M3X ATV71HD22N4	104.00

Kit Contents and Required Documentation (Continued)

1—Identify Your Spare Parts Kit:				2—Identify Your Drive:		3—\$ Price
Kit Catalog Number	Description	Qty	Kit Contents	Frame Size	Catalog Number	
VZ3V1212	Heatsink fan kit	1	Blower, 400 V	10	ATV61HC13N4 ATV71HC11N4	578.00
				11	ATV61HC16N4 ATV71HC13N4	
				12	ATV61HC22N4 ATV71HC16N4	
				13	ATV61HC25N4 ATV61HC31N4 ATV71HC20N4 ATV71HC25N4 ATV71HC28N4	
				14A	ATV61HC40N4 ATV71HC31N4	
				14B	ATV61HC50N4 ATV71HC40N4	
				15	ATV61HC63N4 ATV71HC50N4	
VZ3V1213	Internal fan	1	Fan, 24 Vdc	11	ATV61HC16N4 ATV71HC13N4	47.00
				12	ATV71HC16N4 ATV61HC22N4	
				13	ATV61HC25N4 ATV61HC31N4 ATV71HC20N4 ATV71HC25N4 ATV71HC28N4	
				14A	ATV61HC40N4 ATV71HC31N4	
				14B	ATV61HC50N4 ATV71HC40N4	
				15	ATV61HC63N4 ATV71HC50N4	
VZ3V1214	Internal fan	1 1	Fan, 80x80 Finger guard	9	ATV61HD75M3X ATV61HD90N4 ATV61HD55M3X ATV61HC11N4 ATV71HD90N4 ATV71HD55M3X	42.00
				10	ATV61HC13N4 ATV61HD90M3X ATV71HC11N4 ATV71HD75M3X	
VZ3V1215	Fan kit	3 1 6	Fans, 92x92 Fan Support Screws with captive washers, M4x10	9	ATV61HD75M3X ATV61HD90N4 ATV61HD55M3X ATV61HC11N4 ATV71HD90N4 ATV71HD55M3X	199.00
VZ3V1216	Heatsink fan kit	1	Blower, 200 V	10	ATV61HD90M3X ATV71HD75M3X	1278.00

Description	For Soft Start:	Catalog Number	\$ Price
Control Board	All ATS48 soft starts	VX4G481	530.00
Power Board	ATS48D17Y	VX5G48D17Y	625.00
	ATS48D22Y	VX5G48D22Y	635.00
	ATS48D32Y	VX5G48D32Y	650.00
	ATS48D38Y	VX5G48D38Y	675.00
	ATS48D47Y	VX5G48D47Y	715.00
	ATS48D62Y	VX5G48D62Y	840.00
	ATS48D75Y	VX5G48D75Y	900.00
	ATS48D88Y	VX5G48D88Y	1050.00
	ATS48C11Y	VX5G48C11Y	1110.00
	ATS48C14Y	VX5G48C14Y	1260.00
	ATS48C17Y	VX5G48C17Y	1315.00
	ATS48C21Y	VX5G48C21Y	1425.00
	ATS48C25Y	VX5G48C25Y	1515.00
	ATS48C32Y	VX5G48C32Y	1650.00
	ATS48C41Y	VX5G48C41Y	1795.00
	ATS48C48Y	VX5G48C48Y	1880.00
	ATS48C59Y	VX5G48C59Y	1975.00
	ATS48C66Y	VX5G48C66Y	2070.00
	ATS48C79Y	VX5G48C79Y	2180.00
	ATS48M10Y	VX5G48M10Y	2330.00
ATS48M12Y	VX5G48M12Y	2650.00	
Filter Board	ATS48D17, D22, D32, D38, D47Y	VX4G48161Y	175.00
	ATS48D62, D75, D88, C11Y	VX4G48162Y	215.00
	ATS48C14, C17Y	VX4G48163Y	330.00
	ATS48C21, C25, C32Y	VX4G48164Y	435.00
Firing Board	ATS48C41-C79, M10-M12Y	VX4G48165Y	340.00
SCR Power Module	ATS48D17, D22, D32Y	VZ3TM2056M18	243.00
	ATS48D38, D47Y	VZ3TM2091M18	277.00
	ATS48D62, D75Y	VZ3TM2132M18	372.00
	ATS48D88, C11Y	VZ3TM2162M18	478.00
	ATS48C14, C17Y	VZ3TM2250M18	658.00
	ATS48C21, C25, C32Y	VZ3TM2500M18	872.00
	ATS48C41, C79Y	VZ3TP2600M18	1125.00
	ATSC48-C66Y, M10-M12Y	VZ3TP2M12M18	1495.00
Temperature Sensor	ATS48D17-D88Y, C11-C32Y	VZ3G001	25.00
	ATS48C41-C79Y, M10-M12Y	VZ3G002	19.00
Fan	ATS48D32, D38Y	VZ3V481	65.00
	ATS48D47Y	VZ3V4811	71.00
	ATS48D62-D88, C11Y	VZ3V482	105.00
	ATS48C14, C17Y	VZ3V483	165.00
	ATS48C21, C25, C32Y	VZ3V484	218.00
	ATS48C41-C79Y, M10-M12Y	VZ3V485	293.00

Drive Product Support Group

For support and assistance, contact the Drive Product Support Group. The Drive Product Support Group is staffed from 8:00 am until 6:00 pm Eastern time to assist with product selection, start-up, and diagnosis of product or application problems.

EMERGENCY Technical phone support is available 24 hours a day, 365 days a year.

Toll Free: 1-888-778-2733
 E-mail: drive.products.support@us.schneider-electric.com
 Fax: 919-217-6508

Schneider Electric Service (On-Site)

The Schneider Electric Services division is committed to providing quality on-site service that consistently meets customer expectations. Services responds to your requests, seven days a week, 24 hours a day. Phone: 1-888-778-2733

Schneider Electric Customer Training

Schneider Electric offers a variety of instructor-led skill enhancing and technical product training programs for customers. For a complete list of drives/soft start training with dates, locations and pricing please call:

Phone: 978-975-9306
 Fax: 978-975-2821

Customer Care Center

(Assist with stock checks, assist with claims, and assist with order management issues)

To provide additional support, Schneider Electric has rolled out new Technical Service Representatives in local offices which have the strongest needs.

Due to time zone changes and different time operation requirements, business operation times vary.

Phone: 888-778-2733
 Fax: 888-329-9773

Web Address: <http://www.schneider-electric.us>

Literature Fulfillment Center

To obtain support literature for your product or application needs, contact the Schneider Electric Literature Fulfillment Center.

Phone: 800-888-2448
 Fax: 920-766-6675
 E-mail: SquareD@banta.com

Documentation, Start-up and Training

Standard Documentation

Each AC Drive or Soft Start shipped includes one set of instruction bulletins. Each set of instruction bulletins includes installation, start-up and wiring diagram information. Separate Approval and/or Record Drawings are not included.

Approval Drawings

Standard approval drawings are available for the enclosed drives and soft starts. The price adder for custom approval drawings are listed in the table below.

NOTE: Before manufacturing of the enclosed drive/soft start can begin, the approving parties must stamp and sign the transmittal forms that accompany the drawings. In the unlikely event that approval drawings are not approved and must be resubmitted, the approving parties must mark up, stamp and sign the drawings before a second set of approval drawings can be submitted.

Record Drawings

Record drawings are available for the enclosed drives and soft starts. The price adders for record drawings are listed in the table below.

Table 63: Pricing ▲

Drawing Size	Approval Drawings ■		Record Drawings	
	One set per drive \$ Price	DVD ★ \$ Price	One set per drive \$ Price	DVD ★ \$ Price
A 8.5 x 11	250.00 net	350.00 net	175.00 net	270.00 net
B 11 x 17	250.00 net	350.00 net	175.00 net	270.00 net
C 17 x 22	250.00 net	350.00 net	175.00 net	270.00 net

- ▲ Enter drawing requirement as a separate line item on purchase order.
- Pricing for Approval Drawings include pricing for Record Drawings
- ◆ One set equals a maximum of 8 copies. Additional copies are available at \$75.00 net each.
- ★ The drawings are available in several formats. They are .DWG; .DXF; .IGS; and Microcad.

Table 64: Schneider Electric Services Drives Start-up Pricing

Schneider Electric Service offers standard pricing for start-up under conditions as described below. The pricing is for Drives and Soft Starts located within the U.S., excluding Alaska and Hawaii.

Call 1-888-Square D for scheduling.

Service	Standard Price (Work Performed on weekdays during normal business hours) \$ Price	Premium Price (Work performed outside of normal business hours, Saturday, Sunday or Holidays) \$ Price
On Site Labor	\$165.00/Drive	\$300.00/Drive
Travel and Expense	See Below	See Below

Notes:

- Maximum of six drives or soft starts can be tested per day.
- When less than three days (72 hours) notice of start-up date is provided, the premium rate will be charged.

Travel Time and Expenses

Travel time and expenses will be calculated based on actual "round trip" mileage traveling from the Schneider Electric Sales Office to the job site and return.

Travel and living expenses will be billed at cost plus an administrative charge.

Travel and expense pricing will be based on actual number of trips with travel charges applied to each separate trip Schneider Electric Service makes to the job site.

Schneider Electric USA, Inc.
8001 Knightdale Blvd.
Knightdale, NC 27545
1-888-778-2733
www.schneider-electric.us

Advantys™, Altistart™, Altivar™, E-Flex™, FIPIO™, M-Flex™, Modbus™, PowerGard™, PowerLogic™, Sepam™, S-Flex™, SoMove™, Square D™, TCS™, TeSys™, and Uni-Telway™ are trademarks or registered trademarks of Schneider Electric or its affiliates in the United States and other countries. Other trademarks used herein are the property of their respective owners.

8800PL9701R01/14 © 2014 Schneider Electric All Rights Reserved
Replaces 8800PL9701R08/13 dated 08/2013

01/2014