

Hardware User's Guide

10" / 12" QuickPanel View

Intermediate, Color & Monochrome

IC754VBI10MTD

IC754VGI10MTD

IC754VSI10MTD

IC754VBI12CTD

IC754VGI12CTD

IC754VSI12CTD

IC754VSI12MTD

IC754VBI12MTD

IC754VGI12MTD

June 2006

GFK-2306B



All rights reserved. No part of this publication may be reproduced in any form or by any electronic or mechanical means, including photocopying and recording, without permission in writing from GE Fanuc Automation Americas, Inc..

Disclaimer of Warranties and Liability

The information contained in this manual is believed to be accurate and reliable. However, GE Fanuc Automation Americas, Inc. assumes no responsibilities for any errors, omissions or inaccuracies whatsoever. Without limiting the foregoing, GE Fanuc Automation Americas, Inc. disclaims any and all warranties, expressed or implied, including the warranty of merchantability and fitness for a particular purpose, with respect to the information contained in this manual and the equipment or software described herein. The entire risk as to the quality and performance of such information, equipment and software, is upon the buyer or user. GE Fanuc Automation Americas, Inc. shall not be liable for any damages, including special or consequential damages, arising out of the use of such information, equipment and software, even if GE Fanuc Automation Americas, Inc. has been advised in advance of the possibility of such damages. The use of the information contained in the manual and the software described herein is subject to GE Fanuc Automation Americas, Inc.'s standard license agreement, which must be executed by the buyer or user before the use of such information, equipment or software.

Notice

GE Fanuc Automation Americas, Inc. reserves the right to make improvements to the products described in this publication at any time and without notice.

© 2006 GE Fanuc Automation Americas, Inc. All rights reserved. QuickPanel View is a trademark of GE Fanuc Automation Americas, Inc. Any other trademarks referenced herein are the property of their respective owners and used solely for purposes of identifying compatibility with the products of GE Fanuc Automation Americas, Inc.

The 10" and 12" QuickPanel View models have been tested and found to meet or exceed the requirements of U.S. (47 CFR 15), Canadian (ICES-003), Australian (AS/NZS 3548) and European (EN55022) regulations for Class A digital devices when installed in accordance with guidelines noted in this manual.

The FCC requires the following note to be published according to FCC guidelines:

This equipment has been tested and found to comply with the limits for a Class A digital device, pursuant to Part 15 of the FCC Rules. These limits are designed to provide reasonable protection against harmful interference when the equipment is operated in a commercial environment. This equipment generates, uses, and can radiate radio frequency energy and, if not installed and used in accordance with the instruction manual, may cause harmful interference to radio communications. Operation of this equipment in a residential area is likely to cause harmful interference in which case the user will be required to correct the interference at his own expense.

Any changes or modifications to the product or installation that are not expressly approved by GE Fanuc Automation could void the user's authority to operate the equipment under FCC rules.

Industry Canada requires the following note to be published:

This Class A digital apparatus complies with Canadian ICES-003.

The following statements are required to appear for Class I Div 2 Hazardous Locations.

1. WARNING - EXPLOSION HAZARD - SUBSTITUTION OF COMPONENTS MAY IMPAIR SUITABILITY FOR CLASS 1, DIV. 2.
2. WARNING - EXPLOSION HAZARD -WHEN IN HAZARDOUS LOCATIONS, TURN OFF POWER BEFORE REPLACING OR WIRING MODULES.
3. WARNING - EXPLOSION HAZARD - DO NOT CONNECT OR DISCONNECT EQUIPMENT UNLESS POWER HAS BEEN SWITCHED OFF OR THE AREA IS KNOWN TO BE NON-HAZARDOUS.

Power, input and output (I/O) wiring must be in accordance with Class 1, Division 2 wiring methods, Article 501 4(b) of the National Electric Code, NFPA 70 and in accordance with the authority having jurisdiction.

For a complete list of agency qualifications, please refer to appendix A1.

We want to hear from you. If you have any comments, questions, or suggestions about our documentation, send them to the following email address:
doc@gefanuc.com.

Contents

1	Welcome	1
	Getting Started	.2
	Basic Setup	.2
	QuickPanel View Runtime Setup	.3
	Startup	.3
	Shutdown	.4
	Panel Cutout	.4
	Technical Support	.6
2	Overview	7
	QuickPanel View Hardware	.8
	Layout Diagram	.8
	Block Diagram	.9
	QuickPanel View Software	.10
	Windows CE.NET	.10
	Working with Windows CE	.10
	Pocket Internet Explorer	.11
	Backup	.12
	Reboot	.13
	Storage Manager	.14
	System Information	.14
	Copy Project to Flash Card	.15
	Emulate PPC	.15
	HTTP File Transfer Utility	.16
3	Detailed Operation	19
	Touch Screen Display	.20
	Touch Screen	.23
	Soft Input panel	.26
	Communication Port	.28
	COM1	.28
	Recommended Cabling for TIA/EIA422 or TIA/EIA485	.28
	Working with the COM port	.30
	CF Port	.34
	Ethernet	.35

Expansion Bus	39
DIP Switches	40
Memory	42
Flash Memory	42
SRAM Memory	43
DRAM Memory	43
Boot Loader ROM	44
Memory Expansion Slot	44
Other Subsystems	46
Power Management	46
Battery Backup	46
Real-time Clock	47
A1 Design Specifications	49
Physical	49
DC Power	49
Display	50
Front Panel	50
Touch Screen	50
CPU	50
Memory	51
Memory Expansion Slot	51
Expansion Ports	51
Communication Ports	52
Environmental	52
Battery	52
Calendar/Clock	53
Agency Qualifications	53
A2 Troubleshooting	55
Power up	55
Pocket Internet Explorer	55
Index	57

Congratulations on your purchase of a QuickPanel View, the most advanced compact HMI computer available. The QuickPanel View is available in different configurations to suit your requirements. Equally at home in a networked environment or as a stand-alone unit, the QuickPanel View is the ideal solution for factory floor HMI.

Powered by Microsoft Windows® CE .NET™, today's embedded operating system of choice, the QuickPanel View provides a fast track for application program development. The commonality with other versions of Windows simplifies porting your existing program code. Another benefit of Windows CE is the familiarity of the user interface, shortening the learning curve for operators and developers alike. The availability of third-party application software makes this operating system even more attractive.

The 10"/12" QuickPanel View is an all-in-one microcomputer designed for maximum flexibility. The design, based on an advanced Intel® microprocessor, brings together a high-resolution touch-screen operator interface with a variety of I/O options. With many standard ports and expansion busses from which to choose, you can connect to most industrial equipment.

The QuickPanel View is equipped with several memory types to satisfy even the most demanding applications. A 32MB section of DRAM is split between the operating system, an object store, and application memory. A 32MB section of non-volatile FLASH memory, functioning as a virtual hard drive, is divided equally between the operating system and persistent storage for application programs. The retentive memory consists of 512 KB of battery-backed SRAM for data storage, ensuring your valuable data will never be lost, even during a power failure.

The many features of the QuickPanel View make it an obvious choice for a world of applications. Your smart choice will provide reliable operation for years to come.

GETTING STARTED

Basic Setup

Your 10" or 12" QuickPanel View is shipped ready for use after a few configuration steps. To power up all you need to do is connect a DC power supply via the supplied quick-connect plug. Depending on your application, you may also want to configure communications ports (see page 28) and expansion adapters (see page 39).

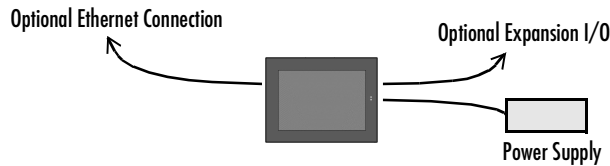

Caution - Electrical Shock Hazard: To avoid personal injury or damage to equipment, ensure that the DC supply is disconnected from power and that the leads are not energized before attaching them to the unit's power supply plug.

To connect a DC power supply

1. Using the three screw terminals shown in the following diagram, attach a 24VDC, 48W power supply to the plug supplied with the QuickPanel View (see specifications on page 49 for conductor size requirements).
2. Insert the plug into the power supply socket and securely tighten the attaching screws.

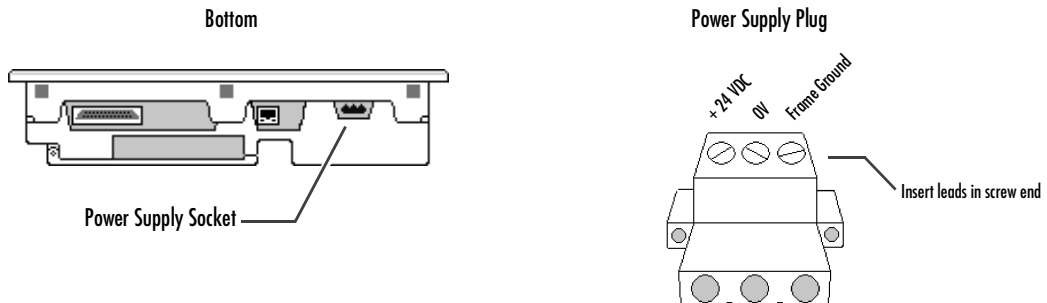

QuickPanel View Runtime Setup

To download a Machine Edition application to a QuickPanel View unit, you must set up a data link between your development workstation and the QuickPanel unit. For more information, see “Ethernet” (page 35) and look up “Downloading a Machine Edition Project” in the Machine Edition online help.

Startup

When you first start up the QuickPanel View, a few configuration steps are necessary.

To start the QuickPanel View









1. Apply DC power to the QuickPanel View.

Once power is applied, the QuickPanel View begins initializing. The first thing to appear on the display is the splash screen.



2. To skip running any programs included in the StartUp folder, tap **Don't run StartUp programs**.

The splash screen disappears automatically after about 5 seconds. The Windows CE desktop then becomes visible.

3. Tap  **Start**, point to  **Settings** and then tap  **Control Panel**.
4. In the Control Panel, double-tap  **Display** to configure the LCD display (see page 21).
5. In the Control Panel, double-tap  **Stylus** to configure the touch screen (see page 23).
6. In the Control Panel, double-tap  **Date and Time** to configure the system clock (see page 47).
7. In the Control Panel, double-tap  **Network and Dial-up Connections** to configure network settings (see page 36).
8. On the desktop, double-tap  **Backup** to save any new settings through a power cycle (see page 12).

Shutdown

There are no specific dangers associated with a power failure or other unplanned shutdown of the QuickPanel View. In general, programs are retained in FLASH memory and user data can be retained in battery-backed SRAM. Some operating system settings are retained only with user intervention, so in order to carry out a graceful shutdown of the QuickPanel View, we recommend you perform the following procedure.

To shut down the QuickPanel View

1. Quit any programs that are running and wait for all file operations to complete.
2. If you have not changed operating system settings (e.g., brightness or touch screen sensitivity) or do not want to save the changes, remove AC power from the 24VDC supply.
3. To save changes to operating system settings (e.g., brightness, touch screen sensitivity), run Backup (see page 12) and then reboot the system (see page 14). When the Windows CE desktop reappears, remove AC power from the 24VDC supply.

Panel Cutout

For enclosure mounting, cut an opening in the panel according to the specifications given with the following diagram.

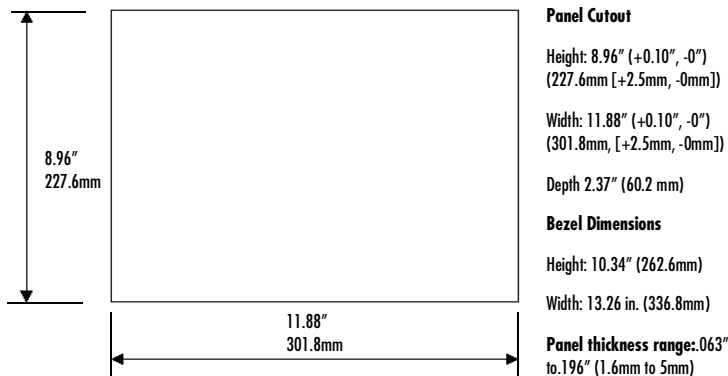

Notes:

- For compliance to NEMA 4, 4x, and 12 qualification, the unit must be mounted in a comparably NEMA rated (IP56 equivalent) panel or enclosure.
- For compliance to ATEX agency qualification, the unit must be mounted in an IP66 panel or enclosure. It is recommended that a minimum panel thickness of 0.1" be used in ATEX applications.

- To avoid gasket degradation, limit repeated insertions or removals of the unit and retightening of the mounting clips. For full protection, always use a fresh gasket. The unit will **not** fit through this cutout with a CF card inserted in the port, with any cables connected, or with the power supply plug inserted in the socket. To secure the QuickPanel View to a panel, use the 10 included mounting clamps. They hook into openings located on the top, bottom, and sides of the housing.

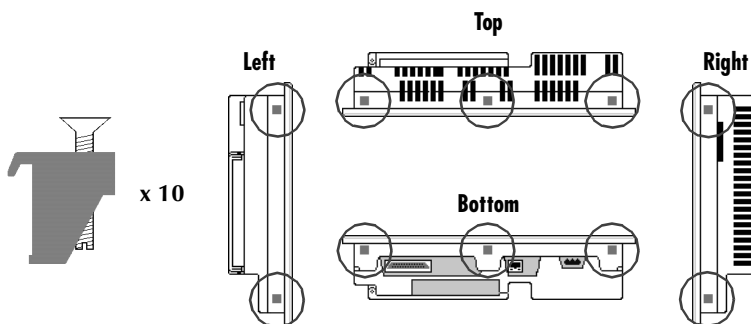

To mount the QuickPanel View in a panel

1. Insert the unit into the panel cutout (without a CF card in the CF port).
2. Insert the hook of each mounting clamp into the housing openings as shown below.
3. Ensure that the gasket is properly seated in the bezel channel and firmly tighten the clamp screws.

Note: The torque range for the mounting clamp screws is 2.6-4.4 inch/lbs (0.3-0.5 Nm)

The mounting clamps hold the unit in place by tension alone. No drilling is required.

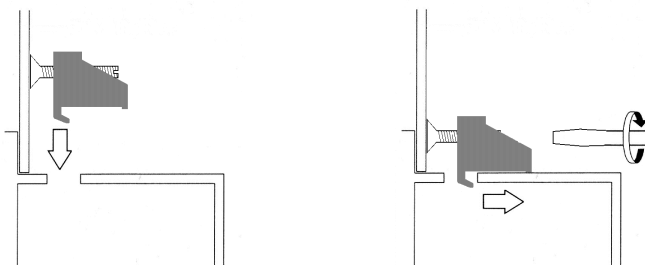

Do not damage the gasket attached to the back of the QuickPanel View's bezel. This gasket prevents shock hazards and damage caused by liquids accidentally entering the unit after installation.

TECHNICAL SUPPORT

If you have technical problems that cannot be resolved with the information in this guide, please contact us by telephone, fax, or email; or visit one of the links on our website:

Telephone: 1-800-GE-FANUC (1-800-433-2682)

Fax: (780) 420-2049

Email: support@gefanuc.com

Comments about our manuals or help: doc@gefanuc.com

Web: To locate product information, specifications, documentation or information on updates, please visit <http://globalcare.gefanuc.com>, then select the Operator Interface Product Category, then select the QuickPanel View Product Name.

2

Overview

This chapter provides introductory information on the 10" and 12" QuickPanel View hardware and software, with descriptive procedures for completing some of the most common tasks you will encounter.

In this chapter:

Layout Diagram	8
Windows CE.NET	10
Working with Windows CE	10
To place a program in the Start menu	10
Pocket Internet Explorer	11
To establish a dial-up connection	11
To configure a Proxy server	11
Backup	12
To run the Backup program	12
To reboot the system	14
System Information	15
To run the System Information program	15
Copy Project to Flash Card	16
To copy a Machine Edition project onto a CF card	16
To update a Machine Edition project	16
Emulate PPC	16
To use Emulate PPC during an ActiveSync session	16
HTTP File Transfer Utility	17
To use the HTTP utility	17

QUICKPANEL VIEW HARDWARE

Layout Diagram

In addition to the primary touch screen interface, the 10" or 12" QuickPanel View supports a variety of communication ports including an expansion bus to allow great flexibility in application. The following diagram shows the physical layout of the QuickPanel View and the locations of ports and connections

The bottom LED is green when power is applied and amber if both backlights fail (IC754Vx110MTD has one backlight);¹ the top LED is tricolor (green, red, or amber) and programmable.

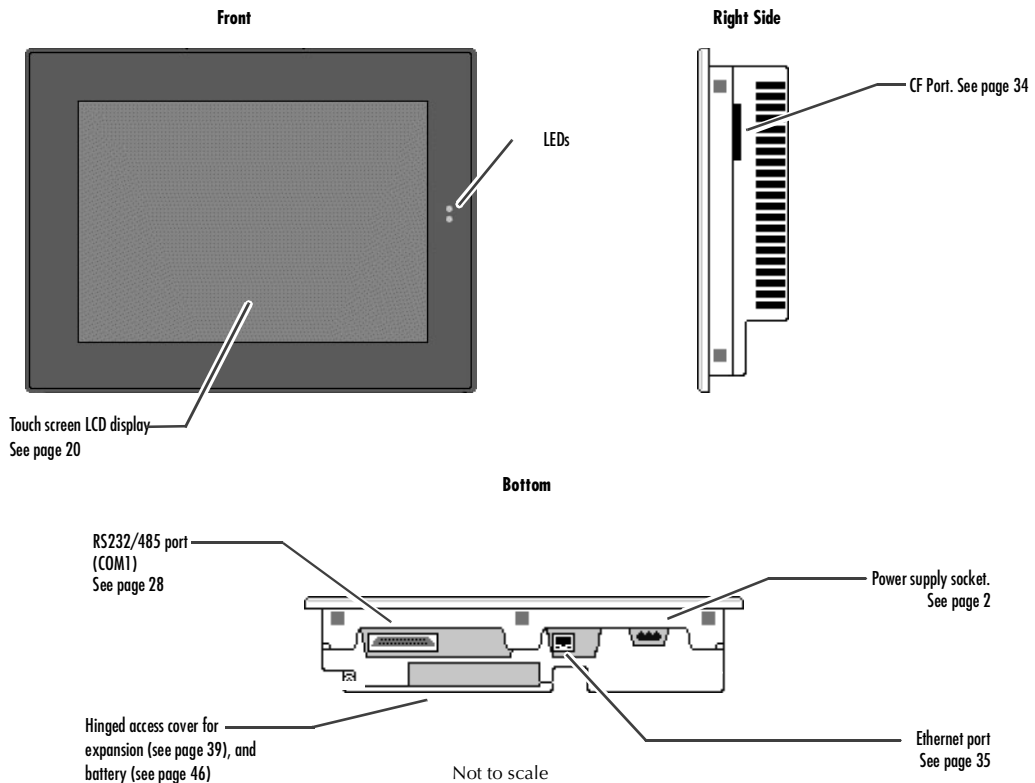

¹ Backlights are not field replaceable.

Block Diagram

The 10" and 12" QuickPanel View hardware is based on the Intel® XScale™ PXA255 microprocessor, and employs large-scale integration to provide high performance with a small footprint. The following block diagram illustrates the major functional hardware areas and the interfaces between them.

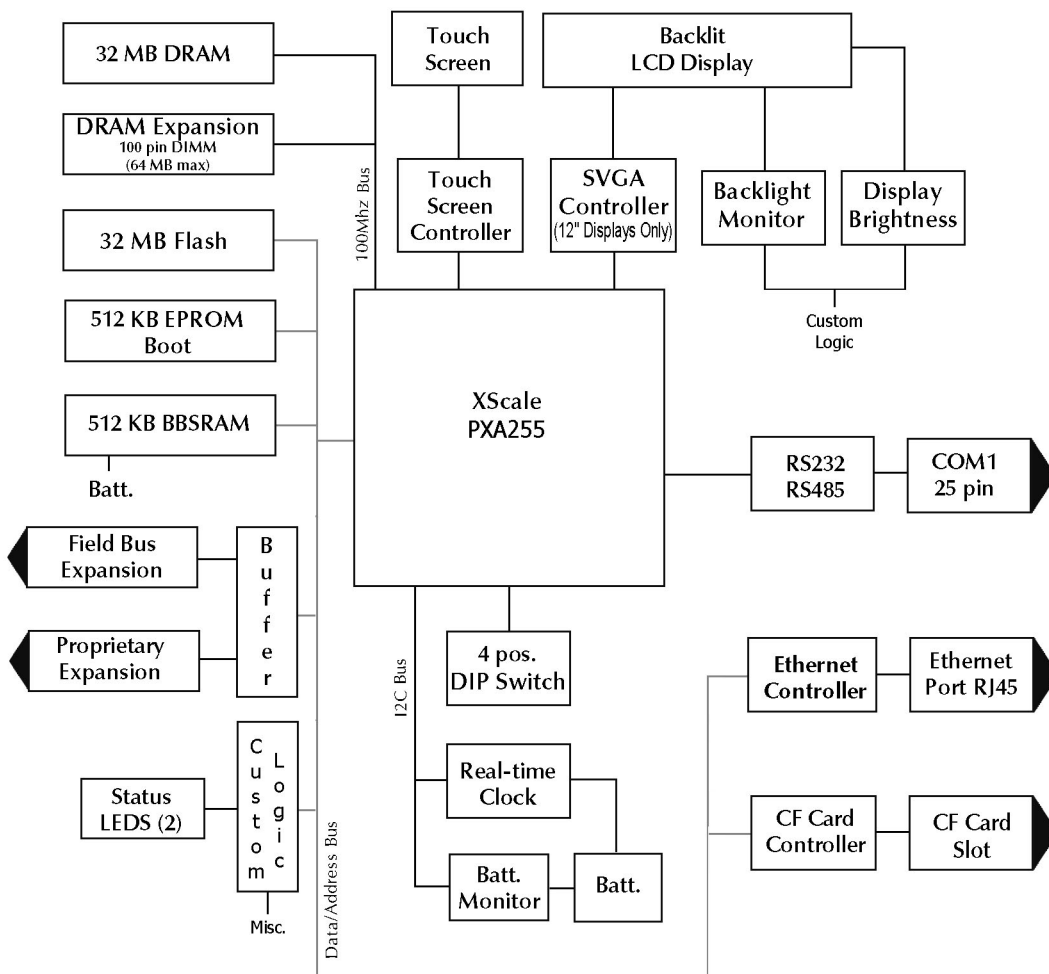

QUICKPANEL VIEW SOFTWARE

Windows CE.NET

Microsoft Windows CE .NET is the operating system for the QuickPanel View. It is a full 32-bit O/S with a graphical user interface. This operating system is finding widespread application in hand-held PCs and embedded HMI's, such as the QuickPanel View. The familiar look and feel of Windows CE shortens the learning curve for users having experience with Windows 95/98/NT/2000/ME/XP. From a software developer's perspective, the CE environment is a subset of the WIN32 application programming interface, simplifying the porting of existing software from other versions of Windows.



Stored in a 16 MB block of FLASH memory, the QuickPanel View operating system is copied to DRAM for execution. The operating system starts automatically following a power-up or reset of the QuickPanel View.

For more on Windows CE visit www.microsoft.com/windows/embedded/ce.

Working with Windows CE

When working with Windows CE on the QuickPanel View, user input is achieved via the touch screen with a stylus or other suitable pointing device. The Soft Input Panel (SIP) is used for character and numeric entry, or for entering keyboard shortcuts. For more information on the Soft Input Panel, including a list of keyboard shortcuts, see page 26.

To place a program in the Start menu

1. Start  Windows Explorer.
2. Navigate to the program you want to place in the  Start menu.
3. Tap the program's icon to select it.
4. From the **Edit** menu, choose **Copy**.
5. Navigate to the `\Windows\Programs\` folder.
6. From the **Edit** menu, choose **Paste Shortcut**.
7. Run the  **Backup** program to retain the change through a power cycle (see page 12).

Caution: Do not cycle power immediately after running Backup.

Pocket Internet Explorer

Microsoft's Pocket Internet Explorer is a full-featured browser that is fully integrated with the Windows CE operating system. This browser allows you to connect with an internet service provider, view web pages and download from FTP sites.

Pocket Internet Explorer supports JScript. Java support can be added from third-party sources. Pocket Internet Explorer does not support VBScript; however, VBScript components are included in the operating system and may be used by third-party applications such as Proficy Machine Edition.

A connection can be established over an Ethernet network (default) or a dial-up connection. The Ethernet or dial-up connection must first be properly configured.

To establish a dial-up connection

1. Start  Pocket Internet Explorer.
2. From the **View** menu, choose **Options**.

The **Options** dialog box appears.

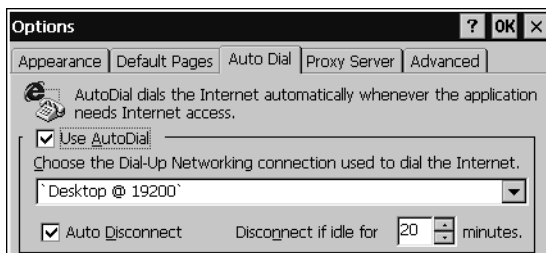

3. On the **Auto Dial** tab, select the **Use AutoDial** check box.
4. Choose either the default or a user-defined connection from the list.
5. Tap **OK**.
6. Run the  **Backup** program to save the settings through a power cycle (see page 12).

Caution: Do not cycle power immediately after running Backup.

To configure a Proxy server

1. Start  Pocket Internet Explorer.
2. From the **View** menu, choose **Options**.

The **Options** dialog box appears.

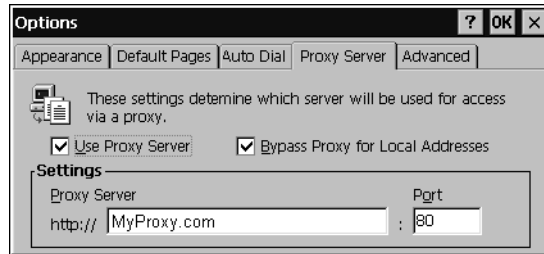

3. On the **Proxy Server** tab, select the **Use Proxy Server** check box.
4. In the **Proxy Server** box, type the URL of your proxy server (see your ISP or network administrator).
5. In the **Port** box, type the server's port number for HTTP access.
6. Select the **Bypass Proxy for Local Addresses** check box to connect directly to sites like your intranet.
7. Tap **OK**.
8. Run the  **Backup** program to retain the new settings through a power cycle (see page 12).

Caution: Do not cycle power immediately after running Backup.

Backup

Backup is a utility that saves any changes made to the Windows Registry or Desktop. This utility is required because the QuickPanel View is not battery powered. Specifically, the Backup command does the following:

- The Windows CE registry (including any control panel settings) is stored in the Flash registry
- Any changes (additions) made to the 'Windows' subtree of the file system are stored in the user block of FLASH memory.

The **Backup** program should be run whenever configuration changes are made to the operating system or installed applications, and prior to shutting down the QuickPanel View. The time the operating system takes to finish all write operations after Backup completes varies depending on other system demands. Because of this, rebooting (see page 13) is recommended before disconnecting power, in order to ensure the completion of all write operations.

To run the Backup program

1. On the desktop, double-tap  **Backup**.

The **Backup** dialog box appears.

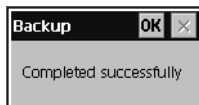

2. Tap **OK**.





Caution: Do not remove power immediately after running Backup because the operating system may still be writing to flash memory. Wait several minutes or reboot the system (see page 13) before disconnecting power, in order to ensure the completion of all write operations.

Reboot

There are two circumstances under which you will reboot the operating system:

- After changing some control panel settings the system indicates you must reboot before the changes take effect.
- Immediately after running Backup (see page 12) and before disconnecting power, reboot in order to ensure all changes have been written to flash memory.

To reboot the system

1. Run the  **Backup** program to retain any changes.
2. Tap  **Start**, point to  **Programs**, then the  **System** folder, and tap  **Reboot**.

A confirmation dialog box appears.

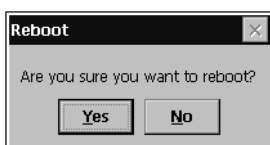

3. Tap **"Yes"**

The operating system restarts.

Storage Manager

Use Storage Manager to repair or format lost or corrupted data volumes. Storage Manager can repair data volumes existing either in Compact Flash (CF) or battery-backed SRAM (BBSRAM). Data volumes existing in the main flash file system of the QuickPanel may not be repaired by Storage Manager.

Storage Manager, accessed from the Control Panels folder, is a Microsoft product for which on-line help is available.

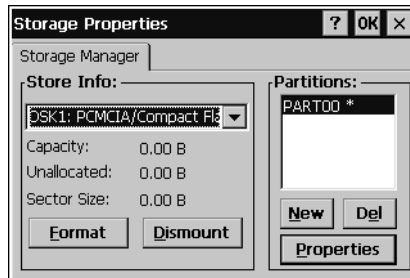

System Information

System Information is a custom utility that displays a splash screen with the following information:

- **Operating System version.** For example, 'Windows CE .NET v4.10'.
- **Platform.** Identifies the host hardware, its version and build number.

Tapping **More Info** on the splash screen opens the Advanced System Information window, which provides information such as hardware version and serial number, CPU type and specifications, etc. This information can be especially useful if you are contacting GE Fanuc Support.

To run the System Information program

1. On the desktop, double-tap  **System Information**.

The **System Information** splash screen appears.

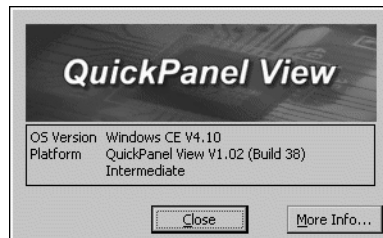

2. Tap **More Info** to open the Advanced System Information window, or tap **Close** to continue.

Network information alone can be viewed by double-tapping the  LAN icon displayed on the taskbar for each connection.

Copy Project to Flash Card

RestorePCCard is a custom utility for transferring Proficity Machine Edition Projects between compatible QuickPanel View units via CF cards.

Caution: Ensure that the copy or update operation is complete (i.e., no busy or wait cursor displays) before disconnecting power.

To copy a Machine Edition project onto a CF card

1. Ensure there is a blank CF card in the in the CF port.
2. Double tap the  **Copy Project to Flash Card** icon on the desktop.
3. Tap **Yes** when the **Proceed with Copy to CF Card** confirmation dialog box appears.

The system copies the project onto the blank CF Card.

To update a Machine Edition project

You can update a Proficity Machine Edition application currently stored on the QuickPanel View with a revision stored on a CF Card.

1. Insert the CF Card containing an upgraded version of the Machine Edition project in the CF port.
2. Reboot the machine (see page 13).

When a valid project is found on the CF card, you will be prompted to install the project or skip it. Tap **OK** to install or **Cancel** to skip the install and continue to reboot. If an invalid project is found, an error message appears in a dialog box. This dialog box must be closed before reboot will continue.

3. Remove the CF Card from the slot.

Emulate PPC

Emulate PPC is a utility that allows the QuickPanel to emulate a Pocket PC 2003 during an ActiveSync session, enabling the download of third-party Pocket PC 2003 software.

To use Emulate PPC during an ActiveSync session

1. Start  **Windows Explorer**, double tap  **Windows**, then double tap  **EmulPPC**.

The Emulate PPC dialog box appears.

2. Start the ActiveSync session. When installation of third-party software is complete, close the dialog box to deactivate Emulate PPC.

HTTP File Transfer Utility

The HTTP File Transfer Utility (HFTU) is a small, standalone command line program that allows you to send and delete files to and from computers over a network. The HFTU uses the HTTP protocol, so you can even send files to computers over the Internet.

Run the HTTP utility from a command line prompt, from a batch file (.BAT) or as an application call in a script. The HTTP utility is an executable (.EXE) file included in the 10" and 12" QuickPanel View's operating system.

The HTTP utility currently supports two file transfer commands: COPY and DELETE.

Note: In order to function, the HTTP File Transfer utility requires both computers to have web servers that support PUT functionality. (Most web servers support PUT, including the CIMPLICITY Machine Edition web server installed with the runtimes for View and Logic Developer - PC.) If in doubt, check the documentation for your web server.

To use the HTTP utility

1. From the  **Start** menu, choose  **Programs**, then choose  **Command Prompt**.

The **Command Line** editor appears.

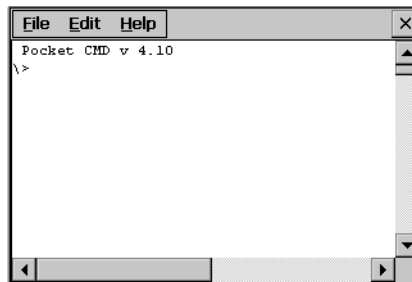

2. Type commands as required.
3. Use the following syntax:

HTTPUTIL COPY source destination

Where "source" is the URL of the source file, and "destination" is the URL of the destination file. For example:

```
HTTPUTIL COPY \MyFile.txt http://MyServer/webfiles/MyFileBACKUP.txt
```

Copies a file called MyFile.txt on drive C: of the local computer to the webfiles folder under the web server at //MyServer. Note that you can rename a file as you copy it.

HTTPUTIL DELETE url

Where “url” is the remote URL of the file you want to delete. This URL must use the “//” or “HTTP://” syntax. For example:

```
HTTPUTIL DELETE http://MyServer/webfiles/MyFileBACKUP.txt
```

Deletes a file called MyFileBACKUP.txt from the webfiles directory under the web server at HTTP://MyServer.

3

Detailed Operation

In this chapter:

Touch Screen Display	20
To adjust the display brightness (12" models)	20
To adjust the display contrast (10" model)	21
To configure backlight auto turn off	21
To calibrate the touch screen	23
To set the double-tap sensitivity	24
Soft Input panel	26
To show/hide the Soft Input Panel	26
Keyboard Shortcuts	27
To display the Soft Input Panel icon in the system tray	27
Communication Port	28
To add a new remote networking connection	30
To add a virtual private network or PPP over Ethernet connection	31
To change the default device properties	32
To change the default TCP/IP settings	33
CF Port	34
Ethernet	35
To set an IP address	36
To set up access to a Windows network	37
To access a remote resource on a Windows network	38
Expansion Bus	39
DIP Switches	40
To configure startup behavior	41
Memory	42
To add Flash memory with a CF Card	42
To change the DRAM memory allocation	43
To install additional DRAM	45
Other Subsystems	46
To access the Power Properties control panel	46
To remove the internal battery	47
To set the real-time clock	47
To display the time on the taskbar	48

TOUCH SCREEN DISPLAY

The QuickPanel View has an integrated flat-panel display providing either color or monochrome, depending on model. The 12" models, IC754Vx12CTD (color), and IC754Vxi12MTD (monochrome), incorporate a backlit, 12.1" diagonal display employing active TFT technology. The 10" model, IC754Vx110MTD (monochrome), incorporates a backlit, 10.4" diagonal display employing passive technology.

The 12" display provides a resolution of 800 x 600 pixels and 32,768 colors (256 shades of gray in the monochrome model), while the 10" display provides a resolution of 640 x 480 pixels and 256 shades of gray.

Both displays have a backlight timer feature allowing the backlight to turn off automatically and extend its life.

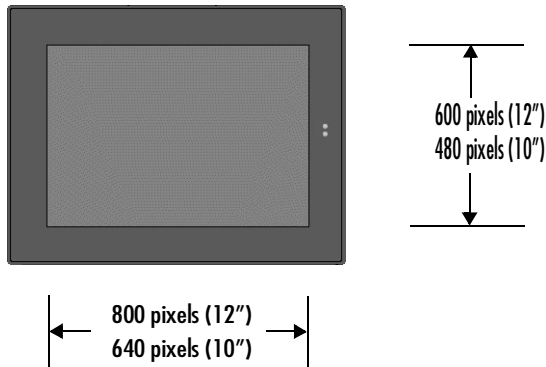

To adjust the display brightness (12" models)

1. In the Control Panel, double-tap  **Display** and choose the **Brightness** tab.

The **Brightness** dialog box appears.

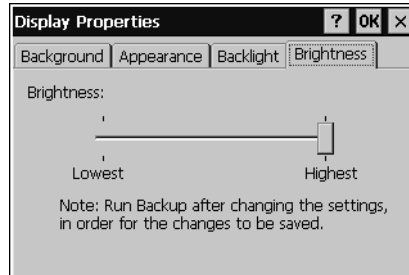

2. Drag the **Brightness** slider between Lowest and Highest.
3. Tap **OK** to exit the control panel.
4. Run the  **Backup** program to save settings through a power cycle (see page 12).

Caution: Do not cycle power immediately after running Backup.

To adjust the display contrast (10" model)

1. In the Control Panel, double-tap  **Display** and choose the **Contrast** tab.

The **Contrast** dialog box appears.

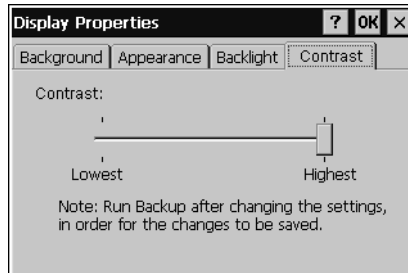

2. Drag the **Contrast** slider between Lowest and Highest.
3. Tap **OK** to exit the control panel.
4. Run the  **Backup** program to save settings through a power cycle (see page 12).

Caution: Do not cycle power immediately after running Backup.

To configure backlight auto turn off

1. In the Control Panel, double-tap  **Display** and choose the **Backlight** tab.

The **Backlight** dialog box appears.

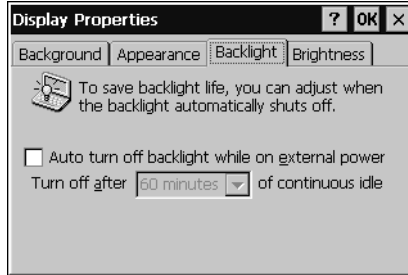

2. Select **Auto turn off backlight while on external power**.
3. Tap **OK** to exit the control panel.
4. Run the  **Backup** program to save settings through a power cycle (see page 12).

Caution: Do not cycle power immediately after running Backup.

Note: Backlight failure notification displays in this dialog box if one of the backlights fails. If both backlights fail, the bottom LED flashes amber and the screen is blank.

Note: The 10" QuickPanel View has only 1 backlight.

Touch Screen

The QuickPanel View display is coupled to a resistive touch panel with 12-bit resolution. When the QuickPanel View is properly calibrated, this translates into a grid of touch cells on the face of the display. Although you can use your finger to actuate the touch screen, use of a blunt stylus is recommended.

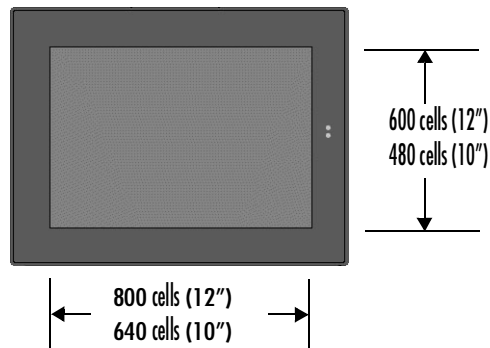

To calibrate the touch screen

1. In the Control Panel, double-tap  Stylus.

The **Stylus Properties** dialog box appears.

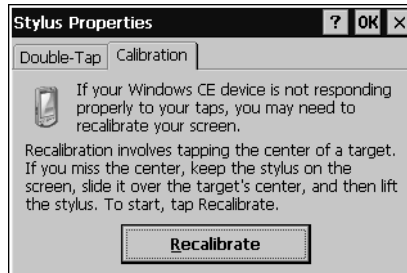

2. Choose the **Calibration** tab
3. Tap the **Recalibrate** button.

A cross hair target is displayed.

Detailed Operation

Touch Screen Display

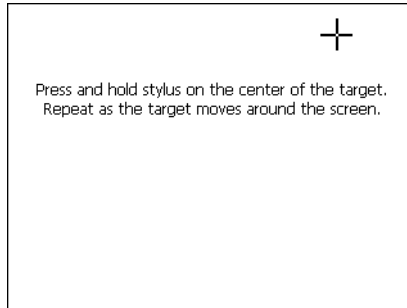

4. Follow the directions given to calibrate the touch screen. While calibrating, do not touch the front of the unit outside the clear area of the membrane or on the black border around the clear center area in order to ensure an accurate calibration.
5. Tap the screen to preserve the new setting or wait out the time limit to revert to previous settings.

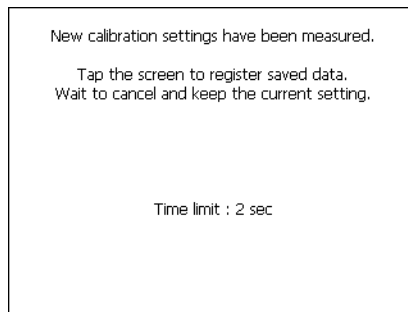

6. Run the  **Backup** program to save the settings through a power cycle (see page 12).

Caution: Do not cycle power immediately after running Backup.

To set the double-tap sensitivity

1. In the Control Panel, double-tap  **Stylus**.

The **Stylus Properties** dialog box appears.

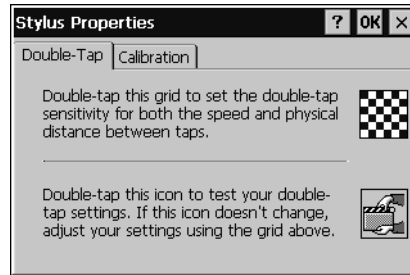

2. Choose the **Double-Tap** tab.
3. Double-tap the grid to enter a setting.
4. Double-tap the test icon to check the setting.

If the test icon doesn't change when you double-tap it, double-tap the grid again.

5. Tap **OK** to finish.
6. Run the  **Backup** program to save the settings through a power cycle (see page 12).

Caution: Do not cycle power immediately after running Backup.

SOFT INPUT PANEL

The Soft Input Panel (SIP) is a software emulation keyboard that can be used as an operator data input device.

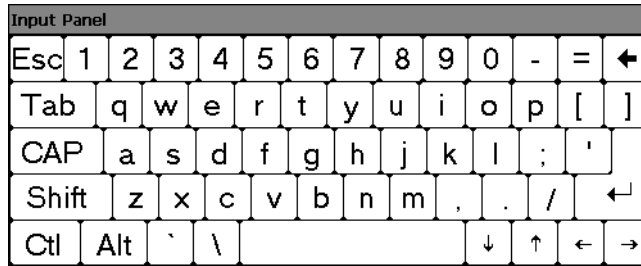

An icon in the system tray lets you view or hide the SIP.



To show/hide the Soft Input Panel

- On the system tray of the task bar, double-tap the  icon. The Soft Input Panel appears/disappears.

Note: When the SIP is visible, it can be dragged around the screen by its title bar to reveal different parts of the screen that would be obstructed from view by the SIP.

Using SHIFT, CAP, CTRL, and ALT on the Soft Input Panel

Uppercase characters are accessed by pressing the SHIFT key once. This is equivalent to holding down the SHIFT key on a conventional keyboard. The SHIFT key is active while the next key is pressed then reverts back to its unselected state. The CAP key does the same thing as SHIFT but does not revert to lower case after another key is pressed. Rather, the Soft Input Panel remains in the Uppercase mode until the CAP key is pressed again. The CTRL and ALT keys behave the same as the SHIFT key.

Keyboard Shortcuts

You can enter the following keyboard shortcuts using the SIP:

Shortcut	Action
CTRL+ESC	Opens the Windows CE Start menu. Use arrow keys to select a program and ENTER to run it.
ALT+TAB	Starts the Task Manager. Use it to quit unresponsive programs.
CTRL+ALT+=	Starts the touch screen calibration.
SPACEBAR	Equivalent to single-tap.
ENTER	Equivalent to double-tap. In a dialog box, equivalent to OK .
TAB	In a dialog box, select next control.
SHIFT+TAB	In a dialog box, select previous control.
CTRL+TAB	In a tabbed dialog box, open the next tab.
ESC	Close dialog box, discarding changes.
ARROW KEYS	In a dialog box, select controls or items from a list box.

To display the Soft Input Panel icon in the system tray

1. In the Control Panel, double-tap  **Input Panel**.

The **Input Panel Properties** dialog box appears.

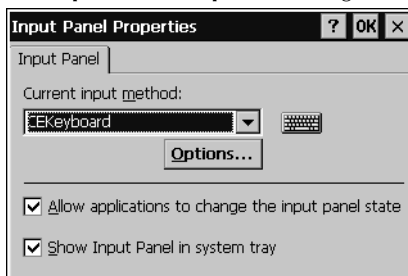

2. Select or clear the **Allow applications to change the input panel state** check box.
3. Select or clear the **Show Input Panel in system tray** check box.
4. Tap **OK**.
5. Run the  **Backup** program to retain the new setting through a power cycle (see page 12).

Caution: Do not cycle power immediately after running Backup.

COMMUNICATION PORT

The QuickPanel View has one serial data communication port, COM1.

COM 1

The COM1 port is a general purpose bidirectional serial data channel that supports the EIA232C and EIA485 electrical standards. The COM1 port can be accessed and configured:

- as a direct or dial-up remote networking connection.
- from a user-created application program.

A connection can be configured to reside on a network supporting a TCP/IP protocol.

A DB25S (female) connector, mounted on the bottom of the enclosure, provides standard signals as described in the following table.

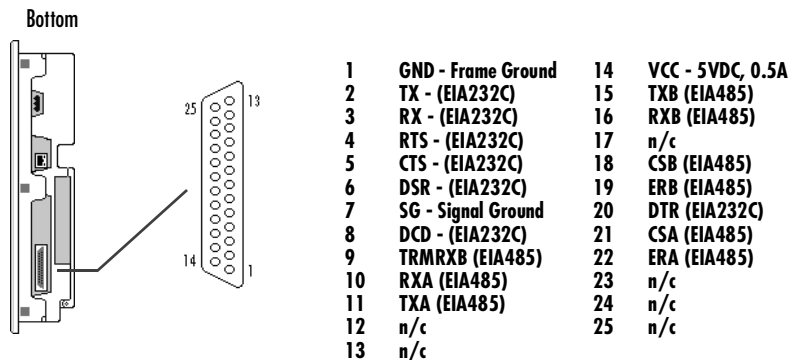

Note: Pin 14 is fused with a field-replaceable, 1.0A fast-blow fuse.

Recommended Cabling for TIA/EIA422 or TIA/EIA485

The COM1 port on the QuickPanel View provides connections to devices, which support either TIA/EIA422 or TIA/EIA485. These electrical standards specify a differential signaling technique which provides high data rates, long distances and good noise rejection. The standards do not address signal encoding (protocol), connectors, or cabling. However, certain characteristics of interfacing these devices should be considered in order to ensure reliable connections.

- Connections** Connect nodes in a daisy chain fashion. Do not connect in other arrangements, especially "star." The standards do not specify the maximum number of nodes or devices that can be connected to a TIA/EIA 422 or 485 network. Instead, the standards limit the number of electrical connections by specifying that a maximum of 32 unit loads (UL) may be connected. The QuickPanel View presents one UL.
- Interconnect media** Always use twisted pair cabling and group complimentary signals into conductor pairs; TXA with TXB, for example. Use a cable with a characteristic impedance of 100 ohms to 120 ohms. A wire gauge of 24 AWG is commonly used. Maximum cable length is 4,000' (1,219.2m), but may be less due to cable impedance, connection quality, data rates, and other factors.
- Termination** Always provide proper termination at each end of the 422/485 network. The QuickPanel View provides built-in termination resistance when pin #9 (TRMRXB) is connected to pin #10 (RXA).
- DO NOT TERMINATE EVERY NODE. ONLY TERMINATE THE END NODES.
- Grounding** A signal return path between transmitting and receiving devices must be provided. This return path is separate from the Rx and Tx data lines and the other 422/485 signals supported by the QuickPanel View, and may be provided by a separate conductor in the cable. Connect both ends of the signal return conductor to Signal Ground (pin #7). Shielding or use of a twisted pair for this connection is not necessary.
- For installations where all devices are in the same cabinet and have the same ground potential between devices, connecting Signal Ground between all the devices on the 422/485 network is adequate to ensure proper voltage levels at the devices.
- However, if there is a difference in ground potential between devices, such as when the devices are in widely separated cabinets, then signal grounds on a 422/485 network should not be tied together. The cable shield and signal ground should be connected together at only one device, closest to the earth ground connection.
- The signal and frame grounds of the QuickPanel View are capacitively coupled, but in some devices these ground references are connected together. Connect Signal Ground (pin #7) to Frame Ground (pin #1) and then to earth ground on the QuickPanel View only in the circumstance where the other devices separate their signal and frame grounds and the QuickPanel View is the only device with frame and signal ground connected to earth ground.

Shielding

Shielded cable is required for compliance with CE Mark and FCC requirements. The cable shield should be connected to the metal connector shell or by pin 1 of the QuickPanel 25-pin serial connector. Shield and signal ground (pin 7 of the 25-pin connector or pin 5 of the 9-pin serial connector) should not be connected directly together.

Caution: Do not connect Signal Ground (pin #7) to Frame Ground (pin #1) on the QuickPanel View, except in the specific and limited circumstances noted in the Grounding section above.

Working with the COM port

To add a new remote networking connection

1. From the  **Start** menu, tap  **Settings** and then  **Network and Dial-up Connections**.

The **Connection** window appears.

2. Double-tap  **Make New Connection**.

The **Make New Connection** wizard appears.

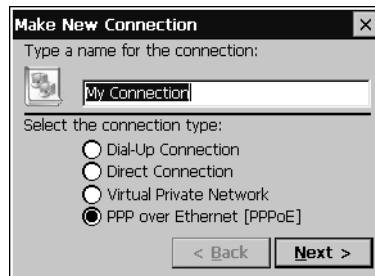

3. Type a name for the new connection.
4. Choose a connection type.
5. Tap **Next**.

The **Modem** or **Device** dialog box appears, depending on the connection type.

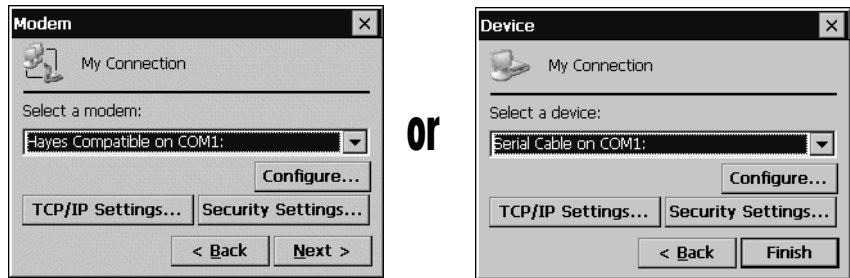



6. From the list, choose the device or modem you want to use. (If a Modem or Serial CF Card is inserted, it will be available in the device list.)

You can **Configure** your device or **TCP/IP Settings** at this time if you wish.

7. Tap **Finish** for direct connection (Device dialog box) or **Next** for dial-up (Modem dialog box).

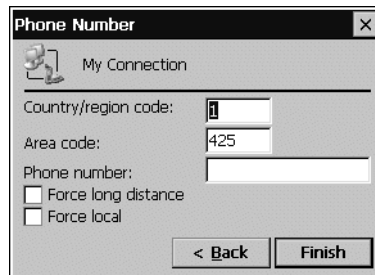



If you are adding a dial-up connection the following dialog box appears.



8. Type the destination **Country/region code**, **Area code**, and **Phone number** in the appropriate boxes.
9. Select or clear the **Force Long Distance** or **Force Local** check boxes.
10. Tap **Finish**.
11. Run the  **Backup** program to save settings through a power cycle (see page 12).

Caution: Do not cycle power immediately after running Backup.

To add a virtual private network or PPP over Ethernet connection

1. From the  **Start** menu, tap  **Settings** and then  **Network and Dial-up Connections**.
The **Connection** window appears.
2. Double-tap  **Make New Connection**.

Detailed Operation

Communication Port

The **Make New Connection** wizard appears.

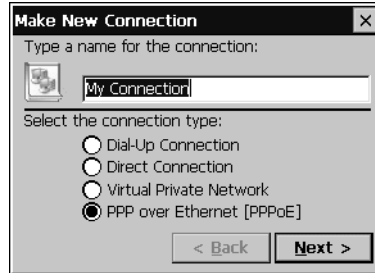

3. Type a name for the new connection.
4. Choose a connection type.
5. Tap **Next**.

The **VPN** or **PPPoE** Connection window appears, depending on the connection type.



or

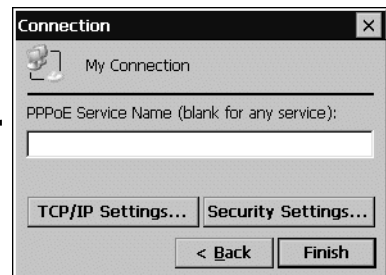

6. Enter the Host Name or IP address for a VPN connection, or a PPPoE Service Name for a PPPoE connection.

You can configure your **TCP/IP Settings** at this time if you wish.

7. Tap **Finish**.
8. Run the  **Backup** program to save settings through a power cycle (see page 12).

Caution: Do not cycle power immediately after running Backup.

To change the default device properties

1. From either the Device or Modem dialog box, tap **Configure**.

The **Device Properties** dialog box appears.

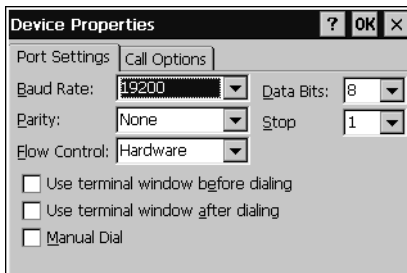

2. In the **Port Settings** tab, choose settings for all connection preferences.
3. If the connection is for terminal emulation, select or clear the terminal-related check boxes.

You can use the QuickPanel View to emulate a terminal attached via a modem link (Hayes compatible) to COM1. A terminal emulation definition is added as a unique session.

To change the default TCP/IP settings

1. Obtain correct TCP/IP settings from your network administrator.
2. From either the **Device, Modem, PPPoE Connection, or VPN Connection** dialog box, tap **TCP/IP Settings**.

The **TCP/IP Settings** dialog box appears.

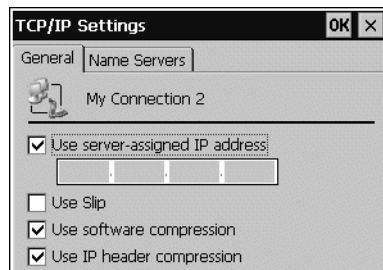

3. Clear the **Use server-assigned IP address** check box.
4. Enter the TCP/IP settings from your network administrator and then click **OK**.
5. Run the  **Backup** program to save settings through a power cycle (see page 12).

Caution: Do not cycle power immediately after running Backup.

CF PORT

To enhance the QuickPanel View's capabilities with additional flash memory, the unit is equipped with a CF (Compact Flash) Type II port on its side.

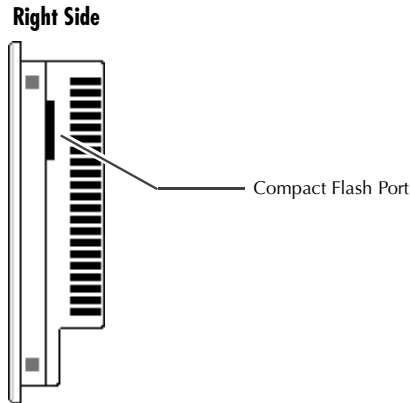

A CF card is inserted in this port with the card's front facing the back of the unit (the narrow side slot on the card should be toward the bottom). The card should slide in easily—to avoid damage, do not force it.

Note: For full protection from electrostatic discharge, peel off the paper label on the side of the CF card facing the bezel to allow contact between the card and the internal frame ground contacts on the CF connector.

The Copy Project to Flash Card utility (see page 15) lets you transfer Proficiency Machine Edition projects between QuickPanel View units via CF Cards.

No Compact Flash cards are supplied with the QuickPanel View. A list of cards (and other devices) that have been tested and are compatible can be found by visiting <http://globalcare.gefanuc.com>, then select the Operator Interface Product Category, then select the QuickPanel View Product Name.

The CF port in the QuickPanel View only supports 3.3v CF cards. 5v CF cards are not supported.

ETHERNET

The QuickPanel View is equipped with an autonegotiating, full or half duplex Ethernet port (IEEE802.3). You can connect an Ethernet network cable (unshielded, twisted pair, UTP CAT 5) to the unit via the RJ45 connector on the bottom of the enclosure. LED indicators on the port indicate channel status. Access to the port is possible either by Windows CE network communications, or by your custom application. The following diagram shows the location, orientation, and pin out of the Ethernet port.

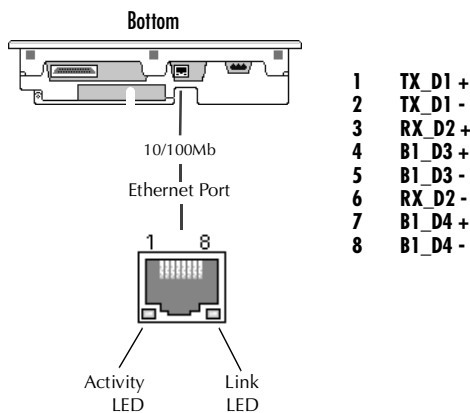

There are two methods for setting an IP address on the QuickPanel View:

- **DHCP (Dynamic Host Configuration Protocol).** This is the default method that is carried out automatically.

Note: There must be a DHCP server on the connected network for a valid IP address to be assigned. Contact your network administrator to ensure correct DHCP server configuration.

- **Manual method.** Using this method, you uniquely specify the numeric addresses for the QuickPanel View, the Subnet Mask, and the Default Gateway (if applicable).

Note: Use a crossover cable to connect the QuickPanel View to a PC directly; when connecting to a LAN HUB, use a straight through cable. Contact your network administrator if you require further information.

To set an IP address

1. From the Control Panel, tap  **Network and Dial-up Connections**.

The **Connection** window appears.

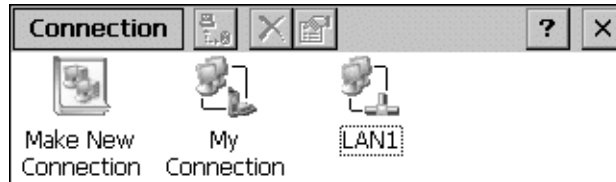

2. Select a  connection and choose  **Properties**.

The **Built-in Ethernet Port Settings** dialog box appears.

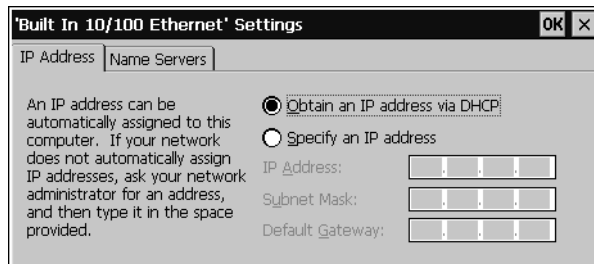

3. Select a method:
 - **Obtain an IP address via DHCP** (automatic).
 - **Specify an IP address** (manual).
4. Enter the **IP Address**, **Subnet Mask** and **Default Gateway** numbers obtained from your network administrator (manual method only).
5. Tap **OK**.
6. Run the  **Backup** program to retain the new settings through a power cycle (see page 12).

Caution: Do not cycle power immediately after running Backup.
7. **Restart the QuickPanel View.**

If the DHCP method was selected, the network server will assign an IP address while the QuickPanel View is initializing. (You must be connected to the network).

After setting an IP address for the QuickPanel View, you can access any network drives or shared resources for which you have permission.

To set up access to a Windows network

1. In the Control Panel, double-tap  **System**.

The **System Properties** dialog box appears.

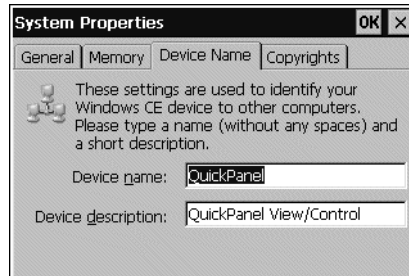

2. On the **Device Name** tab, in the **Device name** box, type a unique name for your QuickPanel View. In the **Device description** box, type a description.
3. Tap **OK**.
4. In the Control Panel, double-tap  **Owner**.

The **Owner Properties** dialog box appears.

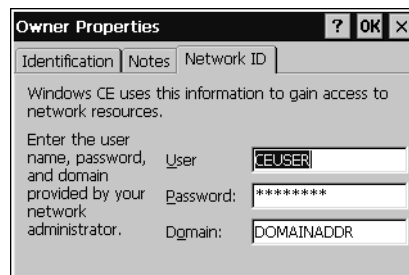

5. On the **Network ID** tab, type your assigned **User name**, **Password** and **Domain**.
6. Tap **OK**.
7. Run the  **Backup** program to retain the settings through a power cycle (see page 12).

Caution: Do not cycle power immediately after running Backup.

Using Windows CE Explorer, you can now access anything on your local network for which you have permission.

To access a remote resource on a Windows network

1. Start  **Windows Explorer**.

The **Explorer** window appears.

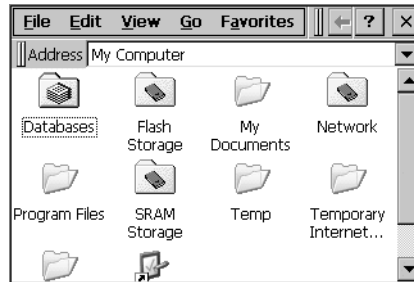

2. Type in the **Address** box, or choose from a list, the path to a remote resource.

For example '\\MyRemoteComputer\MyFolder' specifies the folder named 'MyFolder' on a computer with the name 'MyRemoteComputer'.

3. Press **ENTER**.

The resource specified is displayed as a collection of files and folders. It can take a few moments to retrieve the data from your local network.

Note: You can use the NET command from the shell to map a network resource to the QuickPanel View for frequent access. The resource then appears in the

 **Network** folder.

EXPANSION BUS

An expansion bus is included with the QuickPanel View, and optional modules that mount directly to it are available. For more information on expansion modules, contact your distributor.

The expansion bus connectors are accessed by opening the back of the unit.

Back (open)

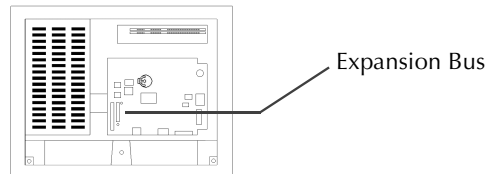

Note: To ensure compliance to CE Mark, the mounting screws must be used when installing an expansion card.

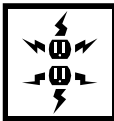

Caution: Disconnect the AC power from your 24 VDC power supply before opening the QuickPanel View. Working on a “live” unit may result in damage to equipment and injury to personnel. Always use anti-static precautions (i.e. grounded wrist strap) when accessing the interior of the unit.

Caution: Ensure all pins are properly aligned when inserting expansion cards. Misalignment could cause damage to the QuickPanel View and/or the expansion card.

DIP SWITCHES

The QuickPanel View is equipped with four DIP switches that each control separate functions.

DIP switches are set to “OFF” by default in the factory. DIP switch 2 is the Force Startup switch. Turning this switch on forces the startup applications to run when the operating system is started.

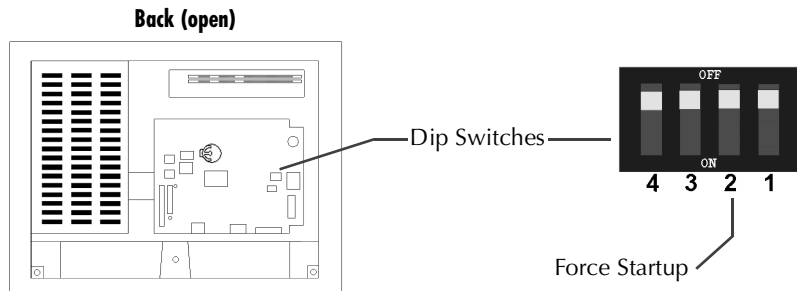

When the switch is set to “OFF”, the QuickPanel View operates normally, displaying the startup splash screen. You can skip running the startup applications by tapping the “Don’t run StartUp Programs” button on the startup splash screen.



When the switch is set to “ON”, the startup programs are forced to run and the “Don’t run Startup Programs” button is not available on the startup splash screen.

Note: Do not adjust switches other than switch 2. They are reserved for factory functions. Also note that the “Off” position of the switches is toward the DIMM connector, “On” toward the COM1 connector.

To configure startup behavior



Caution: Disconnect the AC power from your 24VDC power supply before opening the QuickPanel View. Working on a “live” unit may result in damage to equipment and injury to personnel. Always use anti-static precautions (i.e. grounded wrist strap) when accessing the interior of the unit.

1. Open the back cover of the QuickPanel View.
2. Locate the DIP switches and set DIP switch 2 to “ON”.

The startup applications are now forced.



Note: Do not adjust the other switches. They are reserved for factory functions.

MEMORY

The QuickPanel View supports a variety of memory subsystems to ensure the requirements of your application are met. All system memory is tied directly to the microprocessor's address and data busses for fastest access. To increase DRAM by up to 64 MB, a 100-pin DIMM memory expansion slot is also included.

Flash Memory

This block of non-volatile memory (32 MB) is the main long-term program storage for the QuickPanel View, operating like a virtual hard drive from the point of view of Windows CE. It is divided into two areas, of which only one is accessible from Windows CE Explorer. The  **Flash Storage** folder represents a 16 MB block of memory for long-term storage of user application programs. Another 16MB block is used to store the Windows CE operating system, and is not directly accessible from Windows CE Explorer.

The operating system and all user application programs are transferred from Flash to DRAM for execution. Any user additions to the  **Windows** folder are retained in  **Flash Storage** when the  **Backup** utility is run.

FLASH memory has a limited write-cycle lifetime. That is, the physical memory devices wear out after approximately 100,000 cycles (minimum), so it is advisable to limit file operations such as copy, delete, etc.

The write cycle is much slower for FLASH than it is for other portions of RAM, therefore FLASH is not recommended for the storage of program variables, or any data items whose values are dynamic.

Flash memory can optionally be added with a CF Card, which will appear as the  **PCFlash Storage** folder.

To add Flash memory with a CF Card

- Insert a Compact Flash card into CF Port (see page 34).

The unit immediately reads the new secondary storage. If the disk requires formatting, you will be prompted to do so.

New memory appears in Windows CE Explorer as  **PCFlash Storage**.

External flash memory devices are named after their types of connection and order of attachment. For example, if you connect two flash memory devices, one via the CF port and one via the fieldbus connector, the first device is named *PCFlash*

Storage, the second *PCFlash Storage2*. At powerup, a CF port device is recognized first. Otherwise, naming depends on connection order.

SRAM Memory

This 512 KB block of static RAM is battery-backed to provide data retention through a power cycle. The SRAM memory is made available for user applications by operating as a virtual hard drive and is accessible from the Windows CE Explorer, represented as the  **SRAM Storage** folder. A typical application program would create a file in this folder and store any critical program data in that file.

DRAM Memory

The QuickPanel View is equipped with 32 MB of dynamic RAM. Part of the DRAM (11 MB) is reserved for the Windows CE operating system and is not accessible by user applications. The other 21 MB is split between two functions: an object store for temporary file storage, and the main memory for running programs.

Typically, compressed programs stored in FLASH are expanded and moved to DRAM for execution. Temporary storage of program variables or data files is also provided by DRAM—any data stored in DRAM will not be retained through a power cycle or reboot.

The split between program memory and storage memory may be adjusted as necessary to make more room for one or the other, depending on your specific application needs. For example, if you find that an application is short of memory, use the System Properties dialog box to alter DRAM memory allocation.

Caution: Setting Program Memory too low may prevent additional applications from starting, or may cause currently running applications to fail due to lack of memory. Setting Storage Memory too low may prevent the saving of files into the object store portion of the file system, which may also cause application failures.

To change the DRAM memory allocation

1. In the Control Panel, double-tap  **System**.

Detailed Operation

Memory

The **System Properties** dialog box appears.

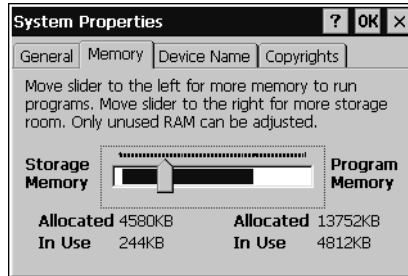

2. On the **Memory** tab, drag the slider to divide the DRAM into Storage and Program memory.

The amount of memory allocated to and used by each area is displayed numerically. The blue bar indicates the current amount of unallocated DRAM and determines the boundaries within which the slider can move.

3. Tap **OK** to apply the new setting.
4. Run the  **Backup** program to retain the new setting through a power cycle (see page 12).

Caution: Do not cycle power immediately after running Backup.

Boot Loader ROM

The Boot Loader ROM provides 512 KB of non-volatile storage for the QuickPanel View's initialization program. This program configures the QuickPanel View hardware then starts the operating system's execution. This memory is not accessible from Windows CE Explorer, nor should any attempts be made to modify the contents of this ROM.

Memory Expansion Slot

The QuickPanel View is equipped with a 100-pin DIMM memory expansion slot which lets you increase DRAM to a total of 96 MB.

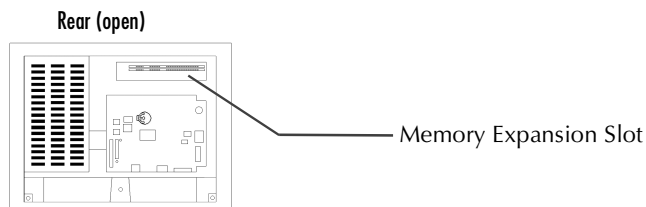



Caution: Disconnect the AC power from your 24VDC power supply before opening the QuickPanel View. Working on a “live” unit may result in damage to equipment and injury to personnel. Always use anti-static precautions when accessing the interior of the QuickPanel View.

To install additional DRAM

1. Disconnect AC power from the 24VDC supply.
2. With a small screwdriver carefully remove the top rear access cover.
3. Insert the new DIMM carefully into the expansion slot, noting the orientation of the pin locators. When the DIMM is fully seated, lift each side clip until it clicks into place.
4. Snap the access cover back into place.

OTHER SUBSYSTEMS

Power Management

The QuickPanel View's Power Properties control panel displays the status of the backup battery. The  Battery Very Low Or Missing icon displays in the taskbar when the battery is either missing or very low.

To access the Power Properties control panel

1. In the Control Panel, double-tap  Power.

The Power Properties dialog box appears.



Battery Backup

Auxiliary backup power for the real-time clock and SRAM is provided by a **non-rechargeable**, internal lithium battery (+3VDC, BR2032), ensuring that no loss of data occurs when the main 24VDC supply is removed. Backup power is enabled or disabled by installing or removing the battery, accessed via the rear panel as shown in the following illustration.

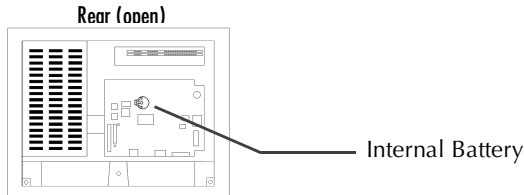

Caution: Disconnect the AC power from your 24VDC power supply before opening the QuickPanel View. Working on a “live” unit may result in damage to equipment and injury to personnel. Always use anti-static precautions when accessing the interior of the QuickPanel View.

To remove the internal battery

1. Disconnect AC power from the 24VDC supply.
2. Open the rear access panel.
3. Release the battery by *gently* lifting it from the completely exposed side, past the small protrusions. To avoid breaking the battery retainer clips, do not apply excessive upward pressure.
4. Slide the battery out of its carrier, noting the arrow on the carrier indicating the direction of removal.

Real-time Clock

The QuickPanel View has a programmable real-time clock capable of reporting the current time in Year/Month/Day/Hour/Minute/Second. The time is set from the Windows CE interface and retained through a power cycle if battery backup is available. Automatic adjustment for daylight savings time is enabled by a check box within the dialog box. The time can be displayed in the system tray on the task bar.

To set the real-time clock

1. In the  Control Panel, double-tap  **Date/Time**.

The **Date/Time Properties** dialog box appears.



Note: Tap Apply after making changes in any box.

2. Tap the year to choose a new year; tap the month to choose a new month.
3. Tap a date to specify the day of month.
4. From the **Time Zone** box, choose your zone.
5. Select **Auto Adjust DST** to have the clock automatically compensate for daylight savings time.
6. In the **Current Time** box, adjust the hours, minutes and seconds.
7. Tap **OK** to finish.
8. Run the  **Backup** program to save Time Zone or Daylight Savings changes through a power cycle (see page 12).

Caution: Do not cycle power immediately after running Backup.

To display the time on the taskbar

1. From the  **Start** menu, choose  **Settings** and then  **Taskbar and Start Menu Properties**.

The **Taskbar Properties** dialog box appears.

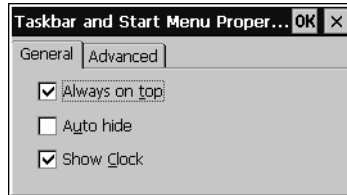

2. On the **Taskbar Options** tab, select **Show Clock**.
3. Tap **OK**.

An hours and minutes display now appears in the taskbar.

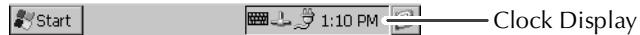

A1

Design Specifications

The specifications listed in this appendix are the design goals for the QuickPanel View. In most cases the “as built” or tested specifications are identical. See page 53 for a list of agency approvals for environmental service and safety.

Physical

Enclosure dimensions (actual - see page 4 for panel cutout specifications)	Height: 8.93 in (226.8 mm) Width: 11.85 in (301.1 mm) Depth: 2.37 in (60.1 mm)
Bezel dimensions	Height: 10.34 in (262.6 mm) Width: 13.26 in. (336.8mm) Depth: 0.38 in (9.7 mm)
Weight	2.5lb (1.16 kg)

DC Power

Input Voltage	12 VDC (@ +/- 20% regulated power supply); 24 VDC (@ +/- 20% regulated power supply)
Power Dip Tolerance	-30% nominal input voltage, 10msec.
Insulation Resistance	268Mohm @ 1000V frame ground to 0v 366Mohm @ 1000V frame ground to 24v
Real Power	12" models - 36W 10" models - 24W
Power Supply Conductor Size	12 to 18 AWG For compliance to CE Mark, the isolated frame ground must be connected. Recommended frame ground connection is via the shortest possible route, using 14 AWG.
Connector (Vendor, p/n)	Phoenix Contact, 1777992

Display

	10"	12"
Size	10.4" (26.4 cm)	12.1" (30.5 cm)
Colors	256 shades of gray	32,768 (15 bits/pixel, color model) 256 shades of gray (monochrome model)
Luminence	200 NITS	250 NITS
Resolution	640 X 480	800 X 600
Fabrication	Passive	TFT
Backlight	Cold Cathode Fluorescent (CCFL) - rated half life: 20,000 hours ¹	Cold Cathode Fluorescent (CCFL) - rated half life: 50,000 hours ¹

Front Panel

Bezel Material	Valox 357U ²
Membrane Material	Lexan HP60 ³
LEDs	Bottom Top
	Power status indicator (green with power applied, flashes amber if both backlights fail) Programmable tri-color (green, red, amber)

Touch Screen

	Mono	Color
Type	Resistive, 12 bit	Resistive, 12 bit
Resolution	X axis- 640 cells Y axis - 480 cells (after calibration)	X axis- 800 cells Y axis - 600 cells (after calibration)

CPU

Processor	Intel XScale PXA255
Clock speed	300 Mhz

¹ Backlight not field replaceable.

² For material specifications, visit www.gepolymerland.com

³ For material specifications, visit gestructuredproducts.com

Memory

FLASH	32 MB
SRAM	512KB (power off retention is the life of the battery)
DRAM	32 MB
ROM	512 KB (Boot loader)

Memory Expansion Slot

Form Factor	100 pin DIMM
Memory Type	SDRAM
Maximum DRAM	64 MB
Maximum Devices/Module	4
Bus Width	32 bits
Bus Speed	100 MHz or faster
Voltage	3.3 VDC
CAS Latency	CL=3
Refresh Cycle Time	64 ms maximum
Error Correction	Non-ECC
Error Detection	No parity
Buffering	None
Device Row Addressing	12 Address Lines (A0 to A11)
Expansion Memory Catalog Number	32MB - IC754ACC32MEM 64MB - IC754ACC64MEM

Expansion Ports

Compact Flash Memory	One slot (Type II), 3.3v only
Expansion Bus	One slot

Communication Ports

Ethernet	IEEE 802.3 10/100BaseT (LAN1) Auto-negotiate Full or half duplex RJ45 connector Two status LEDs
Serial COM1	EIA232C/EIA485, DP25S (female)
Speed	300 bps - 115200 bps
Mounting h/w	M2.6 jackscrew
Fuse	1.0A, 125V fast blow cartridge type, Littlefuse part #154001

Environmental

Operating Temperature	32°F to 122°F (0°C to 50°C)
Operating Humidity	10% to 85% RH, non-condensing (12") 10% to 85% RH, non-condensing (10")
Storage Temperature	-4 to 158°F -20 to 70 °C
Storage Humidity	10% to 85% RH, non-condensing at < 50°C; max. 50% at > 50°C
NEMA Rating	4, 4x, and 12 when mounted in a comparably rated NEMA panel (NEMA 4 is approximately equivalent to IP56; visit www.nema.org)
Operational Vibration	IEC 68-2-6 10 - 57Hz, 0.012" peak to peak displacement 57 - 500Hz, 1.0g acceleration
Operational Shock	IEC 68-2-27 15g, 11ms (sine wave)

Battery

Type	BR2032 (3V, 190mAh, lithium)
Life (Approximate)	5 years

Calendar/Clock

Resolution	1 second
Retention	Life of battery
Accuracy	+/- 2 or 3 minutes/month

Agency Qualifications

Model # ES1221 (color, 12")

Model # ES1201 (monochrome, 12")

Model # ES1001 (monochrome, 10")

Description	Agency Standard or Marking	Comments
North American Safety for Industrial Control Equipment	UL 508/C-UL	Certification by Underwriter's Laboratories to UL standard and equivalent CSA standard
North American Safety for Hazardous Locations Class I, Div. 2, Groups A, B, C, D	UL 1604/C-UL	Certification by Underwriter's Laboratories to UL standard and equivalent CSA standard
Explosive Atmospheres Directive European Safety for Hazardous Locations Equipment Group II, Category 3	ATEX (when mounted in an IP66-rated panel)	Certification in accordance with European directives; refer to Declaration of Conformity and Independent 3 rd Party Assessment Certificate
Low Voltage Directive European Safety for Industrial Control Equipment	CE	Self-declaration in accordance with European directives; refer to Declaration of Conformity
Electromagnetic Compatibility Directive European EMC for Industrial Control Equipment	CE	Certification by competent body in accordance with European directives; refer to Declaration of Conformity

A2

Troubleshooting

The tables contained in this appendix can be used to identify and remedy problems that can occur with the 10" and 12" QuickPanel View.

Power up

Problem	Suggested remedy
Blank screen.	No power: Check all power connections to the QuickPanel CE. Backlight failed: This is further indicated when the bottom LED glows amber. The LED will only light if both top and bottom backlights have failed. Backlight timer expired: Touch screen to reactivate.

Pocket Internet Explorer

Problem	Suggested remedy
Cannot access any URLs when using a dial-up connection to an ISP.	If you have previously set up an IP address on a local Ethernet Network, it must be cleared. Disconnect your Ethernet cable and reboot. Your ISP will reassign an IP address when you reconnect the cable.

Index

A

- accessing
 - Windows network 37, 38
- adding
 - connections 30, 32
- addresses
 - IP 36
- adjusting
 - display brightness 21

B

- backlight
 - (note) 8, 51
 - set for auto turn off 22
- backup 12
- battery 46
 - specifications 52
 - status 46
- baud rate 33
- bezel 50
- block diagram 9
- boot loader ROM 44
- brightness 21

C

- cabling, COM1 28
 - connections 29
 - grounding 29
 - interconnect media 29
 - shielding 30
 - termination 29
- calibrating
 - touch screen 23
- clock 47
- COM1 28
- communication port 28, 52
 - location 8

compact flash

- adding memory 42
- configuring
 - set IP address 36
 - TCP/IP settings 33
- connections
 - adding 30, 32
 - set IP address 36
 - TCP/IP settings 33
 - Windows network 37
- cutout 4
 - see also design specifications

D

- design specifications 49
- device properties, configuring 32
- DHCP (Dynamic Host Configuration Protocol) 35
- dial-up connection 30
- dip switches 40
- displaying
 - real-time clock 48
- double-tap sensitivity
 - setting 23, 24
- DRAM 43
 - partition DRAM memory 43
 - partitioning 43

E

- Emulate PPC 15
- Ethernet 35
 - port settings 36
- expansion bus 39
- expansion busses
 - locations 8
- expansion ports 51
- Explorer, Internet 11

F

- flash 42
- flow control 33
- front panel 8, 50
 - bezel 50
 - LEDs 8, 50
 - membrane 50

I

- input panel
 - displaying 26, 27
- Internet Explorer 11
- IP address
 - setting 36

K

- keyboard shortcuts 27

L

- LEDs
 - Ethernet 35, 52
 - front panel 8, 50

M

- membrane 50
- memory 42, 51
 - adding with CF card 42
 - boot loader ROM 44
 - DRAM 43
 - flash 42
 - partition DRAM memory 43
 - SRAM 43
- memory expansion slot 44
- modem configuration 30
- mounting
 - dimensions 4

hardware 5
mounting directions 5
mounting brackets 5

P

panel cutout 4
 see also design specifications
parity 33
partitioning
 DRAM 43
physical layout 8
Pocket Internet Explorer 11
port
 communication 52
ports
 communication 28
 Ethernet 35
 expansion 51
 locations 8
 serial 28
power management 46
 control panel 46
power supply 2
power supply terminals
 location 8
PPPoE 31
product support 6

programs
 start menu 10
proxy server 11

R

real-time clock 47
 displaying 48
 setting 47

S

serial ports 28
setting
 double-tap sensitivity 24
 sensitivity 23
 IP address 36
 real-time clock 47
setup
 basic 2
 runtime 3
shutdown 4
specifications 49
SRAM 43
start menu 10
startup 3
 configuring behavior 41
 force startup switch 40
 stop startup programs 40

storage card 42, 43
storage manager 14
support 6
switches, dip 40
System Information 14

T

technical support 6
terminal emulation 33
touch screen 23
 calibrating 23
troubleshooting 55

U

utilities
 backup 12
 System Information 14

V

virtual private network 32

W

Windows CE 10
Windows network
 accessing 37, 38