

## A/C Disconnect Technical Data

MODEL NUMBER	REPLACEMENT PARTS			CABINET SIZE	ENCLOSURE STYLE	CABINET DIMENSIONS				KO DETAIL page 42
	COMPLETE BLOCK & PULLER	FUSE BLOCK ONLY	PULLER ONLY			HEIGHT A	WIDTH B	DEPTH C	DEPTH D	
P035F	FR39	—	FR352	6 X 8	FIG. C	8"	5-3/4"	3-1/8"	—	FIG. 1
P065F	FR69	—	FH682	6 X 8	FIG. C	8"	5-3/4"	3-1/8"	—	FIG. 1
P065NA1	—	—	—	5 X 7	FIG. F	7-1/4"	5"	2-1/8"	2-3/4"	FIG. 2
P065P	—	NF65	NF652	6 X 8	FIG. F	8"	6"	5-3/4"	2-3/4"	FIG. 2
P065P1	—	NF65	NF652	5 X 7	FIG. F	7"	5"	2-1/8"	2-3/4"	FIG. 2
U035F010	FR39	—	FR352	6 X 9	FIG. B	9-1/8"	7-1/4"	5-3/16"	—	FIG. 3
U035F2	FR35R	—	FR352R	5 X 7	FIG. A	7"	5"	2-1/8"	2-3/4"	FIG. 2
U0353F/010	265A6035G27	—	265A6035G28	6 X 14	FIG. B	14-3/8"	7-1/4"	5-3/16"	—	FIG. 3
U045F	FR35XFR67	—	FR352 FH682	9 X 17	FIG. B	17-3/8"	9-3/4"	5-3/16"	—	FIG. 4
U0653F/010	265A6036G69	—	265A6036G71	6 X 14	FIG. B	14-3/8"	7-1/4"	5-3/16"	—	FIG. 3
U0653P	265A6036G73	—	265A6036G72	6 X 14	FIG. B	14-3/8"	7-1/4"	5-3/16"	—	FIG. 3
U065F010	FR65	—	FH682	6 X 9	*	9-1/8"	7-1/4"	5-3/16"	*	*
U065F1	FR65	—	FH682	5 X 9	FIG. A	9"	5"	2-1/8"	2-3/4"	FIG. 2
U065NA1	—	—	—	5 X 7	FIG. F	7"	5"	2-1/8"	2-3/4"	FIG. 2
U065NA1010	—	—	—	5 X 7	FIG. F	7"	5"	2-1/8"	2-3/4"	*
U065NA2	—	—	—	7 X 10	FIG. E	10"	7-1/2"	4"	—	FIG. 5
U065P	—	NF65	NF652	5 X 7	FIG. A	7-1/4"	5"	2-1/8"	2-3/4"	FIG. 2
U065P010	—	NF65	NF652	5 X 7	FIG. F	7"	5"	2-1/8"	2-3/4"	FIG. 2
U065PC2	—	NF65	NF652	5 X 7	FIG. F	7"	5"	2-1/8"	2-3/4"	FIG. 2
U065PD	—	NF65	—	7 X 10	FIG. E	10"	7-1/2"	4"	—	FIG. 5
U0653P010	—	—	—	6 X 14	FIG. B	14-3/8"	7-1/4"	5-3/16"	—	FIG. 3
U220H	—	FH1	—	5 X 7	FIG. B	7-1/8"	5-3/4"	5-3/16"	—	FIG. 5
U261F	—	FH1	—	6 X 9	FIG. B	9-1/8"	7-1/4"	5-3/16"	—	FIG. 3
U610F	FR67X2	—	FH682	9 X 17	FIG. B	17-3/8"	9-3/4"	5-3/16"	—	FIG. 4

AC Disconnects

\* Consult Manufacturer.

## A/C Cabinet Dimensions

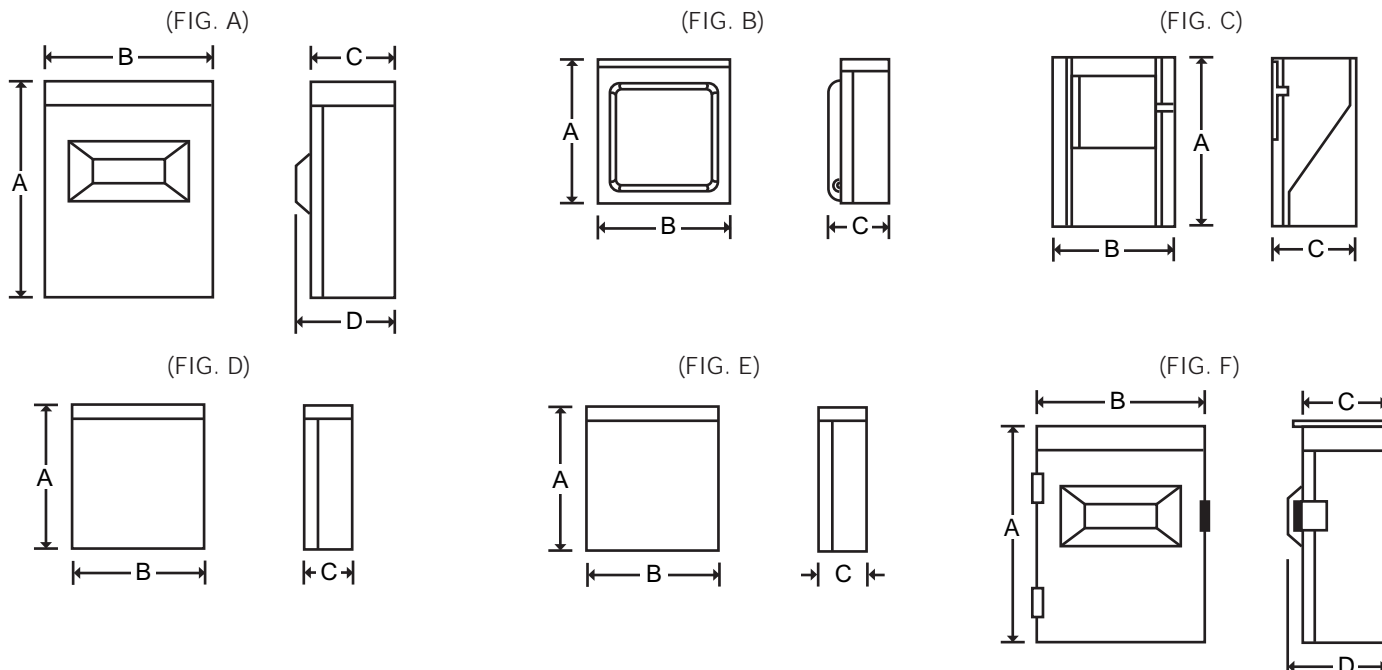

## Knockout Configurations

AC Disconnects

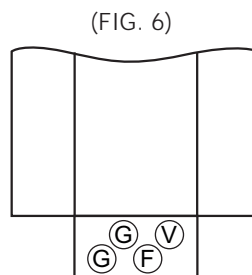
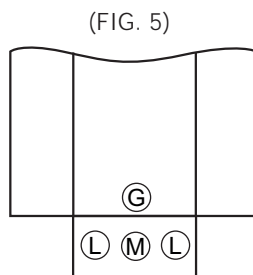
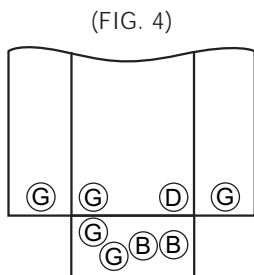
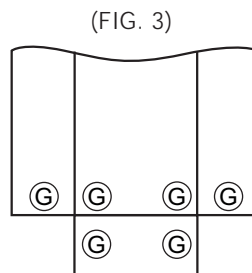
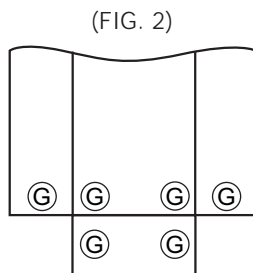
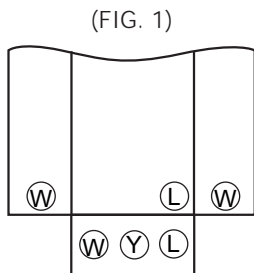

- B= 1", 1-1/4", 1-1/2"
- D= 3/4", 1", 1-1/4"
- F= 1/2"
- G= 1/2", 3/4", 1"
- L= 1/2", 3/4"
- M= 1/2", 3/4", 1", 1-1/4"
- N= 1/2", 3/4", 1", 1-1/4", 1-1/2"
- V= 3/4", 1", 1-1/4", 1-1/2"
- W= 3/4", 1"
- Y= 1", 1-1/4"

## A/C Wire Range Tables

**TABLE D**

Connector	Copper		Aluminum	
	Solid	Strand	Solid	Strand
Line	14-8	14-3	12-8	12-3
Load	14-8	14-3	12-8	12-3
Neutral	----	----	----	----
Equip. Grnd.	12-8	12-2	12-8	12-2

**TABLE Y**

Connector	Copper		Aluminum	
	Solid	Strand	Solid	Strand
Line	14-8	14-1/0	12-8	12-1/0
Load	14-8	14-2	12-10	12-2
Neutral	14-8	14-1/0	12-8	12-1/0

**TABLE E**

Connector	Copper		Aluminum	
	Solid	Strand	Solid	Strand
Line	14-10	14-10	----	----
Load	14-10	14-10	----	----
Neutral	14-10	14-10	----	----
Equip. Grnd.	12-8	12-2		

**TABLE AR**

Connector	Copper		Aluminum	
	Solid	Strand	Solid	Strand
Line	14-10	14-10	----	----
Load	14-10	14-10	----	----
Neutral	----	----	----	----
Equip. Grnd.	12-8	12-2	----	----