



style to live by™



KICHLER.

WELCOME

In so many ways, your home is your voice. It can speak softly or make a bold impression. It can invite friends in for an intimate gathering or welcome the party with a flourish.

Who you are is reflected in every part of your space. At Kichler, we help you bring your story to light. We offer an unparalleled variety of stylish collections, each designed with a unique personality brought to life through inspiring finishes, fresh details and unequalled quality. Simply select a style, and you'll find everything you need to adorn your home: chandeliers, mini chandeliers, wall sconces, ceiling fixtures and more. It's lighting that energizes, as well as enhances, your home. And, it's lighting that tells the world who you are without saying a word.

Style to live by™





TABLE OF CONTENTS

- 4** Contents by Collection Name
- 6** Inspiration Gallery
- 14** Visual Index
- 34** Casual Transitions
- 164** Today's Living
- 232** Clearly Crystal
- 264** New Traditions
- 368** Pendants & Mini Pendants
- 404** Ceiling Lights & Sconces
- 448** Mirrors
- 466** Bath & Vanity
- 572** Outdoor Lanterns
- 718** Accessories
- 724** Index
- 734** Legend



Become a fan of Kichler Lighting at:
[facebook.com](https://www.facebook.com/kichlerlighting), search Kichler Lighting



Follow us on twitter at:
twitter.com/kichlerlight



Find us on Pinterest at:
<http://pinterest.com/kichlerstyle/>



Join us on Houzz at:
<http://www.houzz.com/pro/kichlerlighting/kichler>



Watch us on
[youtube.com/KichlerLighting](https://www.youtube.com/KichlerLighting)



TABLE OF CONTENTS BY COLLECTION NAME

34 CHANDELIER COLLECTIONS

Alameda™ 146-147	Evan™ 54-55	Norwich™ 333
Aliso™ 234-235	Feville™ 318-319	Olsay™ 172-175
Aleeka™ 186-187	Freeport™ 200-201	Olympia™ 122-133
Ansonia™ 114-115	Gracie™ 240-241	Organique™ 66-67
Ara™ 219	Granby™ 98-101	Parker Point™ 252-255
Arbon™ 192-193	Grand Bank™ 36-39	Portsmouth™ 345
Archibald™ 74-75	Hayman Bay™ 46-49	Ravenna™ 292-295
Armida™ 116-119	Hendrik™ 104-109	Reynes™ 230
Arvella™ 112-113	Jardine™ 248-251	Rigate™ 194-195
Barcelona™ 332	Jules™ 242-243	Rizzo™ 238-239
Basel™ 282-283	Kailey™ 150-152	Roswell™ 180-185
Bayberry™ 89	Kambry™ 308-311	Ryegate™ 330-331
Berkley™ 211	Kayde 58	Saldana™ 84-87
Berra™ 40-41	Kearn™ 50-53	Sarabella™ 290-291
Blythe™ 60-61	Kensington™ 306-307	Savina™ 166-167
Braelyn™ 70-72	Khione™ 213	Shasteen™ 145
Brinley™ 73	Krasi™ 62-63	Shindy™ 64-65
Brooklands™ 188-190	Lacey™ 153-159	Sonora™ 144
Bryce™ 110	Ladero™ 136-137	Spyro™ 161
Camerena™ 320-325	Langford™ 364-365	Stafford™ 356-359
Carlisle™ 88	Lara™ 270-276	Stella™ 214-217
Caterham™ 148-149	Larissa™ 296-301	Structures™ 206-210
Caywood™ 80-81	Larkin™ 326-329	Suspension™ 96-97
Celestial™ 82-83	Leanora™ 236-237	Tacoma™ 143
Circolo™ 220-223	Leeds™ 90-95	Tanglewood™ 354-355
City Lights™ 168-171	Leighton™ 162-163	Tara™ 244-247
Clarice™ 344	Loom™ 56-57	Tariton™ 142
Cloudburst™ 218	Louisa™ 160	Telford™ 366-367
Colerne™ 138-139	Lucien™ 78-79	Tremba™ 176-179
Confetti™ 212	Lytham™ 204-205	Triad™ 196-199
Crescent View™ 202-203	Malina™ 266-269	Twigs™ 68-69
Crystal Ball™ 140	Marcele™ 278-279	Wedgeport™ 342-343
Crystal Persuasion™ 256-259	Marchesa™ 284-285	Wellington Square™ 334-335
Crystal Skye™ 260-263	Marisa™ 76-77	Wharton™ 350-351
Dayzie™ 144	Mihaela™ 59	Whitley™ 141
Denman™ 134-135	Mithras™ 286-289	Willowmore™ 336-341
Donington™ 280-281	Modena™ 231	Wilton™ 302-305
Dover™ 360-362	Modern Mosaic™ 230	Wynberg™ 363
Dunsmuir™ 277	Monroe™ 312-317	
Durham™ 346-349	Morton™ 111	
Eileen™ 224-229	Moxie™ 42-45	
Elias™ 102-103	Neillo™ 120-121	
Escala™ 191	Nicholson™ 352-353	

368

MINI PENDANTS 370

PENDANTS 382

RAIL LIGHTS 406

CEILING LIGHTS 410

WALL SCONCES 432

MIRRORS 448

Art Glass Ceiling 413
 Ceiling 410-412, 416, 418-420, 422-424
 Custom Lighting 446-447
 Directional Rail Lights 408-409
 Energy Efficient Ceiling 417, 421, 425-430
 Energy Efficient Sconces 438-445
 LED Ceiling 414-415
 LED Directional Rail Lights 406-407
 LED Wall Sconces 432-435
 Mirrors 448-465
 Wall Sconces 436-437



466 BATH & VANITY

- Adao™ 528
- Allegre™ 490
- Ansonia™ 522
- Armida™ 519-521
- Arvella™ 482-483
- Ashbrook™ 507
- Ayana™ 516
- Bath 523
- Bath Energy Efficient 529
- Bath & Vanity 566-569
- Bazely™ 474
- Bellamy™ 526-527
- Brinbourne™ 501
- Broadview™ 564-565
- Calleigh™ 524-525
- Camerena™ 548-549
- Claro™ 510
- Como™ 468
- Cottage Grove™ 543
- Crescent View™ 472
- Currituck™ 530-531
- Cylinders™ 487
- Dover™ 557
- Drapes™ 506
- Durham™ 546-547
- Eileen™ 513-515
- Energy Efficient 570-571
- Feville™ 553
- Freeport™ 473
- Granby™ 498-499
- Hendrik™ 476-479
- Jardine™ 539
- Jevis™ 491
- Kailey™ 493
- Kambry™ 540
- Kympton™ 492
- Lacey™ 536-537
- Langford™ 502-503
- Larissa™ 541
- Legé™ 486
- Metro Park™ 475
- Monroe™ 550-552
- Nicholson™ 562-563
- Nobu™ Energy Efficient 497
- O'Hara™ 518
- Pavilion™ Energy Efficient 496
- Pocelona™ 538
- Punctuation™ 512
- Quincy™ 534-535
- Revere™ 511
- Rigate™ 481
- Rousseau™ 509
- Santiago™ Energy Efficient 494-495
- Selene™ 469
- Sheila™ 532-533
- Souldern™ 500
- Stafford™ 558
- Structures™ 488-489
- Suspension™ 480
- Tanglewood™ 559
- Telford™ 561
- Telford™ Energy Efficient 560
- Tubes™ 484-485
- Tulare™ 508
- Tully™ 470
- Uptown™ 505
- Urban Ice™ 471
- Wall Sconces Energy Efficient 517
- Washington Square™ 554-555
- Wedgeport™ 556
- Wharton™ 504
- Willowmore™ 544-545
- Wilton™ 542

572 OUTDOOR

- Alameda™ 642
- Antico™ 627
- Ascari™ 606-607
- Atwood™ 647
- Barrie™ 702
- Bay Shore™ 691
- Beach Light™ 710
- Belmez™ 610
- Bowen™ 608-609
- Camden™ Energy Efficient 618-619
- Cameron™ 648
- Caterham™ 632
- Celino™ 602
- Cesya™ LED 578
- Chesapeake™ 706
- Chicago™ 640
- Concord™ 588
- Courtyard™ 672-675
- Courtyard™ Energy Efficient 676
- Cross Creek™ 644
- Dark Sky Accessories 717
- Eau Claire™ 684
- Embassy Row™ 698
- Franceasi™ 650
- Franceasi™ LED 581
- Grove Mill™ 690
- Hanford™ 586
- Hatteras Bay™ 585
- Hatteras Bay™ LED 583
- Kirkwood™ 700-701
- Lakeway™ 677
- Lantana™ Energy Efficient 620-621
- LED 711
- Leeds™ 612
- Lindstrom™ 591
- Luverne™ 670
- Luverne™ Energy Efficient 671
- Lyndon™ 587
- Madison™ 705
- Madison™ Energy Efficient 704
- Manningham™ 628
- Maya Palm™ LED 580
- McAdams™ 678
- Melbern™ 646
- Morris™ 638
- Mount Veronon™ 692-695
- Mount Vernon™ Energy Efficient 696
- Mount Vernon™ LED 582
- New Street™ 713
- Newport™ 602
- Nob Hill™ 656
- Northcreek™ 636
- Outdoor 714-715
- Outdoor Energy Efficient 584, 716
- Pacific Edge™ 598-601
- Portman Square™ 614-617
- Post/Pedestal Mount Accessories 718-719
- Ralston™ 686
- Randolph™ Energy Efficient 697
- Ripley™ 593
- Rivera™ 594-597
- Riverbank™ 637
- Rochdale™ 652
- Rustic™ 589
- Salisbury™ 680-683
- Sausalito™ 685
- Savannah Estates™ 689
- Seaside™ 592
- Sedo™ LED 576
- Sorel™ 623
- Sorel™ LED 575
- Soria™ 634
- South Hope™ 590
- Stonebrook™ 624
- Takil™ LED 580
- Tournaï™ 658-663
- Tremillo™ Energy Efficient 604-605
- Townhouse™ 708
- Trafari™ 626
- Tremillo™ 604
- Trenton™ 688
- Venetian Rain™ 664-667
- Vitalino™ 625
- Warrington™ 712
- Wiscombe Park™ 668
- Woodland Lake™ 630
- Zolder™ 603

718 Accessories

724 Index

734 Legend

CASUAL
TRANSITIONS

34



MOXIE™ | Pg 42

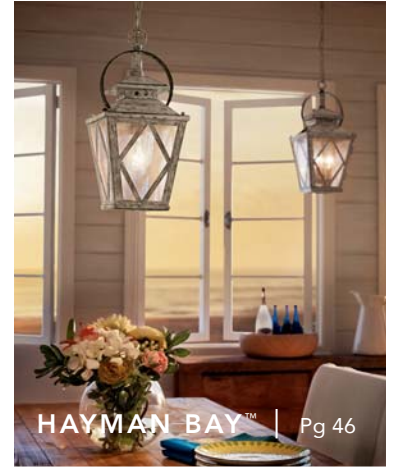

HAYMAN BAY™ | Pg 46



EVAN™ | Pg 54



KRASI™ | Pg 62



ORGANIQUE™ | Pg 66



TWIGS | Pg 68



BRAELYN™ | Pg 70



ARCHIBALD™ | Pg 74



TODAY'S
LIVING

164



SAVINA™ | Pg 166



CITY LIGHTS™ | Pg 168



ROSWELL™ | Pg 180



TRIAD | Pg 196



RIGATE™ | Pg 194

CLEARLY
CRYSTAL

232



JULES™ | Pg 242



PARKER POINT™ | Pg 252



CRYSTAL PERSUASION™ | Pg 256



CRYSTAL SKYE™ | Pg 260

NEW
TRADITIONS

264



MALINA™ | Pg 266

RYEGATE™ | Pg 330



LARKIN™ | Pg 326



LARA™ | Pg 270

PENDANTS

368



EVERLY™ | Pg 382

CEILING

404



RAIL LIGHTS | Pg 406

MIRRORS

448



LUNAR™ | Pg 458



HENDRIK™ | Pg 464

BATH

466



ARVELLA™ | Pg 482



COMO™ | Pg 468



STRUCTURES™ | Pg 488



MONROE™ | Pg 550

OUTDOOR

572



CESYA™ | Pg 578



SOREL™ | Pg 575



MANNINGHAM™ | Pg 628



WISCOMBE PARK™ | Pg 668

CHANDELIER VISUAL INDEX



Alameda™
146-147



Aleeka™
186-187



Aliso™
234-235



Ara™
219



Arbon™
192-193



Archibald™
74-75



Ansonia™
114-115



Armida™
116-119



Arvella™
112-113



Barcelona™
332



Basel™
282-283



Bayberry™
89



Berkley™
211



Berra™
40-41



Blythe™
60-61



Braelyn™
70-72



Brooklands™
188-190



Bryce™
110



Camerena™
320-325



Brinley™
73



Carlisle™
88



Caterham™
148-149



Caywood™
80-81



Celestial™
82-83



Circolo
220-223



City Lights™
168-171



Clarice™
344



Cloudburst™
218



Colerne™
138-139



Confetti
212



Crescent View™
202-203



Crystal Ball™
140



Crystal Persuasion™
256-259



Crystal Sky™
260-263



Dayzie™
144



Denman™
134-135



Donington™
280-281



Dover
360-362



Dunsmuir™
277



Durham™
346-349



Eileen™
226-229



Elias
102-103



Escala™
191



Evan™
54-55

CHANDELIER VISUAL INDEX



Feville™
318-319



Freeport™
200-201



Gracie™
240-241



Grand Bank™
36-39



Granby™
98-101



Hastings™
363



Hayman Bay™
46-49



Hendrik™
104-109



Jardine™
248-251



Jules™
242-243



Kailey™
150-152



Kambry™
308-311



Kayde™
58



Kearn™
50-53



Kensington™
306-307



Khone™
213



Krasi™
62-63



Lacey™
153-159



Ladero™
136-137



Langford™
364-365



Lara™
270-276



Larissa™
296-301



Leanora™
236-237



Larkin™
326-329



Leeds™
90-95



Leighton™
162-163



Loom
56-57



Louisa™
160



Lucien™
78-79



Lytham™
204-205



Malina™
266-269



Marcele™
278-279



Marchesa™
284-285



Marisa™
76-77



Mihaela™
59



Mithras™
286-289



Modena™
231



Modern Mosaic
230



Monroe™
312-317



Morton™
111



Moxie™
42-45



Neillo™
120-121



Nicholson™
352-353



Norwich™
333



CHANDELIER VISUAL INDEX



Olsay™
172-175



Olympia™
122-133



Organique™
66-67



Parker Point™
252-255



Portsmouth™
345



Ravenna™
292-295



Rigate™
194-195



Rizzo™
238-239



Roswell™
180-185



Saldana™
84-87



Ryegate™
330-331



Sarabella™
290-291



Savina™
166-167

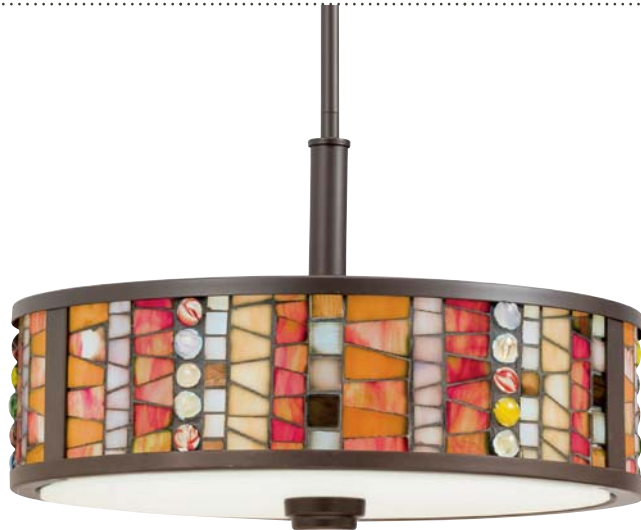

Shasteen™
145

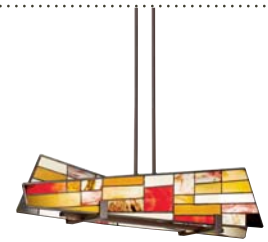

Shindy™
64-65



Sonora™
144



Spyro™
161



Stafford™
356-359



Stella™
214-217



Structures™
206-210



Suspension™
96-97



Tacoma™
143



Tanglewood™
354-355



Tremba™
176-179

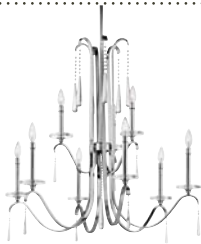

Tara™
244-247



Tarlton™
142



Twigs
68-69



Telford™*
366-367



Triad™
196-199



Wedgeport™
342-343



Wellington Square™
334-335



Wharton
350-351



Whitley™
141



Willowmore™
336-341



Wilton™
302-305



Wynberg™
363

MINI PENDANTS VISUAL INDEX



Ansonia™
114-115



Archibald™
74-75



Armida™
116-119



Arvella™
112-113



Bayberry™
89



Berkley™
211



Berra™
40-41



Blythe™
60-61



Braelyn™
70-72



Brinley™
73



Brooklands™
188-190



Bryce™
110



Camerena™
320-325



Carlisle™
88



Casita™
375



Confetti™
212



Caterham™
148-149



Caywood™
80-81



Clarice™
344



Cloudburst™
218



Colerne™
138-139



Crystal Ball™
140



Crystal Skye™
260-263



Dayzie™
144



Denman™
134-135



Dover™
360-362



Durham™
346-349



Eileen™
224-229



Elias™
102-103



Feville™
318-319



Granby™
98-101



Hendrik™
104-109



Jardine
248-251



Kailey™
150-152



Kayde™
58



Kearn™
50-53



Grand Bank™
36-39



Kensington™
306-307



Khione™
213



Knox™
378



Krazi™
62-63



Lacey™
153-159



Ladero™
136-137



Langford™
364-365



Lara™
270-276



Larissa™
296-301



LED
371



Leeds™
90-95



Leighton™
162-163



Loom
56-57



Louisa™
160



Lucien™
78-79



Lyndon
375



Malina™
266-269



Marisa
76-77



Mihaela™
59



Mini Pendants
373



Mini Pendants
373



Mini Pendants
373

MINI PENDANTS VISUAL INDEX



Mini Pendants
373



Mini Pendants
374



Mini Pendants
373



Mini Pendants
373



Modena™
231



Modern Mosaic
230



Monroe™
312-317



Morton™
111



Neillo™
120-121



Nicholson™
352-353



Olympia™
122-133



Pacific Edge™
378



Praire Ridge™
375



Roswell™
180-185



Reynes™
230



Rigate™
194-195



Rustic™
374



Saddler™
374



Sarabella™
290-291



Savina™
166-167



Shasteen™
145



Shazam™
375



Shindy™
64-65



Stella™
214-217



Sonora
144



Souldern™
378



Spyro™
161



Stafford™
356-359



Structures™
206-210



Suspension™
96-97



Tacoma™
143



Tanglewood™
354-355



Telford™*
366-367



Tremba™
176-179



Twigs
68-69



Wedgeport™
342-343



Wellington Square™
334-335



Wharton™
350-351



Whitley™
141



Willowmore™
336-341



Wilton™
302-305



Woodbury™
375



Yakima™
375

WALL SCONCES VISUAL INDEX



Adao™
528



Alameda
146-147



Aleeka
186-187



Aliso™
234-235



Allegre™
490



Ansonia™
114-115



Armida™
116-119



Arvella™
112-113



Ashbrook™
507



Ayana™
516



Basel™
282-283



Bazely
474



Bath
529



Bath & Vanity
523



Bayberry™
89



Bellamy™
526-527



Braelyn™
70-72



Brinbourne™
501



Brooklands™
188-190



Bryce™
110



Caywood
80-81



Calleigh™
524-525



Camerena™
320-325



Caterham
148-149



Celestial™
82-83



Circolo
220-223



Clarice™
344



Claro™
510



Cloudburst
218



Colerne™
138-139



Como™
468



Confetti
212



Cottage Grove™
543



Crystal Sky
260-263



Crescent View
202-203



Crystal Persuasion™
256-259



Currituck™
530-531



Cylinders
487



Denman™
134-135



Donington™
280-281



Dover™
360-362



Drapes
506



Grand Bank™
36-39



Durham™
346-349



Eileen™
224-229



Elias
102-103



Feville™
318-319



Freeport™
200-201



Granby™
98-101



Hayman Bay™
46-49



Hendrik™
104-109



Jardine
248-251



Jervis™
491



Jules
242-243



Kailey™
150-152



Kensington™
306-307



Kambry™
308-311



Kayde™
58



Kearn™
50-53



Krasi
62-63



Lacey™
153-159



Ladero™
136-137



Langford™
364-365



Lara™
270-276



Larissa™
296-301



Leanora™
236-237

WALL SCONCES VISUAL INDEX



LED
432-435



Leeds™
90-95



Legé™
486



Leighton™
162-163



Loom
56-57



Lucien™
78-79



Malina™
266-269



Marcele™
278-279



Marchesa™
284-285



Metro Park™
475



Mithras™
286-289



Modena
231



Monroe™
312-317



Neillo™
120-121

Moxie
42-45



O'Hara
518



Nicholson™
352-353



Nobu™
497



Norwich™
333



Olympia™
122-133



Parker Point™
252-255



Pavillion™
496



Poncelona™
538



Punctuation
512



Roswell™
180-185



Quincy™
534-535



Ravenna™
292-295



Reynes™
230



Rigate™
194-195



Rizzo™
238-239



Saldana™
84-87



Santiago™
495



Sarabella™
290-291



Savina™
166-167



Selene™
469



Sheila™
532-533



Souldern™
500



Spyro
161



Sonora™
144



Tara™
244-247



Stafford™
356-359



Stella™
214-217



Structures™
206-210



Suspension™
96-97



Tanglewood™
354-355



Tarlton
142



Telford™
366-367



Tremba™
176-179



Tubes™
484-485



Tulare™
508



Tully™
470



Uptown™
505



Urban Ice™
471



Wall Sconces
517



Wedgeport™
342-343



Wellington Square™
334-335



Wharton
350-351



Whitley™
141



Willowmore™
336-341



Wilton™
302-305



Wynberg™
363

BATH & VANITY VISUAL INDEX



Adao™
528



Allegre™
490



Ansonia™
522



Armida™
519-521



Arvella™
482-483



Ashbrook™
507



Ayana
516



Bath
523



Bath
529



Bath & Vanity
566-569



Bazely™
474



Bellamy™
526-527



Brinbourne™
501



Broadview™
564-565



Calleigh™
524-525



Camerena™
548-549



Claro™
510



Como™
468



Cottage Grove™
543



Crescent View™
472



Currituck™
530-531



Cylinders™
487



Dover™
557



Drapes™
506



Durham™
546-547



Eileen™
513-515



Energy Efficient
570-571



Feville™
553



Freeport™
473



Granby™
498-499



Hendrik™
476-479



Jardine
539



Jervis™
491



Kailey™
493



Kambry™
540



Kympton™
492



Lacey™
536-537



Langford™
502-503



Larissa™
541



Legé™
486



Metro Park™
475



Monroe™
550-552



Nicholson™
562-563



Nobu™
497



O'Hara™
518



Pavillion™
496



Pocelona™
538



Punctuation™
512



Quincy™
534-535



Revere™
511



Rigate™
481



Rousseau™
509



Santiago™
494-495



Selene™
469



Sheila™
532-533



Souldern™
500



Stafford™
558



Structures™
488-489



Suspension™
480



Tanglewood™
559



Telford™
560-561



Tubes™
484-485



Tulare™
508



Tully™
470



Uptown™
505



Urban Ice™
471



Wedgeport™
556



Wellington Square™
554-555



Wharton™
504



Willowmore™
544-545



Wilton™
542

OUTDOOR LANTERNS VISUAL INDEX



Alameda™
642



Antico™
627



Ascari™
606



Atwood
647



Barrie
702



Bay Shore™
691



Beach Light™
710



Belmez™
610



Bowen™
608



Camden™ EE
618



Cameron™
648



Caterham™
632



Celino™
602



Cesya™ LED
578



Chesapeake™
706



Chicago™
640



Concord
588



Courtyard™
672-675



Cross Creek™
644



Eau Claire™
684



Embassy Row
698



Franceasi™
650-651



Franceasi™ LED
581



Grove Mill™
690



Hanford™
586



Hatteras Bay™
585



Hatteras Bay™ LED
583



Kirkwood™
700



Lakeway™
677



Lantana™
620



LED
711



Leeds™
612



Lindstrom™
591



Luverne™
670



Lyndon™
587



Madison
704



Manningham™
628



Maya Palm™ LED
580



McAdams™
678



Melbern™
646



Morris™
638



Mount Vernon
692-696



Mount Vernon LED
582



New Street™
713



Nob Hill™
656



North Creek™
636



Outdoor EE
716



Pacific Edge™
598-601



Portman Square™
614-617



Ralston™
686



Randolph™ EE
697



Ripley™
593



Rivera™
594-597



Riverbank™
637



Rochdale™
652-655



Rustic™
589



Salisbury™
680



Sausalito™
685



Savannah Estates™
689



Seaside™
592



Sedo™ LED
576



Sorel™
623



Sorel™ LED
575



Soria™
634



South Hope™
590



Stonebrook™
624



Takil™ LED
580



Tournai™
658-663



Townhouse™
708



Trafari
626



Tremillo™
604



Trenton™
688



Venetian Rain™
664-667



Vitalino™
625



Warrington™
712



Wiscombe Park™
668



Woodland Lake™
630



Zolder™
603

ENERGY EFFICIENT VISUAL INDEX



Adao™
528



Alameda™
642



Allegre™
490



Ara™
219



Arcola™
439



Armida™
519-521



Atwood™
647



Bath™
529



Camden™
618



Ceiling™
425



Ceiling™
421



Ceiling™
428



Ceiling™
422



Ceiling™
423



Ceiling™
430



Chella™
428



Courtyard™
676



Dover™
360-362



Energy Efficient™
571



Energy Efficient™
442



Energy Efficient™
444



Eucia™
441



Freeport™
473



Granby™
98-101



Izona™
442



Jervis™
491



Lantana™
620



Leeds™
90-95



Luverne™
670



Madison™
704



Marbrisa™
426



McAdams™
678



Newport™
444, 602



Nobu™
497



Northcreek™
637



Outdoor™
716

ENERGY EFFICIENT VISUAL INDEX



Outdoor
584



Oviedo
441



Paramount™
440



Pavillion™
496



Pierson™
441



Pira™
426



Rigel™
439



Salisbury™
682



Santiago™
494-495



Seaside™
592



Telford™
560



Tremillo™
604



Verve™
443



Virden™
439



Visalia™
441



Wall Sconce
517



Wedgeport™
342-343

LED VISUAL INDEX



Ceiling LED
415



Cesya™ LED
578



LED Rail Lights
406-409



Franceasi™ LED
581



Hatteras Bay™ LED
583



LED
711



Maya Palm™ LED
580



Mini Pendants LED
370-371



Mount Vernon™ LED
582



Sedo™ LED
576



Sorel™ LED
575



Takil™ LED
580



Wall Sconces
432-433

ENERGY STAR



Kichler Lighting has been a proud sponsor of the Energy Star program since 2002. In conjunction with the newly combined Department of Energy and Environmental Protection Agency's Energy Star revision 1.1 we are making improvements to our

assortment of qualified products. As they are qualified, Energy Star will post them to their website. Please consult the Energy Star website at www.energystar.gov for our current assortment of qualified products, in addition to future Kichler catalogs identifying the Energy Star logo.

CASUAL TRANSITIONS

FRESH & SERENE

Casual. Relaxed. Comfortable. Choose your favorite adjective to describe the laid-back looks found throughout our Casual Transitions collections. Blending modern, clean design with traditional touches, each family offers a fresh look that's far from fussy and miles away from ordinary. Of course, our Casual Transitions collections also feature their own unique twist to capture your interest – whether it be geometric forms, crinkle fabric shades, pearlized white glass or artisan accents. It's a decorating style that offers comfort without feeling overdone.





Grand Bank™ Pendalette® 43189 AUB | Page 38 & Chandelier 43190 AUB | Page 37

GRAND BANK™

AUBURN STAINED WOOD AND DISTRESSED BLACK
METAL FINISH WITH CLEAR SEEDY GLASS



A | 43193 AUB
Chandelier
NOT TO SCALE



GET INSPIRED AT
KICHLER.COM



Auburn Stained Wood

B | 43185 AUB
Chandelier



C | 43190 AUB
Chandelier

GRAND BANK™

ITEM #	FINISH	INCAND. BULB	W	H	OVRL. H	STEM TILT	EXTRA WIRE	CHAIN/STEM	NOTES	
A	43193	AUB	(6) 60W (C)	25	22.5	61		74	36	Additional chain 2996 DBK, additional stem 2999 (12") DBK.
B	43185	AUB	(4) 60W (C)	20	21.5	60	90°	74	36	Additional stem 2999 (12") DBK.
C	43190	AUB	(8) 60W (C)	28	29.5	68	90°	107	36	Additional stem 2999 (12") DBK.

Measurements shown in inches. U.S. & Canadian Patent Pending.

GRAND BANK™

AUBURN STAINED WOOD AND DISTRESSED BLACK METAL FINISH WITH CLEAR SEEDY GLASS



Distressed Black Metal Finish

A | 43186 AUB
Linear Chandelier

PENDALETTE®

Create three distinct lighting options with one fixture:
Mini Pendant, Wall Sconce
or Semi Flush.

B | 43189 AUB



Shown as Mini Pendant - 9.75" H.



Shown as Wall Sconce - 12.5" H.



Shown as Semi Flush - 12.25" H.



C | 43191 AUB
Oval Chandelier

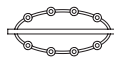

GRAND BANK™

	ITEM #	FINISH	INCAND. BULB	W	H	OVRL. H	L	STEM TILT	EXTRA WIRE	CHAIN/STEM	EXT.	HCWO	NOTES
A	43186	AUB	(5) 60W (C)	2.75	15.75	54	36	90°	94	36	---	---	Additional stem 2999 (12") DBK.
B	43189	AUB	(1) 60W (C)	9	9.75	48	---	90°	58	36	7.5	2.5	Additional stem 2999 (12") DBK.
C	43191	AUB	(8) 60W (C)	16	15.75	56	36	90°	85	36	---	---	Additional stem 2999 (12") DBK.

Measurements shown in inches. U.S. & Canadian Patent Pending.



Berra™ Linear Chandelier 43318 OZ | Page 41

BERRA™

OLDE BRONZE® FINISH WITH
PARCHMENT GLASS



A | 43320 OZ
Mini Pendant



B | 43318 OZ
Linear Chandelier

BERRA™

	ITEM #	FINISH	INCAND. BULB	W	H	OVRLL. H	L	EXTRA WIRE	CHAIN/STEM	NOTES
A	43320	OZ	(1) 100W (M)	9.25	10.25	49	---	67	36	☑ (23-30W CFL) Additional chan 2996 OZ, additional stem 2999 (12") OZ.
B	44318	OZ	(3) 100W (M)	3.5	15.5	54	34	72	36	☑ (23-30W CFL) Additional chan 2996 OZ, additional stem 2999 (12") OZ.

Measurements shown in inches. U.S. & Canadian Patent Pending.



Moxie™ Pendant 42062 CMZ | Page 45

MOXIE™

CAMBRIDGE BRONZE & GOLD FINISH
WITH LINEN FABRIC SHADE AND
SATIN-ETCHED GLASS DIFFUSER



A | 42099 CMZ
Linear Chandelier

MOXIE™

GET INSPIRED AT
KICHLER.COM



ITEM #	FINISH	INCAND. BULB	W	H	OVRL. H	L	EXTRA WIRE	CHAIN/STEM	NOTES
A 42099	CMZ	(4) 100W (M)	16	14	40	48	110	36	(23-30W CFL) Additional chain 2996 CMZ, additional stem 2999 (12") CMZ. Sloped ceiling kit included. Height includes one 6" stem.

Measurements shown in inches. U.S. & Canadian Patent Pending.

MOXIE™

CAMBRIDGE BRONZE & GOLD FINISH
WITH LINEN FABRIC SHADE AND
SATIN-ETCHED GLASS DIFFUSER



A | 42074 CMZ
Large Foyer Pendant



B | 42061 CMZ
Linear Chandelier



C | 42060 CMZ
Wall Sconce

MOXIE™

ITEM #	FINISH	INCAND. BULB	W	H	OVRL H	L	EXTRA WIRE	CHAIN/STEM	EXT.	HCWO	NOTES
A	42074 CMZ	(6) 100W (M)	20	31.5	70	---	67	36	---	---	(23-30W CFL) Additional chain 4901 CMZ, additional stem 4935 (12") CMZ.
B	42061 CMZ	(3) 100W (M)	12	14	46	36	106	36	---	---	(23-30W CFL) Additional chain 2996 CMZ, additional stem 2999 (12") CMZ, Sloped ceiling kit incl. Height includes one 6" stem.
C	42060 CMZ	(2) 40W (C)	12	8	---	---	---	---	7	4	No glass diffuser included.

Measurements shown in inches. U.S. & Canadian Patent Pending.



D | 42073 CMZ
Large Foyer Pendant

Linen Fabric Shade



E | 42097 CMZ
Semi Flush



F | 42062 CMZ
Pendant



G | 42098 CMZ
Pendant

MOXIE™

ITEM #	FINISH	INCAND. BULB	W	H	OVRL. H	EXTRA WIRE	CHAIN/STEM	NOTES
D	CMZ	(4) 100W (M)	16	31	63	67	36	☑ (23-30W CFL) Add. chain 4901 CMZ, add. stem 4935 (12") CMZ. Height includes one 6" stem.
E	CMZ	(2) 100W (M)	16	12.75	---	---	---	☑ (23-30W CFL)
F	CMZ	(2) 100W (M)	18	16	46	72	36	☑ (23-30W CFL) Add. chain 2996 CMZ, add. stem 4935 (12") CMZ, Sloped ceiling kit incl. Height includes one 6" stem.
G	CMZ	(3) 100W (M)	24	14	47	65	36	☑ (23-30W CFL) Add. chain 2996 CMZ, add. stem 4935 (12") CMZ, Sloped ceiling kit incl. Height includes one 6" stem.

Measurements shown in inches. U.S. & Canadian Patent Pending.



Hayman Bay™ Indoor Pendant 43258 DAW & 43246 DAW | Page 47

HAYMAN BAY™

DISTRESSED ANTIQUE WHITE FINISH WITH
CLEAR SEEDY GLASS



A | 43246 DAW
Indoor Pendant



Textured Rust Accent
Color on Loop

B | 43258 DAW
Indoor Pendant



C | 43259 DAW
Indoor Pendant

HAYMAN BAY™

	ITEM #	FINISH	INCAND. BULB	W	H	OVRL. H	EXTRA WIRE	CHAIN/STEM	NOTES
A	43246	DAW	(1) 100W (M)	7	15	89	31	72	Ⓛ (23-30W CFL) Additional chain 2996 DAW.
B	43258	DAW	(2) 60W (C)	8.5	18	92	23	72	Ⓛ Additional chain 2996 DAW.
C	43259	DAW	(4) 60W (C)	15	29.75	104	10	72	Additional chain 2996 DAW.

Measurements shown in inches. U.S. & Canadian Patent Pending.

HAYMAN BAY™

DISTRESSED ANTIQUE WHITE FINISH



A | 43264 DAW
Wall Sconce



B | 43255 DAW
Foyer Chandelier



C | 43256 DAW
Chandelier



GET INSPIRED AT
KICHLER.COM



D | 43263 DAW
Wall Sconce



F | 43257 DAW
Chandelier



Pen Shell Mosaic
Over Glass

E | 43262 DAW
Pendant

HAYMAN BAY™

	ITEM #	FINISH	INCAND. BULB	W	H	OVRL. H	STEM TILT	EXTRA WIRE	CHAIN/STEM	EXT.	HCWO	NOTES
A	43264	DAW	(1) 60W (C)	6	11.25	---	---	---	---	8	9	
B	43255	DAW	(4) 60W (C)	16.25	29.75	104	---	15	72	---	---	Additional chain 2996 DAW.
C	43256	DAW	(5) 60W (C)	28	29.75	104	---	33	72	---	---	Additional chain 2996 DAW.
D	43263	DAW	(2) 60W (C)	12	18.5	---	---	---	---	6.75	14.25	
E	43262	DAW	(3) 100W (M)	19.25	12.25	51	90°	69	36	---	---	Ⓜ (23-30W CFL) Additional stem 4935 (12") DAW.
F	43257	DAW	(6) 60W (C)	27	29.75	104	---	51	72	---	---	Additional chain 2996 DAW.

Measurements shown in inches. U.S. & Canadian Patent Pending.

KEARN™

OLDE BRONZE® FINISH WITH
WRAPPED ROPE ACCENTS



A | 43424 OZ
Chandelier
NOT TO SCALE



GET INSPIRED AT
KICHLER.COM



B | 43426 OZ
Wall Sconce



C | 43425 OZ
Mini Pendant

OPTIONAL SHADES

4121
5 x 4.25 - Mica Shade



4122
4.25 x 6.5 - Clear Seedy Glass



D | 43423 OZ
Chandelier



E | 43422 OZ
Oval Chandelier

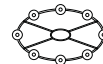

KEARN™

	ITEM #	FINISH	INCAND. BULB	W	H	OVRL. H	L	EXTRA WIRE	CHAIN/STEM	EXT.	HCWO	NOTES
A	43424	OZ	(10) 60W (C)	33.75	39.25	114	---	38	72	---	---	Additional chain 4901 OZ.
B	43426	OZ	(1) 60W (C)	5.25	13.5	---	---	---	---	5.25	6.75	Height includes bulb.
C	43425	OZ	(1) 60W (C)	10	14	52	---	52	36	---	---	Additional chain 2996 OZ, additional stem 2999 (12") OZ. Sloped ceiling kit included.
D	43423	OZ	(6) 60W (C)	26	25	99	---	6	72	---	---	Additional chain 2996 OZ.
E	43422	OZ	(8) 60W (C)	23.75	28.25	103	37.75	37	72	---	---	Additional chain 2996 OZ.

Measurements shown in inches. U.S. & Canadian Patent Pending.

KEARN™

OLDE BRONZE® FINISH WITH WRAPPED
ROPE ACCENTS SHOWN WITH OPTIONAL
GLASS SHADES OR MICA SHADES



Shown with
Optional Mica
Shade 4121

A | 43424 OZ
Chandelier
NOT TO SCALE



GET INSPIRED AT
KICHLER.COM



Shown with
Optional Clear Seedy
Glass Shade 4122

B | 43426 OZ
Wall Sconce



Shown with
Optional Clear Seedy
Glass Shade 4122

C | 43425 OZ
Mini Pendant

OPTIONAL SHADES

4121
5 x 4.25 - Mica Shade



4122
4.25 x 6.5 - Clear Seedy Glass



Shown with
Optional Clear Seedy
Glass Shade 4122

D | 43423 OZ
Chandelier



Shown with
Optional Clear Seedy
Glass Shade 4122

E | 43422 OZ
Oval Chandelier

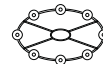

KEARN™

	ITEM #	FINISH	INCAND. BULB	W	H	OVRL. H	L	EXTRA WIRE	CHAIN/STEM	EXT.	HCWO	NOTES
A	43424	OZ	(10) 60W (C)	33.75	39.25	114	---	38	72	---	---	Additional chain 4901 OZ.
B	43426	OZ	(1) 60W (C)	5.25	13.5	---	---	---	---	5.25	6.75	Height includes bulb.
C	43425	OZ	(1) 60W (C)	10	14	52	---	52	36	---	---	Additional chain 2996 OZ, additional stem 2999 (12") OZ. Sloped ceiling kit included.
D	43423	OZ	(6) 60W (C)	26	25	99	---	6	72	---	---	Additional chain 2996 OZ.
E	43422	OZ	(8) 60W (C)	23.75	28.25	103	37.75	37	72	---	---	Additional chain 2996 OZ.

Measurements shown in inches. U.S. & Canadian Patent Pending.

EVAN™

DISTRESSED ANTIQUE GRAY FINISH ON
WOOD WITH ANVIL IRON DETAILING



A | 43327 DAG
Chandelier
NOT TO SCALE
LE



GET INSPIRED AT
KICHLER.COM



B | 43322 DAG
Chandelier



D | 43324 DAG
Chandelier

Anvil Iron
Detailing



Off White
Fabric Shade

Satin-Etched
Glass Diffuser

C | 43323 DAG
Pendant

PENDALETTE®

Create three distinct lighting options with one fixture:
Wall Sconce, Mini Pendant
or Semi Flush.



Shown as Mini Pendant
13.75" H.



Shown as Wall Sconce
16.75" H.

E | 43328 DAG

LE



Shown as Semi Flush
13.75" H.

EVAN™

	ITEM #	FINISH	INCAND. BULB	W	H	OVRL. H	STEM TILT	EXTRA WIRE	CHAIN/STEM	EXT.	HCWO	NOTES
A	43327	DAG	(6) 60W (C)	28.5	37.25	112	---	48	72	---	---	Additional chain 2996 AVI.
B	43322	DAG	(5) 60W (C)	24	27	101	---	18	72	---	---	Additional chain 2996 AVI.
C	43323	DAG	(3) 100W (M)	20	25.75	100	---	20	72	---	---	(23-30W CFL) Additional chain 2996 AVI.
D	43324	DAG	(5) 60W (C)	20	30	104	---	20	72	---	---	Additional chain 2996 AVI.
E	43328	DAG	(2) 60W (C)	13	13.75	52	90°	65	36	7.5	2.5	Additional stem 2999 (12") AVI.

Measurements shown in inches. U.S. & Canadian Patent Pending.

LOOM

OLDE BRONZE® FINISH WITH
OFF-WHITE FABRIC INNER SHADES



A | 43047 OZ
Chandelier/Pendant

Satin-Etched
Glass Diffuser



B | 43046 OZ
Oval Chandelier/Pendant



Open Metal Weave
Pattern Surrounds
Off-White Fabric Shade

LOOM

GET INSPIRED AT
KICHLER.COM



ITEM #	FINISH	INCAND. BULB	W	H	OVRLL.		STEM TILT	EXTRA WIRE	CHAIN/ STEM	NOTES	
					H	L					
A	43047	OZ	(4) 100W (M)	24	20	58	---	---	86	36	Ⓜ (23-30W CFL) Additional chain 2996 OZ, additional stem 2999 (12") OZ. Sloped ceiling kit incl.
B	43046	OZ	(4) 100W (M)	15	12.25	51	36	90°	99	36	Ⓜ (23-30W CFL) Additional stem 2999 (12") OZ.

Measurements shown in inches. U.S. & Canadian Patent Pending.

LOOM

OLDE BRONZE® FINISH WITH
OFF-WHITE FABRIC INNER SHADES



Shown as Pendant - 11.5" H.

CONVERTIBLE

Create two distinct lighting options with one fixture: Pendant or Semi Flush.

C | 43049 OZ



D | 43048 OZ
Mini Pendant



E | 43050 OZ
Wall Sconce
ADA Compliant



Shown as Semi Flush - 11.25" H.

MATCHING MIRROR

78248

See page 460 or kichler.com.



LOOM

ITEM #	FINISH	INCAND. BULB	W	H	OVRLL. H	EXTRA WIRE	CHAIN/STEM	EXT.	HCWO	NOTES	
C	43049	OZ	(3) 100W (M)	15	11.5	50	68	36	---	---	Ⓜ (23-30W CFL) Additional chain 2996 OZ, additional stem 2999 (12") OZ; Sloped ceiling kit included.
D	43048	OZ	(1) 60W (M)	6	10.25	51	65	36	---	---	Ⓜ (13-15W CFL) Additional chain 2996 OZ, additional stem 2999 (12") OZ; Sloped ceiling kit included.
E	43050	OZ	(1) 60W (C)	8.25	10	---	---	---	4	5	ADA

Measurements shown in inches. U.S. & Canadian Patent Pending.

KAYDE™

OLDE BRONZE® FINISH
WITH CLEAR SEEDY GLASS



A | 42125 OZ
Mini Pendant



B | 42126 OZ
Wall Sconce



Vintage
Squirrel Cage
Filament Bulb,
60W Medium
Base

4071 CLR



C | 42124 OZ
Linear Chandelier

KAYDE™

ITEM #	FINISH	INCAND. BULB	W	H	OVRLL. H	L	EXTRA WIRE	CHAIN/STEM	EXT.	HCWO	NOTES	
A	42125	OZ	(1) 100W (M)	4.5	9.75	48	---	67	36	---	---	Ⓜ (23-30W CFL) Additional chain 2996 OZ, additional stem 2999 (12") OZ. Sloped ceiling kit included.
B	42126	OZ	(1) 100W (M)	4.75	12.5	---	---	---	---	5.75	8	Ⓜ (23-30W CFL)
C	42124	OZ	(5) 100W (M)	3.5	15	53	40	98	36	---	---	Ⓜ (23-30W CFL) Additional chain 2996 OZ, additional stem 2999 (12") OZ. Sloped ceiling kit included.

Measurements shown in inches. U.S. & Canadian Patent Pending.

MIHAELA™

SHADOW BRONZE™ FINISH WITH
ART GLASS AND CUT STONE ACCENTS



A | 65345
Semi Flush



B | 65344
Pendant



C | 69144
Wall Sconce
ADA Compliant



D | 65346
Mini Pendant

MIHAELA™

	ITEM #	INCAND. BULB	W	H	OVRL. H	EXTRA WIRE	CHAIN/STEM	EXT.	HCWO	NOTES
A	65345	(3) 100W (M)	16	11.5	---	---	---	---	---	☑ (23-30W CFL)
B	65344	(4) 100W (M)	22	24.5	63	55	36	---	---	☑ (18-25W CFL) Additional chain 2996 SWZ, additional stem 4935 (12") SWZ.
C	69144	(2) 26W (GU24) Ⓢ	8.5	12.5	---	---	---	4	6.25	Ⓢ ADA
D	65346	(1) 100W (M)	8.25	14.5	53	62	36	---	---	☑ (23-30W CFL) Additional chain 2996 SWZ, additional stem 2999 (12") SWZ.

Measurements shown in inches. Art Glass shades are natural materials – colors, patterns and textures will vary from piece to piece.

BLYTHE™

OLDE BRONZE® FINISH WITH
MOSAIC ART GLASS AND WHITE
GLASS DIFFUSER

Mosaic
Art Glass

A | 65383
Mini Pendant
NOT TO SCALE

White Glass
Diffuser

B | 65380
Oval Chandelier/Pendant





Shown as Semi Flush - 11.5" H.



Shown as Semi Flush - 11" H.

CONVERTIBLE
 Create two distinct lighting options with one fixture:
 Pendant or Semi Flush.

C | 65381 **D** | 65382



Shown as Pendant - 11.5" H.



Shown as Pendant - 9.75" H.

BLYPHE™

	ITEM #	INCAND. BULB	W	H	OVRL. H	L	EXTRA WIRE	CHAIN/STEM	NOTES
A	65383	(1) 100W (M)	5.5	9	113	---	---	---	☑ (23-30W CFL) Item does not include diffuser.
B	65380	(4) 100W (M)	9	20	58	36	82	36	☑ (23-30W CFL) Additional chain 2996 OZ, additional stem 2999 (12") OZ. Sloped ceiling kit included.
C	65381	(5) 100W (M)	22	11.5	51	---	78	36	☑ (23-30W CFL) Additional chain 2996 OZ, additional stem 4935 (12") OZ.
D	65382	(3) 100W (M)	16	9.75	49	---	77	36	☑ (23-30W CFL) Additional chain 2996 OZ, additional stem 4935 (12") OZ.

Measurements shown in inches. U.S. & Canadian Patent Pending.



Krasi™ Pendant 42465 WMZ | Page 63

KRASI™

WARM BRONZE™ FINISH WITH
OFF-WHITE FABRIC SHADES

Satin Etched
Cased Opal Glass



A | 42466 WMZ
Pendant

Satin-Etched Cased
Opal Glass



Shown as
Mini Pendant
11" H.

PENDALETTE®

Create three distinct lighting
options with one fixture:
Mini Pendant, Wall Mount
or Semi Flush.

C | 42467 WMZ



Shown as
Semi Flush
11.75" H.



Off White
Fabric Shade

Satin-Etched
Glass Diffuser

B | 42465 WMZ
Pendant



Shown as
Wall Mount
15.75" H.

KRASI™

ITEM #	FINISH	INCAND. BULB	W	H	OVRL. H	EXTRA WIRE	CHAIN/STEM	NOTES
A	WMZ	(1) 100W (M)	7.75	16.25	55	71	36	☑ (23-30W CFL) Additional chain 2996 WMZ, additional stem 2999 (12") WMZ.
B	WMZ	(4) 100W (M)	24	9.5	48	74	36	☑ (23-30W CFL) Additional chain 2996 WMZ, additional stem 2999 (12") WMZ.
C	WMZ	(1) 100W (M)	5.5	11	54	67	36	☑ (23-30W CFL) Additional stem 2999 (12") WMZ.

Measurements shown in inches. U.S. & Canadian Patent Pending.

SHINDY™

OLDE BRONZE® FINISH WITH
ART GLASS AND CUT STONE



A | 65390
Pendant
NOT TO SCALE

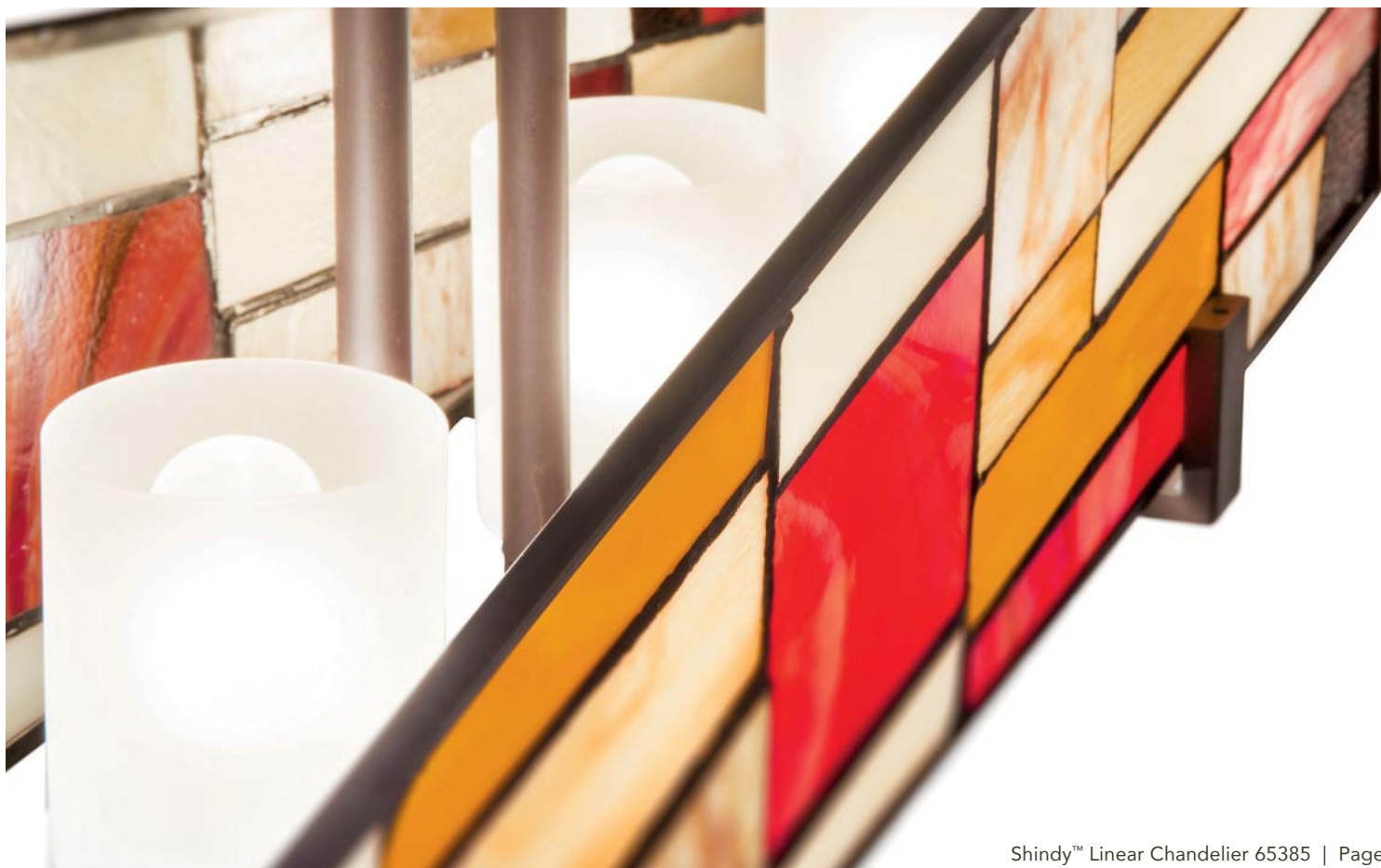

CONVERTIBLE

Create two distinct lighting options with one fixture:
Pendant or Semi Flush.

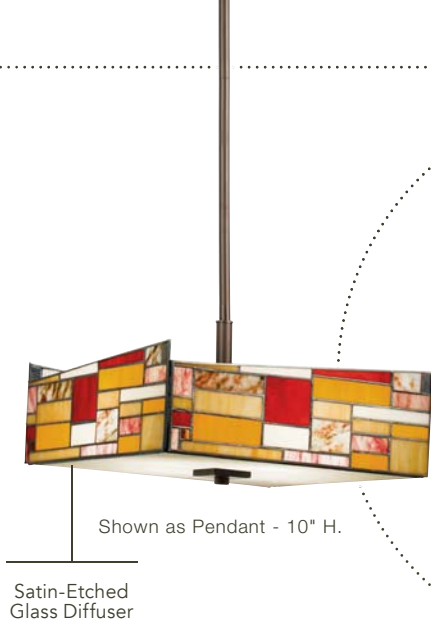

Shown as Pendant - 10" H.

Satin-Etched
Glass Diffuser

B | 65384



Shown as Semi Flush - 10.25" H.

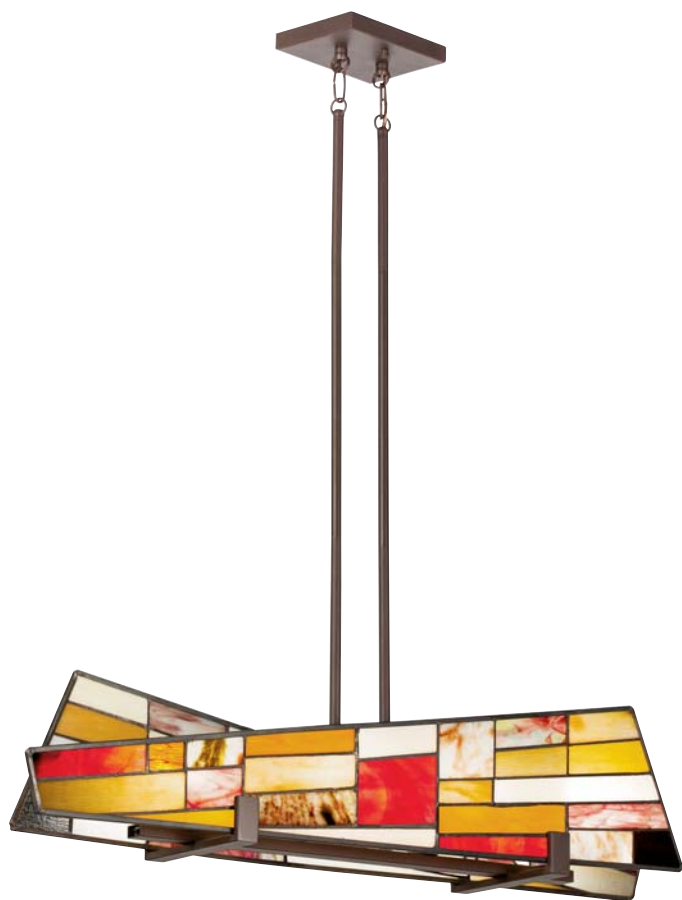

C | 65385
Linear Chandelier

Cut Stone
Accents



D | 65386
Large Foyer Pendant

SHINDY™

ITEM #	INCAND. BULB	W	H	OVRLL. H	L	STEM TILT	EXTRA WIRE	CHAIN/STEM	NOTES
A	65390 (1) 100W (M)	6	17.25	57	---	90°	61	36	(23-30W CFL) Additional stem 2999 (12") OZ.
B	65384 (4) 100W (M) ✓	15	10	50	---	90°	70	36	(23-30W CFL) Additional stem 4935 (12") OZ.
C	65385 (4) 50W (G9) Ⓢ	7	7.5	42	36	---	106	36	Additional chain 2996 OZ, additional stem 2999 (12") OZ. Halogen light source. Height includes one 6" stem.
D	65386 (6) 100W (M)	15	35.5	75	---	90°	53	36	(23-30W CFL) Additional stem 4935 (12") OZ.

Measurements shown in inches. U.S. & Canadian Patent Pending. Art Glass shades are natural materials – colors, patterns and textures will vary from piece to piece.



Organique™ Chandelier 42888 OZ | Page 67

ORGANIQUE™

OLDE BRONZE® FINISH



A | 42886 OZ
Mini Chandelier



B | 42887 OZ
Chandelier



C | 42888 OZ
Chandelier

ORGANIQUE™

	ITEM #	FINISH	INCAND. BULB	W	H	OVRLL. H	EXTRA WIRE	CHAIN/STEM	NOTES
A	42886	OZ	(3) 60W (C)	18	14	88	28	72	Additional chain 2996 OZ.
B	42887	OZ	(5) 60W (C)	24	16	90	26	72	Additional chain 2996 OZ.
C	42888	OZ	(6) 60W (C)	30	20.75	95	58	72	Additional chain 2996 OZ.

Measurements shown in inches. U.S. & Canadian Patent Pending.

TWIGS

OLDE BRONZE® FINISH





A | 43235 OZ
Mini Pendant



B | 78170
Mirror
NOT TO SCALE
See Kichler.com
for more detail



C | 43204 OZ
Oval Chandelier/Pendant



D | 43203 OZ
Pendant

TWIGS

ITEM #	FINISH	INCAND. BULB	W	H	OVRLL. H	L	STEM TILT	EXTRA WIRE	CHAIN/STEM	EXT.	NOTES	
A	43235	OZ	(1) 60W (M)	8	13	46	---	90°	76	36	---	☑ (13-15W CFL) Add. stem 2999 (12") OZ. Height includes one 6" stem.
B	78170	---	---	39	39	---	---	---	---	---	1.5	Twigs™ Beveled Mirror, Burnished Gold Bronze Frame. Mirror size: 23" Diameter.
C	43204	OZ	(2) 100W (M)	14.25	11.25	50	34	---	109	36	---	☑ (23-30W CFL) Add. chain 2996 OZ, add. stem 2999 (12") OZ. G-type lamp recommended.
D	43203	OZ	(1) 100W (M)	21	10.75	50	---	90°	72	36	---	☑ (23-30W CFL) Add. stem 2999 (12") OZ. G-type lamp recommended.

Measurements shown in inches. Fixture is open at bottom. U.S. & Canadian Patent Pending: A, C, D.



Braelyn™ Chandelier 43058 OZ | Page 71

BRAELYN™

OLDE BRONZE® FINISH WITH
CLEAR SEEDY GLASS

Can Also be Mounted
as a Semi Flush



A | 43058 OZ
Chandelier



Olde Bronze® Finish
with Highlights



B | 43059 OZ
Linear Chandelier

BRAELYN™

GET INSPIRED AT
KICHLER.COM



	ITEM #	FINISH	INCAND. BULB	W	H	OVRL. H	L	EXTRA WIRE	CHAIN/STEM	NOTES
A	43058	OZ	(5) 60W (M)	25	11.25	49	---	106	36	(13-15W CFL) Additional chain 2996 OZ, additional stem 4935 (12") OZ.
B	43059	OZ	(6) 60W (M)	15	11.25	49	34	111	36	(13-15W CFL) Additional chain 2996 OZ, additional stem 2999 (12") OZ.

Measurements shown in inches. U.S. & Canadian Patent Pending.

BRAELYN™

OLDE BRONZE® FINISH WITH
CLEAR SEEDY GLASS



Vintage
Squirrel Cage
Filament Bulb,
60W Medium
Base

4071 CLR



Clear Seedy Glass

A | 45457 OZ
Wall Sconce



Olde Bronze® Finish
with Highlights

Can Also be Mounted
as a Semi Flush

Shown as Mini Chandelier - 11" H.

CONVERTIBLE

Create two distinct lighting
options with one fixture:
Mini Chandelier or Semi Flush.

B | 43057 OZ



Shown as Semi Flush - 11.25" H.



C | 43060 OZ
Mini Pendant

BRAELYN™

ITEM #	FINISH	INCAND. BULB	W	H	OVRLL. H	EXTRA WIRE	CHAIN/STEM	EXT.	HCWO	NOTES
A	45457	OZ (1) 60W (M)	5	9.5	---	---	---	5.75	6	Ⓧ (13-15W CFL)
B	43057	OZ (3) 60W (M)	18	11	49	74	36	---	---	Ⓧ (13-15W CFL) Additional chain 2996 OZ, additional stem 2999 (12") OZ.
C	43060	OZ (1) 60W (M)	3.75	8.5	47	67	36	---	---	Ⓧ (13-15W CFL) Additional chain 2996 OZ, additional stem 2999 (12") OZ.

Measurements shown in inches. U.S. & Canadian Patent Pending.

BRINLEY™

OLDE BRONZE® OR BRUSHED NICKEL
FINISH WITH CLEAR GLASS



A | 42878 OZ
Mini Pendant



A | 42878 NI
Mini Pendant

Mason Jar
Inspired Glass

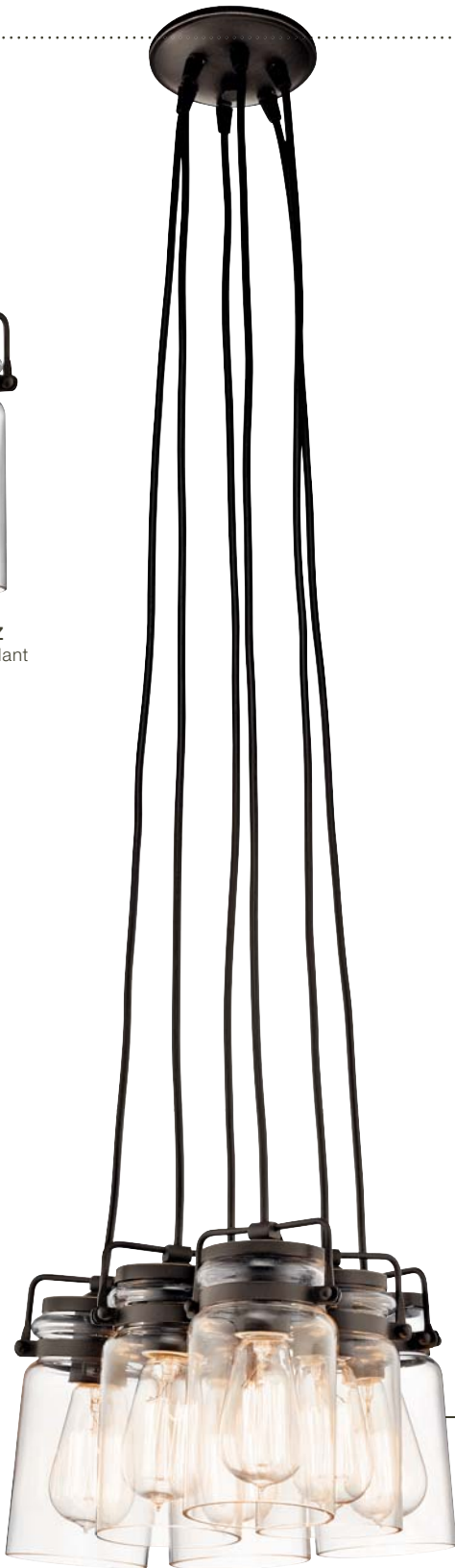

B | 42877 OZ
Pendant



B | 42877 NI
Pendant

Shown with optional
Vintage Squirrel
Cage Filament
Bulb 4071 CLR

BRINLEY™

	ITEM #	FINISH	INCAND. BULB	W	H	OVRL. H	NOTES
A	42878	NI, OZ	(1) 100W (M)	4.75	7.75	113	☑ (23-30W CFL)
B	42877	NI, OZ	(6) 100W (M)	13	7.75	113	☑ (23-30W CFL)

Measurements shown in inches. U.S. & Canadian Patent Pending.



Archibald™ Linear Chandelier 43217 ACO & Mini Pendant 43221 ACO | Page 75

ARCHIBALD™

ANTIQUÉ COPPER FINISH



A | 43221 ACO
Mini Pendant



B | 43217 ACO
Linear Chandelier

ARCHIBALD™

	ITEM #	FINISH	INCAND. BULB	W	H	OVRLL. H	L	STEM TILT	EXTRA WIRE	CHAIN/STEM	NOTES
A	43221	ACO	(1) 60W (C)	1.5	10.75	49	5	90°	48	36	Additional stem 2999 (12") ACO.
B	43217	ACO	(5) 60W (C)	8.5	18.75	57	31	90°	51	36	Additional chain 2996 ACO, additional stem 2999 (12") ACO. Sloped ceiling kit included.

Measurements shown in inches. U.S. & Canadian Patent Pending.



Marisa Linear Chandelier 65397 | Page 77

MARISA

SHADOW BRONZE™ FINISH
WITH ART GLASS



A | 65399
Mini Pendant



B | 65397
Linear Chandelier

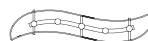

MARISA

ITEM #	INCAND. BULB	W	H	OVRL. H	L	EXTRA WIRE	CHAIN/STEM	NOTES
A	65399 (1) 100W (M)	4.25	10.75	50	7.25	65	36	☑ (23-30W CFL) Additional chain 2996 SWZ, additional stem 2999 (12") SWZ.
B	65397 (5) 100W (M)	8.25	16	58	36	100	36	☑ (23-30W CFL) Additional chain 2996 SWZ, additional stem 2999 (12") SWZ.

Measurements shown in inches. U.S. & Canadian Patent Pending. Art Glass shades are natural materials – colors, patterns and textures will vary from piece to piece.

LUCIEN™

OLDE BRONZE® FINISH



Vintage
Squirrel Cage
Filament Bulb,
60W Medium
Base

4071 CLR

Shown with
optional
Vintage Squirrel
Cage Filament
Bulb 4071 CLR



A | 42708 OZ
Chandelier

LE



May be installed with
bulb up or down.



B | 45308 OZ
Wall Sconce

LE



C | 42710 OZ
Mini Pendant

LE



D | 42257 OZ
Pendant

LUCIEN™

ITEM #	FINISH	INCAND. BULB	W	H	OVRLL. H	EXTRA WIRE	CHAIN/STEM	EXT.	HCWO	NOTES	
A	42708	OZ	(6) 100W (M)	25.25	28.75	103	10	36	---	---	Additional chain 2996 OZ.
B	45308	OZ	(1) 100W (M)	5.5	7	---	---	---	4.75	4.25	ⓘ May be installed with bulb up or down.
C	42710	OZ	(1) 100W (M)	1.75	3.25	42	68	36	---	---	Additional chain 2996 OZ, additional stem 2999 (12") OZ.
D	42257	OZ	(9) 60W (M)	26	16.75	58	79	36	---	---	ⓘ (13-15W CFL) Add. chain 2996 OZ, add. stem 4935 (12") OZ. Width incl. bulbs. Sloped ceiling kit incl.

Measurements shown in inches. U.S. & Canadian Patent Pending.

CAYWOOD™

OLDE BRONZE® FINISH WITH ART GLASS



A | 65391
Large Foyer Pendant
NOT TO SCALE



B | 65394
Mini Pendant



C | 65392
Pendant



D | 69192
Wall Sconce
ADA Compliant

CONVERTIBLE

Create two distinct lighting options with one fixture:
Pendant or Semi Flush.

E | 65393



Shown as Semi Flush - 10.5" H.



Shown as Pendant - 10" H.

CAYWOOD™

ITEM #	INCAND. BULB	W	H	OVRL. H	EXTRA WIRE	CHAIN/STEM	EXT.	HCWO	NOTES
A 65391	(4) 60W (C)	14	28.5	69	51	36	---	---	Additional chain 2996 OZ, additional stem 4935 (12") OZ. Sloped ceiling kit included.
B 65394	(1) 60W (M)	7	15.25	56	65	36	---	---	(13-15W CFL) Additional chain 2996 OZ, additional stem 2999 (12") OZ. Sloped ceiling kit incl.
C 65392	(4) 100W (M)	18	13	54	65	36	---	---	(23-30W CFL) Additional chain 2996 OZ, additional stem 4935 (12") OZ. Sloped ceiling kit incl.
D 69192	(2) 50W (G9)	7	11	---	---	---	4	5.5	ADA Halogen light source.
E 65393	(3) 100W (M)	16	10	48	69	36	---	---	(23-30W CFL) Additional chain 2996 OZ, additional stem 4935 (12") OZ. Sloped ceiling kit incl.

Measurements shown in inches. U.S. & Canadian Patent Pending. Art Glass shades are natural materials – colors, patterns and textures will vary from piece to piece.

CELESTIAL™

CAMBRIDGE BRONZE FINISH WITH
CRINKLE FABRIC SHADES AND
SATIN-ETCHED GLASS DIFFUSERS



Satin-Etched
Glass Diffuser

A | 42192 CMZ
Chandelier/Pendant
NOT TO SCALE



GET INSPIRED AT
KICHLER.COM



B | 42103 CMZ
Wall Sconce



C | 42193 CMZ
Semi Flush



D | 42105 CMZ
Chandelier

CELESTIAL™

	ITEM #	FINISH	INCAND. BULB	W	H	OVRL. H	L	EXTRA WIRE	CHAIN/STEM	EXT.	HCWO	NOTES
A	42192	CMZ	(3) 100W (M)	24	35	109	---	53	72	---	---	☑ (23-30W CFL) Additional chain 2996 CMZ.
B	42103	CMZ	(1) 60W (C)	6.5	22.25	---	---	---	---	8	10	Ⓧ
C	42193	CMZ	(3) 100W (M)	15	13.75	---	---	---	---	---	---	☑ (23-30W CFL)
D	42105	CMZ	(6) 60W (C)	26	41.5	116	44	49	72	---	---	Additional chain 4901 CMZ.

Measurements shown in inches. U.S. & Canadian Patent Pending.



Saldana™ Chandelier 42921 CLP | Page 85

SALDANA™

CLASSIC PEWTER FINISH WITH SATIN-ETCHED
CASED OPAL INNER GLASS AND WHITE
TRANSLUCENT ORGANZA OUTER SHADES



A | 42921 CLP
Chandelier

Satin-Etched Cased
Opal Inner Glass and
White Translucent
Organza Outer Shade



B | 42922 CLP
Oval Chandelier

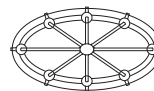

SALDANA™

GET INSPIRED AT
KICHLER.COM



ITEM #	FINISH	INCAND. BULB	W	H	OVRL H	L	EXTRA WIRE	CHAIN/STEM	NOTES	
A	42921	CLP	(5) 50W (G9)	24	14.25	43	---	61	36	Additional chain 2996 CLP, additional stem 4935 (12") CLP. Sloped ceiling included. Halogen light source. Height includes one 12" stem.
B	42922	CLP	(8) 50W (G9)	20	14.25	43	36	97	36	Additional chain 2996 CLP, additional stem 4935 (12") CLP. Sloped ceiling included. Halogen light source. Height includes one 12" stem.

Measurements shown in inches. U.S. & Canadian Patent Pending.

SALDANA™

CLASSIC PEWTER FINISH WITH SATIN-ETCHED
CASED OPAL INNER GLASS AND WHITE
TRANSLUCENT ORGANZA OUTER SHADES



A | 42920 CLP
Linear Chandelier
NOT TO SCALE



GET INSPIRED AT
KICHLER.COM



B | 42924 CLP
Wall Sconce

**COORDINATING
CEILING FAN**

See the full line of Kichler®
Ceiling Fans in catalog K414
or visit kichler.com



C | 300181 AP

CONVERTIBLE

Create two distinct lighting
options with one fixture:
Mini Chandelier or Semi Flush.

D | 42923 CLP



Shown as Semi Flush 14.25" - H.



Shown as Mini Chandelier 14" - H.

SALDANA™

ITEM #	FINISH	INCAND. BULB	W	H	OVRL. H	L	EXTRA WIRE	CHAIN/STEM	EXT.	HCWO	NOTES	
A	42920	CLP	(5) 50W (G9) Ⓢ	8	13.25	42	39	98	36	---	---	Additional chain 2996 CLP, additional stem 2999 (12") CLP. Sloped ceiling included. Halogen light source. Height includes one 12" stem.
B	42924	CLP	(1) 50W (G9) Ⓢ	5.25	6.5	---	---	---	---	5.75	4	Ⓢ
C	300181	AP	---	---	---	---	---	---	---	---	---	See the full line of Kichler® Ceiling Fans in catalog K414 or visit kichler.com.
D	42923	CLP	(3) 50W (G9) Ⓢ	18	14	42	---	62	36	---	---	Additional chain 2996 CLP, additional stem 2999 (12") CLP. Sloped ceiling included. Halogen light source. Height includes one 12" stem.

Measurements shown in inches. U.S. & Canadian Patent Pending.

CARLISLE

BRUSHED NICKEL FINISH WITH ART GLASS

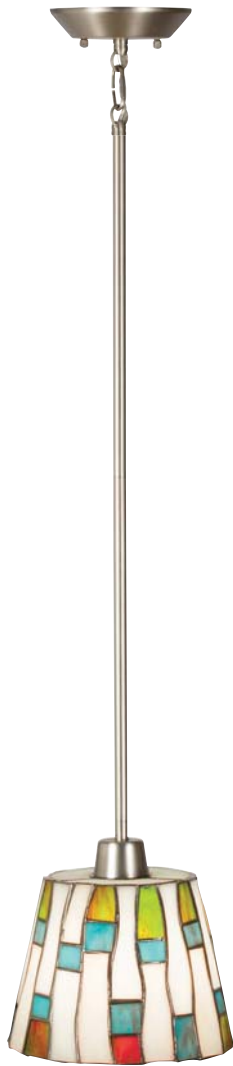

A | 65401
Mini Pendant



Shown as Semi Flush - 14.25" H.

CONVERTIBLE

Create two distinct lighting options with one fixture:
Pendant or Semi Flush.

B | 65400

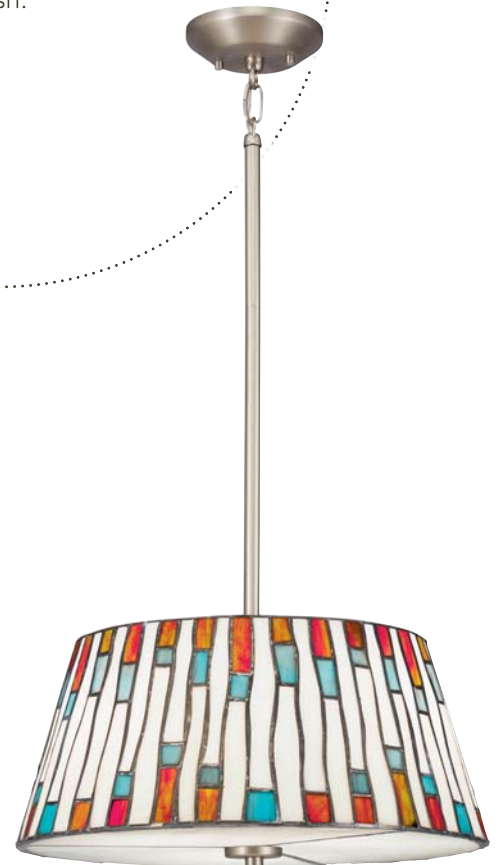

Shown as Pendant - 13.25" H.

CARLISLE

ITEM #	INCAND. BULB	W	H	OVRLL. H	EXTRA WIRE	CHAIN/STEM	NOTES
A 65401	(1) 100W (M)	8	11.25	52	65	36	☑ (23-30W CFL) Additional chain 2996 NI, additional stem 2999 (12") NI and/or 2997 (24") NI.
B 65400	(3) 100W (M)	16	13.25	48	67	36	☑ (23-30W CFL) Additional chain 2996 NI, additional stem 4935 (12") NI. Height includes one 6" stem.

Measurements shown in inches. U.S. & Canadian Patent Pending. Art Glass shades are natural materials – colors, patterns and textures will vary from piece to piece.

BAYBERRY™

OLDE BRONZE® FINISH WITH
ART GLASS AND CUT STONE

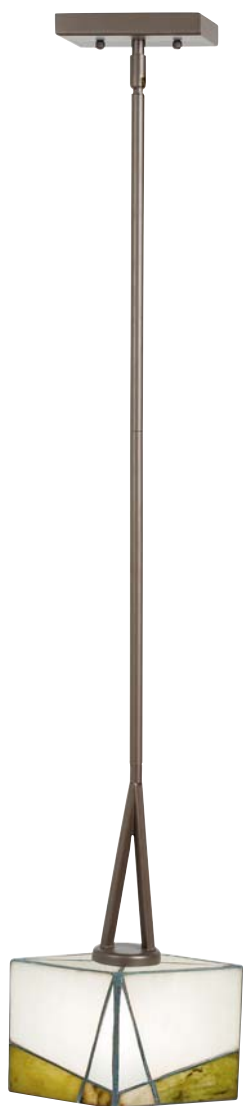

A | 65379
Mini Pendant



B | 69178
Wall Sconce
ADA Compliant



C | 65378
Linear Chandelier

BAYBERRY™

ITEM #	INCAND. BULB	W	H	OVRL. H	L	STEM TILT	EXTRA WIRE	CHAIN/STEM	EXT.	HCWO	NOTES
A 65379	(1) 50W (G9)	4.5	12.25	53	7	90°	62	36	---	---	Additional stem 2999 (12") OZ, Halogen light source.
B 69178	(2) 50W (G9)	11	18.25	---	---	---	---	---	4	3	Halogen light source.
C 65378	(3) 100W (M)	6	25.25	64	33	90°	103	36	---	---	(23-30W CFL) Additional stem 2999 (12") OZ.

Measurements shown in inches. U.S. & Canadian Patent Pending. Art Glass shades are natural materials – colors, patterns and textures will vary from piece to piece.

LEEDS™

ANTIQUPE PEWTER FINISH WITH
SATIN-ETCHED CASED OPAL GLASS



A | 42428 AP
Chandelier



B | 42427 AP
Linear Chandelier

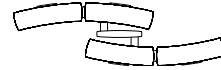

C | 42430 AP
Linear Chandelier



LEEDS™

ITEM #	FINISH	INCAND. BULB	W	H	OVRL. H	L	EXTRA WIRE	CHAIN/STEM	NOTES
A	42428 AP	(9) 100W (M)	36	29	67	---	110	36	Ⓜ (23-30W CFL) Add. chain 4901 AP, add. stem 4935 (12") AP. Sloped ceiling kit included.
B	42427 AP	(8) 60W (C/K) Ⓜ	11	16.5	59	37.5	99	36	Add. chain 4901 AP, add. stem 4935 (12") AP. Sloped ceiling kit incl. Krypton bulb included.
C	42430 AP	(16) 60W (C/K) Ⓜ	14	17.75	56	48.75	94	36	Add. chain 4901 AP, add. stem 4935 (12") AP. Sloped ceiling kit incl. Krypton bulb included.

Measurements shown in inches. U.S. & Canadian Patent Pending.



Shown as Mini Chandelier - 12.75" H.



Shown as Semi Flush - 12" H.



Shown as Wall Mount - 20" H.

COORDINATING
CEILING FAN

See the full line of Kichler®
Ceiling Fans in catalog K414
or visit kichler.com



E | 300427 AP

PENDALETTE®

Create three distinct lighting
options with one fixture:
Mini Chandelier, Wall Mount
or Semi Flush.

D | 42424 AP



F | 42431 AP
Oval Chandelier

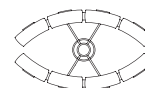

LEEDS™

	ITEM #	FINISH	INCAND. BULB	W	H	OVRL. H	L	EXTRA WIRE	CHAIN/ STEM	EXT.	HCWO	NOTES
D	42424	AP	(3) 60W (C)	11.25	12.75	87	---	37	72	10.5	2.75	Additional chain 2996 AP.
E	300427	AP	---	---	---	---	---	---	---	---	---	See the full line of Kichler® Ceiling Fans in catalog K414 or visit kichler.com.
F	42431	AP	(16) 60W (C/K)	20.75	22.5	61	36.25	110	36	---	---	Additional chain 4901 AP, additional stem 4935 (12") AP. Krypton bulb included.

Measurements shown in inches. U.S. & Canadian Patent Pending: D, F.

LEEDS™

ANTIQUE PEWTER FINISH WITH
SATIN-ETCHED CASED OPAL GLASS



A | 42433 AP
Semi Flush



B | 42432 AP
Mini Pendant



C | 45224 AP
Wall Sconce
ADA Compliant



D | 42426 AP
Chandelier



E | 42425 AP
Mini Chandelier

LEEDS™

ITEM #	FINISH	INCAND. BULB	W	H	OVRLL. H	EXTRA WIRE	CHAIN/STEM	EXT.	HCWO	NOTES
A	42433	AP	(3) 100W (M)	17.25	10	---	---	---	---	(23-30W CFL)
B	42432	AP	(1) 100W (M)	4.5	12.75	51	64	36	---	(23-30W CFL) Additional chain 2996 AP, additional stem 2999 (12") AP. Sloped ceiling kit included.
C	45224	AP	(1) 60W (C)	4.75	8.5	---	---	4	4.5	ADA
D	42426	AP	(5) 60W (C)	24	21.75	60	73	36	---	Additional chain 2996 AP, additional stem 4935 (12") AP. Sloped ceiling kit included.
E	42425	AP	(3) 60W (C)	18	18	56	110	36	---	Additional chain 2996 AP, additional stem 2999 (12") AP. Sloped ceiling kit included.

Measurements shown in inches. U.S. & Canadian Patent Pending.

LEEDS™

SHADOW BRONZE™ FINISH WITH SATIN-ETCHED CASED OPAL GLASS



A | 42427 SWZ
Linear Chandelier



C | 42428 SWZ
Chandelier



B | 42430 SWZ
Linear Chandelier



LEEDS™

ITEM #	FINISH	INCAND. BULB	W	H	OVRLL. H	L	EXTRA WIRE	CHAIN/STEM	NOTES
A	42427 SWZ	(8) 60W (C/K)	11	16.5	59	37.5	99	36	Add. chain 4901 SWZ, add. stem 4935 (12") SWZ. Sloped ceiling kit incl. Krypton bulb incl.
B	42430 SWZ	(16) 60W (C/K)	14	17.75	56	48.75	94	36	Add. chain 4901 SWZ, add. stem 4935 (12") SWZ. Sloped ceiling kit incl. Krypton bulb incl.
C	42428 SWZ	(9) 100W (M)	36	29	67	---	110	36	(23-30W CFL) Add. chain 4901 SWZ, add. stem 4935 (12") SWZ. Sloped ceiling kit incl.

Measurements shown in inches. U.S. & Canadian Patent Pending.

LEEDS™

SHADOW BRONZE™ FINISH WITH
SATIN-ETCHED CASÉD OPAL GLASS

COORDINATING CEILING FAN

See the full line of Kichler®
Ceiling Fans in catalog K414
or visit kichler.com



A | 300427 OBB

PENDALETTE®

Create three distinct lighting
options with one fixture:
Mini Chandelier, Wall Mount
or Semi Flush.

C | 42424 SWZ



Shown as Mini Chandelier - 12.75" H.



Shown as Semi Flush - 12" H.



Shown as Wall Mount - 20" H.



B | 42431 SWZ
Oval Chandelier

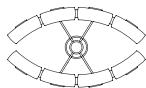

LEEDS™

ITEM #	FINISH	INCAND. BULB	W	H	OVRLL. H	L	EXTRA WIRE	CHAIN/ STEM	EXT.	HCWO	NOTES	
A	300427	OBB	---	---	---	---	---	---	---	---	See the full line of Kichler® Ceiling Fans in catalog K414 or visit kichler.com .	
B	42431	SWZ	(16) 60W (C/K) 	20.75	22.5	61	36.25	110	36	---	Additional chain 4901 SWZ, additional stem 4935 (12") SWZ. Krypton bulb included.	
C	42424	SWZ	(3) 60W (C)	11.25	12.75	87	---	37	72	10.5	2.75	Additional chain 2996 SWZ.

Measurements shown in inches. U.S. & Canadian Patent Pending: B, C.



D | 42433 SWZ
Semi Flush



E | 42432 SWZ
Mini Pendant



F | 45224 SWZ
Wall Sconce
ADA Compliant



G | 42426 SWZ
Chandelier



H | 42425 SWZ
Mini Chandelier

LEEDS™

	ITEM #	FINISH	INCAND. BULB	W	H	OVRL. H	EXTRA WIRE	CHAIN/STEM	EXT.	HCWO	NOTES
D	42433	SWZ	(3) 100W (M)	17.25	10	---	---	---	---	---	☑ (23-30W CFL)
E	42432	SWZ	(1) 100W (M)	4.5	12.75	51	64	36	---	---	☑ (23-30W CFL) Additional chain 2996 SWZ, additional stem 2999 (12") SWZ. Sloped ceiling kit incl.
F	45224	SWZ	(1) 60W (C)	4.75	8.5	---	---	---	4	4.5	Ⓜ ADA
G	42426	SWZ	(5) 60W (C)	24	21.75	60	73	36	---	---	Additional chain 2996 SWZ, additional stem 4935 (12") SWZ. Sloped ceiling kit incl.
H	42425	SWZ	(3) 60W (C)	18	18	56	110	36	---	---	Additional chain 2996 SWZ, additional stem 2999 (12") SWZ. Sloped ceiling kit incl.

Measurements shown in inches. U.S. & Canadian Patent Pending.

SUSPENSION™

BRUSHED NICKEL FINISH WITH
SATIN-ETCHED CASED OPAL GLASS

MATCHING BATH

See matching bath fixtures
on page 480.



B | 42017 NI
Linear Chandelier

A | 45315 NI
Wall Sconce

C | 42016 NI
Mini Pendant

D | 42018 NI
Linear Chandelier

SUSPENSION™

ITEM #	FINISH	INCAND. BULB	W	H	OVRLL. H	L	EXTRA WIRE	CHAIN/STEM	EXT.	HCWO	NOTES
A	NI	(1) 60W (C)	9.5	7	---	---	---	---	4.5	3.5	Krypton bulb included.
B	NI	(3) 60W (C/K)	4.75	11	43	41	101	36	---	---	Additional chain 2996 NI, additional stem 2999 (12") NI and/or 2997 (24") NI. Krypton bulbs included. Height includes one 6" stem.
C	NI	(1) 60W (C/K)	4	11	43	9.25	62	---	---	---	Additional chain 2996 NI, additional stem 2999 (12") NI and/or 2997 (24") NI. Krypton bulbs included. Height includes one 6" stem.
D	NI	(5) 60W (C/K)	4.25	10.5	43	50.75	98	36	---	---	Additional chain 2996 NI, additional stem 2999 (12") NI and/or 2997 (24") NI. Krypton bulbs included. Height includes one 6" stem.

Measurements shown in inches. U.S. & Canadian Patent Pending.

SUSPENSION™

BLACK FINISH WITH
SATIN-ETCHED CASED OPAL GLASS



A | 42016 BK
Mini Pendant



B | 42017 BK
Linear Chandelier



C | 45315 BK
Wall Sconce



D | 42018 BK
Linear Chandelier

SUSPENSION™

ITEM #	FINISH	INCAND. BULB	W	H	OVRLL. H	L	EXTRA WIRE	CHAIN/STEM	EXT.	HCWO	NOTES	
A	42016	BK	(1) 60W (C/K)	4	11	43	9.25	62	---	---	---	Additional chain 2996 BK, additional stem 2999 (12") BK. Krypton bulbs included. Height includes one 6" stem.
B	42017	BK	(3) 60W (C/K)	4.75	11	43	41	101	36	---	---	Additional chain 2996 BK, additional stem 2999 (12") BK. Krypton bulbs included. Height includes one 6" stem.
C	45315	BK	(1) 60W (C)	9.5	7	---	---	---	---	4.5	3.5	Krypton bulb included.
D	42018	BK	(5) 60W (C/K)	4.25	10.5	43	50.75	98	36	---	---	Additional chain 2996 BK, additional stem 2999 (12") BK. Krypton bulbs included. Height includes one 6" stem.

Measurements shown in inches. U.S. & Canadian Patent Pending.



GET INSPIRED AT
KICHLER.COM

GRANBY™

OLDE BRONZE® FINISH WITH
SATIN-ETCHED CASED OPAL GLASS



A | 42559 OZ
Chandelier
NOT TO SCALE

MATCHING BATH

See matching bath fixtures
on pages 498-499.



GET INSPIRED AT
KICHLER.COM





B | 45358 OZ
Wall Sconce



C | 42556 OZ
42556 OZFL
Chandelier/Dinette



D | 42563 OZ
42563 OZFL
Semi Flush

Satin-Etched
White Glass



E | 42557 OZ
42557 OZFL
Chandelier



F | 42562 OZ
42562 OZFL
Mini Pendant



G | 42561 OZ
Inverted Pendant

Satin-Etched
Glass Diffuser

Satin-Etched
White Glass

GRANBY™

ITEM #	FLUOR. ITEM #	FINISH	INCAND. BULB	FLUOR. BULB	W	H	OVRL. H	EXTRA WIRE	CHAIN/STEM	EXT.	HCWO	NOTES
A	42559	---	OZ (9) 100W (M)	---	33.25	32	70	110	36	---	---	Ⓔ (18-25W CFL) Add. chain 4901 OZ, add. stem 4935 (12") OZ.
B	45358	---	OZ (1) 100W (M)	---	5.75	14	---	---	---	7.5	7	Ⓔ (18-25W CFL) May be installed with glass up or down.
C	42556	42556 OZFL	OZ (3) 100W (M)	(3) 13W (GU24) Ⓔ Ⓕ Ⓖ Ⓗ	19	16.5	55	74	36	---	---	Ⓔ (18-25W CFL) Add. chain 2996 OZ, add. stem 2999 (12") OZ, Sloped ceiling kit included.
D	42563	42563 OZFL	OZ (3) 75W (M)	(3) 13W (GU24) Ⓔ Ⓕ Ⓖ Ⓗ	17.25	14	---	---	---	---	---	Ⓔ (18-25W CFL)
E	42557	42557 OZFL	OZ (5) 100W (M)	(5) 13W (GU24) Ⓔ Ⓕ Ⓖ Ⓗ	24	20.5	59	74	36	---	---	Ⓔ (18-25W CFL) Add. chain 2996 OZ, add. stem 2999 (12") OZ, Sloped ceiling kit included.
F	42562	42562 OZFL	OZ (1) 100W (M)	(1) 13W (GU24) Ⓔ Ⓕ Ⓖ Ⓗ	5.25	12.75	47	62	36	---	---	Ⓔ (18-25W CFL) Add. chain 2996 OZ, add. stem 2999 (12") OZ, Sloped ceiling kit included. Height includes one 6" stem.
G	42561	---	OZ (3) 100W (M)	---	24.5	24.5	63	92	36	---	---	Ⓔ (23-30W CFL) Add. chain 2996 OZ, add. stem 2999 (12") OZ, Sloped ceiling kit included.

Measurements shown in inches. U.S. & Canadian Patent Pending.

GRANBY™

BRUSHED PEWTER FINISH WITH
SATIN-ETCHED CASED OPAL GLASS



A | 42559 BPT
Chandelier
NOT TO SCALE

MATCHING BATH

See matching bath fixtures
on pages 498-499.



GET INSPIRED AT
KICHLER.COM





B | 45358 BPT
Wall Sconce



C | 42556 BPT
42556 BPTFL
Chandelier/Dinette



D | 42563 BPT
42563 BPTFL
Semi Flush

Satin-Etched
White Glass



E | 42557 BPT
42557 BPTFL
Chandelier



F | 42562 BPT
42562 BPTFL
Mini Pendant



G | 42561 BPT
Inverted Pendant

Satin-Etched
Glass Diffuser

Satin-Etched
White Glass

GRANBY™

ITEM #	FLUOR. ITEM #	FINISH	INCAND. BULB	FLUOR. BULB	W	H	OVRL. H	EXTRA WIRE	CHAIN/STEM	EXT.	HCWO	NOTES
A	42559	---	BPT (9) 100W (M)	---	33.25	32	70	110	36	---	---	Ⓜ (18-25W CFL) Add. chain 4901 BPT, add. stem 4935 (12") BPT.
B	45358	---	BPT (1) 100W (M)	---	5.75	14	---	---	---	7.5	7	Ⓜ (18-25W CFL) May be installed with glass up or down.
C	42556	42556 BPTFL	BPT (3) 100W (M)	(3) 13W (GU24) Ⓜ Ⓜ Ⓜ	19	16.5	55	74	36	---	---	Ⓜ (18-25W CFL) Add. chain 2996 BPT, add. stem 2999 (12") BPT, Sloped ceiling kit incl.
D	42563	42563 BPTFL	BPT (3) 75W (M)	(3) 13W (GU24) Ⓜ Ⓜ Ⓜ	17.25	14	---	---	---	---	---	Ⓜ (18-25W CFL)
E	42557	42557 BPTFL	BPT (5) 100W (M)	(5) 13W (GU24) Ⓜ Ⓜ Ⓜ	24	20.5	59	74	36	---	---	Ⓜ (18-25W CFL) Add. chain 2996 BPT, add. stem 2999 (12") BPT, Sloped ceiling kit incl.
F	42562	42562 BPTFL	BPT (1) 100W (M)	(1) 13W (GU24) Ⓜ Ⓜ Ⓜ	5.25	12.75	47	62	36	---	---	Ⓜ (18-25W CFL) Add. chain 2996 BPT, add. stem 2999 (12") BPT, Sloped ceiling kit incl. Height incl. one 6" stem.
G	42561	---	BPT (3) 100W (M)	---	24.5	24.5	63	92	36	---	---	Ⓜ (23-30W CFL) Add. chain 2996 BPT, add. stem 2999 (12") BPT, Sloped ceiling kit incl.

Measurements shown in inches. U.S. & Canadian Patent Pending.

ELIAS™

OLDE BRONZE® FINISH WITH
ART GLASS AND CUT STONE



Rectangle
Shape
Art Glass &
Cut Stone
Shades

A | 65373
Linear Chandelier
NOT TO SCALE



Shown as Semi Flush - 10.75" H.

CONVERTIBLE

Create two distinct lighting options with one fixture:
Pendant or Semi Flush.

B | 65374



Shown as Pendant - 10.5" H.



C | 65375
Mini Pendant



E | 69173
Wall Sconce
ADA Compliant



D | 66073
Chandelier

ELIAS™

ITEM #	INCAND. BULB	W	H	OVRL. H	L	EXTRA WIRE	CHAIN/STEM	EXT.	HCWO	NOTES
A	65373 (4) 100W (M)	10	25	64	40	93	36	---	---	☑ (23-30W CFL) Add. chain 2996 OZ, add. stem 2999 (12") OZ. Sloped ceiling kit included.
B	65374 (3) 100W (M)	16	10.5	49	---	70	36	---	---	☑ (23-30W CFL) Add. chain 2996 OZ, add. stem 4935 (12") OZ. Sloped ceiling kit included.
C	65375 (1) 100W (M)	4.75	15	50	---	68	36	---	---	☑ (23-30W CFL) Add. chain 2996 OZ, add. stem 2999 (12") OZ. Sloped ceiling kit included. Height includes one 6" stem.
D	66073 (4) 100W (M)	23	22	63	---	62	36	---	---	☑ (23-30W CFL) Add. chain 2996 OZ, add. stem 2999 (12") OZ. Sloped ceiling kit included.
E	69173 (2) 60W (C)	6	10	---	---	---	---	4	5	☑ ADA

Measurements shown in inches. U.S. & Canadian Patent Pending. Art Glass shades are natural materials – colors, patterns and textures will vary from piece to piece.

HENDRIK™

OLDE BRONZE® FINISH WITH
LIGHT UMBER-ETCHED GLASS

COORDINATING CEILING FAN

See the full line of Kichler®
Ceiling Fans in catalog K414
or visit kichler.com



A | 300114 OZ



B | 1674 OZ
Chandelier
NOT TO SCALE

HENDRIK™

	ITEM #	FINISH	INCAND. BULB	W	H	OVRLL. H	STEM TILT	EXTRA WIRE	CHAIN/STEM	NOTES
A	300114	OZ	---	---	---	---	---	---	---	See the full line of Kichler® Ceiling Fans in catalog K414 or visit kichler.com .
B	1674	OZ	(9) 100W (M)	33.25	25.75	64	45°(12:12)	110	36	 (18-25W CFL) Additional stem 2999 (12") OZ.

Measurements shown in inches. U.S. & Canadian Patent Pending: B.



D | 1672 OZ
Chandelier



E | 3674 OZ
Semi Flush

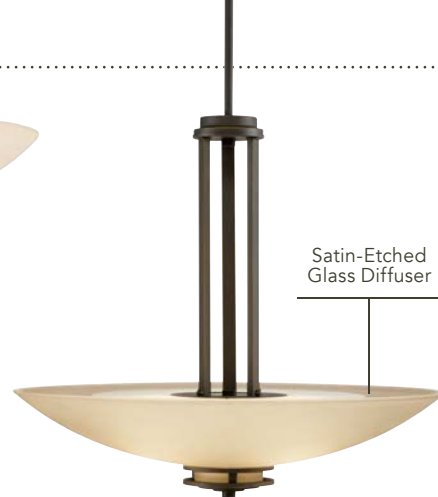

F | 3275 OZ
Inverted Pendant

Satin-Etched
Glass Diffuser



C | 5076 OZ
Wall Sconce



G | 3677 OZ
Semi Flush

MATCHING BATH

See matching bath fixtures
on page 479.



H | 1873 OZ
Chandelier



J | 3875 OZ
Island Chandelier

HENDRIK™

ITEM #	FINISH	INCAND. BULB	W	H	OVRL. H	L	STEM TILT	EXTRA WIRE	CHAIN/STEM	EXT.	HCWO	NOTES
C	5076	NI	(1) 100W (M)	5.25	12	---	---	---	---	8	6	Ⓜ (18-25W CFL) May be installed with glass up or down.
D	1672	NI	(5) 100W (M)	24.5	21.5	60	45°(12:12)	74	36	---	---	
E	3674	NI	(2) 60W (M)	15	10	---	---	---	---	---	---	Ⓜ (13-15W CFL)
F	3275	NI	(3) 100W (M)	24	21.75	60	45°(12:12)	110	36	---	---	Ⓜ (18-25W CFL) Additional chain 2999 (12") NI and/or 2997 (24") NI.
G	3677	NI	(4) 100W (M) ✓	24	12.25	---	---	---	---	---	---	Ⓜ (13-15W CFL)
H	1873	NI	(18) 60W (M)	50.25	41.5	116	---	114	36	---	---	Ⓜ (18-25W CFL) Additional stem 2999 (12") NI and/or 2997 (24") NI.
J	3875	NI	(2) 100W (M)	15	18.5	57	45°(12:12)	104	36	---	---	Additional stem 2999 (12") NI, and/or 2997 (24") NI. G-type bulb recom.

Measurements shown in inches. U.S. & Canadian Patent Pending. Design Patent No: D688,828: C.

HENDRIK™

OLDE BRONZE® FINISH WITH
LIGHT UMBER-ETCHED GLASS



A | 1687 OZ
Mini Pendant
LE



B | 1671 OZ
Chandelier/Dinette



C | 1673 OZ
Oval Chandelier

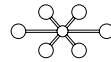

D | 3475 OZ
Mini Pendant



E | 1675 OZ
Chandelier

MATCHING MIRROR

41071 OZ

See page 464 or kichler.com.



HENDRIK™

ITEM #	FINISH	INCAND. BULB	W	H	OVRL. H	L	STEM TILT	EXTRA WIRE	CHAIN/STEM	NOTES
A	1687	OZ (1) 100W (M)	8	8.75	47	---	---	67	36	Ⓜ (23-30W CFL) Additional stem 2999 (12") OZ and/or 2997 (24") OZ.
B	1671	OZ (3) 100W (M)	19	16.75	55	---	45(12:12)	74	36	Ⓜ (18-25W CFL) Additional stem 2999 (12") NI and/or 2997 (24") OZ.
C	1673	OZ (6) 100W (M)	18	22.75	61	35.75	45(12:12)	110	36	Ⓜ (18-25W CFL) Additional stem 2999 (12") NI, and/or 2997 (24") OZ.
D	3475	OZ (1) 100W (M)	5.25	7.5	46	---	---	68	36	Ⓜ (18-25W CFL) Additional chain 2996 NI, additional stem 2999 (12") OZ, and/or 2997 (24") OZ.
E	1675	OZ (15) 75W (M)	42.25	36	110	---	---	74	72	Ⓜ (18-25W CFL) Additional chain 4909 OZ.

Measurements shown in inches. U.S. & Canadian Patent Pending.

HENDRIK™

BRUSHED NICKEL FINISH WITH
SATIN-ETCHED CASED OPAL GLASS

COORDINATING CEILING FAN

See the full line of Kichler®
Ceiling Fans in catalog K414
or visit kichler.com



A | 300114 NI



B | 1674 NI
Chandelier
NOT TO SCALE

HENDRIK™

	ITEM #	FINISH	INCAND. BULB	W	H	OVRL. H	STEM TILT	EXTRA WIRE	CHAIN/STEM	NOTES
A	300114	NI	---							See the full line of Kichler® Ceiling Fans in catalog K414 or visit kichler.com.
B	1674	NI	(9) 100W (M)	33.25	25.75	64	45°(12:12)	110	36	(18-25W CFL) Additional stem 2999 (12") NI and/or 2997 (24") NI.

Measurements shown in inches. U.S. & Canadian Patent Pending

HENDRIK™

BRUSHED NICKEL FINISH WITH
SATIN-ETCHED CASSED OPAL GLASS



A | 1687 NI
Mini Pendant
LE



B | 1671 NI
Chandelier/Dinette



C | 1673 NI
Oval Chandelier

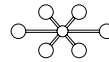

D | 3475 NI
Mini Pendant



E | 1675 NI
Chandelier

MATCHING MIRROR

41071 NI

See page 464 or kichler.com.



HENDRIK™

ITEM #	FINISH	INCAND. BULB	W	H	OVRL. H	L	STEM TILT	EXTRA WIRE	CHAIN/STEM	NOTES
A	1687	NI (1) 100W (M)	8	8.75	47	---	---	67	36	Ⓜ (23-30W CFL) Additional stem 2999 (12") NI and/or 2997 (24") NI.
B	1671	NI (3) 100W (M)	19	16.75	55	---	45(12:12)	74	36	Ⓜ (18-25W CFL) Additional stem 2999 (12") NI and/or 2997 (24") NI.
C	1673	NI (6) 100W (M)	18	22.75	61	35.75	45(12:12)	110	36	Ⓜ (18-25W CFL) Additional stem 2999 (12") NI, and/or 2997 (24") NI.
D	3475	NI (1) 100W (M)	5.25	7.5	46	---	---	68	36	Ⓜ (18-25W CFL) Additional chain 2996 NI, additional stem 2999 (12") NI, and/or 2997 (24") NI.
E	1675	NI (15) 75W (M)	42.25	36	110	---	---	74	72	Ⓜ (18-25W CFL) Additional chain 4909 NI.

Measurements shown in inches. U.S. & Canadian Patent Pending.



G | 1672 NI
Chandelier



H | 3674 NI
Semi Flush

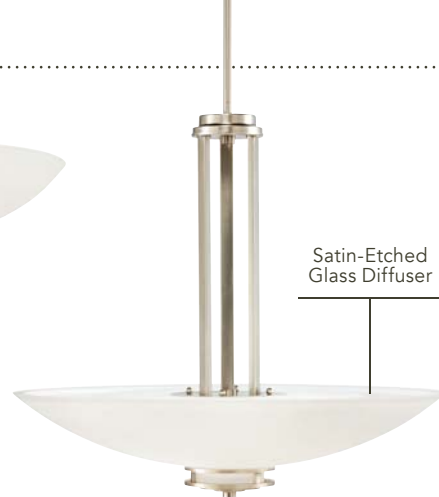

Satin-Etched
Glass Diffuser

J | 3275 NI
Inverted Pendant



F | 5076 NI
Wall Sconce



K | 3677 NI
Semi Flush

MATCHING BATH

See matching bath fixtures
on page 478.



L | 1873 NI
Chandelier



M | 3875 NI
Island Chandelier

HENDRIK™

ITEM #	FINISH	INCAND. BULB	W	H	OVRL. H	L	STEM TILT	EXTRA WIRE	CHAIN/STEM	EXT.	HCWO	NOTES
F	5076	NI	(1) 100W (M)	5.25	12	---	---	---	---	8	6	Ⓢ (18-25W CFL) May be installed with glass up or down.
G	1672	NI	(5) 100W (M)	24.5	21.5	60	---	45°(12:12)	74	36	---	Ⓢ (13-15W CFL)
H	3674	NI	(2) 60W (M)	15	10	---	---	---	---	---	---	Ⓢ (18-25W CFL) Additional chain 2999 (12") NI and/or 2997 (24") NI.
J	3275	NI	(3) 100W (M)	24	21.75	60	---	45°(12:12)	110	36	---	Ⓢ (13-15W CFL)
K	3677	NI	(4) 100W (M)	24	12.25	---	---	---	---	---	---	Ⓢ (18-25W CFL) Additional stem 2999 (12") NI and/or 2997 (24") NI.
L	1873	NI	(18) 60W (M)	50.25	41.5	116	---	---	114	36	---	Ⓢ (18-25W CFL) Additional stem 2999 (12") NI, and/or 2997 (24") NI. G-type bulb recom.
M	3875	NI	(2) 100W (M)	15	18.5	57	36.25	45°(12:12)	104	36	---	Ⓢ (18-25W CFL) Additional stem 2999 (12") NI, and/or 2997 (24") NI. G-type bulb recom.

Measurements shown in inches. U.S. & Canadian Patent Pending. Design Patent No: D688,828: F.

BRYCE

BRUSHED NICKEL FINISH WITH
ART GLASS AND CUT STONE



A | 69164
Semi Flush



B | 69163
Wall Sconce
ADA Compliant



C | 65364
Mini Pendant

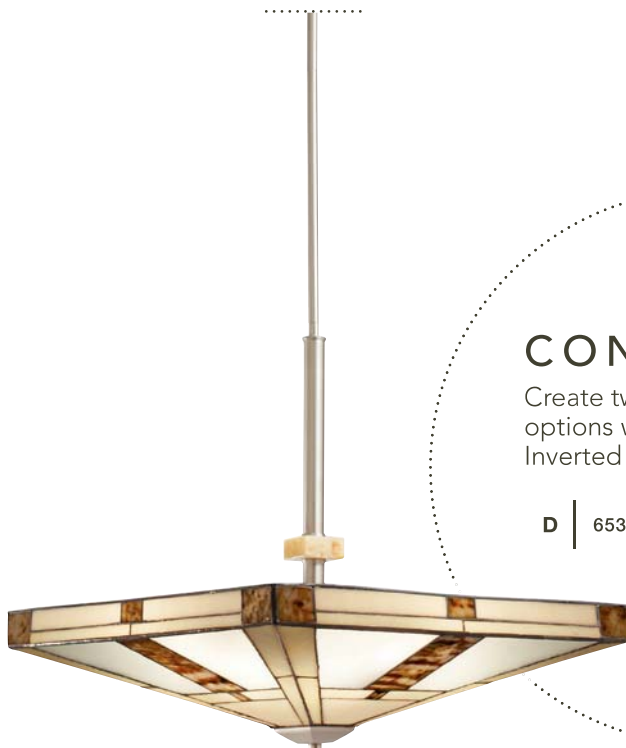

Shown as Inverted Pendant - 20.5" H.

CONVERTIBLE

Create two distinct lighting options with one fixture:
Inverted Pendant or Semi Flush.

D | 65363



Shown as Semi Flush - 20.5" H.

BRYCE

ITEM #	INCAND. BULB	W	H	OVRL. H	EXTRA WIRE	CHAIN/STEM	EXT.	HCWO	NOTES
A	69164 (3) 100W (M)	14	11.75	---	---	---	---	---	☑ (23-30W CFL)
B	69163 (2) 100W (M)	8.25	13	---	---	---	4	6.5	☑ ADA ☑ (23-30W CFL)
C	65364 (1) 100W (M)	6	9.75	48	66	36	---	---	☑ (23-30W CFL) Add. chain 2996 NI, add. stem 2999 (12") and/or 2997 (24") NI. Sloped ceiling kit incl.
D	65363 (4) 100W (M)	20	20.5	62	68	36	---	---	☑ (23-30W CFL) Add. chain 2996 NI, add. stem 4935 (12") NI. Sloped ceiling kit incl.

Measurements shown in inches. U.S. & Canadian Patent Pending. Art Glass shades are natural materials – colors, patterns and textures will vary from piece to piece.

MORTON™

OLDE BRONZE® FINISH WITH
ART GLASS AND CUT STONE



A | 65354
Mini Pendant



B | 65356
Semi Flush



C | 66054
Chandelier



D | 65355
Inverted Pendant

MORTON™

ITEM #	INCAND. BULB	W	H	OVRLL. H	EXTRA WIRE	CHAIN/STEM	NOTES
A 65354	(1) 100W (M)	9	14	51	68	36	☑ (23-30W CFL) Additional chain 2996 OZ, additional stem 2999 (12") OZ. Height includes one 6" stem.
B 65356	(3) 100W (M)	19.75	10.75	---	---	---	☑ (23-30W CFL)
C 66054	(5) 100W (M)	27	20.25	59	74	36	☑ (23-30W CFL) Additional chain 4901 OZ, additional stem 2999 (12") OZ.
D 65355	(4) 150W (M)	26	26	64	91	36	☑ (23-30W CFL) Additional chain 4901 OZ, additional stem 2999 (12") OZ.

Measurements shown in inches. U.S. & Canadian Patent Pending. Art Glass shades are natural materials – colors, patterns and textures will vary from piece to piece.



GET INSPIRED AT
KICHLER.COM

Arvella™ Chandelier 43087 NI & Mini Chandelier 43084 NI | Page 113

ARVELLA™

BRUSHED NICKEL FINISH WITH SATIN-ETCHED CASED OPAL GLASS

Shown as Mini Chandelier - 18.25" H.

CONVERTIBLE

Create two distinct lighting options with one fixture: Mini Chandelier or Semi Flush.

A | 43084 NI



Shown as Semi Flush - 19" H.



B | 45385 NI
Wall Sconce

C | 43089 NI
Mini Pendant



D | 43087 NI
Chandelier



E | 43085 NI
Chandelier

MATCHING BATH

See matching bath fixtures on page 481.



ARVELLA™

ITEM #	FINISH	INCAND. BULB	W	H	OVRL. H	EXTRA WIRE	CHAIN/STEM	EXT.	HCWO	NOTES	
A	43084	NI	(3) 100W (M)	18	18.25	47	74	36	---	---	Ⓜ (23-30W CFL) Add. chain 2996 NI, add. stem 2999 (12") NI and/or 2997 (24") NI. Height includes one 12" stem. Sloped ceiling kit included.
B	45385	NI	(1) 100W (M)	5	10.5	---	---	6.5	8	Ⓜ (23-30W CFL) May be installed with glass up or down.	
C	43089	NI	(1) 100W (M)	5	13	48	68	36	---	---	Ⓜ (23-30W CFL) Add. chain 2996 NI, add. stem 2999 (12") NI and/or 2997 (24") NI. Height includes one 6" stem. Sloped ceiling kit included.
D	43087	NI	(8) 100W (M)	31.75	27.5	57	109	36	---	---	Ⓜ (23-30W CFL) Add. chain 4901 NI, add. stem 2999 (12") NI and/or 2997 (24") NI. Height includes one 12" stem. Sloped ceiling kit included.
E	43085	NI	(4) 100W (M)	25	19	48	109	36	---	---	Ⓜ (23-30W CFL) Add. chain 2996 NI, add. stem 2999 (12") NI and/or 2997 (24") NI. Height includes one 12" stem. Sloped ceiling kit included.

Measurements shown in inches. U.S. & Canadian Patent Pending

ANSONIA™

BRUSHED NICKEL FINISH WITH
SATIN-ETCHED GLASS



A | 3849 NI
Island Chandelier



B | 1749 NI
Chandelier



C | 1748 NI
Chandelier/Dinette

ANSONIA™

ITEM #	FINISH	INCAND. BULB	W	H	OVRL. H	L	EXTRA WIRE	CHAIN/STEM	NOTES	
A	3849	NI	(2) 100W (M)	13	8.5	47	32	110	36	☑ (23-30W CFL) Additional chain 2996 NI, additional stem 2999 (12") NI and/or 2997 (24") NI. G-type bulb recommended.
B	1749	NI	(9) 100W (M)	26	22.75	97	---	27	72	☑ (9-13W CFL) Additional chain 2996 NI.
C	1748	NI	(5) 100W (M)	22	16.25	91	---	31	72	☑ (9-13W CFL) Additional chain 2996 NI. May be installed with glass up or down.
D	3348	NI	(1) 100W (M)	12	15.5	90	---	32	72	☑ (18-25W CFL) Additional chain 2996 NI.

Measurements shown in inches.



Shown as Inverted Pendant - 15.5" H.

CONVERTIBLE

Create two distinct lighting options with one fixture:
Inverted Pendant or Semi Flush.

D | 3348 NI



E | 3349 NI
Pendant



G | 3345 NI
Mini Pendant



H | 5446 NI
Wall Sconce



Shown as Semi Flush - 15" H.



F | 3347 NI
Inverted Pendant

MATCHING BATH

See matching bath fixtures
on page 522.



ANSONIA™

	ITEM #	FINISH	INCAND. BULB	W	H	OVRLL. H	EXTRA WIRE	CHAIN/STEM	EXT.	HCWO	NOTES
E	3349	NI	(1) 150W (M)	15	15	89	32	72	---	---	Ⓜ (23-30W CFL) Additional chain 2996 NI. G-type bulb recommended.
F	3347	NI	(3) 150W (M)	15	20.75	98	26	72	---	---	Ⓜ (23-30W CFL) Additional chain 2996 NI.
G	3345	NI	(1) 100W (M)	4.75	13.75	88	25	72	---	---	Ⓜ (9-13W CFL) Additional chain 2996 NI.
H	5446	NI	(1) 100W (M)	5.5	9.25	---	---	---	5.5	2.75	ⓂⓂ (9-13W CFL) May be installed with glass up or down.

Measurements shown in inches.

ARMIDA™

BRUSHED NICKEL FINISH WITH
SATIN-ETCHED WHITE GLASS



A | 45374 NI
Wall Sconce



C | 43073 NI
43073 NIFL
Mini Chandelier



B | 43077 NI
43077 NIFL
Mini Pendant



D | 43075 NI
Chandelier

ARMIDA™

ITEM #	FLUOR. ITEM #	FINISH	INCAND. BULB	FLUOR. BULB	W	H	OVRL. H	EXTRA WIRE	CHAIN/STEM	EXT.	HCWO	NOTES
A	45374	NI	(1) 100W (M)	---	5	10.75	---	---	---	7.25	7	Ⓜ (23-30W CFL) May be installed with glass up or down.
B	43077	43077 NIFL	(1) 100W (M)	(1) 13W (GU24) Ⓜ Ⓟ Ⓡ	4.75	8	46	68	36	---	---	Ⓜ (23-30W CFL) Add. chain 2996 NI, add. stem 2999 (12") NI and/or 2997 (24") NI.
C	43073	43073 NIFL	(3) 100W (M)	(3) 13W (GU24) Ⓜ Ⓟ Ⓡ	18	14.25	53	65	36	---	---	Ⓜ (23-30W CFL) Additional chain 2996 NI.
D	43075	NI	(9) 100W (M)	---	32.5	26.5	65	56	36	---	---	Ⓜ (23-30W CFL) Additional chain 2996 NI.

Measurements shown in inches. U.S. & Canadian Patent Pending.



Shown as Inverted Pendant - 15.25" H.

CONVERTIBLE

Create two distinct lighting options with one fixture:
Inverted Pendant or Semi Flush.

E | 3694 NIW



Shown as Semi Flush - 13.5" H.



F | 43076 NI
43076 NIFL
Large Foyer Pendant

MATCHING BATH

See matching bath fixtures on page 520.



G | 43074 NI
43074 NIFL
Chandelier

ARMIDA™

GET INSPIRED AT
KICHLER.COM



ITEM #	FLUOR. ITEM #	FINISH	INCAND. BULB	FLUOR. BULB	W	H	OVRL. H	EXTRA WIRE	CHAIN/STEM	EXT.	HCWO	NOTES
E 3694	---	NIW	(2) 100W (M)	---	15	15.25	90	30	72	---	---	☑ (23-30W CFL) Add. chain 2996 NI.
F 43076	43076 NIFL	NI	(1) 100W (M)	(1) 13W (GU24)	12.75	24.25	63	64	36	---	---	☑ (23-30W CFL) Add. chain 2996 NI.
G 43074	43074 NIFL	NI	(5) 100W (M)	(5) 13W (GU24)	25.25	18	56	62	36	---	---	☑ (23-30W CFL) Add. chain 2996 NI.

Measurements shown in inches. U.S. & Canadian Patent Pending: F, G.

ARMIDA™

OLDE BRONZE® FINISH WITH
SATIN-ETCHED WHITE GLASS



A | 45374 OZ
Wall Sconce



C | 43073 OZ
43073 OZFL
Mini Chandelier



B | 43077 OZ
43077 OZFL
Mini Pendant



D | 43075 OZ
Chandelier

ARMIDA™

ITEM #	FLUOR. ITEM #	FINISH	INCAND. BULB	FLUOR. BULB	W	H	OVRL. H	EXTRA WIRE	CHAIN/STEM	EXT.	HCWO	NOTES
A	---	OZ	(1) 100W (M)	---	5	10.75	---	---	---	7.25	7	Ⓢ (23-30W CFL) May be installed with glass up or down.
B	43077 OZFL	OZ	(1) 100W (M)	(1) 13W (GU24) Ⓢ Ⓢ Ⓢ	4.75	8	46	68	36	---	---	Ⓢ (23-30W CFL) Add. chain 2996 OZ, add. stem 2999 (12") OZ.
C	43073 OZFL	OZ	(3) 100W (M)	(3) 13W (GU24) Ⓢ Ⓢ Ⓢ	18	14.25	53	65	36	---	---	Ⓢ (23-30W CFL) Additional chain 2996 OZ.
D	---	OZ	(9) 100W (M)	---	32.5	26.5	65	56	36	---	---	Ⓢ (23-30W CFL) Additional chain 2996 OZ.

Measurements shown in inches. U.S. & Canadian Patent Pending.



Shown as Inverted Pendant - 15.25" H.

CONVERTIBLE

Create two distinct lighting options with one fixture:
Inverted Pendant or Semi Flush.

E | 3694 OZW



Shown as Semi Flush - 13.5" H.



F | 43076 OZ
43076 OZFL
Large Foyer Pendant

MATCHING BATH

See matching bath fixtures on page 521.



G | 43074 OZ
43074 OZFL
Chandelier

ARMIDA™

ITEM #	FLUOR. ITEM #	FINISH	INCAND. BULB	FLUOR. BULB	W	H	OVRL. H	EXTRA WIRE	CHAIN/STEM	EXT.	HCWO	NOTES
E 3694	---	OZW	(2) 100W (M)	---	15	15.25	90	30	72	---	---	☑ (23-30W CFL) Add. chain 2996 OZ.
F 43076	43076 OZFL	OZ	(1) 100W (M)	(1) 13W (GU24)	12.75	24.25	63	64	36	---	---	☑ (23-30W CFL) Add. chain 2996 OZ.
G 43074	43074 OZFL	OZ	(5) 100W (M)	(5) 13W (GU24)	25.25	18	56	62	36	---	---	☑ (23-30W CFL) Add. chain 2996 OZ.

Measurements shown in inches. U.S. & Canadian Patent Pending: F, G.

NEILLO™

ANVIL IRON FINISH AND BRUSHED
NICKEL ACCENTS WITH TEXTURED
FEATHER GLASS

Dramatic Curved
Arm Detail





A | 43028 AVI Mini Pendant



B | 43030 AVI Wall Sconce



C | 43025 AVI Mini Chandelier



D | 43027 AVI Chandelier



E | 43026 AVI Chandelier

NEILLO™

GET INSPIRED AT
KICHLER.COM



ITEM #	FINISH	INCAND. BULB	W	H	OVRL H	STEM TILT	EXTRA WIRE	CHAIN/STEM	EXT.	HCWO	NOTES	
A	43028	AVI	(1) 100W (M)	6.25	13.75	52	90°	67	36	---	---	☑ (23-30W CFL) Add. stem 2999 (12") AVI.
B	43030	AVI	(1) 100W (M)	6.25	14	---	---	---	8.25	6.25	☑ (23-30W CFL) May be installed with glass up or down.	
C	43025	AVI	(3) 100W (M)	18	18.25	59	---	74	36	---	---	☑ (23-30W CFL) Add. chain 2996 AVI, add. stem 2999 (12") AVI. Sloped ceiling kit incl.
D	43027	AVI	(9) 100W (M)	36	34	75	---	110	36	---	---	☑ (23-30W CFL) Add. chain 4901 AVI, add. stem 2999 (12") AVI. Sloped ceiling kit incl.
E	43026	AVI	(4) 100W (M)	25	21.5	62	---	110	36	---	---	☑ (23-30W CFL) Add. chain 2996 AVI, add. stem 2999 (12") AVI. Sloped ceiling kit incl.

Measurements shown in inches. U.S. & Canadian Patent Pending.

OLYMPIA™

ANTIQUE PEWTER FINISH WITH
SATIN-ETCHED WHITE GLASS



A | 1680 AP
Chandelier



B | 1861 AP
Chandelier



C | 1678 AP
Mini Chandelier



D | 1679 AP
10776 AP
Chandelier



E | 1681 AP
Chandelier

**COORDINATING
CEILING FAN**

See the full line of Kichler®
Ceiling Fans in catalog K414
or visit kichler.com



F | 300011 AP

OLYMPIA™

ITEM #	FLUOR. ITEM #	FINISH	INCAND. BULB	FLUOR. BULB	W	H	OVRL. H	STEM TILT	EXTRA WIRE	CHAIN/STEM	NOTES	
A	1680	---	AP	(9) 60W (C)	---	32	25	63	45°(12:12)	109	36	Add. stem 2999 (12") AP.
B	1861	---	AP	(20) 60W (M)	---	59	45.5	84	---	120	36	Ⓢ (9-13W CFL) Add. chain 4909 AP, add. stem 4935 (12") AP.
C	1678	---	AP	(5) 60W (C)	---	16.5	12	50	---	170	36	Add. chain 2996 AP, add. stem 2999 (12") AP.
D	1679	10776	AP	(5) 60W (C)	(5) 13W (GU24) Ⓢ Ⓢ	27	16.75	55	45°(12:12)	73	36	Add. stem 2999 (12") AP. G-type lamp recommended.
E	1681	---	AP	(15) 60W (C)	---	42	34	72	---	106	36	Add. chain 4901 AP, add. stem 2999 (12") AP. G-type lamp recommended.
F	300011	---	AP	---	---	---	---	---	---	---	---	See the full line of Kichler® Ceiling Fans in catalog K414 or visit kichler.com.

Measurements shown in inches. U.S. & Canadian Patent Pending: B, C, E, F; U.S. Design Patent No. D575,446: A; U.S. Design No. D550,886: D.

OLYMPIA™

ANTIQUE PEWTER FINISH WITH
SATIN-ETCHED WHITE GLASS



A | 7779 AP
Directional Rail Light



B | 7703 AP
Directional Rail Light



C | 3279 AP
Inverted Pendant



D | 3278 AP
3278 APFL
Inverted Pendant

OLYMPIA™

ITEM #	FLUOR. ITEM #	FINISH	INCAND. BULB	FLUOR. BULB	W	H	OVRL. H	L	STEM TILT	EXTRA WIRE	CHAIN/STEM	EXT.	HCWO	NOTES
A	7779	---	AP (3) 50W (GU10) MR16 ✓ ⓓ	---	5.5	9.25	---	25.25	---	---	---	7	2.75	ⓓ May be ceiling or wall mounted, Halogen light source.
B	7703	---	AP (4) 50W (GU10) MR16 ✓ ⓓ	---	5.5	9.75	---	32	---	---	---	7.5	2.75	ⓓ May be ceiling or wall mounted, Halogen light source.
C	3279	---	AP (5) 150W (M)	---	36	31	69	---	---	95	36	---	---	ⓓ (23-30W CFL) Add. chain 4901 AP, add. stem 2999 (12") AP.
D	3278	3278 APFL	AP (3) 150W (M)	(3) 13W (GU24) ⓓ ⓔ ⓕ ⓖ ⓗ ⓘ	24	21	59	---	45° (12:12)	59	36	---	---	ⓓ (23-30W CFL) Add. stem 2999 (12") AP.

Measurements shown in inches. U.S. & Canadian Patent Pending: A.



E | 3478 AP
10780 AP
Mini Pendant



F | 3606 AP
Semi Flush



G | 6079 AP
10678 AP
Wall Sconce



H | 3678 AP
3678 APFL
Semi Flush













J | 1676 AP
Chandelier



K | 2978 AP
Island Chandelier

OLYMPIA™

ITEM #	FLUOR. ITEM #	FINISH	INCAND. BULB	FLUOR. BULB	W	H	OVRL. H	L	STEM TILT	EXTRA WIRE	CHAIN/STEM	EXT.	HCWO	NOTES
E	3478	---	AP (1) 60W (C)	---	8	14	52	---	45°(12:12)	59	36	---	---	Add. stem 2999 (12") AP. G-type lamp rec.
E	---	10780		(1) 13W (GU24)  	8	15.75	54	---	45°(12:12)	59	36	---	---	Add. stem 2999 (12") AP. G-type lamp recommended.
F	3606	---	AP (3) 100W (M)	---	24	11.25	---	---	---	---	---	---	---	 (23-30W CFL)
G	6079	10678	AP (1) 60W (C)	(1) 13W (GU24)  	5	12	---	---	---	---	---	6.75	6.75	 G-type lamp rec., May be installed with glass up or down.
H	3678	3678 APFL	AP (1) 150W (M)	(1) 13W (GU24)  	18	12	---	---	---	---	---	---	---	 (30-52W CFL)
J	1676	---	AP (5) 60W (C)	---	27	17	55	---	45°(12:12)	73	36	---	---	Add. stem 2999 (12") AP. G-type lamp rec. for downlight.
K	2978	---	AP (2) 150W (M)	---	14.75	17.5	56	38	45°(12:12)	99	36	---	---	 (18-25W CFL) Add. stem 2999 (12") AP. G-type lamp rec.

Measurements shown in inches. U.S. Patent No. D577,850: H; U.S. Patent No. D563,026: K.

OLYMPIA™

OLDE BRONZE® FINISH WITH
SATIN-ETCHED WHITE GLASS

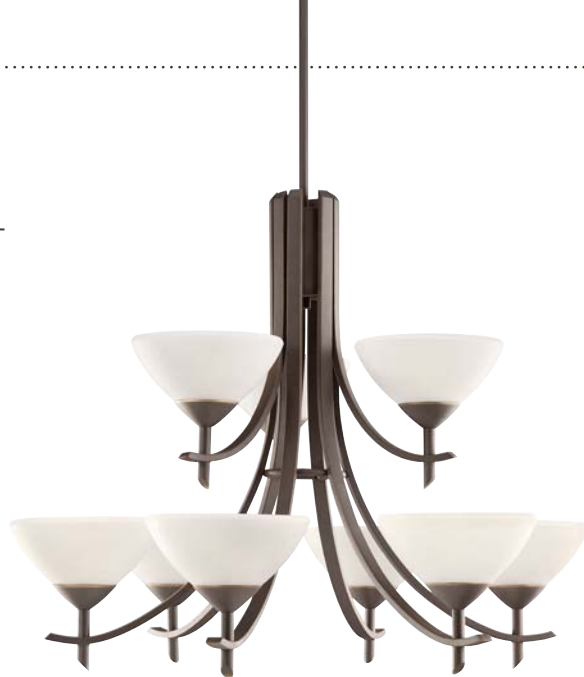

A | 1680 OZW
Chandelier



B | 1861 OZW
Chandelier



C | 1678 OZW
Mini Chandelier



D | 1679 OZW
Chandelier



E | 1681 OZW
Chandelier

**COORDINATING
CEILING FAN**

See the full line of Kichler®
Ceiling Fans in catalog K414
or visit kichler.com



F | 300011 OZW

OLYMPIA™

	ITEM #	FINISH	INCAND. BULB	W	H	OVRL. H	STEM TILT	EXTRA WIRE	CHAIN/STEM	NOTES
A	1680	OZW	(9) 60W (C)	32	25	63	45°(12:12)	109	36	Additional stem 2999 (12") OZ.
B	1861	OZW	(20) 60W (M)	59	45.5	84	---	120	36	① (9-13W CFL) Additional chain 4909 OZ, additional stem 4935 (12") OZ.
C	1678	OZW	(5) 60W (C)	16.5	12	50	---	170	36	Additional chain 2996 OZ, additional stem 2999 (12") OZ.
D	1679	OZW	(5) 60W (C)	27	16.75	55	45°(12:12)	73	36	Additional stem 2999 (12") OZ. G-type lamp rec.
E	1681	OZW	(15) 60W (C)	42	34	72	---	106	36	Additional chain 4901 OZ, additional stem 2999 (12") OZ. G-type lamp rec.
F	300011	OZW	---	---	---	---	---	---	---	See the full line of Kichler® Ceiling Fans in catalog K414 or visit kichler.com.

Measurements shown in inches. U.S. & Canadian Patent Pending; F; U.S. Patent No. D575,446; A; U.S. Patent No. D550,886; D.

OLYMPIA™

OLDE BRONZE® FINISH WITH
SATIN-ETCHED WHITE GLASS



A | 3606 OZW
Semi Flush



B | 3478 OZW
Mini Pendant



C | 3279 OZW
Inverted Pendant



D | 3278 OZW
Inverted Pendant

OLYMPIA™

ITEM #	FINISH	INCAND. BULB	W	H	OVRL. H	STEM TILT	EXTRA WIRE	CHAIN/STEM	NOTES
A	3606 OZW	(3) 100W (M)	24	11.25	---	---	---	---	☑ (23-30W CFL)
B	3478 OZW	(1) 60W (C)	8	14	52	45°(12:12)	59	36	Additional stem 2999 (12") OZ. G-type lamp recommended.
C	3279 OZW	(5) 150W (M)	36	31	69	---	95	36	☑ (23-30W CFL) Additional chain 4901 OZ, additional stem 2999 (12") OZ.
D	3278 OZW	(3) 150W (M)	24	21	59	45°(12:12)	59	36	☑ (23-30W CFL) Additional stem 2999 (12") OZ.

Measurements shown in inches. U.S. & Canadian Patent Pending.



E | 6079 OZW
Wall Sconce



F | 3678 OZW
Semi Flush



G | 1676 OZW
Chandelier



H | 2978 OZW
Island Chandelier

OLYMPIA™

ITEM #	FINISH	INCAND. BULB	W	H	OVRL. H	L	STEM TILT	EXTRA WIRE	CHAIN/STEM	EXT.	HCWO	NOTES	
E	6079	OZW	(1) 60W (C)	5	12	---	---	---	---	---	6.75	6.75	Ⓞ G-type lamp rec., May be installed with glass up or down.
F	3678	OZW	(1) 150W (M)	18	12	---	---	---	---	---	---	---	Ⓜ (30-52W CFL)
G	1676	OZW	(5) 60W (C)	27	17	55	---	45°(12:12)	73	36	---	---	Additional stem 2999 (12") OZ. G-type lamp rec. for downlight.
H	2978	OZW	(2) 150W (M)	14.75	17.5	56	38	45°(12:12)	99	36	---	---	Ⓜ (18-25W CFL) Additional stem 2999 (12") OZ. G-type lamp rec.

Measurements shown in inches. U.S. Design Patent No. D563,026: H.

OLYMPIA™

OLDE BRONZE® FINISH WITH
SUNSET MARBLE GLASS

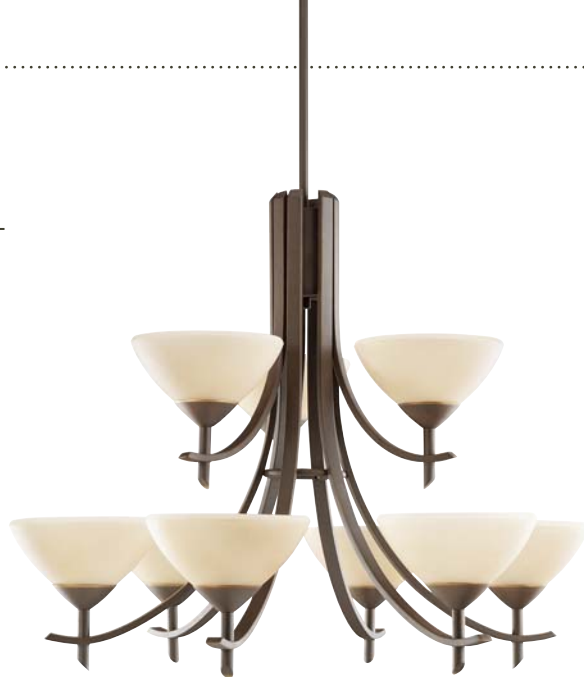

A | 1680 OZ
Chandelier



B | 1861 OZ
Chandelier



C | 1678 OZ
Mini Chandelier



D | 1679 OZ
10776 OZ
Chandelier



E | 1681 OZ
Chandelier

COORDINATING
CEILING FAN

See the full line of Kichler®
Ceiling Fans in catalog K414
or visit kichler.com



F | 300011 OZ

OLYMPIA™

ITEM #	FLUOR. ITEM #	FINISH	INCAND. BULB	FLUOR. BULB	W	H	OVRL. H	STEM TILT	EXTRA WIRE	CHAIN/STEM	NOTES
A	1680	---	OZ (9) 60W (C)	---	32	25	63	45°(12:12)	109	36	Additional stem 2999 (12") OZ.
B	1861	---	OZ (20) 60W (M)	---	59	45.5	84	---	120	36	① (9-13W CFL) Additional chain 4909 OZ, additional stem 4935 (12") OZ.
C	1678	---	OZ (5) 60W (C)	---	16.5	12	50	---	170	36	Additional chain 2996 OZ, additional stem 2999 (12") OZ.
D	1679	10776	OZ (5) 60W (C)	(5) 13W (GU24) ① ②	27	16.75	55	45°(12:12)	73	36	Additional stem 2999 (12") OZ. G-type lamp rec
E	1681	---	OZ (15) 60W (C)	---	42	34	72	---	106	36	Additional chain 4901 OZ, additional stem 2999 (12") OZ. G-type lamp rec.
F	300011	---	OZ	---	---	---	---	---	---	---	See the full line of Kichler® Ceiling Fans in catalog K414 or visit kichler.com

Measurements shown in inches. US Design Patent: D575,446; D: D532,786; D550,886, D585591.

OLYMPIA™

OLDE BRONZE® FINISH WITH
SUNSET MARBLE GLASS



A | 7779 OZ
Directional Rail Light



B | 7703 OZ
Directional Rail Light



C | 3279 OZ
Inverted Pendant



D | 3278 OZ
3278 OZFL
Inverted Pendant

OLYMPIA™

ITEM #	FLUOR. ITEM #	FINISH	INCAND. BULB	FLUOR. BULB	W	H	OVRL. H	L	STEM TILT	EXTRA WIRE	CHAIN/STEM	EXT.	HCWO	NOTES
A	7779	OZ	(3) 50W (GU10) MR16 ✓ ⓓ	---	5.5	9.25	---	25.25	---	---	---	7	2.75	ⓓ May be ceiling or wall mounted, Halogen light source.
B	7703	OZ	(4) 50W (GU10) MR16 ✓ ⓓ	---	5.5	9.75	---	32	---	---	---	7.5	2.75	ⓓ May be ceiling or wall mounted, Halogen light source.
C	3279	OZ	(5) 150W (M)	---	36	31	69	---	---	95	36	---	---	ⓓ (23-30W CFL) Add. chain 4901 OZ, add. stem 2999 (12") OZ.
D	3278	3278 OZFL	(3) 150W (M)	(3) 13W (GU24) ⓓ ⓔ ⓕ ⓖ ⓗ ⓘ	24	21	59	---	45°(12:12)	59	36	---	---	ⓓ (23-30W CFL) Add. stem 2999 (12") OZ.

Measurements shown in inches. U.S. & Canadian Patent Pending: A.



E | 3478 OZ
10780 OZ
Mini Pendant



F | 3606 OZ
Semi Flush



G | 6079 OZ
10678 OZ
Wall Sconce



H | 3678 OZ
3678 OZFL
Semi Flush



J | 1676 OZ
Chandelier



K | 2978 OZ
Island Chandelier

OLYMPIA™

ITEM #	FLUOR. ITEM #	FINISH	INCAND. BULB	FLUOR. BULB	W	H	OVRL. H	L	STEM TILT	EXTRA WIRE	CHAIN/STEM	EXT.	HCWO	NOTES
E	3478	---	(1) 60W (C)	---	8	14	52	---	45°(12:12)	59	36	---	---	Add. stem 2999 (12") OZ. G-Type lamp rec.
E	---	10780		(1) 13W (GU24)	8	15.75	54	---	45°(12:12)	59	36	---	---	Add. stem 2999 (12") OZ. G-type lamp recommended.
F	3606	---	(3) 100W (M)	---	24	11.25	---	---	---	---	---	---	---	(23-30W CFL)
G	6079	10678	(1) 60W (C)	(1) 13W (GU24)	5	12	---	---	---	---	---	6.75	6.75	G-type lamp rec., May be installed with glass up or down.
H	3678	3678 OZFL	(1) 150W (M)	(1) 13W (GU24)	18	12	---	---	---	---	---	---	---	(30-52W CFL)
J	1676	---	(5) 60W (C)	---	27	17	55	---	45°(12:12)	73	36	---	---	Add. stem 2999 (12") OZ. G-type lamp rec. for downlight.
K	2978	---	(2) 150W (M)	---	14.75	17.5	56	38	45°(12:12)	99	36	---	---	(18-25W CFL) Add. stem 2999 (12") OZ. G-type lamp rec.

Measurements shown in inches. U.S. Patent No. D577,850; H; U.S. Patent No. D563,026; K.

DENMAN™

OLDE BRONZE® FINISH WITH
ART GLASS AND CUT STONE



A | 65421
Large Foyer Pendant
NOT TO SCALE
LE



B | 65323
Semi Flush

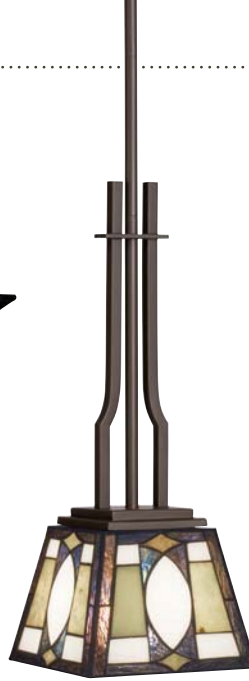

C | 65321
Mini Pendant



D | 69121
Wall Sconce
ADA Compliant



E | 65322
Inverted Pendant



F | 66121
Chandelier/Dinette

DENMAN™

	ITEM #	INCAND. BULB	W	H	OVRLL. H	L	EXTRA WIRE	CHAIN/STEM	EXT.	HCWO	NOTES
A	65421	(4) 100W (M)	16	38.75	113	22.75	19	72			☑ (23-30W CFL) Additional chain 2996 OZ.
B	65323	(2) 100W (M)	14	10.75	---	19.75	---	---	---	---	
C	65321	(1) 100W (M)	7	18.25	57	---	58	36	---	---	Additional chain 2996 OZ, additional stem 2999 (12") OZ.
D	69121	(2) 40W (C) ❖	8	19.5	---	---	---	---	4	3.75	ADA
E	65322	(3) 100W (M)	18	24	98	25.5	58	72	---	---	Additional chain 2996 OZ.
F	66121	(3) 100W (M)	22	20	94	---	37	72	---	---	Additional chain 2996 OZ.

Measurements shown in inches. Art Glass shades are natural materials – colors, patterns and textures will vary from piece to piece.

LADERO™

SHADOW BRONZE™ WITH
SATIN-ETCHED CASÉD OPAL GLASS



A | 42950 SWZ
Wall Sconce



B | 42949 SWZ
Mini Pendant



C | 42947 SWZ
Chandelier



Shown as Mini Chandelier - 20" H

CONVERTIBLE

Create two distinct lighting options with one fixture:
Mini Chandelier or Semi Flush.

D | 42944 SWZ



Shown as Semi Flush - 19.25" H



GET INSPIRED AT
KICHLER.COM

LADERO™

ITEM #	FINISH	INCAND. BULB	W	H	OVRL. H	EXTRA WIRE	CHAIN/STEM	EXT.	HCWO	NOTES
A	42950	SWZ	(1) 100W (M)	5	11.5	---	---	5.25	5.75	(23-30W CFL) May be installed with glass up or down.
B	42949	SWZ	(1) 100W (M)	3.5	11	52	64	36	---	(23-30W CFL) Add. chain 2996 SWZ, add. stem 2999 (12") SWZ. Sloped ceiling kit incl.
C	42947	SWZ	(6) 100W (M)	26	28	68	36	36	---	(23-30W CFL) Add. chain 2996 SWZ, add. stem 2999 (12") SWZ. Sloped ceiling kit incl.
D	42944	SWZ	(3) 100W (M)	17.75	20	61	56	36	---	(23-30W CFL) Add. chain 2996 SWZ, add. stem 2999 (12") SWZ. Sloped ceiling kit incl.

Measurements shown in inches. U.S. & Canadian Patent Pending.

LADERO™

ANTIQUE PEWTER FINISH WITH SATIN-ETCHED CASED OPAL GLASS



A | 42947 AP Chandelier



B | 42949 AP Mini Pendant



C | 42950 AP Wall Sconce



Shown as Mini Chandelier - 20" H

CONVERTIBLE

Create two distinct lighting options with one fixture:
Mini Chandelier or Semi Flush.

D | 42944 AP



Shown as Semi Flush - 19.25" H

LADERO™

ITEM #	FINISH	INCAND. BULB	W	H	OVRLL. H	EXTRA WIRE	CHAIN/STEM	EXT.	HCWO	NOTES	
A	42947	AP	(6) 100W (M)	26	28	68	36	36	---	---	☑ (23-30W CFL) Add. chain 2996 AP, add. stem 2999 (12") AP. Sloped ceiling kit included.
B	42949	AP	(1) 100W (M)	3.5	11	52	64	36	---	---	☑ (23-30W CFL) Add. chain 2996 AP, add. stem 2999 (12") AP. Sloped ceiling kit included.
C	42950	AP	(1) 100W (M)	5	11.5	---	---	---	5.25	5.75	Ⓢ (23-30W CFL) May be installed with glass up or down.
D	42944	AP	(3) 100W (M)	17.75	20	61	56	36	---	---	☑ (23-30W CFL) Add. chain 2996 AP, add. stem 2999 (12") AP. Sloped ceiling kit included.

Measurements shown in inches. U.S. & Canadian Patent Pending.

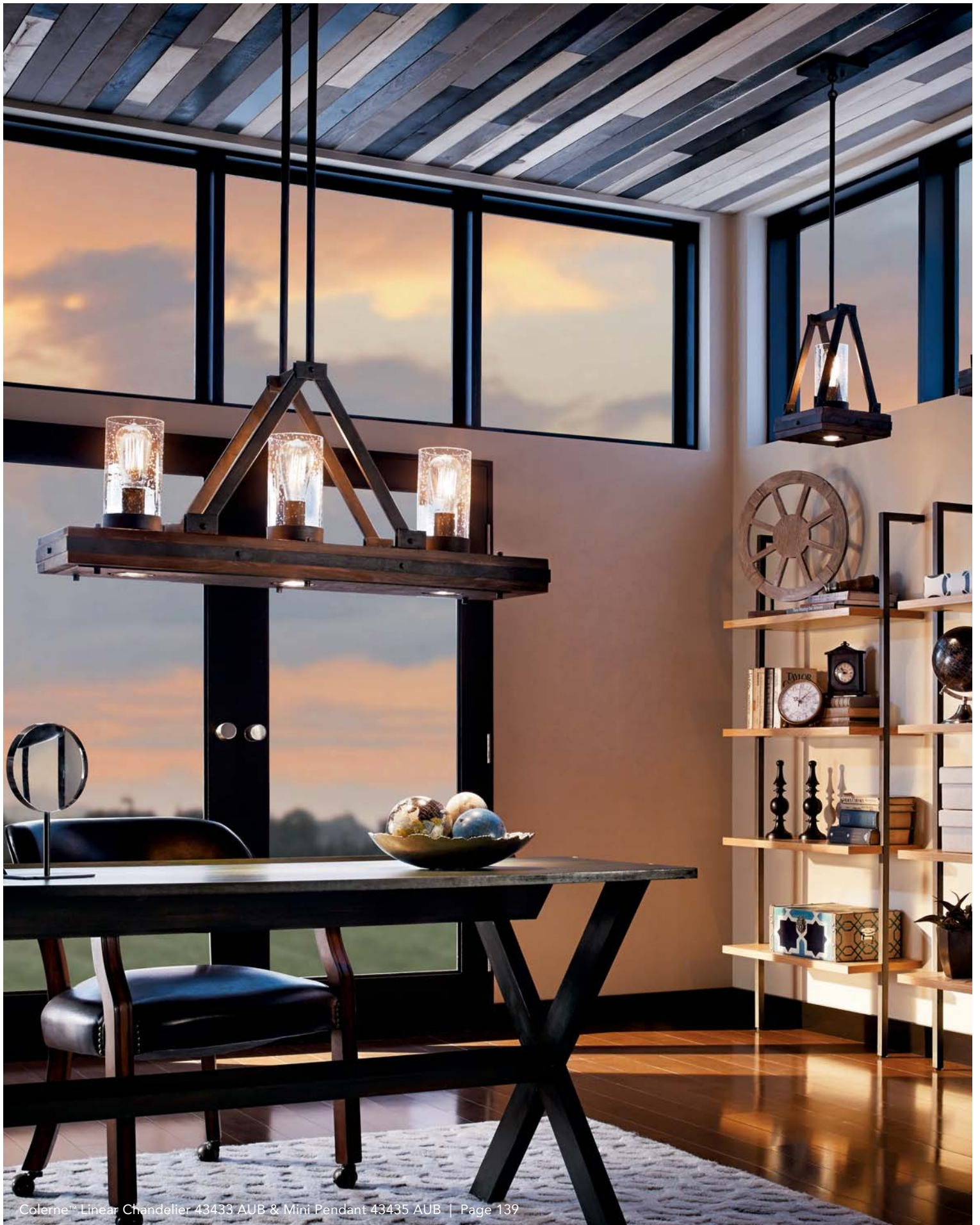

Colerne™ Linear Chandelier 43433 AUB & Mini Pendant 43435 AUB | Page 139

COLERNE™

AUBURN STAINED WOOD
AND DISTRESSED BLACK FINISH
WITH CLEAR SEEDY GLASS



A | 43435 AUB
Pendant



B | 43436 AUB
Wall Sconce



C | 43433 AUB
Linear Chandelier

COLERNE™

GET INSPIRED AT
KICHLER.COM



ITEM #	FINISH	INCAND. BULB	W	H	OVRLL. H	L	EXTRA WIRE	CHAIN/STEM	EXT.	HCWO	NOTES	
A	43435	AUB	(1) 100W (M) & (1) 50W (GU10)	10.5	16.5	55	---	46	36	---	---	Ⓜ (23-30W CFL) Additional chain 2996 AUB, additional stem 4935 (12") AUB.
B	43436	AUB	(1) 100W (M)	8.75	14.75	---	---	---	---	9.5	7.25	Ⓜ (23-30W CFL)
C	43433	AUB	(3) 100W (M) & (3) 50W (GU10)	10.5	16.75	55	35.75	52	36	---	---	Ⓜ (23-30W CFL) Additional chain 4901 AUB, additional stem 4935 (12") AUB.

Measurements shown in inches. U.S. & Canadian Patent Pending.

CRYSTAL BALL

BRUSHED NICKEL FINISH WITH
MOSAIC CRACKLE GLASS



A | 65406



B | 65407



C | 65408

CRYSTAL BALL

ITEM #	INCAND. BULB	W	H	OVRL. H	EXTRA WIRE	CHAIN/STEM	NOTES
A 65406	(1) 100W (M)	8	12.75	51	67	36	☑ (23-30W CFL) Additional chain 2996 NI, additional stem 2999 (12") NI and/or 2997 (24") NI.
B 65407	(1) 100W (M)	8	12.75	51	67	36	☑ (23-30W CFL) Additional chain 2996 NI, additional stem 2999 (12") NI and/or 2997 (24") NI.
C 65408	(1) 100W (M)	8	12.75	51	67	36	☑ (23-30W CFL) Additional chain 2996 NI, additional stem 2999 (12") NI and/or 2997 (24") NI.

Measurements shown in inches.

WHITLEY™

OLDE BRONZE® FINISH WITH SATIN-ETCHED CASED OPAL GLASS



A | 42978 OZ
Mini Pendant



C | 42979 OZ
Wall Sconce



B | 42977 OZ
Chandelier



D | 42976 OZ
Mini Chandelier

WHITLEY™

ITEM #	FINISH	INCAND. BULB	W	H	OVRLL. H	EXTRA WIRE	CHAIN/STEM	EXT.	HCWO	NOTES	
A	42978	OZ	(1) 100W (M)	3.75	14.75	47	68	36	---	---	Ⓜ (23-30W CFL) Add. chain 2996 OZ, add. stem 2999 (12") OZ. Sloped ceiling kit included. Height includes one 6" stem.
B	42977	OZ	(5) 100W (M)	25	29	67	74	36	---	---	Ⓜ (23-30W CFL) Add. chain 2996 OZ, add. stem 2999 (12") OZ. Sloped ceiling kit included.
C	42979	OZ	(1) 100W (M)	5	9.75	---	---	---	5.25	2.5	Ⓜ (23-30W CFL) May be installed with glass up or down.
D	42976	OZ	(3) 100W (M)	18	24	62	74	36	---	---	Ⓜ (23-30W CFL) Add. chain 2996 OZ, add. stem 2999 (12") OZ. Sloped ceiling kit included.

Measurements shown in inches. U.S. & Canadian Patent Pending.

TARLTON™

PATINA BRONZE AND DORÉ BRONZE™
FINISH WITH ART GLASS



A | 69004
Wall Sconce
ADA Compliant



3-Way Pull Chain
Switch

B | 65069
Pendant







C | 69013
Semi Flush



D | 66007
Chandelier

TARLTON™

ITEM #	INCAND. BULB	W	H	OVRL. H	EXTRA WIRE	CHAIN/STEM	EXT.	HCWO	NOTES
A	69004 : (2) 40W (C) 	6.25	13	---	---	---	4	4.75	
B	65069 : (3) 100W (M)	17	9.75	84	32	72	---	---	 (23-30W CFL) Additional chain 2996 DZ.
C	69013 : (2) 100W (M)	14	12	---	---	---	---	---	 (23-30W CFL)
D	66007 : (4) 100W (M)	28	17.5	92	36	72	---	---	 (18-25W CFL) Additional chain 2996 PZ.

Measurements shown in inches. Art Glass shades are natural materials – colors, patterns and textures will vary from piece to piece.

TACOMA™

OLDE BRONZE® FINISH WITH
ART GLASS & CUT STONE



A | 65309
Mini Pendant

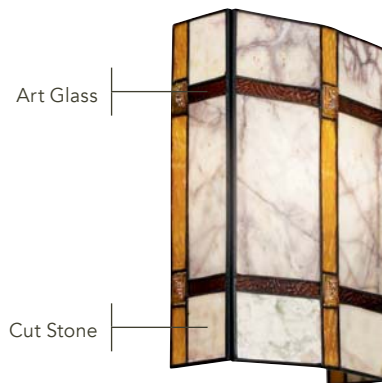

B | 69087
Wall Sconce
ADA Compliant



C | 65308
Linear Chandelier

TACOMA™

ITEM #	INCAND. BULB	W	H	OVRL. H	L	EXTRA WIRE	CHAIN/STEM	EXT.	HCWO	NOTES
A	65309 (1) 100W (M)	5	15	53	8.5	60	36	---	---	Additional chain 2996 OZ, additional stem 2999 (12") OZ.
B	69087 (2) 60W (C)	8	12	---	---	---	---	4	6	ADA
C	65308 (3) 100W (M)	7	17	50	44	95	36	---	---	Additional chain 2996 OZ, additional stem 2999 (12") OZ. Sloped ceiling kit incl.

Measurements shown in inches. Art Glass shades are natural materials – colors, patterns and textures will vary from piece to piece.

DAYZIE™

ANTIQUÉ PEWTER FINISH
WITH MOSAIC ART GLASS



A | 65416
Mini Pendant



Shown as Semi Flush - 15.75" H.

CONVERTIBLE

Create two distinct lighting options with one fixture:
Inverted Pendant or Semi Flush.

B | 65415



Shown as Inverted Pendant - 17.5" H.

SONORA

ART NOUVEAU BRONZE FINISH
WITH ART GLASS



C | 69030
Semi Flush



D | 69032
Wall Sconce
ADA Compliant



E | 65175
Mini Pendant

DAYZIE™ & SONORA

ITEM #	INCAND. BULB	W	H	OVRLL. H	STEM TILT	EXTRA WIRE	CHAIN/STEM	EXT.	HCWO	NOTES
A 65416	(1) 50W (G9)	9.5	4.5	43	90°	68	36	---	---	Additional stem 2999 (12") AP. Halogen light source.
B 65415	(4) 100W (M)	20	17.5	92	---	25	72	---	---	(23-30W) Additional chain 2996 AP.
C 69030	(3) 60W (M)	16.75	6.5	---	---	---	---	---	---	
D 69032	(2) 60W (C)	15	6.5	---	---	---	---	4	2.5	
E 65175	(1) 60W (M)	8	12.75	55	45°(12:12)	68	36	---	---	(18-25W) Additional stem 2999 (12") ANO. Height includes one 6" stem.

Measurements shown in inches. Art Glass shades are natural materials – colors, patterns and textures will vary from piece to piece. U.S. & Canadian Patent Pending: B, C.

SHASTEEN™

OLDE BRONZE® FINISH WITH
MOSAIC ART GLASS



Shown as Pendant - 10.5" H.
NOT TO SCALE

CONVERTIBLE

Create two distinct lighting options with one fixture:
Pendant or Semi Flush.

A | 65403



Shown as Pendant - 10.5" H.

CONVERTIBLE

Create two distinct lighting options with one fixture:
Pendant or Semi Flush.

C | 65404



B | 65405
Mini Pendant



Shown as Semi Flush - 10.5" H.



Shown as Semi Flush - 10.5" H.

SHASTEEN™

ITEM #	INCAND. BULB	W	H	OVRL. H	EXTRA WIRE	CHAIN/STEM	NOTES
A	65403 (5) 100W (M)	21.75	10.5	49	69	36	☑ (23-30W CFL) Additional chain 2996 OZ, additional stem 4935 (12") OZ.
B	65405 (1) 100W (M)	6	7.25	46	68	36	☑ (23-30W CFL) Additional chain 2996 OZ, additional stem 2999 (12") OZ.
C	65404 (3) 100W (M)	16	10.5	48	69	36	☑ (23-30W CFL) Additional chain 2996 OZ, additional stem 2999 (12") OZ.

Measurements shown in inches. Art Glass shades are natural materials – colors, patterns and textures will vary from piece to piece. U.S. & Canadian Patent Pending.

ALAMEDA™

CANYON VIEW™ FINISH OVER
SOLID BRASS WITH HONEY
OPALESCENT ART GLASS PANELS



A | 49090 CV
Indoor/Outdoor Chandelier



B | 49091 CV
Indoor/Outdoor Chandelier



C | 9849 CV
10958 CV
Indoor/Outdoor Pendant



D | 9825 CV
10957 CV
Indoor/Outdoor Flush Mount



E | 9651 CV
10961 CV
Indoor/Outdoor Wall Sconce



F | 9148 CV
Indoor/Outdoor Wall Sconce

ALAMEDA™

ITEM #	FLUOR. ITEM #	FINISH	INCAND. BULB	FLUOR. BULB	W	H	OVRL. H	L	EXTRA WIRE	CHAIN/STEM	EXT.	HCWO	NOTES
A	49090	---	CV (3) 100W (M)	---	6	20	58	36	62	36	---	---	Ⓚ (OD 23-30W CFL) Add. chain 4927 CV, add. stem 2999 (12") CV.
B	49091	---	CV (4) 100W (M)	---	25	17	55	---	65	36	---	---	Ⓚ Add. chain 4927 CV, add. stem 2999 (12") CV.
C	9849	10958	CV (1) 100W (M)	(1) 13W (GU24) Ⓚ Ⓜ	7	11.25	86	---	34	72	---	---	Ⓚ Ⓜ (OD 23-30W CFL) Dark sky compliant with panel inserts 4814WH. Add. chain 4927 CV.
D	9825	10957	CV (2) 75W (M) Ⓚ	(2) 13W (GU24) Ⓚ Ⓜ	11.5	6.25	---	---	---	---	---	---	Ⓚ Ⓜ (OD 18-25W CFL)
E	9651	10961	CV (1) 100W (M)	(1) 13W (GU24) Ⓚ Ⓜ	7	11.5	---	---	---	---	8.5	3	Ⓚ Ⓜ (OD 23-30W CFL) Dark Sky compliant with panel inserts 4812 WH.
F	9148	---	CV (1) 150W (M)	---	7	15	---	---	---	---	8.5	3	Ⓚ Ⓜ (OD 18-25W CFL)

Measurements shown in inches.

CATERHAM™

OLDE BRONZE® FINISH WITH
SATIN-ETCHED CASED OPAL GLASS





A | 49641 OZ
Indoor/Outdoor Semi Flush



B | 49642 OZ
Indoor/Outdoor Wall Sconce



C | 49638 OZ
Indoor/Outdoor Chandelier



D | 49640 OZ
Indoor/Outdoor Mini Pendant

Satin-Etched
Cased Opal Glass

CATERHAM™

ITEM #	FINISH	INCAND. BULB	W	H	OVRL. H	EXTRA WIRE	CHAIN/STEM	EXT.	HCWO	NOTES
A	49641	OZ	(3) 100W (M)	14.75	8.5	---	---	---	---	Ⓧ OD (23-30W CFL)
B	49642	OZ	(1) 100W (M)	6.5	11.75	---	---	7.5	4	Ⓧ OD (23-30W CFL)
C	49638	OZ	(4) 100W (M)	21	12.75	51	73	36	---	Ⓧ OD (23-30W CFL) Additional chain 4927 OZ, additional stem 2999 (12") OZ. Sloped ceiling kit included.
D	49640	OZ	(1) 100W (M)	6.5	16	48	64	36	---	Ⓧ OD (23-30W CFL) Additional chain 4927 OZ, additional stem 2999 (12") OZ. Height includes one 6" stem.

Measurements shown in inches. U.S. & Canadian Patent Pending.



Kailey™ Chandelier 43438 NI | Page 151

KAILEY™

BRUSHED NICKEL FINISH WITH
SATIN-ETCHED GLASS AND
WHITE ORGANZA SHADES



A | 43438 NI
Chandelier
NOT TO SCALE

KAILEY™

GET INSPIRED AT
KICHLER.COM



ITEM #	FINISH	INCAND. BULB	W	H	OVRL. H	EXTRA WIRE	CHAIN/STEM	NOTES
A 43438	NI	(4) 60W (C)	25	13.25	52	64	36	Additional chain 2996 NI, additional stem 2999 (12") NI and/or 2997 (24") NI. G-type bulb recommended.

Measurements shown in inches. U.S. & Canadian Patent Pending.

KAILEY™

BRUSHED NICKEL FINISH WITH
SATIN-ETCHED GLASS AND
WHITE ORGANZA SHADES



A | 45437 NI
Wall Sconce



B | 43442 NI
Mini Pendant



C | 43437 NI
Linear Chandelier

KAILEY™

ITEM #	FINISH	INCAND. BULB	W	H	OVRL. H	L	STEM TILT	EXTRA WIRE	CHAIN/STEM	EXT.	HCWO	NOTES
A	45437	NI	(1) 60W (C)	6	7	---	---	---	---	7.5	4.5	Ⓞ G-type bulb recommended.
B	43442	NI	(1) 50W (G9) Ⓞ	6	10	48	90°	63	36	---	---	Additional stem 2999 (12") NI and/or 2997 (24") NI. Halogen light source.
C	43437	NI	(3) 100W (M)	9	13	51	---	94	36	---	---	Ⓜ (23-30W CFL) Additional chain 2996 NI, additional stem 2999 (12") NI and/or 2997 (24") NI.

Measurements shown in inches. U.S. & Canadian Patent Pending.

LACEY™

ANTIQUE PEWTER FINISH WITH
SATIN-ETCHED CASED OPAL GLASS INNER
DIFFUSERS & WHITE TRANSLUCENT
ORGANZA OUTER SHADES



A | 42383 AP
Chandelier
NOT TO SCALE

LACEY™

GET INSPIRED AT
KICHLER.COM



ITEM #	FINISH	INCAND. BULB	W	H	OVRL. H	EXTRA WIRE	CHAIN/STEM	NOTES
A 42383	AP	(12) 60W (C)	42	32	106	71	72	Additional chain 4901 AP.

Measurements shown in inches. U.S. & Canadian Patent Pending.

LACEY™

ANTIQUPE PEWTER FINISH WITH
SATIN-ETCHED CASED OPAL GLASS INNER
DIFFUSERS & WHITE TRANSLUCENT
ORGANZA OUTER SHADES



A | 42386 AP
Semi Flush



B | 42384 AP
Mini Pendant



C | 42385 AP
Pendant



D | 42387 AP
Semi Flush

Satin-Etched
White Glass

LACEY™

ITEM #	FINISH	INCAND. BULB	W	H	OVRL. H	STEM TILT	EXTRA WIRE	CHAIN/STEM	NOTES
A	42386 AP	(3) 100W (M)	15	10.75	---	---	---	---	Ⓜ (18-25W CFL)
B	42384 AP	(1) 60W (C/K) Ⓜ	6	10.25	49	90°	64	36	Additional stem 2999 (12") AP. Krypton bulb included.
C	42385 AP	(4) 100W (M)	20	23.5	98	---	20	72	Ⓜ (23-30W CFL) Additional chain 2996 AP.
D	42387 AP	(4) 100W (M)	20	13	---	---	---	---	Ⓜ (23-30W CFL)

Measurements shown in inches. U.S. & Canadian Patent Pending.



E | 42381 AP
Chandelier



F | 45281 AP
Wall Sconce

**COORDINATING
CEILING FAN**

See the full line of Kichler®
Ceiling Fans in catalog K414
or visit kichler.com



H | 300181 AP



G | 42382 AP
Chandelier

MATCHING BATH

See matching bath fixtures
on page 536.



LACEY™

	ITEM #	FINISH	INCAND. BULB	W	H	OVRLL. H	EXTRA WIRE	CHAIN/STEM	EXT.	HCWO	NOTES
E	42381	AP	(5) 60W (C)	25	25.75	100	34	72	---	---	Additional chain 2996 AP.
F	45281	AP	(1) 60W (C)	5	10.75	---	---	---	7	6.5	D
G	42382	AP	(9) 60W (C)	34.25	29.5	104	71	72	---	---	Additional chain 4901 AP.
H	300181	AP	---	---	---	---	---	---	---	---	See the full line of Kichler® Ceiling Fans in catalog K414 or visit kichler.com.

Measurements shown in inches. U.S. & Canadian Patent Pending.



Lacey™ Pendant 42385 MIZ | Page 158 & Wall Sconce 45281 MIZ | Page 159

LACEY™

MISSION BRONZE™ FINISH WITH
SATIN-ETCHED CASED OPAL GLASS INNER
DIFFUSERS & LIGHT UMBER TRANSLUCENT
ORGANZA OUTER SHADES



A | 42383 MIZ
Chandelier
NOT TO SCALE

LACEY™

GET INSPIRED AT
KICHLER.COM



ITEM #	FINISH	INCAND. BULB	W	H	OVRL. H	EXTRA WIRE	CHAIN/STEM	NOTES
A 42383	MIZ	(12) 60W (C)	42	32	106	71	72	Additional chain 4901 MIZ.

Measurements shown in inches. U.S. & Canadian Patent Pending.

LACEY™

MISSION BRONZE™ FINISH WITH
SATIN-ETCHED CASED OPAL GLASS INNER
DIFFUSERS & LIGHT UMBER TRANSLUCENT
ORGANZA OUTER SHADES



A | 42386 MIZ
Semi Flush



B | 42384 MIZ
Mini Pendant



C | 42385 MIZ
Pendant



D | 42387 MIZ
Semi Flush

Satin-Etched
Opal Glass

LACEY™

ITEM #	FINISH	INCAND. BULB	W	H	OVRL. H	STEM TILT	EXTRA WIRE	CHAIN/STEM	NOTES	
A	42386	MIZ	(3) 100W (M)	15	10.75	---	---	---	☑ (18-25W CFL)	
B	42384	MIZ	(1) 60W (C/K) Ⓢ	6	10.25	49	90°	64	36	Additional stem 2999 (12") MIZ, Krypton bulb included.
C	42385	MIZ	(4) 100W (M)	20	23.5	98	---	20	72	☑ (23-30W CFL) Additional chain 2996 MIZ.
D	42387	MIZ	(4) 100W (M)	20	13	---	---	---	---	☑ (23-30W CFL)

Measurements shown in inches. U.S. & Canadian Patent Pending.



E | 42381 MIZ Chandelier



F | 45281 MIZ Wall Sconce

COORDINATING CEILING FAN

See the full line of Kichler® Ceiling Fans in catalog K414 or visit kichler.com



H | 300181 OZ



G | 42382 MIZ Chandelier

MATCHING BATH

See matching bath fixtures on pages 537.



LACEY™

	ITEM #	FINISH	INCAND. BULB	W	H	OVRL. H	EXTRA WIRE	CHAIN/STEM	EXT.	HCWO	NOTES
E	42381	MIZ	(5) 60W (C)	25	25.75	100	34	72	---	---	Additional chain 2996 MIZ.
F	45281	MIZ	(1) 60W (C)	5	10.75	---	---	---	7	6.5	ⓓ
G	42382	MIZ	(9) 60W (C)	34.25	29.5	104	71	72	---	---	Additional chain 4901 MIZ.
H	300181	OZ	---	---	---	---	---	---	---	---	See the full line of Kichler® Ceiling Fans in catalog K414 or visit kichler.com .

Measurements shown in inches. U.S. & Canadian Patent Pending.

LOUISA™

OLDE BRONZE® FINISH WITH ART
GLASS AND ORGANZA FABRIC SHADE



Shown as Pendant - 11.25" H



A | 65389
Mini Pendant



Shown as Pendant - 17.25" H



Shown as Semi Flush - 11.25" H

CONVERTIBLE

Create two distinct lighting
options with one fixture:
Pendant or Semi Flush.

B | 65388

C | 65387



Art Glass | Shown as Semi Flush - 17.25" H

LOUISA™

ITEM #	INCAND. BULB	W	H	OVRL. H	STEM TILT	EXTRA WIRE	CHAIN/STEM	NOTES
A 65389	(1) 50W (G9)	10	9	47	90°	65	36	Additional stem 2999 (12") OZ. Halogen light source.
B 65388	(3) 100W (M)	18	11.25	58	---	69	36	(23-30W CFL) Additional chain 2996 OZ, additional stem 4935 (12") OZ. Sloped ceiling kit included.
C 65387	(4) 100W (M)	22	17.25	57	---	64	36	(23-30W CFL) Additional chain 2996 OZ, additional stem 4935 (12") OZ. Sloped ceiling kit included.

Measurements shown in inches. U.S. & Canadian Patent Pending. Art Glass shades are natural materials – colors, patterns and textures will vary from piece to piece.

SPYRO™

OLDE BRONZE® FINISH AND ART GLASS



A | 69125
Semi Flush



C | 69124
Wall Sconce
ADA Compliant



B | 65325
Pendant



D | 65324
Mini Pendant

SPYRO™

	ITEM #	INCAND. BULB	W	H	OVRL. H	EXTRA WIRE	CHAIN/STEM	EXT.	HCWO	NOTES
A	69125	(2) 75W (M)	16	9.25	---	---	---	---	---	
B	65325	(3) 100W (M)	24	26.75	65	54	36	---	---	Additional chain 2996 OZ, additional stem 2999 (12") OZ.
C	69124	(2) 40W (M)	9	14	---	---	---	4	7	ADA
D	65324	(1) 100W (M)	10	14	46	68	36	---	---	Additional chain 2996 OZ, additional stem 2999 (12") OZ. Height includes one 6" stem.

Measurements shown in inches. Art Glass shades are natural materials – colors, patterns and textures will vary from piece to piece.

LEIGHTON™

OLDE BRONZE® FINISH WITH OFF-WHITE
FABRIC SHADES, SATIN-ETCHED GLASS DIFFUSERS
AND OPTICAL CRYSTAL DISCS



A | 42476 OZ
Chandelier



B | 42478 OZ
Chandelier



C | 42484 OZ
Mini Pendant



D | 45178 OZ
Wall Sconce



F | 42482 OZ
Pendant



E | 42480 OZ
Linear Chandelier



G | 42485 OZ
Semi Flush



H | 42486 OZ
Semi Flush
Satin-Etched
Glass Diffuser

LEIGHTON™

ITEM #	FINISH	INCAND. BULB	W	H	OVRL. H	L	EXTRA WIRE	CHAIN/STEM	EXT.	HCWO	NOTES
A	42476	OZ (5) 60W (C/K)	31	28.5	103	---	49	72	---	---	Add. chain 2996 OZ. Krypton or G-type bulb recommended.
B	42478	OZ (9) 60W (C/K)	36	35.75	110	---	53	72	---	---	Add. chain 4901 OZ. Krypton or G-type bulb recommended.
C	42484	OZ (1) 60W (K)	8	19.75	58	---	56	36	---	---	Add. chain 2996 OZ. add. stem 2999 (12") OZ. Krypton light source.
D	45178	OZ (1) 60W (C/K)	8	14.75	---	---	---	---	9.75	8.75	Krypton or G-type bulb recommended.
E	42480	OZ (4) 100W (M)	6	18.25	57	37	74	36	---	---	(23-30W CFL) Add. chain 2996 OZ, add. stem 2999 (12") OZ. Acrylic Diffuser.
F	42482	OZ (3) 100W (M)	26	28	102	---	53	72	---	---	(23-30W CFL) Add. chain 2996 OZ. Satin-etched glass glare shield.
G	42485	OZ (3) 75W (M)	16	11	---	---	---	---	---	---	(23-30W CFL)
H	42486	OZ (4) 100W (M)	22	13.5	---	---	---	---	---	---	(23-30W CFL)

Measurements shown in inches. U.S. & Canadian Patent Pending.

TODAY'S LIVING

CLEAN & STRONG

Oh, how we love geometry. The clean forms, the simple shapes, the balance of all things. It's the foundation for any work of art – and it's the inspiration for each of our Today's Living collections. Strong verticals and horizontals form the base, then we keep it simple with precision – using only materials that enhance the look: polished chrome, deep bronze and brushed nickel to name a few. It's lighting that's sculptural and structural. And lighting that invites you to make your own chic artistic statement.





Rigate™ Pendant 43140 NI & Linear Chandelier 43142 NI | Page 195



Savina Pendant 42746 PN | Page 167

SAVINA™

POLISHED NICKEL FINISH WITH SATIN-ETCHED CASED OPAL GLASS



A | 42746 PN
Mini Pendant



B | 42745 PN
Linear Chandelier

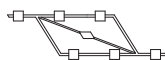

C | 42747 PN
Wall Sconce
ADA Compliant



SAVINA™

GET INSPIRED AT
KICHLER.COM



ITEM #	FINISH	INCAND. BULB	W	H	OVRL. H	L	STEM TILT	EXTRA WIRE	CHAIN/STEM	EXT.	HCWO	NOTES
A	PN	(1) 50W (G9)	3.5	22	57	---	90°	47	36	---	---	Add. stem 2999 (12") PN. Halogen light source.
B	PN	(6) 50W (G9)	10.75	28.5	67	35.5	---	73	36	---	---	Add. chain 2996 PN, add. stem 4935 (12") PN. Halogen light source.
C	PN	(1) 50W (G9)	4.75	13.5	---	---	---	---	---	4	11	ADA Halogen light source.

Measurements shown in inches. U.S. & Canadian Patent Pending.



City Lights™ Chandelier 42940 CLP | Page 169 & Flush Mount 49343 AZ | Page 609

CITY LIGHTS™

CLASSIC PEWTER FINISH WITH SATIN-ETCHED CASÉ OPAL GLASS



Asymmetrical Design

A | 42940 CLP Chandelier

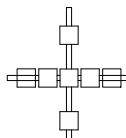

CITY LIGHTS™

GET INSPIRED AT
KICHLER.COM



ITEM #	FINISH	INCAND. BULB	W	H	OVRL. H	L	EXTRA WIRE	CHAIN/STEM	NOTES	
A	42940	CLP	(7) 50W (G9)	23.5	23.75	59	25.75	106	36	Add. chain 2996 CLP, add. stem 4935 (12") CLP. Sloped ceiling kit included. Halogen light source.

Measurements shown in inches. U.S. & Canadian Patent Pending.

CITY LIGHTS™

CLASSIC PEWTER FINISH WITH
SATIN-ETCHED CASED OPAL GLASS



A | 42941 CLP
Linear Chandelier



GET INSPIRED AT
KICHLER.COM



Side View of Linear Chandelier

MATCHING MIRROR

78210

See page 456 or kichler.com.



B | 42942 CLP
Wall Sconce

CITY LIGHTS™

	ITEM #	FINISH	INCAND. BULB	W	H	OVRL. H	L	EXTRA WIRE	CHAIN/STEM	EXT.	HCWO	NOTES
A	42941	CLP	(7) 50W (G9)	3.5	18.5	54	34.5	106	36	---	---	Additional chain 2996 CLP, additional stem 4935 (12") CLP. Sloped ceiling kit included. Halogen light source.
B	42942	CLP	(2) 50W (G9)	15.5	16	---	---	---	---	4.5	7.25	Halogen light source.

Measurements shown in inches. U.S. & Canadian Patent Pending.

OLSAY™

POLISHED CHROME FINISH WITH
SATIN-ETCHED CASÉD OPAL GLASS





Satin-Etched White Glass

A | 42651 CH
Semi Flush



B | 42505 CH
Chandelier



C | 42506 CH
Chandelier

OLSAY™

GET INSPIRED AT
KICHLER.COM



ITEM #	FINISH	INCAND. BULB	W	H	OVRLL. H	EXTRA WIRE	CHAIN/STEM	NOTES
A	CH	(3) 75W (M)	17	11.5	---	---	---	(18-25W CFL)
B	CH	(3) 50W (G9)	22.5	22.75	61	70	36	Additional chain 2996 CH, additional stem 2999 (12") CH. Halogen light source.
C	CH	(4) 50W (G9)	28.75	28.75	67	100	36	Additional chain 2996 CH, additional stem 2999 (12") CH. Halogen light source.

Measurements shown in inches. U.S. & Canadian Patent Pending.

OLSAY™

OLDE BRONZE® FINISH WITH
SATIN-ETCHED CASED OPAL GLASS





Satin-Etched White Glass

A | 42651 OZ
Semi Flush



B | 42505 OZ
Chandelier



C | 42506 OZ
Chandelier

OLSAY™

GET INSPIRED AT
KICHLER.COM



ITEM #	FINISH	INCAND. BULB	W	H	OVRLL. H	EXTRA WIRE	CHAIN/STEM	NOTES
A	OZ	(3) 75W (M)	17	11.5	---	---	---	(18-25W CFL)
B	OZ	(3) 50W (G9)	22.5	22.75	61	70	36	Additional chain 2996 OZ, additional stem 2999 (12") OZ. Halogen light source.
C	OZ	(4) 50W (G9)	28.75	28.75	67	100	36	Additional chain 2996 OZ, additional stem 2999 (12") OZ. Halogen light source.

Measurements shown in inches. U.S. & Canadian Patent Pending.



Tremba™ Mini Pendant 43371 OZ | Page 178

TREMBA™

OLDE BRONZE® FINISH WITH
WHITE FABRIC SHADE AND
SATIN-ETCHED GLASS DIFFUSER



A | 43369 OZ
Large Foyer Pendant
NOT TO SCALE

TREMBA™

GET INSPIRED AT
KICHLER.COM



ITEM #	FINISH	INCAND. BULB	W	H	OVRL. H	EXTRA WIRE	CHAIN/STEM	NOTES
A 43369	OZ	(4) 100W (M)	18	26.5	65	102	36	 (23-30W CFL) Add. chain 2996 OZ, add. stem 4935 (12") OZ. Sloped ceiling kit included.

Measurements shown in inches. U.S. & Canadian Patent Pending.

TREMBA™

OLDE BRONZE® FINISH WITH
WHITE FABRIC SHADE AND
SATIN-ETCHED GLASS DIFFUSER



Satin-Etched
Glass Diffuser

A | 43370 OZ
Oval Chandelier/Pendant
NOT TO SCALE

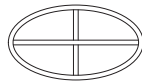

TREMBA™

ITEM #	FINISH	INCAND. BULB	W	H	OVRLL. H	L	EXTRA WIRE	CHAIN/STEM	EXT.	HCWO	NOTES	
A	43370	OZ	(6) 100W (M)	20	8.75	47	36	65	36	---	---	Ⓜ (23-30W CFL) Add. chain 2996 OZ, add. stem 2999 (12") OZ. Sloped ceiling kit incl.
B	43371	OZ	(1) 100W (M)	6.25	12.25	51	---	60	36	---	---	Ⓜ (23-30W CFL) Add. chain 2996 OZ, add. stem 2999 (12") OZ. Sloped ceiling kit incl.
C	45469	OZ	(1) 50W (G9) Ⓞ	6.25	10.5	---	---	---	---	4	5.25	Ⓜ ADA
D	43373	OZ	(4) 100W (M)	20	12.25	51	---	60	36	---	---	Ⓜ (23-30W CFL) Add. chain 2996 OZ, add. stem 4935 (12") OZ. Sloped ceiling kit incl.

Measurements shown in inches. U.S. & Canadian Patent Pending.

CONVERTIBLE

Create two distinct lighting options with one fixture:
Mini Pendant or Semi Flush.

B | 43371 OZ



Shown as Semi Flush - 13.25" H.



Shown as Mini Pendant - 12.25" H.

Satin-Etched
Cased Opal Glass



C | 45469 OZ
Wall Sconce
ADA Compliant



Shown as Semi Flush - 12.25" H.

CONVERTIBLE

Create two distinct lighting options with one fixture:
Pendant or Semi Flush.

D | 43373 OZ



Shown as Pendant - 12.25" H.

ROSWELL™

OLDE BRONZE® OUTER FINISH WITH INNER GOLD TONE HIGHLIGHTS AND INNER OFF-WHITE LINEN FABRIC SHADE WITH SATIN-ETCHED GLASS DIFFUSER





A | 43305 OZ
Wall Sconce
ADA Compliant



B | 43301 OZ
Pendant

Inner Off White Linen
Fabric Shade



C | 43303 OZ
Oval Chandelier/Pendant

Inner Gold Tone Highlights

Satin-Etched
Glass Diffuser



ROSWELL™

GET INSPIRED AT
KICHLER.COM



ITEM #	FINISH	INCAND. BULB	W	H	OVRL H	L	EXTRA WIRE	CHAIN/STEM	EXT.	HCWO	NOTES
A	43305	OZ	(1) 50W (G9)	5	9.5	---	---	---	3.75	4.25	ⓓ ADA Halogen light source. Fixture is open at bottom.
B	43301	OZ	(3) 100W (M)	18	7.25	49	---	72	36	---	ⓓ (23-30W CFL) Add. chain 2996 OZ, add. stem 4935 (12") OZ.
C	43303	OZ	(3) 100W (M)	12.25	8	49	37.25	101	36	---	ⓓ (23-30W CFL) Add. chain 2996 OZ, add. stem 4935 (12") OZ.

Measurements shown in inches. U.S. & Canadian Patent Pending.

ROSWELL™

OLDE BRONZE® OUTER FINISH WITH INNER GOLD TONE HIGHLIGHTS AND INNER OFF WHITE LINEN FABRIC SHADE WITH SATIN-ETCHED GLASS DIFFUSER



A | 43306 OZ
Large Foyer Pendant



B | 43304 OZ
Mini Pendant



C | 43302 OZ
Pendant

ROSWELL™

	ITEM #	FINISH	INCAND. BULB	W	H	OVRLL. H	EXTRA WIRE	CHAIN/STEM	NOTES
A	43306	OZ	(6) 100W (M)	21.25	45.25	90	88	36	☑ (23-30W CFL) Additional chain 4908 OZ, additional stem 4935 (12") OZ.
B	43304	OZ	(1) 100W (M)	5.25	8.5	49	68	36	☑ (23-30W CFL) Additional chain 2996 OZ, additional stem 2999 (12") OZ. Fixture is open at bottom.
C	43302	OZ	(1) 150W (M)	10.75	16	57	60	36	☑ (30-52W CFL) Additional chain 2996 OZ, additional stem 4935 (12") OZ.

Measurements shown in inches. U.S. & Canadian Patent Pending.

ROSWELL™

BRUSHED NICKEL FINISH WITH INNER OFF WHITE LINEN FABRIC SHADE AND SATIN-ETCHED GLASS DIFFUSER



Inner Satin-Etched Glass

A | 43304 NI Mini Pendant



Inner Off White Linen Fabric Shade

B | 43302 NI Pendant

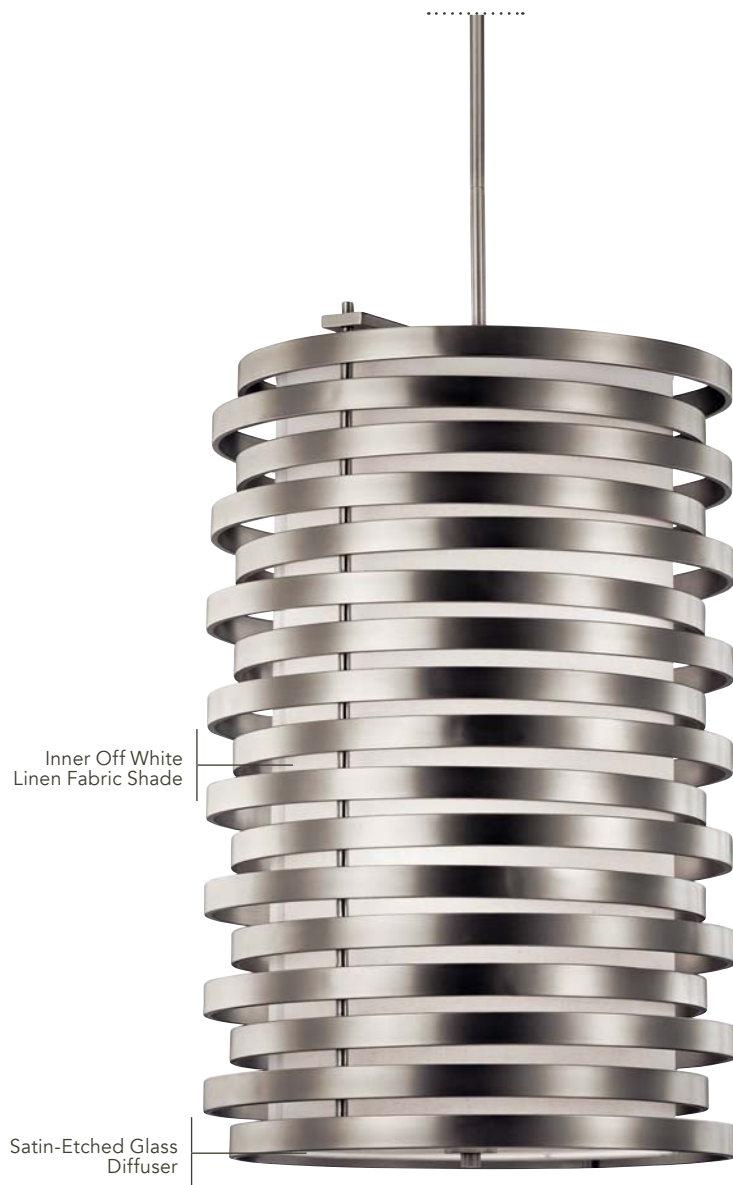

Satin-Etched Glass Diffuser

C | 43306 NI Large Foyer Pendant

ROSWELL™

ITEM #	FINISH	INCAND. BULB	W	H	OVRL. H	EXTRA WIRE	CHAIN/STEM	NOTES	
A	43304	NI	(1) 100W (M)	5.25	8.5	49	68	36	☑ (23-30W CFL) Additional chain 2996 NI, additional stem 2999 (12") NI and/or 2997 (24") NI.
B	43302	NI	(1) 150W (M)	10.75	16	57	60	36	☑ (30-52W CFL) Additional chain 2996 NI, additional stem 4935 (12") NI.
C	43306	NI	(6) 100W (M)	21.25	45.25	90	88	36	☑ (23-30W CFL) Additional chain 4908 NI, additional stem 4935 (12") NI.

Measurements shown in inches. U.S. & Canadian Patent Pending.

ROSWELL™

BRUSHED NICKEL FINISH WITH INNER
OFF-WHITE LINEN FABRIC SHADE AND
SATIN-ETCHED GLASS DIFFUSER





A | 43305 NI
Wall Sconce
ADA Compliant



Inner Off White Linen
Fabric Shade

B | 43301 NI
Pendant



Satin-Etched
Glass Diffuser

C | 43303 NI
Oval Chandelier/Pendant



ROSWELL™

GET INSPIRED AT
KICHLER.COM



ITEM #	FINISH	INCAND. BULB	W	H	OVRL. H	L	EXTRA WIRE	CHAIN STEM	EXT.	HCWO	NOTES
A	NI	(1) 50W (G9)	5	9.5	---	---	---	---	3.75	4.25	Halogen light source. Fixture is open at bottom.
B	NI	(3) 100W (M)	18	7.25	49	---	72	36	---	---	(23-30W CFL) Add. chain 2996 NI, add. stem 4935 (12") NI.
C	NI	(3) 100W (M)	12.25	8	49	37.25	101	36	---	---	(23-30W CFL) Add. chain 2996 NI, add. stem 4935 (12") NI.

Measurements shown in inches. U.S. & Canadian Patent Pending.

ALEEKA™

CLASSIC PEWTER FINISH WITH
SATIN-ETCHED CASED OPAL GLASS



A | 43366 CLP
Chandelier
NOT TO SCALE



GET INSPIRED AT
KICHLER.COM



B | 43364 CLP
Chandelier



C | 45564 CLP
Wall Sconce



D | 43365 CLP
Chandelier

ALEEKA™

ITEM #	FINISH	INCAND. BULB	W	H	OVRL. H	EXTRA WIRE	CHAIN/STEM	EXT.	HCWO	NOTES	
A	43366	CLP	(5) 50W (G9)	28.25	31	72	103	36	---	---	Additional chain 2996 CLP, additional stem 4935 (12") CLP. Halogen light source.
B	43364	CLP	(3) 50W (G9)	28.25	12.75	53	106	36	---	---	Additional chain 2996 CLP, additional stem 2999 (12") CLP. Halogen light source.
C	45564	CLP	(1) 50W (G9)	6	5	---	---	---	8	2.5	Halogen light source.
D	43365	CLP	(5) 50W (G9)	34	17.25	57	104	36	---	---	Additional chain 2996 CLP, additional stem 4935 (12") CLP. Halogen light source.

Measurements shown in inches. U.S. & Canadian Patent Pending.



BROOKLANDS™

POLISHED CHROME FINISH WITH
SATIN-ETCHED CASED OPAL GLASS



A | 43024 CH
Mini Pendant



B | 45521 CH
Wall Sconce



C | 43022 CH
Oval Chandelier

Overall Oval
Shape

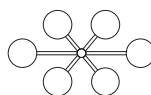

BROOKLANDS™

	ITEM #	FINISH	INCAND. BULB	W	H	OVRL. H	L	STEM TILT	EXTRA WIRE	CHAIN/STEM	EXT.	HCWO	NOTES
A	43024	CH	(1) 50W (G9)	7	7.5	46	---	90°	65	36	---	---	Add. stem 2999 (12") CH. Halogen light source.
B	45521	CH	(1) 50W (G9)	7	6.5	---	---	---	---	---	8	3.25	May be installed with glass up or down. Halogen light source.
C	43022	CH	(6) 50W (G9)	21	15.25	54	36	---	102	36	---	---	Add. chain 2996 CH, add. stem 4935 (12") CH. Halogen light source.

Measurements shown in inches. U.S. & Canadian Patent Pending.

BROOKLANDS™

POLISHED CHROME FINISH WITH
SATIN-ETCHED CASSED OPAL GLASS



Shown as Semi Flush - 12" H.



B | 43021 CH
Chandelier

CONVERTIBLE

Create two distinct lighting
options with one fixture:
Mini Chandelier or Semi Flush.

A | 43020 CH



Shown as Mini Chandelier - 13" H.



C | 43023 CH
Chandelier

BROOKLANDS™

	ITEM #	FINISH	INCAND. BULB	W	H	OVRL. H	EXTRA WIRE	CHAIN/ STEM	NOTES
A	43020	CH	(3) 50W (G9)	18	13	51	67	36	Additional chain 2996 CH, additional stem 2999 (12") CH. Halogen light source.
B	43021	CH	(5) 50W (G9)	26.75	12.5	51	104	36	Additional chain 2996 CH, additional stem 2999 (12") CH. Halogen light source.
C	43023	CH	(9) 50W (G9)	32.5	26	67	63	36	Additional chain 2996 CH, additional stem 4935 (12") CH. Halogen light source.

Measurements shown in inches. U.S. & Canadian Patent Pending.

ESCALA

POLISHED NICKEL FINISH WITH SATIN-ETCHED CASED OPAL GLASS



A | 42036 PN
Pendant

COORDINATING CEILING FAN

See the full line of Kichler® Ceiling Fans in catalog K414 or visit kichler.com



C | 300160 PN



B | 42037 PN
Pendant

3 ARM CANOPY

Create a dramatic cascading foyer centerpiece with our optional 3 Arm Canopy (42036 PN sold separately).

D | 4200 PN



Shown with (3) 42036 PN Pendants, sold separately
NOT TO SCALE

ESCALA

ITEM #	FINISH	INCAND. BULB	W	H	OVRL. H	L	STEM TILT	EXTRA WIRE	CHAIN/STEM	NOTES
A	PN	(1) 100W (M)	8	14	52	26.75	90°	68	36	Ⓜ (23-30W CFL) Additional stem 2999 (12") PN
B	PN	(2) 100W (M)	14	29.25	68	37	90°	50	36	Ⓜ (23-30W CFL) Additional stem 2999 (12") PN
C	PN	---	---	---	---	---	---	---	---	See full line of Kichler® Ceiling Fans in Catalog K414 or visit kichler.com .
D	PN	---	24	4	---	---	---	---	---	3 arm canopy only, pendants sold separately.

Measurements shown in inches. U.S. & Canadian Patent Pending: A, B.

ARBON™

POLISHED CHROME FINISH WITH
WHITE FABRIC SHADES



A | 43360 CH
Oval Chandelier/Pendant

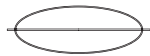

B | 43361 CH
Pendant

MATCHING MIRROR

78204
See page 457 or kichler.com.



ARBON™

	ITEM #	FINISH	INCAND. BULB	W	H	OVRLL. H	L	NOTES
A	43360	CH	(6) 100W (M)	12	13.75	145	36	Ⓜ (23-30W CFL)
B	43361	CH	(1) 100W (M)	12.5	20	142	---	Ⓜ (23-30W CFL)

Measurements shown in inches. U.S. & Canadian Patent Pending.

ARBON™

OLDE BRONZE® FINISH WITH
WHITE FABRIC SHADES



A | 43361 OZ
Pendant



B | 43360 OZ
Oval Chandelier/Pendant



ARBON™

	ITEM #	FINISH	INCAND. BULB	W	H	OVRLL. H	L	NOTES
A	43361	OZ	(1) 100W (M)	12.5	20	142	---	☑ (23-30W CFL)
B	43360	OZ	(6) 100W (M)	12	13.75	145	36	☑ (23-30W CFL)

Measurements shown in inches. U.S. & Canadian Patent Pending.



GET INSPIRED AT
KICHLER.COM

RIGATE™

BRUSHED NICKEL FINISH WITH CLEAR RIBBED OUTER GLASS AND SATIN-ETCHED CASED OPAL INNER GLASS SHADES



A | 43145 NI Mini Pendant



B | 45441 NI Wall Sconce



Shown as Semi Flush - 12" H.

CONVERTIBLE

Create two distinct lighting options with one fixture: Pendant or Semi Flush.

E | 43147 NI



Clear Ribbed Outer Glass

C | 43140 NI Pendant

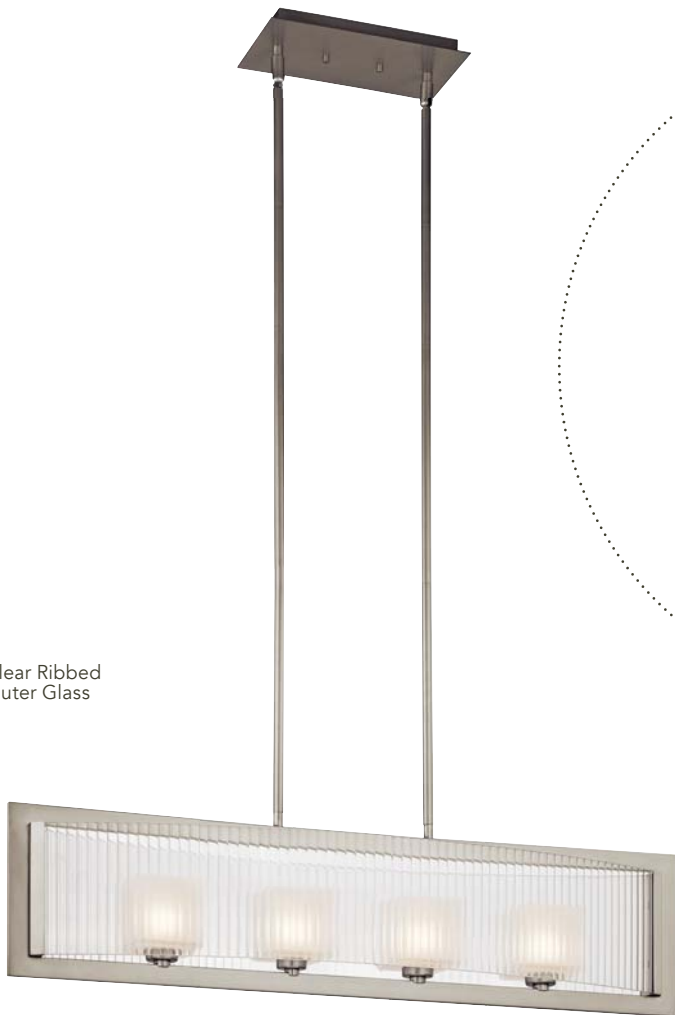

D | 43142 NI Linear Chandelier



Shown as Pendant - 11.75" H.

RIGATE™

	ITEM #	FINISH	INCAND. BULB	W	H	OVRL. H	L	STEM TILT	EXTRA WIRE	CHAIN/STEM	EXT.	HCWO	NOTES
A	43145	NI	(1) 50W (G9)	4.75	7.5	46	10.5	90°	44	36	---	---	Add. stem 2999 (12") NI and/or 2997 (24") NI. Halogen light source.
B	45441	NI	(1) 50W (G9)	9.25	6.75	---	---	---	---	---	4.75	3.5	Halogen light source.
C	43140	NI	(3) 50W (G9)	4.75	23	62	10.5	90°	63	36	---	---	Add. stem 2999 (12") NI and/or 2997 (24") NI. Halogen light source.
D	43142	NI	(4) 50W (G9)	8.5	9	48	33.75	90°	77	36	---	---	Add. stem 2999 (12") NI and/or 2997 (24") NI. Halogen light source.
E	43147	NI	(3) 50W (G9)	20	11.75	51	---	90°	95	36	---	---	Add. stem 4935 (12") NI. Halogen light source.

Measurements shown in inches. U.S. & Canadian Patent Pending.



Triad Linear Chandelier 42548 CLP | Page 197

TRIAD

CLASSIC PEWTER FINISH WITH
CLEAR OUTER GLASS AND WHITE
VETRO MICA GLASS INNER SHADES



A | 42548 CLP
Linear Chandelier

Halogen
Downlight



B | 42549 CLP
Pendant



C | 42547 CLP
Linear Chandelier

TRIAD

GET INSPIRED AT
KICHLER.COM



ITEM #	FINISH	INCAND. BULB	W	H	OVRL. H	L	EXTRA WIRE	CHAIN/STEM	NOTES	
A	42548	CLP	(3) 100W (M) & (3) 50W (GU10)	11.5	23	61	40	87	36	(23-30W CFL) Additional chain 2996 CLP, additional stem 2999 (12") CLP. Sloped ceiling kit included. 3-way turn switch.
B	42549	CLP	(1) 100W (M) & (1) 50W (GU10)	7.75	18	56	12	44	36	(23-30W CFL) Additional chain 2996 CLP, additional stem 2999 (12") CLP. Sloped ceiling kit included. 3-way turn switch.
C	42547	CLP	(3) 100W (M) & (3) 50W (GU10)	7.75	18	56	31.25	81	36	(23-30W CFL) Additional chain 2996 CLP, additional stem 2999 (12") CLP. Sloped ceiling kit included. 3-way turn switch.

Measurements shown in inches. U.S. & Canadian Patent Pending.

TRIAD

OLDE BRONZE® FINISH WITH
CLEAR OUTER GLASS AND VETRO
MICA GLASS INNER SHADES



Halogen
Downlight

A | 42548 OZ
Linear Chandelier
NOT TO SCALE



GET INSPIRED AT
KICHLER.COM



B | 42549 OZ
Pendant



Clear Outer Glass
and Vetro Mica Glass
Inner Shades

C | 42547 OZ
Linear Chandelier

TRIAD

ITEM #	FINISH	INCAND. BULB	W	H	OVRLL. H	L	EXTRA WIRE	CHAIN/STEM	NOTES	
A	42548	OZ	(3) 100W (M) & (3) 50W (GU10)	11.5	23	61	40	87	36	☑ (23-30W CFL) Additional chain 2996 OZ, additional stem 2999 (12") OZ. Sloped ceiling kit included. 3-way turn switch.
B	42549	OZ	(1) 100W (M) & (1) 50W (GU10)	7.75	18	56	12	44	36	☑ (23-30W CFL) Additional chain 2996 OZ, additional stem 2999 (12") OZ. Sloped ceiling kit included. 3-way turn switch.
C	42547	OZ	(3) 100W (M) & (3) 50W (GU10)	7.75	18	56	31.25	81	36	☑ (23-30W CFL) Additional chain 2996 OZ, additional stem 2999 (12") OZ. Sloped ceiling kit included. 3-way turn switch.

Measurements shown in inches. U.S. & Canadian Patent Pending.

FREEPORT™

POLISHED NICKEL FINISH WITH
ETCHED LINEAR TEXTURED GLASS



A | 42087 PN
Linear Chandelier
NOT TO SCALE

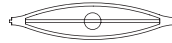

B | 42091 PN
10688 PN
Wall Sconce



C | 45086 PN
10686 PN
Wall Sconce
ADA Compliant



MULTI-POSITIONAL WALL SCONCE

Create two distinct lighting options in one.

D | 45087 PN
10687 PN
Wall Sconce
ADA Compliant (45087 PN Only)



E | 45088 PN
Wall Sconce

MATCHING BATH

See matching bath fixtures on page 473.



FREEPORT™

ITEM #	FLUOR. ITEM #	FINISH	INCAND. BULB	FLUOR. BULB	W	H	OVRLL. H	L	EXTRA WIRE	CHAIN/STEM	EXT.	HCWO	NOTES	
A	42087	---	PN	(6) 50W (G9) Ⓢ	---	8	11.25	46	36	102	36	---	---	Add. chain 2996 PN, add. stem 2999 (12") PN. Halogen light source. Sloped ceiling kit included. Height includes one 6" stem.
B	42091	---	PN	(2) 60W (K) Ⓢ	---	28	5	---	---	---	---	4.75	2.5	Ⓢ Krypton light source.
B	---	10688	PN	---	(2) 18W (GU24) Ⓢ Ⓢ	36	5	---	---	---	---	4.25	2.5	Ⓢ
C	45086	---	PN	(1) 60W (C/K)	---	7	17	---	---	---	---	3.75	4.5	Ⓢ ADA
C	---	10686	PN	---	(1) 13W (GU24) Ⓢ Ⓢ	7	17	---	---	---	---	3.75	4.5	Ⓢ ADA
D	45087	---	PN	(2) 60W (C/K) Ⓢ	---	22	5	---	---	---	---	3.75	2.5	Ⓢ ADA May be installed vertically or horizontally. Krypton bulb included.
D	---	10687	PN	---	(2) 13W (GU24) Ⓢ Ⓢ	28	5	---	---	---	---	4.75	2.5	Ⓢ May be installed vertically or horizontally.
E	45088	---	PN	(4) 60W (C/K) Ⓢ	---	36	5	---	---	---	---	4.25	2.5	Ⓢ May be installed vertically or horizontally, Krypton bulb included.

Measurements shown in inches. A: U.S. Design Patent No. D622,892; B, C, D, E: U.S. & Canadian Patent Pending.

CRESCENT VIEW™

BRUSHED NICKEL FINISH WITH
SATIN-ETCHED CASED OPAL GLASS



A | 42420 NI
Large Foyer Pendant



B | 45218 NI
Wall Sconce



C | 45217 NI
Wall Sconce



D | 42418 NI
Linear Chandelier



E | 42419 NI
Semi Flush

MATCHING BATH

See matching bath fixtures on page 472.



CRESCENT VIEW™

ITEM #	FINISH	INCAND. BULB	W	H	L	OVRL. H	EXTRA WIRE	CHAIN/STEM	EXT.	HCWO	NOTES	
A	42420	NI	(16) 60W (C/K)	14.25	29.25	---	62	66	36	---	---	Add. chain 2996 NI, add. stem 4935 (12") NI. Krypton bulb included. Height includes one 6" stem.
B	45218	NI	(2) 60W (C)	18	6.25	---	---	---	5.75	3		
C	45217	NI	(2) 50W (G9)	5.75	12	---	---	---	4.25	6.25		Halogen light source.
D	42418	NI	(2) 100W (M)	7.25	13	26	46	67	36	---	---	(23-30W CFL) Add. chain 2996 NI, Add. stem 2999 (12") NI and/or 2997 (24") NI. Sloped ceiling kit incl. Height includes one 6" stem.
E	42419	NI	(2) 60W (K)	11.25	5.5	10	---	---	---	---	---	Krypton light source.

Measurements shown in inches. U.S. & Canadian Patent Pending.

LYTHAM™

BRUSHED NICKEL FINISH WITH
SATIN-ETCHED WHITE GLASS



Shown as Inverted Pendant
9.25" H

CONVERTIBLE

Create two distinct lighting options with one fixture:
Inverted Pendant or Semi Flush.

A | 42245 NI



Shown as Semi Flush - 9.5" H



B | 42244 NI
Inverted Pendant



C | 42275 NI
Flush Mount



D | 42246 NI
Semi Flush



E | 42276 NI
Flush Mount

LYTHAM™

ITEM #	FINISH	INCAND. BULB	W	H	OVRLL. H	EXTRA WIRE	CHAIN/STEM	NOTES	
A	42245	NI	(3) 100W (M)	17.5	9.25	48	64	36	Ⓜ (23-40W CFL) Additional chain 2996 NI, additional stem 2999 (12") NI and/or 2997 (24") NI. Sloped ceiling kit included.
B	42244	NI	(4) 100W (M)	20.5	20.25	59	59	36	Ⓜ (23-40W CFL) Add. chain 2996 NI, add. stem 4935 (12") NI. Sloped ceiling kit included.
C	42275	NI	(3) 60W (M) ✓	17.5	5.5	---	---	---	Ⓜ (13-40W CFL)
D	42246	NI	(4) 100W (M)	20.5	10.75	---	---	---	Ⓜ (23-40W CFL)
E	42276	NI	(4) 60W (M) ❖	20.5	5.5	---	---	---	Ⓜ (13-40W CFL)

Measurements shown in inches. U.S. & Canadian Patent Pending.

LYTHAM™

OLDE BRONZE® FINISH WITH SATIN-ETCHED WHITE GLASS



A | 42275 OZ
Flush Mount



B | 42246 OZ
Semi Flush



D | 42244 OZ
Inverted Pendant



Shown as Inverted Pendant
9.25" H.

CONVERTIBLE

Create two distinct lighting options with one fixture:
Inverted Pendant or Semi Flush.

E | 42245 OZ



C | 42276 OZ
Flush Mount



Shown as Semi Flush - 9.5" H.

LYTHAM™

ITEM #	FINISH	INCAND. BULB	W	H	OVRL. H	EXTRA WIRE	CHAIN/STEM	NOTES	
A	42275	OZ	(3) 60W (M) ✓	17.5	5.5	---	---	---	☑ (13-40W CFL)
B	42246	OZ	(4) 100W (M)	20.5	10.75	---	---	---	☑ (23-40W CFL)
C	42276	OZ	(4) 60W (M) ❖	20.5	5.5	---	---	---	☑ (13-40W CFL)
D	42244	OZ	(4) 100W (M)	20.5	20.25	59	59	36	☑ (23-40W CFL) Add. chain 2996 OZ, add. stem 4935 (12") OZ. Sloped ceiling kit included.
E	42245	OZ	(3) 100W (M)	17.5	9.25	48	64	36	☑ (23-40W CFL) Add. chain 2996 OZ, add. stem 2999 (12") OZ. Sloped ceiling kit included.

Measurements shown in inches. U.S. & Canadian Patent Pending.

STRUCTURES™

BRUSHED NICKEL FINISH WITH
SATIN-ETCHED GLASS





A | 3244 NI
Inverted Pendant

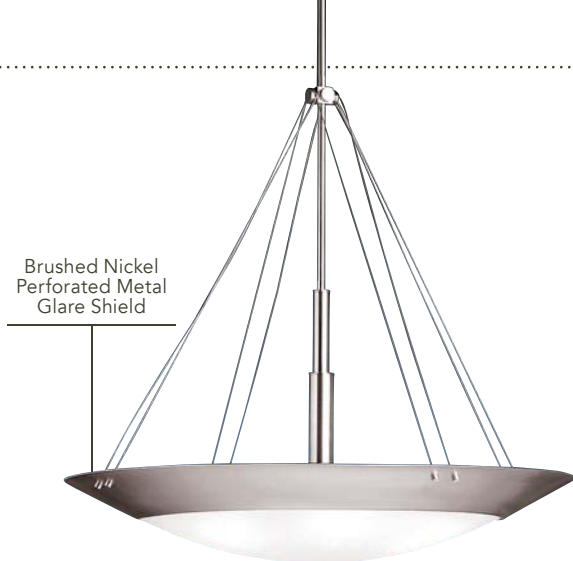

B | 3245 NI
Inverted Pendant



C | 2955 NI
Linear Chandelier

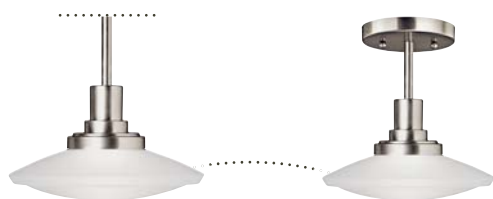

Shown as Mini Pendant - 8.5" H Shown as Semi Flush - 9.5" H

D | 2655 NI

CONVERTIBLE

Create two distinct lighting options with one fixture:
Pendant or Semi Flush.

E | 2652 NI

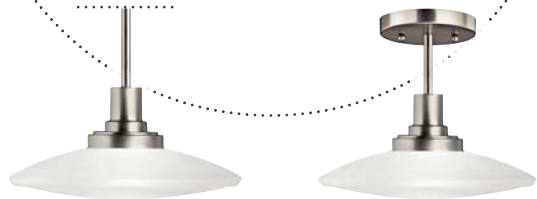

Shown as Pendant - 8.5" H Shown as Semi Flush - 9" H



F | 2055 NI
Chandelier

STRUCTURES™

ITEM #	FINISH	INCAND. BULB	W	H	OVRL. H	L	STEM TILT	EXTRA WIRE	CHAIN/STEM	NOTES	
A	3244	NI	(3) 100W (M)	24	25	63	---	45°	90	36	☑ (18-25W CFL) Add. stem 2999 (12") NI and/or stem 2997 (24") NI.
B	3245	NI	(6) 75W (M)	30	28.5	67	---	45°	86	36	☑ (18-25W CFL) Add. stem 2999 (12") NI and/or stem 2997 (24") NI.
C	2955	NI	(3) 100W (MNCN) Ⓢ	9	21.5	60	37	45°	97	36	Add. stem 2999 (12") NI and/or 2997 (24") NI; Halogen light source.
D	2655	NI	(1) 100W (MNCN) Ⓢ	9	8.5	47	---	45°	65	36	Add. stem 2999 (12") NI and/or 2997 (24") NI; Halogen light source.
E	2652	NI	(1) 100W (MNCN) Ⓢ	10.75	8.5	47	---	45°	107	36	Add. stem 2999 (12") NI and/or 2997 (24") NI; Halogen light source.
F	2055	NI	(5) 100W (MNCN) Ⓢ	30.5	22.5	61	---	45°	96	36	Add. stem 2999 (12") NI and/or 2997 (24") NI; Halogen light source.

Measurements shown in inches. C: U.S. Design Patent No.: D511,858,D512,177; D: U.S. Design Patent No.: D512,177; F: U.S. Design Patent No.: D511,858,D564,123,D512,177.

STRUCTURES™

BRUSHED NICKEL FINISH WITH
SATIN-ETCHED GLASS



A | 6963 NI
Wall Sconce



C | 2667 NI
Pendant



D | 7755 NI
Directional Rail Light

COORDINATING CEILING FAN

See the full line of Kichler®
Ceiling Fans in catalog K414
or visit kichler.com



B | 300009 NI



E | 2043 NI
Linear Chandelier

STRUCTURES™

ITEM #	FINISH	INCAND. BULB	W	H	OVRLL. H	L	STEM TILT	EXTRA WIRE	CHAIN/STEM	EXT.	HCWO	NOTES
A	6963	NI (1) 100W (MNCN)	9	7.5	---	---	---	---	---	10.5	2.5	Halogen light source.
B	300009	NI ---	---	---	---	---	---	---	---	---	---	See the full line of Kichler® Ceiling Fans in catalog K414 or visit kichler.com .
C	2667	NI (1) 100W (MNCN)	18	15	53	---	45°(12:12)	62	36	---	---	Add. stem 2999 (12") NI and/or 2997 (24") NI. Halogen light source.
D	7755	NI (4) 50W (G9)	5	11	---	30	---	---	---	8	2.5	May be ceiling or wall mounted, Halogen light source.
E	2043	NI (4) 100W (MNCN)	9	21.5	60	47.5	45°(12:12)	96	36	---	---	Add. stem 2999 (12") NI and/or 2997 (24") NI. Halogen light source.

Measurements shown in inches. U.S. Patent No. D512,177: A, D578244: C, U.S. & Canadian Patent Pending: B.

STRUCTURES™

OLDE BRONZE® FINISH WITH
LIGHT UMBER GLASS



A | 2667 OZ
Pendant



B | 6963 OZ
Wall Sconce



C | 7755 OZ
Directional Rail Light



D | 2043 OZ
Linear Chandelier

MATCHING MIRROR

41056 NI, OZ
See page 465 or kichler.com.



MATCHING BATH

See matching bath fixtures
on page 489.



STRUCTURES™

ITEM #	FINISH	INCAND. BULB	W	H	OVRL. H	L	STEM TILT	EXTRA WIRE	CHAIN/STEM	EXT.	HCWO	NOTES	
A	2667	OZ	(1) 100W (MNCN)	18	15	53	---	45°(12:12)	62	36	---	---	Add. stem 2999 (12") OZ. Halogen light source.
B	6963	OZ	(1) 100W (MNCN)	9	7.5	---	---	---	---	---	10.5	2.5	Halogen light source.
C	7755	OZ	(4) 50W (G9)	5	11	---	30	---	---	---	8	2.5	May be ceiling or wall mounted, Halogen light source.
D	2043	OZ	(4) 100W (MNCN)	9	21.5	60	47.5	45°(12:12)	96	36	---	---	Add. stem 2999 (12") OZ. Halogen light source.

Measurements shown in inches. U.S. Patent No. D578,244: A; D512,177: B.

STRUCTURES™

OLDE BRONZE® FINISH WITH
LIGHT UMBER GLASS

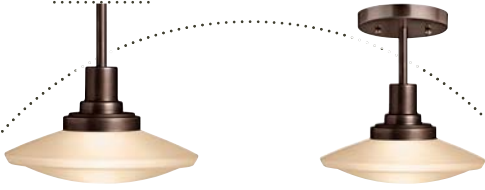

Shown as Mini Pendant - 8.5" H Shown as Semi Flush - 9.5" H

A | 2655 OZ

CONVERTIBLE

Create two distinct lighting options with one fixture:
Pendant or Semi Flush.

B | 2652 OZ

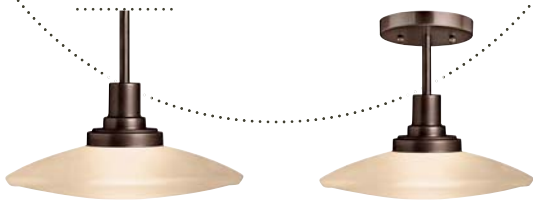

Shown as Pendant - 8.5" H Shown as Semi Flush - 9" H

COORDINATING CEILING FAN

See the full line of Kichler®
Ceiling Fans in catalog K414
or visit kichler.com



C | 300009 OZ



D | 2955 OZ
Linear Chandelier



E | 2055 OZ
Chandelier

STRUCTURES™

C | 300009 OZ

ITEM #	FINISH	INCAND. BULB	W	H	OVRL. H	L	STEM TILT	EXTRA WIRE	CHAIN/STEM	NOTES
A	2655	OZ (1) 100W (MNCN)	9	8.5	47	---	45°	65	36	Add. stem 2999 (12") OZ. Halogen light source.
B	2652	OZ (1) 100W (MNCN)	10.75	8.5	47	---	45°	107	36	Add. stem 2999 (12") OZ. Halogen light source.
C	300009	OZ ---	---	---	---	---	---	---	---	See the full line of Kichler® Ceiling Fans in catalog K414 or visit kichler.com .
D	2955	OZ (3) 100W (MNCN)	9	21.5	60	37	45°	97	36	Add. stem 2999 (12") OZ. Halogen light source.
E	2055	OZ (5) 100W (MNCN)	30.5	22.5	61	---	45°	96	36	Add. stem 2999 (12") OZ. Halogen light source.

Measurements shown in inches. A, B, D: U.S. Design Patent No. D512,177.

BERKLEY

MISSION BRONZE™ FINISH
WITH ART GLASS



A | 65424
Mini Pendant



B | 65425
Linear Chandelier
NOT TO SCALE

BERKLEY

	ITEM #	INCAND. BULB	W	H	OVRL. H	L	EXTRA WIRE	CHAIN/STEM	NOTES
A	65424	(1) 100W (M)	4.75	8	46	10	68	36	(23-30W CFL) Additional chain 2996 MIZ, additional stem 2999 (12") MIZ.
B	65425	(3) 100W (M)	4.75	10.75	49	36	108	36	(23-30W CFL) Additional chain 2996 MIZ, additional stem 2999 (12") MIZ.

Measurements shown in inches. U.S. & Canadian Patent Pending.

CONFETTI

BRUSHED NICKEL FINISH
WITH ART GLASS



A | 69079
Wall Sconce
ADA Compliant



B | 65215
Semi Flush



C | 60263
Mini Pendant









D | 66138
Mini Chandelier



E | 65238
Inverted Pendant

CONFETTI

ITEM #	FLOUR. ITEM #	INCAND. BULB	FLOUR. BULB	W	H	OVRL. H	EXTRA WIRE	CHAIN/STEM	EXT.	HCWO	NOTES	
A	---	69079	---	(1) 18W (GU24)  	14	5.5	---	---	---	4	2.75	
B	65215	---	(2) 60W (M)	---	13.75	10	---	---	---	---	---	 (13-15W CFL)
C	60263	---	(1) 100W (M)	---	5.5	9	109	---	---	---	---	 (23-30W CFL)
D	66138	---	(3) 100W (M)	---	18.5	18	59	74	36	---	---	 (23-30W CFL) Additional chain 2996 NI, additional stem 2999 (12") NI and/or 2997 (24") NI. Sloped ceiling kit included.
E	65238	---	(3) 100W (M)	---	23.25	26.75	101	18	72	---	---	 (23-30W CFL) Additional chain 2996 NI.

Measurements shown in inches. Art Glass shades are natural materials – colors, patterns and textures will vary from piece to piece.

KHIONE™

BRUSHED NICKEL FINISH WITH
ETCHED GLASS AND ART GLASS

CONVERTIBLE

Create two distinct lighting options with one fixture:
Pendant or Semi Flush.

A | 65434



Shown as Pendant - 11.75" H.



Shown as Semi Flush - 12" H.



B | 65433
Linear Chandelier

Etched Glass
and Art Glass



C | 65435
Mini Pendant

Art Glass

KHIONE™

ITEM #	INCAND. BULB	W	H	OVRL H	L	STEM TILT	EXTRA WIRE	CHAIN/STEM	NOTES
A	65434 (4) 100W (M)	18.75	11.75	50	---	---	68	36	☑ (23-30W CFL) Additional chain 2996 NI, additional stem 4935 (12") NI.
B	65433 (4) 50W (G9) Ⓢ	7	7.5	40	34.5	---	106	36	Additional chain 2996 NI, additional stem 2999 (12") NI and/or 2997 (24") NI. Height includes one 6" stem.
C	65435 (1) 50W (G9) Ⓢ	5.5	6.75	45	5.75	90°	67	36	Additional stem 2999 (12") NI and/or 2997 (24") NI.

Measurements shown in inches. U.S. & Canadian Patent Pending. Art Glass shades are natural materials – colors, patterns and textures will vary from piece to piece.

STELLA™

POLISHED CHROME FINISH WITH
SATIN-ETCHED CASED OPAL GLASS





A | 42214 CH
Chandelier



B | 42216 CH
Mini Pendant



C | 45212 CH
Wall Sconce

STELLA™

	ITEM #	FINISH	INCAND. BULB	W	H	OVRL H	STEM TILT	EXTRA WIRE	CHAIN/STEM	EXT.	HCWO	NOTES
A	42214	CH	(24) 40W (C/K)	36	53	91	---	85	36	---	---	Additional chain 4901 CH, additional stem 2999 (12") CH.
B	42216	CH	(1) 60W (C/K)	3.5	16.75	49	45°(12:12)	69	36	---	---	Additional stem 2999 (12") CH. Height includes one 6" stem.
C	45212	CH	(1) 60W (C)	4.75	18	---	---	---	---	7.5	9.75	D

Measurements shown in inches. U.S. & Canadian Patent Pending.

STELLA™

POLISHED CHROME FINISH WITH
SATIN-ETCHED CASED OPAL GLASS



B | 42213 CH
Chandelier



A | 42212 CH
Chandelier

STELLA™

	ITEM #	FINISH	INCAND. BULB	W	H	OVRL. H	STEM TILT	EXTRA WIRE	CHAIN/STEM	NOTES
A	42212	CH	(12) 60W (C/K)	30.25	31.75	70	---	89	36	Additional chain 4901 CH, additional stem 2999 (12") CH.
B	42213	CH	(9) 60W (C/K)	26.5	25	63	45°(12:12)	54	36	Additional stem 2999 (12") CH.

Measurements shown in inches. U.S. & Canadian Patent Pending.



C | 42217 CH
Semi Flush



D | 42215 CH
Chandelier

STELLA™

	ITEM #	FINISH	INCAND. BULB	W	H	OVRL. H	EXTRA WIRE	CHAIN/STEM	NOTES
C	42217	CH	(6) 60W (C/K)	19.75	11.25	---	---	---	
D	42215	CH	(12) 60W (C/K)	25	38.5	77	80	36	Additional chain 4901 CH, additional stem 2999 (12") CH.

Measurements shown in inches. U.S. & Canadian Patent Pending.

CLOUDBURST

POLISHED NICKEL FINISH WITH WISPY WHITE
ART GLASS AND CLEAR JEWEL ACCENTS



B | 65330
Mini Pendant



C | 69094
Wall Sconce
ADA Compliant



A | 65332
Inverted Pendant



D | 65331
Semi Flush

CLOUDBURST

ITEM #	INCAND. BULB	W	H	OVRL. H	EXTRA WIRE	CHAIN/STEM	EXT.	HCWO	NOTES
A	65332 (4) 150W (M)	22	21.5	60	59	36	---	---	Additional chain 2996 PN, additional stem 2999 (12") PN.
B	65330 (1) 100W (M)	5	10.5	49	65	36	---	---	(18-25W CFL) Additional chain 2996 PN, additional stem 2999 (12") PN.
C	69094 (1) 60W (C)	7	11.25	---	---	---	3.5	3.75	ADA
D	65331 (3) 100W (M)	18	10.25	---	---	---	---	---	

Measurements shown in inches. Art Glass shades are natural materials – colors, patterns and textures will vary from piece to piece.

ARA

BRUSHED NICKEL FINISH WITH
MATTE WHITE ACRYLIC DIFFUSER



A | 10710 NI
Pendant



D | 10898 NI
Semi Flush

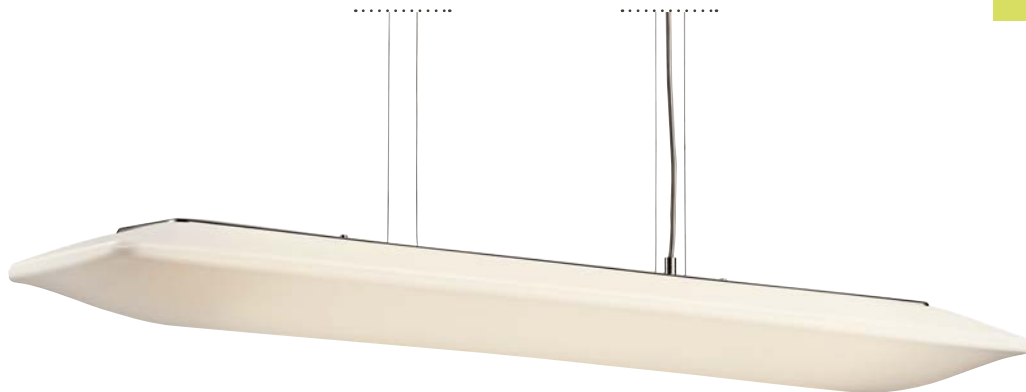

E | 10708 NI
Linear Pendant



B | 10899 NI
Semi Flush

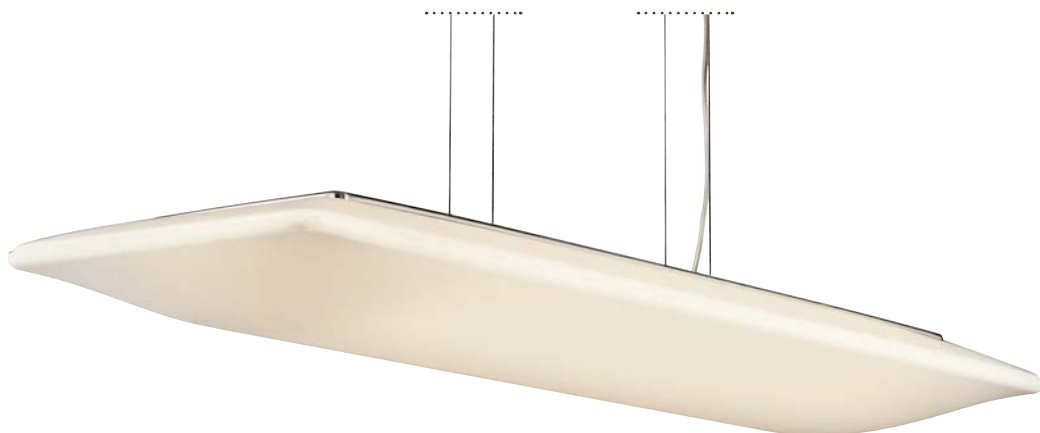



















F | 10709 NI
Linear Pendant



C | 10711 NI
Pendant

ARA

	FLUOR. ITEM #	FINISH	FLUOR. BULB	W	H	L	NOTES
A	10710	NI	(1) 70W (2C, G10Q)    	20	4	---	Adjustable height up to 52.5".
B	10899	NI	(4) 26W (G24Q-3)    	30	10	---	
C	10711	NI	(4) 26W (G24Q-3)    	30	6	---	Adjustable height up to 52.5".
D	10898	NI	(1) 70W (2C, G10Q)  	20	8	---	
E	10708	NI	(2) 21W (T5, G5) 	10	4	43	Adjustable height up to 52.5".
F	10709	NI	(4) 21W (T5, G5)    	15	4.25	43	Adjustable height up to 52.5".

Measurements shown in inches. U.S. & Canadian Patent Pending.

CIRCOLO

BRUSHED NICKEL FINISH WITH CLEAR GLASS
OUTER CYLINDERS AND SATIN-ETCHED
GLASS INNER CYLINDERS



A | 2344 NI
Chandelier



B | 2345 NI
Oval Chandelier

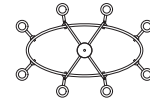

C | 2346 NI
Chandelier



D | 2347 NI
Chandelier



E | 2343 NI
Chandelier/Dinette



Shown as Mini Chandelier - 17" H

CONVERTIBLE

Create two distinct lighting options with one fixture:
Mini Chandelier or Semi Flush.

F | 3743 NI



Shown as Semi Flush - 14.75" H



G | 2943 NI
Linear Chandelier



H | 6144 NI
Wall Sconce



J | 3695 NI
Flush Mount

COORDINATING CEILING FAN

See the full line of Kichler®
Ceiling Fans in catalog K414
or visit kichler.com



K | 300205 NI

CIRCOLO

ITEM #	FINISH	INCAND. BULB	W	H	OVRLL. H	L	STEM TILT	EXTRA WIRE	CHAIN/STEM	EXT.	HCWO	NOTES	
A	2344	NI	(6) 60W (M) T10	26	26.5	65	---	45°(12:12)	38	36	---	---	Additional stem 2999 (12") NI and/or 2997 (24") NI.
B	2345	NI	(8) 60W (M) T10	25	27	65	40.5	45°(12:12)	93	36	---	---	Additional stem 2999 (12") NI and/or 2997 (24") NI.
C	2346	NI	(9) 60W (M) T10	36	35.5	110	---	45°(12:12)	79	36	---	---	Additional stem 2999 (12") NI and/or 2997 (24") NI.
D	2347	NI	(12) 60W (M) T10	44.5	41	79	---	45°(12:12)	70	36	---	---	Additional stem 2999 (12") NI and/or 2997 (24") NI.
E	2343	NI	(3) 60W (M) T10	22	21.5	60	---	45°(12:12)	51	36	---	---	Additional stem 2999 (12") NI and/or 2997 (24") NI.
F	3743	NI	(3) 60W (M) T10	12.25	17	55	---	---	12	36	---	---	Additional chain 2996 NI.
G	2943	NI	(8) 60W (M) T10	14.25	39.25	---	36.25	---	82	---	---	---	Additional chain 2996 NI.
H	6144	NI	(1) 60W (M) T10	4.5	10	---	---	---	---	---	6	5	Ⓧ
J	3695	NI	(1) 100W (M) ⚡	10	9.25	---	---	---	---	---	---	---	Ⓧ (23-30W CFL)
K	300205	NI	---	---	---	---	---	---	---	---	---	---	See the full line of Kichler® Ceiling Fans in catalog K414 or visit kichler.com

Measurements shown in inches. U.S. & Canadian Patent Pending.

CIRCOLO

OLDE BRONZE® FINISH WITH CLEAR GLASS
OUTER CYLINDERS AND UMBER-ETCHED
GLASS INNER CYLINDERS



A | 2344 OZ
Chandelier



B | 2345 OZ
Oval Chandelier

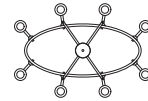

C | 2346 OZ
Chandelier



D | 2347 OZ
Chandelier



E | 2343 OZ
Chandelier/Dinette



Shown as Mini Chandelier - 17" H

CONVERTIBLE

Create two distinct lighting options with one fixture:
Mini Chandelier or Semi Flush.

F | 3743 OZ



Shown as Semi Flush - 14.75" H



G | 2943 OZ
Linear Chandelier



H | 6144 OZ
Wall Sconce



J | 3695 OZ
Flush Mount

COORDINATING CEILING FAN

See the full line of Kichler®
Ceiling Fans in catalog K414
or visit kichler.com



K | 300205 OZ

CIRCOLO

ITEM #	FINISH	INCAND. BULB	W	H	OVRL. H	L	STEM TILT	EXTRA WIRE	CHAIN/STEM	EXT.	HCWO	NOTES	
A	2344	OZ	(6) 60W (M) T10	26	26.5	65	---	45°(12:12)	38	36	---	---	Additional stem 2999 (12") OZ.
B	2345	OZ	(8) 60W (M) T10	25	27	65	40.5	45°(12:12)	93	36	---	---	Additional stem 2999 (12") OZ.
C	2346	OZ	(9) 60W (M) T10	36	35.5	110	---	45°(12:12)	79	36	---	---	Additional stem 2999 (12") OZ.
D	2347	OZ	(12) 60W (M) T10	44.5	41	79	---	45°(12:12)	70	36	---	---	Additional stem 2999 (12") OZ.
E	2343	OZ	(3) 60W (M) T10	22	21.5	60	---	45°(12:12)	51	36	---	---	Additional stem 2999 (12") OZ.
F	3743	OZ	(3) 60W (M) T10	12.25	17	55	---	---	12	36	---	---	Additional chain 2996 OZ.
G	2943	OZ	(8) 60W (M) T10	14.25	39.25	---	36.25	---	82	---	---	---	Additional chain 2996 OZ.
H	6144	OZ	(1) 60W (M) T10	4.5	10	---	---	---	---	---	6	5	Ⓧ
J	3695	OZ	(1) 100W (M) ⚡	10	9.25	---	---	---	---	---	---	---	Ⓧ(23-30W CFL)
K	300205	OZ	---	---	---	---	---	---	---	---	---	---	See the full line of Kichler® Ceiling Fans in catalog K414 or visit kichler.com

Measurements shown in inches. U.S. & Canadian Patent Pending.

EILEEN™

CHROME FINISH WITH
SATIN-ETCHED CASÉ OPAL GLASS



A | 5096 CH
Wall Sconce



C | 3898 CH
Linear Chandelier

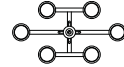

B | 3299 CH
Inverted Pendant

Satin-Etched
White Glass



D | 1897 CH
Chandelier

CONVERTIBLE

Create two distinct lighting options with one fixture:
Inverted Pendant or Semi Flush.



E | 3797 CH

Shown as Inverted Pendant - 14.5" H.



Satin-Etched
White Glass

Shown as Semi Flush - 13.5" H.



F | 3497 CH
Mini Pendant



G | 1896 CH
Chandelier



H | 1894 CH
Mini Chandelier



J | 8043 CH
Flush Mount

MATCHING BATH

See matching bath fixtures
on page 514.



EILEEN™

ITEM #	FINISH	INCAND. BULB	W	H	OVRL. H	L	EXTRA WIRE	CHAIN/STEM	EXT.	HCWO	NOTES
A	5096	CH	(1) 100W (M)	4.5	10.75	---	---	---	7	5.75	Ⓢ (18-25W CFL) May be installed with glass up or down.
B	3299	CH	(4) 150W (M)	25.75	26.25	65	---	91	36	---	Ⓢ (23-30W CFL) Add. chain 2996 CH, add. stem 2999 (12") CH.
C	3898	CH	(6) 100W (M)	16.25	18.5	57	30	95	36	---	Ⓢ (23-30W CFL) Add. chain 2996 CH, add. stem 2999 (12") CH. May be installed with glass up or down.
D	1897	CH	(9) 100W (M)	30	28.25	67	---	95	36	---	Ⓢ (23-30W CFL) Add. chain 2996 CH, add. stem 2999 (12") CH.
E	3797	CH	(3) 100W (M)	17.25	14.5	53	---	21	36	---	Ⓢ (23-30W CFL) Add. chain 2996 CH.
F	3497	CH	(1) 100W (M)	4.5	14	46	---	68	36	---	Ⓢ (23-30W CFL) Add. chain 2996 CH, add. stem 2999 (12") CH. Height includes one 6" stem.
G	1896	CH	(5) 100W (M)	24	16.5	55	---	61	36	---	Ⓢ (23-30W CFL) Add. chain 2996 CH, add. stem 2999 (12") CH. May be installed with glass up or down.
H	1894	CH	(3) 100W (M)	18.5	13.75	52	---	63	36	---	Ⓢ (23-30W CFL) Add. chain 2996 CH, add. stem 2999 (12") CH. May be installed with glass up or down.
J	8043	CH	(1) 100W (M) ❖	5	6.25	---	---	---	---	---	Ⓢ (23-30W CFL)

Measurements shown in inches.

EILEEN™

BRUSHED NICKEL FINISH WITH
SATIN-ETCHED CASÉD OPAL GLASS



A | 5096 NI
Wall Sconce



C | 3898 NI
Linear Chandelier

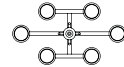

MATCHING MIRROR

41096 NI
See page 464 or kichler.com.



B | 3299 NI
Inverted Pendant

Satin-Etched
White Glass



D | 1897 NI
Chandelier



CONVERTIBLE

Create two distinct lighting options with one fixture:
Inverted Pendant or Semi Flush.

E | 3797 NI



Satin-Etched
White Glass

F | 3497 NI
Mini Pendant

Shown as Inverted Pendant - 14.5" H.

Shown as Semi Flush - 13.5" H.



G | 1896 NI
Chandelier



H | 1894 NI
Mini Chandelier



J | 8043 NI
Flush Mount

MATCHING BATH

See matching bath fixtures
on page 515.



EILEEN™

ITEM #	FINISH	INCAND. BULB	W	H	OVRL. H	L	EXTRA WIRE	CHAIN/STEM	EXT.	HCWO	NOTES
A	5096	NI	(1) 100W (M)	4.5	10.75	---	---	---	7	5.75	Ⓢ (18-25W CFL) May be installed with glass up or down.
B	3299	NI	(4) 150W (M)	25.75	26.25	65	---	91	36	---	Ⓢ (23-30W CFL) Add. chain 2996 NI, add. stem 2999 (12") NI.
C	3898	NI	(6) 100W (M)	16.25	18.5	57	30	95	36	---	Ⓢ (23-30W CFL) Add. chain 2996 NI, add. stem 2999 (12") NI. May be installed with glass up or down.
D	1897	NI	(9) 100W (M)	30	28.25	67	---	95	36	---	Ⓢ (23-30W CFL) Add. chain 2996 NI, add. stem 2999 (12") NI.
E	3797	NI	(3) 100W (M)	17.25	14.5	53	---	21	36	---	Ⓢ (23-30W CFL) Add. chain 2996 NI.
F	3497	NI	(1) 100W (M)	4.5	14	46	---	68	36	---	Ⓢ (23-30W CFL) Add. chain 2996 NI, add. stem 2999 (12") NI. Height includes one 6" stem.
G	1896	NI	(5) 100W (M)	24	16.5	55	---	61	36	---	Ⓢ (23-30W CFL) Add. chain 2996 NI, add. stem 2999 (12") NI. May be installed with glass up or down.
H	1894	NI	(3) 100W (M)	18.5	13.75	52	---	63	36	---	Ⓢ (23-30W CFL) Add. chain 2996 NI, add. stem 2999 (12") NI. May be installed with glass up or down.
J	8043	NI	(1) 100W (M) ❖	5	6.25	---	---	---	---	---	Ⓢ (23-30W CFL)

Measurements shown in inches.

EILEEN™

OLDE BRONZE® FINISH WITH
UMBER ETCHED GLASS



A | 5096 OZ
Wall Sconce



C | 3898 OZ
Linear Chandelier

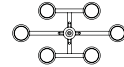

MATCHING MIRROR

41096 OZ
See page 464 or kichler.com.

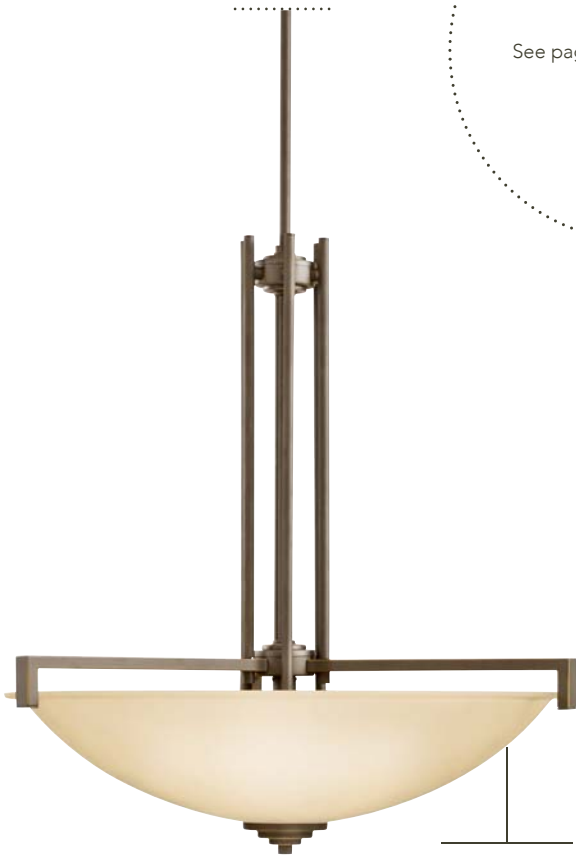

B | 3299 OZ
Inverted Pendant

Umbre Etched
Glass



D | 1897 OZ
Chandelier

CONVERTIBLE

Create two distinct lighting options with one fixture:
Inverted Pendant or Semi Flush.



E | 3797 OZ

Shown as Inverted Pendant - 14.5" H.



Shown as Semi Flush - 13.5" H.



F | 3497 OZ
Mini Pendant



G | 1896 OZ
Chandelier



H | 1894 OZ
Mini Chandelier



J | 8043 OZ
Flush Mount

MATCHING BATH

See matching bath fixtures on page 513.



EILEEN™

ITEM #	FINISH	INCAND. BULB	W	H	OVRL. H	L	EXTRA WIRE	CHAIN/STEM	EXT.	HCWO	NOTES
A	5096	OZ	(1) 100W (M)	4.5	10.75	---	---	---	7	5.75	Ⓢ (18-25W CFL) May be installed with glass up or down.
B	3299	OZ	(4) 150W (M)	25.75	26.25	65	---	91	36	---	Ⓢ (23-30W CFL) Add. chain 2996 OZ, add. stem 2999 (12") OZ.
C	3898	OZ	(6) 100W (M)	16.25	18.5	57	30	95	36	---	Ⓢ (23-30W CFL) Add. chain 2996 OZ, add. stem 2999 (12") OZ. May be installed with glass up or down.
D	1897	OZ	(9) 100W (M)	30	28.25	67	---	95	36	---	Ⓢ (23-30W CFL) Add. chain 2996 OZ, add. stem 2999 (12") OZ.
E	3797	OZ	(3) 100W (M)	17.25	14.5	53	---	21	36	---	Ⓢ (23-30W CFL) Add. chain 2996 OZ.
F	3497	OZ	(1) 100W (M)	4.5	14	46	---	68	36	---	Ⓢ (23-30W CFL) Add. chain 2996 OZ, add. stem 2999 (12") OZ. Height includes one 6" stem.
G	1896	OZ	(5) 100W (M)	24	16.5	55	---	61	36	---	Ⓢ (23-30W CFL) Add. chain 2996 OZ, add. stem 2999 (12") OZ. May be installed with glass up or down.
H	1894	OZ	(3) 100W (M)	18.5	13.75	52	---	63	36	---	Ⓢ (23-30W CFL) Add. chain 2996 OZ, add. stem 2999 (12") OZ. May be installed with glass up or down.
J	8043	OZ	(1) 100W (M) ❖	5	6.25	---	---	---	---	---	Ⓢ (23-30W CFL)

Measurements shown in inches.

REYNES™

POLISHED CHROME FINISH
WITH SATIN-ETCHED CASED OPAL
GLASS AND POLISHED OPTICAL
CRYSTAL DISKS



A | 45018 CH
Wall Sconce



B | 42123 CH
Mini Pendant

MODERN MOSAIC

ANTIQUPE PEWTER FINISH
WITH ART GLASS

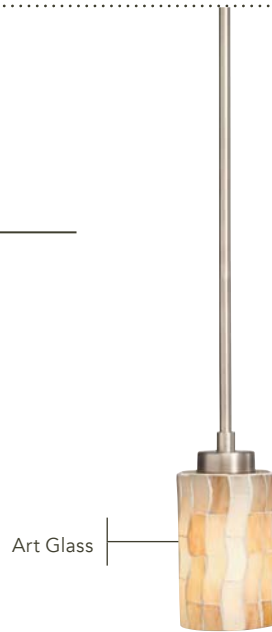

C | 65353
Mini Pendant



D | 66050
Chandelier

REYNES™ & MODERN MOSAIC

ITEM #	FINISH	INCAND. BULB	W	H	OVRL. H	STEM TILT	EXTRA WIRE	CHAIN/STEM	EXT.	HCWO	NOTES
A	45018	CH	(1) 100W (M)	5	13	---	---	---	6.5	6.25	☑ (18-25W CFL) May be installed with glass up or down.
B	42123	CH	(1) 100W (M)	4	14	45°(12:12)	67	36	---	---	☑ (18-25W CFL) Additional stem 2999 (12") CH. Height includes one 6" stem.
C	65353	---	(1) 100W (M)	3.75	7.75	46	---	68	36	---	☑ (23-30W CFL) Additional chain 2996 AP, additional stem 2999 (12") AP. Sloped ceiling kit included.
D	66050	---	(5) 100W (M)	25	21	95	---	19	72	---	☑ (23-30W CFL) Additional chain 2996 AP.

Measurements shown in inches. U.S. Patent Pending: A, B. Art Glass shades are natural materials – colors, patterns and textures will vary from piece to piece.

MODENA™

BRUSHED NICKEL FINISH



A | 3030 NI
Mini Pendant



Alabaster Swirl Glass

B | 6599 NI
11105 NI
Wall Sconce



C | 6598 NI
11104 NI
Wall Sconce
ADA Compliant



Satin-Etched
Cased Opal Glass

D | 3031 NI
Island Chandelier

MODENA™

ITEM #	FLOUR. ITEM #	FINISH	INCAND. BULB	FLOUR. BULB	W	H	OVRLL. H	L	STEM TILT	EXTRA WIRE	CHAIN/STEM	EXT.	HCWO	NOTES
A	3030	---	NI (1) 100W (M)	---	3.5	6.75	45	---	45°(12:12)	68	36	---	---	Ⓢ (18-25W CFL) Add. chain 2996 NI, add. stem 2999 (12") NI, and/or 2997 (24") NI.
B	6599	---	NI (2) 60W (M) ✓	---	5.25	14.25	---	---	---	---	---	4.25	7	ⓓ
B	---	11105	NI	(2) 13W (GU24) ✓ Ⓢ	5.25	14.25	---	---	---	---	---	4.25	7.25	ⓓ ADA
C	6598	11104	NI (1) 60W (M) ✓	(1) 18W (GU24) ✓ Ⓢ	4.5	10.5	---	---	---	---	---	3.25	5.25	ⓓ ADA
D	3031	---	NI (6) 100W (M)	---	15.5	37.75	---	29	---	111	36	---	---	Ⓢ (18-25W CFL) Add. stem 2999 (12") NI and/or 2997 (24") NI.

Measurements shown in inches.

CLEARLY CRYSTAL

SPARKLING & SLEEK

We believe that life, like our Clearly Crystal collections, is multi-faceted. There are so many choices, and each one is perfect in its own way. Whether tiers of brilliant-cut gems are your thing or you're looking for crystal as a pure accent, our collections offer something that will delight with elegant designs and sparkling showstoppers. From subtle to awe-inspiring, each piece features a unique shimmer, balanced with complementary materials like polished chrome, organza fabric and satin-etched cased opal glass. It's an offering that's enchanting, luxurious and warm – all in one.





Jules™ Chandelier 43123 CH | Page 242 & Mirror 78146 | Page 454

ALISO™

POLISHED CHROME FINISH WITH
CLEAR OPTICAL CRYSTAL ACCENTS



Clear Optical
Crystal Pendalogue

A | 42928 CH
Chandelier
NOT TO SCALE



GET INSPIRED AT
KICHLER.COM

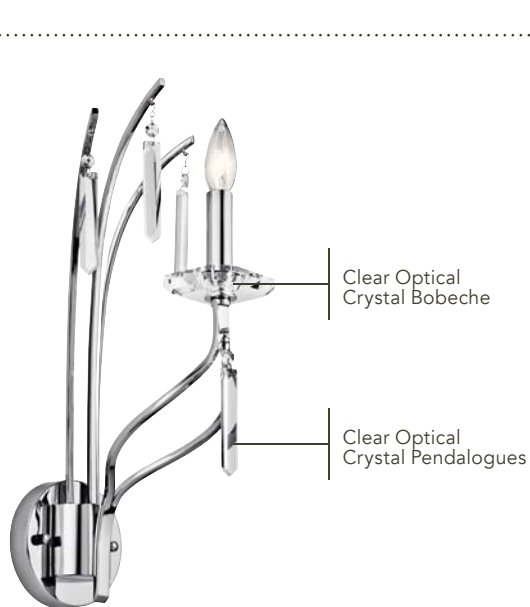

B | 42929 CH
Wall Sconce



D | 42925 CH
Mini Chandelier



C | 42927 CH
Chandelier

MATCHING MIRROR

78218
See page 450 or kichler.com.

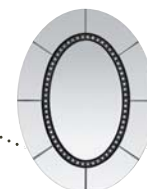

ALISO™

ITEM #	FINISH	INCAND. BULB	W	H	OVRL H.	EXTRA WIRE	CHAIN/STEM	EXT.	HCWO	NOTES
A	CH	(12) 60W (C)	29	29.5	102	54	72	---	---	Additional chain 2996 CH.
B	CH	(1) 60W (C)	9.25	20.5	---	---	---	11	18	D
C	CH	(6) 60W (C)	25.25	26	100	51	72	---	---	Additional chain 2996 CH.
D	CH	(3) 60W (C)	16.25	20.25	95	59	72	---	---	Additional chain 2996 CH.

Measurements shown in inches. U.S. & Canadian Patent Pending.

LEANORA™

POLISHED CHROME FINISH WITH
OPTICAL CRYSTAL CENTER COLUMN,
BOBECHEs AND PENDALOGUES



Crystal Pendalogue

A | 42545 CH
Chandelier
NOT TO SCALE



GET INSPIRED AT
KICHLER.COM



B | 42543 CH
Wall Sconce



D | 42546 CH
Chandelier



C | 42544 CH
Chandelier/Dinette

LEANORA™

	ITEM #	FINISH	INCAND. BULB	W	H	OVRL. H	EXTRA WIRE	CHAIN/STEM	EXT.	HCWO	NOTES
A	42545	CH	(6) 60W (C)	28	28.75	103	55	72	---	---	Additional chain 4901 CH.
B	42543	CH	(2) 60W (C)	15	11.5	---	---	---	5.5	9	
C	42544	CH	(3) 60W (C)	21	24	98	60	72	---	---	Additional chain 2996 CH.
D	42546	CH	(9) 60W (C)	34	35	109	50	72	---	---	Additional chain 4901 CH.

Measurements shown in inches. U.S. & Canadian Patent Pending.

RIZZO™

POLISHED CHROME FINISH
WITH OPTICAL CRYSTAL ACCENTS



Laser Cut Details

A | 42339 CH
Chandelier
NOT TO SCALE



B | 42341 CH
Wall Sconce



D | 42338 CH
Mini Chandelier



C | 42340 CH
Chandelier

RIZZO™

	ITEM #	FINISH	INCAND. BULB	W	H	OVRL. H	EXTRA WIRE	CHAIN/STEM	EXT.	HCWO	NOTES
A	42339	CH	(6) 60W (C)	23.75	25	99	24	72	---	---	Additional chain 2996 CH.
B	42341	CH	(2) 60W (C)	11.5	12.5	---	---	---	6.5	10	ⓓ
C	42340	CH	(12) 60W (C)	36	24.25	99	60	72	---	---	Additional chain 4901 CH.
D	42338	CH	(4) 60W (C)	18	25	99	24	72	---	---	Additional chain 2996 CH.

Measurements shown in inches. U.S. & Canadian Patent Pending.

GRACIE™

SUNRISE MIST™ FINISH WITH
CRYSTAL & BEADED ACCENTS

Optical Crystal Pendalouges



GET INSPIRED AT
KICHLER.COM

A | 42116 SRM
Chandelier
NOT TO SCALE



B | 42115 SRM
Mini Chandelier

OPTIONAL SHADES

4114
3 x 5 x 4.75
White Lace Fabric Shade with
Silver Embroidery and Beige Trim.



4115
3 x 5 x 4.75
Off-White Fabric Shade with
Silver Embroidery and
Beige/White Striped Trim.



Shown as Semi Flush - 20.25" H.

CONVERTIBLE

Create two distinct lighting
options with one fixture:
Mini Chandelier or Semi Flush.

C | 42114 SRM



Shown as Mini Chandelier - 21.75" H.

GRACIE™

ITEM #	FINISH	INCAND. BULB	W	H	OVRL. H	EXTRA WIRE	CHAIN/STEM	NOTES
A	SRM	(8) 60W (C)	28.25	38	112	43	72	Additional chain 4901 SRM.
B	SRM	(5) 60W (C)	17	25.75	100	18	72	Additional chain 2996 SRM.
C	SRM	(3) 60W (C)	13	21.75	96	20	72	Additional chain 2996 SRM.

Measurements shown in inches. U.S. & Canadian Patent Pending.

JULES™

POLISHED CHROME FINISH WITH
OPTICAL CRYSTAL ACCENTS



A | 43123 CH
Chandelier
NOT TO SCALE



GET INSPIRED AT
KICHLER.COM



B | 43121 CH
Chandelier



C | 43120 CH
Mini Chandelier



D | 43125 CH
Wall Sconce



E | 43124 CH
Chandelier



F | 43122 CH
Chandelier

JULES™

	ITEM #	FINISH	INCAND. BULB	W	H	OVRL. H	EXTRA WIRE	CHAIN/STEM	EXT.	HCWO	NOTES
A	43123	CH	(9) 60W (C)	36.25	43.25	118	62	72	---	---	Additional chain 4901 CH.
B	43121	CH	(6) 60W (C)	25.25	23.75	98	65	72	---	---	Additional chain 2996 CH.
C	43120	CH	(3) 60W (C)	17	18	91	128	72	---	---	Additional chain 2996 CH.
D	43125	CH	(2) 60W (C)	13.75	15.25	---	---	---	7.75	6.5	D
E	43124	CH	(12) 60W (C)	44	47	121	59	72	---	---	Additional chain 4901 CH.
F	43122	CH	(8) 60W (C)	28.25	27.25	102	64	72	---	---	Additional chain 2996 CH.

Measurements shown in inches. U.S. & Canadian Patent Pending.

TARA™

POLISHED CHROME FINISH WITH
OPTICAL CRYSTAL ACCENTS

Optical Crystal Accents

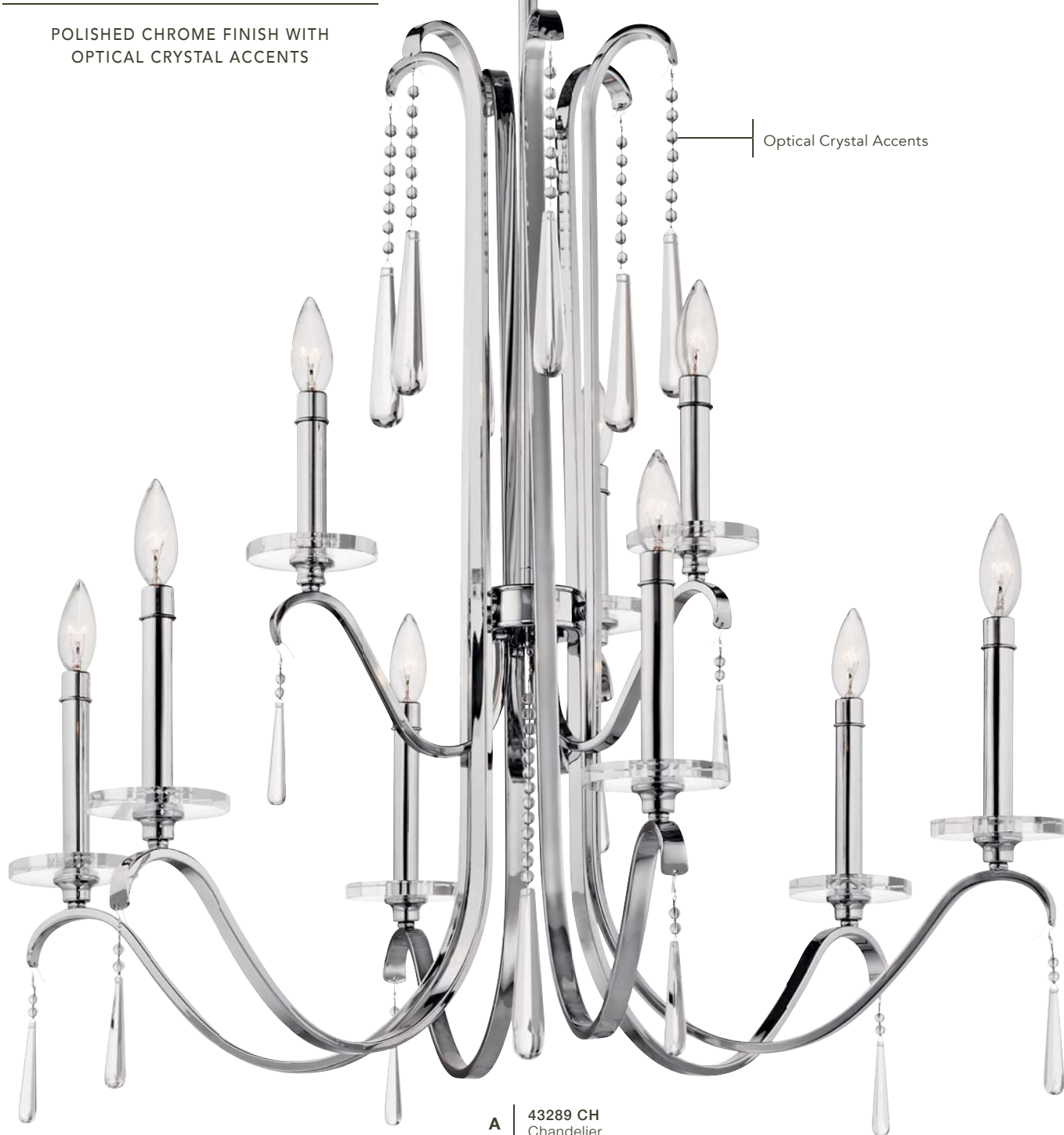

A | 43289 CH
Chandelier
NOT TO SCALE



GET INSPIRED AT
KICHLER.COM

PENDALETTE®

Create three distinct lighting options with one fixture:
Mini Chandelier, Wall Mount or Semi Flush.

B | 43286 CH



Shown as Mini Chandelier - 20.25" H.

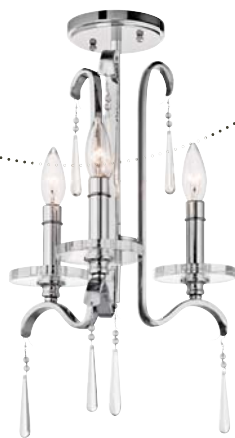

Shown as Semi Flush - 19" H.



Shown as Wall Mount - 27.5" H.



C | 45187 CH
Wall Sconce



D | 43288 CH
Chandelier



E | 43287 CH
Mini Chandelier

Optical Crystal Accents

TARA™

	ITEM #	FINISH	INCAND. BULB	W	H	OVRLL. H	STEM TILT	EXTRA WIRE	CHAIN/STEM	EXT.	HCWO	NOTES
A	43289	CH	(9) 60W (C)	32	34	73	90°	92	36	---	---	Additional stem 4935 (12") CH.
B	43286	CH	(3) 60W (C)	12	20.25	95	---	28	72	12.75	2.5	
C	45187	CH	(1) 60W (C)	6	16.75	---	---	---	---	8.25	8.25	D
D	43288	CH	(5) 60W (C)	25.5	24.5	63	90°	62	36	---	---	Additional stem 2999 (12") CH.
E	43287	CH	(4) 60W (C)	18	23.5	62	90°	62	36	---	---	Additional stem 2999 (12") CH.

Measurements shown in inches. U.S. & Canadian Patent Pending.

TARA™

OLDE BRONZE® FINISH WITH
OPTICAL CRYSTAL ACCENTS



A | 43289 OZ
Chandelier
NOT TO SCALE



GET INSPIRED AT
KICHLER.COM

PENDALETTE®

Create three distinct lighting options with one fixture:
Mini Chandelier, Wall Mount or Semi Flush.

B | 43286 OZ



Shown as Mini Chandelier - 20.25" H.



Shown as Semi Flush - 19" H.



Shown as Wall Mount - 27.5" H.



C | 45187 OZ
Wall Sconce



D | 43288 OZ
Chandelier



E | 43287 OZ
Mini Chandelier

Optical Crystal Accents

TARA™

	ITEM #	FINISH	INCAND. BULB	W	H	OVRLL. H	STEM TILT	EXTRA WIRE	CHAIN/STEM	EXT.	HCWO	NOTES
A	43289	OZ	(9) 60W (C)	32	34	73	90°	92	36	---	---	Additional stem 4935 (12") OZ.
B	43286	OZ	(3) 60W (C)	12	20.25	95	---	28	72	12.75	2.5	
C	45187	OZ	(1) 60W (C)	6	16.75	---	---	---	---	8.25	8.25	D
D	43288	OZ	(5) 60W (C)	25.5	24.5	63	90°	62	36	---	---	Additional stem 2999 (12") OZ.
E	43287	OZ	(4) 60W (C)	18	23.5	62	90°	62	36	---	---	Additional stem 2999 (12") OZ.

Measurements shown in inches. U.S. & Canadian Patent Pending.



JARDINE

POLISHED CHROME FINISH WITH SATIN-ETCHED CASED OPAL GLASS INNER DIFFUSERS AND WHITE TRANSLUCENT ORGANZA OUTER SHADES



A | 42301 CH
Chandelier



C | 42392 CH
Chandelier



B | 42304 CH
Chandelier

MATCHING BATH

See matching bath fixtures on page 539.



JARDINE

	ITEM #	FINISH	INCAND. BULB	W	H	OVRL. H	EXTRA WIRE	CHAIN/STEM	NOTES
A	42301	CH	(5) 60W (C)	25	29.5	104	56	72	Additional chain 2996 CH.
B	42304	CH	(9) 60W (C)	39	36	110	50	72	Additional chain 4901 CH.
C	42392	CH	(16) 60W (C)	39.75	53.5	128	40	72	① Additional chain 4909 CH.

Measurements shown in inches. U.S. & Canadian Patent Pending.

JARDINE

POLISHED CHROME FINISH WITH SATIN-ETCHED
CASED OPAL GLASS INNER DIFFUSERS AND WHITE
TRANSLUCENT ORGANZA OUTER SHADES



A | 42306 CH
Semi Flush



B | 42390 CH
Mini Pendant

Satin-Etched Cased
Opal Glass Inner
Diffusers with White
Translucent Organza
Outer Shades



C | 42302 CH
Chandelier



D | 42307 CH
Wall Sconce

JARDINE

ITEM #	FINISH	INCAND. BULB	W	H	OVRLL. H	STEM TILT	EXTRA WIRE	CHAIN/STEM	EXT.	HCWO	NOTES
A	CH	(3) 60W (C)	15.5	10.75	---	---	---	---	---	---	
B	CH	(1) 100W (M)	6.5	9.25	48	90°	68	36	---	---	☑ (23-30W CFL) Additional stem 2999 (12") CH.
C	CH	(6) 60W (C)	31.25	31.5	106	---	53	72	---	---	Additional chain 2996 CH.
D	CH	(2) 60W (C)	16	21.5	---	---	---	---	8	14.5	ⓓ

Measurements shown in inches. U.S. & Canadian Patent Pending.

MULTI-POSITIONAL WALL FIXTURE

Two distinct lighting fixtures in one!
 Fixture can be installed on the wall horizontally or vertically.

E | 45291 CH
 Wall Sconce



F | 42391 CH
 Chandelier/Pendant



G | 42393 CH
 Oval Chandelier/Pendant



JARDINE

	ITEM #	FINISH	INCAND. BULB	W	H	OVRLL. H	L	EXTRA WIRE	CHAIN/STEM	EXT.	HCWO	NOTES
E	45291	CH	(2) 50W (G9)	25	4.5	---	---	---	---	4.25	2.25	Halogen light source.
F	42391	CH	(3) 100W (M)	24	27.5	102	---	11	72	---	---	(23-30W CFL) Additional chain 4901 CH.
G	42393	CH	(4) 100W (M)	17.75	33.5	108	35.75	48	72	---	---	(23-30W CFL) Additional chain 4901 CH.

Measurements shown in inches. U.S. & Canadian Patent Pending.



Parker Point™ Wall Sconce 42634 CH | Page 255 & Chandelier 42632 CH | Page 253

PARKER POINT™

POLISHED CHROME FINISH WITH
ORGANZA-WRAPPED FABRIC SHADES
AND OPTICAL CRYSTAL ACCENTS



Organza-Wrapped
Fabric Shade

A | 42632 CH
Chandelier
NOT TO SCALE

PARKER POINT™

GET INSPIRED AT
KICHLER.COM



ITEM #	FINISH	INCAND. BULB	W	H	OVRL. H	EXTRA WIRE	CHAIN/STEM	NOTES
A 42632	CH	(8) 60W (C)	36	28	66	95	36	Additional chain 4901 CH, additional stem 4935 (12") CH.

Measurements shown in inches. U.S. & Canadian Patent Pending.

PARKER POINT™

POLISHED CHROME FINISH WITH
ORGANZA-WRAPPED FABRIC SHADES
AND OPTICAL CRYSTAL ACCENTS



A | 42633 CH
Chandelier
NOT TO SCALE

Optical Crystal
Accents



GET INSPIRED AT
KICHLER.COM



B | 42631 CH
Chandelier



C | 42634 CH
Wall Sconce



Shown as Mini Chandelier - 17.75 H.

CONVERTIBLE

Create two distinct lighting options with one fixture:
Mini Chandelier or Semi Flush.

D | 42630 CH



Shown as Semi Flush - 18 H.

PARKER POINT™

ITEM #	FINISH	INCAND. BULB	W	H	OVRLL. H	EXTRA WIRE	CHAIN/STEM	EXT.	HCWO	NOTES
A	CH	(9) 60W (C)	36	33.5	72	99	36	---	---	Additional chain 4901 CH, additional stem 4935 (12") CH.
B	CH	(5) 60W (C)	26	24.5	63	61	36	---	---	Additional chain 2996 CH, additional stem 2999 (12") CH.
C	CH	(1) 60W (C)	6.75	15.5	---	---	---	8.5	10.25	D
D	CH	(3) 60W (C)	17	17.75	56	13	36	---	---	Additional chain 2996 CH, additional stem 2999 (12") CH.

Measurements shown in inches. U.S. & Canadian Patent Pending.



Crystal Persuasion™ Chandelier 42030 CH | Page 258

CRYSTAL PERSUASION™

POLISHED CHROME FINISH WITH
WHITE LINEN FABRIC SHADES, SATIN-ETCHED GLASS
DIFFUSERS AND OPTICAL CRYSTAL ACCENTS



A | 42028 CH
Wall Sconce



B | 42031 CH
Chandelier

CRYSTAL PERSUASION™

GET INSPIRED AT
KICHLER.COM



	ITEM #	FINISH	INCAND. BULB	W	H	OVRL. H	EXTRA WIRE	CHAIN/STEM	EXT.	HCWO	NOTES
A	42028	CH	(1) 60W (C)	8.5	9	---	---	---	7.5	4.75	G-type bulb required.
B	42031	CH	(9) 60W (C)	37	31.5	106	56	72	---	---	Additional chain 4901 CH. G-type bulb required.

Measurements shown in inches. U.S. & Canadian Patent Pending.

CRYSTAL PERSUASION™

POLISHED CHROME FINISH WITH
WHITE LINEN FABRIC SHADES, SATIN-ETCHED GLASS
DIFFUSERS AND OPTICAL CRYSTAL ACCENTS



White Linen Shades

A | 42029 CH
Mini Chandelier



Optical Crystal
Accents

B | 42030 CH
Chandelier



GET INSPIRED AT
KICHLER.COM



C | 42035 CH
Semi Flush



Satin-Etched
Glass Diffuser

D | 42034 CH
Pendant

CRYSTAL PERSUASION™

ITEM #	FINISH	INCAND. BULB	W	H	OVRL. H	EXTRA WIRE	CHAIN/STEM	NOTES
A	CH	(5) 60W (K)	17	13.75	52	159	36	Additional chain 2996 CH. Krypton light source.
B	CH	(5) 60W (C/K)	30	21	95	56	72	Additional chain 2996 CH. G-type bulb required.
C	CH	(3) 100W (M)	15	11.5	---	---	---	(23-30W CFL)
D	CH	(3) 100W (M)	24	21	95	22	72	(23-30W CFL) Additional chain 2996 CH.

Measurements shown in inches. U.S. & Canadian Patent Pending.

CRYSTAL SKYE™

POLISHED CHROME FINISH
WITH OPTICAL CRYSTALS



Crystal Skye™ Chandelier/Pendant 42194 CH | Page 262

CRYSTAL SKYE™

POLISHED CHROME FINISH
WITH OPTICAL CRYSTALS



Prism
Shaped
Crystals

MATCHING MIRROR

78121
See page 454 or kichler.com.



A | 42195 CH
Chandelier/Pendant

CRYSTAL SKYE™

GET INSPIRED AT
KICHLER.COM



ITEM #	FINISH	INCAND. BULB	W	H	OVRL. H	NOTES
A 42195	CH	(8) 50W (G9)	20.75	5	53.5	Halogen light source.

Measurements shown in inches.

CRYSTAL SKYE™

POLISHED CHROME FINISH
WITH OPTICAL CRYSTALS



A | 42175 CH
Wall Sconce
ADA Compliant

Prism Shaped
Crystals

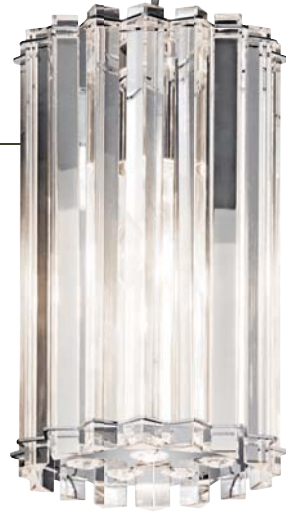

B | 42174 CH
Mini Pendant



C | 42194 CH
Chandelier/Pendant



GET INSPIRED AT
KICHLER.COM

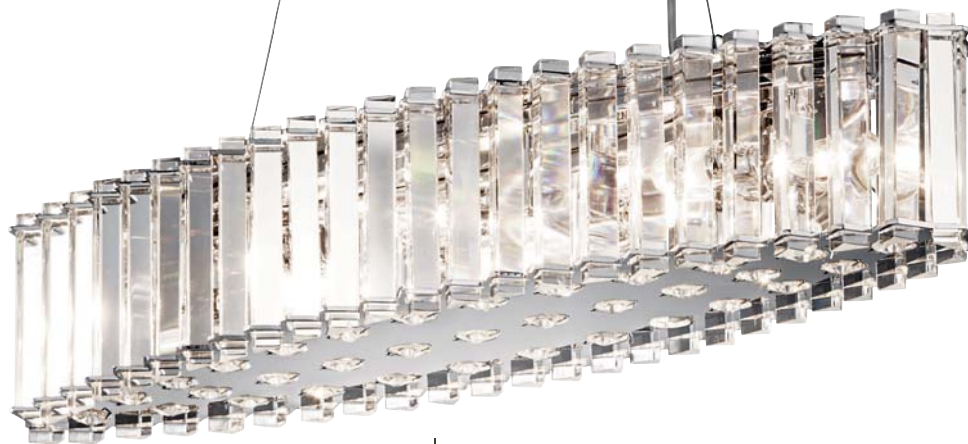

D | 42172 CH
Oval Chandelier/Pendant



Laser-Cut Chrome Diffuser with Suspended Faceted Optical Crystals

E | 42173 CH
Oval Chandelier/Pendant



CRYSTAL SKYE™

	ITEM #	FINISH	INCAND. BULB	W	H	OVRL. H	L	EXT.	HCWO	NOTES
A	42175	CH	(2) 50W (G9)	6.5	11	---	---	4	5.5	Halogen light source.
B	42174	CH	(1) 100W (M)	6.5	11.5	85	---	---	---	(23-30W CFL)
C	42194	CH	(6) 50W (G9)	17.25	5	53.5	---	---	---	Halogen light source.
D	42172	CH	(8) 50W (G9)	7.5	5	79	25.75	---	---	Halogen light source.
E	42173	CH	(12) 50W (G9)	11.75	5	79	35.25	---	---	Halogen light source.

Measurements shown in inches.

NEW TRADITIONS

ELEGANT & INVITING

Whether it's an annual family getaway to the shore or grandma's signature feast at Thanksgiving, traditions help define us. They give us comfort and familiarity that carry on for generations. It's this sense of calm that will draw you into the refined style and extraordinary elegance of our New Traditions collections. All the details are here – tailored forms, intricate embellishments, rich accents. They come together in unique ways, creating styles that are as timeless as they are easy to love.





Larkin™ Foyer Pendant 42565 NI & Foyer Pendant 42566 NI | Page 327

MALINA™

BRUSHED SILVER AND GOLD FINISH
WITH CLEAR OPTIC RAIN GLASS





A | 43243 BRSG
Wall Sconce



Clear Optic
Rain Glass

B | 43241 BRSG
Mini Pendant

Brushed Silver
and Gold Finish



C | 43237 BRSG
Mini Chandelier



D | 43238 BRSG
Chandelier

GET INSPIRED AT
KICHLER.COM



MALINA™

	ITEM #	FINISH	INCAND. BULB	W	H	OVRL. H	STEM TILT	EXTRA WIRE	CHAIN/STEM	EXT.	HCWO	NOTES
A	43243	BRSG	(1) 60W (C)	5.5	18.25	---	---	---	---	6.25	10.25	D
B	43241	BRSG	(1) 60W (C)	8.25	24	64	90°	54	36	---	---	Additional stem 2999 (12") BRSG.
C	43237	BRSG	(3) 60W (C)	18.5	29	103	---	34	72	---	---	Additional chain 2996 BRSG.
D	43238	BRSG	(5) 60W (C)	26	34	108	---	70	72	---	---	Additional chain 2996 BRSG.

Measurements shown in inches. U.S. & Canadian Patent Pending.

MALINA™

BRUSHED SILVER AND GOLD FINISH
WITH CLEAR OPTIC RAIN GLASS

Brushed Silver
and Gold Finish



Optical Crystal Accent

MATCHING MIRROR

78228

See page 454 or kichler.com.



A | 43240 BRSG
Chandelier
NOT TO SCALE

GET INSPIRED AT
KICHLER.COM





B | 43244 BRSG
Chandelier

Organza
Shade

PENDALETTE®

Create three distinct lighting options with one fixture: Mini Chandelier, Wall Mount or Semi Flush.

C | 43242 BRSG



Shown as Mini Chandelier - 19.25" H.



Shown as Semi Flush - 18.5" H.



Shown as Wall Sconce - 26.5" H.

MALINA™

	ITEM #	FINISH	INCAND. BULB	W	H	OVRL. H	EXTRA WIRE	CHAIN/STEM	EXT.	HCWO	NOTES
A	43240	BRSG	(9) 60W (C)	35.25	39.5	114	70	72	---	---	Additional chain 2996 BRSG.
B	43244	BRSG	(5) 60W (C)	23	31.5	106	34	72	---	---	Additional chain 2996 BRSG.
C	43242	BRSG	(3) 60W (C)	12	19.25	94	36	72	13	2.75	Additional chain 2996 BRSG.

Measurements shown in inches. U.S. & Canadian Patent Pending.



Lara™ Chandelier/Pendant 42864 CLP | Page 273

LARA™

CLASSIC PEWTER FINISH WITH
CLEAR GLASS CYLINDERS & MOTTLED
WISPY WHITE GLASS DRIP CANDLES



Optical Crystal Accent

A | 42862 CLP
Oval Chandelier

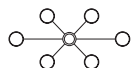

B | 42863 CLP
Chandelier

MATCHING MIRROR

78209

See page 458 or kichler.com.



GET INSPIRED AT
KICHLER.COM

LARA™

ITEM #	FINISH	INCAND. BULB	W	H	OVRLL. H	L	EXTRA WIRE	CHAIN/STEM	NOTES	
A	42862	CLP	(6) 60W (C)	18	33.5	108	36	70	72	Additional chain 2996 CLP.
B	42863	CLP	(9) 60W (C)	32	38.75	113	---	70	72	Additional chain 4901 CLP.

Measurements shown in inches. U.S. & Canadian Patent Pending.

LARA™

CLASSIC PEWTER FINISH WITH
CLEAR GLASS CYLINDERS & MOTTLED
WISPY WHITE GLASS DRIP CANDLES



A | 42860 CLP
Chandelier/Dinette



Optical Crystal Accent

B | 42861 CLP
Chandelier

LARA™

	ITEM #	FINISH	INCAND. BULB	W	H	OVRL. H	EXTRA WIRE	CHAIN/STEM	NOTES
A	42860	CLP	(3) 60W (C)	20	26.5	101	35	72	Additional chain 2996 CLP.
B	42861	CLP	(5) 60W (C)	26.75	32.5	107	35	72	Additional chain 2996 CLP.

Measurements shown in inches. U.S. & Canadian Patent Pending.



C | 45362 CLP
Wall Sconce



D | 42865 CLP
Mini Pendant



E | 42864 CLP
Chandelier/Pendant

Clear Outside Glass with Etched Bottom and Inner Beige Fabric Shade



F | 42866 CLP
Semi Flush

LARA™

	ITEM #	FINISH	INCAND. BULB	W	H	OVRL. H	STEM TILT	EXTRA WIRE	CHAIN/STEM	EXT.	HCWO	NOTES
C	45362	CLP	(1) 60W (C)	4.75	16.25	---	---	---	---	6	9.25	D
D	42865	CLP	(1) 60W (C)	8.75	19.5	58	45°(12:12)	52	36	---	---	Additional stem 2999 (12") CLP.
E	42864	CLP	(3) 100W (M)	25	34	108	---	54	72	---	---	E (23-30W CFL) Additional chain 2996 CLP.
F	42866	CLP	(2) 100W (M)	21.25	18.75	---	---	---	---	---	---	E (23-30W CFL)

Measurements shown in inches. U.S. & Canadian Patent Pending.

LARA™

SHADOW BRONZE™ FINISH
WITH CLEAR GLASS CYLINDERS &
BEIGE GLASS DRIP CANDLES



Optical Crystal Accent

A | 42862 SWZ
Oval Chandelier

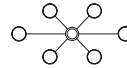

B | 42863 SWZ
Chandelier

LARA™

GET INSPIRED AT
KICHLER.COM



	ITEM #	FINISH	INCAND. BULB	W	H	OVRL. H	L	EXTRA WIRE	CHAIN/STEM	NOTES
A	42862	SWZ	(6) 60W (C)	18	33.5	108	36	70	72	Additional chain 2996 SWZ.
B	42863	SWZ	(9) 60W (C)	32	38.75	113	---	70	72	Additional chain 4901 SWZ.

Measurements shown in inches. U.S. & Canadian Patent Pending.



C | 42860 SWZ
Chandelier/Dinette



D | 42866 SWZ
Semi Flush



E | 42861 SWZ
Chandelier

LARA™

	ITEM #	FINISH	INCAND. BULB	W	H	OVRL. H	EXTRA WIRE	CHAIN/STEM	NOTES
C	42860	SWZ	(3) 60W (C)	20	26.5	101	35	72	Additional chain 2996 SWZ.
D	42866	SWZ	(2) 100W (M)	21.25	18.75	---	---	---	☑ (23-30W CFL)
E	42861	SWZ	(5) 60W (C)	26.75	32.5	107	35	72	Additional chain 2996 SWZ.

Measurements shown in inches. U.S. & Canadian Patent Pending.

LARA™

SHADOW BRONZE™ FINISH
WITH CLEAR GLASS CYLINDERS &
BEIGE GLASS DRIP CANDLES



A | 45362 SWZ
Wall Sconce



B | 42865 SWZ
Mini Pendant



Clear Outside Glass
with Etched Bottom
and Inner Beige
Fabric Shade

C | 42864 SWZ
Chandelier/Pendant

LARA™

	ITEM #	FINISH	INCAND. BULB	W	H	OVRL. H	STEM TILT	EXTRA WIRE	CHAIN/STEM	EXT.	HCWO	NOTES
A	45362	SWZ	(1) 60W (C)	4.75	16.25	---	---	---	---	6	9.25	D
B	42865	SWZ	(1) 60W (C)	8.75	19.5	58	45° (12:12)	52	36	---	---	Additional stem 2999 (12") SWZ.
C	42864	SWZ	(3) 100W (M)	25	34	108	---	54	72	---	---	(23-30W CFL) Additional chain 2996 SWZ.

Measurements shown in inches. U.S. & Canadian Patent Pending.

DUNSMUIR™

ART NOUVEAU BRONZE FINISH
WITH ART GLASS



A | 69048
Semi Flush



B | 65187
Inverted Pendant



Perforated
Aluminum
Glare Shield

C | 65188
Inverted Pendant

DUNSMUIR™

	ITEM #	INCAND. BULB	W	H	OVRL. H	EXTRA WIRE	CHAIN/STEM	NOTES
A	69048	(3) 150W (M)	20	15	---	---	---	
B	65187	(3) 100W (M)	22	31	105	17	72	☑ (23-30W CFL) Additional chain 2996 ANO.
C	65188	(6) 150W (M)	32	36.5	111	50	72	☑ (23-30W CFL) Additional chain 2996 ANO.

Measurements shown in inches. Art Glass shades are natural materials – colors, patterns and textures will vary from piece to piece.

MARCELE™

OLDE BRONZE® FINISH WITH CLEAR
GLASS TEARDROPS



A | 43449 OZ
Chandelier
NOT TO SCALE



GET INSPIRED AT
KICHLER.COM



B | 43446 OZ
Mini Chandelier

Clear Glass
Teardrop Accents



C | 43450 OZ
Wall Sconce



D | 43447 OZ
Mini Chandelier



E | 43448 OZ
Chandelier

MARCELE™

	ITEM #	FINISH	INCAND. BULB	W	H	OVRL. H	EXTRA WIRE	CHAIN/STEM	EXT.	HCWO	NOTES
A	43449	OZ	(9) 60W (C)	35.75	42	116	49	72	---	---	Additional chain 2996 OZ.
B	43446	OZ	(3) 60W (C)	11.5	17.5	92	26	72	---	---	Additional chain 2996 OZ.
C	43450	OZ	(1) 60W (C)	5	9.25	---	---	---	7.75	4.75	ⓐ
D	43447	OZ	(3) 60W (C)	17.75	21.5	96	22	72	---	---	Additional chain 2996 OZ.
E	43448	OZ	(5) 60W (C)	25	26.5	101	17	72	---	---	Additional chain 2996 OZ.

Measurements shown in inches. U.S. & Canadian Patent Pending.

DONINGTON™

OLDE BRONZE® FINISH WITH HIGHLIGHTS
AND OFF-WHITE FABRIC SHADES



A | 43339 OZ
Chandelier
NOT TO SCALE



B | 43343 OZ
Wall Sconce



C | 43341 OZ
Pendant

Satin-Etched
Glass Diffuser



D | 43340 OZ
Chandelier



E | 43342 OZ
Semi Flush



F | 43344 OZ
Chandelier



G | 43345 OZ
Chandelier

DONINGTON™

	ITEM #	FINISH	INCAND. BULB	W	H	OVRLL. H	EXTRA WIRE	CHAIN/STEM	EXT.	HCWO	NOTES
A	43339	OZ	(5) 60W (C)	25.75	26.75	101	17	72	---	---	Additional chain 2996 OZ.
B	43343	OZ	(1) 60W (C)	6.25	14.5	---	---	---	7.25	11.75	Ⓧ
C	43341	OZ	(3) 100W (M)	20	31.5	106	20	72	---	---	Ⓧ (23-30W CFL) Additional chain 2996 OZ.
D	43340	OZ	(5) 60W (C)	24	36.5	111	21	72	---	---	Additional chain 2996 OZ.
E	43342	OZ	(3) 100W (M)	14.75	10.75	---	---	---	---	---	Ⓧ (23-30W CFL)
F	43344	OZ	(8) 60W (C)	33.5	33.5	108	48	72	---	---	Additional chain 2996 OZ.
G	43345	OZ	(9) 60W (C)	33.5	39.25	108	46	72	---	---	Additional chain 2996 OZ.

Measurements shown in inches. U.S. & Canadian Patent Pending.

BASEL™

DISTRESSED BLACK FINISH



A | 43455 DBK
Chandelier
NOT TO SCALE



GET INSPIRED AT
KICHLER.COM



B | 43453 DBK
Mini Chandelier



C | 43456 DBK
Wall Sconce



D | 43454 DBK
Chandelier

BASEL™

	ITEM #	FINISH	INCAND. BULB	W	H	OVRL. H	EXTRA WIRE	CHAIN/STEM	EXT.	HCWO	NOTES
A	43455	DBK	(12) 60W (C)	34	36	110	48	72	---	---	Additional chain 2996 DBK.
B	43453	DBK	(4) 60W (C)	18	18.5	93	26	72	---	---	Additional chain 2996 DBK.
C	43456	DBK	(2) 60W (C)	10	14.5	---	---	---	5.75	11.5	
D	43454	DBK	(6) 60W (C)	26.25	25.75	100	56	72	---	---	Additional chain 2996 DBK.

Measurements shown in inches. U.S. & Canadian Patent Pending.

MARCHESA™

TERRENE BRONZE™ FINISH
WITH PIASTRA GLASS



A | 42230 TRZ
Foyer Chandelier
NOT TO SCALE

COORDINATING CEILING FAN

See the full line of Kichler®
Ceiling Fans in catalog K414
or visit kichler.com



B | 300113 TZ

Piastra
Glass



C | 45131 TRZ
Wall Sconce



D | 42231 TRZ
Semi Flush



E | 42227 TRZ
Chandelier



F | 42229 TRZ
Inverted Pendant

MARCHESA™

	ITEM #	FINISH	INCAND. BULB	W	H	OVRL. H	EXTRA WIRE	CHAIN/STEM	EXT.	HCWO	NOTES
A	42230	TRZ	(4) 60W (C)	18	35	109	9	72	---	---	Additional chain 2996 TRZ.
B	300113	TZ	---	---	---	---	---	---	---	---	Light Kit 380007TZ sold separately.
C	45131	TRZ	(1) 60W (M) ✓	12.75	15	---	---	---	6.75	3.25	Ⓛ (13-15W CFL)
D	42231	TRZ	(3) 60W (M)	15	13.5	---	---	---	---	---	Ⓛ (13-15W CFL)
E	42227	TRZ	(6) 60W (C)	33	31.25	106	54	72	---	---	Additional chain 4901 TRZ.
F	42229	TRZ	(3) 100W (M)	24.75	29.75	104	53	72	---	---	Ⓛ (23-30W CFL) Additional chain 2996 TRZ.

Measurements shown in inches. U.S. & Canadian Patent Pending.

MITHRAS™

TERRENE BRONZE™ FINISH

Shown with Optional
Shades 4087 BG



A | 43281 TRZ
Chandelier
NOT TO SCALE

Shown with Optional Shades 4086 BG



B | 43284 TRZ
Wall Sconce

Shown with Optional Shades 4086 BG



C | 43279 TRZ
Chandelier



D | 43280 TRZ
Chandelier

OPTIONAL SHADES

4085 BG
2.5 x 4.25 x 3.75
Beige Fabric Shade



4086 BG
3.5 x 5.5 x 4.75
Beige Fabric Shade



4087 BG
4 x 6 x 5.25
Beige Fabric Shade



MITHRAS™

	ITEM #	FINISH	INCAND. BULB	W	H	OVRL. H	EXTRA WIRE	CHAIN/STEM	EXT.	HCWO	NOTES
A	43281	TRZ	(15) 60W (C)	42	40.5	115	68	72	---	---	Additional chain 4908 TRZ. Shown with optional fabric shade 4087 BG.
B	43284	TRZ	(1) 60W (C)	5	13.25	---	---	---	6.5	8.75	ⓓ Shown with optional fabric shade 4086 BG.
C	43279	TRZ	(5) 60W (C)	24	22.5	97	57	72	---	---	Additional chain 2996 TRZ. Shown with optional fabric shade 4086 BG.
D	43280	TRZ	(9) 60W (C)	32	29.5	104	51	72	---	---	Additional chain 2996 TRZ.

Measurements shown in inches. U.S. & Canadian Patent Pending.

MITHRAS™

TERRENE BRONZE™ FINISH



A | 43282 TRZ
Foyer Chandelier
NOT TO SCALE



Shown as Mini Chandelier - 13.75" H.

CONVERTIBLE

Create two distinct lighting options with one fixture:
Mini Chandelier or Semi Flush.

B | 43277 TRZ



Shown with
Optional
Shades
4085 BG

Shown as Semi Flush - 13.75" H.



Shown as Mini Chandelier - 21.75" H.

CONVERTIBLE

Create two distinct lighting options with one fixture:
Mini Chandelier
or Semi Flush.

C | 43278 TRZ



Shown with
Optional
Shades
4086 BG

Shown as Semi Flush - 20.75" H.

MITHRAS™

	ITEM #	FINISH	INCAND. BULB	W	H	OVRLL. H	EXTRA WIRE	CHAIN/STEM	NOTES
A	43282	TRZ	(6) 60W (C)	19.75	29.75	104	17	72	Additional chain 2996 TRZ.
B	43277	TRZ	(3) 60W (C)	10.75	13.75	88	36	72	Optional fabric shade 4085 BG. Additional chain 2996 TRZ.
C	43278	TRZ	(3) 60W (C)	16.75	21.75	96	22	72	Optional fabric shade 4086 BG. Additional chain 2996 TRZ.

Measurements shown in inches. U.S. & Canadian Patent Pending.

SARABELLA™

LEGACY BRONZE™ FINISH
WITH WISPY UMBER CRACKLE GLASS



A | 42516 LZ
Wall Sconce
NOT TO SCALE





B | 42509 LZ
Chandelier



C | 42515 LZ
Mini Pendant



D | 42513 LZ
Inverted Pendant



F | 42511 LZ
Chandelier



E | 42514 LZ
Semi Flush



G | 42510 LZ
Chandelier

SARABELLA™

	ITEM #	FINISH	INCAND. BULB	W	H	OVRL. H	EXTRA WIRE	CHAIN/STEM	EXT.	HCWO	NOTES
A	42516	LZ	(1) 100W (M)	6.25	14.5	---	---	---	9	7.75	Ⓧ (18-25W CFL) May be installed with glass up or down.
B	42509	LZ	(3) 100W (M)	24.25	23.5	98	28	72	---	---	Additional chain 2996 LZ.
C	42515	LZ	(1) 100W (M)	8.5	11.5	50	63	36	---	---	Ⓧ (18-25W CFL) Additional chain 2996 LZ.
D	42513	LZ	(3) 100W (M)	23.5	30	104	24	72	---	---	Additional chain 4901 LZ.
E	42514	LZ	(2) 100W (M)	16.5	15	---	---	---	---	---	Ⓧ (23-30W CFL)
F	42511	LZ	(9) 100W (M)	33.5	38.5	113	49	72	---	---	Ⓧ (18-25W CFL) Additional chain 4901 LZ.
G	42510	LZ	(5) 100W (M)	26	28	102	24	72	---	---	Ⓧ (18-25W CFL) Additional chain 4901 LZ.

Measurements shown in inches.

RAVENNA™

RAVENNA™ FINISH ACCENTED WITH OPTICAL
CRYSTAL TRIM & EGGHELL FABRIC SHADES
WITH DECORATIVE TRIM



Optical Crystal Accent

A | 2134 RVN
Chandelier



B | 2101 RVN
Chandelier

RAVENNA™

	ITEM #	FINISH	INCAND. BULB	W	H	OVRL. H	EXTRA WIRE	CHAIN/STEM	NOTES
A	2134	RVN	(28) 60W (C)	71.25	95.5	218	108	120	① Additional chain 4912 RVN.
B	2101	RVN	(21) 60W (C)	53.75	80	202	110	120	① Additional chain 4930 RVN.

Measurements shown in inches.

RAVENNA™

RAVENNA™ FINISH ACCENTED WITH OPTICAL
CRYSTAL TRIM & EGGHELL FABRIC SHADES
WITH DECORATIVE TRIM



A | 2131 RVN
Chandelier



B | 6504 RVN
Wall Sconce



C | 2130 RVN
Chandelier

Eggshell Fabric
Shades with
Decorative Trim



D | 2441 RVN
Chandelier

RAVENNA™

	ITEM #	FINISH	INCAND. BULB	W	H	OVRL. H	EXTRA WIRE	CHAIN/STEM	EXT.	HCWO	NOTES
A	2131	RVN	(12) 60W (C)	44	61.25	184	112	120	---	---	① Additional chain 4930 RVN.
B	6504	RVN	(2) 60W (C)	19.25	22.5	---	---	---	11	12.5	Ⓚ
C	2130	RVN	(6) 60W (C)	30.5	43.5	118	79	72	---	---	Additional chain 4901 RVN.
D	2441	RVN	(9) 60W (C)	24	29.5	104	117	72	---	---	Additional chain 2996 RVN.

Measurements shown in inches. U.S. & Canadian Patent Pending: B

LARISSA™

TANNERY BRONZE™ FINISH WITH
GOLD ACCENTS & CITRINE GLASS



A | 2217 TZG
Chandelier
NOT TO SCALE



B | 2313 TZG
Chandelier



Satin-Etched
Glass
Diffuser

C | 3217 TZG
Inverted Pendant



D | 2219 TZG
Chandelier

LARISSA™

ITEM #	FINISH	INCAND. BULB	W	H	OVRL. H	EXTRA WIRE	CHAIN/STEM	NOTES	
A	2217	TZG	(9) 100W (M)	35.75	45	119	91	72	① (23-30W CFL) Additional chain 4908 TZG.
B	2313	TZG	(6) 100W (M) & (3) 150W (M)	43.25	38	112	87	72	① (23-30W CFL) Additional chain 4908 TZG.
C	3217	TZG	(3) 150W (M)	23.75	32	106	94	72	② (18-25W CFL) Additional chain 2996 TZG.
D	2219	TZG	(21) 100W (M)	56.5	67	141	89	72	① (23-30W CFL) Additional chain 4909 TZG.

Measurements shown in inches.

LARISSA™

TANNERY BRONZE™ FINISH WITH
GOLD ACCENTS & CITRINE GLASS



A | 2220 TZG
Chandelier



B | 2307 TZG
Chandelier



Shown as Inverted Pendant - 23.5" H.

CONVERTIBLE

Create two distinct lighting options with one fixture:
Inverted Pendant or Semi Flush.

C | 2606 TZG



Shown as Semi Flush - 20.5" H.



D | 2216 TZG
Chandelier



E | 2218 TZG
Chandelier

LARISSA™

	ITEM #	FINISH	INCAND. BULB	W	H	OVRL. H	EXTRA WIRE	CHAIN/STEM	NOTES
A	2220	TZG	(28) 75W (M)	73	85	195	68	108	① (23-30W CFL) Additional chain 4930 TZG.
B	2307	TZG	(15) 60W (C)	24	34	108	129	72	Additional chain 2996 TZG.
C	2606	TZG	(3) 100W (M)	17.5	23.5	98	23	72	② (9-13W CFL) Additional chain 2996 TZG.
D	2216	TZG	(6) 150W (M)	29	32.5	107	71	72	② (23-30W CFL) Additional chain 4901 TZG.
E	2218	TZG	(15) 75W (M)	45	58	168	76	108	① (18-25W CFL) Additional chain 4909 TZG.

Measurements shown in inches.

LARISSA™

TANNERY BRONZE™ FINISH WITH GOLD ACCENTS & CITRINE GLASS



A | 6513 TZG
Wall Sconce



B | 8413 TZG
Flush Mount



C | 3713 TZG
Semi Flush



D | 5214 TZG
Wall Sconce



E | 8415 TZG
Flush Mount

COORDINATING CEILING FAN

See the full line of Kichler®
Ceiling Fans in catalog K414
or visit kichler.com



F | 300012 TZG



G | 2304 TZG
Mini Chandelier

LARISSA™

ITEM #	FINISH	INCAND. BULB	W	H	OVRLL. H	EXTRA WIRE	CHAIN/STEM	EXT.	HCWO	NOTES
A	6513	TZG (2) 60W (C) ✓	17.5	5	---	---	---	8.5	2.5	Ⓧ
B	8413	TZG (2) 60W (C) ❖	14.5	7.5	---	---	---	---	---	
C	3713	TZG (2) 100W (M)	15.5	13	---	---	---	---	---	Ⓧ (9-13W CFL)
D	5214	TZG (1) 100W (M)	5.5	10	---	---	---	7.25	3	Ⓧ May be installed with glass up or down.
E	8415	TZG (3) 75W (M) ❖	18	8.75	---	---	---	---	---	Ⓧ (18-25W CFL)
F	300012	TZG ---	---	---	---	---	---	---	---	See the full line of Kichler® Ceiling Fans in catalog K414 or visit kichler.com .
G	2304	TZG (9) 60W (C)	18.5	23.25	98	131	72	---	---	Additional chain 2996 TZG.

Measurements shown in inches.

PENDALETTE®

Create three distinct lighting options with one fixture: Mini Chandelier, Wall Mount or Semi Flush.

H | 2215 TZG



Shown as Mini Chandelier - 14" H.



Shown as Wall Mount - 19.25" H.



Shown as Semi Flush - 14.5" H.



J | 2703 TZG
Mini Pendant



K | 2303 TZG
Mini Chandelier



L | 2049 TZG
Chandelier/Dinette

MATCHING COLLECTION

See matching bath fixtures on page 541.



LARISSA™

	ITEM #	FINISH	INCAND. BULB	W	H	OVRL. H	EXTRA WIRE	CHAIN/STEM	EXT.	HCWO	NOTES
H	2215	TZG	(3) 60W (C)	11.25	14	88	35	72	12	2.5	Ⓟ
J	2703	TZG	(1) 100W (M)	5.5	14	52	61	36	---	---	Ⓟ (18-25W CFL) Additional chain 2996 TZG, additional stem 2999 (12") TZ.
K	2303	TZG	(5) 60W (C)	15.5	18	92	131	72	---	---	Additional chain 2996 TZG.
L	2049	TZG	(5) 100W (M)	22.5	28	102	34	72	---	---	Ⓟ (9-13W CFL) Additional chain 2996 TZG.

Measurements shown in inches.

WILTON™

CARRÉ BRONZE® FINISH WITH
ANTIQUE BARLEY GLASS

MATCHING COLLECTION

See matching bath fixtures
on page 542.



A | 3390 CZ
Inverted Pendant



B | 3391 CZ
Inverted Pendant



C | 6894 CZ
Wall Sconce



D | 2091 CZ
Chandelier



E | 2092 CZ
Chandelier



F | 2088 CZ
Chandelier/Dinette



G | 2089 CZ
Chandelier



H | 2090 CZ
Oval Chandelier

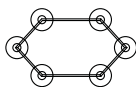

COORDINATING
CEILING FAN

See the full line of Kichler®
Ceiling Fans in catalog K414
or visit kichler.com



J | 300006 CZ

WILTON™

ITEM #	FINISH	INCAND. BULB	W	H	OVRL. H	L	EXTRA WIRE	CHAIN/STEM	EXT.	HCWO	NOTES	
A	3390	CZ	(3) 100W (M)	18.25	27.5	126	---	66	72	---	---	② (9-13W CFL) Additional chain 2996 CZ.
B	3391	CZ	(3) 100W (M)	25.5	35	109	---	37	72	---	---	② (23-30W CFL) Additional chain 2996 CZ.
C	6894	CZ	(1) 60W (C) ✓	13.75	11.25	---	---	---	---	5.5	4	①
D	2091	CZ	(9) 100W (M)	34	45	119	---	77	72	---	---	② (23-30W CFL) Additional chain 4901 CZ.
E	2092	CZ	(12) 100W (M)	40.75	51.75	126	---	66	72	---	---	① ② (23-30W CFL) Additional chain 4908 CZ.
F	2088	CZ	(3) 100W (M)	21.5	25.25	100	---	15	72	---	---	② (23-30W CFL) Additional chain 2996 CZ.
G	2089	CZ	(6) 100W (M)	28	33.5	108	---	48	72	---	---	② (23-30W CFL) Additional chain 4901 CZ.
H	2090	CZ	(6) 100W (M)	22.5	22.5	97	39	43	72	---	---	② (23-30W CFL) Additional chain 4901 CZ.
J	300006	CZ	---	---	---	---	---	---	---	---	---	See the full line of Kichler® Ceiling Fans in catalog K414 or visit kichler.com.

Measurements shown in inches.

WILTON™

CARRÉ BRONZE® FINISH WITH
ANTIQUÉ BARLEY GLASS



A | 8090 CZ
Flush Mount



B | 2471 CZ
Foyer Chandelier



C | 2472 CZ
Foyer Chandelier

PENDALETTE®

Create three distinct lighting options with one fixture: Mini Chandelier, Wall Mount or Semi Flush.

D | 3289 CZ



Shown as Chandelier - 12.5" H.



Shown as Wall Mount - 15.5" H.



Shown as Semi Flush - 19.25" H.



E | 5987 CZ
Wall Sconce



F | 3489 CZ
Mini Pendant



G | 3894 CZ
Island Chandelier

WILTON™

ITEM #	FINISH	INCAND. BULB	W	H	OVRL. H	L	EXTRA WIRE	CHAIN/STEM	EXT.	HCWO	NOTES	
A	8090	CZ	(2) 60W (M) ❖	20.25	7	---	---	---	---	---	🔌 (13-15W CFL)	
B	2471	CZ	(6) 60W (C)	25	49.75	124	---	77	72	---	Additional chain 4901 CZ.	
C	2472	CZ	(9) 60W (C)	31.5	60	134	---	68	72	---	① Additional chain 4908 CZ.	
D	3289	CZ	(3) 60W (C)	10.5	12.5	87	---	39	72	10.75	3.5	🔌
E	5987	CZ	(1) 100W (M)	6.5	22.25	---	---	---	---	10	6.75	🔌🔌 (23-30W CFL) May be installed with glass up or down.
F	3489	CZ	(1) 100W (M)	6.5	18	56	---	57	36	---	---	🔌 (23-30W CFL) Additional chain 2996 CZ, additional stem 2999 (12") CZ.
G	3894	CZ	(2) 150W (M)	18.25	28.5	103	44	48	72	---	---	🔌 (23-30W CFL) Additional chain 4901 (12") CZ. G-type lamp recommended.

Measurements shown in inches. U.S. Patent Pending: B, C, D.

KENSINGTON™

OLDE BRONZE® FINISH



A | 43335 OZ
Chandelier
NOT TO SCALE



B | 43332 OZ
Mini Chandelier
NOT TO SCALE



GET INSPIRED AT
KICHLER.COM



C | 43334 OZ
Wall Sconce



Vintage Squirrel Cage Filament Bulb, 60W Medium Base

4071 CLR



D | 43333 OZ
Mini Pendant

Shown with Optional Vintage Squirrel Cage Filament Bulb 4071 CLR.



Vintage Squirrel Cage Filament Bulb, 40W Candelabra Base

5971 CLR

Shown with optional Vintage Squirrel Cage Filament Bulb 5971 CLR.



E | 43330 OZ
Chandelier



F | 43331 OZ
Chandelier

KENSINGTON™

	ITEM #	FINISH	INCAND. BULB	W	H	OVRL. H	EXTRA WIRE	CHAIN/STEM	EXT.	HCWO	NOTES
A	43335	OZ	(5) 60W (C)	20.25	29.25	70	48	36	---	---	Additional chain 2996 OZ, additional stem 2999 (12") OZ.
B	43332	OZ	(4) 60W (C)	16.25	27	68	50	36	---	---	Additional chain 2996 OZ, additional stem 2999 (12") OZ.
C	43334	OZ	(1) 60W (C)	5.25	13.5	---	---	---	7.5	9.25	Ⓧ
D	43333	OZ	(1) 60W (M)	8.25	16.25	57	68	36	---	---	Ⓧ (23-30W CFL) Additional chain 2996 OZ, additional stem 2999 (12") OZ.
E	43330	OZ	(5) 60W (C)	25	27.25	102	15	72	---	---	Additional chain 2996 OZ.
F	43331	OZ	(9) 60W (C)	33.75	32.75	107	40	72	---	---	Additional chain 2996 OZ.

Measurements shown in inches. U.S. & Canadian Patent Pending.

KAMBRY™

SMOKEY GRAY FINISH

OPTIONAL SHADES

4117 CLR

4.25 x 6 - Clear Glass



4118 SEG

4.25 x 6 - Satin Etched Glass



4119 OWH

5 x 4.5 - Off-White Fabric Shadee



A | 43465 SMG
Chandelier
NOT TO SCALE



GET INSPIRED AT
KICHLER.COM



B | 45465 SMG
Wall Sconce



Shown as Mini Chandelier - 13.75" H.

D | 43462 SMG
Mini Chandelier



F | 43463 SMG
Chandelier

CONVERTIBLE

Create two distinct lighting options with one fixture:
Mini Chandelier or Semi Flush.

C | 43461 SMG



Shown as Semi Flush - 14" H.



E | 43468 SMG
Foyer Chandelier



KAMBRY™

	ITEM #	FINISH	INCAND. BULB	W	H	OVRLL. H	EXTRA WIRE	CHAIN/STEM	EXT.	HCWO	NOTES
A	43465	SMG	(9) 60W (C)	32	30.75	105	53	72	---	---	Additional chain 2996 SMG.
B	45465	SMG	(1) 60W (C)	4.5	14	---	---	---	7.5	10.5	D
C	43461	SMG	(3) 60W (C)	13.25	13.75	88	27	72	---	---	Additional chain 2996 SMG.
D	43462	SMG	(4) 60W (C)	18	16.5	91	24	72	---	---	Additional chain 2996 SMG.
E	43468	SMG	(5) 60W (C)	18	35.75	110	41	72	---	---	Additional chain 2996 SMG.
F	43463	SMG	(5) 60W (C)	25	21.25	96	20	72	---	---	Additional chain 2996 SMG.

Measurements shown in inches. U.S. & Canadian Patent Pending.

KAMBRY™

SMOKEY GRAY FINISH SHOWN WITH
OPTIONAL CLEAR GLASS SHADE,
SATIN-ETCHED GLASS SHADE OR
OFF-WHITE FABRIC SHADE

OPTIONAL SHADES

4117 CLR

4.25 x 6 - Clear Glass



4118 SEG

4.25 x 6 - Satin Etched Glass



4119 OWH

5 x 4.5 - Off-White Fabric Shadee



GET INSPIRED AT
KICHLER.COM

A

43465 SMG
Chandelier
NOT TO SCALE



B | 45465 SMG
Wall Sconce

Shown with optional Clear Glass Shade, 4117 CLR



Shown as Mini Chandelier - 13.75" H.

CONVERTIBLE

Create two distinct lighting options with one fixture:
Mini Chandelier or Semi Flush.

C | 43461 SMG



D | 43462 SMG
Mini Chandelier



E | 43468 SMG
Foyer Chandelier



Shown as Semi Flush - 14" H.



Shown with optional Off-White Fabric Shade, 4119 OWH

F | 43463 SMG
Chandelier

KAMBRY™

	ITEM #	FINISH	INCAND. BULB	W	H	OVRLL. H	EXTRA WIRE	CHAIN/STEM	EXT.	HCWO	NOTES
A	43465	SMG	(9) 60W (C)	32	30.75	105	53	72	---	---	Additional chain 2996 SMG.
B	45465	SMG	(1) 60W (C)	4.5	14	---	---	---	7.5	10.5	ⓐ
C	43461	SMG	(3) 60W (C)	13.25	13.75	88	27	72	---	---	Additional chain 2996 SMG.
D	43462	SMG	(4) 60W (C)	18	16.5	91	24	72	---	---	Additional chain 2996 SMG.
E	43468	SMG	(5) 60W (C)	18	35.75	110	41	72	---	---	Additional chain 2996 SMG.
F	43463	SMG	(5) 60W (C)	25	21.25	96	20	72	---	---	Additional chain 2996 SMG.

Measurements shown in inches. U.S. & Canadian Patent Pending.

MONROE™

BRUSHED NICKEL FINISH WITH
SATIN-ETCHED GLASS



A | 43156 NI
Chandelier



B | 43155 NI
Chandelier/Dinette



C | 43158 NI
Chandelier



D | 43159 NI
Chandelier

MONROE™

ITEM #	FINISH	INCAND. BULB	W	H	OVRL. H	EXTRA WIRE	CHAIN/STEM	NOTES	
A	43156	NI	(5) 100W (M)	27.5	29.5	104	35	72	☑ (23-30W CFL) Additional chain 2996 NI.
B	43155	NI	(3) 100W (M)	23	29.5	104	35	72	☑ (23-30W CFL) Additional chain 2996 NI.
C	43158	NI	(5) 100W (M)	27	25	99	20	72	☑ (23-30W CFL) Additional chain 2996 NI.
D	43159	NI	(9) 100W (M)	33.5	37.75	112	34	72	☑ (23-30W CFL) Additional chain 4901 NI.

Measurements shown in inches.



E | 43172 NI
Pendant



F | 43162 NI
Mini Pendant



G | 43160 NI
Island Chandelier



H | 43192 NI
Chandelier



J | 43171 NI
Wall Sconce



K | 43170 NI
Wall Sconce

MATCHING BATH

See matching bath fixtures on page 552.



MONROE™

ITEM #	FINISH	INCAND. BULB	W	H	OVRL. H	L	STEM TILT	EXTRA WIRE	CHAIN/STEM	EXT.	HCWO	NOTES
E	43172	NI (1) 100W (M)	14	8.75	47	---	---	67	36	---	---	Ⓜ (23-30W CFL) Additional chain 2996 NI, G-type lamp rec.
F	43162	NI (1) 100W (M)	7	16	54	---	90°	60	36	---	---	Ⓜ (23-30W CFL) Additional stem 2999 (12") NI and/or 2997 (24") NI.
G	43160	NI (2) 100W (M)	14	22.25	97	34.5	---	35	72	---	---	Ⓜ (23-30W CFL) Additional chain 2996 NI, G-type lamp rec.
H	43192	NI (16) 75W (M)	45	48	122	---	---	35	72	---	---	Ⓜ (18-25W CFL) Additional chain 4908 NI.
J	43171	NI (2) 100W (M)	14.5	14	---	---	---	---	---	8.75	8	Ⓜ (23-30W CFL) May be installed with glass up or down.
K	43170	NI (1) 100W (M)	6	14	---	---	---	---	---	9.25	8	Ⓜ (23-30W CFL) May be installed with glass up or down.

Measurements shown in inches.

MONROE™

BRUSHED NICKEL FINISH
WITH SATIN-ETCHED GLASS



A | 43168 NI
Semi Flush



B | 43169 NI
Semi Flush



C | 43163 NI
Inverted Pendant



D | 43164 NI
Inverted Pendant



E | 43165 NI
Foyer Chandelier



F | 43166 NI
Foyer Chandelier



G | 43167 NI
Foyer Chandelier

MONROE™

ITEM #	FINISH	INCAND. BULB	W	H	OVRL. H	EXTRA WIRE	CHAIN/STEM	NOTES
A	43168	NI	(4) 60W (C)	10.5	15	---	---	---
B	43169	NI	(2) 100W (M)	17.25	14.25	---	---	☑ (23-30W CFL)
C	43163	NI	(2) 100W (M)	17.5	25	99	20	72 ☑ (23-30W CFL) Additional chain 2996 NI.
D	43164	NI	(3) 100W (M)	26.75	32.75	107	14	72 ☑ (23-30W CFL) Additional chain 2996 NI.
E	43165	NI	(4) 60W (C)	15	27	101	34	72 Additional chain 2996 NI.
F	43166	NI	(8) 60W (C)	23	40.75	115	34	72 Additional chain 2996 NI.
G	43167	NI	(8) 60W (C)	27	44.75	119	34	72 Additional chain 2996 NI.

Measurements shown in inches.

MONROE™

OLDE BRONZE® FINISH WITH
LIGHT UMBER ETCHED GLASS



A | 43164 OZ
Inverted Pendant



B | 43163 OZ
Inverted Pendant



C | 43169 OZ
Semi Flush



D | 43168 OZ
Semi Flush



E | 43167 OZ
Foyer Chandelier



F | 43166 OZ
Foyer Chandelier



G | 43165 OZ
Foyer Chandelier

MONROE™

ITEM #	FINISH	INCAND. BULB	W	H	OVRL. H	EXTRA WIRE	CHAIN/STEM	NOTES	
A	43164	OZ	(3) 100W (M)	26.75	32.75	107	14	72	☑ (23-30W CFL) Additional chain 2996 OZ.
B	43163	OZ	(2) 100W (M)	17.5	25	99	20	72	☑ (23-30W CFL) Additional chain 2996 OZ.
C	43169	OZ	(2) 100W (M)	17.25	14.25	---	---	---	☑ (23-30W CFL)
D	43168	OZ	(4) 60W (C)	10.5	15	---	---	---	
E	43167	OZ	(8) 60W (C)	27	44.75	119	34	72	Additional chain 2996 OZ.
F	43166	OZ	(8) 60W (C)	23	40.75	115	34	72	Additional chain 2996 OZ.
G	43165	OZ	(4) 60W (C)	15	27	101	34	72	Additional chain 2996 OZ.

Measurements shown in inches.

MONROE™

OLDE BRONZE® FINISH WITH
LIGHT UMBER ETCHED GLASS



A | 43156 OZ
Chandelier



B | 43155 OZ
Chandelier/Dinette



C | 43158 OZ
Chandelier



D | 43159 OZ
Chandelier

MONROE™

	ITEM #	FINISH	INCAND. BULB	W	H	OVRL. H	EXTRA WIRE	CHAIN/STEM	NOTES
A	43156	OZ	(5) 100W (M)	27.5	29.5	104	35	72	☑ (23-30W CFL) Additional chain 2996 OZ.
B	43155	OZ	(3) 100W (M)	23	29.5	104	35	72	☑ (23-30W CFL) Additional chain 2996 OZ.
C	43158	OZ	(5) 100W (M)	27	25	99	20	72	☑ (23-30W CFL) Additional chain 2996 OZ.
D	43159	OZ	(9) 100W (M)	33.5	37.75	112	34	72	☑ (23-30W CFL) Additional chain 4901 OZ.

Measurements shown in inches.



E | 43172 OZ
Pendant



F | 43162 OZ
Mini Pendant



G | 43160 OZ
Island Chandelier



H | 43192 OZ
Chandelier



J | 43171 OZ
Wall Sconce



K | 43170 OZ
Wall Sconce

MATCHING BATH

See matching bath fixtures on page 551.



MONROE™

ITEM #	FINISH	INCAND. BULB	W	H	OVRLL. H	L	STEM TILT	EXTRA WIRE	CHAIN/STEM	EXT.	HCWO	NOTES
E	43172	OZ (1) 100W (M)	14	8.75	47	---	---	67	36	---	---	Ⓜ (23-30W CFL) Additional chain 2996 OZ. G-type lamp recommended.
F	43162	OZ (1) 100W (M)	7	16	54	---	90°	60	36	---	---	Ⓜ (23-30W CFL) Additional stem 2999 (12") OZ.
G	43160	OZ (2) 100W (M)	14	22.25	97	34.5	---	35	72	---	---	Ⓜ (23-30W CFL) Additional chain 2996 OZ. G-type lamp recommended.
H	43192	OZ (16) 75W (M)	45	48	122	---	---	35	72	---	---	Ⓜ (18-25W CFL) Additional chain 4908 OZ.
J	43171	OZ (2) 100W (M)	14.5	14	---	---	---	---	---	8.75	8	Ⓜ (23-30W CFL) May be installed with glass up or down.
K	43170	OZ (1) 100W (M)	6	14	---	---	---	---	---	9.25	8	Ⓜ (23-30W CFL) May be installed with glass up or down.

Measurements shown in inches.

FEVILLE™

OLDE BRONZE® FINISH WITH
LIGHT UMBER ETCHED GLASS



A | 45473 OZ
Wall Sconce



B | 43174 OZ
Semi Flush



C | 43180 OZ
Large Foyer Pendant



D | 43178 OZ
Chandelier



E | 43181 OZ
Large Foyer Pendant

FEVILLE™

ITEM #	FINISH	INCAND. BULB	W	H	OVRL. H	EXTRA WIRE	CHAIN/STEM	EXT.	HCWO	NOTES
A	OZ	(1) 100W (M)	6	11.25	---	---	---	8	6.25	Ⓢ (23-30W CFL) May be installed with glass up or down.
B	OZ	(3) 100W (M)	19	12.5	---	---	---	---	---	Ⓢ (23-30W CFL)
C	OZ	(1) 150W (M)	16	26	100	25	72	---	---	Ⓢ (30-52W CFL) Additional chain 2996 OZ.
D	OZ	(16) 60W (M)	45.25	44	118	16	72	---	---	Ⓢ (13-15W CFL) Additional chain 4901 OZ.
E	OZ	(1) 200W (M)	21	30.25	105	24	72	---	---	Ⓢ (30-52W CFL) Additional chain 2996 OZ.

Measurements shown in inches.



F | 43176 OZ
Chandelier/Dinette



G | 43183 OZ
Island Chandelier



H | 43182 OZ
Mini Pendant



J | 43177 OZ
Chandelier



K | 43175 OZ
Chandelier



L | 43179 OZ
Inverted Pendant

MATCHING BATH

See matching bath fixtures on page 553.



FEVILLE™

	ITEM #	FINISH	INCAND. BULB	W	H	OVRL. H	L	STEM TILT	EXTRA WIRE	CHAIN/STEM	NOTES
F	43176	OZ	(5) 100W (M)	23	20.75	95	---	---	30	72	☑ (23-30W CFL) Additional chain 2996 OZ.
G	43183	OZ	(2) 100W (M)	15.75	14.5	---	36.75	---	34	72	☑ (23-30W CFL) Additional chain 2996 OZ. G-type lamp recommended.
H	43182	OZ	(1) 100W (M)	6	13.25	52	---	90°	60	36	☑ (23-30W CFL) Additional stem 2999 (12") OZ, additional chain 2996 OZ.
J	43177	OZ	(9) 100W (M)	31	31	105	---	---	12	72	☑ (23-30W CFL) Additional chain 4901 OZ.
K	43175	OZ	(5) 100W (M)	25	21.75	96	---	---	23	72	☑ (23-30W CFL) Additional chain 2996 OZ.
L	43179	OZ	(3) 100W (M)	18.5	23	97	---	---	24	72	☑ (23-30W CFL) Additional chain 2996 OZ.

Measurements shown in inches.

CAMERENA™

BRUSHED NICKEL FINISH
WITH WHITE SCAVO GLASS



A | 43226 NI
Chandelier



B | 43229 NI
Large Foyer Pendant



C | 43224 NI
Chandelier

CAMERENA™

	ITEM #	FINISH	INCAND. BULB	W	H	OVRL. H	EXTRA WIRE	CHAIN/STEM	NOTES
A	43226	NI	(9) 100W (M)	30	34.5	109	15	72	☑ (23-30W CFL) Additional chain 2996 NI.
B	43229	NI	(1) 200W (M)	20	31.75	106	21	72	☑ (30-52W CFL) Additional chain 2996 NI.
C	43224	NI	(5) 100W (M)	27	31.25	106	11	72	☑ (23-30W CFL) Additional chain 2996 NI.

Measurements shown in inches.



D | 43230 NI
Mini Pendant



E | 43223 NI
Chandelier/Dinette



F | 43234 NI
Chandelier



G | 43225 NI
Chandelier

MATCHING BATH

See matching bath fixtures on page 549.



CAMERENA™

	ITEM #	FINISH	INCAND. BULB	W	H	OVRL. H	STEM TILT	EXTRA WIRE	CHAIN/STEM	NOTES
D	43230	NI	(1) 100W (M)	7	16.5	55	90°	58	36	☑ (23-30W CFL) Additional stem 2999 (12") NI and/or 2997 (24") NI.
E	43223	NI	(3) 100W (M)	20	24.5	99	---	17	72	☑ (23-30W CFL) Additional chain 2996 NI.
F	43234	NI	(16) 75W (M)	45	48.25	123	---	50	72	☑ (18-25W CFL) Additional chain 4901 NI.
G	43225	NI	(5) 100W (M)	27	29	103	---	13	72	☑ (23-30W CFL) Additional chain 2996 NI.

Measurements shown in inches.

CAMERENA™

BRUSHED NICKEL FINISH
WITH WHITE SCAVO GLASS



A | 43232 NI
Semi Flush



B | 45421 NI
Wall Sconce



C | 43233 NI
Pendant



D | 43228 NI
Large Foyer Pendant



E | 43227 NI
Inverted Pendant

White Scavo Glass



F | 43231 NI
Island Chandelier

CAMERENA™

ITEM #	FINISH	INCAND. BULB	W	H	OVRL. H	L	EXTRA WIRE	CHAIN/STEM	EXT.	HCWO	NOTES
A	43232	NI	(3) 100W (M)	18	14.5	---	---	---	---	---	☑ (23-30W CFL)
B	45421	NI	(1) 100W (M)	6	12.5	---	---	---	8.75	8.5	ⓧ☑ (23-30W CFL) May be installed with glass up or down.
C	43233	NI	(1) 100W (M)	15.75	9.25	48	---	67	36	---	☑ (23-30W CFL) Additional chain 2996 NI. G-type lamp recommended.
D	43228	NI	(1) 150W (M)	15.25	27.25	102	---	24	72	---	☑ (30-52W CFL) Additional chain 2996 NI.
E	43227	NI	(3) 100W (M)	18	21.5	96	---	20	72	---	☑ (23-30W CFL) Additional chain 2996 NI.
F	43231	NI	(2) 100W (M)	15.75	23.25	98	37.25	24	72	---	☑ (23-30W CFL) Additional chain 2996 NI. G-type lamp recommended.

Measurements shown in inches.

CAMERENA™

OLDE BRONZE® FINISH AND
WHITE SCAVO GLASS WITH
LIGHT UMBER INSIDE TINT



A | 43224 OZ
Chandelier



C | 43229 OZ
Large Foyer Pendant



B | 43226 OZ
Chandelier

White Scavo Glass
with Light Umber
Inside Tint

CAMERENA™

	ITEM #	FINISH	INCAND. BULB	W	H	OVRL. H	EXTRA WIRE	CHAIN/STEM	NOTES
A	43224	OZ	(5) 100W (M)	27	31.25	106	11	72	☑ (23-30W CFL) Additional chain 2996 OZ.
B	43226	OZ	(9) 100W (M)	30	34.5	109	15	72	☑ (23-30W CFL) Additional chain 2996 OZ.
C	43229	OZ	(1) 200W (M)	20	31.75	106	21	72	☑ (30-52W CFL) Additional chain 2996 OZ.

Measurements shown in inches.

CAMERENA™

OLDE BRONZE® FINISH AND
WHITE SCAVO GLASS WITH
LIGHT UMBER INSIDE TINT



A | 43232 OZ
Semi Flush



B | 45421 OZ
Wall Sconce



C | 43233 OZ
Pendant



D | 43228 OZ
Large Foyer Pendant



E | 43227 OZ
Inverted Pendant



F | 43231 OZ
Island Chandelier

CAMERENA™

ITEM #	FINISH	INCAND. BULB	W	H	OVRLL. H	L	EXTRA WIRE	CHAIN/STEM	EXT.	HCWO	NOTES
A	43232	OZ	(3) 100W (M)	18	14.5	---	---	---	---	---	☑ (23-30W CFL)
B	45421	OZ	(1) 100W (M)	6	12.5	---	---	---	8.75	8.5	Ⓞ ☑ (23-30W CFL) May be installed with glass up or down.
C	43233	OZ	(1) 100W (M)	15.75	9.25	48	---	67	36	---	☑ (23-30W CFL) Additional chain 2996 OZ. G-type lamp recommended.
D	43228	OZ	(1) 150W (M)	15.25	27.25	102	---	24	72	---	☑ (30-52W CFL) Additional chain 2996 OZ.
E	43227	OZ	(3) 100W (M)	18	21.5	96	---	20	72	---	☑ (23-30W CFL) Additional chain 2996 OZ.
F	43231	OZ	(2) 100W (M)	15.75	23.25	98	37.25	24	72	---	☑ (23-30W CFL) Additional chain 2996 OZ. G-type lamp recommended.

Measurements shown in inches.



G | 43230 OZ
Mini Pendant



H | 43223 OZ
Chandelier/Dinette



J | 43234 OZ
Chandelier



K | 43225 OZ
Chandelier

MATCHING BATH

See matching bath fixtures on page 548.



CAMERENA™

	ITEM #	FINISH	INCAND. BULB	W	H	OVRL. H	STEM TILT	EXTRA WIRE	CHAIN/STEM	NOTES
G	43230	OZ	(1) 100W (M)	7	16.5	55	90°	58	36	☑ (23-30W CFL) Additional stem 2999 (12") OZ.
H	43223	OZ	(3) 100W (M)	20	24.5	99	---	17	72	☑ (23-30W CFL) Additional chain 2996 OZ.
J	43234	OZ	(16) 75W (M)	45	48.25	123	---	50	72	☑ (18-25W CFL) Additional chain 4901 OZ.
K	43225	OZ	(5) 100W (M)	27	29	103	---	13	72	☑ (23-30W CFL) Additional chain 2996 OZ.

Measurements shown in inches.



Larkin™ Pendant 42566 NI | Page 327

LARKIN™

BRUSHED NICKEL FINISH



A | 42565 NI
Pendant



Vintage
Squirrel Cage
Filament Bulb,
40W Candelabra
Base

5971 CLR



B | 42566 NI
Pendant

Shown With
Optional Vintage
Squirrel Cage
Filament Bulb
5971 CLR



C | 42568 NI
Foyer Chandelier

LARKIN™

	ITEM #	FINISH	INCAND. BULB	W	H	OVRL. H	EXTRA WIRE	CHAIN/STEM	NOTES
A	42565	NI	(2) 60W (C)	8	14.75	89	26	72	Additional chain 2996 NI.
B	42566	NI	(3) 60W (C)	12	22.25	97	20	72	Additional chain 2996 NI.
B	42568	NI	(6) 60W (C)	18	36.25	111	7	72	Additional chain 2996 NI.

Measurements shown in inches. U.S. & Canadian Patent Pending.

LARKIN™

OLDE BRONZE® FINISH



B | 42568 OZ
Foyer Chandelier



Vintage
Squirrel Cage
Filament Bulb,
40W Candelabra
Base

5971 CLR



A | 42565 OZ
Pendant



Shown With
Optional Vintage
Squirrel Cage
Filament Bulb
5971 CLR

C | 42566 OZ
Pendant

LARKIN™

	ITEM #	FINISH	INCAND. BULB	W	H	OVRL. H	EXTRA WIRE	CHAIN/STEM	NOTES
A	42565	OZ	(2) 60W (C)	8	14.75	89	26	72	Additional chain 2996 OZ.
B	42568	OZ	(6) 60W (C)	18	36.25	111	7	72	Additional chain 2996 OZ.
C	42566	OZ	(3) 60W (C)	12	22.25	97	20	72	Additional chain 2996 OZ.

Measurements shown in inches. U.S. & Canadian Patent Pending.

LARKIN™

ANTIQUÉ COPPER FINISH



A | 42565 ACO
Pendant



Vintage
Squirrel Cage
Filament Bulb,
40W Candelabra
Base

5971 CLR



B | 42566 ACO
Pendant

Shown With
Optional Vintage
Squirrel Cage
Filament Bulb
5971 CLR

Antique Copper Finish

LARKIN™

	ITEM #	FINISH	INCAND. BULB	W	H	OVRLL. H	EXTRA WIRE	CHAIN/STEM	NOTES
A	42565	ACO	(2) 60W (C)	8	14.75	89	26	72	Additional chain 2996 ACO.
B	42566	ACO	(3) 60W (C)	12	22.25	97	20	72	Additional chain 2996 ACO.

Measurements shown in inches. U.S. & Canadian Patent Pending.



GET INSPIRED AT
KICHLER.COM

RYEGATE™

ANTIQUE PEWTER, ANTIQUE COPPER
OR OLDE BRONZE® FINISH



A | 42908 AP
Indoor Pendant



A | 42908 ACO
Indoor Pendant



A | 42908 OZ
Indoor Pendant



B | 42909 AP
Indoor Pendant



B | 42909 ACO
Indoor Pendant



B | 42909 OZ
Indoor Pendant

RYEGATE™

ITEM #	FINISH	INCAND. BULB	W	H	OVALL. H	L	EXTRA WIRE	CHAIN/STEM	NOTES
A 42908	ACO, AP, OZ	(2) 60W (C)	14	23.75	62	10	53	36	Additional chain 2996 ACO, AP, OZ. Additional stem 2999 (12") ACO, AP, OZ.
B 42909	ACO, AP, OZ	(3) 60W (C)	12.75	27.5	66	18	51	36	Additional chain 2996 ACO, AP, OZ. Additional stem 4935 (12") ACO, AP, OZ.

Measurements shown in inches. U.S. & Canadian Patent Pending.

BARCELONA™

TANNERY BRONZE™ FINISH WITH
CLEAR GLASS TEARDROPS



A | 1632 TZ
Chandelier



B | 1631 TZ
Mini Chandelier



C | 1633 TZ
Chandelier

BARCELONA™

	ITEM #	FINISH	INCAND. BULB	W	H	OVRL. H	EXTRA WIRE	CHAIN/STEM	NOTES
A	1632	TZ	(6) 60W (C)	24.5	29.5	104	20	72	Additional chain 2996 TZ.
B	1631	TZ	(5) 60W (C)	17.75	22.25	97	122	72	Additional chain 2996 TZ.
C	1633	TZ	(12) 60W (C)	34.25	33	107	53	72	Additional chain 2996 TZ.

Measurements shown in inches.

NORWICH™

TANNERY BRONZE™ FINISH



A | 2800 TZ
Small Foyer Pendant



B | 6813 TZ
Wall Sconce



C | 1714 TZ
Chandelier



D | 1713 TZ
Chandelier

NORWICH™

	ITEM #	FINISH	INCAND. BULB	W	H	OVRLL. H	EXTRA WIRE	CHAIN/STEM	EXT.	HCWO	NOTES
A	2800	TZ	(2) 60W (C)	10	13.75	88	29	72	---	---	Additional chain 2996 TZ.
B	6813	TZ	(1) 60W (C)	5.5	11	---	---	---	5	4.75	Ⓧ Height includes bulb.
C	1714	TZ	(9) 60W (C)	28	28.5	103	50	72	---	---	Additional chain 2996 TZ.
D	1713	TZ	(6) 60W (C)	25	25	99	19	72	---	---	Additional chain 2996 TZ.

Measurements shown in inches.

WELLINGTON SQUARE™

OLDE BRONZE® OR CLASSIC PEWTER
FINISH WITH SATIN-ETCHED GLASS



A | 43407 CLP, OZ
Island Chandelier



B | 43401 CLP, OZ
Chandelier



C | 43402 CLP, OZ
Chandelier



GET INSPIRED AT
KICHLER.COM



D | 43404 CLP, OZ
Mini Pendant



E | 45401 CLP, OZ
Wall Sconce



F | 43406 CLP, OZ
Semi Flush

**COORDINATING
CEILING FAN**

See the full line of Kichler®
Ceiling Fans in catalog K414
or visit kichler.com



J | 300135 AP



G | 43405 CLP, OZ
Inverted Pendant



H | 43403 CLP, OZ
Small Foyer Pendant

MATCHING BATH

See matching bath fixtures
on pages 554-555.



WELLINGTON SQUARE™

ITEM #	FINISH	INCAND. BULB	W	H	OVRL. H	L	EXTRA WIRE	CHAIN/STEM	EXT.	HCWO	NOTES	
A	43407	CLP, OZ	(2) 100W (M)	15	20	94	37.75	50	72	---	---	☑ (23-30W CFL) Additional chain 2996 CLP, OZ.
B	43401	CLP, OZ	(5) 100W (M)	25.5	24.5	99	---	17	72	---	---	☑ (23-30W CFL) Additional chain 2996 CLP, OZ.
C	43402	CLP, OZ	(9) 100W (M)	33	34	108	---	53	72	---	---	☑ (23-30W CFL) Additional chain 4901 CLP, OZ.
D	43404	CLP, OZ	(1) 100W (M)	6	13.25	45	---	68	36	---	---	☑ (23-30W CFL) Additional chain 2996 CLP, OZ, additional stem 2999 (12") CLP, OZ. Sloped ceiling kit included. Height includes one 6" stem.
E	45401	CLP, OZ	(1) 100W (M)	6	10	---	---	---	---	8	5.5	⊕ (23-30W CFL) May be installed with glass up or down.
F	43406	CLP, OZ	(2) 100W (M)	16.75	13	---	---	---	---	---	---	☑ (23-30W CFL)
G	43405	CLP, OZ	(3) 100W (M)	19.75	22.75	97	---	28	72	---	---	☑ (23-30W CFL) Additional chain 2996 CLP, OZ.
H	43403	CLP, OZ	(1) 100W (M)	10.25	22	96	---	28	72	---	---	☑ (23-30W CFL) Additional chain 2996 CLP, OZ.
J	300135	AP	---	---	---	---	---	---	---	---	---	See the full line of Kichler® Ceiling Fans in catalog K414 or visit kichler.com.

Measurements shown in inches. U.S. & Canadian Patent Pending.



WILLOWMORE™

BRUSHED NICKEL FINISH WITH
SATIN-ETCHED GLASS



Shown as Semi Flush - 14" H.

CONVERTIBLE

Create two distinct lighting options with one fixture:
Mini Chandelier or Semi Flush.

A | 3728 NI



Shown as Mini Chandelier - 14.75" H.



B | 1828 NI
Chandelier



C | 1829 NI
Chandelier



D | 1826 NI
Chandelier/Dinette



E | 3326 NI
Chandelier/Dinette



F | 1827 NI
Chandelier/Dinette



G | 1825 NI
Mini Chandelier

MATCHING BATH

See matching bath fixtures on page 545.



WILLOWMORE™

	ITEM #	FINISH	INCAND. BULB	W	H	OVRL. H	EXTRA WIRE	CHAIN/STEM	NOTES
A	3728	NI	(3) 60W (C)	11.5	14.75	89	30	72	Additional chain 2996 NI.
B	1828	NI	(9) 100W (M)	30.5	30.5	105	71	72	☑ (23-30W CFL) Additional chain 4901 NI.
C	1829	NI	(15) 75W (M)	42	47.75	122	111	72	☑ (18-25W CFL) Additional chain 4908 NI.
D	1826	NI	(5) 100W (M)	22	16	90	36	72	☑ (23-30W CFL) Additional chain 2996 NI.
E	3326	NI	(3) 100W (M)	19	18.5	93	27	72	☑ (23-30W CFL) Additional chain 2996 NI.
F	1827	NI	(5) 100W (M)	22	22.75	97	20	72	☑ (23-30W CFL) Additional chain 2996 NI.
G	1825	NI	(5) 60W (C)	16.5	17.75	92	121	72	Additional chain 2996 NI.

Measurements shown in inches.

WILLOWMORE™

BRUSHED NICKEL FINISH WITH
SATIN-ETCHED GLASS



Shown as Inverted Pendant - 15.75" H



B | 5926 NI
Wall Sconce



C | 3427 NI
Mini Pendant



D | 3325 NI
Inverted Pendant

CONVERTIBLE

Create two distinct lighting options with one fixture:
Inverted Pendant or Semi Flush.

A | 3729 NI



Shown as Semi Flush - 15" H



E | 2929 NI
Island Chandelier

WILLOWMORE™

ITEM #	FINISH	INCAND. BULB	W	H	OVRL. H	L	STEM TILT	EXTRA WIRE	CHAIN/STEM	EXT.	HCWO	NOTES	
A	3729	NI	(1) 100W (M)	16.5	15.75	54	---	---	9	36	---	---	☑ (23-30W CFL) Additional chain 2996 NI.
B	5926	NI	(1) 100W (M)	6.25	12.25	---	---	---	---	---	8	6.25	☑ (23-30W CFL) May be installed with glass up or down.
C	3427	NI	(1) 100W (M)	6.25	14	52	---	90°	60	36	---	---	☑ (23-30W CFL) Additional stem 2999 (12") NI and/or 2997 (24") NI.
D	3325	NI	(2) 100W (M)	16	21	95	---	---	26	72	---	---	☑ (13-15W CFL) Additional chain 2996 NI.
E	2929	NI	(2) 150W (M)	13.25	13	88	34	---	73	72	---	---	☑ (18-25W CFL) Additional chain 2996 NI. G-type lamp recommended.

Measurements shown in inches.

WILLOWMORE™

TANNERY BRONZE™ FINISH WITH
DISTRESSED UMBER-ETCHED GLASS



A | 3325 TZ
Inverted Pendant



B | 3427 TZ
Mini Pendant



C | 5926 TZ
Wall Sconce



Shown as Inverted Pendant - 15.75" H

CONVERTIBLE

Create two distinct lighting options with one fixture:
Inverted Pendant or Semi Flush.

E | 3729 TZ



Shown as Semi Flush - 15" H



D | 2929 TZ
Island Chandelier

WILLOWMORE™

ITEM #	FINISH	INCAND. BULB	W	H	OVRL H	L	STEM TILT	EXTRA WIRE	CHAIN/STEM	EXT.	HCWO	NOTES	
A	3325	TZ	(2) 100W (M)	16	21	95	---	---	26	72	---	---	Ⓜ (13-15W CFL) Additional chain 2996 TZ.
B	3427	TZ	(1) 100W (M)	6.25	14	52	---	90°	60	36	---	---	Ⓜ (23-30W CFL) Additional stem 2999 (12") TZ.
C	5926	TZ	(1) 100W (M)	6.25	12.25	---	---	---	---	8	6.25	---	Ⓜ (23-30W CFL) May be installed with glass up or down.
D	2929	TZ	(2) 150W (M)	13.25	13	88	34	---	73	72	---	---	Ⓜ (18-25W CFL) Additional chain 2996 TZ. G-type lamp recommended.
E	3729	TZ	(1) 100W (M)	16.5	15.75	54	---	---	9	36	---	---	Ⓜ (23-30W CFL) Additional chain 2996 TZ.

Measurements shown in inches.

WILLOWMORE™

TANNERY BRONZE™ FINISH WITH
DISTRESSED UMBER-ETCHED GLASS



Shown as Semi Flush - 14" H.

CONVERTIBLE

Create two distinct lighting
options with one fixture:
Mini Chandelier or Semi Flush.

A | 3728 TZ



Shown as Mini Chandelier - 14.75" H.



B | 1828 TZ
Chandelier



C | 1829 TZ
Chandelier



D | 1826 TZ
Chandelier/Dinette



E | 3326 TZ
Chandelier/Dinette



F | 1827 TZ
Chandelier/Dinette



G | 1825 TZ
Mini Chandelier

MATCHING BATH

See matching bath fixtures on page 544.



WILLOWMORE™

	ITEM #	FINISH	INCAND. BULB	W	H	OVRL. H	EXTRA WIRE	CHAIN/STEM	NOTES
A	3728	TZ	(3) 60W (C)	11.25	14.75	89	30	72	Additional chain 2996 TZ.
B	1828	TZ	(9) 100W (M)	30.5	30.5	105	71	72	☑ (23-30W CFL) Additional chain 4901 TZ.
C	1829	TZ	(15) 75W (M)	42	47.75	122	111	72	☑ (18-25W CFL) Additional chain 4908 TZ.
D	1826	TZ	(5) 100W (M)	22	16	90	36	72	☑ (23-30W CFL) Additional chain 2996 TZ.
E	3326	TZ	(3) 100W (M)	19	18.5	93	27	72	☑ (23-30W CFL) Additional chain 2996 TZ.
F	1827	TZ	(5) 100W (M)	22	22.75	97	20	72	☑ (23-30W CFL) Additional chain 2996 TZ.
G	1825	TZ	(5) 60W (C)	16.5	17.75	92	121	72	Additional chain 2996 TZ.

Measurements shown in inches.

WEDGEPORT™

BRUSHED NICKEL FINISH WITH
SATIN-ETCHED GLASS OR OLDE BRONZE®
FINISH WITH UMBER-ETCHED GLASS



A | 3584 NI, OZ
Mini Pendant



B | 6086 NI, OZ
Wall Sconce



C | 2084 NI, OZ
Chandelier/Dinette



D | 3585 NI, OZ
Inverted Pendant



E | 3587 NI, OZ
Pendant



F | 2085 NI, OZ
Chandelier/Dinette



G | 5284 NI, OZ
Wall Sconce



H | 2086 NI, OZ
Chandelier

WEDGEPORT™

ITEM #	FINISH	INCAND. BULB	W	H	OVRL. H	EXTRA WIRE	CHAIN/STEM	EXT.	HCWO	NOTES
A	3584 NI, OZ	(1) 100W (M)	6.25	13	45	68	36	---	---	Ⓜ (18-25W CFL) Additional chain 2996 NI, OZ, additional stem 2999 (12") NI, OZ and/or 2997 (24") NI. Height includes one 6" stem.
B	6086 NI, OZ	(1) 75W (M) ✓	8.5	8.25	---	---	---	4.25	3.5	Ⓜ (18-25W CFL) May be installed with glass up or down.
C	2084 NI, OZ	(5) 100W (M)	21.5	19.75	94	20	72	---	---	Ⓜ (18-25W CFL) Additional chain 2996 NI, OZ.
D	3585 NI, OZ	(2) 150W (M)	19.25	20.75	95	19	72	---	---	Additional chain 2996 NI, OZ.
E	3587 NI, OZ	(1) 150W (M)	14	15.75	54	66	36	---	---	Additional chain 2996 NI, OZ, additional stem 2999 (12") NI, OZ and/or 2997 (24") NI. G-type lamp recommended.
F	2085 NI, OZ	(5) 100W (M)	21.5	17.5	92	23	72	---	---	Ⓜ (18-25W CFL) Additional chain 2996 NI, OZ.
G	5284 NI, OZ	(1) 100W (M)	6.25	7.25	---	---	---	8	4.5	Ⓜ (18-25W CFL) May be installed with glass up or down.
H	2086 NI, OZ	(9) 100W (M)	32	28	102	54	72	---	---	Ⓜ (18-25W CFL) Additional chain 2996 NI, OZ.

Measurements shown in inches.

WEDGEPORT™ ENERGY EFFICIENT

BRUSHED NICKEL FINISH WITH SATIN-ETCHED
GLASS OR OLDE BRONZE® FINISH
WITH UMBER-ETCHED GLASS

Umber-Etched
Glass



A | 10742 NI, OZ
Inverted Pendant



B | 10636 NI, OZ
Wall Sconce



C | 10743 NI, OZ
Mini Pendant



D | 10741 NI, OZ
Chandelier



E | 10740 NI, OZ
Chandelier/Dinette

MATCHING BATH

See matching bath fixtures
on page 556.



WEDGEPORT™

	FLOUR. ITEM #	FINISH	FLOUR. BULB	W	H	OVRL. H	EXTRA WIRE	CHAIN/STEM	EXT.	HCWO	NOTES
A	10742	NI, OZ	(2) 13W (GU24)	19.25	20.75	95	19	72	---	---	Additional chain 2996 NI, OZ.
B	10636	NI, OZ	(1) 13W (GU24)	6.25	7.5	---	---	---	8	4.5	May be installed with glass up or down.
C	10743	NI, OZ	(1) 13W (GU24)	6.25	13.75	46	67	36	---	---	Additional chain 2996 NI, OZ, additional stem 2999 (12") NI, OZ and/or 2997 (24") NI. Height includes one 6" stem.
D	10741	NI, OZ	(9) 13W (GU24)	32	28	102	54	72	---	---	(18-25W CFL) Additional chain 2996 NI, OZ.
E	10740	NI, OZ	(5) 13W (GU24)	21.5	17.5	92	23	72	---	---	(18-25W CFL) Additional chain 2996 NI, OZ.

Measurements shown in inches.



CLARICE™

TANNERY BRONZE™ FINISH WITH
GOLD ACCENTS AND ART GLASS



B | 65216
Mini Pendant



A | 69046
Semi Flush



C | 69043
Wall Sconce

CLARICE™

	ITEM #	INCAND. BULB	W	H	OVRL. H	STEM TILT	EXTRA WIRE	CHAIN/STEM	EXT.	HCWO	NOTES
A	69046	(2) 100W (M) ✓	19	12.5	---	---	---	---	---	---	☑ (23-30W CFL)
B	65216	(1) 150W (M)	7.5	13.75	47	45°(12:12)	68	36	---	---	☑ (23-30W CFL) Additional stem 2999 (12") TZ. Height includes one 6" stem.
C	69043	(1) 75W (M) ✓	8	12	---	---	---	---	5.25	5.5	☑ (18-25W CFL)

Measurements shown in inches. Art Glass shades are natural materials – colors, patterns and textures will vary from piece to piece.

PORTSMOUTH™

BRUSHED NICKEL OR TANNERY BRONZE™ FINISH



A | 1770 NI, TZ
Mini Chandelier



A | 1770 NI, TZ
Mini Chandelier



B | 2534 NI, TZ
Chandelier



C | 2033 NI, TZ
Chandelier/Dinette

ITEM #	FINISH	INCAND. BULB	W	H	OVRLL. H	EXTRA WIRE	CHAIN/STEM	NOTES
A	1770 NI, TZ	(5) 60W (C)	17	12.75	87	25	72	Additional chain 2996 NI, TZ.
B	2534 NI, TZ	(9) 60W (C)	26	25	99	10	72	Additional chain 2996 NI, TZ.
C	2033 NI, TZ	(5) 60W (C)	21.25	18	92	17	72	Additional chain 2996 NI, TZ.

Measurements shown in inches.

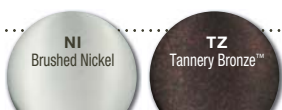

DURHAM™

ANTIQUE PEWTER FINISH
WITH SATIN-ETCHED GLASS



Satin-Etched Glass

A | 42066 AP
Chandelier
NOT TO SCALE

DURHAM™

ITEM #	FINISH	INCAND. BULB	W	H	OVRL. H	EXTRA WIRE	CHAIN/STEM	NOTES
A 42066	AP	(9) 100W (M)	34	28.25	103	72	72	(18-25W CFL) Additional chain 2996 AP.

Measurements shown in inches.



B | 42071 AP
Pendant



C | 42068 AP
Mini Pendant



D | 42072 AP
Small Foyer Pendant



E | 42070 AP
Semi Flush



F | 42064 AP
Chandelier/Dinette



G | 42067 AP
Inverted Pendant



H | 45064 AP
Wall Sconce

MATCHING BATH

See matching bath fixtures on page 547.



DURHAM™

ITEM #	FINISH	INCAND. BULB	W	H	OVRL. H	EXTRA WIRE	CHAIN/STEM	EXT.	HCWO	NOTES	
B	42071	AP	(1) 150W (M)	15	14.75	89	32	72	---	---	Ⓜ (30-52W CFL) Additional chain 2996 AP. G-type lamp recommended.
C	42068	AP	(1) 100W (M)	5	13.25	46	70	36	---	---	Ⓜ (18-25W CFL) Additional chain 2996 AP, additional stem 2999 (12") AP. Height includes one 6" stem.
D	42072	AP	(1) 100W (M)	10.25	21.25	96	27	72	---	---	Ⓜ (23-30W CFL) Additional chain 2996 AP.
E	42070	AP	(2) 100W (M)	15	12.5	---	---	---	---	---	Ⓜ (18-25W CFL)
F	42064	AP	(5) 100W (M)	23	21	95	36	72	---	---	Ⓜ (18-25W CFL) Additional chain 2996 AP.
G	42067	AP	(3) 100W (M)	18	21	95	23	72	---	---	Ⓜ (18-25W CFL) Additional chain 2996 AP.
H	45064	AP	(1) 100W (M)	5	9.5	---	---	---	8	4.5	Ⓜ (18-25W CFL) May be installed with glass up or down.

Measurements shown in inches.

DURHAM™

OLDE BRONZE® FINISH WITH
LIGHT UMBER-ETCHED GLASS



A | 42066 OZ
Chandelier
NOT TO SCALE

DURHAM™

	ITEM #	FINISH	INCAND. BULB	W	H	OVRL. H	EXTRA WIRE	CHAIN/STEM	NOTES
A	42066	OZ	(9) 100W (M)	34	28.25	103	72	72	☑ (18-25W CFL) Additional chain 2996 OZ.

Measurements shown in inches.



B | 42071 OZ
Pendant



C | 42068 OZ
Mini Pendant



D | 42072 OZ
Small Foyer Pendant



E | 42070 OZ
Semi Flush



F | 42064 OZ
Chandelier/Dinette



G | 42067 OZ
Inverted Pendant



H | 45064 OZ
Wall Sconce

MATCHING BATH

See matching bath fixtures on page 546.



DURHAM™

ITEM #	FINISH	INCAND. BULB	W	H	OVRL. H	EXTRA WIRE	CHAIN/STEM	EXT.	HCWO	NOTES	
B	42071	OZ	(1) 150W (M)	15	14.75	89	32	72	---	---	Ⓜ (30-52W CFL) Additional chain 2996 OZ. G-type lamp recommended.
C	42068	OZ	(1) 100W (M)	5	13.25	46	70	36	---	---	Ⓜ (18-25W CFL) Additional chain 2996 OZ, additional stem 2999 (12") OZ. Height includes one 6" stem.
D	42072	OZ	(1) 100W (M)	10.25	21.25	96	27	72	---	---	Ⓜ (23-30W CFL) Additional chain 2996 OZ.
E	42070	OZ	(2) 100W (M)	15	12.5	---	---	---	---	---	Ⓜ (18-25W CFL)
F	42064	OZ	(5) 100W (M)	23	21	95	36	72	---	---	Ⓜ (18-25W CFL) Additional chain 2996 OZ.
G	42067	OZ	(3) 100W (M)	18	21	95	23	72	---	---	Ⓜ (18-25W CFL) Additional chain 2996 OZ.
H	45064	OZ	(1) 100W (M)	5	9.5	---	---	---	8	4.5	ⓂⓂ (18-25W CFL) May be installed with glass up or down.

Measurements shown in inches.

WHARTON

BRUSHED NICKEL FINISH WITH
SATIN-ETCHED CASED OPAL GLASS



A | 5359 NI
Wall Sconce



C | 2709 NI
Mini Pendant



B | 2120 NI
Chandelier



D | 2121 NI
Chandelier

WHARTON

ITEM #	FINISH	INCAND. BULB	W	H	OVRLL. H	EXTRA WIRE	CHAIN/STEM	EXT.	HCWO	NOTES
A	5359	NI	(1) 100W (M)	4.75	9	---	---	6	4.5	Ⓢ (18-25W CFL) May be installed with glass up or down.
B	2120	NI	(5) 100W (M)	27	25.25	100	72	72	---	Ⓢ (23-30W CFL) Additional chain 2996 NI.
C	2709	NI	(1) 100W (M)	5	15	47	67	36	---	Ⓢ (18-25W CFL) Additional chain 2996 NI, additional stem 2999 NI (12") and/or 2997 (24") NI. Height includes one 6" stem.
D	2121	NI	(9) 100W (M)	30.5	32.5	107	72	72	---	Ⓢ (23-30W CFL) Additional chain 2996 NI.

Measurements shown in inches. U.S. & Canadian Patent Pending.



E | 3320 NI
Inverted Pendant



G | 3719 NI
Semi Flush

Satin-Etched
White Glass

MATCHING BATH

See matching bath fixtures
on page 504.



F | 3821 NI
Chandelier



H | 2518 NI
Foyer Chandelier

WHARTON

	ITEM #	FINISH	INCAND. BULB	W	H	OVRL. H	EXTRA WIRE	CHAIN/STEM	NOTES
E	3320	NI	(3) 100W (M)	20	26	100	22	72	☑ (9-13W CFL) Additional chain 2996 NI.
F	3821	NI	(3) 100W (M)	24	20.5	95	36	72	☑ (18-25W CFL) Additional chain 2996 NI.
G	3719	NI	(2) 100W (M) ❖	15	11	---	---	---	☑ (9-13W CFL)
H	2518	NI	(3) 100W (M)	17	28.5	103	50	72	☑ (9-13W CFL) Additional chain 2996 NI.

Measurements shown in inches. U.S. & Canadian Patent Pending.

NICHOLSON™

OLDE BRONZE® OR BRUSHED NICKEL FINISH
WITH SATIN-ETCHED GLASS



A | 42883 NI, OZ
Chandelier/Dinette



B | 42884 NI, OZ
Chandelier



C | 42885 NI, OZ
Chandelier



GET INSPIRED AT
KICHLER.COM



D | 42879 NI, OZ
Semi Flush



E | 45881 NI, OZ
Wall Sconce



F | 42880 NI, OZ
Mini Pendant



G | 42881 NI, OZ
Pendant



H | 42882 NI, OZ
Small Foyer Pendant

MATCHING BATH

See matching bath fixtures on pages 562-563.



NICHOLSON™

	ITEM #	FINISH	INCAND. BULB	W	H	OVRL. H	EXTRA WIRE	CHAIN/STEM	EXT.	HCWO	NOTES
A	42883	NI, OZ	(3) 100W (M)	21	21	95	36	72	---	---	☑ (18-25W CFL) Additional chain 2996 NI, OZ.
B	42884	NI, OZ	(5) 100W (M)	25	21	95	36	72	---	---	☑ (18-25W CFL) Additional chain 2996 NI, OZ.
C	42885	NI, OZ	(9) 100W (M)	34	32	106	72	72	---	---	☑ (18-25W CFL) Additional chain 2996 NI, OZ.
D	42879	NI, OZ	(3) 100W (M)	16	13.25	---	---	---	---	---	☑ (18-25W CFL)
E	45881	NI, OZ	(1) 100W (M)	6	10	---	---	---	8.5	5	Ⓢ (18-25W CFL) May be installed with glass up or down.
F	42880	NI, OZ	(1) 100W (M)	6	8	82	31	72	---	---	☑ (18-25W CFL) Additional chain 2996 NI, OZ.
G	42881	NI, OZ	(1) 150W (M)	16	9.5	84	37	72	---	---	☑ (30-52W CFL) Additional chain 2996 NI, OZ.
H	42882	NI, OZ	(1) 150W (M)	13	21.25	96	30	72	---	---	☑ (30-52W CFL) Additional chain 2996 NI, OZ.

Measurements shown in inches.



TANGLEWOOD™

BRUSHED NICKEL OR OLDE BRONZE® FINISH
WITH SATIN-ETCHED GLASS



A | 45901 NI, OZ
Wall Sconce



B | 42903 NI, OZ
Inverted Pendant



C | 42905 NI, OZ
Chandelier/Dinette



D | 42906 NI, OZ
Chandelier

TANGLEWOOD™

ITEM #	FINISH	INCAND. BULB	W	H	OVRL. H	EXTRA WIRE	CHAIN/STEM	EXT.	HCWO	NOTES
A	45901 NI, OZ	(1) 100W (M)	6	9.25	---	---	---	8.5	5.5	Ⓜ (23-30W CFL) May be installed with glass up or down.
B	42903 NI, OZ	(3) 100W (M)	18	21.75	96	23	72	---	---	Ⓜ (23-30W CFL) Additional chain 2996 NI, OZ.
C	42905 NI, OZ	(3) 100W (M)	20	19.25	94	28	72	---	---	Ⓜ (23-30W CFL) Additional chain 2996 NI, OZ.
D	42906 NI, OZ	(5) 100W (M)	24	19.5	94	24	72	---	---	Ⓜ (23-30W CFL) Additional chain 2996 NI, OZ.

Measurements shown in inches. U.S. & Canadian Patent Pending.



E | 42901 NI, OZ
Mini Pendant



F | 42902 NI, OZ
Pendant



G | 42900 NI, OZ
Semi Flush



H | 42907 NI, OZ
Chandelier

MATCHING BATH

See matching bath fixtures on page 559.



TANGLEWOOD™

GET INSPIRED AT
KICHLER.COM



	ITEM #	FINISH	INCAND. BULB	W	H	OVRLL. H	EXTRA WIRE	CHAIN/STEM	NOTES
E	42901	NI, OZ	(1) 100W (M)	6.25	15	89	25	72	☑ (23-30W CFL) Additional chain 2996 NI, OZ.
F	42902	NI, OZ	(1) 150W (M)	14	10.5	85	30	72	☑ (18-25W CFL) Additional chain 2996 NI, OZ. G-type lamp recommended.
G	42900	NI, OZ	(2) 100W (M)	16	13	---	---	---	☑ (23-30W CFL)
H	42907	NI, OZ	(9) 100W (M)	32	29.75	104	57	72	☑ (23-30W CFL) Additional chain 2996 NI, OZ.

Measurements shown in inches. U.S. & Canadian Patent Pending.



STAFFORD™

ANTIQUE PEWTER FINISH
WITH WHITE TEXTURED GLASS



A | 5556 AP
Wall Sconce



B | 8116 NI
Flush Mount



C | 8112 NI
Flush Mount



D | 8111 NI
Flush Mount



E | 3856 AP
Island Chandelier



F | 2558 AP
Chandelier

STAFFORD™

ITEM #	FINISH	INCAND. BULB	W	H	OVRL. H	L	EXTRA WIRE	CHAIN/STEM	EXT.	HCWO	NOTES
A	5556	AP	(1) 100W (M)	7.5	12	---	---	---	9.5	6	Ⓛ (9-13W CFL) May be installed with glass up or down.
B	8116	NI	(3) 60W (M) ✓	15.25	6.5	---	---	---	---	---	Ⓛ (13-15W CFL) Satin-Etched Glass.
C	8112	NI	(2) 60W (M) ❖	13.25	6	---	---	---	---	---	Ⓛ (13-15W CFL) Satin-Etched Glass.
D	8111	NI	(2) 60W (M) ❖	11.25	6.25	---	---	---	---	---	Ⓛ (13-15W CFL) Satin-Etched Glass.
E	3856	AP	(3) 100W (M)	7.5	21.5	60	27.25	40	36	---	Ⓛ (9-13W CFL) Additional chain 2996 AP, additional stem 2999 (12") AP.
F	2558	AP	(9) 100W (M)	33	32.25	107	---	53	72	---	Ⓛ (9-13W CFL) Additional chain 2996 AP.

Measurements shown in inches.



G | 3356 AP
Inverted Pendant



J | 42071 APW
Pendant



Shown as Inverted Pendant - 14.5" H.

CONVERTIBLE

Create two distinct lighting options with one fixture:
Inverted Pendant or Semi Flush.

K | 3757 AP



H | 3355 AP
Mini Pendant



Shown as Semi Flush - 12.25" H.



L | 2557 AP
Chandelier



M | 2556 AP
Chandelier/Dinette

MATCHING BATH

See matching bath fixtures on page 558.



STAFFORD™

	ITEM #	FINISH	INCAND. BULB	W	H	OVRL. H	STEM TILT	EXTRA WIRE	CHAIN/STEM	NOTES
G	3356	AP	(3) 100W (M)	18.5	22.5	97	---	22	72	Additional chain 2996 AP.
H	3355	AP	(1) 100W (M)	7.5	18.75	58	90°	52	36	(9-13W CFL) Additional stem 2999 (12") AP.
J	42071	APW	(1) 150W (M)	15	14.75	89	---	31	72	(30-52W CFL) Additional chain 2996 AP. G-type lamp recommended.
K	3757	AP	(2) 100W (M)	16	14.5	53	---	12	36	(18-25W CFL) Additional chain 2996 AP.
L	2557	AP	(5) 100W (M)	26	23	97	---	36	72	(9-13W CFL) Additional chain 2996 AP.
M	2556	AP	(3) 100W (M)	22	18.75	93	---	36	72	(9-13W CFL) Additional chain 2996 AP.

Measurements shown in inches.

STAFFORD™

OLDE BRONZE® FINISH
WITH SATIN-ETCHED GLASS



A | 5556 OZ
Wall Sconce



B | 8116 OZ
Flush Mount



C | 8112 OZ
Flush Mount



D | 8111 OZ
Flush Mount



E | 3856 OZ
Island Chandelier



F | 2558 OZ
Chandelier

STAFFORD™

ITEM #	FINISH	INCAND. BULB	W	H	OVRLL. H	L	EXTRA WIRE	CHAIN/STEM	EXT.	HCWO	NOTES
A	5556	OZ	(1) 100W (M)	7.5	12	---	---	---	9.5	6	Ⓛ (9-13W CFL) May be installed with glass up or down.
B	8116	OZ	(3) 60W (M) ✓	15.25	6.5	---	---	---	---	---	Ⓛ (13-15W CFL)
C	8112	OZ	(2) 60W (M) ❖	13.25	6	---	---	---	---	---	Ⓛ (13-15W CFL)
D	8111	OZ	(2) 60W (M) ❖	11.25	6.25	---	---	---	---	---	Ⓛ (13-15W CFL)
E	3856	OZ	(3) 100W (M)	7.5	21.5	60	27.25	40	36	---	Ⓛ (9-13W CFL) Additional chain 2996 OZ, additional stem 2999 (12") OZ.
F	2558	OZ	(9) 100W (M)	33	32.25	107	---	53	72	---	Ⓛ (9-13W CFL) Additional chain 2996 OZ.

Measurements shown in inches.



G | 3356 OZ
Inverted Pendant



J | 42071 OZW
Pendant

Satin-Etched
White Glass



Shown as Inverted Pendant - 14.5" H.

CONVERTIBLE

Create two distinct lighting options with one fixture:
Inverted Pendant or Semi Flush.

K | 3757 OZ



H | 3355 OZ
Mini Pendant



L | 2557 OZ
Chandelier



M | 2556 OZ
Chandelier/Dinette



Shown as Semi Flush - 12.25" H.

MATCHING BATH

See matching bath fixtures on page 558.



STAFFORD™

	ITEM #	FINISH	INCAND. BULB	W	H	OVRLL. H	STEM TILT	EXTRA WIRE	CHAIN/STEM	NOTES
G	3356	OZ	(3) 100W (M)	18.5	22.5	97	---	22	72	Additional chain 2996 OZ.
H	3355	OZ	(1) 100W (M)	7.5	18.75	58	90°	52	36	☑ (9-13W CFL) Additional stem 2999 (12") OZ.
J	42071	OZ	(1) 150W (M)	15	14.75	89	---	31	72	☑ (30-52W CFL) Additional chain 2996 OZ. G-type lamp recommended.
K	3757	OZ	(2) 100W (M)	16	14.5	53	---	12	36	☑ (18-25W CFL) Additional chain 2996 OZ.
L	2557	OZ	(5) 100W (M)	26	23	97	---	36	72	☑ (9-13W CFL) Additional chain 2996 OZ.
M	2556	OZ	(3) 100W (M)	22	18.75	93	---	36	72	☑ (9-13W CFL) Additional chain 2996 OZ.

Measurements shown in inches.

DOVER™

ANTIQUE BRASS, BRUSHED NICKEL, TANNERY BRONZE™ OR OLDE BRONZE® FINISH WITH ETCHED SEEDY OR ALABASTER SWIRL GLASS



A | 6719 NI, TZ
10618 NI, TZ
Wall Sconce



B | 2019 NI, TZ
Mini Chandelier

CONVERTIBLE

Create two distinct lighting options with one fixture:
Inverted Pendant or Semi Flush.

C | 3502 NI, TZ
10702 NI, TZ



Shown as Inverted Pendant - 19" H.



E | 2021 NI, TZ
Chandelier



D | 2523 NI, TZ
Chandelier



F | 2031 NI, TZ
Chandelier



G | 2018 NI, TZ
Chandelier

DOVER™

ITEM #	FLOUR. ITEM #	FINISH	INCAND. BULB	FLOUR. BULB	W	H	OVRL. H	EXTRA WIRE	CHAIN/STEM	EXT.	HCWO	NOTES
A	6719	NI, TZ	(1) 100W (M)	---	6.25	6.5	---	---	---	6.75	4.25	Ⓧ May be installed with glass up or down.
	---	10618	---	(1) 18W (GU24) Ⓡ T24	8.5	8.5	---	---	---	9	6.25	Ⓧ May be installed with glass up or down.
B	2019	NI, TZ	(4) 60W (C)	---	18	16	90	123	72	---	---	Additional chain 2996 NI, TZ.
C	3502	10702	(3) 100W (M)	(1) 40W (2C, G10Q) Ⓡ T24	17.75	19	93	27	72	---	---	Additional chain 2996 NI, TZ.
D	2523	NI, TZ	(15) 60W (C)	---	36.5	45.5	120	86	72	---	---	Additional chain 4901 NI, TZ.
E	2021	NI, TZ	(5) 60W (C)	---	25.5	24.5	99	23	72	---	---	Additional chain 2996 NI, TZ.
F	2031	NI, TZ	(9) 60W (C)	---	32.5	29	103	15	72	---	---	Additional chain 2996 NI, TZ.
G	2018	NI, TZ	(5) 60W (C) & (3) 60W (C)	---	24	22.5	97	23	72	---	---	Additional chain 2996 NI, TZ. G-type lamp recommended.

Measurements shown in inches.



H | 2702 NI, NIS, OZ, TZ
Pendant



J | 2771 NI, TZ
10771 NI, TZ
Mini Pendant



K | 3623 NI, NIA, OZ, TZ
3623 NIFL, OZFL, TZFL
Semi Flush



L | 8655 NI, TZ
Flush Mount



Shown as Wall Mount
17.75" H.

PENDALETTE®

Create three distinct lighting options with one fixture:
Mini Chandelier, Wall Mount or Semi Flush.

M | 1731 NI, TZ



N | 2531 NI, TZ
Small Foyer Pendant



O | 2020 AB, NI, TZ
10320 NI, TZ
Chandelier



Shown as Semi Flush
11.75" H.



Shown as Mini Chandelier
11.5" H.

COORDINATING CEILING FAN

See the full line of Kichler®
Ceiling Fans in catalog K414
or visit kichler.com

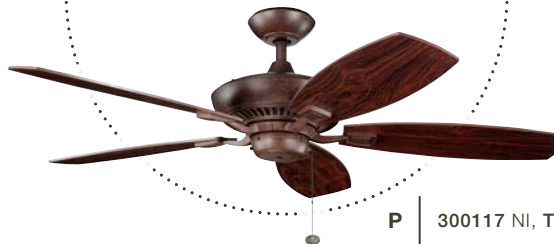

P | 300117 NI, TZ

DOVER™

ITEM #	FLOUR. ITEM #	FINISH	INCAND. BULB	FLOUR. BULB	W	H	OVRL. H	EXTRA WIRE	CHAIN/STEM	EXT.	HCWO	NOTES
H	2702	NI, NIS, TZ, OZ	(1) 150W (M)	---	17.5	8.5	83	36	72	---	---	Ⓔ (9-13W CFL) Add. chain 2996 NI, OZ, TZ. G-type lamp recommended.
J	2771	NI, TZ	(1) 100W (M)	---	6.5	11.5	44	68	36	---	---	Add. chain 2996 NI, TZ, add. stem 2999 (12") NI, TZ and/or 2997 (24") NI. Height incl. one 6" stem.
J	---	10771	---	(1) 13W (GU24) Ⓔ Ⓓ	6.25	12.75	45	68	36	---	---	Add. chain 2996 NI, TZ, add. stem 2999 (12") NI, TZ and/or 2997 (24") NI. Height incl. one 6" stem.
K	3623	NI, NIA, OZ, TZ	(3) 60W (M)	---	15.25	14	---	---	---	---	---	Ⓔ (13-15W CFL)
K	---	3623 NIFL, OZFL, TZFL	---	(3) 13W (GU24) Ⓔ Ⓓ	15.25	14	---	---	---	---	---	
L	8655	NI, TZ	(3) 60W (M) Ⓓ	---	15.25	6.25	---	---	---	---	---	Ⓔ (13-15W CFL) Satin-Etched Glass.
M	1731	NI, TZ	(3) 60W (C)	---	10	11.5	86	30	72	11.25	2.5	Ⓓ Add. chain 2996 NI, TZ.
N	2531	NI, TZ	(3) 60W (C)	---	11	22.5	97	20	72	---	---	Add. chain 2996 NI, TZ.
O	2020	AB, NI, TZ	(5) 60W (C)	---	24	23	97	19	72	---	---	Add. chain 2996 AB, NI, TZ.
O	---	10320	---	(5) 13W (GU24) Ⓔ	24	23	97	55	72	---	---	Add. chain 2996 NI, TZ.
P	300117	NI, TZ	---	---	---	---	---	---	---	---	---	See the full line of Kichler® Ceiling Fans in catalog K414 or visit kichler.com

Measurements shown in inches.



DOVER™

BRUSHED NICKEL OR TANNERY BRONZE™ FINISH
WITH ETCHED SEEDY GLASS



A | 6620 TZ
Wall Sconce

COORDINATING CEILING FAN

See the full line of Kichler®
Ceiling Fans in catalog K414
or visit kichler.com

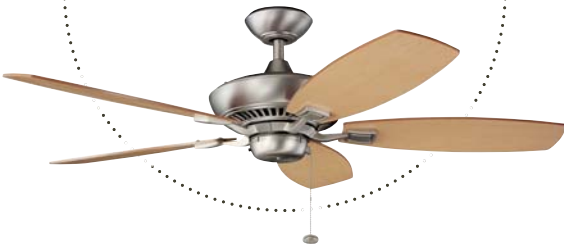

B | 300117 NI, TZ



C | 2520 NI, TZ
Chandelier



D | 8653 NI, TZ
Flush Mount



E | 8064 NI, TZ
Flush Mount



F | 8654 NI, TZ
Flush Mount



G | 8065 NI, TZ
Flush Mount

DOVER™

ITEM #	FINISH	INCAND. BULB	W	H	OVRL. H	EXTRA WIRE	CHAIN/STEM	EXT.	HCWO	NOTES	
A	6620	TZ	(1) 60W (C)	5.25	7.75	---	---	---	5.75	2.75	Ⓧ
B	300117	NI, TZ	---	---	---	---	---	---	---	---	See the full line of Kichler® Ceiling Fans in catalog K414 or visit kichler.com.
C	2520	NI, TZ	(9) 60W (C)	27.75	37	111	57	72	---	---	Additional chain 2996 NI, TZ.
D	8653	NI, TZ	(2) 60W (M) ⚡	11.5	6	---	---	---	---	---	Ⓧ (13-15W CFL) Satin-Etched Glass.
E	8064	NI, TZ	(2) 60W (M) ⚡	13.25	6.25	---	---	---	---	---	Ⓧ (13-15W CFL)
F	8654	NI, TZ	(2) 60W (M) ⚡	13.25	5.5	---	---	---	---	---	Ⓧ (13-15W CFL) Satin-Etched Glass.
G	8065	NI, TZ	(3) 60W (M) ⚡	15.25	7.75	---	---	---	---	---	Ⓧ (13-15W CFL)

Measurements shown in inches.



A | 2807 NI
Mini Pendant



B | 5294 NI, OZ
Wall Sconce

WYNBERG™

BRUSHED NICKEL FINISH WITH ALABASTER SWIRL GLASS OR OLDE BRONZE® FINISH WITH UMBER GLASS



C | 2693 NI, OZ
Mini Pendant



D | 3293 NI, NIZ, OZ, OZU
Chandelier/Dinette



Shown as Inverted Pendant - 15.25" H.

CONVERTIBLE

Create two distinct lighting options with one fixture: Inverted Pendant or Semi Flush.



E | 2022 NI, TZ
Chandelier



F | 2093 NI, OZ
Chandelier

G | 3694 NI, NIW, OZ, OZW



Shown as Semi Flush - 13.5" H.

WYNBERG™

ITEM #	FINISH	INCAND. BULB	W	H	OVRL. H	STEM TILT	EXTRA WIRE	CHAIN/STEM	EXT.	HCWO	NOTES
A	NI	(1) 100W (M)	7	12.25	45	45°(12:12)	68	36	---	---	Add. stem 2999 (12") NI and/or 2997 (24") NI. G-type lamp rec. Satin-Etched Glass. Height includes one 6" stem.
B	NI, OZ	(1) 100W (M)	6	7.5	---	---	---	---	8.5	3.5	Ⓞ May be installed with glass up or down. Satin Etched Glass.
C	NI, OZ	(1) 100W (M)	6	12	44	90°	64	36	---	---	Add. stem 2999 (12") NI, OZ, and/or add. stem 2997 (24") NI. Satin-Etched Glass. Height includes one 6" stem.
D	NI, NIA, OZ, OZU	(3) 100W (M)	21.75	13.25	88	---	64	72	---	---	Ⓜ (9-13W CFL) Add. chain 2996 NI, TZ.
E	NI, TZ	(5) 100W (M)	23	14	88	---	30	72	---	---	Add. chain 2996 NI, TZ. Satin-Etched Seedy Glass.
F	NI, OZ	(5) 100W (M)	24.5	13.75	88	---	25	72	---	---	Ⓜ (23-30W CFL) Add. chain 2996 NI, OZ.
G	NI, NIW, OZ, OZW	(2) 100W (M)	15	15.25	90	---	30	72	---	---	Ⓜ (23-30W CFL) Add. chain 2996 NI, TZ.

Measurements shown in inches.



LANGFORD™

BRUSHED NICKEL FINISH OR
OLDE BRONZE® FINISH WITH
SATIN-ETCHED WHITE GLASS



A | 1782 NI, OZ
Chandelier



B | 5388 NI, OZ
Wall Sconce



C | 1781 NI, OZ
Chandelier/Dinette



D | 1788 NI, OZ
Mini Chandelier



E | 1784 NI, OZ
Chandelier



F | 1789 NI, OZ
Chandelier

LANGFORD™

ITEM #	FINISH	INCAND. BULB	W	H	OVRL. H	EXTRA WIRE	CHAIN/STEM	EXT.	HCWO	NOTES	
A	1782	NI, OZ	(5) 100W (M)	25	18.5	93	24	72	---	---	☑ (9-13W CFL) Additional chain 2996 NI, OZ.
B	5388	NI, OZ	(1) 100W (M)	7.25	8	---	---	---	7.75	4.75	Ⓞ☑ (9-13W CFL) May be installed with glass up or down.
C	1781	NI, OZ	(3) 100W (M)	22	17.25	92	25	72	---	---	☑ (9-13W CFL) Additional chain 2996 NI, OZ.
D	1788	NI, OZ	(5) 100W (M)	16.5	17.25	92	24	72	---	---	☑ (9-13W CFL) Additional chain 2996 NI, OZ.
E	1784	NI, OZ	(9) 100W (M)	33	30.5	105	54	72	---	---	☑ (9-13W CFL) Additional chain 2996 NI, OZ.
F	1789	NI, OZ	(15) 75W (M)	42	43	117	42	72	---	---	☑ (9-13W CFL) Additional chain 2996 NI, OZ.

Measurements shown in inches.



Shown as Inverted Pendant - 15.25" H.



Shown as Inverted Pendant - 15.25" H.



J | 3482 NI, OZ
Mini Pendant

CONVERTIBLE

Create two distinct lighting options with one fixture:
Inverted Pendant or Semi Flush.



Shown as Semi Flush - 13.25" H.



Shown as Semi Flush - 13.5" H.

G | 3681 NI, OZ H | 3694 NI, OZ



L | 3384 NI, OZ
Inverted Pendant



K | 8044 NI, OZ
Flush Mount

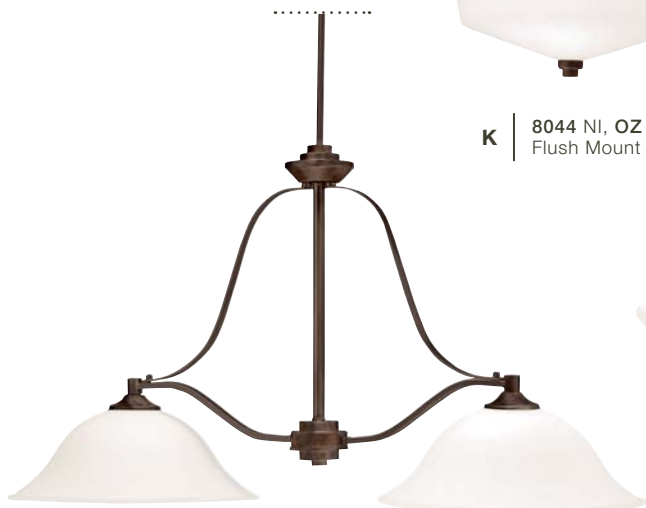

M | 3882 NI, OZ
Island Chandelier



N | 1783 NI, OZ
Chandelier

MATCHING BATH

See matching bath fixtures on pages 502-503.



LANGFORD™

ITEM #	FINISH	INCAND. BULB	W	H	OVRL. H	STEM TILT	EXTRA WIRE	CHAIN/STEM	NOTES
G	3681 NI, OZ	(2) 100W (M)	18.75	15.25	54	---	6	36	(13-15W CFL) Additional chain 2996 NI, OZ.
H	3694 NI, OZ	(2) 100W (M)	15	15.25	90	---	30	72	(23-30W CFL) Additional chain 2996 NI, OZ.
J	3482 NI, OZ	(1) 100W (M)	7	7.75	47	90°	68	72	(18-25W CFL) Additional stem 2999 (12") NI, OZ.
K	8044 NI, OZ	(2) 75W (M) ✦	13	6	---	---	---	---	
L	3384 NI, OZ	(3) 100W (M)	22	25.5	100	---	20	72	(9-13W CFL) Additional chain 2996 NI, OZ.
M	3882 NI, OZ	(2) 150W (M)	15.75	21.5	61	90°	73	36	(23-30W CFL) Additional stem 4935 (12") NI, OZ. G-type lamp recommended.
N	1783 NI, OZ	(5) 100W (M)	27.25	24.5	99	---	17	72	(9-13W CFL) Additional chain 2996 NI, OZ.

Measurements shown in inches.



TELFORD™*

BRUSHED NICKEL FINISH WITH ALABASTER SWIRL GLASS OR OLDE BRONZE® FINISH WITH UMBER-ETCHED GLASS



A | 3476 NI, OZ
Mini Pendant



B | 8076 NI, OZ
Flush Mount



C | 3277 NI, OZ
Inverted Pendant



D | 5991 NI, OZ
Wall Sconce



E | 2076 NI, OZ
Chandelier

MATCHING BATH

See matching bath fixtures on pages 560-561.



F | 2077 NI, OZ
Chandelier

TELFORD™*

ITEM #	FINISH	INCAND. BULB	W	H	OVRL. H	EXTRA WIRE	CHAIN/STEM	EXT.	HCWO	NOTES
A	3476 NI, OZ	(1) 100W (M)	7.25	12.75	45	67	36	---	---	Additional chain 2996 NI, OZ, additional stem 2999 (12") NI, OZ and/or stem 2997 (24") NI. Height includes one 6" stem.
B	8076 NI, OZ	(2) 75W (M) ✦	14	7	---	---	---	---	---	
C	3277 NI, OZ	(3) 100W (M)	17.5	21.5	96	36	72	---	---	Ⓢ (9-13W CFL) Additional chain 2996 NI, OZ.
D	5991 NI, OZ	(1) 100W (M)	7.25	12	---	---	---	9	6	Ⓢ May be installed with glass up or down.
E	2076 NI, OZ	(5) 100W (M)	24	17	91	27	72	---	---	Additional chain 2996 NI, OZ. May be installed with glass up or down.
F	2077 NI, OZ	(9) 100W (M)	33.5	25	99	63	72	---	---	Additional chain 2996 NI, OZ.

Measurements shown in inches.

TELFORD™ ENERGY EFFICIENT

BRUSHED NICKEL FINISH WITH ALABASTER SWIRL GLASS OR OLDE BRONZE® FINISH WITH UMBER-ETCHED GLASS



A | 10704 NI, OZ
Chandelier



B | 10707 NI, OZ
Mini Pendant



C | 10604 NI, OZ
Wall Sconce



D | 10705 NI, OZ
Chandelier



E | 10706 NI, OZ
Inverted Pendant

TELFORD™*

	FLOUR. ITEM #	FINISH	FLOUR. BULB	W	H	OVRL. H	EXTRA WIRE	CHAIN/STEM	EXT.	HCWO	NOTES
A	10704	NI, OZ	(5) 13W (GU24)	24.25	18	92	63	72	---	---	Additional chain 2996 NI, OZ. May be installed with glass up or down.
B	10707	NI, OZ	(1) 13W (GU24)	7.25	13.75	46	67	36	---	---	Additional chain 2996 NI, OZ, additional stem 2999 (12") NI, OZ and/or stem 2997 (24") NI. Height includes one 6" stem.
C	10604	NI, OZ	(1) 13W (GU24)	7.5	12	---	---	---	9	6	D May be installed with glass up or down.
D	10705	NI, OZ	(9) 13W (GU24)	34	24.5	99	61	72	---	---	Additional chain 2996 NI, OZ.
E	10706	NI, OZ	(3) 13W (GU24)	17.5	21.5	96	25	72	---	---	Additional chain 2996 NI, OZ.

Measurements shown in inches.



PENDANTS

STYLISH & FUNCTIONAL

Sometimes one is enough. Other times you need a group to make an impression. Kichler® Pendants are a great *anything goes* light, where the only limit is your imagination. Cluster them above or around kitchen islands, bathroom vanities, office spaces – you name it. Vary the height for visual interest or leave them level for a linear look. Go eclectic and choose from multiple collections. Or go with one alone above a seating area, nightstand or reading nook. Oh the possibilities!





Foyer Pendant 42033 OZ | Page 388

LED MINI PENDANTS

Kichler® LED lighting
exceeds the standards
for efficiency, reliability
and beauty

.....
Long-life light emitting diodes (LED)
provide approx. 40,000-hour
life span to L70 (70% initial lumens) –
about 15 years of standard operation
– and are replaceable.

.....
True optics: pure white light and
controlled beam spread with no
fade or drop off of light.

.....
High Color Rendering Index (CRI)

.....
Standard installation





A | **42517 CH**
LED Mini Pendant



A | **42517 NI**
LED Mini Pendant



A | **42517 OZ**
LED Mini Pendant

Gold Inside



B | **42359 OZ**
LED Mini Pendant



B | **42359 WZC**
LED Mini Pendant

LED OUTPUT

42517 CH/NI/OZ	600 Lumens, 17 Watts 3000 Kelvin, CRI 85, 40K Life
42359 OZ/WZC	853 Lumens, 17 Watts 3000 Kelvin, CRI 85, 40K Life

LED MINI PENDANTS

	LED ITEM #	FINISH	LIGHT SOURCE	W	H	OVRL. H	STEM TILT	EXTRA WIRE	CHAIN/STEM	NOTES
A	42517	CH, NI, OZ	17.1W	3	12.25	50	90°	68	36	Additional stem 2999 (12") CH, NI, OZ and/or 2997 (24") NI.
B	42359	OZ, WZC	17.1W	6	7	45	90°	68	36	Additional stem 2999 (12") OZ, WZC.

Measurements shown in inches. U.S. & Canadian Patent Pending.



MINI PENDANTS



Mini Pendants 42679 OZ and 42679 NI



Mini Pendants 43200 OZ and 43201 OZ



A | 42282 BK



B | 42738 OZ



C | 42753 OZ



C | 42753 NI



D | 43200 OZ
Pendant



E | 42280 OZ



F | 42679 OZ
Mini Pendant



F | 42679 NI
Mini Pendant

ITEM #	FINISH	INCAND. BULB	W	H	OVRL. H	STEM TILT	EXTRA WIRE	CHAIN/STEM	NOTES
A	BK	(1) 100W (M)	9	9.5	113		---	---	☑ (23-30W CFL)
B	OZ	(1) 100W (M)	5.5	10.5	113		---	---	
C	NI, OZ	(1) 100W (M)	6.75	10.25	113		---	---	☑ (23-30W CFL)
D	OZ	(1) 100W (M)	13	8.5	48	90°	61	36	☑ (23-30W CFL) Additional stem 2999 (12") OZ.
E	OZ	(1) 100W (M)	7.75	12.75	51	90°	61	36	☑ (23-30W CFL) Additional stem 2999 (12") OZ.
F	NI, OZ	(1) 60W (M)	6	10	49	90°	62	36	☑ (13-15W CFL) Additional stem 2999 (12") NI, OZ and/or stem 2997 (24") NI.

Measurements shown in inches. U.S. & Canadian Patent Pending



MINI PENDANTS



A | 42225 OZ, PN
Saddler™



B | 4225 OZ
Metal Shade
Shown with fixture
42225 OZ, Metal Shade
accessory sold separately



B | 4225 PN
Metal Shade
Shown with fixture
42225 PN, Metal Shade
accessory sold separately



C | 4223 MUL
Halophane Shade
Shown with fixture 42225 PN,
Halophane Shade accessory
sold separately



D | 42710 OZ
Lucien™



E | 42878 NI
Brinley™



E | 42878 OZ
Brinley™



F | 42308 OZ



G | 9870 RST
Rustic™

MINI PENDANTS

ITEM #	FINISH	INCAND. BULB	W	H	OVRL. H	EXTRA WIRE	CHAIN/STEM	NOTES
A	42225 OZ, PN	(1) 50W (G9)	6	11.5	50	61	36	Additional stem 2999 (12") OZ
B	4225 OZ, PN	---	10	3	---	---	---	Metal Shade accessory sold separately.
C	4223 MUL	---	10	3	---	---	---	Halophane Shade accessory sold separately.
D	42710 OZ	(1) 100W (M)	1.75	3.25	42	68	36	Additional chain 2996 OZ, additional stem 2999 (12") OZ.
E	42878 NI, OZ	(1) 100W (M)	4.75	7.75	113	---	---	☑ (23-30W CFL)
F	42308 OZ	(1) 100W (M)	5	8.75	49	61	36	☑ (23-30W CFL) Additional chain 2996 OZ, additional stem 2999 (12") OZ.
G	9870 RST	(1) 150W (M)	11	17.75	92	29	72	☑ (23-30W CFL) Additional chain 4297 RST.

Measurements shown in inches. U.S. & Canadian Patent Pending: A, B, C.



F | 49446 AZ Lyndon™



G | 49447 AZ Lyndon™



H | 49640 OZ Caterham™



J | 65359 Shazam™



K | 65266 Woodbury™



L | 65336 Casita™



M | 65271 Yakima™



N | 65318 Prairie Ridge™

MINI PENDANTS

ITEM #	FINISH	INCAND. BULB	W	H	OVRL H	STEM TILT	EXTRA WIRE	CHAIN/STEM	NOTES	
F	49446	AZ (1) 75W (M)	5	9.5	47	---	72	36	☑ (18-25W CFL) Additional chain 4927 AZ, additional stem 2999 (12") AZ.	
G	49447	AZ (1) 100W (M)	6	11.75	50	---	71	36	☑ (23-30W CFL) Additional chain 4927 AZ, additional stem 2999 (12") AZ.	
H	49640	OZ (1) 100W (M)	6.5	16	48	---	58	36	☑ (23-30W CFL) Additional chain 4927 OZ, additional stem 2999 (12") OZ, Indoor/Outdoor.	
J	65359	---	(1) 100W (M)	5	15	47	---	55	36	☑ (23-30W CFL) Additional chain 2996 OZ, additional stem 2999 (12") OZ.
K	65266	---	(1) 100W (M)	8	13.5	46	45° (12:12)	62	36	Additional stem 2999 (12") OLZ. Height includes one 6" stem.
L	65336	---	(1) 60W (M)	6.5	7.25	130	---	---	---	☑ (18-25W CFL)
M	65271	---	(1) 100W (M)	9.25	10.25	49	45° (12:12)	59	36	☑ (23-30W CFL) Additional stem 2999 (12") TZ.
N	65318	---	(1) 100W (M)	7	12.75	45	---	62	36	Additional chain 2996 OZ, additional stem 2999 (12") OZ. Height includes one 6" stem.

Measurements shown in inches. U.S. & Canadian Patent Pending: A, B.



MINI PENDANTS



A | 2616 MBZ
Souldern™



B | 42165 PN
Knox™



C | 42166 PN
Knox™



D | 49347 AZ
Pacific Edge™



D | 49347 PSS316
Pacific Edge™



E | 49348 AZ
Pacific Edge™



E | 49348 PSS316
Pacific Edge™

MINI PENDANTS

ITEM #	FINISH	INCAND. BULB	W	H	OVRL. H	STEM TILT	EXTRA WIRE	CHAIN/STEM	NOTES
A	MBZ	(1) 100W (M)	5.5	16.75	55	45°(12:12)	54	36	Ⓧ (23-30W CFL) Additional stem 2999 (12") MBZ.
B	PN	(1) 100W (M)	3.5	8.5	47	---	61	36	Ⓧ (23-30W CFL) Additional chain 2996 PN, additional stem 2999 (12") PN.
C	PN	(1) 100W (M)	6	12.75	51	---	60	36	Ⓧ (23-30W CFL) Additional chain 2996 PN, additional stem 2999 (12") PN.
D	AZ, PSS316	(1) 75W (M)	6	11.5	50	---	65	36	Ⓧ (18-25W CFL) Additional chain 4927 AZ or 2996 PSS316, additional stem 2999 (12") AZ, PSS316.
E	AZ, PSS316	(1) 100W (M)	8	13.75	52	---	64	36	Ⓧ (23-30W CFL) Additional chain 4927 AZ or 2996 PSS316, additional stem 2999 (12") AZ, PSS316.

Measurements shown in inches. U.S. Patent Pending: B, C, D, E.

3-ARM CANOPY

ACCESSORY FOR MINI PENDANTS.
 OPTIONAL CANOPY FOR USE WITH THREE
 PENDANTS TO CREATE A DRAMATIC
 CASCADING FOYER CENTERPIECE.



Shown with Pendant
42467 WMZ



Shown with
Pendant 42308 OZ



A | 4200 WMZ
Canopy



A | 4200 CH
Canopy



A | 4200 OZ
Canopy



A | 4200 NI
Canopy



A | 4200 PN
Canopy

3-ARM CANOPY

ITEM #	FINISH	W	H	NOTES
A 4200	CH, NI, OZ, PN, WMZ	24	4	3-arm canopy only, pendants sold separately.

Measurements shown in inches. U.S. & Canadian Patent Pending.



INDOOR/
OUTDOOR
PENDANTS



A | 49403 RZ
Lindstrom™



B | 49505 WZC
Wiscombe Park™



C | 49536 WZC
Woodland Lake™



D | 49387 OZ
Manningham™



E | 9809 OZLED
9809 BK, OZ
LED Mount Vernon



F | 42908 AP, ACO, OZ
Ryegate™
Indoor only



G | 49448 AZ
Belmez™



H | 49517 OZ
Rochdale™



H | 49517 ACO
Rochdale™



J | 49458 AZ
Belmez™

ITEM #	LED ITEM#	FINISH	INCAND. BULB	LIGHT SOURCE	W	H	OVRL. H	L	EXTRA WIRE	CHAIN/STEM	NOTES
A	49403	---	RZ	(1) 100W (M)	---	6.75	14.5	53	9	62	Ⓛ (23-30W CFL) Add. chain 4927 AGZ, add. stem 2999 (12") AGZ.
B	49505	---	WZC	(4) 60W (C)	---	11	23	97	---	10	Ⓛ Add. chain 4927 WZC.
C	49536	---	WZC	(1) 75W (M)	---	9.25	12.5	97	---	21	Ⓛ (18-25W CFL) Add. chain 4927 WZC.
D	49387	---	OZ	(3) 60W (C)	---	8.5	19	93	---	14	Ⓛ Add. chain 4927 OZ.
E	9809	---	BK, OZ	(1) 150W (M)	---	9.5	18.5	57	---	58	Ⓛ (23-30W CFL) Add. chain 2996 BK, OZ.
E	---	9809 OZLED	OZ	---	9W Ⓛ	9.5	18.5	93	---	30	Add. chain 4927 OZ.
F	42908	---	ACO, AP, OZ	(2) 60W (C)	---	10	23.75	62	14	53	36
G	49448	---	AZ	(1) 150W (M)	---	11	16.5	91	---	32	Ⓛ (30-52W CFL)
H	49517	---	ACO, OZ	(4) 60W (C)	---	11.75	27.75	102	---	6	Ⓛ Add. chain 4927 ACO, OZ.
J	49458	---	AZ	(3) 60W (C)	---	18.5	23.75	98	---	11	Ⓛ

Measurements shown in inches. U.S. & Canadian Patent Pending: A, B, C, D, F, G.



PENDANTS

OLDE BRONZE® FINISH



A | 43201 OZ
Pendant



B | 43200 OZ
Pendant



C | 42280 OZ
Mini Pendant



D | 42279 OZ
Pendant

PENDANTS

	ITEM #	FINISH	INCAND. BULB	W	H	OVRL. H	STEM TILT	EXTRA WIRE	CHAIN/STEM	NOTES
A	43201	OZ	(1) 100W (M)	18	10.5	50	90°	66	36	☑ (23-30W CFL) Additional stem 2999 (12") OZ.
B	43200	OZ	(1) 100W (M)	13	8.5	48	90°	61	36	☑ (23-30W CFL) Additional stem 2999 (12") OZ.
C	42280	OZ	(1) 100W (M)	7.75	12.75	51	90°	61	36	☑ (23-30W CFL) Additional stem 2999 (12") OZ.
D	42279	OZ	(1) 100W (M)	8.75	18.75	57	90°	58	36	☑ (23-30W CFL) Additional stem 2999 (12") OZ.

Measurements shown in inches. U.S. & Canadian Patent Pending.



E | 42466 WMZ
Pendant
Krasi™



F | 42467 WMZ
Mini Pendant
Krasi™



G | 42738 OZ
Mini Pendant

Gold Inside



H | 42792 OZ
Foyer Pendant

PENDANTS

ITEM #	FINISH	INCAND. BULB	W	H	OVRL. H	EXTRA WIRE	CHAIN/STEM	NOTES
E	WMZ	(1) 100W (M)	7.75	16.25	55	71	36	(23-30W CFL) Additional chain 2996 WMZ, additional stem 2999 (12") WMZ.
F	WMZ	(1) 100W (M)	5.5	11	54	67	36	(23-30W CFL) Additional stem 2999 (12") WMZ.
G	OZ	(1) 100W (M)	5.5	10.5	113	---	---	
H	OZ	(4) 100W (M)	15	31.5	69	64	36	(23-30W CFL) Additional chain 4901 OZ, additional stem 4935 (12") OZ.

Measurements shown in inches. U.S. & Canadian Patent Pending.





Everly™ Pendant 42329 OZCS | Page 384

EVERLY™ PENDANTS

OLDE BRONZE® FINISH
WITH CLEAR GLASS



A | 42456 OZCLR
Clear Glass



Vintage Squirrel Cage Filament Bulb 4071 CLR

B | 42141 OZCLR
Clear Glass



C | 42167 OZCLR
Clear Glass



F | 42044 OZ
Clear Glass



E | 42046 OZ
Clear Glass



D | 42047 OZ
Clear Glass

EVERLY™ PENDANTS

ITEM #	FINISH	INCAND. BULB	W	H	OVRL. H	STEM TILT	EXTRA WIRE	CHAIN/STEM	NOTES
A	42456 OZCLR	(1) 100W (M)	7	14	52	90°	57	36	Additional stem 2999 (12") OZ.
B	42141 OZCLR	(1) 100W (M)	10.5	15.75	54	90°	56	36	Additional stem 2999 (12") OZ.
C	42167 OZCLR	(1) 100W (M)	9.5	9.75	48	90°	59	36	Additional stem 2999 (12") OZ.
D	42047 OZ	(1) 100W (M)	8.75	18.25	58	90°	62	36	Additional stem 2999 (12") OZ. Glass is removable.
E	42046 OZ	(1) 100W (M)	13.75	20.25	60	90°	56	36	Additional stem 2999 (12") OZ. Glass is removable.
F	42044 OZ	(1) 100W (M)	12	10.75	50	90°	56	36	Additional stem 2999 (12") OZ. Glass is removable.

Measurements shown in inches. U.S. & Canadian Patent Pending: A, B, C, F.

EVERLY™ PENDANTS

OLDE BRONZE® FINISH WITH CLEAR
SEEDY GLASS, CHAMPAGNE GLASS OR
MERCURY GLASS



A | 42328 OZCS
Clear Seedy Glass



B | 42141 OZCS
Clear Seedy Glass



C | 42456 OZCP
Champagne Glass



D | 42167 OZMER
Mercury Glass



E | 42329 OZCS
Clear Seedy Glass



F | 42046 OZCS
Clear Seedy Glass



G | 42047 OZCP
Champagne Glass



H | 42044 OZMER
Mercury Glass

EVERLY™ PENDANTS

ITEM #	FINISH	INCAND. BULB	W	H	OVRLL. H	STEM TILT	EXTRA WIRE	CHAIN/STEM	NOTES
A	42328	OZCS (1) 100W (M)	12.5	11.5	50	90°	59	36	Additional stem 2999 (12") OZ.
B	42141	OZCS (1) 100W (M)	10.5	15.75	54	90°	56	36	Additional stem 2999 (12") OZ.
C	42456	OZCP (1) 100W (M)	7	14	52	90°	57	36	Additional stem 2999 (12") OZ.
D	42167	OZMER (1) 100W (M)	9.5	9.75	48	90°	59	36	Additional stem 2999 (12") OZ.
E	42329	OZCS (1) 100W (M)	19	16	54	90°	57	36	Additional stem 2999 (12") OZ.
F	42046	OZCS (1) 100W (M)	13.75	20.25	60	90°	56	36	Additional stem 2999 (12") OZ. Glass is removable.
G	42047	OZCP (1) 100W (M)	8.75	18.25	58	90°	62	36	Additional stem 2999 (12") OZ. Glass is removable.
H	42044	OZMER (1) 100W (M)	12	10.75	50	90°	56	36	Additional stem 2999 (12") OZ. Glass is removable.

Measurements shown in inches. U.S. & Canadian Patent Pending: A, B, C, E, F, H.

EVERLY™ PENDANTS

BRUSHED NICKEL FINISH
WITH MERCURY GLASS OR
CLEAR SEEDY GLASS



Vintage
Squirrel Cage
Filament Bulb,
60W Medium
Base

4071 CLR



A | 42167 NIMER
Mercury Glass



B | 42141 NICS
Clear Seedy Glass



C | 42328 NICS
Clear Seedy Glass



Decorative
Fluorescent Bulb,
9W Medium Base

4091



D | 42044 NIMER
Mercury Glass



Decorative
Fluorescent Bulb,
11W Medium
Base

4092



E | 42046 NICS
Clear Seedy Glass



F | 42329 NICS
Clear Seedy Glass

EVERLY™ PENDANTS

ITEM #	FINISH	INCAND. BULB	W	H	OVRL. H	STEM TILT	EXTRA WIRE	CHAIN/STEM	NOTES
A	42167 NIMER	(1) 100W (M)	9.5	9.75	48	90°	59	36	Additional stem 2999 (12") NI and/or 2997 (24") NI.
B	42141 NICS	(1) 100W (M)	10.5	15.75	54	90°	56	36	Additional stem 2999 (12") NI and/or 2997 (24") NI.
C	42328 NICS	(1) 100W (M)	12.5	11.5	50	90°	59	36	Additional stem 2999 (12") NI and/or 2997 (24") NI.
D	42044 NIMER	(1) 100W (M)	12	10.75	50	90°	56	36	Additional stem 2999 (12") NI and/or 2997 (24") NI. Glass is removable.
E	42046 NICS	(1) 100W (M)	13.75	20.25	60	90°	56	36	Additional stem 2999 (12") NI and/or 2997 (24") NI. Glass is removable.
F	42329 NICS	(1) 100W (M)	19	16	54	90°	57	36	Additional stem 2999 (12") NI and/or 2997 (24") NI.

Measurements shown in inches. U.S. & Canadian Patent Pending: A, B, C, D, F.

EVERLY™ PENDANTS

POLISHED CHROME FINISH WITH
CLEAR GLASS OR SMOKE GLASS



A | 42167 CHCLR
Clear Glass



B | 42141 CHCLR
Clear Glass



C | 42456 CHCLR
Clear Glass



C | 42456 CHSMK
Smoke Glass



D | 42044 CH
Clear Glass



E | 42046 CH
Clear Glass



F | 42047 CH
Clear Glass



F | 42047 CHSMK
Smoke Glass

EVERLY™ PENDANTS

ITEM #	FINISH	INCAND. BULB	W	H	OVRL. H	STEM TILT	EXTRA WIRE	CHAIN/STEM	NOTES
A	42167 CHCLR	(1) 100W (M)	9.5	9.75	48	90°	59	36	Additional stem 2999 (12") CH.
B	42141 CHCLR	(1) 100W (M)	10.5	15.75	54	90°	56	36	Additional stem 2999 (12") CH.
C	42456 CHCLR, CHSMK	(1) 100W (M)	7	14	52	90°	57	36	Additional stem 2999 (12") CH.
D	42044 CH	(1) 100W (M)	12	10.75	50	90°	56	36	Additional stem 2999 (12") CH. Glass is removable.
E	42046 CH	(1) 100W (M)	13.75	20.25	60	90°	56	36	Additional stem 2999 (12") CH. Glass is removable.
F	42047 CH, CHSMK	(1) 100W (M)	8.75	18.25	58	90°	62	36	Additional stem 2999 (12") CH. Glass is removable.

Measurements shown in inches. U.S. & Canadian Patent Pending: A, B, C, D.

PENDANTS



A | 2714 NI
Grenoble™



B | 2715 NI
Grenoble™



C | 2641 NI
Galaxie™



D | 2643 NI
Galaxie™



E | 2640 NI
Galaxie™



F | 2713 NI
Seaside™



F | 2713 OB
Seaside™

PENDANTS

ITEM #	FINISH	INCAND. BULB	W	H	OVRLL. H	STEM TILT	EXTRA WIRE	CHAIN/STEM	NOTES	
A	2714	NI	(1) 150W (M)	11	8	46	45°(12:12)	62	36	Ⓜ (13-15W CFL) Add. stem 2999 (12") NI and/or 2997 (24") NI. G-type bulb recommend.
B	2715	NI	(1) 150W (M)	16	9.5	48	45°(12:12)	112	36	Additional stem 2999 (12") NI and/or 2997 (24") NI. G-type bulb recommend.
C	2641	NI	(1) 50W (G9)	10.25	5	43	45°(12:12)	62	36	Additional stem 2999 (12") NI and/or 2997 (24") NI.
D	2643	NI	(1) 60W (M)	14	5.75	44	45°(12:12)	68	36	Additional stem 2999 (12") and/or 2997 (24") NI.
E	2640	NI	(1) 150W (M)	22.25	9.5	48	45°(12:12)	68	36	Additional stem 2999 (12") and/or 2997 (24") NI.
F	2713	NI, OB	(1) 150W (M)	16	13	87	---	36	72	Ⓜ G-type lamp recommended. Additional chain 2996 NI, OB.

Measurements shown in inches.

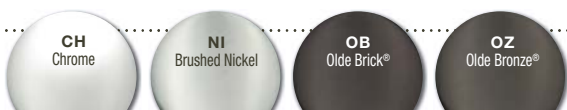

PENDANTS



A | 42033 OZ
Foyer Pendant

Antique Pewter Finish
on Hammered Metal



B | 78200 AP
Missoula™ Pendant

Bronze Finish on
Hammered Metal



C | 78200
Missoula™ Pendant

PENDANTS

	ITEM #	FINISH	INCAND. BULB	W	H	OVRL. H	EXTRA WIRE	CHAIN/STEM	NOTES
A	42033	OZ	(1) 100W (M)	11	21.75	96	26	72	☑ (23-30W CFL) Additional chain 2996 OZ.
B	78200	AP	(1) 100W (M)	13.5	12.75	87	38	72	☑ (23-30W CFL)
C	78200	---	(1) 100W (M)	13.5	12.75	87	38	72	☑ (23-30W CFL)

Measurements shown in inches. U.S. Patent Pending.



MATCHING
FIXTURE

See matching Rail Lights
on page 409.



HATTERAS BAY™ PENDANTS

OLDE BRONZE® FINISH WITH
CLEAR FRESNEL LENS



A | 2664 OZ



B | 2665 OZ



C | 2666 OZ



D | 2682 OZ



E | 2691 OZ

HATTERAS BAY™ PENDANTS

ITEM #	FINISH	INCAND. BULB	W	H	OVRL. H	EXTRA WIRE	CHAIN/STEM	NOTES	
A	2664	OZ	(1) 100W (M)	8	10.25	49	71	36	☑ (18-25W CFL) Additional chain 2996 OZ, additional stem 2999 (12") OZ.
B	2665	OZ	(1) 100W (M)	11.75	10.25	49	71	36	☑ (18-25W CFL) Additional chain 2996 OZ, additional stem 2999 (12") OZ.
C	2666	OZ	(1) 150W (M)	13.25	11.5	50	71	36	☑ (18-25W CFL) Additional chain 2996 OZ, additional stem 2999 (12") OZ.
D	2682	OZ	(1) 150W (M)	18	15	53	70	36	☑ (30-52W CFL) Additional chain 2996 OZ, additional stem 4935 (12") OZ.
E	2691	OZ	(1) 200W (M)	23.75	19.5	58	67	36	☑ (52-65W CFL) Additional chain 4901 OZ, additional stem 4935 (12") OZ.

Measurements shown in inches.

HATTERAS BAY™ PENDANTS

POLISHED NICKEL FINISH WITH
CLEAR FRESNEL LENS

COORDINATING CEILING FAN

See the full line of Kichler®
Ceiling Fans in catalog K414
or visit kichler.com



A | 300018 BSS

MATCHING FIXTURE

See matching Rail Lights
on page 409.



B | 2665 PN



C | 2664 PN



D | 2691 PN



E | 2682 PN



F | 2666 PN

HATTERAS BAY™ PENDANTS

ITEM #	FINISH	INCAND. BULB	W	H	OVRL. H	EXTRA WIRE	CHAIN/ STEM	NOTES
A	300018	BSS	---	---	---	---	---	See the full line of Kichler® Ceiling Fans in catalog K414 or visit kichler.com .
B	2665	PN	(1) 100W (M)	11.75	10.25	49	71	36 (18-25W CFL) Additional chain 2996 PN, additional stem 2999 (12") PN.
C	2664	PN	(1) 100W (M)	8	10.25	49	71	36 (18-25W CFL) Additional chain 2996 PN, additional stem 2999 (12") PN.
D	2691	PN	(1) 200W (M)	23.75	19.5	58	67	36 (52-65W CFL) Additional chain 4901 PN, additional stem 4935 (12") PN.
E	2682	PN	(1) 150W (M)	18	15	53	70	36 (30-52W CFL) Additional chain 2996 PN, additional stem 4935 (12") PN.
F	2666	PN	(1) 150W (M)	13.25	11.5	50	71	36 (18-25W CFL) Additional chain 2996 PN, additional stem 2999 (12") PN.

Measurements shown in inches. U.S. & Canadian Patent Pending: A.

HATTERAS BAY™ PENDANTS

ANTIQUÉ COPPER FINISH WITH CLEAR FRESNEL LENS



A | 2664 ACO



B | 2665 ACO



C | 2666 ACO



D | 2682 ACO



E | 2691 ACO

HATTERAS BAY™ PENDANTS

ITEM #	FINISH	INCAND. BULB	W	H	OVRL. H	EXTRA WIRE	CHAIN/STEM	NOTES	
A	2664	ACO	(1) 100W (M)	8	10.25	49	71	36	☑ (18-25W CFL) Additional chain 2996 ACO, additional stem 2999 (12") ACO.
B	2665	ACO	(1) 100W (M)	11.75	10.25	49	71	36	☑ (18-25W CFL) Additional chain 2996 ACO, additional stem 2999 (12") ACO.
C	2666	ACO	(1) 150W (M)	13.25	11.5	50	71	36	☑ (18-25W CFL) Additional chain 2996 ACO, additional stem 2999 (12") ACO.
D	2682	ACO	(1) 150W (M)	18	15	53	70	36	☑ (30-52W CFL) Additional chain 2996 ACO, additional stem 4935 (12") ACO.
E	2691	ACO	(1) 200W (M)	23.75	19.5	58	67	36	☑ (52-65W CFL) Additional chain 4901 ACO, additional stem 4935 (12") ACO.

Measurements shown in inches.

SAYRE™ PENDANTS

ANTIQUE PEWTER FINISH
WITH CLEAR FRESNEL LENS

COORDINATING CEILING FAN

See the full line of Kichler®
Ceiling Fans in catalog K414
or visit kichler.com



A | 300020 AP



B | 42436 AP



C | 42437 AP

MATCHING FIXTURE

See matching Rail Lights
on page 408.



D | 42438 AP



E | 42440 AP

LE

SAYRE™ PENDANTS

ITEM #	FINISH	INCAND. BULB	W	H	OVRL. H	EXTRA WIRE	CHAIN/ STEM	NOTES	
A	300020	AP	---	---	---	---	---	See the full line of Kichler® Ceiling Fans in catalog K414 or visit kichler.com .	
B	42436	AP	(1) 60W (M)	10	8.5	47	70	36	Ⓚ Additional chain 2996 AP, additional stem 2999 (12") AP. Sloped ceiling kit included.
C	42437	AP	(1) 75W (M)	12	9.25	48	70	36	Ⓚ Additional chain 2996 AP, additional stem 2999 (12") AP. Sloped ceiling kit included.
D	42438	AP	(1) 100W (M)	14	10.5	49	69	36	Ⓚ Additional chain 2996 AP, additional stem 2999 (12") AP. Sloped ceiling kit included.
E	42440	AP	(1) 150W (M)	18	12.25	50	65	36	Ⓚ Additional chain 2996 AP, additional stem 4935 (12") AP.

Measurements shown in inches. U.S. & Canadian Patent Pending.

SAYRE™ PENDANTS

OLDE BRONZE® FINISH
WITH CLEAR FRESNEL LENS



A | 42436 OZ



B | 42437 OZ



C | 42438 OZ



D | 42440 OZ

LE

MATCHING
FIXTURE

See matching Rail Lights
on page 408.



SAYRE™ PENDANTS

ITEM #	FINISH	INCAND. BULB	W	H	OVRL. H	EXTRA WIRE	CHAIN/STEM	NOTES
A	42436	OZ (1) 60W (M)	10	8.5	47	70	36	ⓐ Additional chain 2996 OZ, additional stem 2999 (12") OZ. Sloped ceiling kit included.
B	42437	OZ (1) 75W (M)	12	9.25	48	70	36	ⓐ Additional chain 2996 OZ, additional stem 2999 (12") OZ. Sloped ceiling kit included.
C	42438	OZ (1) 100W (M)	14	10.5	49	69	36	ⓐ Additional chain 2996 OZ, additional stem 2999 (12") OZ. Sloped ceiling kit included.
D	42440	OZ (1) 150W (M)	18	12.25	50	65	36	ⓐ Additional chain 2996 OZ, additional stem 4935 (12") OZ.

Measurements shown in inches. U.S. & Canadian Patent Pending.

KELLER™ CONVERTIBLES

OLDE BRONZE® OR BRUSHED NICKEL
WITH CASED OPAL GLASS



Shown as Pendant - 6" H.

A | 42268 OZ



Shown as Pendant - 7.25" H.

B | 42269 OZ



Shown as Pendant - 8.75" H.

C | 42270 OZ



Shown as Semi Flush - 7.25" H.



Shown as Semi Flush - 8.25" H.



Shown as Semi Flush - 10" H.

CONVERTIBLE

Create two distinct lighting options with one fixture:
Semi Flush or Pendant.

KELLER™

	ITEM #	FINISH	INCAND. BULB	W	H	OVRL. H	EXTRA WIRE	CHAIN/STEM	NOTES
A	42268	OZ	(1) 60W (M)	8	6	44	62	36	Ⓧ Additional chain 2996 OZ, additional stem 2999 (12") OZ. Sloped ceiling kit included.
B	42269	OZ	(1) 75W (M)	10	7.25	46	62	36	Ⓧ (18-25W CFL) Additional chain 2996 OZ, additional stem 2999 (12") OZ. Sloped ceiling kit included.
C	42270	OZ	(1) 100W (M)	12	8.75	47	62	36	Ⓧ (23-30W CFL) Additional chain 2996 OZ, additional stem 4935 (12") OZ. Sloped ceiling kit included.

Measurements shown in inches. U.S. & Canadian Patent Pending.



Shown as Pendant - 6" H.

Shown as Pendant - 7.25" H.

Shown as Pendant - 8.75" H.

A | 42268 NI

B | 42269 NI

C | 42270 NI

Shown as Semi Flush - 7.25" H.

Shown as Semi Flush - 8.25" H.

Shown as Semi Flush - 10" H.

CONVERTIBLE

Create two distinct lighting options with one fixture:
Semi Flush or Pendant.

KELLER™

ITEM #	FINISH	INCAND. BULB	W	H	OVRL. H	EXTRA WIRE	CHAIN/STEM	NOTES	
A	42268	NI	(1) 60W (M)	8	6	44	62	36	Ⓧ Add. chain 2996 NI, add. stem 2999 (12") NI and/or 2997 (24") NI. Sloped ceiling kit included.
B	42269	NI	(1) 75W (M)	10	7.25	46	62	36	Ⓧ (18-25W CFL) Add. chain 2996 NI, add. stem 2999 (12") NI and/or 2997 (24") NI. Sloped ceiling kit included.
C	42270	NI	(1) 100W (M)	12	8.75	47	62	36	Ⓧ (23-30W CFL) Add. chain 2996 NI, add. stem 4935 (12") NI. Sloped ceiling kit included.

Measurements shown in inches. U.S. & Canadian Patent Pending.

LYTHAM™

BRUSHED NICKEL FINISH WITH
SATIN-ETCHED WHITE GLASS



A | 42275 NI
Flush Mount



C | 42244 NI
Inverted Pendant



Shown as Inverted Pendant - 9.25" H.

CONVERTIBLE

Create two distinct lighting
options with one fixture:
Inverted Pendant or Semi Flush.

B | 42245 NI



Shown as Semi Flush - 9.5" H.



D | 42276 NI
Flush Mount



E | 42246 NI
Semi Flush

LYTHAM™

ITEM #	FINISH	INCAND. BULB	W	H	OVRL. H	EXTRA WIRE	CHAIN/STEM	NOTES
A	42275 NI	(3) 60W (M) ✓	17.5	5.5	---	---	---	☑ (13-40W CFL)
B	42245 NI	(3) 100W (M)	17.5	9.25	48	64	36	☑ (23-40W CFL) Additional chain 2996 NI, additional stem 2999 (12") NI and/or 2997 (24") NI. Sloped ceiling kit included.
C	42244 NI	(4) 100W (M)	20.5	20.25	59	53	36	☑ (23-40W CFL) Additional chain 2996 NI, additional stem 4935 (12") NI. Sloped ceiling kit included.
D	42276 NI	(4) 60W (M) ❖	20.5	5.5	---	---	---	☑ (13-40W CFL)
E	42246 NI	(4) 100W (M)	20.5	10.75	---	---	---	☑ (23-40W CFL)

Measurements shown in inches. U.S. & Canadian Patent Pending.

LYTHAM™

OLDE BRONZE® FINISH WITH SATIN-ETCHED WHITE GLASS



A | 42244 OZ
Inverted Pendant



D | 42275 OZ
Flush Mount



B | 42276 OZ
Flush Mount



C | 42246 OZ
Semi Flush



Shown as Inverted Pendant - 9.25" H.

CONVERTIBLE

Create two distinct lighting options with one fixture:
Inverted Pendant or Semi Flush.

E | 42245 OZ



Shown as Semi Flush - 9.5" H.

LYTHAM™

	ITEM #	FINISH	INCAND. BULB	W	H	OVRLL. H	EXTRA WIRE	CHAIN/STEM	NOTES
A	42244	OZ	(4) 100W (M)	20.5	20.25	59	53	36	(23-40W CFL) Additional chain 2996 OZ, additional stem 4935 (12") OZ. Sloped ceiling kit included.
B	42276	OZ	(4) 60W (M) ✦	20.5	5.5	---	---	---	(13-40W CFL)
C	42246	OZ	(4) 100W (M)	20.5	10.75	---	---	---	(23-40W CFL)
D	42275	OZ	(3) 60W (M) ✓	17.5	5.5	---	---	---	(13-40W CFL)
E	42245	OZ	(3) 100W (M)	17.5	9.25	48	64	36	(23-40W CFL) Additional chain 2996 OZ, additional stem 2999 (12") OZ and/or 2997 (24") OZ. Sloped ceiling kit included.

Measurements shown in inches. U.S. & Canadian Patent Pending.

PENDANTS



Shown as Semi Flush - 14.5" H.

A | 42122 NI



Shown as Semi Flush - 14.5" H.

A | 42122 OZ

CONVERTIBLE

Create two distinct lighting options with one fixture:
Semi Flush or Pendant.



Shown as Pendant - 12.25" H.

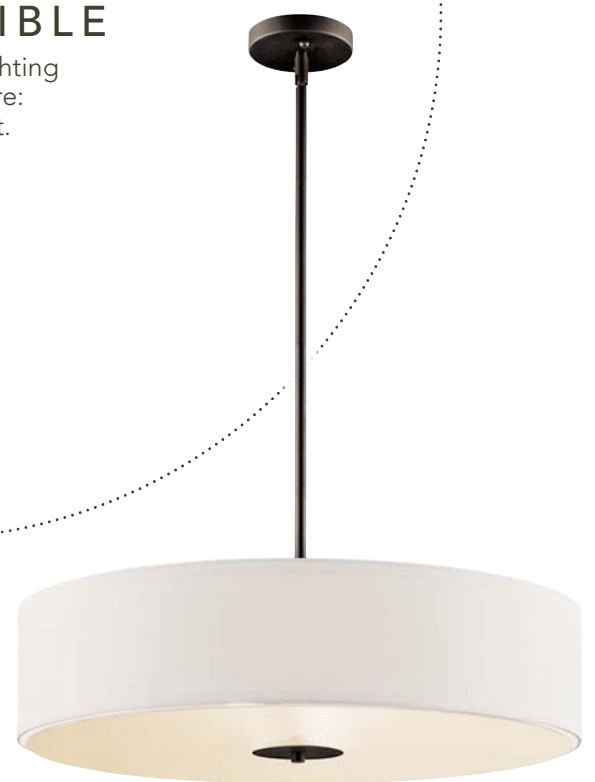

Shown as Pendant - 12.25" H.

PENDANTS

ITEM #	FINISH	INCAND. BULB	W	H	OVRL. H	STEM TILT	EXTRA WIRE	CHAIN/STEM	NOTES
A 42122	NI, OZ	(3) 150W (M)	24	12.25	44	90°	64	36	(32-50W CFL) Additional stem 2999 (12") NI, OZ and/or 2997 (24") NI. Height includes one 6" stem.

Measurements shown in inches. U.S. Patent Pending.



Shown as Semi Flush - 14.5" H.



Shown as Semi Flush - 14.5" H.

B | 42121 NI

B | 42121 OZ

CONVERTIBLE

Create two distinct lighting options with one fixture:
Semi Flush or Pendant.



Shown as Pendant - 11.75" H.



Shown as Pendant - 11.75" H.



C | 42252 AP
Quinn
Pendant

Satin-Etched
Glass Diffuser

PENDANTS

	ITEM #	FINISH	INCAND. BULB	W	H	OVRL. H	STEM TILT	EXTRA WIRE	CHAIN/STEM	NOTES
B	42121	NI, OZ	(3) 100W (M)	20	11.75	44	90°	65	36	(23-30W CFL) Additional stem 2999 (12") NI, OZ and/or 2997 (24") NI. Height includes one 6" stem.
C	42252	AP	(3) 100W (M)	21.5	21	60	45°(12:12)	58	36	(23-30W CFL) Additional stem 2999 (12") AP.

Measurements shown in inches. U.S. Patent Pending.



PENDANTS



A | 2752 NI



B | 3752 NI



C | 3244 NI Structures™



D | 2754 NI



E | 3245 NI Structures™

PENDANTS

ITEM #	FINISH	INCAND. BULB	W	H	OVRLL. H	STEM TILT	EXTRA WIRE	CHAIN/STEM	NOTES
A	NI	(3) 100W (M)	17.5	22	60	45° (12:12)	52	36	☑ (18-25W CFL) Additional stem 2999 (12") NI and/or 2997 (24") NI; Satin-Etched White Glass.
B	NI	(3) 100W (M)	17.5	14	---	---	---	---	☑ (18-25W CFL) Satin-Etched White Glass.
C	NI	(3) 100W (M)	24	25	63	45° (12:12)	90	36	☑ (18-25W CFL) Additional stem 2999 (12") NI and/or stem 2997 (24") NI.
D	NI	(4) 150W (M)	26	24	62	45° (12:12)	87	36	☑ (23-30W CFL) Additional stem 2999 (12") NI and/or 2997 (24") NI; Satin-Etched White Glass.
E	NI	(6) 75W (M)	30	28.5	67	45° (12:12)	86	36	☑ (23-30W CFL) Additional stem 2999 (12") NI and/or stem 2997 (24") NI.

Measurements shown in inches.

PENDANTS ENERGY EFFICIENT



F | 10709 NI
Ara



G | 10710 NI
Ara









H | 10708 NI
Ara



J | 10711 NI
Ara

ENERGY EFFICIENT PENDANTS

	FLUOR. ITEM #	FINISH	FLUOR. BULB	W	H	L	NOTES
F	10709	NI	(4) 21W (T-5, G5) 	15	4.25	43	Adjustable height up to 52.5".
G	10710	NI	(1) 70W (TC-G10Q)  	20	4	---	Adjustable height up to 52.5".
H	10708	NI	(2) 21W (T-5, G5) 	10	4	43	Adjustable height up to 52.5".
J	10711	NI	(4) 26W (G24Q-3)  	30	6	---	Adjustable height up to 52.5".

Measurements shown in inches. U.S. Patent Pending.

PENDANTS



A | 10742 NI
Wedgeport™



A | 10742 OZ
Wedgeport™



Alabaster Swirl Glass





B | 10706 NI
Telford™



Umber-Etched Glass

B | 10706 OZ
Telford™

PENDANTS

	FLUOR. ITEM #	FINISH	FLUOR. BULB	W	H	OVRL H	EXTRA WIRE	CHAIN/STEM	NOTES
A	10742	NI, OZ	(2) 13W (GU24)  	19.25	20.75	95	26	72	Additional chain 2996 NI, OZ.
B	10706	NI, OZ	(3) 13W (GU24)   	17.5	21.5	96	25	72	Additional chain 2996 NI, OZ.

Measurements shown in inches.



C | 42071 AP
Durham™



C | 42071 APW
Stafford™



C | 42071 OZ
Durham™



C | 42071 OZW
Stafford™



D | 42881 CH
Armida™



D | 42881 NIW
Armida™



D | 42881 NI
Nicholson™



D | 42881 OZ
Nicholson™



E | 2702 NI
Hastings™



E | 2702 NIS
Wynberg™



E | 2702 OZ
Wynberg™



E | 2702 TZ
Hastings™

PENDANTS

ITEM #	FINISH	INCAND. BULB	W	H	OVRL. H	EXTRA WIRE	CHAIN/STEM	NOTES
C	42071 AP, APW, OZ, OZW	(1) 150W (M)	15	14.75	89	31	72	☑ (30-52W CFL) Additional chain 2996 AP, OZ. G-type lamp recommended.
D	42881 CH, NI, NIW, OZ	(1) 150W (M)	16	9.5	84	37	72	☑ (30-52W CFL) Additional chain 2996 CH, NI, OZ. G-type lamp recommended.
E	2702 NI, NIS, OZ, TZ	(1) 150W (M)	17.5	8.5	83	30	72	☑ (9-13W CFL) Additional chain 2996 NI, OZ, TZ. G-type lamp recommended.

Measurements shown in inches.



CEILING

AMBIENT & ESSENTIAL

Even Superheroes have an alter ego. Practical one moment; flashy and bold the next. Despite their everyday functionality, Kichler® Ceiling fixtures add that same bit of personality to a room. Bold and striking or simple and subdued, nothing puts light right where you need it like our diverse offering. Plus, our energy efficient options assure that this often-used fixture delivers light sensibly. Flip a switch, and let the transformation begin.





Lacey™ Semi Flush 42387 MIZ & Mini Pendant 42384 MIZ | Page 158



LED Directional Rail Light 10326 NI | Page 407

LED DIRECTIONAL RAIL LIGHTS

Kichler® LED lighting exceeds the standards for efficiency, reliability and beauty:

Long-life light emitting diodes (LED) provide approximately 40,000-hour lifespan to L70 (70% initial lumens) – about 15 years of standard operation – and are replaceable.

True optics: pure white light and controlled beam spread with no fade or drop off of light. High Color Rendering Index (CRI) Standard installation.

LED OUTPUT

10325 NI/OZ	1077 Lumens, 23.4 Watts 2700 Kelvin, CRI 80, 40K Life
10326 NI	1032 Lumens, 23.4 Watts 2700 Kelvin, CRI 80, 40K Life

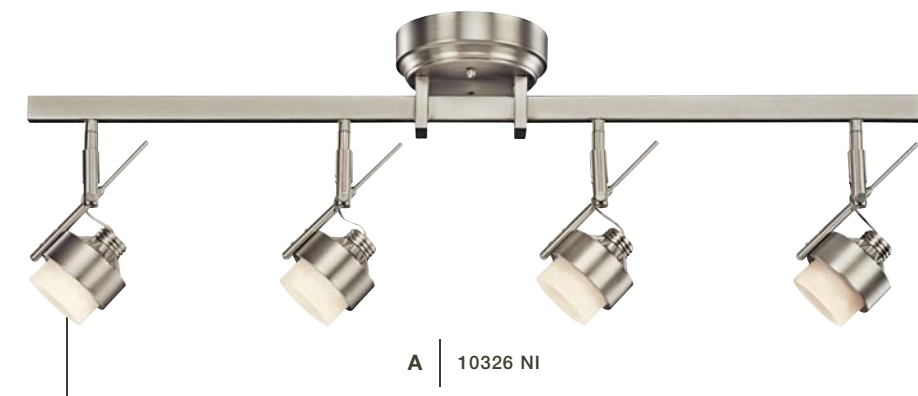

A | 10326 NI

Satin-Etched Glass



B | 10325 NI

Clear Polished Glass with Inside Etch



B | 10325 OZ

Clear Polished Glass with Inside Light Umber Etch

LED DIRECTIONAL RAIL LIGHTS

	LED ITEM #	FINISH	LIGHT SOURCE	W	H	L	EXT.	HCWO	NOTES
A	10326	NI	(4) 6.6W	5.75	11.5	35.25	10.5	3	May be ceiling or wall mounted, 90° vertical rotation, 330° horizontal rotation.
B	10325	NI, OZ	(4) 6.6W	6.25	9.5	33.5	8.5	3.25	May be ceiling or wall mounted, 90° vertical rotation, 330° horizontal rotation.

Measurements shown in inches. U.S. & Canadian Patent Pending.



DIRECTIONAL RAIL LIGHTS

VERSATILE 3 OR 4-LIGHT, SWIVEL-HEAD WALL OR CEILING MOUNTED FIXTURE FOCUSES LIGHT IN MULTIPLE DIRECTIONS. IDEAL FOR HALLWAYS, BATHS AND SETTINGS THAT DEMAND ATTENTION. LAMPS SWIVEL 90° AND ROTATE 330°.



DIRECTIONAL RAIL LIGHTS

	ITEM #	FINISH	INCAND. BULB	W	H	L	EXT.	HCWO	NOTES
A	7744	DBK	(4) 50W (GU10) ✓	5.25	9.25	31.75	7	2.75	Ⓧ May be ceiling or wall mounted, Halogen light source.
B	42439	AP, OZ	(3) 50W (GU10) ✓	6	9.75	24	7.5	3	Ⓧ May be ceiling or wall mounted, Halogen light source.
C	42164	AP, OZ	(4) 50W (GU10) ✓	5.5	8.75	34.25	7.5	2.75	Ⓧ May be ceiling or wall mounted, Halogen light source.
D	7755	NI, OZ	(4) 50W (GU10) ✓	5	11	30	8	2.5	Ⓧ May be ceiling or wall mounted, Halogen light source.

Measurements shown in inches. U.S. Patent Pending: A, B, D.



E | 7779 AP
Olympia™

Satin-Etched
Cased Opal
Glass



F | 7703 AP
Olympia™



E | 7779 OZ
Olympia™

Sunrise
Marble Glass



F | 7703 OZ
Olympia™



G | 7050 OZ
Hatteras Bay™



H | 7704 OZ
Hatteras Bay™



G | 7050 PN
Hatteras Bay™



H | 7704 PN
Hatteras Bay™

DIRECTIONAL RAIL LIGHTS

ITEM #	FINISH	INCAND. BULB	W	H	L	EXT.	HCWO	NOTES
E	7779 AP, OZ	(3) 50W (GU10) ✓	5.5	9.25	25.25	7	2.75	Ⓧ May be ceiling or wall mounted, Halogen light source.
F	7703 AP, OZ	(4) 50W (GU10) ✓	5.5	9.75	32	7.5	2.75	Ⓧ May be ceiling or wall mounted, Halogen light source.
G	7050 OZ, PN	(3) 50W (GU10) ✓	5.5	11.25	22.75	7.25	2.75	Ⓧ May be ceiling or wall mounted, Halogen light source.
H	7704 OZ, PN	(4) 50W (GU10) ✓	5.5	11.25	31.25	7.5	2.75	Ⓧ May be ceiling or wall mounted, Halogen light source.

Measurements shown in inches. U.S. Patent Pending: A,C,D.



CEILING



A | 42063 NI



A | 42063 OZ



B | 42025 NI



B | 42025 OZ



C | 42651 CH
Owego™



C | 42651 NI
Owego™



C | 42651 OZ
Owego™

CEILING

	ITEM #	FINISH	INCAND. BULB	W	H	NOTES
A	42063	NI, OZ	(4) 100W (M) ✓	19.25	11	☑ (23-30W CFL) Satin-Etched White Glass.
B	42025	NI, OZ	(4) 100W (M)	23.25	10	☑ (23-30W CFL) Satin-Etched White Glass.
C	42651	CH, NI, OZ	(3) 75W (M)	17	11.5	☑ (18-25W CFL) Satin-Etched White Glass.

Measurements shown in inches. U.S. & Canadian Patent Pending.

CEILING



D | 3122 NIA



D | 3122 NI



D | 3122 TZ



E | 3121 NI



E | 3121 TZ



F | 3718 NI



F | 3718 TZ

CEILING

	ITEM #	FINISH	INCAND. BULB	W	H	NOTES
D	3122	NI, NIA, TZ	(3) 100W (M)	15	9.75	(18-25W CFL) NI, TZ: Satin-Etched Glass, NIA: Alabaster Swirl Glass.
E	3121	NI, TZ	(1) 100W (M)	10	9.25	(18-25W CFL) NI, TZ: Satin-Etched Glass.
F	3718	NI, TZ	(2) 100W (M)	13	10.5	(13-15W CFL) NI, TZ: Satin-Etched Glass.

Measurements shown in inches.

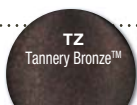

CEILING



A | 3623 NI



A | 3623 NIA



B | 3623 NIFL



A | 3623 TZ



C | 3623 TZFL



A | 3623 OZ



D | 3623 OZFL

CEILING

ITEM #	FLUOR. ITEM #	FINISH	INCAND. BULB	FLUOR. BULB	W	H	NOTES	
A	3623	---	NI, NIA, OZ, TZ	(3) 60W (M)	---	15.25	14	(13-15W CFL) NI, OZ, TZ: Etched Seedy Glass; NIA: Alabaster Swirl Glass.
B	---	3623 NIFL	NI	---	(3) 13W (GU24)	15.25	14	Etched Seedy Glass.
C	---	3623 TZFL	TZ	---	(3) 13W (GU24)	15.25	14	Umber-Etched Seedy Glass.
D	---	3623 OZFL	OZ	---	(3) 13W (GU24)	15.25	14	Etched Seedy Glass.

Measurements shown in inches.



ART GLASS CEILING



A | 69038
Semi Flush



B | 69041
Flush Mount



C | 69045
Semi Flush



D | 69017
Semi Flush



E | 69050
Semi Flush

ART GLASS CEILING

	ITEM #	INCAND. BULB	W	H	NOTES
A	69038	(3) 60W (M) ✓	19	7	☑ (13-15W CFL)
B	69041	(3) 60W (M) ✓	19	7	
C	69045	(3) 60W (M) ✓	19	10.5	
D	69017	(3) 60W (M) ✓	19	6	☑ (13-15W CFL)
E	69050	(3) 150W (M)	24	15.5	☑ (23-30W CFL)

Measurements shown in inches.

LED CEILING

Kichler® LED lighting exceeds the standards for efficiency, reliability and beauty

Long-life light emitting diodes (LED) provide approx. 40,000-hour life span to L70 (70% initial lumens) – about 15 years of standard operation – and are replaceable.

True optics: pure white light and controlled beam spread with no fade or drop off of light.

High Color Rendering Index (CRI)

Standard installation





A | 42379 NI



A | 42379 OZ



B | 42380 NI



B | 42380 OZ



C | 8112 NILED



C | 8112 OZLED



D | 8116 NILED



D | 8116 OZLED

LED CEILING

	LED ITEM #	FINISH	LIGHT SOURCE	W	H	NOTES
A	42379	NI, OZ	25.9W	13.25	3.5	Opal-Etched Glass.
B	42380	NI, OZ	25.9W	14	3.5	Opal-Etched Glass.
C	8112 NILED, 8112 OZLED	NI, OZ	25.9W	13.25	6	Satin-Etched Glass.
D	8116 NILED, 8116 OZLED	NI, OZ	25.9W	15.25	6.5	Satin-Etched Glass.

LED OUTPUT

8112 NILED/OZLED	1771 Lumens, 25.3 Watts, 3000 Kelvin, CRI 80, 40K Life
8116 NILED/OZLED	1771 Lumens, 25.3 Watts, 3000 Kelvin, CRI 80, 40K Life
42379 NI/OZ	1644 Lumens, 25.3 Watts, 3000 Kelvin, CRI 80, 40K Life
42380 NI/OZ	1644 Lumens, 25.3 Watts, 3000 Kelvin, CRI 80, 40K Life

Measurements shown in inches.



CEILING



A | 8653 CH



Satin-Etched Glass

B | 8654 CH



A | 8653 NI



B | 8654 NI



C | 8655 NI



A | 8653 SC



B | 8654 SC



C | 8655 SC



A | 8653 TZ



B | 8654 TZ



C | 8655 TZ

CEILING

ITEM #	FINISH	INCAND. BULB	W	H	NOTES
A 8653	CH, NI, SC, TZ	(2) 60W (M) ✦	11.5	6	✦ (13-15W CFL) Satin-Etched Glass.
B 8654	CH, NI, SC, TZ	(2) 60W (M) ✦	13.25	5.5	✦ (13-15W CFL) Satin-Etched Glass.
C 8655	NI, SC, TZ	(3) 60W (M) ✦	15.25	6.25	✦ (13-15W CFL) Satin-Etched Glass.

Measurements shown in inches. U.S. Patent Pending.

CEILING ENERGY EFFICIENT



A | 10864 NI



C | 10865 NI



A | 10864 TZ



C | 10865 TZ



B | 10835 NI



D | 10836 NI



E | 10837 NI



B | 10835 OZ



D | 10836 OZ



E | 10837 OZ



B | 10835 WH



D | 10836 WH



E | 10837 WH

ENERGY EFFICIENT CEILING

	FLUOR. ITEM #	FINISH	FLUOR. BULB	W	H	NOTES
A	10864	NI, TZ	(2) 13W (GU24)	13	5.5	Satin-Etched Glass.
B	10835	NI, OZ, WH	(1) 18W (GU24)	11.25	6	NI, WH: Alabaster Swirl Glass, OZ: Light Umber-Etched Glass; OZW: White Glass.
C	10865	NI, TZ	(3) 13W (GU24)	15.25	6.25	Satin-Etched Glass.
D	10836	NI, OZ, WH	(2) 18W (GU24)	13.25	6	NI, WH: Alabaster Swirl Glass, OZ: Light Umber-Etched Glass. OZW: White Glass. (2) 18W bulbs included.
E	10837	NI, OZ, WH	(2) 13W (GU24)	15.5	7	NI, WH: Alabaster Swirl Glass, OZ: Light Umber-Etched Glass; OZW: White Glass.

Measurements shown in inches.

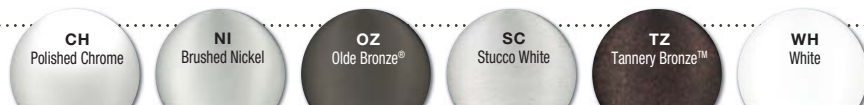

CEILING



A | 8108 NI



C | 8109 NI



E | 8110 NI



A | 8108 OZ



C | 8109 OZ



E | 8110 OZ



A | 8108 TZ



C | 8109 TZ



E | 8110 TZ



B | 8111 NI



D | 8112 NI



F | 8116 NI



B | 8111 OZ



D | 8112 OZ



F | 8116 OZ



G | 216 WH



J | 9834 WH



K | 8010 WH
Twist Lock



H | 7350 WH



L | 7260 WH

CEILING

	ITEM #	FINISH	INCAND. BULB	W	H	NOTES
A	8108	NI, OZ, TZ	(2) 60W (M) ❖	11.25	6.25	☑ (13-15W CFL) NI, TZ: Alabaster Swirl Glass, OZ: Light Umber-Etched Glass.
B	8111	NI, OZ	(2) 60W (M) ❖	11.25	6.25	☑ (13-15W CFL) Satin-Etched Glass.
C	8109	NI, OZ, TZ	(2) 60W (M) ❖	13.25	6	☑ (13-15W CFL) NI, TZ: Alabaster Swirl Glass, OZ: Light Umber-Etched Glass.
D	8112	NI, OZ	(2) 60W (M) ❖	13.25	6	☑ (13-15W CFL) Satin-Etched Glass.
E	8110	NI, OZ, TZ	(3) 60W (M) ✓	15.25	6.25	☑ (13-15W CFL) NI, TZ: Alabaster Swirl Glass, OZ: Light Umber-Etched Glass.
F	8116	NI, OZ	(3) 60W (M) ✓	15.25	6.5	☑ (13-15W CFL) Satin-Etched Glass.
G	216	WH	(1) 75W (M) ✓	5.75	7	☑ (18-25W CFL) White Glass.
H	7350	WH	(3) 60W (M) ✓	15.25	8	☑ (13-15W CFL) White Glass.
J	9834	WH	(1) 65W (M) BR-30 ❖	4.5	8.5	☑ (23-30W CFL)
K	8010	WH	(2) 75W (M) ❖	10.5	6	☑ (18-25W CFL) Satin-Etched Glass. Twist Lock.
L	7260	WH	(2) 60W (M) ✓	12	5.5	☑ (13-15W CFL) White Glass.

Measurements shown in inches.



CEILING



A | 8404 NI



B | 8405 NI



C | 10859 NI



A | 8404 TZ



B | 8405 TZ



C | 10859 TZ



D | 8406 NI



E | 8407 NI



D | 8406 TZ



E | 8407 TZ

CEILING

ITEM #	FLUOR. ITEM #	FINISH	INCAND. BULB	FLUOR. BULB	W	H	NOTES
A	8404	NI, TZ	(1) 100W (M)	---	12	6.25	NI: Etched White Glass, TZ: Etched Sunset Glass.
B	8405	NI, TZ	(2) 75W (M) ❖	---	15	6	NI: Etched White Glass, TZ: Etched Sunset Glass.
C	---	10859	---	(1) 55W (2C,G10Q) Ⓢ	17	6.5	NI: Etched White Glass, TZ: Etched Sunset Glass.
D	8406	NI, TZ	(3) 60W (M) ✓	---	17	6.5	NI: Etched White Glass, TZ: Etched Sunset Glass.
E	8407	NI, TZ	(5) 75W (M) ❖	---	25	9.5	NI: Etched White Glass, TZ: Etched Sunset Glass.

Measurements shown in inches.

CEILING ENERGY EFFICIENT



A | 10827 NI



A | 10827 OZ



B | 10828 NI



B | 10828 OZ



C | 10879 NI



C | 10879 OZ

ENERGY EFFICIENT CEILING

	FLUOR. ITEM #	FINISH	FLUOR. BULB	W	H	L	NOTES
A	10827	NI, OZ	(2) 26W (G4Q-3) ✓	16	3.25	---	White Acrylic Diffuser.
B	10828	NI, OZ	(3) 26W (G24Q-3) ✓	24	4.75	---	White Acrylic Diffuser.
C	10879	NI, OZ	(2) 36W (T5,2G11) ❖	18.25	4.5	32.25	White Acrylic Diffuser.

Measurements shown in inches.



CEILING



A | 8880 NI
8880 NIFL



B | 8881 NI
8881 NIFL



C | 8882 NI
8882 NIFL



A | 8880 OZ
8880 OZFL



B | 8881 OZ
8881 OZFL



C | 8882 OZ
8882 OZFL



A | 8880 TZ



B | 8881 TZ



C | 8882 TZ



A | 8880 WH



B | 8881 WH



C | 8882 WH

CEILING

ITEM #	FLUOR. ITEM #	FINISH	INCAND. BULB	FLUOR. BULB	W	H	NOTES
A	8880	NI, OZ, TZ, WH	(1) 75W (M) ❖	---	10	4.25	ⓓ Satin-Etched Cased Opal Twist-On Glass.
A	---	8880 NIFL, 8880 OZFL	---	(1) 18W (GU24) ⓕ ⓓ	10	4.25	ⓓ Satin-Etched Cased Opal Twist-On Glass.
B	8881	NI, OZ, TZ, WH	(1) 100W (M) ❖	---	14	4.75	ⓓ Satin-Etched Cased Opal Twist-On Glass.
B	---	8881 NIFL, 8881 OZFL	---	(2) 13W (GU24) ⓕ ⓓ	14	4.75	ⓓ Satin-Etched Cased Opal Twist-On Glass.
C	8882	NI, OZ, TZ, WH	(2) 75W (M) ❖	---	16.5	5.5	ⓓ Satin-Etched Cased Opal Twist-On Glass.
C	---	8882 NIFL, 8882 OZFL	---	(3) 13W (GU24) ⓕ ⓓ	16.5	5.5	ⓓ Satin-Etched Cased Opal Twist-On Glass.

Measurements shown in inches.



D | 3620 NI



F | 8064 NI



H | 9817 AP



D | 3620 OZ



F | 8064 TZ



H | 9817 OZ



K | 7003 NI



E | 3627 NI



G | 8065 NI



J | 7011 NI



K | 7003 OZ



E | 3627 OZ



G | 8065 TZ



J | 7011 OZ

CEILING

ITEM #	FINISH	INCAND. BULB	W	H	NOTES
D	3620 NI, OZ	(2) 100W (M) ❖	13.5	7.25	Ⓜ (13-15W CFL) NI: White-Etched Glass, OZ: Umber-Etched Glass.
E	3627 NI, OZ	(3) 100W (M) ❖	15	7.75	Ⓜ (9-13W CFL) NI: White-Etched Glass, OZ: Umber-Etched Glass.
F	8064 NI, TZ	(2) 60W (M) ❖	13.25	6.25	Ⓜ (13-15W CFL) Etched Seedy Glass.
G	8065 NI, TZ	(3) 60W (M) ❖	15.25	7.75	Ⓜ (13-15W CFL) Etched Seedy Glass.
H	9817 AP, OZ	(2) 100W (M) ✓	13	7	Ⓜ (18-25W CFL) AP: Satin-Etched Glass, OZ: Light Umber-Etched Glass.
J	7011 NI, OZ	(4) 60W (M) ❖	18	7.5	Ⓜ (13-15W CFL) NI: Satin-Etched Glass, OZ: Umber-Etched Glass.
K	7003 NI, OZ	(2) 60W (M) ❖	13	4.5	Ⓜ (9-13W CFL) NI: Satin-Etched Glass, OZ: Light Umber-Etched Glass.

Measurements shown in inches. U.S. Patent Pending: H.



CEILING



A | 206 NI



B | 208 WH



E | 209 NI



A | 206 OZ



C | 8206 NI



E | 209 OZ



A | 206 WH



D | 210 WH



E | 209 WH

CEILING

ITEM #	FINISH	INCAND. BULB	W	H	NOTES
A 206	NI, OZ, WH	(1) 60W (M) ✓	7.5	5	☑ (9-13W CFL) White Glass.
B 208	WH	(1) 100W (M)	9.25	5	☑ (18-25W CFL) White Glass.
C 8206	NI	(1) 60W (M) ✓	7.5	5	☑ (13-15W CFL) Alabaster Swirl Glass.
D 210	WH	(2) 75W (M) ❖	12	6.75	White Glass.
E 209	NI, OZ, WH	(2) 60W (M) ❖	9.25	5	White Glass.

Measurements shown in inches.

CEILING & ENERGY EFFICIENT CEILING



A | 8209 NI



B | 8101 NI



B | 8101 WH



C | 8101 NIFL



C | 8101 WHFL



D | 8102 NI



D | 8102 WH



E | 8102 NIFL



E | 8102 WHFL



F | 8103 NI



F | 8103 WH



G | 8103 NIFL



G | 8103 WHFL

CEILING & ENERGY EFFICIENT

ITEM #	FLUOR. ITEM #	FINISH	INCAND. BULB	FLUOR. BULB	W	H	NOTES	
A	8209	NI	(2) 60W (M) ❖	---	9.25	5.5	Alabaster Swirl Glass.	
B	8101	NI, WH	(1) 60W (M) ❖	---	7.5	4.5	☑ (13-15W CFL) White Clip-On Glass.	
C	---	8101 NIFL, 8101 WHFL	NI, WH	---	(1) 13W (GU24) ✓	7.5	4.5	☑ (13-15W CFL) White Clip-On Glass.
D	8102	NI, WH	(2) 60W (M) ❖	---	9.25	5	☑ (13-15W CFL) White Clip-On Glass.	
E	---	8102 NIFL, 8102 WHFL	NI, WH	---	(2) 13W (GU24) ✓	9.25	5.25	☑ (13-15W CFL) White Clip-On Glass.
F	8103	NI, WH	(3) 60W (M) ❖	---	11.75	6.5	☑ (13-15W CFL) White Clip-On Glass.	
G	---	8103 NIFL, 8103 WHFL	NI, WH	---	(3) 13W (GU24) ❖	11.75	6.5	☑ (13-15W CFL) White Clip-On Glass.

Measurements shown in inches.



CEILING ENERGY EFFICIENT



White Linen
Fabric Trim Ring

A | 10885 NI
Santiago



B | 10886 NI
Santiago



White Vinyl
Laminate
Trim Ring with
Matte White
Acrylic Diffuser

C | 10803 BA
Pira™











D | 10804 BA
Pira™



Amber Linen
Fabric Shade

E | 10807 CP
Marbrisa™

ENERGY EFFICIENT CEILING

	FLUOR. ITEM #	FINISH	FLUOR. BULB	W	H	NOTES
A	10885	NI	(2) 13W (G24Q-1)  	13	4.25	
B	10886	NI	(3) 13W (G24Q-1)   	17.25	4.25	
C	10803	BA	(1) 40W (2C,G10Q) 	12	3.5	
D	10804	BA	(1) 55W (2C,G10Q) 	15	3.5	
E	10807	CP	(1) 55W (2C,G10Q) 	16.25	5.5	

Measurements shown in inches.



F | 10885 CP
Santiago



G | 10886 CP
Santiago



H | 10898 NI
Ara



J | 10899 NI
Ara



K | 10824 CP

ENERGY EFFICIENT CEILING

	FLUOR. ITEM #	FINISH	FLUOR. BULB	W	H	NOTES
F	10885	CP	(2) 13W (G24Q-1)	13	4.25	
G	10886	CP	(3) 13W (G24Q-1)	17.25	4.25	
H	10898	NI	(1) 70W (2C,G10Q)	20	8	Matte White Acrylic Diffuser.
J	10899	NI	(4) 26W (G24Q-3)	30	10	Matte White Acrylic Diffuser.
K	10824	CP	(3) 18W (GU24)	22	6.25	

Measurements shown in inches.



CEILING ENERGY EFFICIENT



A | 10308 WH



B | 10314 WH



White Linen
Acrylic Diffuser

C | 10847 OZ
Chella™

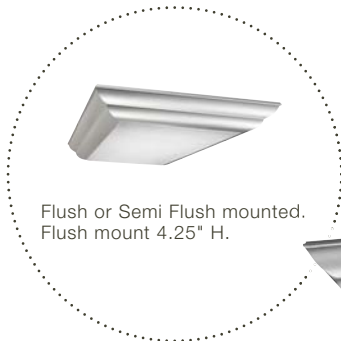

Flush or Semi Flush mounted.
Flush mount 4.25" H.

Gloss White
Acrylic Diffuser



C | 10847 SI
Chella™

ENERGY EFFICIENT CEILING

	FLUOR. ITEM #	FINISH	FLUOR. BULB	W	H	L	NOTES
A	10308	WH	(2) 32W (T8,G13)	15	4	52.5	Matte White Acrylic Diffuser.
B	10314	WH	(4) 32W (T8,G13)	20.5	4	52.5	Matte White Acrylic Diffuser.
C	10847	OZ, SI	(4) 32W (T8,G13)	20	11.5	54	

Measurements shown in inches.



Brushed Aluminum
with White
Vinyl Laminate

F | 10425 BA
Pira™



Matte White
Acrylic Diffuser

G | 10801 SI
Pavillion™



H | 10802 SI
Pavillion™

ENERGY EFFICIENT CEILING

	FLUOR. ITEM #	FINISH	FLUOR. BULB	W	H	L	NOTES
F	10425	BA	(2) 32W (T8,G13) ✦ T12	10.25	3.75	50	Ⓟ
G	10801	SI	(2) 32W (T8,G13) ✦ T12	11.25	5	52.25	Ⓟ
H	10802	SI	(4) 32W (T8,G13) ✦ T12	16.25	5	52.25	Ⓟ

Measurements shown in inches.



CEILING ENERGY EFFICIENT



B | 10304 WH



A | 10301 WH



C | 10303 WH



D | 10839 WH



E | 10838 WH

ENERGY EFFICIENT CEILING

	FLUOR. ITEM #	FINISH	FLUOR. BULB	W	H	L	NOTES
A	10301	WH	(2) 32W (T8,G13)	11.25	4.75	51.5	White Architectural Acrylic Diffuser.
B	10304	WH	(4) 17W (T8)	27.5	4.5	28.5	White Architectural Acrylic Diffuser.
C	10303	WH	(4) 32W (T8,G13)	16.75	5	51.5	White Architectural Acrylic Diffuser.
D	10839	WH	(2) 32W/40W (T9,G10Q)	19	3.5	19	White Acrylic Diffuser.
E	10838	WH	(2) 22W/32W (T9,G10Q)	14	3.25	14	White Acrylic Diffuser.

Measurements shown in inches.



F | 10699 WH



G | 10697 WH



H | 10698 WH



K | 10323 WH



J | 10322 WH



L | 10315 WH



M | 10889 WH



N | 10890 WH



O | 10891 WH

ENERGY EFFICIENT CEILING

FLUOR. ITEM #	FINISH	FLUOR. BULB	W	H	L	EXT.	HCWO	NOTES	
F	10699	WH	(2) 32W (T8,G13)	50.5	6	---	4.5	3	May be installed on the wall or ceiling vertically or horizontally.
G	10697	WH	(2) 17W (T8,G13)	26.5	6	---	4.5	3	May be installed on the wall or ceiling vertically or horizontally.
H	10698	WH	(2) 25W (T8,G13)	38.5	6	---	4.5	3	May be installed on the wall or ceiling vertically or horizontally.
J	10322	WH	(2) 32W (BIPI)	8.5	3.25	---	---	---	
K	10323	WH	(4) 32W (T8,G13)	13.5	3.25	48.75	---	---	Matte White Acrylic Diffuser.
L	10315	WH	(2) 32W (T8,G13)	9	3	48	---	---	Clear Prismatic Diffuser.
M	10889	WH	(1) 22W (T9,G10Q)	11.5	3	---	---	---	Matte White Acrylic Diffuser.
N	10890	WH	(2) 22W/32W (T9,G10Q)	14	3.25	---	---	---	Matte White Acrylic Diffuser.
O	10891	WH	(2) 22W/32W (T9,G10Q)	18	3.25	---	---	---	Matte White Acrylic Diffuser.

Measurements shown in inches.

LED WALL SCONCES

Form + Function

Kichler® LED Wall Sconces continue our tradition of design excellence and innovation with long-lasting, energy efficient LED technology. Emitting warm white, high-quality light, each fixture features:

Four LEDs for generous downlighting

Two LEDs to subtly illuminate etched beveled glass

Sleek 2.5" deep profile ideal for halls, foyers and entries

40,000 hours of life with little or no maintenance

Durable one-piece die-cast aluminum housing – no breakable bulbs!

Order Guide for Sconce & Glass Panel

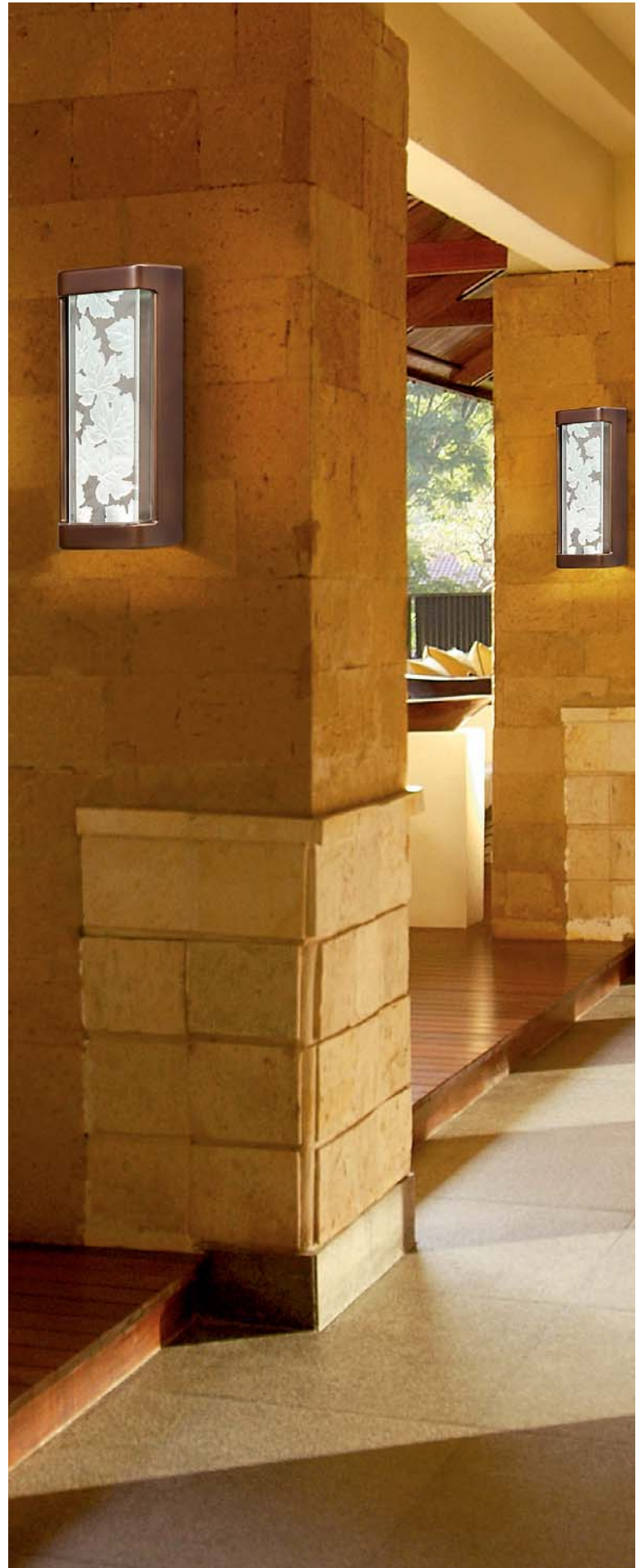
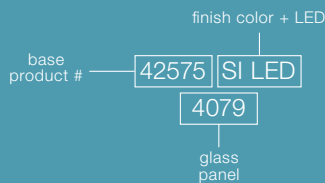

AVAILABLE IN **2** FINISHES + AVAILABLE IN **3** GLASS PANEL DESIGNS



A | **42575 SILED**
ADA Compliant



A | **42575 OZLED**
ADA Compliant



B | 4083



C | 4079



D | 4084



42575 SILED
Shown with
glass panel 4083



42575 OZLED
Shown with
glass panel 4079



42575 SILED
Shown with
glass panel 4084

	LED ITEM #	FINISH	LIGHT SOURCE	W	H	EXT.	HCWO	NOTES
A	42575 OZLED, 42575 SILED	OZ, SI	14.7W	7	14.25	2.5	7.25	ADA
B	4083	---	---	4.25	12	---	---	Glass thickness is .5".
C	4079	---	---	4.25	12	---	---	Glass thickness is .5".
D	4084	---	---	4.25	12	---	---	Glass thickness is .5".

Measurements shown in inches. U.S. & Canadian Patent Pending.



SEDO™ LED

ARCHITECTURAL BRONZE™, PLATINUM
OR SATIN BLACK FINISH



A | **49492 AZ**
Indoor/Outdoor Sconce
ADA Compliant



B | **49434 AZ**
Indoor/Outdoor Sconce
ADA Compliant



C | **49435 AZ**
Indoor/Outdoor Sconce
ADA Compliant



A | **49492 PL**
Indoor/Outdoor Sconce
ADA Compliant



B | **49434 PL**
Indoor/Outdoor Sconce
ADA Compliant



C | **49435 PL**
Indoor/Outdoor Sconce
ADA Compliant

LED OUTPUT

49434 AZ/PL/SBK	850 Lumens, 31 Watts 3000 Kelvin, CRI 83, 40K Life
49435 AZ/PL/SBK	850 Lumens, 31 Watts 3000 Kelvin, CRI 83, 40K Life
49492 AZ/PL/SBK	425 Lumens, 15 Watts 3000 Kelvin, CRI 83, 40K Life



A | **49492 SBK**
Indoor/Outdoor Sconce
ADA Compliant



B | **49434 SBK**
Indoor/Outdoor Sconce
ADA Compliant



C | **49435 SBK**
Indoor/Outdoor Sconce
ADA Compliant

SEDO™

	LED ITEM #	FINISH	LIGHT SOURCE	W	H	EXT.	HCWO	NOTES
A	49492	AZ, PL, SBK	16W	6	12.25	4	6.25	
B	49434	AZ, PL, SBK	39W	6	18.25	4	9	
C	49435	AZ, PL, SBK	39W	6	24.25	4	12	

Measurements shown in inches. U.S. & Canadian Patent Pending.

CESYA™ LED

ARCHITECTURAL BRONZE™, PLATINUM
OR SATIN BLACK FINISH



A | **49437 AZ**
Indoor/Outdoor Scence



B | **49436 AZ**
Indoor/Outdoor Scence



C | **49434 AZ**
Indoor/Outdoor Scence



A | **49437 PL**
Indoor/Outdoor Scence



B | **49436 PL**
Indoor/Outdoor Scence



C | **49434 PL**
Indoor/Outdoor Scence



A | **49436 PL**
Side View



A | **49437 SBK**
Indoor/Outdoor Scence



B | **49436 SBK**
Indoor/Outdoor Scence



C | **49434 SBK**
Indoor/Outdoor Scence

LED OUTPUT

49436 AZ/PL/SBK	708 Lumens, 25 Watts 3000 Kelvin, CRI 83, 40K Life
49437 AZ/PL/SBK	850 Lumens, 31 Watts 3000 Kelvin, CRI 83, 40K Life
49494 AZ/PL/SBK	425 Lumens, 15 Watts 3000 Kelvin, CRI 83, 40K Life

CESYA™

	LED ITEM #	FINISH	LIGHT SOURCE	W	H	EXT.	HCWO	NOTES
A	49437	AZ, PL, SBK	39W	6	24	4.75	12	
B	49436	AZ, PL, SBK	32.5W	6	18	4.75	9	
C	49494	AZ, PL, SBK	16W	6	12	4.75	6	

Measurements shown in inches. U.S. & Canadian Patent Pending.



WALL SCONCES



A | 6520 NI
11101 NI
ADA Compliant



A | 6520 TZ
ADA Compliant

Umber
Mist Glass



B | 6598 NI
11104 NI
Swiss Passport
ADA Compliant

Alabaster
Swirl Glass



C | 6521 NI
11102 NI
ADA Compliant



C | 6521 TZ
ADA Compliant



D | 6599 NI
11105 NI
Swiss Passport

WALL SCONCES

ITEM #	FLOUR. ITEM #	FINISH	INCAND. BULB	FLOUR. BULB	W	H	EXT.	HCWO	NOTES	
A	6520	11101	NI, TZ	(1) 75W (M)	(1) 18W (GU24)	6	8	4	4	ADA NI: Alabaster Swirl Glass, TZ: Umber Mist Glass.
B	6598	11104	NI	(1) 60W (M) ✓	(1) 18W (GU24) ✓	4.5	10.5	3.25	5.25	ADA
C	6521	11102	NI, TZ	(1) 100W (M) ✓	(1) 26W (GU24)	6	10	4	6	ADA NI: Alabaster Swirl Glass, TZ: Umber Mist Glass.
D	6599	---	NI	(2) 60W (M) ✓	---	5.25	14.25	4.25	7.25	ADA
D	---	11105	NI	---	(2) 13W (GU24) ✓	5.25	14.25	4.25	7.25	ADA

Measurements shown in inches.



E | 45224 AP
Leeds™
ADA Compliant



G | 49060 OZ
Ripley™
Indoor/Outdoor



E | 45224 SWZ
Leeds™
ADA Compliant



H | 49059 OZ
Ripley™
Indoor/Outdoor



F | 9044 NI, OB
Grenoble™
Indoor/Outdoor



J | 49061 OZ
Ripley™
Indoor/Outdoor

WALL SCONCES

	ITEM #	FINISH	INCAND. BULB	W	H	EXT.	HCWO	NOTES
E	45224	AP, SWZ	(1) 60W (C)	4.75	8.5	4	4.5	ADA
F	9044	NI, OB	(1) 150W (M)	11	8	11.5	2.5	G-type lamp recommended.
G	49060	OZ	(1) 40W (Type R) or (1) 60W (G-Type)	10	9	11.25	3	Dark sky compliant with use of R14, 40W bulb.
H	49059	OZ	(1) 40W (Type R) or (1) 60W (G-Type)	8	7.5	9.25	2.5	Dark sky compliant with use of R14, 40W bulb.
J	49061	OZ	(1) 40W (Type R) or (1) 60W (G-Type)	12	10	13	3.25	Dark sky compliant with use of R14, 40W bulb.

Measurements shown in inches. U.S. & Canadian Patent Pending: E, H, J, K.

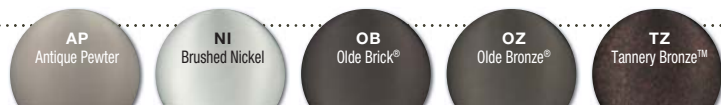

SCONCES

ENERGY EFFICIENT

Beige String Fabric Shade with Matte White Acrylic Diffuser



A | **10438 CPBG**
Santiago
ADA Compliant



B | **10439 CPBG**
Santiago
ADA Compliant

White Linen Fabric Shade with Matte White Acrylic Diffuser



A | **10438 NCH**
Santiago
ADA Compliant



B | **10439 NCH**
Santiago
ADA Compliant

ENERGY EFFICIENT SCONCES

	FLUOR. ITEM #	FINISH	FLUOR. BULB	W	H	EXT.	HCWO	NOTES
A	10438	CPBG, NCH	(1) 13W (G24Q-1)	5.5	14.25	3.75	5.25	ADA
B	10439	CPBG, NCH	(2) 13W (G24Q-1)	11	14.25	3.75	5.25	ADA

Measurements shown in inches.



C | **10630 PN**
Arcola
ADA Compliant



F | **10428 SN**
Virden™
ADA Compliant



D | **10479 PN**
ADA Compliant



Natural Linen
Fabric Shade
with Matte White
Acrylic Diffuser
E | **10421 SN**
Rigel
ADA Compliant

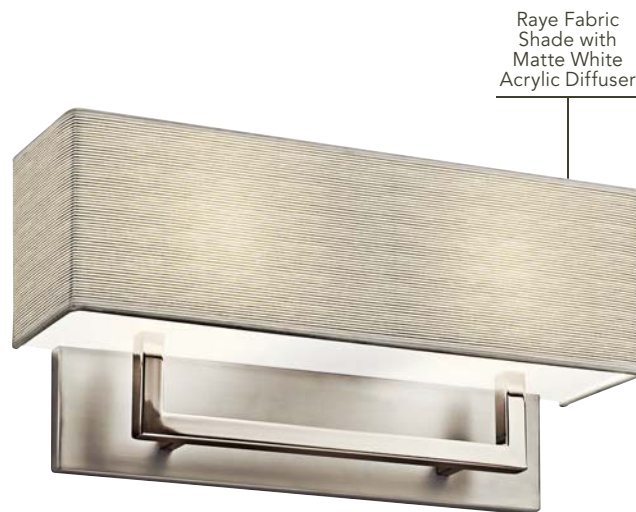

Raye Fabric
Shade with
Matte White
Acrylic Diffuser
G | **10696 SN**
ADA Compliant

ENERGY EFFICIENT SCONCES

	FLUOR. ITEM #	FINISH	FLUOR. BULB	W	H	EXT.	HCWO	NOTES
C	10630	PN	(1) 18W (GU24)	15	5.5	3.75	2.5	ADA
D	10479	PN	(2) 18W (GU24)	16.75	9.5	3.75	4.75	ADA
E	10421	SN	(1) 18W (GU24)	12	10	4	5	ADA
F	10428	SN	(1) 18W (GU24)	12	11	4	2.5	ADA
G	10696	SN	(2) 18W (GU24)	16.25	8.25	4	3	ADA

Measurements shown in inches.



SCONCES

ENERGY EFFICIENT

White Acrylic
Diffuser with Brushed
Nickel Accents



A | **10332 WH**
ADA Compliant

White Acrylic
Diffuser



B | **10333 WH**
ADA Compliant



C | **10656 RBZ**
Paramount™
ADA Compliant

Linen Shade
with Brown Trim



D | **10657 RBZ**
Paramount™
ADA Compliant

ENERGY EFFICIENT SCONCES

	FLUOR. ITEM #	FINISH	FLUOR. BULB	W	H	EXT.	HCWO	NOTES
A	10332	WH	(2) 18W (G24Q-2)	16	8	4	4	ADA
B	10333	WH	(2) 13W (G24Q-1)	16	8	3.5	3.25	ADA
C	10656	RBZ	(1) 18W (G24Q-2)	7.75	18.25	4	3.25	ADA
D	10657	RBZ	(2) 18W (G24Q-2)	13.75	18.25	4	3.25	ADA

Measurements shown in inches.



E | 10448 OZ
ADA Compliant

Opal White
Acrylic Diffuser



F | 10442 RBZ
Pierson™
ADA Compliant

White
Linen Glass



G | 10435 PN
Oveido
ADA Compliant

Satin-Etched
Cased Opal Glass



H | 10441 SI
Pavillion™
ADA Compliant

Matte White
Acrylic Diffuser



J | 10695 CH
ADA Compliant











Matte White
Acrylic Diffuser



K | 10417 NI
Eucia™
ADA Compliant

Matte White
Acrylic Diffuser

ENERGY EFFICIENT SCONCES

	FLUOR. ITEM #	FINISH	FLUOR. BULB	W	H	EXT.	HCWO	NOTES
E	10448	OZ	(1) 24W (G24Q-1)  	5	21	4	16	 ADA
F	10442	RBZ	(2) 13W (G24Q-1)  	14.25	10	4	3.25	 ADA
G	10435	PN	(1) 18W (G24Q-2) 	16	6.5	4	2.25	 ADA
H	10441	SI	(2) 13W (G24Q-1) 	12.5	11	4	5.75	 ADA
J	10695	CH	(1) 18W (G24Q-2) 	11.25	10	4	4	 ADA
K	10417	NI	(1) 36W (T5,2G11) 	8.25	26.25	3.75	7.5	 ADA

Measurements shown in inches.

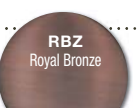

SCONCES

ENERGY EFFICIENT



Opal White Glass

A | 10402 NI
Adao™
ADA Compliant



Tinted Linen on Opal White Glass

A | 10402 OZ
Adao™
ADA Compliant



Clear Outside Glass with White Inside

B | 10654 BKN
Izona™
ADA Compliant



Linen Fabric Shade

C | 10679 AP
ADA Compliant



Clear-Etched Linear Glass

D | 10686 PN
Freeport™
ADA Compliant

ENERGY EFFICIENT SCONCES

	FLUOR. ITEM #	FINISH	FLUOR. BULB	W	H	EXT.	HCWO	NOTES
A	10402	NI, OZ	(1) 18W (GU24)	4.5	4.5	4	2.25	ADA
B	10654	BKN	(1) 18W (G24Q-2)	4.75	19.5	4	11	ADA
C	10679	AP	(1) 18W (GU24)	5	17.25	4	11	ADA
D	10686	PN	(1) 13W (GU24)	7	17	3.75	4.5	ADA

Measurements shown in inches.



E | 10461 NI
ADA Compliant



F | 10636 NI, OZ
Wedgeport™



G | 10685 NI
Verve™



H | 10481 PC
Jervis™
ADA Compliant



J | 10680 CH
ADA Compliant



K | 10604 NI, OZ
Telford™

ENERGY EFFICIENT SCONCES

	FLUOR. ITEM #	FINISH	FLUOR. BULB	W	H	EXT.	HCWO	NOTES
E	10461	NI	(1) 13W (GU24)	5	5	4	2.5	ADA
F	10636	NI, OZ	(1) 13W (GU24)	6.25	8	8	4.5	May be installed with glass up or down.
G	10685	NI	(1) 18W (GU24)	4.5	10.25	4.25	8	
H	10481	PC	(1) 18W (GU24)	4.5	14.25	4	7	ADA
J	10680	CH	(1) 18W (GU24)	5	12.5	4	10	ADA
K	10604	NI, OZ	(1) 13W (GU24)	7.5	12	9	6	

Measurements shown in inches.



SCONCES ENERGY EFFICIENT

White Acrylic Diffuser



A | **10640 AZ**
Newport™
ADA Compliant



A | **10640 NI**
Newport™
ADA Compliant



B | **10691 PN**
ADA Compliant

Matte White
Acrylic Diffuser



C | **10693 PN**
ADA Compliant

Opal White Glass
with Matte White
Acrylic Bottom
Diffuser



D | **10480 NI**

ENERGY EFFICIENT SCONCES

	FLUOR. ITEM #	FINISH	FLUOR. BULB	W	H	EXT.	HCWO	NOTES
A	10640	AZ, NI	(1) 18W (GU24)	9.25	10.25	3.75	5.25	Powder coated aluminum/polycarbonate construction.
B	10691	PN	(1) 36W (T5,2G11)	8.5	22.5	4	11.25	
C	10693	PN	(1) 18W (GU24)	5.75	12.5	4	6.25	
D	10480	NI	(2) 18W (GU24)	11.25	9.75	4.25	4	

Measurements shown in inches.



E | 10669 NI
ADA Compliant



E | 10669 OZ
ADA Compliant

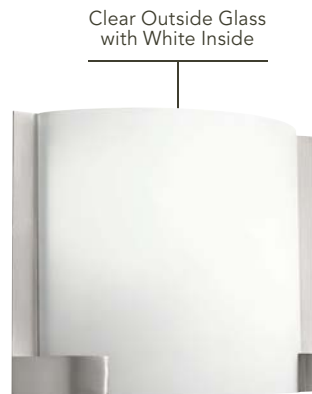

F | 10620 NI
Nobu™
ADA Compliant



G | 10670 NI
ADA Compliant



G | 10670 OZ
ADA Compliant



H | 10334 OZ, WH
ADA Compliant



J | 10453 NI
ADA Compliant

ENERGY EFFICIENT SCONCES

	FLUOR. ITEM #	FINISH	FLUOR. BULB	W	H	EXT.	HCWO	NOTES
E	10669	NI, OZ	(1) 18W (GU24)	5	10.5	4	5.25	NI: Satin Opal Glass. OZ: Amber Linen Glass.
F	10620	NI	(2) 13W (G24Q-1)	13	9.5	4	4.75	
G	10670	NI, OZ	(2) 13W (GU24)	5	16.5	4	8.25	OZ: Amber Linen Glass, NI: Satin Opal Glass.
H	10334	OZ, WH	(1) 18W (G-24Q-2)	8.75	10.75	4	5.25	
J	10453	NI	(2) 18W (GU24)	13.5	9.5	4	4	

Measurements shown in inches.



CUSTOM LIGHTING



A | 11115 BZT, MSI, TBK
ADA Compliant



B | 11116 BZT, TBK
ADA Compliant



C | 11117 BZT, TBK
ADA Compliant



D | 11118 BZT, TBK



E | 11119 BZT, TBK



F | 10747 BZT, MSI
ADA Compliant



G | 10748 BZT, MSI
ADA Compliant



H | 10726 WH



J | 10756 WH



K | 10731 WH

CUSTOM LIGHTING

	FLUOR. ITEM #	FINISH	FLUOR. BULB	W	H	EXT.	HCWO	NOTES
A	11115	BZT, MSI, TBK	(2) 27W (2G11)	12.75	19.75	4	10	ADA
B	11116	BZT, TBK	(2) 13W (G24Q-1)	11.5	15.25	4	7.75	ADA
C	11117	BZT, TBK	(2) 26W (G24Q-3)	11.5	15.25	4	7.75	ADA
D	11118	BZT, TBK	(2) 24W (2G11)	9	21.25	5.5	10.5	
E	11119	BZT, TBK	(2) 36W (2G11)	9	21.25	5.5	10.5	
F	10747	BZT, MSI	(2) 13W (G24Q-1)	10	11	4	5.5	ADA
G	10748	BZT, MSI	(2) 26W (G24Q-3)	10	11	4	5.5	ADA
H	10726	WH	(2) 26W (G24Q-3)	14	14	3.5	7	ADA May be ceiling or wall mounted.
J	10756	WH	(2) 26W (G24Q-3)	19	19	4	8	ADA May be ceiling or wall mounted.
K	10731	WH	(2) 32W (T8, G13)	51	9.5	4	4.25	ADA May be ceiling or wall mounted.

Measurements shown in inches.



M | 10732 MSI
ADA Compliant



N | 11125 MSI
LED
ADA Compliant



O | 10749 MSI
ADA Compliant



P | 10750 MSI
ADA Compliant



Q | 11120 BZT, TBK
LED



R | 11122 BZT, TBK
LED



S | 11121 BZT, TBK
LED



T | 11123 BK, WH
ADA Compliant



U | 10759 NI
LED
ADA Compliant



V | 10758 WH
LED
ADA Compliant

LED OUTPUT

10758 WH	1102 Lumens, 12.5 Watts 3500 Kelvin, CRI 80, 50K Life
10759 SI	772 Lumens, 12.5 Watts 3500 Kelvin, CRI 80, 50K Life
11120 BZT/TBK	1410 Lumens, 26 Watts 3000 Kelvin, CRI 80, 40K Life
11121 BZT/TBK	940 Lumens, 23 Watts 3000 Kelvin, CRI 80, 40K Life
11122 BZT/TBK	1410 Lumens, 27 Watts 3000 Kelvin, CRI 80, 40K Life
11125 BZT/TBK	1430 Lumens, 14 Watts 3500 Kelvin, CRI 80, 40K Life

CUSTOM LIGHTING

	FLUOR. ITEM #	LED ITEM #	FINISH	FLUOR. BULB	LIGHT SOURCE	W	H	EXT.	HCWO	NOTES
M	10732	---	MSI	(2) 26W (G24Q-3)	---	7	16.5	4	8.25	
N	---	11125	MSI	---	6W	7	16.5	4	6.25	
O	10749	---	MSI	(2) 13W (G24Q-1)	---	9	18.5	4	9	
P	10750	---	MSI	(2) 26W (G24Q-3)	---	9	18.5	4	9	
Q	---	11120	BZT, TBK	---	40W	11.5	6.5	6.5	3.25	
R	---	11122	BZT, TBK	---	40W	13	6.75	7.25	3.5	
S	---	11121	BZT, TBK	---	40W	18	7	10	3.5	
T	11123	---	BK, WH	(2) 13W (G24Q-1)	---	10.5	10.5	2	5.25	May be ceiling or wall mounted.
U	---	10759	NI	---	12.5W	14.75	14.75	3.75	7.5	May be ceiling or wall mounted.
V	---	10758	WH	---	12.5W	11	11	3.25	5.5	May be ceiling or wall mounted.

Measurements shown in inches.



MIRRORS

REFLECTIVE & BEAUTIFUL

It's a secret interior designers often use: add a mirror to a room to fill it with reflected light. And no one knows lighting better than Kichler. Our abundance of Mirror choices helps you not only reflect the light (as well as your style), but also allows you to coordinate flawlessly with the other accessories in your room. From unique finishes to a plethora of shapes and sizes, you'll discover a Kichler® Mirror that enhances your room with brilliant style and substance.





Lens Beveled Mirror 78143 | Page 456

MIRRORS

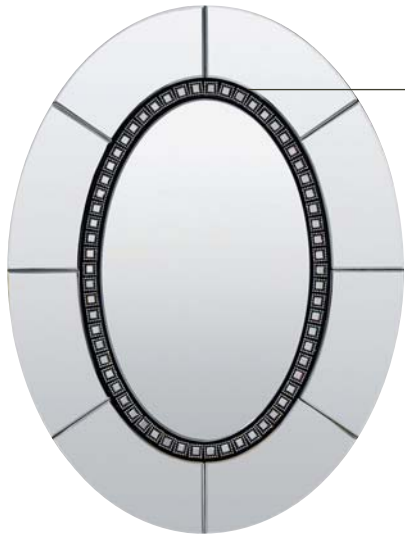

Laser-Cut Mirror Frame with Black Accent and Mirrored Jewel Details

A | 78218 Lorelei™



Clear Mirror Frame with Pearl Bevel

B | 78225 Ribbon



Laser-Cut Mirror Frame

C | 78226 Gretchen



Clear Mirror Frame with Decorative Etching

D | 78229 Sophia

MIRRORS

ITEM #	W	H	MIRROR SIZE	EXT.	NOTES
A 78218	30	40	16.75 x 26	1.5	Lorelei™ Mirror. Mirror Frame with Black Accent and Mirrored Jewel Details. Mounts horizontal or vertical.
B 78225	24	30	16 x 22	.75	Ribbon Beveled Mirror. Clear Mirror Frame with Pearl Bevel. Mounts horizontal or vertical.
C 78226	34	46	23.25 x 35.25	1	Gretchen Mirror. Laser-Cut Mirror Frame with Beveled Mirror Trim. Mounts horizontal or vertical.
D 78229	28	34	19 x 25	.75	Sophia Beveled Mirror. Clear Mirror Frame with Decorative Etching. Mounts horizontal or vertical.

Measurements shown in inches. U.S. & Canadian Patent Pending: D.



E | 78219 Stormy™

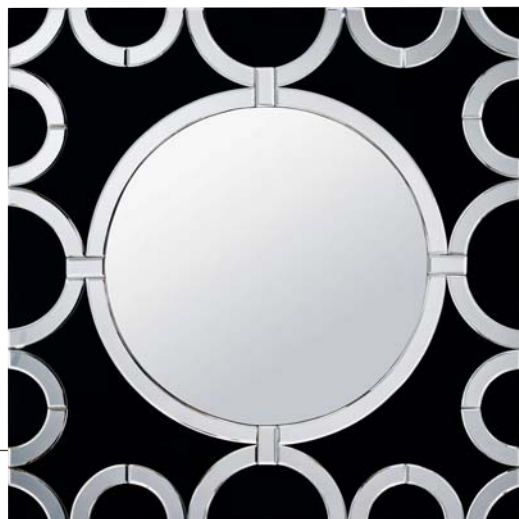

F | 78227 Braxton



G | 78168 Powell



H | 78164 Cutting Edge

MIRRORS

	ITEM #	W	H	MIRROR SIZE	EXT.	NOTES
E	78219	27	37.25	16 x 27.5	1	Stormy™ Mirror. Clear, Gray and Black Glass Frame. Mounts horizontal or vertical.
F	78227	36	36	22 (Dia.)	1.25	Braxton Mirror. Matte Black Frame with Beveled Mirror Accents. Mounts horizontal or diagonal.
G	78168	32	32	19.25 (Dia.)	.75	Powell Beveled Mirror. Beveled Mirror Frame.
H	78164	36.25	46.25	20 x 30	1	Cutting Edge Beveled Mirror. Matte Black and Beveled Mirror Frame. Mounts horizontal or vertical.

Measurements shown in inches.

MIRRORS



A | 78184
Rikrak

Clear and Cocoa Taupe
Beveled Mirror Frame



Distressed Silver Metal Frame

B | 78212
Nogaro™



Clear and Cocoa Taupe
Beveled Mirror Frame

C | 78139
Lydia™

MIRRORS

	ITEM #	W	H	MIRROR SIZE	EXT.	NOTES
A	78184	32	70	22 x 60	.75	Rikrak Beveled Mirror. Clear and Cocoa Taupe Beveled Mirror Frame. Mounts horizontal or vertical.
B	78212	35	37.5	16 (Dia.)	1.75	Nogaro™ Beveled Mirror. Distressed Silver Metal Frame.
C	78139	32.5	41.75	19.5 x 28.5	.75	Lydia™ Beveled Mirror. Clear and Cocoa Taupe Beveled Mirror Frame. Mounts horizontal or vertical.

Measurements shown in inches.

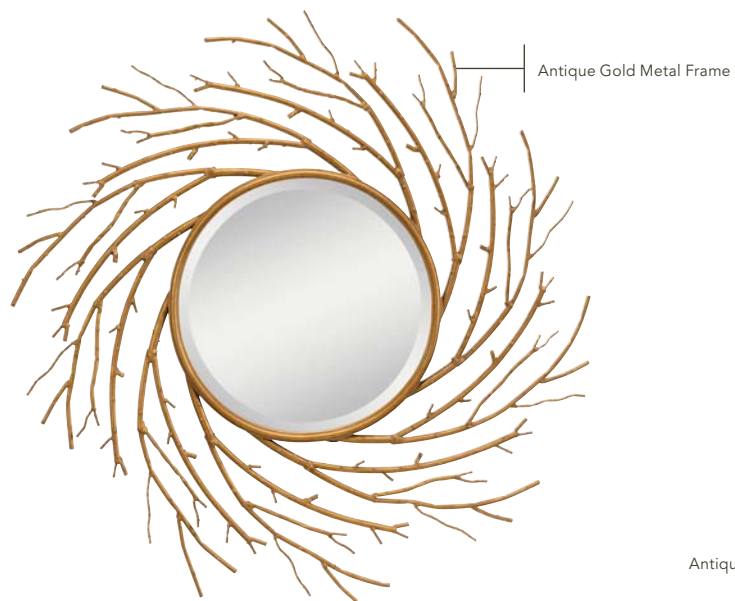

D | 78214
Kayla



E | 78213
Marlowe

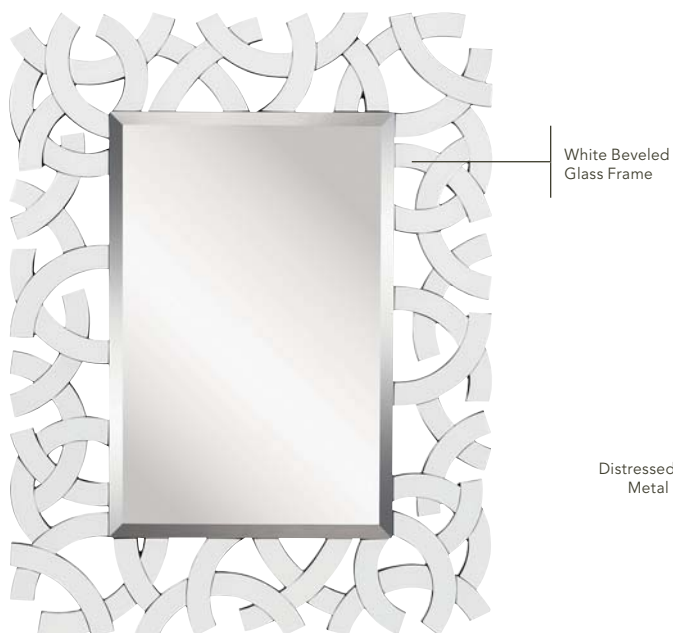

F | 78207
Zeeba™

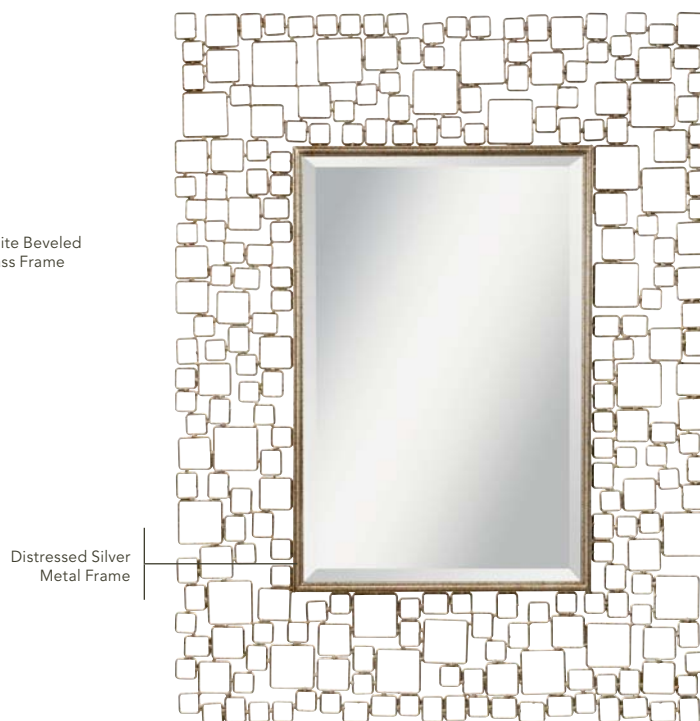

G | 78211
Kubica™

MIRRORS

	ITEM #	W	H	MIRROR SIZE	EXT.	NOTES
D	78214	42	42	17 (Dia.)	2.25	Kayla Beveled Mirror. Antique Gold Metal Frame.
E	78213	28	36	14.75 x 22.75	1.25	Marlowe Beveled Mirror. Antique Gold Metal Frame.
F	78207	34	44	20 x 30	1	Zeeba™ Beveled Mirror. White Beveled Glass Frame. Mounts horizontal or vertical.
G	78211	36	48	18.5 x 28.5	1.25	Kubica™ Beveled Mirror. Distressed Silver Metal Frame. Mounts horizontal or vertical.

Measurements shown in inches.

MIRRORS

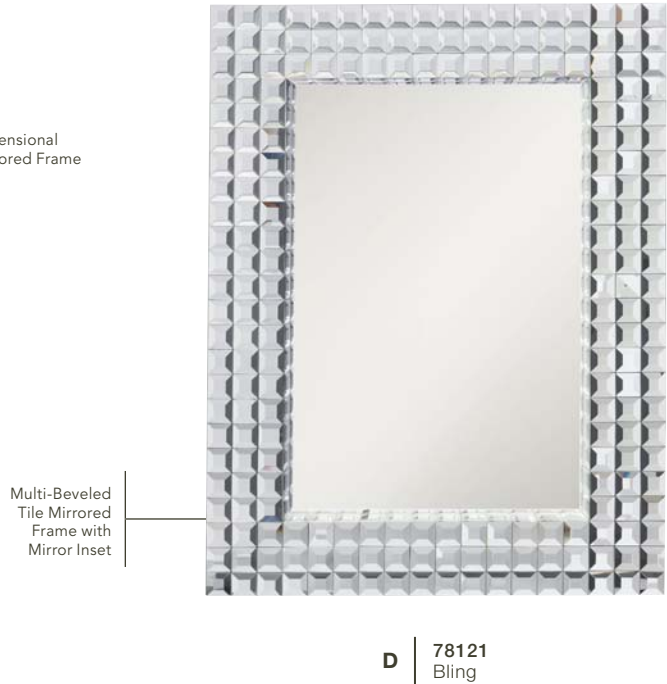
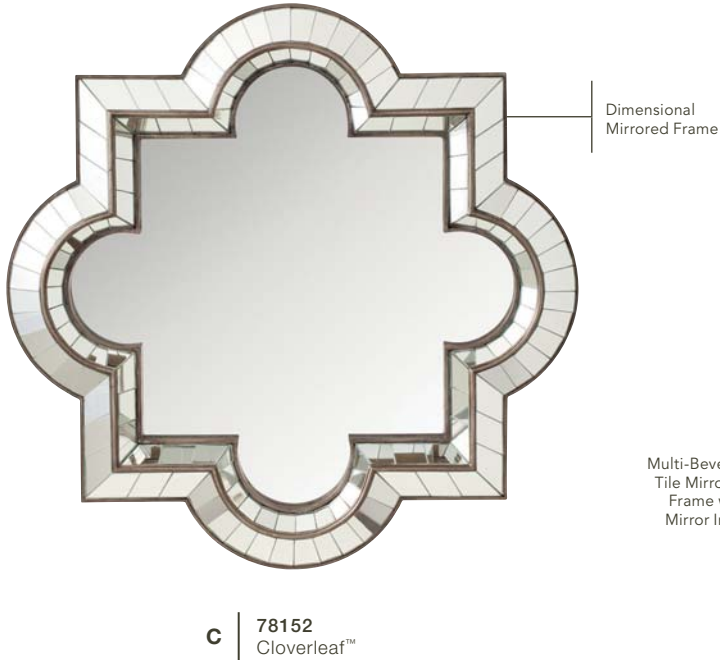
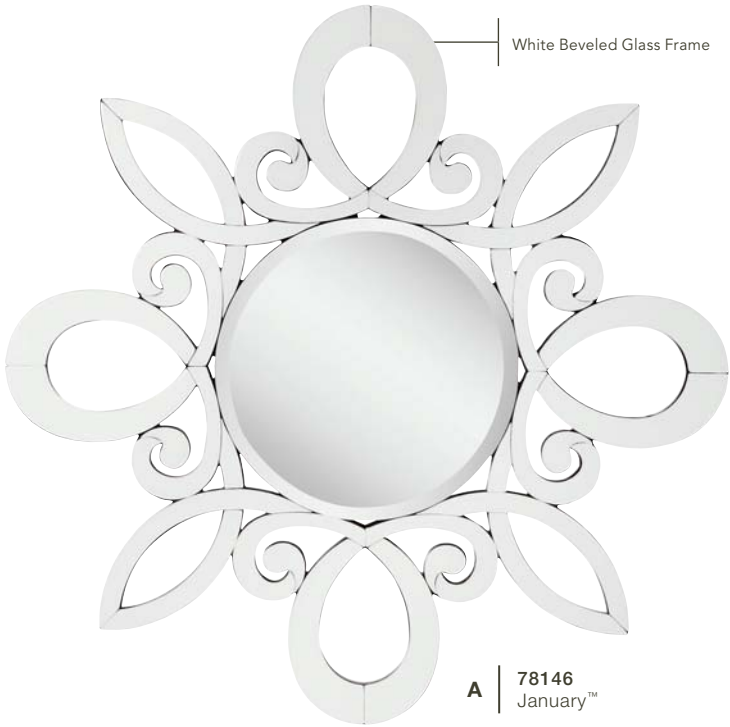

MIRRORS

ITEM #	W	H	MIRROR SIZE	EXT.	NOTES	
A	78146	47.25	47.25	20 (Dia.)	.75	January™ Beveled Mirror. White Beveled Glass Frame.
B	78228	32	32	17.75 (Dia.)	2	Goldsmith™ Beveled Mirror. Gold Antique Mirror Frame.
C	78152	36	36	28.5 x 28.5	3.25	Cloverleaf™ Mirror. Mirrored Frame.
D	78121	28.5	38	19 x 28.5	2.25	Bling Mirror. Multi Beveled Tile Mirrored Frame with Mirror Inset. Mounts horizontal or vertical.

Measurements shown in inches.



E | 78163
Gibraltar™



F | 78148
Teardrop

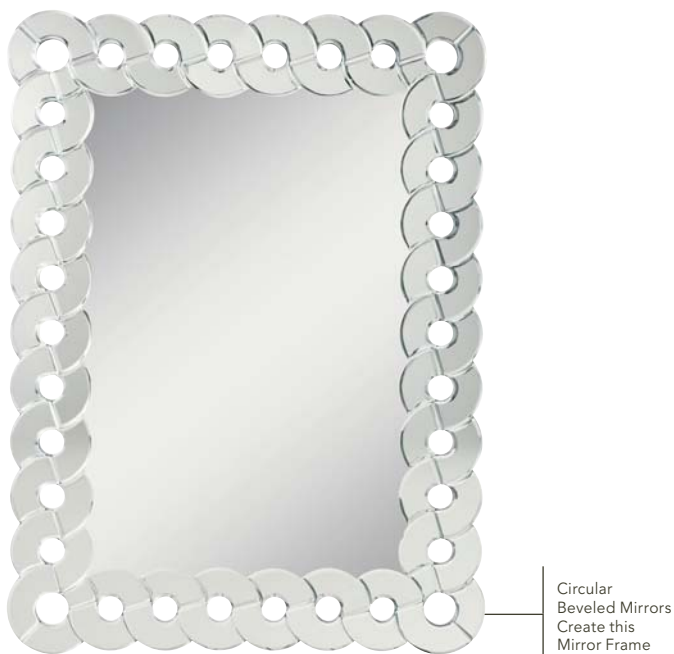

G | 78138
Orbitz



H | 78217
Chelle™

MIRRORS

	ITEM #	W	H	MIRROR SIZE	EXT.	NOTES
E	78163	30	40	17.5 x 27.5	1.75	Gibraltar™ Mirror. Dimensional Beveled Mirrored Frame. Mounts horizontal or vertical.
F	78148	35	35	18.5 (Dia.)	.75	Teardrop Mirror. Mirror Insets in a Distressed Silver Leaf Frame.
G	78138	30.25	40.5	20.5 x 30.75	.5	Orbitz Mirror. Beveled Mirror Frame. Mounts horizontal or vertical.
H	78217	29.5	38.5	19 x 28	3	Chelle™ Beveled Mirror. Beveled Mirror Frame with Shell Inlay. Mounts horizontal or vertical.

Measurements shown in inches.

MIRRORS



Crushed Glass and Brushed Silver Frame

A | 78220
Ice



Beveled Mirror Frame

B | 78190
Asher™

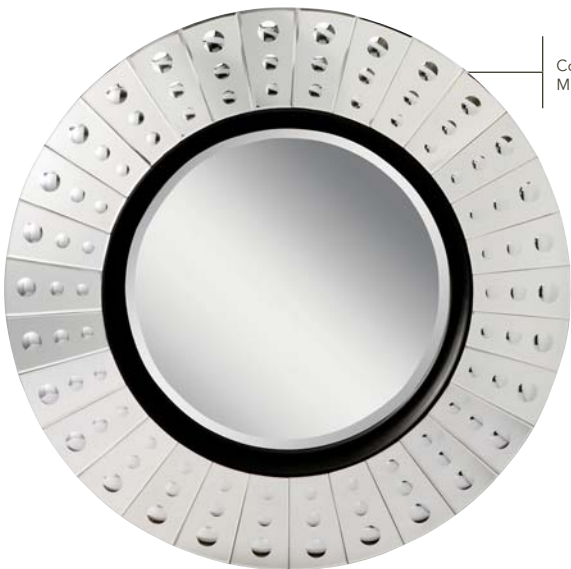

Convex Beveled Mirror Frame

C | 78143
Lens



Beveled Mirror Frame

D | 78210
Xana™

MIRRORS

ITEM #	W	H	MIRROR SIZE	EXT.	NOTES	
A	78220	30	40	20 x 30	0.75	Ice Beveled Mirror. Crushed Glass with Brushed Silver Frame. Mounts horizontal or vertical.
B	78190	26	38	22 x 32.5	1.5	Asher™ Mirror. Clear Beveled Mirror Frame. Mounts horizontal or vertical.
C	78143	42	42	23.75 (Dia.)	2	Lens Beveled Mirror. Convex Beveled Mirrored Frame.
D	78210	32	48	17.25 x 34.75	1.5	Xana™ Beveled Mirror. Beveled Mirror Frame. Mounts horizontal or vertical.

Measurements shown in inches.



E | 78167
Glimmer



F | 78204
Glance™

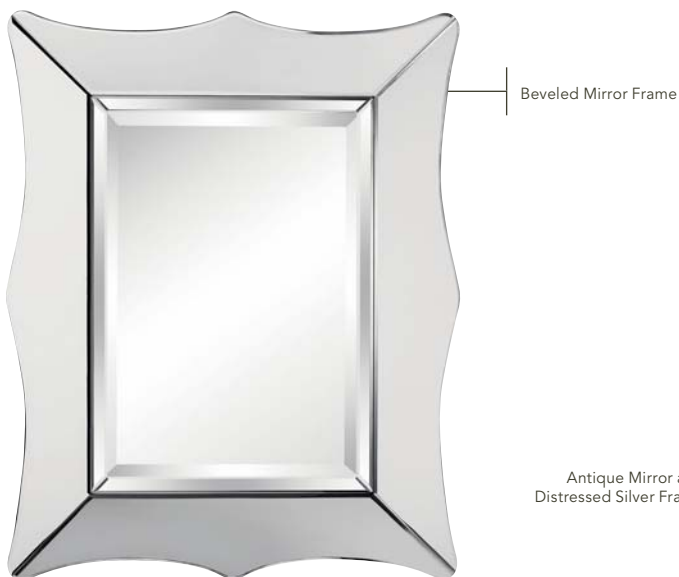

G | 78215
Calista™



H | 78205
Hayworth

MIRRORS

	ITEM #	W	H	MIRROR SIZE	EXT.	NOTES
E	78167	30	30	20 (Dia.)	1.5	Glimmer Beveled Mirror. Beveled Mirror Tile Frame.
F	78204	23.75	31.5	17.5 x 25.25	0.75	Glance™ Beveled Mirror. Beveled Mirror Frame. Mounts horizontal or vertical.
G	78215	31.5	39.5	17.25 x 25.25	2	Calista™ Beveled Mirror. Beveled Mirror Frame. Mounts horizontal or vertical.
H	78205	25	38	17 x 30	1	Hayworth Beveled Mirror. Antique Mirror and Distressed Silver Frame. Mounts horizontal and vertical.

Measurements shown in inches.

MIRRORS



Beveled Mirror and Light Champagne Silver Frame

A | 78209
Zoar™



Aged Copper Bronze Metal Frame

B | 78177
Sunset



C | 78216
Lunar
Shown horizontal

Distressed Silver Frame



78216 Shown vertical

MIRRORS

	ITEM #	W	H	MIRROR SIZE	EXT.	NOTES
A	78209	36.5	36.5	20 (Dia.)	.75	Zoar™ Beveled Mirror. Beveled Mirror and Light Champagne Silver Frame.
B	78177	30.25	30	10.25 (Dia.)	1	Sunset Mirror. Aged Copper Bronze Metal Frame.
C	78216	42	24	---	2	Lunar 3-Piece Mirror. Distressed Silver Frame. Mounts horizontal or vertical.

Measurements shown in inches. U.S. & Canadian Patent Pending; C.



Hammered Metal
Antique Pewter Frame



D | 78223 BZ
Missoula™

D | 78223 AP
Missoula™



Aged Copper Bronze
Metal Frame

E | 78193
Sunset II

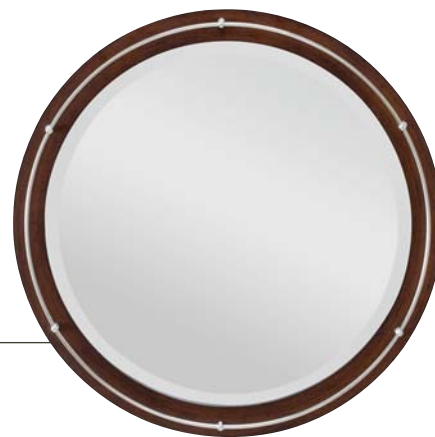

Distressed Brown Frame
with Polished Chrome
Gallery Ring

F | 78181
Stowaway™

MIRRORS

ITEM #	FINISH	W	H	MIRROR SIZE	EXT.	NOTES
D	78223 BZ	28.25	39.5	16.5 x 27.5	1	Missoula™ Beveled Mirror. Hammered Metal Bronze Frame. Mounts horizontal or vertical.
D	78223 AP	28.25	39.5	16.5 x 27.5	1	Missoula™ Beveled Mirror. Hammered Metal Antique Pewter Frame. Mounts horizontal or vertical.
E	78193 ---	40	40	21.5 (Dia.)	2.25	Sunset II Beveled Mirror. Aged Copper Bronze Metal Frame.
F	78181 ---	26	26	22 (Dia.)	2.5	Stowaway™ Beveled Mirror. Distressed Brown Frame with Polished Chrome Gallery Ring.

Measurements shown in inches.

MIRRORS



A | 78187
Ridan™



Olde Bronze® Metal Frame

B | 78248
Loom

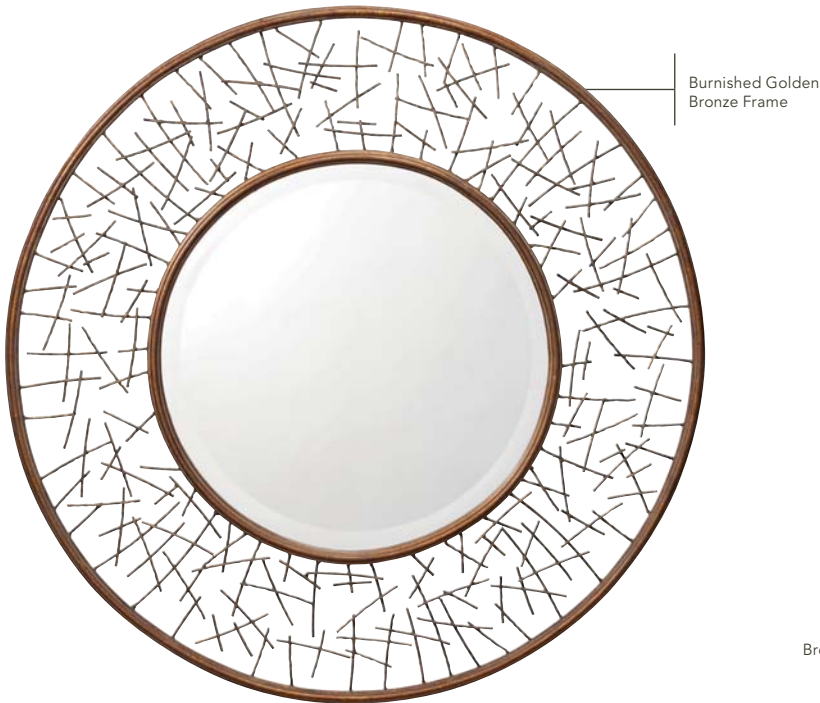

Burnished Golden
Bronze Frame

C | 78170
Twigs



Brown Textured Frame
with Gold Rub

D | 78151
Raleigh™

MIRRORS

ITEM #	W	H	MIRROR SIZE	EXT.	NOTES
A 78187	30	30	22 x 22	2.25	Ridan™ Mirror. Distressed Brown Frame with Copper Undertones. Mounts square or diagonal.
B 78248	27.75	37.75	20 x 29	.5	Loom Mirror. Olde Bronze® Metal Frame. Mounts horizontal or vertical.
C 78170	39	39	23 (Dia.)	1.5	Twigs Beveled Mirror. Burnished Golden Bronze Frame.
D 78151	23.75	38	17.75 x 31.75	1.25	Raleigh™ Oval Beveled Mirror. Brown Textured Frame with Gold Rub. Mounts horizontal or vertical.

Measurements shown in inches.



Golden Brown Crackle Glass and Matte Black Frame

E | 78176
Flicker™



Cocoa Taupe Beveled Mirrors and Burnished Golden Brown Frame

F | 78178
Arcade



Burnished Golden Metal Frame

G | 78162
Etiquette™



Antique Silver Frame with Burnished Bronze Highlights

H | 78161
Quill™
Shown horizontal

MIRRORS

	ITEM #	W	H	MIRROR SIZE	EXT.	NOTES
E	78176	31.5	43.5	23.25 x 35.25	2	Flicker™ Beveled Mirror. Golden Brown Crackle Glass and Matte Black Frame. Mounts horizontal or vertical.
F	78178	31.5	39.5	14.75 x 23.75	1	Arcade Beveled Mirror. Cocoa Taupe Beveled Mirrors and Burnished Golden Brown Frame. Mounts horizontal or vertical.
G	78162	20	36	18 x 34	1.5	Etiquette™ Mirror. Burnished Golden Metal Frame.
H	78161	35	47	23.5 x 35.5	2.5	Quill™ Beveled Mirror. Antique Silver Frame with Burnished Bronze Highlights. Mounts horizontal or vertical.

Measurements shown in inches.

MIRRORS

ILLUMINATED MIRRORS

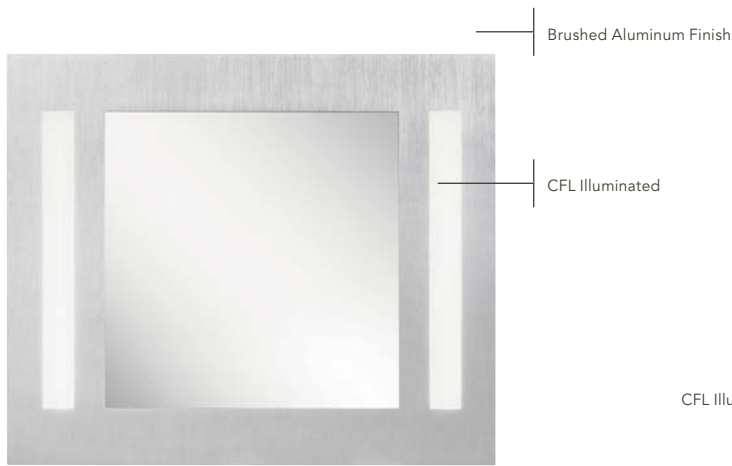

A | 78203

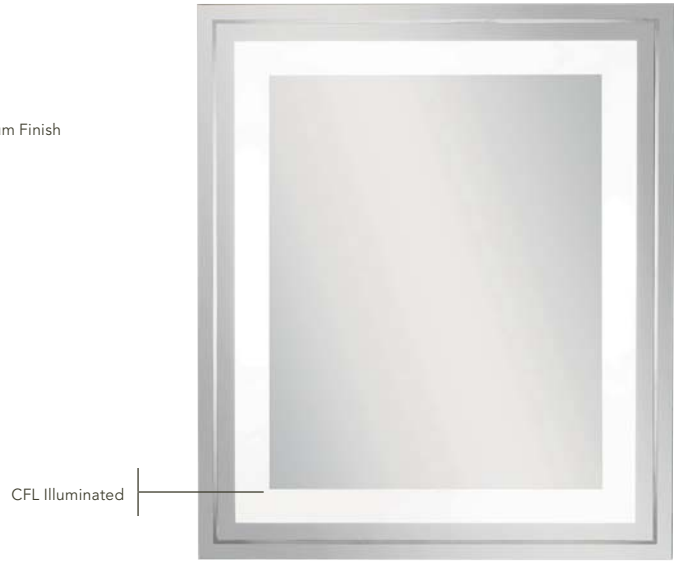

B | 78201

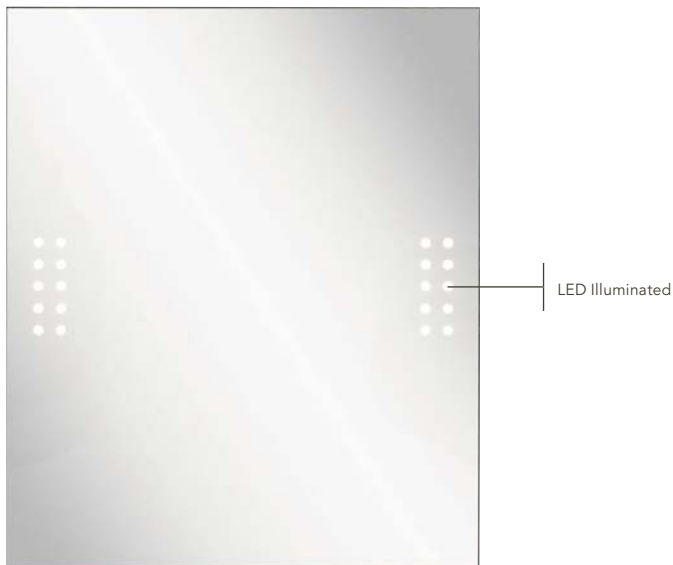

C | 78202

MIRRORS

	ITEM #	W	H	MIRROR SIZE	EXT.	NOTES
A	78203	31.5	26.5	19.25 x 19	2.25	D F Anodized Brushed Aluminum Frame. Fixture: (2) 14W CFL Bulbs, 2700K.
B	78201	28	33	---	2.25	D G Clear Mirror with Etched Glass. Fixture: (1) 40W CFL Bulb, 2700K.
C	78202	28	33	---	1.75	D Clear Mirror with Etched Glass. Fixture: (20) 0.1 W LED's, 3000K.

Measurements shown in inches.

MIRRORS



Antique Pewter Frame

A | 78198 AP Mahoney™



Mission Bronze Frame

Chrome Frame

A | 78198 CH Mahoney™



A | 78198 MIZ Mahoney™



Chrome Frame with White Porcelain Accents

B | 41067 CH Pocolona™



CH
Chrome



OZ
Olde Bronze®



C | 41006 CH, OZ

MIRRORS

	ITEM #	FINISH	W	H	MIRROR SIZE	EXT.	NOTES
A	78198	AP, CH, MIZ	21.5	37.25	20 x 32	0.75	Mahoney™ Beveled Mirror. Antique Pewter, Chrome or Mission Bronze Metal Frame. Mounts horizontal or vertical.
B	41067	CH	24	30	19.75 x 25.75	2.25	Pocolona™ Oval Beveled Mirror. Chrome Frame with White Porcelain Accents. Mounts horizontal or vertical.
C	41006	CH, OZ	24	30	22 x 28	1.5	Chrome or Olde Bronze® Frame. Mounts horizontal or vertical.

Measurements shown in inches.

MIRRORS



A | 41071 NI, OZ
Hendrik™

B | 41096 NI, OZ
Eileen™



C | 78160
Silver Scallop™

D | 41046 NI, TZ
Silverton™

MIRRORS

	ITEM #	FINISH	W	H	MIRROR SIZE	EXT.	NOTES
A	41071	NI, OZ	24	30	20.25 x 26.25	1	Hendrik™ Beveled Mirror. Brushed Nickel or Olde Bronze® Frame.
B	41096	NI, OZ	26.5	39	22 x 34.25	1	Eileen™ Beveled Mirror. Brushed Nickel or Olde Bronze® Frame.
C	78160	---	34	34	32.25 x 32.25	1.5	Silver Scallop™ Mirror. Distressed Antique Silver Frame.
D	41046	NI, TZ	24	33	22 x 31	1.25	Silverton™ Beveled Mirror. Brushed Nickel or Tannery Bronze™ Frame. Mounts horizontal or vertical.

Measurements shown in inches.

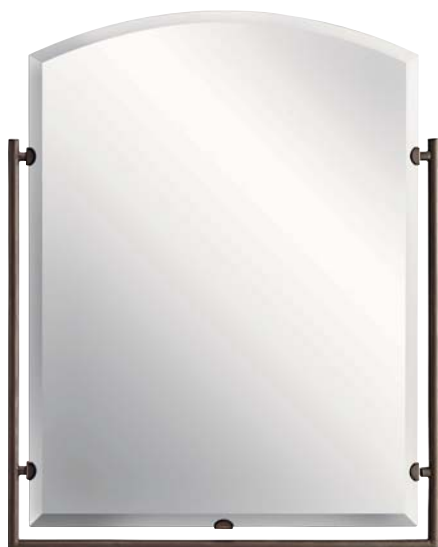

D | 41056 NI, OZ Structures™



E | 41011 CH, DBK, NI, OZ



F | 41055 AP, OLZ Polygon™

MIRRORS

	ITEM #	FINISH	W	H	MIRROR SIZE	EXT.	NOTES
D	41056	NI, OZ	24	30	21.75 x 28.75	.75	Structures™ Beveled Mirror. Brushed Nickel or Olde Bronze® Frame.
E	41011	CH, DBK, NI, OZ	24	30	20 x 26.25	1.5	Beveled Mirror. Chrome, Distressed Black, Brushed Nickel or Olde Bronze® Frame. Mounts horizontal or vertical.
F	41055	AP, OLZ	24.25	32	22 x 32	1.5	Polygon™ Beveled Mirror. Antique Pewter or Oiled Bronze Frame.

Measurements shown in inches.

BATH & VANITY

FRESH & CLEAN

Whether it's the a.m. rush or the p.m. wind-down, your bathrooms are your privacy spaces. Why not illuminate it with a style that suits you? From urban styles to floral-inspired collections to traditional looks, our Bath & Vanity Collection has a lighting family ready to complement your tastes. Choose streamlined or embellished profiles, glistening crystal silhouettes or rich matte black options. Each offers a seemingly endless choice of ambient, task, accent and decorative lighting that allows you to enjoy all the chaos of life in beautiful style.





COMO™

POLISHED CHROME FINISH WITH
INNER ETCHED GLASS SHADES AND
CLEAR OUTER GLASS PANEL

Clear Outer
Glass Panel



A | 45170 CH
Wall Sconce
NOT TO SCALE



B | 45171 CH



C | 45172 CH



D | 45173 CH

COMO™

ITEM #	FINISH	INCAND. BULB	W	H	EXT.	HCWO	NOTES
A	CH	(1) 50W (G9)	8	5.5	4.5	3	Halogen light source. May be installed with glass up or down.
B	CH	(2) 50W (G9)	15.75	5.5	4.5	2.5	Halogen light source. May be installed with glass up or down.
C	CH	(3) 50W (G9)	21.75	5.5	4.5	2.5	Halogen light source. May be installed with glass up or down.
D	CH	(4) 50W (G9)	27.75	5.5	4.5	2.5	Halogen light source. May be installed with glass up or down.

Measurements shown in inches. U.S. & Canadian Patent Pending.

SELENE™

BRUSHED NICKEL FINISH WITH SATIN-ETCHED CASED OPAL GLASS



A | 45432 NI



B | 45433 NI



C | 45434 NI



D | 45431 NI
Wall Sconce
NOT TO SCALE

SELENE™

	ITEM #	FINISH	INCAND. BULB	W	H	EXT.	HCWO	NOTES
A	45432	NI	(2) 50W (G9)	16	5.25	5.25	2.5	Halogen light source.
B	45433	NI	(3) 50W (G9)	24	5.25	5.25	2.5	Halogen light source.
C	45434	NI	(4) 50W (G9)	32.25	5.25	5.25	2.5	Halogen light source.
D	45431	NI	(1) 100W (M)	7.5	9.25	5.5	4.25	(23-30W CFL)

Measurements shown in inches. U.S. & Canadian Patent Pending.

TULLY™

ANTIQUE PEWTER FINISH WITH
SATIN-ETCHED CASSED OPAL GLASS



A | 45149 AP
Wall Sconce
NOT TO SCALE



B | 45150 AP



C | 45151 AP



D | 45152 AP

TULLY™

ITEM #	FINISH	INCAND. BULB	W	H	EXT.	HCWO	NOTES
A	AP	(1) 100W (M)	5	6.5	6.75	4	ⓓ (18-25W CFL) May be installed with glass up or down.
B	AP	(2) 100W (M)	15	6.5	6.75	4	ⓓ (18-25W CFL) May be installed with glass up or down.
C	AP	(3) 100W (M)	24	6.5	6.75	4	ⓓ (18-25W CFL) May be installed with glass up or down.
D	AP	(4) 100W (M)	32	6.5	6.75	4	ⓓ (18-25W CFL) May be installed with glass up or down.

Measurements shown in inches. U.S. & Canadian Patent Pending

URBAN ICE™

ANTIQUE PEWTER FINISH AND CLEAR POLISHED EXTERIOR GLASS WITH INSIDE ETCH OR OLDE BRONZE® FINISH AND CLEAR POLISHED EXTERIOR GLASS WITH INSIDE UMBER ETCH

Clear Polished Exterior Glass with Inside Etch



A | 5460 AP, OZ



B | 5461 AP, OZ



Clear Polished Exterior Glass with Inside Umber Etch

D | 5459 AP, OZ
Wall Sconce
NOT TO SCALE



C | 5462 AP, OZ

MATCHING MIRROR

41011 OZ
See page 465 or kichler.com.



URBAN ICE™

	ITEM #	FINISH	INCAND. BULB	W	H	EXT.	HCWO	NOTES
A	5460	AP, OZ	(2) 100W (M)	12.5	6.25	6.75	3.25	Ⓧ May be installed with glass up or down.
B	5461	AP, OZ	(3) 100W (M)	19.5	6.25	6.75	3	Ⓧ May be installed with glass up or down.
C	5462	AP, OZ	(4) 100W (M)	26.75	6.25	6.75	3	Ⓧ May be installed with glass up or down.
D	5459	AP, OZ	(1) 100W (M)	4.5	8	6.75	4	Ⓧ May be installed with glass up or down.

Measurements shown in inches.



CRESCENT VIEW™

BRUSHED NICKEL FINISH WITH
SATIN-ETCHED CASED OPAL GLASS



A | 45217 NI
Wall Sconce
NOT TO SCALE



B | 45218 NI



C | 45220 NI



D | 45221 NI

MATCHING MIRROR

41011 NI

See page 465 or kichler.com.



CRESCENT VIEW™

ITEM #	FINISH	INCAND. BULB	W	H	EXT.	HCWO	NOTES
A	NI	(2) 50W (G9)	5.75	12	4.25	6.25	Halogen light source.
B	NI	(2) 60W (C)	18	6.25	5.75	3	
C	NI	(3) 60W (C)	24	6.25	5.75	3	
D	NI	(4) 60W (C)	39	6.25	5.75	3	

Measurements shown in inches. U.S. & Canadian Patent Pending.

FREEPORT™

POLISHED NICKEL FINISH WITH ETCHED
LINEAR TEXTURED GLASS



A | 45087 PN
ADA Compliant



B | 42091 PN
10687 PN



C | 45088 PN
10688 PN



D | 45086 PN
10686 PN
Wall Sconce
ADA Compliant
NOT TO SCALE

MATCHING COLLECTION

See entire Freeport™ Collection
on pages 200-201.



FREEPORT™

ITEM #	FLUOR. ITEM #	FINISH	INCAND. BULB	FLUOR. BULB	W	H	EXT.	HCWO	NOTES
A	45087	PN	(2) 60W (C/K)	---	22	5	3.75	2.5	D May be installed vertically or horizontally, Krypton bulb included.
B	42091	PN	(2) 60W (K)	---	28	5	4.75	2.5	D May be installed vertically or horizontally. Krypton light source.
B	---	10687	---	(2) 13W (GU24)	28	5	4.75	2.5	D May be installed vertically or horizontally.
C	45088	PN	(4) 60W (C/K)	---	36	5	4.25	2.5	D May be installed vertically or horizontally, Krypton bulb included.
C	---	10688	---	(2) 18W (GU24)	36	5	4.25	2.5	D May be installed vertically or horizontally.
D	45086	PN	(1) 60W (C)	---	7	17	3.75	4.5	D
D	---	10686	---	(1) 13W (GU24)	7	17	3.75	4.5	D

Measurements shown in inches. U.S. & Canadian Patent Pending.

BAZELY™

BRUSHED NICKEL FINISH WITH
SATIN-ETCHED RIBBED GLASS



B | 45478 NI



A | 45477 NI
Wall Sconce
NOT TO SCALE



C | 45479 NI



D | 45480 NI

BAZELY™

ITEM #	FINISH	INCAND. BULB	W	H	EXT.	HCWO	NOTES
A	NI	(1) 50W (G9)	6	5	4.5	2.75	May be installed with glass up or down. Halogen light source.
B	NI	(2) 50W (G9)	15	5	4.5	2.75	May be installed with glass up or down. Halogen light source.
C	NI	(3) 50W (G9)	24	5	4.5	2.75	May be installed with glass up or down. Halogen light source.
D	NI	(4) 50W (G9)	33	5	4.5	2.75	May be installed with glass up or down. Halogen light source.

Measurements shown in inches. U.S. & Canadian Patent Pending.

METRO PARK™

BRUSHED NICKEL FINISH WITH
SATIN-ETCHED CASED OPAL GLASS



A | 45138 NI



B | 45139 NI



D | 45137 NI
Wall Sconce
NOT TO SCALE



C | 45140 NI

MATCHING MIRROR

41011 NI
See page 465 or kichler.com.



METRO PARK™

	ITEM #	FINISH	INCAND. BULB	W	H	EXT.	HCWO	NOTES
A	45138	NI	(2) 60W (C)	12.75	6.5	5.25	4.25	Ⓧ G-type lamp recommended.
B	45139	NI	(3) 60W (C)	21.75	6.5	5.5	4.25	Ⓧ G-type lamp recommended.
C	45140	NI	(4) 60W (C)	30.75	6.5	5.5	4.25	Ⓧ G-type lamp recommended.
D	45137	NI	(1) 60W (C)	4.5	6.5	5.25	4.25	Ⓧ G-type lamp recommended.

Measurements shown in inches. U.S. & Canadian Patent Pending.



Hendrik™ Wall Sconce 5076 CH | Page 477

HENDRIK™

POLISHED CHROME FINISH WITH SATIN-ETCHED CASED OPAL GLASS



A | 5077 CH



B | 5078 CH



C | 5079 CH



D | 5085 CH



E | 5076 CH
Wall Sconce
NOT TO SCALE

HENDRIK™

ITEM #	FINISH	INCAND. BULB	W	H	EXT.	HCWO	NOTES	
A	5077	CH	(2) 100W (M)	14.5	7.75	6.5	5.5	Ⓧ (18-25W CFL) May be installed with glass up or down.
B	5078	CH	(3) 100W (M)	24	7.75	6.5	5.5	Ⓧ (18-25W CFL) May be installed with glass up or down.
C	5079	CH	(4) 100W (M)	33.75	7.75	6.5	5.5	Ⓧ (18-25W CFL) May be installed with glass up or down.
D	5085	CH	(5) 100W (M)	43	7.75	6.5	5.25	Ⓧ (18-25W CFL) May be installed with glass up or down.
E	5076	CH	(1) 100W (M)	5.25	12	8	6	Ⓧ (18-25W CFL) May be installed with glass up or down.

Measurements shown in inches. U.S. & Canadian Patent Pending; D. U.S. Design Patent No.: D688,828; A, B, C, E.

HENDRIK™

BRUSHED NICKEL FINISH WITH
SATIN-ETCHED CASÉD OPAL GLASS



A | 5076 NI
Wall Sconce
NOT TO SCALE

MATCHING MIRROR

41071 NI
See page 464 or kichler.com.



B | 5077 NI



C | 5078 NI



D | 5079 NI

MATCHING COLLECTION

See entire Hendrik™
Collection on pages 107-109.



E | 5085 NI

HENDRIK™

ITEM #	FINISH	INCAND. BULB	W	H	EXT.	HCWO	NOTES	
A	5076	NI	(1) 100W (M)	5.25	12	8	6	Ⓛ (18-25W CFL) May be installed with glass up or down.
B	5077	NI	(2) 100W (M)	14.5	7.75	6.5	5.5	Ⓛ (18-25W CFL) May be installed with glass up or down.
C	5078	NI	(3) 100W (M)	24	7.75	6.5	5.5	Ⓛ (18-25W CFL) May be installed with glass up or down.
D	5079	NI	(4) 100W (M)	33.75	7.75	6.5	5.5	Ⓛ (18-25W CFL) May be installed with glass up or down.
E	5085	NI	(5) 100W (M)	43	7.75	6.5	5.25	Ⓛ (18-25W CFL) May be installed with glass up or down.

Measurements shown in inches. U.S. & Canadian Patent Pending; E. U.S. Design Patent No.: D688,828: A, B, C, D.

HENDRIK™

OLDE BRONZE® FINISH WITH
LIGHT UMBER GLASS



A | 5077 OZ

MATCHING MIRROR

41071 OZ
See page 464 or kichler.com.



B | 5078 OZ



C | 5079 OZ



D | 5085 OZ



E | 5076 OZ
Wall Sconce
NOT TO SCALE

MATCHING COLLECTION

See entire Hendrik™
Collection on pages 104-106.



HENDRIK™

ITEM #	FINISH	INCAND. BULB	W	H	EXT.	HCWO	NOTES	
A	5077	OZ	(2) 100W (M)	14.5	7.75	6.5	5.5	Ⓧ (18-25W CFL) May be installed with glass up or down.
B	5078	OZ	(3) 100W (M)	24	7.75	6.5	5.5	Ⓧ (18-25W CFL) May be installed with glass up or down.
C	5079	OZ	(4) 100W (M)	33.75	7.75	6.5	5.5	Ⓧ (18-25W CFL) May be installed with glass up or down.
D	5085	OZ	(5) 100W (M)	43	7.75	6.5	5.25	Ⓧ (18-25W CFL) May be installed with glass up or down.
E	5076	OZ	(1) 100W (M)	5.25	12	8	6	Ⓧ (18-25W CFL) May be installed with glass up or down.

Measurements shown in inches. U.S. & Canadian Patent Pending: D. U.S. Design Patent No.: D688,828: A, B, C, E.

SUSPENSION™

BRUSHED NICKEL FINISH WITH
SATIN-ETCHED CASED OPAL GLASS



A | 45315 NI
Wall Sconce
NOT TO SCALE



B | 45316 NI

MATCHING COLLECTION

See entire Suspension™
Collection on page 96.



C | 45317 NI



D | 45319 NI

SUSPENSION™

ITEM #	FINISH	INCAND. BULB	W	H	EXT.	HCWO	NOTES
A	NI	(1) 60W (C/K)	4.25	7	4.5	3.5	Krypton bulb included.
B	NI	(2) 60W (C/K)	20	5	5	2.5	Krypton bulb included.
C	NI	(3) 60W (C/K)	30.25	5	5	2.5	Krypton bulb included.
D	NI	(5) 60W (C/K)	50.75	5	5	2.5	Krypton bulb included.

Measurements shown in inches. U.S. & Canadian Patent Pending.

RIGATE™

BRUSHED NICKEL FINISH WITH CLEAR RIBBED OUTER GLASS AND SATIN-ETCHED CASSED OPAL INNER GLASS SHADES



A | 45442 NI



D | 45441 NI
Wall Sconce
NOT TO SCALE



B | 45443 NI



C | 45444 NI

MATCHING MIRROR

41011 NI
See page 465 or kichler.com.



RIGATE™

	ITEM #	FINISH	INCAND. BULB	W	H	EXT.	HCWO	NOTES
A	45442	NI	(2) 50W (G9)	15.75	6.75	4.75	3.5	Halogen light source.
B	45443	NI	(3) 50W (G9)	23.25	6.75	4.75	3.5	Halogen light source.
C	45444	NI	(4) 50W (G9)	29.75	6.75	5	3.5	Halogen light source.
D	45441	NI	(1) 50W (G9)	9.25	6.75	4.75	3.5	Halogen light source.

Measurements shown in inches. U.S. & Canadian Patent Pending.



Arvella™ Wall Sconce 45385 NI & 2-light Bath Fixture 45386 NI | Page 483

ARVELLA™

BRUSHED NICKEL FINISH WITH
SATIN-ETCHED CASED OPAL GLASS



A | 45386 NI



B | 45387 NI



C | 45388 NI



D | 45385 NI
Wall Sconce
NOT TO SCALE

ARVELLA™

	ITEM #	FINISH	INCAND. BULB	W	H	EXT.	HCWO	NOTES
A	45386	NI	(2) 100W (M)	16.75	10.5	6.5	8	Ⓛ (23-30W CFL) May be installed with glass up or down.
B	45387	NI	(3) 100W (M)	26	10.5	6.5	8	Ⓛ (23-30W CFL) May be installed with glass up or down.
C	45388	NI	(4) 100W (M)	35.25	10.5	6.5	8	Ⓛ (23-30W CFL) May be installed with glass up or down.
D	45385	NI	(1) 100W (M)	5	10.5	6.5	8	Ⓛ (23-30W CFL) May be installed with glass up or down.

Measurements shown in inches. U.S. & Canadian Patent Pending.

TUBES™

BRUSHED NICKEL FINISH WITH
SATIN-ETCHED CASÉD OPAL GLASS



A | 5965 NI
Wall Sconce
NOT TO SCALE



B | 5966 NI



C | 5967 NI



D | 5968 NI

MATCHING MIRROR

41011 NI
See page 465 or kichler.com.



TUBES™

ITEM #	FINISH	INCAND. BULB	W	H	EXT.	HCWO	NOTES
A	NI	(1) 60W (G9)	6.75	4.75	5.25	2.25	Halogen light source.
B	NI	(2) 60W (G9)	13.75	4.75	5.25	2.25	Halogen light source.
C	NI	(3) 60W (G9)	20.75	4.75	5.25	2.25	Halogen light source.
D	NI	(4) 60W (G9)	28	4.75	5.25	2.25	Halogen light source.

Measurements shown in inches. U.S. & Canadian Patent Pending.

TUBES™

POLISHED NICKEL FINISH WITH SATIN-ETCHED CASED OPAL GLASS



A | 5966 PN



D | 5965 PN
Wall Sconce
NOT TO SCALE



B | 5967 PN



C | 5968 PN

TUBES™

	ITEM #	FINISH	INCAND. BULB	W	H	EXT.	HCWO	NOTES
A	5966	PN	(2) 60W (G9)	13.75	4.75	5.25	2.25	Halogen light source.
B	5967	PN	(3) 60W (G9)	20.75	4.75	5.25	2.25	Halogen light source.
C	5968	PN	(4) 60W (G9)	28	4.75	5.25	2.25	Halogen light source.
D	5965	PN	(1) 60W (G9)	6.75	4.75	5.25	2.25	Halogen light source.

Measurements shown in inches. U.S. & Canadian Patent Pending.

LEGÉ™

BRUSHED NICKEL FINISH WITH
SATIN-ETCHED CASÉ OPAL GLASS



A | 5051 NI
Wall Sconce
NOT TO SCALE



B | 5052 NI



C | 5053 NI



D | 5054 NI

MATCHING MIRROR

41011 NI

See page 465 or kichler.com.



LEGÉ™

ITEM #	FINISH	INCAND. BULB	W	H	EXT.	HCWO	NOTES	
A	5051	NI	(1) 100W (M)	4.75	8	5	3.75	ⓓ (23-30W CFL) May be installed with glass up or down.
B	5052	NI	(2) 100W (M)	15.25	9	5.5	6.75	ⓓ (23-30W CFL) May be installed with glass up or down.
C	5053	NI	(3) 100W (M)	22.75	9	5.5	2.25	ⓓ (23-30W CFL) May be installed with glass up or down.
D	5054	NI	(4) 100W (M)	30.5	9	5.5	2.25	ⓓ (23-30W CFL) May be installed with glass up or down.

Measurements shown in inches.

CYLINDERS

POLISHED NICKEL FINISH WITH SATIN-ETCHED CASED OPAL GLASS



A | 5437 PN



B | 5438 PN



D | 5436 PN
Wall Sconce
NOT TO SCALE



C | 5439 PN

CYLINDERS

	ITEM #	FINISH	INCAND. BULB	W	H	EXT.	HCWO	NOTES
A	5437	PN	(2) 100W (M)	12.75	8	5.75	2.5	Ⓧ May be installed with glass up or down.
B	5438	PN	(3) 100W (M)	20.5	8	5.75	5.75	Ⓧ May be installed with glass up or down.
C	5439	PN	(4) 100W (M)	28.5	8	5.75	5.75	Ⓧ May be installed with glass up or down.
D	5436	PN	(1) 100W (M)	4.75	8	5.75	5.75	Ⓧ May be installed with glass up or down.

Measurements shown in inches.



Structures™ 4-Light Bath Fixture 6464 NI | Page 489

STRUCTURES™

BRUSHED NICKEL FINISH WITH SATIN-ETCHED GLASS OR OLDE BRONZE® FINISH WITH LIGHT UMBER-ETCHED GLASS



A | 6162 NI, OZ



B | 6463 NI, OZ



E | 6963 NI, OZ
NOT TO SCALE



C | 6464 NI, OZ



D | 7755 NI, OZ
Directional Rail Light

MATCHING MIRROR

41056 NI, OZ
See page 465 or kichler.com.



MATCHING COLLECTION

See entire Structures™ Collection on pages 206-208.



STRUCTURES™

ITEM #	FINISH	INCAND. BULB	W	H	L	EXT.	HCWO	NOTES
A	6162 NI, OZ	(2) 100W (MNCN) Ⓧ	21	7.5	---	10.5	2.5	Ⓧ Halogen light source.
B	6463 NI, OZ	(3) 100W (MNCN) Ⓧ	30	8.75	---	10.5	2.5	Ⓧ Halogen light source.
C	6464 NI, OZ	(4) 100W (MNCN) Ⓧ	40	8.5	---	10.5	2.25	Ⓧ Halogen light source.
D	7755 NI, OZ	(4) 50W (GU10) ✓Ⓧ	5	11	30	8	2.5	Ⓧ May be ceiling or wall mounted. Halogen light source.
E	6963 NI, OZ	(1) 100W (MNCN) Ⓧ	9	7.5	---	10.5	2.5	Ⓧ Halogen light source.

Measurements shown in inches. U.S. Patent Pending: D. U.S. Patent No. D512,177: A, B, C, E.



ALLEGRE™ ENERGY EFFICIENT

SATIN NICKEL FINISH WITH
ETCHED RIBBED ACRYLIC DIFFUSER



A | 11108 SN
Wall Sconce
NOT TO SCALE

Etched Ribbed
Acrylic Diffuser



11109 SN Shown Vertically
as Wall Sconce



11110 SN Shown Vertically
as Wall Sconce

MULTI-POSITIONAL BATH FIXTURE

Create two distinct lighting options with one
fixture: fixture can be installed on the wall
horizontally or vertically.

B | 11109 SN

C | 11110 SN



11109 SN Shown Horizontally as Linear Bath



11110 SN Shown Horizontally as a Linear Bath

ALLEGRE™ ENERGY EFFICIENT

	FLUOR. ITEM #	FINISH	FLUOR. BULB	W	H	EXT.	HCWO	NOTES
A	11108	SN	(1) 18W (GU24)	4.5	18.5	5.5	7	
B	11109	SN	(1) 24W (T5FL)	26.25	4.5	5.5	2.25	May be installed on the wall vertically or horizontally.
C	11110	SN	(1) 39W (T5FL)	38	4.5	5.5	2.25	May be installed on the wall vertically or horizontally.

Measurements shown in inches.

JERVIS™ ENERGY EFFICIENT

POLISHED CHROME FINISH WITH
ETCHED WHITE OPAL GLASS



A | 10481 PC
ADA Compliant
NOT TO SCALE



10405 PC Shown Horizontally as Linear Bath

B | 10405 PC

MULTI-POSITIONAL BATH FIXTURE









Create two distinct lighting options with one fixture: fixture can be installed on the wall horizontally or vertically.

C | 10406 PC



10406 PC Shown Horizontally as Linear Bath

JERVIS™ ENERGY EFFICIENT

	FLUOR. ITEM #	FINISH	FLUOR. BULB	W	H	EXT.	HCWO	NOTES
A	10481	PC	(1) 18W (GU24) 	4.5	14.25	4	7	 ADA
B	10405	PC	(1) 24W (T5FL)  	27	4.5	5.75	2.25	 May be installed on the wall vertically or horizontally.
C	10406	PC	(1) 39W (T5FL)  	38.75	4.5	5.75	2.25	 May be installed on the wall vertically or horizontally.

Measurements shown in inches.

KYMPTON™

POLISHED NICKEL FINISH WITH
SATIN-ETCHED WHITE GLASS



A | 45026 PN
Linear Bath



B | 45027 PN
Linear Bath

MATCHING MIRROR

41011 CH

See page 465 or kichler.com.



KYMPTON™

	ITEM #	FINISH	INCAND. BULB	W	H	EXT.	HCWO	NOTES
A	45026	PN	(2) 50W (G9)	24	5.75	4.5	2.5	Halogen light source.
B	45027	PN	(4) 50W (G9)	36	5.75	4.5	2.5	Halogen light source.

Measurements shown in inches. U.S. & Canadian Patent Pending.

KAILEY™

BRUSHED NICKEL FINISH WITH
SATIN-ETCHED INNER GLASS SHADES
AND WHITE ORGANZA OUTER SHADES



A | 45438 NI



B | 45439 NI



D | 45437 NI
Wall Sconce
NOT TO SCALE



C | 45440 NI

KAILEY™

	ITEM #	FINISH	INCAND. BULB	W	H	EXT.	HCWO	NOTES
A	45438	NI	(2) 60W (C)	13.5	7	6.75	4.5	ⓓ G-type bulb recommended.
B	45439	NI	(3) 60W (C)	22	7	6.75	4.5	ⓓ G-type bulb recommended.
C	45440	NI	(4) 60W (C)	30.5	7	6.75	4.75	ⓓ G-type bulb recommended.
D	45437	NI	(1) 60W (C)	6	7	7.5	4.5	ⓓ G-type bulb recommended.

Measurements shown in inches. U.S. & Canadian Patent Pending.

SANTIAGO ENERGY EFFICIENT

MOCHA MIST™ AND CHAMPAGNE FINISH
WITH BEIGE STRING SHADE



B | 10885 CP



Matte White Acrylic
Diffuser with Beige
String Trim Ring

C | 10886 CP













Beige String Shade
with Matte White
Acrylic Diffuser

A | 10438 CPBG
Wall Sconce
ADA Compliant
NOT TO SCALE



D | 10439 CPBG
Wall Sconce
ADA Compliant
NOT TO SCALE

SANTIAGO ENERGY EFFICIENT

	FLUOR. ITEM #	FINISH	FLUOR. BULB	W	H	EXT.	HCWO	NOTES
A	10438	CPBG	(1) 13W (G24Q-1)  	5.5	14.25	3.75	5.25	 ADA
B	10885	CP	(2) 13W (QAD4)  	13	4.25	---	---	
C	10886	CP	(3) 13W (QAD4)   	17.25	4.25	---	---	
D	10439	CPBG	(2) 13W (G24Q-1)  	11	14.25	3.75	5.25	 ADA

Measurements shown in inches.

SANTIAGO ENERGY EFFICIENT

BRUSHED NICKEL AND POLISHED CHROME FINISH WITH WHITE LINEN FABRIC SHADE



A | 10885 NI



B | 10886 NI

Matte White Acrylic Diffuser with White Linen Fabric Trim Ring







C | 10439 NCH
Wall Sconce
ADA Compliant
NOT TO SCALE

White Linen Fabric Shade with Matte White Acrylic Diffuser



D | 10438 NCH
Wall Sconce
ADA Compliant
NOT TO SCALE

SANTIAGO ENERGY EFFICIENT

	FLUOR. ITEM #	FINISH	FLUOR. BULB	W	H	EXT.	HCWO	NOTES
A	10885	NI	(2) 13W (QAD4)  	13	4.25	---	---	
B	10886	NI	(3) 13W (QAD4)  	17.25	4.25	---	---	
C	10439	NCH	(2) 13W (G24Q-1)  	11	14.25	3.75	5.25	
D	10438	NCH	(1) 13W (G24Q-1)  	5.5	14.25	3.75	5.25	

Measurements shown in inches.

PAVILLION™ ENERGY EFFICIENT

SILVER FINISH WITH
MATTE WHITE ACRYLIC DIFFUSER



B | 10801 SI
Flush Mount



A | 10441 SI
Wall Sconce
ADA Compliant



Matte White
Acrylic Diffuser

C | 10802 SI
Flush Mount



D | 10601 SI
Linear Bath



Matte White
Acrylic Diffuser

E | 10602 SI
Linear Bath

PAVILLION™ ENERGY EFFICIENT

	FLUOR. ITEM #	FINISH	FLUOR. BULB	W	H	L	EXT.	HCWO	NOTES
A	10441	SI	(2) 13W (G24Q-1)	12.5	11	---	4	5.75	ADA
B	10801	SI	(2) 32W (T8FL)	11.25	5	52.25	---	---	ADA
C	10802	SI	(4) 32W (T8FL)	16.25	5	52.25	---	---	ADA
D	10601	SI	(2) 17W (T8FL)	28.5	3.75	---	6	2	ADA
E	10602	SI	(2) 25W (T8FL)	40.25	3.75	---	6	2	ADA

Measurements shown in inches.

NOBU™ ENERGY EFFICIENT

BRUSHED NICKEL FINISH



A | **10414 NI**
Linear Bath
ADA Compliant



Clear Outside Glass
with White Inside

D | **10620 NI**
Wall Sconce
ADA Compliant
NOT TO SCALE

Matte White
Acrylic Diffuser



B | **10415 NI**
Linear Bath
ADA Compliant



C | **10416 NI**
Linear Bath
ADA Compliant

NOBU™ ENERGY EFFICIENT

	FLUOR. ITEM #	FINISH	FLUOR. BULB	W	H	EXT.	HCWO	NOTES
A	10414	NI	(1) 24W (T5FL)	27.25	4.5	3	2.25	ADA
B	10415	NI	(1) 39W (T5FL)	39	4.5	3	2.25	ADA
C	10416	NI	(1) 54W (T5FL)	50.75	4.5	3	2.25	ADA
D	10620	NI	(2) 13W (G24Q-1)	13	9.5	4	4.75	ADA

Measurements shown in inches.

GRANBY™

BRUSHED PEWTER, OLDE BRONZE®
OR POLISHED CHROME FINISH WITH
SATIN-ETCHED CASÉD OPAL GLASS



A | 45358 CH
Wall Sconce
NOT TO SCALE



B | 45359 CH



C | 45360 CH



D | 45361 CH

MATCHING MIRROR

41011 CH, NI, OZ
See page 465 or kichler.com.



GRANBY™

ITEM #	FINISH	INCAND. BULB	W	H	EXT.	HCWO	NOTES	
A	45358	BPT, CH, OZ	(1) 100W (M)	5.75	14	7.5	7	Ⓧ (18-25W CFL) May be installed with glass up or down.
B	45359	BPT, CH, OZ	(2) 100W (M)	17	9.5	6.5	3	Ⓧ (18-25W CFL) May be installed with glass up or down.
C	45360	BPT, CH, OZ	(3) 100W (M)	25	9.5	6.5	6.5	Ⓧ (18-25W CFL) May be installed with glass up or down.
D	45361	BPT, CH, OZ	(4) 100W (M)	32.75	9.5	6.75	6.5	Ⓧ (18-25W CFL) May be installed with glass up or down.

Measurements shown in inches. U.S. & Canadian Patent Pending.





A | 45358 BPT
Wall Sconce
NOT TO SCALE



B | 45359 BPT



C | 45360 BPT



D | 45361 BPT



A | 45358 OZ
Wall Sconce
NOT TO SCALE



B | 45359 OZ



C | 45360 OZ



D | 45361 OZ

SOULDERN™

MARBLED BRONZE FINISH WITH
DISTRESSED UMBER-ETCHED GLASS



B | 2616 MBZ



C | 5315 MBZ



A | 6016 MBZ
Wall Sconce
NOT TO SCALE



D | 5316 MBZ



E | 5317 MBZ

SOULDERN™

ITEM #	FINISH	INCAND. BULB	W	H	OVRL. H	STEM TILT	EXTRA WIRE	CHAIN/STEM	EXT.	HCWO	NOTES
A	6016	MBZ	(1) 100W (M)	4.5	20.25	---	---	---	6.75	10.25	Ⓛ (23-30W CFL) May be installed with glass up or down.
B	2616	MBZ	(1) 100W (M)	5.5	16.75	55	45°(12:12)	54	36	---	Ⓛ (23-30W CFL) Additional stem 2999 (12") MBZ.
C	5315	MBZ	(2) 100W (M)	15.75	9.5	---	---	---	6.5	7.25	Ⓛ (23-30W CFL) May be installed with glass up or down.
D	5316	MBZ	(3) 100W (M)	23.5	9.5	---	---	---	6.5	7.25	Ⓛ (23-30W CFL) May be installed with glass up or down.
E	5317	MBZ	(4) 100W (M)	30	9.5	---	---	---	6.5	2.25	Ⓛ (23-30W CFL) May be installed with glass up or down.

Measurements shown in inches.

BRINBOURNE™

ANVIL IRON FINISH WITH
SATIN-ETCHED CASSED OPAL GLASS



A | 45262 AVI



B | 42265 AVI
Mini Pendant



C | 45263 AVI



E | 42267 AVI
Wall Sconce
NOT TO SCALE



D | 45264 AVI

BRINBOURNE™

ITEM #	FINISH	INCAND. BULB	W	H	OVRL. H	STEM TILT	EXTRA WIRE	CHAIN/STEM	EXT.	HCWO	NOTES
A	AVI	(2) 100W (M)	14.25	9	---	---	---	---	6.5	6.5	Ⓧ (23-30W CFL) May be installed with glass up or down.
B	AVI	(1) 100W (M)	4.75	9	47	45°(12:12)	67	36	---	---	Ⓧ (23-30W CFL) Additional stem 2999 (12") AVI.
C	AVI	(3) 100W (M)	24	9	---	---	---	---	6.5	6.5	Ⓧ (23-30W CFL) May be installed with glass up or down.
D	AVI	(4) 100W (M)	34	9.5	---	---	---	---	6.5	6.5	Ⓧ (23-30W CFL) May be installed with glass up or down.
E	AVI	(1) 100W (M)	5	9.5	---	---	---	---	6.5	4.75	Ⓧ (23-30W CFL) May be installed with glass up or down.

Measurements shown in inches. U.S. & Canadian Patent Pending.

LANGFORD™

BRUSHED NICKEL FINISH
WITH ETCHED WHITE GLASS



B | 8044 NI
Flush Mount



A | 5388 NI
Wall Sconce
NOT TO SCALE



C | 5389 NI



D | 5390 NI



E | 5391 NI

MATCHING COLLECTION

See entire Langford™
Collection on pages 364-365.



LANGFORD™

ITEM #	FINISH	INCAND. BULB	W	H	EXT.	HCWO	NOTES	
A	5388	NI	(1) 100W (M)	7.25	8	7.75	4.75	Ⓧ (9-13W CFL) May be installed with glass up or down.
B	8044	NI	(2) 75W (M) ✦	13	6	---	---	
C	5389	NI	(2) 100W (M)	17.75	8.5	8.25	6.25	Ⓧ (9-13W CFL) May be installed with glass up or down.s
D	5390	NI	(3) 100W (M)	26.5	7.75	8.25	6.25	Ⓧ (9-13W CFL) May be installed with glass up or down.
E	5391	NI	(4) 100W (M)	35.25	7.5	8.25	6.25	Ⓧ (9-13W CFL) May be installed with glass up or down.

Measurements shown in inches.

LANGFORD™

OLDE BRONZE® FINISH WITH
ETCHED WHITE GLASS



A | 8044 OZ
Flush Mount



B | 5389 OZ



C | 5390 OZ



D | 5391 OZ



E | 5388 OZ
Wall Sconce
NOT TO SCALE

MATCHING COLLECTION

See entire Langford™
Collection on pages 364-365.



LANGFORD™

ITEM #	FINISH	INCAND. BULB	W	H	EXT.	HCWO	NOTES	
A	8044	OZ	(2) 75W (M) ❖	13	6	---	---	
B	5389	OZ	(2) 100W (M)	17.75	8.5	8.25	6.25	ⓓ (9-13W CFL) May be installed with glass up or down.
C	5390	OZ	(3) 100W (M)	26.5	7.75	8.25	6.25	ⓓ (9-13W CFL) May be installed with glass up or down.
D	5391	OZ	(4) 100W (M)	35.25	7.5	8.25	6.25	ⓓ (9-13W CFL) May be installed with glass up or down.
E	5388	OZ	(1) 100W (M)	7.25	8	7.75	4.75	ⓓ (9-13W CFL) May be installed with glass up or down.

Measurements shown in inches.

WHARTON

BRUSHED NICKEL FINISH WITH
SATIN-ETCHED CASÉ OPAL GLASS



A | 5359 NI
Wall Sconce
NOT TO SCALE



B | 5360 NI



C | 5361 NI

MATCHING COLLECTION

See entire Wharton Collection
on pages 350-351.



D | 5362 NI

WHARTON

ITEM #	FINISH	INCAND. BULB	W	H	EXT.	HCWO	NOTES	
A	5359	NI	(1) 100W (M)	4.75	9	6	4.5	(9-13W CFL) May be installed with glass up or down.
B	5360	NI	(2) 100W (M)	13.75	9	6	2.25	(9-13W CFL) May be installed with glass up or down.
C	5361	NI	(3) 100W (M)	21.75	9	6	6.75	(9-13W CFL) May be installed with glass up or down.
D	5362	NI	(4) 100W (M)	30.25	9	6	6.75	(9-13W CFL) May be installed with glass up or down.

Measurements shown in inches. U.S. & Canadian Patent Pending.

UPTOWN™

BRUSHED NICKEL FINISH WITH
SATIN-ETCHED CASED OPAL GLASS



A | 5402 NI
NOT TO SCALE



B | 5403 NI

MATCHING MIRROR

41011 NI
See page 465 or kichler.com.



C | 5404 NI

UPTOWN™

	ITEM #	FINISH	INCAND. BULB	W	H	EXT.	HCWO	NOTES
A	5402	NI	(2) 100W (M)	15.25	7.5	6.5	3.75	Ⓧ May be installed with glass up or down.
B	5403	NI	(3) 100W (M)	24	7.5	6.5	3.75	Ⓧ May be installed with glass up or down.
C	5404	NI	(4) 100W (M)	32.75	7.5	6.5	3.75	Ⓧ May be installed with glass up or down.

Measurements shown in inches.

DRAPES

BRUSHED NICKEL FINISH
WITH CLEAR ICE GLASS



A | 6311 NI
Wall Sconce
NOT TO SCALE



B | 6312 NI



C | 6313 NI



D | 6314 NI

MATCHING MIRROR

41011 NI

See page 465 or kichler.com.



DRAPES

ITEM #	FINISH	INCAND. BULB	W	H	EXT.	HCWO	NOTES	
A	6311	NI	(1) 60W (C)	8	6.5	7	3.75	ⓓ
B	6312	NI	(2) 60W (C)	17.5	6.5	7	3.75	ⓓ
C	6313	NI	(3) 60W (C)	26.5	6.5	7	3.75	ⓓ
D	6314	NI	(4) 60W (C)	35.25	6.5	7	3.75	ⓓ

Measurements shown in inches.

ASHBROOK™

POLISHED CHROME FINISH
WITH CASED OPAL GLASS



A | 45518 CH



B | 45519 CH



D | 45517 CH
Wall Sconce
NOT TO SCALE



C | 45520 CH

ASHBROOK™

	ITEM #	FINISH	INCAND. BULB	W	H	EXT.	HCWO	NOTES
A	45518	CH	(2) 100W (M)	15	10.5	6	2.5	Ⓧ May be installed with glass up or down.
B	45519	CH	(3) 100W (M)	24	10.5	6	2.5	Ⓧ May be installed with glass up or down.
C	45520	CH	(4) 100W (M)	33.5	10.5	6	2.5	Ⓧ May be installed with glass up or down.
D	45517	CH	(1) 100W (M)	5	11.25	6.25	8.75	Ⓧ May be installed with glass up or down.

Measurements shown in inches. U.S. & Canadian Patent Pending.

TULARE™

POLISHED CHROME FINISH
WITH POLISHED CLEAR GLASS
AND INSIDE ETCH



A | 45036 CH
Wall Sconce
NOT TO SCALE



B | 45037 CH



C | 45038 CH



D | 45039 CH

MATCHING MIRROR

41011 NI

See page 465 or kichler.com.



TULARE™

ITEM #	FINISH	INCAND. BULB	W	H	EXT.	HCWO	NOTES	
A	45036	CH	(1) 60W (K)	7.75	5	6	2.75	Krypton light source.
B	45037	CH	(2) 60W (K)	18	5.5	6	3.25	Krypton light source.
C	45038	CH	(3) 60W (K)	28	5.75	6	3.25	Krypton light source.
D	45039	CH	(4) 60W (K)	36	5.75	6	3.25	Krypton light source.

Measurements shown in inches. U.S. & Canadian Patent Pending.

ROUSSEAU™

POLISHED CHROME FINISH WITH SATIN-ETCHED CASED OPAL GLASS



A | 45060 CH
NOT TO SCALE



B | 45061 CH



C | 45062 CH

ROUSSEAU™

	ITEM #	FINISH	INCAND. BULB	W	H	EXT.	HCWO	NOTES
A	45060	CH	(2) 100W (M)	13	8.5	5	5	Ⓧ (23-30W CFL) May be installed with glass up or down.
B	45061	CH	(3) 100W (M)	20.5	8.5	5	5	Ⓧ (23-30W CFL) May be installed with glass up or down.
C	45062	CH	(4) 100W (M)	29	8.5	5	5	Ⓧ (23-30W CFL) May be installed with glass up or down.

Measurements shown in inches. U.S. & Canadian Patent Pending.

CLARO™

BRUSHED NICKEL FINISH WITH
SATIN-ETCHED CASÉ OPAL GLASS



A | 45113 NI
Wall Sconce
NOT TO SCALE



B | 45114 NI



C | 45115 NI



D | 45116 NI

MATCHING MIRROR

41011 NI

See page 465 or kichler.com.



CLARO™

ITEM #	FINISH	INCAND. BULB	W	H	EXT.	HCWO	NOTES
A	NI	(1) 60W (C/K)	6	9.75	5.5	4.5	May be installed with glass up or down. Krypton bulb included.
B	NI	(2) 60W (C/K)	15	6.25	5.5	3.5	May be installed with glass up or down. Krypton bulb included.
C	NI	(3) 60W (C/K)	24	6.25	5.5	3.5	May be installed with glass up or down. Krypton bulb included.
D	NI	(4) 60W (C/K)	33	6.25	5.5	3.5	May be installed with glass up or down. Krypton bulb included.

Measurements shown in inches. U.S. & Canadian Patent Pending.

REVERE

ANTIQUPE WETER FINISH WITH
CHROME ACCENTS AND
SATIN-ETCHED CASED OPAL GLASS



A | 45321 AP
NOT TO SCALE



B | 45322 AP



Chrome Ball Accents

C | 45323 AP

REVERE

	ITEM #	FINISH	INCAND. BULB	W	H	EXT.	HCWO	NOTES
A	45321	AP	(2) 50W (G9)	17	7	6	2.25	D May be installed with glass up or down. Halogen light source.
B	45322	AP	(3) 50W (G9)	24	7	6	4.5	D May be installed with glass up or down. Halogen light source.
C	45323	AP	(4) 50W (G9)	32	7	6	4.5	D May be installed with glass up or down. Halogen light source.

Measurements shown in inches. U.S. & Canadian Patent Pending.

PUNCTUATION™

MISSION BRONZE™ FINISH WITH
WHITE LINEN GLASS



MULTI-POSITIONAL BATH FIXTURE

Create two distinct lighting options with one fixture: fixture can be installed on the wall horizontally or vertically.

A | 45353 MIZ



MULTI-POSITIONAL BATH FIXTURE

Create two distinct lighting options with one fixture: fixture can be installed on the wall horizontally or vertically.

C | 45351 MIZ
Wall Sconce
ADA Compliant



Shown as Inverted Pendant - 12.75" H.

CONVERTIBLE

Create two distinct lighting options with one fixture:
Inverted Pendant or Semi Flush.

B | 42051 MIZ



Shown as Semi Flush - 11" H.

PUNCTUATION™

ITEM #	FINISH	INCAND. BULB	W	H	OVRL. H	EXTRA WIRE	CHAIN/STEM	EXT.	HCWO	NOTES	
A	45353	MIZ	(4) 60W (K)	36	4.75	---	---	---	4.5	2.5	Ⓚ Krypton light source.
B	42051	MIZ	(3) 100W (M)	15	12.75	87	33	72	---	---	Ⓜ (23-30W CFL) Additional chain 2996 MIZ.
C	45351	MIZ	(2) 60W (K)	24	5	---	---	---	4	2.5	Ⓚ ADA Krypton light source.

Measurements shown in inches.

EILEEN™

OLDE BRONZE® FINISH WITH
UMBER-ETCHED GLASS



A | 5097 OZ



B | 5098 OZ



C | 5099 OZ



D | 5096 OZ
Wall Sconce
NOT TO SCALE

MATCHING MIRROR

41096 OZ
See page 464 or kichler.com.



EILEEN™

ITEM #	FINISH	INCAND. BULB	W	H	EXT.	HCWO	NOTES
A	OZ	(2) 100W (M)	14.25	9.25	6	7	Ⓧ (18-25W CFL) May be installed with glass up or down.
B	OZ	(3) 100W (M)	24	9.25	6	7	Ⓧ (18-25W CFL) May be installed with glass up or down.
C	OZ	(4) 100W (M)	33.75	9.25	6	7	Ⓧ (18-25W CFL) May be installed with glass up or down.
D	OZ	(1) 100W (M)	4.5	10.75	7	5.75	Ⓧ (18-25W CFL) May be installed with glass up or down.

Measurements shown in inches.

EILEEN™

POLISHED CHROME FINISH WITH
SATIN-ETCHED CASSED OPAL GLASS



A | 5096 CH
Wall Sconce
NOT TO SCALE



B | 5097 CH



C | 5098 CH



D | 5099 CH

MATCHING MIRROR

41011 CH

See page 465 or kichler.com.



EILEEN™

ITEM #	FINISH	INCAND. BULB	W	H	EXT.	HCWO	NOTES
A	5096	CH (1) 100W (M)	4.5	10.75	7	5.75	Ⓧ (18-25W CFL) May be installed with glass up or down.
B	5097	CH (2) 100W (M)	14.25	9.25	6	7	Ⓧ (18-25W CFL) May be installed with glass up or down.
C	5098	CH (3) 100W (M)	24	9.25	6	7	Ⓧ (18-25W CFL) May be installed with glass up or down.
D	5099	CH (4) 100W (M)	33.75	9.25	6	7	Ⓧ (18-25W CFL) May be installed with glass up or down.

Measurements shown in inches.

EILEEN™

BRUSHED NICKEL FINISH WITH SATIN-ETCHED CASED OPAL GLASS



A | 5097 NI

MATCHING COLLECTION

See entire Eileen™ Collection on pages 226-227.



B | 5098 NI



D | 5096 NI
Wall Sconce
NOT TO SCALE



C | 5099 NI

MATCHING MIRROR

41011 NI
See page 465 or kichler.com.



EILEEN™

ITEM #	FINISH	INCAND. BULB	W	H	EXT.	HCWO	NOTES	
A	5097	NI	(2) 100W (M)	14.25	9.25	6	7	ⓓ (18-25W CFL) May be installed with glass up or down.
B	5098	NI	(3) 100W (M)	24	9.25	6	7	ⓓ (18-25W CFL) May be installed with glass up or down.
C	5099	NI	(4) 100W (M)	33.75	9.25	6	7	ⓓ (18-25W CFL) May be installed with glass up or down.
D	5096	NI	(1) 100W (M)	4.5	10.75	7	5.75	ⓓ (18-25W CFL) May be installed with glass up or down.

Measurements shown in inches.

AYANA

BRUSHED NICKEL FINISH WITH
SATIN-ETCHED CASED OPAL GLASS



45126 NI Shown Vertically
as Wall Sconce



A | 45126 NI
Linear Bath
ADA Compliant

MULTI-POSITIONAL WALL FIXTURE

Create two distinct lighting options with one fixture: fixture can be installed on the wall horizontally or vertically.



B | 45127 NI
Linear Bath
ADA Compliant

AYANA

	ITEM #	FINISH	INCAND. BULB	W	H	EXT.	HCWO	NOTES
A	45126	NI	(2) 60W (G9)	15.5	4.25	4	2.25	Halogen light source.
B	45127	NI	(3) 60W (G9)	23.25	4.25	4	2.25	Halogen light source.

Measurements shown in inches. U.S. & Canadian Patent Pending.

WALL SCONCE ENERGY EFFICIENT

BRUSHED NICKEL FINISH
OR OLDE BRONZE® FINISH



10670 OZ Shown Vertically as Wall Sconce

A | 10670 NI, OZ
Linear Bath
ADA Compliant

MULTI-POSITIONAL WALL SCONCE

Create two distinct lighting options with one fixture: fixture can be installed on the wall horizontally or vertically.

10669 NI Shown Vertically as Wall Sconce

B | 10669 NI, OZ
Linear Bath
ADA Compliant

WALL SCONCE ENERGY EFFICIENT

	FLUOR. ITEM #	FINISH	FLUOR. BULB	W	H	EXT.	HCWO	NOTES
A	10670	NI, OZ	(2) 13W (GU24)	5	16.5	4	8.25	OZ: Amber Linen Glass, NI: Satin-Etched Cased Opal Glass.
B	10669	NI, OZ	(1) 18W (GU24)	5	10.5	4	5.25	OZ: Amber Linen Glass, NI: Satin-Etched Cased Opal Glass.

Measurements shown in inches.



O'HARA

POLISHED CHROME FINISH WITH
SATIN-ETCHED CASÉ OPAL GLASS



A | 45500 CH
Wall Sconce
NOT TO SCALE



Crystal Accent

B | 45501 CH



C | 45502 CH



D | 45503 CH

O'HARA

ITEM #	FINISH	INCAND. BULB	W	H	EXT.	HCWO	NOTES
A	CH	(1) 50W (G9)	5	6.5	5.25	4	May be installed with glass up or down. Halogen light source.
B	CH	(2) 50W (G9)	13	6.25	5	4	May be installed with glass up or down. Halogen light source.
C	CH	(3) 50W (G9)	22	6.25	5	4	May be installed with glass up or down. Halogen light source.
D	CH	(4) 50W (G9)	31	6.25	5	4	May be installed with glass up or down. Halogen light source.

Measurements shown in inches. U.S. & Canadian Patent Pending.

ARMIDA™

POLISHED CHROME FINISH WITH SATIN-ETCHED WHITE GLASS



A | 45375 CH



B | 45376 CH



D | 45374 CH
Wall Sconce
NOT TO SCALE



C | 45377 CH

ARMIDA™

	ITEM #	FINISH	INCAND. BULB	W	H	EXT.	HCWO	NOTES
A	45375	CH	(2) 100W (M)	14	8.75	5.75	6.5	Ⓧ (23-30W CFL) May be installed with glass up or down.
B	45376	CH	(3) 100W (M)	23	8.5	5.75	6	Ⓧ (23-30W CFL) May be installed with glass up or down.
C	45377	CH	(4) 100W (M)	32.25	9	5.75	6.5	Ⓧ (23-30W CFL) May be installed with glass up or down.
D	45374	CH	(1) 100W (M)	5	10.75	7.25	7	Ⓧ (23-30W CFL) May be installed with glass up or down.

Measurements shown in inches. U.S. & Canadian Patent Pending.

ARMIDA™

BRUSHED NICKEL FINISH WITH
SATIN-ETCHED WHITE GLASS



A | 45374 NI
Wall Sconce
NOT TO SCALE



B | 45375 NI



C | 45376 NI

MATCHING COLLECTION

See entire Armida™ Collection
on pages 116-117.



D | 45377 NI

ARMIDA™

	ITEM #	FINISH	INCAND. BULB	W	H	EXT.	HCWO	NOTES
A	45374	NI	(1) 100W (M)	5	10.75	7.25	7	Ⓢ (23-30W CFL) May be installed with glass up or down.
B	45375	NI	(2) 100W (M)	14	8.75	5.75	6.5	Ⓢ (23-30W CFL) May be installed with glass up or down.
C	45376	NI	(3) 100W (M)	23	8.5	5.75	6	Ⓢ (23-30W CFL) May be installed with glass up or down.
D	45377	NI	(4) 100W (M)	32.25	9	5.75	6.5	Ⓢ (23-30W CFL) May be installed with glass up or down.

Measurements shown in inches. U.S. & Canadian Patent Pending.

ARMIDA™

OLDE BRONZE® FINISH WITH SATIN-ETCHED WHITE GLASS



A | 45375 OZ



B | 45376 OZ



C | 45377 OZ



D | 45374 OZ
Wall Sconce
NOT TO SCALE

MATCHING COLLECTION

See entire Armida™ Collection on pages 118-119.



ARMIDA™

	ITEM #	FINISH	INCAND. BULB	W	H	EXT.	HCWO	NOTES
A	45375	OZ	(2) 100W (M)	14	8.75	5.75	6.5	Ⓛ (23-30W CFL) May be installed with glass up or down.
B	45376	OZ	(3) 100W (M)	23	8.5	5.75	6	Ⓛ (23-30W CFL) May be installed with glass up or down.
C	45377	OZ	(4) 100W (M)	32.25	9	5.75	6.5	Ⓛ (23-30W CFL) May be installed with glass up or down.
D	45374	OZ	(1) 100W (M)	5	10.75	7.25	7	Ⓛ (23-30W CFL) May be installed with glass up or down.

Measurements shown in inches. U.S. & Canadian Patent Pending.

ANSONIA™

POLISHED CHROME FINISH, BRUSHED NICKEL FINISH OR OLDE BRONZE® FINISH WITH SATIN-ETCHED GLASS



A | 5446 CH, NI, OZ
Wall Sconce
NOT TO SCALE



B | 5447 CH, NI, OZ



C | 5448 CH, NI, OZ



D | 5449 CH, NI, OZ

MATCHING MIRROR

41011 NI

See page 465 or kichler.com.



ANSONIA™

ITEM #	FINISH	INCAND. BULB	W	H	EXT.	HCWO	NOTES	
A	5446	CH, NI, OZ	(1) 100W (M)	5.5	9.25	5.5	6.5	D (9-13W CFL) May be installed with glass up or down.
B	5447	CH, NI, OZ	(2) 100W (M)	14.75	8.75	5.5	6.5	D (9-13W CFL) May be installed with glass up or down.
C	5448	CH, NI, OZ	(3) 100W (M)	23	8.75	5.5	2.25	D (9-13W CFL) May be installed with glass up or down.
D	5449	CH, NI, OZ	(4) 100W (M)	31.25	8.75	5.5	2.25	D (9-13W CFL) May be installed with glass up or down.

Measurements shown in inches.



BATH

BRUSHED NICKEL FINISH



A | 5150 NI



D | 5149 NI
NOT TO SCALE



B | 5151 NI

Opal Etched Glass



C | 6083 NI

MATCHING MIRROR

41011 NI
See page 465 or kichler.com.



BATH

	ITEM #	FINISH	INCAND. BULB	W	H	EXT.	HCWO	NOTES
A	5150	NI	(3) 100W (M)	21.75	8.5	7.25	6.25	Ⓧ (9-13W CFL) May be installed with glass up or down.
B	5151	NI	(4) 100W (M)	30	8.5	7.25	2.25	Ⓧ (9-13W CFL) May be installed with glass up or down.
C	6083	NI	(3) 100W (M)	24	9	7	2.25	Ⓧ (9-13W CFL) May be installed with glass up or down.
D	5149	NI	(2) 100W (M)	13.5	8.5	7.25	6.25	Ⓧ (9-13W CFL) May be installed with glass up or down.

Measurements shown in inches.

CALLEIGH™

BRUSHED NICKEL WITH
SATIN-ETCHED CASSED OPAL GLASS



A | 45117 NI
Wall Sconce
NOT TO SCALE



B | 45118 NI



C | 45119 NI



D | 45120 NI

MATCHING MIRROR

41056 NI

See page 465 or kichler.com.



CALLEIGH™

ITEM #	FINISH	INCAND. BULB	W	H	EXT.	HCWO	NOTES
A	NI	(1) 100W (M)	6	8	7.25	4.5	Ⓢ (18-25W CFL) May be installed with glass up or down.
B	NI	(2) 100W (M)	16	8	7	5.5	Ⓢ (18-25W CFL) May be installed with glass up or down.
C	NI	(3) 100W (M)	26	8.5	7	2.5	Ⓢ (18-25W CFL) May be installed with glass up or down.
D	NI	(4) 100W (M)	34.5	9	7	2.5	Ⓢ (18-25W CFL) May be installed with glass up or down.

Measurements shown in inches.

CALLEIGH™

OLDE BRONZE® FINISH WITH
SATIN-ETCHED CASED OPAL GLASS



A | 45118 OZ



B | 45119 OZ



C | 45120 OZ



D | 45117 OZ
Wall Sconce
NOT TO SCALE

MATCHING MIRROR

41006 OZ
See page 463 or kichler.com.



CALLEIGH™

	ITEM #	FINISH	INCAND. BULB	W	H	EXT.	HCWO	NOTES
A	45118	OZ	(2) 100W (M)	16	8	7	5.5	ⓓ (18-25W CFL) May be installed with glass up or down.
B	45119	OZ	(3) 100W (M)	26	8.5	7	2.5	ⓓ (18-25W CFL) May be installed with glass up or down.
C	45120	OZ	(4) 100W (M)	34.5	9	7	2.5	ⓓ (18-25W CFL) May be installed with glass up or down.
D	45117	OZ	(1) 100W (M)	6	8	7.25	4.5	ⓓ (18-25W CFL) May be installed with glass up or down.

Measurements shown in inches.

BELLAMY™

ANTIQUE PEWTER FINISH WITH
SATIN-ETCHED CASÉ OPAL GLASS



A | 45161 AP
Wall Sconce
NOT TO SCALE



B | 45162 AP



C | 45163 AP



D | 45164 AP



E | 42164 AP
Directional Rail Light

BELLAMY™

ITEM #	FINISH	INCAND. BULB	W	H	L	EXT.	HCWO	NOTES	
A	45161	AP	(1) 60W (C/K)	6	13	---	8.75	6.25	May be installed with glass up or down. Krypton bulb included.
B	45162	AP	(2) 60W (C/K)	15	7	---	7.25	4.25	May be installed with glass up or down. Krypton bulb included.
C	45163	AP	(3) 60W (C/K)	23.75	7	---	7.25	4.25	May be installed with glass up or down. Krypton bulb included.
D	45164	AP	(4) 60W (C/K)	33	7	---	7.25	3.75	May be installed with glass up or down. Krypton bulb included.
E	42164	AP	(4) 50W (GU10)	5.5	8.75	34.25	7.5	2.75	May be ceiling or wall mounted. Halogen light source.

Measurements shown in inches.

BELLAMY™

OLDE BRONZE® FINISH WITH
UMBER-ETCHED GLASS



A | 45162 OZ



B | 45163 OZ



C | 45164 OZ



E | 45161 OZ
Wall Sconce
NOT TO SCALE



D | 42164 OZ
Directional Rail Light

BELLAMY™

	ITEM #	FINISH	INCAND. BULB	W	H	L	EXT.	HCWO	NOTES
A	45162	OZ	(2) 60W (C/K)	15	7	---	7.25	4.25	May be installed with glass up or down. Krypton bulb included.
B	45163	OZ	(3) 60W (C/K)	23.75	7	---	7.25	4.25	May be installed with glass up or down. Krypton bulb included.
C	45164	OZ	(4) 60W (C/K)	33	7	---	7.25	3.75	May be installed with glass up or down. Krypton bulb included.
D	42164	OZ	(4) 50 W (GU10)	5.5	8.75	34.25	7.5	2.75	May be ceiling or wall mounted. Halogen light source.
E	45161	OZ	(1) 60W (C/K)	6	13	---	8.75	6.25	May be installed with glass up or down. Krypton bulb included.

Measurements shown in inches.

ADAO™ ENERGY EFFICIENT

BRUSHED NICKEL FINISH WITH WHITE OPAL GLASS
OR OLDE BRONZE® FINISH WITH TINTED
LINEN ON WHITE OPAL GLASS



A | **10402 NI, OZ**
Wall Sconce
ADA Compliant
NOT TO SCALE



B | **10403 NI**
ADA Compliant

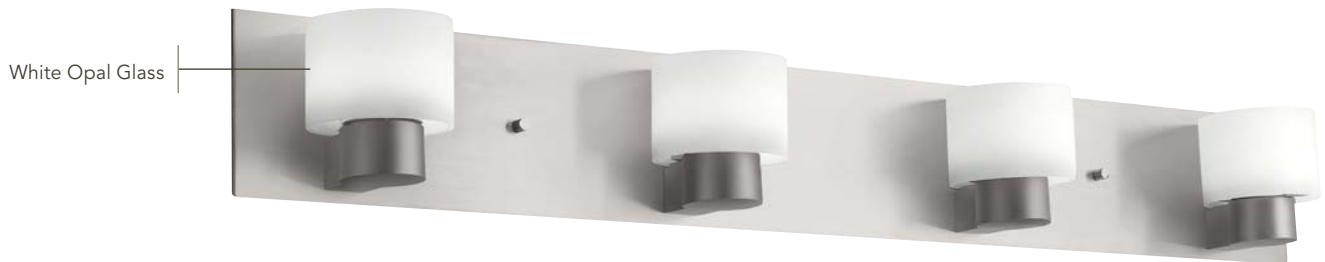

C | **10404 NI**
ADA Compliant

ADAO™ ENERGY EFFICIENT

	FLUOR. ITEM #	FINISH	FLUOR. BULB	W	H	EXT.	HCWO	NOTES
A	10402	NI, OZ	(1) 18W (GU24) (E24)	4.5	4.5	4	2.25	ADA
B	10403	NI	(3) 18W (GU24) (E24)	26	4.5	4	2.25	ADA
C	10404	NI	(4) 18W (GU24) (E24)	36	4.5	4	2.25	ADA

Measurements shown in inches.



BATH ENERGY EFFICIENT

BRUSHED NICKEL FINISH WITH WHITE OPAL GLASS



A | 10463 NI
ADA Compliant



C | 10461 NI
Wall Sconce
ADA Compliant
NOT TO SCALE



White Opal Glass

B | 10464 NI
ADA Compliant

BATH ENERGY EFFICIENT

	FLUOR. ITEM #	FINISH	FLUOR. BULB	W	H	EXT.	HCWO	NOTES
A	10463	NI	(3) 13W (GU24)	25	4.75	4	2.25	ADA
B	10464	NI	(4) 13W (GU24)	33.5	4.75	4	2.25	ADA
C	10461	NI	(1) 13W (GU24)	5	5	4	2.5	ADA

Measurements shown in inches.

CURRITUCK™

POLISHED CHROME FINISH WITH
SATIN-ETCHED CASÉD OPAL GLASS



A | 45486 CH
Wall Sconce
NOT TO SCALE



B | 45487 CH



C | 45488 CH



D | 45489 CH

CURRITUCK™

ITEM #	FINISH	INCAND. BULB	W	H	EXT.	HCWO	NOTES
A	CH	(1) 100W (M)	5.25	9.75	6.5	2.5	ⓓ (23-30W CFL)
B	CH	(2) 100W (M)	16	9.75	6.25	2.5	ⓓ (23-30W CFL)
C	CH	(3) 100W (M)	23.25	9.75	6.25	2.5	ⓓ (23-30W CFL)
D	CH	(4) 100W (M)	32.25	9.75	6.5	2.25	ⓓ (23-30W CFL)

Measurements shown in inches. U.S. & Canadian Patent Pending.

CURRITUCK™

OIL-RUBBED BRONZE FINISH WITH SATIN-ETCHED CASED OPAL GLASS



A | 45487 ORZ



B | 45488 ORZ



D | 45486 ORZ
Wall Sconce
NOT TO SCALE



C | 45489 ORZ

CURRITUCK™

	ITEM #	FINISH	INCAND. BULB	W	H	EXT.	HCWO	NOTES
A	45487	ORZ	(2) 100W (M)	16	9.75	6.25	2.5	Ⓧ (23-30W CFL)
B	45488	ORZ	(3) 100W (M)	23.25	9.75	6.25	2.5	Ⓧ (23-30W CFL)
C	45489	ORZ	(4) 100W (M)	32.25	9.75	6.5	2.25	Ⓧ (23-30W CFL)
D	45486	ORZ	(1) 100W (M)	5.25	9.75	6.5	2.5	Ⓧ (23-30W CFL)

Measurements shown in inches. U.S. & Canadian Patent Pending.

SHEILA™

CLASSIC PEWTER FINISH WITH
SATIN-ETCHED CASSED OPAL GLASS



A | 45046 CLP
Wall Sconce
NOT TO SCALE



B | 45047 CLP



C | 45048 CLP



D | 45049 CLP

SHEILA™

ITEM #	FINISH	INCAND. BULB	W	H	EXT.	HCWO	NOTES	
A	45046	CLP	(1) 100W (M)	6	8.5	7.75	5.5	ⓓ (18-25W CFL) May be installed with glass up or down.
B	45047	CLP	(2) 100W (M)	16	8.5	7.75	5.5	ⓓ (18-25W CFL) May be installed with glass up or down.
C	45048	CLP	(3) 100W (M)	24	8.5	7.75	5.5	ⓓ (18-25W CFL) May be installed with glass up or down.
D	45049	CLP	(4) 100W (M)	33	8.5	7.75	5.5	ⓓ (18-25W CFL) May be installed with glass up or down.

Measurements shown in inches. U.S. & Canadian Patent Pending.

SHEILA™

CLASSIC BRONZE FINISH WITH SATIN-ETCHED CASED OPAL GLASS



A | 45047 CLZ



B | 45048 CLZ



D | 45046 CLZ
Wall Sconce
NOT TO SCALE



C | 45049 CLZ

SHEILA™

	ITEM #	FINISH	INCAND. BULB	W	H	EXT.	HCWO	NOTES
A	45047	CLZ	(2) 100W (M)	16	8.5	7.75	5.5	Ⓚ (18-25W CFL) May be installed with glass up or down.
B	45048	CLZ	(3) 100W (M)	24	8.5	7.75	5.5	Ⓚ (18-25W CFL) May be installed with glass up or down.
C	45049	CLZ	(4) 100W (M)	33	8.5	7.75	5.5	Ⓚ (18-25W CFL) May be installed with glass up or down.
D	45046	CLZ	(1) 100W (M)	6	8.5	7.75	5.5	Ⓚ (18-25W CFL) May be installed with glass up or down.

Measurements shown in inches. U.S. & Canadian Patent Pending.

QUINCY™

CLASSIC PEWTER FINISH WITH
SATIN-ETCHED CASÉ OPAL GLASS



A | 45453 CLP
Wall Sconce
NOT TO SCALE



B | 45454 CLP



C | 45455 CLP



D | 45456 CLP

QUINCY™

ITEM #	FINISH	INCAND. BULB	W	H	EXT.	HCWO	NOTES	
A	45453	CLP	(1) 100W (M)	5.5	7.75	6.5	4	Ⓟ (23-30W CFL)
B	45454	CLP	(2) 100W (M)	12.5	7.75	6.5	4	Ⓟ (23-30W CFL)
C	45455	CLP	(3) 100W (M)	22	7.75	6.5	4	Ⓟ (23-30W CFL)
D	45456	CLP	(4) 100W (M)	26.5	7.75	6.5	4	Ⓟ (23-30W CFL)

Measurements shown in inches. U.S. & Canadian Patent Pending.

QUINCY™

CLASSIC BRONZE FINISH WITH SATIN-ETCHED CASED OPAL GLASS



A | 45454 CLZ



B | 45455 CLZ



D | 45453 CLZ
Wall Sconce
NOT TO SCALE



C | 45456 CLZ

QUINCY™

ITEM #	FINISH	INCAND. BULB	W	H	EXT.	HCWO	NOTES
A	CLZ	(2) 100W (M)	12.5	7.75	6.5	4	ⓓ (23-30W CFL)
B	CLZ	(3) 100W (M)	22	7.75	6.5	4	ⓓ (23-30W CFL)
C	CLZ	(4) 100W (M)	26.5	7.75	6.5	4	ⓓ (23-30W CFL)
D	CLZ	(1) 100W (M)	5.5	7.75	6.5	4	ⓓ (23-30W CFL)

Measurements shown in inches. U.S. & Canadian Patent Pending.

LACEY™

ANTIQUPE WETER OR MISSION BRONZE™
FINISH WITH SATIN-ETCHED CASED OPAL INNER
GLASS DIFFUSERS AND WHITE TRANSLUCENT
ORGANZA OUTER SHADES



A | 45281 AP
Wall Sconce
NOT TO SCALE



B | 45282 AP



C | 45283 AP

MATCHING COLLECTION

See entire Lacey™
Collection on pages 153-155.



D | 45284 AP



E | 45282 MIZ
NOT TO SCALE



F | 45283 MIZ



G | 45284 MIZ

LACEY™

	ITEM #	FINISH	INCAND. BULB	W	H	EXT.	HCWO	NOTES
A	45281	AP	(1) 60W (C)	5	10.75	7	6.5	Ⓚ
B	45282	AP	(2) 60W (C)	14	10	8.25	6.75	Ⓚ
C	45283	AP	(3) 60W (C)	22	10	8.25	7	Ⓚ
D	45284	AP	(4) 60W (C)	31	10	8.25	7	Ⓚ
E	45282	MIZ	(2) 60W (C)	14	10	8.25	6.75	Ⓚ
F	45283	MIZ	(3) 60W (C)	22	10	8.25	7	Ⓚ
G	45284	MIZ	(4) 60W (C)	31	10	8.25	7	Ⓚ

Measurements shown in inches. U.S. & Canadian Patent Pending.



POCELONA™

POLISHED CHROME FINISH WITH WHITE
PORCELAIN DETAILS AND CASÉD OPAL GLASS



B | 5368 CH



A | 5367 CH
Wall Sconce
NOT TO SCALE



C | 5369 CH



D | 5370 CH



E | 5371 CH

MATCHING MIRROR

41067 CH

See page 463 or kichler.com.



POCELONA™

ITEM #	FINISH	INCAND. BULB	W	H	EXT.	HCWO	NOTES	
A	5367	CH	(1) 100W (M)	5.5	9	7.5	5.25	Ⓧ May be installed with glass up or down.
B	5368	CH	(2) 100W (M)	14.5	9	6.25	6.5	Ⓧ May be installed with glass up or down.
C	5369	CH	(3) 100W (M)	24	9	7.5	2.25	Ⓧ May be installed with glass up or down.
D	5370	CH	(4) 100W (M)	33	9	7.5	2.25	Ⓧ May be installed with glass up or down.
E	5371	CH	(5) 100W (M)	36	24	9	2.25	Ⓧ

Measurements shown in inches.

JARDINE

POLISHED CHROME FINISH WITH SATIN-ETCHED CASED OPAL GLASS INNER DIFFUSERS AND WHITE TRANSLUCENT ORGANZA OUTER SHADES

MATCHING COLLECTION

See entire Jardine Collection on pages 248-251.



A | 42390 CH
Mini Pendant



C | 42307 CH
Wall Sconce
NOT TO SCALE



45291 CH Shown Horizontally as Linear Bath



45291 CH Shown Vertically as Wall Sconce

MULTI-POSITIONAL WALL SCONCE

Create two distinct lighting options with one fixture: fixture can be installed on the wall horizontally or vertically.

B | 45291 CH

Satin-Etched Glass Diffuser with Decorative Crystal



D | 45293 CH

JARDINE

ITEM #	FINISH	INCAND. BULB	W	H	OVRLL. H	STEM TILT	EXTRA WIRE	CHAIN/STEM	EXT.	HCWO	NOTES	
A	42390	CH	(1) 100W (M)	6.5	9.25	48	90°	68	36	---	---	☑ (23-30W CFL) Additional stem 2999 (12") CH.
B	45291	CH	(2) 50W (G9) Ⓡ	25	4.5	---	---	---	4.25	2.25	Ⓧ Halogen light source.	
C	42307	CH	(2) 60W (C)	16	21.5	---	---	---	8	14.5	Ⓧ	
D	45293	CH	(4) 50W (G9) Ⓡ	36.5	4.5	---	---	---	4.25	2.25	Ⓧ Halogen light source.	

Measurements shown in inches. U.S. & Canadian Patent Pending.

KAMBRY™

SMOKEY GRAY FINISH WITH
SATIN-ETCHED GLASS SHADES



Shown with Optional
Satin-Etched Glass
Shade 4118 SEG

A | 45465 SMG
Wall Sconce
NOT TO SCALE



B | 45466 SMG



C | 45467 SMG



D | 45468 SMG

MATCHING COLLECTION

See entire Kamby™
Collection on pages 308-311.



KAMBRY™

ITEM #	FINISH	INCAND. BULB	W	H	EXT.	HCWO	NOTES
A	SMG	(1) 60W (C)	4.5	14	7.5	10.5	D
B	SMG	(2) 100W (M)	13	11.25	5.75	9	D (23-30W CFL) May be installed with glass up or down. Satin-Etched Glass Shade included.
C	SMG	(3) 100W (M)	22	11.5	8	9	D (23-30W CFL) May be installed with glass up or down. Satin-Etched Glass Shade included.
D	SMG	(4) 100W (M)	30.5	11.5	6	9	D (23-30W CFL) May be installed with glass up or down. Satin-Etched Glass Shade included.

Measurements shown in inches. U.S. & Canadian Patent Pending.

LARISSA™

TANNERY BRONZE® FINISH WITH GOLD ACCENTS AND CITRINE GLASS



A | 5215 TZG



B | 5216 TZG



C | 5217 TZG



E | 5214 TZG
Wall Sconce
NOT TO SCALE



D | 5218 TZG

MATCHING COLLECTION

See entire Larissa™ Collection on pages 296-301.



LARISSA™

	ITEM #	FINISH	INCAND. BULB	W	H	EXT.	HCWO	NOTES
A	5215	TZG	(2) 100W (M)	15.5	10	7.25	7.25	ⓁⓂ (9-13W CFL) May be installed with glass up or down.
B	5216	TZG	(3) 100W (M)	22.5	10	7	7.25	ⓁⓂ (9-13W CFL) May be installed with glass up or down.
C	5217	TZG	(5) 100W (M)	36.5	10	7	3	ⓁⓂ (9-13W CFL) May be installed with glass up or down.
D	5218	TZG	(6) 100W (M)	48	10	7.25	3	ⓁⓂ (9-13W CFL) May be installed with glass up or down.
E	5214	TZG	(1) 100W (M)	5.5	10	7.25	7.25	ⓁⓂ (9-13W CFL) May be installed with glass up or down.

Measurements shown in inches.

WILTON™

CARRÉ BRONZE® FINISH WITH
ANTIQUÉ BARLEY GLASS



A | 5987 CZ
Wall Sconce
NOT TO SCALE



B | 6894 CZ
Wall Sconce



C | 5988 CZ



D | 5989 CZ



E | 5990 CZ

WILTON™

ITEM #	FINISH	INCAND. BULB	W	H	EXT.	HCWO	NOTES
A	5987 CZ	(1) 100W (M)	6.5	22.25	10	6.75	Ⓛ (23-30W CFL) May be installed with glass up or down.
B	6894 CZ	(1) 60W (C) ✓	13.5	11.25	5.5	4	Ⓛ
C	5988 CZ	(2) 100W (M)	16	10.25	8.75	5.25	Ⓛ (23-30W CFL) May be installed with glass up or down.
D	5989 CZ	(3) 100W (M)	25	10.25	8.75	4.75	Ⓛ (23-30W CFL) May be installed with glass up or down.
E	5990 CZ	(4) 100W (M)	34	10.25	8.75	4.75	Ⓛ (23-30W CFL) May be installed with glass up or down.

Measurements shown in inches.

COTTAGE GROVE™

CARRÉ BRONZE® FINISH WITH MOCHA WISP GLASS



A | 5056 CZ



B | 5057 CZ



D | 6857 CZ
Wall Sconce
NOT TO SCALE



C | 5058 CZ

COTTAGE GROVE™

ITEM #	FINISH	INCAND. BULB	W	H	EXT.	HCWO	NOTES	
A	5056	CZ	(2) 100W (M)	15.5	9.5	9.5	4.5	Ⓢ (18-25W CFL) May be installed with glass up or down.
B	5057	CZ	(3) 100W (M)	26	9.75	10	4.75	Ⓢ (18-25W CFL) May be installed with glass up or down.
C	5058	CZ	(4) 100W (M)	35.5	9.5	9.5	4.75	Ⓢ (18-25W CFL) May be installed with glass up or down.
D	6857	CZ	(1) 100W (M)	7	11.25	10.75	5.5	Ⓢ (18-25W CFL) May be installed with glass up or down.

Measurements shown in inches. U.S. Design Patent No.: D575,438

WILLOWMORE™

TANNERY BRONZE™ FINISH WITH
DISTRESSED UMBER-ETCHED GLASS



A | 5926 TZ
Wall Sconce
NOT TO SCALE



B | 3729 TZ
Flush Mount



C | 5929 TZ

MATCHING COLLECTION

See entire Willowmore™
Collection on pages 339-341.



D | 5928 TZ



E | 5927 TZ

WILLOWMORE™

ITEM #	FINISH	INCAND. BULB	W	H	OVRL. H	EXTRA WIRE	CHAIN/ STEM	EXT.	HCWO	NOTES	
A	5926	TZ	(1) 100W (M)	6.25	12.25	---	---	---	8	6.25	Ⓛ (23-30W CFL) May be installed with glass up or down.
B	3729	TZ	(1) 100W (M)	16.5	15.75	54	8	36	---	---	Ⓛ (23-30W CFL) Additional chain 2996 TZ.
C	5929	TZ	(4) 100W (M)	31.5	11	---	---	---	7.5	3.5	Ⓛ (23-30W CFL) May be installed with glass up or down.
D	5928	TZ	(3) 100W (M)	23.5	11	---	---	---	7.5	7.5	Ⓛ (23-30W CFL) May be installed with glass up or down.
E	5927	TZ	(2) 100W (M)	15.5	11	---	---	---	7.5	7.5	Ⓛ (23-30W CFL) May be installed with glass up or down.

Measurements shown in inches.

WILLOWMORE™

BRUSHED NICKEL FINISH
WITH SATIN-ETCHED GLASS



A | 3729 NI
Semi Flush

MATCHING MIRROR

41011 NI
See page 465 or kichler.com.



E | 5926 NI
Wall Sconce
NOT TO SCALE



B | 5929 NI



C | 5928 NI



D | 5927 NI

MATCHING COLLECTION

See entire Willowmore™
Collection on pages 336-338.



WILLOWMORE™

ITEM #	FINISH	INCAND. BULB	W	H	OVRL. H	EXTRA WIRE	CHAIN/STEM	EXT.	HCWO	NOTES	
A	3729	NI	(1) 100W (M)	16.5	15.75	54	8	36	---	---	Ⓜ (23-30W CFL) Additional chain 2996 NI.
B	5929	NI	(4) 100W (M)	31.5	11	---	---	7.5	3.5	Ⓜ (23-30W CFL) May be installed with glass up or down.	
C	5928	NI	(3) 100W (M)	23.5	11	---	---	7.5	7.5	Ⓜ (23-30W CFL) May be installed with glass up or down.	
D	5927	NI	(2) 100W (M)	15.5	11	---	---	7.5	7.5	Ⓜ (23-30W CFL) May be installed with glass up or down.	
E	5926	NI	(1) 100W (M)	6.25	12.25	---	---	8	6.25	Ⓜ (23-30W CFL) May be installed with glass up or down.	

Measurements shown in inches.

DURHAM™

OLDE BRONZE® FINISH WITH
LIGHT UMBER-ETCHED GLASS



A | 45064 OZ
Wall Sconce
NOT TO SCALE

MATCHING MIRROR

41011 OZ
See page 465 or kichler.com.



B | 45065 OZ



C | 45066 OZ

MATCHING COLLECTION

See entire Durham™ Collection
on pages 348-349.



D | 45067 OZ

DURHAM™

ITEM #	FINISH	INCAND. BULB	W	H	EXT.	HCWO	NOTES	
A	45064	OZ	(1) 100W (M)	5	9.5	8	4.5	Ⓢ (18-25W CFL) May be installed with glass up or down.
B	45065	OZ	(2) 100W (M)	16	10.25	9.25	5.75	Ⓢ (18-25W CFL) May be installed with glass up or down.
C	45066	OZ	(3) 100W (M)	23.25	10.25	9.25	4.5	Ⓢ (18-25W CFL) May be installed with glass up or down.
D	45067	OZ	(4) 100W (M)	32.25	10.25	9.25	4.5	Ⓢ (18-25W CFL) May be installed with glass up or down.

Measurements shown in inches.

DURHAM™

ANTIQUE PEWTER FINISH
WITH SATIN-ETCHED GLASS



A | 45065 AP

MATCHING MIRROR

41011 NI
See page 465 or kichler.com.



B | 45066 AP



D | 45064 AP
Wall Sconce
NOT TO SCALE



C | 45067 AP

MATCHING COLLECTION

See entire Durham™ Collection
on pages 346-347.



DURHAM™

ITEM #	FINISH	INCAND. BULB	W	H	EXT.	HCWO	NOTES	
A	45065	AP	(2) 100W (M)	16	10.25	9.25	5.75	Ⓧ (18-25W CFL) May be installed with glass up or down.
B	45066	AP	(3) 100W (M)	23.25	10.25	9.25	4.5	Ⓧ (18-25W CFL) May be installed with glass up or down.
C	45067	AP	(4) 100W (M)	32.25	10.25	9.25	4.5	Ⓧ (18-25W CFL) May be installed with glass up or down.
D	45064	AP	(1) 100W (M)	5	9.5	8	4.5	Ⓧ (18-25W CFL) May be installed with glass up or down.

Measurements shown in inches.

CAMERENA™

OLDE BRONZE® FINISH WITH WHITE SCAVO GLASS
AND LIGHT UMBER INSIDE TINT



A | 45421 OZ
Wall Sconce
NOT TO SCALE



B | 45422 OZ



C | 45423 OZ



D | 45424 OZ

MATCHING COLLECTION

See entire Camerena™
Collection on pages 323-325.



CAMERENA™

	ITEM #	FINISH	INCAND. BULB	W	H	EXT.	HCWO	NOTES
A	45421	OZ	(1) 100W (M)	6	12.5	8.75	8.5	ⓁⓂ (23-30W CFL) May be installed with glass up or down.
B	45422	OZ	(2) 100W (M)	18	9	8.25	5	ⓁⓂ (23-30W CFL) May be installed with glass up or down.
C	45423	OZ	(3) 100W (M)	24	9	8.25	5	ⓁⓂ (23-30W CFL) May be installed with glass up or down.
D	45424	OZ	(4) 100W (M)	36	9	8.25	5	ⓁⓂ (23-30W CFL) May be installed with glass up or down.

Measurements shown in inches.

CAMERENA™

BRUSHED NICKEL FINISH WITH
WHITE SCAVO GLASS



A | 45422 NI



B | 45423 NI



C | 45424 NI



D | 45421 NI
Wall Sconce
NOT TO SCALE

MATCHING COLLECTION

See entire Camerena™
Collection on pages 320-322.



CAMERENA™

	ITEM #	FINISH	INCAND. BULB	W	H	EXT.	HCWO	NOTES
A	45422	NI	(2) 100W (M)	18	9	8.25	5	Ⓧ (23-30W CFL) May be installed with glass up or down.
B	45423	NI	(3) 100W (M)	24	9	8.25	5	Ⓧ (23-30W CFL) May be installed with glass up or down.
C	45424	NI	(4) 100W (M)	36	9	8.25	5	Ⓧ (23-30W CFL) May be installed with glass up or down.
D	45421	NI	(1) 100W (M)	6	12.5	8.75	8.5	Ⓧ (23-30W CFL) May be installed with glass up or down.

Measurements shown in inches.



Monroe™ Wall Sconce 43170 OZ | Page 551 & Monroe™ Chandelier/Dinette 43155 OZ | Page 316

MONROE™

OLDE BRONZE® FINISH WITH
LIGHT UMBER-ETCHED GLASS



A | 45054 OZ



B | 45055 OZ



C | 45056 OZ



D | 43170 OZ
Wall Sconce
NOT TO SCALE

MATCHING COLLECTION

See entire Monroe™
Collection on pages 315-317.



MONROE™

ITEM #	FINISH	INCAND. BULB	W	H	EXT.	HCWO	NOTES	
A	45054	OZ	(2) 100W (M)	18	11.75	8	5	Ⓧ (23-30W CFL) May be installed with glass up or down.
B	45055	OZ	(3) 100W (M)	24	11.5	8	5	Ⓧ (23-30W CFL) May be installed with glass up or down.
C	45056	OZ	(4) 100W (M)	36	11.5	8	5	Ⓧ (23-30W CFL) May be installed with glass up or down.
D	43170	OZ	(1) 100W (M)	6	14	9.25	8	Ⓧ (23-30W CFL) May be installed with glass up or down.

Measurements shown in inches.

MONROE™

BRUSHED NICKEL FINISH
WITH SATIN-ETCHED GLASS



A | 43170 NI
Wall Sconce
NOT TO SCALE



B | 45054 NI



C | 45055 NI



D | 45056 NI

MATCHING COLLECTION

See entire Monroe™
Collection on pages 312-314.



MONROE™

	ITEM #	FINISH	INCAND. BULB	W	H	EXT.	HCWO	NOTES
A	43170	NI	(1) 100W (M)	6	14	9.25	8	ⓓ (23-30W CFL) May be installed with glass up or down.
B	45054	NI	(2) 100W (M)	18	11.75	8	5	ⓓ (23-30W CFL) May be installed with glass up or down.
C	45055	NI	(3) 100W (M)	24	11.5	8	5	ⓓ (23-30W CFL) May be installed with glass up or down.
D	45056	NI	(4) 100W (M)	36	11.5	8	5	ⓓ (23-30W CFL) May be installed with glass up or down.

Measurements shown in inches.

FEVILLE™

OLDE BRONZE® FINISH WITH
LIGHT UMBER-ETCHED GLASS



A | 45474 OZ



B | 45475 OZ



C | 45476 OZ



D | 45473 OZ
Wall Sconce
NOT TO SCALE

MATCHING COLLECTION

See entire Feville™
Collection on pages 318-319.



FEVILLE™

	ITEM #	FINISH	INCAND. BULB	W	H	EXT.	HCWO	NOTES
A	45474	OZ	(2) 100W (M)	18	10.5	8	5.75	Ⓧ (23-30W CFL) May be installed with glass up or down.
B	45475	OZ	(3) 100W (M)	24	10.5	8	5.75	Ⓧ (23-30W CFL) May be installed with glass up or down.
C	45476	OZ	(4) 100W (M)	36	10.5	8	5.75	Ⓧ (23-30W CFL) May be installed with glass up or down.
D	45473	OZ	(1) 100W (M)	6	11.25	8	6.25	Ⓧ (23-30W CFL) May be installed with glass up or down.

Measurements shown in inches.

WELLINGTON SQUARE™

CLASSIC PEWTER FINISH WITH SATIN-ETCHED WHITE GLASS



A | 45401 CLP
NOT TO SCALE



B | 45404 CLP



C | 45403 CLP



D | 45402 CLP

MATCHING COLLECTION

See entire Wellington Square™ Collection on pages 334-335.



MATCHING MIRROR

41011 NI

See page 465 or kichler.com.



WELLINGTON SQUARE™

ITEM #	FINISH	INCAND. BULB	W	H	EXT.	HCWO	NOTES	
A	45401	CLP	(1) 100W (M)	6	10	8	5.5	Ⓧ (23-30W CFL) May be installed with glass up or down.
B	45404	CLP	(4) 100W (M)	33	7.75	8	4.75	Ⓧ (23-30W CFL) May be installed with glass up or down.
C	45403	CLP	(3) 100W (M)	24	7.75	8	4.75	Ⓧ (23-30W CFL) May be installed with glass up or down.
D	45402	CLP	(2) 100W (M)	16	7.75	8	4.75	Ⓧ (23-30W CFL) May be installed with glass up or down.

Measurements shown in inches. U.S. & Canadian Patent Pending.

WELLINGTON SQUARE™

OLDE BRONZE® FINISH WITH SATIN-ETCHED WHITE GLASS



A | 45404 OZ



D | 45401 OZ
NOT TO SCALE



B | 45403 OZ



C | 45402 OZ

MATCHING COLLECTION

See entire Wellington Square™ Collection on pages 334-335.



MATCHING MIRROR

41011 NI
See page 465 or kichler.com.



WELLINGTON SQUARE™

ITEM #	FINISH	INCAND. BULB	W	H	EXT.	HCWO	NOTES
A	OZ	(4) 100W (M)	33	7.75	8	4.75	Ⓧ (23-30W CFL) May be installed with glass up or down.
B	OZ	(3) 100W (M)	24	7.75	8	4.75	Ⓧ (23-30W CFL) May be installed with glass up or down.
C	OZ	(2) 100W (M)	16	7.75	8	4.75	Ⓧ (23-30W CFL) May be installed with glass up or down.
D	OZ	(1) 100W (M)	6	10	8	5.5	Ⓧ (23-30W CFL) May be installed with glass up or down.

Measurements shown in inches. U.S. & Canadian Patent Pending.

WEDGEPORT™

BRUSHED NICKEL FINISH WITH SATIN-ETCHED
GLASS OR OLDE BRONZE® FINISH
WITH UMBER-ETCHED GLASS



A | 5284 NI, OZ
10636 NI, OZ
Wall Sconce



B | 5285 NI, OZ
10637 NI, OZ

C | 6086 NI, OZ
Wall Sconce



D | 5286 NI, OZ
10638 NI, OZ



E | 5287 NI, OZ
10639 NI, OZ

MATCHING COLLECTION

See entire Wedgeport™
Collection on pages 342-343.



MATCHING MIRROR

41011 NI
See page 465 or kichler.com.



WEDGEPORT™

	ITEM #	FLUOR. ITEM #	FINISH	INCAND. BULB	FLUOR. BULB	W	H	EXT.	HCWO	NOTES
A	5284	10636	NI, OZ	(1) 100W (M)	(1) 13W (GU24)	6.25	7.25	8	4.5	(18-25W CFL) May be installed with glass up or down.
B	5285	10637	NI, OZ	(2) 100W (M)	(2) 13W (GU24)	15	8.25	8.75	6	(18-25W CFL) May be installed with glass up or down.
C	6086	---	NI, OZ	(1) 75W (M) ✓	---	8.5	8.25	4.25	3.5	(18-25W CFL) May be installed with glass up or down.
D	5286	10638	NI, OZ	(3) 100W (M)	(3) 13W (GU24)	23.25	8.25	8.75	2.25	(18-25W CFL) May be installed with glass up or down.
E	5287	10639	NI, OZ	(4) 100W (M)	(4) 13W (GU24)	32	8.75	8.75	6	(18-25W CFL) May be installed with glass up or down.

Measurements shown in inches.

DOVER™

BRUSHED NICKEL OR TANNERY BRONZE™
FINISH WITH ETCHED SEEDY GLASS



A | 6322 NI, TZ



B | 6323 NI, TZ



C | 6324 NI, TZ



D | 6719 NI, TZ
Wall Sconce

MATCHING MIRROR

41011 NI
See page 465 or kichler.com.



MATCHING COLLECTION

See entire Dover™
Collection on pages 360-362.



DOVER™

ITEM #	FINISH	INCAND. BULB	W	H	EXT.	HCWO	NOTES
A	6322 NI, TZ	(2) 100W (M)	14.25	9	8	6.5	Ⓚ May be installed with glass up or down.
B	6323 NI, TZ	(3) 100W (M)	22.5	8	8	5.75	Ⓚ May be installed with glass up or down.
C	6324 NI, TZ	(4) 100W (M)	30.5	9	8	6.25	Ⓚ May be installed with glass up or down.
D	6719 NI, TZ	(1) 100W (M)	6.25	6.5	6.75	4.25	Ⓚ May be installed with glass up or down..

Measurements shown in inches.



STAFFORD™

ANTIQUE PEWTER OR OLDE BRONZE®
FINISH WITH WHITE TEXTURED GLASS



A | 5556 AP, OZ
Wall Sconce
NOT TO SCALE



B | 5557 AP, OZ



C | 5558 AP, OZ



D | 5559 AP, OZ

MATCHING COLLECTION

See entire Stafford™
Collection on pages 356-359.



MATCHING MIRROR

41011 NI, OZ
See page 465 or kichler.com.



STAFFORD™

ITEM #	FINISH	INCAND. BULB	W	H	OVRL. H	EXTRA WIRE	CHAIN/STEM	EXT.	HCWO	NOTES
A	5556	AP, OZ	(1) 100W (M)	7.5	12	---	---	9.5	6	ⓓ (9-13W CFL) May be installed with glass up or down.
B	5557	AP, OZ	(2) 100W (M)	18	9.25	---	---	9.5	7	ⓓ (9-13W CFL) May be installed with glass up or down.
C	5558	AP, OZ	(3) 100W (M)	24.25	9.25	---	---	9.5	7	ⓓ (9-13W CFL) May be installed with glass up or down.
D	5559	AP, OZ	(4) 100W (M)	33	9.25	---	---	9.5	2.25	ⓓ (9-13W CFL) May be installed with glass up or down.

Measurements shown in inches.

TANGLEWOOD™

BRUSHED NICKEL OR OLDE BRONZE®
FINISH WITH SATIN-ETCHED GLASS



A | 45902 NI, OZ



B | 45903 NI, OZ



C | 45904 NI, OZ



D | 45901 NI, OZ
Wall Sconce
NOT TO SCALE

MATCHING MIRROR

41011 NI
See page 465 or kichler.com.



MATCHING COLLECTION

See entire Tanglewood™
Collection on pages 354-355.



TANGLEWOOD™

ITEM #	FINISH	INCAND. BULB	W	H	EXT.	HCWO	NOTES
A	45902 NI, OZ	(2) 100W (M)	14.75	9.25	8.5	6.5	ⓓ (23-30W CFL) May be installed with glass up or down.
B	45903 NI, OZ	(3) 100W (M)	23.25	9.25	8.5	6.5	ⓓ (23-30W CFL) May be installed with glass up or down.
C	45904 NI, OZ	(4) 100W (M)	30.5	9.25	8.5	6.5	ⓓ (23-30W CFL) May be installed with glass up or down.
D	45901 NI, OZ	(1) 100W (M)	6	9.25	8.5	5.25	ⓓ (23-30W CFL) May be installed with glass up or down.

Measurements shown in inches. U.S. & Canadian Patent Pending.



TELFORD™* ENERGY EFFICIENT

BRUSHED NICKEL FINISH WITH
ALABASTER SWIRL GLASS OR OLDE BRONZE®
FINISH WITH UMBER-ETCHED GLASS



A | 10604 NI, OZ
Wall Sconce
NOT TO SCALE



B | 10608 NI, OZ



C | 10609 NI, OZ



















D | 10610 NI, OZ

MATCHING COLLECTION

See entire Telford®
Energy Efficient™ Collection
on pages 366-367.



TELFORD™* ENERGY EFFICIENT

	FLUOR. ITEM #	FINISH	FLUOR. BULB	W	H	EXT.	HCWO	NOTES
A	10604	NI, OZ	(1) 13W (GU24)   	7.5	12	9.25	6	 May be installed with glass up or down.
B	10608	NI, OZ	(2) 13W (GU24)   	18.5	10	9.25	5	 May be installed with glass up or down.
C	10609	NI, OZ	(3) 13W (GU24)   	24.75	10	9.25	5	 May be installed with glass up or down.
D	10610	NI, OZ	(4) 13W (GU24)   	33.5	10	9.25	5	 May be installed with glass up or down.

Measurements shown in inches.

TELFORD™*

POLISHED CHROME OR BRUSHED NICKEL FINISH WITH ALABASTER SWIRL GLASS OR OLDE BRONZE® FINISH WITH UMBER-ETCHED GLASS



A | 5992 CH, NI, OZ



B | 5993 CH, NI, OZ



C | 5994 CH, NI, OZ



D | 5991 CH, NI, OZ
Wall Sconce
NOT TO SCALE

MATCHING MIRROR

41011 OZ
See page 465 or kichler.com.



TELFORD™*

ITEM #	FINISH	INCAND. BULB	W	H	EXT.	HCWO	NOTES
A	5992 CH, NI, OZ	(2) 100W (M)	18	9	9	4	ⓐ May be installed with glass up or down.
B	5993 CH, NI, OZ	(3) 100W (M)	24.5	9	9	4	ⓐ May be installed with glass up or down.
C	5994 CH, NI, OZ	(4) 100W (M)	33.25	9	9	5	ⓐ May be installed with glass up or down.
D	5991 CH, NI, OZ	(1) 100W (M)	7.25	12	9	6	ⓐ May be installed with glass up or down.

Measurements shown in inches.



NICHOLSON™

BRUSHED NICKEL FINISH WITH
SATIN-ETCHED GLASS



A | 45881 NI
Wall Sconce
NOT TO SCALE



B | 45882 NI



C | 45883 NI



D | 45884 NI

MATCHING COLLECTION

See entire Nicholson™
Collection on pages 352-353.



NICHOLSON™

	ITEM #	FINISH	INCAND. BULB	W	H	EXT.	HCWO	NOTES
A	45881	NI	(1) 100W (M)	6	10	8.5	5	Ⓧ (18-25W CFL) May be installed with glass up or down.
B	45882	NI	(2) 100W (M)	16	10	8.5	5	Ⓧ (18-25W CFL) May be installed with glass up or down.
C	45883	NI	(3) 100W (M)	24	10	8.5	5	Ⓧ (18-25W CFL) May be installed with glass up or down.
D	45884	NI	(4) 100W (M)	33	10	8.5	5	Ⓧ (18-25W CFL) May be installed with glass up or down.

Measurements shown in inches.

NICHOLSON™

OLDE BRONZE® FINISH WITH
SATIN-ETCHED GLASS



A | 45882 OZ



B | 45883 OZ



C | 45884 OZ



D | 45881 OZ
Wall Sconce
NOT TO SCALE

MATCHING COLLECTION

See entire Nicholson™
Collection on pages 352-353.



NICHOLSON™

	ITEM #	FINISH	INCAND. BULB	W	H	EXT.	HCWO	NOTES
A	45882	OZ	(2) 100W (M)	16	10	8.5	5	Ⓧ (18-25W CFL) May be installed with glass up or down.
B	45883	OZ	(3) 100W (M)	24	10	8.5	5	Ⓧ (18-25W CFL) May be installed with glass up or down.
C	45884	OZ	(4) 100W (M)	33	10	8.5	5	Ⓧ (18-25W CFL) May be installed with glass up or down.
D	45881	OZ	(1) 100W (M)	6	10	8.5	5	Ⓧ (18-25W CFL) May be installed with glass up or down.

Measurements shown in inches.

BROADVIEW™

BRUSHED NICKEL, POLISHED CHROME
OR OLDE BRONZE® FINISH



A | 6292 NI
NOT TO SCALE



Alabaster Swirl Glass

C | 6293 NI



D | 6294 NI



B | 6482 CH
NOT TO SCALE



E | 6483 CH

MATCHING MIRROR

41011 NI

See page 465 or kichler.com.



Cased Opal Glass

F | 6484 CH



G | 6492 OZ
NOT TO SCALE



H | 6493 OZ



J | 6494 OZ

BROADVIEW™

	ITEM #	FINISH	INCAND. BULB	W	H	EXT.	HCWO	NOTES
A	6292	NI	(2) 100W (M)	18	10	8.25	2.75	Ⓧ May be installed with glass up or down.
B	6482	CH	(2) 100W (M)	18	10	8.25	2.75	Ⓧ May be installed with glass up or down.
C	6293	NI	(3) 100W (M)	24	10.5	8.5	2.75	Ⓧ May be installed with glass up or down.
D	6294	NI	(4) 100W (M)	36	9.25	9.25	2.75	Ⓧ May be installed with glass up or down.
E	6483	CH	(3) 100W (M)	24	10.5	8.5	2.75	Ⓧ May be installed with glass up or down.
F	6484	CH	(4) 100W (M)	36	9	8.5	2.75	Ⓧ May be installed with glass up or down.
G	6492	OZ	(2) 100W (M)	18	10	8.25	2.75	Ⓧ May be installed with glass up or down.
H	6493	OZ	(3) 100W (M)	24	10.5	8.5	2.75	Ⓧ May be installed with glass up or down.
J	6494	OZ	(4) 100W (M)	36	9	8.5	2.75	Ⓧ May be installed with glass up or down.

Measurements shown in inches.



BATH & VANITY

BRUSHED NICKEL OR POLISHED CHROME FINISH



A | 6121 CH, NI
Wall Sconce
NOT TO SCALE



Cased Opal Glass

B | 6122 CH, NI



C | 6123 CH, NI



D | 6124 CH, NI

BATH & VANITY

ITEM #	FINISH	INCAND. BULB	W	H	EXT.	HCWO	NOTES	
A	6121	CH, NI	(1) 100W (M)	5	8.75	7.75	5.75	ⓐ May be installed with glass up or down.
B	6122	CH, NI	(2) 100W (M)	13.5	8.5	6.75	3.75	ⓐ May be installed with glass up or down.
C	6123	CH, NI	(3) 100W (M)	18	8.75	9.25	3.25	ⓐ May be installed with glass up or down.
D	6124	CH, NI	(4) 100W (M)	25.5	8.5	10.25	3.25	ⓐ May be installed with glass up or down.

Measurements shown in inches.

BATH & VANITY

BRUSHED NICKEL, POLISHED CHROME
OR TANNERY BRONZE™ FINISH



A | 5336 CH, NI, TZ



B | 5337 CH, NI, TZ



C | 5338 CH, NI, TZ



D | 5339 CH, NI, TZ



E | 5334 CH, NI, TZ
Wall Sconce
NOT TO SCALE

Alabaster Swirl Glass

BATH & VANITY

ITEM #	FINISH	INCAND. BULB	W	H	EXT.	HCWO	NOTES
A	5336 CH, NI, TZ	(2) 100W (M)	12	8	8	3.5	ⓐ (9-13W CFL) May be installed with glass up or down.
B	5337 CH, NI, TZ	(3) 100W (M)	24	8	8	3.5	ⓐ (9-13W CFL) May be installed with glass up or down.
C	5338 CH, NI, TZ	(4) 100W (M)	30	8	8	3.5	ⓐ (9-13W CFL) May be installed with glass up or down.
D	5339 CH, NI, TZ	(5) 100W (M)	36	8	8	3.5	ⓐ (9-13W CFL) May be installed with glass up or down.
E	5334 CH, NI, TZ	(1) 100W (M)	5.25	8	8	4.25	ⓐ (9-13W CFL) May be installed with glass up or down.

Measurements shown in inches.



BATH & VANITY

BRUSHED NICKEL, POLISHED CHROME
OR TANNERY BRONZE™ FINISH



A | 6091 NI



B | 6090 NI



C | 5017 CH, NI, TZ

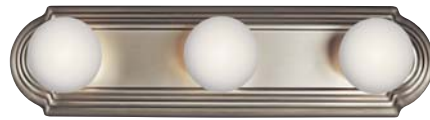

D | 5003 CH, NI, TZ



E | 5018 CH, NI, TZ



F | 5019 CH, NI, TZ

BATH & VANITY

ITEM #	FINISH	INCAND. BULB	W	H	EXT.	HCWO	NOTES	
A	6091	NI	(4) 60W (C)	36	4.5	4.75	2.25	Ⓧ G-25 lamp recommended.
B	6090	NI	(3) 60W (C)	24	4.5	4.75	2.25	Ⓧ G-25 lamp recommended.
C	5017	CH, NI, TZ	(4) 60W (M)	24	4.75	6	2.25	Ⓧ (13-15W CFL) G-25 lamp recommended.
D	5003	CH, NI, TZ	(3) 60W (M)	18	4.75	6	2.25	Ⓧ (13-15W CFL) G-25 lamp recommended.
E	5018	CH, NI, TZ	(6) 60W (M)	36	4.75	6	2.25	Ⓧ (13-15W CFL) G-25 lamp recommended.
F	5019	CH, NI, TZ	(8) 60W (M)	48	4.75	6	2.25	Ⓧ (13-15W CFL) G-25 lamp recommended.

Measurements shown in inches.



A | 623 CH, NI



B | 624 CH, NI



C | 625 CH, NI



D | 626 CH, NI



E | 628 CH, NI



F | 630 CH, NI



G | 632 CH, NI

BATH & VANITY

BRUSHED NICKEL OR
POLISHED CHROME FINISH

BATH & VANITY

ITEM #	FINISH	INCAND. BULB	W	H	EXT.	HCWO	NOTES	
A	623	CH, NI	(3) 60W (M)	18	4.5	5.5	2.25	(13-15W CFL) G-25 lamp recommended.
B	624	CH, NI	(4) 60W (M)	24	4.5	5.5	2.25	(13-15W CFL) G-25 lamp recommended.
C	625	CH, NI	(5) 60W (M)	30	4.5	5.5	2.25	(13-15W CFL) G-25 lamp recommended.
D	626	CH, NI	(6) 60W (M)	36	4.5	5.5	2.25	(13-15W CFL) G-25 lamp recommended.
E	628	CH, NI	(8) 60W (M)	48	4.5	5.5	2.25	(13-15W CFL) G-25 lamp recommended.
F	630	CH, NI	(10) 60W (M)	60	4.5	5.5	2.25	(13-15W CFL) G-25 lamp recommended.
G	632	CH, NI	(12) 60W (M)	72	4.5	5.5	2.25	(13-15W CFL) G-25 lamp recommended.

Measurements shown in inches.



ENERGY EFFICIENT

WHITE ACRYLIC DIFFUSER



A | 10697 WH



B | 10698 WH













C | 10699 WH



D | 10423 BA



E | 10424 BA

	FLUOR. ITEM #	FINISH	FLUOR. BULB	W	H	EXT.	HCWO	NOTES
A	10697	WH	(2) 17W (T8, FL) 	26.5	6	4.5	3	 May be installed on the ceiling or on the wall vertically or horizontally.
B	10698	WH	(2) 25W (T8, FL) 	38.5	6	4.5	3	 May be installed on the ceiling or on the wall vertically or horizontally.
C	10699	WH	(2) 32W (T8, FL) 	50.5	6	4.5	3	 May be installed on the ceiling or on the wall vertically or horizontally.
D	10423	BA	(1) 24W (T5, FL) 	25	4.5	3.75	2	
E	10424	BA	(1) 39W (T5, FL) 	36.75	4.5	3.75	2	

Measurements shown in inches.

LINEAR BATH



F | 10328 OZ, WH



G | 10329 OZ, WH

















H | 10330 OZ, WH



J | 10331 OZ, WH



K | 10335 OZ, WH

	FLUOR. ITEM #	FINISH	FLUOR. BULB	W	H	EXT.	HCWO	NOTES
F	10328	OZ, WH	(2) 13W (G24Q-1)  	12.75	5.75	4.25	2.75	 May be installed on the wall vertically or horizontally.
G	10329	OZ, WH	(2) 18W (G24Q-2)  	18.75	5.75	4.25	2.75	 May be installed on the wall vertically or horizontally.
H	10330	OZ, WH	(2) 17W (T8, G13)  	25.25	5.75	4.25	2.75	 May be installed on the wall vertically or horizontally.
J	10331	OZ, WH	(2) 25W (T8, G13)  	37.25	5.75	4.25	2.75	 May be installed on the wall vertically or horizontally.
K	10335	OZ, WH	(2) 32W (T8, FL)  	50	5.75	4.25	2.75	 May be installed on the wall vertically or horizontally.

Measurements shown in inches.



OUTDOOR

STYLE & SAFETY

Buzzwords abound when it comes to the beauty of your home's exterior. Curb appeal. Architectural interest. And let's not forget "location, location, location." Because, after all, there are so many places you can put the style -- and so many ways it can make your home safer and more functional at night. Our distinctive offering illuminates all those important locations with coordinated ease: entryways, driveways, pathways, decks, dining areas and more. And with more light comes more reasons to head outside -- extending the function of your outdoor spaces well after dark.





LED OUTDOOR

Kichler® LED lighting exceeds the standards for efficiency, reliability and beauty.

Long-life light emitting diodes (LED) provide approx. 40,000-hour life span to L70 (70% initial lumens) – about 15 years of standard operation – and are replaceable. Light equivalent to a 60W incandescent bulb.

True optics: pure white light and controlled beam spread with no fade or drop off of light.

High Color Rendering Index (CRI)

Standard installation



SOREL™ LED

ARCHITECTURAL BRONZE® FINISH
WITH RIBBED CLEAR GLASS



A | 49117 AZLED

Sorel™ is also
available in
Incandescent.
See pages 623



B | 49118 AZLED

LED OUTPUT

49117 OZLED	544 Lumens, 9.9 Watts 3000 Kelvin, CRI 80, 40K Life
49118 OZLED	544 Lumens, 9.9 Watts 3000 Kelvin, CRI 80, 40K Life

SOREL™ LED

	LED ITEM #	FINISH	LIGHT SOURCE	W	H	EXT.	HCWO	NOTES
A	49117 AZLED	AZ	9W	5.25	10.75	5.75	5.5	
B	49118 AZLED	AZ	9W	6.5	16	5.75	8	

Measurements shown in inches. U.S. & Canadian Patent Pending.

SEDO™ LED

ARCHITECTURAL BRONZE™, PLATINUM
OR SATIN BLACK FINISH



A | 49492 PL
Indoor/Outdoor Sconce



B | 49434 PL
Indoor/Outdoor Sconce



C | 49435 PL
Indoor/Outdoor Sconce



A | 49492 SBK
Indoor/Outdoor Sconce



B | 49434 SBK
Indoor/Outdoor Sconce



C | 49435 SBK
Indoor/Outdoor Sconce



A | **49492 AZ**
Indoor/Outdoor Sconce



B | **49434 AZ**
Indoor/Outdoor Sconce



C | **49435 AZ**
Indoor/Outdoor Sconce

SEDO™ LED

LED ITEM #	FINISH	LIGHT SOURCE	W	H	EXT.	HCWO	NOTES
A 49492	AZ, PL, SBK	16W	6	12.25	4	6.25	
B 49434	AZ, PL, SBK	39W	6	18.25	4	9	
C 49435	AZ, PL, SBK	39W	6	24.25	4	12	

LED OUTPUT

49492 AZ/PL/SBK	425 Lumens, 15 Watts, 3000 Kelvin, CRI 83, 40K Life
49434 AZ/PL/SBK	850 Lumens, 31 Watts, 3000 Kelvin, CRI 83, 40K Life
49435 AZ/PL/SBK	850 Lumens, 31 Watts, 3000 Kelvin, CRI 83, 40K Life

Measurements shown in inches. U.S. & Canadian Patent Pending.

CESYA™ LED

ARCHITECTURAL BRONZE™, PLATINUM
OR SATIN BLACK FINISH



A | **49494 PL**
Indoor/Outdoor Sconce



B | **49436 PL**
Indoor/Outdoor Sconce



C | **49437 PL**
Indoor/Outdoor Sconce



A | **49494 SBK**
Indoor/Outdoor Sconce



B | **49436 SBK**
Indoor/Outdoor Sconce



C | **49437 SBK**
Indoor/Outdoor Sconce



A | **49494 AZ**
Indoor/Outdoor Sconce



B | **49436 AZ**
Indoor/Outdoor Sconce



C | **49437 AZ**
Indoor/Outdoor Sconce



Side View

CESYA™ LED

	LED ITEM #	FINISH	LIGHT SOURCE	W	H	EXT.	HCWO	NOTES
A	49494	AZ, PL, SBK	16W	6	12	4.75	6	
B	49436	AZ, PL, SBK	32.5W	6	18	4.75	9	
C	49437	AZ, PL, SBK	39W	6	24	4.75	12	

LED OUTPUT

49494 AZ/PL/SBK	425 Lumens, 15 Watts, 3000 Kelvin, CRI 83, 40K Life
49436 AZ/PL/SBK	708 Lumens, 25 Watts, 3000 Kelvin, CRI 83, 40K Life
49437 AZ/PL/SBK	850 Lumens, 31 Watts, 3000 Kelvin, CRI 83, 40K Life

Measurements shown in inches. U.S. & Canadian Patent Pending.

MAYA PALM™ LED

AGED BRONZE FINISH



A | 49248 AGZLED



B | 49249 AGZLED

TAKIL™ LED

AGED BRONZE FINISH



C | 49250 AGZLED



D | 49251 AGZLED

LED OUTPUT

49248 AGZLED	273 Lumens, 9.4 Watts 3000 Kelvin, CRI 83, 40K Life
49249 AGZLED	346 Lumens, 12.1 Watts 3000 Kelvin, CRI 83, 40K Life
49250 AGZLED	273 Lumens, 9.4 Watts 3000 Kelvin, CRI 83, 40K Life
49251 AGZLED	346 Lumens, 12.1 Watts 3000 Kelvin, CRI 83, 40K Life

MAYA PALM™ LED & TAKIL™ LED

CAST ALUMINUM
CONSTRUCTION

	LED ITEM #	FINISH	LIGHT SOURCE	W	H	EXT.	HCWO	NOTES
A	49248 AGZLED	AGZ	9.4W	7.75	10.75	5.75	3.25	
B	49249 AGZLED	AGZ	12.1W	9.5	13.25	6.75	4	
C	49250 AGZLED	AGZ	9.4W	8	10.25	6.5	4.5	
D	49251 AGZLED	AGZ	12.1W	10	12.75	7.75	4.75	

Measurements shown in inches. U.S. & Canadian Patent Pending.

FRANCEASI™ LED

OLDE BRONZE® FINISH



A | 49229 OZLED



B | 49228 OZLED



C | 49227 OZLED

LED OUTPUT

49226 OZLED	273 Lumens, 9.4 Watts 3000 Kelvin, CRI 83, 40K Life
49227 OZLED	273 Lumens, 9.4 Watts 3000 Kelvin, CRI 83, 40K Life
49228 OZLED	346 Lumens, 12.1 Watts 3000 Kelvin, CRI 83, 40K Life
49229 OZLED	346 Lumens, 12.1 Watts 3000 Kelvin, CRI 83, 40K Life



D | 49226 OZLED

Open Filigree
Lantern Back

MATCHING COLLECTION

See matching Incandescent
Lanterns on pages 650-651.



FRANCEASI™ LED

	LED ITEM #	FINISH	LIGHT SOURCE	W	H	EXT.	HCWO	NOTES
A	49229 OZLED	OZ	12.1W	10	25	12.25	8.75	
B	49228 OZLED	OZ	12.1W	8.5	22	10.5	7.5	
C	49227 OZLED	OZ	9.4W	7	18	9	5.75	
D	49226 OZLED	OZ	9.4W	5.5	14.5	7.25	4.5	

CAST ALUMINUM
CONSTRUCTION

Measurements shown in inches. U.S. & Canadian Patent Pending.

MOUNT VERNON LED

OLDE BRONZE® FINISH OVER SOLID BRASS
WITH ETCHED SEEDY GLASS



A | 9707 OZLED



B | 9708 OZLED



C | 9809 OZLED
Outdoor Pendant

Mount Vernon
is also available in
Incandescent and
Energy Efficient
versions. See pages
692-696

LED OUTPUT

9707 OZLED	584 Lumens, 9.9 Watts 3000 Kelvin, CRI 80, 40K Life
9708 OZLED	584 Lumens, 9.9 Watts 3000 Kelvin, CRI 80, 40K Life
9709 OZLED	584 Lumens, 9.9 Watts 3000 Kelvin, CRI 80, 40K Life
9809 OZLED	584 Lumens, 9.9 Watts 3000 Kelvin, CRI 80, 40K Life
9909 OZLED	584 Lumens, 9.9 Watts 3000 Kelvin, CRI 80, 40K Life



D | 9709 OZLED



E | 9909 OZLED
Post Lantern

MOUNT VERNON LED

	LED ITEM #	FINISH	LIGHT SOURCE	W	H	OVRLL. H	EXTRA WIRE	CHAIN/STEM	EXT.	HCWO	NOTES
A	9708 OZLED	OZ	9W	7.5	16.75	---	---	---	8.25	6.75	
B	9709 OZLED	OZ	9W	9.5	19.5	---	---	---	10.25	7.25	
C	9707 OZLED	OZ	9W	5.75	12.5	---	---	---	6.25	5.25	
D	9809 OZ LED	OZ	9W	9.5	18.5	93	28	72	---	---	Additional chain 2996 OZ.
E	9909 OZLED	OZ	9W	9.5	20.75	---	---	---	---	---	

Measurements shown in inches.

LED OUTPUT

49065 OZLED	485 Lumens, 9.9 Watts 3000 Kelvin, CRI 80, 40K Life
49067 OZLED	485 Lumens, 9.9 Watts 3000 Kelvin, CRI 80, 40K Life

HATTERAS BAY™ LED

OLDE BRONZE® FINISH WITH
CLEAR FRESNEL GLASS



A | 49067 OZLED



B | 49065 OZLED

Hatteras Bay™ is also available in Incandescent. See page 585

LED OUTPUT

11250 AZT/BKT	374 Lumens, 11 Watts 3000 Kelvin, CRI 85, 40K Life
11251 AZT/BKT	574 Lumens, 15 Watts 3000 Kelvin, CRI 85, 40K Life
11077 AZT/BKT	425 Lumens, 16 Watts 3000 Kelvin, CRI 84, 40K Life

LED

TEXTURED ARCHITECTURAL BRONZE™
OR TEXTURED BLACK FINISH



C | 11251 AZT, BKT



D | 11250 AZT, BKT
Dark Sky Compliant



E | 11077 AZT, BKT
Dark Sky Compliant

HATTERAS BAY™ LED & LED

LED ITEM #	FINISH	LIGHT SOURCE	W	H	EXT.	HCWO	NOTES	
A	49067 OZLED	OZ	9W	10.5	10.25	11.75	4	W C
B	49065 OZLED	OZ	9W	8.75	9.5	10	3.5	W C
C	11251	AZT, BKT	4.89W Uplight / 9.78W Downlight LED	5	12.25	6.5	6.25	W
D	11250	AZT, BKT	11.23W LED	5	7	6.5	3.25	W C
E	11077	AZT, BKT	(6) 15.42W	5	5.5	6	2.75	W C

Measurements shown in inches. U.S. & Canadian Patent Pending.

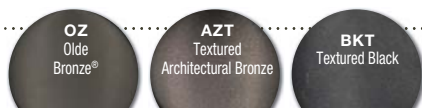

OUTDOOR ENERGY EFFICIENT

DISTRESSED COPPER FINISH



A | 10924 DCO















B | 10926 DCO



C | 10925 DCO

OUTDOOR ENERGY EFFICIENT

ALUMINUM
CONSTRUCTION

	FLUOR. ITEM #	FINISH	FLUOR. BULB	W	H	EXT.	HCWO	NOTES
A	10924	DCO	(1) 13W (GU24)  	5	9.25	7.5	5.25	 
B	10926	DCO	(1) 18W (GU24)  	9	14.5	12	7.75	 
C	10925	DCO	(1) 13W (GU24)  	7	11	9	6	 

Measurements shown in inches.

HATTERAS BAY™

OLDE BRONZE® FINISH WITH
CLEAR FRESNEL GLASS



A | 49064 OZ



Can be converted
to Dark Sky by
installing fresnel
glass inward

Hatteras Bay™
is also
available
in LED.
See page 583.



B | 49065 OZ



C | 49067 OZ

HATTERAS BAY™

ALUMINUM &
SOLID BRASS
CONSTRUCTION

ITEM #	FINISH	INCAND. BULB	W	H	EXT.	HCWO	NOTES
A	OZ	(1) 60W (M)	6.5	8	8.75	3.5	Ⓜ Dark Sky compliant when fresnel lens is installed inward.
B	OZ	(1) 75W (M)	8.75	9.5	10	3.5	Ⓜ Ⓜ OD (9-13W CFL) Dark Sky compliant when fresnel lens is installed inward.
C	OZ	(1) 100W (M)	10.5	10.25	11.75	4	Ⓜ Ⓜ OD (23-30W CFL) Dark Sky compliant when fresnel lens is installed inward.

Measurements shown in inches. U.S. & Canadian Patent Pending.

HANFORD™

ANVIL IRON FINISH WITH
CLEAR SEEDY GLASS



Vintage
Squirrel Cage
Filament Bulb,
60W Medium
Base

4071 CLR



A | 49093 AVI
Outdoor Pendant
LE



B | 49094 AVI
Outdoor Pendant
LE



C | 49008 AVI
Post Lantern

Shown with Black
Post 9506 BK



D | 49006 AVI



E | 49007 AVI

HANFORD™

CAST ALUMINUM
CONSTRUCTION

ITEM #	FINISH	INCAND. BULB	W	H	OVRL. H	EXTRA WIRE	CHAIN/STEM	EXT.	HCWO	NOTES
A	AVI	(1) 60W (M)	7.75	16.25	91	23	72	---	---	Ⓧ Ⓧ OD (13-15W CFL) Additional chain 4927 AVI.
B	AVI	(1) 100W (M)	9.5	19.25	94	23	72	---	---	Ⓧ Ⓧ OD (23-30W CFL) Additional chain 4927 AVI.
C	AVI	(1) 100W (M)	9.5	20	---	---	---	---	---	Ⓧ Ⓧ OD (23-30W CFL)
D	AVI	(1) 60W (M)	7.5	14.5	---	---	---	6.75	11.25	Ⓧ Ⓧ OD (13-15W CFL)
E	AVI	(1) 100W (M)	9.5	18	---	---	---	8.5	13.5	Ⓧ Ⓧ OD (23-30W CFL)

Measurements shown in inches. U.S. & Canadian Patent Pending.

LYNDON™

ARCHITECTURAL BRONZE™ FINISH
WITH CLEAR SEEDY GLASS



A | 49447 AZ
Outdoor Pendant
LE



B | 49446 AZ
Outdoor Pendant
LE



Vintage
Squirrel Cage
Filament Bulb,
60W Medium
Base

4071 CLR



C | 49444 AZ
NOT TO SCALE

Can Only Be
Mounted with
Glass Facing Down
for Outdoor Use



D | 49445 AZ
NOT TO SCALE

LYNDON™

CAST ALUMINUM
CONSTRUCTION

ITEM #	FINISH	INCAND. BULB	W	H	OVRL. H	EXTRA WIRE	CHAIN/STEM	EXT.	HCWO	NOTES
A	AZ	(1) 100W (M)	6	11.75	50	71	36	---	---	Ⓧ OD (23-30W CFL) Add. chain 4927 AZ, add. stem 2999 (12") AZ. Indoor/Outdoor.
B	AZ	(1) 75W (M)	5	9.5	48	72	36	---	---	Ⓧ OD (18-25W CFL) Add. chain 4927 AZ, add. stem 2999 (12") AZ. Indoor/Outdoor.
C	AZ	(1) 75W (M)	5	11.25	---	---	---	7.5	3.75	Ⓧ OD (18-25W CFL) Indoor/Outdoor.
D	AZ	(1) 100W (M)	6	15	---	---	---	8	5	Ⓧ OD (23-30W CFL) Indoor/Outdoor.

Measurements shown in inches. U.S. & Canadian Patent Pending. Suitable for indoor use with glass facing up or down.

CONCORD

OLDE BRICK® FINISH WITH SEEDY GLASS



A | 9477 OB



B | 9478 OB



C | 9479 OB



Shown with Black Post 9506 BK

D | 9979 OB Post Lantern

CONCORD

SOLID BRASS
CONSTRUCTION

ITEM #	FINISH	INCAND. BULB	W	H	EXT.	HCWO	NOTES	
A	9477	OB	(1) 100W (M)	4.75	10.75	5	3.25	W E OD (23-30W CFL)
B	9478	OB	(1) 100W (M)	6.25	14.25	6.5	3.5	W E OD (23-30W CFL)
C	9479	OB	(1) 100W (M)	8	17	8.25	3.75	W E OD (23-30W CFL)
D	9979	OB	(1) 100W (M)	7.75	19.75	---	---	W E OD (23-30W CFL)

Measurements shown in inches.

RUSTIC™

RUSTIC™ FINISH OVER SOLID BRASS WITH CLEAR BEVELED GLASS PANELS



A | 9761 RST



B | 9760 RST



C | 9759 RST



D | 9762 RST



E | 9870 RST
Outdoor Pendant



Shown with Black Post 9506 BK

F | 9962 RST
Post Lantern

RUSTIC™

SOLID BRASS
CONSTRUCTION

ITEM #	FINISH	INCAND. BULB	W	H	OVRL. H	EXTRA WIRE	CHAIN/STEM	EXT.	HCWO	NOTES
A	9761	RST	(1) 150W (M)	9.5	17.75	---	---	10.5	7	W E OD (23-30W CFL)
B	9760	RST	(1) 100W (M)	7	13.25	---	---	7.75	5.5	W E OD (23-30W CFL)
C	9759	RST	(1) 100W (M)	6	10	---	---	6.75	2.5	W E OD (23-30W CFL)
D	9762	RST	(1) 150W (M)	11	20.25	---	---	11.75	8	W E OD (23-30W CFL)
E	9870	RST	(1) 150W (M)	11	17.75	92	32	72	---	D E OD (23-30W CFL) Additional chain 2996 RST.
F	9962	RST	(1) 150W (M)	9.5	18.5	---	---	---	---	W E OD (23-30W CFL)

Measurements shown in inches.

SOUTH HOPE™

RUBBED BRONZE™ FINISH WITH
SATIN-ETCHED CASED OPAL GLASS



A | 49474 RZ



B | 49476 RZ

Cylindrical
Glass Diffuser



C | 49475 RZ

CONVERTIBLE

Post Lantern & Column Mount
Lantern Installation Options.
Hardware included.



Shown with
Architectural
Bronze Post
9506 AZ

D | 49478 RZ
Post Lantern

SOUTH HOPE™

CAST ALUMINUM
CONSTRUCTION

ITEM #	FINISH	INCAND. BULB	W	H	EXT.	HCWO	NOTES	
A	49474	RZ	(1) 60W (C)	5.5	11.75	6.25	7.25	⚠ B-type lamp recommended.
B	49476	RZ	(1) 100W (M)	9	19.75	9.5	---	⚠ OD (23-30W CFL) Variable height mounting hardware included, Junction box 10"-13.25".
C	49475	RZ	(1) 60W (M)	7	17.75	7.75	9.5	⚠ OD (13-15W CFL) T-type lamp recommended.
D	49478	RZ	(1) 100W (M)	9	21.5	---	---	⚠ OD (23-30W CFL) Convertible from post to column mount.

Measurements shown in inches. U.S. & Canadian Patent Pending.

LINDSTROM™

RUBBED BRONZE™ FINISH WITH CLEAR BEVELED GLASS AND INSIDE SATIN-ETCHED CASED OPAL GLASS CYLINDRICAL DIFFUSER



A | 49402 RZ



B | 49401 RZ



C | 49400 RZ



D | 49403 RZ
Outdoor Pendant



E | 49404 RZ
Post Lantern

LINDSTROM™

CAST ALUMINUM
CONSTRUCTION

ITEM #	FINISH	INCAND. BULB	W	H	OVRL. H	L	EXTRA WIRE	CHAIN/STEM	EXT.	HCWO	NOTES
A	49402	RZ	(1) 100W (M)	9	14	---	---	---	8	2.5	Ⓜ Ⓜ OD (23-30W CFL) A15 or B type lamp required.
B	49401	RZ	(1) 60W (M)	7	11	---	---	---	6.75	2.5	Ⓜ Ⓜ OD (9-13W CFL) A15 or B type lamp required.
C	49400	RZ	(1) 60W (M)	5.75	9	---	---	---	6.5	2.5	Ⓜ Ⓜ OD (9-13W CFL) A15 or B type lamp required.
D	49403	RZ	(1) 100W (M)	6.75	14.5	53	9	68	36	---	Ⓜ Ⓜ OD (23-30W CFL) Additional chain 4927 AGZ, additional stem 2999 (12") AGZ.
E	49404	RZ	(1) 100W (M)	6.75	16.5	---	9	---	---	---	Ⓜ Ⓜ OD (23-30W CFL)

Measurements shown in inches. U.S. & Canadian Patent Pending.

SEASIDE™

BLACK, BRUSHED NICKEL, OLDE BRICK®,
OLDE BRONZE® OR WHITE FINISH



A | 2621 NI
Outdoor Pendant



B | 9021 BK, NI,
OB, OZ

COORDINATING CEILING FAN

See the full line of Kichler®
Ceiling Fans in catalog K414
or visit kichler.com



C | 310131 NI, OZ



D | 9044 NI



D | 9044 OB



E | 9022 BK, NI,
OB, OZ, WH

MATCHING LANDSCAPE LIGHTING

15438 OZ | Path Light
See the complete line of
Kichler® Landscape Lighting at
LandscapeLighting.com



F | 11098 NI



G | 11099 NI



H | 9023 BK, NI,
OB, OZ

SEASIDE™

ALUMINUM
CONSTRUCTION

ITEM #	FLUOR. ITEM #	FINISH	INCAND. BULB	FLUOR. BULB	W	H	OVRLL. H	STEM TILT	EXTRA WIRE	CHAIN/STEM	EXT.	HCWO	NOTES	
A	2621	---	NI	(1) 100W (M)	---	8	9.75	48	45° (12:12)	68	36	---	---	D OD (18-25W CFL) Add. stem 2999 (12") NI and/or 2997 (24") NI, G-type lamp rec.
B	9021	---	BK, NI, OB, OZ	(1) 60W (M)	---	6	7.5	---	---	---	6.5	2.25	---	W G-type lamp recommended.
C	310131	---	NI, OZ	---	---	---	---	---	---	---	---	---	---	W See the full line of Kichler® Ceiling Fans in catalog K414 or visit kichler.com .
D	9044	---	NI, OB	(1) 150W (M)	---	11	8	---	---	---	11.5	2.5	---	W G-type lamp recommended.
E	9022	---	BK, NI, OB, OZ, WH	(1) 100W (M)	---	8	12	---	---	---	9	6	---	W G-type lamp recommended.
F	---	11098	NI	---	(1) 14W (GU24) T9 T24	8	12	---	---	---	9.25	6	---	W PBCFA14 decorative bulb included.
G	---	11099	NI	---	(1) 14W (GU24) T9 T24	10.5	14.25	---	---	---	12	9	---	W PBCFA14 decorative bulb included.
H	9023	---	BK, NI, OB, OZ	(1) 150W (M)	---	10.25	14.25	---	---	---	11.5	8.75	---	W G-type lamp recommended.

Measurements shown in inches. U.S. Patent Design No. D382079; C. D383239; F.



RIPLEY™

OLDE BRONZE® FINISH



A | 49062 OZ
Outdoor Pendant



B | 49060 OZ



C | 49059 OZ



D | 49063 OZ
Post Lantern

Shown with
Architectural Bronze™
Post 9506 AZ



E | 49061 OZ

RIPLEY™

ALUMINUM
CONSTRUCTION

ITEM #	FINISH	INCAND. BULB	W	H	OVRLL. H	EXTRA WIRE	CHAIN/STEM	EXT.	HCWO	NOTES
A	49062	OZ (1) 40W (Type R) or 60W (G Type)	10	8	46	107	36	---	---	D C Dark sky compliant with use of R14, 40W bulb. Additional chain 4927 OZ, additional stem 2999 (12") OZ.
B	49060	OZ (1) 40W (Type R) or 60W (G Type)	10	9	---	---	---	11.25	3	W C Dark sky compliant with use of R14, 40W bulb.
C	49059	OZ (1) 40W (Type R) or 60W (G Type)	8	7.5	---	---	---	9.25	2.5	W C Dark sky compliant with use of R14, 40W bulb.
D	49063	OZ (1) 40W (Type R) or 60W (G Type)	12	16	---	---	---	---	---	W C Dark sky compliant with use of R14, 40W bulb.
E	49061	OZ (1) 40W (Type R) or 60W (G Type)	12	10	---	---	---	13	3.25	W C Dark sky compliant with use of R14, 40W bulb.

Measurements shown in inches. U.S. & Canadian Patent Pending.

RIVERA™

PLATINUM FINISH WITH
SATIN-ETCHED CASÉ OPAL GLASS



A | 49467 PL



B | 49468 PL



C | 49469 PL

RIVERA™

CAST ALUMINUM
CONSTRUCTION

ITEM #	FINISH	INCAND. BULB	W	H	OVRL. H	L	EXTRA WIRE	CHAIN/STEM	EXT.	HCWO	NOTES	
A	49467	PL	(1) 50W (G9)	5	10.25	---	---	---	---	4.75	5.5	W
B	49468	PL	(1) 75W (M)	6.5	13.25	---	---	---	---	6	7	W OD (18-25W CFL)
C	49469	PL	(1) 100W (M)	8	16.25	---	---	---	---	7	9	W OD (23-30W CFL)
D	49470	PL	(1) 150W (M)	10	20	---	---	---	---	9	11	W OD (30-52W CFL)
E	49472	PL	(1) 100W (M)	5.5	19.5	58	10	60	36	---	---	D OD (23-30W CFL) Additional stem 2999 (12") PL.
F	9557	PL	(1) 100W (M)	10.5	6.25	---	---	---	---	---	---	D OD (23-30W CFL)
G	49471	PL	(1) 150W (M)	5.75	22.25	---	10	---	---	---	---	W OD (30-52W CFL)

Measurements shown in inches. U.S. & Canadian Patent Pending.



D | 49470 PL



E | 49472 PL
Outdoor Pendant



F | 9557 PL
Outdoor Ceiling



Shown with
Brushed
Aluminum Post
9506 BA

G | 49471 PL
Post Lantern

RIVERA™

ARCHITECTURAL BRONZE™ FINISH WITH
SATIN-ETCHED CASÉ OPAL GLASS



A | 49467 AZ



B | 49468 AZ



C | 49469 AZ

RIVERA™

CAST ALUMINUM
CONSTRUCTION

ITEM #	FINISH	INCAND. BULB	W	H	OVRL. H	L	EXTRA WIRE	CHAIN/STEM	EXT.	HCWO	NOTES	
A	49467	AZ	(1) 50W (G9)	5	10.25	---	---	---	4.75	5.5	W	
B	49468	AZ	(1) 75W (M)	6.5	13.25	---	---	---	6	7	W OD (18-25W CFL)	
C	49469	AZ	(1) 100W (M)	8	16.25	---	---	---	7	9	W OD (23-30W CFL)	
D	49470	AZ	(1) 150W (M)	10	20	---	---	---	9	11	W OD (30-52W CFL)	
E	49472	AZ	(1) 100W (M)	5.5	22.25	58	10	60	36	---	---	D OD (23-30W CFL) Additional stem 2999 (12") AZ.
F	9557	AZ	(1) 100W (M)	10.5	6.25	---	---	---	---	---	---	D OD (23-30W CFL)
G	49471	AZ	(1) 150W (M)	5.75	22.25	---	10	---	---	---	---	W OD (30-52W CFL)

Measurements shown in inches. U.S. & Canadian Patent Pending.



D | 49470 AZ



E | 49472 AZ
Outdoor Pendant



F | 9557 AZ
Outdoor Ceiling



Shown with
Architectural
Bronze™ Post
9506 AZ

G | 49471 AZ
Post Lantern

PACIFIC EDGE™

POLISHED STAINLESS STEEL MARINE GRADE 316
WITH SATIN-ETCHED CASSED OPAL GLASS



A | 49344 PSS316



B | 49345 PSS316



C | 49346 PSS316

LifeBrite™
BY KICHLER®

MARINE GRADE 316
STAINLESS STEEL
CONSTRUCTION

PACIFIC EDGE™

ITEM #	FINISH	INCAND. BULB	W	H	OVRL. H	EXTRA WIRE	CHAIN/STEM	EXT.	HCWO	NOTES	
A	49344	PSS316	(1) 75W (M)	6	10.5	---	---	---	6.5	7	W E OD (18-25W CFL)
B	49345	PSS316	(1) 100W (M)	8	13	---	---	---	8.75	9.25	W E OD (23-30W CFL)
C	49346	PSS316	(1) 150W (M)	9.5	16	---	---	---	10.25	11.5	W E OD (30-52W CFL)
D	49349	PSS316	(1) 150W (M)	9.5	19	---	---	---	---	---	W E OD (30-52W CFL)
E	49347	PSS316	(1) 75W (M)	6	11.5	50	65	36	---	---	D E OD (18-25W CFL) Additional chain 2996 PSS316, additional stem 2999 (12") PSS316.
F	49348	PSS316	(1) 100W (M)	8	13.5	52	64	36	---	---	D E OD (23-30W CFL) Additional chain 2996 PSS316, additional stem 2999 (12") PSS316.
G	9557	PSS316	(1) 100W (M)	10.5	6.25	---	---	---	---	---	D E OD (23-30W CFL)

Measurements shown in inches. U.S. & Canadian Patent Pending. LifeBrite™ Finish has a lifetime finish guarantee to withstand the harshest elements, salt air and extreme weather conditions.



D | 49349 PSS316
Post Lantern

Shown with
Brushed Aluminum
Post 9506 BA



E | 49348 PSS316
Outdoor Pendant



F | 49347 PSS316
Outdoor Pendant



G | 9557 PSS316
Outdoor Ceiling

PACIFIC EDGE™

ARCHITECTURAL BRONZE™ FINISH WITH
SATIN-ETCHED CASÉD OPAL GLASS



A | 49344 AZ



B | 49345 AZ



C | 49346 AZ

PACIFIC EDGE™

CAST ALUMINUM
CONSTRUCTION

ITEM #	FINISH	INCAND. BULB	W	H	OVRL. H	EXTRA WIRE	CHAIN/STEM	EXT.	HCWO	NOTES	
A	49344	AZ	(1) 75W (M)	6	10.5	---	---	---	6.5	7	W E OD (18-25W CFL)
B	49345	AZ	(1) 100W (M)	8	13	---	---	---	8.75	9.25	W E OD (23-30W CFL)
C	49346	AZ	(1) 150W (M)	9.5	16	---	---	---	10.25	11.5	W E OD (30-52W CFL)
D	49349	AZ	(1) 150W (M)	9.5	19	---	---	---	---	---	W E OD (30-52W CFL)
E	49347	AZ	(1) 75W (M)	6	11.5	50	65	36	---	---	D E OD (18-25W CFL) Additional chain 2996 AZ, additional stem 2999 (12") AZ.
F	49348	AZ	(1) 100W (M)	8	13.5	52	64	36	---	---	D E OD (23-30W CFL) Additional chain 2996 AZ, additional stem 2999 (12") AZ.
G	9557	AZ	(1) 100W (M)	10.5	6.25	---	---	---	---	---	D E OD (23-30W CFL)

Measurements shown in inches. U.S. & Canadian Patent Pending.



D | 49349 AZ
Post Lantern

Shown with
Architectural
Bronze™ Post
9506 AZ



E | 49348 AZ
Outdoor Pendant



F | 49347 AZ
Outdoor Pendant



G | 9557 AZ
Outdoor Ceiling

CELINO™

BRUSHED ALUMINUM OR BLACK
WITH WHITE-ETCHED OPAL GLASS



A | 9109 BA



A | 9109 BK

NEWPORT™

ARCHITECTURAL BRONZE™, BRUSHED
NICKEL OR POLISHED STAINLESS STEEL
MARINE GRADE 316 FINISH WITH WHITE
ACRYLIC DIFFUSER AND HOUSING

White Acrylic Diffuser
and Housing



B | 6040 AZ
ADA Compliant



B | 6040 NI
10640 NI
ADA Compliant



B | 6040 PSS316
ADA Compliant



C | 6048 AZ
ADA Compliant



C | 6048 NI
ADA Compliant



C | 6048 PSS316
ADA Compliant

White Acrylic Diffuser
and Housing

LifeBrite™
BY KICHLER®
MARINE GRADE 316
STAINLESS STEEL
CONSTRUCTION

CELINO™ & NEWPORT™

ITEM #	FLUOR. ITEM #	FINISH	INCAND. BULB	FLUOR. BULB	W	H	EXT.	HCWO	NOTES
A	9109	---	(1) 100W (M)	---	5	13.25	5	10.25	WADA OD (23-30W CFL)
B	6040	AZ, NI, PSS316	(1) 30W CFL (M) or (1) 60W INCAND. (M)	(1) 18W (GU24)	9.25	10.25	3.75	5.25	WADA PSS316: 316 marine grade stainless steel/polycarbonate construction. AZ: Powder coated aluminum/polycarbonate construction, NI: 304 stainless steel/polycarbonate construction.
C	6048	AZ, NI, PSS316	(2) 30W CFL (M) or (2) 40W INCAND. (M)	---	9.25	15.25	3.75	5	WADA PSS316: 316 marine grade stainless steel/polycarbonate construction. AZ: Powder coated aluminum/polycarbonate construction, NI: 304 stainless steel/polycarbonate construction.

Measurements shown in inches. LifeBrite™ Finish has a lifetime finish guarantee to withstand the harshest elements, salt air and extreme weather conditions.

ZOLDER™

ARCHITECTURAL BRONZE™ FINISH
OR POLISHED STAINLESS STEEL
MARINE GRADE 316 FINISH WITH
SATIN-ETCHED CASED OPAL GLASS

Aluminum
Construction

Also Suitable
for Indoor Use.

Polished Stainless
Steel Marine
Grade 316



A | 49151 AZ



B | 49149 AZ



A | 49151 PSS316



B | 49149 PSS316

ALUMINUM
CONSTRUCTION

LifeBrite™
BY KICHLER®

MARINE GRADE 316
STAINLESS STEEL
CONSTRUCTION

ZOLDER™

	ITEM #	FINISH	INCAND. BULB	W	H	EXT.	HCWO	NOTES
A	49151	AZ	(2) 60W (K)	4.5	26.5	4.25	13.25	Krypton light source. Indoor/Outdoor.
B	49149	AZ	(1) 60W (K)	4.5	17	4.5	10.75	Krypton light source. Indoor/Outdoor.

Measurements shown in inches. U.S. & Canadian Patent Pending. LifeBrite™ Finish has a lifetime finish guarantee to withstand the harshest elements, salt air and extreme weather conditions.



TREMILLO™

BLACK FINISH WITH SATIN-ETCHED
CASED OPAL GLASS



A | 49206 BK
49206 BKFL
Outdoor Ceiling



B | 49200 BK
49200 BKFL



C | 49202 BK
49202 BKFL



D | 49203 BK
49203 BKFL

TREMILLO™

ITEM #	FLUOR. ITEM #	FINISH	INCAND. BULB	FLUOR. BULB	W	H	EXT.	HCWO	NOTES
A	49206 BKFL	BK	(2) 60W (M)	(2) 18W (GU24)	11.5	6.5	---	---	OD (9-13W CFL)
B	49200 BKFL	BK	(1) 100W (M)	(1) 13W (GU24)	5.75	11.75	6.75	5	OD (18-25W CFL)
C	49202 BKFL	BK	(1) 150W (M)	(1) 18W (GU24)	8.5	17.25	9.75	7.25	OD (30-52W CFL)
D	49203 BKFL	BK	(1) 150W (M)	(1) 18W (GU24)	10	20.25	11.25	8.5	OD (30-52W CFL)

Measurements shown in inches.



E | 49201 BK
49201 BKFL



F | 49205 BK
49205 BKFL
Outdoor Pendant



G | 49204 BK
49204 BKFL
Post Lantern

Shown with Black Post 9506 BK



H | 49207 BK
49207 BKFL
Post Lantern

TREMILLO™

CAST ALUMINUM
CONSTRUCTION

ITEM #	FLUOR. ITEM #	FINISH	INCAND. BULB	FLUOR. BULB	W	H	OVRL. H	L	EXTRA WIRE	CHAIN/STEM	EXT.	HCWO	NOTES
E	49201	49201 BKFL	BK	(1) 100W (M)	(1) 13W (GU24)	7	14.25	---	---	---	8	6	W E OD (23-30W CFL)
F	49205	49205 BKFL	BK	(1) 100W (M)	(1) 18W (GU24)	6.5	17	91	7	25	72	---	D E OD (23-30W CFL) Additional chain 4927 BK.
G	49204	49204 BKFL	BK	(1) 150W (M)	(1) 18W (GU24)	10	23	---	---	---	---	---	W E OD (30-52W CFL)
H	49207	49207 BKFL	BK	(1) 150W (M)	(1) 18W (GU24)	8.5	20	---	---	---	---	---	W E OD (30-52W CFL)

Measurements shown in inches.

ASCARI™

ARCHITECTURAL BRONZE™ FINISH
WITH CLEAR OUTER GLASS AND
ETCHED STEPPED INNER GLASS



A | 49364 AZ



B | 49365 AZ



C | 49366 AZ



Shown with Architectural
Bronze™ Post 9506 AZ

D | 49367 AZ
Post Lantern



E | 49368 AZ
Outdoor Pendant

ASCARI™

CAST ALUMINUM
CONSTRUCTION

ITEM #	FINISH	INCAND. BULB	W	H	OVRL. H	EXTRA WIRE	CHAIN/STEM	EXT.	HCWO	NOTES
A	AZ	(1) 50W (G9)	5.5	10	---	---	---	7.25	3.75	Ⓜ Halogen light source.
B	AZ	(1) 100W (M)	7	13	---	---	---	9.25	4.75	Ⓜ Ⓜ OD (23-30W CFL)
C	AZ	(1) 150W (M)	8.25	16.5	---	---	---	10.75	8.25	Ⓜ Ⓜ OD (30-52W CFL)
D	AZ	(1) 150W (M)	8.25	17.5	---	---	---	---	---	Ⓜ Ⓜ OD (30-52W CFL)
E	AZ	(1) 100W (M)	8.25	17	91	27	72	---	---	Ⓜ Ⓜ OD (23-30W CFL) Additional chain 4927 AZ.

Measurements shown in inches. U.S. & Canadian Patent Pending.

ASCARI™

PLATINUM FINISH WITH
CLEAR OUTER GLASS AND
ETCHED STEPPED INNER GLASS



A | 49366 PL



B | 49365 PL



C | 49364 PL



D | 49368 PL
Outdoor Pendant



Shown with Brushed
Aluminum Post 9506 BA

E | 49367 PL
Post Lantern

ASCARI™

CAST ALUMINUM
CONSTRUCTION

ITEM #	FINISH	INCAND. BULB	W	H	OVRL. H	EXTRA WIRE	CHAIN/STEM	EXT.	HCWO	NOTES	
A	49366	PL	(1) 150W (M)	8.25	16.5	---	---	---	10.75	8.25	W OD (30-52W CFL)
B	49365	PL	(1) 100W (M)	7	13	---	---	---	9.25	4.75	W OD (23-30W CFL)
C	49364	PL	(1) 50W (G9)	5.5	10	---	---	---	7.25	3.75	W Halogen light source.
D	49368	PL	(1) 100W (M)	8.25	17	91	27	72	---	---	OD (23-30W CFL) Additional chain 4927 PL.
E	49367	PL	(1) 150W (M)	8.25	17.5	---	---	---	---	---	W OD (30-52W CFL)

Measurements shown in inches. U.S. & Canadian Patent Pending.

BOWEN™

ARCHITECTURAL BRONZE™ FINISH WITH
SATIN-ETCHED CASÉD OPAL GLASS



A | 49336 AZ



B | 49337 AZ



C | 49338 AZ



D | 49339 AZ



E | 49341 AZ
Outdoor Pendant



F | 49343 AZ
Outdoor Ceiling



Shown with
Architectural Bronze™
Post 9506 AZ

G | 49342 AZ
Post Lantern

BOWEN™

**CAST ALUMINUM
CONSTRUCTION**

ITEM #	FINISH	INCAND. BULB	W	H	OVRLL. H	EXTRA WIRE	CHAIN/STEM	EXT.	HCWO	NOTES
A	AZ	(1) 75W (M)	5.5	9.5	---	---	---	6.5	4	Ⓜ Ⓜ OD (18-25W CFL)
B	AZ	(1) 100W (M)	7.25	13	---	---	---	8.5	5.75	Ⓜ Ⓜ OD (23-30W CFL)
C	AZ	(1) 150W (M)	9	15.75	---	---	---	10.25	7	Ⓜ Ⓜ OD (30-52W CFL)
D	AZ	(2) 100W (M)	7.25	18	---	---	---	8.5	5.75	Ⓜ Ⓜ OD (23-30W CFL)
E	AZ	(2) 100W (M)	7.25	20.25	95	27	72	---	---	Ⓜ Ⓜ OD (23-30W CFL) Additional chain 4927 AZ.
F	AZ	(2) 75W (M) ✓	11	6.5	---	---	---	---	---	Ⓜ Ⓜ OD (18-25W CFL)
G	AZ	(1) 150W (M)	9	18.5	---	---	---	---	---	Ⓜ Ⓜ OD (30-52W CFL)

Measurements shown in inches. U.S. & Canadian Patent Pending.

BELMEZ™

ARCHITECTURAL BRONZE™ FINISH
WITH SATIN-ETCHED CASSED OPAL GLASS



A | 49454 AZ



B | 49455 AZ



C | 49456 AZ

BELMEZ™

ALUMINUM
CONSTRUCTION

ITEM #	FINISH	INCAND. BULB	W	H	OVRL. H	EXTRA WIRE	CHAIN/STEM	EXT.	HCWO	NOTES	
A	49454	AZ	(1) 75W (M)	7	10.75	---	---	---	7.75	4.25	W E OD (18-25W CFL)
B	49455	AZ	(1) 100W (M)	9	14	---	---	---	9.75	5	W E OD (23-30W CFL)
C	49456	AZ	(1) 150W (M)	11	16.5	---	---	---	12	6.5	W E OD (30-52W CFL)
D	49448	AZ	(1) 150W (M)	11	16.5	91	32	72	---	---	D E OD (30-52W CFL) Additional chain 4927 AZ.
E	49458	AZ	(3) 60W (C)	18.5	23.75	98	11	72	---	---	D Additional chain 4927 AZ.
F	49459	AZ	(1) 150W (M)	11	19.5	---	---	---	---	---	W E OD (30-52W CFL)
G	49460	AZ	(2) 75W (M) ❖	11	5.5	---	---	---	---	---	D E OD (18-25W CFL)

Measurements shown in inches. U.S. & Canadian Patent Pending.



D | 49448 AZ
Outdoor Pendant



E | 49458 AZ
Indoor/Outdoor
Hanging Lantern



Shown with Architectural
Bronze™ Post 9506 AZ

F | 49459 AZ
Post Lantern



G | 49460 AZ
Outdoor Ceiling

LEEDS™

ANVIL IRON FINISH WITH
SATIN-ETCHED CASSED OPAL GLASS



A | 49110 AVI
49110 AVIFL



B | 49112 AVI
49112 AVIFL



C | 49111 AVI
49111 AVIFL



D | 49113 AVI
49113 AVIFL



E | 49115 AVI
Outdoor Pendant



F | 49116 AVI
Outdoor Ceiling

























G | 49114 AVI
Post Lantern

Shown with Black Post 9595 BK

LEEDS™

CAST ALUMINUM
CONSTRUCTION

ITEM #	FLUOR. ITEM #	FINISH	INCAND. BULB	FLUOR. BULB	W	H	OVRL. H	L	EXTRA WIRE	CHAIN/STEM	EXT.	HCWO	NOTES
A	49110	49110 AVIFL	AVI (1) 100W (M)	(1) 18W (GU24)  	5.75	12.25	---	---	---	---	5	6	  OD (13-15W CFL)
B	49112	49112 AVIFL	AVI (1) 100W (M)	(1) 18W (GU24)  	7.5	16.5	---	---	---	---	5.75	8.25	  OD (23-30W CFL)
C	49111	49111 AVIFL	AVI (2) 75W (M)	(2) 18W (GU24)  	5.75	17.75	---	---	---	---	5	8.75	  OD (13-15W CFL)
D	49113	49113 AVIFL	AVI (2) 100W (M)	(2) 18W (GU24)  	9.5	20	---	---	---	---	7	10	  OD (23-30W CFL)
E	49115	---	AVI (1) 100W (M)	---	7.5	19	93	8.5	26	72	---	---	  OD (23-30W CFL) Additional chain 4927 AVI.
F	49116	---	AVI (2) 60W (M) 	---	14	6	---	---	---	---	---	---	  OD (13-15W CFL)
G	49114	---	AVI (1) 100W (M)	---	7.5	19.25	---	8.5	---	---	---	---	  OD (23-30W CFL)

Measurements shown in inches. U.S. & Canadian Patent Pending.

PORTMAN SQUARE™

BRUSHED FINISH OVER SOLID
STAINLESS STEEL CONSTRUCTION
WITH ETCHED SEEDY GLASS



A | 49157 SS



B | 49158 SS



C | 49159 SS



D | 49160 SS

PORTMAN SQUARE™

ITEM #	FINISH	INCAND. BULB	W	H	EXT.	HCWO	NOTES
A	SS	(1) 100W (M)	6	8	6.5	4	W E OD (23-30W CFL)
B	SS	(1) 100W (M)	7	10.75	7.75	5.25	W E OD (23-30W CFL)
C	SS	(1) 150W (M)	9	14	9.75	7.25	W E OD (30-52W CFL)
D	SS	(2) 100W (M)	11	22	6.25	10	W E OD (23-30W CFL)

Measurements shown in inches. U.S. & Canadian Patent Pending.



E | 49161 SS
Outdoor Pendant



F | 49164 SS
Outdoor Ceiling



Shown with Black Post 9506 BK

G | 49162 SS
Post Lantern



Shown with Black Post 9506 BK

H | 49163 SS
Post Lantern

PORTMAN SQUARE™

STAINLESS STEEL
CONSTRUCTION

ITEM #	FINISH	INCAND. BULB	W	H	OVRL. H	EXTRA WIRE	CHAIN/STEM	NOTES	
E	49161	SS	(1) 100W (M)	11	18.5	93	25	72	D W OD (23-30W CFL) Additional chain 4927 SS.
F	49164	SS	(2) 60W (M)	12	5	---	---	---	D W OD (13-15W CFL)
G	49162	SS	(1) 100W (M)	9	16.25	---	---	---	W W OD (23-30W CFL)
H	49163	SS	(1) 150W (M)	11	18.25	---	---	---	W W OD (30-52W CFL)

Measurements shown in inches. U.S. & Canadian Patent Pending.

PORTMAN SQUARE™

OLDE BRONZE® FINISH OVER SOLID BRASS WITH ETCHED SEEDY GLASS



A | 49157 OZ



B | 49158 OZ



C | 49159 OZ



D | 49160 OZ

PORTMAN SQUARE™

ITEM #	FINISH	INCAND. BULB	W	H	EXT.	HCWO	NOTES	
A	49157	OZ	(1) 100W (M)	6	8	6.5	4	Ⓜ Ⓜ OD (23-30W CFL)
B	49158	OZ	(1) 100W (M)	7	10.75	7.75	5.25	Ⓜ Ⓜ OD (23-30W CFL)
C	49159	OZ	(1) 150W (M)	9	14	9.75	7.25	Ⓜ Ⓜ OD (30-52W CFL)
D	49160	OZ	(2) 100W (M)	11	22	6.25	10	Ⓜ Ⓜ OD (23-30W CFL)

Measurements shown in inches. U.S. & Canadian Patent Pending.



E | 49161 OZ
Outdoor Pendant



F | 49164 OZ
Outdoor Ceiling



G | 49162 OZ
Post Lantern

Shown with Olde Bronze® Post 9595 OZ



H | 49163 OZ
Post Lantern

Shown with Olde Bronze® Post 9595 OZ

PORTMAN SQUARE™

SOLID BRASS
CONSTRUCTION

	ITEM #	FINISH	INCAND. BULB	W	H	OVRL. H	EXTRA WIRE	CHAIN/STEM	NOTES
E	49161	OZ	(1) 100W (M)	11	18.5	93	25	72	Ⓛ OD (23-30W CFL) Additional chain 4927 OZ.
F	49164	OZ	(2) 60W (M)	12	5	---	---	---	Ⓛ OD (13-15W CFL)
G	49162	OZ	(1) 100W (M)	9	16.25	---	---	---	Ⓛ OD (23-30W CFL)
H	49163	OZ	(1) 150W (M)	11	18.25	---	---	---	Ⓛ OD (30-52W CFL)

Measurements shown in inches. U.S. & Canadian Patent Pending.

CAMDEN™

ANVIL IRON FINISH WITH
OPAL-ETCHED GLASS



A | 49119 AVI
49119 AVIFL





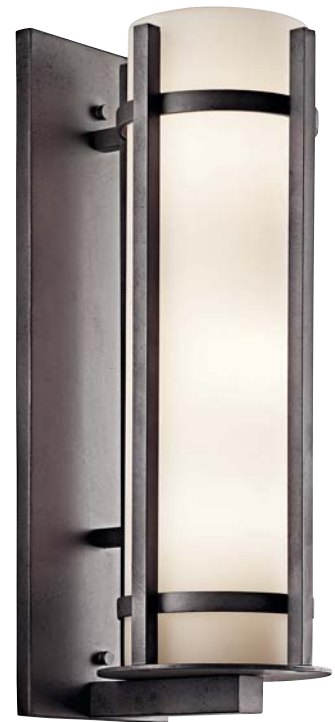









B | 49120 AVI
49120 AVIFL



C | 49121 AVI
49121 AVIFL

CAMDEN™

ITEM #	FLUOR. ITEM #	FINISH	INCAND. BULB	FLUOR. BULB	W	H	EXT.	HCWO	NOTES
A	49119 AVIFL	AVI	(1) 100W (M)	(1) 13W (GU24)  	5	11	5.75	5.5	  OD (23-30W CFL)
B	49120 AVIFL	AVI	(2) 100W (M)	(2) 18W (GU24)  	6.25	19.5	7.25	9.75	  OD (23-30W CFL)
C	49121 AVIFL	AVI	(2) 75W (M)	(2) 18W (GU24)  	7	22.5	8.25	11.25	  OD (18-25W CFL)

Measurements shown in inches.



D | 49122 AVI
49122 AVIFL



E | 49124 AVI
49124 AVIFL
Outdoor Pendant



F | 49125 AVI
49125 AVIFL
Outdoor Ceiling



Shown with
Black Post
9595 BK

G | 49123 AVI
49123 AVIFL
Post Lantern

CAMDEN™

CAST ALUMINUM
CONSTRUCTION

ITEM #	FLUOR. ITEM #	FINISH	INCAND. BULB	FLUOR. BULB	W	H	OVRL. H	EXTRA WIRE	CHAIN/STEM	EXT.	HCWO	NOTES
D	49122 AVIFL	AVI	(3) 100W (M)	(3) 18W (GU24)	9	26	---	---	---	11.25	---	
E	49124 AVIFL	AVI	(1) 150W (M)	(1) 18W (GU24)	9.5	18.75	93	24	72	---	---	OD (30-52W CFL)
F	49125 AVIFL	AVI	(1) 75W (M)	(1) 18W (GU24)	9.75	5.5	---	---	---	---	---	OD (18-25W CFL)
G	49123 AVIFL	AVI	(1) 150W (M)	(1) 26W (GU24)	9.5	17	---	---	---	---	---	OD (30-52W CFL)

Measurements shown in inches.

LANTANA™

ARCHITECTURAL BRONZE™ FINISH
WITH LIGHT UMBER GLASS



A | 7002 AZ
Outdoor Ceiling



B | 9166 AZ
11067 AZ



C | 9167 AZ
11068 AZ



Shown with
Architectural Bronze™
Post 9505 AZ

D | 9967 AZ
11070 AZ
Post Lantern



E | 9567 AZ
Outdoor Pendant



F | 9168 AZ
11069 AZ

LANTANA™

CAST ALUMINUM
CONSTRUCTION

ITEM #	FLUOR. ITEM #	FINISH	INCAND. BULB	FLUOR. BULB	W	H	OVRLL. H	EXTRA WIRE	CHAIN/STEM	EXT.	HCWO	NOTES
A	7002	AZ	(1) 75W (M) ✓	---	9	5.5	---	---	---	---	---	ⓓ Ⓜ OD (18-25W CFL)
B	9166	AZ	(1) 75W (M)	(1) 13W (GU24) Ⓜ Ⓡ	7	10	---	---	---	5.75	3.25	Ⓜ Ⓜ OD (18-25W CFL)
C	9167	AZ	(1) 100W (M)	(1) 13W (GU24) Ⓜ Ⓡ	9	13	---	---	---	7.5	4	Ⓜ Ⓜ OD (23-30W CFL)
D	9967	AZ	(1) 150W (M)	(1) 18W (GU24) Ⓜ Ⓡ	10.5	19.5	---	---	---	---	---	Ⓜ Ⓜ OD (23-30W CFL)
E	9567	AZ	(1) 150W (M)	---	10.5	17.25	92	26	72	---	---	ⓓ Ⓜ OD (23-30W CFL) Add. chain 4927 AZ.
F	9168	AZ	(1) 150W (M)	(1) 18W (GU24) Ⓜ Ⓡ	10.5	15	---	---	---	8.75	4	Ⓜ Ⓜ OD (23-30W CFL)

Measurements shown in inches. U.S. & Canadian Patent Pending: B, C, D, E, F.

LANTANA™

GRANITE FINISH WITH
ETCHED OPAL GLASS



A | 9167 GNT



B | 9166 GNT



C | 7002 GNT
Outdoor Ceiling



D | 9967 GNT
Post Lantern

Shown with
Black Post
9506 BK



E | 9567 GNT
Outdoor Pendant



F | 9168 GNT

LANTANA™

CAST ALUMINUM
CONSTRUCTION

ITEM #	FINISH	INCAND. BULB	W	H	OVRL. H	EXTRA WIRE	CHAIN/STEM	EXT.	HCWO	NOTES
A	9167	GNT	(1) 100W (M)	9	13	---	---	7.5	4	W E OD (23-30W CFL)
B	9166	GNT	(1) 75W (M)	7	10	---	---	5.75	3.25	W E OD (18-25W CFL)
C	7002	GNT	(1) 75W (M) ✓	9	5.5	---	---	---	---	D E OD (18-25W CFL) Additional chain 4927 GNT.
D	9967	GNT	(1) 150W (M)	10.5	19.5	---	---	---	---	W E OD (23-30W CFL)
E	9567	GNT	(1) 150W (M)	10.5	17.25	92	26	72	---	D E OD (23-30W CFL) Additional chain 4927 GNT.
F	9168	GNT	(1) 150W (M)	10.5	15	---	---	8.75	4	W E OD (23-30W CFL)

Measurements shown in inches. U.S. & Canadian Patent Pending: A, B, D, E, F.



Sorel™ Wall Sconce 49118 AZ | Page 623

SOREL™

ARCHITECTURAL BRONZE® FINISH
WITH RIBBED CLEAR GLASS



A | 49117 AZ

Sorel™ is also available in LED.
See page 575.



B | 49118 AZ

SOREL™

	ITEM #	FINISH	INCAND. BULB	W	H	EXT.	HCWO	NOTES
A	49117	AZ	(1) 50W (GU10)	5.25	10.75	5.75	5.5	Halogen light source.
B	49118	AZ	(1) 50W (GU10)	6.5	16	5.75	8	Halogen light source.

Measurements shown in inches. U.S. & Canadian Patent Pending.

STONEBROOK™

ARCHITECTURAL BRONZE™ FINISH WITH
SATIN-ETCHED CASSED OPAL GLASS



A | 49258 AZ



B | 49257 AZ

STONEBROOK™

CAST ALUMINUM
CONSTRUCTION

	ITEM #	FINISH	INCAND. BULB	W	H	EXT.	HCWO	NOTES
A	49258	AZ	(1) 150W (M)	8.5	23.25	11	8.75	Ⓜ Ⓜ OD (30-52W CFL)
B	49257	AZ	(1) 100W (M)	6.5	17.75	8.75	6.75	Ⓜ Ⓜ OD (23-30W CFL)

Measurements shown in inches. U.S. & Canadian Patent Pending.

VITALINO™

ANVIL IRON FINISH WITH
SATIN-ETCHED CASED OPAL GLASS



A | 49024 AVI
Indoor/Outdoor



B | 49025 AVI
Indoor/Outdoor

Can Only Be Mounted
with Glass Facing Down
for Outdoor Use



Suitable for
Indoor use with
Glass Facing
Up or Down.

VITALINO™

CAST ALUMINUM
CONSTRUCTION

	ITEM #	FINISH	INCAND. BULB	W	H	EXT.	HCWO	NOTES
A	49024	AVI	(1) 75W (M)	4.75	16.25	6.25	3.25	W E OD (18-25W CFL) Wet location with glass in downward position only.
B	49025	AVI	(1) 100W (M)	5	20	7.25	4	W E OD (23-30W CFL) Wet location with glass in downward position only.

Measurements shown in inches. U.S. & Canadian Patent Pending.

TRAFARI™

ARCHITECTURAL BRONZE™ FINISH
WITH VETRO MICA GLASS



A | 49356 AZ



B | 49357 AZ



C | 49358 AZ



Shown with
Architectural Bronze™
Post 9506 AZ

D | 49360 AZ
Post Lantern

TRAFARI™

CAST ALUMINUM
CONSTRUCTION

ITEM #	FINISH	INCAND. BULB	W	H	EXT.	HCWO	NOTES
A	AZ	(1) 75W (M)	6	9.25	6.25	4.5	W E OD (18-25W CFL)
B	AZ	(1) 100W (M)	7.75	12	6.75	5.75	W E OD (23-30W CFL)
C	AZ	(1) 150W (M)	10	14.75	8.25	7	W E OD (30-52W CFL)
D	AZ	(1) 150W (M)	10	17.5	---	---	W E OD (30-52W CFL)

Measurements shown in inches. U.S. & Canadian Patent Pending.

ANTICO™

ANTIQUÉ COPPER OR OLDE BRONZE® FINISH WITH CLEAR GLASS



A | 49155 ACO



B | 49154 ACO



Vintage Squirrel Cage Filament Bulb, 40W Candelabra Base

5971 CLR



A | 49155 OZ

Shown with Vintage Squirrel Cage Filament Bulb 5971 CLR

Natural Brass Finish Candle Sleeves



B | 49154 OZ

ANTICO™

SOLID COPPER & ALUMINUM CONSTRUCTION

	ITEM #	FINISH	INCAND. BULB	W	H	EXT.	HCWO	NOTES
A	49155	ACO, OZ	(2) 60W (C)	9.5	15.5	4.75	11.75	Ⓜ
B	49154	ACO, OZ	(2) 60W (C)	7.5	12	4.25	8.25	Ⓜ

Measurements shown in inches. U.S. & Canadian Patent Pending.

MANNINGHAM™

OLDE BRONZE® FINISH WITH CLEAR SEEDY GLASS



A | 49386 OZ
NOT TO SCALE

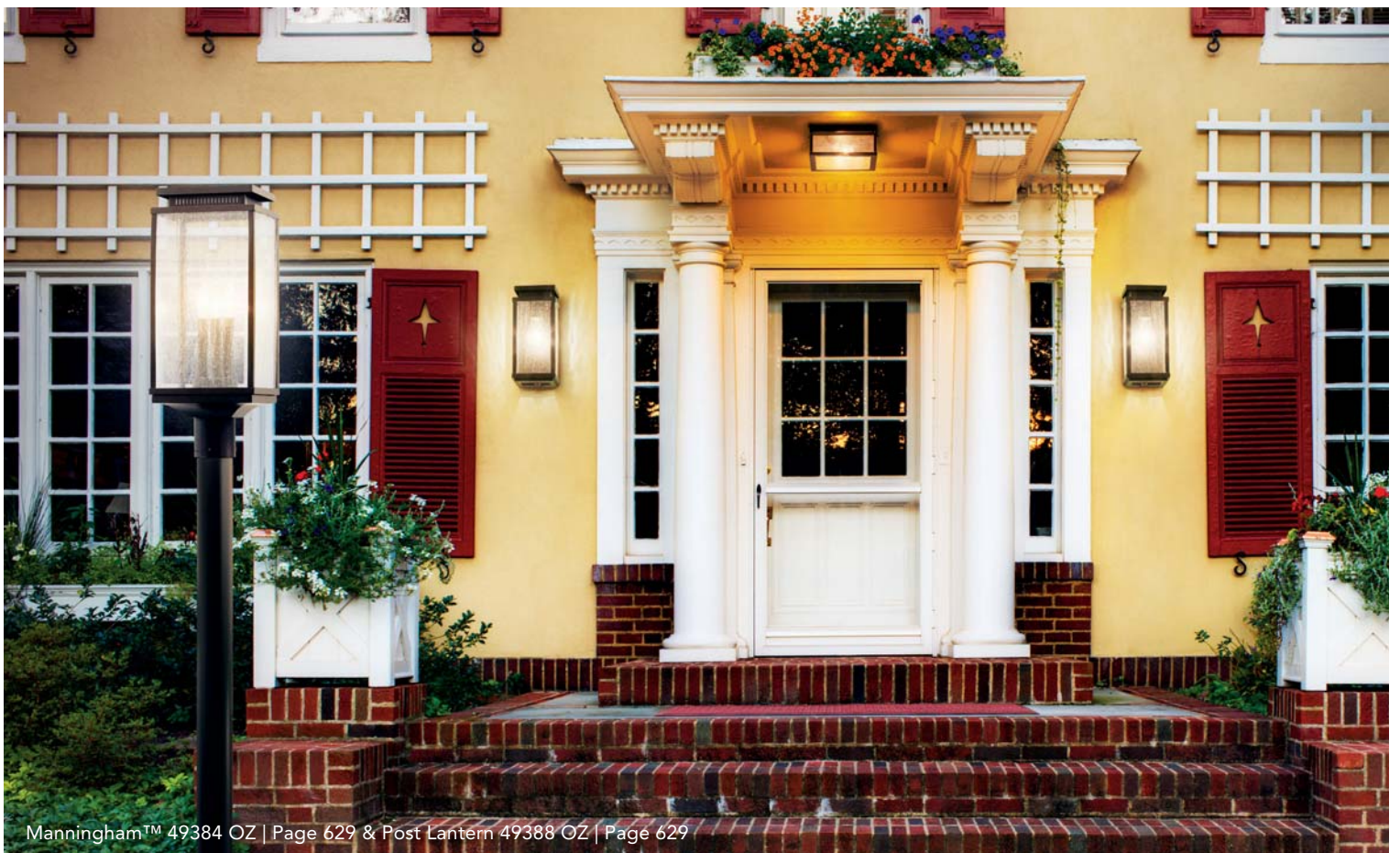

Manningham™ 49384 OZ | Page 629 & Post Lantern 49388 OZ | Page 629



B | 49389 OZ
Outdoor Ceiling



C | 49385 OZ



D | 49384 OZ



E | 49388 OZ
Post Lantern



F | 49387 OZ
Outdoor Pendant

MANNINGHAM™

CAST ALUMINUM
CONSTRUCTION

ITEM #	FINISH	INCAND. BULB	W	H	OVRL. H	EXTRA WIRE	CHAIN/STEM	EXT.	HCWO	NOTES
A	49386	OZ	(3) 60W (C)	9	22.25	---	---	11	14.5	W
B	49389	OZ	(2) 75W (M) ❖	11.75	5	---	---	---	---	D OD (18-25W CFL)
C	49385	OZ	(2) 60W (C)	7.5	18.75	---	---	10	12	W
D	49384	OZ	(1) 75W (M)	5	10.75	---	---	5	6	W OD (18-25W CFL)
E	49388	OZ	(3) 60W (C)	8.5	21	---	---	---	---	
F	49387	OZ	(3) 60W (C)	8.5	19	93	14	72	---	D Additional chain 4927 OZ.

Measurements shown in inches. U.S. & Canadian Patent Pending.

WOODLAND LAKE™

WEATHERED ZINC FINISH WITH
CLEAR SEEDY, INSIDE ETCHED GLASS



A | 49530 WZC



B | 49531 WZC



C | 49532 WZC



D | 49533 WZC

WOODLAND LAKE™

ITEM #	FINISH	INCAND. BULB	W	H	EXT.	HCWO	NOTES
A	WZC	(1) 75W (M)	9.25	12.5	9.25	6	W E OD (18-25W CFL)
B	WZC	(1) 100W (M)	12.5	16.75	14	10	W E OD (23-30W CFL)
C	WZC	(1) 100W (M)	14.5	19.25	16	11	W E OD (23-30W CFL)
D	WZC	(1) 150W (M)	17.25	23	18.75	14	W E OD (30-52W CFL)

Measurements shown in inches. U.S. & Canadian Patent Pending.



E | 49535 WZC
Outdoor Pendant



Shown with Black Post 9506 BK

F | 49534 WZC
Post Lantern



G | 49536 WZC
Outdoor Pendant

WOODLAND LAKE™

ALUMINUM
CONSTRUCTION

ITEM #	FINISH	INCAND. BULB	W	H	OVRL. H	EXTRA WIRE	CHAIN/STEM	NOTES
E	WZC	(1) 100W (M)	14.5	19.5	94	25	72	Ⓚ Ⓜ Ⓜ (23-30W CFL) Additional chain 4927 WZC.
F	WZC	(1) 100W (M)	12.5	20.25	---	---	---	Ⓚ Ⓜ Ⓜ (23-30W CFL)
G	WZC	(1) 75W (M)	9.25	12.5	97	21	72	Ⓚ Ⓜ Ⓜ (18-25W CFL) Additional chain 4927 WZC.

Measurements shown in inches. U.S. & Canadian Patent Pending.

CATERHAM™

OLDE BRONZE® FINISH WITH SATIN-ETCHED CASED OPAL GLASS.



A | 49642 OZ



B | 49640 OZ
Indoor/Outdoor Pendant



C | 49643 OZ



D | 49644 OZ

CATERHAM™

ITEM #	FINISH	INCAND. BULB	W	H	OVRL. H	EXTRA WIRE	CHAIN/STEM	EXT.	HCWO	NOTES	
A	49642	OZ	(1) 100W (M)	6.5	11.75	---	---	---	7.5	4	Ⓜ ⓄD (23-30W CFL) Indoor/Outdoor.
B	49640	OZ	(1) 100W (M)	6.5	16	48	58	36	---	---	Ⓜ ⓄD (23-30W CFL) Add. chain 4927 OZ, add. stem 2999 (12") OZ. Height includes one 6" stem. Indoor/Outdoor.
C	49643	OZ	(1) 100W (M)	8	14.75	---	---	---	9	4	Ⓜ ⓄD (23-30W CFL)
D	49644	OZ	(1) 150W (M)	10	17.5	---	---	---	10.75	4.5	Ⓜ ⓄD (30-52W CFL) Indoor/Outdoor.

Measurements shown in inches. U.S. & Canadian Patent Pending.



E | 49638 OZ
Indoor/Outdoor Chandelier



F | 49641 OZ
Indoor/Outdoor Ceiling



Shown with
Architectural Bronze™
Post 9506 AZ

G | 49646 OZ
Post Lantern

CATERHAM™

CAST ALUMINUM
CONSTRUCTION

ITEM #	FINISH	INCAND. BULB	W	H	CHAIN/STEM	OVRLL. H	EXTRA WIRE	NOTES
E	49638 OZ	(4) 100W (M)	21	12.75	36	51	67	Ⓚ Ⓜ OD (23-30W CFL) Add. chain 4927 OZ, add. stem 2999 (12") OZ, Indoor/Outdoor. Sloped ceiling kit incl.
F	49641 OZ	(3) 100W (M)	14.75	8.5	---	---	---	Ⓚ Ⓜ OD (23-30W CFL) Indoor/Outdoor.
G	49646 OZ	(1) 100W (M)	10	16.75	---	---	---	Ⓚ Ⓜ OD (23-30W CFL)

Measurements shown in inches.

SORIA™

AGED BRONZE FINISH WITH
VETRO MICA GLASS



A | 49450 AGZ



Vetro Mica Glass

B | 49449 AGZ



C | 49451 AGZ

SORIA™

	ITEM #	FINISH	INCAND. BULB	W	H	EXT.	HCWO	NOTES
A	49450	AGZ	(1) 100W (M)	7.5	11.75	8.5	2.25	Ⓜ Ⓜ Ⓜ OD (23-30W CFL)
B	49449	AGZ	(1) 75W (M)	6	10.25	7	2.25	Ⓜ Ⓜ Ⓜ OD (18-25W CFL)
C	49451	AGZ	(1) 150W (M)	9	15.25	10	2.75	Ⓜ Ⓜ Ⓜ OD (30-52W CFL)

Measurements shown in inches.



D | 49452 AGZVM
Outdoor Pendant



E | 49153 AGZVM
Outdoor Ceiling



Shown with Aged
Bronze Post 9595 AGZ

F | 49453 AGZ
Post Lantern

SORIA™

CAST ALUMINUM
CONSTRUCTION

ITEM #	FINISH	INCAND. BULB	W	H	OVRL. H	EXTRA WIRE	CHAIN/STEM	NOTES
D	AGZ	(1) 100W (M)	9	13.75	88	28	72	Ⓚ Ⓜ OD (23-30W CFL) Additional chain 4927 AGZ.
E	AGZVM	(2) 60W (C) ⚡	9.5	5.25	---	---	---	Ⓚ
F	AGZ	(1) 150W (M)	9	16	---	---	---	Ⓜ Ⓜ OD (30-52W CFL)

Measurements shown in inches. U.S. & Canadian Paten Pending: E.

NORTH CREEK™

OLDE BRONZE® FINISH WITH
LIGHT UMBER-ETCHED SEEDY GLASS



A | 49175 OZ
49175 OZFL



B | 49176 OZ
49176 OZFL



C | 49177 OZ
49177 OZFL



















Shown with
Olde Bronze® Post
9595 OZ

D | 49178 OZ
49178 OZFL
Post Lantern

NORTH CREEK™

CAST ALUMINUM
CONSTRUCTION

ITEM #	FLUOR. ITEM #	FINISH	INCAND. BULB	FLUOR. BULB	W	H	EXT.	HCWO	NOTES	
A	49175	49175 OZFL	OZ	(1) 100W (M)	(1) 18W (GU24)  	8.25	13.5	9.25	2.75	  OD (23-30W CFL)
B	49176	49176 OZFL	OZ	(1) 100W (M)	(1) 18W (GU24)  	10.5	16.5	11.25	4.5	  OD (18-25W CFL)
C	49177	49177 OZFL	OZ	(1) 150W (M)	(1) 26W (GU24)  	12.5	18	13.25	5	  OD (23-30W CFL)
D	49178	49178 OZFL	OZ	(1) 100W (M)	(1) 18W (GU24)  	10.5	20	---	---	  OD (23-30W CFL)

Measurements shown in inches.

RIVERBANK™

AGED BRONZE FINISH WITH
WHITE LINEN MIST GLASS



A | 49148 AGZ



B | 49147 AGZ



C | 49146 AGZ



D | 49150 AGZ
Post Lantern

Shown with
Aged Bronze Post
9595 AGZ



E | 49152 AGZ
Outdoor Pendant



F | 49153 AGZ
Outdoor Ceiling

RIVERBANK™

CAST ALUMINUM
CONSTRUCTION

ITEM #	FINISH	INCAND. BULB	W	H	OVRL. H	EXTRA WIRE	CHAIN/STEM	EXT.	HCWO	NOTES	
A	49148	AGZ	(1) 150W (M)	9	13.5	---	---	---	11.25	4	W E OD (23-30W CFL)
B	49147	AGZ	(1) 100W (M)	7	10.5	---	---	---	8.75	3	W E OD (23-30W CFL)
C	49146	AGZ	(1) 100W (M)	5	8.25	---	---	---	6.5	3.75	W E OD (18-25W CFL)
D	49150	AGZ	(1) 150W (M)	9	16.5	---	---	---	---	---	W E OD (30-52W CFL)
E	49152	AGZ	(1) 150W (M)	9	14.75	99	26	72	---	---	D E OD (30-52W CFL) Additional chain 2996 AGZ.
F	49153	AGZ	(2) 60W (C) ❖	9.5	5.25	---	---	---	---	---	D

Measurements shown in inches. U.S. & Canadian Patent Pending.

MORRIS™

DISTRESSED COPPER FINISH WITH
INSIDE-ETCHED IRIDIZED SEEDY GLASS



A | 9024 DCO

B | 9025 DCO

C | 9027 DCO

MORRIS™

CAST ALUMINUM
CONSTRUCTION

ITEM #	FINISH	INCAND. BULB	W	H	OVRL. H	EXTRA WIRE	CHAIN/STEM	EXT.	HCWO	NOTES
A	9024	DCO	(1) 60W (M)	6.5	8.25	---	---	7.25	2.75	W
B	9025	DCO	(1) 100W (M)	8	9.25	---	---	8.75	2.75	W
C	9027	DCO	(1) 200W (M)	12	13.25	---	---	13	4.5	W, E, OD (23-30W CFL)
D	9031	DCO	(1) 100W (M)	8	15	---	---	8.75	6	W, E, OD (23-30W CFL)
E	9838	DCO	(2) 60W (M) ✦	11.75	6	---	---	---	---	D, E, OD (13-15W CFL)
F	9920	DCO	(1) 200W (M)	12	14.75	---	---	---	---	W, E, OD (23-30W CFL)
G	9837	DCO	(1) 150W (M)	12	12.75	87	28	72	---	D, E, OD (23-30W CFL) Additional chain 4927 DCO.

Measurements shown in inches. U.S. & Canadian Patent Pending.



D | 9031 DCO



E | 9838 DCO
Outdoor Ceiling



Shown with Black
Post 9506 BK

F | 9920 DCO
Post Lantern



G | 9837 DCO
Outdoor Pendant

CHICAGO™

AGED BRONZE FINISH WITH
TEXTURED LINEN SEEDY GLASS



A | 9364 AGZ



B | 9365 AGZ



C | 9366 AGZ

CHICAGO™

CAST ALUMINUM
CONSTRUCTION

ITEM #	FINISH	INCAND. BULB	W	H	OVRL. H	EXTRA WIRE	CHAIN/STEM	EXT.	HCWO	NOTES	
A	9364	AGZ	(1) 60W (M)	6.75	9.5	---	---	---	7.75	3	W E OD (13-15W CFL)
B	9365	AGZ	(1) 75W (M)	8	10.75	---	---	---	9	3	W E OD (18-25W CFL)
C	9366	AGZ	(1) 100W (M)	10	12.75	---	---	---	11	3	W E OD (23-30W CFL)
D	9367	AGZ	(1) 150W (M)	12	14.75	---	---	---	13.25	3.5	W E OD (23-30W CFL)
E	9827	AGZ	(1) 100W (M)	10	12.75	97	27	72	---	---	D E OD (23-30W CFL) Additional chain 4927 AGZ
F	9975	AGZ	(1) 150W (M)	12	16	---	---	---	---	---	W E OD (23-30W CFL)
G	9867	AGZ	(2) 75W (M) ❖	12	6	---	---	---	---	---	D E OD (18-25W CFL)

Measurements shown in inches.



D | 9367 AGZ



E | 9827 AGZ
Outdoor Pendant



Shown with Black
Post 9595 AGZ

F | 9975 AGZ
Post Lantern



G | 9867 AGZ
Outdoor Ceiling

ALAMEDA™

CANYON VIEW™ FINISH OVER
SOLID BRASS WITH HONEY
OPALESCENT ART GLASS PANELS



A | 9649 CV
10962 CV



B | 49090 CV
Indoor/Outdoor Linear Chandelier
NOT TO SCALE



C | 9651 CV
10961 CV



D | 9652 CV
10960 CV



E | 9148 CV

ALAMEDA™

ITEM #	FLUOR. ITEM #	FINISH	INCAND. BULB	FLUOR. BULB	W	H	L	EXTRA WIRE	CHAIN/STEM	EXT.	HCWO	NOTES	
A	9649	10962	CV	(1) 75W (M)	(1) 13W (GU24)	5	7	---	---	---	5.75	4	OD (18-25W CFL)
B	49090	---	CV	(3) 100W (M)	---	6	20	36	56	36	---	---	OD (23-30W CFL) Add. chain 2996 CV or 4927 CV, add. stem 2999 (12") CV, Indoor/Outdoor.
C	9651	10961	CV	(1) 100W (M)	(1) 13W (GU24)	7	11.5	---	---	---	8.5	3	OD (23-30W CFL) Dark Sky compliant with panel inserts 4812 WH, Indoor/Outdoor.
D	9652	10960	CV	(1) 150W (M)	(1) 18W (GU24)	9	14.25	---	---	---	10.5	3.5	OD (23-30W CFL)
E	9148	---	CV	(1) 150W (M)	---	7	15	---	---	---	8.5	3	OD (18-25W CFL) Indoor/Outdoor.

Measurements shown in inches.



F | 49091 CV
Indoor/Outdoor Chandelier



G | 9825 CV
10957 CV
Outdoor Ceiling



H | 9143 CV



J | 9849 CV
10958 CV
Outdoor Pendant



K | 9147 CV



Removable Cup for
Column Mounting

Shown with
Olde Bronze®
Post 9595 OZ

L | 9953 CV
10959 CV
Post Lantern

ALAMEDA™

SOLID BRASS
CONSTRUCTION

ITEM #	FLUOR. ITEM #	FINISH	INCAND. BULB	FLUOR. BULB	W	H	OVRL. H	EXTRA WIRE	CHAIN/STEM	EXT.	HCWO	NOTES
F	49091	---	CV (4) 100W (M)	---	25	17	55	59	36	---	---	Ⓚ Add. chain 2996 CV or 4927 CV, add. stem 2999 (12") CV, Indoor/Outdoor
G	9825	10957	CV (2) 75W (M) ⚡	(2) 13W (GU24) Ⓢ Ⓜ	11.5	6.25	---	---	---	---	---	Ⓚ Ⓜ Ⓞ (18-25W CFL) Indoor/Outdoor.
H	9143	---	CV (1) 100W (M)	---	7	8.25	---	---	---	4.75	3.75	Ⓢ Ⓜ Ⓞ (23-30W CFL)
J	9849	10958	CV (1) 100W (M)	(1) 13W (GU24) Ⓢ Ⓜ	7	11.25	86	28	72	---	---	Ⓚ Ⓜ Ⓞ (23-30W CFL) Add. chain 4927 CV, Indoor/Outdoor.
K	9147	---	CV (1) 100W (M)	---	9	10.25	---	---	---	5.5	4	Ⓢ Ⓜ Ⓞ (23-30W CFL)
L	9953	10959	CV (1) 150W (M)	(1) 18W (GU24) Ⓢ Ⓜ	9	12.25	---	---	---	---	---	Ⓢ Ⓜ Ⓞ (23-30W CFL) Convert from post to column mount.

Measurements shown in inches.

CROSS CREEK™

AGED BRONZE FINISH WITH
TEXTURED LINEN SEEDY GLASS



A | 9128 AGZ



B | 9129 AGZ



C | 9130 AGZ

Backplate Detail



D | 9131 AGZ



E | 9132 AGZ

CROSS CREEK™

ITEM #	FINISH	INCAND. BULB	W	H	EXT.	HCWO	NOTES
A	AGZ	(1) 100W (M)	6	8.5	7.25	2.5	Ⓜ Ⓜ Ⓜ OD (9-13W CFL)
B	AGZ	(1) 150W (M)	7.5	13.5	8.75	3	Ⓜ Ⓜ Ⓜ OD (23-30W CFL)
C	AGZ	(1) 150W (M)	9	15.75	10.25	3	Ⓜ Ⓜ Ⓜ OD (23-30W CFL)
D	AGZ	(1) 150W (M)	11.5	18.5	12.75	3.5	Ⓜ Ⓜ Ⓜ OD (23-30W CFL)
E	AGZ	(1) 200W (M)	13.5	22	14.5	3.5	Ⓜ Ⓜ Ⓜ OD (23-30W CFL)

Measurements shown in inches. U.S. & Canadian Patent Pending.



F | 9656 AGZ



G | 9829 AGZ
Outdoor Pendant



H | 9830 AGZ
Outdoor Ceiling



Shown with
Aged Bronze
Post 9595 AGZ

J | 9527 AGZ
Post Lantern



Shown with
Architectural Bronze
Post 9506 AZ

K | 9529 AGZ
Post Lantern

MATCHING
LANDSCAPE
LIGHTING

15322 AGZ | Path Light
See the complete line of
Kichler® Landscape Lighting at
LandscapeLighting.com



CROSS CREEK™

CAST ALUMINUM
CONSTRUCTION

ITEM #	FINISH	INCAND. BULB	W	H	OVRLL. H	EXTRA WIRE	CHAIN/STEM	EXT.	HCWO	NOTES
F	AGZ	(2) 150W (M)	7.25	24	---	---	---	9.5	11.75	W E OD (23-30W CFL)
G	AGZ	(1) 150W (M)	11.5	14.5	89	25	72	---	---	D E OD (23-30W CFL) Additional chain 4927 AGZ.
H	AGZ	(2) 75W (M) ✦	9	5.75	---	---	---	---	---	D E OD (18-25W CFL)
J	AGZ	(1) 100W (M)	9	14	---	---	---	---	---	W E OD (23-30W CFL)
K	AGZ	(1) 150W (M)	11.5	17	---	---	---	---	---	W E OD (23-30W CFL)

Measurements shown in inches. U.S. & Canadian Patent Pending: G.

MELBERN™

AGED BRONZE FINISH WITH LIGHT
UMBER-ETCHED GLASS



A | 9051 AGZ



B | 9052 AGZ



C | 9555 AGZ
Outdoor Ceiling



D | 9054 AGZ



Shown with
Black Post
9506 BK

E | 9955 AGZ
Post Lantern

MELBERN™

CAST ALUMINUM
CONSTRUCTION

ITEM #	FINISH	INCAND. BULB	W	H	EXT.	HCWO	NOTES	
A	9051	AGZ	(1) 75W (M)	7	11	8	2.75	W OD (18-25W CFL)
B	9052	AGZ	(1) 100W (M)	9	13.5	10	2.75	W OD (23-30W CFL)
C	9555	AGZ	(1) 100W (M) ❖	9.75	7.25	---	---	D OD (18-25W CFL)
D	9054	AGZ	(1) 100W (M)	13	18	14.75	3.75	W OD (23-30W CFL)
E	9955	AGZ	(1) 100W (M)	11	16.25	---	---	W OD (23-30W CFL)

Measurements shown in inches. U.S. & Canadian Patent Pending.

ATWOOD

BROWN STONE FINISH WITH
LIGHT UMBER MIST GLASS



A | 49073 BST
49073 BSTFL



B | 49072 BST
49072 BSTFL



C | 49071 BST
49071 BSTFL



Shown with
Brown Stone Post
9595 BST





















D | 49074 BST
49074 BSTFL
Post Lantern



E | 49075 BST
49075 BSTFL
Outdoor Pendant

ATWOOD

CAST ALUMINUM
CONSTRUCTION

ITEM #	FLUOR. ITEM #	FINISH	INCAND. BULB	FLUOR. BULB	W	H	OVRL. H	EXTRA WIRE	CHAIN/STEM	EXT.	HCWO	NOTES	
A	49073	49073 BSTFL	BST	(1) 150W (M)	(1) 18W (GU24)  	10	17.75	---	---	---	11	3.25	  OD (30-52W CFL)
B	49072	49072 BSTFL	BST	(1) 100W (M)	(1) 18W (GU24)  	8	14.25	---	---	---	9	3	  OD (23-30W CFL)
C	49071	49071 BSTFL	BST	(1) 100W (M)	(1) 13W (GU24)  	6	11	---	---	---	7	2.5	  OD (23-30W CFL)
D	49074	49074 BSTFL	BST	(1) 150W (M)	(1) 18W (GU24)  	10	22.25	---	---	---	---	---	  OD (30-52W CFL)
E	49075	49075 BSTFL	BST	(1) 150W (M)	(1) 18W (GU24)  	10	17.75	92	23	72	---	---	  OD (23-30W CFL) Add. chain 4927 BST

Measurements shown in inches.

CAMERON™

PRAIRIE ROCK™ FINISH WITH
WHITE ETCHED LINEN GLASS



A | 9718 PR
11017 PR



B | 9719 PR
11018 PR



C | 9720 PR
11019 PR



D | 9721 PR

CAMERON™

ITEM #	FLUOR. ITEM #	FINISH	INCAND. BULB	FLUOR. BULB	W	H	EXT.	HCWO	NOTES	
A	9718	11017	PR	(1) 60W (M)	(1) 13W (GU24)	6	10.75	7	3	OD (13-15W CFL)
B	9719	11018	PR	(1) 150W (M)	(1) 18W (GU24)	8	14.25	9.25	3.75	OD (23-30W CFL)
C	9720	11019	PR	(1) 200W (M)	(1) 18W (GU24)	10	17.75	11.25	4.5	OD (23-30W CFL)
D	9721	---	PR	(1) 200W (M)	---	12	20.5	13.25	4.5	OD (23-30W CFL)

Measurements shown in inches.



E | 9511 PR
Outdoor Pendant



F | 9811 PR
Outdoor Ceiling



Shown with Black Post 9506 BK

G | 9902 PR
11020 PR
Post Lantern

CAMERON™

CAST ALUMINUM
CONSTRUCTION

ITEM #	FLUOR. ITEM #	FINISH	INCAND. BULB	FLUOR. BULB	W	H	OVRL. H	EXTRA WIRE	CHAIN/STEM	NOTES
E	9511	PR	(1) 200W (M)	---	10	17.75	92	57	72	OD (23-30W CFL) Additional chain 2996 OLZ.
F	9811	PR	(3) 40W (C)	---	13	6.75	---	---	---	
G	9902	PR	(1) 150W (M)	(1) 18W (GU24)	10	20	---	---	---	OD (23-30W CFL)

Measurements shown in inches.

FRANCEASI™

OLDE BRONZE® FINISH WITH LIGHT
UMBER-ETCHED SEEDY GLASS



A | 49226 OZ



B | 49227 OZ



C | 49228 OZ

FRANCEASI™

	ITEM #	FINISH	INCAND. BULB	W	H	EXT.	HCWO	NOTES
A	49226	OZ	(1) 100W (M)	5.5	14.5	7.25	4.5	W E OD (18-25W CFL)
B	49227	OZ	(1) 100W (M)	7	18	9	5.75	W E OD (23-30W CFL)
C	49228	OZ	(1) 100W (M)	8.5	22	10.5	7.5	W E OD (23-30W CFL)

Measurements shown in inches. U.S. & Canadian Patent Pending.



D | 49229 OZ



E | 49231 OZ
Outdoor Pendant



F | 49232 OZ
Outdoor Ceiling

MATCHING
COLLECTION

See entire matching LED
Lanterns on page 581.



FRANCEASI™

CAST ALUMINUM
CONSTRUCTION

	ITEM #	FINISH	INCAND. BULB	W	H	OVRL H	EXTRA WIRE	CHAIN/STEM	EXT.	HCWO	NOTES
D	49229	OZ	(1) 150W (M)	10	25	---	---	---	12.25	8.75	W 3 OD (30-52W CFL)
E	49231	OZ	(1) 100W (M)	7	20.25	95	19	72	---	---	D 3 OD (23-30W CFL) Additional chain 4927 OZ.
F	49232	OZ	(2) 60W (M) ❖	11	6.5	---	---	---	---	---	D 3 OD (13-15W CFL)

Measurements shown in inches. U.S. & Canadian Patent Pending.

ROCHDALE™

ANTIQUÉ COPPER FINISH OVER
SOLID COPPER CONSTRUCTION
WITH CLEAR VERTICAL RAIN GLASS



A | 49513 ACO



B | 49512 ACO



C | 49514 ACO

ROCHDALE™

	ITEM #	FINISH	INCAND. BULB	W	H	EXT.	HCWO	NOTES
A	49513	ACO	(2) 60W (C)	9	24.75	10.5	13.5	Ⓜ
B	49512	ACO	(1) 100W (M)	7	19.25	8.5	10	Ⓜ Ⓜ OD (23-30W CFL)
C	49514	ACO	(4) 60W (C)	11	39.75	12.75	---	Ⓜ Variable height mounting hardware included. Junction box 16.75"-25".

Measurements shown in inches. U.S. & Canadian Patent Pending.



D | 49515 ACO



E | 49517 ACO
Outdoor Pendant



Shown with Architectural
Bronze™ Post 9506 AZ

F | 49516 ACO
Post Lantern



G | 49518 ACO
Outdoor Ceiling

ROCHDALE™

SOLID COPPER
CONSTRUCTION

	ITEM #	FINISH	INCAND. BULB	W	H	OVRLL. H	EXTRA WIRE	CHAIN/STEM	EXT.	HCWO	NOTES
D	49515	ACO	(6) 60W (C)	13	46.75	6	---	---	15	23.75	W
E	49517	ACO	(4) 60W (C)	11.75	27.75	102	6	72	---	---	D Additional chain 4927 ACO.
F	49516	ACO	(4) 60W (C)	11	30.25	---	---	---	---	---	W
G	49518	ACO	(2) 60W (M) ❖	12	---	---	---	---	---	---	D EOD (13-15W CFL)

Measurements shown in inches. U.S. & Canadian Patent Pending.

ROCHDALE™

OLDE BRONZE® FINISH
WITH VERTICAL RAIN GLASS



A | 49513 OZ



B | 49512 OZ



C | 49514 OZ

ROCHDALE™

	ITEM #	FINISH	INCAND. BULB	W	H	EXT.	HCWO	NOTES
A	49513	OZ	(2) 60W (C)	9	24.75	10.5	13.5	W
B	49512	OZ	(1) 100W (M)	7	19.25	8.5	10	W EOD (23-30W CFL)
C	49514	OZ	(4) 60W (C)	11	39.75	12.75	---	W Variable height mounting hardware included. Junction box 16.75"-25".

Measurements shown in inches. U.S. & Canadian Patent Pending.



D | 49515 OZ



E | 49517 OZ
Outdoor Pendant



Shown with Black Post 9506 BK

F | 49516 OZ
Post Lantern



G | 49518 OZ
Outdoor Ceiling

ROCHDALE™

ALUMINUM
CONSTRUCTION

	ITEM #	FINISH	INCAND. BULB	W	H	OVRL. H	EXTRA WIRE	CHAIN/STEM	EXT.	HCWO	NOTES
D	49515	OZ	(6) 60W (C)	13	46.75	---	---	---	15	23.75	W
E	49517	OZ	(4) 60W (C)	11.75	27.75	102	6	72	---	---	D Additional chain 4927 OZ.
F	49516	OZ	(4) 60W (C)	11	30.25	---	---	---	---	30.25	W
G	49518	OZ	(2) 60W (M) ✦	12	6	---	---	---	---	---	D EOD (13-15W CFL)

Measurements shown in inches. U.S. & Canadian Patent Pending.

NOB HILL™

RUBBED BRONZE™ FINISH WITH
ETCHED SEEDY GLASS



A | 49415 RZ



B | 49416 RZ



C | 49417 RZ



D | 49420 RZ
NOT TO SCALE

NOB HILL™

ITEM #	FINISH	INCAND. BULB	W	H	EXT.	HCWO	NOTES	
A	49415	RZ	(1) 75W (M)	6	9.25	7.25	2.75	W E OD (18-25W CFL)
B	49416	RZ	(1) 100W (M)	8	16.5	10.25	5	W E OD (23-30W CFL)
C	49417	RZ	(1) 150W (M)	10	20.5	12.75	5.25	W E OD (30-52W CFL)
D	49420	RZ	(1) 150W (M)	13	28.25	16.5	---	W E OD (30-52W CFL) Variable height mounting hardware included. Junction box 8.25"-12.5".

Measurements shown in inches.



E | 49419 RZ
Outdoor Pendant



Shown with Olde
Bronze Post 9510 OZ

G | 49418 RZ
Post Lantern



F | 49035 RZ
Outdoor Ceiling

NOB HILL™

CAST ALUMINUM
CONSTRUCTION

ITEM #	FINISH	INCAND. BULB	W	H	OVRLL. H	EXTRA WIRE	CHAIN/STEM	EXT.	HCWO	NOTES
E	RZ	(1) 150W (M)	10	19.5	94	22	72	---	---	D OD (30-52W CFL) Additional chain 4927 RZ.
F	RZ	(2) 40W (C)	10	6.25	---	---	---	---	---	D
G	RZ	(1) 150W (M)	12.5	22.25	---	---	---	---	---	W OD (30-52W CFL)

Measurements shown in inches. U.S. and Canadian Patent Pending: E.



Large Scale Lantern
5' 9" tall

A | 9362 LD
NOT TO SCALE

TOURNAI™

LONDONDERRY™ FINISH WITH CLEAR SEEDY GLASS



B | 9357 LD



C | 9356 LD



D | 9355 LD



E | 9360 LD



F | 9359 LD



G | 9358 LD

TOURNAI™

CAST ALUMINUM
CONSTRUCTION

ITEM #	FINISH	INCAND. BULB	W	H	EXT.	HCWO	NOTES
A	9362**	LD (5) 100W (M)	25.5	69.5	36.5	---	Ⓜ ⓘ Ⓢ OD (23-30W CFL) Variable height mounting hardware included. Junction Box 22"-42".
B	9357	LD (2) 60W (C)	10	24	14.75	---	Ⓜ ⓘ Variable height mounting hardware included. Junction Box 6"-17.5".
C	9356	LD (1) 150W (M)	7.5	18	11.25	---	Ⓜ ⓘ Ⓢ OD (23-30W CFL) Variable height mounting hardware included. Junction Box 5.75"-11.75".
D	9355	LD (1) 100W (M)	6	10.5	7.75	4	Ⓜ Ⓢ OD (23-30W CFL)
E	9360	LD (4) 100W (M)	17	46	25	24.5	Ⓜ ⓘ Ⓢ OD (23-30W CFL)
F	9359	LD (4) 60W (C)	14	37.75	20.75	---	Ⓜ ⓘ Variable height mounting hardware included. Junction Box 11"-33.25".
G	9358	LD (3) 60W (C)	11.75	29	17.75	---	Ⓜ ⓘ Variable height mounting hardware included. Junction Box 6.5"-21.5".

Measurements shown in inches. **Special Order, call for delivery.

TOURNAI™

LONDONDERRY™ FINISH WITH
CLEAR SEEDY GLASS



A | 9854 LD
Outdoor Ceiling



B | 9855 LD
Outdoor Pendant



C | 9564 LD
Outdoor Pendant



D | 9568 LD
Outdoor Pendant



Shown with Londonderry™
Post 9523 LD

E | 9558 LD
Post Lantern



F | 9559 LD
Post Lantern



G | 9565 LD
Post Lantern

TOURNAI™

CAST ALUMINUM
CONSTRUCTION

ITEM #	FINISH	INCAND. BULB	W	H	OVRLL. H	EXTRA WIRE	CHAIN/STEM	NOTES	
A	9854	LD	(2) 60W (C)	12	7.5	---	---	---	Additional chain 4927 LD.
B	9855	LD	(3) 60W (C)	12	24.75	99	21	72	Additional chain 4908 LD.
C	9564	LD	(4) 100W (M)	17	33.5	108	12	72	(23-30W CFL) Additional chain 4930 LD.
D	9568	LD	(8) 100W (M)	25.5	47.5	123	3	72	(23-30W CFL) Additional chain 4930 LD.
E	9558	LD	(3) 60W (C)	12	27	---	---	---	Requires 3" Post.
F	9559	LD	(4) 60W (C)	14	30	---	---	---	Requires 3" Post.
G	9565	LD	(4) 100W (M)	17	37.5	---	---	---	(23-30W CFL) Requires 4" Post.

Measurements shown in inches.

TOURNAI™

TEXTURED BLACK FINISH WITH
CLEAR SEEDY GLASS



A | 9362** BKT
NOT TO SCALE

Large Scale
Lantern
5' 9" tall

TOURNAI™

CAST ALUMINUM
CONSTRUCTION

ITEM #	FINISH	INCAND. BULB	W	H	EXT.	HCWO	NOTES
A 9362**	BKT	(5) 100W (M)	25.5	69.5	36.5	---	Ⓜ Ⓢ Ⓞ (23-30W CFL) Variable height mounting hardware included. Junction Box 22"-42".

Measurements shown in inches. **Special Order, call for delivery.

TOURNAI™

TEXTURED BLACK FINISH WITH
CLEAR SEEDY GLASS



A | 9355 BKT



B | 9356 BKT



C | 9357 BKT



D | 9358 BKT



E | 9359 BKT



F | 9360 BKT

TOURNAI™

ITEM #	FINISH	INCAND. BULB	W	H	EXT.	HCWO	NOTES	
A	9355	BKT	(1) 100W (M)	6	10.5	7.75	4	W E OD (23-30W CFL)
B	9356	BKT	(1) 150W (M)	7.5	18	11.25	---	W I E OD (23-30W CFL) Variable height mounting hardware included. Junction Box 5.75"-11.75".
C	9357	BKT	(2) 60W (C)	10	24	14.75	---	W I Variable height mounting hardware included. Junction Box 6"-17.5".
D	9358	BKT	(3) 60W (C)	11.75	29	17.75	---	W I Variable height mounting hardware included. Junction Box 6.5"-21.5".
E	9359	BKT	(4) 60W (C)	14	37.75	20.75	---	W I Variable height mounting hardware included. Junction Box 11"-33.25".
F	9360	BKT	(4) 100W (M)	17	46	---	24.5	W I E OD (23-30W CFL)

Measurements shown in inches.

Large Scale
Hanging Lantern
47.5" tall



G | 9568 BKT
Outdoor Pendant



H | 9564 BKT
Outdoor Pendant



J | 9855 BKT
Outdoor Pendant



K | 9854 BKT
Outdoor Ceiling



L | 9565 BKT
Post Lantern

Shown with Textured
Black Post 9523 BKT



M | 9559 BKT
Post Lantern



N | 9558 BKT
Post Lantern

TOURNAI™

CAST ALUMINUM
CONSTRUCTION

ITEM #	FINISH	INCAND. BULB	W	H	OVRLL. H	EXTRA WIRE	CHAIN/STEM	NOTES	
G	9568	BKT	(8) 100W (M)	25.5	47.5	123	3	72	W E OD (23-30W CFL) Additional chain 4930 BK.
H	9564	BKT	(4) 100W (M)	17	33.5	108	12	72	W E OD (23-30W CFL) Additional chain 4908 BK.
J	9855	BKT	(3) 60W (C)	12	24.75	99	21	72	D Additional chain 4927 BK.
K	9854	BKT	(2) 60W (C) ❖	12	7.5	---	---	---	D
L	9565	BKT	(4) 100W (M)	17	37.5	---	---	---	W E OD (23-30W CFL) Requires 4" Post.
M	9559	BKT	(4) 60W (C)	14	30	---	---	---	W Requires 3" Post.
N	9558	BKT	(3) 60W (C)	12	27	---	---	---	W Requires 3" Post.

Measurements shown in inches.

VENETIAN RAIN

BRUSHED BRONZE FINISH WITH
VERTICAL RAIN GLASS



A | 49130 BRZ
ADA Compliant



B | 49131 BRZ



C | 49132 BRZ



D | 49135 BRZ
NOT TO SCALE



E | 49134 BRZ
Outdoor Pendant



F | 49136 BRZ
Outdoor Ceiling

Shown with
Architectural Bronze™
Post 9506 AZ



G | 49133 BRZ
Post Lantern

VENETIAN RAIN

CAST ALUMINUM
CONSTRUCTION

	ITEM #	FINISH	INCAND. BULB	W	H	OVRL. H	EXTRA WIRE	CHAIN/STEM	EXT.	HCWO	NOTES
A	49130	BRZ	(1) 60W (C)	6.75	11.75	---	---	---	3.75	7.25	Ⓜ ADA
B	49131	BRZ	(2) 60W (C)	7.25	25.25	---	---	---	10.5	6	Ⓜ
C	49132	BRZ	(3) 60W (C)	9.25	31	---	---	---	13.5	7	Ⓜ
D	49135	BRZ	(4) 40W (C)	11.25	37	---	---	---	16	9	Ⓜ
E	49134	BRZ	(2) 60W (C)	7.25	24.75	99	16	72	---	---	Ⓜ Additional chain 4927 BRZ.
F	49136	BRZ	(2) 40W (C) ❖	9.25	5.5	---	---	---	---	---	Ⓜ
G	49133	BRZ	(3) 60W (C)	9.25	32.5	---	---	---	15.5	---	Ⓜ

Measurements shown in inches. U.S. & Canadian Patent Pending.

VENETIAN RAIN

BLACK FINISH AND GOLD HIGHLIGHTS
WITH VERTICAL RAIN GLASS



A | 49130 BKG
ADA Compliant



B | 49131 BKG



C | 49132 BKG



Gold
Highlights

D | 49135 BKG
NOT TO SCALE



E | 49134 BKG
Outdoor Pendant



F | 49136 BKG
Outdoor Ceiling



Shown with Black Post 9506 BK

G | 49133 BKG
Post Lantern

VENETIAN RAIN

CAST ALUMINUM
CONSTRUCTION

	ITEM #	FINISH	INCAND. BULB	W	H	OVRL. H	EXTRA WIRE	CHAIN/STEM	EXT.	HCWO	NOTES
A	49130	BKG	(1) 60W (C)	6.75	11.75	---	---	---	3.75	7.25	Ⓜ ADA
B	49131	BKG	(2) 60W (C)	7.25	25.25	---	---	---	10.5	6	Ⓜ
C	49132	BKG	(3) 60W (C)	9.25	31	---	---	---	13.5	7	Ⓜ
D	49135	BKG	(4) 40W (C)	11.25	37	---	---	---	16	9	Ⓜ
E	49134	BKG	(2) 60W (C)	7.25	24.75	99	16	72	---	---	Ⓧ Additional Chain 4927 BKG.
F	49136	BKG	(2) 40W (C) Ⓧ	9.25	5.5	---	---	---	---	---	Ⓧ
G	49133	BKG	(3) 60W (C)	9.25	32.5	---	---	---	15.5	---	Ⓜ

Measurements shown in inches. U.S. & Canadian Patent Pending.

WISCOMBE PARK™

WEATHERED ZINC FINISH
WITH CLEAR SEEDY GLASS



A | 49504 WZC





B | 49503 WZC



C | 49502 WZC



D | 49501 WZC



E | 49505 WZC
Outdoor Pendant



Shown with Black Post 9506 BK

F | 49506 WZC
Post Lantern

WISCOMBE PARK™

CAST ALUMINUM
CONSTRUCTION

	ITEM #	FINISH	INCAND. BULB	W	H	OVRL. H	EXTRA WIRE	CHAIN/STEM	EXT.	HCWO	NOTES
A	49504	WZC	(4) 60W (C)	11	30.5	---	---	---	13.5	18.25	Ⓜ
B	49503	WZC	(4) 60W (C)	9	26.25	---	---	---	11.5	15.75	Ⓜ
C	49502	WZC	(3) 60W (C)	7.5	21.75	---	---	---	9.75	---	Ⓜ
D	49501	WZC	(1) 100W (M)	6	12.25	---	---	---	6.5	7.5	Ⓜ Ⓜ OD (23-30W CFL)
E	49505	WZC	(4) 60W (C)	11	23	97	10	72	---	---	Ⓜ Additional chain 4927 WZC.
F	49506	WZC	(4) 60W (C)	9	23.25	---	---	---	---	---	Ⓜ

Measurements shown in inches. U.S. & Canadian Patent Pending.

LUVERNE™

RUBBED BRONZE™ FINISH WITH
CLEAR RIBBED GLASS



A | 49001 RZ



B | 49002 RZ



C | 49003 RZ



D | 49005 RZ
Outdoor Pendant



Shown with
Black Post
9506 BK

E | 49004 RZ
Post Lantern

LUVERNE™

CAST ALUMINUM
CONSTRUCTION

ITEM #	FINISH	INCAND. BULB	W	H	OVRL. H	EXTRA WIRE	CHAIN/STEM	EXT.	HCWO	NOTES
A	RZ	(1) 100W (M)	7	13.25	---	---	---	7.75	4	W 3 OD (9-13W CFL)
B	RZ	(1) 100W (M)	9	18	---	---	---	11	6.25	W 3 OD (23-30W CFL)
C	RZ	(1) 150W (M)	11	22.25	---	---	---	13.5	6.5	W 3 OD (30-52W CFL)
D	RZ	(1) 150W (M)	11	19.75	94	24	72	---	---	D 3 OD (23-30W CFL) Additional chain 4927 RZ.
E	RZ	(1) 150W (M)	11	20.75	---	---	---	---	---	W 3 OD (23-30W CFL)

Measurements shown in inches. U.S. & Canadian Patent Pending.

LUVERNE™ ENERGY EFFICIENT

RUBBED BRONZE™ FINISH WITH
SATIN-ETCHED RIBBED GLASS



A | 11031 RZ



B | 11030 RZ



Shown with
Black Post,
9506 BK

C | 11035 RZ
Post Lantern



D | 11032 RZ

LUVERNE™

CAST ALUMINUM
CONSTRUCTION

	FLUOR. ITEM #	FINISH	FLUOR. BULB	W	H	EXT.	HCWO	NOTES
A	11031	RZ	(1) 18W (GU24)	9	18	11	6.25	
B	11030	RZ	(1) 13W (GU24)	7	13.25	7.75	4	
C	11035	RZ	(1) 18W (GU24)	11	20.75	---	---	
D	11032	RZ	(1) 26W (GU24)	11	22.25	13.5	6.5	

Measurements shown in inches. U.S. & Canadian Patent Pending.

COURTYARD™

TEXTURED BLACK FINISH WITH
CLEAR SEEDY GLASS



A | 9032 BKT



B | 9033 BKT



C | 9034 BKT



D | 9060 BKT



E | 9081 BKT

Clear Seedy
Glass

COURTYARD™

ITEM #	FINISH	INCAND. BULB	W	H	EXT.	HCWO	NOTES
A	9032	BKT (1) 100W (M)	6.25	11	7	3.5	Ⓜ Ⓜ OD (23-30W CFL)
B	9033	BKT (1) 150W (M)	8.25	17.75	11	7.75	Ⓜ Ⓜ OD (23-30W CFL)
C	9034	BKT (3) 60W (C)	10.25	22.25	13.5	9	Ⓜ
D	9060	BKT (3) 100W (M)	13.5	40.25	16.5	---	Ⓜ Ⓜ Ⓜ OD (23-30W CFL) Variable height mounting hardware included. Junction Box 18"-24".
E	9081	BKT (4) 60W (C)	15	46.75	20	---	Ⓜ Ⓜ Ⓜ Ⓜ Variable height mounting hardware included. Junction Box 18.25"-26.25".

Measurements shown in inches.



F | 9035 BKT



G | 9539 BKT
Outdoor Pendant



H | 9538 BKT
Outdoor Ceiling



Shown with Black Post 9506 BK

J | 9533 BKT
Post Lantern



K | 9532 BKT
Post Lantern

COURTYARD™

CAST ALUMINUM
CONSTRUCTION

ITEM #	FINISH	INCAND. BULB	W	H	OVRL. H	EXTRA WIRE	CHAIN/STEM	EXT.	HCWO	NOTES
F	9035	BKT	(3) 60W (C)	12.25	26.5	---	---	16.5	12.5	W
G	9539	BKT	(3) 60W (C)	12.25	21.5	96	19	72	---	D Additional chain 4927 BK.
H	9538	BKT	(3) 40W (C) ✓	12.25	6.25	---	---	---	---	D
J	9533	BKT	(3) 60W (C)	12.25	27	---	---	---	---	W
K	9532	BKT	(1) 200W (M)	10.25	23.75	---	---	---	---	W EOD (30-52W CFL)

Measurements shown in inches.

COURTYARD™

RUBBED BRONZE™ FINISH WITH
CLEAR SEEDY GLASS



A | 9032 RZ



B | 9033 RZ



C | 9034 RZ



D | 9060 RZ



E | 9081 RZ

Clear Seedy Glass

COURTYARD™

ITEM #	FINISH	INCAND. BULB	W	H	EXT.	HCWO	NOTES
A	9032	RZ (1) 100W (M)	6.25	11	7	3.5	Ⓜ Ⓜ Ⓜ OD (23-30W CFL)
B	9033	RZ (1) 150W (M)	8.25	17.75	11	7.75	Ⓜ Ⓜ Ⓜ OD (23-30W CFL)
C	9034	RZ (3) 60W (C)	10.25	22.25	13.5	9	Ⓜ
D	9060	RZ (3) 100W (M)	13.5	40.25	16.5	---	Ⓜ ⓘ Ⓜ Ⓜ Ⓜ OD (23-30W CFL) Variable height mounting hardware included. Junction Box 18" - 24".
E	9081	RZ (4) 60W (C)	15	46.25	20	---	Ⓜ ⓘ Variable height mounting hardware included. Junction box. 18.25" - 26.25".

Measurements shown in inches.



F | 9035 RZ



G | 9539 RZ
Outdoor Pendant



H | 9538 RZ
Outdoor Ceiling



Shown with Post 9506 BK

J | 9533 RZ
Post Lantern



K | 9532 RZ
Post Lantern

COURTYARD™

CAST ALUMINUM
CONSTRUCTION

ITEM #	FINISH	INCAND. BULB	W	H	OVRL. H	EXTRA WIRE	CHAIN/STEM	EXT.	HCWO	NOTES
F	9035	RZ (3) 60W (C)	12.25	26.5	---	---	---	16.5	12.5	W
G	9539	RZ (3) 60W (C)	12.25	21.5	96	19	72	---	---	D Additional chain 4927 RZ.
H	9538	RZ (3) 40W (C) ✓	12.25	6.25	---	---	---	---	---	D
J	9533	RZ (3) 60W (C)	12.25	27	---	---	---	---	---	W
K	9532	RZ (1) 200W (M)	10.25	23.75	---	---	---	---	---	W EOD (30-52W CFL)

Measurements shown in inches.

COURTYARD™ ENERGY EFFICIENT

RUBBED BRONZE™ FINISH WITH
ETCHED SEEDY GLASS



Etched Seedy Glass

A | 11010 RZ



B | 11011 RZ



C | 11012 RZ



D | 11013 RZ



E | 11016 RZ
Outdoor Pendant



Shown with Black Post 9506 BK

F | 11014 RZ
Post Lantern



G | 11015 RZ
Post Lantern

COURTYARD™ ENERGY EFFICIENT

	FLUOR. ITEM #	FINISH	FLUOR. BULB	W	H	OVRL. H	EXTRA WIRE	CHAIN/STEM	EXT.	HCWO	NOTES
A	11010	RZ	(1) 13W (GU24)	6.25	11	---	---	---	7	3.5	
B	11011	RZ	(1) 18W (GU24)	8.25	17.75	---	---	---	11	7.75	
C	11012	RZ	(1) 18W (GU24)	10.25	22.25	---	---	---	13.5	9	
D	11013	RZ	(1) 26W (GU24)	12.25	26.5	---	---	---	16.5	12.5	
E	11016	RZ	(1) 26W (GU24)	12.25	21.5	96	20	72	---	---	Additional chain 4927 RZ.
F	11014	RZ	(1) 18W (GU24)	10.25	23.75	---	---	---	---	---	
G	11015	RZ	(1) 26W (GU24)	12.25	27	---	---	---	---	---	

Measurements shown in inches.

LAKEWAY™

RUBBED BRONZE™ FINISH WITH
ETCHED SEEDY GLASS



A | 49433 RZ



B | 49430 RZ



C | 49429 RZ



D | 49428 RZ



E | 49035 RZ
Outdoor Ceiling



F | 49432 RZ
Outdoor Pendant



Shown with
Post 9510 OZ

G | 49431 RZ
Post Lantern

LAKEWAY™

CAST ALUMINUM
CONSTRUCTION

ITEM #	FINISH	INCAND. BULB	W	H	OVRL. H	EXTRA WIRE	CHAIN/STEM	EXT.	HCWO	NOTES
A	49433	RZ	(1) 200W (M)	11	17	---	---	9.5	3.75	W E OD (30-52W CFL)
B	49430	RZ	(1) 150W (M)	8.5	13.75	---	---	7.5	3	W E OD (30-52W CFL)
C	49429	RZ	(1) 100W (M)	7	11.25	---	---	6.25	2.75	W E OD (23-30W CFL)
D	49428	RZ	(1) 60W (M)	5.25	7.75	---	---	5	3.5	W
E	49035	RZ	(2) 40W (C) ✦	10	6.25	---	---	---	---	D
F	49432	RZ	(1) 150W (M)	8.5	13.75	88	27	72	---	D E OD (30-53W CFL) Additional chain 4927 RZ.
G	49431	RZ	(1) 150W (M)	8.5	16.25	---	---	---	---	W E OD (30-52W CFL)

Measurements shown in inches. U.S. & Canadian Patent Pending.

McADAMS™

RUBBED BRONZE™ FINISH WITH
LIGHT UMBER-ETCHED SEEDY GLASS



A | 49270 RZ
49270 RZFL



B | 49271 RZ
49271 RZFL



C | 49272 RZ



D | 49273 RZ

McADAMS™

ITEM #	FLUOR. ITEM #	FINISH	INCAND. BULB	FLUOR. BULB	W	H	EXT.	HCWO	NOTES
A	49270 RZFL	RZ	(1) 100W (M)	(1) 13W (GU24)	5.5	9.5	6.75	5.25	OD (18-25W CFL)
B	49271 RZFL	RZ	(1) 100W (M)	(1) 18W (GU24)	8	14	9.5	6.5	OD (23-30W CFL)
C	---	RZ	(1) 150W (M)	---	10	17.5	11.5	8	OD (30-52W CFL)
D	---	RZ	(1) 150W (M)	---	12	21	14.25	9	OD (30-52W CFL)

Measurements shown in inches. U.S. & Canadian Patent Pending.



E | 49277 RZ
49277 RZFL
Outdoor Ceiling



F | 49276 RZ
Outdoor Pendant



Shown with
Olde Bronze®
Post 9510 OZ

G | 49275 RZ
Post Lantern



H | 49274 RZ
Post Lantern

McADAMS™

CAST ALUMINUM
CONSTRUCTION

ITEM #	FLUOR. ITEM #	FINISH	INCAND. BULB	FLUOR. BULB	W	H	OVRL. H	EXTRA WIRE	CHAIN/STEM	EXT.	HCWO	NOTES
E	49277	49277 RZFL	RZ	(2) 75W (M)	(2) 13W (GU24)	11.5	5.5	---	---	---	---	OD (13-15W CFL)
F	49276	---	RZ	(1) 150W (M)	---	10	22.25	97	23	72	---	OD (30-52W CFL) Add. chain 4927 RZ.
G	49275	---	RZ	(1) 200W (M)	---	12	26	---	---	---	---	OD (30-52W CFL)
H	49274	---	RZ	(1) 150W (M)	---	10	22.25	---	---	---	---	OD (30-52W CFL)

Measurements shown in inches. U.S. & Canadian Patent Pending.

SALISBURY™

BLACK FINISH WITH WHITE LINEN GLASS



A | 9039 BK



B | 9041 BK



C | 9043 BK



D | 9099 BK

SALISBURY™

ITEM #	FINISH	INCAND. BULB	W	H	EXT.	HCWO	NOTES	
A	9039	BK	(1) 60W (M)	6	10.25	7	3.5	Ⓜ Ⓜ OD (13-15W CFL)
B	9041	BK	(1) 100W (M)	8	19.25	10.75	9.25	Ⓜ Ⓜ OD (23-30W CFL)
C	9043	BK	(1) 200W (M)	12	29	16.25	14.25	Ⓜ Ⓜ OD (23-30W CFL)
D	9099	BK	(4) 60W (C)	15	42	20	---	Ⓜ Ⓜ Variable height mounting hardware included. Junction Box 17.5"-25.5".

Measurements shown in inches.



E | 9843 BK
Outdoor Pendant



F | 9040 BK



G | 9848 BK
Outdoor Ceiling



H | 9042 BK



J | 9940 BK
Post Lantern



K | 9938 BK
Post Lantern

Shown with Black Post 9506 BK

SALISBURY™

**CAST ALUMINUM
CONSTRUCTION**

ITEM #	FINISH	INCAND. BULB	W	H	OVRL. H	EXTRA WIRE	CHAIN/STEM	EXT.	HCWO	NOTES	
E	9843	BK	(1) 200W (M)	12	25	99	22	72	---	---	ⓓ Ⓜ OD (23-30W CFL) Additional chain 4927 BK.
F	9040	BK	(1) 100W (M)	8	19.25	---	---	---	10.75	7	Ⓜ Ⓜ OD (23-30W CFL)
G	9848	BK	(2) 60W (M)	13.5	7.5	---	---	---	---	---	ⓓ Ⓜ OD (13-15W CFL)
H	9042	BK	(1) 150W (M)	10	24.25	---	---	---	13.25	12.25	Ⓜ Ⓜ OD (23-30W CFL)
J	9940	BK	(1) 200W (M)	12	25.5	---	---	---	---	---	Ⓜ Ⓜ OD (23-30W CFL)
K	9938	BK	(1) 150W (M)	10	21.75	---	---	---	---	---	Ⓜ Ⓜ OD (23-30W CFL)

Measurements shown in inches.

SALISBURY™

RUBBED BRONZE™ FINISH WITH
WHITE LINEN GLASS



A | 9039 RZ
11001 RZ



B | 9041 RZ



C | 9043 RZ
11005 RZ



D | 9099 RZ

SALISBURY™

ITEM #	FLUOR. ITEM #	FINISH	INCAND. BULB	FLUOR. BULB	W	H	EXT.	HCWO	NOTES	
A	9039	11001	RZ	(1) 60W (M)	(1) 13W (GU24)	6	10.25	7	3.5	OD (13-15W CFL)
B	9041	---	RZ	(1) 100W (M)	---	8	19.25	10.75	9.25	OD (23-30W CFL)
C	9043	---	RZ	(1) 200W (M)	---	12	29	16.25	14.25	OD (23-30W CFL)
C	---	11005	RZ	---	(1) 26W (GU24)	12	29.25	16.25	15.5	
D	9099	---	RZ	(4) 60W (C)	---	15	42	20	---	Variable height mounting hardware included. Junction Box. 17.5" - 25.5".

Measurements shown in inches.



E | 9843 RZ
11006 RZ
Outdoor Pendant



F | 9040 RZ
11002 RZ



G | 9848 RZ
Outdoor Ceiling



H | 9042 RZ
11004 RZ



J | 9940 RZ
11009 RZ
Post Lantern



K | 9938 RZ
11008 RZ
Post Lantern

Shown with
Architectural
Bronze™ Post
9506 AZ

SALISBURY™

**CAST ALUMINUM
CONSTRUCTION**

ITEM #	FLUOR. ITEM #	FINISH	INCAND. BULB	FLUOR. BULB	W	H	OVRL. H	EXTRA WIRE	CHAIN/STEM	EXT.	HCWO	NOTES	
E	9843	11006	RZ	(1) 200W (M)	(1) 26W (GU24)	12	25	99	22	72	---	---	OD (23-30W CFL) Add. chain 4927 RZ.
F	9040	---	RZ	(1) 100W (M)	---	8	19.25	---	---	---	10.75	7	OD (23-30W CFL)
F	---	11002	RZ	---	(1) 18W (GU24)	8	19.5	---	---	---	10.75	6.75	
G	9848	---	RZ	(2) 60W (M)	---	13.5	7.5	---	---	---	---	---	OD (13-15W CFL)
H	9042	11004	RZ	(1) 150W (M)	(1) 18W (GU24)	10	24.25	---	---	---	13.25	12.25	OD (23-30W CFL)
J	9940	11009	RZ	(1) 200W (M)	(1) 26W (GU24)	12	25.5	---	---	---	---	---	OD (23-30W CFL)
K	9938	11008	RZ	(1) 150W (M)	(1) 18W (GU24)	10	21.75	---	---	---	---	---	OD (23-30W CFL)

Measurements shown in inches.

EAU CLAIRE™

OLDE BRONZE® FINISH WITH
ANTIQUÉ CLEAR GLASS



A | 9346 OZ



B | 9347 OZ



C | 9348 OZ



D | 9349 OZ



E | 9847 OZ
Outdoor Pendant



F | 9547 OZ
Post Lantern

Shown with
Architectural Bronze™
Post 9506 AZ

EAU CLAIRE™

ALUMINUM
CONSTRUCTION

ITEM #	FINISH	INCAND. BULB	W	H	OVRL. H	EXTRA WIRE	CHAIN/STEM	EXT.	HCWO	NOTES	
A	9346	OZ	(1) 100W (M)	7	14.75	---	---	---	9.75	8.25	W ② OD (23-30W CFL)
B	9347	OZ	(1) 150W (M)	9	18.25	---	---	---	12.75	10.25	W ② OD (23-30W CFL)
C	9348	OZ	(3) 60W (C)	11	32	---	---	---	15	---	W ① Variable height mounting hardware included. Junction Box 12.75"-20".
D	9349	OZ	(4) 60W (C)	13	37	---	---	---	17	---	W ① Variable height mounting hardware included. Junction Box 12.75"-24.25".
E	9847	OZ	(3) 60W (C)	13	23.75	98	11	72	---	---	② Additional chain 4927 OZ.
F	9547	OZ	(3) 60W (C)	11	25	---	---	---	---	---	W

Measurements shown in inches.

SAUSALITO™

OLDE BRONZE® FINISH WITH
CLEAR RIBBED OPTIC GLASS



A | 9492 OZ



B | 9452 OZ



C | 9412 OZ



E | 9932 OZ
Post Lantern

Shown with
Architectural Bronze™
Post 9506 AZ



D | 9832 OZ
Outdoor Pendant

SAUSALITO™

ALUMINUM
CONSTRUCTION

ITEM #	FINISH	INCAND. BULB	W	H	OVRL. H	EXTRA WIRE	CHAIN/STEM	EXT.	HCWO	NOTES
A	OZ	(3) 60W (C)	11	28	---	---	---	13.5	10.5	Ⓜ
B	OZ	(3) 60W (C)	9.5	24	---	---	---	12	10	Ⓜ
C	OZ	(1) 100W (M)	7	19.5	---	---	---	9	7.5	Ⓜ Ⓜ OD (23-30W CFL)
D	OZ	(3) 60W (C)	11.5	23	97	15	72	---	---	Ⓧ Additional chain 4927 OZ.
E	OZ	(3) 60W (C)	11.5	24.5	---	---	---	---	---	Ⓜ

Measurements shown in inches.

RALSTON™

BLACK FINISH WITH SATIN-ETCHED GLASS



A | 49409 BK



B | 49410 BK



C | 49411 BK



D | 49414 BK



E | 9848 BKS
Outdoor Ceiling



F | 49412 BK
Outdoor Pendant



G | 49413 BK
Post Lantern

Shown with Black Post 9510 BK

RALSTON™

CAST ALUMINUM
CONSTRUCTION

ITEM #	FINISH	INCAND. BULB	W	H	OVRL. H	EXTRA WIRE	CHAIN/STEM	EXT.	HCWO	NOTES	
A	49409	BK	(1) 75W (M)	6	10.5	---	---	---	7	5	W 3 OD (18-25W CFL)
B	49410	BK	(1) 100W (M)	8	14	---	---	---	9	6.75	W 3 OD (23-30W CFL)
C	49411	BK	(1) 100W (M)	10	16.75	---	---	---	11.25	6.5	W 3 OD (23-30W CFL)
D	49414	BK	(1) 100W (M)	11.75	25	---	---	---	14	10	W 3 OD (23-30W CFL)
E	9848	BKS	(2) 60W (M)	13.5	7.5	---	---	---	---	---	D 3 OD (13-15W CFL)
F	49412	BK	(1) 100W (M)	10	17	91	25	72	---	---	D 3 OD (23-30W CFL) Additional chain 4927 RZ.
G	49413	BK	(1) 100W (M)	10	22.5	---	---	---	---	---	W 3 OD (23-30W CFL)

Measurements shown in inches.

RALSTON™

RUBBED BRONZE™ FINISH WITH SATIN-ETCHED GLASS



A | 49414 RZ



B | 49411 RZ



C | 49410 RZ



D | 49409 RZ



E | 49413 RZ
Post Lantern

Shown with
Olde Bronze®
Post 9510 OZ



F | 49412 RZ
Outdoor Pendant



G | 9848 RZS
Outdoor Ceiling

RALSTON™

CAST ALUMINUM
CONSTRUCTION

ITEM #	FINISH	INCAND. BULB	W	H	OVRL H	EXTRA WIRE	WIRE (CHAIN/STEM)	EXT.	HCWO	NOTES	
A	49414	RZ	(1) 100W (M)	11.75	25	---	---	---	14	10	W E OD (23-30W CFL)
B	49411	RZ	(1) 100W (M)	10	16.75	---	---	---	11.25	6.5	W E OD (23-30W CFL)
C	49410	RZ	(1) 100W (M)	8	14	---	---	---	9	6.75	W E OD (23-30W CFL)
D	49409	RZ	(1) 75W (M)	6	10.5	---	---	---	7	5	W E OD (18-25W CFL)
E	49413	RZ	(1) 100W (M)	10	22.5	---	---	---	---	---	W E OD (23-30W CFL)
F	49412	RZ	(1) 100W (M)	10	17	91	25	72	---	---	D E OD (23-30W CFL) Additional chain 4927 RZ.
G	9848	RZS	(2) 60W (M)	13.5	7.5	---	---	---	---	---	D E OD (13-15W CFL)

Measurements shown in inches.

TRENTON™

BLACK FINISH WITH
CLEAR BEVELED GLASS



A | 9250 BK



B | 9251 BK



C | 9252 BK



D | 9851 BK
Outdoor Pendant



E | 9951 BK
Post Lantern

Shown with Black
Post 9506 BK

TRENTON™

CAST ALUMINUM
CONSTRUCTION

ITEM #	FINISH	INCAND. BULB	W	H	OVRL. H	EXTRA WIRE	CHAIN/STEM	EXT.	HCWO	NOTES
A	9250	BK	(1) 100W (M)	8	13.5	---	---	8.75	3.25	W OD (23-30W CFL)
B	9251	BK	(3) 60W (C)	9.5	23	---	---	10.75	17.5	W
C	9252	BK	(3) 60W (C)	13	33.25	---	---	15	27.75	W
D	9851	BK	(3) 60W (C)	8.25	15.75	90	18	72	---	D Additional chain 4927 BK.
E	9951	BK	(3) 60W (C)	13	29.25	---	---	---	---	W

Measurements shown in inches.

SAVANNAH ESTATES™

OLDE BRONZE® FINISH OVER SOLID BRASS WITH CLEAR BEVELED GLASS



A | 9631 OZ



B | 9677 OZ



C | 9676 OZ



D | 9931 OZ
Post Lantern

Shown with
Olde Bronze®
Post 9510 OZ



E | 9831 OZ
Outdoor Pendant

SAVANNAH ESTATE™

SOLID BRASS
CONSTRUCTION

ITEM #	FINISH	INCAND. BULB	W	H	OVRL. H	EXTRA WIRE	CHAIN/STEM	EXT.	HCWO	NOTES
A	9631	OZ (4) 60W (C)	13	35	---	---	---	16	---	Ⓜ ⓘ Variable height mounting hardware included. Junction Box 18-25.5".
B	9677	OZ (3) 60W (C)	12	24.75	---	---	---	11.5	12	Ⓜ
C	9676	OZ (2) 60W (C)	9.5	19.25	---	---	---	9	10	Ⓜ
D	9931	OZ (3) 60W (C)	12.25	25	---	---	---	---	---	Ⓜ
E	9831	OZ (4) 60W (C)	15	30.25	105	12	72	---	---	Ⓜ Additional chain 4927 OZ.

Measurements shown in inches.

GROVE MILL™

LIFEBRITE™ POLISHED BRASS FINISH OVER SOLID BRASS WITH CLEAR BEVELED GLASS PANELS



A | 9409 PB



B | 9439 PB



C | 9489 PB



D | 9889 PB
Outdoor Pendant



Shown with Black Post 9506 BK

E | 9989 PB
Post Lantern

GROVE MILL™

SOLID BRASS WITH
LifeBrite™
BY KICHLER®

ITEM #	FINISH	INCAND. BULB	W	H	OVRLL. H	EXTRA WIRE	CHAIN/STEM	EXT.	HCWO	NOTES
A	9409	PB (1) 100W (M)	7.5	12.25	---	---	---	7	3.25	W OD (23-30W CFL)
B	9439	PB (2) 60W (C)	9.5	20	---	---	---	9.5	10	W
C	9489	PB (3) 60W (C)	11.25	23.75	---	---	---	11.25	11.75	W
D	9889	PB (3) 60W (C)	11.5	21.5	96	16	72	---	---	D
E	9989	PB (3) 60W (C)	9.75	25.25	---	---	---	---	---	W

Measurements shown in inches. Kichler's LifeBrite™ Finish has a lifetime finish guarantee to withstand the harshest elements, salt air and extreme weather conditions.

BAY SHORE™

LIFEBRITE™ POLISHED BRASS FINISH OVER SOLID BRASS WITH CLEAR BEVELED GLASS PANELS



A | 9712 PB



B | 9711 PB



Shown with Black Post 9506 BK

C | 9913 PB
Post Lantern



D | 9713 PB

BAY SHORE™

SOLID BRASS WITH
LifeBrite™
BY KICHLER®

ITEM #	FINISH	INCAND. BULB	W	H	EXT.	HCWO	NOTES
A	9712	PB (1) 100W (M)	7	15.5	7.75	12	W OD (23-30W CFL)
B	9711	PB (1) 100W (M)	5.75	10.25	6.75	4	W OD (23-30W CFL)
C	9913	PB (1) 100W (M)	9.5	22.5	---	---	W OD (23-30W CFL)
D	9713	PB (1) 100W (M)	9.5	20	10.75	15.5	W OD (23-30W CFL)

Measurements shown in inches. Kichler's LifeBrite™ Finish has a lifetime finish guarantee to withstand the harshest elements, salt air and extreme weather conditions.

MOUNT VERNON

BLACK FINISH OVER SOLID BRASS
WITH CLEAR SEEDY GLASS



A | 9707 BK



B | 9708 BK



C | 9709 BK



D | 9704 BK



E | 9703 BK

MOUNT VERNON

ITEM #	FINISH	INCAND. BULB	W	H	EXT.	HCWO	NOTES	
A	9707	BK	(1) 100W (M)	5.5	12.5	6.25	5.5	W E OD (23-30W CFL)
B	9708	BK	(1) 150W (M)	7.5	16.75	8.25	6.75	W E OD (23-30W CFL)
C	9709	BK	(1) 150W (M)	9.5	19.5	10.25	7.25	W E OD (23-30W CFL)
D	9704	BK	(4) 60W (C)	13	27.75	13.75	11.25	W
E	9703	BK	(6) 60W (C)	16	32.5	17	12.25	W

Measurements shown in inches.

Mount Vernon is also available in LED. See pages 582.



F | 9809 BK
Outdoor Pendant



G | 9804 BK
Outdoor Pendant



Shown with Black Post 9506 BK

H | 9909 BK
Post Lantern

MOUNT VERNON

SOLID BRASS
CONSTRUCTION

ITEM #	FINISH	INCAND. BULB	W	H	OVRLL. H	EXTRA WIRE	CHAIN/STEM	NOTES	
F	9809	BK	(1) 150W (M)	9.5	18.5	57	64	36	Ⓚ 0D (23-30W CFL) Additional chain 4927 BK.
G	9804	BK	(4) 60W (C)	13	26	100	13	72	Ⓚ Additional chain 4927 BK.
H	9909	BK	(1) 150W (M)	9.5	20.75	---	---	---	Ⓚ 0D (23-30W CFL)

Measurements shown in inches.

MOUNT VERNON

OLDE BRONZE® FINISH OVER SOLID BRASS
WITH CLEAR SEEDY GLASS



A | 9707 OZ



B | 9708 OZ



C | 9709 OZ



D | 9704 OZ



E | 9703 OZ

MOUNT VERNON

ITEM #	FINISH	INCAND. BULB	W	H	EXT.	HCWO	NOTES	
A	9707	OZ	(1) 100W (M)	5.5	12.5	6.25	5.5	W E OD (23-30W CFL)
B	9708	OZ	(1) 150W (M)	7.5	16.75	8.25	6.75	W E OD (23-30W CFL)
C	9709	OZ	(1) 150W (M)	9.5	19.5	10.25	7.25	W E OD (23-30W CFL)
D	9704	OZ	(4) 60W (C)	13	27.75	13.75	11.25	W
E	9703	OZ	(6) 60W (C)	16	32.5	17	12.25	W

Measurements shown in inches.

Mount Vernon is also available in LED. See pages 582.



F | 9809 OZ
Outdoor Pendant



G | 9804 OZ
Outdoor Pendant



Shown with Architectural Bronze™ Post 9506 AZ

H | 9909 OZ
Post Lantern

MOUNT VERNON

SOLID BRASS
CONSTRUCTION

ITEM #	FINISH	INCAND. BULB	W	H	OVRL. H	EXTRA WIRE	CHAIN/STEM	NOTES	
F	9809	OZ	(1) 150W (M)	9.5	18.5	57	64	36	Ⓚ Additional chain 4927 BK.
G	9804	OZ	(4) 60W (C)	13	26	100	13	72	Ⓚ Additional chain 4927 OZ.
H	9909	OZ	(1) 150W (M)	9.5	20.75	---	---	---	Ⓚ Additional chain 4927 OZ.

Measurements shown in inches.

MOUNT VERNON ENERGY EFFICIENT

OLDE BRONZE® FINISH OVER SOLID BRASS
WITH ETCHED SEEDY GLASS



A | 10907 OZ



B | 10908 OZ



C | 10909 OZ



D | 10910 OZ
Outdoor Pendant

















E | 10911 OZ
Post Lantern

Shown with
Architectural Bronze™
Post 9506 AZ

MOUNT VERNON ENERGY EFFICIENT

SOLID BRASS
CONSTRUCTION

	FLUOR. ITEM #	FINISH	FLUOR. BULB	W	H	OVRLL. H	EXTRA WIRE	CHAIN/STEM	EXT.	HCWO	NOTES
A	10907	OZ	(1) 13W (GU24)  	5.5	12.5	---	---	---	6.25	5.25	
B	10908	OZ	(1) 13W (GU24)  	7.5	16.75	---	---	---	8.25	7	
C	10909	OZ	(1) 18W (GU24)  	9.5	19.5	---	---	---	10.25	7.25	
D	10910	OZ	(1) 18W (GU24)  	9.5	18.5	93	23	72	---	---	 Additional chain 4927 OZ.
E	10911	OZ	(1) 18W (GU24)  	9.5	21.25	---	---	---	---	---	

Measurements shown in inches.

RANDOLPH ENERGY EFFICIENT

PRAIRIE ROCK FINISH WITH
UMBER-ETCHED SEEDY GLASS



A | 10903 PR











C | 10906 PR
Post Lantern



B | 10904 PR

RANDOLPH ENERGY EFFICIENT

	FLUOR. ITEM #	FINISH	FLUOR. BULB	W	H	EXT.	HCWO	NOTES
A	10903	PR	(1) 13W (GU24)  	5.75	13.25	7.25	5	
B	10904	PR	(1) 18W (GU24)  	7.5	16	9	5.5	
C	10906	PR	(1) 18W (GU24)  	7.5	20	---	---	

Measurements shown in inches.

EMBASSY ROW

ANTIQUE PEWTER FINISH OVER SOLID BRASS WITH CLEAR BEVELED GLASS PANELS



A | 9783 AP



B | 9784 AP



C | 9785 AP



Shown with Black Post 9506 BK

D | 9985 AP Post Lantern

EMBASSY ROW

SOLID BRASS
CONSTRUCTION

ITEM #	FINISH	INCAND. BULB	W	H	EXT.	HCWO	NOTES	
A	9783	AP	(1) 100W (M)	7	10.75	7	4	W OD (23-30W CFL)
B	9784	AP	(1) 100W (M)	8.25	14.75	8	5.5	W OD (23-30W CFL)
C	9785	AP	(3) 60W (C)	10.5	21	9.75	8.25	W
D	9985	AP	(3) 60W (C)	10.5	20.75	---	---	W

Measurements shown in inches.

EMBASSY ROW

OLDE BRONZE® FINISH OVER SOLID BRASS WITH CLEAR BEVELED GLASS PANELS



A | 9785 OZ



B | 9784 OZ



C | 9783 OZ



Shown with
Olde Bronze®
Post 9510 OZ

D | 9985 OZ
Post Lantern



E | 9885 OZ
Outdoor Pendant

EMBASSY ROW

SOLID BRASS
CONSTRUCTION

ITEM #	FINISH	INCAND. BULB	W	H	OVRL. H	EXTRA WIRE	CHAIN/STEM	EXT.	HCWO	NOTES
A	9785	OZ (3) 60W (C)	10.5	21	---	---	---	9.75	8.25	W
B	9784	OZ (1) 100W (M)	8.25	14.75	---	---	---	8	5.5	W OD (23-30W CFL)
C	9783	OZ (1) 100W (M)	7	10.75	---	---	---	7	4	W OD (23-30W CFL)
D	9985	OZ (3) 60W (C)	10.5	20.75	---	---	---	---	---	W
E	9885	OZ (3) 60W (C)	10.5	19.5	94	14	72	---	---	D Additional chain 4927 OZ.

Measurements shown in inches.

KIRKWOOD™

TANNERY BRONZE™ FINISH
WITH SEEDY GLASS



A | 9028 TZ



B | 9029 TZ



C | 9030 TZ



D | 9859 TZ
Outdoor Ceiling



E | 9810 TZ
Outdoor Pendant



Shown with
Tannery Bronze™
Post 9506 TZ

F | 9918 TZ
Post Lantern

KIRKWOOD™

CAST ALUMINUM
CONSTRUCTION

ITEM #	FINISH	INCAND. BULB	W	H	OVRLL. H	EXTRA WIRE	CHAIN/STEM	EXT.	HCWO	NOTES	
A	9028	TZ	(1) 100W (M)	6.5	12.75	---	---	---	7.5	8	W E OD (23-30W CFL)
B	9029	TZ	(1) 150W (M)	8.5	17	---	---	---	9.5	10.25	W E OD (23-30W CFL)
C	9030	TZ	(3) 60W (C)	9.75	21	---	---	---	11.25	13	W
D	9859	TZ	(1) 100W (M) ✓	7.25	7.25	---	---	---	---	---	D E OD (9-13W CFL)
E	9810	TZ	(1) 150W (M)	8.5	18	92	22	72	---	---	D E OD (23-30W CFL) Additional chain 4927 TZ.
F	9918	TZ	(3) 60W (C)	9.75	23.5	---	---	---	---	---	W

Measurements shown in inches.

KIRKWOOD™

BLACK FINISH WITH SEEDY GLASS



A | 9030 BK



B | 9029 BK



C | 9028 BK



Shown with Black Post 9506 BK

D | 9918 BK
Post Lantern



E | 9810 TZ
Outdoor Pendant



F | 9859 BK
Outdoor Ceiling

KIRKWOOD™

CAST ALUMINUM
CONSTRUCTION

ITEM #	FINISH	INCAND. BULB	W	H	OVRLL. H	EXTRA WIRE	CHAIN/STEM	EXT.	HCWO	NOTES	
A	9030	BK	(3) 60W (C)	9.75	21	---	---	11.25	13	W	
B	9029	BK	(1) 150W (M)	8.5	17	---	---	9.5	10.25	W E OD (23-30W CFL)	
C	9028	BK	(1) 100W (M)	6.5	12.75	---	---	7.5	8	W E OD (23-30W CFL)	
D	9918	BK	(3) 60W (C)	9.75	23.5	---	---	---	---	W	
E	9810	BK	(1) 150W (M)	8.5	18	92	22	72	---	---	D E OD (23-30W CFL) Additional chain 4927 BK.
F	9859	BK	(1) 100W (M) ✓	7.25	7.25	---	---	---	---	---	D E OD (9-13W CFL)

Measurements shown in inches.

BARRIE

BLACK OR TANNERY BRONZE™ FINISH
WITH CLEAR BEVELED GLASS



A | 9794 BK, TZ



B | 49183 BK, TZ



C | 9735 BK, TZ



D | 49186 BK, TZ



E | 9736 BK, TZ

BARRIE

ITEM #	FINISH	INCAND. BULB	W	H	EXT.	HCWO	NOTES
A	9794 BK, TZ	(1) 100W (M)	4.75	8.5	5.75	2.75	W 3 OD (23-30W CFL)
B	49183 BK, TZ	(1) 100W (M)	6.25	10.25	6.5	1.75	W 3 OD (23-30W CFL)
C	9735 BK, TZ	(1) 100W (M)	8	15.5	8	6.25	W 3 OD (23-30W CFL)
D	49186 BK, TZ	(1) 100W (M)	9.75	19	9.5	7.75	W 3 OD (23-30W CFL)
E	9736 BK, TZ	(1) 100W (M)	8	21.75	8	15	W 3 OD (23-30W CFL)

Measurements shown in inches.



F | 9835 BK, TZ
Outdoor Pendant



G | 9886 BK, TZ
Outdoor Ceiling



Shown with Tannery Bronze™ Post 9595 TZ

H | 49187 BK, TZ
Post Lantern



Shown with Tannery Bronze™ Post 9506 TZ

J | 9935 BK, TZ
Post Lantern

BARRIE

CAST ALUMINUM
CONSTRUCTION

	ITEM #	FINISH	INCAND. BULB	W	H	OVRL. H	EXTRA WIRE	CHAIN/STEM	NOTES
F	9835	BK, TZ	(1) 100W (M)	8	13.5	88	25	72	ⓓ Ⓜ OD (23-30W CFL) Additional chain 4927 BK, TZ.
G	9886	BK, TZ	(2) 40W (C) ❖	12	7	---	---	---	ⓓ
H	49187	BK, TZ	(1) 100W (M)	9.75	18	---	---	---	Ⓜ Ⓜ OD (23-30W CFL)
J	9935	BK, TZ	(1) 100W (M)	8	16	---	---	---	Ⓜ Ⓜ OD (23-30W CFL)

Measurements shown in inches.



MADISON ENERGY EFFICIENT

TANNERY BRONZE™ FINISH WITH
LIGHT LINEN GLASS



A | 10950 TZ



B | 10954 TZ



C | 10953 TZ



D | 10955 TZ

















Shown with
Tannery Bronze™
Post, 9506 TZ

E | 10956 TZ
Post Lantern

MADISON ENERGY EFFICIENT

CAST ALUMINUM
CONSTRUCTION

	FLUOR. ITEM #	FINISH	FLUOR. BULB	W	H	EXT.	HCWO	NOTES
A	10950	TZ	(1) 13W (GU24)  	8	14.75	8.5	4.25	
B	10954	TZ	(1) 18W (GU24)  	9.5	17	10.25	6.5	
C	10953	TZ	(1) 13W (GU24)  	8	19.75	8.5	15.5	
D	10955	TZ	(1) 18W (GU24)  	9.5	23.25	10.25	17.5	
E	10956	TZ	(1) 18W (GU24)  	9.5	22.75	---	---	

Measurements shown in inches.

MADISON

BLACK, TANNERY BRONZE™ OR WHITE FINISH
WITH CLEAR BEVELED GLASS



A | 9654 BK, TZ, WH



B | 9653 BK, TZ, WH



C | 9655 BK, TZ



D | 9650 BK, TZ, WH



Shown with
Black Post
9506 BK

E | 9956 BK, TZ
Post Lantern



F | 9805 BK, TZ, WH
Outdoor Pendant



G | 9850 BK, TZ
Outdoor Ceiling

MADISON

CAST ALUMINUM
CONSTRUCTION

ITEM #	FINISH	INCAND. BULB	W	H	OVRL. H	EXTRA WIRE	CHAIN/STEM	EXT.	HCWO	NOTES
A	9654 BK, TZ, WH	(1) 150W (M)	9.5	22.75	---	---	---	10	16.5	W E OD (23-30W CFL)
B	9653 BK, TZ, WH	(1) 100W (M)	8	19.5	---	---	---	8.5	15.5	W E OD (23-30W CFL)
C	9655 BK, TZ	(1) 100W (M)	9.25	17	---	---	---	10	6	W E OD (23-30W CFL)
D	9650 BK, TZ, WH	(1) 100W (M)	8	14.75	---	---	---	8.5	4.75	W E OD (23-30W CFL)
E	9956 BK, TZ	(1) 150W (M)	9.5	22.75	---	---	---	---	---	W E OD (23-30W CFL)
F	9805 BK, TZ, WH	(1) 100W (M)	9.25	13.5	88	32	72	---	---	D E OD (23-30W CFL) Additional chain 4927 BK,TZ.
G	9850 BK, TZ	(2) 60W (C) ❖	10.75	7.25	---	---	---	---	---	D

Measurements shown in inches.



CHESAPEAKE™

BLACK, TANNERY BRONZE™ OR WHITE FINISH
WITH CLEAR BEVELED GLASS PANELS



A | 49255 BK



A | 49255 TZ



A | 49255 WH



Shown with Black Post 9506 BK

B | 49256 BK Post Lantern

Shown with Tannery Bronze™ Post 9506 TZ



B | 49256 TZ Post Lantern

Shown with White Post 9501 WH



B | 49256 WH Post Lantern

CHESAPEAKE™

	ITEM #	FINISH	INCAND. BULB	W	H	EXT.	HCWO	NOTES
A	49255	BK, TZ, WH	(1) 100W (M)	6.5	17	7.75	14	Ⓜ Ⓜ OD (23-30W CFL)
B	49256	BK, TZ, WH	(1) 100W (M)	6.5	18	---	---	Ⓜ Ⓜ OD (23-30W CFL)

Measurements shown in inches.



C | 9776 BK



C | 9776 WH



D | 9774 BK



D | 9774 WH



E | 9977 BK
Post Lantern

Shown with Black Post 9506 BK



E | 9977 WH
Post Lantern

Shown with Black Post 9506 BK



F | 9777 BK



F | 9777 WH

CHESAPEAKE™

CAST ALUMINUM
CONSTRUCTION

	ITEM #	FINISH	INCAND. BULB	W	H	EXT.	HCWO	NOTES
C	9776	BK, WH	(1) 100W (M)	6.5	11.75	8	3.25	W E OD (23-30W CFL)
D	9774	BK, WH	(1) 60W (M)	5.5	10.25	6.25	2.25	W E OD (23-30W CFL)
E	9977	BK, WH	(3) 60W (C)	7.25	17.5	---	---	W
F	9777	BK, WH	(3) 60W (C)	7.25	14.75	8.5	3.5	W

Measurements shown in inches.



TOWNHOUSE™

BLACK OR TANNERY BRONZE™ FINISH WITH
CLEAR CURVED BEVELED GLASS PANELS



A | 9788 BK, TZ



B | 9789 BK, TZ



C | 9790 BK, TZ



D | 9791 BK, TZ



E | 49185 BK, TZ

TOWNHOUSE™

ITEM #	FINISH	INCAND. BULB	W	H	EXT.	HCWO	NOTES	
A	9788	BK, TZ	(1) 100W (M)	6.5	11.75	6.5	2.75	W E OD (23-30W CFL)
B	9789	BK, TZ	(1) 100W (M)	7.25	15.25	9	4.5	W E OD (23-30W CFL)
C	9790	BK, TZ	(1) 100W (M)	7.25	21.5	9.75	16.75	W E OD (23-30W CFL)
D	9791	BK, TZ	(1) 100W (M)	9.25	26.75	10.25	21	W E OD (23-30W CFL)
E	49185	BK, TZ	(3) 60W (C)	12.25	31	12.25	25.25	W

Measurements shown in inches.



F | 9892 BK, TZ
Outdoor Pendant



G | 9886 BK, TZ
Outdoor Ceiling



H | 49188 BK, TZ
Post Lantern

Shown with Tannery Bronze™ Post 9595 TZ



J | 9992 BK, TZ
Post Lantern

TOWNHOUSE™

CAST ALUMINUM
CONSTRUCTION

	ITEM #	FINISH	INCAND. BULB	W	H	OVRL. H	EXTRA WIRE	CHAIN/STEM	NOTES
F	9892	BK, TZ	(1) 100W (M)	9.25	24.5	99	23	72	Ⓛ Ⓜ Ⓞ (23-30W CFL) Additional chain 4927 BK, TZ.
G	9886	BK, TZ	(2) 40W (C) ❖	12	7	---	---	---	Ⓛ
H	49188	BK, TZ	(3) 60W (C)	12.5	29.5	---	---	---	Ⓜ
J	9992	BK, TZ	(1) 100W (M)	9.25	24.25	---	---	---	Ⓜ Ⓛ Ⓞ (23-30W CFL)

Measurements shown in inches.



BEACH LIGHT™

ARCHITECTURAL BRONZE™, BLACK
OR PLATINUM FINISH



A | 49081 AZ



A | 49081 BK



A | 49081 PL



B | 49082 AZ



B | 49082 BK



B | 49082 PL



C | 11120 BZT, TBK
LED



D | 11122 BZT, TBK
LED



E | 11121 BZT, TBK
LED

LED OUTPUT

11120 BZT/TBK	1410 Lumens, 26 Watts, 3000 Kelvin, CRI 80, 40K Life
11121 BZT/TBK	940 Lumens, 23 Watts, 3000 Kelvin, CRI 80, 40K Life
11122 BZT/TBK	1410 Lumens, 27 Watts, 3000 Kelvin, CRI 80, 40K Life

BEACH LIGHT™

CAST ALUMINUM
CONSTRUCTION

ITEM #	LED ITEM #	FINISH	INCAND. BULB	LIGHT SOURCE	W	H	EXT.	HCWO	NOTES	
A	49081	AZ, BK, PL	(1) 60W (M) ✓	---	5	6.25	6.75	2.5	Ⓜ Ⓞ Dark sky compliant with use of A15 or R14 bulb.	
B	49082	AZ, BK, PL	(1) 75W (M)	---	5.75	7	8.25	2.5	Ⓜ Ⓞ	
C	---	11120	BZT, TBK	---	40W ✓ Ⓞ	11.5	6.25	7.75	3.25	Ⓜ Ⓞ
D	---	11122	BZT, TBK	---	40W ✓ Ⓞ	13	6.75	7.25	3.5	Ⓜ Ⓞ
E	---	11121	BZT, TBK	---	20W ✓ Ⓞ	10	7	9	4.5	Ⓜ Ⓞ

Measurements shown in inches. U.S. & Canadian Patent Pending. Cast Aluminum Construction; Harsh Environment, anodized/powder-coated finish: A, B.

LED

TEXTURED ARCHITECTURAL BRONZE™
OR TEXTURED BLACK FINISH



A | **11250 AZT**
Dark Sky Compliant



A | **11250 BKT**
Dark Sky Compliant

LED OUTPUT

11250 AZT/BKT	374 Lumens, 11 Watts, 3000 Kelvin, CRI 85, 40K Life
11251 AZT/BKT	574 Lumens, 15 Watts, 3000 Kelvin, CRI 85, 40K Life
11077 AZT/BKT	425 Lumens, 16 Watts, 3000 Kelvin, CRI 84, 40K Life



B | **11251 AZT**



B | **11251 BKT**



C | **11077 AZT**
Dark Sky Compliant



C | **11077 BKT**
Dark Sky Compliant

LED

CAST ALUMINUM
CONSTRUCTION

	LED ITEM #	FINISH	LIGHT SOURCE	W	H	EXT.	HCWO	NOTES
A	11250	AZT, BKT	11.23W LED	5	7	6.5	3.25	W, C
B	11251	AZT, BKT	4.89W Uplight / 9.78W Downlight LED	5	12.25	6.5	6.25	W
C	11077	AZT, BKT	15.42W	5	5.5	6	2.75	W, C

Measurements shown in inches.

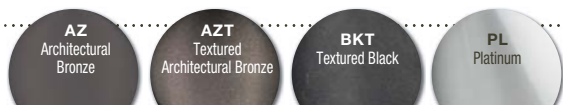

WARRINGTON™

TANNERY BRONZE™ FINISH WITH
CLEAR SEEDY GLASS



A | 9368 TZ



B | 9369 TZ



C | 9370 TZ



D | 9372 TZ



E | 9881 TZ
Outdoor Ceiling



F | 9371 TZ
Outdoor Pendant



G | 9898 TZ
Post Lantern

Shown with
Tannery Bronze™
Post 9506 TZ

WARRINGTON™

CAST ALUMINUM
CONSTRUCTION

ITEM #	FINISH	INCAND. BULB	W	H	OVRL. H	EXTRA WIRE	CHAIN/STEM	EXT.	HCWO	NOTES	
A	9368	TZ	(1) 100W (M)	7.25	13	---	---	---	7.75	3.25	W 3 OD (23-30W CFL)
B	9369	TZ	(1) 150W (M)	9.25	16	---	---	---	10.25	5.5	W 3 OD (30-52W CFL)
C	9370	TZ	(1) 150W (M)	9.25	19.25	---	---	---	10.25	13.75	W 3 OD (30-52W CFL)
D	9372	TZ	(3) 60W (C)	11.5	24	---	---	---	12.5	16.75	W
E	9881	TZ	(2) 40W (C) ❖	12	7.25	---	---	---	---	---	D
F	9371	TZ	(3) 60W (C)	11.5	19.5	94	14	72	---	---	D Additional chain 4927 TZ.
G	9898	TZ	(3) 60W (C)	11.5	25.25	---	---	---	---	---	W

Measurements shown in inches.

NEW STREET™

ASSORTED FINISHES AND GLASSES



A | 345 BK, TZ
Outdoor Ceiling



B | 365 BK, TZ
Outdoor Ceiling



C | 9322 BK, WH
Outdoor Ceiling



D | 9320 BK, WH
Outdoor Ceiling



E | 9817 AP, OZ
Outdoor Ceiling



F | 9618 OZ, SS



G | 9611 BK, OZ,
SS, TZ, WH



H | 9859 BK, TZ
Outdoor Ceiling



J | 1148 BK, TZ, WH

NEW STREET™

ITEM #	FINISH	INCAND. BULB	W	H	EXT.	HCWO	NOTES
A	345 BK, TZ	(2) 60W (M) ❖	9.25	5.25	---	---	Ⓧ OD (9-13W CFL) Textured Clear Glass.
B	365 BK, TZ	(1) 60W (M) ❖	7.5	5	---	---	Ⓧ OD (9-13W CFL) Textured Clear Glass.
C	9322 BK, WH	(2) 60W (M) ✓	10.5	5.5	---	---	Ⓧ Etched White Acrylic Panels.
D	9320 BK, WH	(1) 60W (M)	8.5	5	---	---	Ⓧ Etched White Acrylic Panels.
E	9817 AP, OZ	(2) 100 (M) ✓	13	7	---	---	Ⓧ OD (18-25W CFL) AP: Satin Etched Glass; OZ: Light Umber Etched Glass.
F	9618 OZ, SS	(1) 100W (M)	5.5	10.25	5.75	3.25	Ⓧ OD (23-30W CFL) OZ: Solid Brass Construction, SS: Stainless Steel Construction.
G	9611 BK, OZ, SS, TZ, WH	(1) 60W (M)	5	8.25	5.75	3	Ⓧ OD (23-30W CFL) Aluminum construction.
H	9859 BK, TZ	(1) 100W (M) ✓	7.25	7.25	---	---	Ⓧ OD (9-13W CFL) Seedy Glass.
J	1148 BK, TZ, WH	(1) 75W (M)	4.5	7.5	5.75	2.25	Ⓧ OD (18-25W CFL) Clear Glass.

Measurements shown in inches.



OUTDOOR

ASSORTED FINISHES



A | 9246 AZ, WH



B | 9236 AZ



C | 9234 AZ, WH



D | 9834 WH



E | 9244 AZ, WH

LENS ACCESSORIES

9534 BK Glass Lens use with 9234, 9244

9536 BK Glass Lens use with 9236, 9246

Convert open top units to outdoor applications.
Heat-resistant glass lens with black frame.



F | 6052 AZ, WH



G | 6051 AZ, WH

BRIGHTNESS CONTROL ACCESSORIES

9544 BK Grooved Baffle use with 9234, 9244

9546 BK Grooved Baffle use with 9236, 9246

Grooved black plastic baffles achieve low,
even surface brightness.



9544 BK



9536 BK



9544 BK



9546 BK



H | 9095 AZ
10922 AZ

OUTDOOR

ITEM #	FLUOR. ITEM #	FINISH	INCAND. BULB	FLUOR. BULB	W	H	EXT.	HCWO	NOTES	
A	9246	---	AZ, WH	(2) 120W (M) BR-40	---	6	15	8.5	7.5	☐ OD (23-30W CFL)
B	9236	---	AZ	(1) 120W (M) BR-40	---	6	7.75	8.5	4	⚡ OD (13-15W CFL)
C	9234	---	AZ, WH	(1) 65W (M) BR-30	---	4.5	7	7	3.5	⚡ OD (13-15W CFL)
D	9834	---	WH	(1) 65W (M) BR-30 ✦	---	4.5	8.5	---	---	☐ OD (23-30W CFL)
E	9244	---	AZ, WH	(2) 65W (M) BR-30	---	4.5	12	7	6	☐ OD (13-15W CFL)
F	6052	---	AZ, WH	(2) 120W (M) BR-40 or 150W (M) PAR 38	---	6	11.25	---	---	⚡ Fixture can be wall or ceiling mounted.
G	6051	---	AZ, WH	(1) 120W (M) BR-40 or 150W (M) PAR 38	---	6	11.25	---	---	⚡ Fixture can be wall or ceiling mounted.
H	9095	10922	AZ	(1) 100W (M)	(1) 13W (GU24) ⚡	7	12	5.5	6	⚡ Dark Sky Panels included.

Measurements shown in inches.



J | 9322 BK
Outdoor Ceiling



J | 9322 WH
Outdoor Ceiling



K | 365 BK
Outdoor Ceiling



K | 365 TZ
Outdoor Ceiling



L | 9320 BK
Outdoor Ceiling



L | 9320 WH
Outdoor Ceiling



M | 345 BK
Outdoor Ceiling



M | 345 TZ
Outdoor Ceiling



N | 9859 BK
Outdoor Ceiling



N | 9859 TZ
Outdoor Ceiling



O | 9817 AP
Outdoor Ceiling



O | 9817 OZ
Outdoor Ceiling

OUTDOOR

ITEM #	FINISH	INCAND. BULB	W	H	NOTES
J	9322 BK, WH	(2) 60W (M) ✓	10.5	5.5	Ⓧ Etched White Acrylic Panels.
K	365 BK, TZ	(1) 60W (M) ❖	7.5	5	Ⓧ OD (9-13W CFL) Textured Clear Glass.
L	9320 BK, WH	(1) 60W (M)	8.5	5	Ⓧ Etched White Acrylic Panels.
M	345 BK, TZ	(2) 60W (M) ❖	9.25	5.25	Ⓧ OD (9-13W CFL) Textured Clear Glass.
N	9859 BK, TZ	(1) 100W (M)	7.25	7.25	Ⓧ OD (9-13W CFL)
O	9817 AP, OZ	(2) 100W (M) ✓	13	7	Ⓧ OD (18-25W CFL) AP: Satin Etched Glass; OZ: Light Umber Etched Glass.

Measurements shown in inches.



OUTDOOR ENERGY EFFICIENT

ASSORTED FINISHES



A | 10923 BK, TZ



B | 10941 BK, WH



C | 11029 BK, WH



D | 10622 BK, WH



E | 11026 BK, WH
Outdoor Ceiling



F | 11027 BK, WH
Outdoor Ceiling



G | 11028 BK, WH
Outdoor Ceiling

OUTDOOR ENERGY EFFICIENT

	FLUOR. ITEM #	FINISH	FLUOR. BULB	W	H	EXT.	HCWO	NOTES
A	10923	BK, TZ	(1) 13W (GU24)	4.75	9	5.75	2.5	W Satin-Etched Glass
B	10941	BK, WH	(1) 18W (GU24)	7.75	9.75	4.25	4.25	W White Acrylic Panels
C	11029	BK, WH	(1) 13W (GU24)	5	8.5	4.5	4.25	W Frosted Ribbed Glass
D	10622	BK, WH	(1) 18W (GU24)	10	9.5	5	5	W Frosted Ribbed Glass.
E	11026	BK, WH	(1) 18W (GU24)	7.5	5	---	---	D Satin-Etched Glass
F	11027	BK, WH	(2) 18W (GU24)	9.25	5.25	---	---	D Satin-Etched Glass
G	11028	BK, WH	(1) 18W (GU24)	11.25	4.75	---	---	W Etched Acrylic Panels

Measurements shown in inches.



DARK SKY ACCESSORIES



9707 OZ
Mount Vernon
Panel Set 4826 WH



10907 OZ
Mount Vernon
Panel Set 4826 WH



9708 OZ
Mount Vernon
Panel Set 4827 WH



10908 OZ
Mount Vernon
Panel Set 4827 WH



Evening View of Outdoor Lantern
without Dark Sky Panel Inserts



Evening View of Outdoor Lantern
with Dark Sky Panel Inserts

Help fight light pollution with Kichler® Dark Sky Accessories. Made of lightweight, powder coated aluminum, our Dark Sky panels easily slide behind your light fixture's existing glass. During the day, your light fixture may look conventional. Yet, at night, the panels prevent light from passing through its glass – only to emit a subtle downlight from the fixture's open bottom.

All Fixtures shown here can be retrofitted with a Dark Sky Adaptor Panel. Panel Sets consist of enough panels to retrofit one fixture. Installation instructions are included.

While we believe these panels will work for most current laws, Dark Sky and Turtle Protection legislation may have specific parameters that need to be met for a municipality or region. It is advisable to review the legislation to ensure compliance is met with these product additions.



9649 CV
Alameda™
Panel Set 4820 WH



9651 CV
Alameda™
Panel Set 4812 WH



9652 CV
Alameda™
Panel Set 4813 WH



9849 CV
Alameda™
Panel Set 4814 WH

Dark sky
panel
insert sets

For use
With these
fixtures

4812 WH	9651 CV
4813 WH	9652 CV
4814 WH	9849 CV
4820 WH	9649 CV
4826 WH	9707 OZ
4826 WH	10907 OZ
4827 WH	9708 OZ
4827 WH	10908 OZ

ACCESSORIES

CAST ALUMINUM CONSTRUCTION

DECORATIVE LAMP POSTS & PEDESTAL MOUNTS



A | 9523 BKT, LD
Shown with Tournai™
Lantern 9565 LD



B | 9510 BK, BST,
LD, OZ



C | 9542 BK, BST,
LD, OZ



D | 9506 AZ, BA,
BK, OB, TZ



E | 9595 AGZ, BK,
BST, OZ



AGZ
Aged Bronze



AZ
Architectural Bronze™



BA
Brushed Aluminum



BK
Black



BST
Brown Stone



LD
Londonderry™



OB
Olde Brick™



OZ
Olde Bronze®



PB
Polished Brass



RZ
Rubbed Bronze™



TZ
Tannery Bronze™



TZG
Tannery Bronze™
with Gold



WH
White

DECORATIVE LAMP POSTS

ITEM #	FINISH	W	H	NOTES
A 9523	BKT, LD	4	96	Cast Aluminum Pedestal Mount, Hardware included (J-bolts).
B 9510	BK, BST, LD, OZ	3	72	Cast Aluminum Post, hardware incl. (J-bolts) for use at time of concrete base pour.
C 9542	BK, BST, LD, OZ	3	96	Cast Aluminum Post, hardware incl. (J-bolts) for use at time of concrete base pour .
D 9506	AZ, BA, BK, OB, TZ	3	84	Direct Burial Aluminum Post.
E 9595	AGZ, BK, BST, OZ	3	84	Direct Burial Fluted Aluminum Post.

Measurements shown in inches.

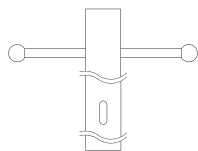

F | 9501 BK, WH

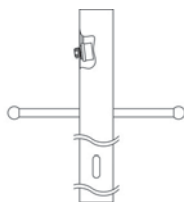

G | 9502 BK

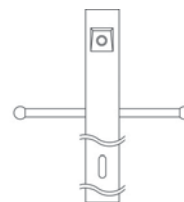

H | 49904 AZ, BK, WH

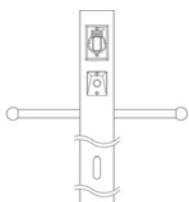

J | 49907 AZ, BK, WH

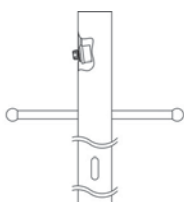

K | 49950 BK

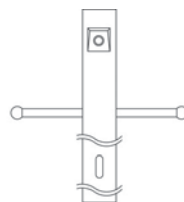

L | 49951 BK, WH

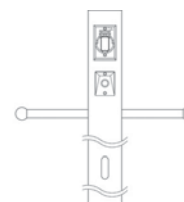

M | 49952 BK, WH



N | 9531 BK



P | 9540 BKT



P | 9540 LD



Q | 9530 BK, OB, OZ, PB, TZG, WH



R | 9549 BKT



R | 9549 LD



O | 9551 BK



S | 9592 AGZ



S | 9592 AZ



S | 9592 BK



S | 9592 RZ

PEDESTAL MOUNT ADAPTERS & MISCELLANEOUS

ITEM #	FINISH	W	H	NOTES
F	9501 BK, WH	3	84	Direct Burial Aluminum Post with Ladder Rest
G	9502 BK	3	84	Direct Burial Aluminum Post with Ladder Rest and Internal Photocell (Repl. Internal Photocell 49950)
H	49904 AZ, BK, WH	3	84	Direct Burial Aluminum Post with Ladder Rest and External Photocell (Repl. External Photocell 49951)
J	49907 AZ, BK, WH	3	84	Direct Burial Aluminum Post with Ladder Rest, External Photocell and GCO (Replacement External Photocell 49951 or GCO 49952)
K	49950 BK	---	---	Replacement Internal Photocell (Black Only) (Not Shown).
L	49951 BK, WH	---	---	Replacement External Photocell (Not Shown).
M	49952 BK, WH	---	---	Replacement GCO (Not Shown).
N	9531 BK	8	9	Cast Aluminum Pedestal Mount, Hardware included (#10 Philips, SS wood screws).
O	9551 BK	9.5	9.5	Cast Aluminum Pedestal Mount, Hardware included (#10 Philips, SS wood screws).
P	9540 BKT, LD	10	4.75	Cast Aluminum Pedestal Mount, Hardware included (J-bolts).
Q	9530 BK, OB, OZ, PB, TZG, WH	7	3.5	Cast Aluminum Pedestal Mount (PB is Solid Cast Brass), Hardware not included.
R	9549 BKT, LD	10	5.75	Cast Aluminum Pedestal Mount, Hardware included (J-bolts).
S	9592 AGZ, AZ, BK, RZ	5.75	3.5	

Measurements shown in inches. Do not mount post to Pedestal Mount Adaptor. Fixtures assemble directly to Adaptor.

LIGHT BULB REFERENCE

Incandescent and Compact Fluorescent Light Bulbs

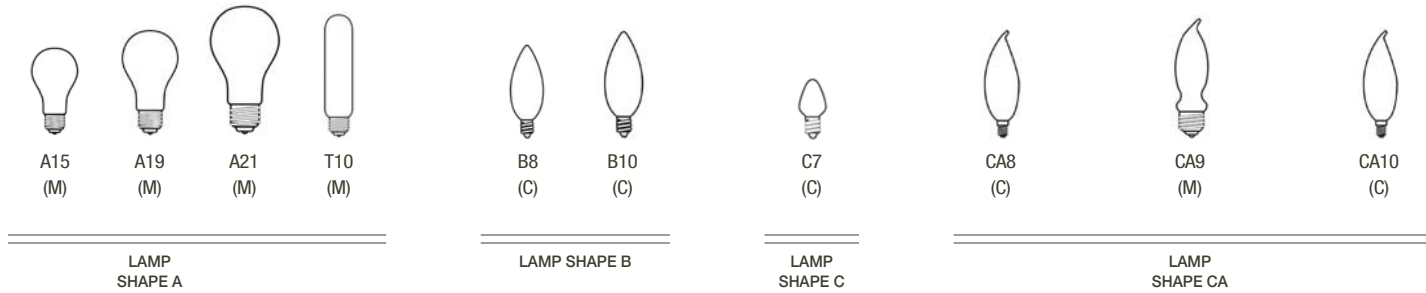

Compact Fluorescent Bulbs (CFL)

 Look for this symbol throughout our catalog. This symbol indicates the products best suited for Indoor use with self-ballasted, compact fluorescent lamps sold through electrical distributors and lighting showrooms across the U.S.

 This symbol indicates the product best suited for Outdoor use with self-ballasted, compact fluorescent lamps sold through electrical distributors and lighting showrooms across the U.S.









If a light fixture is connected to a dimmer or 3-way switch, you'll need to use a qualified CFL designed to work in these applications. Make sure to look for CFLs that specify use with dimmers or 3-way switches.

Equivalent Light Output

To determine which qualified CFL light bulbs will provide the same amount of light as your current incandescent light bulbs, consult the following chart:

INCANDESCENT LIGHT BULBS WATTS (W)	INCANDESCENT MINIMUM LIGHT OUTPUT LUMENS	COMMON CFL LIGHT BULBS WATTS (W)
40	450	9-13
60	800	13-15
75	1,100	18-25
100	1,600	23-30
150	2,600	30-52

Fluorescent Lamps

PRODUCT ID	DESCRIPTION	PRODUCT ID	DESCRIPTION
4013	Replacement Ballast	4031	Replacement Ballast, SU13, G24q-1 Base 
4014	Replacement Lamp, PLC 26, G24q-3 Base	4032	Replacement Ballast, SU18, G24q-2 Base
4025	Replacement Lamp, PLC 13, G24q-1 Base 	4034	Replacement Ballast, 40W circline, G10q Base
4026	Replacement Lamp, PLC 18, G24q-2 Base	4035	Replacement Ballast, 55W circline, G10q Base 
4028	Replacement Lamp, 2C T6 40W, G10q Base	4036	Replacement Ballast, 70W circline, G10q Base
4029	Replacement Lamp, 2C T6 55W, G10q Base 	4043	Replacement Lamp, MLS13GUWW, 13W, GU24
4030	Replacement Lamp, 2C T6 70W, G10q Base	4044	Replacement Lamp, MLS18GUWW, 18W, GU24 
4033	Replacement Lamp, 13 Watt Anti-Turn Ballast	4045	Replacement Lamp, MLS26GUWW, 26W, GU24
4037	Replacement Lamp, PLG 18, G24q-2 Base 	4050	Replacement Lamp, 13 Watt GU24 Squat Bulb 
		4051	Replacement Lamp, 18 Watt GU24 Squat Bulb 
		4074	Replacement Lamp, 11 Watt GU24 Spiral Bulb
		4075	Replacement Lamp, 18 Watt GU24 Quad Tube Bulb

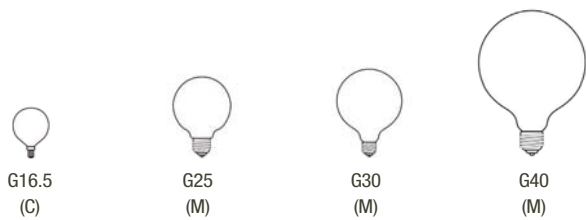

LAMP
SHAPE G



COMPACT
FLUORESCENT

KRYPTON

Optional Shades



4114
White Lace Fabric Shade with Silver Embroidery and Beige Trim
3" x 5" x 4.75"



4115
Off-White Fabric Shade with Silver Embroidery and Beige/White Striped Trim
3" x 5" x 4.75"



4085 BG
Beige Fabric Shade
2.5" x 4.25" x 3.75"



4086 BG
Beige Fabric Shade
3.5" x 5.5" x 4.75"



4087 BG
Beige Fabric Shade
4" x 6" x 5.25"



4122
Clear Seedy Glass
4.5" x 6.5"



4117 CLR
Clear Glass
4.25" x 6"



4118 SEG
Satin Etched Glass
4.25" x 6"



4119 OWH
Off-White Fabric Shade
3" x 5" x 4.5"



4121
Mica Fabric Shade
3.25" x 5" x 4.25"



4225 OZ
Olde Bronze®
3" x 10"



4225 PN
Polished Nickel
3" x 10"

Decorative Light Bulbs



4071 CLR
60W (M)



5971 CLR
40W (C)



4091
9W (M)



4092
11W (M)

Halogen & Krypton Lamps

PRODUCT ID	DESCRIPTION
5901 CLR	Clear 50W T-3 Double Contact, Bayonet Base, Tungsten (Suitable for use with all Kichler lights requiring Halogen Lamps)
5902 FST	Frosted 50W GU10 Halogen Lamp
5903 CLR	Clear 100W T-3 Mini-Can Base, Tungsten Halogen Lamp
5904 CLR	Clear 20W T-3 Candelabra Base Krypton Lamp
5904 FST	Frosted 20W T-3 Candelabra Base Krypton Lamp
5905 CLR	Clear 60W T-3 Candelabra Base Krypton Lamp

PRODUCT ID	DESCRIPTION
5905 FST	Frosted 60W T-3 Candelabra Base Krypton Lamp
5907 CLR	Clear 40W T-3 Candelabra Base Krypton Lamp
5907 FST	Frosted 40W T-3 Candelabra Base Krypton Lamp
5908 FST	Frosted 60W G9 Halogen Lamp
5909	50W MR16 Shielded GU10 Lamp
5910 CLR	Clear 75W T-3 Mini-Can Base, Tungsten Halogen Lamp

ACCESSORIES

Standard Gauge Chain

Chain may be ordered in 3' lengths to supplement existing chain supplied with Kichler® fixtures. To order additional chain, look for the chain recommendations listed for fixtures requiring chain.

- 2979 PB** Polished Brass (LifeBrite™)
- 2996 AB** Antique Brass
- 2996 ACO** Antique Copper
- 2996 AP** Antique Pewter
- 2996 AVI** Anvil Iron
- 2996 BPT** Brushed Pewter
- 2996 BRSG** Brushed Silver and Gold
- 2996 BST** Brown Stone
- 2996 CH** Chrome
- 2996 CLP** Classic Pewter
- 2996 CMZ** Cambridge Bronze
- 2996 CST** Canyon Slate™
- 2996 CTZ** Colton Bronze™
- 2996 CYZ** Cayman Bronze™
- 2996 CZ** Carré Bronze®
- 2996 DAW** Distressed Antique White
- 2996 DBK** Distressed Black
- 2996 DZ** Doré Bronze™
- 2996 HB** Heritage Bronze™
- 2996 LBZ** Lincoln Bronze™
- 2996 LZ** Legacy Bronze™
- 2996 MBZ** Marbled Bronze
- 2996 MCH** Midnight Chrome
- 2996 MIZ** Mission Bronze™
- 2996 NI** Brushed Nickel
- 2996 OI** Olde Iron
- 2996 OLZ** Oiled Bronze
- 2996 OZ** Olde Bronze®
- 2996 PN** Polished Nickel
- 2996 PRZ** Parisian Bronze™

- 2996 PSS316** Polished Stainless Steel 316
- 2996 PZ** Patina Bronze
- 2996 RVN** Ravenna™
- 2996 SMG** Smokey Gray
- 2996 SRM** Sunrise Mist
- 2996 SWZ** Shadow Bronze™
- 2996 TRZ** Terrene Bronze
- 2996 TZ** Tannery Bronze™
- 2996 TZG** Tannery Bronze™ with Gold Accents
- 2996 WMZ** Warm Bronze™
- 2996 WZC** Weathered Zinc

Heavy Gauge Chain

- 4901 AB** Antique Brass
- 4901 AP** Antique Pewter
- 4901 AVI** Anvil Iron
- 4901 BK** Black
- 4901 BPT** Brushed Pewter
- 4901 BRSG** Brushed Silver and Gold
- 4901 CH** Chrome
- 4901 CMZ** Cambridge Bronze
- 4901 CST** Canyon Slate™
- 4901 CTZ** Colton Bronze™
- 4901 CYZ** Cayman Bronze™
- 4901 CZ** Carré Bronze®
- 4901 DAW** Distressed Antique White
- 4901 DBK** Distressed Black
- 4901 HB** Heritage Bronze
- 4901 LBZ** Lincoln Bronze™
- 4901 LD** Londonderry™
- 4901 LZ** Legacy Bronze™
- 4901 MBZ** Marbled Bronze
- 4901 MIZ** Mission Bronze™
- 4901 NI** Brushed Nickel
- 4901 OI** Olde Iron

- 4901 OLZ** Oiled Bronze
- 4901 OZ** Olde Bronze®
- 4901 PN** Polished Nickel
- 4901 PRZ** Parisian Bronze™
- 4901 PZ** Patina Bronze
- 4901 RVN** Ravenna™
- 4901 SRM** Sunrise Mist
- 4901 SWZ** Shadow Bronze™
- 4901 TRZ** Terrene Bronze
- 4901 TZ** Tannery Bronze™
- 4901 TZG** Tannery Bronze™ with Gold Accents

Extra Heavy Gauge Chain

- 4908 AP** Antique Pewter
- 4908 CTZ** Colton Bronze™
- 4908 CZ** Carré Bronze®
- 4908 DBK** Distressed Black
- 4908 HB** Heritage Bronze
- 4908 LBZ** Lincoln Bronze™
- 4908 NI** Brushed Nickel
- 4908 OI** Olde Iron
- 4908 OLZ** Oiled Bronze
- 4908 OZ** Olde Bronze®
- 4908 PRZ** Parisian Bronze™
- 4908 SRM** Sunrise Mist
- 4908 TRZ** Terrene Bronze™
- 4908 TZ** Tannery Bronze™
- 4908 TZG** Tannery Bronze™ with Gold Accents
- 4909 AP** Antique Pewter
- 4909 BAB** Burnished Antique Brass
- 4909 CH** Chrome
- 4909 CZ** Carré Bronze®
- 4909 DBK** Distressed Black
- 4909 HB** Heritage Bronze™
- 4909 LBZ** Lincoln Bronze™

- 4909 NI** Brushed Nickel
- 4909 OI** Olde Iron
- 4909 OLZ** Oiled Bronze
- 4909 OZ** Olde Bronze®
- 4909 TZG** Tannery Bronze™ with Gold Accents
- 4912 RVN** Ravenna™
- 4930 CZ** Carré Bronze®
- 4930 LD** Londonderry™
- 4930 OI** Olde Iron
- 4930 RVN** Ravenna™
- 4930 TZG** Tannery Bronze™ with Gold Accents

Decorative Chain

- 4904 TZG** Tannery Bronze™ with Gold Accents
- 4905 TZ** Tannery Bronze®
- 4915 TZ** Tannery Bronze™
- 4917 TZ** Tannery Bronze™
- 4919 TZ** Tannery Bronze™
- 4920 TZ** Tannery Bronze™

Outdoor Solid Brass Chain

- 4927 ACO** Antique Copper
- 4927 AGZ** Aged Bronze
- 4927 AVI** Anvil Iron
- 4927 AZ** Architectural Bronze®
- 4927 BK** Black
- 4927 BKG** Black with Gold
- 4927 BRZ** Brushed Bronze
- 4927 CV** Canyon View™
- 4927 DCO** Distressed Copper
- 4927 GNT** Textured Granite
- 4927 LD** Londonderry™
- 4927 LZ** Legacy Bronze™
- 4927 OB** Olde Brick®

- 4927 OI** Olde Iron
- 4927 OLZ** Oiled Bronze
- 4927 OZ** Olde Bronze®
- 4927 PL** Platinum
- 4927 PR** Prairie Rock™
- 4927 RST** Rustic™
- 4927 RZ** Rubbed Bronze
- 4927 SS** Stainless Steel
- 4927 TZ** Tannery Bronze™
- 4927 TZG** Tannery Bronze™
with Gold Accents
- 4927 WZC** Weathered Zinc

Wall Mount Pendant Assembly

- BeautyWrap™ Adapter Kit**
- 4931 NI** Brushed Nickel

Ceiling Mount Pendant Suspender Kit

Suspend 2- or 3-mini pendants, even Mini-Chandeliers, over a kitchen island, breakfast nook, or almost anywhere. Kit includes a central outlet box canopy cover and (2) 16-1/2" arms with mounting hardware. It's easy and so versatile – add additional fixtures to create a more modular look!

- 4900 NI** Brushed Nickel
- 4900 TZ** Tannery Bronze™

Hang-Straight Canopy Kit

Maintain the clean look of stem-mounted fixtures on ceilings with slopes of 45° (12:12). Kit includes a canopy, mounting strap and hardware with complete instructions. Convert chain hung fixtures to stem-mounted versions by combining with 2997 and 2999 stem segments. Or, for added design flexibility, alter overall fixture length by removing or adding 12" or 24" stem segments.

- 3000 BK** Black
- 3000 NI** Brushed Nickel
- 3000 WH** White

Light Lift Adapters

With the addition of these adaptors, the fixture's supplied mounting hardware can be connected to commercially available light lifts.

- 4015** Light Lift Mounting Adapter
For use with Light Lift #ALL200 and ALL300.
- 4016** Light Lift Mounting Adapter
For use with Light Lift #ALL300, ALL700, and ALL1000.

Stem Segments

To increase the fixture overall length to a maximum of 5-stem segments you may order:

- 12" Length
- 2995 AP** Antique Pewter
- 2995 BK** Black
- 2995 CH** Chrome
- 2995 OZ** Olde Bronze®
- 2998 AB** Antique Brass
- 2998 AP** Antique Pewter
- 2998 BK** Black
- 2998 BPT** Brushed Pewter
- 2998 CH** Chrome
- 2998 CST** Canyon Slate™

- 2998 CZ** Carré Bronze®
- 2998 DBK** Distressed Black
- 2998 DZ** Doré Bronze™
- 2998 LBZ** Lincoln Bronze™
- 2998 LZ** Legacy Bronze™
- 2998 NI** Brushed Nickel
- 2998 OI** Olde Iron
- 2998 OLZ** Oiled Bronze
- 2998 OZ** Olde Bronze®
- 2998 PRZ** Parisian Bronze™
- 2998 PZ** Patina Bronze
- 2998 TG** Tuscan Gold®
- 2999 AB** Antique Brass
- 2999 AP** Antique Pewter
- 2999 AVI** Anvil Iron
- 2999 BK** Black
- 2999 BPT** Brushed Pewter
- 2999 BRSG** Brushed Silver and Gold
- 2999 CH** Chrome
- 2999 CLP** Classic Pewter
- 2999 CMZ** Cambridge Bronze
- 2999 CST** Canyon Slate™
- 2999 CTZ** Colton Bronze™
- 2999 CZ** Carré Bronze®
- 2999 DAW** Distressed Antique White
- 2999 DBK** Distressed Black
- 2999 DZ** Doré Bronze™
- 2999 LBZ** Lincoln Bronze™
- 2999 LZ** Legacy Bronze™
- 2999 MBZ** Marbled Bronze
- 2999 MCH** Midnight Chrome
- 2999 MIZ** Mission Bronze™
- 2999 NI** Brushed Nickel
- 2999 OI** Olde Iron
- 2999 OLZ** Oiled Bronze
- 2999 OZ** Olde Bronze®
- 2999 PN** Polished Nickel

- 2999 PRZ** Parisian Bronze™
- 2999 PSS316** Polished Stainless Steel 316
- 2999 PZ** Patina Bronze
- 2999 SWZ** Shadow Bronze
- 2999 TZ** Tannery Bronze™
- 2999 WMZ** Warm Bronze™
- 2999 WZC** Weathered Zinc
- 4934 CST** Canyon Slate™
- 4934 DBK** Distressed Black
- 4934 NI** Brushed Nickel
- 4935 AP** Antique Pewter
- 4935 AVI** Anvil Iron
- 4935 BK** Black
- 4935 BPT** Brushed Pewter
- 4935 CH** Chrome
- 4935 CLP** Classic Pewter
- 4935 CMZ** Cambridge Bronze
- 4935 CST** Canyon Slate™
- 4935 CTZ** Colton Bronze™
- 4935 CYZ** Cayman Bronze™
- 4935 DAW** Distressed Antique White
- 4935 DBK** Distressed Black
- 4935 NI** Brushed Nickel
- 4935 OI** Olde Iron
- 4935 OZ** Olde Bronze®
- 4935 PN** Polished Nickel
- 4935 SWZ** Shadow Bronze
- 4935 WMZ** Warm Bronze™
- 4937 OLZ** Oiled Bronze
- 4938 OLZ** Oiled Bronze
- 24" Length
- 2997 NI** Brushed Nickel

INDEX

206 NI	424	1781 NI	364	2090 CZ	303	2667 OZ	209
206 OZ	424	1781 OZ	364	2091 CZ	302	2682 OZ	389
206 WH	424	1782 NI	364	2092 CZ	302	2682 PN	390
208 WH	424	1782 OZ	364	2093 NI	363	2682 ACO	391
209 NI	424	1783 NI	365	2093 OZ	363	2691 OZ	389
209 OZ	424	1783 OZ	365	2101 RVN	293	2691 PN	390
209 WH	424	1784 NI	364	2120 NI	350	2691 ACO	391
210 WH	424	1784 OZ	364	2121 NI	350	2693 NI	363
216 WH	419	1788 NI	364	2130 RVN	295	2693 OZ	363
345 BK	713, 715	1788 OZ	364	2131 RVN	294	2702 NI	361, 403
345 TZ	713, 715	1789 NI	364	2134 RVN	292	2702 NIS	361, 403
365 BK	713, 715	1789 OZ	364	2215 TZG	301	2702 OZ	361, 403
365 TZ	713, 715	1825 NI	337	2216 TZG	299	2702 TZ	361, 403
623 CH	569	1825 TZ	341	2217 TZG	296	2703 TZG	301
623 NI	569	1826 NI	337	2218 TZG	299	2709 NI	350
624 CH	569	1826 TZ	341	2219 TZG	297	2713 NI	387
624 NI	569	1827 NI	337	2220 TZG	298	2713 OB	387
625 CH	569	1827 TZ	341	2303 TZG	301	2714 NI	387
625 NI	569	1828 NI	336	2304 TZG	300	2715 NI	387
626 CH	569	1828 TZ	340	2307 TZG	298	2752 NI	400
626 NI	569	1829 NI	336	2313 TZG	297	2754 NI	400
628 CH	569	1829 TZ	340	2343 NI	221	2771 NI	361
628 NI	569	1861 AP	122	2343 OZ	223	2771 TZ	361
630 CH	569	1861 OZW	126	2344 NI	220	2800 TZ	333
630 NI	569	1861 OZ	131	2344 OZ	222	2807 NI	363
632 CH	569	1873 OZ	105	2345 NI	220	2929 NI	338
632 NI	569	1873 NI	109	2345 OZ	222	2929 TZ	339
		1894 CH	225	2346 NI	220	2943 NI	221
		1894 NI	227	2346 OZ	222	2943 OZ	223
		1894 OZ	229	2347 NI	220	2955 NI	207
		1896 CH	225	2347 OZ	222	2955 OZ	210
		1896 NI	227	2441 RVN	295	2978 AP	125
		1896 OZ	229	2471 CZ	304	2978 OZW	129
		1897 CH	227	2472 CZ	304	2978 OZ	133
		1897 NI	227	2518 NI	351		
		1897 OZ	229	2520 NI	362	3030 NI	231
				2520 TZ	362	3031 NI	231
		2018 NI	360	2523 NI	360	3121 NI	411
		2018 TZ	360	2523 TZ	360	3121 TZ	411
		2019 NI	360	2531 NI	361	3122 NI	411
		2019 TZ	360	2531 TZ	361	3122 NIA	411
		2020 AB	361	2534 NI	345	3122 TZ	411
		2020 NI	361	2534 TZ	345	3217 TZG	297
		2020 TZ	361	2556 AP	357	3244 NI	207, 400
		2021 NI	360	2556 OZ	359	3245 NI	207, 400
		2021 TZ	360	2557 AP	357	3275 NI	109
		2022 NI	363	2557 OZ	359	3275 OZ	105
		2022 TZ	363	2558 AP	356	3277 NI	105, 366
		2031 NI	360	2558 OZ	358	3277 OZ	109, 366
		2031 TZ	360	2606 TZG	299	3278 AP	124
		2033 NI	345	2616 MBZ	376, 500	3278 APFL	124
		2033 TZ	345	2621 NI	592	3278 OZW	128
		2043 NI	208	2640 NI	387	3278 OZ	132
		2043 OZ	209	2641 NI	387	3278 OZFL	132
		2049 TZG	301	2643 NI	387	3279 AP	124
		2055 NI	207	2652 NI	207	3279 OZW	128
		2055 OZ	210	2652 OZ	210	3279 OZ	132
		2076 NI	366	2655 NI	207	3289 CZ	305
		2076 OZ	366	2655 OZ	210	3293 NI	363
		2077 NI	366	2664 OZ	389	3293 NIA	363
		2077 OZ	366	2664 PN	390	3293 OZ	363
		2084 NI	342	2664 ACO	391	3293 OZU	363
		2084 OZ	342	2665 OZ	389	3299 CH	224
		2085 NI	342	2665 PN	390	3299 NI	226
		2085 OZ	342	2665 ACO	391	3299 OZ	228
		2086 NI	342	2666 OZ	389	3320 NI	351
		2086 OZ	342	2666 PN	390	3325 NI	338
		2088 CZ	303	2666 ACO	391	3325 TZ	339
		2089 CZ	303	2667 NI	208	3326 NI	337

3326 TZ	341	3719 NI	351	5085 CH	477	5403 NI	505
3345 NI	115	3728 NI	336	5085 NI	478	5404 NI	505
3347 NI	115	3728 TZ	340	5085 OZ	479	5436 PN	487
3348 NI	115	3729 TZ	339, 544	5096 CH	224, 514	5437 PN	487
3349 NI	115	3729 NI	338, 545	5096 NI	226, 515	5438 PN	487
3355 AP	357	3743 NI	221	5096 OZ	228, 513	5439 PN	487
3355 OZ	359	3743 OZ	223	5097 CH	514	5446 CH	522
3356 AP	357	3752 NI	400	5097 NI	515	5446 NI	115, 522
3356 OZ	359	3757 AP	357	5097 OZ	513	5446 OZ	522
3384 NI	365	3757 OZ	359	5098 CH	514	5447 CH	522
3384 OZ	365	3797 CH	225	5098 NI	515	5447 NI	522
3390 CZ	302	3797 NI	227	5098 OZ	513	5447 OZ	522
3391 CZ	302	3797 OZ	229	5099 CH	514	5448 CH	522
3427 NI	338	3821 NI	351	5099 NI	515	5448 NI	522
3427 TZ	339	3849 NI	114	5099 OZ	513	5448 OZ	522
3475 OZ	106	3856 AP	356	5149 NI	523	5449 CH	522
3475 NI	108	3856 OZ	358	5150 NI	523	5449 NI	522
3476 NI	366	3875 NI	105	5151 NI	523	5449 OZ	522
3476 OZ	366	3875 NI	109	5214 TZG	300, 541	5459 AP	471
3478 AP	125	3882 NI	365	5215 TZG	541	5459 OZ	471
3478 OZW	128	3882 OZ	365	5216 TZG	541	5460 AP	471
3478 OZ	133	3894 CZ	305	5217 TZG	541	5460 OZ	471
3482 NI	365	3898 CH	224	5218 TZG	541	5461 AP	471
3482 OZ	365	3898 NI	227	5284 NI	342, 556	5461 OZ	471
3489 CZ	305	3898 OZ	228	5284 OZ	342, 556	5462 AP	471
3497 CH	225			5285 NI	556	5462 OZ	471
3497 NI	227	4079	433	5285 OZ	556	5556 AP	356
3497 OZ	229	4083	433	5286 NI	556	5556 OZ	358
3502 NI	360	4084	433	5286 OZ	556	5557 AP	558
3502 TZ	360	4200 CH	377	5287 NI	556	5557 OZ	558
3584 NI	342	4200 NI	377	5287 OZ	556	5558 AP	558
3584 OZ	342	4200 OZ	377	5294 NI	363	5558 OZ	558
3585 NI	342	4200 PN	377	5294 OZ	363	5559 AP	558
3585 OZ	342	4200 WMZ	377	5315 MBZ	500	5559 OZ	558
3587 NI	342	4223 MUL	374	5316 MBZ	500	5926 NI	338, 545
3587 OZ	342	4225 OZ	374	5317 MBZ	500	5926 TZ	339, 544
3606 OZW	128	4225 PN	374	5334 CH	567	5927 NI	545
3606 OZ	133			5334 NI	567	5927 TZ	544
3620 NI	423	5003 CH	568	5334 TZ	567	5928 NI	545
3620 OZ	423	5003 NI	568	5336 CH	567	5928 TZ	544
3623 NI	361, 412	5003 TZ	568	5336 NI	567	5929 NI	545
3623 NIA	361, 412	5017 CH	568	5336 TZ	567	5929 TZ	544
3623 OZ	361, 412	5017 NI	568	5337 CH	567	5965 NI	484
3623 TZ	361, 412	5017 TZ	568	5337 NI	567	5965 PN	485
3623 TZFL	361, 412	5018 CH	568	5337 TZ	567	5966 NI	484
3623 NIFL	361, 412	5018 NI	568	5338 CH	567	5966 PN	485
3623 OZFL	361, 412	5018 TZ	568	5338 NI	567	5967 NI	484
3627 NI	423	5019 CH	568	5338 TZ	567	5967 PN	485
3627 OZ	423	5019 NI	568	5339 CH	567	5968 NI	484
3674 OZ	105	5019 TZ	568	5339 NI	567	5968 PN	485
3674 NI	109	5051 NI	486	5339 TZ	567	5987 CZ	305, 542
3677 OZ	105	5052 NI	486	5359 NI	350, 504	5988 CZ	542
3677 NI	109	5053 NI	486	5360 NI	504	5989 CZ	542
3678 AP	125	5054 NI	486	5361 NI	504	5990 CZ	542
3678 APFL	125	5056 CZ	543	5362 NI	504	5991 CH	366, 561
3678 OZW	129	5057 CZ	543	5367 CH	538	5991 NI	366, 561
3678 OZ	133	5058 CZ	543	5368 CH	538	5991 OZ	366, 561
3678 OZFL	133	5076 CH	477	5369 CH	538	5992 CH	561
3681 NI	365	5076 NI	109, 478	5370 CH	538	5992 NI	561
3681 OZ	365	5076 OZ	105, 479	5371 CH	538	5992 OZ	561
3694 NIW	117, 363	5077 CH	477	5388 NI	364, 502	5993 CH	561
3694 OZW	119, 363	5077 NI	478	5388 OZ	364, 503	5993 NI	561
3694 NI	363, 365	5077 OZ	479	5389 NI	502	5993 OZ	561
3694 OZ	363, 365	5078 CH	477	5389 OZ	503	5994 CH	561
3695 NI	221	5078 NI	478	5390 NI	502	5994 NI	561
3695 OZ	223	5078 OZ	479	5390 OZ	503	5994 OZ	561
3713 TZG	300	5079 CH	477	5391 NI	502		
3718 NI	411	5079 NI	478	5391 OZ	503	6016 MBZ	500
3718 TZ	411	5079 OZ	479	5402 NI	505	6040 AZ	602

INDEX

6040 NI	602	7002 AZ	620	8405 TZ	420	9039 RZ	682
6040 PSS316	602	7002 GNT	621	8406 NI	420	9040 BK	681
6048 AZ	602	7003 NI	423	8406 TZ	420	9040 RZ	683
6048 NI	602	7003 OZ	423	8407 NI	420	9041 BK	680
6048 PSS316	602	7011 NI	423	8407 TZ	420	9041 RZ	682
6051 AZ	714	7011 OZ	423	8413 TZG	300	9042 BK	681
6051 WH	714	7050 OZ	409	8415 TZG	300	9042 RZ	683
6052 AZ	714	7050 PN	409	8653 CH	416	9043 BK	680
6052 WH	714	7260 WH	419	8653 NI	362, 416	9043 RZ	682
6079 AP	125	7350 WH	419	8653 SC	416	9044 NI	437, 592
6079 OZW	129	7703 AP	124, 409	8653 TZ	362, 416	9044 OB	437, 592
6079 OZ	133	7703 OZ	132, 409	8654 CH	416	9051 AGZ	646
6083 NI	523	7704 OZ	409	8654 NI	362, 416	9052 AGZ	646
6086 NI	342, 556	7704 PN	409	8654 SC	416	9054 AGZ	646
6086 OZ	342, 556	7744 DBK	408	8654 TZ	362, 416	9060 BKT	672
6090 NI	568	7755 NI	208, 408, 489	8655 NI	361, 416	9060 RZ	674
6091 NI	568	7755 OZ	209, 408, 489	8655 SC	416	9081 BKT	672
6121 CH	566	7779 AP	124, 409	8655 TZ	361, 416	9081 RZ	674
6121 NI	566	7779 OZ	132, 409	8880 NI	422	9095 AZ	714
6122 CH	566			8880 OZ	422	9099 BK	680
6122 NI	566	8010 WH	419	8880 TZ	422	9099 RZ	682
6123 CH	566	8043 CH	225	8880 WH	422	9109 BA	602
6123 NI	566	8043 NI	227	8880 NIFL	422	9109 BK	602
6124 CH	566	8043 OZ	229	8880 OZFL	422	9128 AGZ	644
6124 NI	566	8044 NI	365, 502	8881 NI	422	9129 AGZ	644
6144 NI	221	8044 OZ	365, 503	8881 OZ	422	9130 AGZ	644
6144 OZ	223	8064 NI	362, 423	8881 TZ	422	9131 AGZ	644
6162 NI	489	8064 TZ	362, 423	8881 WH	422	9132 AGZ	644
6162 OZ	489	8065 NI	362, 423	8881 NIFL	422	9143 CV	643
6292 NI	564	8065 TZ	362, 423	8881 OZFL	422	9147 CV	643
6293 NI	564	8076 NI	366	8882 NI	422	9148 CV	147, 642
6294 NI	564	8076 OZ	366	8882 OZ	422	9166 AZ	620
6311 NI	506	8090 CZ	304	8882 TZ	422	9166 GNT	621
6312 NI	506	8101 NI	425	8882 WH	422	9167 AZ	620
6313 NI	506	8101 WH	425	8882 NIFL	422	9167 GNT	621
6314 NI	506	8101 NIFL	425	8882 OZFL	422	9168 AZ	620
6322 NI	557	8101 WHFL	425			9168 GNT	621
6322 TZ	557	8102 NI	425	9021 BK	592	9234 AZ	714
6323 NI	557	8102 WH	425	9021 NI	592	9234 WH	714
6323 TZ	557	8102 NIFL	425	9021 OB	592	9236 AZ	714
6324 NI	557	8102 WHFL	425	9021 OZ	592	9244 AZ	714
6324 TZ	557	8103 NI	425	9022 BK	592	9244 WH	714
6463 NI	489	8103 WH	425	9022 NI	592	9246 AZ	714
6463 OZ	489	8103 NIFL	425	9022 OB	592	9246 WH	714
6464 NI	489	8103 WHFL	425	9022 OZ	592	9250 BK	688
6464 OZ	489	8108 NI	418	9022 WH	592	9251 BK	688
6482 CH	564	8108 OZ	418	9023 BK	592	9252 BK	688
6483 CH	564	8108 TZ	418	9023 NI	592	9320 BK	713, 715
6484 CH	564	8109 NI	418	9023 OB	592	9320 WH	713, 715
6492 OZ	565	8109 OZ	418	9023 OZ	592	9322 BK	713, 715
6493 OZ	565	8109 TZ	418	9024 DCO	638	9322 WH	713, 715
6494 OZ	565	8110 NI	418	9025 DCO	638	9346 OZ	684
6504 RVN	295	8110 OZ	418	9027 DCO	638	9347 OZ	684
6513 TZG	300	8110 TZ	418	9028 TZ	700	9348 OZ	684
6520 NI	436	8111 NI	356, 418	9028 BK	701	9349 OZ	684
6520 TZ	436	8111 OZ	358, 418	9029 TZ	700	9355 LD	659
6521 NI	436	8112 NI	356, 418	9029 BK	701	9355 BKT	662
6521 TZ	436	8112 OZ	358, 418	9030 TZ	700	9356 LD	659
6598 NI	231, 436	8112 NILED	415	9030 BK	701	9356 BKT	662
6599 NI	231, 436	8112 OZLED	415	9031 DCO	639	9357 LD	659
6620 TZ	362	8116 NI	356, 418	9032 BKT	672	9357 BKT	662
6719 NI	360, 557	8116 OZ	358, 418	9032 RZ	674	9358 LD	659
6719 TZ	360, 557	8116 NILED	415	9033 BKT	672	9358 BKT	662
6813 TZ	333	8116 OZLED	415	9033 RZ	674	9359 LD	659
6857 CZ	543	8206 NI	424	9034 BKT	672	9359 BKT	662
6894 CZ	302, 542	8209 NI	425	9034 RZ	674	9360 LD	659
6963 NI	208, 489	8404 NI	420	9035 BKT	673	9360 BKT	662
6963 OZ	209, 489	8404 TZ	420	9035 RZ	675	9362 LD	658
		8405 NI	420	9039 BK	680	9362 BKT	661

9364 AGZ	640	9558 LD	660	9735 BK	702	9859 TZ	700, 713, 715
9365 AGZ	640	9558 BKT	663	9735 TZ	702	9859 BK	701, 713, 715
9366 AGZ	640	9559 LD	660	9736 BK	702	9867 AGZ	641
9367 AGZ	641	9559 BKT	663	9736 TZ	702	9870 RST	374, 589
9368 TZ	712	9564 LD	660	9759 RST	589	9881 TZ	712
9369 TZ	712	9564 BKT	663	9760 RST	589	9885 OZ	699
9370 TZ	712	9565 LD	660	9761 RST	589	9886 BK	703, 709
9371 TZ	712	9565 BKT	663	9762 RST	589	9886 TZ	703, 709
9372 TZ	712	9567 AZ	620	9774 BK	707	9889 PB	690
9409 PB	690	9567 GNT	621	9774 WH	707	9892 BK	709
9412 OZ	685	9568 LD	660	9776 BK	707	9892 TZ	709
9439 PB	690	9568 BKT	663	9776 WH	707	9898 TZ	712
9452 OZ	685	9592 AGZ	719	9777 BK	707	9902 PR	649
9477 OB	588	9592 AZ	719	9777 WH	707	9909 OZLED	582
9478 OB	588	9592 BK	719	9783 AP	698	9909 BK	693
9479 OB	588	9592 RZ	719	9783 OZ	699	9909 OZ	695
9489 PB	690	9595 AGZ	718	9784 AP	698	9913 PB	691
9492 OZ	685	9595 AZ	718	9784 OZ	699	9918 TZ	700
9501 BK	719	9595 BK	718	9785 AP	698	9918 BK	701
9501 WH	719	9595 BST	718	9785 OZ	699	9920 DCO	639
9502 AZ	719	9595 LZ	718	9788 BK	708	9931 OZ	689
9502 BK	719	9595 OB	718	9788 TZ	708	9932 OZ	685
9506 AZ	718	9595 OZ	718	9789 BK	708	9935 BK	703
9506 BA	718	9595 TZ	718	9789 TZ	708	9935 TZ	703
9506 BK	718	9611 BK	713	9790 BK	708	9938 BK	681
9506 OB	718	9611 OZ	713	9790 TZ	708	9938 RZ	683
9506 TZ	718	9611 SS	713	9791 BK	708	9940 BK	681
9510 BK	718	9611 TZ	713	9791 TZ	708	9940 RZ	683
9510 BST	718	9611 WH	713	9794 BK	702	9951 BK	688
9510 LD	718	9618 OZ	713	9794 TZ	702	9953 CV	643
9510 LZ	718	9618 SS	713	9804 BK	693	9955 AGZ	646
9510 OZ	718	9631 OZ	689	9804 OZ	695	9956 BK	705
9511 PR	649	9649 CV	642	9805 BK	705	9956 TZ	705
9523 BK	718	9650 BK	705	9805 TZ	705	9962 RST	589
9523 LD	718	9650 TZ	705	9805 WH	705	9967 AZ	620
9527 AGZ	645	9650 WH	705	9809 BK	379, 693	9967 GNT	621
9529 AGZ	645	9651 CV	147, 642	9809 OZ	379, 695	9975 AGZ	641
9530 BK	719	9652 CV	642	9809 OZLED	379, 582	9977 BK	707
9530 LZ	719	9653 BK	705	9810 TZ	700	9977 WH	707
9530 OB	719	9653 TZ	705	9810 BK	701	9979 OB	588
9530 OZ	719	9653 WH	705	9811 PR	649	9985 AP	698
9530 PB	719	9654 BK	705	9817 AP	423, 713, 715	9985 OZ	699
9530 TZG	719	9654 TZ	705	9817 OZ	423, 713, 715	9989 PB	690
9530 WH	719	9654 WH	705	9825 CV	147, 643	9992 BK	709
9531 BK	719	9655 BK	705	9827 AGZ	641	9992 TZ	709
9531 LZ	719	9655 TZ	705	9829 AGZ	645		
9532 BKT	673	9656 AGZ	645	9830 AGZ	645	10301 WH	430
9532 RZ	675	9676 OZ	689	9831 OZ	689	10303 WH	430
9533 BKT	673	9677 OZ	689	9832 OZ	685	10304 WH	430
9533 RZ	675	9703 BK	692	9834 WH	419, 714	10308 WH	428
9538 BKT	673	9703 OZ	694	9835 BK	703	10314 WH	428
9538 RZ	675	9704 BK	692	9835 TZ	703	10315 WH	431
9539 BKT	673	9704 OZ	694	9837 DCO	639	10320 NI	361
9539 RZ	675	9707 OZLED	582	9838 DCO	639	10320 TZ	361
9540 BKT	719	9707 BK	692	9843 BK	681	10322 WH	431
9540 LD	719	9707 OZ	694	9843 RZ	683	10323 WH	431
9542 BK	718	9708 OZLED	582	9847 OZ	684	10325 NI	407
9542 BST	718	9708 BK	692	9848 BK	681	10325 OZ	407
9542 LD	718	9708 OZ	694	9848 RZ	683	10326 NI	407
9542 LZ	718	9709 OZLED	582	9848 BKS	686	10328 OZ	571
9542 OZ	718	9709 BK	692	9848 RZS	687	10328 WH	571
9547 OZ	684	9709 OZ	694	9849 CV	147, 643	10329 OZ	571
9549 BKT	719	9711 PB	691	9850 BK	705	10329 WH	571
9549 LD	719	9712 PB	691	9850 TZ	705	10330 OZ	571
9551 BK	719	9713 PB	691	9851 BK	688	10330 WH	571
9555 AGZ	646	9718 PR	648	9854 LD	660	10331 OZ	571
9557 PL	595	9719 PR	648	9854 BKT	663	10331 WH	571
9557 PSS316	599	9720 PR	648	9855 LD	660	10332 WH	440
9557 AZ	597, 601	9721 PR	648	9855 BKT	663	10333 WH	440

INDEX

10334 OZ	445	10678 OZ	133	10836 WH	417	11018 PR	648
10334 WH	445	10679 AP	442	10837 NI	417	11019 PR	648
10335 OZ	571	10680 CH	443	10837 OZ	417	11020 PR	649
10335 WH	571	10685 NI	443	10837 WH	417	11026 BK	716
10402 NI	442, 528	10686 PN	201, 442, 473	10838 WH	430	11026 WH	716
10402 OZ	442, 528	10687 PN	201, 473	10839 WH	430	11027 BK	716
10403 NI	528	10688 PN	201, 473	10847 OZ	428	11027 WH	716
10404 NI	528	10691 PN	444	10847 SI	428	11028 BK	716
10405 PC	491	10693 PN	444	10859 NI	420	11028 WH	716
10406 PC	491	10695 CH	441	10859 TZ	420	11029 BK	716
10414 NI	497	10696 SN	439	10864 NI	417	11029 WH	716
10415 NI	497	10697 WH	431, 570	10864 TZ	417	11030 RZ	671
10416 NI	497	10698 WH	431, 570	10865 NI	417	11031 RZ	671
10417 NI	441	10699 WH	431, 570	10865 TZ	417	11032 RZ	671
10421 SN	439	10702 NI	360	10879 NI	421	11035 RZ	671
10423 BA	570	10702 TZ	360	10879 OZ	421	11067 AZ	620
10424 BA	570	10704 NI	367	10885 NI	426	11068 AZ	620
10425 BA	429	10704 OZ	367	10885 CP	427, 494	11069 AZ	620
10428 SN	439	10705 NI	367	10885 NI	495	11070 AZ	620
10435 PN	441	10705 OZ	367	10886 NI	426, 495	11077 AZT	583, 711
10438 CPBG	438, 494	10706 NI	367, 402	10886 CP	427, 494	11077 BKT	583, 711
10438 NCH	438, 495	10706 OZ	367, 402	10889 WH	431	11098 NI	592
10439 CPBG	438, 494	10707 NI	367	10890 WH	431	11099 NI	592
10439 NCH	438, 495	10707 OZ	367	10891 WH	431	11101 NI	436
10441 SI	441, 496	10708 NI	219, 401	10898 NI	219, 427	11101 TZ	436
10442 RBZ	441	10709 NI	219, 401	10899 NI	219, 427	11102 NI	436
10448 OZ	441	10710 NI	219, 401	10903 PR	697	11102 TZ	436
10453 NI	445	10711 NI	219, 401	10904 PR	697	11104 NI	436
10461 NI	443, 529	10726 WH	446	10906 PR	697	11105 NI	436
10463 NI	529	10731 WH	446	10907 OZ	696	11108 SN	490
10464 NI	529	10732 MSI	447	10908 OZ	696	11109 SN	490
10479 PN	439	10740 NI	343	10909 OZ	696	11110 SN	490
10480 NI	444	10740 OZ	343	10910 OZ	696	11115 BZT	446
10481 PC	443, 491	10741 NI	343	10911 OZ	696	11115 MSI	446
10601 SI	496	10741 OZ	343	10922 AZ	714	11115 TBK	446
10602 SI	496	10742 NI	343, 402	10923 BK	716	11116 BZT	446
10604 NI	367, 443, 560	10742 OZ	343, 402	10923 TZ	716	11116 TBK	446
10604 OZ	367, 443, 560	10743 NI	343	10924 DCO	584	11117 BZT	446
10608 NI	560	10743 OZ	343	10925 DCO	584	11117 TBK	446
10608 OZ	560	10747 BZT	446	10926 DCO	584	11118 BZT	446
10609 NI	560	10747 MSI	446	10941 BK	716	11118 TBK	446
10609 OZ	560	10748 BZT	446	10941 WH	716	11119 BZT	446
10610 NI	560	10748 MSI	446	10950 TZ	704	11119 TBK	446
10610 OZ	560	10749 MSI	447	10953 TZ	704	11120 BZT	447, 710
10618 NI	360	10750 MSI	447	10954 TZ	704	11120 TBK	447, 710
10618 TZ	360	10756 WH	446	10955 TZ	704	11121 BZT	447, 710
10620 NI	445, 497	10757 NI	447	10956 TZ	704	11121 TBK	447, 710
10622 BK	716	10758 WH	447	10957 CV	147, 643	11122 BZT	447, 710
10622 WH	716	10771 NI	361	10958 CV	147, 643	11122 TBK	447, 710
10630 PN	439	10771 TZ	361	10959 CV	643	11123 BK	447
10636 NI	343, 443, 556	10776 AP	123	10960 CV	642	11123 WH	447
10636 OZ	343, 443, 556	10776 OZ	131	10961 CV	147, 642	11124 BTK	446
10637 NI	556	10780 AP	125	10962 CV	642	11125 MSI	447
10637 OZ	556	10780 OZ	133	11001 RZ	682	11250 AZT	583, 711
10638 NI	556	10801 SI	429, 496	11002 RZ	683	11250 BKT	583, 711
10638 OZ	556	10802 SI	429, 496	11004 RZ	683	11251 AZT	583, 711
10639 NI	556	10803 BA	426	11005 RZ	682	11251 BKT	583, 711
10639 OZ	556	10804 BA	426	11006 RZ	683	41006 CH	463
10640 AZ	444, 602	10807 CP	426	11008 RZ	683	41006 OZ	463
10640 NI	444, 602	10824 CP	427	11009 RZ	683	41011 CH	465
10640 PSS316	602	10827 NI	421	11010 RZ	676	41011 DBK	465
10654 BKN	442	10827 OZ	421	11011 RZ	676	41011 NI	465
10656 RBZ	440	10828 NI	421	11012 RZ	676	41011 OZ	465
10657 RBZ	440	10828 OZ	421	11013 RZ	676	41046 NI	464
10669 NI	445, 517	10835 NI	417	11014 RZ	676	41046 TZ	464
10669 OZ	445, 517	10835 OZ	417	11015 RZ	676	41055 AP	465
10670 NI	445, 517	10835 WH	417	11016 RZ	676	41055 OLZ	465
10670 OZ	445, 517	10836 NI	417	11017 PR	648	41056 NI	465
10678 AP	125	10836 OZ	417				

41056 OZ	465	42121 NI	399	42328 NICS	385	42476 OZ	163
41067 CH	463	42121 OZ	399	42329 OZCS	384	42478 OZ	163
41071 NI	464	42122 NI	398	42329 NICS	385	42480 OZ	163
41071 OZ	464	42122 OZ	398	42338 CH	239	42482 OZ	163
41096 NI	464	42123 CH	230	42339 CH	238	42484 OZ	163
41096 OZ	464	42124 OZ	58	42340 CH	239	42485 OZ	163
42016 NI	96	42125 OZ	58	42341 CH	239	42486 OZ	163
42016 BK	97	42126 OZ	58	42359 OZ	371	42505 CH	173
42017 NI	96	42141 OZCLR	383	42359 WZC	371	42505 OZ	175
42017 BK	97	42141 OZCS	384	42379 NI	415	42506 CH	173
42018 NI	96	42141 NICS	385	42379 OZ	415	42506 OZ	175
42018 BK	97	42141 CHCLR	386	42380 NI	415	42509 LZ	291
42025 NI	410	42164 AP	408, 526	42380 OZ	415	42510 LZ	291
42025 OZ	410	42164 OZ	408, 527	42381 AP	155	42511 LZ	291
42028 CH	257	42165 OZ	376	42381 MIZ	159	42513 LZ	291
42029 CH	258	42165 PN	376	42382 AP	155	42514 LZ	291
42030 CH	258	42166 OZ	376	42382 MIZ	159	42515 LZ	291
42031 CH	257	42166 PN	376	42383 AP	153	42516 LZ	290
42033 OZ	388	42167 OZCLR	383	42383 MIZ	157	42517 CH	371
42034 CH	259	42167 OZMER	384	42384 AP	154	42517 NI	371
42035 CH	259	42167 NIMER	385	42384 MIZ	158	42517 OZ	371
42036 PN	191	42167 CHCLR	386	42385 AP	154	42543 CH	237
42037 PN	191	42172 CH	263	42385 MIZ	158	42544 CH	237
42044 OZ	383	42173 CH	263	42386 AP	154	42545 CH	236
42044 OZMER	384	42174 CH	262	42386 MIZ	158	42546 CH	237
42044 NIMER	385	42175 CH	262	42387 AP	154	42547 CLP	197
42044 CH	386	42192 CMZ	83	42387 MIZ	158	42547 OZ	199
42046 OZ	383	42193 CMZ	83	42390 CH	250, 539	42548 CLP	197
42046 OZCS	384	42194 CH	262	42391 CH	251	42548 OZ	198
42046 NICS	385	42195 CH	261	42392 CH	249	42549 CLP	197
42046 CH	386	42212 CH	216	42393 CH	251	42549 OZ	199
42047 OZ	383	42213 CH	216	42418 NI	203	42556 OZ	99
42047 OZCP	384	42214 CH	215	42419 NI	203	42556 OZFL	99
42047 CH	386	42215 CH	217	42420 NI	203	42556 BPT	101
42047 CHSMK	386	42216 CH	215	42424 AP	91	42556 BPTFL	101
42051 MIZ	512	42217 CH	217	42424 SWZ	94	42557 OZ	99
42060 CMZ	44	42227 TRZ	285	42425 AP	92	42557 OZFL	99
42061 CMZ	44	42229 TRZ	285	42425 SWZ	95	42557 BPT	101
42062 CMZ	45	42230 TRZ	284	42426 AP	92	42557 BPTFL	101
42063 NI	410	42231 TRZ	285	42426 SWZ	95	42559 OZ	98
42063 OZ	410	42244 NI	204, 396	42427 AP	90	42559 BPT	100
42064 AP	347	42244 OZ	205, 397	42427 SWZ	93	42561 OZ	99
42064 OZ	349	42245 NI	204, 396	42428 AP	90	42561 BPT	101
42066 AP	346	42245 OZ	205, 397	42428 SWZ	93	42562 OZ	99
42066 OZ	348	42246 NI	204, 396	42430 AP	90	42562 OZFL	99
42067 AP	347	42246 OZ	205, 397	42430 SWZ	93	42562 BPT	101
42067 OZ	349	42252 AP	399	42431 AP	91	42562 BPTFL	101
42068 AP	347	42257 OZ	79	42431 SWZ	94	42563 OZ	99
42068 OZ	349	42265 AVI	501	42432 AP	92	42563 OZFL	99
42070 AP	347	42267 AVI	501	42432 SWZ	95	42563 BPT	101
42070 OZ	349	42268 OZ	394	42433 AP	92	42563 BPTFL	101
42071 AP	347, 403	42268 NI	395	42433 SWZ	95	42565 NI	327
42071 OZW	349, 403	42269 OZ	394	42436 AP	392	42565 OZ	328
42071 APW	357, 403	42269 NI	395	42436 OZ	393	42565 ACO	329
42071 OZ	359, 403	42270 OZ	394	42437 AP	392	42566 NI	327
42072 AP	347	42270 NI	395	42437 OZ	393	42566 OZ	328
42072 OZ	349	42275 NI	204, 396	42438 AP	392	42566 ACO	329
42073 CMZ	45	42275 OZ	205, 397	42438 OZ	393	42568 NI	327
42074 CMZ	44	42276 NI	204, 396	42439 AP	408	42568 OZ	328
42087 PN	200	42276 OZ	205, 397	42439 OZ	408	42575 OZLED	433
42091 PN	200, 473	42279 OZ	380	42440 AP	392	42575 SILED	433
42097 CMZ	45	42280 OZ	373, 380	42440 OZ	393	42630 CH	255
42098 CMZ	45	42301 CH	373, 249	42456 OZCLR	383	42631 CH	255
42099 CMZ	43	42302 CH	250	42456 OZCP	384	42632 CH	253
42103 CMZ	83	42304 CH	249	42456 CHCLR	386	42633 CH	254
42105 CMZ	83	42306 CH	250	42456 CHSMK	386	42634 CH	255
42114 SRM	241	42307 CH	250, 539	42465 WMZ	63	42651 CH	173, 410
42115 SRM	241	42308 OZ	374	42466 WMZ	63, 381	42651 NI	410
42116 SRM	240	42328 OZCS	384	42467 WMZ	63, 381	42651 OZ	175, 410

INDEX

42679 NI	373	42921 CLP	85	43125 CH	243	43226 OZ	323
42679 OZ	373	42922 CLP	85	43140 NI	195	43227 NI	322
42708 OZ	78	42923 CLP	87	43142 NI	195	43227 OZ	324
42710 OZ	79, 374	42924 CLP	87	43145 NI	195	43228 NI	322
42738 OZ	373, 381	42925 CH	235	43147 NI	195	43228 OZ	324
42745 PN	167	42927 CH	235	43155 NI	312	43229 NI	320
42746 PN	167	42928 CH	234	43155 OZ	316	43229 OZ	323
42747 PN	167	42929 CH	235	43156 NI	312	43230 NI	321
42753 NI	373	42940 CLP	169	43156 OZ	316	43230 OZ	325
42753 OZ	373	42941 CLP	170	43158 NI	312	43231 NI	322
42792 OZ	381	42942 CLP	171	43158 OZ	316	43231 OZ	324
42860 CLP	272	42944 SWZ	136	43159 NI	312	43232 NI	322
42860 SWZ	275	42944 AP	137	43159 OZ	316	43232 OZ	324
42861 CLP	272	42947 SWZ	136	43160 NI	313	43233 NI	322
42861 SWZ	275	42947 AP	137	43160 OZ	317	43233 OZ	324
42862 CLP	271	42949 SWZ	136	43162 NI	313	43234 NI	321
42862 SWZ	274	42949 AP	137	43162 OZ	317	43234 OZ	325
42863 CLP	271	42950 SWZ	136	43163 NI	314	43235 OZ	69
42863 SWZ	274	42950 AP	137	43163 OZ	315	43237 BRSG	267
42864 CLP	273	42976 OZ	141	43164 NI	314	43238 BRSG	267
42864 SWZ	276	42977 OZ	141	43164 OZ	315	43240 BRSG	268
42865 CLP	273	42978 OZ	141	43165 NI	314	43241 BRSG	267
42865 SWZ	276	42979 OZ	141	43165 OZ	315	43242 BRSG	269
42866 CLP	273	43020 CH	190	43166 NI	314	43243 BRSG	267
42866 SWZ	275	43021 CH	190	43166 OZ	315	43244 BRSG	269
42877 NI	73	43022 CH	189	43167 NI	314	43246 DAW	47
42877 OZ	73	43023 CH	190	43167 OZ	315	43255 DAW	48
42878 NI	73, 374	43024 CH	189	43168 NI	314	43256 DAW	48
42878 OZ	73, 374	43025 AVI	121	43168 OZ	315	43257 DAW	49
42879 NI	353	43026 AVI	121	43169 NI	314	43258 DAW	47
42879 OZ	353	43027 AVI	121	43169 OZ	315	43259 DAW	47
42880 NI	353	43028 AVI	121	43170 NI	313	43262 DAW	49
42880 OZ	353	43030 AVI	121	43170 OZ	317, 551	43263 DAW	49
42881 NI	353, 403	43046 OZ	56	43170 NI	552	43264 DAW	49
42881 OZ	353, 403	43047 OZ	56	43171 NI	313	43277 TRZ	289
42881 CH	403	43048 OZ	57	43171 OZ	317	43278 TRZ	289
42881 NIW	403	43049 OZ	57	43172 NI	313	43279 TRZ	287
42882 NI	353	43050 OZ	57	43172 OZ	317	43280 TRZ	287
42882 OZ	353	43057 OZ	72	43174 OZ	318	43281 TRZ	286
42883 NI	352	43058 OZ	71	43175 OZ	319	43282 TRZ	289
42883 OZ	352	43059 OZ	71	43176 OZ	319	43284 TRZ	287
42884 NI	352	43060 OZ	72	43177 OZ	319	43286 CH	245
42884 OZ	352	43073 NI	116	43178 OZ	318	43286 OZ	247
42885 NI	352	43073 NIFL	116	43179 OZ	319	43287 CH	245
42885 OZ	352	43073 OZ	118	43180 OZ	318	43287 OZ	247
42886 OZ	67	43073 OZFL	118	43181 OZ	318	43288 CH	245
42887 OZ	67	43074 NI	117	43182 OZ	319	43288 OZ	247
42888 OZ	67	43074 NIFL	117	43183 OZ	319	43289 CH	244
42900 NI	355	43074 OZ	119	43185 AUB	37	43289 OZ	246
42900 OZ	355	43074 OZFL	119	43186 AUB	38	43301 OZ	181
42901 NI	355	43075 NI	116	43189 AUB	38	43301 NI	185
42901 OZ	355	43075 OZ	118	43190 AUB	37	43302 OZ	182
42902 NI	355	43076 NI	117	43191 AUB	39	43302 NI	183
42902 OZ	355	43076 NIFL	117	43192 NI	313	43303 OZ	181
42903 NI	354	43076 OZ	119	43192 OZ	317	43303 NI	185
42903 OZ	354	43076 OZFL	119	43193 AUB	36	43304 OZ	182
42905 NI	354	43077 NI	116	43200 OZ	373, 380	43304 NI	183
42905 OZ	354	43077 NIFL	116	43201 OZ	380	43305 OZ	181
42906 NI	354	43077 OZ	118	43203 OZ	69	43305 NI	185
42906 OZ	354	43077 OZFL	118	43204 OZ	69	43306 OZ	182
42907 NI	355	43084 NI	113	43217 ACO	75	43306 NI	183
42907 OZ	355	43085 NI	113	43221 ACO	75	43318 OZ	41
42908 ACO	331, 379	43087 NI	113	43223 NI	321	43320 OZ	41
42908 AP	331, 379	43089 NI	113	43223 OZ	325	43322 DAG	55
42908 OZ	331, 379	43120 CH	243	43224 NI	320	43323 DAG	55
42909 ACO	331, 379	43121 CH	243	43224 OZ	323	43324 DAG	55
42909 AP	331, 379	43122 CH	243	43225 NI	321	43327 DAG	55
42909 OZ	331, 379	43123 CH	242	43225 OZ	325	43328 DAG	55
42920 CLP	86	43124 CH	243	43226 NI	320	43330 OZ	307

43331 OZ	307	45039 CH	508	45218 NI	472	45423 OZ	548
43332 OZ	306	45046 CLP	532	45220 NI	472	45423 NI	549
43333 OZ	307	45046 CLZ	533	45221 NI	472	45424 OZ	548
43334 OZ	307	45047 CLP	532	45224 AP	92, 437	45424 NI	549
43335 OZ	306	45047 CLZ	533	45224 SWZ	95, 437	45431 NI	469
43339 OZ	280	45048 CLP	532	45262 AVI	501	45432 NI	469
43340 OZ	281	45048 CLZ	533	45263 AVI	501	45433 NI	469
43341 OZ	281	45049 CLP	532	45264 AVI	501	45434 NI	469
43342 OZ	281	45049 CLZ	533	45281 AP	155, 536	45437 NI	152, 493
43343 OZ	281	45054 OZ	551	45281 MIZ	159	45438 NI	493
43344 OZ	281	45054 NI	552	45282 AP	536	45439 NI	493
43345 OZ	281	45055 OZ	551	45282 MIZ	537	45440 NI	493
43360 CH	192	45055 NI	552	45283 AP	536	45441 NI	195, 481
43360 OZ	193	45056 OZ	551	45283 MIZ	537	45442 NI	481
43361 CH	192	45056 NI	552	45284 AP	536	45443 NI	481
43361 OZ	193	45060 CH	509	45284 MIZ	537	45444 NI	481
43364 CLP	187	45061 CH	509	45291 CH	251, 539	45453 CLP	534
43365 CLP	187	45062 CH	509	45293 CH	539	45453 CLZ	535
43366 CLP	186	45064 AP	347, 547	45308 OZ	79	45454 CLP	534
43369 OZ	177	45064 OZ	349, 546	45315 NI	96, 480	45454 CLZ	535
43370 OZ	178	45065 OZ	546	45315 BK	97	45455 CLP	534
43371 OZ	179	45065 AP	547	45316 NI	480	45455 CLZ	535
43373 OZ	179	45066 OZ	546	45317 NI	480	45456 CLP	534
43401 CLP	334	45066 AP	547	45319 NI	480	45456 CLZ	535
43401 OZ	334	45067 OZ	546	45321 AP	511	45457 OZ	72
43402 CLP	334	45067 AP	547	45322 AP	511	45465 SMG	309, 311, 540
43402 OZ	334	45086 PN	201, 473	45323 AP	511	45466 SMG	540
43403 CLP	335	45087 PN	201, 473	45351 MIZ	512	45467 SMG	540
43403 OZ	335	45088 PN	201, 473	45353 MIZ	512	45468 SMG	540
43404 CLP	335	45113 NI	510	45358 OZ	99, 499	45469 OZ	179
43404 OZ	335	45114 NI	510	45358 BPT	101, 498	45473 OZ	318, 553
43405 CLP	335	45115 NI	510	45359 CH	498	45474 OZ	553
43405 OZ	335	45116 NI	510	45359 OZ	499	45475 OZ	553
43406 CLP	335	45117 NI	524	45360 BPT	498	45476 OZ	553
43406 OZ	335	45117 OZ	525	45360 CH	498	45477 NI	474
43407 CLP	334	45118 NI	524	45360 OZ	499	45478 NI	474
43407 OZ	334	45118 OZ	525	45361 BPT	498	45479 NI	474
43422 OZ	51, 53	45119 NI	524	45361 CH	498	45480 NI	474
43423 OZ	51, 53	45119 OZ	525	45361 OZ	499	45486 CH	530
43424 OZ	50, 52	45120 NI	524	45362 CLP	273	45486 ORZ	531
43425 OZ	51, 53	45120 OZ	525	45362 SWZ	276	45487 CH	530
43426 OZ	51, 53	45126 NI	516	45374 CH	116, 519	45487 ORZ	531
43433 AUB	139	45127 NI	516	45374 NI	116, 520	45488 CH	530
43435 AUB	139	45131 TRZ	285	45374 OZ	118, 521	45488 ORZ	531
43436 AUB	139	45137 NI	475	45375 CH	519	45489 CH	530
43437 NI	152	45138 NI	475	45375 NI	520	45489 ORZ	531
43438 NI	151	45139 NI	475	45375 OZ	521	45500 CH	518
43442 NI	152	45140 NI	475	45376 CH	519	45501 CH	518
43446 OZ	279	45149 AP	470	45376 NI	520	45502 CH	518
43447 OZ	279	45150 AP	470	45376 OZ	521	45503 CH	518
43448 OZ	279	45151 AP	470	45377 CH	519	45517 CH	507
43449 OZ	278	45152 AP	470	45377 NI	520	45518 CH	507
43450 OZ	279	45161 AP	526	45377 OZ	521	45519 CH	507
43453 DBK	283	45161 OZ	527	45385 NI	113, 483	45520 CH	507
43454 DBK	283	45162 AP	526	45386 NI	483	45521 CH	189
43455 DBK	282	45162 OZ	527	45387 NI	483	45564 CLP	187
43456 DBK	283	45163 AP	526	45388 NI	483	45881 NI	353, 562
43461 SMG	309	45163 OZ	527	45401 CLP	335, 554	45881 OZ	353, 563
43461 SMG	309, 311	45164 AP	526	45401 OZ	335, 555	45882 NI	562
43462 SMG	309, 311	45164 OZ	527	45402 CLP	554	45882 OZ	563
43463 SMG	309, 311	45170 CH	468	45402 OZ	555	45883 NI	562
43465 SMG	308, 311	45171 CH	468	45403 CLP	554	45883 OZ	563
43468 SMG	309, 311	45172 CH	468	45403 OZ	555	45884 NI	562
45018 CH	230	45173 CH	468	45404 CLP	554	45884 OZ	563
45026 PN	492	45178 OZ	163	45404 OZ	555	45901 NI	354, 559
45027 PN	492	45187 CH	245	45421 NI	322, 549	45901 OZ	354, 559
45036 CH	508	45187 OZ	247	45421 OZ	324, 548	45902 NI	559
45037 CH	508	45212 CH	215	45422 OZ	548	45902 OZ	559
45038 CH	508	45217 NI	203, 472	45422 NI	549	45903 NI	559

INDEX

45903 OZ	559	49124 AVI	619	49201 BK	605	49360 AZ	626
45904 NI	559	49124 AVIFL	619	49201 BKFL	605	49364 AZ	606
45904 OZ	559	49125 AVI	619	49202 BK	604	49364 PL	607
49001 RZ	670	49125 AVIFL	619	49202 BKFL	604	49365 AZ	606
49002 RZ	670	49130 BRZ	664	49203 BK	604	49365 PL	607
49003 RZ	670	49130 BKG	666	49203 BKFL	604	49366 AZ	606
49004 RZ	670	49131 BRZ	664	49204 BK	605	49366 PL	607
49005 RZ	670	49131 BKG	666	49204 BKFL	605	49367 AZ	606
49006 AVI	586	49132 BRZ	664	49205 BK	605	49367 PL	607
49007 AVI	586	49132 BKG	666	49205 BKFL	605	49368 AZ	606
49008 AVI	586	49133 BRZ	665	49206 BK	604	49368 PL	607
49024 AVI	625	49133 BKG	667	49206 BKFL	604	49384 OZ	629
49025 AVI	625	49134 BRZ	665	49207 BK	605	49385 OZ	629
49035 RZ	657, 677	49134 BKG	667	49207 BKFL	605	49386 OZ	628
49059 OZ	437, 593	49135 BRZ	664	49226 OZLED	581	49387 OZ	378, 629
49060 OZ	437, 593	49135 BKG	666	49226 OZ	650	49388 OZ	629
49061 OZ	437, 593	49136 BRZ	665	49227 OZLED	581	49389 OZ	629
49062 OZ	593	49136 BKG	667	49227 OZ	650	49400 RZ	591
49063 OZ	593	49146 AGZ	637	49228 OZLED	581	49401 RZ	591
49064 OZ	585	49147 AGZ	637	49228 OZ	650	49402 RZ	591
49065 OZLED	583	49148 AGZ	637	49229 OZLED	581	49403 RZ	378, 591
49065 OZ	585	49149 AZ	603	49229 OZ	651	49404 RZ	591
49067 OZLED	583	49149 PSS316	603	49231 OZ	651	49409 BK	686
49067 OZ	585	49150 AGZ	637	49232 OZ	651	49409 RZ	687
49071 BST	647	49151 AZ	603	49248 AGZLED	580	49410 BK	686
49071 BSTFL	647	49151 PSS316	603	49249 AGZLED	580	49410 RZ	687
49072 BST	647	49152 AGZ	637	49250 AGZLED	580	49411 BK	686
49072 BSTFL	647	49153 AGZVM	635	49251 AGZLED	580	49411 RZ	687
49073 BST	647	49153 AGZ	637	49255 BK	706	49412 BK	686
49073 BSTFL	647	49154 ACO	627	49255 TZ	706	49412 RZ	687
49074 BST	647	49154 OZ	627	49255 WH	706	49413 BK	686
49074 BSTFL	647	49155 ACO	627	49256 BK	706	49413 RZ	687
49075 BST	647	49155 OZ	627	49256 TZ	706	49414 BK	686
49075 BSTFL	647	49157 SS	614	49256 WH	706	49414 RZ	687
49081 AZ	710	49157 OZ	616	49257 AZ	624	49415 RZ	656
49081 BK	710	49158 SS	614	49258 AZ	624	49416 RZ	656
49081 PL	710	49158 OZ	616	49270 RZ	678	49417 RZ	656
49082 AZ	710	49159 SS	614	49270 RZFL	678	49418 RZ	657
49082 BK	710	49159 OZ	616	49271 RZ	678	49419 RZ	657
49082 PL	710	49160 SS	614	49271 RZFL	678	49420 RZ	656
49090 CV	146, 642	49160 OZ	616	49272 RZ	678	49428 RZ	677
49091 CV	146, 643	49161 SS	615	49273 RZ	679	49429 RZ	677
49093 AVI	586	49161 OZ	617	49274 RZ	679	49430 RZ	677
49094 AVI	586	49162 SS	615	49275 RZ	679	49431 RZ	677
49110 AVI	612	49162 OZ	617	49276 RZ	679	49432 RZ	677
49110 AVIFL	612	49163 SS	615	49277 RZ	679	49433 RZ	677
49111 AVI	612	49163 OZ	617	49277 RZFL	679	49434 AZ	434, 577
49111 AVIFL	612	49164 SS	615	49336 AZ	608	49434 PL	434, 576
49112 AVI	612	49164 OZ	617	49337 AZ	608	49434 SBK	434, 576
49112 AVIFL	612	49175 OZ	636	49338 AZ	608	49435 AZ	434, 577
49113 AVI	612	49175 OZFL	636	49339 AZ	608	49435 PL	434, 577
49113 AVIFL	612	49176 OZ	636	49341 AZ	609	49435 SBK	434, 577
49114 AVI	613	49176 OZFL	636	49342 AZ	609	49436 AZ	435, 579
49115 AVI	613	49177 OZ	636	49343 AZ	609	49436 PL	435, 578
49116 AVI	613	49177 OZFL	636	49344 PSS316	598	49436 SBK	435, 578
49117 AZLED	575	49178 OZ	636	49344 AZ	600	49437 AZ	435, 579
49117 AZ	623	49178 OZFL	636	49345 PSS316	598	49437 PL	435, 578
49118 AZLED	575	49183 BK	702	49345 AZ	600	49437 SBK	435, 578
49118 AZ	623	49183 TZ	702	49346 AZ	600	49444 AZ	587
49119 AVI	618	49185 BK	708	49347 PSS316	376, 599	49445 AZ	587
49119 AVIFL	618	49185 TZ	708	49347 AZ	376, 601	49446 AZ	375, 587
49120 AVI	618	49186 BK	702	49348 PSS316	376, 599	49447 AZ	375, 587
49120 AVIFL	618	49186 TZ	702	49348 AZ	376, 601	49448 AZ	379, 611
49121 AVI	618	49187 BK	703	49349 PSS316	599	49449 AGZ	634
49121 AVIFL	618	49187 TZ	703	49349 AZ	601	49450 AGZ	634
49122 AVI	619	49188 BK	709	49356 AZ	626	49451 AGZ	634
49122 AVIFL	619	49188 TZ	709	49357 AZ	626	49452 AGZ	635
49123 AVI	619	49200 BK	604	49358 AZ	626	49453 AGZ	635
49123 AVIFL	619	49200 BKFL	604			49454 AZ	610

49455 AZ.....	610	49951 BK.....	719	65421.....	134	78204.....	457
49456 AZ.....	610	49951 WH.....	719	65424.....	211	78205.....	457
49458 AZ.....	379, 611	49952 BK.....	719	65425.....	211	78207.....	453
49459 AZ.....	611	49952 WH.....	719	65433.....	213	78209.....	458
49460 AZ.....	611			65434.....	213	78210.....	456
49467 PL.....	594	60263.....	212	65435.....	213	78211.....	453
49467 AZ.....	596	65069.....	142	66007.....	142	78212.....	452
49468 PL.....	594	65175.....	144	66050.....	230	78213.....	453
49468 AZ.....	596	65187.....	277	66054.....	111	78214.....	453
49469 PL.....	594	65188.....	277	66073.....	103	78215.....	457
49469 AZ.....	596	65215.....	212	66121.....	134	78216.....	458
49470 PL.....	594	65216.....	344	66138.....	212	78217.....	455
49470 AZ.....	597	65238.....	212	69004.....	142	78218.....	450
49471 PL.....	595	65266.....	375	69013.....	142	78219.....	451
49471 AZ.....	597	65271.....	375	69017.....	413	78220.....	456
49472 PL.....	595	65308.....	143	69030.....	144	78223 BZ.....	459
49472 AZ.....	597	65309.....	143	69032.....	144	78223 AP.....	459
49474 RZ.....	590	65318.....	375	69038.....	412	78225.....	450
49475 RZ.....	590	65321.....	135	69041.....	413	78226.....	450
49476 RZ.....	590	65322.....	135	69043.....	344	78227.....	451
49478 RZ.....	590	65323.....	135	69045.....	412	78228.....	454
49492 AZ.....	434, 577	65324.....	161	69046.....	344	78229.....	450
49492 PL.....	434, 576	65325.....	161	69048.....	277	78248.....	460
49492 SBK.....	434, 576	65330.....	218	69050.....	413		
49494 AZ.....	435, 579	65331.....	218	69079.....	212	300006 CZ.....	303
49494 PL.....	435, 578	65332.....	218	69087.....	143	300009 NI.....	208
49494 SBK.....	435, 576	65336.....	375	69094.....	218, 437	300009 OZ.....	210
49501 WZC.....	669	65344.....	59	69121.....	135	300011 AP.....	123
49502 WZC.....	669	65345.....	59	69124.....	161	300011 OZW.....	127
49503 WZC.....	669	65346.....	59	69125.....	161	300011 OZ.....	131
49504 WZC.....	668	65353.....	230	69144.....	59	300012 TZG.....	300
49505 WZC.....	378, 669	65354.....	111	69163.....	110	300018 BSS.....	390
49506 WZC.....	669	65355.....	111	69164.....	110	300020 AP.....	392
49512 ACO.....	652	65356.....	111	69173.....	103	300113 TZ.....	284
49512 OZ.....	654	65359.....	375	69178.....	89	300114 OZ.....	104
49513 ACO.....	652	65363.....	110	69192.....	81	300114 NI.....	107
49513 OZ.....	654	65364.....	110			300117 NI.....	361, 362
49514 ACO.....	652	65373.....	102	78121.....	454	300117 TZ.....	361, 362
49514 OZ.....	654	65374.....	103	78138.....	455	300135 AP.....	335
49515 ACO.....	653	65375.....	102	78139.....	452	300160 PN.....	191
49515 OZ.....	655	65378.....	89	78143.....	456	300181 AP.....	87, 155
49516 ACO.....	653	65379.....	89	78146.....	454	300181 OZ.....	159
49516 OZ.....	655	65380.....	60	78148.....	455	300205 NI.....	221
49517 ACO.....	379, 653	65381.....	61	78151.....	460	300205 OZ.....	223
49517 OZ.....	379, 655	65382.....	61	78152.....	454	300427 AP.....	91
49518 ACO.....	653	65383.....	60	78160.....	464	300427 OBB.....	94
49518 OZ.....	655	65384.....	65	78161.....	461	310131 NI.....	592
49530 WZC.....	630	65385.....	65	78162.....	461	310131 OZ.....	592
49531 WZC.....	630	65386.....	65	78163.....	455		
49532 WZC.....	630	65387.....	160	78164.....	451		
49533 WZC.....	630	65388.....	160	78167.....	457		
49534 WZC.....	631	65389.....	160	78168.....	451		
49535 WZC.....	631	65390.....	64	78170.....	69, 460		
49536 WZC.....	378, 631	65391.....	80	78176.....	461		
49638 OZ.....	149, 633	65392.....	81	78177.....	458		
49640 OZ.....	149, 375, 632	65393.....	81	78178.....	461		
49641 OZ.....	149, 633	65394.....	81	78181.....	459		
49642 OZ.....	149, 632	65397.....	77	78184.....	452		
49643 OZ.....	632	65399.....	77	78187.....	460		
49644 OZ.....	632	65400.....	88	78190.....	456		
49646 OZ.....	633	65401.....	88	78193.....	459		
49720 RZFL.....	678	65403.....	145	78198 AP.....	463		
49904 AZ.....	719	65404.....	145	78198 CH.....	463		
49904 BK.....	719	65405.....	145	78198 MIZ.....	463		
49904 WH.....	719	65406.....	140	78200 AP.....	388		
49907 AZ.....	719	65407.....	140	78200.....	388		
49907 BK.....	719	65408.....	140	78201.....	462		
49907 WH.....	719	65415.....	144	78202.....	462		
49950 BK.....	719	65416.....	144	78203.....	462		

LEGEND/SYMBOL GUIDE

- = This symbol indicates the product best suited for Indoor use with self-ballasted, compact fluorescent lamps sold through electrical distributors and lighting showrooms across the U.S.
- = This symbol indicates the product best suited for Outdoor use with self-ballasted, compact fluorescent lamps sold through electrical distributors and lighting showrooms across the U.S.
- (C) = Candelabra base lamp (E-12).
- (C/K) = Candelabra base lamp (E-12) or Krypton candelabra base lamp.
- (K) = Krypton candelabra base lamp.
- (M) = Medium base lamp (E-26).
- (MNCN) = Mini-can base halogen lamp.
- ✓ = Fixture requires supply wire rated for at least 75° C.
- ❖ = Fixture requires supply wire rated for at least 90° C.
- ☆ = When electrical connection is made inside the fixture, supply wire must be rated at least 75° C. When electrical connection is made in an outlet box, supply wire must be rated at least 60° C.
- ⓘ = Installation Instructions: Fixture must be supported independently of the outlet box unless the outlet box is UL listed for the weight to be supported. Consult a qualified electrician/installer. Required installation parts included.
- D = Diameter
- Ext. = Extension
- Fluor. = Fluorescent
- H = Height
- HCWO = Height from Center of Wall Opening
- Incand. = Incandescent
- L = Length

- Ovrl. H = Overall Height
- W = Width
- Extra Wire = Extra wire beyond chain or stems.
- Chain/Stem = Length of chain or stem supplied with fixture.
- = Title 24 is a document that contains the building codes for the state of California. All lighting fixtures in this catalog that comply with the August 1, 2009 revision of the California Title 24 standards are marked with the T24 logo. For more information, visit www.energy.ca.gov/title24.
- = ADA Compliant
- = DAMP
- = Dark Sky
- = Lamp Included
- = CFL Lamp Included
- = LED
- = WET
- = Line Extension
- ★ = Kichler® Lighting Products are not produced or associated with any Native American Indians, nor are they a Native American product or the product of a particular Indian, Indian tribe or Indian arts and crafts organization as defined by 25 U.S.C. §305 et. seq.

- Bulbs not included unless otherwise noted.
- Wattages stated are the maximum recommended, however, you may use lower wattage lamps to suit your lighting needs. Some recommended lamps are not available in the maximum allowable wattage.
- All electrical products are rated as 120-volt, AC unless otherwise noted.
- All electrical products are certified and listed to UL/CSA/ETL Standards for use in U.S.A. and Canada except where noted.
- Many long life tungsten halogen capsule lamps are now available as alternates to conventional incandescent light bulbs. The halogen capsule lamps may be used to replace any lamp of a higher wattage, but not to exceed the existing specified maximum wattage, i.e., 72W may replace a 75W.
- On some products, in order to accommodate higher than normal ceiling height, extra lead wire is supplied and specified. With additional sections of chain (not included), this allows an added measure of design flexibility.
- Finishes for fixtures installed outdoors are subject to change due to prolonged exposure to sunlight, airborne pollutants and other forms of weathering.
- To serve you better, Kichler® Lighting reserves the right to make improvements to the products in this catalog. Therefore, some products may change during the life of the catalog and the product information contained in this catalog may also have changed.
- All products featured in the outdoor section are certified and listed to UL/CSA standards for wet location except where noted.

Kichler Lighting has been a proud sponsor of the Energy Star program since 2002. In conjunction with the newly combined Department of Energy and Environmental Protection Agency's Energy Star revision 1.1 we are making improvements to our assortment of qualified products. As they are qualified, Energy Star will post them to their website. Please consult the Energy Star website at www.energystar.gov for our current assortment of qualified products, in addition to future Kichler catalogs identifying the Energy Star logo.

We go to great lengths to assure the metal and glass finishes shown in the catalog match the actual products, but printing variations and variations in chemical finishes and the nature of hand applied finishing will cause some differences between the printed images and actual product, and from one product to another. We use only non-ferrous materials on the exterior parts of our outdoor lantern products, and use the best available weather-resistant finishes. However, due to some extreme environmental conditions such as acid rain, salt air and ultraviolet exposure, we cannot guarantee our exterior finishes, with the exception of our LifeBrite® lanterns. Due to environmental conditions such as soil acidity, concrete alkalinity and other corrosive soil and air conditions, we cannot guarantee our direct burial posts.

KICHLER World Headquarters
7711 E. Pleasant Valley Rd
PO Box 318010
Cleveland, Ohio 44131-8010



ABBREVIATION KEY

AB	Antique Brass	NIA	Brushed Nickel with Alabaster
ABZ	Antique Bronze		Swirl Glass
ACK	Antique Crackle™	NICS	Brushed Nickel with Clear Seedy Glass
ACO	Antique White		
ADC	Adobe Cream™	NIMER	Brushed Nickel with Mercury Glass
AGZ	Aged Bronze	NIS	Brushed Nickel with Satin Etched Glass
AGZS	Aged Bronze with Satin Etched		
	Cased Opal Glass	NISW	Brushed Nickel with Satin Etched White Glass
AP	Antique Pewter		
AUB	Auburn	NIW	Brushed Nickel with White Fabric Shade
AVI	Anvil Iron	OAU	Olde Auburn™
AZ	Architectural Bronze™	OB	Olde Brick®
BA	Brushed Aluminum	OBZ	Olde Brick® with Oil Rubbed Bronze™
BAB	Burnished	OLZ	Oiled Bronze
	Antique Brass	OMC	Olde Mill Copper™
BBZ	Burnished Bronze™	ORZ	Oil Rubbed Bronze
BCZ	Burnished	OWH	Off-White
	Copper Bronze	OZ	Olde Bronze®
BGN	Burnished Granite™	OZCLR	Olde Bronze® with Clear Glass
BK	Black	OZCP	Olde Bronze® with Light Champagne Glass
BKG	Black with Gold Highlights	OZCS	Olde Bronze® with Clear Seedy Glass
BKS	Black with Satin Etched Glass	OZMER	Olde Bronze® with Mercury Glass
BKT	Textured Black	OZS	Olde Bronze® with Satin Etched Glass
BKZ	Berkshire Bronze™	OZSW	Olde Bronze® with Satin Etched White Glass
BMB	Brushed Modern Bronze	OZU	Olde Bronze® with Umber Glass
BPT	Brushed Pewter	OZW	Olde Bronze® with Satin Etched White Glass
BRZ	Brushed Bronze	PB	Polished Brass
BS	Burnished Silver	PBC	Polished Brass with Chrome
BRSG	Burnished Silver and Gold	PGR	Pebbled Granite™
BST	Brown Stone	PL	Platinum
BZ	Bronze	PN	Polished Nickel
BZT	Textured Bronze	PPW	Polished Pewter
CH	Polished Chrome	PR	Prairie Rock™
CHCLR	Polished Chrome with Clear Glass	PRZ	Parisian Bronze™
	Polished Chrome with Smokey Glass	PSS316	Polished Stainless Steel Marine Grade
CHSMK	Polished Chrome with Smokey Glass	PZ	Patina Bronze
CHW	Polished Chrome with Satin Etched White Glass	RNX	Rubbed Onyx
		RST	Rustic™
CLP	Classic Pewter	RVN	Ravenna™
CLR	Clear	RZ	Rubbed Bronze™
CLZ	Classic Bronze	RZS	Rubbed Bronze™ with Satin Etched Glass
CMB	Cambridge	SBK	Satin Black
CMZ	Cambridge Bronze	SC	Stucco White
CST	Canyon Slate™	SCK	Seine Crackle™
CTZ	Colton Bronze™	SEG	Satin-Etched Glass
CV	Canyon View™	SGE	Sage
CZ	Carré Bronze®	SI	Silver
DAG	Distressed Antique Gray	SMG	Smokey Gray
DAW	Distressed Antique White	SS	Stainless Steel
DBK	Distressed Black	SWZ	Shadow Bronze™
DBR	Distressed Brass	SZ	Sedona Bronze™
DCO	Distressed Copper	TBK	Textured Black
DZ	Dore Bronze™	TRZ	Terrane Bronze™
FDS	Feldspar™	TZ	Tannery Bronze™
FZ	Franciscan Bronze™	TZG	Tannery Bronze™ with Gold
GD	Gold	TZP	Tannery Bronze™ with Polished Brass Accents
GNT	Granite	VNB	Vintage Natural Brass™
GST	Galvanized Steel	WCP	Weathered Copper
HB	Heritage Bronze™	WSP	Weathered Steel
LBZ	Lincoln Bronze™	WH	White
LD	Londonderry™	WZC	Weathered Zinc
LED	Light Emitting Diode		
LZ	Legacy Bronze™		
LZG	Legacy Bronze™ with Gold Accents		
MBZ	Marbled Bronze		
MCH	Midnight Chrome		
MIZ	Mission Bronze™		
MPC	Mottled Pecan™		
MSI	Matte Silver		
MUL	Multicolor		
NBR	Natural Brass		
NCH	Brushed Nickel & Polished Chrome		
NI	Brushed Nickel		

See your dealer for information on our full line of
Cabinet Lighting Systems



VIEW THIS
PRODUCT ON
KICHLER.COM

scan with your
smartphone app.

See your dealer for information on our full line of
Ceiling Fans



VIEW THIS
PRODUCT ON
KICHLER.COM

scan with your
smartphone app.

See your dealer for information on our full line of
Lamps & Mirrors



VIEW THIS
PRODUCT ON
KICHLER.COM

scan with your
smartphone app.

See your dealer for information on our full line of
Landscape Lighting



VIEW THIS
PRODUCT ON
KICHLER.COM

scan with your
smartphone app.



Featured on Front Cover:
Organique™ Collection
Chandelier 42887 OZ Page 67

Featured on Back Cover:
Everly™ Collection
Pendant 42141 CHCLR Page 386
Pendant 42141 OZCS Page 384

KICHLER

.....
Style to live by™

Catalog No. **K114**
www.kichler.com
Printed in USA
12-KD-2450-300M
© Copyright. All rights reserved. Kichler®
The majority of newer Kichler fixtures
are U.S. and Canadian Patent Pending.