



Miniature and Molded Case Circuit Breakers



H-Frame



J-Frame



L-Frame



M-Frame



P-Frame



R-Frame

Selection Information 7-2

QO™ and QOU Miniature Circuit Breakers 7-10

- QO™ Miniature Circuit Breakers 7-10
- QO™ Circuit Breaker Accessories 7-12
- QO™ and Multi 9™ Mounting Bases 7-13
- QOU Miniature Circuit Breakers and QYU Supplementary Protectors 7-14
- QOU Accessories 7-15

Multi 9™ Miniature Circuit Breakers 7-16

PowerPact™ Molded Case Circuit Breakers 7-21

- PowerPact Family 7-21
- New!* H- and J-Frame Circuit Breakers 7-22
- Q-Frame Circuit Breakers 7-24
- New!* L-Frame Circuit Breakers 7-25
- M-Frame Circuit Breakers 7-26
- P-Frame Circuit Breakers 7-27
- R-Frame Circuit Breakers 7-28

Motor Circuit Protectors 7-29

- New!* PowerPact™ H- and J-Frame Electronic Motor Circuit Protectors 7-29
- H-Frame and J-Frame MCP Selector 7-30
- New!* Motor Circuit Protectors and Motor Protector Circuit Breakers 7-31
- H-, J-, and LA-Frame MCP Selection 7-32
- Motor Protection Selection Tables 7-33

Automatic Switches 7-34

500 Vdc Circuit Breakers 7-35

Mission Critical Circuit Breakers 7-37

PowerPact™ Circuit Breaker Accessories 7-39

Micrologic™ Electronic Trip Units 7-46

Masterpact™ Universal Power Circuit Breakers 7-50

Ground-Fault Protection 7-51

Dimensions and Shipping Weights 7-54

Circuit Breaker Enclosures 7-56

New! **Photovoltaic Circuit Breakers and Switches** 7-59

7 MINIATURE AND MOLDED CASE CIRCUIT BREAKERS



by Schneider Electric
© 2012 Schneider Electric
All Rights Reserved



		HOM Circuit Breakers										QO™ Circuit Breakers																						
Circuit Breaker Type	Plug-on	HOM	HOM-AFI	HOM-GFI	HOM-EPD	HOMT	QO	QO-H	QO-VH	QH	QOT	QO-CAFI	QO-VHAFI	QO-GFI	QO-VHGFI	QO-EPD QO-EPE	QOB	QOB-H	QOB-VH	QHB	QOB-CAFI	QOB-VHAFI	QOB-GFI	QOB-VHGFI	QOB-EPD QOB-EPE									
	Bolt-on	—	—	—	—	—	—	—	—	—	—	—	—	—	—	—	—	—	—	—	—	—	—	—										
	Unit Mount	—	—	—	—	—	—	—	—	—	—	—	—	—	—	—	—	—	—	—	—	—	—	—										
Number of Poles		1	2	1	1	2	1	2	1	1	2	3	1	2	3	2	1	2	3	1	2,3▲	1,2	3	1	1	1	1	2	3	1	1	2	3	
Current Range		15-50	15-200♦	15-20	15-20	15-50	15-20	15-50	15-50	15-50	15-50	15-50	10-70	10-200♦	10-100	15-100	15-70	15-125	15-100	15-70	15-150	15-30	15-30	15-30	15-20	15-30	15-30	15-60	15-50	15-30	15-30	15-60	15-50	
Interrupting Ratings																																		
UL/CSA Rating (kA) (50/60 Hz)	120 Vac	10	10	10	10	10	10	10	10	10	10	10	10	10	10	10	10	10	10	10	10	10	10	10	10	10	10	10	10	10	10	10	10	
	120/240 Vac	10	10	—	—	—	—	—	—	—	—	—	—	—	—	—	—	—	—	—	—	—	—	—	—	—	—	—	—	—	—	—	—	
	208Y/120	—	—	—	—	—	—	—	—	—	—	—	—	—	—	—	—	—	—	—	—	—	—	—	—	—	—	—	—	—	—	—	—	
	240 Vac ★	—	—	—	—	—	—	—	—	—	—	—	—	—	—	—	—	—	—	—	—	—	—	—	—	—	—	—	—	—	—	—	—	
	277 Vac	—	—	—	—	—	—	—	—	—	—	—	—	—	—	—	—	—	—	—	—	—	—	—	—	—	—	—	—	—	—	—	—	
DC Ratings	480Y/277 Vac	—	—	—	—	—	—	—	—	—	—	—	—	—	—	—	—	—	—	—	—	—	—	—	—	—	—	—	—	—	—	—	—	
	48 Vdc	—	—	—	—	—	—	—	—	—	—	—	—	—	—	—	—	—	—	—	—	—	—	—	—	—	—	—	—	—	—	—	—	
	60 Vdc	—	—	—	—	—	—	—	—	—	—	—	—	—	—	—	—	—	—	—	—	—	—	—	—	—	—	—	—	—	—	—	—	
	65 Vdc	—	—	—	—	—	—	—	—	—	—	—	—	—	—	—	—	—	—	—	—	—	—	—	—	—	—	—	—	—	—	—	—	—
	125 Vdc	—	—	—	—	—	—	—	—	—	—	—	—	—	—	—	—	—	—	—	—	—	—	—	—	—	—	—	—	—	—	—	—	—
IEC 60947-2 (50/60 Hz) □	IEC (Icu)	—	—	—	—	—	—	—	—	—	—	—	—	—	—	—	—	—	—	—	—	—	—	—	—	—	—	—	—	—	—	—	—	
	IEC (Ics)	—	—	—	—	—	—	—	—	—	—	—	—	—	—	—	—	—	—	—	—	—	—	—	—	—	—	—	—	—	—	—	—	—
Special Ratings																																		
CCC																																		
Fed. Specs W-C-375B/GEN		X	X	X	X	X	X	X	X	X	X	X	X	X	X	X	X	X	X	X	X	X	X	X	X	X	X	X	X	X	X	X	X	
Other Standard		HACR ♦	NOM	HACR ♦										HACR★			HACR★			HACR★			HACR★			NOM			NOM					
Accessories and Modifications																																		
Shunt Trip ▽		—	—	—	—	—	—	—	—	—	—	—	X	X	X	X	X	X	X	X	X	X	X	X	X	X	X	X	X	X	X	X	X	
Undervoltage Trip		—	—	—	—	—	—	—	—	—	—	—	—	—	—	—	—	—	—	—	—	—	—	—	—	—	—	—	—	—	—	—	—	
Auxiliary Switches ▽		—	—	—	—	—	—	—	—	—	—	—	X	X	X	X	X	X	X	X	X	X	X	X	X	X	X	X	X	X	X	X	X	
Alarm Switch ▽		—	—	—	—	—	—	—	—	—	—	—	X	X	X	X	X	X	X	X	X	X	X	X	X	X	X	X	X	X	X	X	X	
Handle Operators		—	—	—	—	—	—	—	—	—	—	—	—	—	—	—	—	—	—	—	—	—	—	—	—	—	—	—	—	—	—	—	—	
Handle Padlock Attachment		X	X	X	—	—	—	—	—	X*	X	X	X	X	X	X	X	X	X	X	X	X	X	X	X	X	X	X	X	X	X	X	X	X
Trip System Type																																		
Thermal-magnetic		X	X	X	X	X	X	X	X	X	X	X	X	X	X	X	X	X	X	X	X	X	X	X	X	X	X	X	X	X	X	X	X	
Molded Case Switch		—	—	—	—	—	—	—	—	—	—	X	X	X	—	—	—	—	—	—	—	—	—	—	—	—	—	—	—	—	—	—	—	
Dimensions (1P Unit Mount)																																		
Dimensions (1P Unit Mount) in. (mm)	Height	3.13 (79)										3.5 (89) ▲						4.75 (121)			4.12 (103)													
	Width	1.00 (25)										0.75 (19) ▲																						
	Depth	2.98 (76)										2.92 (74) ▲																						
Pages		Page 1-13										Pages 7-10, 7-11																						

7 MINIATURE AND MOLDED CASE CIRCUIT BREAKERS

- ▲ See page 7-54 for dimensions for: QOB2150VH, QOB3110VH, QOB3125VH and QOB3150VH.
- HOMT tandem is 30 A maximum. HOMT quad tandem has 20 A maximum on outside poles, and 50 A maximum on the inside poles.
- ♦ AFI, EPD and GFI products are rated 60 Hz only.
- ★ See the Supplemental Digest Page 3-22 for 3Ø corner grounded systems.
- ▲ 22 kA @ 240 Vac for 3P only.
- ▽ 1P and 2P, 10-70 A and 3P 10-60 A only.
- See the Supplemental Digest Section 10 for circuit breakers with IEC ratings.
- ♦ HACR on HOM 1P 15-50 A and 2P 15-100 A
- ★ HACR on QO, QOB 1P 10-70 A, 2P 15-100 A, 3P 10-100 A; QOB-VH 1P 15-70 A, 2P 15-125 A, 3P 15-100 A
- ▽ Factory-installed option only
- Factory-installed accessories are not available on QOB-VH 2P150 A and 3P 110-150 A
- * Handle padlock attachment available for HOMT quad tandem only.
- ♦ 2P 150-200 A requires 4P width.

		QOU Circuit Breakers			QOM1 and QOM2 Main Circuit Breakers			Multi 9™ Circuit Breakers and Supplementary Protectors						EDB Circuit Breakers								
																						
Circuit Breaker Type	Plug-on	—			—			—						—								
	Bolt-on	—			QOM1-VH QOM2-VH			—						EDB EGB EJB								
	Unit Mount	QOU			QYU▲			UL 489 C60			UL1077 C60■			C60H-DC								
Number of Poles		1	2	3	1	2	2	1	2	3	1	2	3,4	1	2	1	2,3	1	2,3	1	2,3	
Current Range		10-100	10-125	10-100	10-30	50-125	100-225	0.5-35	0.5-35	0.5-35	0.5-63	1-63	1-63	0.5-40	0.5-40	15-70	15-125	15-70	15-125	15-70	15-125	
Interrupting Ratings																						
UL/CSA Rating (kA RMS) (50/60 Hz)		120 Vac	10	10	10	—	22	22	10	—	—	10	10	10	—	—	25	25	65	65	100	100
		120/240 Vac	10	10	10	—	22	22	5	10	10	10	10	10	—	—	18	25	35	65	65	100
DC Ratings		240 Vac◆	—	—	10	—	—	5	10	10	10	10	10	—	—	18	25	35	65	65	100	
		277 Vac	—	—	—	5	—	—	—	—	5	5	5	—	—	18	18	35	35	65	65	
IEC 60947-2 (50/60 Hz) Icu		480Y/277 Vac	—	—	—	—	—	10	10	10	—	5	5	—	—	18	—	—	35	—	65	
		48 Vdc	5★	5★	5★	—	—	—	—	—	10	10	—	5	5	—	—	—	—	—	—	
		60 Vdc	5▼	5▼	5▼	—	—	—	10	10	—	—	—	5	5	—	—	—	—	—	—	
		65 Vdc	—	—	—	—	—	—	—	—	10	10	—	5	5	—	—	—	—	—	—	
		125 Vdc	—	—	—	—	—	—	—	10	—	—	—	5	5	—	—	—	—	—	—	
		250 Vdc	—	—	—	—	—	—	—	—	—	—	—	5	5	—	—	—	—	—	—	
Other Standard		240 Vac	—	—	—	—	—	20	20	20	10	10	10	20	10	20	—	—	—	—	—	
		415 Vac	—	—	—	—	—	—	10	10	—	5	5	—	—	10	—	—	—	—	—	
Special Ratings																						
CCC		X*	X*	X*	—	—	—	—	—	—	—	—	—	—	—	—	—	—	—	—	—	—
Fed. Specs W-C-375B/GEN		X	X	X	X	X	X	X	X	—	—	—	—	—	X	X	X	X	X	X	X	X
Other Standard		HACR Δ			—	—	—	—	—	□	—	—	—	—	HACR							
Accessories and Modifications																						
Shunt Trip		X◇	X◇	X◇	X◇	—	X◇	X	X	X	X	X	X	X	X	X	X◇	X◇	X◇	X◇	X◇	X◇
Undervoltage Trip		—	—	—	—	—	—	X	X	X	X	X	X	X	X	—	—	—	—	—	—	—
Auxiliary Switches		X◇	X◇	X◇	X◇	—	—	X	X	X	X	X	X	X	X	X◇	X◇	X◇	X◇	X◇	X◇	X◇
Alarm Switch		X◇	X◇	X◇	X◇	—	—	X	X	X	X	X	X	X	X	X◇	X◇	X◇	X◇	X◇	X◇	X◇
Handle Operators		—	—	—	—	—	—	X	X	X	X	X	X	X	X	—	—	—	—	—	—	
Handle Padlock Attachment		X	X	X	X	X	X	X	X	X	X	X	X	X	X	X	X	X	X	X	X	X
Trip System Type																						
Thermal-magnetic		X	X	X	X	X	X	X	X	X	X	X	X	X	X	X	X	X	X	X	X	X
Molded Case Switch		—	X	X	—	—	—	—	—	—	—	—	—	—	—	—	—	—	—	—	—	—
Dimensions (1P Unit Mount)																						
(1P Unit Mount) in. (mm)		Height	4.05 (103)			5.09 (129)★	5.60 (142)★	4.21 (107)▽			3.19 (81)			3.19 (81)			5.66 (144)					
		Width	0.75 (19)			5.00 (127)★	5.07 (129)★	0.71 (18)			0.71 (18)			0.71 (18) 1.42 (36)			0.98 (25)					
		Depth	2.92 (74)			3.47 (88)★	3.60 (91)★	2.76 (70)			2.76 (70)			2.56 (65)			4.05 (103)					
Pages		Pages 7-14			Pages 1-2			Pages 7-16 through 7-19						Page 9-17								

Note: All circuit breakers on this chart are UL Listed and CSA Certified unless otherwise noted.

- ▲ QYU is a UL 1077 supplementary protector.
- C60 are recognized components per UL 1077.
- ◆ For information regarding 3Ø corner grounded systems see the Supplemental Digest. Page 3-22
- ★ 1P and 2P, 10-70 A and 3P 10-60 A only.
- ▼ QOU is UL Listed for 60 Vdc per pole 80-100 A, 1P; 80-125 A, 2P; and 70-100 A, 3P.
- △ HACR on QOU 1P and 3P 15-100 A, 2P 15-125 A;
- UL 489A for DC Telecom applications (1-pole only).
- ◇ Factory-installed option only
- ★ QOM1 and QOM2 dimensions are for 2-pole unit.
- ▽ 480 V C60 height is 5.56 in. (141 mm).
- 2 poles must be wired in series for 500 Vdc.
- * 15-70 A 1P and 2P, 15-60 A 3P

7 MINIATURE AND MOLDED CASE CIRCUIT BREAKERS

		PowerPact™ 150 A H-Frame					PowerPact 250 A J-Frame				
		<p>New! Electronic Trip Version</p>					<p>New! Electronic Trip Version</p>				
Circuit Breaker Type		HD	HG	HJ	HL	HR	JD	JG	JJ	JL	JR
Number of Poles		2, 3	2, 3	2, 3▲	2, 3▲	3	2, 3▲	2, 3▲	2, 3▲	2, 3▲	3
Current Range		15–150 A	15–150 A	15–150 A	15–150 A	15–150 A	70–250 A■	70–250 A■	70–250 A■	70–250 A■	70–250 A■
Interrupting Ratings											
UL/CSA/NOM Rating (kA RMS) (50/60 Hz)	240 Vac	25	65	100	125	200	25	65	100	125	200
	480Y/277 Vac	18	35	65	100	200	18	35	65	100	200
	480 Vac	18	35	65	100	200	18	35	65	100	200
	600Y/347 Vac	14	18	25	50	100	14	18	25	50	100
DC Ratings	250 Vdc◆	20	20	20	20	—	20	20	20	20	—
	500 Vdc◆	—	—	—	—	—	—	20	—	—	—
IEC Rating (kA RMS) Icu/Ics★	240 Vac	25/25	65/65	100/100	125/125	125/125	25/25	65/65	100/100	125/125	125/125
	415 Vac	18/18	35/35	65/65	100/100	100/100	18/18	35/35	65/65	100/100	100/100
IEC 50/60 Hz											
Special Ratings											
CCC		X	X	X	X	X	X	X	X	X	X
Fed. Specs W-C-375B/GEN		X	X	X	X	X	X	X	X	X	X
HACR (2P, 3P)		X	X	X	X	X	X	X	X	X	X
Connections/Terminations											
Unit Mount		X	X	X	X	X	X	X	X	X	X
I-Line™		X	X	X	X	X	X	X	X	X	X
Rear Connection		X▼	X▼	X	X	X	X	X	X	X	X
Drawout		X▼	X▼	X	X	X	X	X	X	X	X
Optional Lugs		X▼	X▼	X	X	X	X	X	X	X	X
Accessories and Modifications											
Shunt Trip		X	X	X	X	X	X	X	X	X	X
Undervoltage Trip		X	X	X	X	X	X	X	X	X	X
Auxiliary Switches		X	X	X	X	X	X	X	X	X	X
Alarm Switch		X	X	X	X	X	X	X	X	X	X
Motor Operator		X▼	X▼	X	X	X	X	X	X	X	X
Handle Operators		X▼	X▼	X	X	X	X	X	X	X	X
Mechanical Interlocks (3P)		X	X	X	X	X	X	X	X	X	X
Handle Padlock Attachment		X▼	X▼	X	X	X	X	X	X	X	X
Cylinder Lock (3P)		—	—	—	—	—	—	—	—	—	—
Optional GF Protection		—	—	—	—	—	—	—	—	—	—
Trip System Type											
Thermal-magnetic		X	X	X	X	—	X	X	X	X	X
Instantaneous-only (MCP)		—	—	X△	X△	X△	—	X△	X△	X	X
Molded Case Switch (Automatic)		X	X	X	X	X	X	X	X	X	X
Electronic		X△	X△	X△	X△	X△	X△	X△	X△	X△	X△
Enclosures (Pages 7-56–7-58)											
General Purpose (NEMA 1)		X	X	X	X	—	X	X	X	—	—
Raintight (NEMA 3R)		X	X	X	X	—	X	X	X	—	—
Dust-tight (NEMA 12)		X	X	X	X	—	X	X	X	—	—
Watertight (NEMA 4, 4X, 5)		X	X	X	X	—	X	X	X	—	—
Explosion Proof (NEMA 7, 9)		—	—	—	—	—	—	—	—	—	—
Dimensions (3P Unit Mount) in. (mm)	Height	6.4 (163)					7.5 (191)				
	Width	4.1 (104)					4.1 (104)				
	Depth	3.4 (86)					3.4 (86)				
Pages (Unit Mount)/(I-Line)		Pages 7-22, 7-23, 7-29, 7-34/9-25					Pages 7-22, 7-23, 7-29, 7-34, 7-35/9-25				

Note: All circuit breakers on this chart are UL Listed and CSA Certified unless otherwise noted.

- ▲ 2P in a 3P module.
- 70–250 A with electronic trip system
- ◆ Not available with electronic trip units
- ★ Dual UL and IEC ratings and CE markings on circuit breakers. For additional IEC ratings, see the Supplemental Digest, Section 10
- ▼ Not available in HD and HG 2P rating (2P module).
- △ 3P only.

		PowerPact 250 A Q-Frame				PowerPact 600 A L-Frame				
										
Circuit Breaker Type		QB	QD	QG	QJ	LD	LG	LJ	LL	LR
Number of Poles		2, 3	2, 3	2, 3	2, 3	3, 4	3, 4	3, 4	3, 4	3, 4
Current Range		70–250■	70–250■	70–250■	70–250■	70–600	70–600	70–600	70–600	70–600
Interrupting Ratings										
UL/CSA/NOM Rating (kA RMS) (50/60 Hz)	240 Vac	10	25	65	100	25	65	100	125	200
	480Y/277 Vac	—	—	—	—	18	35	65	100	200
	480 Vac	—	—	—	—	18	35	65	100	200
	600Y/347 Vac	—	—	—	—	14	18	25	50	100
DC Ratings	600 Vac	—	—	—	—	14	18	25	50	100
	250 Vdc★	—	—	—	—	—	—	—	—	—
IEC Rating (kA RMS) Icu/Ics★	500 Vdc◆★	—	—	—	—	—	—	—	—	—
	240 Vac	10/5	10/5	10/5	10/5	25/25	65/65	100/100	125/125	125/125
		415 Vac	10/5	10/5	10/5	10/5	18/18	35/35	65/65	100/100
IEC 50/60 Hz										
Special Ratings										
CCC		—	—	—	—	X	X	X	X	X
Fed. Specs W-C-375B/GEN		X	X	X	X	—	—	—	—	—
HACR (2P, 3P)		X	X	X	—	X	X	X	X	X
Connections/Terminations										
Unit Mount		X	X	X	X	X	X	X	X	X
I-Line™		X	X	X	X	X	X	X	X	X
Rear Connection		—	—	—	—	X	X	X	X	X
Drawout		—	—	—	—	X	X	X	X	X
Optional Lugs		—	—	—	—	X	X	X	X	X
Accessories and Modifications										
Shunt Trip		—	—	—	—	X	X	X	X	X
Undervoltage Trip		—	—	—	—	X	X	X	X	X
Auxiliary Switches		—	—	—	—	X	X	X	X	X
Alarm Switch		—	—	—	—	X	X	X	X	X
Motor Operator		—	—	—	—	X	X	X	X	X
Handle Operators		—	—	—	—	X	X	X	X	X
Mechanical Interlocks (3P)		X	X	X	X	X	X	X	X	X
Handle Padlock Attachment		X	X	X	X	X	X	X	X	X
Cylinder Lock (3PΔ)		—	—	—	—	—	—	—	—	—
Optional GF Protection▼		—	—	—	—	X	X	X	X	X
Trip System Type										
Thermal-magnetic		X	X	X	X	—	—	—	—	—
Instantaneous-only (MCP)		—	—	—	—	X	X	X	X	X
Molded Case Switch (Automatic)		X	—	—	—	—	X	—	X	X
Electronic		—	—	—	—	X	X	X	X	X
Enclosures (Pages 7-56–7-58)										
General Purpose (NEMA 1)		X	X	X	X	—	—	—	—	—
Raintight (NEMA 3R)		X	X	X	X	—	—	—	—	—
Dust-tight (NEMA 12)		—	—	—	—	—	—	—	—	—
Watertight (NEMA 4, 4X, 5)		—	—	—	—	—	—	—	—	—
Explosion Proof (NEMA 7, 9)		—	—	—	—	—	—	—	—	—
Dimensions (3P Unit Mount) in. (mm)	Height	6.47 (164)				13.38 (340)				
	Width	4.5 (114)				5.51 (140)				
	Depth	3.93 (100)				4.33 (110)				
Pages (Unit Mount)/(I-Line)		Pages 7-24/9-24				Pages 7-25/7-33				



Note: All circuit breakers on this chart are UL Listed and CSA Certified unless otherwise noted.

- ▲ 2P in a 3P module
- ◆ I-Line Q-frame circuit breakers are available 70–225 A only. 250 A Q-frame unit-mount circuit breakers are limited to Cu conductors only.
- Ungrounded UPS systems only. See page 7-35. Special DC J-Frame only.
- ★ Dual UL and IEC ratings and CE markings on circuit breakers. For additional IEC ratings, see the Supplemental Digest, Section 10.
- ▼ Requires factory-installed “G” shunt trip and 3P module.
- △ Factory-installed option only.
- 3P only.
- ◆ 70–250 A with electronic trip system
- ★ Not available with electronic trip units

	PowerPact 800 A M-Frame		PowerPact 1200 A P-Frame				PowerPact 3000 A R-Frame				
Circuit Breaker Type	MG	MJ	PG	PJ	PK	PL	RG	RJ	RK	RL	
Number of Poles	2, 3	2, 3	2, 3, 4	2, 3, 4	2, 3, 4	2, 3, 4	2, 3, 4	2, 3, 4	2, 3, 4	2, 3, 4	
Current Range	300-800	300-800	100-1200	100-1200	100-1200	100-1200	240-3000	240-3000	240-3000	240-3000	
Interrupting Ratings											
UL/CSA/NOM Rating (kA RMS) (50/60 Hz)	240 Vac	65	100	65	100	65	125	65	100	65	125
	480Y/277 Vac	35	65	35	65	50	100	35	65	65	100
	480 Vac	35	65	35	65	50	100	35	65	65	100
	600Y/347 Vac	18	25	18	25	50	25	18	25	65	50
DC Ratings	250 Vdc	—	—	—	—	—	—	—	—	—	—
	500 Vdc▲	—	—	—	—	—	—	—	—	—	—
IEC (kA RMS) Icu/Ics■	240 Vac	50/25	65/35	50/25	65/35	50/25	125/65	50/25	65/35	85/65	125/65
	415 Vac	35/20	50/25	35/20	50/25	50/25	85/45	35/20	50/25	70/55	85/45
IEC 50/60 Hz											
Special Ratings											
CCC	X	X	X	X	X	X	X	X	X	X	X
Fed. Specs W-C-375B/GEN	X	X	X	X	X	X	X	X	X	X	X
HACR (2P, 3P)	X	X	X	X	X	X	X	X	X	X	X
Connections/Terminations											
Unit Mount	X	X	X	X	X	X	X	X	X	X	X
I-Line™	X	X	X	X	X	X	X▼	X▼	X▼	X▼	X▼
Rear Connection	—	—	—	—	—	—	—	—	—	—	—
Drawout	—	—	X★	X★	X★	X★	—	—	—	—	—
Optional Lugs	X	X	X	X	X	X	X	X	X	X	X
Accessories and Modifications											
Shunt Trip	X	X	X	X	X	X	X	X	X	X	X
Undervoltage Trip	X	X	X	X	X	X	X	X	X	X	X
Auxiliary Switches	X	X	X	X	X	X	X	X	X	X	X
Alarm Switch	X	X	X	X	X	X	X	X	X	X	X
Motor Operator	—	—	X★	X★	X★	X★	—	—	—	—	—
Handle Operators	—	—	X★	X★	X★	X★	—	—	—	—	—
Mechanical Interlocks (3P)	—	—	X	X	X	X	—	—	—	—	—
Handle Padlock Attachment	X	X	X	X	X	X	X	X	X	X	X
Cylinder Lock (3P)	—	—	—	—	—	—	—	—	—	—	—
Optional GF Protection	—	—	X	X	X	X	X	X	X	X	X
Trip System Type											
Thermal-magnetic	—	—	—	—	—	—	—	—	—	—	—
Instantaneous-only (MCP)	—	—	—	X	X	—	—	—	—	—	—
Molded Case Switch (Automatic)	—	—	X	X	X	X	X	X	X	X	X
Electronic	X	X	X	X	X	X	X	X	X	X	X
Enclosures (Pages 7-56-7-58)											
General Purpose (NEMA 1)	X	X	X	X	X	X	—	—	—	—	—
Raintight (NEMA 3R)	X	X	X	X	X	X	—	—	—	—	—
Dust-tight (NEMA 12)	X	X	X	X	X	X	—	—	—	—	—
Watertight (NEMA 4, 4X, 5)	X	X	—	—	—	—	—	—	—	—	—
Explosion Proof (NEMA 7, 9)	—	—	—	—	—	—	—	—	—	—	—
Dimensions (3P Unit Mount)	Height—in. (mm)	12.80 (325)		16.20 (413)				15 (381)			
	Width—in. (mm)	8.30 (210)		8.30 (210)				16.50 (420)			
	Depth—in. (mm)	8.10 (205)		8.10 (205)				14.40 (366)			
Pages (Unit Mount)/(I-Line)	Page 7-26/9-28		Page 7-27, 7-31, 7-34/9-29				Page 7-28, 7-34/9-30				

Note: All circuit breakers on this chart are UL Listed and CSA Certified unless otherwise noted.

- ▲ Ungrounded UPS systems only. See page 7-35.
- ◆ Dual UL and IEC ratings and CE markings on circuit breakers. For additional IEC ratings, see the Supplemental Digest, Section 10.
- ♦ Requires breaker with WB suffix
- ★ 65/50 kA Icu/Ics for 450-600 A ratings.
- ▼ 1000 A and 1200 A only..

		Masterpact 1200 A					Masterpact 6000 A							
														
Circuit Breaker Type		NT-N	NT-H	NT-L1	NT-L	NT-LF ▲	NW-N	NW-H	NW-L	NW-LF ▲	NW-H	NW-L	NW-H	NW-L
Number of Poles		3, 4	3, 4	3	3	3	3, 4	3, 4	3	3	3, 4	3	3, 4	3
Current Range		100-1200	100-1200	100-1200	100-1200	100-1200	100-2000	100-2000	100-2000	100-2000	640-3000	640-3000	1200-6000	1200-6000
Interrupting Ratings														
UL/CSA/NOM Rating (kA RMS) (50/60 Hz)	240 Vac	50	65	100	200	200	65	100	200	200	100	200	100	200
	480Y/277 Vac	50	50	65	100	100	65	100	150	150	100	150	100	150
	480 Vac	50	50	65	100	100	65	100	150	150	100	150	100	150
	600Y/347 Vac	35	50	—	—	—	50	85	100	100	85	100	85	100
DC Ratings	250 Vdc	—	—	—	—	—	—	—	—	—	—	—	—	—
	500 Vdc	—	—	—	—	—	—	—	—	—	—	—	—	—
IEC (kA RMS) Icu/Ics	240 Vac	—	—	—	—	—	—	—	—	—	—	—	—	—
	415 Vac	—	—	—	—	—	—	—	—	—	—	—	—	—
Special Ratings														
CCC		—	—	—	—	—	—	—	—	—	—	—	—	—
Fed. Specs W-C-375B/GEN		—	—	—	—	—	—	—	—	—	—	—	—	—
HACR (2P, 3P)		—	—	—	—	—	—	—	—	—	—	—	—	—
Connections/Terminations														
Unit Mount		X	X	X	X	X	X	X	X	X	X	X	X	X
I-Line™		—	—	—	—	—	—	—	—	—	—	—	—	—
Rear Connection		X	X	X	X	X	X	X	X	X	X	X	X	X
Drawout		X	X	X	X	X	X	X	X	X	X	X	X	X
Optional Lugs		—	—	—	—	—	—	—	—	—	—	—	—	—
Accessories and Modifications														
Shunt Trip		X	X	X	X	X	X	X	X	X	X	X	X	X
Undervoltage Trip		X	X	X	X	X	X	X	X	X	X	X	X	X
Auxiliary Switches		X	X	X	X	X	X	X	X	X	X	X	X	X
Alarm Switch		X	X	X	X	X	X	X	X	X	X	X	X	X
Motor Operator		X	X	X	X	X	X	X	X	X	X	X	X	X
Handle Operators		—	—	—	—	—	—	—	—	—	—	—	—	—
Mechanical Interlocks		X	X	X	X	X	X	X	X	X	X	X	X	X
Padlock Attachment		X	X	X	X	X	X	X	X	X	X	X	X	X
Cylinder Lock		—	—	—	—	—	—	—	—	—	—	—	—	—
Optional GF Protection		X	X	X	X	X	X	X	X	X	X	X	X	X
Trip System Type														
Thermal-magnetic		—	—	—	—	—	—	—	—	—	—	—	—	—
Instantaneous-only (MCP)		—	—	—	—	—	—	—	—	—	—	—	—	—
Molded Case Switch (Automatic)		X	X	X	X	X	X	X	X	X	X	X	X	X
Electronic		X	X	X	X	X	X	X	X	X	X	X	X	X
Enclosures														
General Purpose (NEMA 1)		—	—	—	—	—	—	—	—	—	—	—	—	—
Raintight (NEMA 3R)		—	—	—	—	—	—	—	—	—	—	—	—	—
Dust-tight (NEMA 12)		—	—	—	—	—	—	—	—	—	—	—	—	—
Watertight (NEMA 4, 4X, 5)		—	—	—	—	—	—	—	—	—	—	—	—	—
Explosion Proof (NEMA 7, 9)		—	—	—	—	—	—	—	—	—	—	—	—	—
Dimensions (3P Unit Mount) in. (mm)	Height	12.67 (322)					17.28 (439)				17.28 (439)		17.28 (439)	
	Width	11.25 (286)					17.74 (450)				17.74 (450)		30.94 (786)	
	Depth	13.00 (331)					18.38 (467)				18.38 (467)		18.38 (467)	
Pages	Page 7-50 and Catalog 0613CT0001						Page 7-50 and Catalog 0613CT0001							

Note: All circuit breakers on this chart are UL Listed and CSA Certified unless otherwise noted.

- ▲ Tested to show arc flash hazard risk category as reference by NFPA70E.
- See Catalog 0613CT0001 for additional ratings and other information.

		100 A Frame					100 A F-Frame			
Circuit Breaker Type		FA (240 V)		FA	FH	FH■	FH	FI	FY	
Number of Poles		1, 2, 3	1	2, 3	1	2, 3	2, 3	2, 3	1	
Current Range		15-100	15-100	15-100	15-30	35-100	15-100	20-100	15-30	
Interrupting Ratings										
UL/CSA/NOM Rating (kA RMS) (50/60 Hz)	240 Vac	10◐	25◐	25	65	25	65	200	14	
	480Y/277 Vac	—	18	18	65	25	25	200	14	
	480 Vac	—	—	18	—	—	25	200	—	
	600Y/347 Vac	—	—	14	—	—	18	100	—	
DC Ratings	250 Vdc*	5◆	10◆	10	10◆	10◆	50	—	—	
	500 Vdc▲*	—	—	—	—	—	20	—	—	
IEC Rating (kA RMS) Icu/Ics★	240 Vac	—	18/9	—	18/9	—	—	—	—	
	415 Vac	10/2.5	10/2.5	10/2.5	10/2.5	10/2.5	10/2.5	6/1.5	—	
IEC 50/60 Hz		For additional IEC ratings, see the Supplemental Digest, Section 10.						For additional IEC ratings, see the		
Special Ratings										
CCC		—	—	—	—	—	—	—	—	
Fed. Specs W-C-375B/GEN		X	X	X	X	X	X	X	—	
HACR (2P, 3P)		X	—	X	—	—	—	—	—	
Connections/Terminations										
Unit Mount		X	X	X	X	X	X	X	—	
I-Line™		X	X	X	X	X	X	X	X	
Rear Connection		X	X	X	—	—	—	—	—	
Drawout		—	—	—	—	—	—	—	—	
Optional Lugs		X	X	X	X	X	X	X	—	
Accessories and Modifications										
Shunt Trip		X△▼	—	X△	—	—	X△	X△	—	
Undervoltage Trip		X△▼	—	X△	—	—	X△	X△	—	
Auxiliary Switches		X△▼	—	X△	—	—	X△	X△	—	
Alarm Switch		X△▼	X△	X△	X△	X△	X△	X△	—	
Motor Operator		—	—	X	—	—	X	X	—	
Handle Operators		X	—	X	X	X	X	—	—	
Mechanical Interlocks (3P)		—	—	X	—	—	X	—	—	
Handle Padlock Attachment		X	X	X	X	X	X	X	X	
Cylinder Lock (3P△)		—	—	X	—	—	X	—	—	
Optional GF Protection□		—	—	X	—	—	X	X	—	
Trip System Type										
Thermal-magnetic		X	X	X	X	X	X	X	X	
Instantaneous-only (MCP)		—	—	X	—	—	X	—	—	
Molded Case Switch (Automatic)		—	—	—	—	—	X	—	—	
Electronic		—	—	—	—	—	—	—	—	
Enclosures (Pages 7-56-7-58)										
General Purpose (NEMA 1)		X	X	X	X	X	X	X	—	
Raintight (NEMA 3R)		X	X	X	X	X	X	X	—	
Dust-tight (NEMA 12)		X	X	X	X	X	X	X	—	
Watertight (NEMA 4, 4X, 5)		X	X	X	X	X	X	X	—	
Explosion Proof (NEMA 7, 9)		X	X	X	X	X	X	—	—	
Dimensions (3P Unit Mount) in. (mm)	Height	6 (152)				6 (152)			8 (203)	
	Width	4.5 (114)				4.5 (114)			4.5 (114)	
	Depth	4.13 (105)				4.13 (105)			4.75 (121)	
Pages (Unit Mount)/(I-Line)		Supplemental Digest Section 3/ Pages 9-23			Supplemental Digest Section 3/Page 9-24			Supplemental Digest Section 3/Pages 9-24		

Note: All circuit breakers on this chart are UL Listed and CSA Certified unless otherwise noted.
 ▲ Ungrounded UPS systems only. See page 7-35.
 ■ 65 kA @ 120 Vac
 ◆ 1Ø 125 Vdc rating only.
 ★ Dual UL and IEC ratings and CE markings on circuit breakers. For additional IEC ratings, see the Supplemental Digest, Section 10
 ▼ Not available on 1P FA (240 V).

△ Factory-installed option only.
 □ Requires factory-installed "G" Shunt trip and 3P module.
 ◆ Not available in HD and HG 2P rating (2P module).
 ★ 2P in a 3P module.
 ▼ 3P only.
 ◐ 1P FA is 120 Vac.
 * Not available with electronic trip units

7 MINIATURE AND MOLDED CASE CIRCUIT BREAKERS

	250 A K-Frame	400 A L-Frame			600 A L-Frame		
							
Circuit Breaker Type	KI	Q4	LA	LH	LI	LXI	
Number of Poles	2, 3	2, 3	2, 3	2, 3	2, 3	3	
Current Range	110-250	250-400	125-400	125-400	300-600	100-600	
Interrupting Ratings							
UL/CSA/NOM Rating (kA RMS) (50/60 Hz)	240 Vac	200	25	42	65	200	200
	480Y/277 Vac	200	—	30	35	200	200
	480 Vac	200	—	30	35	200	200
	600Y/347 Vac	100	—	22	25	100	100
	600 Vac	100	—	22	25	100	100
DC Ratings	250 Vdc	—	—	10	50	—	—
	500 Vdc▲	—	—	—	20	—	—
IEC 60947-2 (kA RMS) Icu/lcs■	240 Vac	—	—	—	—	—	—
	415 Vac	130/65	—	20/5	20/5	—	—
IEC 50/60 Hz	For additional IEC ratings, see the Supplemental Digest Section 10.						
Special Ratings							
CCC	—	—	—	—	—	—	
Fed. Specs W-C-375B/GEN	X	X	X	X	X	X	
HACR (2P, 3P)	—	—	X	X	—	—	
Connections/Terminations							
Unit Mount	X	X	X	X	X	X	
I-Line™	X	X	X	X	X	X	
Rear Connection	—	X	X	X	—	—	
Drawout	—	—	—	—	—	—	
Optional Lugs	X	X	X	X	X	X	
Accessories and Modifications							
Shunt Trip	X♦	X	X	X	X	—	
Undervoltage Trip	X♦	X	X	X	X	X	
Auxiliary Switches	X♦	X	X	X	X	X	
Alarm Switch	X♦	X	X	X	X	X	
Motor Operator	X	X	X	X	—	—	
Handle Operators	—	X	X	X	—	—	
Mechanical Interlocks (3P)	—	—	X★	X★	—	—	
Handle Padlock Attachment	X	X	X	X	X	X	
Cylinder Lock (3P)	—	X	X	X	—	—	
Optional GF Protection	X▼♦	—	—	—	—	X★	
Trip System Type							
Thermal-magnetic	X	X	X	X	X	—	
Instantaneous-only (MCP)	—	—	X	X	—	—	
Molded Case Switch (Automatic)	—	—	—	X	—	—	
Electronic	—	—	—	—	—	X	
Enclosures (Pages 7-56-7-58)							
General Purpose (NEMA 1)	—	X	X	X	—	—	
Rain-tight (NEMA 3R)	X	X	X	X	—	—	
Dust-tight (NEMA 12)	X	X	X	X	X	X	
Watertight (NEMA 4, 4X, 5)	X	X	X	X	—	—	
Explosion Proof (NEMA 7, 9)	—	—	—	—	—	—	
Dimensions (3P Unit Mount) in. (mm)	Height	8 (203)	11 (279)			11.86 (301)	
	Width	4.5 (114)	6 (152)			7.5 (190)	
	Depth	4.75 (121)	5.84 (148)			6.74 (171)	
Pages (Unit Mount)/(I-Line)	Supplemental Digest Section 3 / Pages 9-26		Supplemental Digest Section 3 / Pages 9-27			Supplemental Digest Section 3 / Pages 9-27	

Note: All circuit breakers on this chart are UL Listed and CSA Certified unless otherwise noted.

- ▲ Ungrounded UPS systems only. See page 7-35.
- Dual UL and IEC ratings and CE markings on circuit breakers. For additional IEC ratings, see the Supplemental Digest, Section 10.
- ♦ Factory-installed option only.
- ★ Requires circuit breaker with WB suffix.
- ▼ Requires factory-installed "G" Shunt trip. Available only for 3P.
- △ 65/50 kA Icu/lcs for 450 A-600 A ratings

QO™ miniature circuit breakers are plug-on products for use in QO load centers, NQOD panelboards, NQOD OEM interiors or Speed-D™ switchboard distribution panels. Bolt-on QOB circuit breakers are for use in NQOD panelboards or interiors.▲
The QO exclusive Qwik-Open™ mechanism, with a trip reaction within 1/60th of a second, is standard on all 1P 15 A and 20 A QO circuit breakers.

Table 7.1: Plug-On Circuit Breakers

Ampere Rating ■	1P—120/240 Vac		2P—120/240 Vac Common Trip		2P—240 Vac ♦ Common Trip		3P—240 Vac Common Trip	
	Cat. No.	\$ Price	Cat. No.	\$ Price	Cat. No.	\$ Price	Cat. No.	\$ Price
10 k AIR								
10 A	QO110	29.10	QO210	67.00	—	—	QO310	248.00
15 A	QO115*▼	29.10	QO215*	67.00	QO215H	200.00	QO315*	248.00
20 A	QO120*▼	29.10	QO220*	67.00	QO220H	200.00	QO320*	248.00
25 A	QO125*	29.10	QO225*	67.00	QO225H	200.00	QO325*	248.00
30 A	QO130*	29.10	QO230*	67.00	QO230H	200.00	QO330*	248.00
35 A	QO135*	29.10	QO235*	67.00	—	—	QO335*	248.00
40 A	QO140*	29.10	QO240*	67.00	QO240H	200.00	QO340*	248.00
45 A	QO145*	29.10	QO245*	67.00	—	—	QO345*	248.00
50 A	QO150*	29.10	QO250*	67.00	QO250H	200.00	QO350*	248.00
60 A	QO160*	29.10	QO260*	67.00	QO260H	200.00	QO360*	248.00
70 A	QO170*	67.00	QO270*	134.00	QO270H	224.00	QO370*	315.00
80 A	—	—	QO280*	189.00	QO280H	315.00	QO380*	366.00
90 A	—	—	QO290*	189.00	QO290H	315.00	QO390*	366.00
100 A	—	—	QO2100*	189.00	QO2100H	315.00	QO3100*	366.00
110 A	—	—	QO2110*	428.00	—	—	—	—
125 A	—	—	QO2125*	428.00	—	—	—	—
150 A	—	—	QO2150*△△	491.00	—	—	—	—
175 A	—	—	QO2175*△△	491.00	—	—	—	—
200 A	—	—	QO2200*△△	491.00	—	—	—	—
Molded Case Switch 60 A max.—240 Vac		—	—	—	QO200	70.00	QO300	248.00
Molded Case Switch 100 A max.—240 Vac		—	—	—	QO2000*	200.00	QO3000*	366.00
22 k AIR*								
15 A	QO115VH▼	63.00	QO215VH□	146.00	—	—	QO315VH□	371.00
20 A	QO120VH▼	63.00	QO220VH□	146.00	—	—	QO320VH□	371.00
25 A	QO125VH	73.00	QO225VH□	146.00	—	—	QO325VH□	371.00
30 A	QO130VH	73.00	QO230VH□	146.00	—	—	QO330VH□	371.00
40 A	QO140VH	73.00	QO240VH□	146.00	—	—	QO340VH□	371.00
50 A	QO150VH	73.00	QO250VH□	146.00	—	—	QO350VH□	371.00
60 A	QO160VH	73.00	QO260VH□	146.00	—	—	QO360VH□	371.00
70 A	QO170VH	112.00	QO270VH□	224.00	—	—	QO370VH□	477.00
80 A	—	—	QO280VH□	315.00	—	—	QO380VH□	530.00
90 A	—	—	QO290VH□	315.00	—	—	QO390VH□	530.00
100 A	—	—	QO2100VH□◇	315.00	—	—	QO3100VH□	530.00
110 A	—	—	QO2110VH□◇	1034.00	—	—	—	—
125 A	—	—	QO2125VH□◇	1034.00	—	—	—	—
150 A	—	—	QO2150VH△◇	1061.00	—	—	—	—
175 A	—	—	QO2175VH△◇	1061.00	—	—	—	—
200 A	—	—	QO2200VH△◇	1061.00	—	—	—	—
42 k AIR*								
40 A	—	—	QOH240*	317.00	—	—	—	—
45 A	—	—	QOH245*	317.00	—	—	—	—
50 A	—	—	QOH250*	317.00	—	—	—	—
60 A	—	—	QOH260*	317.00	—	—	—	—
70 A	—	—	QOH270	528.00	—	—	—	—
80 A	—	—	QOH280	651.00	—	—	—	—
90 A	—	—	QOH290	651.00	—	—	—	—
100 A	—	—	QOH2100	651.00	—	—	—	—
110 A	—	—	QOH2110*	1389.00	—	—	—	—
125 A	—	—	QOH2125	1389.00	—	—	—	—
65 k AIR*								
15 A	QH115▼	117.00	QH215	293.00	—	—	QH315*	507.00
20 A	QH120▼	117.00	QH220	293.00	—	—	QH320	507.00
25 A	QH125*	117.00	QH225*	293.00	—	—	QH325*	507.00
30 A	QH130	117.00	QH230	293.00	—	—	QH330	507.00

Table 7.2: QO-QOB Ring Terminal (20% \$ Price Adder)—Factory Installed Only

Ampere Rating	Poles	Suffix
10–30 A	1, 2, 3	5237
35–60 A	1, 2	—
35–50 A	3	5238
70–110 A	2	—
60–100 A	3	5273

Table 7.3: Wire Sizes ■

Circuit Breaker Type	Ampere Rating	Wire Size (AWG/kcmil)
QO 1P	10–30 A	14–8 Al/Cu
	10–30 A	(2) 14–10 Cu
	35–70 A	8–2 Al/Cu
QO 2P	10–30 A	14–8 Al/Cu
	10–30 A	(2) 14–10 Cu
	35–70 A	8–2 Al/Cu
	80–125 A	4–2/0 Al/Cu
QO 3P	150–200 A	4–300 Al/Cu
	10–30 A	14–8 Al/Cu, (2) 14–10 Cu
QOB-VH	10–30 A	8–2 Al/Cu
	80–125 A	4–2/0 Al/Cu
QOB-VH	110–150 A	4–300 Al/Cu
QOT	15–20 A	12–8 Al 14–8 Cu
QO-AFI, QO-GFI & QO-EPD	15–30 A	12–8 Al 14–8 Cu
	40, 50, 60 A	12–4 Al 14–6 Cu
QO-PL	10–60 A	12–2 Al 14–2 Cu

Table 7.4: QOT Tandem Circuit Breakers

Ampere Rating ■	Cat. No.*	\$ Price
1P—120/240 Vac		
15 A & 15 A	QOT1515	58.00
15 A & 20 A	QOT1520	58.00
20 A & 20 A	QOT2020	58.00
2P—120/240 Vac		

Order two QOT1515 or QOT2020 circuit breakers and handle tie QOTHT for common switching of center two poles.

Table 7.5: Replacement Tandem Circuit Breakers

For Use in Old Style Non-Class CTL QO Load Centers—10 k AIR

Ampere Rating ■	Cat. No.*	\$ Price
1P—120/240 Vac—1 Space Required		
15 A & 15 A	QO1515	73.00
15 A & 20 A	QO1520	73.00
20 A & 20 A	QO2020	73.00
20 A & 30 A	QO2030	73.00
30 A & 20 A	QO3020	73.00
Two 1P Individual Trip—120/240 Vac—2 Spaces Required		
15 A & 15 A	—	—
15 A & 20 A	—	—
20 A & 20 A	—	—
20 A & 30 A	QO203020▼	134.00
30 A & 20 A	—	—

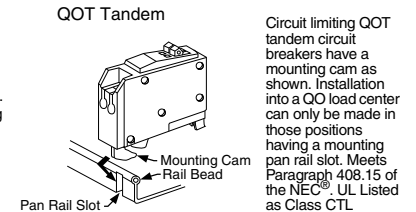

7 MINIATURE AND MOLDED CASE CIRCUIT BREAKERS

- ▲ See Digest Section 1 for load centers, and Section 9 for panelboards and interiors.
- 10–30 A circuit breakers are suitable for use with 60°C or 75°C conductors. 35–125 A circuit breakers are suitable for use with 75°C conductors.
- ♦ UL Listed 5 k AIR on corner grounded Delta systems.
- ★ UL Listed as HACR type for use with air conditioning, heating and refrigeration equipment having motor group combinations and marked for use with HACR type circuit breakers.
- ▼ UL Listed as SWD (switching duty) rated. Suitable for switching 120 Vac fluorescent lighting loads.
- △ Requires four spaces (1 AWG–300 kcmil Al/Cu). Suitable for switching 120 Vac fluorescent lighting loads.
- UL Listed for use ahead of QO, QO-GFI, QO-EPD, QO-AFI, QOT, QOCAFI, and QO-PL 10 k AIR circuit breakers to permit their application at 22 kA fault level.
- ◇ 100 A maximum branch mounted opposite.
- ☆ Order only. Contact your local Field Office.
- ▼ Includes two circuit breakers (one QO2030 and one QO3020) and handle tie QOTHT.
- Not suitable for use in 3Ø panels. Use only in 1Ø panel rated 150 A or greater.

Interrupting Ratings Page 7-2
Accessories Page 7-12
Dimensions Page 7-54

QO™ and QOU Miniature Circuit Breakers

QO™ Miniature Circuit Breakers

Class 685, 690, 730, 912, 950 / Refer to Catalog 0730CT9801

New! QO™ Arc-Fault Circuit Breaker (Pigtail and Plug-On Neutral)

QO Pigtail circuit breakers provide branch feeder protection for series and parallel-type arcing as required by the NEC and local code adoption, and comply with UL1699.



1P QO-CAFI 1P QO-PCAFI



1P QO-GFI 2P QO-GFI



3P QO-GFI



Two-wire QO-SWN



Three-wire QO-EPD/EPE



QO 1P With Shunt Trip



QO-K Key Operated

Table 7.6: QO Arc Fault Circuit Breakers*

Circuit Breaker Type	Ampere Rating	1P 120 Vac		1P 120 Vac	
		10 k AIR		22 k AIR	
		1 Space Required		1 Space Required	
		Cat. No.	\$ Price	Cat. No.	\$ Price
Combination Arc-fault Interrupter	15 A	QO115CAFI	282.00	QO115VHCAFI	534.00
	20 A	QO120CAFI	282.00	QO120VHCAFI	534.00
Plug-On Neutral Arc-fault Interrupter	15 A	QO115PCAFI	282.00	QO115VHPCAFI	534.00
	20 A	QO120PCAFI	282.00	QO120VHPCAFI	534.00

QO-GFI

Qwik-Gard™ circuit breakers provide overload and short circuit protection, combined with Class A ground fault protection. Class A denotes a ground fault circuit interrupter that will trip when a fault current to ground is 6 mA or more, for people protection. Do not connect to more than 250 feet of load conductor for the total one-way run to prevent nuisance tripping.

Table 7.7: QO-GFI Circuit Breakers

Qwik-Gard Circuit Breakers With Ground Fault Circuit Interrupter								
Ampere Rating (A)	1P 120 Vac		2P Common Trip 120/240 Vac		3P Common Trip 208Y/120 Vac			
	10 k AIR		22 k AIR		10 k AIR		10 k AIR	
	1 Space Required		1 Space Required		2 Spaces Required		3 Spaces Required	
	Cat. No.	\$ Price	Cat. No.	\$ Price	Cat. No.	\$ Price	Cat. No.	\$ Price
15	QO115GFI	233.	QO115VHGFI	482.	QO215GFI	413.	QO315GFI	791.
20	QO120GFI	233.	QO120VHGFI	482.	QO220GFI	413.	QO320GFI	791.
25	QO125GFI	233.	QO125VHGFI	482.	QO225GFI	413.	—	—
30	QO130GFI	233.	QO130VHGFI	482.	QO230GFI	413.	QO330GFI	791.
40	—	—	—	—	QO240GFI	413.	QO340GFI	791.
50	—	—	—	—	QO250GFI	413.	QO350GFI	791.
60	—	—	—	—	QO260GFI*	413.	—	—

QO-EPD/EPE

QO-EPD/EPE circuit breakers provide overload and short circuit protection combined with Class B ground fault protection. They are designed to provide ground fault protection of equipment at a 30 milliampere level (EPD) or 100 milliamp level (EPE). They are not designed to protect people from electrical shock.

Table 7.8: QO-EPD Circuit Breakers

Ampere Rating (A)	1P 120 Vac		2P Common Trip 120/240 Vac		3P Common Trip 240 Vac			
	10 k AIR		10 k AIR		10 k AIR			
	1 Space Required		2 Spaces Required		3 Spaces Required			
	Cat. No.	\$ Price	Cat. No.	\$ Price	Cat. No.	\$ Price	Cat. No.	\$ Price
15	QO115EPD	410.	QO215EPD	660.	QO315EPD	1077.	QO315EPE	1077.
20	QO120EPD	410.	QO220EPD	660.	QO320EPD	1077.	QO320EPE	1077.
25	QO125EPD	410.	QO225EPD	660.	—	—	—	—
30	QO130EPD	410.	QO230EPD	660.	QO330EPD	1077.	QO330EPE	1077.
40	—	—	QO240EPD	660.	QO340EPD	1077.	QO340EPE	1077.
50	—	—	QO250EPD	660.	QO350EPD	1077.	QO350EPE	1077.
60	—	—	QO260EPD*	660.	—	—	—	—

QO-SWN

Switch Neutral Common Trip 2008 NEC™ 514.11

Table 7.9: QO-SWN Circuit Breakers

Ampere Rating	2 Wire 120 Vac		3 Wire 120/240 Vac	
	10 k AIR		10 k AIR	
	2 Spaces Required		3 Spaces Required	
	Cat. No.	\$ Price	Cat. No.	\$ Price
10 A	QO210SWN	95.00	—	—
15 A	QO215SWN	95.00	QO315SWN	143.00
20 A	QO220SWN	95.00	QO320SWN	143.00
25 A	QO225SWN	95.00	—	—
30 A	QO230SWN	95.00	QO330SWN	143.00
40 A	QO240SWN	95.00	QO340SWN	143.00
50 A	QO250SWN	95.00	QO350SWN	143.00

QO-HID

HID circuit breakers are for use on circuits feeding fluorescent and high intensity discharge (HID) lighting systems such as mercury vapor, metal halide, or high pressure sodium. These circuit breakers are physically interchangeable with QO circuit breakers.

Table 7.10: QO-HID Circuit Breakers

Ampere Rating	1P 120/240 Vac		2P Common Trip 120/240 Vac		3P Common Trip 240 Vac	
	10 k AIR		10 k AIR		10 k AIR	
	1 Space Required		2 Spaces Required		3 Spaces Required	
	Cat. No.	\$ Price	Cat. No.	\$ Price	Cat. No.	\$ Price
15 A	QO115HID	38.10	QO215HID	87.00	QO315HID	300.00
20 A	QO120HID	38.10	QO220HID	87.00	QO320HID	300.00
25 A	QO125HID	38.10	QO225HID	87.00	QO325HID	300.00
30 A	QO130HID	38.10	QO230HID	87.00	QO330HID	300.00
40 A	QO140HID	38.10	QO240HID	87.00	—	—
50 A	QO150HID	38.10	QO250HID	87.00	—	—

QO-K

Key operated QO circuit breakers are available in single-pole construction and can be mounted in any single-pole space which will accept a standard QO. These circuit breakers can be turned ON or OFF or to RESET with a special key (catalog number QOK10) included with the circuit breaker. These circuit breakers are UL Listed and available as shown in the table.

Table 7.11: QO-K Circuit Breakers

120 Vac—10 k AIR (1 Space Required)		
Ampere Rating	Cat. No.	\$ Price
10 A	QO110K	164.00
15 A	QO115K	164.00
20 A	QO120K	164.00
30 A	QO130K	164.00

QO-HM

High magnetic trip circuit breakers are recommended for applications where high initial inrush may occur and for individual dimmer applications.

Table 7.12: QO-HM Circuit Breakers

Ampere Rating	1P	
	Cat. No.	\$ Price
120 Vac—10 k AIR		
15 A	QO115HM	30.60
20 A	QO120HM	30.60

Non-automatic (Standard) Miniature Switches

Miniature non-automatic switches have the same physical packaging as miniature circuit breakers, but open only when the handle is switched to the OFF position.

Non-automatic switches provide no overcurrent protection or short circuit protection. They must not be used on systems that have an available fault current greater than the values listed in the table.

Non-automatic switches are UL Listed per UL 1087 and are CSA certified.

Table 7.13: QO Non-Automatic Miniature Switches, 240 Vac 10 kA

Ampere Rating	2P		3P	
	Cat. No.	\$ Price	Cat. No.	\$ Price
60 A	QO200	70.00	QO300	248.00
100 A	QO2000	200.00	QO3000	366.00

- ▲ UL Listed as HACR type for use with air conditioning, heating and refrigeration equipment having motor group combinations and marked for use with HACR type circuit breakers.
- UL Listed as SWD (switching duty) rated. Suitable for switching 120 Vac fluorescent lighting loads.
- ◆ 10–30 A circuit breakers are suitable for use with 60° C or 75° C conductors. 35–60 A circuit breakers are suitable for use with 75° C conductors.
- ★ Suitable only for feeding 240 Vac and 208 Vac two-wire loads. Does not contain load neutral connection.
- ▼ See note in Instruction Bulletin when using in an enclosure with a QO403 or QON prefix.

Interrupting RatingsPage 7-2
AccessoriesPage 7-12
DimensionsPage 7-54

7 MINIATURE AND MOLDED CASE CIRCUIT BREAKERS

Table 7.14: Accessories for Use with QO™ and QOB Miniature Circuit Breakers

Handle Attachments	Description	Cat. No.	\$ Price	Schedule
Handle Tie:	Converts any two adjacent 120/240 Vac 1P QO circuit breakers to independent trip 2P	QO1HT	3.80	DE2E
	Converts any two adjacent 120/240 Vac 1P side-by-side QOT circuit breakers to independent trip 2P	QOTHT	3.80	DE2E
	Handle tie and lock-off for three 1P QO, QOB circuit breakers	QO3HT	13.40	DE2E
Handle Clamp:	Clamp for holding QO 1P handle in ON or OFF position	QO1LO	3.80	DE2E
	Clamp for holding QO or Q1 1P, 2P or 3P circuit breaker handles in ON or OFF position	HLO1	9.90	DE2E
Handle Padlock Attachment: for Padlocking in ON or OFF position	For padlocking 1P QO circuit breaker in ON or OFF position			
	Loose attachment	QOHPL	9.50	DE2E
	Fixed attachment	QO1PA	10.70	DE2E
	For padlocking 1P side-by-side QOT circuit breaker in ON or OFF position	QOTHPA	11.10	DE2E
	For padlocking 2P and 3P QO-GFI, QO-EPD, and QO-EPE in either ON or OFF position, fixed attachment.	GFI2PA	9.20	DE2A
	For 2P and 3P QO and Q1 standard circuit breakers which require padlocking in either ON or OFF position.			
Handle Padlock Attachment: for Padlocking in OFF position	Loose attachment	QO1HPL	10.70	DE2E
	Fixed attachment	QO1PL	10.70	DE2E
	For padlocking 1P QO circuit breaker in OFF position only, fixed attachment.	QO1PAF	43.50	DE2E
Ring Terminal	For padlocking 2P and 3P QO circuit breakers in OFF position only, fixed attachment.	QO2PAF	25.80	DE2E
	For padlocking 1P QO-GFI, QO-AFI, QO-CAFI, QO-PCAFI, and QO-EPD circuit breakers in OFF position only, fixed attachment.	QOGFI1PAF	51.00	DE2E
	For padlocking 2P and 3P QO-GFI, QO-EPD, and QO-EPE circuit breakers in OFF position only, fixed attachment.	QOGFI2PAF	38.40	DE2E
	Ring terminals are available as a factory-installed option.	See Page 7-10	+20% Price Adder	DE2A
Sub-Feed Lugs	60 A 2P plug-on – 2 spaces required (6–2 Al/Cu)	QO60SL	47.10	DE2A
	125 A 2P plug-on – 2 spaces required (12–2/0 Al/Cu)	QO2125SL	137.00	DE2A
	225 A 2P plug-on – 4 spaces required (4–300 Al/Cu)	QO225SL▲	308.00	DE2A
	125 A 3P plug-on – 3 spaces required (12–2/0 Al/Cu)	QO3125SL	137.00	DE3
Mechanical Interlock Attachment	For interlocking the handles of two 2P or one 2P and one 1P QO and Q1 circuit breakers mounted side-by-side so that only one circuit breaker can be ON at a time (Not QOU)	QO2DTI	24.90	DE2E
With Retaining Kit:	QO2DTI mechanical interlock attachment with retaining kits for securing two adjacent back-fed circuit breakers in dual power supply applications. Can be used with (2) 2Ps or (1) 2P and (1) 1P QO circuit breakers in QO816L100 load centers.	QO2DTIM	63.00	DE2E

▲ Not suitable for use in 3Ø panels. Use only in 1Ø panel rated 150 A or greater.

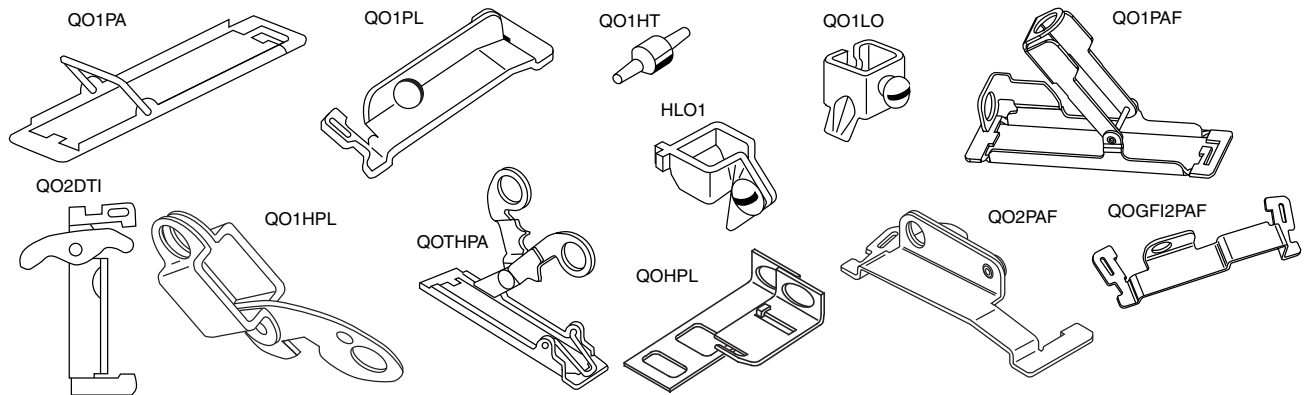

Factory-Installed Accessories for Use with QO and QOB Miniature Circuit Breakers

Factory-installed electrical accessories take up an additional pole space on QO™, QO-GFI, QO-EPD, QO-SWN and QOU circuit breakers. All AC electrical accessories shown below are rated for 50/60 Hz. Accessories are not available for QOB-VH (2P 150 A and 3P 110–150 A) circuit breakers or QO, QOU molded case switches. QO circuit breakers will accept only one accessory per circuit breaker. Undervoltage trip is not available on miniature circuit breakers. Factory-installed accessories are not available for QO-AFI, QO-CAFI or QO-PCAFI Arc Fault Circuit Breakers or on QO2150, QO2175, or QO2200 circuit breakers.

Table 7.15: Factory-Installed Accessories

Accessory	Description	Rated Voltage	Coil Burden	Cat. No. Suffix	\$ Price Adder	Accessory	Description	Contact Comb.	Max. Voltage	Max. Load	Cat. No. Suffix	\$ Price Adder
Shunt Trip	Trips the circuit breaker from a remote location by means of a trip coil energized from a separate circuit. A 120 Vac shunt trip will operate at 55% or more of rated voltage. All other shunt trips will operate at 75% or more of rated voltage.	AC/DC	12	60 VA	-1042	Auxiliary Switches	Monitors circuit breaker contact status and provides a remote signal indicating the circuit breaker contacts are OPEN or CLOSED.	1A 1B	AC 120 AC 120	5 A 5 A	-1200	132.00
			24	168 VA	-1201						-1201	
		AC	208	228 VA	-1021	132.00						
Alarm Switches	Used with control circuits and is actuated only when the circuit breaker has tripped. Standard construction includes a normally-open contact.					Alarm Switches		1A	AC 120	5 A	-2100	132.00
											Application	



SN12125



QON2L40

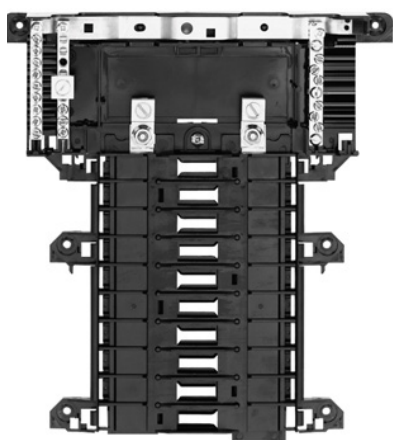

QON120L1251

Table 7.16: QO OEM Mounting Bases—UL Recognized Components

Voltage System	Main Lug Rating	1P Spaces	Max. No. 1P	Mounting Bases		Main Wire Size AWG/kcmil	
				Cat. No.	\$ Price		
QO Plug-On Mounting Bases—For unit mounting QO, QO-GFI, QO-AFI and QO-EPD circuit breakers							
1Ø2W 240 Vac Max. 10 k AIC (Without Neutral Assembly)	70 A	2	2	QON2L70	27.30	14–4 Cu, 12–3 Al	
	125 A	4	4	SK9948BW	75.00	12–1/0 Cu/Al	
	125 A	4	4	SK9842	78.00	12–1/0 Cu/Al	
	125 A	6	6	SK9795	84.00	12–1/0 Cu/Al	
	125 A	6	6	SK9801	108.00	12–1/0 Cu/Al	
	150 A	6	6	SK9796BW	131.00	8–3/0 Cu/Al	
1Ø3W 240 Vac Max. 10 k AIC	150 A	8	8	SK9797	140.00	8–3/0 Cu/Al	
	40 A	2	2	QON2L40	35.00	14–6 Cu, 12–6 Al	
	70 A	2	4	QON24L70	50.00	14–4 Cu, 12–3 Al	
	100 A	6	12	QON612L100	70.00	8–1/0 Cu/Al	
	100 A	8	16	QON816L100	92.00	8–1/0 Cu/Al	
	100 A	12	12	QON12L100	113.00	12–2/0 Cu/Al	
	100 A	12	12	QON12L100SF	161.00	6–2/0 Cu/Al	
	125 A	12	12	QON112L125I	120.00	4–2/0 Cu/Al	
	125 A	12	24	QON11224L125I	168.00	4–2/0 Cu/Al	
	125 A	16	16	QON116L125I	131.00	4–2/0 Cu/Al	
	125 A	16	24	QON11624L125I	191.00	4–2/0 Cu/Al	
	125 A	20	20	QON120L125I	225.00	4–2/0 Cu/Al	
	125 A	24	24	QON124L125I	263.00	6–2/0 Cu/Al	
	125 A	32	32	QON132L125I	360.00	4–2/0 Cu/Al	
	125 A	20	24	QON12024L125I	263.00	4–2/0 Cu/Al	
3Ø3W 240 Vac Max. 10 k AIC (Without Neutral Assy.)	150 A	24	24	QON124L150I	263.00	4–250 Cu/Al	
	200 A	12	12	QON124L200I	339.00	4–250 Cu/Al	
	200 A	12	12	QON12L200FTL	500.00	4–250 Cu/Al	
	200 A	24	24	QON124L200I	339.00	4–250 Cu/Al	
	200 A	24	24	QON124L200DL	500.00	(2) 4–300 Cu/Al	
	200 A	30	30	QON130L200I	417.00	4–250 Cu/Al	
	225 A	42	42	QON142L225I	599.00	4–300 Cu/Al	
	125 A	12	12	QON312L125	251.00	4–2/0 Cu/Al	
	125 A	20	20	QON320L125	380.00	4–2/0 Cu/Al	
	125 A	24	24	QON324L125	395.00	4–2/0 Cu/Al	
3Ø4W 240 Vac Max. 10 k AIC	200 A	18	18	QON318L200	327.00	4–300 Cu/Al	
	200 A	24	24	QON324L200	402.00	4–300 Cu/Al	
	200 A	30	30	QON330L200	477.00	4–300 Cu/Al	
	225 A	42	42	QON342L225	674.00	4–300 Cu/Al	
	60 A	3	3	QON403L60N	49.80	12–6 Cu/Al	
	125 A	12	12	QON312L125I	281.00	4–2/0 Cu/Al	
QO Plug-On Mounting Bases—For unit mounting QO, QO-GFI and QO-EPD circuit breakers	125 A	20	20	QON320L125I	441.00	4–2/0 Cu/Al	
	125 A	24	24	QON324L125I	461.00	4–2/0 Cu/Al	
	200 A	18	18	QON318L200I	426.00	4–300 Cu/Al	
	200 A	24	24	QON324L200I	468.00	4–300 Cu/Al	
QOB Bolt-On Mounting Bases—For unit mounting QOB, QOB-GFI, QOB-EPD circuit breakers	200 A	30	30	QON330L200I	528.00	4–300 Cu/Al	
	225 A	42	42	QON342L225I	716.00	4–300 Cu/Al	
	1Ø2W 240 Vac Max. 10 k AIC (Without Neutral Assembly)	70 A	1	1	QOMB1	29.60	14–4 Cu 12–2 Al
	70 A	2	2	QOMB2	59.00	14–4 Cu 12–2 Al	
70 A	3	3	QOMB3	87.00	14–4 Cu 12–2 Al		
3Ø3W 240 Vac Max. 10 k AIC (Without Neutral Assembly)	100 A	3	3	QON3B	56.00	12–1 Cu/Al	

- ▲ Also IEC rated and CE marked for IEC 60439-1. Use only Square D brand Type QOXC, QOXD, QOHX and QOE circuit breakers for 415Y/240 Vac max. systems.
- ◆ Device comes with factory-installed sub-feed lugs.
- ♦ Device comes with factory-installed feed-thru lugs.
- ★ Device comes with factory-installed dual-line lugs.

Table 7.17: Solid Neutral Assemblies

Main Lug Rating	Number of Branch Neutral Terminals	Cat. No.	\$ Price	Main Neutral Lug Wire Size		Branch Neutral Terminal Wire Size	
				Cu/Al		Cu	Al
125 A	12	SN12125	36.30	4–2/0 AWG		14–4 AWG	12–4 AWG
125 A	20	SN20	39.50	4–2/0 AWG		14–4 AWG	12–4 AWG
200 A	12	SN12200	40.70	4 AWG–300 kcmil		14–4 AWG	12–4 AWG
200 A	30	SN30	54.00	4 AWG–300 kcmil		14–4 AWG	12–4 AWG
225 A	42	SN42	63.00	4 AWG–300 kcmil		14–4 AWG	12–4 AWG

Table 7.18: Multi-9 Mounting Bases for UL489 C60, 240 Vac max.

Description	Poles	Amperes	Length		Cat. No. ▼	\$ Price
			in.	mm		
One-conductor Mounting Base	12	200 A	10.4	264	US11220018	330.00
	24		14.4	366	US12420018	476.00
	36		19	483	US13620018	632.00
	48		23	584	US14820018	810.00
	60		27.5	699	US16020018	972.00
Two-conductor Mounting Base	12	150 A	10.4	264	US21215018	429.00
	24		14.4	366	US22420018	645.00
	36		19	483	US23620018	887.00
	48		23	584	US24820018	1140.00
	60		27.5	699	US26020018	1359.00
Three-conductor Mounting Base	12	100 A	10.4	264	US31210018	467.00
	24		14.4	366	US32420018	701.00
	36		19	483	US33620018	960.00
	48		23	584	US34820018	1245.00
	60		27.5	699	US36020018	1547.00



US Mounting Base for UL489 C60 (3 conductor shown)

Table 7.19: Accessories for US Mounting Base for UL489 C60

Description	Cat. No. ▼	\$ Price
Main lug kit for US mounting bases, 1 lug per kit, for 6 AWG to 300 kcmil cable	USMBLK	24.00
Terminal cover for US mounting base; provides IP20 ingress protection per IEC 60529; suitable for jumper bars or cable	USBTC	49.50

▼ DE2 Discount Schedule

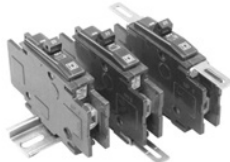

Low Ampere QOU

Low Ampere QOU Miniature Circuit Breakers

QOU unit mount miniature circuit breakers (cable-in/cable-out) are ideal for OEM applications. They have the Square D™ circuit breaker's unique Visi-Trip™ feature and can be DIN rail-mounted or surface- or flush-mounted using mounting feet.

General Specifications Common to All Low Ampere QOU Circuit Breakers

- For convenient flush mount, surface mount or DIN mount (symmetrical rail 35 x 7.5 DIN/EN 50 022)
- Single handle with internal common trip
- Terminal lug wire size (1) 14–2 AWG Cu or Al
- Reversible line and load lugs
- Field-installable quick connectors
- UL Listed 48 Vdc (5 k AIR)
- UL Listed as HACR Type: 10–70 A
- High magnetic trip circuit breakers (QOU-HM) are recommended for applications where high initial inrush may occur and for individual dimmer applications.
- For DIN mounting rails, see IEC Starters and Relays, Section 18.

Table 7.20: QOU Low Ampere Miniature Circuit Breakers

Ampere Rating	1P 120/240 Vac		2P 120/240 Vac		2P 240 Vac		3P 240 Vac	
	Cat. No.	\$ Price	Cat. No.	\$ Price	Cat. No.▲	\$ Price	Cat. No.	\$ Price
10 k AIR								
10 A	QOU110	40.20	QOU210	87.00	—	168.00	QOU310	285.00
15 A	QOU115		QOU215		QOU215H		QOU315	
20 A	QOU120		QOU220		QOU220H		QOU320	
25 A	QOU125		QOU225		QOU225H		QOU325	
30 A	QOU130		QOU230		QOU230H		QOU330	
35 A	QOU135		QOU235		—		QOU335	
40 A	QOU140		QOU240		—		QOU340	
45 A	QOU145		QOU245		—		QOU345	
50 A	QOU150		QOU250		—		QOU350	
60 A	QOU160		QOU260		—		QOU360	
70 A	QOU170	78.00	QOU270	171.00	—	—	QOU370	363.00
22 k AIR								
15 A	QOU115VH	101.00	QOU215VH	189.00	—	—	QOU315VH	426.00
20 A	QOU120VH		QOU220VH		—		QOU320VH	
25 A	QOU125VH		QOU225VH		—		QOU325VH	
30 A	QOU130VH		QOU230VH		—		QOU330VH	
35 A	QOU135VH		QOU235VH		—		—	
40 A	QOU140VH		QOU240VH		—		—	
45 A	QOU145VH		QOU245VH		—		—	
50 A	QOU150VH		QOU250VH		—		—	
60 A	QOU160VH		QOU260VH		—		—	

▲ QOU-H interrupting rating is 10 kA at 240 Vac.

Table 7.21: QOU-HM Miniature Circuit Breakers (10 k AIR)

Ampere Rating	1P 120/240 Vac		2P 120/240 Vac		2P 240 Vac		3P 240 Vac	
	Cat. No.	\$ Price	Cat. No.	\$ Price	Cat. No.	\$ Price	Cat. No.	\$ Price
15 A	QOU115HM	40.20	—	—	—	—	—	—
20 A	QOU120HM		—	—	—	—	—	—

Table 7.22: QYU UL1077 Recognized Supplementary Protectors (5 k AIR)

Ampere Rating	1P 277 Vac		2P 120/240 Vac		2P 240 Vac		3P 240 Vac	
	Cat. No.	\$ Price	Cat. No.	\$ Price	Cat. No.	\$ Price	Cat. No.	\$ Price
10 A	QYU110	122.00	—	—	—	—	—	—
15 A	QYU115		—	—	—	—	—	—
20 A	QYU120		—	—	—	—	—	—
25 A	QYU125		—	—	—	—	—	—
30 A	QYU130		—	—	—	—	—	—

High Ampere QOU Circuit Breakers

General Specifications Common to All High Ampere QOU Circuit Breakers

- Flush mount, surface mount, and DIN rail mount.
- Internal common trip.
- Non-reversible line and load lugs.
- Terminal lug wire size (1) 12–2/0 AWG Cu or Al.
- UL Listed 60 Vdc per pole (5 k AIR). (Note: except switches)
- UL Listed as HACR type, 80–125 A.
- Non-automatic switches have the same physical packaging as miniature circuit breakers, but provide no overcurrent or short circuit protection. They are UL Listed per UL1087 and are CSA certified.

Table 7.23: QOU High Ampere Miniature Circuit Breakers (10 k AIR)

Ampere Rating	1P 120/240 Vac		2P 120/240 Vac		2P 240 Vac		3P 240 Vac	
	Cat. No.	\$ Price	Cat. No.	\$ Price	Cat. No.	\$ Price	Cat. No.	\$ Price
80 A	QOU180	176.00	QOU280	246.00	—	—	QOU380	416.00
90 A	QOU190		QOU290		—	—	QOU390	
100 A	QOU1100		QOU2100		—	—	QOU3100	
125 A	—	—	QOU2125	452.00	—	—	—	—

Table 7.24: QOU Non-Automatic Switches

Ampere Rating	1P 120 Vac		2P 120/240 Vac		2P 240 Vac		3P 240 Vac	
	Cat. No.	\$ Price	Cat. No.	\$ Price	Cat. No.	\$ Price	Cat. No.	\$ Price
60 A	—	—	—	—	QOU200	87.00	QOU300	285.00
100 A	—	—	—	—	QOU2000	246.00	QOU3000	416.00
125 A	—	—	—	—	QOU20001	452.00	QOU30001	716.00

Interrupting Ratings Page 7-3
 Accessories Page 7-12, 7-15
 Dimensions Page 7-54



High Ampere QOU

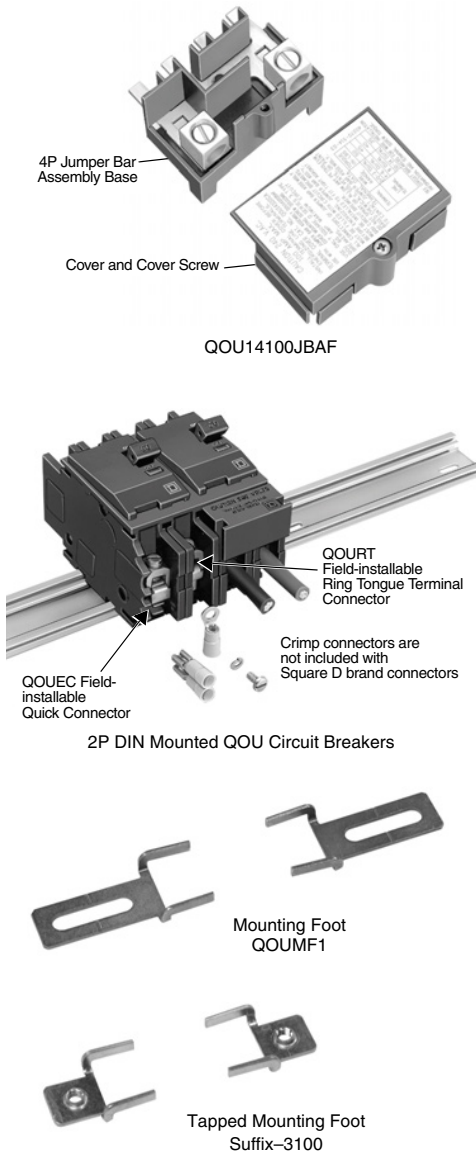

Table 7.25: Accessories for QOU Low Ampere Circuit Breakers (Except as Noted)

Description	Order Qty.	Cat. No.	Unit \$ Price
Factory-installed ring tongue terminal, 10–32 screw, for 1P, 2P, 3P QOU, 10–60 A	—	Suffix -5283	Add 20% to price
Hex drive 5/32 in. wire binding screw for QOU	—	Suffix -5280	Add 20% to price
For padlocking 1P low ampere QOU circuit breaker in OFF or ON position	—	QOU1PA	10.10
For padlocking 2P and 3P low ampere QOU circuit breaker in OFF or ON position	—	QOU1PL	10.10
For padlocking 1P low ampere QOU circuit breaker in OFF position only	—	QOU1PAFLA ♦	43.50
For padlocking 2P and 3P low ampere QOU circuit breaker in OFF position only	—	QOU2PAFLA ♦	25.80
For padlocking 2P and 3P high ampere QOU circuit breaker in OFF position only	—	Suffix -7100	Add 20% to price
Handle lock-out, ON or OFF position	—	HLO1 ♦	9.90
4P 100 A Jumper bar assy. w/front wiring with base, cover and screw	1	QOU14100JBAF	73.00
4P 100 A Jumper bar assy. w/right side wiring with base, cover and screw	1	QOU14100JBAR	73.00
4P 100 A Jumper bar assy. w/left side wiring with base, cover and screw	1	QOU14100JBAL	73.00
1Ø, 4P, 100 A Jumper bar base with front wiring	40	QOU14100BAFB	53.00
1Ø, 4P, 100 A Jumper bar base with left side wiring	40	QOU14100BALB	53.00
1Ø, 4P, 100 A Jumper bar base with right side wiring	40	QOU14100BARB	53.00
4P Jumper bar cover	40	QOU14100CAB	13.20
Mounting screw for jumper bar cover	40	QOU1CMSB	0.35
6P 150 A Jumper bar assy. w/front wiring with base, cover and screw	1	QOU16150JBAF	99.00
1Ø, 6P, 150 A Jumper bar base with front wiring	40	QOU16150BAFB	69.00
1Ø, 6P, 150 A Jumper bar base with left side wiring	40	QOU16150BALB	69.00
1Ø, 6P, 150 A Jumper bar base with right side wiring	40	QOU16150BARB	69.00
6P jumper bar cover	40	QOU16150CAB	17.10
Vertical rainproof cover 2P and 3P QO, QOU, FA and KA	1 10	BCV▲♦♦ BCVB▲♦♦	30.80 30.80
Horizontal rainproof cover 2P QO, QOU, and 3P Q2, EH	1 10	BCH▲♦♦ BCHB▲♦♦	30.80 30.80
1P Fingersafe™ cover for high ampere QOU circuit breaker	1 40	QOUHFSC1 QOUHFSC1B	2.60 2.10
1P Fingersafe cover for low ampere QOU circuit breaker	1 40	QOULFSC1 QOULFSC1B	2.60 2.10
Cover plate for one 2P QOU circuit breaker	1 40	QOUCP2 QOUCP2B	8.30 6.60
Cover plate for one 3P QOU circuit breaker	1 40	QOUCP3 QOUCP3B	15.80 12.80
Cover plate for two 2P QOU circuit breakers	1 40	QOUCP4 QOUCP4B	9.90 7.90
Cover plate for three 2P QOU circuit breakers	1 40	QOUCP6 QOUCP6B	15.60 12.20
Field-installable ring tongue terminal adaptor	1 80	QOURT QOVRTB	5.70 4.40
Quick connector end connection wiring	1 40	QOUEC QOUECB	5.70 4.40
Quick connector forward or reverse wiring	1 40	QOUFR QOUFRB	5.70 4.40
1P QOU mounting foot	1 80	QOUMF1▲ QOUMF1B▲	0.71 0.54
2P QOU mounting foot	1 40	QOUMF2▲ QOUMF2B▲	1.40 1.10
3P QOU mounting foot	1 24	QOUMF3▲ QOUMF3B▲	2.30 1.70
Tapped mounting foot for QOU, 1P and 2P 10–70 A, 3P 10–60 A		Suffix -3100	Add 20% to price
Packaged with circuit breaker	1	QOUMFS1	2.40
Individually packaged	80	QOUMFS1B	2.30
Mechanical interlock attachment: Used to interlock two circuit breakers mounted side-by-side so that only one circuit breaker can be ON at a time. A 1P or 2P circuit breaker can be mounted on the left and interlocked with a 2P or 3P circuit breaker on the right.	1	QOU2DTILA ■	24.90

▲ For use on low and high ampere QOU.
■ 10–70 A 1P and 2P, 10–60 A 3P.
♦ DE2E Discount Schedule

7 MINIATURE AND MOLDED CASE CIRCUIT BREAKERS

For QOUQ Low Ampere Circuit Breakers with Four-Point Quick-Connect Terminals

QOUQ low ampere circuit breakers with four-point quick-connect terminals are provided with permanent factory-installed terminals which are affixed to the Load or OFF end of the circuit breaker. This special terminal will accommodate up to four 1/4-inch insulated female quick connect wire terminations. Total ampacity of these connections must not exceed the rating of the circuit breaker.

Table 7.26: QOUQ Four-Point Quick-Connect Terminals

	Poles	Order Qty.	Cat. No.	Unit \$ Price Adder
Four-Point Quick-Connect Terminals	1	1	Change QOU to QOUQ	8.90
	2	1		17.70
	3	1		26.40



1P C60

2P C60

Multi 9 C60 UL 489 Listed 240 V Miniature Circuit Breakers

- UL 489 Listed and CSA 22.2 No. 5.1 for branch circuit protection
- Eliminates concerns and uncertainty of using a UL 1077 device where a UL 489 device is required
- Replaces fuses in low-ampere range; 17 ratings up to 35 A

- 10 k AIR (1P @ 120 Vac; 2P and 3P @ 240 Vac)
- 60 Vdc for 1P and 125 Vdc for 2P (on C-curve circuit breakers only, see table below)
- Increased installation flexibility with standard box lugs or optional ring terminals
- Allows easy front-mounting and rear wiring when using ring terminals
- A wide range of electrical and mechanical accessories
- Suitable for reverse feeding
- Trip-free mechanism
- Positive indication of contact disconnect

Trip Curve	Use	Magnetic Release
C	For typical loads	7–10 x ampere rating (7–14 for DC)
D	For high inrush	10–14 x ampere rating

Table 7.27: UL 489 Circuit Breakers (120/240 V)

Rating (A)	C Curve—7–10 Times Ampere Rating (7–14 DC)						D Curve—10–14 Times Ampere Rating					
	1P ▲		2P ■		3P		1P		2P		3P	
	Cat. No.	\$ Price	Cat. No.	\$ Price	Cat. No.	\$ Price	Cat. No.	\$ Price	Cat. No.	\$ Price	Cat. No.	\$ Price
Box Lug/Box Lug												
0.5	60100	125.00	60134	269.00	—	—	60117	125.00	60151	269.00	—	—
1	60101	125.00	60135	269.00	60168	387.00	60118	125.00	60152	269.00	60184	387.00
1.5	60102	125.00	60136	269.00	60169	387.00	60119	125.00	60153	269.00	60185	387.00
2	60103	125.00	60137	269.00	60170	387.00	60120	125.00	60154	269.00	60186	387.00
3	60104	125.00	60138	269.00	60171	387.00	60121	125.00	60155	269.00	60187	387.00
4	60105	125.00	60139	269.00	60172	387.00	60122	125.00	60156	269.00	60188	387.00
5	60106	125.00	60140	269.00	60173	387.00	60123	125.00	60157	269.00	60189	387.00
6	60107	114.00	60141	246.00	60174	356.00	60124	114.00	60158	246.00	60190	356.00
7	60108	114.00	60142	246.00	60175	356.00	60125	114.00	60159	246.00	60191	356.00
8	60109	114.00	60143	246.00	60176	356.00	60126	114.00	60160	246.00	60192	356.00
10	60110	114.00	60144	246.00	60177	356.00	60127	114.00	60161	246.00	60193	356.00
13	60111	114.00	60145	246.00	60178	356.00	60128	114.00	60162	246.00	60194	356.00
15	60112	114.00	60146	246.00	60179	356.00	60129	114.00	60163	246.00	60195	356.00
20	60113	114.00	60147	246.00	60180	356.00	60130	114.00	60164	246.00	60196	356.00
25	60114	114.00	60148	246.00	60181	356.00	60131	114.00	60165	246.00	60197	356.00
30	60115	120.00	60149	257.00	60182	372.00	60132	120.00	60166	257.00	60198	372.00
35	60116	120.00	60150	257.00	60183	372.00	60133	120.00	60167	257.00	60199	372.00
Ring Tongue/Ring Tongue												
0.5	60200	131.00	60234	282.00	—	—	60217	131.00	60251	282.00	—	—
1	60201	131.00	60235	282.00	60268	410.00	60218	131.00	60252	282.00	60284	410.00
1.5	60202	131.00	60236	282.00	60269	410.00	60219	131.00	60253	282.00	60285	410.00
2	60203	131.00	60237	282.00	60270	410.00	60220	131.00	60254	282.00	60286	410.00
3	60204	131.00	60238	282.00	60271	410.00	60221	131.00	60255	282.00	60287	410.00
4	60205	131.00	60239	282.00	60272	410.00	60222	131.00	60256	282.00	60288	410.00
5	60206	131.00	60240	282.00	60273	410.00	60223	131.00	60257	282.00	60289	410.00
6	60207	122.00	60241	261.00	60274	378.00	60224	122.00	60258	261.00	60290	378.00
7	60208	122.00	60242	261.00	60275	378.00	60225	122.00	60259	261.00	60291	378.00
8	60209	122.00	60243	261.00	60276	378.00	60226	122.00	60260	261.00	60292	378.00
10	60210	122.00	60244	261.00	60277	378.00	60227	122.00	60261	261.00	60293	378.00
13	60211	122.00	60245	261.00	60278	378.00	60228	122.00	60262	261.00	60294	378.00
15	60212	122.00	60246	261.00	60279	378.00	60229	122.00	60263	261.00	60295	378.00
20	60213	122.00	60247	261.00	60280	378.00	60230	122.00	60264	261.00	60296	378.00
25	60214	122.00	60248	261.00	60281	378.00	60231	122.00	60265	261.00	60297	378.00
30	60215	126.00	60249	273.00	60282	395.00	60232	126.00	60266	273.00	60298	395.00
35	60216	126.00	60250	273.00	60283	395.00	60233	126.00	60267	273.00	60299	395.00

▲ 1P dual rated 120 Vac/60 Vdc.
■ 2P dual rated 240 Vac/125 Vdc.

Interrupting ratings Page 7-3
 Accessories Page 7-20
 Dimensions Page 7-54
 Mounting Bases Page 7-13
 DIN Mounting Rail Section 18



3P C60



Box Lug C60



Ring Tongue C60



Box/Ring C60

7 MINIATURE AND MOLDED CASE CIRCUIT BREAKERS

Multi 9 C60 UL 489 Listed 480V Miniature Circuit Breakers

- UL 489 Listed, CSA C22.2 No. 5.1; Also IEC 60947-2; CE marked
- 480Y/277 Vac @ 10 kA (2P and 3P), 277 Vac @ 10 kA (1P)
- 0.5 A through 20 A
- 1P, 2P, 3P, 18 mm wide per pole

Trip Curve	Use	Magnetic Release
C	For typical loads	7–10 x ampere rating (7–14 for DC)
D	For high inrush	10–14 x ampere rating

- UL 486B Listed single-barrel lug: (2) 18–10 AWG (1-25 mm²) cables, Cu only
- Optional ring tongue terminals
- A wide range of electrical and mechanical accessories
- Suitable for reverse feeding
- Trip-free mechanism
- Positive indication of contact disconnect

Table 7.28: UL 489 Circuit Breakers (480Y/277 Vac)

Rating (A)	C Curve—7–10 Times Ampere Rating (7–14 DC)						D Curve—10–14 Times Ampere Rating					
	1P		2P		3P		1P		2P		3P	
	Cat. No.	\$ Price	Cat. No.	\$ Price	Cat. No.	\$ Price	Cat. No.	\$ Price	Cat. No.	\$ Price	Cat. No.	\$ Price
Single-Barrel Wire Lug												
0.5	MGN61300	168.00	—	—	—	—	MGN61333	168.00	—	—	—	—
1	MGN61301	168.00	MGN61312	357.00	MGN61323	519.00	MGN61334	168.00	MGN61345	357.00	MGN61356	519.00
2	MGN61302	168.00	MGN61313	357.00	MGN61324	519.00	MGN61335	168.00	MGN61346	357.00	MGN61357	519.00
3	MGN61303	168.00	MGN61314	357.00	MGN61325	519.00	MGN61336	168.00	MGN61347	357.00	MGN61358	519.00
4	MGN61304	168.00	MGN61315	357.00	MGN61326	519.00	MGN61337	168.00	MGN61348	357.00	MGN61359	519.00
5	MGN61305	168.00	MGN61316	357.00	MGN61327	519.00	MGN61338	168.00	MGN61349	357.00	MGN61360	519.00
6	MGN61306	168.00	MGN61317	357.00	MGN61328	519.00	MGN61339	168.00	MGN61350	357.00	MGN61361	519.00
8	MGN61307	168.00	MGN61318	357.00	MGN61329	519.00	MGN61340	168.00	MGN61351	357.00	MGN61362	519.00
10	MGN61308	168.00	MGN61319	357.00	MGN61330	519.00	MGN61341	168.00	MGN61352	357.00	MGN61363	519.00
15	MGN61309	168.00	MGN61320	357.00	MGN61331	519.00	MGN61342	168.00	MGN61353	357.00	MGN61364	519.00
20	MGN61310	168.00	MGN61321	357.00	MGN61332	519.00	MGN61343	168.00	MGN61354	357.00	MGN61365	519.00
Ring Tongue Terminal												
0.5	MGN61366	168.00	—	—	—	—	MGN61399	168.00	—	—	—	—
1	MGN61367	168.00	MGN61378	357.00	MGN61389	519.00	MGN61400	168.00	MGN61411	357.00	MGN61422	519.00
2	MGN61368	168.00	MGN61379	357.00	MGN61390	519.00	MGN61401	168.00	MGN61412	357.00	MGN61423	519.00
3	MGN61369	168.00	MGN61380	357.00	MGN61391	519.00	MGN61402	168.00	MGN61413	357.00	MGN61424	519.00
4	MGN61370	168.00	MGN61381	357.00	MGN61392	519.00	MGN61403	168.00	MGN61414	357.00	MGN61425	519.00
5	MGN61371	168.00	MGN61382	357.00	MGN61393	519.00	MGN61404	168.00	MGN61415	357.00	MGN61426	519.00
6	MGN61372	168.00	MGN61383	357.00	MGN61394	519.00	MGN61405	168.00	MGN61416	357.00	MGN61427	519.00
8	MGN61373	168.00	MGN61384	357.00	MGN61395	519.00	MGN61406	168.00	MGN61417	357.00	MGN61428	519.00
10	MGN61374	168.00	MGN61385	357.00	MGN61396	519.00	MGN61407	168.00	MGN61418	357.00	MGN61429	519.00
15	MGN61375	168.00	MGN61386	357.00	MGN61397	519.00	MGN61408	168.00	MGN61419	357.00	MGN61430	519.00
20	MGN61376	168.00	MGN61387	357.00	MGN61398	519.00	MGN61409	168.00	MGN61420	357.00	MGN61431	519.00

Multi 9 C60 UL 489A Listed Miniature Circuit Breakers for DC Telecommunication Applications

A limited range of C60 products are UL Listed as UL 489A circuit breakers for protection of DC telecommunication circuits.

Table 7.29: UL 489A Circuit Breakers for DC Telecommunications Applications (1P, 2 Modules, C curve)

Rating (A)	Cat. No.	\$ Price	Rating (A)	Cat. No.	\$ Price
0.5	60406	120.00	10	60414	101.00
1	60407	101.00	13	60415	101.00
2	60408	101.00	15	60416	101.00
3	60409	101.00	20	60417	101.00
4	60410	101.00	30	60418	101.00
5	60411	101.00	40	60419	111.00
6	60412	101.00	50	60420	117.00
8	60413	101.00	60	60421	123.00

Interrupting RatingPage 7-3
Accessories Page 7-20
Dimensions Page 7-54

7 MINIATURE AND MOLDED CASE CIRCUIT BREAKERS



1P C60H-DC



2P C60H-DC

Multi 9 C60H-DC UL 1077 Recognized Supplementary Protectors (250 and 500 Vdc)

The C60H-DC supplementary protectors are used in direct current circuits (industrial control and automation, transport, renewable energy, etc.). They provide overcurrent protection within appliances or electrical equipment.

- Range from 0.5–40 A
- 5 k AIR at 250 Vdc (1-pole) and 5 k AIR at 500 Vdc (2-pole, wired in series)
- Trip-free mechanism
- Positive indication of contact disconnect
- C-Curve: 7 to 14 times ampere rating
- UL 1077, IEC 60947-2, EN 60947-2, GB 14048.2, CCC and CE mark

Table 7.30: Multi 9 C60H-DC UL 1077 Recognized Supplementary Protectors

Current (A) [▲]	1-Pole 24–250 Vdc		2-Pole 24–500 Vdc	
	Cat. No.	\$ Price	Cat. No.	\$ Price
0.5	MGN61500	182.00	MGN61520	392.00
1	MGN61501	182.00	MGN61521	392.00
2	MGN61502	182.00	MGN61522	392.00
3	MGN61503	182.00	MGN61523	392.00
4	MGN61504	182.00	MGN61524	392.00
5	MGN61505	182.00	MGN61525	392.00
6	MGN61506	182.00	MGN61526	392.00
10	MGN61508	182.00	MGN61528	392.00
13	MGN61509	182.00	MGN61529	392.00
15	MGN61510	182.00	MGN61530	392.00
16	MGN61511	182.00	MGN61531	392.00
20	MGN61512	182.00	MGN61532	392.00
25	MGN61513	182.00	MGN61533	392.00
30	MGN61514	182.00	MGN61534	392.00
32	MGN61515	182.00	MGN61535	392.00
40	MGN61517	200.00	MGN61537	412.00

▲ At 25°C/77°F, for other temperatures see temperature derating table in Multi 9 Catalog 0860CT0201R1/08

Multi 9 UL1053 Listed GFP Ground Fault Protectors

- Provides ground fault protection for electrical circuits.
- Available in 2P (2-wire) and 4P (3- or 4-wire) versions
- Provides no thermal or magnetic protection. The circuit must be protected by an upstream device.
- Contains Si Technology to increase immunity to noise and to minimize the potential for nuisance tripping in noisy electrical environments.
- Tripped condition due to a ground fault is displayed on the front face by a red mechanical indicator.
- DIN rail mounting for easy installation.

Table 7.31: Multi 9 UL 1053 Listed GFP Ground Fault Protectors

Current (A)	Maximum Sensitivity (mA)	Tripping Range	Family	2P				4P	
				UL1053 120/240 Vac, 240 Vac, 60 Hz		UL1053 277 Vac, 480Y/277 Vac, 60 Hz		UL1053 240 Vac, 480Y/277 Vac, 60 Hz	
				IEC 61008 230 Vac, 240 Vac, 50 Hz		IEC 61008 230/400 Vac, 240/415 Vac, 50 Hz		IEC 61008 230/400 Vac, 240/415 Vac, 50 Hz	
				Cat. No.	\$ Price	Cat. No.	\$ Price	Cat. No.	\$ Price
25	30	22.1 to 29.9 mA	GFP 30	60949	633.00	60969	696.00	60989	720.00
	100	73.1 to 98.9 mA	GFP 100	60950	570.00	60970	627.00	60990	648.00
	300	221 to 299 mA	GFP 300	60951	444.00	60971	488.00	60991	504.00
40	30	22.1 to 29.9 mA	GFP 30	60952	666.00	60972	734.00	60992	758.00
	100	73.1 to 98.9 mA	GFP 100	60953	600.00	60973	660.00	60993	683.00
	300	221 to 299 mA	GFP 300	60954	467.00	60974	513.00	60994	531.00
63	30	22.1 to 29.9 mA	GFP 30	60955	1001.00	60975	1100.00	60995	1136.00
	100	73.1 to 98.9 mA	GFP 100	60956	900.00	60976	990.00	60996	1023.00
	300	221 to 299 mA	GFP 300	60957	701.00	60977	770.00	60997	795.00
80	300	221 to 299 mA	GFP 300	60958	933.00	60978	1026.00	60998	1272.00
	100	300	221 to 299 mA	GFP 300	60959	1097.00	60979	1206.00	60999

Interrupting Ratings Page 7-3
Accessories Page 7-20
Dimensions Page 7-54



2P GFP



4P GFP (3- or 4-wire)

7 MINIATURE AND MOLDED CASE CIRCUIT BREAKERS

Multi 9™ Miniature Circuit Breakers

UL 1077 C60 Supplementary Protectors

Class 860 / Refer to Catalog 0860CT0201

Intended for use within equipment where branch circuit protection is already provided or not needed

- Range from 0.5 to 63 A
- 10 k AIR @ 120/240 Vac; 5 k AIR at 480Y/277; 10 k AIR @ 50 Vdc (1P) and 125 Vdc (2P)
- Suitable for reverse feeding
- DIN mounting for easy installation
- Suitable for reverse feeding

- A wide range of electrical and mechanical accessories
- Trip-free mechanism
- Positive indication of contact disconnect

Trip Curve	Use	Magnetic Release
B	For sensitive equipment	3.2–4.8 x ampere rating
C	For typical loads	7–10 x ampere rating (7–14 for DC)
D	For high inrush	10–14 x ampere rating

Table 7.32: UL 1077 Supplementary Protectors

Rating (A)	1P	\$ Price	2P	\$ Price	3P	\$ Price	4P	\$ Price
B Curve—Magnetic Setting Between 3.2 and 4.8 Times Ampere Rating								
1	MG24110	101.00	MG24125	218.00	MG24140	315.00	MG24155	416.00
1.2	MG17402	101.00	MG17432	218.00	—	—	—	—
1.5	MG17403	101.00	MG17433	218.00	—	—	—	—
2	MG24111	101.00	MG24126	218.00	MG24141	315.00	MG24156	416.00
3	MG24112	101.00	MG24127	218.00	MG24142	315.00	MG24157	416.00
4	MG24113	101.00	MG24128	218.00	MG24143	315.00	MG24158	416.00
5	MG17404	101.00	MG17434	218.00	—	—	—	—
6	MG24114	101.00	MG24129	218.00	MG24144	315.00	MG24159	416.00
7	MG17405	101.00	MG17435	218.00	—	—	—	—
8	MG24115	101.00	MG24130	218.00	MG24145	315.00	MG24160	416.00
10	MG24116	101.00	MG24131	218.00	MG24146	315.00	MG24161	416.00
13	MG24117	101.00	MG24132	218.00	MG24147	315.00	MG24162	416.00
15	MG17406	101.00	MG17436	218.00	MG17461	315.00	—	—
16	MG24118	101.00	MG24133	218.00	MG24148	315.00	MG24163	416.00
20	MG24119	101.00	MG24134	218.00	MG24149	315.00	MG24164	416.00
25	MG24120	101.00	MG24135	218.00	MG24150	315.00	MG24165	416.00
30	MG17407	101.00	MG17437	218.00	MG17462	315.00	—	—
32	MG24121	101.00	MG24136	218.00	MG24151	315.00	MG24166	416.00
35	MG17408	101.00	MG17438	218.00	MG17463	315.00	—	—
40	MG24122	111.00	MG24137	224.00	MG24152	324.00	MG24167	420.00
50	MG24123	117.00	MG24138	240.00	MG24153	338.00	MG24168	438.00
60	MG17409	123.00	MG17439	252.00	MG17464	353.00	—	—
63	MG24124	123.00	MG24139	252.00	MG24154	353.00	MG24169	450.00
C Curve—Magnetic Setting Between 7 and 10 Times Ampere Rating								
0.5	MG17411	120.00	—	—	—	—	—	—
1	MG24425	101.00	MG24442	218.00	MG24459	315.00	MG24476	416.00
1.2	MG17412	101.00	MG17442	218.00	—	—	—	—
1.5	MG17413	101.00	MG17443	218.00	—	—	—	—
2	MG24426	101.00	MG24443	218.00	MG24460	315.00	MG24477	416.00
3	MG24427	101.00	MG24444	218.00	MG24461	315.00	MG24478	416.00
4	MG24428	101.00	MG24445	218.00	MG24462	315.00	MG24479	416.00
5	MG17414	101.00	MG17444	218.00	—	—	—	—
6	MG24430	101.00	MG24447	218.00	MG24464	315.00	MG24481	416.00
7	MG17415	101.00	MG17445	218.00	—	—	—	—
8	MG24431	101.00	MG24448	218.00	MG24465	315.00	MG24482	416.00
10	MG24432	101.00	MG24449	218.00	MG24466	315.00	MG24483	416.00
13	MG24433	101.00	MG24450	218.00	MG24467	315.00	MG24484	416.00
15	MG17416	101.00	MG17446	218.00	MG17466	315.00	—	—
16	MG24434	101.00	MG24451	218.00	MG24468	315.00	MG24485	416.00
20	MG24435	101.00	MG24452	218.00	MG24469	315.00	MG24486	416.00
25	MG24436	101.00	MG24453	218.00	MG24470	315.00	MG24487	416.00
30	MG17417	101.00	MG17447	218.00	MG17467	315.00	—	—
32	MG24437	101.00	MG24454	218.00	MG24471	315.00	MG24488	416.00
35	MG17418	101.00	MG17448	218.00	MG17468	315.00	—	—
40	MG24438	111.00	MG24455	224.00	MG24472	324.00	MG24489	420.00
50	MG24439	117.00	MG24456	240.00	MG24473	338.00	MG24490	438.00
60	MG17419	123.00	MG17449	252.00	MG17469	353.00	—	—
63	MG24440	123.00	MG24457	252.00	MG24474	353.00	MG24491	450.00
D Curve—Magnetic Setting Between 10 and 14 Times Ampere Rating								
0.5	MG17421	120.00	—	—	—	—	—	—
1	MG24500	101.00	MG24516	218.00	MG24532	315.00	MG24548	416.00
1.2	MG17422	101.00	MG17452	218.00	—	—	—	—
1.5	MG17423	101.00	MG17453	218.00	—	—	—	—
2	MG24501	101.00	MG24517	218.00	MG24533	315.00	MG24549	416.00
3	MG24502	101.00	MG24518	218.00	MG24534	315.00	MG24550	416.00
4	MG24503	101.00	MG24519	218.00	MG24535	315.00	MG24551	416.00
5	MG17424	101.00	MG17454	218.00	—	—	—	—
6	MG24504	101.00	MG24520	218.00	MG24536	315.00	MG24552	416.00
7	MG17425	101.00	MG17455	218.00	—	—	—	—
8	MG24505	101.00	MG24521	218.00	MG24537	315.00	MG24553	416.00
10	MG24506	101.00	MG24522	218.00	MG24538	315.00	MG24554	416.00
13	MG24507	101.00	MG24523	218.00	MG24539	315.00	MG24555	416.00
15	MG17426	101.00	MG17456	218.00	MG17471	315.00	—	—
16	MG24508	101.00	MG24524	218.00	MG24540	315.00	MG24556	416.00
20	MG24509	101.00	MG24525	218.00	MG24541	315.00	MG24557	416.00
25	MG24510	101.00	MG24526	218.00	MG24542	315.00	MG24558	416.00
30	MG17427	101.00	MG17457	218.00	MG17472	315.00	—	—
32	MG24511	101.00	MG24527	218.00	MG24543	315.00	MG24559	416.00
35	MG17428	101.00	MG17458	218.00	MG17473	315.00	—	—
40	MG24512	111.00	MG24528	224.00	MG24544	324.00	MG24560	420.00
50	MG24513	117.00	MG24529	240.00	MG24545	338.00	MG24561	438.00
60	MG17429	123.00	MG17459	252.00	MG17474	353.00	—	—
63	MG24514	123.00	MG24530	252.00	MG24546	353.00	MG24562	450.00

Interrupting Ratings Page 7-3
Accessories Page 7-20
Dimensions Page 7-54

7 MINIATURE AND MOLDED CASE CIRCUIT BREAKERS



1P
UL 1077 C60



2P
UL 1077 C60



3P
UL 1077 C60



4P
UL 1077 C60

Electrical Accessories for C60 Circuit Breakers and Supplementary Protectors

Possible Combinations

Mounted to the left of the circuit breaker with a maximum width of 54 mm.

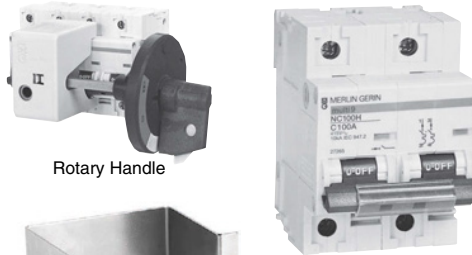
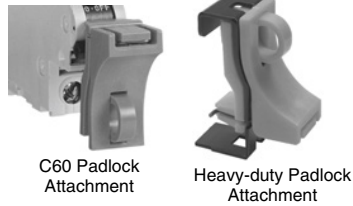
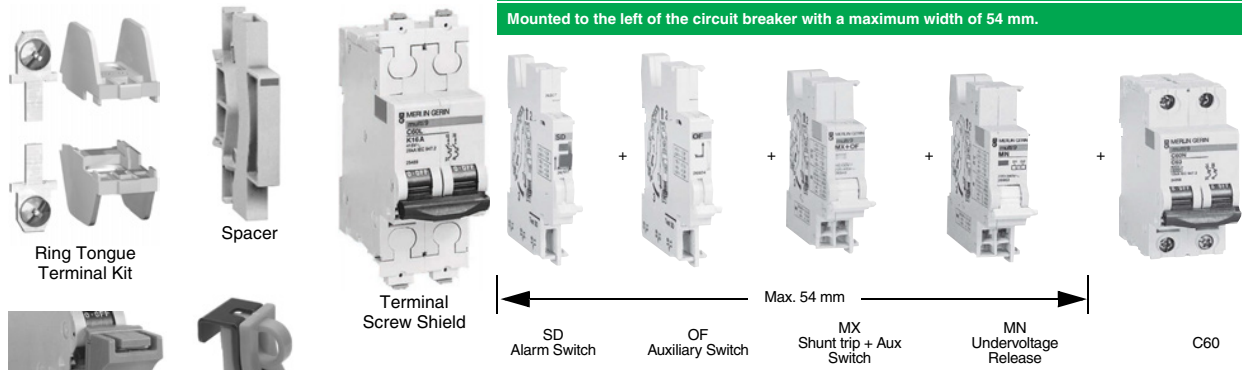

Front Mounting Kit for C60
1P, 2P, 3P, 4P
(1 per circuit breaker)

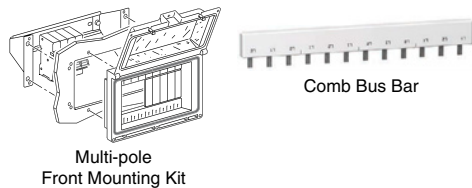
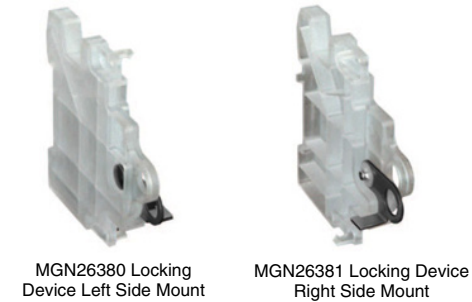

Table 7.33: Multi 9 C60 Electrical Accessories

Descriptions	Control Voltage		Width in 9 mm modules	C60 UL/IEC	
	Vac	Vdc		Cat. No.	\$ Price
OF Auxiliary Switch (1a1b)	12-277	12-125	1	MG26925	60.00
SD Alarm Switch (1a1b)	12-277	12-125	1	MG26928	60.00
MX Shunt Trip + OF Auxiliary Switch (1a1b)	24	24	2	27118	140.00
	48	48	2	27110	
	110-240-277	125	2	27109	
MN Undervoltage Release	24	24	2	27108	201.00
	48	48	2	27106	
	120	—	2	27107	
	240	—	2	27105	
Multi-9 GFP UL 1053 Listed Ground Fault Protectors	120 to 480Y/277 Vac; 30, 100, and 300 mA; 2P and 4Ps. See page 7-18 Handout, 0860HO0602 or Catalog 0860CT0201				

Table 7.34: Multi 9 C60 Mechanical Accessories

Descriptions		C60	
		Cat. No.	\$ Price
Ring tongue terminal kit for UL1077 C60	For one pole	17400	15.80
Spacer for DIN rail, Not UL Recognized	9 mm wide	MG27062	9.30
Padlock Attachment (1 per for 1P, 2P, 3P or 4P)	2 per pack	MG26970	33.20
Heavy-duty Padlock Attachment for C60, Locks OFF only	2 per pack	M9PAF	60.00
Padlocking Device Left Side Mount, Locks OFF only▲	1 per pack	MGN26380	37.50
Padlocking Device Right Side Mount, Locks OFF only■		MGN26381	37.50
Front Mounting Kit	1P	MG26983	16.80
	2P	MG26984	16.80
	3P	MG26985	16.80
	4P	MG26989	16.80
Label holders for 2, 3 or 4P C60 (Not UL Recognized)	Bag of 10	MG27150	51.00
Terminal Screw Shield (Not UL Recognized)	Bag of two 4P shields	MG26981	51.00
Terminal cover (Not UL Recognized)	1P	MG26975	26.10
	2P	MG26976	51.00
	3P	MG26975+MG26976	102.00
	4P	MG26978	102.00
Comb Bus Bar Kit for UL1077 C60, 12 poles, Fixed Length	1Ø	MG10285	63.00
	2Ø	MG10286	69.00
	3Ø	MG10287	80.00
Tooth Caps for UL Comb Bus Bar, Bag of 20		60488	37.80
Rotary Handle for C60 (Non UL Recognized)			
Operating Subassembly	2P/3P/4P	MG27046	129.00
Door Interlock Handle		MG27047	107.00
Fixed Handle (Front or Lateral)		MG27048	117.00
Multi-pole Front Mounting Kit			
Rail Support (20 of 9 mm modules)		14211	54.00
Hinged Transparent Cover		14210	158.00

- ▲ Left-side mounted padlocking device cannot be used in conjunction with accessories SD, OF, MX or MN. Use right-side mounted padlocking device when accessories are required.
- Right-side mounted padlocking device cannot be used in conjunction with VIGI module. Use left-side mounted padlocking device when VIGI Module is required.

7 MINIATURE AND MOLDED CASE
CIRCUIT BREAKERS

The PowerPact Advantage

- **Proven Performance:** Industry-leading circuit breaker innovation and protection for heavy-duty commercial and industrial applications.
- **Smart:** Integrated metering options provide a cost-effective solution to reduce energy consumption, optimize energy costs, and improve energy availability for your facilities.
- **Flexible:** Full range of thermal-magnetic and electronic trip molded case circuit breakers from 15 A to 3000 A, delivering the ratings, configurations, and operators for your unique applications.
- **Simple:** Common catalog numbers, standardized ratings, and a full range of field-installable accessories make product selection, installation and maintenance easier than ever.
- **Common Design Features:** Mounting holes, door trim, and handle accessories

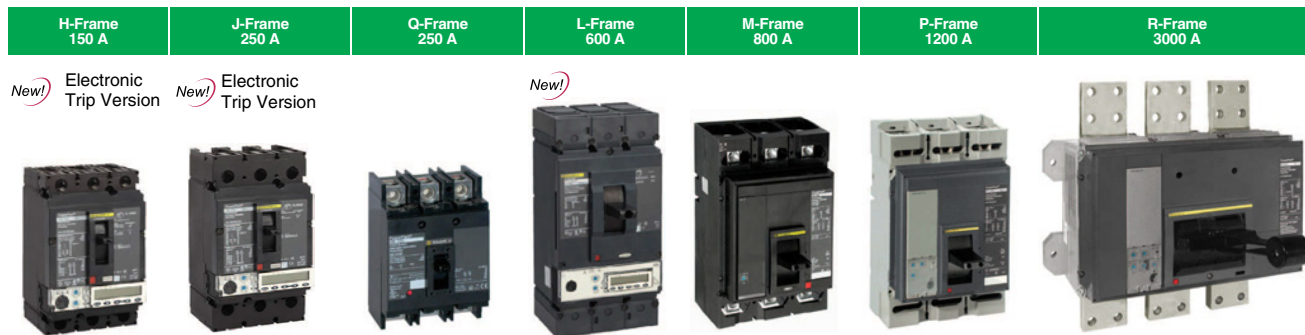
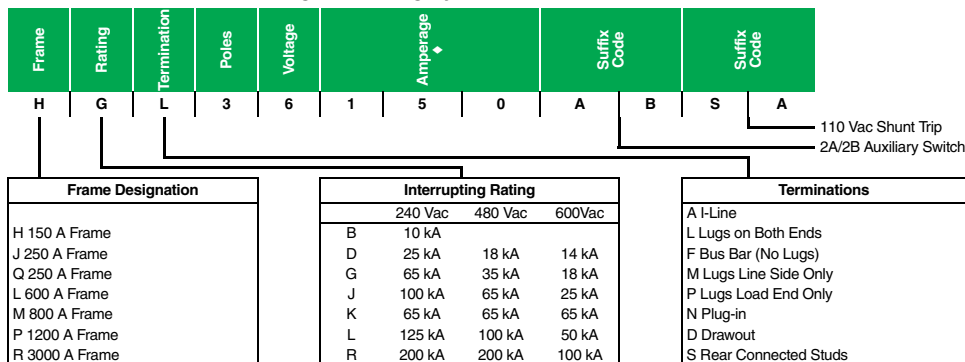

Table 7.35: PowerPact Interrupting Ratings

Voltage	Interrupting Rating						
	B	D	G	J	K	L	R
240 Vac	10 kA	25 kA	65 kA	100 kA	65 kA	125 kA	200 kA
480 Vac		18 kA	35 kA	65 kA	65 kA ▲	100 kA	200 kA
600 Vac		14 kA	18 kA	25 kA	65 kA ▲	50 kA ■	100 kA

▲ P-frame K interrupting is 50 kA at 480 and 600 Vac.
■ P-frame L interrupting is 25 kA at 600 Vac.

Table 7.36: Common Catalog Numbering System



◆ For amperage of M-, P- or R-frame circuit breakers, add a zero to the three amperage digits; for example, 120 = 1200 A.

Description	Page
H- and J-Frame Circuit Breakers	7-22
H- and J-Frame Circuit Breakers	7-23
Q-Frame Circuit Breakers	7-24
L-Frame Circuit Breakers	7-25
P-Frame Circuit Breakers	7-27
R-Frame Circuit Breakers	7-28
PowerPact™ H- and J-Frame Electronic Motor Circuit Protectors	7-29
Motor Circuit Protectors and Motor Protector Circuit Breakers	7-31
Automatic Switches	7-34
500 Vdc Circuit Breakers	7-35
Mission Critical Circuit Breakers	7-37
PowerPact™ Circuit Breaker Accessories	7-39
Motor Operators and Rotary Handles	7-40
Locks, Installation Accessories, and Rear Connections	7-41
Mechanical Lugs	7-41
Compression Lugs and Power Distribution Connectors (PDC)	7-43
Terminal Nuts, Terminal Pads, Terminal Shields and Accessories	7-44
Plug-In and Drawout Mountings	7-45
Micrologic™ Electronic Trip Units	7-46
Micrologic™ Trip Unit Accessories	7-48



HD and HG 2P
Thermal-Magnetic Trip Unit
(2P HJ, HL in 3P module)



H-Frame
Thermal-Magnetic Trip Unit

Table 7.37: H-Frame 150 A Thermal-Magnetic UL Current-Limiting★ Circuit Breakers(600 Vac, 250 Vdc) With Factory Sealed Trip Unit Suitable for Reverse Connection▲

Current Rating @ 40°C	Fixed AC Magnetic Trip		Cat. No. ■◆	Interrupting Rating (2nd Letter of Catalog Number)								Terminal Wire Range
				D		G		J★		L★		
				\$ Price								
Hold	Trip		80% Rated	100% Rated	80% Rated	100% Rated	80% Rated	100% Rated	80% Rated	100% Rated		
H-Frame, 150A 2P, 600 Vac 50/60 Hz, 250 Vdc												
15 A	350 A	750 A	H(J)L26015(C)	870.00	1044.00	1269.00	1523.00	1559.00	1871.00	2364.00	2837.00	AL150HD 14-3/0 AWG Al or Cu
20 A	350 A	750 A	H(J)L26020(C)	870.00	1044.00	1269.00	1523.00	1559.00	1871.00	2364.00	2837.00	
25 A	350 A	750 A	H(J)L26025(C)	870.00	1044.00	1269.00	1523.00	1559.00	1871.00	2364.00	2837.00	
30 A	350 A	750 A	H(J)L26030(C)	870.00	1044.00	1269.00	1523.00	1559.00	1871.00	2364.00	2837.00	
35 A	400 A	850 A	H(J)L26035(C)	870.00	1044.00	1269.00	1523.00	1559.00	1871.00	2364.00	2837.00	
40 A	400 A	850 A	H(J)L26040(C)	870.00	1044.00	1269.00	1523.00	1559.00	1871.00	2364.00	2837.00	
45 A	400 A	850 A	H(J)L26045(C)	870.00	1044.00	1269.00	1523.00	1559.00	1871.00	2364.00	2837.00	
50 A	400 A	850 A	H(J)L26050(C)	870.00	1044.00	1269.00	1523.00	1559.00	1871.00	2364.00	2837.00	
60 A	800 A	1450 A	H(J)L26060(C)	870.00	1044.00	1269.00	1523.00	1559.00	1871.00	2364.00	2837.00	
70 A	800 A	1450 A	H(J)L26070(C)	1062.00	1274.00	1497.00	1797.00	1721.00	2066.00	2613.00	3137.00	
80 A	800 A	1450 A	H(J)L26080(C)	1062.00	1274.00	1497.00	1797.00	1721.00	2066.00	2613.00	3137.00	
90 A	800 A	1450 A	H(J)L26090(C)	1062.00	1274.00	1497.00	1797.00	1721.00	2066.00	2613.00	3137.00	
100 A	800 A	1700 A	H(J)L26100(C)	1062.00	1274.00	1497.00	1797.00	1721.00	2066.00	2613.00	3137.00	
110 A	900 A	1700 A	H(J)L26110(C)	2072.00	2486.00	3059.00	3671.00	4449.00	5339.00	5534.00	6641.00	
125 A	900 A	1700 A	H(J)L26125(C)	2072.00	2486.00	3059.00	3671.00	4449.00	5339.00	5534.00	6641.00	
150 A	900 A	1700 A	H(J)L26150(C)	2072.00	2486.00	3059.00	3671.00	4449.00	5339.00	5534.00	6641.00	
H-Frame 150A 3P, 600 Vac 50/60 Hz, 250 Vdc												
15 A	350 A	750 A	H(J)L36015(C)	1088.00	1305.00	1493.00	1791.00	1949.00	2339.00	2849.00	3419.00	AL150HD 14-3/0 AWG Al or Cu
20 A	350 A	750 A	H(J)L36020(C)	1088.00	1305.00	1493.00	1791.00	1949.00	2339.00	2849.00	3419.00	
25 A	350 A	750 A	H(J)L36025(C)	1088.00	1305.00	1493.00	1791.00	1949.00	2339.00	2849.00	3419.00	
30 A	350 A	750 A	H(J)L36030(C)	1088.00	1305.00	1493.00	1791.00	1949.00	2339.00	2849.00	3419.00	
35 A	400 A	850 A	H(J)L36035(C)	1088.00	1305.00	1493.00	1791.00	1949.00	2339.00	2849.00	3419.00	
40 A	400 A	850 A	H(J)L36040(C)	1088.00	1305.00	1493.00	1791.00	1949.00	2339.00	2849.00	3419.00	
45 A	400 A	850 A	H(J)L36045(C)	1088.00	1305.00	1493.00	1791.00	1949.00	2339.00	2849.00	3419.00	
50 A	400 A	850 A	H(J)L36050(C)	1088.00	1305.00	1493.00	1791.00	1949.00	2339.00	2849.00	3419.00	
60 A	800 A	1450 A	H(J)L36060(C)	1088.00	1305.00	1493.00	1791.00	1949.00	2339.00	2849.00	3419.00	
70 A	800 A	1450 A	H(J)L36070(C)	1328.00	1592.00	1701.00	2042.00	2099.00	2519.00	3149.00	3779.00	
80 A	800 A	1450 A	H(J)L36080(C)	1328.00	1592.00	1701.00	2042.00	2099.00	2519.00	3149.00	3779.00	
90 A	800 A	1450 A	H(J)L36090(C)	1328.00	1592.00	1701.00	2042.00	2099.00	2519.00	3149.00	3779.00	
100 A	800 A	1700 A	H(J)L36100(C)	1328.00	1592.00	1701.00	2042.00	2099.00	2519.00	3149.00	3779.00	
110 A	900 A	1700 A	H(J)L36110(C)	2600.00	3120.00	3599.00	4319.00	5174.00	6209.00	6749.00	8099.00	
125 A	900 A	1700 A	H(J)L36125(C)	2600.00	3120.00	3599.00	4319.00	5174.00	6209.00	6749.00	8099.00	
150 A	900 A	1700 A	H(J)L36150(C)	2600.00	3120.00	3599.00	4319.00	5174.00	6209.00	6749.00	8099.00	

Table 7.38: J-Frame 250 A Thermal-Magnetic UL Current-Limiting★ Circuit Breakers (600 Vac, 250 Vdc) With Factory Sealed Trip Unit Suitable for Reverse Connection▲

Current Rating @ 40°C	Adjustable AC Magnetic Trip		Cat. No. ■◆	Interrupting Rating (2nd Letter of Catalog Number)								Terminal Wire Range		
				D		G		J★		L★			R★	
				\$ Price										
Low	High		80% Rated	100% Rated	80% Rated	100% Rated	80% Rated	100% Rated	80% Rated	100% Rated	80% Rated	100% Rated		
J-Frame 250A 2P, 600 Vac 50/60 Hz, 250 Vdc														
150 A	750 A	1500 A	J(J)L26150(C)	2175.00	2610.00	3212.00	3854.00	4671.00	5606.00	5811.00	6972.00	—	—	AL175JD 4-4/0 AWG Al or Cu
175 A	875 A	1750 A	J(J)L26175(C)	2175.00	2610.00	3212.00	3854.00	4671.00	5606.00	5811.00	6972.00	—	—	AL175JD 4-4/0 AWG Al or Cu
200 A	1000 A	2000 A	J(J)L26200(C)	2175.00	2610.00	3212.00	3854.00	4671.00	5606.00	5811.00	6972.00	—	—	AL250JD 3/0 AWG-350 kcmil Al or Cu
225 A	1125 A	2250 A	J(J)L26225(C)	2175.00	2610.00	3212.00	3854.00	4671.00	5606.00	5811.00	6972.00	—	—	AL250JD 3/0 AWG-350 kcmil Al or Cu
250 A	1250 A	2500 A	J(J)L26250(C)	2988.00	3585.00	4251.00	5102.00	6225.00	7469.00	7194.00	8633.00	—	—	AL250JD 3/0 AWG-350 kcmil Al or Cu
J-Frame 250A 3P, 600 Vac 50/60 Hz, 250 Vdc														
150 A	750 A	1500 A	J(J)L36150(C)	2730.00	3276.00	3779.00	4535.00	5432.00	6519.00	7086.00	8504.00	9212.00	11055.00	AL175JD 4-4/0 AWG Al or Cu
175 A	875 A	1750 A	J(J)L36175(C)	2730.00	3276.00	3779.00	4535.00	5432.00	6519.00	7086.00	8504.00	9212.00	11055.00	AL175JD 4-4/0 AWG Al or Cu
200 A	1000 A	2000 A	J(J)L36200(C)	2730.00	3276.00	3779.00	4535.00	5432.00	6519.00	7086.00	8504.00	9212.00	11055.00	AL250JD 3/0 AWG-350 kcmil Al or Cu
225 A	1125 A	2250 A	J(J)L36225(C)	2730.00	3276.00	3779.00	4535.00	5432.00	6519.00	7086.00	8504.00	9212.00	11055.00	AL250JD 3/0 AWG-350 kcmil Al or Cu
250 A	1250 A	2500 A	J(J)L36250(C)	3749.00	4499.00	5001.00	6002.00	7238.00	8685.00	8993.00	10791.00	11169.00	13402.00	AL250JD 3/0 AWG-350 kcmil Al or Cu

- ▲ See Supplemental Digest pages 3-2 and 3-4 for circuit breakers with field interchangeable trip units.
- ◆ To complete catalog number, replace the blank with the appropriate rating (D, G, J, L).
- For 100% rated circuit breakers add a "C" in the 9th character place (for example, HDL26015C or JDL26150C). 100% rated H- and J-frame circuit breakers have copper lugs and can only be used with copper wire.
- ★ Circuit breakers with J, L, and R interrupting ratings are UL certified as current limiting.

Table 7.39: H- and J-Frame Termination Options

Termination Letter	
A = I-Line (See Section 9)	
F = No Lugs (includes terminal nut kit on both ends)	
L = Lugs both ends	
M = Lugs ON end Terminal Nut Kit OFF end	
P = Lugs OFF end Terminal Nut Kit ON end	
N = Plug-in ▼	
D = Drawout ▼	
S = Rear Connected ▼	

For factory-installed termination, place termination letter in the third block of the circuit breaker catalog number.

H₁G₁L₁3,6,1,0,0

Termination Letter

▼ For N and D pricing, add termination pricing on page 7-45 to price. For S pricing, add termination pricing on page 7-41 to price.

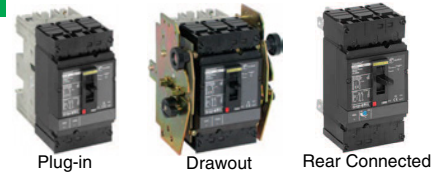

Table 7.40: H- and J-Frame Interrupting Ratings

Voltage	Interrupting Rating				
	D	G	J	L	R
240 Vac	25 kA	65 kA	100 kA	125 kA	200 kA
480 Vac	18 kA	35 kA	65 kA	100 kA	200 kA
600 Vac	14 kA	18 kA	25 kA	50 kA	100 kA

Accessories	Page 7-39
Optional Lugs	Page 7-42
Dimensions	Page 7-55
Enclosures	Page 7-56

New! Electronic Trip Version

Table 7.41: H-Frame 150 A and J-Frame 250 A Electronic Trip UL Current-Limiting▲ Circuit Breakers (600 Vac) With Factory Sealed Trip Unit■ Suitable for Reverse Connection □

Electronic Trip Unit			Sensor Rating	Cat. No. ◆	Interrupting Rating (2nd Letter of Catalog Number)										Terminal
Type	Function	Trip Unit			D		G		J▲		L▲		R▲		
					80% Rated	100% Rated	80% Rated	100% Rated	80% Rated	100% Rated	80% Rated	100% Rated	80% Rated	100% Rated	
600 Vac, 50/60 Hz, 3P															
Micrologic Standard	LI	3.2Δ	60 A	H (L36060)(C)U31X	1247.00	1455.00	1652.00	1928.00	2108.00	2460.00	3008.00	3510.00	3971.00	4633.00	AL150HD★
			100 A	H (L36100)(C)U31X	1487.00	1735.00	1860.00	2171.00	2258.00	2635.00	3308.00	3860.00	4367.00	5095.00	
Micrologic Standard	LSI	3.2SΔ	60 A	H (L36060)(C)U33X	1433.00	1641.00	1838.00	2113.00	2294.00	2646.00	3194.00	3696.00	4216.00	4879.00	AL150HD★
			100 A	H (L36100)(C)U33X	1673.00	1921.00	2046.00	2356.00	2444.00	2821.00	3494.00	4046.00	4612.00	5341.00	
Micrologic Ammeter	LSI	5.2A	60 A	H (L36060)(C)U43X	2031.00	2240.00	2436.00	2712.00	2892.00	3244.00	3792.00	4295.00	5005.00	5669.00	AL150HD★
			100 A	H (L36100)(C)U43X	2271.00	2520.00	2644.00	2955.00	3042.00	3419.00	4092.00	4645.00	5401.00	6131.00	
Micrologic Energy	LSI	5.2E	60 A	H (L36060)(C)U53X	2391.00	2599.00	2796.00	3072.00	3252.00	3604.00	4152.00	4654.00	5481.00	6143.00	AL150HD★
			100 A	H (L36100)(C)U53X	2631.00	2879.00	3004.00	3314.00	3402.00	3779.00	4452.00	5004.00	5877.00	6605.00	
Micrologic Ammeter	LSIG	6.2A	60 A	H (L36060)(C)U44X	2751.00	2960.00	3156.00	3432.00	3612.00	3964.00	4512.00	5015.00	5956.00	6620.00	AL150HD★
			100 A	H (L36100)(C)U44X	2991.00	3240.00	3364.00	3675.00	3762.00	4139.00	4812.00	5365.00	6352.00	7082.00	
Micrologic Energy	LSIG	6.2E	60 A	H (L36060)(C)U54X	3111.00	3319.00	3516.00	3792.00	3972.00	4324.00	4872.00	5374.00	6431.00	7094.00	AL150HD★
			100 A	H (L36100)(C)U54X	3351.00	3599.00	3724.00	4034.00	4122.00	4499.00	5172.00	5724.00	6827.00	7556.00	

- ▲ Circuit breakers with J, L, and R interrupting ratings are UL certified as current limiting.
- ◆ See Supplemental Digest page 3-2 for circuit breakers with field-interchangeable trip units
- ◆ For 100% rated circuit breakers, add a "C" in the 9th character place (for example, HGL36150CU31X, JGL36250CU43X)
- ★ 100% rated H- and J-frame circuit breakers have copper lugs and can only be used with copper wire.
- ★ AL150HD wire range is 14–3/0 AWG Al or Cu.
- ▲ AL250JD wire range is 3/0 AWG–350 kcmil Al or Cu. For smaller wire range (4–4/0 AWG Al or Cu), replace the lug's wire binding screws with the larger binding screws provided.
- Δ 3P circuit breakers with this trip unit can be used for 2P applications.
- For applications requiring communications see page 7-49.

Table 7.42: H- and J-Frame Termination Options

Termination Letter
A - I-Line (See Section 9)
F = No Lugs (includes terminal nut kit on both ends)
L = Lugs both ends
M = Lugs ON end Terminal Nut Kit OFF end
P = Lugs OFF end Terminal Nut Kit ON end
N = Plug-in ◆
D = Drawout ◆
S = Rear Connected ◆

For factory-installed termination, place termination letter in the third block of the circuit breaker catalog number.

H | D | L | 3 | 6 | 0 | 1 | 5 | T

Termination Letter

◆ For N and D pricing, add termination pricing on page 7-45 to price. For S pricing, add termination pricing on page 7-41 to price.



H-Frame Micrologic™ Trip Unit

Table 7.43: H- and J-Frame Interrupting Ratings

Voltage	Interrupting Rating				
	D	G	J	L	R
240 Vac	25 kA	65 kA	100 kA	125 kA	200 kA
480 Vac	18 kA	35 kA	65 kA	100 kA	200 kA
600 Vac	14 kA	18 kA	25 kA	50 kA	100 kA



J-Frame Micrologic™ Trip Unit

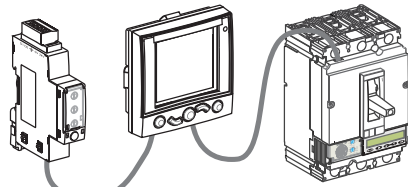

H-Frame Circuit Breaker with Optional FDM and IFM Modules

Accessories	Page 7-39
Optional Lugs	Page 7-42
Dimensions	Page 7-55
Enclosures	Page 7-56

7 MINIATURE AND MOLDED CASE CIRCUIT BREAKERS



QBL 2P
70–250 A



QBL 3P
70–250 A

Table 7.44: PowerPact Q-Frame▲250 A Thermal-Magnetic Circuit Breaker (240 Vac)

Ampere Rating	Fixed AC Magnetic Trip		Interrupting Rating								Terminal Wire Range
			B		D		G		J		
	Hold	Trip	Cat. No.	\$ Price	Cat. No.	\$ Price	Cat. No.	\$ Price	Cat. No.	\$ Price	
2P, 240 Vac											
70 A	1000 A	1800 A	QBL22070	474.00	QDL22070	1143.00	QGL22070	1521.00	QJL22070	1890.00	#4 AWG - 300 kcmil Al/Cu
80 A	1000 A	1800 A	QBL22080	474.00	QDL22080	1143.00	QGL22080	1521.00	QJL22080	1890.00	
90 A	1000 A	1800 A	QBL22090	474.00	QDL22090	1143.00	QGL22090	1521.00	QJL22090	1890.00	
100 A	1200 A	2400 A	QBL22100	474.00	QDL22100	1143.00	QGL22100	1521.00	QJL22100	1890.00	
110 A	1200 A	2400 A	QBL22110	474.00	QDL22110	1143.00	QGL22110	1521.00	QJL22110	1890.00	
125 A	1200 A	2400 A	QBL22125	474.00	QDL22125	1143.00	QGL22125	1521.00	QJL22125	1890.00	
150 A	1200 A	2400 A	QBL22150	474.00	QDL22150	1143.00	QGL22150	1521.00	QJL22150	1890.00	
175 A	1200 A	2400 A	QBL22175	474.00	QDL22175	1143.00	QGL22175	1521.00	QJL22175	1890.00	
200 A	1200 A	2400 A	QBL22200	474.00	QDL22200	1143.00	QGL22200	1521.00	QJL22200	1890.00	
225 A	1200 A	2400 A	QBL22225	474.00	QDL22225	1143.00	QGL22225	1521.00	QJL22225	1890.00	
250 A■	1200 A	2400 A	QBL22250	693.00	QDL22250	1544.00	QGL22250	1970.00	QJL22250	2348.00	
3P, 240 Vac											
70 A	1000 A	1800 A	QBL32070	1248.00	QDL32070	1784.00	QGL32070	2442.00	QJL32070	2796.00	#4 AWG - 300 kcmil Al/Cu
80 A	1000 A	1800 A	QBL32080	1248.00	QDL32080	1784.00	QGL32080	2442.00	QJL32080	2796.00	
90 A	1000 A	1800 A	QBL32090	1248.00	QDL32090	1784.00	QGL32090	2442.00	QJL32090	2796.00	
100 A	1200 A	2400 A	QBL32100	1248.00	QDL32100	1784.00	QGL32100	2442.00	QJL32100	2796.00	
110 A	1200 A	2400 A	QBL32110	1248.00	QDL32110	1784.00	QGL32110	2442.00	QJL32110	2796.00	
125 A	1200 A	2400 A	QBL32125	1248.00	QDL32125	1784.00	QGL32125	2442.00	QJL32125	2796.00	
150 A	1200 A	2400 A	QBL32150	1248.00	QDL32150	1784.00	QGL32150	2442.00	QJL32150	2796.00	
175 A	1200 A	2400 A	QBL32175	1248.00	QDL32175	1784.00	QGL32175	2442.00	QJL32175	2796.00	
200 A	1200 A	2400 A	QBL32200	1248.00	QDL32200	1784.00	QGL32200	2442.00	QJL32200	2796.00	
225 A	1200 A	2400 A	QBL32225	1248.00	QDL32225	1784.00	QGL32225	2442.00	QJL32225	2796.00	
250 A■	1200 A	2400 A	QBL32250	1812.00	QDL32250	2442.00	QGL32250	3150.00	QJL32250	3465.00	

- ▲ Replacement lugs and electrical accessories are not available for PowerPact Q-frame circuit breakers.
- 250 A requires the use of copper cables only.

Table 7.45: Q-Frame Termination Options

Termination Letter	Description
A	I-Line (See Section 9)
E	Bolt-on I-Line (See Section 9)
F	No lugs
L	Lugs both ends
M	Lugs ON end, studs on OFF end
P	Lugs OFF end, studs on ON end

For factory-installed termination, place termination letter in the third block of the circuit breaker catalog number.
Q1G1L32200

- ▼ Add TS suffix for studs on both ends without nuts and washers. See Catalog 0734CT0201 for additional information.

Table 7.46: Q-Frame Interrupting Ratings

Voltage	Interrupting Rating			
	B	D	G	J
240 Vac♦	10 kA	25 kA	65 kA	100 kA★

- ♦ Q-frame circuit breakers are 240 Vac only.
- ★ 3P QJ circuit breakers are rated at 208Y/120 Vac only.

DimensionsPage 7-55
EnclosuresPage 7-56

New!

Table 7.47: L-Frame 600 A Circuit Breakers with Lugs and Factory-Sealed Electronic Trip Units Suitable for Reverse Connection Δ*

Electronic Trip Unit			Sensor Rating	Cat. No. □	Interrupting Rating (2nd Letter of Catalog Number)								Terminal		
Type	Function	Trip Unit			D		G		J ◇		L ◇			R ◇	
					80% Rated	100% Rated	80% Rated	100% Rated	80% Rated	100% Rated	80% Rated	100% Rated		80% Rated	100% Rated
600 Vac, 50/60 Hz, 3P															
Micrologic Standard	LI	3.3★	250 A	L(L)36250(C)U31X	4827.00	5648.00	5081.00	5945.00	8478.00	9919.00	9918.00	11604.00	11406.00	13345.00	AL400L61K3▽
			400 A 600 A	L(L)36400(C)U31X L(L)36600U31X	4827.00 7109.00	5648.00	5081.00 7484.00	5945.00	8478.00 10541.00	9919.00	9918.00 11837.00	11604.00	11406.00 13613.00	13345.00	AL600LS52K3◊
Micrologic Standard	LSI	3.3S★	250 A	L(L)36250(C)U33X	5391.00	6211.00	5674.00	6538.00	9071.00	10513.00	10511.00	12198.00	12088.00	14028.00	AL400L61K3▽
			400 A 600 A	L(L)36400(C)U33X L(L)36600U33X	5391.00 7673.00	6211.00	5674.00 8077.00	6538.00	9071.00 11134.00	10513.00	10511.00 12430.00	12198.00	12088.00 14295.00	14028.00	AL600LS52K3◊
Micrologic Ammeter	LSI	5.3A	400 A 600 A	L(L)36400(C)U43X L(L)36600U43X	6253.00 8535.00	7073.00	6582.00 8984.00	7445.00	9979.00 12041.00	11420.00	11419.00 13337.00	13105.00	13132.00 15338.00	15071.00	AL600LS52K3◊
Micrologic Energy	LSI	5.3E	400 A 600 A	L(L)36400(C)U53X L(L)36600U53X	7200.00 9483.00	8021.00	7579.00 9982.00	8443.00	10976.00 13039.00	12418.00	12416.00 14335.00	14103.00	14278.00 16485.00	16218.00	
Micrologic Ammeter	LSIG	6.3A	400 A 600 A	L(L)36400(C)U44X L(L)36600U44X	8149.00 10431.00	8969.00	8578.00 10980.00	9441.00	11975.00 14037.00	13416.00	13415.00 15333.00	15101.00	15427.00 17633.00	17366.00	
Micrologic Energy	LSIG	6.3E	400 A 600 A	L(L)36400(C)U54X L(L)36600U54X	9097.00 11379.00	9917.00	9575.00 11978.00	10439.00	12972.00 15035.00	14414.00	14412.00 16331.00	16099.00	16574.00 18781.00	18514.00	
600 Vac, 50/60 Hz, 4P															
Micrologic Standard	LI	3.3	250 A	L(L)46250(C)U31X	5327.00	6233.00	5581.00	6530.00	8978.00	10501.00	10418.00	12189.00	11981.00	14017.00	
			400 A 600 A	L(L)46400(C)U31X L(L)46600U31X	6227.00 8509.00	6233.00	6481.00 8884.00	7583.00	9878.00 11941.00	11557.00	11318.00 13237.00	13242.00	13016.00 15223.00	15228.00	AL600LS52K4◊
Micrologic Standard	LSI	3.3S	250 A	L(L)46250(C)U33X	5891.00	6796.00	6174.00	7123.00	9571.00	11098.00	11011.00	12783.00	12663.00	14700.00	AL400L61K4▽
			400 A 600 A	L(L)46400(C)U33X L(L)46600U33X	6791.00 9073.00	7849.00	7074.00 9477.00	8176.00	10471.00 12534.00	12151.00	11911.00 13830.00	13836.00	13698.00 15905.00	15911.00	AL600LS52K4◊
Micrologic Ammeter	LSI	5.3A	400 A 600 A	L(L)46400(C)U43X L(L)46600U43X	7653.00 9935.00	8711.00	7982.00 10384.00	9083.00	11379.00 13441.00	13058.00	12819.00 14737.00	14743.00	14742.00 16948.00	16954.00	AL600LS52K4◊
Micrologic Energy	LSI	5.3E	400 A 600 A	L(L)46400(C)U53X L(L)46600U53X	8600.00 10883.00	9659.00	8979.00 11382.00	10081.00	12376.00 14439.00	14056.00	13816.00 15735.00	15741.00	15888.00 18095.00	18102.00	
Micrologic Ammeter	LSIG	6.3A	400 A 600 A	L(L)46400(C)U44X L(L)46600U44X	9549.00 11831.00	10607.00	9978.00 12380.00	11079.00	13375.00 15437.00	15054.00	14815.00 16733.00	16739.00	17037.00 19243.00	19250.00	
Micrologic Energy	LSIG	6.3E	400 A 600 A	L(L)46400(C)U54X L(L)46600U54X	10497.00 12779.00	11555.00	10975.00 13378.00	12077.00	14372.00 16435.00	16052.00	15812.00 17731.00	17791.00	18184.00 20391.00	20460.00	

- △ See Supplemental Digest page 3-4 for circuit breakers with field-interchangeable trip units
- For 100% rated circuit breakers (250 A and 400 A only), add a "C" in the 9th character place (for example, LGL36400CU31X)
- ◇ Circuit breakers with J, L, and R interrupting ratings are UL certified as current limiting.
- ★ 3P circuit breakers with this trip unit can be used for 2P applications.
- ▽ AL400L61K3 terminal wire ranges are (1) 2 AWG-600 kcmil Cu or 1) 2 AWG-500 kcmil Al.
- ◊ AL600LS52K3 terminal wire range is (2) 2/0 AWG-500 kcmil Al/Cu.
- * For applications requiring communications see page 7-49.



L-Frame Circuit Breaker

Table 7.48: Termination Options

Termination Letter	Termination Option
A	I-Line (See Section 9)
F	No lugs
L	Lugs both ends
M	Lugs ON end, terminal nut kit OFF end
P	Lugs OFF end, terminal nut kit ON end
N◇	Plug In
D◇	Drawout
S◇	Rear Connected

For factory-installed termination, place termination letter in the third block of the circuit breaker catalog number.

L G L 3 6 6 0 0 U 4 4 X
└ Termination Letter

- ◇ For N and D pricing, add termination pricing on page 7-45 to price. For S pricing, add termination pricing on page 7-41 to price.

Table 7.49: Interrupting Ratings

Voltage	Interrupting Rating				
	D	G	J	L	R
240 Vac	25 kA	65 kA	100 kA	125 kA	200 kA
480 Vac	18 kA	35 kA	65 kA	100 kA	200 kA
600 Vac	14 kA	18 kA	25 kA	50 kA	100 kA

Accessories	page 7-39
Optional Lugs	page 7-42
Dimensions	page 7-55
Enclosures	page 7-56

7 MINIATURE AND MOLDED CASE CIRCUIT BREAKERS



M-Frame Circuit Breaker

Table 7.50: M-Frame 800 A, Basic Electronic Trip System Type ET 1.0 Factory-Sealed Trip Unit

Electronic Trip Unit		Sensor Rating	Interrupting Rating				Terminal Wire Range (AWG/kcmil)
Type	Function		G		J		
			Cat. No.	\$ Price	Cat. No.	\$ Price	
2P, 600 Vac 50/60 Hz							
Basic	Fixed Long-time, Adjustable Instantaneous Trip	300 A	MGL26300	5960.00	MJL26300	7829.00	AL800M23K (3) 3/0–500 Al/Cu
		350 A	MGL26350	5960.00	MJL26350	7829.00	
		400 A	MGL26400	5960.00	MJL26400	7829.00	
		450 A	MGL26450	5960.00	MJL26450	7829.00	
		500 A	MGL26500	5960.00	MJL26500	7829.00	
		600 A	MGL26600	5960.00	MJL26600	7829.00	
		700 A	MGL26700	7719.00	MJL26700	9657.00	
800 A	MGL26800	7719.00	MJL26800	9657.00			
3P, 600 Vac 50/60 Hz							
Basic	Fixed Long-time, Adjustable Instantaneous Trip	300 A	MGL36300	7560.00	MJL36300	9456.00	AL800M23K (3) 3/0–500 Al/Cu
		350 A	MGL36350	7560.00	MJL36350	9456.00	
		400 A	MGL36400	7560.00	MJL36400	9456.00	
		450 A	MGL36450	7560.00	MJL36450	9456.00	
		500 A	MGL36500	7560.00	MJL36500	9456.00	
		600 A	MGL36600	7560.00	MJL36600	9456.00	
		700 A	MGL36700	9927.00	MJL36700	11882.00	
800 A	MGL36800	9927.00	MJL36800	11882.00			

o The ET 1.0 trip unit cannot be field replaced or have the long-time trip point setting adjusted. It is considered an electronic equivalent of a thermal-magnetic circuit breaker.

Table 7.51: Termination Options

Termination Letter	Termination Option
A	I-Line (See Section 9)
F	No lugs
L	Lugs both ends
M	Lugs ON end, terminal nut kit OFF end
P	Lugs OFF end, terminal nut kit ON end

For factory-installed termination, place termination letter in the third block of the circuit breaker catalog number.

M, G, L, 3, 6, 4, 0, 0

Termination Letter

Table 7.52: Frame Interrupting Ratings

Voltage	Interrupting Rating			
	D	G	J	L
240 Vac	25 kA	65 kA	100 kA	125 kA
480 Vac	18 kA	35 kA	65 kA	100 kA
600 Vac	14 kA	18 kA	25 kA	50 kA

Accessories page 7-39
 Optional Lugs page 7-42
 Dimensions page 7-55
 Enclosures page 7-56

Table 7.53: P-Frame 1200 A (600 Vac, 50/60 Hz) 3P▲ Circuit Breaker with Electronic Trip Unit

Electronic Trip Unit			Sensor Rating	Cat. No. ■ ◆	\$ Price								Terminal Wire Range
Type	Function	Trip Unit			G ■		J ■		K ■		L ■ ★		
					80% Rated	100% Rated ◆	80% Rated	100% Rated ◆	80% Rated	100% Rated ◆	80% Rated	100% Rated ◆	
Basic Electronic Trip Unit (Not Interchangeable)	Fixed long-time, Adjustable Instantaneous	ET1.0I	600 A	P (L)36060	13905.00	—	14783.00	—	14783.00	—	15660.00	—	(3) 3/0 AWG-500 kcmil Al or Cu
			800 A	P (L)36080	—	—	—	—	—	—	—	—	
Micrologic Interchangeable Standard Trip Unit	LI	3.0	250 A	P (L)36025(C)U31A	14693.00	21510.00	15570.00	22868.00	15570.00	22868.00	16448.00	24224.00	(3) 3/0 AWG-500 kcmil Al or Cu
			400 A	P (L)36040(C)U31A									
			600 A	P (L)36060(C)U31A									
			800 A	P (L)36080(C)U31A									
			1000 A	P (L)36100(C)U31A									
			1200 A	P (L)36120(C)U31A									
	LSI	5.0	250 A	P (L)36025(C)U33A	15032.00	21812.00	15909.00	23187.00	15909.00	23187.00	16787.00	24564.00	(3) 3/0 AWG-500 kcmil Al or Cu
			400 A	P (L)36040(C)U33A									
			600 A	P (L)36060(C)U33A									
			800 A	P (L)36080(C)U33A									
			1000 A	P (L)36100(C)U33A									
			1200 A	P (L)36120(C)U33A									
Micrologic Interchangeable Ammeter Trip Unit	LI	3.0A	250 A	P (L)36025(C)U41A	15543.00	22266.00	16421.00	23670.00	16421.00	23670.00	17298.00	25076.00	(3) 3/0 AWG-500 kcmil Al or Cu
			400 A	P (L)36040(C)U41A									
			600 A	P (L)36060(C)U41A									
			800 A	P (L)36080(C)U41A									
			1000 A	P (L)36100(C)U41A									
			1200 A	P (L)36120(C)U41A									
	LSI	5.0A	250 A	P (L)36025(C)U43A	17043.00	23597.00	17921.00	25085.00	17921.00	25085.00	18798.00	26574.00	(3) 3/0 AWG-500 kcmil Al or Cu
			400 A	P (L)36040(C)U43A									
			600 A	P (L)36060(C)U43A									
			800 A	P (L)36080(C)U43A									
			1000 A	P (L)36100(C)U43A									
			1200 A	P (L)36120(C)U43A									
LSIG	6.0A	250 A	P (L)36025(C)U44A	18909.00	25256.00	19787.00	26849.00	19787.00	26849.00	20664.00	28442.00	(3) 3/0 AWG-500 kcmil Al or Cu	
		400 A	P (L)36040(C)U44A										
		600 A	P (L)36060(C)U44A										
		800 A	P (L)36080(C)U44A										
		1000 A	P (L)36100(C)U44A										
		1200 A	P (L)36120(C)U44A										
Micrologic Interchangeable Power Trip Unit	LSI	5.0P	250 A	P (L)36025(C)U63AE1	21455.00	27516.00	22332.00	29252.00	22332.00	29252.00	23210.00	30986.00	(3) 3/0 AWG-500 kcmil Al or Cu
			400 A	P (L)36040(C)U63AE1									
			600 A	P (L)36060(C)U63AE1									
			800 A	P (L)36080(C)U63AE1									
			1000 A	P (L)36100(C)U63AE1									
			1200 A	P (L)36120(C)U63AE1									
	LSIG	6.0P	250 A	P (L)36025(C)U64AE1	22536.00	28476.00	23414.00	30272.00	23414.00	30272.00	24291.00	32067.00	(3) 3/0 AWG-500 kcmil Al or Cu
			400 A	P (L)36040(C)U64AE1									
			600 A	P (L)36060(C)U64AE1									
			800 A	P (L)36080(C)U64AE1									
			1000 A	P (L)36100(C)U64AE1									
			1200 A	P (L)36120(C)U64AE1									
Micrologic Interchangeable Harmonic Trip Unit	LSI	5.0H	250 A	P (L)36025(C)U73AE1	25538.00	31140.00	26415.00	33104.00	26415.00	33104.00	27291.00	35067.00	(3) 3/0 AWG-500 kcmil Al or Cu
			400 A	P (L)36040(C)U73AE1									
			600 A	P (L)36060(C)U73AE1									
			800 A	P (L)36080(C)U73AE1									
			1000 A	P (L)36100(C)U73AE1									
			1200 A	P (L)36120(C)U73AE1									
	LSIG	6.0H	250 A	P (L)36025(C)U74AE1	26619.00	32100.00	27497.00	34125.00	27497.00	34125.00	28374.00	36150.00	(3) 3/0 AWG-500 kcmil Al or Cu
			400 A	P (L)36040(C)U74AE1									
			600 A	P (L)36060(C)U74AE1									
			800 A	P (L)36080(C)U74AE1									
			1000 A	P (L)36100(C)U74AE1									
			1200 A	P (L)36120(C)U74AE1									

- ▲ For 2P and 4P information see Catalog 0612CT0101.
- To complete the catalog number, replace the () with the appropriate interrupting rating (G, J, K or L).
- ◆ For 100% rated circuit breakers add a "C" in the 9th character place. For example, the catalog number for a 100% trip unit with LI trip functions at 250A would be PGL36025C U31A.
- ★ For all L interrupting rating, change the 5th character (voltage rating) from a 6 (600V) to a 4 (480V); for example, PLL34025U31A. The 480V AIR is standard 100 kA.

Table 7.54: P-Frame Termination Options

Termination Letter	
F = No Lugs (Includes terminal nut kit on both ends)	For factory-installed termination, place termination letter in the third block of the circuit breaker catalog number.
L = Lugs both ends	
M = Lugs ON end, terminal nut kit OFF end	
P = Lugs OFF end, terminal nut kit ON end	
D = Drawout▲	
A = I-Line (See Section 9)	

P G L 3 6 0 4 0 U 4 1 A
L Termination Letter

▲ For D pricing add termination pricing on page 7-45.

Table 7.55: P-Frame and R-Frame Interrupting Ratings

Voltage	P-Frame Interrupting Rating				R-Frame Interrupting Rating			
	G	J	K	L	G	J	K	L
240 Vac	65 kA	100 kA	65 kA	125 kA	65 kA	100 kA	65 kA	125 kA
480 Vac	35 kA	65 kA	50 kA	100 kA	35 kA	65 kA	65 kA	100 kA
600 Vac	18 kA	25 kA	50 kA	25 kA	18 kA	25 kA	65 kA	50 kA

R-frame catalog numbers and pricing Page 7-28
Dimensions Page 7-55
Trip Unit Options Page 7-47
Optional Lugs Page 7-42
Alternate Rating Plugs Page 7-48
Enclosure Page 7-56
Accessories Page 7-39

7 MINIATURE AND MOLDED CASE CIRCUIT BREAKERS

Table 7.56: R-Frame 3000 A (600 Vac, 50/60 Hz) 3P▲ Circuit Breaker with Electronic Trip Unit

Electronic Trip Unit			Sensor Rating	Cat. No.◆	\$ Price							
Type	Function	Trip Unit			G▲		J▲		K▲		L▲	
					80% Rated	100% Rated	80% Rated	100% Rated	80% Rated	100% Rated	80% Rated	100% Rated
Basic Electronic Trip Unit (Not Interchangeable)	Fixed long-time, Adjustable Instantaneous	ET1.0I	1200 A	R()F36120		—		—		—		—
			1600 A	R()F36160	22373.00	—		23549.00		23549.00		24723.00
			2000 A	R()F36200		—		—		—		—
			2500 A	R()F36250	35639.00	—		37512.00		37512.00		39383.00
Micrologic Interchangeable Standard Trip Unit	LI	3.0	600 A	R()F36060(C)U31A	23160.00	27759.00	24336.00	29301.00	24336.00	29301.00	25511.00	30843.00
			800 A	R()F36080(C)U31A								
			1000 A	R()F36100(C)U31A								
			1200 A	R()F36120(C)U31A								
			1600 A	R()F36160(C)U31A								
			2000 A	R()F36200(C)U31A								
	2500 A	R()F36250(C)U31A	36426.00	57075.00	38300.00	60248.00	38300.00	60248.00	40170.00	63417.00		
	3000 A	R()F36300(C)U31A	54027.00	62451.00	57236.00	65738.00	57236.00	65738.00	60246.00	69024.00		
	LSI	5.0	600 A	R()F36060(C)U33A	23501.00	28065.00	24675.00	29624.00	24675.00	29624.00	25851.00	31184.00
			800 A	R()F36080(C)U33A								
			1000 A	R()F36100(C)U33A								
			1200 A	R()F36120(C)U33A								
1600 A			R()F36160(C)U33A									
2000 A			R()F36200(C)U33A									
2500 A	R()F36250(C)U33A	36767.00	57383.00	38640.00	60570.00	38640.00	60570.00	40511.00	63758.00			
3000 A	R()F36300(C)U33A	54513.00	62757.00	57542.00	66060.00	57542.00	66060.00	60570.00	69363.00			
Micrologic Interchangeable Ammeter Trip Unit	LI	3.0A	600 A	R()F36060(C)U41A	24012.00	28493.00	25188.00	30075.00	25188.00	30075.00	26363.00	31658.00
			800 A	R()F36080(C)U41A								
			1000 A	R()F36100(C)U41A								
			1200 A	R()F36120(C)U41A								
			1600 A	R()F36160(C)U41A								
			2000 A	R()F36200(C)U41A								
	2500 A	R()F36250(C)U41A	37278.00	57809.00	39152.00	61020.00	39152.00	61020.00	41022.00	64232.00		
	3000 A	R()F36300(C)U41A	54918.00	63185.00	57969.00	66510.00	57969.00	66510.00	61020.00	69836.00		
	LSI	5.0A	600 A	R()F36060(C)U43A	25511.00	29874.00	26685.00	31533.00	26685.00	31533.00	27860.00	33194.00
			800 A	R()F36080(C)U43A								
			1000 A	R()F36100(C)U43A								
			1200 A	R()F36120(C)U43A								
1600 A			R()F36160(C)U43A									
2000 A			R()F36200(C)U43A									
2500 A	R()F36250(C)U43A	38777.00	59190.00	40649.00	62478.00	40649.00	62478.00	42521.00	65768.00			
3000 A	R()F36300(C)U43A	56231.00	64569.00	59354.00	67968.00	59354.00	67968.00	62480.00	71367.00			
LSIG	6.0A	600 A	R()F36060(C)U44A	27378.00	31556.00	28553.00	33308.00	28553.00	33308.00	29729.00	35061.00	
		800 A	R()F36080(C)U44A									
		1000 A	R()F36100(C)U44A									
		1200 A	R()F36120(C)U44A									
		1600 A	R()F36160(C)U44A									
		2000 A	R()F36200(C)U44A									
2500 A	R()F36250(C)U44A	40644.00	60870.00	43368.00	64253.00	43368.00	64253.00	44388.00	67635.00			
3000 A	R()F36300(C)U44A	57827.00	66255.00	60965.00	69743.00	60965.00	69743.00	64254.00	73230.00			
Micrologic Interchangeable Power Trip Unit	LSI	5.0P	600 A	R()F36060(C)U63AE1	29922.00	33845.00	31097.00	35724.00	31097.00	35724.00	32273.00	37605.00
			800 A	R()F36080(C)U63AE1								
			1000 A	R()F36100(C)U63AE1								
			1200 A	R()F36120(C)U63AE1								
			1600 A	R()F36160(C)U63AE1								
			2000 A	R()F36200(C)U63AE1								
	2500 A	R()F36250(C)U63AE1	43188.00	63161.00	45062.00	66671.00	45062.00	66671.00	46932.00	70179.00		
	3000 A	R()F36300(C)U63AE1	60003.00	68553.00	63338.00	72161.00	63338.00	72161.00	66671.00	75858.00		
	LSIG	6.0P	600 A	R()F36060(C)U64AE1	31004.00	34818.00	32180.00	36753.00	32180.00	36753.00	33354.00	38687.00
			800 A	R()F36080(C)U64AE1								
			1000 A	R()F36100(C)U64AE1								
			1200 A	R()F36120(C)U64AE1								
1600 A			R()F36160(C)U64AE1									
2000 A			R()F36200(C)U64AE1									
2500 A	R()F36250(C)U64AE1	44270.00	64136.00	46143.00	67698.00	46143.00	67698.00	48014.00	71261.00			
3000 A	R()F36300(C)U64AE1	60929.00	69528.00	64313.00	73188.00	64313.00	73188.00	67698.00	76848.00			
Micrologic Interchangeable Harmonic Trip Unit	LSI	5.0H	600 A	R()F36060(C)U73AE1	34005.00	37518.00	35180.00	39603.00	35180.00	39603.00	36354.00	41687.00
			800 A	R()F36080(C)U73AE1								
			1000 A	R()F36100(C)U73AE1								
			1200 A	R()F36120(C)U73AE1								
			1600 A	R()F36160(C)U73AE1								
			2000 A	R()F36200(C)U73AE1								
	2500 A	R()F36250(C)U73AE1	47271.00	66836.00	49143.00	70548.00	49143.00	70548.00	51015.00	74262.00		
	3000 A	R()F36300(C)U73AE1	63494.00	72236.00	67020.00	76038.00	67020.00	76038.00	70550.00	79841.00		
	LSIG	6.0H	600 A	R()F36060(C)U74AE1	35087.00	38493.00	36261.00	40631.00	36261.00	40631.00	37436.00	42770.00
			800 A	R()F36080(C)U74AE1								
			1000 A	R()F36100(C)U74AE1								
			1200 A	R()F36120(C)U74AE1								
1600 A			R()F36160(C)U74AE1									
2000 A			R()F36200(C)U74AE1									
2500 A	R()F36250(C)U74AE1	48353.00	67809.00	50225.00	71576.00	50225.00	71576.00	52097.00	75344.00			
3000 A	R()F36300(C)U74AE1	64419.00	73212.00	67997.00	77066.00	67997.00	77066.00	71577.00	80919.00			

Note: R-frame circuit breakers can be bus- or cable-connected. For cable connections, optional terminal pad kit RLTB or equivalent bus structure is required. Each RLTB kit contains terminal pads for one end of the circuit breaker only and has provisions for mounting a maximum of 8 lugs per phase (9 lugs for 3000 A). RLTB kits are included with 2500 A 100% rated circuit breakers. The RL3TB kits are included with the 3000 A, 80% and 100% rated circuit breakers. For other circuit breakers, order terminal pad kit (RLTB) and optional lugs separately. See pages 7-42-7-44.

- ▲ For 2P and 4P information see Catalog 0612CT0101.
- To complete the catalog number, replace the blank () with the appropriate interrupting rating (G, J, K or L).
- ◆ Listed catalog numbers are for 80% rated circuit breakers. For 100% rated circuit breakers add a "C" in the 9th character place. For example, the catalog number for a 100% standard trip unit with LI trip functions at 2500A would be RGF36250CJ31A.
- ★ See page 7-27 for interrupting ratings table.

7 MINIATURE AND MOLDED CASE CIRCUIT BREAKERS

PowerPact H- and J-frame electronic Motor Circuit Protectors (MCP) are magnetic-only instantaneous-trip circuit breakers. They are designed to offer short circuit protection and are National Electrical Code (NEC) compliant when installed as part of a combination controller having motor overload protection. MCP circuit breakers accept the same accessories and terminals as the equivalent thermal-magnetic circuit breakers.

Determine the hp rating from the nameplate of the motor. Select a MCP with an ampere rating recommended for the hp and voltage involved. When using the automatic settings the MCP microprocessor automatically adjusts the trip settings for both current and time to align with the start-up characteristic for the motor type, whether it is a standard or energy-efficient motor. This includes a dampening means to accommodate a transient motor in-rush current without nuisance tripping of the circuit breaker.

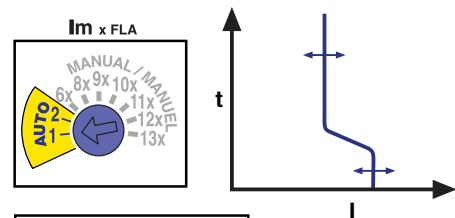
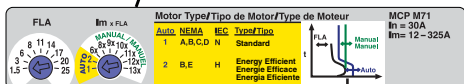
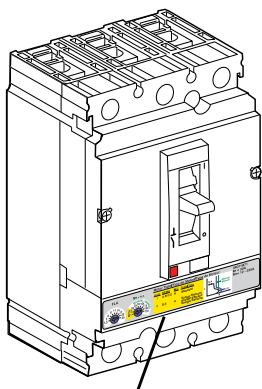

Motor Type / Tipo de Motor / Type de Moteur			
Auto	NEMA	IEC	Type/Typo
1	A,B,C,D	N	Standard
2	B,E	H	Energy Efficient Energie Efficace Energia Efficiente

Table 7.57: H- and J-Frame Electronic Motor Circuit Protectors (MCP)

Frame	Sensor Rating	Full Load Amperes Range	Adjustable Instantaneous Trip Range	Suffix	Interrupting Rating			
					J (See SCCR Table Below)		L (See SCCR Table Below)	
					Cat. No.	\$ Price	Cat. No.	\$ Price
H-Frame	30 A	1.5–25 A	9–325 A	M71	HJL36030M71	1089.00	HLL36030M71	1223.00
	50 A	14–42 A	84–546 A	M72	HJL36050M72	1385.00	HLL36050M72	1553.00
	100 A	30–80 A	180–1040 A	M73	HJL36100M73	1646.00	HLL36100M73	1827.00
	150 A	58–130 A	348–1690 A	M74	HJL36150M74	2069.00	HLL36150M74	2306.00
J-Frame	250 A	114–217 A	684–2500 A	M75	JJL36250M75	2393.00	JLL36250M75	2673.00

Table 7.58: Maximum Rating or Setting of Motor Protective Devices▲

Type of Motor		Percentage of Full-load Current	
		Setting	Not to Exceed■
A, B, C, D	Standard	800%	1300%
B, E	Energy Efficient	1100%	1700%

- ▲ Based on 2005 NEC Table 430.52.
- See NEC Exception No. 1 to Table 430.52. The NEC 1300% maximum setting may be inadequate for instantaneous trip circuit breakers to withstand current surges typical of the magnetization current of autotransformer type reduced voltage starters, or open transition wye-delta starters during transfer from "start" to "run," constant hp multi-speed motors, and motors labeled "high efficiency."

Table 7.59: MCP Selection by HP Ratings♦ of Induction-type Squirrel-Cage and Wound-rotor Motors★

3Ø 60 Hz Voltages ▼				Full-Load Amperes	Suffix
200 Vac	230 Vac	460 Vac	575 Vac		
.5–5	.5–7.5	.75–15	1–20	1.5–25	M71
5–10	5–15	10–30	15–40	14–42	M72
10–25	15–30	25–60	30–75	30–80	M73
20–40	25–50	50–100	60–125	58–130	M74
40–60	50–75	100–150	125–200	114–217	M75

- ♦ Based on 2005 NEC Table 430.250.
- ★ Per NEC 430.3, part-winding motors should select two circuit breakers, each at not more than one-half the allowable trip setting for the horsepower rating. The two circuit breakers should operate simultaneously as a disconnecting means per NEC 430.103.
- ▼ Listed voltages are rated motor voltages. Corresponding system voltages are 200 Vac, 220–240 Vac, 440–480 Vac and 550–600 Vac. Select wire and circuit breakers based on horsepower rather than nameplate full-load current per NEC 430.6 (A) for general motor applications.

Short Circuit Current Rating (SCCR)

Tested to meet NEC and UL508A requirements for short circuit current ratings as part of an approved combination controller.

Table 7.60: Short Circuit Current Ratings (SCCR)

Contactor/Starter	Interrupting Rating					
	J			L		
	200–240 Vac	480 Vac	600 Vac	200–240 Vac	480 Vac	600 Vac
Tesys D-line and F-line	100 kA	65 kA	25 kA	125 kA	100 kA	50 kA
NEMA Type S	100 kA	65 kA	25 kA	125 kA	100 kA	50 kA

See www.us.schneider-electric.us for specific ratings and combination ID numbers.

AccessoriesPage 7-39
Optional LugsPage 7-42
DimensionsPage 7-55
EnclosuresPage 7-56

To select combination starters and motor controllers using MCP's meeting NEC Article 430, refer to pages 16-35—16-37.

7 MINIATURE AND MOLDED CASE CIRCUIT BREAKERS



Motor Circuit Protector



Motor Protector Circuit Breaker

Motor Circuit Protectors

Mag-Gard™ Motor Circuit Protectors (MCP) are instantaneous-trip magnetic-only circuit breakers. They have a single adjustment which simultaneously sets the magnetic trip level of each individual pole. Mag-Gard™ circuit breakers comply with NEC requirements for providing motor circuit protection when installed as part of a UL Listed combination controller having motor overload protection. Interrupting ratings are established for these UL Recognized Components only when they are used in combination with motor starters with properly sized overload relays and contactors.

All Mag-Gard circuit breakers will accept the same lugs and accessories as equivalent circuit breakers. Mag-Gard circuit breakers are available with I-Line construction. ☆ High-interruption (H) construction Mag-Gard circuit breakers (LHL) are also available.

Table 7.62: Magnetic Only 3 Pole, 600 Vac, 50/60 Hz☆—Three Device Solutions□

Ampere Rating	Trip Unit	Adjustable Δ Trip Range (A)	24 Vdc Multiplier	Cat. No.	\$ Price
LAL	400	500–1000 A	High = 1.2 Low = 1.4	LAL3640022M	4619.00
		750–1600 A		LAL3640028M	4619.00
		1000–2000 A		LAL3640030M	4619.00
		1125–2250 A		LAL3640031M	4619.00
		1250–2500 A		LAL3640032M	4619.00
		1500–3000 A		LAL3640033M	4619.00
		1750–3500 A		LAL3640035M	4619.00
		2000–4000 A		LAL3640036M	4619.00

For PowerPact L- and P-Frames, an instantaneous-only version of the electronic trip circuit breaker is also available for motor circuit protection. These MCPs comply with NEC® requirements for providing short-circuit protection when installed as part of a Listed combination controller having motor overload protection.

Table 7.63: Magnetic Only 3 Pole, 600 Vac, 50/60 Hz☆—Three Device Solutions□

Sensor Rating	Trip Unit	Adjustable Δ Trip Range (A)	Interrupting Rating								
			G		J		L		R		
			Cat. No.	\$ Price	Cat. No.	\$ Price	Cat. No.	\$ Price	Cat. No.	\$ Price	
PowerPact L-Frame☆	400	1.3 M	500–1200%	LGL36400M37X	4619.00	LJL36400M37X	4727.00	LLL36400M37X	5007.00	LRL36400M37X	5307.00
	600		500–1200%	LGL36600M37X	6790.00	LJL36600M37X	6949.00	LLL36600M37X	7360.00	LRL36600M37X	7802.00
PowerPact P.JL, PLL☆	600	1.3 M	1200–10000 A	—	—	PJL36060M68	7560.00	PLL34060M68	8006.00	—	—
	800		1200–10000 A	—	—	PJL36080M68	9927.00	PLL34080M68	10514.00	—	—
	1000		1500–10000 A	—	—	PJL36100M69	12705.00	PLL34100M69	13455.00	—	—
	1200		1800–10000 A	—	—	PJL36120M70	16517.00	PLL34120M70	17492.00	—	—

- △ UL magnetic trip tolerances are -20%/+30% from the nominal values shown.
- Three-device solutions are the traditional solutions: motor circuit protector plus motor starter plus overload relay.
- ◇ 250 Vdc ratings are available. No UL component recognition
- ☆ These electronic magnetic only motor circuit protectors are available with I-Line constructions. Consult the factory.

Motor Protector Circuit Breakers

New! Motor protection circuit breakers provide built-in thermal and magnetic protection. They are used in two-device motor feeder solutions to provide protection against short-circuits, overloads, and phase unbalance.

Table 7.64: H-Frame (150 A), J-Frame (250 A) and L-Frame (600 A) Electronic Motor Protector Circuit Breakers (UL Ratings)—Two Device Solutions▽

Electronic Trip Unit Type	Frame	Sensor Rating	Trip Unit	Full Load Amperes Range (FLA)	Isd (x FLA)	Interrupting Rating								
						G		J		L		R		
						Cat. No.	\$ Price	Cat. No.	\$ Price	Cat. No.	\$ Price	Cat. No.	\$ Price	
Standard	H-Frame	30	2.2 M	14–25	5-13 x FLA	HGL36030M38X	1608.00	HJL36030M38X	1658.00	HLL36030M38X	1812.00	HRL36030M38X	1993.00	
				14–42	5-13 x FLA	HGL36050M38X	1938.00	HJL36050M38X	1998.00	HLL36050M38X	2191.00	HRL36050M38X	2410.00	
				30–80	5-13 x FLA	HGL36100M38X	2229.00	HJL36100M38X	2298.00	HLL36100M38X	2506.00	HRL36100M38X	2757.00	
				58–130	5-13 x FLA	HGL36150M38X	2701.00	HJL36150M38X	2785.00	HLL36150M38X	3057.00	HRL36150M38X	3363.00	
	J-Frame	250	2.3 M	114–217	5-13 x FLA	JGL36250M38X	3105.00	JJL36250M38X	3201.00	JLL36250M38X	3523.00	JRL36250M38X	3875.00	
				L-Frame	600	190–348	5-13 x FLA	LGL36400M38X	6041.00	LJL36400M38X	6160.00	LLL36400M38X	6468.00	LRL36400M38X
							312–520	5-13 x FLA	LGL36600M38X	8429.00	LJL36600M38X	8604.00	LLL36600M38X	9156.00

- ▽ Two-device solutions (these electronic motor protector circuit breakers include short circuit and overload protection)
 - 1 electronic motor circuit protector with a Micrologic 2.2 M plus
 - 1 contactor
- The standard trip unit offers Class 5, 10 and 20 and phase unbalance or phase loss protection.

Accessories Page 7-39 and Supplemental Digest Pages 3-24–3-31
 Optional Lugs Page 7-42 and Supplemental Digest Pages 3-29–3-30
 Dimensions Pages 7-54 and 7-55
 Enclosures Page 7-56

To select combination starters and motor controllers using MCP's meeting NEC Article 430, refer to pages 16-35—16-37.

7 MINIATURE AND MOLDED CASE CIRCUIT BREAKERS



Adjustable instantaneous-trip circuit breakers are intended for use in combination with motor starters with overload relays for the protection of motor circuits from short circuits. Other specific applications include rectifiers and resistance welders. These circuit breakers contain a magnetic trip element in each pole with the trip point adjustable from the front. Interrupting ratings are determined by testing the instantaneous-trip circuit breakers in combination with a contactor and overload relay.

Select instantaneous-trip circuit breakers as follows:

This selection table is suitable for motors, other than NEMA Design E, with locked-rotor indicating code letters per NEC® Table 430.7 (b) as follows:

Table 7.65: Locked-Rotor Indicating Codes

Horsepower	Motor Code letter
1/2 or less	A-L
3/4 to 1-1/2	A-K
2 to 3	A-J
5 to 25	A-H
30 to 125	A-G
150 or more	A-F

- For other motors order a special thermal-magnetic circuit breaker with magnetic trip settings for the specific motor—specify motor horsepower, voltage, frequency, full-load current and code letter or locked rotor current.
- Determine motor hp rating from the motor nameplate.
- Refer to the tables and select an instantaneous-trip circuit breaker with an ampere rating recommended for the hp and voltage involved.
- Select an adjustable trip setting of at least 800%, not to exceed 1300%, of the motor full-load amperes (FLA) for other than Design E motors. For Design E motors, select an adjustable trip setting of at least 1100% not to exceed 1700% of FLA.
- The NEC 1300% maximum setting may be inadequate for instantaneous-trip circuit breakers to withstand current surges typical of the magnetization current of autotransformer type reduced voltage starters, or open transition wye-delta starters during transfer from “start” to “run,” constant hp multi-speed motors, and motors labeled “high efficiency.” Select thermal-magnetic circuit breakers from page 7-33 for those applications.
- Part-winding motors, per NEC 430.3, should have two circuit breakers selected from the above at not more than one half the allowable trip setting for the horsepower rating. The two circuit breakers should operate simultaneously as a disconnecting means per NEC 430.103.
- Based on NEC 430.52 and NEC Table 430.150. See page 7-31 for available Adjustable Instantaneous-Trip Circuit Breakers.

Table 7.66: PowerPact H-Frame and L-Frame Motor Protector Circuit Breaker

Hp Ratings of Induction Type Squirrel-Cage and Wound Rotor Motors				Full Load Amperes▲	PowerPact Family Motor Protector Circuit Breaker Cat. No.■	Magnetic Trip Settings♦	
3Ø 60 Hz						MIN	MAX
200 Vac	230 Vac	460 Vac	575 Vac				
5	5	10	15	14 15.2 17 17.5	H(L)J36030M38X H(L)J36030M38X H(L)J36030M38X	500%	1300%
		15	20	21 22 25.3	H(L)J36030M38X H(L)J36030M38X H(L)J36030M38X		
			25	27	H(L)J36050M38X		
10	7-1/2	10	30	28 32 32.2 34	H(L)J36050M38X H(L)J36050M38X H(L)J36050M38X H(L)J36050M38X	500%	1300%
			15	40	40 41 42 48.3		
		20		50	52 54 62 65		
75	10	200	250	221 240 242 248	L(L)J36400M38X L(L)J36400M38X L(L)J36400M38X L(L)J36400M38X	500%	1300%
			300	285 289 302 312	L(L)J36400M38X L(L)J36400M38X L(L)J36400M38X L(L)J36400M38X		
				350	336 359 360 361		
150	15	300	400	382 414 472 477 480	L(L)J36600M38X L(L)J36600M38X L(L)J36600M38X L(L)J36600M38X L(L)J36600M38X	500%	1300%
			500				
				200			

Table 7.67: LAL Adjustable Instantaneous-Trip Circuit Breakers for Single Motor Circuit Protection

Hp Ratings of Induction Type Squirrel-Cage and Wound Rotor Motors				Full Load Amperes▲	Mag-Gard Circuit Breaker Cat. No.	Magnetic Trip Settings♦	
3Ø 60 Hz						MIN	MAX
200 Vac	230 Vac	460 Vac	575 Vac				
75	5	100	250	221 240 242 248	LAL3640033M LAL3640035M LAL3640035M LAL3640035M	700%	1400%
			300	285 289 302 312	LAL3640036M LAL3640036M LAL3640036M LAL3640036M	700%	1400%
		125				600%	1300%

- ▲ Motor full-load currents are taken from NEC Table 430.150. Select wire and circuit breakers on basis of horsepower rather than nameplate full-load current per NEC 430.6 (A) for general motor applications. Do not use these values to select overload relay thermal units. See Digest pages 14-129–14-152 for selection of thermal units when actual full load current is not known. The voltages listed are rated motor voltages. Corresponding nominal system voltages are 200–208, 220–240, 440–480 and 550–600 V.
- To complete catalog number, replace the blank with the appropriate rating (G, J, or L). M38X is for standard trip units. For advanced trip units (LCD display, metering and communication, replace with M58X).
- ♦ Only MIN and MAX settings are shown, intermediate settings are available on all circuit breakers.
- ★ See NEC 430.52(A) for circuit breaker settings above 800%.
- ▼ If due to motor starting characteristics, trip settings at the 1300% maximum permitted level are needed, the next size Mag-Gard circuit breaker should be chosen.

7 MINIATURE AND MOLDED CASE CIRCUIT BREAKERS



Table 7.68: Selection Tables for Conductors, Safety Switches and Thermal-Magnetic Circuit Breakers Based on 2005 NEC® Tables 430.147, 430.148 & 430.150

Horsepower Ratings										Full Load Amperage Δ	Amperage of Thermal-Magnetic \diamond Inverse Time Circuit Breaker			QMB and Heavy Duty Switch with Time Delay Fuses \square	Minimum Size metallic Conduit 75° C, C Wire Field-Installed Sized for 125% FLA ∇			
Squirrel-Cage and Wound-Rotor Motors with Norm. Torque Characteristics Operating at usual Speeds				1 ϕ 10 Hz ac		Average Direct Current Motors Operating at Base Speed		For Motor Code Letter B to E			For Motor Code Letter F to V \star	AWG kcmil	Conduit 3 W					
3 ϕ 60 Hz				200 Vac	230 Vac	460 Vac	575 Vac	115 Vac	200 Vac				230 Vac		120 Vdc	240 Vdc	Ordinary Service \dagger	Heavy Service and Energy Efficient \star
200 Vac	230 Vac	460 Vac	575 Vac	115 Vac	200 Vac	230 Vac	575 Vac	115 Vac	200 Vac		230 Vac	120 Vdc	240 Vdc		Ordinary Service \dagger	Heavy Service and Energy Efficient \star	THHN THWN XHHW	THW
2		5		1/3		3/4		3.4					15 A	20 A				
			7-1/2		1				1				20 A	25 A	14	1/2 in.	N/A	
3	3			1/2		1-1/2							20 A	25 A				
		7-1/2	10		1-1/2	2			1-1/2	3			25 A	35 A				
5	5			1		3		2					30 A	35 A				
			15		3					5			35 A	40 A	12	1/2 in.	N/A	
	7-1/2	15		1-1/2									40 A	45 A				
				2					3				45 A	50 A				
7-1/2													50 A	60 A	10	1/2 in.	N/A	
	10	20	25		5				7-1/2				60 A	70 A				
			30							10			60 A	80 A				
10		25		3									80 A	90 A	60 A	8	1/2 in. \blacktriangle	N/A
					7-1/2					5			80 A	100 A				
													90 A	110 A				
15				7-1/2									90 A	125 A	6	3/4 in.	1 in.	
	20	40	50		10								110 A	150 A				
				5									125 A	175 A				
									7-1/2	15			150 A	200 A				
20		60											175 A	250 A				
	25	50								10			200 A	300 A				
													225 A	400 A				
25		75		7-1/2									250 A	500 A				
	30	60	75							25			300 A	600 A				
													350 A	700 A				
30		100											400 A	800 A				
													450 A	900 A				
													500 A	1000 A				
	40	75	100	10									600 A	1200 A				
													700 A	1400 A				
													800 A	1600 A				
													900 A	1800 A				
													1000 A	2000 A				
													1100 A	2200 A				
													1200 A	2400 A				
													1300 A	2600 A				
													1400 A	2800 A				
													1500 A	3000 A				
													1600 A	3200 A				
													1700 A	3400 A				
													1800 A	3600 A				
													1900 A	3800 A				
													2000 A	4000 A				
													2100 A	4200 A				
													2200 A	4400 A				
													2300 A	4600 A				
													2400 A	4800 A				
													2500 A	5000 A				
													2600 A	5200 A				
													2700 A	5400 A				
													2800 A	5600 A				
													2900 A	5800 A				
													3000 A	6000 A				
													3100 A	6200 A				
													3200 A	6400 A				
													3300 A	6600 A				
													3400 A	6800 A				
													3500 A	7000 A				
													3600 A	7200 A				
													3700 A	7400 A				
													3800 A	7600 A				
													3900 A	7800 A				
													4000 A	8000 A				
													4100 A	8200 A				
													4200 A	8400 A				
													4300 A	8600 A				
													4400 A	8800 A				
													4500 A	9000 A				
													4600 A	9200 A				
													4700 A	9400 A				
													4800 A	9600 A				
													4900 A	9800 A				
													5000 A	10000 A				
													5100 A	10200 A				
													5200 A	10400 A				
													5300 A	10600 A				
													5400 A	10800 A				
													5500 A	11000 A				
													5600 A	11200 A				
													5700 A	11400 A				
													5800 A	11600 A				
													5900 A	11800 A				
													6000 A	12000 A				
													6100 A	12200 A				
													6200 A	12400 A				

▲ 8 XHHW requires 3/4 in. conduit for 3W.
 ■ 200 V motors are commonly used on 208 V services.
 ◆ Ordinary service for normal starting duty only, acceleration time of 10 sec. or less.
 ★ Heavy service is jogging or plugging duty or cycling load with over 25 starts per hour or over 5 starts per minute. Energy efficient motors are polyphase motors defined in NEMA Standard MG1 and exhibit high starting current.
 ▼ NEC 430.22 for Single Motor, Smaller conductors may be permitted for light duty-cycle service per 430.22 (B) Exception No. 1. DC motors operating from rectified 1 ϕ power supply will require larger conductors per 430.22 (A) Exception No. 1. For motor-generator arc welders, see 630.11.
 Δ Motor full load currents thru 200 hp are taken from NEC Tables 430.147, 148 and 150. Above 200 hp from UL 98. Select wire size, circuit breakers, or fuses on basis of hp rather than nameplate full load current per NEC 430.6. Do not use these values to select overload relay thermal units. See Digest pages 16-129—16-152 for selection of thermal units when actual full load current is not known. Voltages listed are rated motor voltages. Corresponding nominal system voltages are 110–120 V, 200–208 V, 220–240 V, 440–480 V and 550–600 V.
 □ Switch size only is shown in table. Selected fuses should not exceed maximum percent of full-load current as given in NEC Table 430.52. Above 50 hp dc switches are not hp rated by UL as Motor Circuit Switches, but as General Use Switches only and are not necessarily capable of interrupting the max. operating overload current of a motor. See NEC 100 for definition of General Use Switch. When protecting a 3 ϕ , Design E energy efficient motor, the switch is required by NEC 430.109 to have a hp rating of not less than 1.4 times that of a motor rated 3–100 hp, or not less than 1.3 times that of a motor rated over 100 hp. Switches shown in this table do not necessarily comply with that requirement.
 ◇ Thermal-magnetic circuit breaker ampere ratings recommended are approximate for average conditions, based on trip characteristics of Square D circuit breakers and NEC Table 430.52. Under some conditions, the next size larger switch or circuit breaker rating may be necessary to accommodate the motor starting current and is permitted by NEC 430.52(C)(1) Exception 2. High starting currents are anticipated with Design E and other energy efficient motors. For explanation of Code letter markings, see NEC 430.7(B). For Busway Plug-in units, see page 9-7.
 ★ Thermal-magnetic breaker ampere ratings recommended are approximate for average conditions and based on trip characteristics of Square D circuit breakers and NEC Tables 430.7(B) and 430.52.
 ▼ Type LC, LI, LX, LXI, and LE circuit breakers are NOT recommended for use on single motor branch circuits.

Contact your local Field Office for circuit breaker selection on constant horsepower multi-speed motors.

7 MINIATURE AND MOLDED CASE CIRCUIT BREAKERS

Automatic molded case switches open instantaneously at a factory preset magnetic trip point, calibrated to protect only the molded case switch itself, when it is subjected to high fault currents. The trip point is nonadjustable and provides no overload or low level fault protection.



J-Frame Switch L-Frame Switch

Molded case switches open when the handle is switched to the OFF position or in response to an auxiliary tripping device such as a shunt trip.

All molded case switches will accept the same lugs and accessories as equivalent thermal-magnetic circuit breakers, with the exception of Q-frame switches which do not have electrical accessories available.

Automatic molded case switches are UL Listed per UL 489 and are CSA Certified.

Table 7.69: H-Frame, J-Frame, and L-Frame PowerPact™ Automatic Molded Case Switches, 600 Vac

Circuit Breaker	Poles	Ampere Rating	G Withstand			L Withstand			R Withstand			Terminal	Wire Range
			Cat. No.	\$ Price	Trip Point	Cat. No.	\$ Price	Trip Point	Cat. No.	\$ Price	Trip Point		
New! H-Frame J-Frame	2	150 A	HGL26000S15▲	1349.00	2250A	HLL26000S15	1590.00	2250 A	—	—	—	AL150HD	14 AWG–3/0 AWG Al/Cu
		175 A	JGL26000S17	1827.00	3125 A	JLL26000S17	1980.00	3125 A	—	—	—	AL175JD	4–4/0 AWG Al/Cu
		250 A	JGL26000S25	1827.00	3125 A	JLL26000S25	1980.00	3125 A	—	—	—	AL250JD	3/0 AWG–350 kcmil Al/Cu
	3	150 A	HGL36000S15	1799.00	2250 A	HLL36000S15	1988.00	2250 A	—	—	—	AL150HD	14 AWG–3/0 AWG Al/Cu
		175 A	JGL36000S17	2286.00	3125 A	JLL36000S17	2475.00	3125 A	JRL36000S17	2673.00	3125 A	AL175JD	4–4/0 AWG Al/Cu
		250 A	JGL36000S25	2286.00	3125 A	JLL36000S25	2475.00	3125 A	JRL36000S25	2673.00	3125 A	AL250JD	3/0 AWG–350 kcmil Al/Cu
L-Frame	3	400 A	LGL36000S40X	4572.00	4800 A	LLL36000S40X	4972.00	4800 A	LRL36000S40X	5370.00	4800 A	AL150HD	AL600LS52K3
		600 A	LGL36000S60X	5065.00	6600A	LLL36000S60X	5465.00	6600 A	LRL36000S60X	5902.00	6600 A	AL250JD	(2) 2/0 AWG–500 kcmil Al/Cu
	4	400 A	LGL46000S40X	5972.00	4800 A	LLL46000S40X	6372.00	4800 A	LRL46000S40X	6882.00	4800 A	AL150HD	AL600LS52K4
		600 A	LGL46000S60X	6465.00	6600A	LLL46000S60X	6865.00	6600 A	LRL46000S60X	7414.00	6600 A	AL250JD	(2) 2/0 AWG–500 kcmil Al/Cu

▲ True 2P device. Others are a 2P in a 3P module.

Table 7.70: Q-Frame (240 Vac) PowerPact™ Automatic Molded Case Switches

Circuit Breaker	Poles	Ampere Rating	J Withstand			Wire Range
			Cat. No.	\$ Price	Trip Point	
Q-Frame■	2	225 A	QBL22000S22◆	440.00	4500 A	4 AWG–300 kcmil
	3	225 A	QBL32000S22◆	1193.00	4500 A	

■ Withstand rating of 10 kA at 240 Vac.
◆ DE2A discount schedule.

Table 7.71: P-Frame and R-Frame PowerPact™ Automatic Molded Case Switches▼, 600 Vac

Frame	Poles	Ampere Rating	J Withstand			K Withstand			L Withstand			Terminal	Wire Range
			Cat. No.	\$ Price	Trip Point	Cat. No.	\$ Price	Trip Point	Cat. No.	\$ Price	Trip Point		
P	2	600 A	PJL26000S60	5340.00	10 kA	PKL26000S60	5340.00	24 kA	PLL24000S60★	5715.00	10 kA	AL800M23K	(3) 3/0 AWG–500 kcmil Al or Cu
		800 A	PJL26000S80	5991.00	10 kA	PKL26000S80	5991.00	24 kA	PLL24000S80★	6414.00	10 kA		
		1000 A	PJL26000S10	7469.00	10 kA	PKL26000S10	7469.00	24 kA	PLL24000S10★	7995.00	10 kA		
		1200 A	PJL26000S12	11744.00	10 kA	PKL26000S12	11744.00	24 kA	PLL24000S12★	10887.00	10 kA		
	R	3	600 A	PJL36000S60	6584.00	10 kA	PKL36000S60	6584.00	24 kA	PLL34000S60★	6974.00	10 kA	AL800M23K
800 A			PJL36000S80	7236.00	10 kA	PKL36000S80	7236.00	24 kA	PLL34000S80★	7667.00	10 kA		
1000 A			PJL36000S10	9287.00	10 kA	PKL36000S10	9287.00	24 kA	PLL34000S10★	9837.00	10 kA		
1200 A			PJL36000S12	11867.00	10 kA	PKL36000S12	11867.00	24 kA	PLL34000S12★	12570.00	10 kA		
2			1200 A	—	—	—	RKF26000S12	12213.00	57 kA	RLF26000S12	12855.00	48 kA	
	1600 A	—	—	—	RKF26000S16	14685.00	57 kA	RLF26000S16	14825.00	48 kA			
	2000 A	—	—	—	RKF26000S20	15687.00	57 kA	RLF26000S20	15837.00	48 kA			
	2500 A	—	—	—	RKF26000S25	24948.00	57 kA	RLF26000S25	25185.00	48 kA			
	1200 A	—	—	—	RKF36000S12	13602.00	57 kA	RLF36000S12	14318.00	48 kA			
3	1600 A	—	—	—	RKF36000S16	15911.00	57 kA	RLF36000S16	16062.00	48 kA	AL1200P25K	(4) 3/0 AWG–500 kcmil Al or Cu	
	2000 A	—	—	—	RKF36000S20	19374.00	57 kA	RLF36000S20	19559.00	48 kA			
	2500 A	—	—	—	RKF36000S25	30836.00	57 kA	RLF36000S25	31130.00	48 kA			
	3000 A	—	—	—	RKF36000S30	41104.00	57 kA	RLF36000S30	41496.00	48 kA			

★ P-frame L-interrupting is available in 480 Vac only.
▼ UL magnetic trip tolerances are -20% / +30% from the nominal values shown.

Table 7.72: H-, J-, L- P-, and R-Frame Withstand Ratings△

Voltage	Withstand				
	G	J	K	L	R
240 Vac	65 kA	100 kA	65 kA	125 kA	200 kA
480 Vac	35 kA	65 kA	50 kA□	100 kA	200 kA
600 Vac	18 kA	25 kA	50 kA□	50 kA	100 kA

△ The withstand rating is the fault current at rated voltage that the molded case switch will withstand without damage when protected by a circuit breaker with an equal continuous current rating.
□ R-frame withstand is 65 kA.

Accessories Page 7-39 and Supplemental Digest Pages 3-24–3-31
Optional Lugs Page 7-42 and Supplemental Digest Pages 3-29–3-30
Dimensions Pages 7-54 and 7-55
Enclosures Pages 7-56–7-58

7 MINIATURE AND MOLDED CASE CIRCUIT BREAKERS

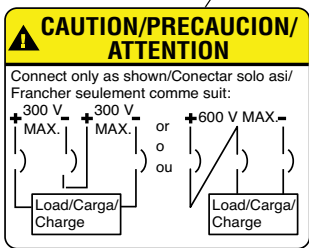

Source = 600 Vdc max. (floating)
500 Vdc max. (loaded)

DC Circuit Breaker Label

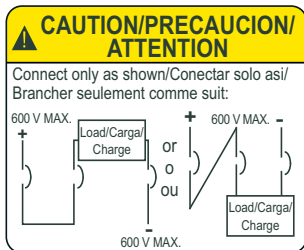

Source = 600 Vdc max. (floating)
500 Vdc max. (loaded)

MHL-DCH Breaker Only

The UL Listed thermal-magnetic molded case circuit breakers shown below are specifically designed for use on ungrounded dc systems having a maximum short-circuit voltage of 500 Vdc or a maximum floating (unloaded) voltage of 600 Vdc. The circuit breakers are suitable for use only with UPS (uninterruptible power supplies) and ungrounded systems.

This two-level voltage rating allows these circuit breakers to be applied to battery sources having a short-circuit availability of 20,000 amperes for LH, and MH circuit breakers and 25,000 amperes for PAF circuit breakers at 500 Vdc.

LH and MH circuit breakers are provided with an adjustable magnetic trip that is readily accessible by means of a single adjustment on the face of the circuit breaker. PAF circuit breakers have a fixed magnetic trip range.

These circuit breakers are UL Listed for the interrupting ratings shown only if applied with three poles connected in series (series connection is external to circuit breaker). See diagram below.

NOTE: Due to external series connection, I-Line™ circuit breakers are not available for this application.

Table 7.73: DC Molded Case Circuit Breakers

Ampere Rating	Circuit Breaker Cat. No.	Adjustable Magnetic Trip Range—DC Amperes▲		Interrupting Rating @ 500 Vdc	\$ Price
		Low	High		
100 A	JGL37100D81	400	600	20 k AIR	3779.00
125 A	JGL37125D81	400	600		3779.00
150 A	JGL37150D81	400	600		3779.00
175 A	JGL37175D81	400	600		3779.00
200 A	JGL37200D82	500	850	20 k AIR	3779.00
225 A	JGL37225D82	500	850		5001.00
250 A	JGL37250D82	500	850		5001.00
250 A	LHL3625025DC	625	1250	20 k AIR	7598.00
300 A	LHL3630026DC	750	1500		7598.00
350 A	LHL3635029DC	875	1750		7598.00
400 A	LHL3640030DC	1000	2000		7598.00
450 A	MHL3645031DC	1125	2250		9456.00
500 A	MHL3650032DC	1250	2500		9456.00
600 A	MHL3660033DC	1500	3000		9456.00
700 A	MHL3670035DC	1750	3500	20 k AIR	11882.00
800 A	MHL3680036DC	2000	4000		11882.00
900 A	MHL3690039DC	2500	5000		14078.00
1000 A	MHL36100040DC	2500	5000		14078.00
1200 A	MHL36120040DC■	2500	5000	25 k AIR	16758.00
450 A	MHL3645031DCH	1125	2250	50 k AIR	12506.00
500 A	MHL3650032DCH	1250	2500		12506.00
600 A	MHL3660033DCH	1500	3000		12506.00
700 A	MHL3670035DCH	1750	3500		14932.00
800 A	MHL3680036DCH	2000	4000		14932.00
900 A	MHL3690039DCH	2500	5000		17128.00
1000 A	MHL36100040DCH	2500	5000		17128.00
1200 A	MHL36120040DCH■	2500	5000		50 k AIR

- ▲ Magnetic trip tolerances are -20%/+30% from the nominal values shown.
- Suitable for use only in a ventilated enclosure. Minimum enclosure dimensions are 38" h x 20" w x 7" d with a minimum of 300 square inches of ventilation near the top and bottom of the enclosure.

Ampere Rating	Circuit Breaker Cat. No.	Fixed Magnetic Trip Range—DC Amperes▲		Interrupting Rating @ 500 Vdc	\$ Price
		Hold	Trip		
1200 A	PAF361200DC	1200	1620	25 k AIR	24726.00
1600 A	PAF361600DC	1600	2160		24726.00
2000 A	PAF362000DC	2000	2700		24726.00
2500 A	PCF362500DC	2500	3375	25 k AIR	39365.00

Accessories. Page 7-39 and Supplemental Digest Pages 3-24–3-31
 Optional Lugs Page 7-42 and Supplemental Digest Page 3-29
 Dimensions Page 7-55 and Supplemental Digest Page 3-33
 Enclosures. Pages 7-56–7-58

7 MINIATURE AND MOLDED CASE CIRCUIT BREAKERS



Masterpact NW DC Circuit Breaker

Table 7.74: Masterpact NW DC Circuit Breakers

Ampere Rating	Circuit Breaker Cat. No.	Interrupting Rating 500 Vdc (max 600 Vdc unloaded)	\$ Price Fixed Circuit Breaker		\$ Price Drawout Circuit Breaker		\$ Price Cradle	
			Version C	Version C1	Version C	Version C1	Version C	Version C1
800 A	NW08NDC	35 kA	42214.00	42746.00	39824.00	40888.00	11778.00	12842.00
1200 A	NW12NDC	35 kA	42214.00	42746.00	39824.00	40888.00	11778.00	12842.00
1600 A	NW16NDC	35 kA	42214.00	42746.00	39824.00	40888.00	11778.00	12842.00
2000A	NW20NDC	35 kA	42214.00	42746.00	39824.00	40888.00	11778.00	12842.00
2500 A	NW25NDC	35 kA	56158.00	56690.00	56662.00	57726.00	11778.00	12842.00
3000 A	NW30NDC	35 kA	70100.00	70632.00	73500.00	74564.00	11778.00	12842.00
4000 A	NW40NDC	35 kA	84044.00	84576.00	90338.00	90142.00	11778.00	12842.00
800 A	NW08HDC	85 kA	46858.00	47448.00	44205.00	45386.00	11778.00	12842.00
1200 A	NW12HDC	85 kA	46858.00	47448.00	44205.00	45386.00	11778.00	12842.00
1600 A	NW16HDC	85 kA	46858.00	47448.00	44205.00	45386.00	11778.00	12842.00
2000A	NW20HDC	85 kA	46858.00	47448.00	44205.00	45386.00	11778.00	12842.00
2500 A	NW25HDC	85 kA	62335.00	62926.00	64076.00	64076.00	11778.00	12842.00
3000 A	NW30HDC	85 kA	77811.00	78402.00	81585.00	82766.00	11778.00	12842.00
4000 A	NW40HDC	85 kA	93289.00	93879.00	100275.00	100058.00	11778.00	12842.00

7 MINIATURE AND MOLDED CASE CIRCUIT BREAKERS

208 Y/120 V 3 Phase Panel

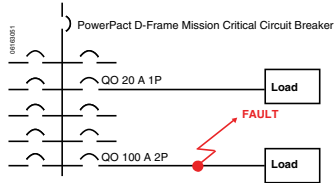

Designed for selectively coordinated systems, mission critical circuit breakers maximize continuity of the electrical service by allowing the branch circuit breaker to clear the fault.

Mission critical circuit breakers are engineered with technology that optimizes current, time and energy selectivity so the fault is cleared by the circuit breaker immediately upstream of the occurrence. This technology (see figure below) allows the remaining areas of the electrical system to continue operation without disruption. In addition to unique design attributes, Square D mission critical circuit breakers have also undergone rigorous testing procedures to certify the coordination with downstream circuit breakers—combining innovative engineering with validated test results.

Apply Square D mission critical circuit breakers in emergency power distribution systems, data centers, hospitals or anywhere continuity of service is desired.

The PowerPact™ J- and L-Frame Mission Critical circuit breakers deliver high levels of selective coordination in a flexible design that can be easily configured for a variety of applications. Tested to be selectively coordinated with the QO™ family of miniature circuit breakers and the ED, EG, and EJ circuit breakers, this solution provides peace of mind when power availability is critical.

An electronic trip unit provides adjustable long-time settings in four sensor sizes, allowing coverage from 50 A through 600 A on a 120–240, 208Y/120, 240, 480Y/277, and 480 V systems.

Table 7.75: PowerPact J- and L-Frame Mission Critical Circuit Breakers

Ratings	Available Configurations
UL 489 Listed CSA Certified Voltage: 480 V	I-Line mounting Main circuit breaker in NO and NF panelboards Unit mount for OEM users Plug-in base for OEM users Drawout base for OEM users

Table 7.76: J-Frame 250 A Electronic Trip Mission Critical Circuit Breakers (480/277 Vac) with Factory Sealed Trip Units Suitable for Reverse Connection▲

Electronic Trip Unit Type	Trip Function	Trip Unit	Continuous Current	D Interrupting		G Interrupting		J Interrupting		L Interrupting		Terminal
				Cat. No.	\$ Price	Cat. No.	\$ Price	Cat. No.	\$ Price	Cat. No.	\$ Price	
Standard	LI	3.2 W	250	JDL34250WU31X	3489.	JGL34250WU31X	4727.	JJL34250WU31X	6678.	JLL34250WU31X	8629.	AL250JD■
Standard	LSI	3.2S-W	250	JDL34250WU33X	3801.	JGL34250WU33X	5039.	JJL34250WU33X	6989.	JLL34250WU33X	8941.	AL250JD■
High Perf. Ammeter	LSI	5.2A-W	250	JDL34250WU43X	4809.	JGL34250WU43X	6046.	JJL34250WU43X	7997.	JLL34250WU43X	9949.	AL250JD■
High Perf. Energy	LSI	5.2E-W	250	JDL34250WU53X	5414.	JGL34250WU53X	6652.	JJL34250WU53X	8602.	JLL34250WU53X	10554.	AL250JD■
High Perf. Ammeter	LSIG	6.2A-W	250	JDL34250WU44X	6018.	JGL34250WU44X	7256.	JJL34250WU44X	9206.	JLL34250WU44X	11158.	AL250JD■
High Perf. Energy	LSIG	6.2E-W	250	JDL34250WU54X	6623.	JGL34250WU54X	7861.	JJL34250WU54X	9812.	JLL34250WU54X	11763.	AL250JD■

- ▲ Standard rated (80%). Not available in 100% rated.
- AL250JD terminal wire range is (1) 3/0 AWG–350 kcmil Al or Cu.

Table 7.77: L-Frame 600 A Electronic Trip Mission Critical Circuit Breakers (480/277 Vac) with Factory Sealed Trip Units Suitable for Reverse Connection▲

Electronic Trip Unit Type	Trip Function	Trip Unit	Continuous Current	D Interrupting		G Interrupting		J Interrupting		L Interrupting		Terminal
				Cat. No.	\$ Price	Cat. No.	\$ Price	Cat. No.	\$ Price	Cat. No.	\$ Price	
480/277 Vac, 50/60 Hz, 3P												
Standard	LI	3.3 W	250	LDL34250WU31X	5696.	LGL34250WU31X	5996.	LJL34250WU31X	10004.	LLL34250WU31X	11703.	AL400L61K3■
			400	LDL34400WU31X	5696.	LGL34400WU31X	5996.	LJL34400WU31X	10004.	LLL34400WU31X	11703.	AL600LS2K3◆
			600	LDL34600WU31X	8389.	LGL34600WU31X	8631.	LJL34600WU31X	12438.	LLL34300WU31X	13968.	AL600LS2K3◆
Standard	LSI	3.3S-W	250	LDL34250WU33X	6361.	LGL34250WU33X	6695.	LJL34250WU33X	10704.	LLL34250WU33X	12403.	AL400L61K3■
			400	LDL34400WU33X	6361.	LGL34400WU33X	6695.	LJL34400WU33X	10704.	LLL34400WU33X	12403.	AL600LS2K3◆
			600	LDL34600WU33X	9054.	LGL34600WU33X	9531.	LJL34600WU33X	14208.	LLL34300WU33X	14667.	AL600LS2K3◆
High Perf. Ammeter	LSI	5.3A-W	400	LDL34400WU43X	7379.	LGL34400WU43X	7767.	LJL34400WU43X	11775.	LLL34400WU43X	13474.	AL600LS2K3◆
High Perf. Energy	LSI	5.3E-W	400	LDL34600WU43X	10071.	LGL34600WU43X	10601.	LJL34600WU43X	14208.	LLL34300WU43X	15738.	AL600LS2K3◆
High Perf. Ammeter	LSI	5.3E-W	400	LDL34400WU53X	8496.	LGL34400WU53X	8943.	LJL34400WU53X	12952.	LLL34400WU53X	14651.	AL600LS2K3◆
			600	LDL34600WU53X	11190.	LGL34600WU53X	11779.	LJL34600WU53X	15366.	LLL34300WU53X	16915.	AL600LS2K3◆
			400	LDL34400WU44X	9616.	LGL34400WU44X	10122.	LJL34400WU44X	14131.	LLL34400WU44X	15830.	AL600LS2K3◆
High Perf. Ammeter	LSIG	6.3A-W	400	LDL34600WU44X	12309.	LGL34600WU44X	12956.	LJL34600WU44X	16844.	LLL34300WU44X	18093.	AL600LS2K3◆
			600	LDL34400WU54X	10734.	LGL34400WU54X	11299.	LJL34400WU54X	15307.	LLL34400WU54X	17006.	AL600LS2K3◆
			400	LDL34600WU54X	13427.	LGL34600WU54X	14134.	LJL34600WU54X	17741.	LLL34300WU54X	19271.	AL600LS2K3◆
480/277 Vac, 50/60 Hz, 4P												
Standard	LI	3.3 W	250	LDL44250WU31X	6196.	LGL44250WU31X	6496.	LJL44250WU31X	10504.	LLL44250WU31X	12203.	AL400L61K4■
			400	LDL44400WU31X	7096.	LGL44400WU31X	7396.	LJL44400WU31X	11404.	LLL44400WU31X	13103.	AL600LS2K4◆
			600	LDL44600WU31X	9789.	LGL44600WU31X	10231.	LJL44600WU31X	13898.	LLL44300WU31X	15368.	AL600LS2K4◆
Standard	LSI	3.3S-W	250	LDL44250WU33X	6861.	LGL44250WU33X	7195.	LJL44250WU33X	11204.	LLL44250WU33X	12903.	AL400L61K4■
			400	LDL44400WU33X	7761.	LGL44400WU33X	8095.	LJL44400WU33X	12104.	LLL44400WU33X	13803.	AL600LS2K4◆
			600	LDL44600WU33X	10454.	LGL44600WU33X	10931.	LJL44600WU33X	14538.	LLL44300WU33X	16067.	AL600LS2K4◆
High Perf. Ammeter	LSI	5.3A-W	400	LDL44400WU43X	8779.	LGL44400WU43X	9167.	LJL44400WU43X	13175.	LLL44400WU43X	14714.	AL600LS2K4◆
High Perf. Energy	LSI	5.3E-W	400	LDL44600WU43X	11471.	LGL44600WU43X	12001.	LJL44600WU43X	15608.	LLL44300WU43X	17138.	AL600LS2K4◆
High Perf. Ammeter	LSI	5.3E-W	400	LDL44400WU53X	9896.	LGL44400WU53X	10343.	LJL44400WU53X	14352.	LLL44400WU53X	16051.	AL600LS2K4◆
			600	LDL44600WU53X	12590.	LGL44600WU53X	13179.	LJL44600WU53X	16786.	LLL44300WU53X	18315.	AL600LS2K4◆
			400	LDL44400WU44X	11016.	LGL44400WU44X	11522.	LJL44400WU44X	15531.	LLL44400WU44X	17230.	AL600LS2K4◆
High Perf. Ammeter	LSIG	6.3A-W	400	LDL44600WU44X	13709.	LGL44600WU44X	14356.	LJL44600WU44X	18244.	LLL44300WU44X	19493.	AL600LS2K4◆
			600	LDL44400WU54X	12134.	LGL44400WU54X	12699.	LJL44400WU54X	16707.	LLL44400WU54X	18406.	AL600LS2K4◆
			400	LDL44600WU54X	14827.	LGL44600WU54X	15534.	LJL44600WU54X	19141.	LLL44300WU54X	20671.	AL600LS2K4◆

- ▲ Standard rated (80%). Not available in 100% rated.
- AL400L61K3 terminal wire ranges are (1) #2 AWG–500 kcmil Al or (1) #2 AWG–600 kcmil Cu.
- ◆ AL600LS2K3 terminal wire ranges are (2) 2/0 AWG–500 kcmil Al or Cu.

Table 7.78: J-Frame Termination Options

Termination Letter	Description
A = I-Line (See Section 9)	
F = No Lugs (includes terminal nut kit on both ends)▲	
L = Lugs both ends	
M = Lugs ON end Terminal Nut Kit OFF end	
P = Lugs OFF end Terminal Nut Kit ON end	
N = Plug-in ■	
D = Drawout ■	
S = Rear Connected ■	

For factory-installed termination, place termination letter in the third block of the circuit breaker catalog number.
H₁G₁L₁3,6,1,0,0₁

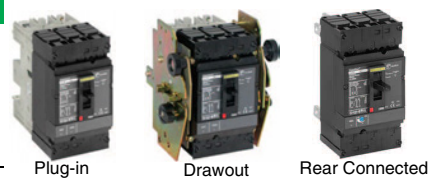

- ▲ Add TS suffix for circuit breaker without terminal nut kit.
- For N and D pricing, add termination pricing on page 7-45 to price. For S pricing, add termination pricing on page 7-41 to price.

Table 7.79: H- and J-Frame Interrupting Ratings

Voltage	Interrupting Rating			
	D	G	J	L
240 Vac	25 kA	65 kA	100 kA	125 kA
480 Vac	18 kA	35 kA	65 kA	100 kA

Accessories	Page 7-39
Optional Lugs	Page 7-42
Dimensions	Page 7-55
Enclosures	Page 7-56

7 MINIATURE AND MOLDED CASE CIRCUIT BREAKERS

LA Mission Critical Circuit Breakers

The LA High Magnetic Withstand MC Circuit Breakers are designed to trip at a higher magnetic trip level (18–20 times handle rating) than typical molded case circuit breakers (MCCBs) (which trip at 5–10 times the handle rating).

The high magnetic withstand value of these LA circuit breakers allow the downstream branch circuit breaker to clear the fault.

Table 7.80: L-Frame—400 A, Thermal-Magnetic, High Magnetic Withstand Circuit Breakers For Mission Critical Loads

Ampere Rating	AC Magnetic Level Factory Set		Standard Interrupting		High Interrupting		Terminal	
	Hold	Trip	Cat. No.	\$ Price	Cat. No.	\$ Price	Cat. No.	Wire Range
LA/LH MC Circuit Breaker, 3P, 480 Vac								
200 A	3400 A	4000 A	LAL34200MC	4962.00	LHL34200MC	7941.00	AL250LAMC	(1) 250–350 kcmil Al (1) 3/0 AWG–350 kcmil Cu
225 A	3825 A	4500 A	LAL34225MC	4962.00	LHL34225MC	7941.00		
250 A	4250 A	5000 A	LAL34250MC	5355.00	LHL34250MC	8336.00		
400 A	6000 A	7200 A	LAL34400MC	6615.00	LHL34400MC	9596.00	AL400LA	(1) 1 AWG–600 kcmil Al or (2) 1 AWG–250 kcmil Al

Table 7.81: L-Frame Interrupting Table





	LAL	LHL
240 Vac	42 kA	65 kA
480 Vac	30 kA	35 kA

PowerPact™ Circuit Breakers with Micrologic™ Electronic Trip Units

The advantages of being able to adjust the trip curve of a circuit breaker equipped with an electronic trip system are obvious. There are other advantages, such as being able to adjust or turn off the instantaneous trip function on some circuit breakers and models of trip units.

Accessories Supplemental Digest Pages 3-29–3-30
 Compression and PDC Lugs Supplemental Digest Page 3-30
 Dimensions Page 7-54
 Enclosures Page 7-56

Table 7.82: Electrical Accessories *New!*

Accessory	Description	Rated Voltage	H-, J-, and L-Frame				M-, P-, and R-Frame				
			Factory-Installed Cat. Suffix	H- and J-Frame		L-Frame		Factory Installed Cat. Suffix	Field-Installable Cat. No.	\$ Price	
				Field-Installable Cat. No.	\$ Price	Field-Installable Cat. No.	\$ Price				
 <p>Auxiliary and Alarm Switches (OF, SD, SDE) H-, J-, L-, M-, P, and R-Frame</p>	<p>Provides circuit breaker contact status.</p> <p>Note: The location of the accessory in the circuit breaker determines its function.</p>	Standard Min Load = 10mA with 24V	1 auxiliary switch (OF) 1a1b	AA	S29450	297.00	S29450	297.00	AA	S29450	297.00
			2 auxiliary switch (OF) 2a2b	AB	2x S29450	594.00	2x S29450	594.00	AB	2x S29450	594.00
			3 auxiliary switch (OF) 3a3b	AC	—	—	3x S29450	891.00	AC	3x S29450	891.00
			Alarm Switch (SD) 1a1b	BC	S29450	297.00	S29450	297.00	BC	S29450	297.00
			Overcurrent trip switch (SDE) 1a1b	BD	—	338.00	S29450	297.00	BD	S29450	297.00
			Consisting of:	OF Switch	—	S29450	297.00	—	—	—	—
		SDE Adapter	—	—	S29451	40.00	—	—	—	—	
		Alarm switch and Overcurrent trip switch	BE	—	635.00	2x S29450	594.00	BE	2x S29450	594.00	
		Consisting of:	OF Switch	2x	S29450	594.00	—	—	—	—	
		SDE Adapter	—	—	S29451	40.00	—	—	—	—	
		Auxiliary Switch/Alarm Switch/Adapter (OF/SD/SDE) Kit	—	—	—	—	—	—	S33801♦	297.00	
		Low Level Min Load = 1mA with 24V	One auxiliary switch (OF) 1a1b	AE	S29452	372.00	S29452	372.00	AE	S29452	372.00
			Two auxiliary switches (OF) 2a2b	AF	2x S29452	744.00	2x S29452	744.00	AF	2x S29452	744.00
			3 auxiliary switches (OF) 3a3b	AG	—	—	3x S29452	1116.00	AG	3x S29452	1116.00
Alarm Switch (SD) 1a1b	BH		S29452	372.00	S29452	372.00	BH	S29452	372.00		
Overcurrent trip switch (SDE) 1a1b	BJ		—	413.00	S29452	372.00	BJ▼	S29452	372.00		
Consisting of:	OF Switch		—	S29452	372.00	—	—	—	—		
SDE Adapter	—	—	S29451	40.00	—	—	—	—			
Alarm switch and Overcurrent trip switch	BK	—	785.00	2x S29452	744.00	BK▼	2x S29452	744.00			
Consisting of:	OF Switch	2x	S29452	744.00	—	—	—	—			
SDE Adapter★	—	—	S29451	40.00	—	—	—	—			
 <p>Shunt Trip (MX) H-, J-, and L-Frame</p>	<p>Trips the circuit breaker from a remote location by means of a trip coil energized from a separate supply voltage circuit.</p>	AC	24	SK	S29384	—	S29384	—	SK	S33659	—
			48	SL	S29385	—	S29385	—	SL	S33660	—
			110-130	SA	S29386	—	S29386	—	SA	S33661	—
			220-240	—	—	717.00	—	717.00	—	—	755.00
			208-277	SD	S29387	—	S29387	—	SD	S33662	—
			380-480	SH	S29388	—	S29388	—	SH	S33664	—
		525-600	SJ	S29389	—	S29389	—	—	—	—	
		DC	12	SN	S29382	—	S29382	—	SN	S33658	—
			24	SO	S29390	—	S29390	—	SK	S33659	—
			30	SU	S29391	—	S29391	—	SK	S33659	—
			48	SP	S29392	717.00	S29392	717.00	SL	S33660	755.00
			60	SV	S29383	—	S29383	—	SL	S33660	—
			125	SR	S29393	—	S29393	—	SA	S33661	—
			250	SS	S29394	—	S29394	—	SA	S33661	—
—	—		—	—	—	—	SC	S33662	—		
 <p>Undervoltage Trip (MN) H-, J-, and L-Frame</p>	<p>Instantaneously opens the circuit breaker when the under-voltage trip supply voltage drops to a value between 35% and 70% of its rated voltage. Closing is allowed when the supply voltage of the undervoltage trip reaches 85% of rated voltage.</p>	AC	24	UK	S29404	—	S29404	—	UK	S33668	—
			48	UL	S29405	—	S29405	—	UL	S33669	—
			110-130	UA	S29406	—	S29406	—	UA	S33670	—
			220-240	—	—	717.00	—	717.00	—	—	755.00
			208-277	UD	S29407	—	S29407	—	UC	S33671	—
			380-480	UH	S29408	—	S29408	—	UH	S33673	—
		525-600	UJ	S29409	—	S29409	—	—	—	—	
		DC	12	UN	S29402	—	S29402	—	—	—	—
			24	UO	S29410	—	S29410	—	UK	S33668	—
			30	UU	S29411	—	S29411	—	UK	S33668	—
			48	UP	S29412	717.00	S29412	717.00	UL	S33669	755.00
			60	UV	S29403	—	S29403	—	UL	S33669	—
			125	UR	S29413	—	S29413	—	UA	S33670	—
			250	US	S29414	—	S29414	—	UC	S33671	—
—	—		—	—	—	—	—	—	—		
 <p>Time Delay Unit</p>	<p>Undervoltage trip with externally mounted adjustable time delay unit for UVR of 0.5, 0.9, 1.5, 3.0 seconds before circuit breaker trips</p>	AC/DC	48	—	S33680	—	S33680	—	FL	S33680▲■	—
			100-130	—	S33681	1140.00	S33681	1140.00	FA	S33681▲■	1140.00
			220-250	—	S33682	—	S33682	—	FC	S33682▲■	—
			380-480	—	—	—	—	—	FH	S33683▲■	—
	<p>Undervoltage trip with externally mounted non-adjustable time delay unit of 0.25 sec before circuit breaker trips.</p>	AC/DC	48	—	S29426	930.00	S29426	930.00	—	—	—
			100-130	—	—	—	—	—	KA	S33684▲■	930.00
			200-250	—	—	—	—	—	KC	S33685▲■	—
			220-240	—	S29427	930.00	S29427	930.00	—	—	—
			—	—	—	—	—	—	—	—	—
			—	—	—	—	—	—	—	—	—

▲ Field-installable kit includes time delay module only. Order undervoltage trip separately.
■ Discount schedule DE2F.
♦ P-frame drawout circuit breaker only.
★ SDE Adapter used for H- and J-frame only.
▼ Not available on electrically operated P-frame.

7 MINIATURE AND MOLDED CASE CIRCUIT BREAKERS

Table 7.83: Motor Operators for H-, J-, and L-Frame Circuit Breakers

Description	Rated Voltage	Factory Installed Cat. No. Suffix	Field-Installable Kit						
			H-Frame▲		J-Frame		L-Frame 600 A		
			Cat. No.	\$ Price	Cat. No.	\$ Price	Cat. No.	\$ Price	
 <p>Standard motor for electrically-operated circuit breakers★</p>	AC	48-60	ML	S29440	1161.00	S31548	3123.00	S432639	3395.00
		110-130	MA	S29433		S31540		S432640	
		208-277	MD	S29434		S31541		S432641	
		380-415	MF	—		—		S432642	
		440-480	MH	S29435		S31542		S432647	
	DC	24-30	MO	S29436	S31543	S432643			
		48-60	MV	S29437	S31544	S432644			
		110-130	MR	S29438	S31545	S432645			
		250	MS	S29439	S31546	S432646			
		AC	220-240	NC	S429441	1509.00	S431549	4060.00	S432652
Communicating motor for electrically-operated circuit breakers▼	AC	220-240	NC	S429441	1509.00	S431549	4060.00	S432652	4414.00
		Mounting hardware	—	—	—	—	—	S32649	59.00
		Ronis lock	—	S41940	146.00	S41940	146.00	S41940	146.00
		Profalux lock	—	S42888	146.00	S42888	146.00	S42888	146.00
Locking device	Mounting hardware plus Ronis lock		—	S429449	155.00	S429449	155.00	—	—
	Operations counter		—	—	—	—	—	S32648	225.00
Adapter for I-Line circuit breaker	—	—	—	S37420	119.00	S37420	119.00	—	—

Table 7.84: Spring-Charging Motors for Electrically-Operated P-Frame Circuit Breakers

Description	Rated Voltage	Factory Installed		P-Frame (For Field-replacement Only)		Replacement Coils			
		Cat. No. Suffix	\$ Price	Spring Charging Motor Cat. No.	\$ Price ♦	Opening/Closing Coil Cat. No.	\$ Price		
 <p>Standard motor for electrically-operated circuit breakers. Factory-installed includes motor and opening/closing coils.</p>	AC	48	ML	5090.00	S47391	3580.00	S33660	755.00	
		100-130	MA		S47395		S33661		
		220-240	MC		S47396		S33662		
		380-415	MF		S47398		S33664		
		440-480	MH		S47399		S33659		
	DC	24-30	MO	S47390	5090.00	S47391	3580.00	S33660	755.00
		48-60	MV	S47391		S33660			
		110-130	MR	S47392		S33661			
		200-250	MS	S47393		S33662			
		250	MS	S47393		S33662			
AC	48	NL	S47391	5090.00	S47391	3580.00	S33034	755.00	
	100-130	NA	S47395		S33035				
	220-240	NC	S47396		S33036				
	380-415	NF	S47398		S33038				
	440-480	NH	S47399		S33033				
DC	24-30	NO	S47390	5090.00	S47391	3580.00	S33034	755.00	
	48-60	NV	S47391		S33034				
	110-130	NR	S47392		S33035				
	200-250	NS	S47393		S33036				
	250	NS	S47393		S33036				

Table 7.85: Rotary Operated Handles

Device	Description	H- and J-Frame▲			L-Frame			P-Frame		
		Factory Installed Cat. No. Suffix	Field Installable Cat. No.	\$ Price	Factory Installed Cat. No. Suffix	Field Installable Cat. No.	\$ Price	Factory Installed Cat. No. Suffix	\$ Price	
Direct Mounted	Standard black handle	Handle only	RD10	S29337	225.00	RD10	S32597	366.00	RD10	539.00
	Standard black handle with	Two early-break and two early make switches	—	—	—	—	—	—	RD16	822.00
		One early-break switch	RD12	S29337 + S29345	345.00	RD12	S32597 + S32605	486.00	—	—
	Red handle on yellow bezel	Two early-make switches	RD13	S29337 + S29346	404.00	RD13	S32597 + S29346	545.00	—	—
		Handle only	RD20	S29339	234.00	RD20	S32599	407.00	—	—
	MCC conversion accessory	One early-break switch	RD22	S29339 + S29345	354.00	RD22	S32599 + S32605	527.00	—	—
		Two early-make switches	RD23	S29339 + S29346	413.00	RD23	S32599 + S29346	586.00	—	—
	Telescoping	MCC conversion accessory	—	S429341	102.00	—	S32606	102.00	—	—
	—	CNOMO conversion accessory	—	—	—	—	S32602	102.00	—	—
	Door Mounted	Standard black handle	Handle only	RE10	S29338	383.00	RE10	S32598	557.00	RE10
Standard black handle with:		Two early-break and two early make switches	—	—	—	—	—	—	RE16	1268.00
		Two early make switches	RE13	S29338 + S29346	503.00	RE13	S32598 + S29346	736.00	—	—
—	Red handle on yellow bezel	Handle only	RE20	S29340	399.00	RE20	S32600	597.00	—	—
—	Rotary Handle Replacement Kit	—	—	—	—	—	—	S33875	795.00	
Accessories	Key lock adapter	—	RT10	S29343	492.00	RT10	S32603	617.00	—	—
	Key locks	Ronis 1351.500	—	S41940	146.00	—	S41940	146.00	—	—
		Profalux KS5 B24 D4Z	—	—	S42888	146.00	—	S42888	146.00	—
		2 Ronis keylocks with 1 key	—	—	S41950	185.00	—	S41950	185.00	—
		2 Profalux keylocks with 1 key	—	—	S42878	185.00	—	S42878	185.00	—
	Indication Auxiliary Switch	One early-break switch	—	—	S29445	120.00	—	S32605	120.00	—
Two early-make switches		—	—	S29346	179.00	—	S29346	179.00	—	

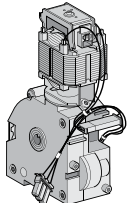
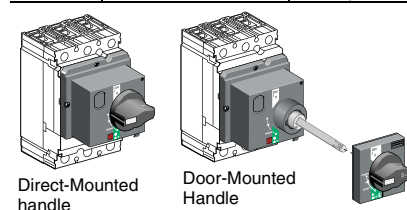

- ▲ Not available in H-frame 2P modules.
- CP1 discount schedule.
- ♦ DE2F discount schedule.
- ★ Factory and field-installed standard motor operators for H- and J-frame circuit breakers require the SDE switch and SDE adapter (both included).
- ★ Factory and field-installed standard motor operators for L-frame circuit breakers require the SDE switch (included).
- ▼ Installation requires BSCM with NSX Cord. See Table 7.118, page 7-49 for ordering information.

Table 7.86: Locks, Interlocking *New!*

Device	Description	H- and J-Frame			Q-Frame		L-Frame		M- and P-Frame			R-Frame		
		Factory Installed Cat. No. Suffix	Field-Installed Cat. No.	\$ Price	Field-Installed Cat. No.	\$ Price	Field-Installed Cat. No.	\$ Price	Factory Installed Cat. No. Suffix	Field-Installed Cat. No.	\$ Price	Factory Installed Cat. No. Suffix	Field-Installed Cat. No.	\$ Price
Handle Padlocking Device	Removable (lock OFF only)	—	S29370	50.00	—	—	S29370	50.00	—	S44936	50.00	—	S33996	50.00
	Fixed (lock OFF or ON)	YP	S29371	77.00	QBPA	77.00	S32631	122.00	YP	S32631	122.00	YP	S32631	122.00
	Fixed (lock OFF only)▲	YQ	S37422	122.00	QBPAF	77.00	NJPAF	122.00	YQ	MPPPAF	122.00	YQ	MPPPAF	122.00
	Fixed (lock OFF only)—2P	YQ	H2PHLA	122.00	—	—	—	—	—	—	—	—	—	—
Interlocking (Not UL listed)	Mechanical for circuit breakers with rotary handles▲	—	S29369	494.00	—	—	S32621	494.00	—	S33890	1220.00	—	—	—
	Mechanical for circuit breakers with toggles▲	—	S29354	494.00	QBMK	90.00	S32614	494.00	—	—	—	—	—	—
Key Locking	Provision only, vertical mount, 1 or 2 locks	Kirk	—	—	—	—	—	—	JA	—	323.00	—	—	—
	Provisions only, vertical mounting one key interlock including padlock provision, open position only.	Kirk	—	—	—	—	—	—	JE■	—	445.00	JE	—	445.00
	Provision only, horizontal mount 1 lock, M- and P-frame 1 or 2 locks, R-frame	Kirk	—	—	—	—	—	—	JK	—	323.00	JK	—	323.00
		Ronis	—	—	—	—	—	—	JB♦	—	323.00	JB	—	323.00
		Profalux	—	—	—	—	—	—	JD♦	—	323.00	JD	—	323.00
	Provision and 1 lock, vertical mount	Kirk	—	—	—	—	—	—	JG	—	1796.00	—	—	—
		Kirk	—	—	—	—	—	—	JL	—	1796.00	JL	—	1796.00
		Ronis	—	—	—	—	—	—	JC♦	—	2285.00	JC	—	2285.00
	Provision and 2 locks keyed alike	Profalux	—	—	—	—	—	—	JF♦	—	2285.00	JF	—	2285.00
		Kirk	—	—	—	—	—	—	JN	—	2285.00	JN	—	2285.00
Provision and 2 locks keyed differently	Kirk	—	—	—	—	—	—	JP	—	3269.00	JP	—	3269.00	

- ▲ Not available in M frame or HD and HG 2P modules.
- Not available on M-frame.
- ♦ Not available for M, P or P frame drawout. Only available on P frame electronic.

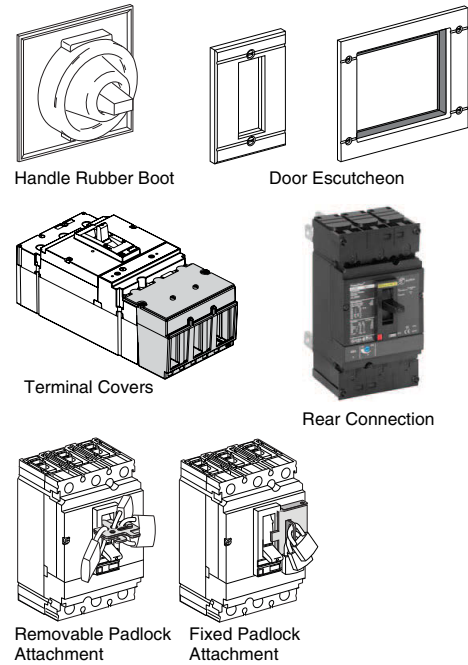

Table 7.87: Installation Accessories for H-, J-, and L-Frame Circuit Breakers *New!*

Description	H- and J-Frame		L-Frame	
	Field-Installed Cat. No.	\$ Price	Field-Installed Cat. No.	\$ Price
Front Panel Escutcheon for Toggle Breakers	S29315	48.00	32556	55.00
Front Panel Escutcheon for Rotary Handle, Motor Operator, or extended escutcheon	S29317	63.00	S32558	74.00
Phase Barriers (set of 6)	S29329	53.00	32570	72.00
Handle Rubber Boot★	S29319	135.00	S32560	171.00
Sealing Accessories (for front cover screws)	S29375	42.00	S29375	42.00
DIN rail mounting kit (requires 15 mm depth on a 35 mm DIN rail)★	S29305	188.00	—	—
DIN rail adapter	—	—	—	—
Handle Extensions (set of 5)	S29313	140.00	S432553	165.00

★ Not available in HD and HG 2P modules.

Table 7.88: Installation Accessories for M-, P-, and R-Frame Circuit Breakers

Description		Frame	Field-Installed Cat. No.	\$ Price
Door Escutcheon	Accessory Cover	M-, P-Frame	S33718▼	176.00
		R-Frame	S33929	176.00
	Toggle Handle	M-, P-Frame	S33717	47.00
Drawout	P-Frame	S33857▼	308.00	
	Short lug cover 3P	P-Frame	S33932	165.00
Short lug cover 4P	S33933		216.00	
Long lug cover 3P	S33934		216.00	
Long lug cover 4P	S33935		281.00	
Replacement Handle	R-Frame		S33997	111.00
Standard Short	M-, P-Frame	S46998	44.00	
	Long	M-, P-Frame	S46996	44.00

▼ DE2F discount schedule.

Table 7.89: Rear Connections *New!*

Device	Description	H-Frame			J-Frame			L-Frame					
		Poles	Factory-Installed Termination No.	Field-Installed Cat. No.	\$ Price	Poles	Factory-Installed Termination No.	Field-Installed Cat. No.	\$ Price	Poles	Factory-Installed Termination No.	Field-Installed Cat. No.	\$ Price
Mixed Rear Connection Kit▲		2	S	—	—	2	S	—	—	3	S	S32477	1059.00
		3	S	S37432	381.00	3	S	S37437	381.00	4	S	S32478	1344.00
Consisting of:	Short rear connections (set of 2)	2 or 3	—	2x S37433□	84.00	2 or 3	—	2x S37438□	84.00	3	—	2x S432475□	219.00
	Long rear connections (set of 2)		—	S37434	105.00		—	S37439♦	105.00		—	2x S432476□	261.00
	Short terminal cover (3P)	3	—	S37436	119.00	3	—	S37440	119.00	3	—	2x S32562□	149.00
	Short terminal cover (4P)	4	—	—	—	4	—	—	—	4	—	2x S32563□	161.00

- ▲ Kit contains 4 short rear connections, 2 long rear connections (4 long rear connections for 4P), hardware, and 2 terminal covers..
- Price shown is for quantity one.
- ♦ For use with 3P circuit breakers only.

MINIATURE AND MOLDED CASE CIRCUIT BREAKERS

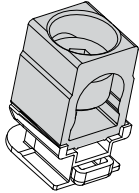

J-Frame Lug

Table 7.90: Mechanical Lug Kits for H-Frame and J-Frame Circuit Breakers▲

Description	Circuit Breaker Application			Ampere Rating	Number of Wires Per Lug and Wire Range	Kit Cat. No.	Qty Per Kit	\$ Price Per Kit
	Standard	Ampere Rating	Optional					
Al Lugs for Use with Al or Cu Wire	HD, HG, HJ, HL	15-150 A			(1) 14-3/0 AWG Al or Cu	AL150HD	3	75.00
	JD, JG, JJ, JL	150-175 A			(1) 4-4/0 AWG Al or Cu	AL175JD	3	113.00
	JD, JG, JJ, JL	200-250 A	JD,JG,JJ,JL	150-175 A	(1) 3/0-350 kcmil Al or Cu	AL250JD	3	113.00
Cu Lugs for Use with Cu Wire Only			HD,HG,HJ,HL	15-150 A	(1) 14-2/0 AWG Cu	CU150HD	3	156.00
			JD,JG,JJ,JL	150-250 A	(1) 1/0-300 kcmil Cu	CU250JD	3	314.00
Control Wire Terminal for H-frame lug kit						S37423	2	53.00
Control Wire Terminal for J-frame lug kit						S37424	2	53.00

▲ See page 7-44 for terminal nuts/bus bar connections.

New!

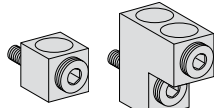

L-Frame Lugs

Table 7.91: Mechanical Lug Kits for L-Frame Circuit Breakers

Description	Circuit Breaker Application				Number of Wires Per Lug and Wire Range	Kit Cat. No.	Qty Per Kit	\$ Price Per Kit
	Ampere Rating	Poles	Unit Mount	I-Line				
Al Lugs for Use with Al or Cu Wire	250	3	X	X	(1) 2 AWG-500 kcmil Al	AL400L61K3	3	143.00
		4	X	—	(1) 2 AWG-600 kcmil Cu	AL400L61K4	4	176.00
	400/600	3	X	—	(2) 2/0 AWG-500 kcmil Al or Cu	AL600LS52K3	3	341.00
		4	X	—		AL600LS52K4	4	449.00
Cu Lugs for Use with Cu Wire Only	400/600	3	X	X	(2) 3/0 AWG-500 kcmil Al or Cu	AL600LF52K3	3	831.00
	250/400	3	X	X		CU400L61K3	3	75.00
		4	X	—	(1) 2 AWG-600 kcmil Cu	CU400L61K4	4	983.00
	400/600	3	X	—	(1) 2/0 AWG-500 kcmil Cu	CU600LS52K3	3	1832.00
		4	X	—		CU600LS52K4	4	2385.00
	400/600	3	X	X	(1) 3/0 AWG-500 kcmil Cu	CU600LF52K3	3	2395.00

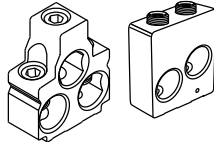

M- and P-Frame Lugs (800 A and below)

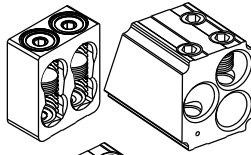

P-Frame Lugs (Above 800 A)

Table 7.92: Mechanical Lug Kits for M-Frame, P-Frame and R-Frame Circuit Breakers▼

Description	Circuit Breaker Application				Wires per Lug and Wire Range	Cat. No.	Lugs Per Kit	\$ Price Per Kit
	Standard	Rating	Optional	Ampere Rating				
Al Lugs for AL or Cu Wire	M-, P-Frame	800 A	—	800 A	(3) 3/0 AWG-500 kcmil	AL800M23K	3	284.00
						AL800M23K4	4	378.00
		1200 A	PG, PJ, PL, MG, MJ	800 A	(4) 3/0 AWG-500 kcmil	AL1200P24K	1	155.00
		—	PG, PJ, PL, MG, MJ	800 A	(2) 3/0 AWG-600 kcmil	AL800P6K	3	416.00
						AL800P6K4	4	554.00
	P-Frame	—	PG, PJ, PL, MG, MJ	800 A	(2) 3/0 AWG-750 kcmil 750 kcmil: compact AL only	AL800P7K	3	464.00
						AL800P7K4	4	602.00
		1200 A	PG, PJ, PL	800 A	(4) 3/0 AWG-500 kcmil	AL1200P25K	3	378.00
						AL1200P25K4	4	504.00
		—	PG, PJ, PL	800-1200 A	(3) 350-600 kcmil	AL1200P6KU	3	786.00
R-Frame	PG,PJ,PL	—	PG, PJ, PL	1200 A	(3) 3/0 AWG-750 kcmil 750 kcmil: compact AL only	AL1200P7KU	3	1233.00
					AL1200P7KU4	4	1635.00	
	1200 A	I-Line	—	(4) 3/0 AWG-600 kcmil	AL1200R53K	1	215.00	
Cu Lugs for Cu Wire Only	M-, P-Frame	2500 A	Unit Mount	—	(1) 1/0 AWG-750 kcmil	AL2500RK	2	132.00
		—	PJ	100-150 A	(1) 1-1/0 AWG	CU250P1K	3	990.00
	800 A	MG, MJ, PG, PJ, PL	—	(3) 3/0 AWG-500 kcmil	CU800M23K	3	1647.00	
						CU800M23K4	4	2190.00
	1200 A	MG, MJ, PG, PJ, PL	800-1200 A	(4) 3/0 AWG-500 kcmil	CU1200P24K	1	569.00	
	P-Frame	1200 A	PG, PJ, PL	800-1200 A	(4) 3/0 AWG-500 kcmil	CU1200P25K	3	4886.00
						CU1200P25K4	4	6503.00
	R-Frame	1200 A	I-Line	—	(4) 3/0 AWG-500 kcmil	CU1200R53K	1	548.00

- Does not fit onto ON end of unit-mount P-frame circuit breakers.
- ◆ For unit-mount circuit breaker only.
- ★ All unit-mount R-frame circuit breakers require terminal pads for mounting lugs of any type. See page 7-44.
- ▼ For lug with a tapped hole for control wire, add a "T" before the "K" in the catalog number (for example, AL800P6TK).
- ▲ This lug can only be used on low amp PJ frame breakers where the Instantaneous setting must not be turned OFF. The cables must be laced with rope per lug instructions.

7 MINIATURE AND MOLDED CASE CIRCUIT BREAKERS

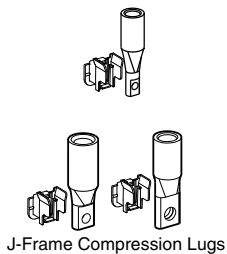
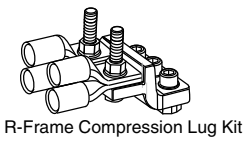
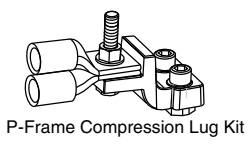

Table 7.93: Compression Lug Kits for PowerPact™ Circuit Breakers

Description	Circuit Breaker Type	Ampere Rating	System Range	Mounting Type	Dimension A (in)	Max. Lugs per Terminal	Cat. No.	Qty. Per Kit	\$ Price Per Kit	
Compression Lug Kits for H-Frame and J-Frame Circuit Breakers										
Aluminum Compression Lug Kits	H-frame	60 A	6-2 AWG Al or Cu	Unit/I-line	1.2	1	YA060HD	3	194.00	
		150 A	1/0-4/0 AWG Al or Cu		2.5	1	YA150HD	3	294.00	
	J-frame	150 A	1-3/0 AWG Al or Cu		1.2	1	YA150JD	3	237.00	
		250 A	3/0-350 kcmil Al or Cu		2.5	1	YA250J35	3	305.00	
Copper Compression Lug Kits	H-frame	60 A	6-1/0 AWG Cu	Unit/I-line	1.0	1	CYA060HD	3	194.00	
		150 A	4-2/0 AWG Cu		1.2	1	CYA150HD	3	194.00	
	J-frame	150 A	6-1/0 AWG Cu		0.7	1	CYA150JD	3	194.00	
		250 A	2/0-300 kcmil Cu		1.1	1	CYA250J3	3	194.00	
Compression Lug Kits for L-Frame Circuit Breakers										
Aluminum Compression Lug Kits	L-frame	250 A	4-300 kcmil Al/Cu	Unit/I-line	1.2	1	YA400L31K3	3	294.00	
		400 A	4-300 kcmil Al/Cu		2.5	2	YA600L32K3	6	540.00	
		250 A	2/0-500 kcmil Al/Cu		1	1	YA400L51K3	3	361.00	
		600 A	2/0-500 kcmil Al/Cu		2	2	YA600L52K3	6	718.00	
		400 A	500-750 kcmil Al		1	1	YA400L71K3	3	425.00	
		500 kcmil Cu	1			1	YA400L31K4	4	383.00	
		250 A	4-300 kcmil Al/Cu		1	1	YA400L31K4	4	383.00	
		400 A	4-300 kcmil Al/Cu			2	2	YA600L32K4	8	709.00
		250 A	2/0-500 kcmil Al/Cu		1	1	YA400L51K4	4	474.00	
		600 A	2/0-500 kcmil Al/Cu			2	2	YA600L52K4	8	950.00
Copper Compression Lug Kits	L-frame	250 A	500-750 kcmil Al	Unit/I-line	1.2	2	YA400L71K4	4	560.00	
		400 A	500 kcmil Cu		2.5	1	YA400L71K4	4	560.00	
		250 A	2/0-300 kcmil Cu		1	1	CYA400L31K3	3	461.00	
		400 A	2/0-300 kcmil Cu			2	2	CYA600L32K3	6	873.00
		250 A	250-500 kcmil Cu		1	1	CYA400L51K3	3	384.00	
		600 A	250-500 kcmil Cu			2	2	CYA600L52K3	6	764.00
		250 A	2/0-300 kcmil Cu		1	1	CYA400L31K4	4	606.00	
		400 A	2/0-300 kcmil Cu			2	2	CYA600L32K4	8	1147.00
		250 A	250-500 kcmil Cu		1	1	CYA400L51K4	4	505.00	
		600 A	250-500 kcmil Cu			2	2	CYA600L52K4	8	1011.00
Compression Lug Kits for M-Frame, P-Frame, and R-Frame Circuit Breakers										
Aluminum Compression Lug Kits	M-, P-frame	250 A	2/0-300 kcmil	Unit/I-line	3.7	2	YA250P3	1	663.00	
		300 A	4/0-500 kcmil		3.9	2	YA300P5	1	519.00	
		400 A	2/0-300 kcmil		4.3	2	YA400P3	2	542.00	
		400 A	500-750 kcmil		3.7	2	YA400P7	1	747.00	
		600 A	4/0-500 kcmil		3.9	2	YA600P5	2	788.00	
		800 A	500-750 kcmil		4.3	2	YA800P7	2	845.00	
	R-frame	1200 A	2/0-300 kcmil	I-line	3.8	4	YA1200R3	4	663.00	
		1200 A	4/0-500 kcmil		4.0	4	YA1200R5	4	707.00	
		1200 A	500-750 kcmil		4.4	4	YA1200R7	4	888.00	
		2000 A	2/0-300 kcmil		▲	8	YA2000R3	2	317.00	
Copper Compression Lug Kits	M-, P-frame	2000 A	4/0-500 kcmil	Unit	▲	8	YA2000R5	2	291.00	
		2500 A	500-750 kcmil		▲	8	YA2500R7	2	350.00	
		400 A	4/0-500 kcmil		Unit	3.3	2	CYA400P5	1	651.00
		600 A	4/0-500 kcmil			3.3	2	CYA600P5	2	753.00
R-frame	I-Line	800 A	500-750 kcmil	I-Line	3.6	2	CYA800P7	2	554.00	
		1200 A	4/0-500 kcmil		3.5	4	CYA1200R5	4	987.00	
		1200 A	500-750 kcmil		3.8	4	CYA1200R7	4	920.00	

New!



- ▲ All unit-mount R-frame circuit breakers require terminal pads for mounting lugs of any type. See page 7-44.
- ◆ 9 lugs for 3000 A circuit breakers
- Not for use on I-Line™ circuit breakers unless wire bending space is adequate.

Table 7.94: Power Distribution Connectors for H-Frame, J-Frame and L-Frame Circuit Breakers

Use with Circuit Breaker Type	Circuit Breaker Ampere Rating	Wires Per Terminal & Wire Range	Dimension A (in.)	Cat. No.	Qty. Per Kit	\$ Price Per Kit
HD, HG, HJ, HL★	15-150	(6) 14-6 AWG Cu	1.0	PDC6HD6	3	443.00
	15-150	(3) 14-2 AWG Cu	1.2	PDC3HD2	3	434.00
JD, JG, JJ, JL★	150-250	(6) 14-4 AWG Cu	1.0	PDC6JD4	3	305.00
	150-250	(2) 14-1 AWG and (1) 3-2/0 AWG Cu	1.5	PDC3JD20	3	594.00
LD, LG, LJ, LL	150-600	(3) 14-1 AWG and (2) 3-2/0 AWG	1.28Δ	PDC5DG20L3	3	387.00
	150-600	(12) 14-4 AWG	1.31Δ	PDC12DG4L3	3	387.00

★ OFF end only when OFF end is the load end.

Table 7.95: Power Distribution Connectors for M-Frame and P-Frame Circuit Breakers

Use for multiple load connections on one circuit breaker in place of standard distribution block to save space and time.	Ampere Rating	(Wires Per Terminal) Wire Range	Cat. No.	Qty Per Kit	\$ Price Per Kit
Use on load end of circuit breaker only. • Use in UL508 Industrial Control applications only. • Use in UL1995/CSA C22.2 No. 236 heating and cooling equipment. • For Cu wire only.	250-1200 A	(6) 12-2/0 AWG Cu	PDC6P20	3	573.00
		(6) 12-2/0 AWG Cu	PDC6P204	4	756.00
	250-1200 A	(12) 10-4 AWG Cu	PDC12P4	3	866.00
			PDC12P44	4	929.00

- ▼ Not for use with I-Line™ circuit breakers.
- Δ Kit includes long terminal shield and cover, which adds 1.65 inches to standard lug with short terminal shield.

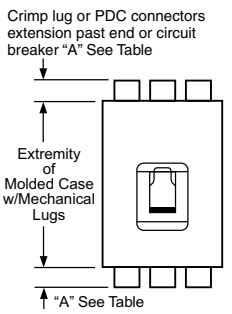
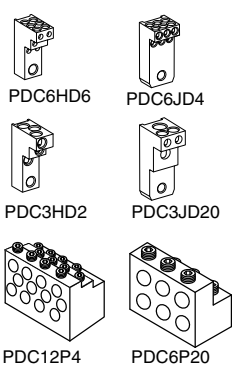

7 MINIATURE AND MOLDED CASE CIRCUIT BREAKERS

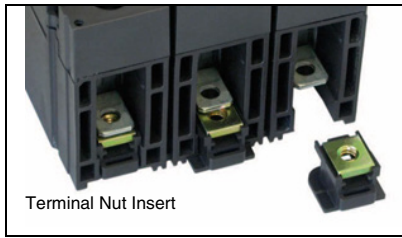

Terminal Nut Insert

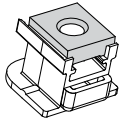

H-Frame Lug With Terminal Nut

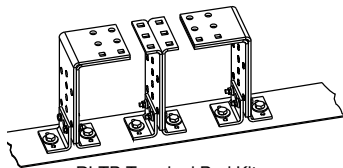

RLTB Terminal Pad Kit

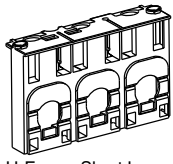

H-Frame Short Lug Shield

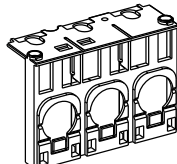

J-Frame Short Lug Shield

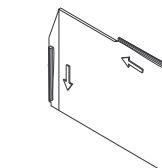
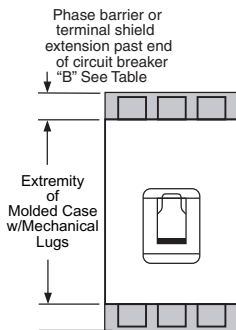

R-Frame Phase Barrier

7 MINIATURE AND MOLDED CASE CIRCUIT BREAKERS

Table 7.96: Terminal Nuts for Bus Bar Connection of H-Frame and J-Frame Circuit Breakers

Description	Frame	Tap	Cat. No.	Qty Per Kit	\$ Price Per Kit
H-Frame Terminal Nut Insert–English	HD/HG/HJ/HL	1/4-20	S37425	2	53.00
H-Frame Terminal Nut Insert–English	HD/HG/HJ/HL	1/4-20	S37444	3	75.00
H-Frame Terminal Nut Insert–Metric	HD/HG/HJ/HL	M6	S37426	2	53.00
J-Frame Terminal Nut Insert–English	JD/JG/JJ/JL	1/4-20	S37427	2	75.00
J-Frame Terminal Nut Insert–English	JD/JG/JJ/JL	1/4-20	S37445	3	113.00
J-Frame Terminal Nut Insert–Metric	JD/JG/JJ/JL	M8	S37428	2	75.00
Control Wire Terminal for H-Frame Terminal Nut	HD/HG/HJ/HL		S37429	2	53.00
Control Wire Terminal for J-Frame Terminal Nut	JD/JG/JJ/JL		S37430	2	53.00

Table 7.97: Bus Bar Connections Hardware for L-Frame, M-Frame and P-Frame Circuit Breakers

New!

Frame	Description	Term. No.	Poles	Cat. No.	\$ Price
L-Frame	Set of 4 terminal screws and washers for one side	F	4	S36967	31.00
M- and P-Frame	Bus Connector Kit for one pole, one end		1	S33928	28.00

Table 7.98: Terminal Pad Kits for R-Frame Circuit Breakers

R-Frame Circuit Breaker	Terminal Pad Kit		Field-Installable Kits			
	Usage	Lugs per Phase	3P Kit (One End Only)		4P Kit (One End Only)	
			Cat. No.	\$ Price.	Cat. No.	\$ Price
3000 A, 100% Rated	Required for cable or bus	9	RL3TB	1440.00	RL3TB4	2016.00
3000 A, Standard (80% Rated)	Required for cable or bus					
2500 A, 100% Rated	Required for cable or bus					
2500 A, Standard (80% Rated)	Required for cable, optional for bus	8	RLTB	914.00	RLTB4	1280.00
All Other R-Frame Circuit Breakers	Required for cable, optional for bus					

For cable connection to RLTB, use AL2500RK lug. See page 7-43.

Table 7.99: Terminal Shields and Phase Barriers

New!

Used With	Description			Dimension B (in.)	Cat. No.	Qty Per Kit	\$ Price	
H- and J-Frame Mechanical Lugs	Short Lug Shield▲	Frame	Max. Wire Size					
		H-Frame 60 A	3 AWG	0.50	S37446	1	149.00	
		H-Frame 150 A	3/0 AWG	0.50	S37447	1	149.00	
		J-Frame	350 kcmil	0.24	S37448	1	149.00	
H- and J-Frame Power Distribution Connectors and Compression Lugs	Compatible with:	PDC	Compression Lugs		2.24	S37449	1	209.00
			Aluminum	Copper				
	H-Frame Long Lug Shield	PDC6HD6	YA060HD	CYA060HD	1.68	S37450	1	209.00
		PDC3HD2	YA150HD	CYA150HD				
	J-Frame Long Lug Shield	PDC6JD4	YA150JD	CYA150JD	1.68	S37450	1	209.00
		PDC3JD2	■	CYA250J3				
M-, P-Frame	Phase Barriers				S33646	3	47.00	
R-Frame	Phase Barriers				S33998			

- ▲ Short lug shields provide IP20 protection for mechanical lugs and are compatible with control wire terminals.
- J-frame terminal shield is not compatible with the YA250J35 compression terminal.

Table 7.100: Miscellaneous H-, J-, and L-Frame Circuit Breaker Accessories

Accessory	Description	Field-Installed Cat. No.	\$ Price
Spare Parts	Bag of screws for accessory cover, L-frame	S432552	63.00
	1 spare toggle extension, L-frame	32595	342.00
	Set of 10 identification labels	LV429226	82.00

◆ DE5A Discount Schedule



H-Frame and J-Frame Plug-in Mounting



H-Frame and J-Frame Drawout Mounting

Table 7.101: Plug-In and Drawout Mountings for H- and J-Frame Circuit Breakers (3P or 2P in a 3P module)

Description		Factory Installed Cat. No.	Field-Installed Cat. No.	\$ Price	
Complete Factory-Assembled Circuit Breakers	Plug-in base shipped with circuit breaker	N		638.00	
	Drawout cradle shipped with circuit breaker	D		1419.00	
Special Order Options for Plug-In and Drawout Circuit Breakers	Plug-In Base	HJ00		290.00	
	Circuit breaker Only		S29278	348.00	
	Drawout Cradle	HJ00		485.00	
			Circuit breaker only	S29278	348.00
	Plug-in base kit		S29282	587.00	
	Cradle side plates (fixed part of chassis)		S29283	195.00	
	Circuit breaker side plates (moving part of chassis)				
Accessories for Plug-In and Drawout	H-Frame Shutter Kit (set of two)		S37442	48.00	
	J-Frame Shutter Kit (set of two)		S37443	48.00	
	Secondary Disconnect Blocks	Fixed part 9-wire connector (mounted on base)		S29273	95.00
		Moving part 9-wire connector (mounted on circuit breaker)		S29274	60.00
		Support for 2-moving connectors		S29275	33.00
	Extended escutcheon with extended toggle handle		S29284	77.00	
	Two position indicating switches (connected/disconnected)		S29287	207.00	
	H-Frame Short Terminal Cover (3P)		S37436	119.00	
J-Frame Short Terminal Cover (3P)		S37440	119.00		



L-Frame Plug-In Mounting



L-Frame Drawout Mounting

Table 7.102: Plug-In and Drawout Mountings for L-Frame Circuit Breakers

Description	Poles	Plug-in Mounting			Drawout Mounting			
		Factory Installed Cat. No.	Field-Installed Cat. No.	\$ Price	Factory Installed Cat. No.	Field-Installed Cat. No.	\$ Price	
Kit (stationary and moving parts)	3	N		1542.00	D		2466.00	
	4	N		2082.00	D		3281.00	
Stationary Part	Plug-in base	4		S32514	1065.00		S32514	1065.00
				S32515	1439.00		S32515	1439.00
	Fixed part of chassis					S32532	693.00	
Moving Part	Circuit breaker only		HJ00	710.00	HJ00		710.00	
	Moving part of chassis					S32533	231.00	
	Short terminal covers	3		2x S32562	149.00		2x S32562	149.00
4			2x S32563	161.00		2x S32563	161.00	

▲ Price shown is for quantity of 1.

Table 7.103: Plug-In and Drawout Accessories for L-Frame Circuit Breakers

Description		Field-Installed Cat. No.	\$ Price
Secondary Disconnecting Blocks	Fixed Part	9-wire connector	S29273 95.00
	Moving Part	9-wire connector	S32523 60.00
		Support for 3 moving connectors	S32525 43.00
	Fixed + Moving	9-wire manual auxiliary connector	S29272 480.00
Shutters	Two shutters for plug-in base	32521	81.00
Chassis Accessories	Extended escutcheon for toggle	S32534	104.00
	Locking device (key lock is not included)	S29286	164.00
	Two position indicating switches (connected/disconnected)	29287	207.00

Table 7.104: Termination Options

Termination Letter	Description
N = Plug-in	For factory-installed termination, place termination letter in the third block of the circuit breaker catalog number.
D = Drawout	

LGL36400U31X
L—Termination No.

Table 7.105: Drawout Cradle and Accessories for P-Frame Circuit Breakers

Description	Cat. No.	\$ Price
Drawout Cradle	Product Selector	6400.00
Cradle	SFCF12 ■ ◆	716.00
Connectors	SRCTV12 ■ ◆	408.00
Modbus™ cradle communication module	S33852	2237.00
Safety shutters	S48933 ◆	342.00
Secondary disconnects terminal shield	S33763 ◆	220.00
Cradle position switch 1a/1b Form C—Connected/test/disconnected	S33170 ◆	148.00
Low level cradle position switch 1a/1b Form C—Connected/test/disconnected	S33171 ◆	216.00
Cell keying kit	S33767 ◆	97.00
Disconnected position key locking—provision for Kirk or Federal Pioneer Lock	S33772 ◆	908.00
Door interlock kit	S33786 ◆	330.00
Racking interior kit	S33788 ◆	358.00
Door escutcheon (for replacement only, included with circuit breaker)	S33857 ◆	308.00
Transparent cover	S33859 ◆	1290.00
Push-in terminal kit (3 wires)	S33098 ◆	120.00
Push-in terminal kit (6 wires)	S33099 ◆	240.00
Finger cluster	S33166 ◆	164.00
Cluster grease (12 oz. tube)	S48899 ◆	132.00

■ Needs 2 kits per cradle.
◆ Discount Schedule DE2F

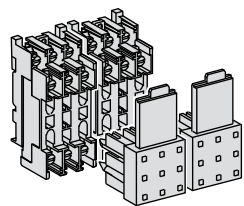

L-Frame Disconnecting Blocks

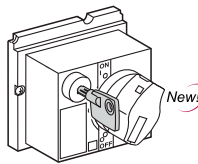

L-Frame Locking Device

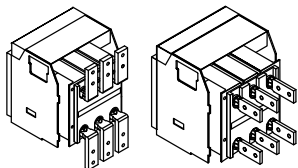

P-Frame Drawout Cradle Connections

New!

PowerPact™ H-, J-, and L-Frame Micrologic™ Trip Units



Micrologic Standard Trip Unit



Micrologic Ammeter and Energy Trip Unit

PowerPact™ H-, J-, and L-frame molded case circuit breakers may be specified with any of the following Micrologic Electronic Trip Units.

Micrologic Standard 3.2/3.3 Trip Units

- True RMS sensing
- LI, LSI trip configurations
- Field-interchangeable trip units
- LED long-time pickup and trip indication
- Test kits available
- Thermal imaging

Micrologic Ammeter 5.2A/5.3A/6.2A/6.3A Trip Units

Includes all features listed for Micrologic standard trip unit, as well as:

- Advanced user interface
- Neutral protection
- Incremental fine tuning of settings
- Up to 12 alarms
- Digital ammeter—phase and neutral (4-pole only)
- Phase loading bar graph
- Maintenance indicators including contact wear, number of operations, operating hours, and load profiles
- Cause of trip information for troubleshooting assistance
- LCD Display
- Zone-selective interlocking (ZSI) (short-time & ground-fault)
- Optional Modbus™ communications—PowerLogic™ compatible

Micrologic Energy 5.2E/5.3E/6.2E/6.3E Trip Units

Includes all features listed for Micrologic ammeter trip unit, as well as:

- Ground-fault trip with programmable ground fault alarm (available on 6.2E/6.3E only)
- Power and energy measurement
- Power quality measurements
- Current demand and power demand measurements

Table 7.106: Micrologic Trip Units★ for PowerPact H-, J-, and L-Frame Circuit breakers

x – Standard Feature o – Available Option

Features	Standard		Ammeter		Energy	
	3.2/3.3	3.2S/3.3S	5.2A/5.3A	6.2A/6.3A	5.2E/5.3E	6.2E/6.3E
LI	x					
LSI★		x	x		x	
LSIG / Ground-Fault Trip▼				x		x
Ground-Fault Alarm/Trip▼				x		x
Current Setting Directly in Amperes	x	x	x	x	x	x
True RMS Sensing	x	x	x	x	x	x
UL Listed	x	x	x	x	x	x
Thermal Imaging	x	x	x	x	x	x
LED for Long-time Pickup	x	x	x	x	x	x
LED for Trip Indication	x	x	x	x	x	x
LED for Green "Ready"	x	x	x	x	x	x
Up to 12 Alarms Used Together			x	x	x	x
Digital Ammeter			x	x	x	x
Zone-selective Interlocking△			x	x	x	x
Communications	o	o	o	o	o	o
LCD Display			x	x	x	x
Front Display Module FDM121			o	o	o	o
Advanced User Interface			x	x	x	x
Neutral Protection▼			x	x	x	x
Contact Wear Indication□			x	x	x	x
Incremental Fine Tuning of Settings			x	x	x	x
Load Profile◇,◇			x	x	x	x
Power Measurement					x	x
Power Quality Measurements					x	x

- ★ The LSI with 3.2S/3.3S trip units have fixed short time and long time delays.
- ▼ Requires neutral current transformer on the three-phase four-wire loads
- △ ZSI for H/J frames in only IN. for L-frame ZSI is In and OUT.
- Indication available using the communication system only.
- ◇ % of hours in 4 current ranges: 0–49%, 50–79%, 80–89%, and >90% In.
- ☆ DC not available with electronic trip units.

Table 7.107: Micrologic Trip Unit Settings for H- and J-Frame

Model	Trip Function	Trip Unit	Ampere Setting
Standard	LI	3.2	15-20-25-30-35-40-45-50-60 35-40-45-50-60-70-80-90-100 50-60-70-80-90-100-110-125-150 70-80-100-125-150-175-200-225-250
			LSI
Ammeter	LSI	5.2A	
			LSIG
Energy	LSI	5.2E	
			LSIG

Table 7.108: Micrologic Trip Unit Settings for L-Frame

Model	Trip Function	Trip Unit	Ampere Setting
Standard	LI	3.3	70-80-100-125-150-175-200-225-250 125-150-175-200-225-250-300-350-400 200-225-250-300-350-400-450-500-600
			LSI
Ammeter	LSI	5.3A	
			LSIG
Energy	LSI	5.3E	
			LSIG

7 MINIATURE AND MOLDED CASE CIRCUIT BREAKERS

PowerPact P- and R-Frame Micrologic Trip Units



PowerPact™ P- and R-frame molded case circuit breakers may be specified with any of the following Micrologic Electronic Trip Units.

Micrologic (Standard) 3.0 and 5.0 Trip Units

- True RMS sensing
- LI, LSI trip configurations
- Field-interchangeable long-time rating plugs
- LED long-time pickup indication
- Test kits available
- Thermal imaging

Micrologic (Ammeter) 3.0A, 5.0A and 6.0A Trip Units

Includes all features listed for Micrologic standard trip unit, as well as:

- LSI trip configurations
- Digital ammeter—phase and neutral (4-pole only)
- Phase loading bar graph
- LED trip indication
- Zone-selective interlocking (ZSI) (short-time & ground-fault)
- Optional Modbus™ communications—PowerLogic™ compatible

Micrologic (Power) 5.0P and 6.0P Trip Units

Power measurement and advanced protection features includes all features listed for Micrologic ammeter trip unit, as well as:

- LSI trip configuration with programmable ground fault alarm
- LSI (Ground-fault trip) with programmable ground fault alarm
- Incremental “fine tuning” of L, S, I, and G pickup and delay settings
- LCD dot matrix display and LED trip indication
- Advanced user interface
- Advanced protection IDMTL—selectable long-time delay bands
- Neutral protection
- Power measurement
- Contact wear indication
- Modbus communications—PowerLogic compatible
- Local and remote settings

Micrologic (Harmonic) 5.0H and 6.0H Trip Units

Power quality measurement and advanced protection features. Includes all features listed for the Micrologic power trip unit, as well as:

- Enhanced power measurements functions
- Power quality measurements

Adjustable Rating Plugs for PowerPact™ P-Frame and R-Frame and Masterpact™ NT and NW Circuit Breakers—Selection

To provide maximum design flexibility, system protection, and field upgradeability, each Micrologic™ trip unit is equipped with an interchangeable long-time rating plug. Each trip unit requires an adjustable rating plug to determine the long-time pickup range of the circuit breaker. These plugs are factory installed on new trip units, or can be ordered separately for field-installable upgrades.

Adjustable rating plugs are offered in eight different ranges of long-time pickup adjustments. The following chart show the ranges of adjustments. Each adjustment times the sensor rating (I_r X I_n) of the circuit breaker sets the long-time pickup value of the circuit breaker.

Table 7.109: Long-time Pickup Settings

Rating Plug	Long-time Pickup Settings								
A	.40	.45	.50	.60	.63	.70	.80	.90	1.0
B	.40	.44	.50	.56	.63	.75	.88	.95	1.0
C	.42	.50	.53	.58	.67	.75	.83	.95	1.0
D	.40	.48	.64	.70	.80	.90	.93	.95	1.0
E	.60	.70	.75	.80	.85	.90	.93	.95	1.0
F	.84	.86	.88	.90	.92	.94	.96	.98	1.0
G	.66	.68	.70	.72	.74	.76	.78	.80	.82
H	.48	.50	.52	.54	.56	.58	.60	.62	.64

Table 7.110: Micrologic Trip Units

x – Standard Feature o – Available Option

Features	Standard		Ammeter			Power		Harmonic	
	3.0	5.0	3.0A	5.0A	6.0A	5.0P	6.0P	5.0H	6.0H
LI	x			x					
LSI (Instantaneous can be turned off)		x		x		x	x	x	x
LSIG / Ground-Fault Trip ▲							x		x
Ground-Fault Alarm (No Trip) ▲■							x		x
Ground-Fault Alarm and Trip ▲								x	x
Adjustable Rating Plugs	x	x	x	x	x	x	x	x	x
True RMS Sensing	x	x	x	x	x	x	x	x	x
UL Listed	x	x	x	x	x	x	x	x	x
Thermal Imaging	x	x	x	x	x	x	x	x	x
Phase Loading Bar Graph			x	x	x	x	x	x	x
LED for Long-time Pickup	x	x	x	x	x	x	x	x	x
LED for Trip Indication			x	x	x	x	x	x	x
Digital Ammeter			x	x	x	x	x	x	x
Zone-selective Interlocking			x	x	x	x	x	x	x
Communications				o	o	o	x	x	x
LCD Dot Matrix Display							x	x	x
Advanced User Interface							x	x	x
Protective Relay Functions							x	x	x
Neutral Protection							x	x	x
Contact Wear Indication							x	x	x
Incremental Fine Tuning of Settings							x	x	x
Selectable Long-time Delay Bands							x	x	x
Power Measurement							x	x	x
Power Quality Measurements									x
Waveform Capture									x

- ▲ Requires neutral current transformer in 3Ø4W systems.
- Requires M2C or M6C Programmable Contact Module.

Table 7.111: Micrologic Trip Unit and Options

Model	Protection	Additional Features	Field-Installable Cat. No. †	Kit \$ Price / Circuit Breaker \$ Price Adder
2.0 (IEC only)	LSO		S132R	2920.00
3.0 (UL/ANSI only)	LI	None	S131A	2920.00
5.0	LSI		S133A	4176.00
2.0A (IEC only)	LSO		S142R★	4554.00
3.0A (UL/ANSI only)	LI	Ammeter	S141A★	4554.00
5.0A	LSI		S143A★	5812.00
6.0A	LSIG		S144A★	7418.00
5.0P	LSI	Metering, Adv. Protection	S163A★★	8720.00
6.0P	LSIG		S164A★★	10324.00
5.0H	LSI	Metering, Adv. Protection & Harmonic Analysis	S173A★★	14770.00
6.0H	LSIG		S174A★★	16374.00

- † The standard rating plug supplied with a trip unit will be the “A” rating plug. To specify an alternative adjustable rating plug, please add the letter designation to the end of the catalog number. Please refer to page 7-48 for a complete listing of adjustable settings available with each plug. (Example: S143B would specify a “B” rating plug instead of the standard “A” plug.) Use suffix “N” if no rating plug is required, deduct \$200.00 from the complete trip unit kit price.
- ★ When replacing a standard trip unit with Type A (Ammeter), P (Power metering) or H (Harmonic analysis) trip unit, order the 12-pin connector kit S33101 for the Masterpact NW and NT and the PowerPact P-frame drawout circuit breakers or kit S33100 for PowerPact P-frame and R-frame unit-mount and I-Line circuit breakers. See page 7-48.
- ▼ Requires Circuit Breaker Communications Module.
- △ The LSI with 3.2S/3.3S trip units have fixed short time and long time delays.
- Requires neutral current transformer on the three-phase four-wire loads
- ◇ ZSI for H/J frames in only IN, for L-frame ZSI is In and OUT.
- ☆ Indication available using the communication system only.
- ▽ % of hours in 4 current ranges: 0–49%, 50–79%, 80–89%, and >90% In.

Table 7.112: Special Options

Description	Factory-Installed Suffix	Field-Installable Cat. No.	\$ Price
Ship circuit breaker in closed position	YK	N/A	N/C
CT Characterization (Calibrated trip system)	Q	N/A	3308.00

Adjustable rating plug "A" is installed as standard on all Micrologic trip unit orders. However, an alternative selection may be specified from the "Assembled" table below, and factory installed with your trip unit order at no additional charge. To order, please attach the appropriate catalog suffix to the end of the trip unit Cat. No. (after specifying trip unit options). Adjustable rating plugs may also be purchased as field-installable components from the table below.



Full Function Test Kit

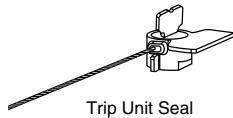

Trip Unit Seal



Sensor Plug

Table 7.113: Rating Plugs

Rating Plug▲	Factory-Installed		Field-Installable	
	Cat. Suffix	\$ Price Adder	Cat. No.■	\$ Price
A	A (standard)	N/C	S48818	200.00
B	B	N/C	S48819	200.00
C	C	N/C	S48820	200.00
D	D	N/C	S48836	200.00
E	E	N/C	S48837	200.00
F	F	N/C	S48838	200.00
G	G	N/C	S48839	200.00
H	H	N/C	S48840	200.00

- ▲ Long-time pickup amperes (In) = Sensor Rating (In) X Setting of rating plug. "Fine adjustment tuning" is included on Micrologic Power and Harmonic trip units, allowing for incremental settings of 1 A between the plug setting and .40 X Sensor Rating.
- DE2F Discount Schedule

Table 7.114: Neutral Current Transformers

For Use with Circuit Breaker	Cat. No.	Sensor	\$ Price
H-Frame	S429521	60-100	588.00
J-Frame	S430562	150	588.00
L-Frame	S432575	250	588.00
P-Frame	S33575 ♦,★	400-600	647.00
	S33576 ♦,★	150	1914.00
R-Frame	S48916 ♦,★	250	1914.00
	S34036 ♦,★	400-1600	2014.00
	S48896 ♦,★	2000	2044.00
	S48182 ♦,★	3000	2208.00
All	NCTWIRING	All	204.00

- ♦ DE2F Discount Schedule
- ★ Includes NCTWIRING kit.

Table 7.115: Trip Unit Accessories

Device	Frame	Cat. No.♦	\$ Price
Pocket Tester		S434206	1000.00
UTA Tester		STRV00910	16365.00
Spare UTA Tester		STRV00911	6000.00
BLuetooth/Modbus for UTA Tester		SVW3A8114	2800.00
Spare Power Supply for UTA Tester 110-120 Vac		TRV00915	771.00
Micrologic Cord for UTA Tester		TRV00917	1210.00
Micrologic 5/6 Cover, Transparent	H/J	S429478	19.00
Micrologic 2/3 Cover, Transparent		S429481	41.00
Micrologic 5/6 Cover, Transparent	L	S432459	36.00
Micrologic 2/3 Cover, Transparent		S432461	156.00
LCD Display for Micrologic 5	H/J/L	S429483	575.00
LCD Display for Micrologic 6		S429484	575.00
Hand-held Test Kit		S33594	5386.00
Primary Injection Test Adaptor		S33937	252.00
Full-function Adaptor Kit		S48981	19699.00
Full-function Test Kit	P/R	S33595	33792.00
Seven-pin Test Cable (for connection between test kit and trip unit)▼		S48907	1488.00
Two-pin Test Cable (for connection between test kit and trip unit)△		S48908	784.00
230 Vac Filtered Power Cord□	P/R	S48856	166.00
120 Vac Filtered Power Cord□		S48855	61.00
Trip Unit Battery for Trip Indicator Lights		S33593	438.00
Power supply with:			
24-30 Vdc input	H/J/L/P/R	685823	1130.00
48/60 Vdc input		685824	
125 Vdc input		685825	
110-130 Vac input		685826	
200-240 Vac input		685827	
380-415 Vac input		685829	
Micrologic A Trip Unit Cover, clear	P/R	S33592	16.00
Micrologic P/H Trip Unit Cover, opaque gray		S47067	16.00
Trip Unit Seal (6 pieces) for compliance with NEC 240.6(c)	H/J/L/P/R	MICROTUSEAL	60.00
12-pin Trip Unit Connector for NT/NW Masterpact Circuit Breakers	P/R	S33101	228.00
12-pin Trip Unit Connector for P- and R-Frame Circuit Breakers		S33100★	255.00
Battery Back-up (12 Hours)		685831	3570.00

- ▼ Used for testing Micrologic trip units. Included in the price of the Hand-held/Full-function Test Kits. Kit for replacement only.
- △ Used for testing STR trip units. Included in the price of the Hand-held/Full-function Test Kits. Kit for replacement only.
- Included in the price of the Full-function Test Kit. Kit for replacement only.
- ♦ DE2F Discount Schedule.
- ★ DE2 Discount Schedule.

Table 7.116: Sensor Plugs for P- and R-Frame Circuit Breakers▽♦

Circuit Breaker	Sensor Plug Range	Sensor Plug Catalog No.	Circuit Breaker Frames Accepting Sensor Plug										\$ Price ◊
			250 A	400 A	600 A	630 A*	800 A	1000 A	1200 A	1250 A*	1600 A		
P-Frame Circuit Breaker			250 A	400 A	600 A	630 A*	800 A	1000 A	1200 A	1250 A*	1600 A		
UL	250 A	S47052	X									1040.00	
	400 A	S47053		X			X					1040.00	
	600 A	S48823			X		X	X				1040.00	
	800 A	S33092					X	X	X			1040.00	
	1000 A	S33093						X	X			1040.00	
	1200 A	S48824							X			1040.00	
IEC	630 A	S33091				X	X	X	X	X	X	1040.00	
	800 A	S33092					X	X	X	X	X	1040.00	
	1000 A	S33093						X	X	X	X	1040.00	
	1250 A	S33094							X	X	X	1040.00	
	1600 A	S33095								X	X	1040.00	
R-Frame Circuit Breaker			600 A	800 A	1000 A	1200 A	1600 A	2000 A	2500 A	3000 A	3200 A		
UL	600 A	S48823	X	X								1040.00	
	800 A	S33092		X	X	X	X					1040.00	
	1000 A	S33093			X	X	X					1040.00	
	1200 A	S48824				X	X	X				1040.00	
	1600 A	S33095					X	X	X	X		1040.00	
	2000 A	S33982						X	X	X		1040.00	
	2500 A	S33983							X	X		1040.00	
	3000 A	S48825								X		1040.00	
IEC	1600 A	S33095					X	X	X	X	X	1040.00	
	2000 A	S33982						X	X	X	X	1040.00	
	2500 A	S33983							X	X	X	1040.00	
	3200 A	S33984								X	X	1040.00	

- ▽ For use only with circuit breakers with date codes later than 07011.
- ◊ DE2F Discount Schedule.
- * IEC Only.
- ♦ See rating plug for long-time pickup range on page 7-47.

7 MINIATURE AND MOLDED CASE CIRCUIT BREAKERS

Table 7.117: Trip Unit Field-Installable Accessories for P- and R-Frame Circuit Breakers

Description	Factory-Installed		Field-Installable Kit Cat. No.							\$ Price
	Cat. No. Suffix	\$ Price Adder	P-Frame				R-Frame			
			Unit Mount	I-Line	Motor Operated	Drawout	With Rotary Handle	Unit Mount	I-Line	
Circuit Breaker Communication Module (BCM) (Modbus)	E1	1778.00	S64205	S64205	S64207	S64206	S64205	S64205	S64205	2805.00
Two Programmable Contacts Module (M2C)	V	1248.00	S64273	S64273	S64273	S64273	S64273	S64273	S64273	1248.00
Six Programmable Contacts Module (M6C)	W	1599.00	S64204	S64204	S64204	S64202	S64204	S64204	S64201	1665.00
External Voltage Sensing (EVS)	YV	290.00	S64203	S64203	S64210	S64209	S64210	S64208	S64208	330.00

New!

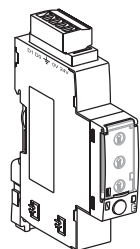

Modbus Interface Module (IFM)

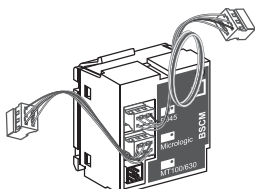

Breaker Status and Control Module (BSCM)

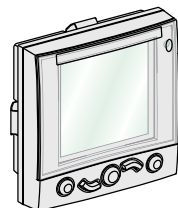

Front Display Module (FDM)

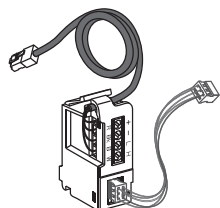

NSX Cord for Modbus Communications

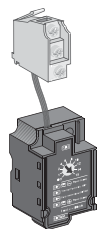

SDTAM Module (Remote indication relay for motor applications)

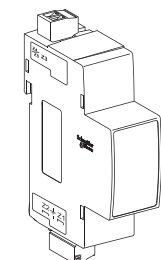

ZSI Interface Module (Connects PowerPact H/J/L circuit breakers to PowerPact P/R and Masterpact NT/NW circuit breakers)

Table 7.118: Trip Unit Field-Installable Accessories for H-, J-, and L-Frame Circuit Breakers

Description	Factory-Installed		Field-Installable Kit Cat. No.	
	Cat. No. Suffix	\$ Price Adder	Cat. No.	\$ Price
External Accessories				
Modbus Interface Module IFM▲	—	—	STRV00210	1000.00
Stacking Connections for IFM (10)	—	—	TRV00217	946.00
Front Display Module FDM121▲	—	—	STRV00121	1500.00
FDM Mounting Accessory (Dia. 22 mm)	—	—	TRV00128	26.00
Isolated Modbus Repeater Module	—	—	STRV00211	1508.00
ZSI Interface Module	—	—	S434212	975.00
Internal Accessories				
NSX Cord ■ (for Modbus Communication)	L = 1.3 m	EA	S434201	480.00
	L = 3 m	EB	S434202	500.00
BSCM (Breaker Status and Control Module) with NSX Cord■	L = 1.3 m	EGΔ	S434201BS	1480.00
	L = 3 m	EHΔ	S434202BS	1500.00
Replacement BSCM	—	—	S434205	1000.00
NSX Cord for V > 480 Vac■	L = 1.3 m	ED	S434204	2400.00
	L = 3 m	EE	S434303	2500.00
BSCM with NSX Cord for V > 480 Vac■	L = 1.3 m	EKΔ	S434204BS	3400.00
	L = 3 m	ELΔ	S434303BS	3500.00
24 Vdc Terminal Block	—	—	S434210	400.00
SDTAM 24/415 Vac/dc Module♦	—	—	S429424	928.00
SDX Module 24/415 Vac/dc★	—	—	S429532	1517.00

- ▲ Require NSX Cord
- Installation requires IFM (STRV00210) for Modbus communication and/or FDM (STRV00121) for external display
- ♦ Remote indication relay for motor applications
- ★ Remote indication relay
- ▼ For proper selection, see catalog 0611CT1001.
- Δ If using with motor operator requires communicating motor operator (suffix NC).

Table 7.119: Wire Harness□ and ULP Cords for H-, J-, and L-Frame Circuit Breakers

Description	Factory-Installed		Field-Installable Kit Cat. No.	
	Cat. No. Suffix	\$ Price Adder♦	Cat. No.	\$ Price
ZSI Wire Harness, H/J Frame	YH3	237.00	S434300	197.00
ZSI Wire Harness, L-Frame	YH3	237.00	S434301	197.00
ENCT Wire Harness	YH2	237.00	S434302	197.00
OF Wire Harness	YH1	237.00	S434500	197.00
SD/SDE Wire Harness	YH1	237.00	S434501	197.00
SDx/SDTAM Wire Harness	YH1	237.00	S434502	197.00
MN Wire Harness	YH1	237.00	S434503	197.00
MX Wire Harness	YH1	237.00	S434504	197.00
24 Vdc Terminal Block Wire Harness★	YH1	237.00	S434505	197.00
Motor Operator Wire Harness	YH1	237.00	S434506	197.00
Communicating Motor Operator Wire Harness	YH1	237.00	S434507	197.00
NSX Wire Harness★	YH1	237.00	S434508	197.00
ENCT and ZSI Wire Harness	YH4	237.00	—	—
10 RJ45 Connectors female/female	—	—	TRV00870	195.00
10 ULP Line Terminations	—	—	TRV00880	130.00
10 RJ45/RJ45 Male Cords	L = 0.3 m	—	TRV00803	200.00
	L = 0.6 m	—	TRV00806	320.00
5 RJ45/RJ45 Male Cords	L = 1 m	—	TRV00810	195.00
	L = 2 m	—	TRV00820	300.00
	L = 3 m	—	TRV00830	500.00
1 RJ45/RJ45 Male Cord	L = 5 m	—	TRV00850	155.00

- Wire harness is required for I-Line applications, optional for unit-mount applications
- YH1 = all installed accessories but ZSI and ENCT
- YH2 = ENCT and all installed accessories
- YH3 = ZSI and all installed accessories
- YH4 = ZSI, ENCT and all installed accessories
- ♦ Price adder is for each accessory ordered.
- ★ I-Line wire harness is included for communication network accessories. Optional wire harness for unit mount requires YH1 suffix.

7 MINIATURE AND MOLDED CASE CIRCUIT BREAKERS



Masterpact NT



Masterpact NW

The Masterpact universal power circuit breaker offers a family of circuit protection products meeting the most common world standards, ANSI, UL and IEC. The basic design platform for each is common. The final result is UL, ANSI and IEC circuit breakers with the same basic external dimensions, features and accessories.

Full-Featured Performance

- Complete product offering up to 200 k AIR without fuses
- Circuit breakers tested to show arc flash hazard risk category as referenced by NFPA70E
- 800 A to 6000 A frames, fixed and draw-out
- Rated for AC voltage systems through 600 V (635 V ANSI)
- Short-time withstand ratings up to 100 kA
- Cradle position indicator: connected, test and disconnected
- Simple, visual contact wear indicators
- Full complement of field-installable accessories common to all standards
- Four interchangeable Micrologic trip units to choose from
- Available PowerLogic™ based power metering and monitoring capabilities
- Available protective relay functions as defined by ANSI C37.2 and C37.90

The following charts show the Masterpact NW and NT ratings for ANSI and UL 489. See Pricing Guide 0613PL0001 and Catalog 0613CT0001.

Table 7.120: Masterpact NW Circuit Breaker Ratings

Standard	ANSI C37 Certified/UL 1066 Listed																UL 489 Listed																									
	800-1600 A						2000 A				3200/4000 A△				4000/5000 A				800/1200/1600/2000 A				2500/3000 A		4000/5000/6000 A																	
Frame Rating	N1		H1		H2		H3		L1□		L1F□		H1		H2		H3		L1□		H2		H3		L1□		N		H		L□		LF□		H		L□		H		L□	
Interrupting Current (kA RMS) 50/60 Hz	240 Vac		42	65	85	100	200	200	65	85	100	200	200	65	85	100	200	85	100	200	65	100	200	200	100	200	100	200	200	100	200	100	200	100	200	100	200	100	200	100	200	
	480 Vac		42	65	85	100	200	200	65	85	100	200	200	65	85	100	200	85	100	200	65	100	200	200	100	200	100	200	100	200	100	200	100	200	100	200	100	200	100	200	100	200
	600 Vac		42	65	85	85	130	130	65	85	85	130	130	65	85	85	130	85	85	130	85	85	130	50	85	100	100	85	100	85	100	85	100	85	100	85	100	85	100	85	100	85
Short-time Withstand Current (kA RMS)	42		65	85	85	30	22	65	85	85	30	22	65	85	85	100	85	85	100	42▲	65▲	30▲■	22	65	65	85	85	100	—	—	—	—	—	—	—	—	—	—	—	—	—	—
Built-in Instantaneous Override (kA RMS ±10%)	◆		◆	◆	85	35◆	24	—	—	85	35	24	—	—	85	117	—	—	117	40	40	35▲■	24	65	65	75	75	75	—	—	—	—	—	—	—	—	—	—	—	—	—	
Close and latch rating (kA RMS)	42		65	40	40	25	22	65	40	40	25	22	65	40	40	25	22	65	40	40	85	75	40	40	40	40	40	40	40	40	40	40	40	40	40	40	40	40	40	40	40	
Tested to show the arc flash hazard risk category as referenced by NFPA70E	—		—	—	—	—	—	—	—	—	—	—	—	—	—	—	—	—	—	—	—	—	—	—	—	—	—	—	—	—	—	—	—	—	—	—	—	—	—	—	—	—
Breaking time	25-30 ms with no intentional delay (9 ms for L1, L1F, L and LF)																																									
Closing time	70 ms																																									
Sensor Rating	100-250 A 400-800 A 800-1600 A						1000-2000 A				1600-3200 A				2000-4000 A 2500-5000 A				100-250 A 400-800 A 600-1200 A 800-1600 A 1000-2000 A				1200-2500 A 1600-3000 A		2000-4000 A 2500-5000 A 3000-6000 A																	
Endurance Rating (C/O Cycles) With No Maintenance	Mechanical		12,500						10,000				10,000				5k				5,000				12,500▼		10,000		5,000													
	Electrical		2800						1,000				1,000				1k				1,000				2800▼		1,000		1,000													

- ▲ 24 kA RMS for 800 A circuit breaker frame with 100 A or 250 A sensor.
- 65 kA RMS for 2000 A.
- ◆ None except 24 kA RMS for 800 A circuit breaker frame with 100 A or 250 A sensor.
- ★ 40 kA RMS for 2000 A.
- ▼ The endurance rating for 2000 A, N/H/L/LF is 10,000 for mechanical and 1000 for electrical.
- △ 4000 A standard width circuit breaker is not available in L1 interrupting rating code or drawout construction (fixed mounting only).
- Drawout mounted only.

Table 7.121: Masterpact NT Circuit Breaker Ratings

Standard	ANSI C37 Certified/UL 1066 Listed						UL 489 Listed																															
	800 A						800 A						1200 A						1600 A◇																			
Frame Rating	N1						N		H		L1		L		LF★		N		H		L1		L		LF★		N		H		L1		L					
Interrupting Current (kA RMS) 50/60 Hz	240 Vac		42				50	65	100	200	200	50	65	100	200	200	50	65	100	200	200	50	65	100	200	50	65	100	200	50	65	100	200					
	480 Vac		42				50	50	65	100	100	50	50	65	100	100	50	50	65	100	100	50	50	65	100	100	50	50	65	100	50	65	100	100				
	600 Vac		—				35	50	—	—	—	35	50	—	—	—	35	50	—	—	—	35	50	—	—	—	35	50	N/A	N/A	—	—	—	—				
Short-time Withstand Current (kA RMS)	42		35				35	35	10	10	10	35	35	10	10	10	35	35	10	10	10	35	35	10	10	10	35	35	10	10	10							
Built-in Instantaneous Override (kA RMS ±10%)	—		—				40	40	10	10	10	40	40	10	10	10	40	40	10	10	10	40	40	10	10	10	40	40	10	10	10							
Close and latch rating (kA RMS)	40		25				25	25	10	10	10	25	25	10	10	10	25	25	10	10	10	25	25	10	10	10	25	25	10	10	10							
Tested to show the arc flash hazard risk category as referenced by NFPA70E	—		—				—	—	—	—	—	Yes	—	—	—	—	—	—	—	—	—	—	—	—	—	—	—	—	—	—	—	—	—	—	—	—	—	—
Breaking time	25-30 ms with no intentional delay						25-30 ms with no intentional delay (9 ms for L and LF)																															
Closing time	< 50 ms																																					
Sensor Rating	100-250 A 400-800 A						100-250 A 400-800 A						600-1200 A						800-1600 A																			
Endurance Rating (C/O Cycles) With No Maintenance	Mechanical		12,500						12,500						12,500						12,500																	
	Electrical		2800						2800						2800						2800																	

- ◇ Fixed-mounted only.
- ★ Drawout mounted only.



NWMPPRT

Table 7.122: Masterpact NW/NT Circuit Breaker Remote Racking

Description	Cat. No.	\$ Price
Masterpact NW/NT Remote Racking Devices▼	NWNTMPRRT	32000.00
Masterpact NW Remote Racking Device▼	NWMPRRT	21500.00
Masterpact NT Remote Racking Device▼	NTMPRRT	21500.00
Mounting Bracket Kit for NW Remote Racking (contains 10 mounting brackets)◉	S47100	215.00
Mounting Bracket Kit for NT Remote Racking (contains 10 mounting brackets)◉	S47104	215.00
Control Unit for NW Remote Racking◉	S47101	3650.00
30 ft Control Cable for NW Remote Racking◉	S47102	620.00
Drive Shaft for NW Remote Racking◉	S47103	290.00
Drive Shaft for NT Remote Racking◉	S47105	290.00

- ▼ Unit comes with 10 mounting brackets included.
- ◉ For replacement only.

GC-200 Ground-Fault Relay System

The GC-200 Ground-fault relay system protects a grounded distribution system from low-level arcing ground faults. The system includes the GC-200 relay, a sensor (current transformer), and optional GC DSP display and is used with a bolted pressure switch or circuit breaker to open a circuit upon detection of a ground fault. (Replaces GC-100 relay.)

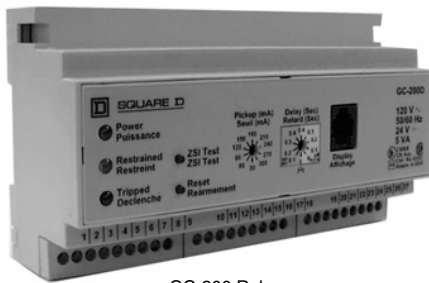

GC-200 Relay

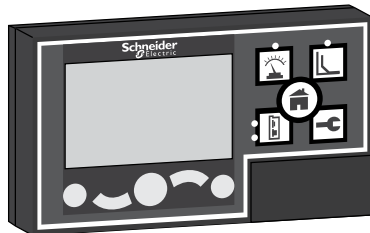

GC2DSP Display



T3B Toroid Sensor



GT912 Rectangular Sensor

GC-200 Relay Features

- Five models with sensitivities suitable for main, feeder, or branch circuits
- Ten adjustable pickup settings for each model
- Small, non-metallic enclosure mounts on DIN rail
- 10 A and 5 A output contacts for trip and alarm
- Zone-selective interlocking (ZSI) to optimize coordinated systems
- I²t inverse time characteristics

GC2DSP Display (Optional)

- Real-time display of ground-fault values
- Also recalls ground-fault at last trip or at maximum since reset
- Allows remote testing or resetting of the relay
- LCD back-lit display
- Surface mounts over panel meter cutout
- Fine adjust pickup settings (D and E versions only)

Sensors

- Zero sequence sensing current transformers for all phases and neutral
- Several sizes of toroids and rectangular CTs
- Many are split-core or open frame for ease of installation

Table 7.123: Ground-Fault Relay

Cat. No.	Description	Specifications	\$ Price
GC200C	Ground-fault relay	3.0 A–30.0 A	2960.00
GC200D		30.0 A–300 A	2960.00
GC200E		120 A–1200 A	2960.00
GC2DSP	Display module		948.00
VW3A1104R10	Display cable ■	1 m	35.00
VW3A1104R30		3 m	35.00
VW3A1104R50		5m	35.00
VW3A1104R100		10 m	45.00
GC2ADAPTER	Adapter plate	To replace GSDSP with GC2DSP	59.00

▲ One GC12 twelve foot cable is included with GCDSP display modules.
■ Discout schedule CP4C

Table 7.124: GC-200 Relay Settings

Cat. No.	Adjustable Pickup Settings (in Amperes)									
	3	6	9	12	15	18	21	24	27	30
GC200C	3	6	9	12	15	18	21	24	27	30
GC200D	30	90	90	120	150	180	210	240	270	300
GC200E	120	240	360	480	600	720	840	960	1080	1200

Table 7.125: GC-200 Sensors

Relay Cat. No.	Sensor Cat. No.	Type	CT Ratio	Window Dimensions		\$ Price
				in	mm	
GC200C GC200D	T2A	Toroid	1000:1	1.875 dia.	48 dia.	704.00
	T3A	Toroid		2.75 dia.	70 dia.	774.00
	T6A	Toroid		5.75 dia.	146 dia.	774.00
	T6AS	Toroid, split-core		5.75 dia.	146 dia.	1326.00
	T9A	Toroid		8.75 dia.	222 dia.	1106.00
	R713A R417A R826A	Rectangular		7.5 x 13.5	191 x 343	3063.00
		4.25 x 17.625	108 x 448	3650.00		
		8 x 26.5	203 x 674	4446.00		
All "A" type sensors above, plus:						
	RZ511	Rectangular, Open Frame	1000:1	4.5 x 11	114 x 280	1914.00
	RZ521		1000:1	4.5 x 21	114 x 534	2255.00
	RZ531		1000:1	4.5 x 31	114 x 788	2706.00
	RZ535		1000:1	4.5 x 35	114 x 890	2834.00
GC200E	RZ1011	Rectangular, Open Frame	1000:1	10.5 x 11	267 x 280	2450.00
	RZ1021		1000:1	10.5 x 21	267 x 514	3075.00
	RZ1031		1000:1	10.5 x 31	114 x 788	4233.00
	GT912	Rectangular, Open Frame	600:1	5.5 x 8.5	140 x 216	1769.00
	GT918		600:1	5.5 x 14.5	140 x 368	2058.00
	GT930		600:1	5.5 x 26.5	140 x 673	2766.00
	GT1218	Rectangular, Open Frame	600:1	8.5 x 14.5	216 x 368	2645.00
	GT1224		600:1	8.5 x 20.5	216 x 521	2901.00
	GT1230		600:1	8.5 x 26.5	292 x 673	3246.00
	GT1327		Rectangular, Open Frame	600:1	9.5 x 24	241 x 610
	GT1330	600:1		9.5 x 27	241 x 686	3219.00
	GT1530	Rectangular, Open Frame	600:1	11.5 x 26.5	292 x 673	3726.00

7 MINIATURE AND MOLDED CASE CIRCUIT BREAKERS

Vigirex™ Ground-Fault Relay System

The Vigirex ground-fault relays, with associated sensors (current transformers), measure the residual current in an electrical installation to detect levels which may be damaging. When used for protection, they cause an associated circuit breaker or switch to interrupt the supply of power to the protected system. They may also be used for monitoring only, with output to an alarm. The product line includes fixed sensitivities from 30 mA to 1 A and adjustable sensitivities up to 30 A.

The Vigirex relays may be easily mounted on DIN rail or may be panel mounted in a meter cutout. Sensors for conductors range from a little more than an inch diameter toroids, to large rectangular sensors measuring 6 x 18 inches. The compact size of the relay and its sensor make it ideal for protection of OEM equipment as well as branch circuits.



RH99M



RH99P



PA50



SA200

Table 7.126: Vigirex Ground-Fault Relays (UL 1053 Listed)

Model	Delay	Reset	Control Voltage	Sensitivity	Cat. No.	\$ Price
DIN Rail Mounted						
RH10M	Instantaneous	Manual	12–24 Vac/12–48 Vdc	30 mA 100 mA 300 mA 500 mA 1 A	56300 56302 56305 56306 56307	1988.00
			110–130 Vac	30 mA 100 mA 300 mA 500 mA 1 A	56320 56322 56325 56326 56327	
			220–240 Vac	30 mA 100 mA 300 mA 500 mA 1 A	56330 56332 56335 56336 56337	
RH21M	Instantaneous or 60 msec (2 settings)	Manual	12–24 Vac/12–48 Vdc 110–130 Vac 220–240 Vac	30 mA▲ or 300 mA (2 settings)	56360 56362 56363	2363.00
RH99M	Adjustable (9 settings): 0, 0.06, 0.15, 0.23, 0.31, 0.5, 0.8, 1.0, 4.5 sec	Manual	12–24 Vac/12–48 Vdc 110–130 Vac 220–240 Vac	Adjustable, (9 settings): 0.03▲, 0.1, 0.3, 0.5, 1, 3, 5, 10, 30 A	56370TD 56372TD 56373TD	2700.00
		Automatic	12–24 Vac/12–48 Vdc 110–130 Vac 220–240 Vac		56390TD 56392TD 56393TD	
Panel Mounted						
RH10P	Instantaneous	Manual	12–24 Vac/12–48 Vdc	30 mA 100 mA 300 mA 500 mA 1 Amp	56400 56402 56405 56406 56407	2063.00
			110–130 Vac	30 mA 100 mA 300 mA 500 mA 1 Amp	56420 56422 56425 56426 56427	
			220–240 Vac	30 mA 100 mA 300 mA 500 mA 1 A	56430 56432 56435 56436 56437	
RH21P	Instantaneous or 60 msec (2 settings)	Manual	12–24 Vac/12–48 Vdc 110–130 Vac 220–240 Vac	30 mA▲ or 300 mA (2 settings)	56460 56462 56463	2438.00
RH99P	Adjustable (9 settings): 0, 0.06, 0.15, 0.23, 0.31, 0.5, 0.8, 1.0, 4.5 sec	Manual	12–24 Vac/12–48 Vdc 110–130 Vac 220–240 Vac	Adjustable (9 settings): 0.03▲, 0.1, 0.3, 0.5, 1, 3, 5, 10, 30 A	56470TD 56472TD 56473TD	2813.00
		Automatic	12–24 Vac/12–48 Vdc 110–130 Vac 220–240 Vac		56490TD 56492TD 56493TD	

▲ 30 mA is instantaneous only, except for RH99M and RH99P models. Their suffix TD indicates time delay at 30 mA. For models with no time delay (IEC compliant) consult catalog 0972CT0401.

Table 7.127: Sensors for Vigirex Ground-Fault Relays

Sensors	Type	Maximum Current♦	Inside Diameter		Cat. No.	\$ Price
			in.	mm		
Closed Toroids, Type A	TA30	65 A	1.18	30	50437	375.00
	PA50	85 A	1.97	50	50438	488.00
	IA80	160 A	3.15	80	50439	615.00
	MA120	250 A	4.72	120	50440	833.00
	SA200	400 A	7.87	200	50441	1253.00
	GA300	630 A	11.81	300	50442	2295.00
Vigirex Sensor Iron Rings (Optional)	TA30	65 A	0.79	20	56055	56.00
	PA50	85 A	1.58	40	56056	59.00
	IA80	160 A	2.76	70	56057	62.00
	MA120	250 A	4.33	110	56058	83.00
Split toroids, Type OA	POA■	85 A	1.81	46	50485	1718.00
	GOA■	250 A	4.33	110	50486	3015.00
Rectangular Sensors	280 x 115	1600 A	11.02 x 4.53	280 x 115	56053	5333.00
	470 x 160	3200 A	18.50 x 6.30	470 x 160	56054	7088.00

■ POA and GOA are not UL recognized
♦ Use as a guideline for sizing wire through sensor.

7 MINIATURE AND MOLDED CASE CIRCUIT BREAKERS



Micrologic™ Add-on Ground-Fault Module (GFM)

The Micrologic ground-fault module (GFM) is a UL Listed circuit breaker accessory for equipment protection. It is a combination ground-fault relay and ground-fault sensing device.

Micrologic Add-on Ground-fault Module Features:

- A shunt trip may be field-installed in the HD, HG, HJ, HL, JD, JG, JJ and JL circuit breakers.
- Shunt trip S29382 (12 Vdc) for circuit breaker may be factory- installed (suffix SN) or field-installed
- Adjustable ground-fault pickup levels
- Adjustable ground-fault time delays
- Integral ground fault push-to-test feature and ground-fault indicator
- All GFMs are supplied for I-Line™ mounting, easily convertible to unit mount by removing the I-Line brackets
- Optional neutral current transformer for 3-phase 4-wire applications. Refer to instructions for proper installation
- Zone-selective interlocking capability is standard with upstream Micrologic trip system circuit breakers. The GFM can also be zone interlocked with the GC ground-fault system by using a restraint interface module. See Supplemental Digest page 3-33.
- 120 Vac control power is required for integral test feature. Meets NEC 230-95(c)

NOTE: Ground-fault modules cannot be used for alarming only.

Table 7.128: Module/Enclosure Selection Chart▲

Companion Circuit Breaker Prefix	Cat. No. ■	I-Line Switchboard	Ground-fault Pickup Adjustment Range	GFM \$ Price
HD, HG, HJ, HL	GFM150HD	LA	20–100 A	4250.00
JD, JG, JJ, JL	GFM250JD	LA	40–200 A	4250.00
Accessories				
H & J	GFM25CT	Optional Neutral Current Transformer (required for 4-wire loads)		375.00

- ▲ At 250 A, the GFM250JD can be used with 80% rated circuit breakers only.
- See Supplemental Digest page 3-37 for additional GFMs.

Earth Leakage Module (ELM) for PowerPact H- and J-Frame MCCBs

The Earth Leakage Module (ELM) is an add-on module which, when connected to a PowerPact H- or J-frame MCCB, provides low-level ground-fault sensing and ground-fault relay functions.

Because these ELMs are highly sensitive (30 mA to 3 A), they provide much greater protection than GFMs (20 Amps to 200 Amps sensitivity). The ELMs provide greater protection of control circuits and other sensitive equipment. The associated circuit breaker must have a 48 Vdc shunt trip, which may be field-installed (kit S29392) or factory-installed (suffix –SP) in the H- or J-Frame circuit breaker.

Add-on Earth Leakage Module (ELM) Features:

- Adjustable ground-fault pickup levels as low as 30 mA
- Adjustable ground-fault time delays from instantaneous to 500 msec (Time delay can be applied to the 30 mA setting)
- Integral ground fault push-to-test feature
- Ground-fault indicator (LED for local status; contacts for remote indication)
- All ELMs are supplied for I-Line™ mounting and are easily convertible to unit-mount by removing the I-Line brackets
- Three poles; 240 to 600 Vac maximum: 3-wire applications only (no neutral)
- Line-power obtained through internal bus to provide power for electronics, shunt trip, and integral test feature.
- A shunt trip is required in the circuit breaker; it may be field-installed or factory-installed in the PowerPact H and J circuit breakers.
- UL 1053 – Ground-fault Sensing and Relaying Equipment



I-Line™ J-Frame with ELM installed

Table 7.129: ELM Selection Chart♦

Companion Circuit Breaker★	Enclosure Space Required I-Line Switchboard	Pick-Up Adjustment Range	Catalog Number	\$ Price	
Prefix	Size				
HD, HG, HJ, HL	15–150 A	LA	30 mA–3 A	ELM150HD	4500.00
JD, JG, JJ, JL	150–250 A	LA	30 mA–3 A	ELM250JD	4650.00

- ♦ At 250 A, the ELM250JD can be used with 80% rated circuit breakers only.
- ★ For Factory Installation of ELM Module: For termination designation (3rd letter of catalog number) use ONLY "M". Add factory installed 48 Vdc shunt trip (suffix SP) to breaker plus suffix VL or VM. SP – \$717. adder. Use VL for H frame – \$4736. adder. Use VM for J frame – \$4886. adder. Plus the List Price of the H or J breaker.

7 MINIATURE AND MOLDED CASE CIRCUIT BREAKERS

Miniature and Molded Case Circuit Breakers

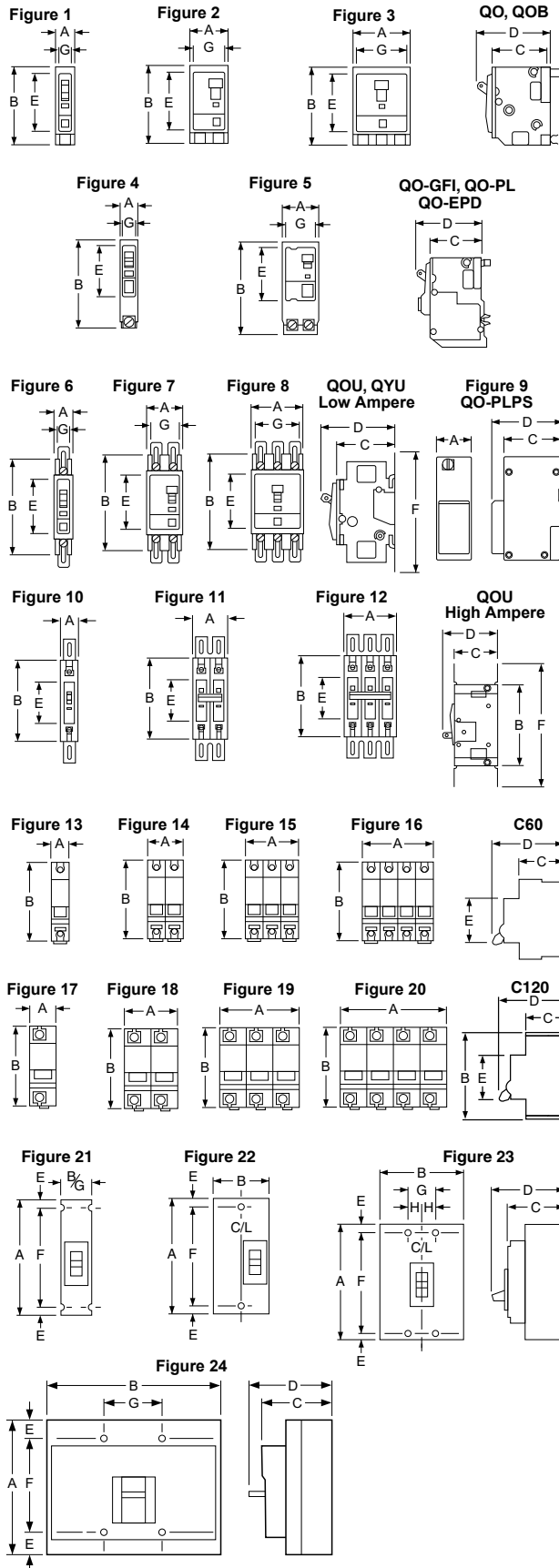

Table 7.130: QO™, QOU, Multi 9™ Circuit Breakers

Circuit Breaker Cat. No. Prefix	Poles	Fig. No.	Dimensions—Inches						
			A	B	C	D	E	F	G
QO, QOB	1	1	0.75	3.00▲	2.31	2.91	2.25	—	0.59
	2	2	1.50	3.00▲	2.31	2.91	2.25	—	1.34
	3	3	2.25	3.00▲	2.31	2.91	2.25	—	2.09
QOB-VH 150 A QOB-VH 110–150 A	2	2	3.0	5.72	2.53	4.90	3.78	—	2.85
	3	3	4.50	5.72	2.53	4.90	3.78	—	4.35
QO-PL QO-GFI QO-EPD	1	4	0.75	4.12■	2.31	2.91	2.25	—	0.59
	2	5	1.50	4.12■	2.31	2.91	2.25	—	1.34
	3	5	2.25	4.12■	2.31	2.91	2.25	—	2.09
QOU QYU Low Ampere	1	6	0.75	4.05♦	2.38	2.98	2.25	5.00★	0.62
	2	7	1.50	4.05♦	2.38	2.98	2.25	5.00★	1.37
	3	8	2.25	4.05★	2.38	2.98	2.25	5.00△	2.12
QOU High Ampere	1	10	0.75	4.45	2.37	2.96	2.25	6.78	—
	2	11	1.50	4.45	2.37	2.96	2.25	6.78	—
	3	12	2.25	4.45	2.37	2.96	2.25	6.78	—
Multi 9™ C60	1	13	0.71	3.19	1.73	2.76	1.77	—	—
	2	14	1.42	3.19	1.73	2.76	1.77	—	—
	3	15	2.13	3.19	1.73	2.76	1.77	—	—
	4	16	2.84	3.19	1.73	2.76	1.77	—	—
QO-PLPS Power Supply	2	9	1.45	4.35	2.42	3.11	—	—	—

- ▲ 35–70 A is 3.12 in; 80–100 A 2P and 70–100 A 3P are 3.50 in.
- QO-PL is 4.55 in.
- ♦ 80–100 A 1P and 80–125 A 2P are 4.45 in.
- ★ 80–100 A 1P and 80–125 A 2P are 6.78 in.
- ▼ 70–100 A 4.45 in.
- △ 70–100 A is 6.78 in.

Table 7.131: QB, QD, QG, QJ, Q4, FA, FI, KI, LA, LI, LX, LXI Circuit Breakers

Circuit Breaker Cat. No. Prefix	Poles	Fig. No.	Dimensions—Inches							
			A	B	C	D	E	F	G	H
QB, QD, QG, QJ	2	22	6.47	3.00	3.02	3.93	□	4.25	—	—
	3	23	6.47	4.50	3.02	3.93	□	4.25	1.50	0.75
FAL, FHL	1	21	6.00	1.50	3.16	4.13	0.44	5.13	1.50	—
	2	22	6.00	3.00	3.16	4.13	0.44	5.13	—	—
	3	23	6.00	4.50	3.16	4.13	0.44	5.13	1.50	0.75
FIL, KIL	2 & 3	23	8.00	4.50	3.66	4.75	0.44	7.13	1.50	0.75
Q4L, LAL, LHL	2 & 3	23	11.00	6.00	4.06	5.84	0.88	9.25	2.00	1.00
LIL, LXIL	2 & 3	24	11.86	7.50	5.48	6.74	0.55	10.75	2.50	—

□ Dimensions E are 1.59 in at ON end and 0.63 in at OFF end.

Table 7.132: Shipping Weights

Frame Size	Approx. Shipping Weight (Lbs.)	Frame Size	Approx. Shipping Weight (Lbs.)
FAL, FHL 1P	2	KIL	9
FAL, FHL 2P	3	LAL, LHL	15
FAL, FHL 3P	5	LIL LXIL	25
FIL	8	Q4L	15
QB, QD, QG, QJ	4		

◇ All weights are for 3P circuit breakers unless otherwise noted.

7 MINIATURE AND MOLDED CASE CIRCUIT BREAKERS

Figure 25

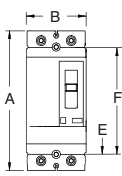

Figure 26

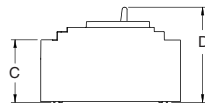
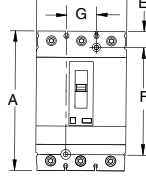

Figure 27

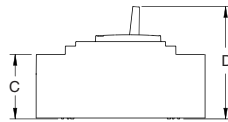
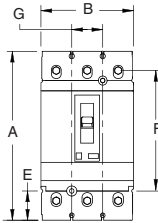

Figure 28

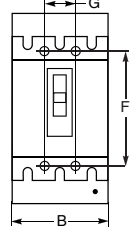
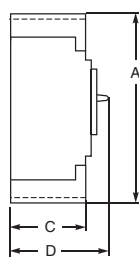

Figure 29

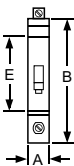

Figure 30

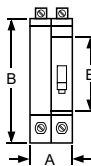

Figure 31

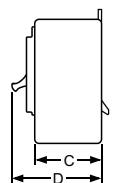
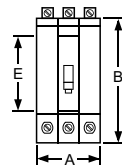

Figure 32

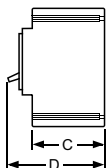
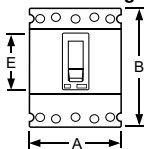

Figure 33

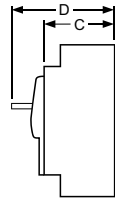
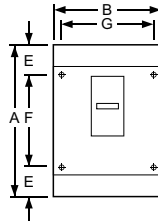

Figure 34

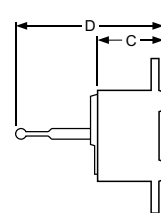
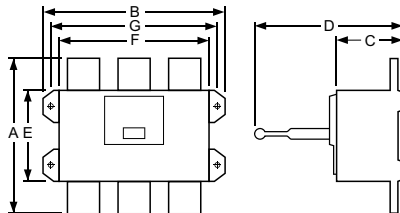

Table 7.133: HD, HG, HJ, HL, HR, JD, JG, JJ, JL, JR, LG, LJ, LL, and LR Circuit Breakers

Circuit Breaker Cat. No. Prefix	No. of Poles	Fig. No.	Dimensions — Inches						
			A	B	C	D	E	F	G
HD, HG, HJ, HL, HR	2▲	25	6.40	2.74	2.87	4.36	0.74	4.92	—
	3	26	6.40	4.12	2.87	4.36	0.74	4.92	1.38
JD, JG, JJ, JL, JR	3	27	7.52	4.12	2.87	5.00	1.30	4.92	1.38
LG, LJ, LL, LR	3	28	13.38	5.51	3.75	6.61	2.22	7.87	1.77

▲ Only HD and HG are in 2P module, HJ, HL and HR 2P are in 3P module.

Table 7.134: ED, EG, and EJ Circuit Breakers

Circuit Breaker Cat. No. Prefix	No. of Poles	Fig. No.	Dimensions — Inches				
			A	B	C	D	E
ED, EG, EJ	1	29	0.98	5.66	3.09	4.05	3.32
ED, EG, EJ	2	30	1.96	5.66	3.09	4.05	3.32
ED, EG, EJ	3	31	2.94	5.66	3.09	4.05	3.32
GJ	3	32	3.54	4.72	2.76	3.94	2.20

Table 7.135: MG, MJ, PG, PJ, PL, RG, RJ and RL Circuit Breakers

Circuit Breaker Cat. No. Prefix	No. of Poles	Fig. No.	Dimensions — Inches						
			A	B	C	D	E	F	G
MG, MJ (800 A and below)	2, 3	33	12.86	8.27	5.77	8.05	2.49	7.87	7.83
PG, PJ, PK, PL (1000-1200 A)	2, 3	33	16.16	8.27	5.77	8.05	4.19	7.87	7.83
RG, RJ, RL	2, 3	34	16.24	16.54	6.63	14.49	8.73	14.25	15.35

Table 7.136: Shipping Weights▲

Frame Size	Approx. Shipping Weight (Lbs.)	Frame Size	Approx. Shipping Weight (Lbs.)
HD, HG, HJ, HL 2P	4	JD, JG, JJ, JL, JR	5
HD, HG, HJ, HL, HR 3P	5	LD, LG, LJ, LL, LR	14
ED, EG, EJ 1P	2	MG, MJ	29
ED, EG, EJ 2P	3	PG, PJ, PK, PL	32
ED, EG, EJ 3P	4	RG, RJ, RK, RL (Without RLTB)	52

▲ All weights are for 3P circuit breakers unless otherwise noted.



FA100S



FA100RB



FA100DS

- Circuit breaker enclosures are UL Listed, CSA Certified and are suitable for use as service equipment except as footnoted.
- The short circuit rating of an enclosed circuit breaker is equal to the rating of the circuit breaker installed, except as footnoted.
- Circuit breakers are ordered and shipped separately for field installation.
- For enclosure accessories and dimensions refer to page 7-58.
- See Supplemental Digest page 3-35 for NEMA 7 and 9 enclosures for FAL circuit breakers.

Table 7.137: Circuit Breaker Enclosures

Circuit Breaker			Enclosure					
Cat. No. Prefix	Rating	Poles	Cat. No.	\$ Price	Cat. No.	\$ Price	Cat. No.	\$ Price
			NEMA 1 Flush		NEMA 1 Surface		NEMA 3R▲	
FAL, FHL, FCL	15–100 A	1, 2, 3	FA100F	189.00	FA100S	189.00	FA100RB	500.00
QBL, QDL, QGL, QJL	100–200 A	2	—	—	Q22200NS■	176.00	Q22200NRB■	380.00
	100–225 A	2, 3	Q23225NF■	218.00	Q23225NS■	218.00	Q23225NRB■	417.00
HDL, HGL, HJL, HLL	15–150 A	2, 3	J250F◆★★	285.00	J250S◆★★	285.00	J250R◆★★	840.00
JDL, JGL, JJL, JLL	150–250 A	2, 3	—	—	—	—	—	—
HDL	15–100 A	3	—	—	HD100S△◆★	285.00	—	—
JDL	150–250 A	3	—	—	JD250S★◆△◆▼	285.00	—	—
LAL, LHL, Q4L	125–400 A	2, 3	LA400F	356.00	LA400S	356.00	LA400R	1655.00
LAL	125–400 A	3	—	—	LA400LS◆★w	356.00	—	—
MGL, MJL, PGL, PJL, PKL, PLL	300–800 A	2, 3	—	—	M800S▼◆	783.00	M800R▼◆	2159.00
PGL, PJL, PKL, PLL	250–1200 A	2, 3	—	—	P1200S◆	1260.00	P1200R◆	2790.00
			NEMA 4, 4X, 5, 3, 3R Stainless Steel (Hubs—See page 3-9)		NEMA 12/3R, 12K (Hubs—See page 3-9)			
					With Knockouts (NEMA 12K)		Without Knockouts (NEMA 12/3R, 5)	
FAL, FHL, FCL	15–100 A	1, 2, 3	FA100DS	1431.00	FA100A	351.00	FA100AWK	335.00
HDL, HGL, HJL, HLL	15–150 A	2, 3	J250DS◆★★	3405.00	—	—	J250AWK◆★★	582.00
JDL, JGL, JJL, JLL	150–250 A	2, 3	—	—	—	—	—	—
KIL◆, KCL	110–250 A	2, 3	IK250DS	5238.00	—	—	IK250AWK	878.00
LAL, LHL, Q4L	125–400 A	2, 3	LA400DS	5673.00	—	—	LA400AWK	903.00
LEL, LXL, LXIL	100–600 A	3	—	—	—	—	LX600AWK	3728.00
LCL, LIL	300–600 A	2, 3	—	—	—	—	LX600AWK	3728.00
MGL, MJL, PGL, PJL, PKL, PLL	300–800 A	2, 3	M800DS◆	10125.00	—	—	M800AWK◆	2459.00
PGL, PJL, PKL, PLL★	600–1200 A	2, 3	—	—	—	—	P1200AWK◆	5700.00
			Nema 7‡ Cast Aluminum		Nema 9u Cast Aluminum			
JDL, JGL†◆v	150–250 A	2, 3	J225X	4083.00	J225Y	2834.00	—	—

- ▲ Enclosures with NRB or RB suffix have provisions for 3/4 in. through 2-1/2 in. bolt-on hubs in top endwall. Enclosures with R suffix have blank endwalls and require field cut opening. For details and hub catalog numbers see page 3-9.
- Not CSA Certified.
- ◆ Accepts standard rated 80% breakers. Not rated at 100%.
- ★ Maximum short circuit rating is 25 kAIR at 600 Vac, 65 kAIR at 480 Vac, 125 kAIR at 240 Vac.
- ▼ Earth Leakage Module and Ground Fault Module are not compatible with these enclosures.
- △ Maximum short circuit rating is 25 kAIR, 240 Vac.
- Order service ground kit PKOGTA2 if required.
- ◇ Maximum short circuit rating is 18 kAIR, 480 Vac and 240 Vac.
- ★ Copper wire only.
- ▼ When using a CT in the M800S and R enclosure the unit will no longer accommodate a 200% neutral solution.
- ◆ CE certified per IEC60439-1, IP20D, PE type TN-C or TN-S
- * Accepts MGL or MJL standard rated (80%) breakers. Accepts PGL, PJL or PLL circuit breakers rated 80% (1200 A maximum) or 100% rated breakers, (800A maximum).
- ◇ CE certified per IEC60439-1, IP24D, PE type TN-C or TN-S
- ◆ Suitable for rainproof NEMA 3R application by removing drain screw from bottom endwall.
- ◆ CE certified per IEC60439-1, IP56, PE type TN-C or TN-S
- ◆ LEL 100% rated circuit breaker except for 600 A sensor.
- ◆ Short circuit rating is 100 k AIR at 480 Vac maximum.
- ‡ NEMA 7—Indoor Hazardous Locations—Division 1 and 2, Class I, Groups C and D; Class II, Groups E, F, and G; Class III.
- † 80% rated circuit breakers only; SCCR 65 kA @ 240 Vac, 25 kA @ 480 Vac, 18 kA @ 600 Vac.
- Not UL Listed due to wire bending space.
- u NEMA 9—Indoor Hazardous Locations—Division 1 and 2, Class II, Groups E, F, and G; Class III.
- v Has a tapped 2-1/2 in. conduit opening on top and bottom end wall
- w Short circuit current rating is 30 k AIR at 480 Vac.

316 Grade Stainless Steel Circuit Breaker Enclosures—NEMA 3, 3R, 4X, 5 and 12

Type 316 stainless steel circuit breaker enclosures offer superior corrosion resistance to a wider range of chemicals than Type 304 stainless steel enclosures. Type 316 better resists chloride and is often used in marine, waste treatment and transportation applications. Use watertight hubs from Section 3 page 10 of Digest 176. For other accessories reference Table 7.142 and Table 7.143. For dimensional information, reference Table 7.144.

Table 7.138: 316 Grade Stainless Steel Circuit Breaker Enclosures

Circuit Breaker _y			NEMA 3, 3R, 4X, 5 and 12	
Cat. No. Prefix...Suffix	Ampere Rating	Poles	Enclosure Cat. No.	\$ Price
HDL, HGL, HJL, HLL	15–150 A	2, 3	J250SS	4698.00
JDL, JGL, JJL, JLL	150–250 A	2, 3		
MGL, MJL, PGL, PJL	300–800 A	2, 3	M800SS	13972.00
PKL, PLL				

Table 7.139: DC Circuit Breaker Enclosures for MA and MH DC-Rated Circuit Breakers

Circuit Breaker _y			NEMA 1 Surface Enclosure _x	
Cat. No. Prefix...Suffix	Ampere Rating	Poles	Enclosure Cat. No.	\$ Price
MAL, MHL	125–1000 A	2, 3	MA1200S	1355.00

- x UL Listed Only
- y Use 500 Vdc or 250 Vdc rated circuit breakers only.

Accessories Page 7-58
Dimensions Page 7-58

7 MINIATURE AND MOLDED CASE CIRCUIT BREAKERS

Table 7.140: Enclosures for Walking Beam Manually Operated Mechanical Interlock Circuit Breakers (UL Listed)▲

Circuit Breaker			NEMA 1 Surface■		NEMA 3R ■◆	
Cat. No. Prefix...Suffix	Ampere Rating	Poles	Enclosure Cat. No.	\$ Price	Enclosure Cat. No.	\$ Price
FAL...WB, FHL...WB	15-250 A	2, 3	KA250SWB	1040.00	KA250RWB	1827.00

- ▲ Catalog number in table is enclosure only. For complete installation, the following must be ordered separately: WB Circuit Breakers (qty. 2, Supplemental Digest page 3-27), Walking Beam Assembly (Supplemental Digest page 3-27), Mounting Pan (Supplemental Digest) page 3-27, Neutral (page 7-56) and Service Ground Kit (page 7-58).
- Enclosure has blank top endwall.
- ◆ For applications above 200 A requiring a neutral, use copper wire only.

Enclosed Motor-Operated Molded Case Circuit Breakers

For information on Enclosed Motor-Operated Molded Case Circuit Breakers see the Supplemental Digest page 3-35.

Enclosed Molded Case Switches

For ordering information on molded case switches see page 7-34. For ordering information on enclosed molded case switches, see Supplemental Digest 175 Section 3-36.

Enclosed Walking Beam Mechanical Interlock

NOTE: Contact local Field Office for catalog number prior to quoting or placing an order.

Industrial molded case circuit breakers with walking beam mechanical interlocks are available in NEMA 1 and 3R construction as completely enclosed device. Walking beam mechanical interlock is available manually operated or electrically operated using (2) 120 Vac motor operators. Not UL Listed.

Enclosed walking beam mechanically interlocked circuit breaker.

- Specify circuit breaker catalog numbers
- Specify manually or electrically operated (electrically operated factory installed only)
- Specify enclosure type (NEMA 1 or 3R)
- Specify if neutrals are required. (Same price)

Table 7.141: Enclosed Walking Beam Mechanical Interlock

Circuit Breaker Cat. No. Prefix (Standard Thermal-Magnetic Only)	\$ Price▲			
	Manually Operated		Electrically Operated	
	NEMA 1	NEMA 3R	NEMA 1	NEMA 3R
FAL—240 V 100 A	—	—	5783.00	3675.00
FAL—480 V 100 A	—	—	6311.00	6896.00
FAL—600 V 100 A	—	—	6879.00	7446.00
FHL—600 V 100 A	—	—	8691.00	9407.00

- ▲ Price includes (2) walking beam 3P circuit breakers, walking beam operator and mounting pan, (2) neutrals (if specified), and (2) motor operators (if specified) factory assembled in specified enclosure.
- Not available factory assembled. Refer to page 7-56 for merchandise enclosure.

NOTE: Contact local Field Office for catalog number prior to quoting or placing an order.

Table 7.142: Insulated Groundable Neutral Assembly

Circuit Breaker		Neutral Assembly For Use With						Terminal Lug Data—Total Available (Line plus Load) AWG/kcmil
Cat. No. Prefix	Ampere Rating	NEMA 1 & 3R		NEMA 4, 4X, 5, 12 & 12K		NEMA 7 & 9		
		Cat. No.	\$ Price	Cat. No.	Price	Cat. No.	\$ Price	
FAL, FHL, FCL	100	SN100FA	72.00	SN100FA	72.00	—	—	(4) 14–1/0 Cu or (4) 12–1/0 Al FA060X/Y—(1) 14–6 Cu, plus (1) 14–4 Cu FA100X/Y—(1) 14–3 Cu, plus (1) 14–4 Cu
FAL, FHL, FIL	100	—	—	—	—	100SNA	150.00	
HDL,HGL,HJL,HLL	15–100	SN100FA	72.00	SN100FA	72.00	—	—	(4) 14–1/0 Cu or (4) 12–1/0 Al
HDL,HGL,HJL,HLL	125–150	SN400LA	251.00	SN400LA	251.00	225SNA	198.00	(2) 1–600 or (4) 1–250 Al/Cu, plus (2) 4–300 Al/Cu
JDL,JGL,JJL,JLL	150–250	SN400LA	251.00	SN400LA	251.00	—	—	(2) 1–600 or (4) 1–250 Al/Cu, plus (2) 4–300 Al/Cu
KIL, KCL	225	SN225KA	201.00	—	—	—	—	(2) 4–300 Al/Cu, plus (2) 14–1/0 Al/Cu
	225	—	—	SN225KA	201.00	—	—	(2) 4–300 Al/Cu, plus (2) 14–1/0 Al/Cu
	225	—	—	—	—	—	—	(4) 6–300 Cu
	250	—	—	SN400LA	251.00	—	—	(2) 1–600 or (4) 1–250 Al/Cu, plus (2) 4–300 Al/Cu
FAL...WB, FHL...WB	200	Requires (2) SN20A plus (1) SN20NI link	(2) @\$200.00 ea plus (1) @\$27.60 ea	—	—	—	—	(4) 6–250 Al/Cu, plus (2) 14–1/0 Al/Cu
LAL, LHL, Q4L	400	400SN	248.00	—	—	—	—	(2) 1–600 or (4) 1–250 Al/Cu, plus (2) 4–300 Al/Cu
LAL, LHL, Q4L, LCL, LIL, LXL, LXIL	400	—	—	SN400LA	251.00	—	—	(2) 1–600 or (4) 1–250 Al/Cu, plus (2) 4–300 Al/Cu
LCL, LIL, LXL, LXIL	400	—	—	SNC400LX	1152.00	—	—	(2) 2–600 Cu, plus (2) 6–250 Cu
LCL, LXL, LIL, LXIL, LEL	600	—	—	SNC800LX	1506.00	—	—	(4) 2–600 Cu, plus (1) 2–4/0 Cu
LCL, LXL, LIL, LXIL, LEL	1000★	AL800SN	365.00	—	—	—	—	(6) 3/0–500 Al/Cu, plus (2) 6–250 Al/Cu
LCL, LXL, LIL, LXIL, LEL	1000★	—	—	SN1000MA	365.00	—	—	(6) 3/0–500 Al/Cu, plus (1) 1–4/0 Al/Cu
MGL, MJL	300–800 A	AL800SN	365.00	AL800SN	365.00	—	—	(6) 3/0–500 Al/Cu, plus (2) 6–250 Al/Cu
PGL, PJL, PKL, PLL	250–1200 A	SN1200	1034.00	SN1200	1034.00	—	—	(8) 3/0–500 Al/Cu, plus (2) 350 4–300 Al/Cu

- ▲ For applications above 200 A requiring a neutral, use copper wire only.
- When using MXL, MEL, LXL, LEL or LXIL circuit breaker with integral ground fault protection on a 3Ø4W system, neutral assembly SN1000MA or SNC800LX must be used for neutral CT. Order neutral CT separately.
- ◆ All Cu neutral assembly.
- ★ Rated maximum 900 A when used with Al wire.
- ▲ For NEMA 1 and 3R 200% neutral applications order Jumper kit SN800SNI and 2 of kit SN1200. (No 200% neutral is available for NEMA 4X or 12 devices.)
- △ For applications with integral ground fault protection order Neutral Mounting Kit S33576MK and Neutral CT S33576 (400–1200 A only).

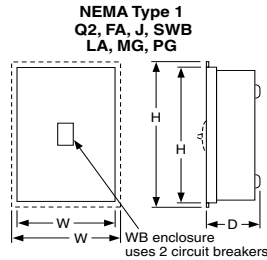

Table 7.143: Service Ground Kits

Circuit Breaker Cat. No. Prefix	Ground Bar Cat. No.	Number of Terminals	Conductors Per Terminal	Wire Range AWG/kcmil	\$ Price	
					Field-Installable	Factory-Installed
QBL, QDL, QGL, QJL FAL, FHL, FCL, FIL, FAL...WB, FHL...WB KCL, KIL, LAL, LHL, Q4L	PKOGTA2	2	1	10–2/0 Cu or 6–2/0 Al	56.00	191.00
HDL,HGL,HJL,HLL,JDL,JGL,JJL,JLL	PKOGTJ250	2	1	6–300 Al/Cu	75.00	195.00
LCL, LEL, LIL, LXL, LXIL MGL, MJL PGL, PJL, PKL, PLL	PKOGTA4	4	1	6–250 Al or Cu	213.00	263.00

□ Quantity (2) required if ground wires are run in parallel.

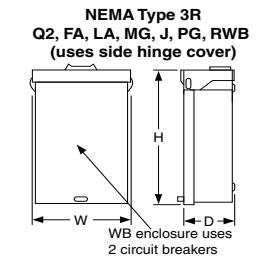
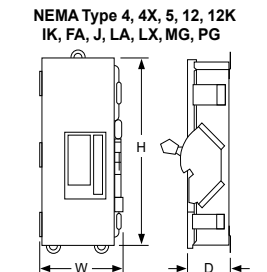
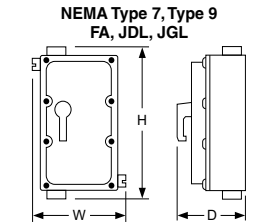

Table 7.144: Dimensions

Cat. No.	Series	Approximate Dimension						Cat. No.	Series	Approximate Dimension					
		H		W		D				H		W		D	
		in.	mm	in.	mm	in.	mm			in.	mm	in.	mm	in.	mm
FA100A, AWK	E2	19.50	495	9.13	232	4.88	124	LA400AWK	E2	42.25	1073	13.75	349	7.25	184
FA100DS	E2	19.50	495	9.13	232	4.88	124	LA400DS	E2	42.25	1073	13.75	349	7.25	184
FA100F	E2	19.50	495	9.88	251	4.13	105	LA400F	E2	45.63	1159	16.50	419	6.50	165
FA100RB	E2	18.00	457	8.88	226	4.88	124	LA400R	E2	44.00	1118	15.38	391	7.88	200
FA100S	E2	18.13	461	8.63	219	4.13	105	LA400S	E2	44.50	1130	15.38	391	6.50	165
IK250AWK	E2	42.25	1073	13.88	353	7.50	191	LA400LS	A1	27.40	696.0	15.40	391.2	6.625	168.3
IK250DS	E2	42.25	1073	13.88	353	7.50	191	M800S	A1	40-3/8	1025.52	21	533.4	9-3/4	247.65
HD100S	A1	17.00	431.8	7.90	200.7	4.75	120.7	M800R	A1	40-3/8	1025.52	21	533.4	9-3/4	247.65
J250F	A01	32.40	823	15.40	391	6.00	152	M800DS	A1	40-7/8	1036.96	20-3/4	527.05	9-1/2	241.3
J250S	A01	31.36	797	14.36	365	6.00	152	M800SS	A1	40-7/8	1036.96	20-3/4	527.05	9-1/2	241.3
J250R	A01	31.05	789	14.47	368	6.28	160	M800AWK	A1	40-7/8	1036.96	20-3/4	527.05	9-1/2	241.3
J250DS	A01	32.26	819	9.72	247	7.94	202	P1200S	A1	52-1/8	1323.98	21	533.4	9-3/4	247.65
J250SS	A01	32.26	819	9.72	247	7.94	202	P1200R	A1	52-1/8	1323.98	21	533.4	9-3/4	247.65
J250AWK	A01	32.26	819	9.72	247	7.94	202	P1200AWK	A1	53	1346.20	20-3/4	527.05	9-1/2	241.3
JD250S	A1	26.40	670.6	8.90	226.1	5.50	139.7	Q22200NRB	E3	23.38	594	7.63	194	4.75	121
J225X	A1	22.70	577	10.93	278	7.70	196	Q22200NS	E3	23.13	588	7.63	194	4.25	108
J225Y	A1	22.70	577	10.93	278	7.70	196	Q23225NF	E3	26.25	667	9.88	251	4.75	121
KA250SWB	E2	20.00	508	19.00	483	5.63	143	Q23225NRB	E3	26.25	667	9.88	251	5.50	140
KA250RWB	E2	20.25	514	19.00	483	7.12	181	Q23225NS	E3	26.25	667	9.88	251	4.75	121



See Supplemental Digest 3-37 and 3-38 for:

- Special paint
- Stainless steel fronts
- Pilot lights, push buttons
- Lock-on SPL0
- Key interlock systems
- Legend plates

Photovoltaic Circuit Breakers and Switches

600 Vdc and 1000 Vdc PV Circuit Breakers and Switches

Class 611 / Refer to Catalog 0611CT1302



The UL listed thermal-magnetic molded case circuit breakers and switches shown below are specifically designed for use in PV applications, rated at 50°C, offering grounded or ungrounded configurations.

The products are fully tested and calibrated under the PV UL489B standard.

The products come ready to install, including specially designed serial connectors for optimal thermal response, and adapted terminal covers for optimal isolation. Circuit Breakers come 100% rated for ease of use and selection.

These two new frames are fully compatible with the current line of PowerPact accessories, from aux contacts and shunt trips to motor operators and rotary handles.

Table 7.145: PV Molded Case Circuit Breakers

Ampere Rating	600 Vdc (3 poles)				1000 Vdc (4 poles)			
	Ungrounded		Grounded		Ungrounded		Grounded	
	Part Number	\$ Price	Part Number	\$ Price	Part Number	\$ Price	Part Number	\$ Price
50	TGL36050L	911.00	TGL36050K	984.00	TBL41050L	1212.00	TBL41050K	1309.00
60	TGL36060L	911.00	TGL36060K	984.00	TBL41060L	1212.00	TBL41060K	1309.00
70	TGL36070L	1013.00	TGL36070K	1094.00	TBL41070L	1212.00	TBL41070K	1309.00
80	TGL36080L	1013.00	TGL36080K	1094.00	TBL41080L	1212.00	TBL41080K	1309.00
100	TGL36100L	1125.00	TGL36100K	1215.00	TBL41100L	1347.00	TBL41100K	1455.00
125	TGL36125L	1250.00	TGL36125K	1350.00	TBL41125L	1496.00	TBL41125K	1616.00
150	TGL36150L	1250.00	TGL36150K	1350.00	TBL41150L	1496.00	TBL41150K	1616.00
175	TGL36175L	1438.00	TGL36175K	1553.00	TBL41175L	1721.00	TBL41175K	1859.00
200	TGL36200L	1438.00	TGL36200K	1553.00	TBL41200L	1721.00	TBL41200K	1859.00
225	UGL36225L	1703.00	UGL36225K	1839.00	UCL41225L	2044.00	UCL41225K	2207.00
250	UGL36250L	1892.00	UGL36250K	2043.00	UCL41250L	2271.00	UCL41250K	2453.00
300	UGL36300L	2270.00	UGL36300K	2451.00	UCL41300L	2611.00	UCL41300K	2820.00
350	UGL36350L	2270.00	UGL36350K	2451.00	UCL41350L	2611.00	UCL41350K	2820.00
400	UGL36400L	2306.00	UGL36400K	2490.00	UCL41400L	2765.00	UCL41400K	2986.00
450	UGL36450L	2536.00	UGL36450K	2739.00	UCL41450L	3041.00	UCL41450K	3284.00
500▲	N/A		UGL36500G	2739.00	UCL41500J	3041.00	UCL41500G	3284.00

▲ 500 A 80% rated.

Table 7.146: PV Circuit Breaker Max. Interrupting Ratings

Frame	600 Vdc	1000 Vdc
T-Frame	10 kA	3 kA
U-Frame	10 kA	5 kA

Table 7.147: Circuit Breaker Numbering

Brand	Frame	Rating	Termination	Poles	Voltage	Amperage	Grounding	Suffix Code	Suffix Code
	T U	G	L	3 4	6 1	0 5 0	G	A B	S A
Brand Blank: Schneider Electric	Frame T: T-Frame U: U-Frame	Ratings B: 3 kA C: 5 kA G: 10 kA	Terminations L: Lugs Line/Load Side F: Bus Bar S: Rear Connected	Poles 3: 3P 4: 4P	Voltage 6: 600 Vdc 1: 1000 Vdc	Amperage 050: 50 A 060: 60 A 070: 70 A 080: 80 A 100: 100 A 125: 125 A 150: 150 A 175: 175 A 200: 200 A 225: 225 A 250: 250 A 300: 300 A 350: 350 A 400: 400 A 450: 450 A 500: 500 A	Grounding G: Grounded, 80% rated (500 A Only) J: Ungrounded, 80% rated (500 A Only) K: Grounded, 100% rated L: Ungrounded, 100% rated	Accessory Suffix Cells (See Table 7.155)	Accessory Suffix Cells (See Table 7.155)

Table 7.148: PV Molded Case Non-Automatic Switches

Ampere Rating	600 Vdc (3 poles)				1000 Vdc (4 poles)			
	Ungrounded		Grounded		Ungrounded		Grounded	
	Part Number	\$ Price	Part Number	\$ Price	Part Number	\$ Price	Part Number	\$ Price
100	TBL36000JZ10	872.00	TBL36000GZ10	934.00	TBL41000JZ10	1048.00	TBL41000GZ10	1122.00
150	TBL36000JZ15	960.00	TBL36000GZ15	1028.00	TBL41000JZ15	1156.00	TBL41000GZ15	1237.00
200	TBL36000JZ20	1104.00	TBL36000GZ20	1182.00	TBL41000JZ20	1332.00	TBL41000GZ20	1426.00
250	UDL36000JZ25	1455.00	UDL36000GZ25	1557.00	UDL41000JZ25	1748.00	UDL41000GZ25	1870.00
300	UDL36000JZ30	1676.00	UDL36000GZ30	1794.00	UDL41000JZ30	2012.00	UDL41000GZ30	2153.00
400	UDL36000JZ40	1876.00	UDL36000GZ40	2007.00	UDL41000JZ40	2254.00	UDL41000GZ40	2412.00
500	UDL36000JZ50	2401.00	UDL36000GZ50	2569.00	UDL41000JZ50	2711.00	UDL41000GZ50	2901.00

Table 7.149: PV Switches Withstand Ratings

Frame	600/1000 Vdc
T-Frame	3 kA
U-Frame	7.5 kA

Table 7.150: Switch Numbering

Brand	Frame	Rating	Termination	Poles	Voltage	Amperage	Grounding	Trip System	Suffix Code	Suffix Code
	T U	D	L	3 4	6 1	0 0 0	G	Z 1 0	A B	S A
Brand Blank: Schneider Electric only	Frame T: T-Frame U: U-Frame	Ratings B: 3 kA D: 7.5 kA	Terminations L: Lugs Line/Load Side F: Bus Bar S: Rear Connected	Poles 3: 3P 4: 4P	Voltage 6: 600 Vdc 1: 1000 Vdc	Amperage 000: Switch	Grounding G: Grounded, 80% rated J: Ungrounded, 80% rated	Trip System—## (Z: Non-Automatic Switch) (##: Amperage Rating) Z10: 100 A Z15: 150 A Z20: 200 A Z25: 250 A Z30: 300 A Z40: 400 A Z50: 500 A	Accessory Suffix Cells (See Table 7.155)	Accessory Suffix Cells (See Table 7.155)

7 MINIATURE AND MOLDED CASE CIRCUIT BREAKERS

Table 7.151: Auxiliary Switches

Contacts	Factory-Installed Suffix	Field-Installable Kit No.	Kit Qty.	\$ Price
1A/1B Standard	AA	S29450	1	297.00
2A/2B Standard	AB	S29450	2	594.00
3A/3B Standard▲	AC	S29450	3	891.00
1A/1B Low-Level (Gold)	AE	S29452	1	372.00
2A/2B Low-Level (Gold)	AF	S29452	2	744.00
3A/3B Low-Level (Gold)▲	AG	S29452	3	1116.00

▲ U-Frame only.

Table 7.152: Alarm/Overcurrent Trip Switches

Suffix	Switch	Kit No.	Kit Qty.	\$ Price
PowerPact T-Frame				
BC	Alarm Switch	S29450	1	297.00
BH	Alarm Switch, Low-Level	S29452	1	372.00
BD	Overcurrent Trip Switch, Standard	S29450	1	338.00
	SDE Actuator	S29451	1	
BJ	Overcurrent Trip Switch, Low-Level	S29452	1	413.00
	SDE Actuator	S29451	1	
BE	Alarm Switch and Overcurrent Trip Switch, Standard	S29450	2	635.00
	SDE Actuators	S29451	2	
BK	Alarm Switch and Overcurrent Trip Switch, Low-Level	S29452	2	785.00
	SDE Actuators	S29451	2	
PowerPact U-Frame				
BC	Alarm Switch	S29450	1	297.00
BH	Alarm Switch, Low-Level	S29452	1	372.00
BD	Overcurrent Trip Switch, Standard	S29450	1	297.00
BJ	Overcurrent Trip Switch, Low-Level	S29452	1	372.00
BE	Alarm Switch and Overcurrent Trip Switch, Standard	S29450	2	594.00
BK	Alarm Switch and Overcurrent Trip Switch, Low-Level	S29452	2	744.00

Table 7.153: Shunt Trips

Voltage	Shunt Trip (MX)		
	Factory-Installed Suffix	Field-Installable Kit No.	\$ Price
120 Vac	SA	S29386	717.00
24 Vdc	SO	S29390	717.00
48 Vdc	SP	S29392	717.00
125 Vdc	SR	S29393	717.00

Table 7.154: Rotary Operated Handles

Device	Description	Factory Installed Suffix	T-Frame		U-Frame	
			Field Installable Kit No.	\$ Price	Field Installable Kit No.	\$ Price
Direct Mounted	Standard Handle Black	Handle Only	RD10	S29337 255.00	S32597	366.00
Door Mounted	Standard Black Handle	Handle Only	RE10	S29338 383.00	S32598	557.00

Table 7.155: Locks

Device	Description	Factory Installed Suffix	T-Frame		U-Frame	
			Field Installable Kit No.	\$ Price	Field Installable Kit No.	\$ Price
Handle Padlocking Device	Handle Padlock, ON or OFF	YP	S29371	77.00	S32631	122.00

NOTE: For a complete list of field installable accessories and details, including also motor operator (electrical only) and locks, refer to accessories information for the PowerPact, J-Frame (compatible with T-Frame) and L-Frame (Compatible with U-Frame). Or consult Photovoltaic offer catalog 0611CT1302.

Table 7.156: PV Unit Mount Terminal Covers

Choose termination "L" for having the termination kit factory installed with the breaker (Lugs, Term Covers, Serial Connectors)

Frame	Description ▲	Poles	Configuration				Field Installable Catalog No.	\$ Price
			Ungrounded Top	Ungrounded Bottom	Grounded Top	Grounded Bottom		
T-Frame	Long Terminal Cover (3P)	3	X				S35175	145.00
	Long Terminal Cover (3P/1SC)	3		X	X	X	S35176	145.00
	Long Terminal Cover (4P)	4		X			S35177	162.00
	Long Terminal Cover (4P/2SC)	4	X		X		S35178	162.00
	Long Terminal Cover (4P/1SC)	4				X	S35179	162.00
U-Frame	Long Terminal Cover (3P)	3	X				S32593	185.00
	Extended Term Cover (3P/1SC)	3		X	X	X	S38291	205.00
	Long Terminal Cover (4P)	4		X			S32594	198.00
	Extended Term Cover (4P/2SC)	4	X		X		S38293	215.00
	Extended Term Cover (4P/1SC)	4				X	S38294	215.00

▲ P: Poles, SC: Serial connector.

Table 7.157: PV Rear Connection Terminal Covers and Connectors

Choose termination "S" for having the termination kit included with the breaker (Rear Connectors, Term Covers, Serial Connectors)

Frame	Description ◆	Poles	Configuration				Field Installable Catalog No.	\$ Price
			Ungrounded Top	Ungrounded Bottom	Grounded Top	Grounded Bottom		
T-Frame	Short Terminal Cover (3P)	3	X				S29515	121.00
	Long Terminal Cover (3P/1SC)	3		X	X	X	S35169	145.00
	Short Terminal Cover (4P)	4		X			S29516	141.00
	Long Terminal Cover (4P/1SC)	4				X	S35170	162.00
	Long Terminal Cover (4P/2SC)	4	X		X		S35178	162.00
U-Frame	Short Rear Connector (set of 2)▲	3, 4		X		X	S29235	162.00
	Long Rear Connector (set of 2)▲	3, 4		X			S29236	206.00
	Short Terminal Cover (3P)	3	X				S32562	149.00
	Extended Terminal Cover (3P/1SC)	3		X	X	X	S35171	205.00
	Short Terminal Cover (4P)	4		X			S32563	161.00
U-Frame	Extended Term Cover (4P/1SC)	4				X	S35172	215.00
	Extended Term Cover (4P/2SC)	4	X		X		S38293	215.00
	Short Rear Connector (set of 2)▲◆	3, 4		X		X	S432475	219.00
	Long Rear Connector (set of 2)▲◆	3, 4		X			S432476	261.00

▲ The ungrounded configurations (3P or 4P) need 2 short and 2 long rear connectors. The grounded configurations only use 2 short rear connectors.

◆ Parts only, no hardware is included. See Table 7.159 U-Frame, below.

◆ P: Poles, SC: Serial connector.

Table 7.158: PV T-Frame Bus Bar and Rear Connections Hardware

Choose termination "F" for having the termination kit included with the breaker (Terminal Nuts, Term Covers, Serial Connectors)

Description	Cat. No.	\$ Price
T-Frame Term Nut Insert-Metric/M8 (12)	S30554	150.00

Table 7.159: PV U-Frame Bus Bar and Rear Connections Hardware

Choose termination "F" for having the termination kit included with the breaker (Screws and Washers, Term Covers, Serial Connectors)

Description	Cat. No.	\$ Price
Set of 4 M10 x 25 terminal screws and washers for one side	S36967	31.00

Table 7.160: Mechanical Lug Kits for T- and U-Frame Circuit Breakers and Switches

Frame	Description	Conductor		Current	Cat. No.	Qty. Per Kit	\$ Price
		Type	No. Per Lug / Size				
T-Frame	Lug(2) T-Frame, 12-4 AWG, Al/Cu	Al	1 #12-#4 AWG (4-25 mm ²)	50-60 A	S35167	2	86.00
		Cu	1 #14-#4 AWG (2.5-25 mm ²)				
	Lugs(2) T-Frame, 4-4/0 AWG, Al/Cu	Al/Cu	1 #4-#4/0 AWG (25-95 mm ²)	70-150 A	S29255	2	86.00
U-Frame	Lug(2) T-Frame, 250-350 kcmil, Al/Cu	Al	1 #250-350 AWG (120-185 mm ²)	175-200 A	S35168	2	86.00
		Cu	1 #2/0-350 AWG (70-185 mm ²)				
	Lug(2) U-Frame, 2/0 AWG-500 kcmil, Al/Cu	Al	2 2/0 AWG-500 kcmil (70-240 mm ²)	225-500 A	S35180	2	225.00
Cu	2 2/0 AWG-500 kcmil (70-240 mm ²)						

NOTE: For availability dates of field installable accessories in Tables 7.156, 7.157, 7.158 and 7.160 contact Schneider Electric.

Table 7.161: PV T-Frame Circuit Breaker and Switches Dimensions

	A2	A3	B1	B2	C2	C3
in	7.40	11.42	4.13	5.51	3.39	4.96
mm	188	290	105	140	86	126

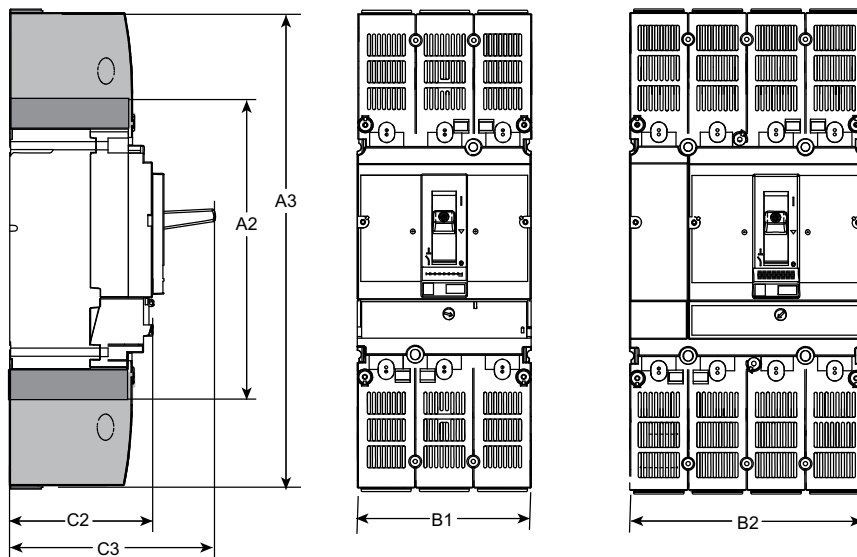

A2: Short
A3: Long

Table 7.162: Terminal Cover Configuration According to Wiring Configuration

Wiring Configuration	Connection Type		Terminal Cover Configuration	
	Unit Mount/Bus	Rear Connected	Top	Bottom
3P Ungrounded	X	X	Long	Long
			Short	Long
3P Grounded	X	X	Long	Long
4P Ungrounded	X	X	Long	Long
Long			Short	
4P Grounded	X	X	Long	Long

Table 7.163: Approximate Weights

T-Frames	Product Weight (lbs)	Shipping Weights (lbs)
3P Ungrounded	5	8
3P Grounded	5.5	8.5
4P Ungrounded	6.3	9.3
4P Grounded	6.7	9.7

Table 7.164: PV U-Frame Circuit Breaker and Switches Dimensions

	A2	A3	A4	B1	B2	C2	C3
in	11.2	15.7	19.1	5.5	7.2	4.3	6.6
mm	285	400	484	140	183	110	168

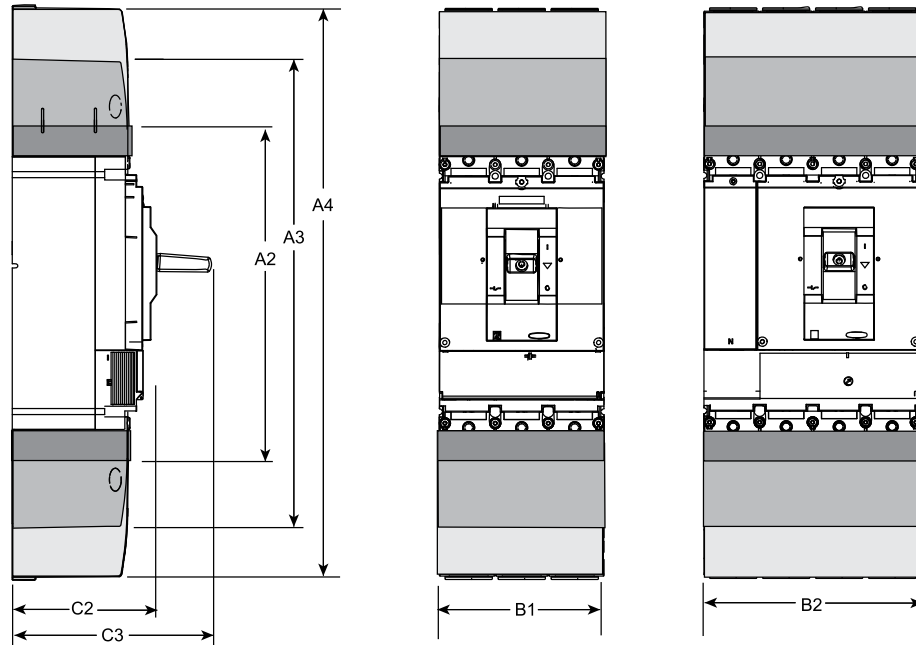

A2: Short
A3: Long
A4: Extended

Table 7.165: Terminal Cover Configuration According to Wiring Configuration

Wiring Configuration	Connection Type		Terminal Cover Configuration	
	Unit Mount/Bus	Rear Connected	Top	Bottom
3P Ungrounded	X		Long Short	Extended
3P Grounded	X	X		
4P Ungrounded	X		Extended	Long Short
4P Grounded	X	X		Extended

Table 7.166: Approximate Weights

U-Frames	Product Weight (lbs)	Shipping Weights (lbs)
3P Ungrounded	15	19.5
3P Grounded	17	21.5
4P Ungrounded	21	25.5
4P Grounded	23	27.5

Table 7.167: PV T- and U-Frame Circuit Breakers and Switches Wiring Configurations

