



2018

BOLT EV Owner's Manual



chevrolet.com (U.S.)
chevrolet.ca (Canada)



Contents

Introduction	2
In Brief	5
Keys, Doors, and Windows	32
Seats and Restraints	56
Storage	105
Instruments and Controls	108
Lighting	150
Infotainment System	157
Climate Controls	186
Driving and Operating	193
Vehicle Care	254
Service and Maintenance	321
Technical Data	330
Customer Information	332
Reporting Safety Defects	342
OnStar	346
Index	358

Introduction



The names, logos, emblems, slogans, vehicle model names, and vehicle body designs appearing in this manual including, but not limited to, GM, the GM logo, CHEVROLET, the CHEVROLET Emblem, and BOLT are trademarks and/or service marks of General Motors LLC, its subsidiaries, affiliates, or licensors.

For vehicles first sold in Canada, substitute the name "General Motors of Canada Company" for Chevrolet Motor Division wherever it appears in this manual.

This manual describes features that may or may not be on the vehicle because of optional equipment that was not purchased on the vehicle, model variants, country specifications, features/applications that may not be available in your region, or changes subsequent to the printing of this owner's manual.

Refer to the purchase documentation relating to your specific vehicle to confirm the features.

Keep this manual in the vehicle for quick reference.

Canadian Vehicle Owners

A French language manual can be obtained from your dealer, at www.helminc.com, or from:

Propriétaires Canadiens

On peut obtenir un exemplaire de ce guide en français auprès du concessionnaire ou à l'adresse suivante:

Helm, Incorporated
Attention: Customer Service
47911 Halyard Drive
Plymouth, MI 48170
USA

Using this Manual

To quickly locate information about the vehicle, use the Index in the back of the manual. It is an alphabetical list of what is in the manual and the page number where it can be found.

Danger, Warning, and Caution

Warning messages found on vehicle labels and in this manual describe hazards and what to do to avoid or reduce them.

Danger

Danger indicates a hazard with a high level of risk which will result in serious injury or death.

Warning

Warning indicates a hazard that could result in injury or death.

Caution

Caution indicates a hazard that could result in property or vehicle damage.





A circle with a slash through it is a safety symbol which means “Do Not,” “Do not do this,” or “Do not let this happen.”

Symbols

The vehicle has components and labels that use symbols instead of text. Symbols are shown along with the text describing the operation or information relating to a specific component, control, message, gauge, or indicator.















 : Shown when the owner’s manual has additional instructions or information.

 : Shown when the service manual has additional instructions or information.

 : Shown when there is more information on another page — “see page.”

Vehicle Symbol Chart

Here are some additional symbols that may be found on the vehicle and what they mean. See the features in this manual for information.

-  : Airbag Readiness Light
-  : Air Conditioning
-  : Antilock Brake System (ABS)
-  : Brake System Warning Light
-  : Charging System (12-Volt Battery)
-  : Cruise Control
-  : Do Not Puncture
-  : Do Not Service
-  : Energy Usage and Charge Mode Selection
-  : Exterior Lamps
-  : Flame/Fire Prohibited
-  : First Responder
-  : Fuses
-  : Headlamp High/Low-Beam Changer

4 Introduction

 : High Voltage

 : ISOFIX/LATCH System Child Restraints

 : Power

 : Remote Vehicle Start

 : Seat Belt Reminders

 : Service Vehicle Soon

 : Tire Pressure Monitor

 : Traction Control/StabiliTrak

 : Under Pressure

 : Vehicle Ready

 : Windshield Washer Fluid

In Brief

Instrument Panel

Instrument Panel	6
------------------------	---

Initial Drive Information

Initial Drive Information	8
Remote Keyless Entry (RKE) System	8
Remote Start	8
Door Locks	9
Liftgate	10
Windows	11
Seat Adjustment	11
Heated Seats	12
Head Restraint Adjustment	13
Seat Belts	13
Passenger Sensing System	13
Mirror Adjustment	14
Steering Wheel Adjustment	14
Interior Lighting	14
Exterior Lighting	15
Windshield Wiper/Washer	16
Climate Controls	17

Vehicle Features

Radio(s)	17
Satellite Radio	18
Portable Audio Devices	18

Bluetooth	18
Steering Wheel Controls	18
Cruise Control	19
Driver Information Center (DIC)	20
Forward Collision Alert (FCA) System	20
Forward Automatic Braking (FAB)	20
Front Pedestrian Braking (FPB) System	20
Lane Keep Assist (LKA)	21
Lane Change Alert (LCA)	21
Rear Vision Camera (RVC)	21
Rear Cross Traffic Alert (RCTA) System	21
Parking Assist	21
Power Outlets	22

Battery and Efficiency

High Voltage Safety Information	22
Charging	23
Regenerative Braking	28
Service	28

Performance and Maintenance

Traction Control/Electronic Stability Control	29
Tire Pressure Monitor	29

Driving for Better Energy Efficiency	30
Roadside Assistance Program	31

Instrument Panel

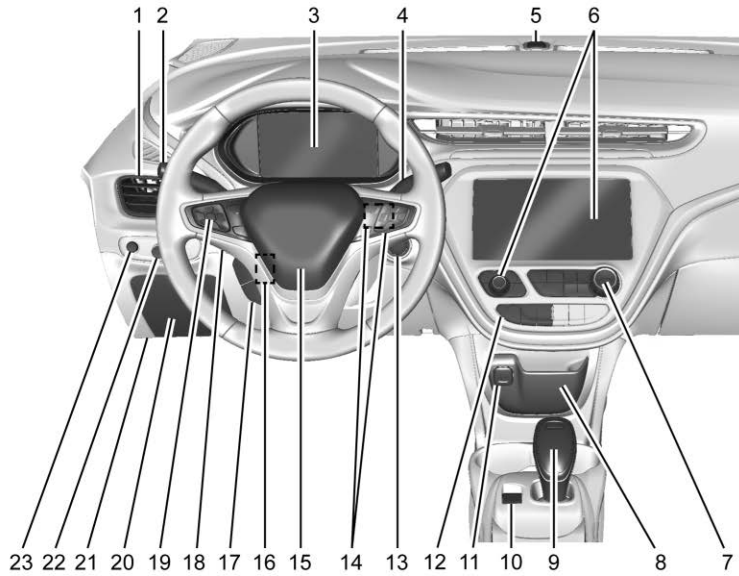

1. *Air Vents* ⇨ 190.
2. *Turn and Lane-Change Signals* ⇨ 154.
IntelliBeam System Button (If Equipped). See *Exterior Lamp Controls* ⇨ 150.
3. *Instrument Cluster* ⇨ 118.
Driver Information Center (DIC) ⇨ 141.
4. *Windshield Wiper/Washer* ⇨ 111.
5. *Charging Status Feedback* ⇨ 240.
Automatic Headlamp System ⇨ 153.
Indicator Light and Solar Sensor (ILSS). See “Sensors” under *Automatic Climate Control System* ⇨ 186.
6. *Infotainment System*. See *AM-FM Radio* ⇨ 162.
Heated Front Seats ⇨ 60 (If Equipped).
7. *Automatic Climate Control System* ⇨ 186.
8. *Storage Compartments* ⇨ 105.
9. *Shift Lever*. See *Electric Drive Unit* ⇨ 208.
10. *Electric Parking Brake* ⇨ 213.
11. *Power Outlets* ⇨ 114.
12. *Hazard Warning Flashers* ⇨ 153.
Traction Control/Electronic Stability Control ⇨ 217.
Driver Selected Operating Modes ⇨ 208.
13. *Power Button* ⇨ 204.
14. *Steering Wheel Controls* ⇨ 109 (If Equipped).
15. *Horn* ⇨ 110.
16. *Steering Wheel Adjustment* ⇨ 109 (Out of View).
17. *Steering Wheel Controls* ⇨ 109 (If Equipped).
18. *Regen on Demand* (Out of View). See *Regenerative Braking* ⇨ 215.
19. *Cruise Control* ⇨ 219.
Heated Steering Wheel ⇨ 110 (If Equipped).
Forward Collision Alert (FCA) System ⇨ 225 (If Equipped).
Lane Keep Assist (LKA) ⇨ 233 (If Equipped).
20. *Instrument Panel Fuse Block* ⇨ 276.
21. *Data Link Connector (DLC)* (Out of View). See *Service Vehicle Soon Light* ⇨ 126.
22. *Exterior Lamp Controls* ⇨ 150.
23. *Instrument Panel Illumination Control* ⇨ 154.

Initial Drive Information

This section provides a brief overview about some of the important features that may or may not be on your specific vehicle.

For more detailed information, refer to each of the features which can be found later in this owner's manual.

Remote Keyless Entry (RKE) System

The Remote Keyless Entry (RKE) transmitter may work up to 60 m (197 ft) away from the vehicle.





Press the key release button to extend the key. The key can be used for all locks.

 : Press to unlock the driver door or all doors, depending on the vehicle personalization setting.

 : Press to lock all doors.

 : Press and release one time to initiate vehicle locator. Press and hold for at least three seconds to sound the panic alarm. Press again to cancel the panic alarm.

 : Press and release  and then immediately press and hold  for at least four seconds to start the

vehicle's heating or air conditioning systems and rear window defogger from outside the vehicle using the RKE transmitter.



See *Remote Keyless Entry (RKE) System Operation* ⇨ 33.

Remote Start

Remote Starting the Vehicle

Use remote start to heat or cool the interior when the vehicle is plugged in to maximize electric range by utilizing electricity from the electrical outlet. Normal operation of the system will return after the vehicle has been turned on.

To remote start the vehicle:



1. Press and release  on the RKE transmitter.
2. Immediately press and hold  for at least four seconds or until the turn signal lamps flash.

- After entering the vehicle during a remote start, press POWER  with the brake pedal applied to operate as normal.

When the vehicle starts, the parking lamps will turn on. Remote start run time can be extended.

Canceling Remote Start



To cancel a remote start, do any of the following:

- Press and hold  until the parking lamps turn off.
- Turn on the hazard warning flashers.
- Press POWER  with the brake pedal applied, then press POWER  again to turn the vehicle off.



See *Remote Start* ⇨ 39.

Door Locks

To lock or unlock the doors from outside the vehicle:

- Use the key in the driver door to lock and unlock the door.
- Press  or  on the Remote Keyless Entry (RKE) transmitter to lock and unlock the doors.

To lock or unlock the doors from inside the vehicle:

- Press  or  on the power door lock switch.
- Use the lock knob on the top of the door panel to lock the door only. Press  to unlock the door.

Power Door Locks



 : Press to unlock the doors.

 : Press to lock the doors.

Keyless Access

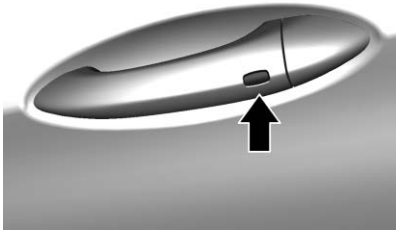

The Keyless Access system allows the doors and liftgate to be locked and unlocked without pressing the RKE transmitter button. The RKE transmitter must be within 1 m (3 ft) of the door being opened. If the vehicle has this feature, there will be a button on both outside front and rear door handles.



Keyless Access can be programmed to unlock all doors on the first unlock/lock button press from the driver door.

See “Keyless Access Operation” in *Remote Keyless Entry (RKE) System Operation* ⇨ 33.

Liftgate

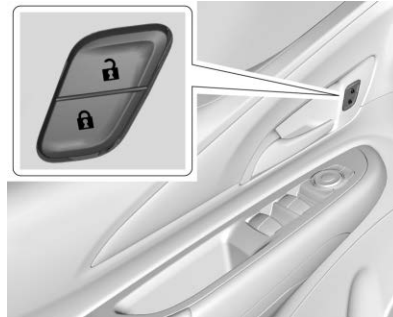
To lock or unlock the liftgate from the outside, press  or  on the RKE transmitter.



To lock or unlock the liftgate from the inside, press  or .

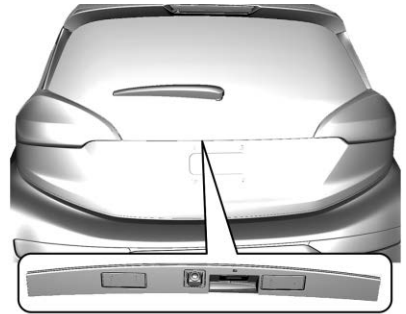

To open the liftgate, press the touch pad on the underside of the liftgate and lift up.

When closing the liftgate, use the pull cup.

See *Liftgate* ⇨ 47.

Windows

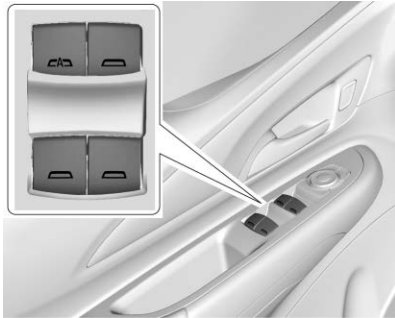

The window switches on the driver door control all windows. Each passenger door has a switch that controls only that window.

Press the switch to lower the window. Pull the front of the switch to raise it.

The driver window has an express feature which allows the window to be lowered or raised without holding the switch.

The front and rear passenger windows have express open only.

See *Retained Accessory Power (RAP)* ⇨ 206 and *Power Windows* ⇨ 53.

Seat Adjustment

Seat Position



To adjust a manual seat:

1. Pull the handle at the front of the seat.
2. Slide the seat to the desired position and release the handle.

3. Try to move the seat back and forth to be sure it is locked in place.

See *Seat Adjustment* ⇨ 59.

Seat Height Adjuster



Move the lever on the outboard side of the seat up or down to manually adjust the seat height.

See "Seat Height Adjuster" under *Seat Adjustment* ⇨ 59.

Reclining Seatbacks



To recline the seatback:

1. Lift the lever.
2. Move the seatback to the desired position, and then release the lever to lock the seatback in place.
3. Push and pull on the seatback to make sure it is locked.

To return the seatback to the upright position:

1. Lift the lever fully without applying pressure to the seatback, and the seatback will return to the upright position.
2. Push and pull on the seatback to make sure it is locked.

See *Reclining Seatbacks* ⇨ 59.

Heated Seats

Front Heated Seats

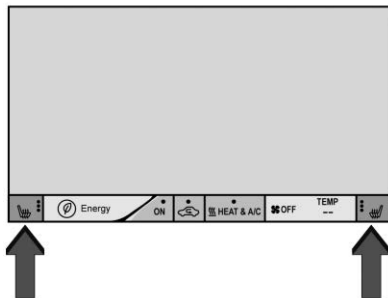

If equipped, the heated seat controls are on the infotainment display. To operate, the vehicle must be on.

Touch or to heat the driver or passenger seat cushion. Indicator lights on the infotainment display show the current setting.

Touch the screen once for the highest setting. With each touch of the screen, the heated seat will change to the next lower setting, and then off. The lights indicate three for the highest setting and one for the lowest.

The passenger seat may take longer to heat up.

See *Heated Front Seats* ⇨ 60.



Auto Heated Seats

When the vehicle is on, this feature will automatically activate the heated seats at the level required by the vehicle's interior temperature. The auto heated seats feature can be programmed to always be enabled when the vehicle is on. See *Vehicle Personalization* ⇨ 143.

Rear Heated Seats



If equipped, the rear heated seat buttons are on the rear doors.

Press  or  to heat the left outboard or right outboard seat cushion.

See *Heated Rear Seats* ⇨ 64.

Head Restraint Adjustment

Do not drive until the head restraints for all occupants are installed and adjusted properly.

To achieve a comfortable seating position, change the seatback recline angle as little as necessary while keeping the seat and the head restraint height in the proper position.

See *Head Restraints* ⇨ 57 and *Seat Adjustment* ⇨ 59.

Seat Belts

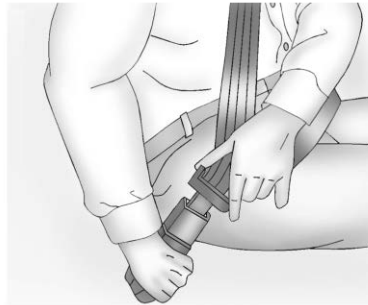

Refer to the following sections for important information on how to use seat belts properly:

- *Seat Belts* ⇨ 65.



- *How to Wear Seat Belts Properly* ⇨ 66.
- *Lap-Shoulder Belt* ⇨ 67.
- *Lower Anchors and Tethers for Children (LATCH System)* ⇨ 90.

Passenger Sensing System



United States



Canada

The passenger sensing system turns off the front outboard passenger frontal airbag and knee airbag under certain conditions. No other airbag is affected by the

14 In Brief



passenger sensing system. See *Passenger Sensing System* ⇨ 77 for important information.

The passenger airbag status indicator will be visible on the overhead console when the vehicle is started. See *Passenger Airbag Status Indicator* ⇨ 125.

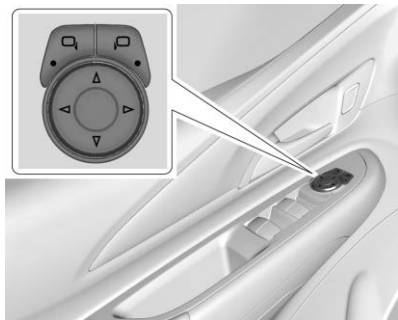

Mirror Adjustment

Power Mirrors



1. Press  or  to choose the driver or passenger mirror.

2. Press the arrows on the control pad to move each mirror in the desired position.

3. Press  or  again to deselect the mirror.

See *Power Mirrors* ⇨ 50.

Steering Wheel Adjustment



To adjust the steering wheel:

1. Pull the lever down.
2. Move the steering wheel up or down.



3. Pull or push the steering wheel closer or away from you.
4. Pull the lever up to lock the steering wheel in place.

Do not adjust the steering wheel while driving.

Interior Lighting

Dome Lamps



The dome lamp controls are in the overhead console above the front seats.

 **OFF** : Press to turn the lamps off, even when a door is open.

 : When the button is returned to the middle position, the lamps turn on automatically when a door is opened.

 **ON** : Press to turn on the dome lamps.

Front and Rear Reading Lamps





The front reading lamps are in the overhead console.

Press the lamp lenses to turn the reading lamps on or off.



The rear reading lamps are in the headliner.

 **OFF** : Press to turn the lamp off.

 **ON** : Press to turn the lamp on.

For more information on interior lighting, see *Instrument Panel Illumination Control* ↗ 154.

Exterior Lighting

Exterior Lamp Controls

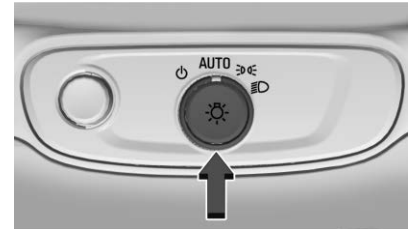

The exterior lamp control is on the instrument panel to the left of the steering column.

 : Turns the exterior lamps on and off.

AUTO : Turns the exterior lamps on and off automatically, depending on outside lighting.

 : Turns on the parking lamps including all lamps, except the headlamps. The instrument panel lights also turn on.

 : Turns on the headlamps together with the parking lamps and instrument panel lights.

16 In Brief

See:

- *Exterior Lamp Controls* ⇨ 150.
- *Daytime Running Lamps (DRL)* ⇨ 152.

Windshield Wiper/Washer

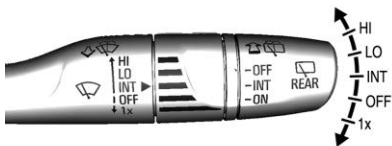

The windshield wiper/washer lever is on the side of the steering column. With the vehicle on or in Service Mode, move the windshield wiper lever to select the wiper speed.

HI : Use for fast wipes.

LO : Use for slow wipes.

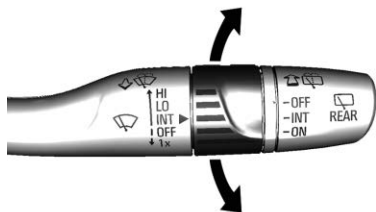

INT : If equipped with intermittent wipes, move the windshield wiper lever to INT. Turn the band up for more frequent wipes or down for less frequent wipes.

OFF : Use to turn the wipers off.

1X : For a single wipe, briefly move the lever down. For multiple wipes, hold the lever down.

 : Pull the windshield wiper lever toward you to spray windshield washer fluid and activate the wipers.

Rear Window Wiper/Washer

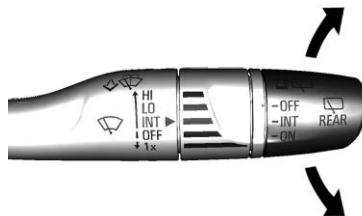

The controls are on the end of the windshield wiper lever. Move the control to:

ON : To turn on.

OFF : To turn off.

INT : To turn on intermittent rear wipes.

 : Push the windshield wiper lever to spray washer fluid on the rear window.

See *Windshield Wiper/Washer* ⇨ 111.

Climate Controls

The climate control buttons on the center stack and on the climate control display are used to adjust the heating, cooling, and ventilation.

Center Stack Climate Controls

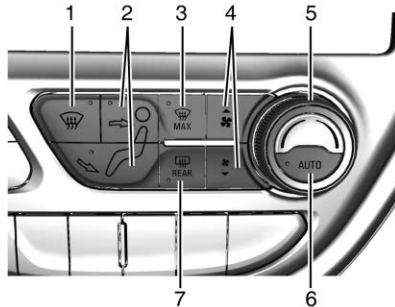

1. Defrost/Defog
2. Air Delivery Mode Controls
3. Max Defrost
4. Manual Fan Control Buttons
5. Temperature Control Knob
6. AUTO (Automatic Operation)
7. Rear Window Defogger

Climate Control Display

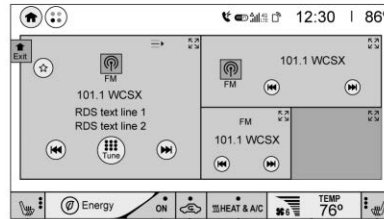

1. Driver and Passenger Heated Seats (If Equipped)
2. Climate On-Off
3. Recirculation
4. Heat & A/C (Air Conditioning) Power
5. Fan Speed and Temperature Status

See *Automatic Climate Control System* ⇨ 186.

Vehicle Features

Radio(s)

Volume Knob : Turn to increase or decrease the volume.

⏻ : Press and hold to enter the Clean Screen Mode. The radio will be in a low power mode with the infotainment display turned off.

Press to cancel the Clean Screen Mode or to mute/unmute the audio when the system is on.

🏠 : Press to go to the Home Page. Press and hold to launch Apple CarPlay or Android Auto, if equipped.

⏮ or ⏭ : For radio and SiriusXM, press to seek the previous or next strongest station or channel. For USB content, press to go to the previous or next content or press and hold to fast rewind or fast forward music.

See *Overview* ⇨ 158.

Satellite Radio

If equipped, a SiriusXM satellite radio tuner and a valid SiriusXM satellite radio subscription can receive SiriusXM programming.

SiriusXM Satellite Radio Service

SiriusXM is a satellite radio service based in the 48 contiguous United States and 10 Canadian provinces. SiriusXM satellite radio has a wide variety of programming and commercial-free music, coast to coast, and in digital-quality sound. A fee is required to receive the SiriusXM service.

Refer to:

- www.siriusxm.com or call 1-888-601-6296 (U.S.).
- www.siriusxm.ca or call 1-877-438-9677 (Canada).

See *Satellite Radio* ⇨ 164.

Portable Audio Devices

This vehicle has a 3.5 mm (1/8 in) auxiliary input and two USB ports in the center console for data and charging. If equipped, there are two USB charge ports in the rear of the center console. External devices such as iPods, MP3 players, and USB storage devices may be connected.

See *Auxiliary Devices* ⇨ 172 and *USB Port* ⇨ 166.

Bluetooth

The Bluetooth system allows users with a Bluetooth-enabled mobile phone to make and receive hands-free calls using the vehicle audio system and controls.

The Bluetooth-enabled mobile phone must be paired with the in-vehicle Bluetooth system before it can be used in the vehicle. Not all phones will support all functions.

See *Bluetooth* ⇨ 175.

Steering Wheel Controls

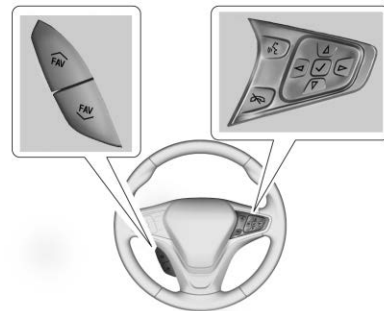



If equipped, some audio controls can be adjusted at the steering wheel.

 : If equipped with OnStar or a Bluetooth system, press to interact with those systems.

See *OnStar Overview* ⇨ 346 or *Bluetooth* ⇨ 175.

 : Press to decline an incoming call or end a current call. Press to mute or unmute the infotainment system when not on a call.

 or  : Press to go to the previous or next selection.

◀ or ▶ : Press to move between the interactive display zones in the cluster.

✓ : Press to select a highlighted menu option.

^ FAV or FAV v : Press to display a list of favorites and select the next or previous favorite when listening to the radio.

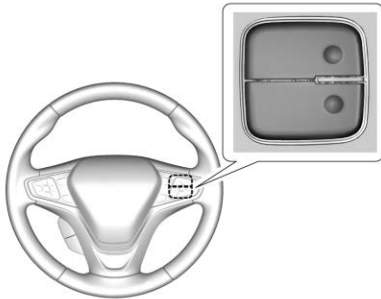

The volume switches are on the right rear side of the steering wheel. Press to increase or decrease the volume.

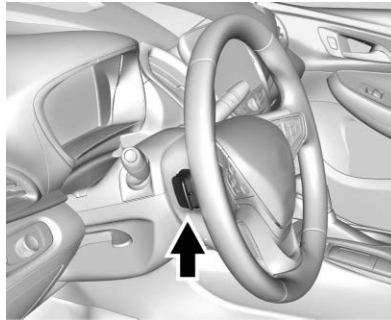

There is a paddle on the left rear side of the steering wheel for regenerative braking. See *Regenerative Braking* ⇨ 215.

Cruise Control

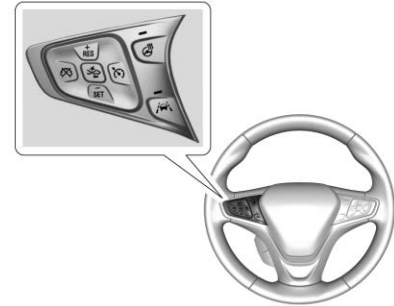

Ⓞ : Press to turn the cruise control system on and off. A white indicator comes on in the instrument cluster when cruise is turned on.

ⓧ : Press to disengage cruise control without erasing the set speed from memory.

+RES : If there is a set speed in memory, press to resume that speed or press and hold to accelerate. If cruise control is already active, use to increase vehicle speed.

-SET : Press briefly to set the speed and activate cruise control. If cruise control is already active, use to decrease vehicle speed.

See *Cruise Control* ⇨ 219.

Driver Information Center (DIC)

The DIC display is in the instrument cluster. It shows the status of many vehicle systems.

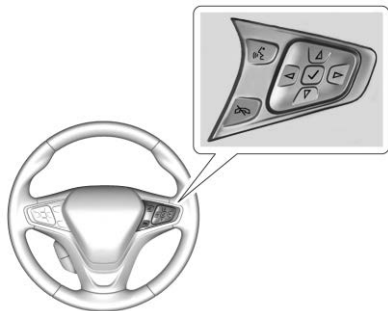

△ or ▽ : Press to move up or down in a list.

◀ or ▶ : Press to move between the interactive display zones in the cluster.

✓ : Press to open a menu or select a menu item. Press and hold to reset values on certain screens.

See *Instrument Cluster* ⇨ 118 and *Driver Information Center (DIC)* ⇨ 141.

Forward Collision Alert (FCA) System

If equipped, FCA may help avoid or reduce the harm caused by front-end crashes. FCA provides a green indicator, , when a vehicle is detected ahead. This indicator displays amber if you follow a vehicle much too closely. When approaching a vehicle ahead too quickly, FCA provides a red flashing alert on the windshield and rapidly beeps.

See *Forward Collision Alert (FCA) System* ⇨ 225.

Forward Automatic Braking (FAB)

If the vehicle has Forward Collision Alert (FCA), it also has FAB, which includes Intelligent Brake Assist (IBA). When the system detects a vehicle ahead in your path that is traveling in the same direction that you may be about to crash into, it can provide a boost to braking or automatically brake the vehicle. This can help avoid or lessen the severity of crashes when driving in a forward gear.

See *Forward Automatic Braking (FAB)* ⇨ 227.

Front Pedestrian Braking (FPB) System

If equipped, the FPB system may help avoid or reduce the harm caused by front-end crashes with nearby pedestrians when driving in a forward gear. FPB displays an amber indicator, , when a nearby pedestrian is detected directly ahead. When approaching a

detected pedestrian too quickly, FPB provides a red flashing alert on the windshield and rapidly beeps. FPB can provide a boost to braking or automatically brake the vehicle.

See *Front Pedestrian Braking (FPB) System* ⇨ 229.

Lane Keep Assist (LKA)

If equipped, LKA may help avoid crashes due to unintentional lane departures. It may assist by gently turning the steering wheel if the vehicle approaches a detected lane marking without using a turn signal in that direction. It may also provide a Lane Departure Warning (LDW) alert as the lane marking is crossed. The system will not assist or alert if it detects that you are actively steering. Override LKA by turning the steering wheel. LKA uses a camera to detect lane markings between 60 km/h (37 mph) and 150 km/h (93 mph).

See *Lane Departure Warning (LDW)* ⇨ 233 and *Lane Keep Assist (LKA)* ⇨ 233.

Lane Change Alert (LCA)

If equipped, the LCA system is a lane-changing aid that assists drivers with avoiding lane change crashes that occur with moving vehicles in the side blind zone (or spot) areas or with vehicles rapidly approaching these areas from behind. The LCA warning display will light up in the corresponding outside mirror and will flash if the turn signal is on. The Side Blind Zone Alert (SBZA) system is included as part of the LCA system.

See *Side Blind Zone Alert (SBZA)* ⇨ 231 and *Lane Change Alert (LCA)* ⇨ 231.

Rear Vision Camera (RVC)

If equipped, RVC shows a view of the area behind the vehicle on the infotainment display when the vehicle is shifted into R (Reverse) to aid with parking and low-speed backing maneuvers.

See *Assistance Systems for Parking or Backing* ⇨ 222.

Rear Cross Traffic Alert (RCTA) System

If equipped, the RCTA system uses a triangle with an arrow on the infotainment display to warn of traffic behind your vehicle that may cross your vehicle's path while in R (Reverse). In addition, beeps will sound.

See *Assistance Systems for Parking or Backing* ⇨ 222.

Parking Assist

If equipped, Rear Parking Assist (RPA) uses sensors on the rear bumper to assist with parking and avoiding objects while in R (Reverse). It operates at speeds less than 8 km/h (5 mph). RPA may show a warning triangle on the infotainment display and/or a graphic on the instrument cluster to provide the object distance. In addition, multiple beeps may occur if very close to an object.

See *Assistance Systems for Parking or Backing* ⇨ 222.

Power Outlets

The accessory power outlet can be used to plug in electrical equipment, such as a mobile phone or MP3 player. The accessory power outlet only works with the vehicle turned on.

The vehicle has an accessory power outlet on the lower center stack below the climate control.

Open the cover to access and replace when not in use.

See *Power Outlets* ⇨ 114.

Battery and Efficiency

High Voltage Safety Information

Warning

Exposure to high voltage can cause shock, burns, and even death. The high voltage components in the vehicle can only be serviced by technicians with special training.

High voltage components are identified by labels. Do not remove, open, take apart, or modify these components. High voltage cable or wiring has orange covering or labels. Do not probe, tamper with, cut, or modify high voltage cable or wiring.

This vehicle has a high voltage battery and a standard 12-volt battery.

If the vehicle is in a crash, the sensing system may shut down the high voltage system. When this occurs, the high voltage battery is disconnected and the vehicle will not start. The SERVICE VEHICLE SOON message in the Driver Information Center (DIC) will be displayed. Before the vehicle can be operated again, it must be serviced at your dealer.

Warning

Damage to the high voltage battery or high voltage system can create a risk of electric shock, overheating, or fire.

If the vehicle is damaged from a moderate to severe crash, flood, fire, or other event, the vehicle should be inspected as soon as possible. Until the vehicle has been inspected, store it outside at least 15 m (50 ft) from any

(Continued)

Warning (Continued)

structure or anything that can burn. Ventilate the vehicle by opening a window or a door.

Contact Customer Assistance as soon as possible to determine whether an inspection is needed. See *Customer Assistance Offices* ⇨ 334.

See *Battery - North America* ⇨ 264 for important safety information. If an airbag has inflated, see *What Will You See after an Airbag Inflates?* ⇨ 75.

Only a trained service technician with the proper knowledge and tools should inspect, test, or replace the high voltage battery. See your dealer if the high voltage battery needs service.

See *Battery - North America* ⇨ 264.

Charging

This section explains the process for charging the high voltage battery. Do not allow the vehicle to remain in temperature extremes for long periods without being driven or plugged in. It is recommended that the vehicle be plugged in when temperatures are below 0 °C (32 °F) and above 32 °C (90 °F) to maximize high voltage battery life.

When using a 120-volt AC electrical outlet, it will take approximately 50 hours to charge the vehicle with the 12 amp AC current setting, allowing approximately 6 km (4 mi) for every hour of charging.

When using a 240-volt charging station, it will take approximately 9.5 hours to charge the vehicle with the 32 amp setting, allowing approximately 40 km (25 mi) for every hour of charging.

Charge times will vary based on battery condition, charge level, and outside temperature. See *Programmable Charging* ⇨ 131 for charge mode selection.

The charging system may run fans and pumps that result in sounds from the vehicle while it is turned off. Additional unexpected clicking sounds may be caused by the electrical devices used while charging.

The vehicle does not require indoor charging area ventilation before, during, or after charging.

While the charge cord is plugged into the vehicle, the vehicle cannot be driven.

Charging Override

A CHARGING OVERRIDE/ INTERRUPTION OCCURRED message may display to indicate that a charging override or interruption has occurred.

See *Plug-In Charging* ⇨ 235 and *Programmable Charging* ⇨ 131.

AC Charging

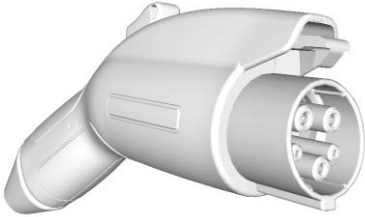

AC Charge Cord Vehicle Plug

Start Charge

A portable charge cord used to charge the vehicle high voltage battery is stored in the rear cargo area.

1. Make sure the vehicle is parked.



2. Push the rearward edge of the charge port door and release to open the door.

In cold weather conditions, ice may form around the charge port door. Remove ice from the area before attempting to open or close the charge port door.



3. Open the liftgate, lift the load floor cover, and remove the charge cord.
4. Plug the charge cord into the electrical outlet. See *Electrical Requirements for Battery Charging* ⇨ 251. Verify the charge cord status. See *Charge Cord* ⇨ 243. Select the appropriate charge level. See “Charge Current Limit Selection” under *Programmable Charging* ⇨ 131.



5. Plug in the AC vehicle plug of the charge cord into the charge port on the vehicle. Make sure the AC vehicle plug is fully connected to the AC charge port. If it is not properly seated, the charge may not occur.
6. Verify that the Charging Status Indicator illuminates on top of the instrument panel and an audible chirp occurs. See *Charging Status Feedback* ⇨ 240.
7. To arm the charge cord theft alert, lock the vehicle twice with the RKE transmitter. To disarm

this feature, see “Energy Settings” under *Energy Information* ⇨ 138.

End Charge

1. Unlock the vehicle with the RKE transmitter to disarm the charge cord theft alert.
2. Unplug the vehicle plug of the charge cord from the vehicle. Unlock the vehicle plug of the charge cord from the vehicle by pressing the button on the top of the charge cord plug.
3. Close the charge port door by pressing firmly in the center until it latches.
4. Unplug the charge cord from the electrical outlet.
5. Place the charge cord into the storage compartment.

DC Charging (If Equipped)

DC Charging Station Hardware

Check the charge station DC vehicle plug for compatibility with the DC charge port on this vehicle. When recharging at a DC fast

charge station, the power cable connected to the vehicle must be less than 10 m (33 ft) in length.

Follow the steps listed on the charging station to perform a DC vehicle charge.

If for any reason DC charging does not begin or is interrupted, check the DC charge station display for messages. Unplug to restart the DC charge process.

Start Charge

1. Make sure the vehicle is parked.
2. Push the rearward edge of the charge port door and release to open the door.

In cold weather conditions, ice may form around the charge port door. The charge port door may not open on the first attempt. Remove ice from the area and repeat attempting to open the charge port door.

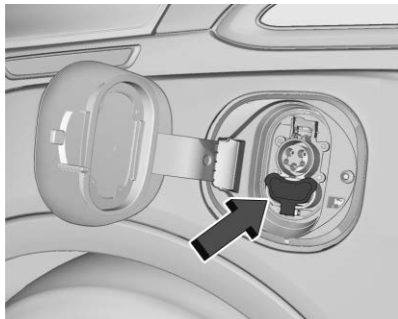

3. Unlatch the DC charging dust cover and lower it fully.
4. Plug in the DC vehicle plug into the DC charge port on the vehicle. Make sure that the DC vehicle plug is fully connected to the DC charge port. If it is not properly seated then the charge may not occur. Proper plug connection can be checked by information on the DIC.
5. Follow the steps listed on the charging station to start charging. The Electric Parking

Brake will automatically apply once the charge process has been started.

6. Once charging, the DC vehicle plug will be locked to the DC charge port and cannot be disconnected while charging is active.
7. Verify that the Charging Status Indicator illuminates on top of the instrument panel and an audible chirp occurs. See *Charging Status Feedback* ⇨ 240.

Caution

Do not attempt to disconnect the DC vehicle plug while charging is active. This action may damage vehicle or charging station hardware.

Stop Charge

Controls on the charging station can be used to stop the charge process at any time.

To stop the charge when inside the vehicle, you may use the stop charging button on the Charging screen. See *Programmable Charging* ⇨ 131.

There is also an available mobile app with several charging functions. See *KeyPass* ⇨ 45.

Stop Charge — Automatic

When the vehicle no longer needs to use power from the charging station, it will stop charging and the DC vehicle plug will be unlocked from the DC charge port.

Energy can still be consumed from the charging station when the vehicle's displays and indicators show that the battery is fully charged. This is to ensure the battery is in optimal temperature operating range to maximize vehicle range. See *Programmable Charging* ⇨ 131.

End Charge

1. Wait until the charging process has been fully stopped, the vehicle plug is unlocked, and the Charging Status Indicator is solid green or off.

If the vehicle plug does not unlock from the vehicle charge port after a charge, contact Roadside Assistance for assistance. See *Roadside Assistance Program* ⇨ 336.

2. Unplug the DC vehicle plug from the DC charge port on the vehicle and close the dust cover.
3. Close the charge port door by pressing firmly in the center until it latches.
4. The Electric Parking Brake should be manually disengaged before driving the vehicle.
5. To start another DC charge, remove the DC vehicle plug and reconnect.

Charge Cord

See *Radio Frequency Statement* ⇨ 342.

Important Information about Portable Electric Vehicle Charging

- Charging an electric vehicle can stress a building's electrical system more than a typical household appliance.
- Before plugging into any electrical outlet, have a qualified electrician inspect and verify the electrical system (electrical outlet, wiring, junctions, and protection devices) for heavy-duty service at a 12 amp continuous load.
- Electrical outlets may wear out with normal usage or may be damaged over time, making them unsuitable for electric vehicle charging.
- Check the electrical outlet/plug while charging and discontinue use if the electrical outlet/plug is

hot, then have the electrical outlet serviced by a qualified electrician.

- When outdoors, plug into an electrical outlet that is weatherproof while in use.
- Mount the charge cord to reduce strain on the electrical outlet/plug.
- Do not place the charge cord in a position where it is expected to be submerged in water.

Danger

Improper use of portable electric vehicle charge cords may cause a fire, electrical shock, or burns, and may result in damage to property, serious injury, or death.

- Do not use extension cords, multi-outlet power strips, splitters, grounding adaptors, surge protectors, or similar devices.

(Continued)

Danger (Continued)

- Do not use an electrical outlet that is worn or damaged, or will not hold the plug firmly in place.
- Do not use an electrical outlet that is not properly grounded.
- Do not use an electrical outlet that is on a circuit with other electrical loads.

Charge Cord Status Indicators

See *Charge Cord* ⇨ 243.

Charge Level Selection

Charge level selection can be made using the Charge Mode tab on the Charging screen on the infotainment display. See “Charge Current Limit Selection” under *Programmable Charging* ⇨ 131.

⚠ Warning

Using a charge level that exceeds the electrical circuit or electrical outlet capacity may start a fire or damage the electrical circuit. Use the lowest charge level until a qualified electrician inspects the electrical circuit capacity. Use the lowest charge level if the electrical circuit or electrical outlet capacity is not known.

Regenerative Braking

Regenerative braking takes some of the energy from the moving vehicle and turns it back into electrical energy. This energy is then stored in the high voltage battery system, contributing to increased energy efficiency.

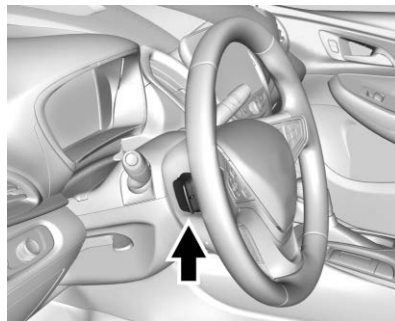
Regen on Demand

This feature is activated using the steering wheel paddle. Regen on Demand slows the vehicle by recapturing energy.

See *Regenerative Braking* ⇨ 215.

Service**⚠ Warning**

Never try to do your own service on high voltage components. You can be injured and the vehicle

(Continued)





Warning (Continued)

can be damaged if you try to do your own service work. Service and repair of these high voltage components should only be performed by a trained service technician with the proper knowledge and tools. See *Doing Your Own Service Work* ⇨ 256.

Performance and Maintenance**Traction Control/
Electronic Stability
Control**

The Traction Control System (TCS) limits wheel spin. The system turns on automatically every time the vehicle is powered up.

The Electronic Stability Control system called StabiliTrak assists with directional control of the vehicle in difficult driving conditions. The system turns on automatically every time the vehicle is on.

- To turn off TCS, press and release , on the center stack.  illuminates and the appropriate Driver Information Center (DIC) message is displayed.
- To turn off both TCS and StabiliTrak, press and hold , until  and  come on and stay



on in the instrument cluster and the appropriate DIC message is displayed.

- Press and release  to turn on both systems.

See *Traction Control/Electronic Stability Control* ⇨ 217.

Tire Pressure Monitor

This vehicle may have a Tire Pressure Monitor System (TPMS).



The low tire pressure warning light alerts to a significant loss in pressure of one of the vehicle's tires. If the warning light comes on, stop as soon as possible and inflate the tires to the recommended pressure shown on the Tire and Loading Information label. See

Vehicle Load Limits ⇨ 200. The warning light will remain on until the tire pressure is corrected.

The low tire pressure warning light may come on in cool weather when the vehicle is first started, and then turn off as the vehicle is driven. This may be an early indicator that the tire pressures are getting low and the tires need to be inflated to the proper pressure.

The TPMS does not replace normal monthly tire maintenance. Maintain the correct tire pressures.

See *Tire Pressure Monitor System* ⇨ 285.

Driving for Better Energy Efficiency

Use the following tips to help maximize energy efficiency and range.

In colder temperatures, while these efficiency tips will help, the electric vehicle driving range may be lower due to higher energy usage.

Acceleration/Braking/Coasting

Avoid unnecessary rapid accelerations and decelerations.

Electric range is maximized at 89 km/h (55 mph) and below. Higher speeds use more energy and can significantly reduce electric range.

Use cruise control when appropriate.

Plan ahead for decelerations and coast whenever possible. For example, do not rush to traffic signals.

Do not shift to N (Neutral) to coast. The vehicle recovers energy while coasting and braking in D (Drive) or L (Low).

Climate Setting

Using the heat and air conditioning systems decreases the energy available for electric driving.

Optimal energy efficiency is achieved with the heat, air conditioning, and fan turned off.

Operating with the climate control system off is the most energy efficient climate setting.

Use the heated seat feature instead of climate settings. Heating the seat uses less energy than heating the vehicle interior.

Use remote start to heat or cool the interior when the vehicle is plugged in to maximize the electric range by utilizing electricity from the electrical outlet.

In hot weather, avoid parking in direct sunlight or use sunshades inside the vehicle.

Turn off the front and rear window defog/defrost when they are no longer needed.

Avoid driving with the windows open at highway speeds.

Vehicle Charging/Maintenance

Charging

Keep the vehicle plugged in, even when fully charged, to keep the battery temperature ready for the

next drive. This is important when outside temperatures are extremely hot or cold.

Maintenance

Always keep the tires properly inflated and the vehicle properly aligned.

The weight of excess cargo in the vehicle affects efficiency and range. Avoid carrying more than is needed.

Avoid unnecessary use of electrical accessories. Power used for functions other than propelling the vehicle will reduce EV range.

Using a rooftop carrier will reduce efficiency due to additional weight and drag.

Roadside Assistance Program

U.S.: 1-888-811-1926

TTY Users (U.S. Only):
1-888-889-2438

Canada: 1-800-268-6800

As the owner of a new Chevrolet, you are automatically enrolled in the Roadside Assistance program. This program provides security and convenience in the event of an on-road failure or emergency situation. Service is provided 24 hours a day, 365 days a year for the duration of the vehicle's powertrain warranty.

See *Roadside Assistance Program*
⇨ 336.



Keys, Doors, and Windows

Keys and Locks

Keys	32
Remote Keyless Entry (RKE) System	33
Remote Keyless Entry (RKE) System Operation	33
Remote Start	39
Door Locks	41
Power Door Locks	43
Delayed Locking	43
Automatic Door Locks	43
Lockout Protection	44
Safety Locks	44
KeyPass	45

Doors

Liftgate	47
----------------	----

Vehicle Security

Vehicle Security	48
Vehicle Alarm System	48
Immobilizer	48
Immobilizer Operation	49

Exterior Mirrors

Convex Mirrors	50
----------------------	----

Power Mirrors	50
Folding Mirrors	50

Interior Mirrors

Interior Rearview Mirrors	51
Manual Rearview Mirror	51
Automatic Dimming Rearview Mirror	51
Rear Camera Mirror	51

Windows

Windows	53
Power Windows	53
Sun Visors	55

Keys and Locks

Keys

Warning

Leaving children in a vehicle with a Remote Keyless Entry (RKE) transmitter is dangerous and children or others could be seriously injured or killed. They could operate the power windows or other controls or make the vehicle move. The windows will function with the RKE transmitter in the vehicle, and children or others could be caught in the path of a closing window. Do not leave children in a vehicle with an RKE transmitter.



The key that is part of the Remote Keyless Entry (RKE) transmitter can be used for all locks.



To remove the key, press the button near the bottom of the transmitter, and pull the key out. Never pull the key out without pressing the button.

See your dealer if a new key is needed.

If locked out of the vehicle, see *Roadside Assistance Program* ⇨ 336.

With an active OnStar service plan, an OnStar Advisor may remotely unlock the vehicle. See *OnStar Overview* ⇨ 346.

Remote Keyless Entry (RKE) System

See *Radio Frequency Statement* ⇨ 342.

If there is a decrease in the Remote Keyless Entry (RKE) operating range:

- Check the distance. The transmitter may be too far from the vehicle.

- Check the location. Other vehicles or objects may be blocking the signal.
- Check the transmitter's battery. See "Battery Replacement" later in this section.
- If the transmitter is still not working correctly, see your dealer or a qualified technician for service.

Remote Keyless Entry (RKE) System Operation

The Keyless Access system allows for vehicle entry when the transmitter is within 1 m (3 ft).

The transmitter functions may work up to 60 m (197 ft) away from the vehicle.

Other conditions, such as those previously stated, can impact the performance of the transmitter.





 : Press to lock all doors.

The turn signal indicators may flash and/or the horn may sound on the second press to indicate locking. See *Vehicle Personalization* ⇨ 143.

If the driver door is open when  is pressed, all doors lock except the driver door, if enabled through vehicle personalization. See *Vehicle Personalization* ⇨ 143.

If the passenger door is open when  is pressed, all doors lock.



Pressing  may also arm the alarm system. See *Vehicle Alarm System* ⇨ 48.



 : Press to unlock the driver door. Press unlock again within 5 seconds to unlock all doors. The RKE transmitter can be programmed to unlock all doors on the first button press. See *Vehicle Personalization* ⇨ 143.

The turn signal indicators may flash to indicate unlocking. See *Vehicle Personalization* ⇨ 143.

Pressing  will disarm the alarm system. See *Vehicle Alarm System* ⇨ 48.

 : Press and release one time to initiate vehicle locator. The exterior lamps flash and the horn chirps three times.

Press and hold  for at least three seconds to sound the panic alarm. The horn sounds and the turn signals flash for about 30 seconds until  is pressed again or the vehicle is started.

 : Press and release  and then immediately press and hold  for at least four seconds to start the vehicle's heating or air conditioning systems and rear window defogger from outside the vehicle using the RKE transmitter. See *Remote Start* ⇨ 39.

Keyless Access Operation

The Keyless Access system allows the doors and liftgate to be locked and unlocked without pressing the RKE transmitter button. The RKE transmitter must be within 1 m (3 ft) of the door or trunk being opened. If the vehicle has this feature, there will be a button on both outside front and rear door handles.

Keyless Access can be programmed to unlock all doors on the first unlock/lock button press from the driver door. See *Vehicle Personalization* ⇨ 143.

Keyless Unlocking/Locking from the Driver Door

When the doors are locked and the RKE transmitter is within 1 m (3 ft) of the driver door handle, pressing the lock/unlock button on the driver door handle will unlock the driver door. If the lock/unlock button is pressed again within five seconds, all passenger doors will unlock. Pull the door handle to unlatch the door.

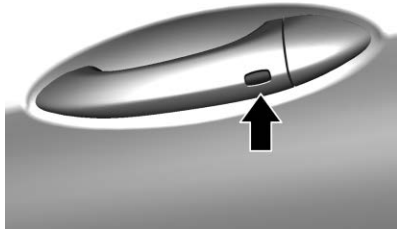

Pressing the lock/unlock button will cause all doors to lock if any of the following occur:

- It has been more than five seconds since the first lock/unlock button press.
- Two lock/unlock button presses were used to unlock all doors.
- Any vehicle door has opened and all doors are now closed.

See *Vehicle Personalization* ⇨ 143.

Keyless Unlocking/Locking from Passenger Doors

When the doors are locked and the RKE transmitter is within 1 m (3 ft) of the door handle, pressing the lock/unlock button on that door handle will unlock all doors.

Pressing the lock/unlock button will cause all doors to lock if any of the following occur:

- The lock/unlock button was used to unlock all doors.
- Any vehicle door has opened and all doors are now closed.



Passive Locking

The Keyless Access system will lock the vehicle several seconds after all doors are closed, if the vehicle is off and at least one RKE transmitter has been removed from the interior or none remain in the interior.

If other electronic devices interfere with the RKE transmitter signal, the vehicle may not detect the RKE transmitter inside the vehicle.

If passive locking is enabled, the doors may lock with the RKE transmitter inside the vehicle. Do not leave the RKE transmitter in an unattended vehicle.

To customize doors to automatically lock when exiting the vehicle, see *Vehicle Personalization* ⇨ 143.

Temporary Disable of the Passive Locking Feature

Temporarily disable passive locking by pressing and holding  on the interior door switch with a door open for at least four seconds, or until three chimes are heard. Passive

locking will then remain disabled until  on the interior door is pressed, or until the vehicle is started.

Remote Left In Vehicle Alert

When the vehicle is turned off and an RKE transmitter is left in the vehicle, the horn will chirp three times after all doors are closed.

To turn on or off see *Vehicle Personalization* ⇨ 143.

Remote No Longer In Vehicle Alert

If the vehicle is on, with a door open, and then all doors are closed, the vehicle will check for RKE transmitter(s) inside. If an RKE transmitter is not detected, the DIC will display NO REMOTE DETECTED and the horn will chirp three times.

This occurs only once each time the vehicle is driven.

See *Vehicle Personalization* ⇨ 143.

Keyless Liftgate Opening

Press the touch pad on the underside of the liftgate glass and lift up to open if the RKE transmitter is within 1 m (3 ft) and the doors are locked. If the doors are unlocked, the transmitter is not required to open the liftgate. See *Liftgate* ⇨ 47.

Keyed Access

To access a vehicle with a weak transmitter battery, see *Door Locks* ⇨ 41.

Programming Transmitters to the Vehicle

Only RKE transmitters programmed to the vehicle will work. If a transmitter is lost or stolen, a replacement can be purchased and programmed through your dealer. The vehicle can be reprogrammed so that lost or stolen transmitters no longer work. Any remaining transmitters will need to be reprogrammed. Each vehicle can have up to eight transmitters matched to it.



Programming with Two Recognized Transmitters

A new transmitter can be programmed to the vehicle when there are two recognized transmitters. To program, the vehicle must be off and all of the transmitters, both currently recognized and new, must be with you.

1. Place the two recognized transmitters in the cupholder.
2. Remove the key lock cylinder cover on the driver door handle. See *Door Locks* ⇨ 41. Insert the vehicle key of the new transmitter into the key lock cylinder on the driver door handle and turn the key to the unlock position five times within 10 seconds.

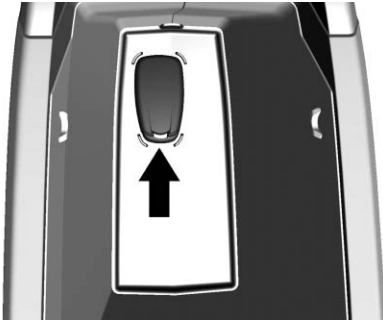
The Driver Information Center (DIC) displays READY FOR REMOTE # 3, 4, 5, 6, 7, or 8.



3. Open the center console and take the small tray out of the center console. Place the transmitter in the transmitter pocket with the buttons facing down.
4. Press POWER  to start the vehicle. When the transmitter is learned, the DIC will show that it is ready to program the next transmitter.
5. Remove the transmitter from the transmitter pocket and press  or .

To program additional transmitters, repeat Steps 3–5.

When all additional transmitters are programmed, press and hold POWER  for 12 seconds to exit programming mode.

6. Put the key back into the transmitter.

Programming without Two Recognized Transmitters

If two currently recognized transmitters are not available, follow this procedure to program up to eight transmitters. This feature is not available in Canada. This procedure will take approximately 30 minutes to complete. The vehicle must be off and all of the transmitters to be programmed must be with you.

1. Remove the key lock cylinder cover on the driver door handle. See *Door Locks*  41. Insert the vehicle key of the transmitter into the key lock cylinder on the driver door handle and turn the key to the unlock position five times within 10 seconds.



The Driver Information Center (DIC) displays REMOTE LEARN PENDING, PLEASE WAIT.



2. Wait for 10 minutes until the DIC displays PRESS ENGINE START BUTTON TO LEARN and then press POWER .

The DIC will again show REMOTE LEARN PENDING, PLEASE WAIT.

3. Repeat Step 2 two additional times. After the third time, all previously known transmitters will no longer work with the vehicle. Remaining transmitters can be relearned during the next steps.

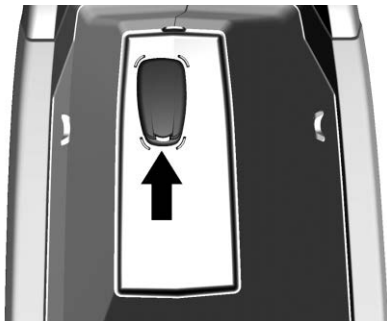
The DIC should now show READY FOR REMOTE # 1.



4. Open the center console and take the small tray out of the center console. Place the transmitter in the transmitter pocket with the buttons facing down.
5. Press POWER  to start the vehicle. When the transmitter is learned, the DIC will show that it is ready to program the next transmitter.
6. Remove the transmitter from the transmitter pocket and press  or .

To program additional transmitters, repeat Steps 4–6.

When all additional transmitters are programmed, press and hold POWER  for 12 seconds to exit programming mode.

7. Put the key back into the transmitter.

Starting the Vehicle with a Low Transmitter Battery

While trying to start the vehicle, if the transmitter battery is weak or if there is interference with the signal, the DIC may display NO REMOTE DETECTED or USE TRANSMITTER POCKET TO START. The REPLACE BATTERY IN REMOTE KEY message may also be displayed at this time.

To start the vehicle:

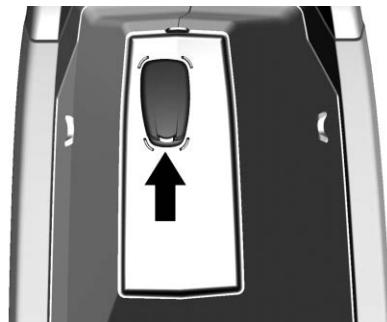

1. Open the center console and take the small tray out of the center console. Place the transmitter in the pocket with the buttons facing down.
2. With the vehicle in P (Park) or N (Neutral), press the brake pedal and press POWER . Replace the transmitter battery as soon as possible.

Battery Replacement

Replace the battery if the REPLACE BATTERY IN REMOTE KEY message displays in the DIC.

Caution

When replacing the battery, do not touch any of the circuitry on the transmitter. Static from your body could damage the transmitter.

The battery is not rechargeable. To replace the battery:



1. Press the button on the side of the transmitter near the bottom and pull the key out.

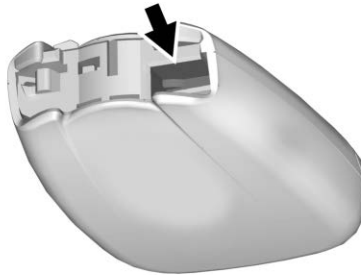

2. Separate the two halves of the transmitter using a flat tool inserted into the area near the key slot.



3. Remove the battery by pushing on the battery and sliding it toward the bottom of the transmitter.
4. Insert the new battery, positive side facing the back cover. Push the battery down until it is held in place. Replace with a CR2032 or equivalent battery.
5. Snap the battery cover back on to the transmitter.

Remote Start

This feature starts the heating or air conditioning systems and the rear window defogger from outside the vehicle.

Use remote start to heat or cool the interior when the vehicle is plugged in to maximize electric range by utilizing electricity from the electrical outlet. Normal operation of the system will return after the vehicle has been turned on.

 : This button is on the RKE transmitter.

The climate control system will use the previous settings during a remote start. The rear defog may come on during remote start based on cold ambient conditions. The rear defog indicator light does not come on during a remote start.

Laws in some local communities may restrict the use of remote starters. For example, some laws require a person using remote start to have the vehicle in view. Check local regulations for any requirements.



If the vehicle is low on energy, do not use the remote start feature. The vehicle may run out of energy.

The RKE transmitter range may be less while the vehicle is running.

Other conditions can affect the performance of the transmitter. See *Remote Keyless Entry (RKE) System* ⇨ 33.

Remote Starting the Vehicle

To remote start the vehicle:

1. Press and release  on the RKE transmitter.
2. Immediately press and hold  for at least four seconds or until the turn signal lamps flash.
3. After entering the vehicle during a remote start, press POWER  with the brake pedal applied to start the vehicle and operate as normal.

Remote start will automatically shut off after 20 minutes unless a time extension is done.

When the vehicle starts, the parking lamps will turn on. Remote start run time can be extended.

Extending Vehicle Run Time

The vehicle run time can also be extended by another 20 minutes, if after 30 seconds and during the first 20 minutes Steps 1 and 2 are

repeated while the vehicle is running. This provides a total of 40 minutes.



The remote start can only be extended once.

A maximum of two remote starts, or a single start with an extension, are allowed between ignition cycles using POWER .

For additional remote starts, turn the vehicle on with the transmitter in the vehicle.

Canceling Remote Start

To cancel a remote start, do any of the following:

- Press and hold  until the parking lamps turn off.
- Turn on the hazard warning flashers.
- Press POWER  with the brake pedal applied, then press POWER  again to turn the vehicle off.

Conditions in Which Remote Start Will Not Work

The remote vehicle start feature will not operate if:

- The RKE transmitter is in the vehicle.
- The hood is not closed.
- The hazard warning flashers are on.
- The service vehicle soon light is on.
- The electric drive unit coolant temperature is too high.
- Two remote vehicle starts, or a single remote start with an extension, have already been used.
- The vehicle is not in P (Park).

Door Locks

Warning

Unlocked doors can be dangerous.

- Passengers, especially children, can easily open the doors and fall out of a moving vehicle. The doors can be unlocked and opened while the vehicle is moving. The chance of being thrown out of the vehicle in a crash is increased if the doors are not locked. So, all passengers should wear seat belts properly and the doors should be locked whenever the vehicle is driven.
- Young children who get into unlocked vehicles may be unable to get out. A child can be overcome by extreme heat and can suffer



(Continued)

Warning (Continued)

permanent injuries or even death from heat stroke. Always lock the vehicle whenever leaving it.



- Outsiders can easily enter through an unlocked door when you slow down or stop the vehicle. Locking the doors can help prevent this from happening.

To lock or unlock the doors from outside the vehicle:

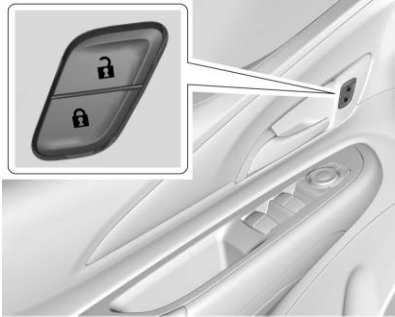
- Use the key in the driver door to lock and unlock the door without the RKE (Remote Keyless Entry) transmitter. The key cylinder is covered with a cap. See “Driver Door Key Lock Cylinder Access (In Case of Dead Battery)” later in this section.
- Press  or  on the RKE transmitter to lock and unlock the doors.



To lock or unlock the doors from inside the vehicle:

- Press  or  on the power door lock switch.
- Pull the door handle. Pulling an interior door handle will unlock the door. Pulling the door handle again unlatches it.

Keyless Access

The RKE transmitter must be within 1 m (3 ft) of the liftgate or door being opened. Press the button on the door handle to open. See “Keyless

Access Operation” in *Remote Keyless Entry (RKE) System Operation* ⇨ 33.

Driver Door Key Lock Cylinder Access (In Case of Dead Battery)

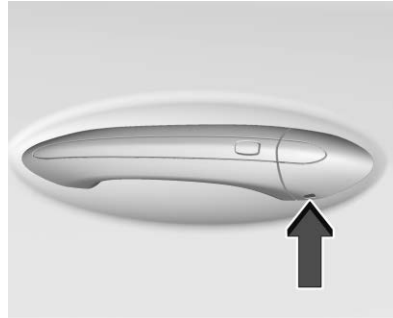

To access the driver door key lock cylinder:

1. Insert the key into the slot on the bottom of the cap.
2. Lift the key upward to remove the cap.
3. Insert the key into the cylinder and turn to unlock.

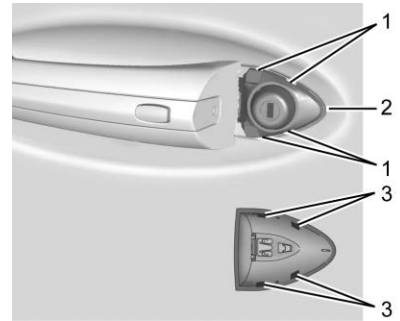

To replace the cap:

1. Position the bottom edge of the cap under the lower edge of the metal piece (2). The tabs (3) attach to the metal piece (2) at the positions (1).

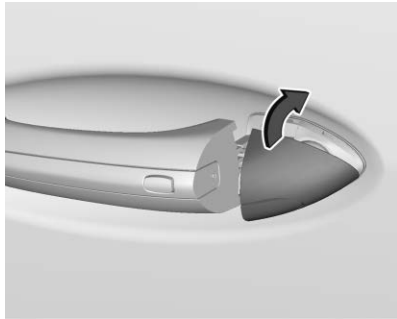



2. Rotate the cap upward and install into place.
3. Check that the cap is secure.

Free-Turning Locks

The door key lock cylinder turns freely when either the wrong key is used, or the correct key is not fully inserted. The free-turning door lock feature prevents the lock from being forced open. To reset the lock, turn it to the vertical position with the correct key fully inserted. Remove the key and insert it again. If this does not reset the lock, turn the key halfway around in the cylinder and repeat the reset procedure.

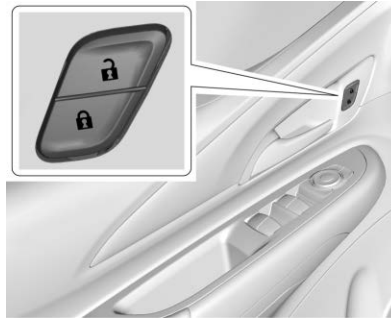
Power Door Locks



 : Press to unlock the doors.

 : Press to lock the doors.

Locking and unlocking the doors will also unlock the liftgate. See *Liftgate* ⇨ 47.



Delayed Locking

This feature delays the actual locking of the doors until five seconds after all doors are closed.

Delayed locking can only be turned on when the Unlocked Door Anti Lockout feature has been turned off.

Press  on the power door lock switch with the door open.

The doors will then lock automatically five seconds after all doors are closed. If a door is reopened before five seconds have elapsed, the five-second timer will reset once all the doors are closed again.

Press  on the door lock switch again or press  on the RKE transmitter to override this feature and lock the doors immediately.

Delayed locking can be programmed. See *Vehicle Personalization* ⇨ 143.

Automatic Door Locks

The doors will lock automatically when all doors are closed, the vehicle is on, and the shift lever is out of P (Park).

44 Keys, Doors, and Windows

If a vehicle door is unlocked and then opened and closed, the doors will lock either when your foot is removed from the brake or the vehicle speed becomes faster than 13 km/h (8 mph).

To unlock the doors:

- Press  on a door.
- Shift the vehicle into P (Park).

Automatic door unlocking can be programmed. See *Vehicle Personalization* ⇨ 143.

Lockout Protection

If the vehicle is on or in Service Mode and the power door lock switch is pressed with the driver door open, all the doors will lock and only the driver door will unlock.

If the vehicle is off and locking is requested while a door is open, when all doors are closed the vehicle will check for RKE transmitters inside. If an RKE transmitter is detected and the number of RKE transmitters inside

has not reduced, the driver door will unlock and the horn will chirp three times.

Lockout Protection can be manually overridden with the driver door open by pressing and holding  on the power door lock switch.

If Unlocked Door Anti Lockout is turned on and the vehicle is off, the driver door is open, and locking is requested, all the doors will lock and only the driver door will unlock. The Unlocked Door Anti Lockout feature can be turned on or off. See *Vehicle Personalization* ⇨ 143.

Safety Locks



If equipped, the safety lock is on the inside edge of the rear doors. To use the safety lock:

1. Move the lever forward to the lock position.
2. Close the door.
3. Do the same for the other rear door.

To open a rear door when the safety lock is on:

1. Unlock the door by using the inside handle, the power door lock switch, or the Remote Keyless Entry (RKE) transmitter.
2. Open the door from the outside.

When the safety lock is enabled, adults and older children will not be able to open the rear door from the inside. Cancel the safety locks to enable the doors to open from the inside.

To cancel the safety lock:

1. Unlock the door and open it from the outside.
2. Move the lever rearward to unlock. Do the same for the other door.

KeyPass

If equipped, this feature allows a smartphone to be connected to the vehicle and remote vehicle functions to be requested. Features vary depending on availability.

Features include:

- Remote commands – Use to lock/unlock the vehicle, remote start for the cabin climate, or sound or cancel the horn and flash the lights.
- Vehicle status – View the vehicle’s range and battery level, charging status, and tire pressure.
- Welcome lighting – Request light when approaching the vehicle.
- Location services – Save the parked location or start navigation at the vehicle’s GPS coordinates.

Setup Function

- KeyPass Setup
 - Managing Priority Setting



- Modifying Priority Setting

- Revocation

Active Remote Function

- Door Lock/Unlock
- Remote Start/Stop
- Panic Alarm Activation/ Termination
- Remote Charge Termination
- High Voltage Charge Functions
 - Temporary Charging Override Update
 - Change the Charging Mode Permanently
 - Update Departure Time Schedule
 - High Voltage Priority Charging Activate and De-activate
 - Select Charge Level/Limit Preference Screen
- Vehicle Locator
- Routing w/Available Mileage

Passive Function

Approach Detection/Welcome Lighting

Visual Display for Vehicle Information

- Low Battery Indication
- Tire Pressure
- Remote Start Status
- Odometer Reading
- Rear Closure Ajar Switch Status
- Electric Parking Brake Status
- Hood Status
- High Voltage Battery State of Charge Status
- GPS Signal for End of Trip
- Charge Mode Status
 - Available Mileage
 - Charge Start and End Times Status
 - Full Week of Time Based Delayed Charging Status
 - Disable Rate Based and Delayed Charging Status

- High Voltage Charging System Fault (Unable to Charge)
- High Voltage Charger Power Level
- High Voltage Battery Charge Cord Connected Indication
- Charge Complete
- Usable State of Charge
- High Voltage Depletion Mode Range
- High Voltage Battery State of Charge Status

Pairing

A smartphone must be paired to the KeyPass Module and then it must be connected to the vehicle before it can be used.

Setup Information

- Up to three smartphones can be set up and connected to the vehicle.
- Setup is disabled when the vehicle is moving.

- Pairing only needs to be completed once per smartphone, unless the pairing information on the smartphone changes or the smartphone is deleted.

Setup Process

1. Enable the KeyPass function through vehicle personalization. See *Vehicle Personalization* ⇨ 143.
2. Download the myChevrolet app to the smartphone from the appropriate app store.
3. The vehicle must be on and in P (Park).
4. Open the app and touch Search for New Vehicles.
5. Choose your vehicle and touch Done.
6. Aim the smartphone camera at the QR code on the infotainment display to scan the security key. If the camera is not working, the QR code can be entered manually.

- The infotainment display provides confirmation that the pairing process was completed successfully.



Deleting a Paired Smartphone

- Select Settings from the Home Page on the infotainment display.
- Select KeyPass.
- Select Manage KeyPass Devices.
- Touch Delete next to the smartphone to be deleted, and follow the prompts.



Doors

Liftgate

Caution
To avoid damage to the liftgate or liftgate glass, make sure the area above and behind the liftgate is clear before opening it.

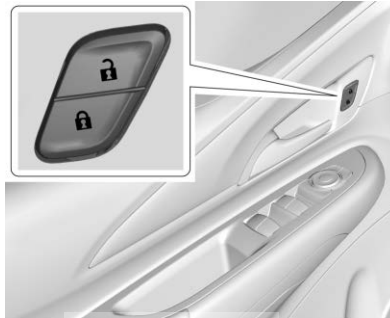
To lock or unlock the liftgate from the outside, press  or  on the RKE transmitter.



To lock or unlock the liftgate from the inside, press  or .

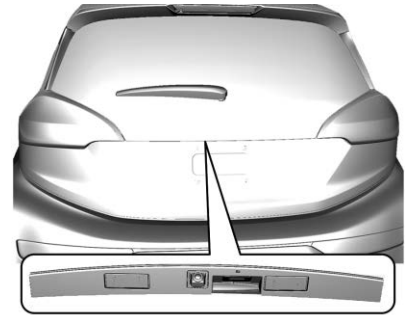

To open the liftgate, press the touch pad and lift up.

When closing the liftgate, use the pull cup.

Keyless Liftgate Opening

Press the touch pad on the underside of the liftgate glass and lift up to open if the RKE transmitter is within 1 m (3 ft) and the doors are locked. If the doors are unlocked, the transmitter is not required to open the liftgate.



Vehicle Security

This vehicle has theft-deterrent features; however, they do not make the vehicle impossible to steal.

Vehicle Alarm System

This vehicle has an anti-theft alarm system.

Arming the Alarm System

1. Close the liftgate, then turn off the vehicle.
2. Lock the vehicle in one of three ways:
 - Use the RKE transmitter.
 - Use the Keyless Access system.
 - With a door open, press the inside .
3. After 30 seconds the alarm system will arm. Pressing  on the RKE transmitter a second time will bypass the 30-second delay and immediately arm the alarm system.

The vehicle alarm system will not arm if the doors are locked with the key.

If the driver door is opened without first unlocking with the RKE transmitter, the horn will chirp and the lights will flash to indicate pre-alarm. If the vehicle is not started, or the door is not unlocked by pressing  on the RKE transmitter during the 10-second pre-alarm, the alarm will be activated.

If a door or the liftgate is opened without first disarming the system, the turn signals will flash and the horn will sound for about 30 seconds. The alarm system will then re-arm to monitor for the next unauthorized event.

Disarming the System

Do one of the following to disarm the alarm system or turn off the alarm if it has been activated:

- Press  on the RKE transmitter.
- Unlock the vehicle using the Keyless Access system.

- Start the vehicle.

To avoid setting off the alarm by accident:

- Lock the vehicle after all occupants have left the vehicle.
- Always unlock a door with the RKE transmitter.

Unlocking the driver door with the key will not disarm the system or turn off the alarm.

How to Detect a Tamper Condition

If  is pressed on the RKE transmitter and the horn chirps and the lights flash three times, an alarm occurred previously while the alarm system was armed.

If the alarm has been activated, a message will appear on the DIC.

Immobilizer

See *Radio Frequency Statement* ⇨ 342.

Immobilizer Operation

This vehicle has a passive theft-deterrent system.

The system does not have to be manually armed or disarmed.

The vehicle is automatically immobilized when the transmitter leaves the vehicle.

The immobilization system is disarmed when POWER  is pressed and a valid transmitter is found in the vehicle.



The security light on the instrument cluster comes on when there is a problem with arming or disarming the theft-deterrent system.

The system has one or more transmitters matched to an immobilizer control unit in the vehicle. Only a correctly matched

transmitter will start the vehicle. If the transmitter is damaged, you may not be able to start the vehicle.

When trying to start the vehicle, the security light comes on briefly when the vehicle is turned on.

If the vehicle does not start and the security light stays on, there is a problem with the system. Turn the vehicle off and try again.

If the RKE transmitter appears to be undamaged, try another transmitter, or place the transmitter in the transmitter pocket.

See “Starting the Vehicle with a Low Transmitter Battery” under *Remote Keyless Entry (RKE) System Operation* ⇨ 33.

If the vehicle does not start with the other transmitter or with the transmitter placed in the transmitter pocket, the vehicle needs service.

See your dealer who can service the theft-deterrent system and have a new transmitter programmed to the vehicle.

Do not leave the transmitter or device that disarms or deactivates the theft-deterrent system in the vehicle.

Exterior Mirrors

Convex Mirrors

Warning



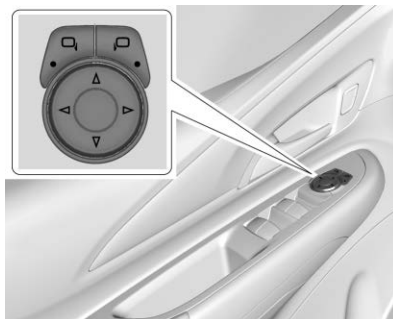

A convex mirror can make things, like other vehicles, look farther away than they really are. If you cut too sharply into the right lane, you could hit a vehicle on the right. Check the inside mirror or glance over your shoulder before changing lanes.

The passenger side mirror is convex shaped. A convex mirror's surface is curved so more can be seen from the driver seat.

Power Mirrors



To adjust the mirrors:

1. Press  or  to choose the driver or passenger mirror. An indicator will show the selected mirror.
2. Press the arrows on the control pad to move each mirror in the desired position.
3. Press  or  again to deselect the mirror.

Folding Mirrors

Manual Folding Mirrors

The vehicle has manual folding mirrors. These mirrors can be folded inward to prevent damage when going through an automatic car wash. To fold, pull the mirror toward the vehicle. Push the mirror outward to return it to the original position.

Interior Mirrors

Interior Rearview Mirrors

Adjust the rearview mirror for a clear view of the area behind your vehicle.

Do not spray glass cleaner directly on the mirror. Use a soft towel dampened with water.

Manual Rearview Mirror

Push the tab forward for daytime use and pull it rearward for nighttime use to avoid glare of the headlamps from behind.

Automatic Dimming Rearview Mirror

If equipped, automatic dimming reduces the glare of headlamps from behind. The dimming feature comes on when the vehicle is started.

Rear Camera Mirror

If equipped, this automatic dimming mirror provides a wide angle camera view of the area behind the vehicle.

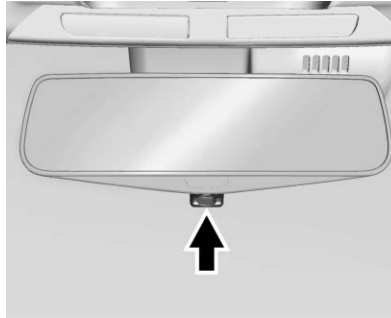

Pull the tab to turn on the display. Push the tab to turn it off. When off, the mirror is automatic dimming. Adjust the mirror for a clear view of the area behind the vehicle while the display is off.

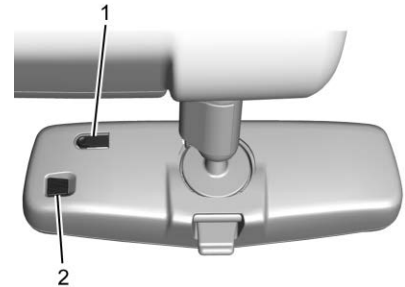

To adjust the brightness, press the button (1) on the back of the rearview mirror without covering the light sensor (2).



Each button press cycles the brightness between five settings.

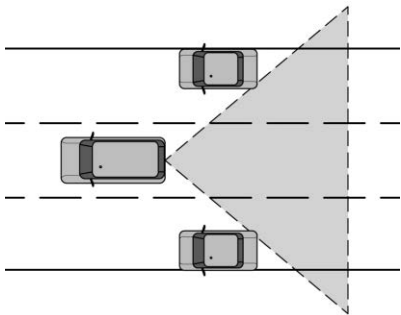

Warning

The Rear Camera Mirror (RCM) has a limited view. Portions of the road, vehicles, and other objects may not be seen. Do not drive or park the vehicle using only this camera. Objects may appear closer than they are. Check the outside mirrors or glance over your shoulder when making lane changes or merging. Failure to use proper care may result in injury, death, or vehicle damage.



The camera that provides the Rear Camera Mirror (RCM) image is above the license plate, next to the Rear Vision Camera (RVC).

To clean the rear camera, see *Windshield Wiper/Washer* ⇨ 111.

Troubleshooting

If the tab is in the rearward position and a blue screen and  are displayed in the mirror and the display shuts off, see your dealer for service.

The RCM may not work properly or display a clear image if:

- There is glare from the sun or headlamps. This may obstruct objects from view.
- Dirt, snow, or other debris blocks the camera lens. Clean the lens with a soft damp cloth.
- The back of the vehicle has been damaged and the position and mounting angle of the camera has changed.

Windows

Warning

Never leave a child, a helpless adult, or a pet alone in a vehicle, especially with the windows closed in warm or hot weather.

They can be overcome by the extreme heat and suffer permanent injuries or even death from heat stroke.

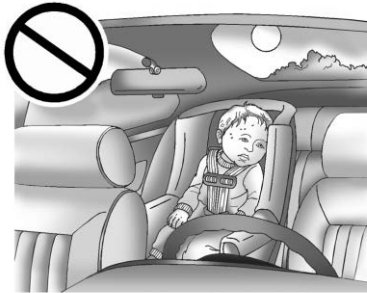

The vehicle aerodynamics are designed to improve electric range performance. This may result in a pulsing sound when either rear window is down and the front windows are up. To reduce the sound, open a front window.

Power Windows

Warning

Leaving children in a vehicle with the RKE transmitter is dangerous for many reasons; children or others could be badly injured or even killed. They could operate the power windows or other controls or even make the vehicle move. The windows will function with the RKE transmitter in the vehicle and they could be seriously injured or killed if caught in the path of a closing window. Do not leave the RKE transmitter in a vehicle with children.

(Continued)

Warning (Continued)

When there are children in the rear seat, use the window lockout switch to prevent unintentional operation of the windows.

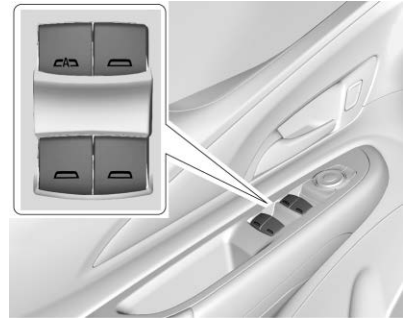

Press the switch to open the window. Pull the front of the switch up to close it.

The window switches on the driver door control all windows.

54 Keys, Doors, and Windows

The power windows only operate with the vehicle on or in Service Mode, or when Retained Accessory Power (RAP) is active.

Express Window Operation

The driver window has an express feature which allows the window to be lowered or raised without holding the switch. To automatically raise or lower the window, pull the driver window switch up or press it down all the way and release. Stop the window by pressing or pulling the switch in the same direction a second time, or by briefly operating the switch to the first position in either direction. The front and rear passenger windows have express open only.

Safety Function

This is for vehicles with the express-up feature. If any object is in the path of the window when the express-up feature is active, the window will stop and auto-reverse to a preset position. Weather conditions may cause the window to auto-reverse. The window switch

may be held up to the second position to close the window. The window will return to normal operation once the obstruction or condition is removed.

Safety Function Override

This is for vehicles with the express-up feature. If the battery on the vehicle has been recharged or disconnected, or is not working, the windows will need to be reprogrammed for the express-up feature to work. Before reprogramming, replace or recharge the vehicle's battery.

To program the driver window:

1. Close all doors with the vehicle on or in Service Mode.
2. Press and hold the power window switch until the window is fully open.
3. Pull the power window switch up until the window is fully closed.

4. Continue holding the switch up for approximately two seconds after the window is completely closed.

Window Lockout

This feature prevents the rear passenger windows from operating, except from the driver position.

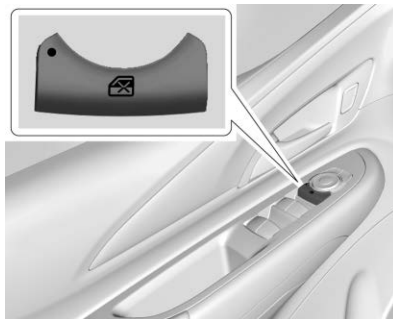

Press  on the driver door to activate the window lockout. The indicator light in the switch will illuminate when activated.

Press  again to deactivate the window lockout.

Sun Visors

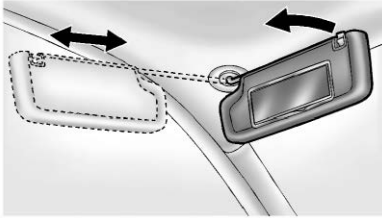

Pull the sun visor down to block glare. Detach the sun visor from the center mount to pivot to the side window or, if equipped, extend along the rod.

Visor Vanity Mirror

The vehicle may have vanity mirrors and card holders on the back of the sun visors. Swing down the sun visor to expose the vanity mirror.

Seats and Restraints

Head Restraints

Head Restraints 57

Front Seats

Seat Adjustment 59

Reclining Seatbacks 59

Heated Front Seats 60

Rear Seats

Rear Seats 62

Rear Seat Armrest 64

Heated Rear Seats 64

Seat Belts

Seat Belts 65

How to Wear Seat Belts

Properly 66

Lap-Shoulder Belt 67

Seat Belt Use During

Pregnancy 69

Seat Belt Extender 69

Safety System Check 69

Seat Belt Care 70

Replacing Seat Belt System

Parts after a Crash 70

Airbag System

Airbag System 71

Where Are the Airbags? 72

When Should an Airbag

Inflate? 74

What Makes an Airbag

Inflate? 75

How Does an Airbag

Restrain? 75

What Will You See after an

Airbag Inflates? 75

Passenger Sensing System ... 77

Servicing the Airbag-Equipped

Vehicle 81

Adding Equipment to the

Airbag-Equipped Vehicle 81

Airbag System Check 82

Replacing Airbag System Parts

after a Crash 82

Child Restraints

Older Children 83

Infants and Young Children 85

Child Restraint Systems 87

Where to Put the Restraint 89

Lower Anchors and Tethers for

Children (LATCH System) 90

Replacing LATCH System Parts

After a Crash 99

Securing Child Restraints (With
the Seat Belt in the

Rear Seat) 99

Securing Child Restraints (With
the Seat Belt in the

Front Seat) 101

Head Restraints

The vehicle's front and rear seats have adjustable head restraints in the outboard seating positions.

Warning

With head restraints that are not installed and adjusted properly, there is a greater chance that occupants will suffer a neck/spinal injury in a crash. Do not drive until the head restraints for all occupants are installed and adjusted properly.



Adjust the head restraint so that the top of the restraint is at the same height as the top of the occupant's head. This position reduces the chance of a neck injury in a crash.

Front Seats

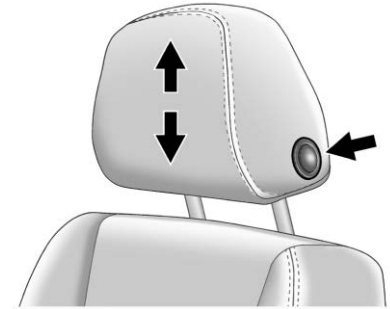

The height of the head restraint can be adjusted. To raise or lower the head restraint, press the button located on the side of the head restraint, and pull up or push the head restraint down, and release the button. Pull and push on the head restraint after the button is released to make sure that it is locked in place.

The front seat outboard head restraints are not removable.

Rear Seats

The vehicle's rear seats have adjustable head restraints in the outboard seating positions.

The height of the head restraint can be adjusted.

Pull the head restraint up to raise it. Try to move the head restraint to make sure it is locked in place.

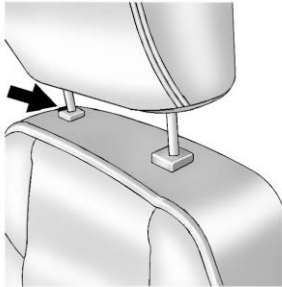

To lower the head restraint, press the button on the top of the seatback and push the head restraint down. Try to move the

head restraint after the button is released to make sure it is locked in place.

If installing a child restraint in the rear seat, see "Securing a Child Restraint Designed for the LATCH System" under *Lower Anchors and Tethers for Children (LATCH System)* ⇨ 90.

Folding the Rear Head Restraint

The head restraint can be folded rearward to allow for better visibility when the rear seat is unoccupied.

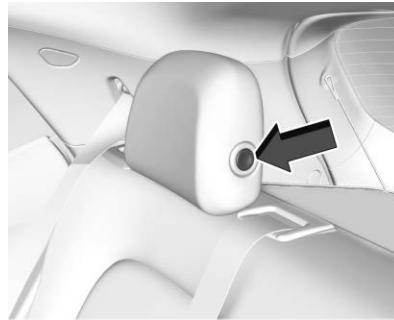

To fold the head restraint, press the button on the side of the head restraint.



The head restraint will fold rearward automatically.

When an occupant or child restraint is in the seat, always return the head restraint to the full upright position. Pull the head restraint up and forward until it locks into place. Push and pull on the head restraint to make sure that it is locked.

Always adjust the head restraint so that the top of the restraint is at the same height as the top of the occupant's head.

Front Seats

Seat Adjustment

Manual Seats

Warning

You can lose control of the vehicle if you try to adjust a driver seat while the vehicle is moving. Adjust the driver seat only when the vehicle is not moving.

Seat Position



To adjust the seat:

1. Pull the handle at the front of the seat.
2. Slide the seat to the desired position and release the handle.
3. Try to move the seat back and forth to be sure it is locked in place.

Seat Height Adjuster



Move the lever on the outboard side of the seat up or down to manually adjust the seat height.



Reclining Seatbacks

Warning

If either seatback is not locked, it could move forward in a sudden stop or crash. That could cause injury to the person sitting there. Always push and pull on the seatbacks to be sure they are locked.



To recline the seatback:

1. Lift the lever.

60 Seats and Restraints

2. Move the seatback to the desired position, and then release the lever to lock the seatback in place.
3. Push and pull on the seatback to make sure it is locked.

To return the seatback to the upright position:

1. Lift the lever fully without applying pressure to the seatback, and the seatback will return to the upright position.
2. Push and pull on the seatback to make sure it is locked.

Warning

Sitting in a reclined position when the vehicle is in motion can be dangerous. Even when buckled up, the seat belts cannot do their job.

(Continued)

Warning (Continued)

The shoulder belt will not be against your body. Instead, it will be in front of you. In a crash, you could go into it, receiving neck or other injuries.

The lap belt could go up over your abdomen. The belt forces would be there, not at your pelvic bones. This could cause serious internal injuries.

For proper protection when the vehicle is in motion, have the seatback upright. Then sit well back in the seat and wear the seat belt properly.



Do not have a seatback reclined if the vehicle is moving.

Heated Front Seats

Warning

If temperature change or pain to the skin cannot be felt, the seat heater may cause burns. To reduce the risk of burns, use care when using the seat heater, especially for long periods of time. Do not place anything on the seat that insulates against

(Continued)

Warning (Continued)

heat, such as a blanket, cushion, cover, or similar item. This may cause the seat heater to overheat. An overheated seat heater may cause a burn or may damage the seat.

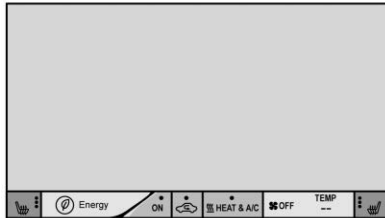

Heated Seat Buttons

If equipped, the heated seat controls are on the infotainment display. To operate, the vehicle must be on.

Touch or to heat the driver or passenger seat cushion. Indicator lights on the infotainment display show the current setting with three level indicators for high, medium, or low.

Touch the screen once for the highest setting. With each touch of the screen, the heated seat will change to the next lower setting, and then to the off setting. The lights indicate three for the highest setting and one for the lowest.

The passenger seat may take longer to heat up.

Auto Heated Seats

When the vehicle is on, this feature will automatically activate the heated seats at the level required by the vehicle's interior temperature. In auto mode, the indicators automatically show the level setting required.

Use the manual heated seat buttons to turn auto heated seats off. Once this feature is turned off, the auto heated seats will be activated the

next time the vehicle is started. In manual mode, the controls can be accessed while the vehicle is on by touching or .

If the passenger seat is unoccupied, the auto heated seats feature will not activate that seat.

The auto heated seats feature can be programmed to always be enabled when the vehicle is on. See *Vehicle Personalization* ⇨ 143.

Remote Start Heated Seats

When it is cold outside, the heated seats can be turned on automatically during a remote vehicle start.

The heated seats will be canceled when the vehicle is started. If the auto heated seats are enabled in vehicle personalization, the seat heating level will automatically change to the level required by the vehicle's interior temperature when the vehicle is on.

The temperature performance of an unoccupied seat may be reduced. This is normal.

The heated seats will not turn on during a remote start unless the heated seat feature is enabled. See *Vehicle Personalization* ⇨ 143.

Rear Seats

Rear Seat Reminder

If equipped, the message REAR SEAT REMINDER LOOK IN REAR SEAT displays under certain conditions indicating there may be an item or passenger in the rear seat. Check before exiting the vehicle.

This feature will activate when a second row door is opened while the vehicle is on or up to 10 minutes before the vehicle is turned on. There will be an alert when the vehicle is turned off. The alert does not directly detect objects in the rear seat; instead, under certain conditions, it detects when a rear door is opened and closed, indicating that there may be something in the rear seat.

The feature is active only once each time the vehicle is turned on and off, and will require reactivation by opening and closing the second row doors. There may be an alert even when there is nothing in the rear seat; for example, if a child entered

the vehicle through the rear door and left the vehicle without the vehicle being shut off.

The feature can be turned on or off. See *Vehicle Personalization* ⇨ 143.

Folding the Seatback

Either side of the seatback can be folded down for more cargo space. Fold a seatback only when the vehicle is not moving.

Caution

Folding a rear seat with the seat belts still fastened may cause damage to the seat or the seat belts. Always unbuckle the seat belts and return them to their normal stowed position before folding a rear seat.

To fold the seatback down:

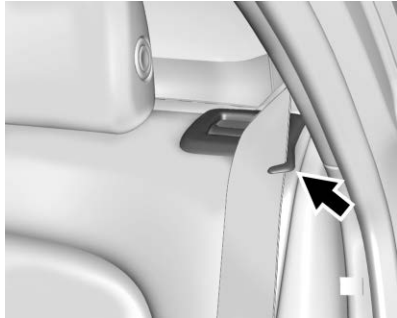

1. Make sure the seat belt is in the retainer hook.

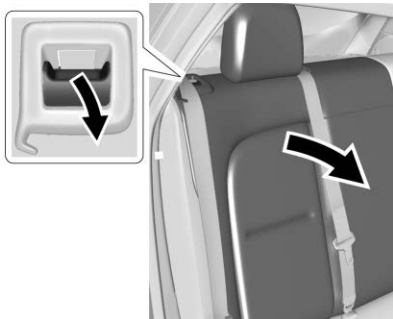

2. Pull the lever on top of the seatback to unlock the seatback.
A red indicator near the seatback lever is exposed when the seatback is unlocked.
3. Fold the seatback down.
Repeat Steps 1–3 for the other seatback, if desired.

Raising the Seatback

Warning

If either seatback is not locked, it could move forward in a sudden stop or crash. That could cause injury to the person sitting there. Always push and pull on the seatbacks to be sure they are locked.

Warning

A seat belt that is improperly routed, not properly attached, or twisted will not provide the protection needed in a crash. The person wearing the belt could be seriously injured. After raising the rear seatback, always check to be sure that the seat belts are properly routed and attached, and are not twisted.

To raise a seatback:

1. Lift the seatback up and push it rearward to lock it in place. Make sure the seat belt is in the retainer hook and is not twisted or caught in the seatback.

A tab near the seatback lever retracts when the seatback is locked in place.

64 Seats and Restraints

The center rear seat belt may lock when you raise the seatback. If this happens, let the belt go back all the way and start again.

2. Push and pull the top of the seatback to be sure it is locked into position.
3. Repeat Steps 1 and 2 for the other seatback, if necessary.

When the seat is not in use, it should be kept in the upright, locked position.

Rear Seat Armrest

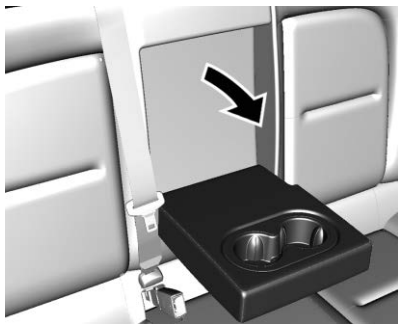

The rear seat has an armrest in the center of the seatback. Lower the armrest to access the two cupholders.

To fold, lift the armrest up and push it rearward until it is flush with the seatback.



Heated Rear Seats

Warning

If you cannot feel temperature change or pain to the skin, the seat heater may cause burns. To reduce the risk of burns, people with such a condition should use care when using the seat heater, especially for long periods of time. Do not place anything on the seat that insulates against heat, such as a blanket, cushion, cover, or similar item. This may cause the seat heater to overheat. An overheated seat heater may cause a burn or may damage the seat.



If equipped, the rear heated seat buttons are on the rear doors.

Press  or  to heat the left outboard or right outboard seat cushion.

Seat Belts

This section describes how to use seat belts properly, and some things not to do.

Warning

Do not let anyone ride where a seat belt cannot be worn properly. In a crash, if you or your passenger(s) are not wearing seat belts, injuries can be much worse than if you are wearing seat belts. You can be seriously injured or killed by hitting things inside the vehicle harder or by being ejected from the vehicle. In addition, anyone who is not buckled up can strike other passengers in the vehicle.

It is extremely dangerous to ride in a cargo area, inside or outside of a vehicle. In a collision, passengers riding in these areas are more likely to be seriously injured or killed. Do not allow

(Continued)

Warning (Continued)

passengers to ride in any area of the vehicle that is not equipped with seats and seat belts.

Always wear a seat belt, and check that all passenger(s) are restrained properly too.

This vehicle has indicators as a reminder to buckle the seat belts. See *Seat Belt Reminders* ⇨ 123.

Why Seat Belts Work



When riding in a vehicle, you travel as fast as the vehicle does. If the vehicle stops suddenly, you keep going until something stops you. It could be the windshield, the instrument panel, or the seat belts!

When you wear a seat belt, you and the vehicle slow down together. There is more time to stop because you stop over a longer distance and, when worn properly, your strongest bones take the forces from the seat belts. That is why wearing seat belts makes such good sense.

Questions and Answers About Seat Belts

Q: Will I be trapped in the vehicle after a crash if I am wearing a seat belt?

A: You *could* be — whether you are wearing a seat belt or not. Your chance of being conscious during and after a crash, so you *can* unbuckle and get out, is *much* greater if you are belted.

Q: If my vehicle has airbags, why should I have to wear seat belts?

A: Airbags are supplemental systems only. They work *with* seat belts — not instead of them. Whether or not an airbag is provided, all occupants still have to buckle up to get the most protection.

Also, in nearly all states and in all Canadian provinces, the law requires wearing seat belts.

How to Wear Seat Belts Properly

This section is only for people of adult size.

There are special things to know about seat belts and children, and there are different rules for smaller children and infants. If a child will be riding in the vehicle, see *Older Children* ⇨ 83 or *Infants and Young Children* ⇨ 85. Follow those rules for everyone's protection.

It is very important for all occupants to buckle up. Statistics show that unbelted people are hurt more often in crashes than those who are wearing seat belts.

There are important things to know about wearing a seat belt properly.

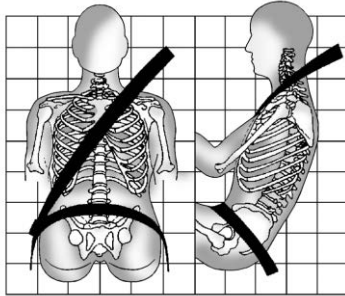

- Sit up straight and always keep your feet on the floor in front of you.
- Always use the correct buckle for your seating position.
- Wear the lap part of the belt low and snug on the hips, just touching the thighs. In a crash,

this applies force to the strong pelvic bones and you would be less likely to slide under the lap belt. If you slid under it, the belt would apply force on your abdomen. This could cause serious or even fatal injuries.

- Wear the shoulder belt over the shoulder and across the chest. These parts of the body are best able to take belt restraining forces. The shoulder belt locks if there is a sudden stop or crash.

Warning

You can be seriously injured, or even killed, by not wearing your seat belt properly.

- Never allow the lap or shoulder belt to become loose or twisted.
- Never wear the shoulder belt under both arms or behind your back.
- Never route the lap or shoulder belt over an armrest.

Lap-Shoulder Belt

All seating positions in the vehicle have a lap-shoulder belt.

The following instructions explain how to wear a lap-shoulder belt properly.

1. Adjust the seat, if the seat is adjustable, so you can sit up straight. To see how, see "Seats" in the Index.

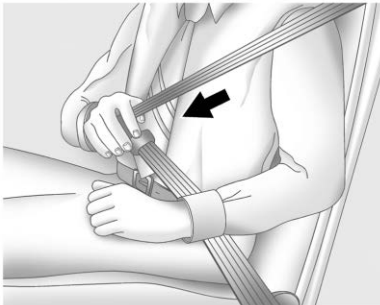

2. Pick up the latch plate and pull the belt across you. Do not let it get twisted.

The lap-shoulder belt may lock if you pull the belt across you very quickly. If this happens, let the belt go back slightly to unlock it. Then pull the belt across you more slowly.

If the shoulder portion of a passenger belt is pulled out all the way, the child restraint locking feature may be engaged. If this happens, let the belt go back all the way and start again.

Engaging the child restraint locking feature in the front outboard seating position may affect the passenger sensing system. See *Passenger Sensing System* ⇨ 77.

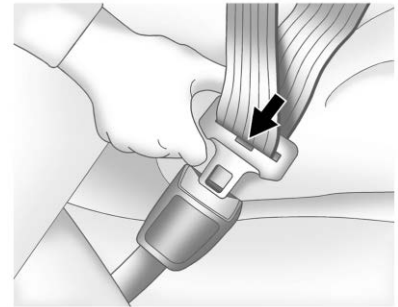

3. Push the latch plate into the buckle until it clicks.

Pull up on the latch plate to make sure it is secure. If the belt is not long enough, see *Seat Belt Extender* ⇨ 69.

Position the release button on the buckle so that the seat belt could be quickly unbuckled if necessary.



4. To make the lap part tight, pull up on the shoulder belt.

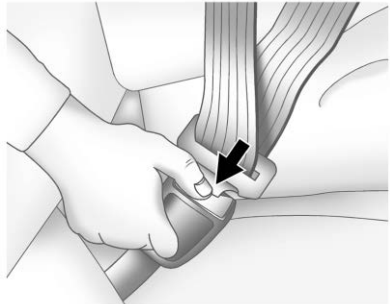

To unlatch the belt, push the button on the buckle. The belt should return to its stowed position.

Always stow the seat belt slowly. If the seat belt webbing returns quickly to the stowed position, the retractor may lock and cannot be pulled out. If this happens, pull the seat belt straight out firmly to unlock the webbing, and then release it. If the webbing is still locked in the retractor, see your dealer.

Before a door is closed, be sure the belt is out of the way. If a door is slammed against a seat belt, damage can occur to both the seat belt and the vehicle.

Seat Belt Pretensioners

This vehicle has seat belt pretensioners for the front outboard occupants. Although the seat belt pretensioners cannot be seen, they are part of the seat belt assembly. They can help tighten the seat belts during the early stages of a moderate to severe frontal, near frontal, or rear crash if the threshold conditions for pretensioner

activation are met. Seat belt pretensioners can also help tighten the seat belts in a side crash or a rollover event.

Pretensioners work only once. If the pretensioners activate in a crash, the pretensioners and probably other parts of the vehicle's seat belt system will need to be replaced. See *Replacing Seat Belt System Parts after a Crash* ⇨ 70.

Do not sit on the outboard seat belt while entering or exiting the vehicle or at any time while sitting in the seat. Sitting on the seat belt can damage the webbing and hardware.

Rear Seat Belt Comfort Guides

Rear seat belt comfort guides may provide added seat belt comfort for older children who have outgrown booster seats and for some adults. When installed on a shoulder belt, the comfort guide positions the shoulder belt away from the neck and head.

Comfort guides are available through your dealer for the rear outboard seating positions. Instructions are included with the guide.

Seat Belt Use During Pregnancy

Seat belts work for everyone, including pregnant women. Like all occupants, they are more likely to be seriously injured if they do not wear seat belts.



A pregnant woman should wear a lap-shoulder belt, and the lap portion should be worn as low as possible, below the rounding, throughout the pregnancy.

The best way to protect the fetus is to protect the mother. When a seat belt is worn properly, it is more likely that the fetus will not be hurt in a crash. For pregnant women, as for anyone, the key to making seat belts effective is wearing them properly.

Seat Belt Extender

If the vehicle's seat belt will fasten around you, you should use it.

But if a seat belt is not long enough, your dealer will order you an extender. When you go in to order it, take the heaviest coat you will wear, so the extender will be long enough for you. To help avoid personal injury, do not let someone else use it, and use it only for the seat it is made to fit. The extender has been designed for adults. Never use it for securing child restraints. For more

information on the proper use and fit of seat belt extenders see the instruction sheet that comes with the extender.

Safety System Check

Periodically check the seat belt reminder, seat belts, buckles, latch plates, retractors, shoulder belt height adjusters (if equipped), and seat belt anchorages to make sure they are all in working order. Look for any other loose or damaged seat belt system parts that might keep a seat belt system from performing properly. See your dealer to have it repaired. Torn or frayed seat belts may not protect you in a crash. They can rip apart under impact forces. If a belt is torn or frayed, have it replaced immediately.

Make sure the seat belt reminder light is working. See *Seat Belt Reminders* ⇨ 123.

Keep seat belts clean and dry. See *Seat Belt Care* ⇨ 70.

Seat Belt Care

Keep belts clean and dry.

Warning

Do not bleach or dye seat belt webbing. It may severely weaken the webbing. In a crash, they might not be able to provide adequate protection. Clean and rinse seat belt webbing only with mild soap and lukewarm water. Allow the webbing to dry.

Seat belts should be properly cared for and maintained.

Seat belt hardware should be kept dry and free of dust or debris. As necessary exterior hard surfaces and seat belt webbing may be lightly cleaned with mild soap and water. Ensure there is not excessive dust or debris in the mechanism. If dust or debris exists in the system please see the dealer. Parts may need to be replaced to ensure proper functionality of the system.

Replacing Seat Belt System Parts after a Crash

Warning

A crash can damage the seat belt system in the vehicle. A damaged seat belt system may not properly protect the person using it, resulting in serious injury or even death in a crash. To help make sure the seat belt systems are working properly after a crash, have them inspected and any necessary replacements made as soon as possible.

After a minor crash, replacement of seat belts may not be necessary. But the seat belt assemblies that were used during any crash may have been stressed or damaged. See your dealer to have the seat belt assemblies inspected or replaced.

New parts and repairs may be necessary even if the seat belt system was not being used at the time of the crash.

Have the seat belt pretensioners checked if the vehicle has been in a crash, or if the airbag readiness light stays on after you start the vehicle or while you are driving. See *Airbag Readiness Light* ⇨ 124.

Airbag System

The vehicle has the following airbags:

- A frontal airbag for the driver
- A frontal airbag for the front outboard passenger
- A knee airbag for the driver
- A knee airbag for the front outboard passenger
- A seat-mounted side impact airbag for the driver
- A seat-mounted side impact airbag for the front outboard passenger
- A roof-rail airbag for the driver and the area directly behind the driver
- A roof-rail airbag for the front outboard passenger and the area directly behind the front outboard passenger

Sedan models may have the following airbags:

- Seat-mounted side impact airbags for the second row outboard passengers

All vehicle airbags have the word AIRBAG on the trim or on a label near the deployment opening.

For frontal airbags, the word AIRBAG is on the center of the steering wheel for the driver and on the instrument panel for the front outboard passenger.

For knee airbags, the word AIRBAG is on the lower part of the instrument panel.

For seat-mounted side impact airbags, the word AIRBAG is on the side of the seat closest to the door.

For roof-rail airbags, the word AIRBAG is on the ceiling or trim.

Airbags are designed to supplement the protection provided by seat belts. Even though today's airbags are also designed to help reduce

the risk of injury from the force of an inflating bag, all airbags must inflate very quickly to do their job.

Here are the most important things to know about the airbag system:

Warning

You can be severely injured or killed in a crash if you are not wearing your seat belt, even with airbags. Airbags are designed to work with seat belts, not replace them. Also, airbags are not designed to inflate in every crash. In some crashes seat belts are the only restraint. See *When Should an Airbag Inflate?* ⇨ 74.

Wearing your seat belt during a crash helps reduce your chance of hitting things inside the vehicle or being ejected from it. Airbags are “supplemental restraints” to the seat belts. Everyone in the vehicle should wear a seat belt properly, whether or not there is an airbag for that person.

Warning

Because airbags inflate with great force and faster than the blink of an eye, anyone who is up against, or very close to, any airbag when it inflates can be seriously injured or killed. Do not sit unnecessarily close to any airbag, as you would be if sitting on the edge of the seat or leaning forward. Seat belts help keep you in position before and during a crash. Always wear a seat belt, even with airbags. The driver should sit as far back as possible while still maintaining control of the vehicle. The seat belts and the front outboard passenger airbags are most effective when you are sitting well back and upright in the seat with both feet on the floor.

(Continued)

Warning (Continued)

Occupants should not lean on or sleep against the door or side windows in seating positions with seat-mounted side impact airbags and/or roof-rail airbags.

Warning

Children who are up against, or very close to, any airbag when it inflates can be seriously injured or killed. Always secure children properly in the vehicle. To read how, see *Older Children* ⇨ 83 or *Infants and Young Children* ⇨ 85.

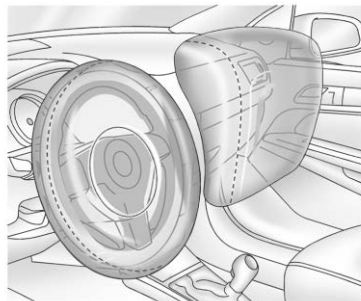

There is an airbag readiness light on the instrument cluster, which shows the airbag symbol. The system checks the airbag electrical system for malfunctions. The light tells you if there is an electrical problem. See *Airbag Readiness Light* ⇨ 124 for more information.

Where Are the Airbags?

The driver frontal airbag is in the center of the steering wheel.

The front outboard passenger frontal airbag is in the passenger side instrument panel.



The driver knee airbag is below the steering column. The front outboard passenger knee airbag is below the glove box.

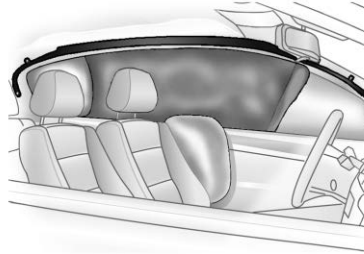

Driver Side Shown, Passenger Side Similar

The driver and front outboard passenger seat-mounted side impact airbags are in the side of the seatbacks closest to the door.

The roof-rail airbags for the driver, front outboard passenger, and second row outboard passengers are in the ceiling above the side windows.

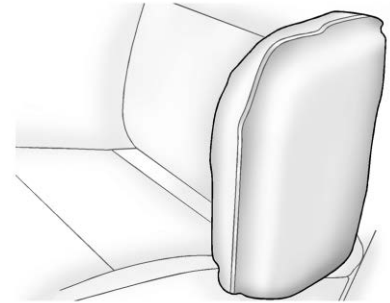

Rear Seat Driver Side Shown, Passenger Side Similar

On vehicles with second row seat-mounted side impact airbags, they are in the sides of the seatback closest to the door.

⚠ Warning

If something is between an occupant and an airbag, the airbag might not inflate properly or it might force the object into that person causing severe injury or even death. The path of an

(Continued)

Warning (Continued)

inflating airbag must be kept clear. Do not put anything between an occupant and an airbag, and do not attach or put anything on the steering wheel hub or on or near any other airbag covering.

Do not use seat accessories that block the inflation path of a seat-mounted side impact airbag.

Never secure anything to the roof of a vehicle with roof-rail airbags by routing a rope or tie-down through any door or window opening. If you do, the path of an inflating roof-rail airbag will be blocked.

When Should an Airbag Inflate?

This vehicle is equipped with airbags. Airbags are designed to inflate if the impact exceeds the specific airbag system's deployment

threshold. Deployment thresholds are used to predict how severe a crash is likely to be in time for the airbags to inflate and help restrain the occupants. The vehicle has electronic sensors that help the airbag system determine the severity of the impact. Deployment thresholds can vary with specific vehicle design.

Frontal airbags are designed to inflate in moderate to severe frontal or near frontal crashes to help reduce the potential for severe injuries, mainly to the driver's or front outboard passenger's head and chest.

Whether the frontal airbags will or should inflate is not based primarily on how fast the vehicle is traveling. It depends on what is hit, the direction of the impact, and how quickly the vehicle slows down.

Frontal airbags may inflate at different crash speeds depending on whether the vehicle hits an object straight on or at an angle, and

whether the object is fixed or moving, rigid or deformable, narrow or wide.

Frontal airbags are not intended to inflate during vehicle rollovers, rear impacts, or in many side impacts.

In addition, the vehicle has advanced technology frontal airbags. Advanced technology frontal airbags adjust the restraint according to crash severity.

Knee airbags are designed to inflate in moderate to severe frontal or near frontal impacts. Knee airbags are not designed to inflate during vehicle rollovers, in rear impacts, or in many side impacts.

Seat-mounted side impact airbags are designed to inflate in moderate to severe side crashes depending on the location of the impact. Seat-mounted side impact airbags are not designed to inflate in frontal impacts, near frontal impacts, rollovers, or rear impacts. A seat-mounted side impact airbag is designed to inflate on the side of the vehicle that is struck.



Roof-rail airbags are designed to inflate in moderate to severe side crashes depending on the location of the impact. In addition, these roof-rail airbags are designed to inflate during a rollover or in a severe frontal impact. Roof-rail airbags are not designed to inflate in rear impacts. Both roof-rail airbags will inflate when either side of the vehicle is struck or if the sensing system predicts that the vehicle is about to roll over on its side, or in a severe frontal impact.

In any particular crash, no one can say whether an airbag should have inflated simply because of the vehicle damage or repair costs.

What Makes an Airbag Inflate?

In a deployment event, the sensing system sends an electrical signal triggering a release of gas from the inflator. Gas from the inflator fills the airbag causing the bag to break out of the cover. The inflator, the airbag, and related hardware are all part of the airbag module.

For airbag locations, see *Where Are the Airbags?* ⇨ 72.

How Does an Airbag Restrain?

In moderate to severe frontal or near frontal collisions, even belted occupants can contact the steering wheel or the instrument panel. In moderate to severe side collisions, even belted occupants can contact the inside of the vehicle.

Airbags supplement the protection provided by seat belts by distributing the force of the impact more evenly over the occupant's body.

Rollover capable roof-rail airbags are designed to help contain the head and chest of occupants in the outboard seating positions in the first and second rows. The rollover capable roof-rail airbags are designed to help reduce the risk of full or partial ejection in rollover events, although no system can prevent all such ejections.



But airbags would not help in many types of collisions, primarily because the occupant's motion is not toward those airbags. See *When Should an Airbag Inflate?* ⇨ 74.

Airbags should never be regarded as anything more than a supplement to seat belts.

What Will You See after an Airbag Inflates?

After the frontal, knee, and seat-mounted side impact airbags inflate, they quickly deflate, so quickly that some people may not even realize the airbags inflated. Roof-rail airbags may still be at least partially inflated for some time after they inflate. Some components of the airbag module may be hot for several minutes. For location of the airbags, see *Where Are the Airbags?* ⇨ 72.

The parts of the airbag that come into contact with you may be warm, but not too hot to touch. There may be some smoke and dust coming from the vents in the deflated

airbags. Airbag inflation does not prevent the driver from seeing out of the windshield or being able to steer the vehicle, nor does it prevent people from leaving the vehicle.

Warning

When an airbag inflates, there may be dust in the air. This dust could cause breathing problems for people with a history of asthma or other breathing trouble. To avoid this, everyone in the vehicle should get out as soon as it is safe to do so. If you have breathing problems but cannot get out of the vehicle after an airbag inflates, then get fresh air by opening a window or a door. If you experience breathing problems following an airbag deployment, you should seek medical attention.

The vehicle has a feature that may automatically unlock the doors, turn on the interior lamps and hazard warning flashers after the airbags

inflate. The feature may also activate, without airbag inflation, after an event that exceeds a predetermined threshold. After turning the ignition off and then on again, the doors can be locked, the interior lamps can be turned off, and the hazard warning flashers can be turned off using the controls for those features. If any of these systems are damaged in the crash they may not operate as normal.

Warning

A crash severe enough to inflate the airbags may have also damaged important functions in the vehicle, such as the brake and steering systems, etc. Even if the vehicle appears to be drivable after a moderate crash, there may be concealed damage that could make it difficult to safely operate the vehicle.

Use caution if attempting to restart the vehicle after a crash has occurred.

If an airbag inflates or the vehicle has been in a crash, the sensing system may shut down the high voltage system. When this occurs, the high voltage battery is disconnected and the vehicle will not start. Before the vehicle can be operated again, it must be serviced at your dealer.

In many crashes severe enough to inflate the airbag, windshields are broken by vehicle deformation. Additional windshield breakage may also occur from the front outboard passenger airbag.

- Airbags are designed to inflate only once. After an airbag inflates, you will need some new parts for the airbag system. If you do not get them, the airbag system will not be there to help protect you in another crash. A new system will include airbag modules and possibly other parts. The service manual for the vehicle covers the need to replace other parts.

- The vehicle has a crash sensing and diagnostic module which records information after a crash.
See *Vehicle Data Recording and Privacy* ⇨ 344 and *Event Data Recorders* ⇨ 344.
- Let only qualified technicians work on the airbag systems. Improper service can mean that an airbag system will not work properly. See your dealer for service.

Passenger Sensing System

The vehicle has a passenger sensing system for the front outboard passenger position. The passenger airbag status indicator will light on the overhead console when the vehicle is started.

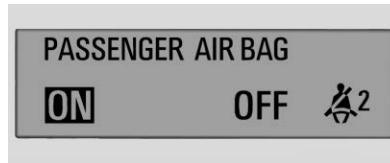

United States



Canada

The words ON and OFF, or the symbol for on and off, will be visible during the system check. When the system check is complete, either the word ON or OFF, or the symbol for on or off, will be visible. See *Passenger Airbag Status Indicator* ⇨ 125.

The passenger sensing system turns off the front outboard passenger frontal airbag and knee airbag under certain conditions. No other airbag is affected by the passenger sensing system.

The passenger sensing system works with sensors that are part of the front outboard passenger seat and seat belt. The sensors are designed to detect the presence of a properly seated occupant and determine if the front outboard passenger frontal airbag and knee airbag should be allowed to inflate or not.

According to accident statistics, children are safer when properly secured in a rear seat in the correct child restraint for their weight and size.

Whenever possible, children aged 12 and under should be secured in a rear seating position.

Never put a rear-facing child seat in the front. This is because the risk to the rear-facing child is so great, if the airbag inflates.

Warning

A child in a rear-facing child restraint can be seriously injured or killed if the passenger frontal airbag inflates. This is because the back of the rear-facing child restraint would be very close to the inflating airbag. A child in a forward-facing child restraint can be seriously injured or killed if the passenger frontal airbag inflates and the passenger seat is in a forward position.

Even if the passenger sensing system has turned off the front outboard passenger airbag(s), no system is fail-safe. No one can guarantee that an airbag will not deploy under some unusual circumstance, even though the airbag(s) are off.

Never put a rear-facing child restraint in the front seat, even if the airbag is off. If securing a forward-facing child restraint in

(Continued)

Warning (Continued)

the front outboard passenger seat, always move the seat as far back as it will go. It is better to secure child restraints in the rear seat. Consider using another vehicle to transport the child when a rear seat is not available.

If the vehicle does not have a rear seat that will accommodate a rear-facing child restraint, a rear-facing child restraint should not be installed in the vehicle, even if the airbag is off.

The passenger sensing system is designed to turn off the front outboard passenger frontal airbag and knee airbag if:

- The front outboard passenger seat is unoccupied.
- The system determines an infant is present in a child restraint.
- A front outboard passenger takes his/her weight off of the seat for a period of time.

- There is a critical problem with the airbag system or the passenger sensing system.

When the passenger sensing system has turned off the front outboard passenger frontal airbag and knee airbag, the off indicator will light and stay lit as a reminder that the airbags are off. See *Passenger Airbag Status Indicator* ⇨ 125.

The passenger sensing system is designed to turn on the front outboard passenger frontal airbag and knee airbag anytime the system senses that a person of adult size is sitting properly in the front outboard passenger seat. When the passenger sensing system has allowed the airbags to be enabled, the on indicator will light and stay lit as a reminder that the airbags are active.

For some children, including children in child restraints, and for very small adults, the passenger sensing system may or may not turn off the front outboard passenger frontal airbag and knee airbag,

depending upon the person's seating posture and body build. Everyone in the vehicle who has outgrown child restraints should wear a seat belt properly — whether or not there is an airbag for that person.

 **Warning**

If the airbag readiness light ever comes on and stays on, it means that something may be wrong with the airbag system. To help avoid injury to yourself or others, have the vehicle serviced right away. See *Airbag Readiness Light* ⇨ 124 for more information, including important safety information.

If the On Indicator Is Lit for a Child Restraint

The passenger sensing system is designed to turn off the front outboard passenger frontal airbag and knee airbag if the system determines that an infant is present

in a child restraint. If a child restraint has been installed and the on indicator is lit:

1. Turn the vehicle off.
2. Remove the child restraint from the vehicle.
3. Remove any additional items from the seat such as blankets, cushions, seat covers, seat heaters, or seat massagers.
4. Reinstall the child restraint following the directions provided by the child restraint manufacturer and refer to *Securing Child Restraints (With the Seat Belt in the Rear Seat)* ⇨ 99 or *Securing Child Restraints (With the Seat Belt in the Front Seat)* ⇨ 101.

Make sure the seat belt retractor is locked by pulling the shoulder belt all the way out of the retractor when installing the child restraint, even if the child restraint is equipped with a seat belt lock off. When the retractor lock is

set, the belt can be tightened but not pulled out of the retractor.

5. If, after reinstalling the child restraint and restarting the vehicle, the on indicator is still lit, turn the vehicle off. Then slightly recline the vehicle seatback and adjust the seat cushion, if adjustable, to make sure that the vehicle seatback is not pushing the child restraint into the seat cushion. Also make sure the child restraint is not trapped under the vehicle head restraint. If this happens, adjust the head restraint. See *Head Restraints* ⇨ 57.
6. Restart the vehicle.

The passenger sensing system may or may not turn off the airbags for a child in a child restraint depending upon the child's size. It is better to secure the child restraint in a rear seat. Consider using another vehicle to transport the child when a rear seat is not available. Never put

a rear-facing child restraint in the front seat, even if the on indicator is not lit.

If the Off Indicator Is Lit for an Adult-Sized Occupant



If a person of adult size is sitting in the front outboard passenger seat, but the off indicator is lit, it could be because that person is not sitting properly in the seat or that the child restraint locking feature is engaged. Use the following steps to allow the

system to detect that person and enable the front outboard passenger frontal airbag and knee airbag:

1. Turn the vehicle off.
2. Remove any additional material from the seat, such as blankets, cushions, seat covers, seat heaters, or seat massagers.
3. Place the seatback in the fully upright position.
4. Have the person sit upright in the seat, centered on the seat cushion, with legs comfortably extended.
5. If the shoulder portion of the belt is pulled out all the way, the child restraint locking feature will be engaged. This may unintentionally cause the passenger sensing system to turn the airbag off for some adult-sized occupants. If this happens, unbuckle the belt and let the belt go back all the way, and then buckle the belt again without pulling the belt out all the way.

6. Restart the vehicle and have the person remain in this position for two to three minutes after the on indicator is lit.

Warning

If the front outboard passenger airbag is turned off for an adult-sized occupant, the airbag will not be able to inflate and help protect that person in a crash, resulting in an increased risk of serious injury or even death. An adult-sized occupant should not ride in the front outboard passenger seat, if the passenger airbag off indicator is lit.

Additional Factors Affecting System Operation

Seat belts help keep the passenger in position on the seat during vehicle maneuvers and braking, which helps the passenger sensing system maintain the passenger airbag status. See “Seat Belts” and

“Child Restraints” in the Index for additional information about the importance of proper restraint use.

A thick layer of additional material, such as a blanket or cushion, or aftermarket equipment such as seat covers, seat heaters, and seat massagers can affect how well the passenger sensing system operates. We recommend that you not use seat covers or other aftermarket equipment except when approved by GM for your specific vehicle. See *Adding Equipment to the Airbag-Equipped Vehicle* ⇨ 81 for more information about modifications that can affect how the system operates.

The on indicator may be lit if an object, such as a briefcase, handbag, grocery bag, laptop, or other electronic device is put on an unoccupied seat. If this is not desired, remove the object from the seat.

Warning

Stowing of articles under the passenger seat or between the passenger seat cushion and seatback may interfere with the proper operation of the passenger sensing system.

Servicing the Airbag-Equipped Vehicle

Airbags affect how the vehicle should be serviced. There are parts of the airbag system in several places around the vehicle. Your dealer and the service manual have information about servicing the vehicle and the airbag system. To purchase a service manual, see *Service Publications Ordering Information* ⇨ 341.

Warning

For up to 10 seconds after the vehicle is turned off and the 12-volt battery is disconnected, an airbag can still inflate during improper service. You can be injured if you are close to an airbag when it inflates. Avoid yellow connectors. They are probably part of the airbag system. Be sure to follow proper service procedures, and make sure the person performing work for you is qualified to do so.

Adding Equipment to the Airbag-Equipped Vehicle

Adding accessories that change the vehicle's frame, bumper system, height, front end, or side sheet metal may keep the airbag system from working properly. The operation of the airbag system can also be affected by changing any parts of the front seats, seat belts, airbag sensing and diagnostic

82 Seats and Restraints

module, steering wheel, instrument panel, inner door seals including the speakers, any of the airbag modules, ceiling or pillar garnish trim, overhead console, front sensors, side impact sensors, or airbag wiring.

Your dealer and the service manual have information about the location of the airbag sensors, sensing and diagnostic module, and airbag wiring.

In addition, the vehicle has a passenger sensing system for the front outboard passenger position, which includes sensors that are part of the passenger seat. The passenger sensing system may not operate properly if the original seat trim is replaced with non-GM covers, upholstery, or trim; or with GM covers, upholstery, or trim designed for a different vehicle. Any object, such as an aftermarket seat heater or a comfort-enhancing pad or device, installed under or on top of the seat fabric, could also interfere with the operation of the passenger sensing system. This

could either prevent proper deployment of the passenger airbag(s) or prevent the passenger sensing system from properly turning off the passenger airbag(s). See *Passenger Sensing System* ⇨ 77.

If the vehicle has rollover roof-rail airbags, see *Different Size Tires and Wheels* ⇨ 293 for additional important information.

If you have to modify your vehicle because you have a disability and have questions about whether the modifications will affect the vehicle's airbag system, or if you have questions about whether the airbag system will be affected if the vehicle is modified for any other reason, call Customer Assistance. See *Customer Assistance Offices* ⇨ 334.

Airbag System Check

The airbag system does not need regularly scheduled maintenance or replacement. Make sure the airbag readiness light is working. See *Airbag Readiness Light* ⇨ 124.



Caution

If an airbag covering is damaged, opened, or broken, the airbag may not work properly. Do not open or break the airbag coverings. If there are any opened or broken airbag coverings, have the airbag covering and/or airbag module replaced. For the location of the airbags, see *Where Are the Airbags?* ⇨ 72. See your dealer for service.

Replacing Airbag System Parts after a Crash

Warning

A crash can damage the airbag systems in the vehicle. A damaged airbag system may not properly protect you and your passenger(s) in a crash, resulting in serious injury or even death. To

(Continued)

Warning (Continued)

help make sure the airbag systems are working properly after a crash, have them inspected and any necessary replacements made as soon as possible.

If an airbag inflates, you will need to replace airbag system parts. See your dealer for service.

If the airbag readiness light stays on after the vehicle is started or comes on when you are driving, the airbag system may not work properly. Have the vehicle serviced right away. See *Airbag Readiness Light* ⇨ 124.

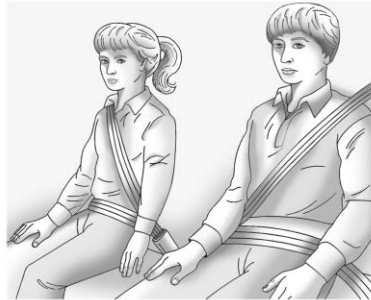
Child Restraints**Older Children**

Older children who have outgrown booster seats should wear the vehicle's seat belts.

The manufacturer instructions that come with the booster seat state the weight and height limitations for that booster. Use a booster seat with a lap-shoulder belt until the child passes the fit test below:

- Sit all the way back on the seat. Do the knees bend at the seat edge? If yes, continue. If no, return to the booster seat.
- Buckle the lap-shoulder belt. Does the shoulder belt rest on the shoulder? If yes, continue. If no, try using the rear seat belt comfort guide, if available. See “Rear Seat Belt Comfort Guides” under *Lap-Shoulder Belt* ⇨ 67. If a comfort guide is not available, or if the shoulder belt still does not rest on the shoulder, then return to the booster seat.
- Does the lap belt fit low and snug on the hips, touching the thighs? If yes, continue. If no, return to the booster seat.

84 Seats and Restraints

- Can proper seat belt fit be maintained for the length of the trip? If yes, continue. If no, return to the booster seat.

Q: What is the proper way to wear seat belts?

A: An older child should wear a lap-shoulder belt and get the additional restraint a shoulder belt can provide. The shoulder belt should not cross the face or neck. The lap belt should fit snugly below the hips, just touching the top of the thighs. This applies belt force to the child's pelvic bones in a crash. It should never be worn over the abdomen, which could cause severe or even fatal internal injuries in a crash.

Also see “Rear Seat Belt Comfort Guides” under *Lap-Shoulder Belt* ⇨ 67.

According to accident statistics, children are safer when properly restrained in a rear seating position.

In a crash, children who are not buckled up can strike other people who are buckled up, or can be thrown out of the vehicle. Older children need to use seat belts properly.

⚠ Warning

Never allow more than one child to wear the same seat belt. The seat belt cannot properly spread the impact forces. In a crash, they can be crushed together and seriously injured. A seat belt must be used by only one person at a time.

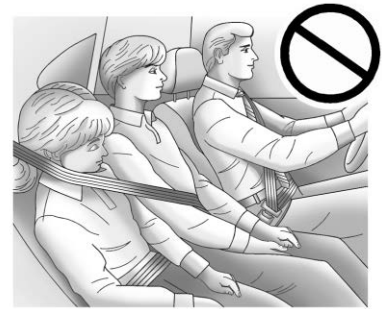

⚠ Warning

Never allow a child to wear the seat belt with the shoulder belt behind their back. A child can be seriously injured by not wearing the lap-shoulder belt properly. In a crash, the child would not be restrained by the shoulder belt. The child could move too far forward increasing the chance of head and neck injury. The child might also slide under the lap belt. The belt force would then be applied right on the abdomen.

(Continued)

Warning (Continued)

That could cause serious or fatal injuries. The shoulder belt should go over the shoulder and across the chest.



Infants and Young Children

Everyone in a vehicle needs protection! This includes infants and all other children. Neither the distance traveled nor the age and size of the traveler changes the

need, for everyone, to use safety restraints. In fact, the law in every state in the United States and in every Canadian province says children up to some age must be restrained while in a vehicle.

Warning

Children can be seriously injured or strangled if a shoulder belt is wrapped around their neck. The shoulder belt can tighten but cannot be loosened if it is locked. The shoulder belt locks when it is pulled all the way out of the retractor. It unlocks when the shoulder belt is allowed to go all the way back into the retractor, but it cannot do this if it is wrapped around a child's neck. If the shoulder belt is locked and tightened around a child's neck, the only way to loosen the belt is to cut it.

(Continued)



Warning (Continued)

Never leave children unattended in a vehicle and never allow children to play with the seat belts.

Every time infants and young children ride in vehicles, they should have the protection provided by appropriate child restraints. Neither the vehicle's seat belt system nor its airbag system is designed for them.

Children who are not restrained properly can strike other people, or can be thrown out of the vehicle.

Warning

Never hold an infant or a child while riding in a vehicle. Due to crash forces, an infant or a child will become so heavy it is not possible to hold it during a crash. For example, in a crash at only 40 km/h (25 mph), a 5.5 kg (12 lb)

(Continued)

Warning (Continued)

infant will suddenly become a 110 kg (240 lb) force on a person's arms. An infant or child should be secured in an appropriate restraint.

**Warning**

Children who are up against, or very close to, any airbag when it inflates can be seriously injured
(Continued)

Warning (Continued)

or killed. Never put a rear-facing child restraint in the front outboard seat. Secure a rear-facing child restraint in a rear seat. It is also better to secure a forward-facing child restraint in a rear seat. If you must secure a forward-facing child restraint in the front outboard seat, always move the front passenger seat as far back as it will go.



Child restraints are devices used to restrain, seat, or position children in the vehicle and are sometimes called child seats or car seats.

There are three basic types of child restraints:

- Forward-facing child restraints
- Rearward-facing child restraints
- Belt-positioning booster seats

The proper child restraint for your child depends on their size, weight, and age, and also on whether the child restraint is compatible with the vehicle in which it will be used.

For each type of child restraint, there are many different models available. When purchasing a child restraint, be sure it is designed to be used in a motor vehicle. If it is, the restraint will have a label saying that it meets federal motor vehicle safety standards. The restraint manufacturer's instructions that come with the restraint state the weight and height limitations for a particular child restraint. In addition,

there are many kinds of restraints available for children with special needs.

Warning

To reduce the risk of neck and head injury in a crash, infants and toddlers should be secured in a rear-facing child restraint until age two, or until they reach the maximum height and weight limits of their child restraint.

Warning

A young child's hip bones are still so small that the vehicle's regular seat belt may not remain low on the hip bones, as it should. Instead, it may settle up around the child's abdomen. In a crash, the belt would apply force on a body area that is unprotected by any bony structure. This alone could cause serious or fatal

(Continued)

Warning (Continued)

injuries. To reduce the risk of serious or fatal injuries during a crash, young children should always be secured in appropriate child restraints.

Child Restraint Systems

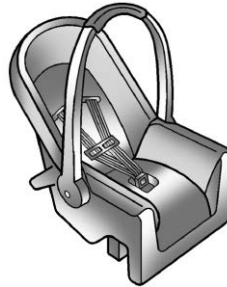

Rear-Facing Infant Restraint

A rear-facing child restraint provides restraint with the seating surface against the back of the infant.

The harness system holds the infant in place and, in a crash, acts to keep the infant positioned in the restraint.



Forward-Facing Child Restraint

A forward-facing child restraint provides restraint for the child's body with the harness.

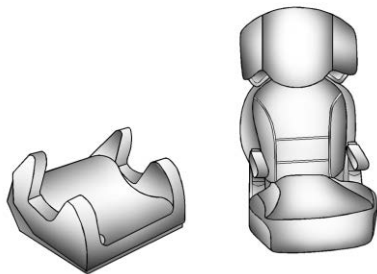

Booster Seats

A belt-positioning booster seat is used for children who have outgrown their forward-facing child restraint. Boosters are designed to improve the fit of the vehicle's seat belt system until the child is large enough for the vehicle seat belts to fit properly without a booster seat. See the seat belt fit test in *Older Children* ⇨ 83.

Securing an Add-On Child Restraint in the Vehicle

Warning

A child can be seriously injured or killed in a crash if the child restraint is not properly secured in the vehicle. Secure the child restraint properly in the vehicle using the vehicle's seat belt or LATCH system, following the instructions that came with that child restraint and the instructions in this manual.

To help reduce the chance of injury, the child restraint must be secured in the vehicle. Child restraints must be secured in vehicle seats by lap belts or the lap belt portion of a lap-shoulder belt, or by the LATCH system. See *Lower Anchors and Tethers for Children (LATCH System)* ⇨ 90 for more information. Children can be endangered in a crash if the child restraint is not properly secured in the vehicle.



When securing an add-on child restraint, refer to the instructions that come with the restraint which may be on the restraint itself or in a booklet, or both, and to this manual. The child restraint instructions are important, so if they are not available, obtain a replacement copy from the manufacturer.

Keep in mind that an unsecured child restraint can move around in a collision or sudden stop and injure people in the vehicle. Be sure to properly secure any child restraint in the vehicle — even when no child is in it.

In some areas of the United States and Canada, Certified Child Passenger Safety Technicians (CPSTs) are available to inspect and demonstrate how to correctly use and install child restraints. In the U.S., refer to the National Highway Traffic Safety Administration (NHTSA) website to locate the nearest child safety seat inspection station. For CPST

availability in Canada, check with Transport Canada or the Provincial Ministry of Transportation office.

Securing the Child Within the Child Restraint

Warning

A child can be seriously injured or killed in a crash if the child is not properly secured in the child restraint. Secure the child properly following the instructions that came with that child restraint.

Where to Put the Restraint

According to accident statistics, children and infants are safer when properly restrained in an appropriate child restraint secured in a rear seating position.

Whenever possible, children aged 12 and under should be secured in a rear seating position.

Never put a rear-facing child restraint in the front. This is because the risk to the rear-facing child is so great if the airbag deploys.

Warning

A child in a rear-facing child restraint can be seriously injured or killed if the front passenger airbag inflates. This is because the back of the rear-facing child restraint would be very close to the inflating airbag. A child in a forward-facing child restraint can be seriously injured or killed if the front passenger airbag inflates and the passenger seat is in a forward position.

Even if the passenger sensing system has turned off the front passenger frontal airbag, no system is fail-safe. No one can guarantee that an airbag will not deploy under some unusual circumstance, even though it is turned off.

Warning (Continued)

Secure rear-facing child restraints in a rear seat, even if the airbag is off. If you secure a forward-facing child restraint in the front seat, always move the front passenger seat as far back as it will go. It is better to secure the child restraint in a rear seat.

See *Passenger Sensing System* ⇨ 77 for additional information.

If the vehicle does not have a rear seat that will accommodate a rear-facing child restraint, a rear-facing child restraint should not be installed in the vehicle, even if the airbag is off.

When securing a child restraint with the seat belts in a rear seat position, study the instructions that came with the child restraint to make sure it is compatible with this vehicle.

Child restraints and booster seats vary considerably in size, and some may fit in certain seating positions better than others.

Depending on where you place the child restraint and the size of the child restraint, you may not be able to access adjacent seat belts or LATCH anchors for additional passengers or child restraints. Adjacent seating positions should not be used if the child restraint prevents access to or interferes with the routing of the seat belt.

Wherever a child restraint is installed, be sure to follow the instructions that came with the child restraint and secure the child restraint properly.

Keep in mind that an unsecured child restraint can move around in a collision or sudden stop and injure people in the vehicle. Be sure to properly secure any child restraint in the vehicle — even when no child is in it.

Lower Anchors and Tethers for Children (LATCH System)

The LATCH system secures a child restraint during driving or in a crash. LATCH attachments on the child restraint are used to attach the child restraint to the anchors in the vehicle. The LATCH system is designed to make installation of a child restraint easier.

In order to use the LATCH system in your vehicle, you need a child restraint that has LATCH attachments. LATCH-compatible rear-facing and forward-facing child seats can be properly installed using either the LATCH anchors or the vehicle's seat belts. Do not use both the seat belts and the LATCH anchorage system to secure a rear-facing or forward-facing child seat.

Booster seats use the vehicle's seat belts to secure the child and the booster seat. If the manufacturer recommends that the booster seat be secured with the LATCH system,

this can be done as long as the booster seat can be positioned properly and there is no interference with the proper positioning of the lap-shoulder belt on the child.

Make sure to follow the instructions that came with the child restraint, and also the instructions in this manual.

When installing a child restraint with a top tether, you must also use either the lower anchors or the seat belts to properly secure the child restraint. A child restraint must never be installed using only the top tether and anchor.

The LATCH anchorage system can be used until the combined weight of the child plus the child restraint is 29.5 kg (65 lbs). Use the seat belt alone instead of the LATCH anchorage system once the combined weight is more than 29.5 kg (65 lbs).

See *Securing Child Restraints (With the Seat Belt in the Rear Seat)* ⇨ 99 or *Securing Child Restraints (With the Seat Belt in the Front Seat)* ⇨ 101.

Child restraints built after March 2014 will be labeled with the specific child weight up to which the LATCH system can be used to install the restraint.

The following explains how to attach a child restraint with these attachments in the vehicle.

Not all vehicle seating positions have lower anchors. In this case, the seat belt must be used (with top tether where available) to secure the child restraint.

See *Securing Child Restraints (With the Seat Belt in the Rear Seat)* ⇨ 99 or *Securing Child Restraints (With the Seat Belt in the Front Seat)* ⇨ 101.

Lower Anchors

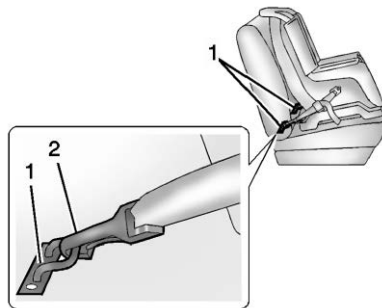

Lower anchors (1) are metal bars built into the vehicle. There are two lower anchors for each LATCH seating position that will accommodate a child restraint with lower attachments (2).

Top Tether Anchor

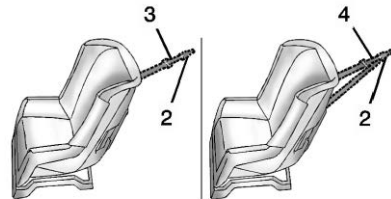

A top tether (3, 4) is used to secure the top of the child restraint to the vehicle. A top tether anchor is built into the vehicle. The top tether attachment hook (2) on the child restraint connects to the top tether anchor in the vehicle in order to reduce the forward movement and rotation of the child restraint during driving or in a crash.

The child restraint may have a single tether (3) or a dual tether (4). Either will have a single attachment hook (2) to secure the top tether to the anchor.

92 Seats and Restraints

Some child restraints with top tether are designed for use with or without the top tether being attached. Others require the top tether always to be attached. In Canada, the law requires that forward-facing child restraints have a top tether, and that the tether be attached. Be sure to read and follow the instructions for your child restraint.

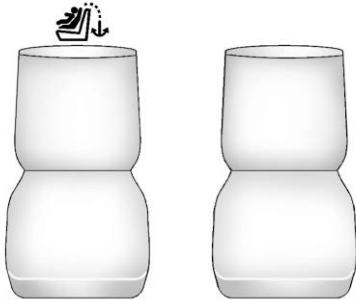

Lower Anchor and Top Tether Anchor Locations

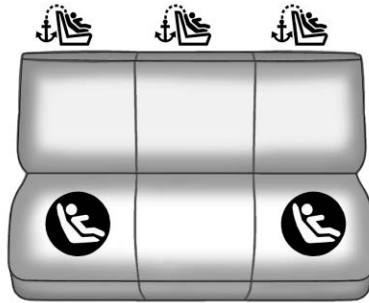

Rear Seat Delete Model



Sedan Models

-  : Seating positions with top tether anchors.
-  : Seating positions with two lower anchors.



To assist in locating the lower anchors, each seating position with lower anchors has two labels, near the crease between the seatback and the seat cushion.

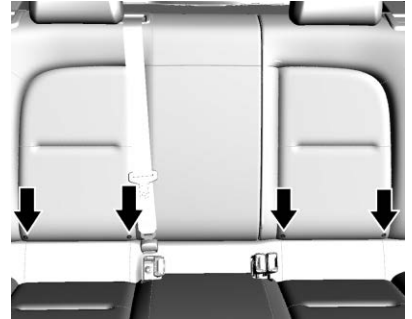

The outboard lower anchors are behind the vertical openings in the rear seat trim.



To assist in locating the top tether anchors on sedan models, the top tether anchor symbol is on the trim near the anchor.

For sedan models, the top tether anchors are behind the rear seats.

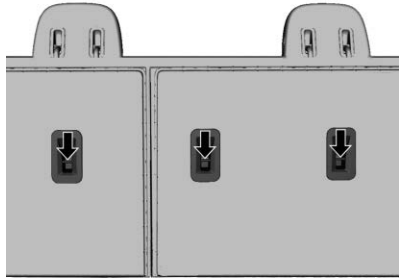

Sedan Model

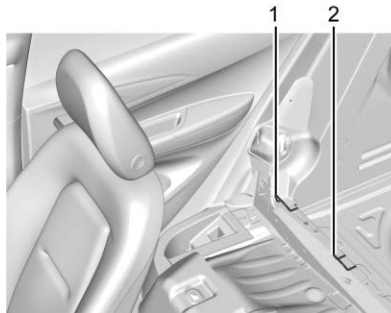

Rear Seat Delete Model

For rear seat delete models, the top tether anchors (1, 2) are located on the rear floor behind the passenger seat.



To assist in locating the top tether anchors on rear seat delete models, the top tether anchor symbol is near the anchor. The top tether anchors

may be covered. If the top tether anchors are covered, the top tether anchor symbol is on the cover.



Do not attach the top tether to this location. Use only the approved top tether anchors identified previously in this section.

Be sure to use an anchor on the same side of the vehicle as the seating position where the child restraint will be placed.

Do not secure a child restraint in a position without a top tether anchor if a national or local law requires that the top tether be attached, or if

94 Seats and Restraints

the instructions that come with the child restraint say that the top tether must be attached.

According to accident statistics, children and infants are safer when properly restrained in a child restraint system or infant restraint system secured in a rear seating position. See *Where to Put the Restraint* ⇨ 89 for additional information.

Securing a Child Restraint Designed for the LATCH System

Warning

A child could be seriously injured or killed in a crash if the child restraint is not properly attached to the vehicle using either the LATCH anchors or the vehicle seat belt. Follow the instructions that came with the child restraint and the instructions in this manual.

Warning

To reduce the risk of serious or fatal injuries during a crash, do not attach more than one child restraint to a single anchor. Attaching more than one child restraint to a single anchor could cause the anchor or attachment to come loose or even break during a crash. A child or others could be injured.

Warning

Children can be seriously injured or strangled if a shoulder belt is wrapped around their neck. The shoulder belt can tighten but cannot be loosened if it is locked. The shoulder belt locks when it is pulled all the way out of the retractor. It unlocks when the shoulder belt is allowed to go all the way back into the retractor,

(Continued)

Warning (Continued)

but it cannot do this if it is wrapped around a child's neck. If the shoulder belt is locked and tightened around a child's neck, the only way to loosen the belt is to cut it.

Buckle any unused seat belts behind the child restraint so children cannot reach them. Pull the shoulder belt all the way out of the retractor to set the lock, and tighten the belt behind the child restraint after the child restraint has been installed.

Caution

Do not let the LATCH attachments rub against the vehicle's seat belts. This may damage these parts. If necessary, move buckled seat belts to avoid rubbing the LATCH attachments.

(Continued)

Caution (Continued)

Do not fold the rear seatback when the seat is occupied. Do not fold the empty rear seat with a seat belt buckled. This could damage the seat belt or the seat. Unbuckle and return the seat belt to its stowed position, before folding the seat.

If you need to secure more than one child restraint in the rear seat, see *Where to Put the Restraint* ⇨ 89 for additional information.

Rear Seat Delete Model

1. For models without a rear seat, forward-facing child restraints should only be installed in the right front seating position with belts and a top tether. See *Securing Child Restraints (With the Seat Belt in the Rear Seat)* ⇨ 99 or *Securing Child Restraints (With the Seat Belt in the Front Seat)* ⇨ 101.

If the child restraint manufacturer recommends that the top tether be attached, attach and tighten the top tether to the top tether anchor, if your vehicle has one. Refer to the child restraint instructions and the following steps:

- 1.1. Find the top tether anchor.
- 1.2. Route, attach, and tighten the top tether according to your child restraint instructions and the following instructions:

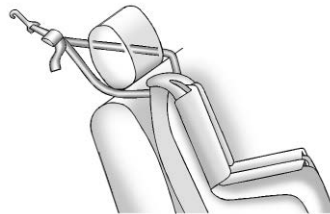

If the position you are using has an adjustable head restraint and you

are using a dual tether, route the tether around the head restraint.

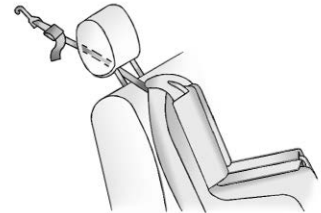

If the position you are using has an adjustable head restraint and you are using a single tether, raise the head restraint and route the tether under the head restraint and in between the head restraint posts.

2. Secure the child restraint in the right front seating position with the vehicle belts.

See *Securing Child Restraints (With the Seat Belt in the Rear Seat)* ⇨ 99 or *Securing Child Restraints (With the Seat Belt in the Front Seat)* ⇨ 101.

3. Before placing a child in the child restraint, make sure it is securely held in place. To check, grasp the child restraint at the belt path and attempt to move it side to side and back and forth. There should be no more than 2.5 cm (1 in) of movement for proper installation.

Sedan Models

1. Attach and tighten the lower attachments to the lower anchors. If the child restraint does not have lower attachments or the desired seating position does not have lower anchors, secure the child restraint with the top tether and the seat belts. Refer to the

child restraint manufacturer instructions and the instructions in this manual.

- 1.1. Find the lower anchors for the desired seating position.
- 1.2. Put the child restraint on the seat.

For rear outboard seating positions, if the head restraint interferes with the proper installation of the child restraint, the head restraint may be removed. See “Head Restraint Removal and Reinstallation” at the end of this section.

When installing a rear-facing child restraint, it may be necessary to move the front seat forward to properly install the child restraint per the child restraint manufacturer instructions.

- 1.3. Attach and tighten the lower attachments on the child restraint to the lower anchors.

2. If the child restraint manufacturer recommends that the top tether be attached, attach and tighten the top tether to the top tether anchor, if equipped. Refer to the child restraint instructions and the following steps:

- 2.1. Find the top tether anchor.
- 2.2. Remove the cargo cover before installing the top tether. Place the cargo cover in its original location after installing your child restraint when the head restraint is removed.
- 2.3. Route, attach, and tighten the top tether according to your child restraint instructions and the following instructions:

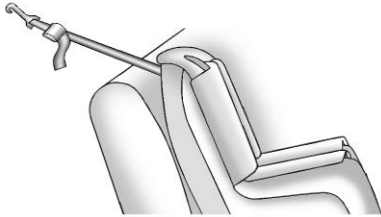

If the position you are using does not have a headrest or head restraint and you are using a single tether, route the tether over the seatback.

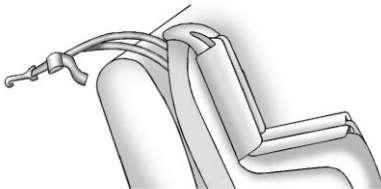

If the position you are using does not have a headrest or head restraint

and you are using a dual tether, route the tether over the seatback.

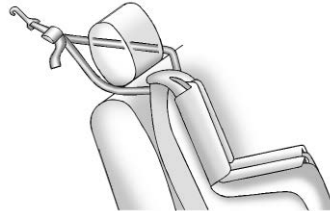

If the position you are using has an adjustable headrest or head restraint and you are using a dual tether, raise the headrest or head restraint and route the tether under the headrest or head restraint and around the headrest or head restraint posts.

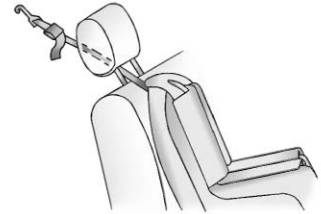

If the position you are using has an adjustable headrest or head restraint and you are using a single tether, raise the headrest or head restraint and route the tether under the headrest or head restraint and in between the headrest or head restraint posts.

3. Before placing a child in the child restraint, make sure it is securely held in place. To check, grasp the child restraint at the LATCH path and attempt to move it side to side and back and forth. There should

98 Seats and Restraints

be no more than 2.5 cm (1 in) of movement for proper installation.

Head Restraint Removal and Reinstallation

The rear outboard head restraints can be removed if they interfere with the proper installation of the child restraint.

To remove the head restraint:

1. Partially fold the seatback forward. See *Rear Seats* ⇨ 62 for additional information.

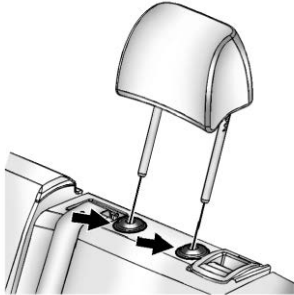

2. Press both buttons on the head restraint posts at the same time, and pull up on the head restraint.
3. Store the head restraint in a secure place.
4. When the child restraint is removed, reinstall the head restraint before the seating position is used.

Warning

With head restraints that are not installed and adjusted properly, there is a greater chance that occupants will suffer a neck/spinal injury in a crash. Do not drive until the head restraints for all occupants are installed and adjusted properly.

To reinstall the head restraint:

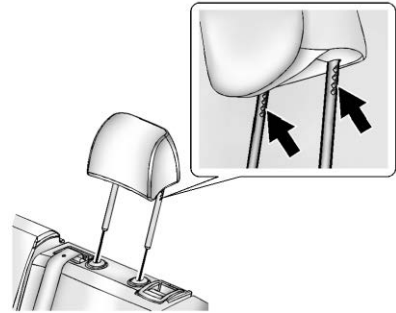

1. Partially fold the seatback forward. See *Rear Seats* ⇨ 62.
2. Insert the head restraint posts into the holes in the top of the seatback. The notches on the posts must face the driver side of the vehicle.
3. Push the head restraint down.

If necessary, press the height adjustment release button to further lower the head restraint. See *Head Restraints* ⇨ 57.

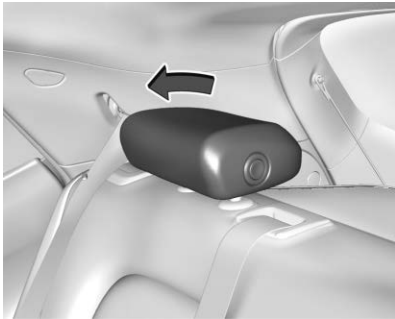

4. Return the head restraint to the full upright position if folded. Pull the head restraint up and forward until it locks into place.
5. Try to move the head restraint in all directions to make sure that it is locked in place.

Always adjust the head restraint so that the top of the restraint is at the same height as the top of the occupant's head. See *Head Restraints* ⇨ 57.

Replacing LATCH System Parts After a Crash

Warning

A crash can damage the LATCH system in the vehicle. A damaged LATCH system may not properly secure the child restraint, resulting in serious injury or even death in a crash. To help make sure the LATCH system is working properly after a crash, see your dealer to have the system inspected and any necessary replacements made as soon as possible.

If the vehicle has the LATCH system and it was being used during a crash, new LATCH system parts may be needed.

New parts and repairs may be necessary even if the LATCH system was not being used at the time of the crash.

Securing Child Restraints (With the Seat Belt in the Rear Seat)

When securing a child restraint in a rear seating position, study the instructions that came with the child restraint to make sure it is compatible with this vehicle.

If the child restraint has the LATCH system, see *Lower Anchors and Tethers for Children (LATCH System)* ⇨ 90 for how and where to install the child restraint using LATCH. If a child restraint is secured in the vehicle using a seat belt and it uses a top tether, see *Lower Anchors and Tethers for Children (LATCH System)* ⇨ 90 for top tether anchor locations.

Do not secure a child restraint in a position without a top tether anchor if a national or local law requires that the top tether be anchored, or if the instructions that come with the child restraint say that the top strap must be anchored.

100 Seats and Restraints

If the child restraint or vehicle seat position does not have the LATCH system, you will be using the seat belt to secure the child restraint. Be sure to follow the instructions that came with the child restraint.

If more than one child restraint needs to be installed in the rear seat, be sure to read *Where to Put the Restraint* ⇨ 89.

1. Put the child restraint on the seat.

If the head restraint interferes with the proper installation of the child restraint, the head restraint may be removed. See “Head Restraint Removal and Reinstallation” under *Lower Anchors and Tethers for Children (LATCH System)* ⇨ 90.

2. Pick up the latch plate, and run the lap and shoulder portions of the vehicle's seat belt through or around the restraint. The child restraint instructions will show you how.

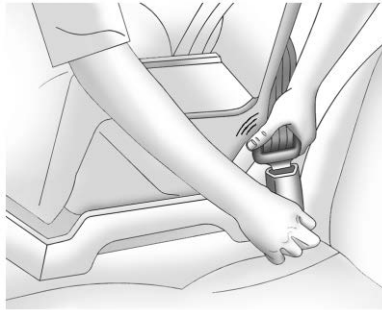

3. Push the latch plate into the buckle until it clicks.

Position the release button on the buckle, away from the child restraint, so that the seat belt could be quickly unbuckled if necessary.

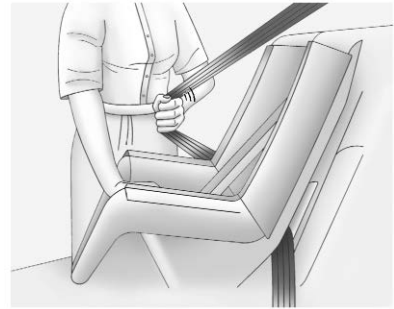

4. Pull the shoulder belt all the way out of the retractor to set the lock. When the retractor lock is set, the belt can be tightened but not pulled out of the retractor.

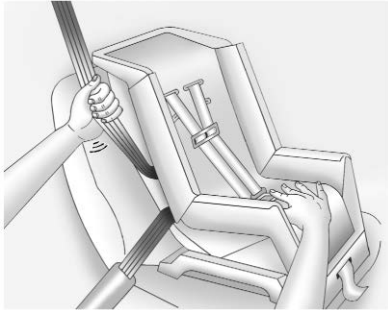

5. To tighten the belt, push down on the child restraint, pull the shoulder portion of the belt to tighten the lap portion of the belt, and feed the shoulder belt back into the retractor. When installing a forward-facing child restraint, it may be helpful to use your knee to push down on the child restraint as you tighten the belt.

Try to pull the belt out of the retractor to make sure the retractor is locked. If the retractor is not locked, repeat Steps 4 and 5.

6. If the child restraint has a top tether, follow the child restraint manufacturer's instructions regarding the use of the top tether. See *Lower Anchors and Tethers for Children (LATCH System)* ⇨ 90.
7. Before placing a child in the child restraint, make sure it is securely held in place. To check, grasp the child restraint at the seat belt path and attempt to move it side to side and back and forth. When the child restraint is properly installed, there should be no more than 2.5 cm (1 in) of movement.

To remove the child restraint, unbuckle the vehicle seat belt and let it return to the stowed position. If the top tether is attached to a top tether anchor, disconnect it. If the head restraint was removed, reinstall it before the seating position is used. See "Head Restraint Removal and Reinstallation" under *Lower Anchors and Tethers for Children (LATCH*

System) ⇨ 90 for additional information on installing the head restraint properly.

Securing Child Restraints (With the Seat Belt in the Front Seat)

This vehicle has airbags. A rear seat is a safer place to secure a forward-facing child restraint. See *Where to Put the Restraint* ⇨ 89.

In addition, the vehicle has a passenger sensing system which is designed to turn off the front outboard passenger frontal airbag and knee airbag under certain conditions.

See *Passenger Sensing System* ⇨ 77 and *Passenger Airbag Status Indicator* ⇨ 125 for more information, including important safety information.

Never put a rear-facing child seat in the front. This is because the risk to the rear-facing child is so great if the airbag deploys.

 **Warning**

A child in a rear-facing child restraint can be seriously injured or killed if the front outboard passenger frontal airbag inflates. This is because the back of the rear-facing child restraint would be very close to the inflating airbag. A child in a forward-facing child restraint can be seriously injured or killed if the front outboard passenger frontal airbag inflates and the passenger seat is in a forward position.

Even if the passenger sensing system has turned off the front outboard passenger airbag(s), no system is fail-safe. No one can guarantee that an airbag will not deploy under some unusual circumstance, even though the airbag(s) are off.

Secure rear-facing child restraints in a rear seat, even if the airbag(s) are off. If you secure a

(Continued)

Warning (Continued)

forward-facing child restraint in the front outboard passenger seat, always move the seat as far back as it will go. It is better to secure the child restraint in a rear seat.

See *Passenger Sensing System* ⇨ 77 for additional information.

If the vehicle does not have a rear seat that will accommodate a rear-facing child restraint, a rear-facing child restraint should not be installed in the vehicle, even if the airbag is off.

If the child restraint uses a top tether, see *Lower Anchors and Tethers for Children (LATCH System)* ⇨ 90 for top tether anchor locations.

Do not secure a child restraint in a position without a top tether anchor if a national or local law requires that the top tether be anchored, or if

the instructions that come with the child restraint say that the top tether must be anchored.

In Canada, the law requires that forward-facing child restraints have a top tether, and that the tether be attached.

When using the lap-shoulder belt to secure the child restraint in this position, follow the instructions that came with the child restraint and the following instructions:

1. Move the seat as far back as it will go before securing the forward-facing child restraint. Move the seat upward or the seatback to an upright position, if needed, to get a tight installation of the child restraint.

When the passenger sensing system has turned off the front outboard passenger frontal airbag and knee airbag, the off indicator on the passenger airbag status indicator should

light and stay lit when you start the vehicle. See *Passenger Airbag Status Indicator* ⇨ 125.

2. Put the child restraint on the seat.
3. Pick up the latch plate, and run the lap and shoulder portions of the vehicle's seat belt through or around the restraint. The child restraint instructions will show you how.

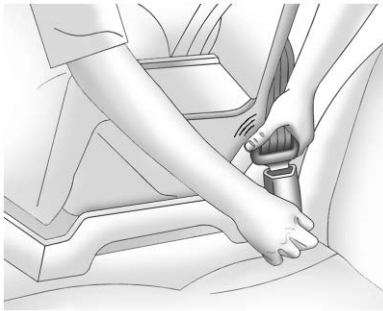

4. Push the latch plate into the buckle until it clicks.

Position the release button on the buckle, away from the child restraint, so that the seat belt could be quickly unbuckled if necessary.



5. Pull the shoulder belt all the way out of the retractor to set the lock. When the retractor lock is set, the belt can be tightened but not pulled out of the retractor.

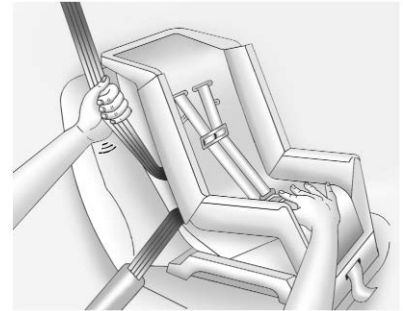

6. To tighten the belt, push down on the child restraint, pull the shoulder portion of the belt to tighten the lap portion of the belt, and feed the shoulder belt back into the retractor. When installing a forward-facing child restraint, it may be helpful to use your knee to push down on the child restraint as you tighten the belt.

Try to pull the belt out of the retractor to make sure the retractor is locked. If the retractor is not locked, repeat Steps 5 and 6.

7. If the vehicle does not have a rear seat and the child restraint manufacturer recommends using a top tether anchor, attach the top tether to the top tether anchor. Refer to the instructions that came with the child restraint and to *Lower Anchors and Tethers for Children (LATCH System)* ⇨ 90.
8. Before placing a child in the child restraint, make sure it is securely held in place. To check, grasp the child restraint at the seat belt path and attempt to move it side to side and back and forth. When the child restraint is properly installed, there should be no more than 2.5 cm (1 in) of movement.

If the airbags are off, the off indicator in the passenger airbag status indicator will come on and stay on when the vehicle is started.

If a child restraint has been installed and the on indicator is lit, see “If the On Indicator Is Lit for a Child Restraint” under *Passenger Sensing System* ⇨ 77.

To remove the child restraint, unbuckle the vehicle seat belt and let it return to the stowed position. If the top tether is attached to a top tether anchor, disconnect it.

Storage

Storage Compartments

Storage Compartments 105
 Instrument Panel Storage 105
 Cupholders 105
 Center Console Storage 106

Additional Storage Features

Cargo Cover 106
 Cargo Management System 107

Storage Compartments

⚠ Warning

Do not store heavy or sharp objects in storage compartments. In a crash, these objects may cause the cover to open and could result in injury.

Instrument Panel Storage

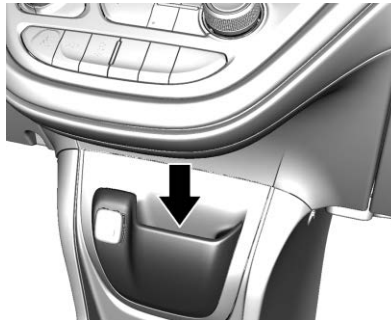

The instrument panel storage is near the power outlet.



Cupholders

The front cupholders are near the shift lever.

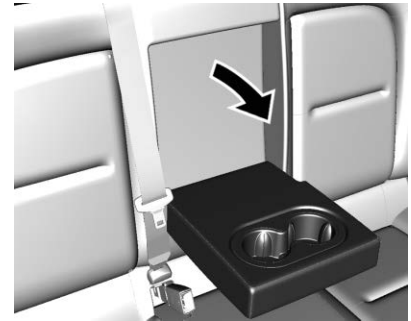

If equipped, lower the armrest to access the rear cupholders. The liner is removable for cleaning.

Center Console Storage

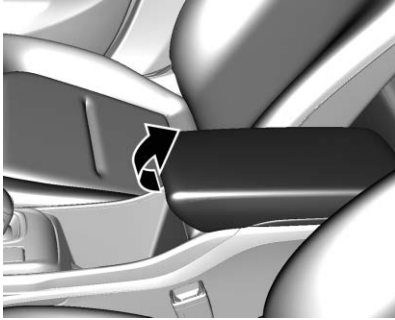

There is storage in the center console. Move the armrest rearward and lift the lever on the front to open.

There may be a small tray and additional storage when the small tray is detached.

Additional Storage Features

Cargo Cover

Warning

An unsecured cargo cover could strike people in a sudden stop or turn, or in a crash. Store the cargo cover securely or remove it from the vehicle.

If equipped, the cargo cover can be used to cover items in the rear of the vehicle.

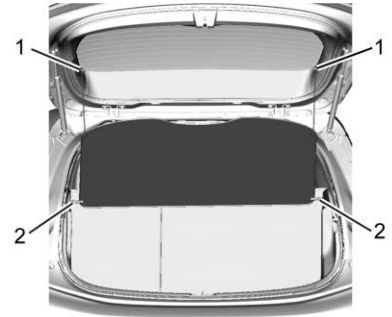

To remove the cargo cover:

1. Remove the cords from the hooks at the top of the liftgate (1).
2. Disconnect the loops from the hooks on the trim panel (2).

To install the cargo cover:

1. Attach the loops to the hooks on the trim panel (2).
2. Reconnect both of the cords to the hooks at the top of the liftgate (1).

Cargo Management System

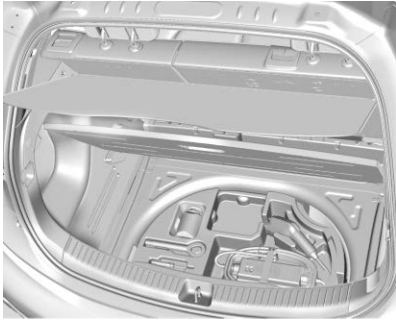

Pull up on the load floor cover to access the cargo management system, if equipped.

Instruments and Controls

Controls

Steering Wheel Adjustment ...	109
Steering Wheel Controls	109
Heated Steering Wheel	110
Horn	110
Pedestrian Safety Signal	110
Windshield Wiper/Washer	111
Rear Window Wiper/ Washer	112
Compass	113
Clock	114
Power Outlets	114
Wireless Charging	115

Warning Lights, Gauges, and Indicators

Warning Lights, Gauges, and Indicators	118
Instrument Cluster	118
Speedometer	121
Odometer	121
Trip Odometer	121
Battery Gauge (High Voltage)	122
Driver Efficiency Gauge	122

Power Indicator Gauge	123
Seat Belt Reminders	123
Airbag Readiness Light	124
Passenger Airbag Status Indicator	125
Charging System Light (12-Volt Battery)	125
Service Vehicle Soon Light ...	126
Brake System Warning Light	126
Electric Parking Brake Light	126
Service Electric Parking Brake Light	127
Antilock Brake System (ABS) Warning Light	127
Sport Mode Light	127
Lane Keep Assist (LKA) Light	127
Vehicle Ahead Indicator	128
Pedestrian Ahead Indicator ...	128
Traction Off Light	128
StabiliTrak OFF Light	128
Traction Control System (TCS)/ StabiliTrak Light	129
Tire Pressure Light	129
Security Light	130
Vehicle Ready Light	130
High-Beam On Light	130
Lamps On Reminder	130

Cruise Control Light	130
Door Ajar Light	131

Information Displays

Power Flows	131
Programmable Charging	131
Energy Information	138
Energy Settings	140
Driver Information Center (DIC)	141

Vehicle Messages

Vehicle Messages	142
Propulsion Power Messages	143
Vehicle Speed Messages	143

Vehicle Personalization

Vehicle Personalization	143
-------------------------------	-----

Controls

Steering Wheel Adjustment



To adjust the steering wheel:

1. Pull the lever down.
2. Move the steering wheel up or down.
3. Pull or push the steering wheel closer or away from you.
4. Pull the lever up to lock the steering wheel in place.

Do not adjust the steering wheel while driving.



Steering Wheel Controls





If equipped, some audio controls can be adjusted at the steering wheel.



 : If equipped with OnStar or a Bluetooth system, press to interact with those systems. See *OnStar Overview* ⇨ 346 or *Bluetooth* ⇨ 175.

 : Press to decline an incoming call or end a current call. Press to mute or unmute the infotainment system when not on a call.

 or  : Press to go to the previous or next selection.

 or  : Press to move between the interactive display zones in the cluster.

 : Press to select a highlighted menu option.

 **FAV** or  **FAV** : Press to display a list of favorites and select the next or previous favorite when listening to the radio.

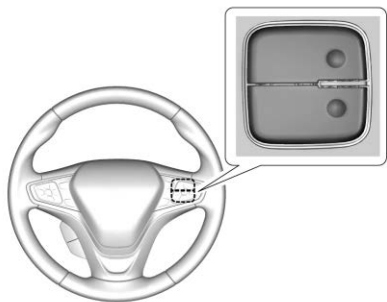

The volume switches are on the right rear side of the steering wheel. Press to increase or decrease the volume.

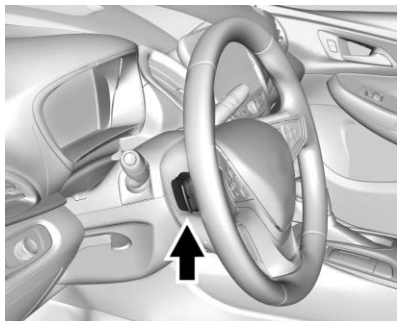

There is a paddle on the left rear side of the steering wheel for regenerative braking. See *Regenerative Braking* ⇨ 215.

Heated Steering Wheel



 : If equipped, press to turn on or off. An indicator light on the button displays when the feature is turned on.

The steering wheel takes about three minutes to start heating.

If equipped with an auto heated steering wheel, the heated steering wheel will turn on automatically in

remote start along with the heated seats when it is cold outside. The heated steering wheel indicator light may not come on. See *Heated Front Seats* ⇨ 60.

Horn

Press  on the steering wheel pad to sound the horn.

Pedestrian Safety Signal

The vehicle is equipped with automatic sound generation.

The automatic sound is generated to indicate the vehicle presence to pedestrians. The sound changes if the vehicle is speeding up or slowing down. It is activated when the vehicle is shifted into a forward gear or R (Reverse), up to 33 km/h (20 mph).

Windshield Wiper/Washer

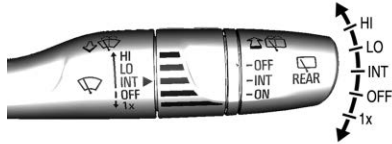

The windshield wiper/washer lever is on the side of the steering column. With the vehicle on or in Service Mode, move the windshield wiper lever to select the wiper speed.

HI : Use for fast wipes.

LO : Use for slow wipes.

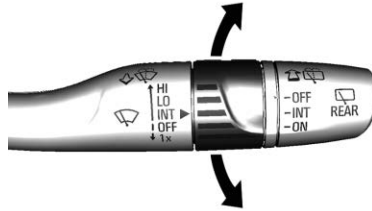

INT : If equipped with intermittent wipes, move the windshield wiper lever to INT. Turn the band up for more frequent wipes or down for less frequent wipes.

OFF : Use to turn the wipers off.

1X : For a single wipe, briefly move the lever down. For multiple wipes, hold the lever down.

Clear snow and ice from the wiper blades and windshield before using them. If frozen to the windshield, carefully loosen or thaw them.

Damaged blades should be replaced. See *Wiper Blade Replacement* ⇨ 266.

Heavy snow or ice can overload the wiper motor. If the wiper motor overheats, the windshield wipers will stop until the motor cools and the wiper control is turned off. See *Electrical System Overload* ⇨ 271.

Wiper Parking

If the vehicle is turned off while the wipers are on LO, HI, or INT, they will immediately stop. If the windshield wiper lever is then moved to OFF before the driver door is opened or within 10 minutes, the wipers will restart and move to the base of the windshield. If the vehicle is turned off while the wipers are performing wipes due to windshield washing, the wipers continue to run until they reach the base of the windshield.

 : Pull the windshield wiper lever toward you to spray windshield washer fluid and activate the wipers.

112 Instruments and Controls

The wipers will continue until the lever is released or the maximum wash time is reached. When the lever is released, additional wipes may occur depending on how long the windshield washer had been activated. See *Washer Fluid* ⇨ 261 for information on filling the windshield washer fluid reservoir.

Warning

In freezing weather, do not use the washer until the windshield is warmed. Otherwise the washer fluid can form ice on the windshield, blocking your vision.

Rear Window Wiper/Washer

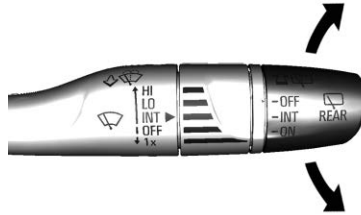

The controls are on the end of the windshield wiper lever.

Move the control to:

ON : To turn on.

OFF : To turn off.

INT : To turn on intermittent rear wiper.



 : Push the windshield wiper lever forward to spray washer fluid on the rear window. If equipped with the rear camera mirror, the washer fluid is sprayed on the rear camera at the same time. The lever returns to its starting position when released.

 **Warning**

In freezing weather, do not use the washer until the windshield is warmed. Otherwise the washer fluid can form ice on the windshield, blocking your vision.

Auto Wipe in Reverse Gear

If the rear wiper control is off, the rear wiper will automatically operate continuously when the vehicle is in R (Reverse), and the front windshield wiper is performing low or high speed wipes. If the rear wiper control is off, the vehicle is in R (Reverse), and the front windshield wiper is performing intermittent wipes, then the rear wiper automatically performs intermittent wipes.

This feature can be turned on or off. See *Vehicle Personalization* ⇨ 143.

The windshield washer reservoir is used for the windshield and the rear window. Check the fluid level in the reservoir if either washer is not working.

Rear Wiper Arm Assembly Protection

Wiper operation returns to normal when the shift lever is no longer in N (Neutral) or the vehicle speed increases. The rear wiper will also stop when the liftgate is open.

When using an automatic car wash, move the rear wiper control to OFF to disable the rear wiper. If the shift lever is in N (Neutral) and the vehicle speed is very slow, the rear wiper will automatically stop at the base of the rear window.

Compass

The vehicle has a compass display in the instrument cluster above the speedometer. The compass receives its heading and other information from the Global Positioning System (GPS) antenna and vehicle speed information.

The compass system has automatic calibration and zone adjustment features.

Avoid covering the GPS antenna for long periods of time with objects that may interfere with the antenna's ability to receive a satellite signal. The compass system is designed to operate for a certain number of miles or degrees of turn before needing a signal from the GPS satellites. The compass system will automatically determine when a GPS signal is restored and provide a heading.



Clock

The infotainment system controls are used to access the time and date settings through the menu. This can also be changed by touching the clock, then touch  to go to the Time and Date Settings menu.

 : Press to access the Home Page.

 : Touch to access the Icon View.



 : Drag the scroll bar to navigate the list.

 or  : Touch to set up items.



 : Touch to exit or return to the previous screen or menu.

Setting the Time

When Auto Set is enabled, the time cannot be manually set.



1. Press , then touch .
2. Touch Settings.
3. Touch Time and Date, then touch Set Time.

4. Touch + or - to adjust the value.

5. Touch  or  to adjust AM or PM for 12 hour format.

6. Touch .

Setting the Date

1. Press , then touch .



2. Touch Settings.

3. Touch Time and Date, then touch Set Date.

4. Touch + or - to adjust the value.

5. Touch .

Auto Set

1. Press , then touch .



2. Touch Settings.

3. Touch Time and Date, then touch Auto Set.

4. Select from the available options.

5. Touch .

Setting the 12/24 Hour Format

1. Press , then touch .

2. Touch Settings.

3. Touch Time and Date, then touch Set Time.

4. Select 12 hr or 24 hr format.

5. Touch .

Power Outlets

The accessory power outlet can be used to plug in electrical equipment, such as a mobile phone or MP3 player. The accessory power outlet only works with the vehicle turned on.

The vehicle has an accessory power outlet on the lower center stack below the climate control.

Open the cover to access and replace when not in use.

Caution

Leaving electrical equipment plugged in for an extended period of time while the vehicle is off will drain the battery. Always unplug electrical equipment when not in use and do not plug in equipment that exceeds the maximum 20 amp rating.

Certain accessory power plugs may not be compatible with the accessory power outlet and could overload vehicle or adapter fuses. If a problem is experienced, see your dealer.

When adding electrical equipment, be sure to follow the proper installation instructions included with the equipment. See *Add-On Electrical Equipment* ⇨ 252.

Caution

Hanging heavy equipment from the power outlet can cause damage not covered by the vehicle warranty. The power outlets are designed for accessory power plugs only, such as cell phone charge cords.

Wireless Charging

The vehicle may have a wireless charging pocket outside the armrest of the center console. The system operates at 145 kHz and wirelessly charges one Qi compatible mobile device. The power output of the system is capable of charging at a rate up to 3 amp (19.5W), as requested by the compatible mobile device. See *Radio Frequency Statement* ⇨ 342.

To check for mobile phone or other device compatibility:

- In the U.S., see www.my.chevrolet.com/learn.



- In Canada, see www.gmtotalconnect.ca.
- Or, see your dealer for details.

Warning

Wireless charging can affect the operation of an implanted pacemaker or other medical devices. If you have one, it is recommended to consult with your doctor before using the wireless charging system.

The vehicle must be on, in Service Mode, or Retained Accessory Power (RAP) must be active. The wireless charging feature may not correctly indicate charging when the vehicle is in RAP. See *Retained Accessory Power (RAP)* ⇨ 206.

The operating temperature is -20 °C (-4 °F) to 60 °C (140 °F) for the charging system and 0 °C (32 °F) to 35 °C (95 °F) for the mobile phone.

Warning

Remove all objects from the charging pocket before charging your mobile phone. Objects, such as coins, keys, rings, paper clips, or cards, between the mobile phone and the charger will become very hot. On the rare occasion that the charging system does not detect an object, and the object gets wedged between the mobile phone and the charger, remove the mobile phone and allow the object to cool before removing it from the charging pocket, to prevent burns.

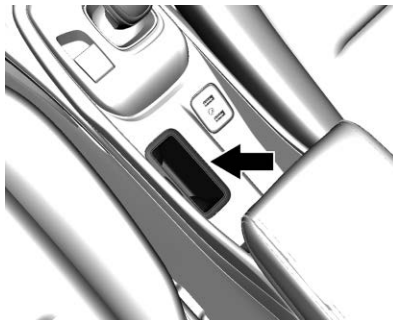

To charge a mobile device:

1. Remove all objects from the charging pocket. The system may not charge if there are any objects between the mobile device and charging pocket.
2. With the mobile device screen facing the driver side, insert the device into the charging pocket and  will appear on the infotainment display. This indicates that the mobile device is properly positioned and charging.

If  does not appear on the infotainment display:

1. Remove the mobile device from the pocket and wait three seconds.
2. Turn the mobile device 180 degrees and insert it back into the pocket with the screen facing the driver side.

Software Acknowledgements

Certain Wireless Charging Module product from LG Electronics, Inc. ("LGE") contains the open source software detailed below. Refer to the indicated open source licenses (as are included following this notice) for the terms and conditions of their use.

OSS Notice Information

To obtain the source code that is contained in this product, please visit <http://opensource.lge.com>. In addition to the source code, all referred license terms, warranty disclaimers and copyright notices are available for download. LG Electronics will also provide open

source code to you on CD-ROM for a charge covering the cost of performing such distribution (such as the cost of media, shipping, and handling) upon email request to opensource@lge.com. This offer is valid for three (3) years from the date on which you purchased the product.

Freescale-WCT library

Copyright (c) 2012-2014 Freescale Semiconductor, Inc.. All rights reserved.

- 1. Redistributions of source code must retain the above copyright notice, this list of conditions and the following disclaimer.
- 2. Redistributions in binary form must reproduce the above copyright notice, this list of conditions and the following disclaimer in the documentation and/or other materials provided with the distribution.

- 3. Neither the name of the copyright holder nor the names of its contributors may be used to endorse or promote products derived from this software without specific prior written permission.

THIS SOFTWARE IS PROVIDED BY THE COPYRIGHT HOLDERS AND CONTRIBUTORS "AS IS" AND ANY EXPRESS OR IMPLIED WARRANTIES, INCLUDING, BUT NOT LIMITED TO, THE IMPLIED WARRANTIES OF MERCHANTABILITY AND FITNESS FOR A PARTICULAR PURPOSE ARE DISCLAIMED. IN NO EVENT SHALL THE COPYRIGHT HOLDER OR CONTRIBUTORS BE LIABLE FOR ANY DIRECT, INDIRECT, INCIDENTAL, SPECIAL, EXEMPLARY, OR

CONSEQUENTIAL DAMAGES (INCLUDING, BUT NOT LIMITED TO, PROCUREMENT OF SUBSTITUTE GOODS OR SERVICES; LOSS OF USE, DATA, OR PROFITS; OR BUSINESS INTERRUPTION) HOWEVER CAUSED AND ON ANY THEORY OF LIABILITY, WHETHER IN CONTRACT, STRICT LIABILITY, OR TORT (INCLUDING NEGLIGENCE OR OTHERWISE) ARISING IN ANY WAY OUT OF THE USE OF THIS SOFTWARE, EVEN IF ADVISED OF THE POSSIBILITY OF SUCH DAMAGE.



Warning Lights, Gauges, and Indicators

Warning lights and gauges can signal that something is wrong before it becomes serious enough to cause an expensive repair or replacement. Paying attention to the warning lights and gauges could prevent injury.

Some warning lights come on briefly when the propulsion system is started to indicate they are working. When one of the warning lights comes on and stays on while driving, or when one of the gauges shows there may be a problem, check the section that explains what to do. Waiting to do repairs can be costly and even dangerous.

Instrument Cluster

The instrument cluster displays a preview of information that includes electric range, charging, odometer, and battery status. This happens upon entry when the driver door is opened, before starting the vehicle. This preview will dismiss after starting the vehicle or soon after closing the driver door.

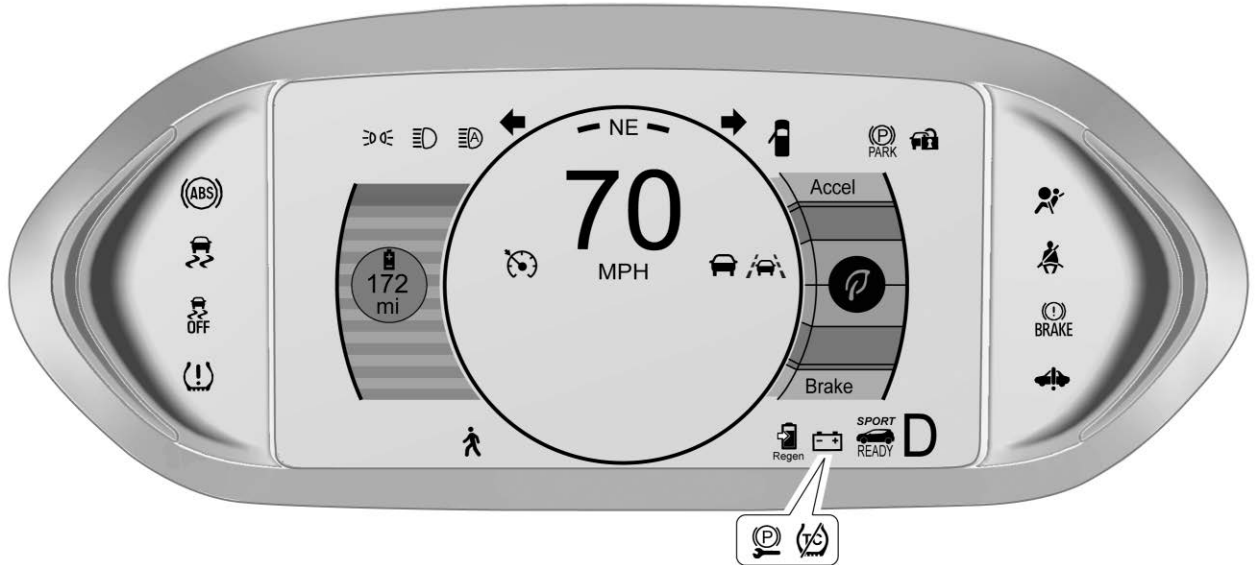

Modern English Cluster Shown, Others and Metric Similar

Reconfigurable Instrument Cluster

The cluster layout can be changed. There are three display configurations to choose from: Classic, Modern, and Enhanced. Use the steering wheel control to move between the different display zones and scroll through the different displays. See “Layout” under “Cluster Menu” following.

- Classic configuration displays the speedometer with a simplified battery gauge and efficiency light.
- Modern configuration displays the speedometer with a battery gauge and efficiency gauge.
- Enhanced configuration displays the speedometer with battery gauge, efficiency ring, and power gauge.

Cluster Menu

There is an interactive display area in the center of the instrument cluster.

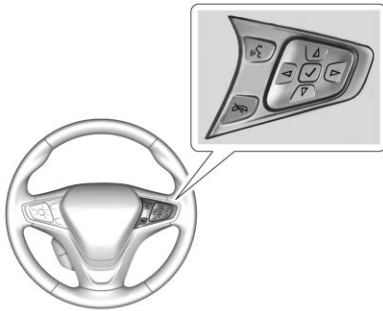

Use the right steering wheel control to open and scroll through the different items and displays.

Press ◀ to access the cluster applications. Use ▲ or ▼ to scroll through the list of available applications. Press ✓ to select the application, then press ▶ to enter the application menu. Exit the menu by pressing ◀.

Not all applications will be available on all vehicles.

Cluster Menu Applications

- Vehicle info. This is where the Driver Information Center (DIC) displays can be viewed. See *Driver Information Center (DIC)* ⇨ 141.
- Audio
- Phone
- Onstar Navigation
- Layout
- Options

Audio

In the main view of the Audio application, press ▲ or ▼ to scroll through radio stations or move to the next/previous track of a USB/Bluetooth device that is connected to the vehicle. Press ✓ to select the Audio app, then press ▶ to enter the Audio menu. In the Audio menu browse for music, select from the favorites, or change the audio source.

Phone

In the Phone menu, if there is no active phone call, view recent calls, scroll through contacts, or select from the favorites. If there is an active call, mute or unmute the phone or switch to handset or handsfree operation.

Onstar Navigation

This display is used for OnStar Turn-by-Turn guidance, if equipped.

Layout

Choose Classic, Modern, or Enhanced layout by pressing \checkmark while the desired item is highlighted. Exit the Layout menu by pressing \triangleleft .

Options

Press \checkmark to select the Options app.

Use \triangle or ∇ to scroll through the items in the Options menu. Exit the Options menu by pressing \triangleleft .

Units : Press \triangleright while Units is displayed to enter the Units menu. Use \triangle or ∇ to scroll through the items. Choose U.S., Metric, or Imperial by pressing \checkmark while the desired item is highlighted.

Speed Warning : The speed warning display allows the driver to set a speed that they do not want to exceed. To set the speed warning, press \checkmark when Speed Warning is displayed. Press \triangle or ∇ to adjust the value. Press \checkmark to set the speed. Once set, this feature can be turned off by pressing \checkmark while viewing this page. If the selected speed limit is exceeded, a pop-up warning is displayed and a chime may sound.

Help : Press \triangleright while Help is displayed to enter the Help menu. Use \triangle or ∇ to scroll through the items in the Help menu.

Open Source Software : Press \checkmark while Open Source Software is highlighted to display open source software information.

Speedometer

The speedometer shows the vehicle's speed in either kilometers per hour (km/h) or miles per hour (mph).

Odometer

The odometer shows how far the vehicle has been driven, in either kilometers or miles.

Trip Odometer

The trip odometer shows how far the vehicle has been driven since the trip odometer was last reset.

The trip odometer is accessed and reset through the Driver Information Center (DIC). See *Driver Information Center (DIC)* \diamond 141.

Battery Gauge (High Voltage)

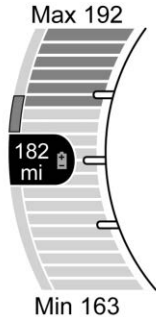

Enhanced Battery Gauge

This displays the high voltage battery state of charge. The value in the center is an estimate of how far the vehicle can be driven on the remaining charge as estimated from driving habits and conditions learned over several days.

The Max and Min values above and below the display indicate the longest and shortest possible range as estimated from current vehicle conditions and climate settings.

The mileage estimate and Max and Min numbers are affected by climate control system usage. Estimated range may increase or decrease based upon changes in climate control energy consumption.

A trend bar on the far left indicates how recent vehicle conditions and climate settings are affecting the learned range prediction.

When the high voltage battery state of charge is very low the estimated range value in the center will change to Low. Max and Min ranges will no longer be displayed. Additional alerts may display and a sound may also be heard at low state of charge.

Driver Efficiency Gauge

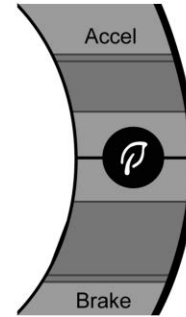

Modern Efficiency Gauge Shown, Classic Similar

This gauge is a guide to driving in an efficient manner.

Efficient Driving

- Classic layout: Keep the gauge and leaf green.
- Modern layout: Keep the ball green and in the center of the gauge.
- Enhanced layout: Keep the outer ring of the speedometer green.

Inefficient Driving

- Classic layout: The gauge and leaf turn yellow.
- Modern layout: The ball turns yellow and moves above the center of the gauge.
- Enhanced layout: The outer ring of the speedometer turns yellow.

Aggressive Braking

- Classic layout: The gauge and leaf turn yellow.
- Modern layout: The ball turns yellow and moves below the center of the gauge.
- Enhanced layout: The outer ring of the speedometer turns yellow.

Power Indicator Gauge

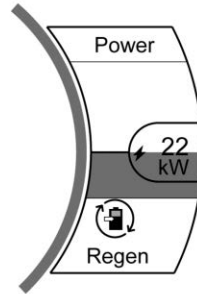

The power indicator gauge displays the instantaneous charge and discharge power flowing either into or out of the high voltage battery. Maximum discharge power is available when the high voltage battery is fully charged. During normal operation, a slight reduction in discharge power may occur as the high voltage battery state of charge decreases.

Regenerative Braking

When regenerative braking is active, the regen battery icon with arrows appears green and a horizontal bar may display on the gauge.

Regenerative Power Limited

Regenerative power may be limited when the high voltage battery is near full charge or cold. The regen battery icon will appear gray when limited.

Seat Belt Reminders

Driver Seat Belt Reminder Light

There is a driver seat belt reminder light on the instrument cluster.



When the vehicle is started, this light flashes and a chime may come on to remind the driver to fasten

their seat belt. Then the light stays on solid until the belt is buckled. This cycle may continue several times if the driver remains or becomes unbuckled while the vehicle is moving.

If the driver seat belt is buckled, neither the light nor the chime comes on.

Passenger Seat Belt Reminder Light

There is a passenger seat belt reminder light near the passenger airbag status indicator.



When the vehicle is started, this light flashes and a chime may come on to remind passengers to fasten their seat belt. Then the light stays on solid until the belt is buckled. This cycle continues several times if

the passenger remains or becomes unbuckled while the vehicle is moving.

If the passenger seat belt is buckled, neither the chime nor the light comes on.

The front passenger seat belt reminder light and chime may turn on if an object is put on the seat such as a briefcase, handbag, grocery bag, or other electronic device. To turn off the reminder light and/or chime, remove the object from the seat or buckle the seat belt.

Airbag Readiness Light

This light shows if there is an electrical problem with the airbag system. The system check includes the airbag sensor(s), passenger sensing system, the pretensioners (if equipped), the airbag modules, the wiring, and the crash sensing and diagnostic module.



The airbag readiness light comes on for several seconds when the vehicle is started. If the light does not come on then, have it fixed immediately.

Warning

If the airbag readiness light stays on after the vehicle is started or comes on while driving, it means the airbag system might not be working properly. The airbags in the vehicle might not inflate in a crash, or they could even inflate without a crash. To help avoid injury, have the vehicle serviced right away.

If there is a problem with the airbag system, a Driver Information Center (DIC) message may also come on.

Passenger Airbag Status Indicator

The vehicle has a passenger sensing system. See *Passenger Sensing System* ⇨ 77 for important safety information. The overhead console has a passenger airbag status indicator.

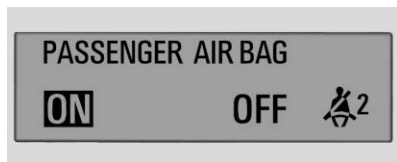

United States



Canada

When the vehicle is started, the passenger airbag status indicator will light ON and OFF, or the symbol for on and off, for several seconds as a system check. Then, after

several seconds, the status indicator will light either ON or OFF, or the on or off symbol to let you know the status of the front outboard passenger frontal airbag and knee airbag.

If the word ON or the on symbol is lit on the passenger airbag status indicator, it means that the front outboard passenger frontal airbag and knee airbag are allowed to inflate.

If the word OFF or the off symbol is lit on the passenger airbag status indicator, it means that the passenger sensing system has turned off the front outboard passenger frontal airbag and knee airbag.

If, after several seconds, both status indicator lights remain on, or if there are no lights at all, there may be a problem with the lights or the passenger sensing system. See your dealer for service.

Warning

If the airbag readiness light ever comes on and stays on, it means that something may be wrong with the airbag system. To help avoid injury to yourself or others, have the vehicle serviced right away. See *Airbag Readiness Light* ⇨ 124 for more information, including important safety information.

Charging System Light (12-Volt Battery)

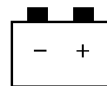

The charging system light comes on briefly when the vehicle is started, as a check to show the light is working.

If the light stays on, or comes on while driving, there could be a problem with the electrical charging system. Have it checked by your dealer. Driving while this light is on could drain the 12-volt battery.

If a short distance must be driven with the light on, be sure to turn off all accessories, such as the radio.

Service Vehicle Soon Light



This light comes on if a condition exists that may require the vehicle to be taken in for service.

If the light comes on, take the vehicle to your dealer for service as soon as possible.

Brake System Warning Light

The vehicle brake system consists of two hydraulic circuits. If one circuit is not working, the remaining circuit can still work to stop the vehicle. For normal braking performance, both circuits need to be working.

If the warning light comes on, there is a brake problem. Have the brake system inspected right away.

Warning

The brake system might not be working properly if the brake system warning light is on. Driving with the brake system warning light on can lead to a crash. If the light is still on after the vehicle has been pulled off the road and carefully stopped, have the vehicle towed for service.



Metric



BRAKE

English

This light should come on briefly when the vehicle is started. If it does not come on then, see your dealer for service.

If the light comes on and stays on, there is a brake problem.

Electric Parking Brake Light



Metric



PARK

English

This light comes on when the parking brake is applied. If the light flashes and stays on after the

parking brake is released, or while driving, there is a problem with the Electric Parking Brake system.

If the light does not come on, or remains flashing, see your dealer.

Service Electric Parking Brake Light



The service electric parking brake light should come on briefly when starting the vehicle. If it does not come on, have the vehicle serviced by your dealer.

If this light stays on, there is a problem with a system on the vehicle that is causing the parking brake system to work at a reduced level. The vehicle can still be driven, but should be taken to a dealer as soon as possible. See *Electric*

Parking Brake ⇨ 213. A message may also display in the Driver Information Center (DIC).

Antilock Brake System (ABS) Warning Light



The ABS warning light will come on briefly when the vehicle is started. This is normal. If the light does not come on then, have it fixed so it will be ready to warn if there is a problem.

If the light stays on or comes on while driving, stop as soon as possible and turn the vehicle off. Then start the vehicle again to reset the system. If the light still stays on, or comes on again while driving, the vehicle needs service. See your dealer. If the regular brake system warning light is not on, the brakes will still work, but the antilock brakes

will not work. If the regular brake system warning light is also on, the antilock brakes will not work and there is a problem with the regular brakes.

Sport Mode Light



This light comes on when Sport Mode is selected.

Lane Keep Assist (LKA) Light



If available, this light comes on briefly while starting the vehicle.

If it does not come on, have the vehicle serviced.

This light is green if LKA is available to assist.

LKA may assist by gently turning the steering wheel if the vehicle approaches a detected lane marking without using the turn signal in that direction. The LKA light will turn amber.

This light is amber and flashes as a Lane Departure Warning (LDW) alert, to indicate that the lane marking has been crossed.

Vehicle Ahead Indicator



If equipped, this indicator will display green when a vehicle is detected ahead and amber when you are following a vehicle ahead much too closely.

Pedestrian Ahead Indicator



If equipped, this indicator will display amber when a nearby pedestrian is detected directly in front of the vehicle.

See *Front Pedestrian Braking (FPB) System* ⇨ 229.

Traction Off Light



This light comes on briefly while starting the vehicle. If it does not, have the vehicle serviced by your

dealer. If the system is working normally, the indicator light then turns off.

The traction off light comes on when the Traction Control System (TCS) has been turned off by pressing and releasing the TCS/StabiliTrak button.

This light and the StabiliTrak OFF light come on when StabiliTrak is turned off.

If the TCS is off, wheel spin is not limited. Adjust driving accordingly.

StabiliTrak OFF Light



This light comes on briefly while starting the vehicle. If it does not, have the vehicle serviced by your dealer.

This light comes on when the StabiliTrak system is turned off. If StabiliTrak is off, the Traction Control System (TCS) is also off.

If StabiliTrak and TCS are off, the system does not assist in controlling the vehicle. Turn on the TCS and the StabiliTrak systems, and the warning light turns off.

See *Traction Control/Electronic Stability Control* ⇨ 217.

Traction Control System (TCS)/StabiliTrak Light



This light comes on briefly when the vehicle is started.

If the light does not come on, have the vehicle serviced by your dealer. If the system is working normally, the indicator light turns off.

If the light is on and not flashing, the TCS, and potentially the StabiliTrak system have been disabled. A DIC message may display. Check the DIC messages to determine which feature(s) is no longer functioning and whether the vehicle requires service.

If the indicator/warning light is on and flashing, the TCS and/or the StabiliTrak system is actively working.

Tire Pressure Light



For vehicles with the Tire Pressure Monitor System (TPMS), this light comes on briefly when the vehicle is started. It provides information about tire pressures and the TPMS.

When the Light is On Steady

This indicates that one or more of the tires are significantly underinflated.

A message in the Driver Information Center (DIC) may also display. Stop as soon as possible, and inflate the tires to the pressure value shown on the Tire and Loading Information label.

When the Light Flashes First and Then Is On Steady

This indicates that there may be a problem with the TPMS. The light flashes for about one minute and stays on steady until the vehicle is off. This sequence repeats each time the vehicle is started.

Security Light



The security light should come on briefly as the vehicle is started. If it does not come on, have the vehicle serviced by your dealer. If the system is working normally, the indicator light turns off.

If the light stays on and the vehicle does not start, there could be a problem with the theft-deterrent system.

Vehicle Ready Light



The vehicle ready light comes on whenever the vehicle is ready to be driven.

High-Beam On Light



This light comes on when the high-beam headlamps are in use.

IntelliBeam® Light



This light comes on when the IntelliBeam system, if equipped, is enabled.

Lamps On Reminder



This light comes on when the exterior lamps are in use.

Cruise Control Light



The cruise control light is white when the cruise control is on and ready, and turns green when the cruise control is set and active.

The light turns off when the cruise control is turned off. See *Cruise Control* ⇨ 219.

Door Ajar Light



This light comes on when a door is open or not securely latched.

Information Displays

Power Flows

To view the Power Flow screens on the infotainment display, touch Energy and then touch Flow.

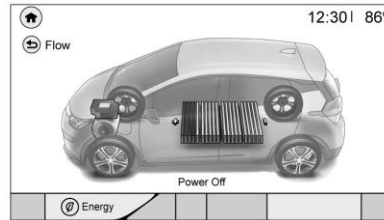

The Power Flow screens indicate the current operating condition. The screens show energy flow to and from the high voltage battery while the vehicle is being driven. These components will be highlighted when they are active.

Programmable Charging

Important Information about Portable Electric Vehicle Charging

- Charging an electric vehicle can stress a building's electrical system more than a typical household appliance.
- Before you plug in to any electrical outlet, have a qualified electrician inspect and verify the electrical system (electrical outlet, wiring, junctions, and protection devices) for heavy-duty service at a 12 amp continuous load.
- Electrical outlets may wear out with normal usage or may be damaged over time, making them unsuitable for electric vehicle charging.
- Check the electrical outlet/plug while charging and discontinue use if the electrical outlet/plug is hot, then have the electrical outlet serviced by a qualified electrician.

- When outdoors, plug into an electrical outlet that is weatherproof while in use.
- Mount the charge cord to reduce strain on the electrical outlet/plug.
- Do not place the charge cord in a position where it is expected to be submerged in water.

Danger

Improper use of portable electric vehicle charge cords may cause a fire, electrical shock, or burns, and may result in damage to property, serious injury, or death.

- Do not use extension cords, multi-outlet power strips, splitters, grounding adaptors, surge protectors, or similar devices.
- Do not use an electrical outlet that is worn or damaged, or will not hold the plug firmly in place.

(Continued)

Danger (Continued)

- Do not use an electrical outlet that is not properly grounded.
- Do not use an electrical outlet that is on a circuit with other electrical loads.

See *Charge Cord* ⇨ 243.

Programmable Charging Modes

To view the current charge mode status, touch Energy on the infotainment display, and then touch Charging.

The charge Start and charge Complete time estimations are also displayed. These estimations are most accurate when the vehicle is plugged in and in moderate temperature conditions.

Charge Mode Selection

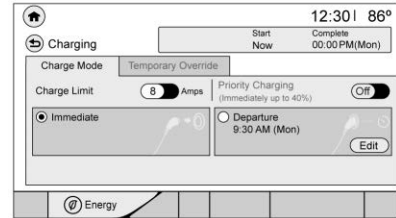

Immediate : The vehicle starts charging as soon as it is connected to an electrical outlet. This may be the only mode available at public DC charge stations. See *Plug-In Charging* ⇨ 235.

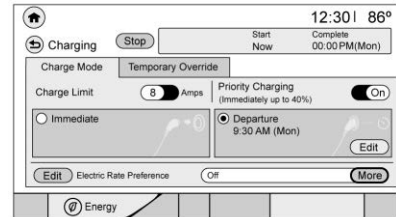



Departure : The vehicle will schedule charging to complete by the programmed departure time. The vehicle estimates the charging schedule based on programmed departure times, charge rate limits, electric rate preference and schedule, and priority charging settings. If there is not sufficient time after the charge cord is plugged in, the vehicle will not be fully charged by the departure time.

Departure Time Entry

The Departure charge mode allows for the departure time to be entered to match your personal schedule.

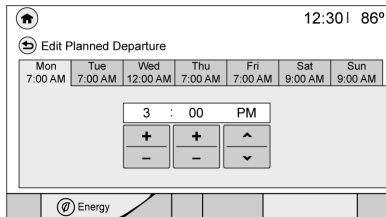
1. With Departure charge mode selected, touch Edit.



2. The current programmed departure time is displayed on the tab with the day of the week. Select the tab for the day of the week to be edited.
3. Touch + or - to change the hours and minutes.
4. Touch \wedge or \vee to change AM or PM.
5. Touch  to exit the screen.

Charge Current Limit Selection

The charge current limit setting allows the vehicle's charge current to be selected so it matches the capability of the charging location. If the vehicle consistently stops charging after being plugged in, or if a circuit breaker continues to trip, reducing to a lower charge current limit setting may resolve the issue.

The charge current limit setting should be configured to match the electrical current rating for the electrical outlet that the charge cord is connected to. On the Charge Mode tab, change the Charge Limit selection between:

- 12 amps
- 8 amps

Exact current levels may vary from the values shown in this manual. Check the vehicle for the available levels.

The charge limit can be changed and saved using Location Based Charging settings. The default value is the lower current limit. The charge current limit will reset to the lower value when the vehicle is shifted from P (Park) unless the Location Based Charging feature is active and set to retain this preference. See "Location Based Charging" later in this section.

Warning

Using a charge level that exceeds the electrical circuit or electrical outlet capacity may start a fire or damage the electrical circuit. Use the lowest charge level until a qualified electrician inspects the electrical circuit capacity. Use the

(Continued)

Warning (Continued)

lowest charge level if the electrical circuit or electrical outlet capacity is not known.

Electric Rate Preference

The vehicle estimates the charging start time based on the utility rate schedule, utility rate preference, and programmed departure time for the current day of the week. The vehicle will charge during the least expensive rate periods to achieve a full battery charge by the departure time. Electrical rate information from the utility company for the charging location is required for this mode. If the selected charge mode is Departure, then electric rate preference selection will display.

Electric Rate Preference Selection

From the Charge Mode tab on the Charging screen with Departure charge mode selected, touch More to select the Electric Rate Preference.

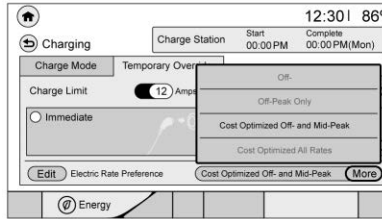

Touch one of the following options to select the Electric Rate Preference:

- Off: Delay charging based on departure.
- Off-Peak Only: Charge during Off-Peak Rates.
- Cost Optimized Off- and Mid-Peak: Charge during Mid-Peak and Off-Peak Rates.
- Cost Optimized All Rates: Charge during Peak, Mid-Peak, and Off-Peak Rates.

Charging begins at the start time and is complete by the departure time only if sufficient time is allowed after the charge cord is plugged in. For example, if the vehicle is plugged in for only one hour prior to

the departure time, and the battery is completely discharged, the vehicle will not be fully charged by the departure time regardless of the rate selection.

Also, if the selected electric rate settings result in a very long charge completion time, the vehicle will start charging immediately upon plug-in. For example, if the electric rate table is set up with all Peak rates and the rate preference is to charge during Off-Peak rates only, then the vehicle will start charging immediately upon plug-in.

Electric Rate Schedule

From the Charge Mode tab on the Charging screen, with Departure charge mode and an Electric Rate Preference selected, touch Edit next to Electric Rate Preference.

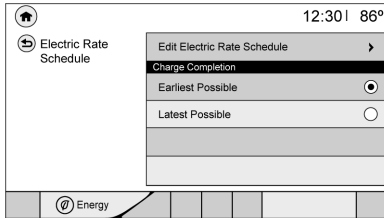

Select one of the following for the Charge Completion option:

- Earliest Possible
- Latest Possible

Edit Electric Rate Schedule

Electric rates, or cost per unit, may vary based on time, weekday/ weekend, and season. During the day when the demand for electricity is high, the rates are usually higher and called Peak rates. At night when the demand for electricity is low, the rates are usually lower and called Off-Peak rates. In some areas, a Mid-Peak rate is offered.

Contact the utility company to obtain the rate schedule for your area. The summer and winter start dates must be established to use a summer/ winter schedule.

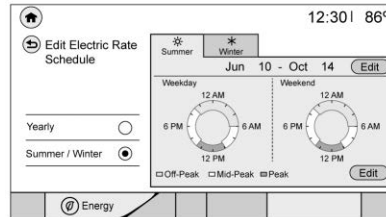



Touch Edit Electric Rate Schedule from the Electric Rate Schedule screen and select the desired schedule.

- Yearly
- Summer/Winter

Summer/Winter Schedule Start Date Editing

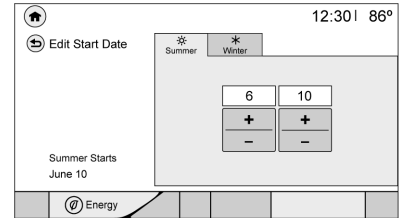
With Summer/Winter as the preferred rate schedule, touch Edit on the Summer tab next to the dates.



1. Touch + or - to change the month and day for the start of Summer.
2. Select the Winter tab.
3. Touch + or - to change the month and day for the start of Winter.
4. Touch  to exit the screen.

Electric Rate Schedule Editing

Electric rate information from the utility company for the charging location is required.

1. Touch Edit Electric Rate Schedule from the Electric Rate Schedule screen and select the desired schedule.

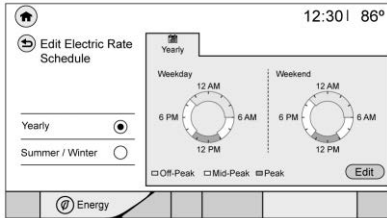

Yearly Shown, Summer/Winter Similar

2. Touch Edit in the lower right corner of the screen to edit the electric rate schedule.
 - Weekdays are Monday through Friday and use the same rate schedule.
 - Weekends are Saturday and Sunday and use the same rate schedule.

Both weekday and weekend schedules must be set. The rate schedule only applies for a 24-hour period, starting at 12 AM and ending at 12 AM. There

can be five rate changes for each day; not all must be used.

Select Weekday or Weekend.

3. Touch Set next to the row to be edited.

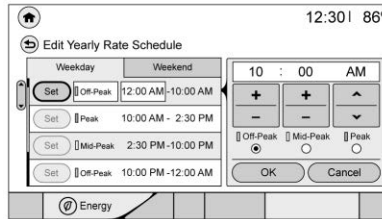

Yearly Shown, Summer/Winter Similar

4. Select Peak, Mid-Peak, or Off-Peak. Use + or - to enter the time, and ^ or v to change AM or PM.

The finish times must be consecutive. If a finish time does not follow a start time, an error message displays.

5. Touch OK.

Priority Charging

The priority charging feature will work when the Departure charge mode is selected. This feature is designed to ensure that the high voltage battery has a minimal amount of energy prior to delaying a charge. Upon completion of priority charging, the vehicle will return to normal Programmable Charging operation.

The feature can be enabled/disabled by selecting On/Off from the Charge Mode tab on the Charging screen when the Departure charge mode is selected. When enabled, Priority Charging will only prevent Programmable Charging while the high voltage battery is recharged from a depleted state to a 40% state of charge.

Temporary Charge Mode Override and Cancel

Programmed delayed charge modes can be temporarily overridden to an Immediate charge mode for one charge cycle. Also, the next planned departure time can be temporarily

overridden for one charge cycle. In addition to the in-vehicle overrides through the programmable charging screens, there are other ways to temporarily override a delayed charge mode. See *Plug-In Charging* ⇨ 235.

Temporary Override of a Delayed Charge Mode

The Temporary Override provides the ability to set temporary charge items for the next charge cycle.

1. Touch the Temporary Override tab on the Charging screen.

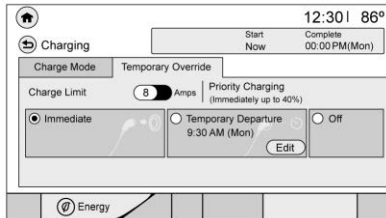

2. Select:
 - Immediate: Charge immediately at plug in.

- Temporary Departure: Set the temporary departure time.
- Off: Cancel the Temporary Override.

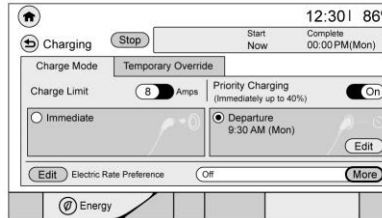

To override or cancel an active DC charging cycle, touch Stop on the charging screen.

Location Based Charging

With Location Based Charging enabled, the Charge Mode and Charge Limit Preference are saved and set back to the customer's preference every time the vehicle is returned to the saved home location. When the vehicle is not at the saved home location, then the vehicle will default to the lower limit of Charge Limit Preference and the

Charge Mode will be set to Immediate. When Location Based Charging is on and the vehicle is away from the saved home location, then the selection for the charge mode will be disabled and the selection will be grayed out.

After 90 days, a notification will display and the Charge Limit Preference will need to be reset for the next 90 days. See Important "Information about Portable Electric Vehicle Charging" earlier in this section.

When the GPS location is not available, dashes will be displayed and Location Based Charging will be disabled until the GPS is restored.

Using Location Based Charging

To use location based charging, a home location must first be stored. To store a home location:

1. From the Energy Home screen, touch Energy Settings.
2. Touch Location Based Charging.

3. Touch Set Home Location .
4. Touch OK.
5. Touch On to enable Location Based Charging.

To change the stored home location:

1. Touch Update Home Location  on the Location Based Charging screen.
2. Touch Update, then OK to set the new home location.
 - Touch Cancel to make no changes.
 - Touch Remove to clear the location and turn Location Based Charging off.

Charging Interrupted or Overridden Pop-Up

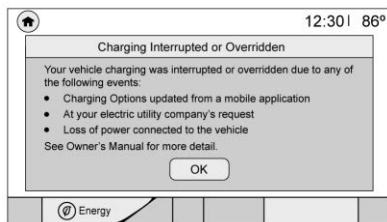

The Charging Interrupted or Overridden pop-up will appear if any of the following conditions occur:



- The charging options have been updated through the mobile app. See *KeyPass*  45.
- The charge process was interrupted by the utility company.
- There was an unintended loss of AC power during the plug-in charge event. For example, there was a power outage or the charge cord was unplugged from the wall.

See *Utility Interruption of Charging*  250.

Programmable Charging Disabled

When the Programmable Charging system is disabled, the Unable to Charge screen will display.

Energy Information

To view Energy Detail, Energy Usage Score, and Efficiency History, touch Energy on the infotainment display, and then touch Information. Touch  or  to go to the next screen.

Energy Detail

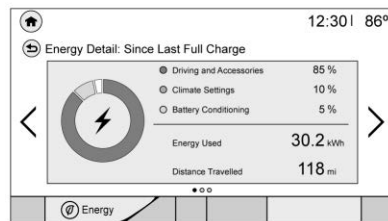

This screen displays how energy is being used since the last time the high voltage battery was fully charged. It includes Driving and Accessories, Climate Settings, and Battery Conditioning. The circle graph displays these percentages. Energy Used and Distance Traveled are also displayed on the screen.

Energy Usage Score

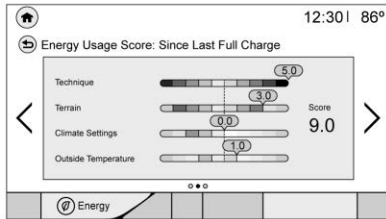

This screen provides an estimate of the factors that influence energy usage since the last full charge of the high voltage battery. A positive Score is desired to reach the vehicle's optimal energy usage rating.

- **Technique** includes accelerating and braking.

- **Terrain** includes road conditions, such as hills, rain, and snow and may be affected by wind and tire pressure.
- **Climate Settings** includes how the heat and air conditioning are used.
- **Outside Temperature** includes the effect that hot or cold air has on vehicle aerodynamics.
- **Score** is the sum of the individual scores.

The individual scores provide an understanding of how energy usage is different from day to day, even when traveling the same route.

All values are reset after a complete charge and may not be stable until approximately 16 km (10 mi) have been driven.

Efficiency History

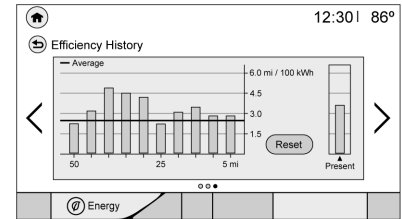

With Efficiency History, a bar graph shows the average amount of energy that has been used over the last 50 mi or 50 mi. The Present bar provides the average energy efficiency for the current 5 mi or 5 mi.

Touch Reset to clear the history data.

Energy Settings

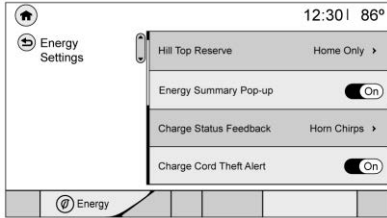

To view and change the Energy Settings, touch Energy and then touch Energy Settings. Use the arrows to scroll through the list.

The following list of menu items may be available:

- Location Based Charging:** This feature allows the charging settings to be remembered at the saved GPS coordinates for the home location. See “Location Based Charging” in *Programmable Charging* ⇨ 131.

- Hill Top Reserve :** Select Off, On, On - Home Only, or On - Away Only. See “Hill Top Reserve” in *Regenerative Braking* ⇨ 215.
- Energy Summary Pop-up :** Set the energy summary pop-up feature to On or Off.
- Charge Status Feedback :** Set the charge status feedback feature to Horn Chirps or Off.
- Charge Cord Theft Alert :** This feature allows the theft alert to sound when there is an attempt to remove the portable charge cord and the system is armed. Set the charge cord theft alert feature to On or Off.
- Charge Power Loss Alert :** This feature allows an alert to sound when the vehicle is charging and loses power at the electrical outlet. Set the charge power loss alert feature to On or Off.

- Radio Power Down :** This allows for automatic conservation of high voltage battery power based on level of battery charge.

Select Off, 2%, 4%, 6%, 8%, or 10%. When the selected high voltage battery power level is reached, a message will show on the infotainment display asking if the radio should enter Low Power Mode. Touch Yes or No.

Low Power Mode

To enter Low Power Mode manually:

- Press and hold ⏻. A message will show on the infotainment display asking if the radio should enter Low Power Mode.
- Touch Yes. The screen will turn off, and the audio will pause.
- Press ⏻ again to turn the radio on.

Driver Information Center (DIC)

The DIC is displayed in the instrument cluster. It shows the status of many vehicle systems. The controls for the DIC are on the right steering wheel control. See *Instrument Cluster* ⇨ 118.

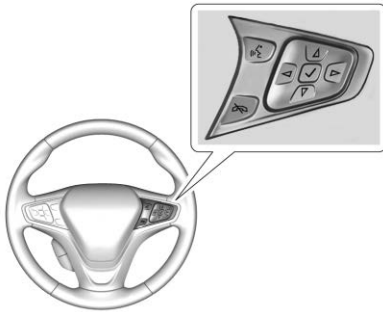

△ or ▽ : Press to move up or down in a list.

◀ or ▶ : Press to move between the interactive display zones in the cluster.

✓ : Press to open a menu or select a menu item. Press and hold to reset values on certain screens.

DIC Info Page Options

The info pages on the DIC can be turned on or off through the Options menu.

1. Press ◀ to access the cluster applications.
2. Press △ or ▽ to scroll to the Options application.
3. Press ✓ to enter the Options menu.
4. Scroll to Info Pages and press ▶.
5. Press △ or ▽ to move through the list of possible information displays.
6. Press ✓ while an item is highlighted to select or deselect that item. When an item is selected, a checkmark will appear next to it.

DIC Info Pages

The following is the list of all possible DIC info page displays. Some may not be available for your particular vehicle. Some items may not be turned on by default but can be turned on through the Options app. See “DIC Info Page Options” earlier in this section.

Trip and Average Electrical

Energy Economy : The Trip display shows the current distance traveled, in either kilometers (km) or miles (mi), since the trip odometer was last reset. The trip odometer can be reset by pressing and holding ✓ while this display is active.

The Average Electrical Energy Economy display shows the approximate average kWh per 100 kilometers (kWh/100 km) or miles per kWh. This number is calculated based on the number of kWh/100 km recorded since the last time this menu item was reset. This number reflects only the approximate average electrical

energy economy that the vehicle has right now, and will change as driving conditions change. The Average Electrical Energy Economy can be reset along with the trip odometer by pressing and holding ✓ while this display is active.

Tire Pressure : Shows the approximate pressures of all four tires. Tire pressure is displayed in either kilopascal (kPa) or in pounds per square inch (psi). If the pressure is low, the value for that tire is shown in amber.

Average Speed : Shows the average speed of the vehicle in kilometers per hour (km/h) or miles per hour (mph). This average is calculated based on the various vehicle speeds recorded since the last reset of this value. The average speed can be reset by pressing and holding ✓ while this display is active.

Timer : This display can be used as a timer. To start the timer, press ✓ while this display is active. The display will show the amount of time that has passed since the timer was last reset. To stop the timer, press ✓ briefly while this display is active and the timer is running. To reset the timer to zero, press and hold ✓ while this display is active.

Follow Distance Indicator : The current follow time to the vehicle ahead is displayed as a time value on this page.

Blank Page : The Blank Page display allows for no information to be displayed in the cluster info display areas.

Vehicle Messages

Messages displayed on the DIC indicate the status of the vehicle or some action that may be needed to correct a condition. Multiple messages may appear one after another.

The messages that do not require immediate action can be acknowledged and cleared by pressing ✓. The messages that require immediate action cannot be cleared until that action is performed.

All messages should be taken seriously; clearing the message does not correct the problem.

If a SERVICE message appears, see your dealer.

Follow the instructions given in the messages. The system displays messages regarding the following topics:

- Service Messages
- Fluid Levels
- Vehicle Security

- Brakes
- Ride Control Systems
- Driver Assistance Systems
- Cruise Control
- Lighting and Bulb Replacement
- Wiper/Washer Systems
- Doors and Windows
- Seat Belts
- Airbag Systems
- Engine and Transmission
- Tire Pressure
- Battery

Propulsion Power Messages

PROPULSION POWER IS REDUCED

This message displays when the vehicle's propulsion power is reduced. Reduced propulsion power can affect the vehicle's ability to accelerate. If this message is on, but there is no observed reduction in performance, proceed to your

destination. The performance may be reduced the next time the vehicle is driven. The vehicle may be driven while this message is on, but maximum acceleration and speed may be reduced. Anytime this message stays on, or displays repeatedly, the vehicle should be taken to your dealer for service as soon as possible.

Vehicle Speed Messages

SPEED LIMITED TO XXX KM/H (MPH)

This message shows that the vehicle speed has been limited to the speed displayed. The limited speed is a protection for various propulsion and vehicle systems, such as lubrication, thermal, suspension, Teen Driver if equipped, or tires.



Vehicle Personalization

Use the audio system controls to access the personalization menus for customizing vehicle features.

The following are all possible personalization features. Depending on the vehicle, some may not be available.

 : Press to access the Home Page.

 : Touch to access the Icon view.

 : Drag the scroll bar to navigate the list.

 : Touch to exit or return to the previous screen or menu.

To access the menu:

1. Touch .
2. Touch Settings.
3. Touch the menu item to select it.

Each of the menus is detailed in the following information.

Personalization Menu

The following list of menu items may be available:

- Time and Date
- Rear Seat Reminder
- Language (Language)
- Teen Driver
- Radio Settings
- Vehicle
- Devices
- Device Remote Access
- Bluetooth Phone
- Apple CarPlay
- Android Auto
- KeyPass
- USB Auto Launch
- Wi-Fi
- Display Settings
- Rear Camera
- Return to Factory Settings
- Audible Touch Feedback

- Text Scroll
- Software Information

Each menu is detailed in the following information.

Time and Date

Manually set the time and date. See *Clock* ⇨ 114.

Rear Seat Reminder

This message displays under certain conditions indicating there may be an item or passenger in the rear seat. Check before exiting the vehicle.

This feature allows for a chime and a message when the rear door has been opened before or during operation of the vehicle.

Select Off or On.

Language (Language)

Select Language, then select from the available language(s).

Teen Driver

See *Teen Driver* ⇨ 181.

Radio Settings

To manage the radio features, see "Radio Settings" under *Settings* ⇨ 180.

Vehicle

Select and the following may display:

- Climate and Air Quality
- Comfort and Convenience
- Collision / Detection Systems
- Lighting
- Power Door Locks
- Remote Lock / Unlock / Start

Climate and Air Quality

Select and the following may display:

- Auto Fan Speed
- Auto Heated Seats
- Auto Defog

Auto Fan Speed

This feature will set the maximum auto fan speed.

Select Low, Medium, or High.

Auto Heated Seats

When set to On and it is cold outside, both the heated seats and the heated steering wheel will automatically turn on when the vehicle is started. See *Automatic Climate Control System* ⇨ 186.

Select Off or On.

Auto Defog

When set to On, the front defog will automatically come on when the vehicle is started. See *Automatic Climate Control System* ⇨ 186.

Select Off or On.

Comfort and Convenience

Select and the following may display:

- Chime Volume
- Auto Wipe in Reverse Gear

Chime Volume

This allows the selection of the chime volume level.

Select + or – to adjust the volume.

Auto Wipe in Reverse Gear

This allows the feature to be turned on or off. See *Rear Window Wiper/Washer* ⇨ 112.

Select Off or On.

Collision / Detection Systems

Select and the following may display:

- Forward Collision System
- Front Pedestrian Detection
- Park Assist
- Rear Cross Traffic Alert
- Lane Change Alert

Forward Collision System

This feature will turn on or off the Forward Collision Alert (FCA) and Forward Automatic Braking (FAB). The Off setting disables all FCA and FAB functions. With the Alert and Brake setting, both FCA and FAB are available. The Alert setting disables FAB. See *Forward Automatic Braking (FAB)* ⇨ 227.

Select Off, Alert, or Alert and Brake.

Front Pedestrian Detection

This allows the feature's notification to be customized.

Select Off, Alert, or Alert and Brake.

Park Assist

This allows the feature to be turned on or off.

Select Off or On.

Rear Cross Traffic Alert

This allows the Rear Cross Traffic Alert feature to be turned on or off.

Select Off or On. See *Assistance Systems for Parking or Backing* ⇨ 222.

Lane Change Alert

This allows the Lane Change Alert feature to be turned on or off.

Select Off or On. See *Lane Change Alert (LCA)* ⇨ 231.

Lighting

Select and the following may display:

- Vehicle Locator Lights

- Exit Lighting

Vehicle Locator Lights

This feature will flash the exterior lamps and allows some of the exterior lamps and most of the interior lamps to turn on briefly when  on the Remote Keyless Entry (RKE) transmitter is pressed to locate the vehicle.

Select Off or On.

Exit Lighting

This allows the selection of how long the exterior lamps stay on when leaving the vehicle when it is dark outside.

Select Off, 30 Seconds, 60 Seconds, or 120 Seconds.

Power Door Locks

Select and the following may display:

- Unlocked Door Anti Lock Out
- Auto Door Unlock
- Delayed Door Lock

Unlocked Door Anti Lock Out

When on, this feature will keep the driver door from locking when the door is open. If Off is selected, the Delayed Door Lock menu will be available.

Select Off or On.

Auto Door Unlock

This allows selection of which of the doors will automatically unlock when the vehicle is shifted into P (Park).

Select Off, All Doors, or Driver Door.

Delayed Door Lock

When on, this feature will delay the locking of the doors. To override the delay, press the power door lock switch on the door.

Select Off or On.

Remote Lock / Unlock / Start

Select and the following may display:

- Remote Unlock Light Feedback
- Remote Lock Feedback
- Remote Door Unlock

- Remote Start Auto Heat Seats
- Passive Door Unlock
- Passive Door Lock
- Remote Left in Vehicle Alert

Remote Unlock Light Feedback

When on, the exterior lamps will flash when unlocking the vehicle with the RKE transmitter.

Select Off or Flash Lights.

Remote Lock Feedback

This allows selection of what type of feedback is given when locking the vehicle with the RKE transmitter.

Select Off, Lights and Horn, Lights Only, or Horn Only.

Remote Door Unlock

This allows selection of which doors will unlock when pressing  on the RKE transmitter.

Select All Doors or Driver Door.

Remote Start Auto Heat Seats

If equipped and turned on, this feature will turn the heated seats on when using remote start on cold days.

Select Off or On.

Passive Door Unlock

This allows the selection of what doors will unlock when using the button on the outside driver door handle to unlock the vehicle.

Select All Doors or Driver Door Only.

Passive Door Lock

This allows passive locking to be turned on or off and selects feedback.

Select Off, On with Horn Chirp, or On.

Remote Left in Vehicle Alert

This feature sounds an alert when the RKE transmitter is left in the vehicle. This menu also enables Remote No Longer in Vehicle Alert.

Select Off or On.

Devices

This shows status of the connected device.

Touch Add Device if a device needs to be added.

Device Remote Access

This will allow devices to control system functionality and access data.

Select Off or On.

Bluetooth Phone

This allows the connected Bluetooth phone to be configured. See “Bluetooth Phone” in *Settings* ⇨ 180.

- My Number
- Privacy
- Sort Contacts
- Resync Device Contacts

My Number

This displays the phone number of the connected Bluetooth device.

Privacy

This allows call alerts to appear on the infotainment display.

Select Off or On.

Sort Contacts

Touch to sort by first or last name.

Resync Device Contacts

This resyncs the contacts on the phone.

Apple CarPlay

This feature allows Apple devices to be connected to the infotainment system through a USB port.

Select Off or On.

Android Auto

This feature allows Android devices to be connected to the infotainment system through a USB port.

Select Off or On.

KeyPass

Select and the following may display:

- KeyPass

- Manage KeyPass Devices

KeyPass

This feature allows smartphones to be connected to the vehicle. See *KeyPass* ⇨ 45.

Select to turn Off or On.

Manage KeyPass Devices

Select to manage smartphones. Smartphones must be on for this feature to be accessed.

USB Auto Launch

This allows Android and Apple CarPlay devices to automatically connect when plugged into the USB port.

Select Off or On.

Wi-Fi

Select and the following may display:

- Wi-Fi
- Manage Wi-Fi Networks

Wi-Fi

This feature allows for a connection to available protected Wi-Fi networks in range of the vehicle to be turned off or on.

Select Off or On.

Manage Wi-Fi Networks

Select to manage a list of available protected networks. Wi-Fi must be set to On for this feature to be accessed.

Display Settings

Select and the following choices will display:

- Blue Sky
- Sunset Orange
- Black Eclipse

Choose one of these options to change the display settings.

Rear Camera

Select and the following may display:

- Symbols

- Guidelines

Symbols

Select to turn Off or On.

Guidelines

Select to turn Off or On.

Return to Factory Settings

Select and the following may display:

- Reset Vehicle Settings
- Clear All Private Data
- Restore Radio Settings

Reset Vehicle Settings

This allows vehicle settings to be reset.

Select Continue or Cancel.

Clear All Private Data

This allows all private information from the vehicle to be cleared.

Select Continue or Cancel.

Restore Radio Settings

This allows radio settings preferences to be restored to the default.

Select Continue or Cancel.

Audible Touch Feedback

Select to turn Off or On.

Text Scroll

Select to turn Off or On.

Software Information

Select and the following may display:

- Open Source
- Software Update
- Update Preference

Open Source

Select to view the infotainment system current software information.

Software Update

This allows the ability to search for available vehicle software updates when Internet connectivity is available through the vehicle's built

in OnStar connection, if equipped, or a secure Wi-Fi hotspot, such as a mobile hotspot, home or public network. Applicable data rates may apply.

Update Preference

Select to download new vehicle software updates in the background. Select Off or On. Software downloads require Internet connectivity through the vehicle's built-in OnStar connection, if equipped, or a secure Wi-Fi hotspot, such as a mobile hotspot, home or public network. Applicable data rates may apply.

Lighting

Exterior Lighting

Exterior Lamp Controls	150
Exterior Lamps Off	
Reminder	152
Headlamp High/Low-Beam	
Changer	152
Flash-to-Pass	152
Daytime Running	
Lamps (DRL)	152
Automatic Headlamp	
System	153
Hazard Warning Flashers	153
Turn and Lane-Change	
Signals	154

Interior Lighting

Instrument Panel Illumination	
Control	154
Courtesy Lamps	155
Dome Lamps	155
Reading Lamps	155

Lighting Features

Entry Lighting	156
Exit Lighting	156
Battery Power Protection	156
Exterior Lighting Battery	
Saver	156

Exterior Lighting

Exterior Lamp Controls

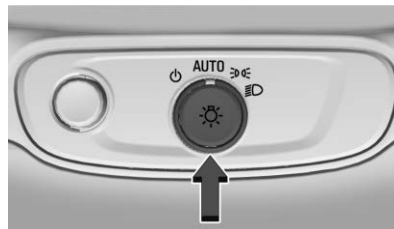

The exterior lamp control is on the instrument panel to the left of the steering column.

 : Turns the exterior lamps on and off.

AUTO : Turns the exterior lamps on and off automatically depending on outside lighting.

 : Turns on the parking lamps including all lamps, except the headlamps. The instrument panel lights also turn on.

 : Turns on the headlamps together with the parking lamps and instrument panel lights.

IntelliBeam® System

If equipped, this system turns the vehicle's high-beam headlamps on and off according to surrounding traffic conditions.



The system turns the high-beam headlamps on when it is dark enough and there is no other traffic present.

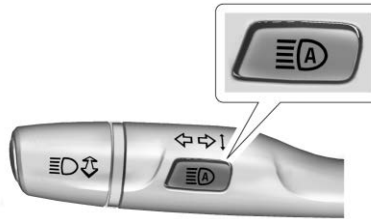

This light comes on in the instrument cluster when the IntelliBeam system is enabled.

Turning On and Enabling IntelliBeam



To enable the IntelliBeam system, press  on the turn signal lever when the exterior lamp control is in the AUTO or  position.

The blue high-beam on light appears on the instrument cluster when the high beams are on.



Driving with IntelliBeam

The system only activates the high beams when driving over 40 km/h (25 mph).

There is a sensor near the top center of the windshield that automatically controls the system.

Keep this area of the windshield clear of debris to allow for best system performance.

The high-beam headlamps remain on, under the automatic control, until one of the following situations occurs:

- The system detects an approaching vehicle's headlamps.
- The system detects a preceding vehicle's taillamps.
- The outside light is bright enough that high-beam headlamps are not required.
- The vehicle's speed drops below 20 km/h (12 mph).
- The IntelliBeam system is disabled by the button on the turn signal lever. If this happens, press  on the turn signal lever when the exterior lamp control is in the AUTO or  position.

The instrument cluster light will come on to indicate the IntelliBeam system is reactivated.

The high beams may not turn off automatically if the system cannot detect another vehicle's lamps because of any of the following:

- The other vehicle's lamps are missing, damaged, obstructed from view, or otherwise undetected.
- The other vehicle's lamps are covered with dirt, snow, and/or road spray.
- The other vehicle's lamps cannot be detected due to dense exhaust, smoke, fog, snow, road spray, mist, or other airborne obstructions.
- The vehicle's windshield is dirty, cracked, or obstructed by something that blocks the view of the light sensor.

- The vehicle is loaded such that the front end points upward, causing the light sensor to aim high and not detect headlamps and taillamps.
- Driving on winding or hilly roads.

The IntelliBeam system may need to be disabled if any of the above conditions exist.

Exterior Lamps Off Reminder

A warning chime sounds if the driver door is opened while the vehicle is off and the exterior lamps are on.

Headlamp High/Low-Beam Changer

Push the turn signal lever away from you and release, to turn the high beams on. To return to low beams, push the lever again or pull it toward you and release.



This indicator light turns on in the instrument cluster when the high-beam headlamps are on.

Flash-to-Pass

To flash the high beams, pull the turn signal lever toward you, and release.

Daytime Running Lamps (DRL)

DRL can make it easier for others to see the front of your vehicle during the day. Fully functional DRL are required on all vehicles first sold in Canada.

The DRL system comes on in daylight when the following conditions are met:

- The power button is on.

- The exterior lamp control is in AUTO.
- The light sensor determines it is daytime.
- The vehicle is not in P (Park).

When the DRL are on, the taillamps, sidemarker lamps, instrument panel lights, and other lamps will not be on.

The DRL turn off when the headlamps are turned to  or the vehicle is off.

For vehicles first sold in Canada, the DRL can only be turned off when the vehicle is parked.

Automatic Headlamp System

The headlamps come on automatically when the exterior lamp control is set to AUTO and it is dark enough outside.

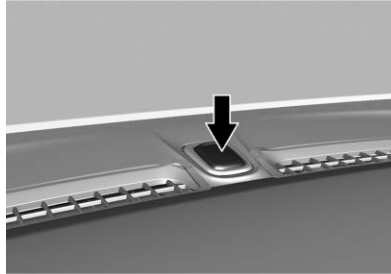

There is a light sensor on top of the instrument panel. Do not cover the sensor, otherwise the headlamps will come on when they are not needed.



The system may also turn on the headlamps when driving through a parking garage or tunnel.

When it is bright enough outside, the headlamps will turn off or may change to Daytime Running Lamps (DRL).

The automatic headlamp system turns off when the exterior lamp control is turned to  or the vehicle is off.

Lights On with Wipers

If the windshield wipers are activated in daylight with the vehicle on, and the exterior lamp control is in AUTO, the headlamps, parking lamps, and other exterior lamps come on. The transition time for the lamps coming on varies based on wiper speed. When the wipers are not operating, these lamps turn off.

Move the exterior lamp control to  or  to disable this feature.

Hazard Warning Flashers

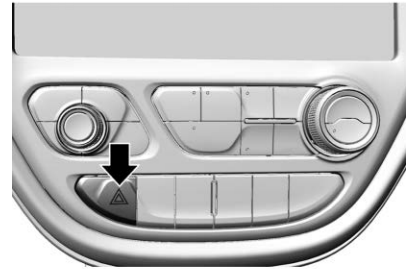

154 Lighting

The hazard warning flasher button is on the center stack.

△ : Press to make the front and rear turn signal lamps flash on and off. This warns others that you are having trouble. Press the button again to turn the flashers off.

When the hazard warning flashers are on, the turn signals will not work.

Turn and Lane-Change Signals

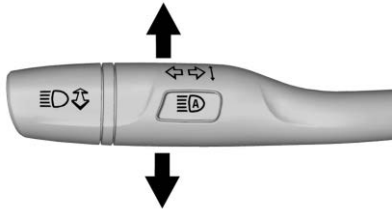

Move the lever all the way up or down to signal a turn.

An arrow on the instrument cluster flashes in the direction of the turn or lane change.

Raise or lower the lever until the arrow starts to flash to signal a lane change. Hold it there until the lane change is completed.

If the lever is briefly pressed and released, the turn signal flashes three times.

The turn and lane-change signal can be turned off manually by moving the lever back to its original position.

If after signaling a turn or lane change, the arrow flashes rapidly or does not come on, a signal bulb may be burned out.

Replace any burned out bulbs. If a bulb is not burned out, check the fuse. See *Underhood Compartment Fuse Block* ⇨ 272.

Interior Lighting

Instrument Panel Illumination Control

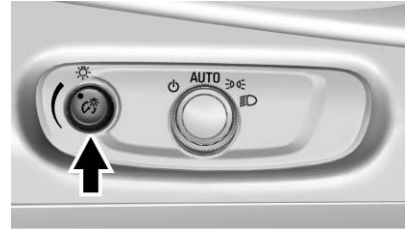

The brightness of the instrument cluster display, infotainment display and controls, steering wheel controls, and all other illuminated controls, as well as feature status indicators can be adjusted.

The knob for this feature is on the instrument panel beside the steering column.

Courtesy Lamps

The courtesy lamps come on when any door is opened and the dome lamp is in the  position.

Dome Lamps



The dome lamp controls are in the headliner above the front seats.

 **OFF** : Press to turn the lamps off, even when a door is open.

 : When the button is returned to the middle position, the lamps turn on automatically when a door is opened.

 **ON** : Press to turn on the dome lamps.

Reading Lamps

There are front and rear reading lamps.





The front reading lamps are in the overhead console.

Press the lamp lenses to turn the reading lamps on or off.



The rear reading lamps are in the headliner.

 **OFF** : Press to turn the lamp off.

 **ON** : Press to turn the lamp on.

Lighting Features

Entry Lighting

Some exterior lamps and the interior lamps turn on briefly at night when the Remote Keyless Entry (RKE) transmitter  is pressed. See *Remote Keyless Entry (RKE) System Operation* ⇨ 33. The lights turn off immediately when the vehicle is started or automatically after a brief period.

This feature can be turned on or off. See “Vehicle Locator Lights” under *Vehicle Personalization* ⇨ 143.

Exit Lighting

Some exterior lamps come on at night when the vehicle is turned off and the driver door is opened. Some interior lamps also come on when the vehicle is turned off. The exterior lamps and interior lamps remain on after the door is closed for a brief period and then turn off.

This feature can be turned on or off. See *Vehicle Personalization* ⇨ 143.

Battery Power Protection

The battery saver feature is designed to protect the vehicle's 12-volt battery.

If some interior lamps and/or the headlamps are left on and the vehicle is turned off, the battery rundown protection system automatically turns the lamp off after some time.

Exterior Lighting Battery Saver

The exterior lamps turn off about 10 minutes after the ignition is turned off, if the parking lamps or headlamps have been manually left on. This protects against draining the battery. To restart the 10-minute timer, turn the exterior lamp control to the off position and then back to the parking lamp or headlamp position.

To keep the lamps on for more than 10 minutes, the ignition must be on or in ACC/ACCESSORY.

Infotainment System

Introduction

Introduction	157
Theft-Deterrent Feature	158
Overview	158
Operation	159
Software Updates	161

Radio

AM-FM Radio	162
Satellite Radio	164
Multi-Band Antenna	165

Audio Players

USB Port	166
Auxiliary Devices	172
Bluetooth Audio	172

OnStar System

OnStar System	175
---------------------	-----

Phone

Bluetooth	175
Apple CarPlay and Android Auto	177
Hands-Free Phone	178

Settings

Settings	180
Teen Driver	181

Trademarks and License

Agreements

Trademarks and License Agreements	184
--	-----

Introduction

Read the following pages to become familiar with the features.

Warning

Taking your eyes off the road for too long or too often while using any infotainment feature can cause a crash. You or others could be injured or killed. Do not give extended attention to infotainment tasks while driving. Limit your glances at the vehicle displays and focus your attention on driving. Use voice commands whenever possible.

The infotainment system has built-in features intended to help avoid distraction by disabling some functions when driving. These functions may gray out when they are unavailable. Many infotainment features are also available through the instrument cluster and steering wheel controls.

Before driving:

- Become familiar with the operation of the center stack controls and the infotainment system.
- Set up the audio by presetting favorite stations, setting the tone, and adjusting the speakers.
- Set up phone numbers in advance so they can be called easily by pressing a single control or by using a single voice command if equipped with Bluetooth phone capability.

See *Defensive Driving* ⇨ 194.

To play the infotainment system with the vehicle off, see *Retained Accessory Power (RAP)* ⇨ 206.

Theft-Deterrent Feature

The infotainment system has an electronic security system installed to prevent theft.

The infotainment system only works in the vehicle in which it was first installed, and cannot be used in another vehicle.

Overview

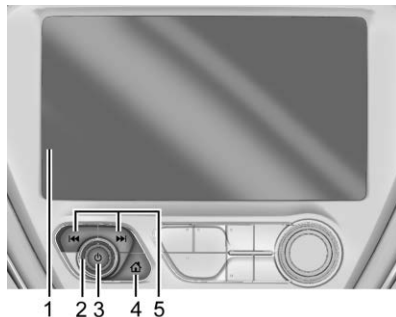

1. Infotainment Display:

- Display for Play/Reception/Menu information.

2. Volume Knob:

- Turn the volume knob to adjust the volume.

3.  :

- Press and hold to enter the Clean Screen Mode. The radio will be in a low power mode with the infotainment display turned off.
- Press to cancel the Clean Screen Mode or to mute/unmute the audio when the system is on.

4.  :

- Press to go to the Home Page.
- Press and hold to launch Apple CarPlay or Android Auto, if equipped.

5.  :

- Radio: Press to seek the previous or next strongest station or channel.
- USB/Music/Pictures: Press to go to the previous or next content. Press and hold to fast rewind or fast forward.

Operation

Turning On/Off Automatically

When the vehicle is on, the infotainment system turns on automatically.

When the vehicle is off and the driver door of the vehicle is opened, the infotainment system turns off automatically.

If  is pressed and held when the vehicle is off, the infotainment system will turn on. The system will turn off automatically after approximately 10 minutes.

Full Screen Clock

- Touch the time display on the screen to display a full screen of the clock.
- Touch  to return to the previous screen.

Volume Control

Turn the volume knob to adjust the volume. The current volume is indicated.

- If equipped, use the volume switches on the back of the steering wheel to adjust the volume. See *Steering Wheel Controls* ⇨ 109.
- Turning on the infotainment system power will set the volume level to its previous selection if it is lower than the maximum starting volume level.
- If the volume level is louder than the maximum starting volume level when the infotainment system is turned on, the infotainment system is adjusted automatically to the maximum starting volume level.

Edit Home Page Layout

1. When the vehicle is stationary, touch  Edit on the Home Page.

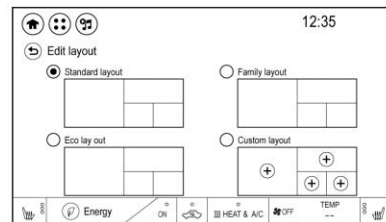

2. Select the desired layout: Standard, Family, Eco, or Custom.

If Custom is selected, the display will switch to custom layout editing. This allows the changing of location and content of information displayed on the Home Page.

Using Icon View

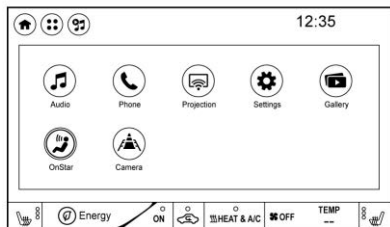

Touch .

Icon view may vary depending on vehicle options.

Audio : Touch to select AM, FM, SXM (if equipped), AUX, or USB/iPod/Bluetooth Audio.

Phone : Touch to activate the phone features. See *Bluetooth* ⇨ 175.

Projection : Touch to access supported devices when connected. See *USB Port* ⇨ 166.

Settings : Touch to access the Personalization menu. See *Vehicle Personalization* ⇨ 143.

Gallery : Touch to view a picture. See “Gallery” under “Selecting a Function” following.

OnStar : Touch to use the OnStar function. See *OnStar Overview* ⇨ 346.

Camera : Touch to access the Rear Vision Camera. See *Assistance Systems for Parking or Backing* ⇨ 222.

Selecting a Function

Audio

1. Touch .
2. Touch Audio, then Source.
 - Touch AM to select AM radio.
 - Touch FM to select FM radio.
 - Touch SXM to select SiriusXM radio (if equipped).

- Touch iPod to select iPod music.
- Touch USB1 to select USB1 music.
- Touch USB2 to select USB2 music.
- Touch Bluetooth to select Bluetooth music.
- Touch AUX to select auxiliary sound input.

If the playback source (iPod/USB/AUX/Bluetooth) is not connected to the infotainment system, this function is not available.



Audio source availability may vary depending on the region.

The infotainment system can only support two USB devices for the front USB ports.

Phone

To operate Bluetooth Hands-Free function, connect the Bluetooth phone to the infotainment system.



1. Touch .

2. Touch Phone, then touch  on the infotainment display, or press  on the steering wheel controls.

Settings

1. Touch .
2. Touch Settings, then select an item from the menu and adjust the settings by selecting from the available options. See *Settings* ⇨ 180.

Gallery

1. Touch .
2. Touch Gallery, then touch  menu to view picture files contained in the USB storage device.

Software Updates

Over-the-Air Software Updates

If equipped, the infotainment system can download and install select software updates over a wireless connection. The system will prompt

for certain updates to be downloaded and installed. There is also an option to check for updates manually.

To manually check for updates, touch Settings on the Home Page, followed by Software Information, and then System Update. Follow the on-screen prompts. Steps for downloading and installing updates may vary by vehicle.

Downloading Over-the-Air vehicle software updates requires Internet connectivity, which can be accessed through the vehicle's built-in OnStar 4G LTE connection, if equipped and active. If required, data plans are provided by a third party. Optionally, a secure Wi-Fi hotspot such as a compatible mobile device hotspot, home hotspot, or public hotspot can be used. Applicable data rates may apply.

To connect the infotainment system to a secured mobile device hotspot, home hotspot, or public hotspot, touch Settings on the Home Page, followed by Wi-Fi, and then Manage Wi-Fi Networks. Select the

appropriate Wi-Fi network, and follow the on-screen prompts. Download speeds may vary.

On most compatible mobile devices, activation of the Wi-Fi hotspot is in the Settings menu under Mobile Network Sharing, Personal Hotspot, Mobile Hotspot, or similar.

Availability of Over-the-Air vehicle software updates varies by vehicle and country. For more information on this feature, see www.my.chevrolet.com/learn.

Radio



AM-FM Radio

Listening to AM-FM Radio

1. Touch .
2. Touch Audio, then Source.
3. Touch FM or AM. The most recently listened to AM or FM radio station is displayed.

RDS (Radio Data System) function is only available in countries that support this function.

Searching for Stations Automatically

Press  or  to automatically search for an available station with good reception.

If RDS is supported, it will tune to the station and may include additional information such as time, station identification, and program information.

Searching for Stations Directly



1. Touch Tune.

2. Using the keypad, enter the desired station number.

Touching the period between digits is not necessary. The radio will add it automatically at the correct location.

Favorite Preset Operation

Saving Favorites

1. Select the band.
2. Select the desired station.
3. Touch  or touch and hold the favorite in the Favorites list to overwrite.
4. To delete it from the Favorites list, touch , or swipe the station from the list on the right.

Up to 15 radio stations can be saved in the Favorites list.

Listening to Favorites Directly

1. Touch Favorites to see the list of favorites.
2. Touch the desired station.

The steering wheel controls can also be used to select favorites. See *Steering Wheel Controls* ⇨ 109.

Using the AM or FM Radio Menu

General Operation of the Menu

1. Select the desired band.
2. Touch Menu.
3. Touch the desired menu to select the item or to display the item's detailed menu.
4. Touch  Now Playing to return to the previous menu.

Current Station Information

1. From the FM Menu, touch Browse Audio.
2. Touch Current Station Information to display the station information.

AM or FM Stations

1. From the AM or FM Menu, touch Browse Audio.

2. Touch AM Stations or FM Stations. The AM List or FM List is displayed.

FM Categories

1. From the FM Menu, touch Browse Audio.
2. Touch FM Categories.
3. Touch the desired category and station.

The FM category list is only available for RDS (Radio Data System).

Update AM or FM Stations

1. From the FM or AM Menu, touch Browse Audio.
2. Touch Update AM Stations or Update FM Stations.

Tone Settings

1. From the AM or FM Menu, touch Audio Settings.

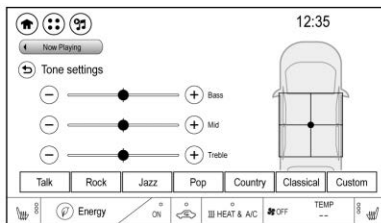

2. Touch Tone Settings to enter the sound setup mode. The Tone settings menu is displayed.

- Bass : Touch - or + to adjust the bass level manually.
- Mid (Midrange) : Touch - or + to adjust the midrange level manually.
- Treble : Touch - or + to adjust the treble level manually.

- Fade : Adjust the front/rear speaker balance by dragging the dot in the vehicle interior image.
 - Balance : Adjust the left/right speaker balance by dragging the dot in the vehicle interior image.
 - EQ (Equalizer) : Select or turn off the sound style: Talk, Rock, Jazz, Pop, Country, Classical, or Custom. If equipped with Bose premium audio, only Talk and Custom are available.
3. Touch  to return to the previous menu.

Auto Volume

When Auto Volume is turned on, the volume will automatically be controlled according to the vehicle speed to offset the noise from outside.

1. From the AM or FM Menu, touch Audio Settings.
2. Touch Auto Volume.

3. Select the desired option: Off, Low, Medium-Low, Medium, Medium-High, or High.

RDS

The RDS function can be set for FM.

1. From the FM Menu, touch Audio Settings.
2. Set RDS to On or Off.

Satellite Radio

Vehicles equipped with a SiriusXM® satellite radio tuner and a valid SiriusXM satellite radio subscription can receive SiriusXM programming.

SiriusXM Satellite Radio Service

SiriusXM is a satellite radio service based in the 48 contiguous United States and 10 Canadian provinces. SiriusXM satellite radio has a wide variety of programming and commercial-free music, coast to coast, and in digital-quality sound. A fee is required to receive the SiriusXM service.

Refer to:

- www.siriusxm.com or call 1-888-601-6296 (U.S.).
- www.siriusxm.ca or call 1-877-438-9677 (Canada).

Listening to SXM Radio

1. Touch .
2. Touch Audio, then Source.
3. Touch SXM. The most recently listened to SXM channel is displayed.

Searching for Channels Automatically



Press  or  to automatically search for available channels.

Searching for Channels Directly

1. Touch Tune.
2. Using the keypad, enter the desired channel.

Searching for Channels Using Favorites

Saving Favorites

1. Select the desired channel.
2. Touch  or touch and hold the favorite in the list to overwrite.
3. To delete a channel from Favorites, touch , or swipe the channel from the list on the right.

Up to 15 channels can be saved in the Favorites list.

Listening to Favorites Directly

1. Touch Favorites to see the list of favorites.
2. Touch the desired channel.

Using the SXM Radio Menu

General Operation of the Menu

1. Touch Menu on the SXM radio screen.
2. Touch Browse Audio or Audio Settings to select and display the item's detailed menu.

3. Touch ◀ Now Playing to return to the previous screen.

Browse Audio

- Current Channel Information
Touch Current Channel Information. The channel information is displayed.
- SXM Channels
Touch SXM Channels. The SXM List is displayed.
- SXM Categories
SXM categories are defined by the SiriusXM service provider.
Touch SXM Categories, then touch the desired category and channel.

Audio Settings

- Tone Settings
Set up sound features from the Tone Settings menu. See “Tone Settings” under “AM-FM Radio” previously in this section.

- Auto Volume
Volume will be automatically controlled. See “Auto Volume” under “AM-FM Radio” previously in this section.
- Explicit Content Filter
Choose this menu item to turn On or Off the filtering of explicit channels from SXM. When selected, this item will give a brief description of the feature and a list item can be set to On or Off. From the SXM Menu, touch Audio Settings. Set Explicit Content Filter feature to On or Off to allow for a filtered list of channels.

Multi-Band Antenna

If equipped, the roof antenna is for GPS (Global Positioning System). Keep clear of obstructions for clear reception.

Mobile Phone Usage

Mobile phone usage can cause interference with the vehicle’s radio. Unplug the mobile phone or turn it off if this occurs.

AM

The range for most AM stations is greater than for FM, especially at night. The longer range can cause station frequencies to interfere with each other. Static can occur when things like storms and power lines interfere with radio reception. When this happens, try reducing the treble on the radio.

Audio Players

USB Port

The USB ports are in the center console and are for data and charging. If equipped, there are two USB charge ports in the rear of the center console. The infotainment system can play the music files contained in the USB storage device or a device that supports MTP or iPod/iPhone devices.

Before Using the Audio System

Supported Audio File Formats

- MP3 (MPEG-1 Layer 3, MPEG-2 Layer 3)
 - Constant Bit Rate (CBR) between 8 and 320 kbps
 - Variable Bit Rate (VBR)
 - Sampling frequencies of 8, 11.025, 12, 16, 22.05, 24, 32, 44.1, and 48 kHz
- Windows Media Audio
 - Windows Media Audio 10

CBR between 32 and 768 kbps
VBR (Standard), Professional, Lossless, or higher according to Microsoft specifications

Sampling frequencies of 8, 12, 16, 22, 32, 44.1, and 48 kHz

- AAC (MPEG-4 AAC, Low Complexity Profile) and AAC+ CBR between 8 and 320 kbps
- OGG Vorbis
- Waveform (WAV – PCM Windows format)
- Audio Interchange File Format (AIFF)
- 3GPP (Generally used for mobile devices)
- Audio Books (MP3, WMA, AAC, AA)

Guidelines for Using a USB Storage Device and iPod/iPhone

- Operation cannot be guaranteed if the HDD built-in USB mass storage device or CF or SD memory card is connected by

using a USB adaptor. Use a USB or flash memory type storage device.

- Avoid static electricity discharge when connecting or disconnecting the USB. If connection and disconnection are repeated many times in a short time, this may cause a problem in using the device.
- Operation is not guaranteed if the connecting terminal of the USB device is not metal.
- Connection with i-Stick Type USB storage devices may be faulty due to vehicle vibration.
- Do not touch the USB connecting terminal with an object or any part of your body.
- The USB storage device can only be recognized when it is formatted in FAT16/32, NTFS, HFS+. exFAT and other file systems cannot be recognized.

- According to the type and capacity of the USB storage device and the type of the stored file, the time it takes to recognize the files may differ.
- Files in some USB storage devices may not be recognized due to compatibility problems.
- Do not disconnect the USB storage device while it is being played. This may cause damage to the device or may affect the performance of the USB device.
- The infotainment system can only support two USB devices for the front USB ports.
- Disconnect the connected USB storage device when the vehicle is off.
- USB storage devices can only be connected to this device for the purpose of playing music, viewing photo files, or upgrading.
- The USB terminal of the device should not be used to charge USB accessory equipment since

the heat generation using the USB terminal may cause performance issues or damage to the device.

- When the logical drive is separated from a mass USB storage device, only the files from the top-level logical drive can be played for USB music files. For this reason, store music files to be played in the top-level drive of the device. Music files in a particular USB storage device may not play normally if an application is loaded by partitioning a separate drive inside the USB device.
- Music files to which DRM (Digital Right Management) is applied cannot be played.
- The infotainment system can support USB storage devices that are in capacity with a limit of 5,000 files (music and photo), and 15 stages of folder structure. Normal usage cannot be guaranteed for storage devices that exceed this limit.

The iPod/iPhone can play all music files supported. The music file lists display up to 5,000 files on the screen in alphabetical order.

- Some iPod/iPhone devices may not support the connectivity or functionality of the infotainment system.
- Only connect the iPod/iPhone with connection cables supported by iPod/iPhone devices. Other connection cables cannot be used.
- When the iPod/iPhone device is not being used, keep it disconnected from the USB port when the vehicle is off.
- Connect the iPod/iPhone to the USB port by using the iPod/iPhone cable to play the music files on the iPod/iPhone. When the iPod/iPhone is connected to the AUX port, the music files are played, but not controlled by MyLink.
- iPod/iPhone movie file playback is not supported.

168 Infotainment System

- The playback functions and the information display items of the iPod/iPhone used with this infotainment system may be different from the iPod/iPhone in terms of play order, method, and information displayed.
- See the manufacturer for information related to the search function provided by the iPod/iPhone device.

USB Player

Playing USB Storage Device Music Files

Connect the USB storage device containing the music files to the USB port.

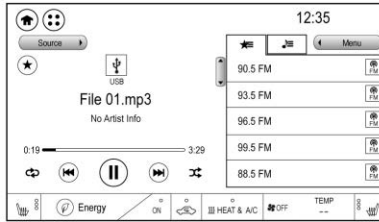

- Once the infotainment system finishes reading the information on the USB storage device, play will begin automatically unless USB Auto Launch has been set to Off in Settings.
- If a non-readable USB storage device is connected, an error message will appear and the infotainment system will automatically switch to the previous audio function.

If the USB storage device is already connected, touch , Audio, Source, and USB to play the USB music files.

Ending USB Music File Playback

1. Touch Source.
2. Select another function by touching AM, FM, AUX, or Bluetooth.

To remove the USB storage device, select another function, and then remove the USB storage device.

Pause Touch during playback.

Touch  to resume playback.

Playing the Next File

Touch  to play the next file.

Playing the Previous File

Touch  within five seconds of playback time to play the previous file.

Returning to the Beginning of the Current File

Touch  after five seconds of playback time.

Scanning Forward or Backward

Touch and hold ◀◀ or ▶▶ during playback to rewind or fast forward. Release ◀◀ or ▶▶ to resume playback at normal speed.

Playing Files Randomly

Touch ⌘ during playback.
Touch ⌘ again to return to normal playback.

Playing Files Repeatedly

1. Touch ↺ during playback.
2. Touch the desired option.
 - Repeat All: Plays all files repeatedly.
 - Repeat Song: Plays a current file repeatedly.
 - Repeat Off: Cancels the repeat function.

Searching for a File by Using the Favorites

Saving Favorites

1. Select the desired file.

2. Touch ★, or touch and hold the favorite in the list to overwrite.
3. To delete it from the Favorites list, touch ★, or swipe the file from the list on the right.

Up to 15 media files can be saved in the Favorites list.

Listening to Favorites Directly

1. Touch the Favorites menu to see the Favorites list.
2. Touch the desired favorite to listen.

General Operation of the USB Music Menu

1. Touch Menu on the USB music screen.
2. Touch the desired menu to select the item or to display the item's detailed menu.
3. Touch ◀ Now Playing to return to the previous screen.

Browse Music

1. From the USB music menu, touch Browse Music.

2. Touch the desired item: Playlists, Folders, Artists, Songs, Albums, Genres, and Composers.
3. Touch the desired music to listen.

The Infotainment Module will recognize playlist files by the extensions .asx, m3u, pls, wpl, b4s, and .xspf.

Tone Settings

Set up sound features from the Tone Settings menu. See "Tone Settings" under "AM-FM Radio" previously in this section.

Auto Volume

See "Auto Volume" under "AM-FM Radio" previously in this section.

MTP (Media Transfer Protocol) Player

Playing Music from a Supported MTP Device

Connect the supported MTP device containing music files to the USB port.

- Once the infotainment system finishes reading the information on the device that supports MTP (Media Transfer Protocol), it will be automatically played. If USB Auto Launch is set to Off in Settings, it will not be automatically played.
- If a non-readable device that supports MTP is connected, then an error message will appear and the infotainment system will automatically switch to the previous audio function.
- Depending on the connected device, some files may not play.
- File loading may take a few minutes depending on the type of MTP device or the number of files/folders stored in the MTP device.
- When connecting the MTP device, the infotainment system scans audio files first, and then picture files. While scanning picture files, these files may not be available until the loading

indicator on the audio screen disappears even if the audio file in the MTP device is playing.

- If connecting an MTP device that has external memory, it may be recognized as USB1/USB2.
- Other operations are the same as the USB player. See “USB Player” under “USB Port” previously in this section.
- The USB connection setting on the device may need to be changed to MTP.

iPod/iPhone Player

This is limited to devices supporting the iPod/iPhone connection.

Playing iPod/iPhone Music Files

Use an Apple certified cord to connect the iPod/iPhone containing the music files to the USB port.

- Once the infotainment system finishes reading the information on the iPod/iPhone, it will be automatically played from the previously played point. If Auto

Launch in Settings is set to Off, it will not be automatically played.

If the iPod/iPhone is already connected, touch , Audio, Source, then iPod to play the iPod/iPhone.

Ending iPod/iPhone Playback

1. Touch Source.
2. Select another function by touching AM, FM, AUX, or Bluetooth, or unplug the iPod/iPhone.

To remove the iPod/iPhone, select another function, and then remove the iPod/iPhone.

Pause

Touch  during playback.

Touch  to resume playback.

Playing the Next Song

Touch  to play the next song.



Playing the Previous Song



Touch  within two seconds of playback time to play the previous song.

Returning to the Beginning of the Current Song

Touch  after two seconds of playback time.

Scanning Forward or Backward

Hold  or  during playback to rewind or fast forward.

Release  or  to resume playback at normal speed.

Playing Files Randomly

Touch  during playback.

Touch  again to return to normal playback.

General Operation of the iPod Music Menu

1. Touch Menu on the iPod music screen.
2. Touch the desired menu to select the item or to display the item's detailed menu.
3. Touch  Now Playing to return to the previous screen.

Browse Music

1. From the iPod music menu, touch Browse Music.
2. Touch the desired music.

Tone Settings

Set up sound features from the Tone Settings menu. See "Tone Settings" under "AM-FM Radio" previously in this section.

Auto Volume

Volume will be automatically controlled. See "Auto Volume" under "AM-FM Radio" previously in this section.

Gallery (Pictures)



The infotainment system can view picture files contained in the USB storage device.

Before Using the Picture System

- Only the following file extensions are supported: *.jpg, *.bmp, *.png, *.gif.
- Animated GIF is not supported.

- Some files may not operate due to a different format or the condition of the file.

Viewing a Picture

1. Connect the USB storage device containing the picture files to the USB port.
 2. Press , then .
 3. Touch Gallery, then select the desired picture folder.
 4. Select the desired file.
- Touch the screen to hide the control bar. Touch the screen again to show the control bar.
 - Some features are disabled while the vehicle is in motion.

Viewing a Slide Show

- Touch  from the picture screen and the slide show will play.
- Touch the screen to cancel the slide show during slide show playback.

Viewing a Previous or Next Picture

From the picture screen, touch < or > to view the previous or next picture.

Rotating a Picture

From the picture screen, touch  to rotate the picture.

Enlarging a Picture

From the picture screen, touch  to enlarge the picture.

Using the USB Picture Menu

1. From the picture screen, touch Menu.
2. Touch the desired menu.
 - Slide Show Time: Select the slide show interval.
 - Clock/Temp Display: To display the clock and temperature on the full screen, select On or Off.
 - Display Settings: Adjust the brightness and contrast.

3. After the setting is complete, touch .

Auxiliary Devices

The AUX port is in the center console. The infotainment system can play auxiliary music connected by the auxiliary device.

Playing Music from an Auxiliary Device

Connect the auxiliary device containing the music source to the AUX port. Once connected with the infotainment system, music can be played from the device.

- If the auxiliary device is already connected, touch , Audio, Source, then AUX to play music from the auxiliary device.
- Use an AUX cable with a 3.5 mm (1/8 in) type connector.

Tone Settings

From the AUX screen, touch Tone. See "Tone Settings" under "AM-FM Radio" previously in this section.

Bluetooth Audio

Bluetooth Music

If equipped, music may be played from a paired Bluetooth device. Refer to the Phone section for help pairing a device.

Before Playing Bluetooth Music

- The paired bluetooth device must support Bluetooth profiles: A2DP or AVRCP.
- Bluetooth music may not be supported depending on the mobile phone or Bluetooth device.
- From the mobile phone or Bluetooth device, find the Bluetooth device type to set/connect the item.
- A  will appear on the screen to indicate a successful Audio Bluetooth connection.
- The sound played by the Bluetooth device is delivered through the infotainment system.



- Bluetooth music can be played only when a Bluetooth device has been connected. To play Bluetooth music, connect the Bluetooth phone to the infotainment system.
- If the Bluetooth device is disconnected while playing music, the music is discontinued. The audio streaming function may not be supported in some Bluetooth phones. Only one function can be used at a time between the Bluetooth hands-free phone function or the Phone music function. For example, if switching to Bluetooth hands-free phone mode while playing Phone music, the music streaming function will be discontinued.
- For Bluetooth music to play, the music must be played at least once from the music player mode of the mobile phone or Bluetooth device after connecting as a stereo headset. After being played at least once,

the music player will be automatically played upon entering play mode, and it will be automatically stopped when the music player mode ends. If the mobile phone or Bluetooth device is not in the waiting screen mode, some devices may not automatically play in Bluetooth music play mode.

Playing Bluetooth Music

1. Touch .
2. Touch Audio, then Source on the screen.
3. Touch Bluetooth to select the connected Bluetooth device music play mode.

Pause

Touch  during playback.
Touch  again to resume playback.

Playing the Next Music

Touch  to play the next music.





Playing the Previous Music

Touch  within two seconds of playback time to play the previous music.



Returning to the Beginning of the Current Music

Touch  after two seconds of playback time.

Scanning Forward or Backward

Hold  or  during playback to rewind or fast forward.
Release  or  to resume playback at normal speed.

Playing Files Randomly

Touch  during playback.
Touch  again to return to normal playback.

Playing Files Repeatedly

1. Touch  during playback.
2. Touch the desired option.
 - Repeat All: Plays all files repeatedly.
 - Repeat Song: Plays a current file repeatedly.

- Repeat Off: Cancels repeat function.

General Operation of the Bluetooth Music Menu

1. Touch Menu on the Bluetooth music screen.
2. Touch the desired menu to select the item or to display the item's detailed menu.
3. Touch ◀ Now Playing to return to the previous menu.

Browse Music

This function may not be supported depending on the mobile phone.

1. From the Bluetooth music menu, touch Browse Music.
2. Touch the desired item. The number of relevant songs is displayed.
3. Touch the desired music to listen.

Tone Settings

From the Bluetooth music menu, sound features can be set up. See "Tone Settings" under "AM-FM Radio" previously in this section.

Auto Volume

Volume will be automatically controlled. See "Auto Volume" under "AM-FM Radio" previously in this section.

Manage Bluetooth Devices

1. From the Bluetooth music menu, touch Audio Settings.
2. Touch Manage Bluetooth Devices.
3. Select the desired device and then connect/disconnect or delete.

Playing Bluetooth Music

- Do not change the track too quickly when playing Bluetooth music.
- It takes some time to transmit data from the mobile phone or Bluetooth device to the

infotainment system. The infotainment system outputs the audio from the mobile phone or Bluetooth device as it is transmitted.

- If the mobile phone or Bluetooth device is not in the idle screen mode, it may not automatically play despite being carried out from the Bluetooth music play mode.
- The infotainment system transmits the order to play from the mobile phone in the Bluetooth music play mode. If this is done in a different mode, then the device transmits the order to stop. Depending on the mobile phone's options, this order to play/stop may take time to activate.
- If Bluetooth music playback is not functioning, then check to see if the mobile phone is in the idle screen mode.
- Sometimes, sounds may be cut off during Bluetooth music playback.

OnStar System

OnStar with 4G LTE



If equipped with OnStar 4G LTE, up to seven devices, such as smartphones, tablets, and laptops, can be connected to high-speed Internet through the vehicle's built-in Wi-Fi hotspot.

Call 1-888-4-ONSTAR (1-888-466-7827) to connect to an OnStar Advisor for assistance. See www.onstar.com for a detailed instruction guide, vehicle availability, details, and system limitations. Services and apps vary by make, model, year, carrier, availability, and conditions. 4G LTE service is available in select markets. 4G LTE performance is based on industry averages and vehicle systems design. Some services require a data plan.

Phone

Bluetooth

Bluetooth Wireless Technology

Bluetooth wireless technology establishes a wireless link between two devices supported with Bluetooth. After the initial pairing, the two devices can connect automatically when turned on. Bluetooth allows wireless transmission of information among Bluetooth phones, PDAs, or other devices within close range by using 2.45 GHz frequency short-distance wireless telecommunication technologies. Within this vehicle, users can make hands-free calls, transmit hands-free data, and play audio streaming files by connecting a mobile phone with the system.

- There may be restrictions on using Bluetooth wireless technology in some locations.

- Due to the variety of Bluetooth devices and their firmware versions, the device may respond differently when performing over Bluetooth.
- See the device's user guide for questions about Bluetooth functionality.
- Multi-pairing is not supported.

Pairing and Connecting Bluetooth

To use the Bluetooth feature, make sure the Bluetooth on the device is turned on and the device is in discoverable mode. See the Bluetooth device's user guide.

When There Is no Paired Device on the Infotainment System



1. Touch .
2. Touch Phone, then Add Device.
3. From the device's Bluetooth settings list, select Chevrolet MyLink.
4. Touch Code Matches.





5. Verify phone matches.

When the Bluetooth device and infotainment system are successfully paired, the Phone screen appears on the infotainment display.

When the connection fails, a failure message appears on the infotainment display.

When There Is a Paired Device on the Infotainment System

1. Touch .
2. Touch Settings, then Devices on the display.
3. Touch the device to pair from the list, and then follow Step 5.
To add a device not in the list, touch Add Device.
4. From the device's Bluetooth settings list, select Chevrolet MyLink.
5. When the Bluetooth device and the infotainment system are successfully paired,  /  is displayed.

- The connected mobile phone is highlighted by a  mark.
- The  /  mark indicates the hands-free and mobile phone music function are enabled.
- The  mark indicates only Hands-Free function is enabled.
- The  mark indicates only Bluetooth music is enabled.

- When the Bluetooth device and the infotainment system are successfully paired, the contact list downloads automatically, depending on the type of mobile phone. If the contact list does not download automatically, proceed with the download on the mobile phone. Always accept the contact list request on the initial pairing of the mobile phone.
- The infotainment system can register up to 10 Bluetooth devices.

- When the connection fails, the failure message displays on the infotainment system.
- If the contact list has more than 5,000 contacts, the infotainment system may not properly list the remaining entries.
- Depending on the number of contact entries, pairing time may vary.

Checking the Connected Bluetooth Device

1. Touch .
2. Touch Settings, then Devices.
3. The connected device will be displayed on the top of the list.

Disconnecting the Bluetooth Device

1. Touch .
2. Touch Settings, then Devices.
3. Touch the name of the device to disconnect.
4. Touch Disconnect Device.

Connecting the Bluetooth Device

1. Touch .
2. Touch Settings, then Devices.
3. Touch the device to connect.

Deleting the Bluetooth Device

1. Touch .
2. Touch Settings, then Devices.
3. Touch Delete next to the device to delete.
4. Touch Delete.

Apple CarPlay and Android Auto

If equipped, Android Auto and/or Apple CarPlay capability may be available through a compatible smartphone. If available, Projection will appear on the Home Page of the infotainment display.

To use Android Auto or Apple CarPlay:

1. Download the Android Auto app to your phone from the Google Play store. No app is required for Apple CarPlay.
2. Connect an Android phone or iPhone by using the compatible phone USB cable and plugging into a USB data port. For best performance, use the device's factory-provided USB cable. Aftermarket or third-party cables may not work.
3. When the phone is first connected to activate Apple CarPlay or Android Auto, the message "Device Projection Privacy Consent" will appear.
 - Select Continue to launch Apple CarPlay or Android Auto.
 - Select Disable to remove Apple CarPlay and Android Auto capability from the vehicle Settings menu. Other functions may still work.

Projection on the Home Page will change to Android Auto or Apple CarPlay depending on the phone. Android Auto and/or Apple CarPlay may automatically launch upon USB connection. If not, touch the Android Auto and/or Apple CarPlay icon on the Home Page to launch.

Press  on the center stack to return to the Home Page.



For further information on how to set up Android Auto and Apple CarPlay in the vehicle, see www.my.chevrolet.com or see *Customer Assistance Offices* ⇨ 334.

Android Auto is provided by Google and is subject to Google's terms and privacy policy. Apple CarPlay is provided by Apple and is subject to Apple's terms and privacy policy. Data plan rates apply. For Android Auto support see <https://support.google.com/androidauto>. For Apple CarPlay support see www.apple.com/ios/carplay/. Apple or Google may change or suspend availability at any time. Android Auto, Android, Google, Google Play,

and other marks are trademarks of Google Inc.; Apple CarPlay is a trademark of Apple Inc.

Hands-Free Phone

Making a Call by Entering the Phone Number

1. Touch .
2. Touch Phone.
3. Enter the phone number using the keypad on the Phone screen.
4. Touch  on the display to call the phone number.

If the wrong number is entered, touch **X** to delete the entered number one digit at a time. Or touch and hold **X** to delete all entered numbers.

Switching a Call to the Mobile Phone (Private Mode)

1. To switch the call to the mobile phone instead of the Bluetooth hands-free, touch .

2. To switch the call back to the Bluetooth hands-free, touch  again.



Switching the Microphone On/Off



Switch the microphone on/off by touching .

Calling by Re-Dial

Touch  on the display.

Taking Calls

1. When a phone call comes through the Bluetooth connected mobile phone, the playing track will be cut off and the phone will ring with the relevant information displayed.
2. To talk on the phone, press  on the steering wheel control or touch  on the display.

To reject the call, press  on the steering wheel control or touch  on the display.

Using the Contacts Menu





1. Touch the contacts menu on the Phone screen.
2. Select the contact entry to call.
 - To call another phone number in the same contacts, touch More in the Contacts screen and touch the desired phone number.
 - In the Contacts screen, touch ★ to add the contact to favorites. Touch ★ again to remove the contact from favorites.

Making a Call from Favorites

1. Touch the favorites menu on the Phone screen.
2. Select the contact to call.

The Favorites list is not synchronized with the mobile phone and is stored separately.

Making a Call from Call History

1. Touch  RECENT on the Phone screen.
2. Select the contact to call.
 - : Incoming call
 - : Outgoing call
 - : Missed call

Making a Call with Speed Dial Numbers

Touch and hold a speed dial number using the keypad on the Phone screen.

Only speed dial numbers already stored on the mobile phone can be used for speed dial calls. Up to two-digit speed dial numbers are supported.

For two-digit speed dial numbers, touch and hold the second digit to make a call to the speed dial number.

Voice Mail

The default voice mail number is the phone number of the currently connected mobile phone. The voice mail number can be changed in Bluetooth settings.



To dial a voice mail number:

1. Touch .
2. Touch Phone, then Voice Mail.

Settings

Operation of the Settings Menu

The infotainment system can be customized to make it easier to use.

1. Touch .
2. Touch Settings.
3. Touch the desired menu to select the item or to display the item's detailed menu.
4. Touch  to return to the previous menu.

Settings menus and functions may vary depending on vehicle options.

Radio Settings

1. Touch .
2. Touch Settings, then touch Radio Settings.
 - Auto Volume: Volume will be automatically controlled. See "Auto Volume" under "AM-FM Radio" previously in this section.

- Maximum Start-up volume: Set the Maximum start-up volume from 13 to 37.
- Audio Cues: Set the Audio Cues feature to On or Off.
- Audio Cues Volume: Set the Audio Cues Volume from 10 to 63.

Audio Cues Volume is only available when Audio Cues is set to On.

Devices

1. Touch .
2. Touch Settings, then touch Devices.
3. Select the desired device and connect/disconnect or delete.

To add a new Bluetooth device, touch Add Device.

Bluetooth Phone

1. Touch .

2. Touch Settings, then Bluetooth Phone and touch  to scroll to the desired mobile phone. This is only available when the device is connected.

- My Number: Displays the current connected phone number.
- Privacy: Set whether or not incoming call alerts are shown on the infotainment display.
- Sort Contacts: Set to First name, surname or Surname, first name.
- Resync Device Contacts: Resync the contacts list for the current connected mobile phone.

Apple CarPlay

1. Touch .
2. Touch Settings and find Apple CarPlay.
3. Select On or Off.

Android Auto

1. Touch .
2. Touch Settings and find Android Auto.
3. Select On or Off.

Even if Projection is set to Off, connecting the device and touching Projection on the Home Page will display a pop-up message:

- For Apple CarPlay function: "While active, Apple CarPlay will be displayed on this screen."
- For Android Auto function: "While active, Android Auto will be displayed on this screen."

When the device is first connected, the device projection privacy consent pop-up message will be displayed.

- Touch Continue to activate the projection feature.
- Touch Disable and the device is charging only.

If Android Auto is not activated, make sure the mobile phone's USB connection mode is set to MTP.

If the device has not previously been paired, the consent pop-up will display when touching continue.

Teen Driver

If equipped, this allows multiple keys to be registered for beginner drivers, to encourage safe driving habits. When the vehicle is started with a Teen Driver key, it will automatically activate certain safety systems, allow setting of some features, and limit the use of others. The Report Card will record vehicle data about driving behavior that can be viewed later. When the vehicle is started with a registered key, the Driver Information Center (DIC) displays a message that Teen Driver is active.

To access:

1. Touch Settings on the Home Page, then touch Teen Driver.

2. Create a Personal Identification Number (PIN) by choosing a four-digit PIN. Re-enter the PIN to confirm. To change the PIN, select Change PIN.

The PIN is required to:

- Register or unregister keys.
- Change Teen Driver settings.
- Change or clear the Teen Driver PIN.
- Access or delete Report Card data.

Register keys to activate:

Any vehicle key can be registered, up to a maximum of eight keys. Label the key to tell it apart from the other keys.

1. Start the vehicle.
2. The vehicle must be in P (Park).
3. From the Settings menu, select Teen Driver.
4. Enter the PIN.

5. Place the Remote Keyless Entry (RKE) transmitter key in the transmitter pocket. See *Remote Keyless Entry (RKE) System Operation* ⇨ 33 for the transmitter pocket location.
6. From the Teen Driver Menu, select Key Registration.
 - If the transmitter key is in the transmitter pocket, it will identify whether the transmitter key is registered or unregistered.
 - If the transmitter key is not registered, the option to register displays. Select Register and a confirmation message displays.
 - If the transmitter key is already registered, the option to unregister displays. If Unregister is selected, the transmitter key is no longer registered and a confirmation message displays.

If a Teen Driver transmitter key and a non-Teen Driver transmitter key are both present at start up, the vehicle will recognize the non-Teen Driver transmitter key to start the vehicle. The Teen Driver settings will not be active.

Manage Settings

Use the PIN to change the following settings:

Audio Volume Limit : Allows a maximum radio volume to be set. Turn the audio volume limit On or Off, and if equipped, choose the maximum level for the audio volume.

Teen Driver Speed Warning : Allows for setting a visual and audible warning when a certain speed is exceeded. The speed warning is selectable from 64 km/h (40 mph) to 121 km/h (75 mph). The speed warning does not limit the speed of the vehicle.

Teen Driver Speed Limiter (If Equipped) : Allows the maximum speed of the vehicle to be limited to 137 km/h (85 mph). When the speed

limiter is turned On and the vehicle is started with a Teen Driver key, the DIC displays a message that the top speed is limited to 137 km/h (85 mph).

When Teen Driver is Active:

- The radio will mute when the driver seat belt is not fastened, and in some vehicles, when the right front passenger seat belt is not fastened. The audio from any device paired to the vehicle will also be muted.
- Certain electronic devices placed on the front passenger seat could cause the passenger sensing system to falsely sense an unbuckled front passenger and mute the radio. See *Passenger Sensing System* ⇨ 77.
- Some safety systems, such as Forward Automatic Braking, if equipped and supported, cannot be turned off.
- The gap setting for the Forward Collision Alert, if equipped, cannot be changed.

Report Card

The vehicle owner must secure the driver's consent to record certain vehicle data when the vehicle is driven with a registered Teen Driver key. There is one Report Card per vehicle. Data is not recorded when Teen Driver is not active.

The Report Card data is collected from the time Teen Driver is activated or the last time the Report Card was reset. The following items may be recorded:

- Distance Driven – the total distance driven.
- Maximum Speed – the maximum vehicle speed recorded.
- Overspeed Warnings – the number of times the speed warning setting was exceeded.
- Forward Collision Alerts – the number of times the driver was notified when approaching a vehicle ahead too quickly and at potential risk for a crash.

- Forward Collision Avoidance Braking – the number of times the vehicle detected that a forward collision was imminent and applied the brakes. Also referred to as Forward Automatic Braking.
- Stability Control – the number of events which required the use of electronic stability control.
- ABS Active – the number of Antilock Brake System activations.
- Tailgating Alerts – the number of times the driver was alerted for following the vehicle ahead too closely.
- Traction Control – the number of times the Traction Control System activated to reduce wheel spin or loss of traction.
- Wide Open Throttle – the number of times the accelerator pedal was pressed nearly all the way down.

Delete Report Card Data

Data is saved for all trips until the data is deleted using the PIN or until the maximum count is exceeded. Each item will report a maximum of 1,000 counts. The distance driven will report a maximum of 64,374 km (40,000 mi).

To delete Report Card data, do one of the following:

- From the Report Card display, select Reset.
- Select Clear All Teen Keys/PIN from the Teen Driver menu. This will also unregister any Teen Driver keys and delete the PIN.

Forgotten PIN

See your dealer to reset the PIN.

Trademarks and License Agreements

FCC Information

See *Radio Frequency Statement* ↪ 342.

Bluetooth®

The Bluetooth word mark and logos are owned by the Bluetooth® SIG, Inc. and any use of such marks by General Motors is under license. Other trademarks and trade names are those of their respective owners.

Made for



iPod



iPhone

“Made for iPod” and “Made for iPhone” mean that an electronic accessory has been designed to connect specifically to iPod or iPhone and has been certified by the developer to meet Apple performance standards.

iPod and iPhone are trademarks of Apple Computer, Inc., registered in the U.S. and other countries.



Fees and Taxes: Subscription fee, taxes, one time activation fee, and other fees may apply. Subscription fee is consumer only. All fees and programming subject to change. Subscriptions subject to Customer Agreement available at www.siriusxm.com or www.siriusxm.ca. SiriusXM® service only available in the 48 contiguous United States and Canada.

In Canada: Some deterioration of service may occur in extreme northern latitudes. This is beyond the control of SiriusXM® Satellite Radio.



It is prohibited to copy, decompile, disassemble, reverse engineer, hack, manipulate, or otherwise make available any technology or software incorporated in receivers compatible with the SiriusXM Satellite Radio System or that support the SiriusXM website, the Online Service or any of its content. Furthermore, the AMBER voice compression software included in this product is protected by intellectual property rights including patent rights, copyrights, and trade secrets of Digital Voice Systems, Inc.

General Requirements:

1. A License Agreement from SiriusXM is required for any product that incorporates SiriusXM Technology and/or for use of any of the SiriusXM marks to be manufactured, distributed, or marketed in the SiriusXM Service Area.

2. For products to be distributed, marketed, and/or sold in Canada, a separate agreement is required with Canadian Satellite Radio Inc. (operating as SiriusXM Canada).

FreeType 2

Portions of this software are copyright © 2007-2012 The FreeType Project (www.freetype.org). All rights reserved.

Libjpeg

The navigation software is based in part on the work of the independent JPEG Group.

Climate Controls

Climate Control Systems

Automatic Climate Control System 186

Air Vents

Air Vents 190

Maintenance

Air Intake 191
 Passenger Compartment Air Filter 191
 Air Conditioning Regular Operation 192
 Service 192

Climate Control Systems

Automatic Climate Control System

The climate control buttons on the center stack and on the climate control display are used to adjust the heating, cooling, and ventilation.

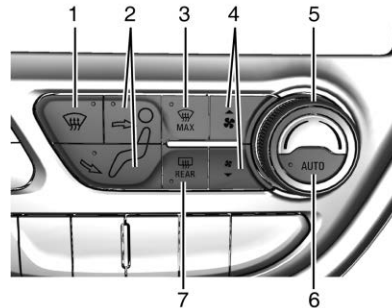

Center Stack Climate Controls

1. Defrost/Defog
2. Air Delivery Mode Controls
3. Max Defrost
4. Manual Fan Control Buttons

5. Temperature Control Knob
6. AUTO (Automatic Operation)
7. Rear Window Defogger

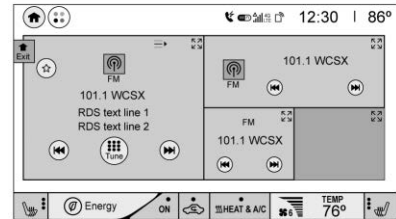

Climate Control Display

1. Driver and Passenger Heated Seats (If Equipped)
2. Climate On-Off
3. Recirculation
4. Heat & A/C (Air Conditioning) Power
5. Fan Speed and Temperature Status

Climate Control Display

The heated seats, if equipped, climate on/off, recirculation, heat, and air conditioning can be controlled by touching Climate Settings on the infotainment Home Page.

A selection can then be made on the climate settings page.

Automatic Operation

The system automatically controls the fan speed, air delivery, air conditioning, electric heating, and recirculation to heat or cool the vehicle to the selected temperature.

When AUTO is lit, all five functions operate automatically. Each function can also be manually set and the selected setting is displayed or the indicator is lit. Functions not manually set will continue to be automatically controlled, even if the AUTO indicator is not lit.

For automatic operation:



1. Press AUTO.

2. Set the temperature. An initial setting of 22 °C (72 °F) is recommended. Allow the system time to stabilize. Adjust the temperature as needed.



Manual Operation

ON : Touch to turn the climate control system on and off.

The climate control system will turn on when any climate control button is pressed on the center stack or touched on the climate control display. To turn the system off, touch ON again.

 or  : Press the buttons to increase or decrease the fan speed. The fan speed setting appears on the climate control display. Manually adjusting the fan speed cancels automatic fan control. Press AUTO to return to automatic operation. Touch ON to turn off the fan and the climate control system.

Temperature Control : Turn the knob clockwise or counterclockwise to increase or decrease the temperature setting.

Air Delivery Mode Control : Press , , or  on the center stack to change the direction of airflow. Any combination of the three buttons can be selected. The selected air delivery mode button indicator is lit.

Pressing any button cancels automatic air delivery control and the direction of the airflow can be controlled manually. Press AUTO to return to automatic operation.

 : Air is directed to the windshield.

 : Air is directed to the instrument panel outlets.

 : Air is directed to the floor outlets.

 **MAX** : Air is directed to the windshield and the fan runs at a higher speed. Fog or frost is cleared from the windshield more quickly. When the button is pressed again, the system returns to the previous mode setting.

For best results, clear all snow and ice from the windshield before defrosting.

 : Touch to turn on recirculation.

An indicator light comes on. Air is recirculated to quickly cool the inside of the vehicle or to reduce the entry of outside air and odors. Using the recirculation mode for extended periods may cause the windows to fog. If this happens, select the defrost mode.

Using air conditioning and recirculation together for long periods of time may cause the air inside the vehicle to become too dry. To prevent this from happening, after the air in the vehicle has cooled, turn the recirculation mode off.

Touching this button cancels automatic recirculation. Press AUTO to return to automatic operation; recirculation runs automatically as needed.



 **HEAT & A/C** : Touch to turn the air conditioning and heater on when the fan is on.

Auto Defog : The system will monitor high humidity inside the vehicle. When high humidity is detected, the climate control system may adjust to outside air supply and turn on the air conditioner or the heater. The fan speed may slightly increase to help prevent fogging. When high humidity is no longer detected, the system will return to its prior operation. To turn Auto Defog off or on, see “Climate and Air Quality” under *Vehicle Personalization* ⇨ 143.

Auto Heated Seats : If equipped, when the vehicle is on, this feature will automatically activate the heated seats at the level required by the vehicle’s interior temperature. In auto mode, the indicators automatically show the level setting required.

Use the manual heated seat buttons on the infotainment display to turn auto heated seats off. Once this

feature is turned off, the auto heated seats will be activated the next time the vehicle is turned on.

In manual mode, the controls can be accessed while the vehicle is on by touching  or  with three level indicators high, medium, low or off on the climate control display. If the passenger seat is unoccupied, the auto heated seats feature will not activate that seat.

See *Heated Front Seats* ⇨ 60 and *Vehicle Personalization* ⇨ 143.

Rear Window Defogger

 **REAR** : Press to turn the rear window defogger on or off. An indicator light on the button comes on to show that the rear window defogger is on.

The defogger only works when the vehicle is on. The defogger will turn off if the vehicle is turned off.

Caution

Do not try to clear frost or other material from the inside of the front windshield and rear window with a razor blade or anything else that is sharp. This may damage the rear window defogger grid and affect the radio's ability to pick up stations clearly. The repairs would not be covered by the vehicle warranty.

Remote Start : The climate control system may be started by using the Remote Keyless Entry (RKE) transmitter. The climate control system will default to an appropriate heating or cooling mode. See *Remote Start* ⇨ 39.

The rear window defogger turns on if it is cold outside.

Mobile Application Feature

If equipped, this feature allows a smartphone to set the start-up climate control settings. The following features can be set:

- Temperature
- Fan Speed
- Air Delivery Mode
- Climate Mode
- Recirculation

Once the settings are saved through the application, the vehicle will use these settings when turned on. After the vehicle is turned on, use the climate controls if additional adjustments are desired.

Sensors

Indicator Light and Solar Sensor (ILSS)

The ILSS is on top of the instrument panel, near the windshield, where it monitors solar intensity.

The climate control system uses the sensor information to adjust the temperature, fan speed, recirculation, and air delivery mode for best comfort.

Do not cover the sensor; otherwise the automatic climate control system may not work properly.

Humidity Sensor

The humidity sensor is near the base of the inside rearview mirror. The climate control system uses the sensor information to adjust the temperature and recirculation for best comfort.

Outside Air Temperature Sensor

The outside air temperature sensor is behind the front grille of the vehicle. The vehicle uses the sensor information to display outside air temperature. The climate control system uses the information to adjust the climate system operation.

Air Vents

Adjustable air vents are in the center and on the side of the instrument panel.

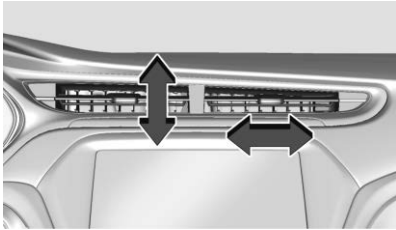

Move the slats to change the direction of the airflow. The center air vent does not close completely.

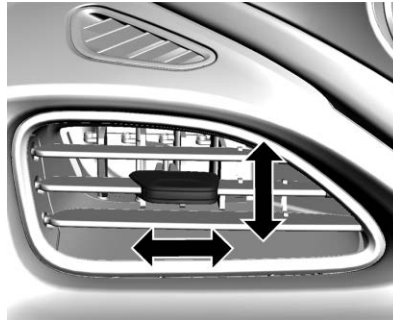

Move the slats to change the direction of the airflow.

Additional air vents are located beneath the windshield and the driver and passenger side door windows, and in the footwells. These are fixed and cannot be adjusted.

Operation Tips

- Keep all outlets open whenever possible for best system performance.
- Clear snow off the hood to improve visibility and help decrease moisture drawn into the vehicle.

- Keep the path under all seats clear of objects to help circulate the air inside the vehicle more effectively.
- Use of non-GM approved hood deflectors can adversely affect the performance of the system.
- Do not attach any devices to the air vent slats. This restricts airflow and may cause damage to the air vents.

Maintenance

Air Intake

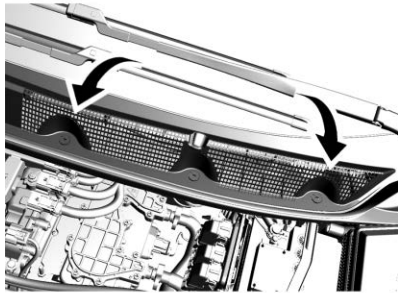

The air intake at the base of the windshield under the hood must be kept clear to allow the flow of air into the vehicle. Clear away any ice, snow, or leaves.

Passenger Compartment Air Filter

The filter reduces the dust, pollen, and other airborne irritants from outside air that is pulled into the vehicle.

Replace the filter as part of routine scheduled maintenance.



1. Open the glove box.

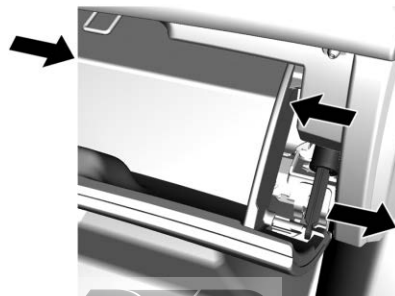

DEP
DEALER ePROCESS

2. Pull the damper and push the side wall to unlock the stopper.
3. Lower the glove box completely.

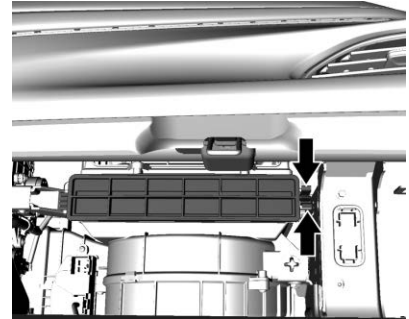

4. Hold the right side of the filter cover, and then pull and remove it.
5. Install the new air filter.
6. Reinstall the filter cover.
7. Reconnect the glove box damper.
8. Reinstall the glove box.

See your dealer if additional assistance is needed.

Air Conditioning Regular Operation

To ensure continuous efficient performance, operate the air conditioning for a few minutes once a month. The air conditioning will not operate if the outside temperature is too low.

Caution

Damage caused by improper refrigerant usage could lead to costly repairs and may not be covered by the vehicle warranty. Refrigerant systems should only be serviced by qualified personnel. Always use the correct refrigerant.

Warning

Performing service work to the climate control system could cause personal injury or damage
(Continued)

Warning (Continued)

to the vehicle. Climate control systems are serviced by qualified personnel only.

Service

All vehicles have a label underhood that identifies the refrigerant used in the vehicle. The refrigerant system should only be serviced by trained and certified technicians. The air conditioning evaporator should never be repaired or replaced by one from a salvage vehicle. It should only be replaced by a new evaporator to ensure proper and safe operation.

During service, all refrigerants should be reclaimed with proper equipment. Venting refrigerants directly to the atmosphere is harmful to the environment and may also create unsafe conditions based on inhalation, combustion, frostbite, or other health-based concerns.

Driving and Operating

Driving Information

Distracted Driving	194
Defensive Driving	194
Drunk Driving	195
Control of a Vehicle	195
Braking	195
Steering	195
Off-Road Recovery	196
Loss of Control	196
Driving on Wet Roads	197
Hill and Mountain Roads	198
Winter Driving	198
If the Vehicle Is Stuck	199
Vehicle Load Limits	200

Starting and Operating

New Vehicle Break-In	203
Power Button	204
Starting and Stopping the Vehicle	205
Retained Accessory Power (RAP)	206
Shifting Into Park	206
Shifting out of Park	207
Extended Parking	207

Electric Vehicle Operating Modes

Driver Selected Operating Modes	208
---------------------------------	-----

Electric Drive Unit

Electric Drive Unit	208
---------------------	-----

Brakes

Antilock Brake System (ABS)	213
Electric Parking Brake	213
Brake Assist	215
Hill Start Assist (HSA)	215
Regenerative Braking	215

Ride Control Systems

Traction Control/Electronic Stability Control	217
---	-----

Cruise Control

Cruise Control	219
----------------	-----

Driver Assistance Systems

Driver Assistance Systems	221
Assistance Systems for Parking or Backing	222
Assistance Systems for Driving	225
Forward Collision Alert (FCA) System	225

Forward Automatic Braking (FAB)	227
Front Pedestrian Braking (FPB) System	229
Side Blind Zone Alert (SBZA)	231
Lane Change Alert (LCA)	231
Lane Departure Warning (LDW)	233
Lane Keep Assist (LKA)	233

Charging

When to Charge	235
Plug-In Charging	235
Delayed Charging Override	239
Charging Status Feedback	240
Charge Cord	243
Utility Interruption of Charging	250
Electrical Requirements for Battery Charging	251

Trailer Towing

General Towing Information	252
----------------------------	-----

Conversions and Add-Ons

Add-On Electrical Equipment	252
-----------------------------	-----



Driving Information

Distracted Driving

Distraction comes in many forms and can take your focus from the task of driving. Exercise good judgment and do not let other activities divert your attention away from the road. Many local governments have enacted laws regarding driver distraction. Become familiar with the local laws in your area.

To avoid distracted driving, keep your eyes on the road, keep your hands on the steering wheel, and focus your attention on driving.

- Do not use a mobile phone in demanding driving situations. Use a hands-free method to place or receive necessary phone calls.
- Watch the road. Do not read, take notes, or look up information on mobile phones or other electronic devices.

- Designate a front seat passenger to handle potential distractions.
- Become familiar with vehicle features before driving, such as programming favorite radio stations and adjusting climate control and seat settings. Program all trip information into any navigation device prior to driving.
- Wait until the vehicle is parked to retrieve items that have fallen to the floor.
- Stop or park the vehicle to tend to children.
- Keep pets in an appropriate carrier or restraint.
- Avoid stressful conversations while driving, whether with a passenger or on a mobile phone.



Warning

Taking your eyes off the road too long or too often could cause a crash resulting in injury or death. Focus your attention on driving.

Refer to the Infotainment section for more information on using that system, including pairing and using a mobile phone.

Defensive Driving

Defensive driving means “always expect the unexpected.” The first step in driving defensively is to wear the seat belt.

- Assume that other road users (pedestrians, bicyclists, and other drivers) are going to be careless and make mistakes. Anticipate what they might do and be ready.
- Allow enough following distance between you and the driver in front of you.
- Focus on the task of driving.

Drunk Driving

Death and injury associated with drinking and driving is a global tragedy.

Warning

Drinking and then driving is very dangerous. Your reflexes, perceptions, attentiveness, and judgment can be affected by even a small amount of alcohol. You can have a serious — or even fatal — collision if you drive after drinking.

Do not drink and drive or ride with a driver who has been drinking. Ride home in a cab; or if you are with a group, designate a driver who will not drink.

Control of a Vehicle

Braking, steering, and accelerating are important factors in helping to control a vehicle while driving.

Braking

Braking action involves perception time and reaction time. Deciding to push the brake pedal is perception time. Actually doing it is reaction time.

Average driver reaction time is about three-quarters of a second. In that time, a vehicle moving at 100 km/h (60 mph) travels 20 m (66 ft), which could be a lot of distance in an emergency.

Helpful braking tips to keep in mind include:

- Keep enough distance between you and the vehicle in front of you.
- Avoid needless heavy braking.
- Keep pace with traffic.

Steering

Electric Power Steering

The vehicle has electric power steering. It does not have power steering fluid. Regular maintenance is not required.

If power steering assist is lost due to a system malfunction, the vehicle can be steered, but may require increased effort.

If the steering assist is used for an extended period of time while the vehicle is not moving, power assist may be reduced.

If the steering wheel is turned until it reaches the end of its travel and is held against that position for an extended period of time, power steering assist may be reduced.

Normal use of the power steering assist should return when the system cools down.

See your dealer if there is a problem.

Curve Tips

- Take curves at a reasonable speed.
- Reduce speed before entering a curve.
- Maintain a reasonable steady speed through the curve.

- Wait until the vehicle is out of the curve before accelerating gently into the straightaway.

Steering in Emergencies

- There are some situations when steering around a problem may be more effective than braking.
- Holding both sides of the steering wheel allows you to turn 180 degrees without removing a hand.
- The Antilock Brake System (ABS) allows steering while braking.

Off-Road Recovery

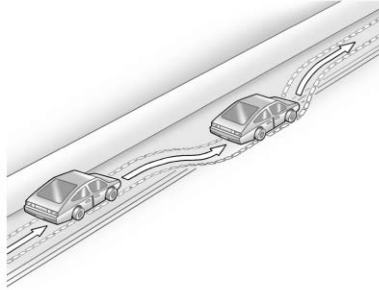

The vehicle's right wheels can drop off the edge of a road onto the shoulder while driving. Follow these tips:

1. Ease off the accelerator and then, if there is nothing in the way, steer the vehicle so that it straddles the edge of the pavement.
2. Turn the steering wheel about one-eighth of a turn, until the right front tire contacts the pavement edge.

3. Turn the steering wheel to go straight down the roadway.

Loss of Control

Skidding

There are three types of skids that correspond to the vehicle's three control systems:

- Braking Skid — wheels are not rolling.
- Steering or Cornering Skid — too much speed or steering in a curve causes tires to slip and lose cornering force.
- Acceleration Skid — too much throttle causes the driving wheels to spin.

Defensive drivers avoid most skids by taking reasonable care suited to existing conditions, and by not overdriving those conditions. But skids are always possible.

If the vehicle starts to slide, follow these suggestions:

- Ease your foot off the accelerator pedal and steer the way you want the vehicle to go. The vehicle may straighten out. Be ready for a second skid if it occurs.
- Slow down and adjust your driving according to weather conditions. Stopping distance can be longer and vehicle control can be affected when traction is reduced by water, snow, ice, gravel, or other material on the road. Learn to recognize warning clues — such as enough water, ice, or packed snow on the road to make a mirrored surface — and slow down when you have any doubt.
- Try to avoid sudden steering, acceleration, or braking, including reducing vehicle speed by shifting to a lower gear. Any sudden changes could cause the tires to slide.

Remember: Antilock brakes help avoid only the braking skid.

Driving on Wet Roads

Rain and wet roads can reduce vehicle traction and affect your ability to stop and accelerate. Always drive slower in these types of driving conditions and avoid driving through large puddles and deep-standing or flowing water.

Warning

Wet brakes can cause crashes. They might not work as well in a quick stop and could cause pulling to one side. You could lose control of the vehicle.

After driving through a large puddle of water or a car/vehicle wash, lightly apply the brake pedal until the brakes work normally.

(Continued)

Warning (Continued)

Flowing or rushing water creates strong forces. Driving through flowing water could cause the vehicle to be carried away. If this happens, you and other vehicle occupants could drown. Do not ignore police warnings and be very cautious about trying to drive through flowing water.

Hydroplaning

Hydroplaning is dangerous. Water can build up under the vehicle's tires so they actually ride on the water. This can happen if the road is wet enough and you are going fast enough. When the vehicle is hydroplaning, it has little or no contact with the road.

There is no hard and fast rule about hydroplaning. The best advice is to slow down when the road is wet.

Other Rainy Weather Tips

Besides slowing down, other wet weather driving tips include:

- Allow extra following distance.
- Pass with caution.
- Keep windshield wiping equipment in good shape.
- Keep the windshield washer fluid reservoir filled.
- Have good tires with proper tread depth.
- Turn off cruise control.

Hill and Mountain Roads

Driving on steep hills or through mountains is different than driving on flat or rolling terrain.

- Keep the vehicle serviced and in good shape.
- Check all fluid levels and brakes, tires, cooling system, and electric drive unit.
- Keep the vehicle in gear when going down steep or long hills.

Warning

Coasting downhill in N (Neutral) or with the vehicle turned off is dangerous. The brakes will have to do all the work of slowing down the vehicle and could become too hot. Hot brakes may not be able to slow the vehicle enough to maintain speed and control. You could crash. Always have the vehicle running and in gear when going downhill. This will allow the electric drive unit to assist in slowing and maintaining speed.

- Drive at speeds to keep the vehicle in its own lane. Do not swing wide or cross the center line.
- Be alert on top of hills. Something could be in your lane (e.g., stalled car, accident).

- Pay attention to special road signs (e.g., falling rocks area, winding roads, long grades, passing or no-passing zones) and take appropriate action.

Winter Driving

Driving on Snow or Ice

Snow or ice between the tires and the road creates less traction or grip, so drive carefully. Wet ice can occur at about 0 °C (32 °F) when freezing rain begins to fall. Avoid driving on wet ice or in freezing rain until roads can be treated.

For Slippery Road Driving:

- Recommend using D (Drive) in slippery conditions.
- Accelerate gently. Accelerating too quickly causes the wheels to spin and makes the surface under the tires slick.
- Turn on the Traction Control System (TCS).

- The Antilock Brake System (ABS) improves vehicle stability during hard stops, but the brakes should be applied sooner than when on dry pavement.
- Allow greater following distance and watch for slippery spots. Icy patches can occur on otherwise clear roads in shaded areas. The surface of a curve or an overpass can remain icy when the surrounding roads are clear. Avoid sudden steering maneuvers and braking while on ice.
- Turn off cruise control.

Blizzard Conditions

Being stuck in snow can be a serious situation. Stay with the vehicle unless there is help nearby. If possible, use Roadside Assistance. See *Roadside Assistance Program* ⇨ 31. To get help and keep everyone in the vehicle safe:

- Turn on the hazard warning flashers.

- Tie a red cloth to an outside mirror.

To save energy, run the vehicle for only short periods as needed to warm the vehicle and then shut the vehicle off and partially close the window. Moving about to keep warm also helps.

If the Vehicle Is Stuck

Slowly and cautiously spin the wheels to free the vehicle when stuck in sand, mud, ice, or snow.

The Traction Control System (TCS) must be turned off by pressing the TCS/ESC button. Traction control is not completely off, but will only engage if the maneuver can cause damage to the electric drive unit.

 Warning
<p>If the vehicle's tires spin at high speed, they can explode, and you or others could be injured. The vehicle can overheat, causing an underhood compartment fire or</p>
<p>(Continued)</p>



<p>Warning (Continued)</p>
<p>other damage. Spin the wheels as little as possible and avoid going above 56 km/h (35 mph).</p>

Rocking the Vehicle to Get it Out

Turn the steering wheel left and right to clear the area around the front wheels. Turn off TCS. Shift back and forth between R (Reverse) and a low forward gear, spinning the wheels as little as possible. To prevent electric drive unit wear, wait until the wheels stop spinning before shifting gears. Release the accelerator pedal while shifting, and press lightly on the accelerator pedal when the electric drive unit is in gear. Slowly spinning the wheels in the forward and reverse directions causes a rocking motion that could free the vehicle. If that does not get the vehicle out after a few tries, it might need to be towed out. See *Towing the Vehicle* ⇨ 307.

Vehicle Load Limits

It is very important to know how much weight the vehicle can carry. This weight is called the vehicle capacity weight and includes the weight of all occupants, cargo, and all nonfactory-installed options. Two labels on the vehicle may show how much weight it may properly carry: the Tire and Loading Information label and the Certification label.

Warning

Do not load the vehicle any heavier than the Gross Vehicle Weight Rating (GVWR), or either the maximum front or rear Gross Axle Weight Rating (GAWR). This can cause systems to break and change the way the vehicle handles. This could

(Continued)

Warning (Continued)

cause loss of control and a crash. Overloading can also reduce stopping distance, damage the tires, and shorten the life of the vehicle.

Tire and Loading Information Label

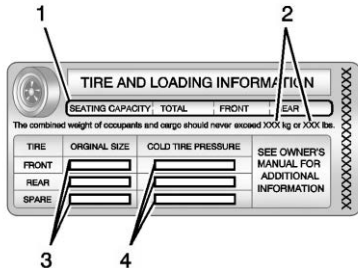

Label Example

A vehicle-specific Tire and Loading Information label is attached to the vehicle's center pillar (B-pillar). The Tire and

Loading Information label shows the number of occupant seating positions (1), and the maximum vehicle capacity weight (2) in kilograms and pounds.

The Tire and Loading Information label also shows the tire size of the original equipment tires (3) and the recommended cold tire inflation pressures (4). For more information on tires and inflation see *Tires* ⇨ 278 and *Tire Pressure* ⇨ 284.

There is also important loading information on the Certification label. It may show the Gross Vehicle Weight Rating (GVWR) and the Gross Axle Weight Rating (GAWR) for the front and rear axle. See "Certification Label" later in this section.

“Steps for Determining Correct Load Limit–

1. Locate the statement "The combined weight of occupants and cargo should never exceed XXX kg or XXX lbs." on your vehicle's placard.
2. Determine the combined weight of the driver and passengers that will be riding in your vehicle.
3. Subtract the combined weight of the driver and passengers from XXX kg or XXX lbs.
4. The resulting figure equals the available amount of cargo and luggage load capacity. For example, if the "XXX" amount equals 1400 lbs. and there will be five 150 lb passengers in your vehicle, the amount of available cargo and luggage

load capacity is 650 lbs.
(1400-750 (5 x 150) = 650 lbs.)

5. Determine the combined weight of luggage and cargo being loaded on the vehicle. That weight may not safely exceed the available cargo and luggage load capacity calculated in Step 4.
6. If your vehicle will be towing a trailer, load from your trailer will be transferred to your vehicle. Consult this manual to determine how this reduces the available cargo and luggage load capacity of your vehicle."

This vehicle is neither designed nor intended to tow a trailer.

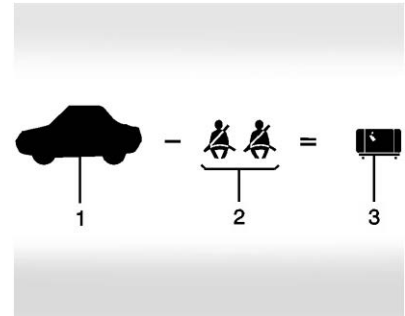

Example 1

1. Vehicle Capacity Weight for Example 1 = 453 kg (1,000 lbs).
2. Subtract Occupant Weight @ 68 kg (150 lbs) × 2 = 136 kg (300 lbs).
3. Available Occupant and Cargo Weight = 317 kg (700 lbs).

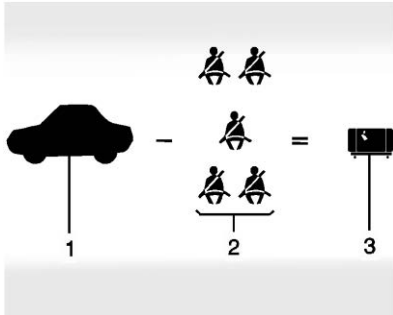

Example 2

1. Vehicle Capacity Weight for Example 2 = 453 kg (1,000 lbs).
2. Subtract Occupant Weight @ 68 kg (150 lbs) × 5 = 340 kg (750 lbs).
3. Available Cargo Weight = 113 kg (250 lbs).

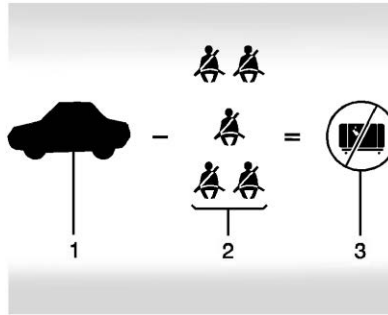

Example 3

1. Vehicle Capacity Weight for Example 3 = 453 kg (1,000 lbs).
2. Subtract Occupant Weight @ 91 kg (200 lbs) × 5 = 453 kg (1,000 lbs).
3. Available Cargo Weight = 0 kg (0 lbs).

Refer to the vehicle's Tire and Loading Information label for specific information about the vehicle's capacity weight and seating positions. The combined

weight of the driver, passengers, and cargo should never exceed the vehicle's capacity weight.

Certification Label

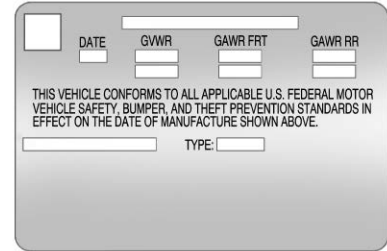

Label Example

A vehicle-specific Certification label is attached to the vehicle's center pillar (B-pillar). The label may show the gross weight capacity of the vehicle, called the Gross Vehicle Weight Rating (GVWR). The GVWR includes the weight of the vehicle, all occupants, fuel, and cargo.

 **Warning**

Things inside the vehicle can strike and injure people in a sudden stop or turn, or in a crash.

- Put things in the cargo area of the vehicle. In the cargo area, put them as far forward as possible. Try to spread the weight evenly.
- Never stack heavier things, like suitcases, inside the vehicle so that some of them are above the tops of the seats.

(Continued)

Warning (Continued)

- Do not leave an unsecured child restraint in the vehicle.
- Secure loose items in the vehicle.
- Do not leave a seat folded down unless needed.

Starting and Operating

New Vehicle Break-In

Caution

Avoid making hard stops for the first 322 km (200 mi). During this time the new brake linings are not yet broken in. Hard stops with new linings can mean premature wear and earlier replacement. Follow this breaking-in guideline every time you get new brake linings. Following break-in, vehicle speed and load can be gradually increased.

Power Button

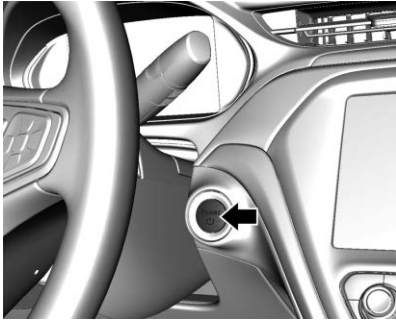



The vehicle has an electronic pushbutton start.

The Remote Keyless Entry (RKE) transmitter must be in the vehicle for the system to operate. If the vehicle will not start, place the RKE transmitter in the transmitter pocket, inside the center console.

ON/RUN : This position is for starting and driving. With the vehicle off, and the brake pedal applied, pressing POWER  once will place the vehicle in ON/RUN. When the vehicle ready light is on in the

instrument cluster, the vehicle is ready to be driven. This could take up to 15 seconds at extremely cold temperatures.

Service Mode

This power mode is available for service and diagnostics, and to verify the proper operation of the service vehicle soon light as may be required for emission inspection purposes. With the vehicle off, and the brake pedal not applied, pressing and holding POWER  for more than five seconds will place the vehicle in Service Mode. The instruments and audio systems will operate as they do in ON/RUN, but the vehicle will not be able to be driven. The propulsion system will not start in Service Mode. Press POWER  again to turn the vehicle off.

Caution

Placing the vehicle in Service Mode will use the 12-volt battery. Do not use Service Mode for an extended period, or the vehicle may not start.

STOPPING THE VEHICLE/OFF :

To turn the vehicle off, apply the brakes, press the button on top of the shift lever to shift to P (Park) and press POWER .

Alternatively, apply the brakes and press POWER . The electric drive unit will shift to P (Park) then shut off automatically.

Retained Accessory Power (RAP) will remain active until the driver door is opened.

If the vehicle must be shut off in an emergency:

1. Brake using a firm and steady pressure. Do not pump the brakes repeatedly. This may deplete power assist, requiring increased brake pedal force.
2. Shift the vehicle to N (Neutral). This can be done while the vehicle is moving. After shifting to N (Neutral), firmly apply the brakes and steer the vehicle to a safe location.
3. Come to a complete stop, shift to P (Park), and turn the vehicle off by pressing POWER ⏻.
4. Set the parking brake.

Warning

Turning off the vehicle while moving may disable the airbags. While driving, only shut the propulsion system off in an emergency.

If the vehicle cannot be pulled over, and must be shut off while driving, press and hold POWER ⏻ for longer than two seconds, or press twice in five seconds.

Starting and Stopping the Vehicle

Starting Procedure

Press the P (Park) button on the shift lever, or move the shift lever into N (Neutral). The propulsion system will not start in any other position.

Caution

Do not try to shift to P (Park) if the vehicle is moving or the electric drive unit could be damaged. Shift to P (Park) only when the vehicle is stopped.

Caution

If you add electrical parts or accessories, you could change the way the vehicle operates. Any resulting damage would not be covered by the vehicle warranty.

The Remote Keyless Entry (RKE) transmitter must be in the vehicle. Press the brake pedal, then press and release POWER ⏻.

If the RKE transmitter is not in the vehicle or something is interfering with the transmitter, a message displays in the Driver Information Center (DIC).

If the vehicle will not start due to a low RKE transmitter battery, the vehicle can still be driven. See *Remote Keyless Entry (RKE) System Operation* ⇨ 33.



A vehicle ready light displays in the lower right corner of the instrument cluster when the vehicle is ready to be driven.

The instrument cluster also displays an active battery gauge when the vehicle is ready to be driven.

Restarting Procedure

If the vehicle must be restarted while it is still moving, move the shift lever to N (Neutral) and press POWER  twice without pressing the brake pedal. The propulsion system will not restart in any other position.

A chime will sound if the driver door is opened while the vehicle is on.

Always press POWER  to turn the vehicle off before exiting.

Stopping Procedure

For information on how to turn the vehicle off, see *Power Button* ⇨ 204.

Retained Accessory Power (RAP)

The following features will operate for up to 10 minutes or until the driver door is opened:

- Audio System
- Accessory Power Outlets
- Power Windows

Shifting Into Park

To shift into P (Park):

1. Hold the brake pedal down and set the parking brake. See *Electric Parking Brake* ⇨ 213.
2. Press the button on top of the shift lever to shift into P (Park). See *Electric Drive Unit* ⇨ 208.
3. The P indicator on the shift lever will turn red when the vehicle is in P (Park).
4. Turn the vehicle off.

Leaving the Vehicle with the Propulsion System On



Warning

It is dangerous to get out of the vehicle if the P (Park) button is not pressed with the parking brake set. The vehicle can roll.

Do not leave the vehicle when the propulsion system is running. If you have left the propulsion system running, the vehicle can move suddenly. You or others could be injured. To be sure the vehicle will not move, even when you are on fairly level ground, always set the parking brake and press the P (Park) button.

If the vehicle must be left with the propulsion system on, be sure that the vehicle is in P (Park) with the parking brake set, before leaving the vehicle. After pressing the P (Park) button, hold down the regular brake pedal. If you cannot

see the P (Park) indicator in instrument cluster, it means that the vehicle has not shifted to P (Park).

Shifting out of Park

To shift out of P (Park), the vehicle must be on, the brake pedal must be applied, and the charge cord must be unplugged.

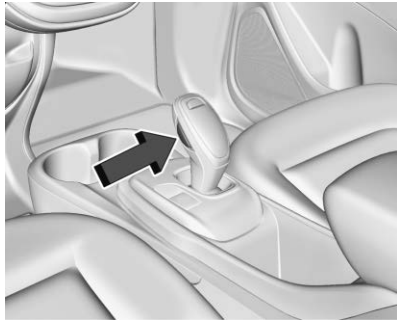

This vehicle is equipped with an electric drive unit. The shift lock release button is designed to prevent inadvertent shifting out of P (Park) unless the ignition is on, the brake pedal is applied, and the shift lock release button is pressed.

Parking the vehicle in extreme cold for several days without the charge cord connected may cause the vehicle not to start. The vehicle will need to be plugged in to allow the high voltage battery to be warmed sufficiently.

The shift lock is always functional except in the case of an uncharged or low charged 12-volt battery (less than 9 volts).

If the vehicle has an uncharged 12-volt battery or a 12-volt battery with low voltage, try charging or jump starting the 12-volt battery.

To shift out of P (Park):

1. Apply the brake pedal.
2. Press POWER  to start the vehicle.
3. Verify that the vehicle is unplugged and the vehicle ready light is on.
4. Press the shift lock release button on the side of the shift lever.

5. Move the shift lever into the desired position.
6. The P indicator will turn white and the gear indicator on the shift lever will turn red when the vehicle is no longer in P (Park).
7. After releasing the shift lever, it will return to the center position.

Extended Parking

It is best not to park with the vehicle running. If the vehicle is left running, be sure it will not move. See *Shifting Into Park* ⇨ 206.

If the vehicle is left parked and running with the Remote Keyless Entry (RKE) transmitter outside the vehicle, it will turn off after one hour.

If the vehicle is left parked and running with the RKE transmitter inside the vehicle, it will turn off after two hours.

The timer will reset if the vehicle is taken out of P (Park) while it is running.

Electric Vehicle Operating Modes

Driver Selected Operating Modes

Sport Mode

Sport Mode provides more responsive acceleration than Normal Mode, but can reduce efficiency. When the SPORT indicator is not on, the vehicle is in Normal Mode.

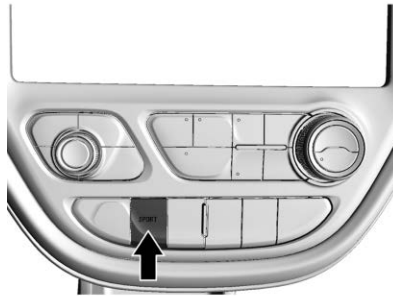

Press SPORT to select Sport Mode.

Press SPORT again to return to Normal Mode.

An indicator will display in the instrument cluster.

Each time the vehicle is started, it will return to Normal Mode.

Sport Mode may be unavailable if the battery charge is too low.

Electric Drive Unit

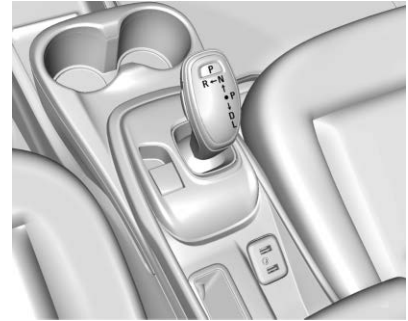

The vehicle uses an electric drive unit. The shift lever always starts from a center position. An amber dot is displayed on the shift pattern. After releasing the shift lever, it will return to the center position.

P : This position locks the front wheels. It is the best position to use when starting the propulsion system because the vehicle cannot move easily.

Warning

It is dangerous to get out of the vehicle if the P (Park) button is not pressed with the parking brake set. The vehicle can roll.

Do not leave the vehicle when the propulsion system is running. If you have left the propulsion system running, the vehicle can move suddenly. You or others could be injured. To be sure the vehicle will not move, even when you are on fairly level ground, always set the parking brake and press the P (Park) button.

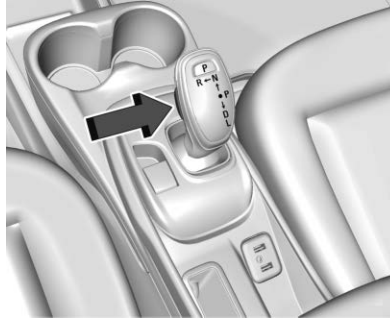

The shift lock release button is designed to prevent inadvertent shifting out of P (Park) unless the vehicle has been started, the brake pedal is applied, and the shift lock release button is pressed.

When the vehicle is stopped, apply the brakes and press the button on top of the shift lever to shift to P (Park).

The vehicle will not shift into P (Park) if it is moving too fast. Stop the vehicle and shift into P (Park).

To shift in and out of P (Park), see Shifting Into Park and Shifting out of Park.

R : Use this gear to back up.

If the vehicle is shifted from either R (Reverse) to D (Drive), or D (Drive) to R (Reverse) while the speed is too high, the vehicle will shift to N (Neutral). Reduce the vehicle speed and try the shift again.

To shift into R (Reverse):

1. Bring the vehicle to a complete stop.
2. Press the shift lock release button on the side of the shift lever.
3. From the center position, move the shift lever forward, and then to the left. R is illuminated in red.
4. After releasing the shift lever, it will return to the center position.

To shift out of R (Reverse):

1. Bring the vehicle to a complete stop.
2. Shift to the desired gear.

3. After releasing the shift lever, it will return to the center position.

At low vehicle speeds, R (Reverse) can be used to rock the vehicle back and forth to get out of snow, ice, or sand without damaging the electric drive unit.

N : In this position, the propulsion system does not connect with the wheels. To restart the propulsion system when the vehicle is already moving, use N (Neutral) only.

Caution

The vehicle is not designed to stay in N (Neutral) for extended periods of time. It will automatically shift into P (Park).

To shift into N (Neutral):

1. From the center position, move the shift lever forward. If the vehicle is in P (Park), apply the brake pedal and press the shift lock release button while

moving the shift lever forward. The shift lever indicator is illuminated in red.

2. After releasing the shift lever, it will return to the center position.

To shift out of N (Neutral):

1. Bring the vehicle to a complete stop.
2. Shift to the desired gear.
3. After releasing the shift lever, it will return to the center position.

Car Wash Mode

This vehicle includes a Car Wash Mode that allows the vehicle to remain in N (Neutral) for use in automatic car washes.

Car Wash Mode (Vehicle Off) - Driver In Vehicle

To place the vehicle in N (Neutral) with the vehicle off and occupied:

1. Drive to the entrance of the car wash.
2. Apply the brake pedal.

3. Shift to N (Neutral).
4. Turn off the vehicle and release the brake pedal.
5. The indicator should continue to show N. If it does not, repeat steps 2–4.
6. The vehicle is now ready for the car wash.

Car Wash Mode (Vehicle Off) - Driver Out of Vehicle

To place the vehicle in N (Neutral) with the vehicle off and unoccupied:

1. Drive to the entrance of the car wash.
2. Apply the brake pedal.
3. Open the door.
4. Shift to N (Neutral).
5. Turn off the vehicle and release the brake pedal.
6. The indicator should continue to show N. If it does not, repeat steps 2–5.
7. Exit the vehicle and close the door. The vehicle is now ready for the car wash.

- The vehicle may have automatically shifted to P (Park) upon reentry.

Car Wash Mode (Vehicle On) - Driver In Vehicle

To place the vehicle in N (Neutral) with the vehicle on and occupied:

- Drive to the entrance of the car wash.
- Apply the brake pedal.
- Shift to N (Neutral).
- Release the brake pedal.
- The vehicle is now ready for the car wash.

Car Wash Mode (Vehicle On) - Driver Out of Vehicle

To place the vehicle in N (Neutral) with the vehicle on and unoccupied:

- Drive to the entrance of the car wash.
- Apply the brake pedal.
- Open the door.
- Shift to N (Neutral). Then release the brake pedal.

- The indicator should continue to show N. If it does not, repeat steps 2–4.
- Exit the vehicle and close the door. The vehicle is now ready for the car wash.
- The vehicle may have automatically shifted to P (Park) upon reentry.

D : This position is for normal driving. If more power is needed for passing, press the accelerator pedal down.

To shift into D (Drive):

- Bring the vehicle to a complete stop.
- From the center position, move the shift lever back. If the vehicle is in P (Park) press the shift lock release button on the side of the shift lever, while moving the shift lever back. D is illuminated in red.
- After releasing the shift lever, it will return to the center position.

To shift out of D (Drive):

- Bring the vehicle to a complete stop.
- Shift to the desired gear.
- After releasing the shift lever, it will return to the center position.

Caution

Spinning the tires excessively may damage the electric drive unit. The repair will not be covered by the vehicle warranty. If you are stuck, do not spin the tires.

When stopping on a steep hill, use the brakes to hold the vehicle in place.

When shifting to P (Park) on a hill, use the brakes to hold the vehicle then shift to P (Park).



212 Driving and Operating

L : This position reduces vehicle speed without using the brakes. Use L (Low) on very steep hills, in deep snow, in mud, or in stop-and-go traffic.

One-Pedal Driving

With One-Pedal Driving, the accelerator pedal can be used to control the deceleration of the vehicle down to a complete stop.

Completely lifting off the accelerator pedal will result in aggressive deceleration. Slowly lifting off the accelerator pedal will allow the deceleration of the vehicle to be adjusted as desired.

To use One-Pedal Driving, place the vehicle in L (Low). Press the accelerator pedal to the desired speed. The deceleration provided by One-Pedal Driving provides full regenerative braking and helps increase energy efficiency. The brake lamps may come on when the accelerator pedal is released or during substantial deceleration from regenerative braking.

While driving on grades, One-Pedal Driving may not be able to bring the vehicle to a complete stop or hold the vehicle at a stop.

If the vehicle cannot maintain the grade while using One-Pedal Driving, the Electric Parking Brake (EPB) may apply to hold the vehicle stationary. To drive again, press the accelerator pedal, and the EPB will automatically disengage.

One-Pedal Driving may become disabled and the vehicle may continue to creep forward, or if stopped, may apply the EPB or shift to P (Park). This can be caused by the following:

- The driver door is open.
- The driver seat belt is unbuckled.
- The vehicle has remained stationary for five minutes.
- There is a problem with the propulsion system.

Additional deceleration can be achieved by using the Regen on Demand paddle. See *Regenerative Braking* ⇨ 215.

Brakes

Antilock Brake System (ABS)

This vehicle has an Antilock Brake System (ABS), an advanced electronic braking system that helps prevent a braking skid.

When propulsion is active and the vehicle begins to drive away, ABS checks itself. A momentary motor or clicking noise might be heard while this test is going on, and it might even be noticed that the brake pedal moves a little. This is normal.



If there is a problem with ABS, this warning light stays on. See *Antilock Brake System (ABS) Warning Light* ◊ 127.

If driving safely on a wet road and it becomes necessary to slam on the brakes and continue braking to avoid a sudden obstacle, a computer senses that the wheels are slowing down. If one of the wheels is about to stop rolling, the computer will separately work the brakes at each wheel.

ABS can change the brake pressure to each wheel, as required, faster than any driver could. This can help the driver steer around the obstacle while braking hard.

As the brakes are applied, the computer keeps receiving updates on wheel speed and controls braking pressure accordingly.

Remember: ABS does not change the time needed to get a foot up to the brake pedal or always decrease stopping distance. If you get too close to the vehicle in front of you, there will not be enough time to apply the brakes if that vehicle suddenly slows or stops. Always leave enough room up ahead to stop, even with ABS.



Using ABS

Do not pump the brakes. Just hold the brake pedal down firmly and let ABS work. You might hear the ABS pump or motor operating and feel the brake pedal pulsate, but this is normal.

Braking in Emergencies

ABS allows the driver to steer and brake at the same time. In many emergencies, steering can help more than even the very best braking.

Electric Parking Brake

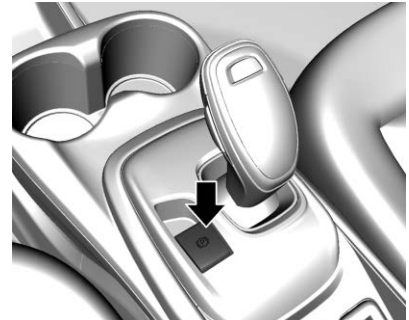

The vehicle has an Electric Parking Brake (EPB). The EPB can always be activated, even if the vehicle is off.

The system has a red parking brake status light and an amber parking brake warning light.

There are also parking brake-related Driver Information Center (DIC) messages.

In case of insufficient electrical power, the EPB cannot be applied or released.

Before leaving the vehicle, check the red parking brake status light to ensure that the parking brake is applied.

EPB Apply

To apply the EPB:

1. Be sure the vehicle is at a complete stop.
2. Pull the EPB switch momentarily.

The red parking brake status light will flash and then stay on once the EPB is fully applied. If the red

parking brake status light flashes continuously, then the EPB is only partially applied or there is a problem with the EPB. A DIC message will display. Release the EPB and try to apply it again. If the light does not come on, or keeps flashing, have the vehicle serviced. Do not drive the vehicle if the red parking brake status light is flashing. See your dealer.

If the amber parking brake warning light is on, lift up on the EPB switch and hold it up. Continue to hold the switch until the red parking brake status light remains on. If the amber parking brake warning light is still on, see your dealer.

If the EPB is applied while the vehicle is moving, the vehicle will decelerate as long as the switch is held up. If the switch is held up until the vehicle comes to a stop, the EPB will remain applied.

The vehicle may automatically apply the EPB in some situations when the vehicle is not moving. This is

normal, and is done to periodically check the correct operation of the EPB system.

If the EPB fails to apply, block the rear wheels to prevent vehicle movement.

EPB Release

To release the EPB:

1. Press POWER  to start the vehicle.
2. Apply and hold the brake pedal.
3. Press momentarily on the EPB switch.

The EPB is released when the red parking brake status light is off.

If the amber parking brake warning light is on, release the EPB by pressing down on the EPB switch and holding it down. Continue to hold the switch until the red parking brake status light is off. If either light stays on after release is attempted, see your dealer.

Caution

Driving with the parking brake on can overheat the brake system and cause premature wear or damage to brake system parts. Make sure that the parking brake is fully released and the brake warning light is off before driving.

Automatic EPB Release

The EPB will automatically release if the vehicle is running, placed into gear, and an attempt is made to drive away. Avoid rapid acceleration when the EPB is applied, to preserve parking brake lining life.

Brake Assist

The Brake Assist feature is designed to assist the driver in stopping or decreasing vehicle speed in emergency driving conditions. This feature uses the stability system hydraulic brake control module to supplement the power brake system under

conditions where the driver has quickly and forcefully applied the brake pedal in an attempt to quickly stop or slow down the vehicle. The stability system hydraulic brake control module increases brake pressure at each corner of the vehicle until the ABS activates. Minor brake pedal pulsation or pedal movement during this time is normal and the driver should continue to apply the brake pedal as the driving situation dictates. The Brake Assist feature will automatically disengage when the brake pedal is released or brake pedal pressure is quickly decreased.

Hill Start Assist (HSA)

The Hill Start Assist (HSA) feature will activate when the vehicle is stopped on a moderate to steep grade to help prevent it from rolling in an unintended direction. After the brake pedal has been released and before the accelerator pedal has been pressed, HSA uses braking

pressure to hold the vehicle stationary. If HSA is holding the vehicle, a DIC message displays.

HSA will not activate in a forward drive gear when facing downhill, or in R (Reverse) when facing uphill.

Regenerative Braking

Some braking energy from the moving vehicle is turned back into electrical energy. This energy is then stored back into the high voltage battery system, increasing energy efficiency.

Regen on Demand

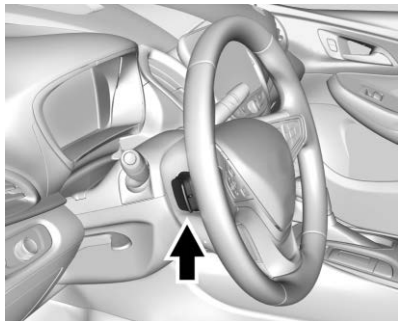

Regen on Demand allows increased deceleration by pressing and holding the steering wheel paddle. It works in D (Drive) and L (Low). The accelerator pedal can be used to manage deceleration while using Regen on Demand.

Cruise control will turn off and the brake lamps may come on when this feature is activated.

If the vehicle is in D (Drive) and is brought to a complete stop while the Regen on Demand paddle is held, the vehicle will not creep forward

when the paddle is released. The accelerator pedal must be pressed to move the vehicle forward. See “One-Pedal Driving” under *Electric Drive Unit* ⇨ 208.

If the vehicle is on a steep grade, the brake pedal must be used to hold the vehicle.

Regenerative power may be limited when the battery is near full charge or cold. The regen battery icon will appear gray when limited. The Regen power limit is also displayed as a horizontal bar on the power indicator gauge.

Hill Top Reserve

Hill Top Reserve enables regenerative braking efficiency to be maximized when driving from a higher elevation immediately after charging. When turned on, this feature will stop the charge before the battery is full, allowing space for energy from regenerative braking.

This feature also integrates with the Location Based Charging feature, allowing the system to be configured so it is enabled when at

home (On - Home Only) or away (On - Away Only). See “Location Based Charging” under *Programmable Charging* ⇨ 131.

Regenerative power may be limited when the battery is near full charge or cold. The regen battery icon in the power indicator gauge will appear gray when limited. The regen power limit is also displayed as a horizontal bar on the power indicator gauge. See *Power Indicator Gauge* ⇨ 123.

Ride Control Systems

Traction Control/ Electronic Stability Control

System Operation

The vehicle has a Traction Control System (TCS) and StabiliTrak®, an electronic stability control system. These systems help limit wheel slip and assist the driver in maintaining control, especially on slippery road conditions.

TCS activates if it senses that any of the drive wheels are spinning or beginning to lose traction. When this happens, TCS applies the brakes to the spinning wheels and reduces propulsion system power to limit wheel spin.

StabiliTrak activates when the vehicle senses a difference between the intended path and the direction the vehicle is actually traveling. StabiliTrak selectively applies braking pressure to any one of the

vehicle wheel brakes to assist the driver in keeping the vehicle on the intended path.

If cruise control is being used and TCS or StabiliTrak begins to limit wheel spin, cruise control will disengage. Cruise control may be turned back on when road conditions allow.

Both systems come on automatically when the vehicle is started and begins to move. The systems may be heard or felt while they are operating or while performing diagnostic checks. This is normal and does not mean there is a problem with the vehicle.

It is recommended to leave both systems on for normal driving conditions, but it may be necessary to turn TCS off if the vehicle gets stuck in sand, mud, ice, or snow. See “Turning the Systems Off and On” later in this section.



The indicator light for both systems is in the instrument cluster. This light will:

- Flash when TCS is limiting wheel spin.
- Flash when StabiliTrak is activated.
- Turn on and stay on when either system is not working.

If either system fails to turn on or to activate, a message displays in the Driver Information Center (DIC), and  comes on and stays on to indicate that the system is inactive and is not assisting the driver in maintaining control. The vehicle is safe to drive, but driving should be adjusted accordingly.

If  comes on and stays on:

1. Stop the vehicle.

218 Driving and Operating

2. Turn the vehicle off and wait 15 seconds.
3. Start the vehicle.



Drive the vehicle. If  comes on and stays on, the vehicle may need more time to diagnose the problem. If the condition persists, see your dealer.



Turning the Systems Off and On







Caution

Do not repeatedly brake or accelerate heavily when TCS is off. The vehicle driveline could be damaged.



To turn off only TCS, press and release . The traction off light  displays in the instrument cluster, and the appropriate message is displayed in the DIC.

To turn TCS on again, press and release . The traction off light  displayed in the instrument cluster will turn off.

If TCS is limiting wheel spin when  is pressed, the system will not turn off until the wheels stop spinning.

To turn off both TCS and StabiliTrak, press and hold  until the traction off light  and StabiliTrak OFF light  come on and stay on in the instrument cluster. The appropriate

messages are displayed in the DIC. StabiliTrak can only be disabled below 56 km/h (35 mph).

To turn TCS and StabiliTrak on again, press and release . The traction off light  and StabiliTrak OFF light  in the instrument cluster turn off.

Adding accessories can affect the vehicle performance. See *Accessories and Modifications* ⇨ 256.

Cruise Control

The cruise control lets the vehicle maintain a speed of about 40 km/h (25 mph) or more without keeping your foot on the accelerator. Cruise control does not work at speeds below 40 km/h (25 mph).

Warning

Cruise control can be dangerous where you cannot drive safely at a steady speed. Do not use cruise control on winding roads or in heavy traffic.

Cruise control can be dangerous on slippery roads. On such roads, fast changes in tire traction can cause excessive wheel slip, and you could lose control. Do not use cruise control on slippery roads.

With the Traction Control System (TCS) or Electronic Stability Control (ESC), the system may begin to limit wheel spin while you are using cruise control. If this happens, the cruise control will automatically

disengage. See *Traction Control/Electronic Stability Control* ⇨ 217. If a collision alert occurs when cruise control is activated, cruise control is disengaged. See *Forward Collision Alert (FCA) System* ⇨ 225. When road conditions allow you to safely use it again, cruise control can be turned back on.

If the brakes or the Regen on Demand paddle are applied, cruise control disengages.

Cruise control will disengage if either TCS or StabiliTrak is turned off.

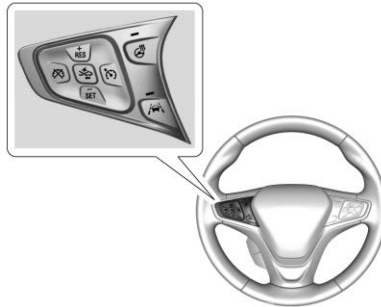



 : Press to turn the cruise control system on and off. A white indicator comes on in the instrument cluster when cruise is turned on.

 : Press to disengage cruise control without erasing the set speed from memory.

+RES : If there is a set speed in memory, press briefly to resume that speed or press and hold to accelerate. If cruise control is already active, use to increase vehicle speed.

-SET : Press briefly to set the speed and activate cruise control. If cruise control is already active, use to decrease vehicle speed.

Setting Cruise Control

If  is on when not in use, -SET or +RES could get bumped and go into cruise when not desired. Keep  off when cruise is not being used.

To set a speed:

1. Press  to turn the cruise system on.

2. Get up to the desired speed.
3. Press and release –SET. The desired set speed briefly appears in the instrument cluster.
4. Remove foot from the accelerator pedal.

The cruise control indicator on the instrument cluster turns green after cruise control has been set to the desired speed. See *Instrument Cluster* ⇨ 118.

Resuming a Set Speed

If the cruise control is set at a desired speed and then the brakes are applied or  is pressed, the cruise control is disengaged without erasing the set speed from memory.

Once the vehicle speed reaches about 40 km/h (25 mph) or more, briefly press +RES. The vehicle returns to the previous set speed.

Increasing Speed While Using Cruise Control

If the cruise control system is already activated:

- Press and hold +RES until the vehicle accelerates to the desired speed, then release it.
- To increase the speed in small increments, briefly press +RES. For each press, the vehicle goes about 1 km/h (1 mph) faster.

The speedometer reading can be displayed in either English or metric units. See *Instrument Cluster* ⇨ 118. The increment value used depends on the units displayed.

Reducing Speed While Using Cruise Control

If the cruise control system is already activated:

- Press and hold –SET until the desired lower speed is reached, then release it.

- To slow down in small increments, briefly press –SET. For each press, the vehicle goes about 1 km/h (1 mph) slower.

The speedometer reading can be displayed in either English or metric units. See *Instrument Cluster* ⇨ 118. The increment value used depends on the units displayed.

Passing Another Vehicle While Using Cruise Control

Use the accelerator pedal to increase the vehicle speed. When you take your foot off the pedal, the vehicle will slow down to the previous set cruise speed. While pressing the accelerator pedal or shortly following the release to override cruise control, briefly pressing –SET will result in cruise control set to the current vehicle speed.



Using Cruise Control on Hills

How well the cruise control works on hills depends upon the vehicle speed, load, and the steepness of the hills. When going up steep hills, you might have to step on the

accelerator pedal to maintain the vehicle speed. When going downhill, you might have to brake or shift to a lower gear to keep your speed down. If the brake pedal is applied, cruise control will disengage.

Ending Cruise Control

There are five ways to end cruise control:

- Step lightly on the brake pedal.
- Press .
- Shift the electric drive unit to N (Neutral).
- Press  to turn the cruise control system off completely.
- Activate Regen on Demand. See “Regen on Demand” under *Regenerative Braking* ⇨ 215.

Erasing Speed Memory

The cruise control set speed is erased from memory if  is pressed or if the vehicle is turned off.

Driver Assistance Systems

This vehicle may have features that work together to help avoid crashes or reduce crash damage while driving, backing, and parking. Read this entire section before using these systems.

Warning

Do not rely on the Driver Assistance Systems. These systems do not replace the need for paying attention and driving safely. You may not hear or see alerts or warnings provided by these systems. Failure to use proper care when driving may result in injury, death, or vehicle damage. See *Defensive Driving* ⇨ 194.

(Continued)

Warning (Continued)

Under many conditions, these systems will not:

- Detect children, pedestrians, bicyclists, or animals.
- Detect vehicles or objects outside the area monitored by the system.
- Work at all driving speeds.
- Warn you or provide you with enough time to avoid a crash.
- Work under poor visibility or bad weather conditions.
- Work if the detection sensor is not cleaned or is covered by ice, snow, mud, or dirt.
- Work if the detection sensor is covered up, such as with a sticker, magnet, or metal plate.

(Continued)

Warning (Continued)

- Work if the area surrounding the detection sensor is damaged or not properly repaired.

Complete attention is always required while driving, and you should be ready to take action and apply the brakes and/or steer the vehicle to avoid crashes.

Audible Alert

Some driver assistance features alert the driver of obstacles by beeping. To change the volume of the warning chime, see “Comfort and Convenience” under *Vehicle Personalization* ⇨ 143.

Assistance Systems for Parking or Backing

If equipped, the Rear Vision Camera (RVC), Rear Parking Assist (RPA), and Rear Cross Traffic Alert (RCTA)

may help the driver park or avoid objects. Always check around the vehicle when parking or backing.

Rear Vision Camera (RVC)

When the vehicle is shifted into R (Reverse), the RVC displays an image of the area behind the vehicle in the infotainment display. The previous screen displays when the vehicle is shifted out of R (Reverse) after a short delay. To return to the previous screen sooner, press  on the center stack, shift into P (Park), or reach a vehicle speed of approximately 12 km/h (8 mph).

Turn  to adjust the display brightness while viewing the infotainment display.

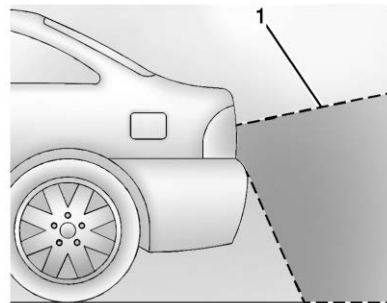

1. View Displayed by the Camera

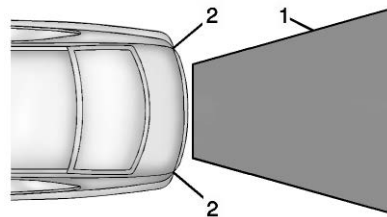

1. View Displayed by the Camera
2. Corners of the Rear Bumper

Displayed images may be farther or closer than they appear. The area displayed is limited and objects that are close to either corner of the bumper or under the bumper do not display.

A warning triangle may display to show that RPA has detected an object. This triangle changes from amber to red and increases in size the closer the object.

If  or a service message appears on the infotainment display, there may be a camera malfunction. See your dealer.

Surround Vision

If equipped, Surround Vision displays an image of the area surrounding the vehicle, along with the front or rear camera views in the infotainment display. The front camera is in the grille or near the front emblem, the side cameras are on the bottom of the outside mirrors, and the rear camera is above the license plate.

 **Warning**

The Surround Vision Cameras have blind spots and will not display all objects near the corners of the vehicle. Folding side mirrors that are out of position will not display surround view correctly. Always check around the vehicle when parking or backing.



1. Views Displayed by the Surround Vision Cameras
2. Area Not Shown

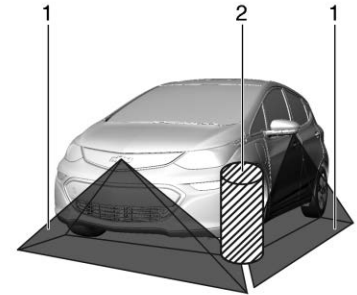

1. Views Displayed by the Surround Vision Cameras
2. Area Not Shown

Front Vision Camera



If equipped, a view of the area in front of the vehicle appears in the infotainment display. The front view shows after shifting from R (Reverse) to D (Drive) and when the vehicle is moving forward slower than 8 km/h (5 mph).

Warning

The camera(s) do not display children, pedestrians, bicyclists, crossing traffic, animals, or any
(Continued)

Warning (Continued)

other object outside of the cameras' field of view, below the bumper, or under the vehicle. Shown distances may be different from actual distances. Do not drive or park the vehicle using only these camera(s). Always check behind and around the vehicle before driving. Failure to use proper care may result in injury, death, or vehicle damage.

Parking Assist

If equipped with Rear Parking Assist (RPA), as the vehicle moves at speeds of less than 8 km/h (5 mph) the sensors on the bumpers may detect objects up to 2.3 m (7.5 ft) behind the vehicle within a zone of 25 cm (10 in) high off the ground and below bumper level. These detection distances may be shorter during warmer or humid weather. Blocked sensors will not detect objects and can also cause false detections. Keep the sensors clean

of mud, dirt, snow, ice, and slush; and clean sensors after a car wash in freezing temperatures.

Warning

The Parking Assist system does not detect children, pedestrians, bicyclists, animals, or objects located below the bumper or that are too close or too far from the vehicle. It is not available at speeds greater than 8 km/h (5 mph). To prevent injury, death, or vehicle damage, even with parking assist, always check the area around the vehicle and check all mirrors before moving forward or backing.

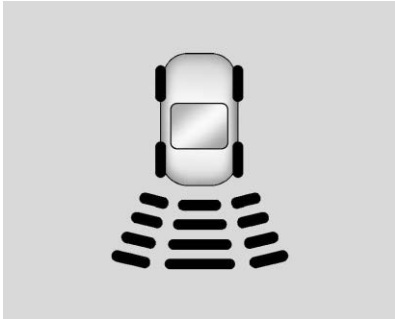

The instrument cluster may have a Parking Assist display with bars that show “distance to object” and object location information for RPA. As the object gets closer, more bars light up and the bars change color from yellow to amber to red. When an object is first detected in the rear, one beep will be heard from the rear. When an object is very close, <math><0.6\text{ m}</math> (2 ft) in the vehicle rear, five beeps will sound from the rear depending on object location.

Rear Cross Traffic Alert (RCTA)

If equipped, when the vehicle is shifted into R (Reverse), RCTA uses a red warning triangle with a left or right pointing arrow on the infotainment display to warn of traffic coming from the left or right. This system detects objects coming from up to 20 m (65 ft) from the left or right side of the vehicle. When an object is detected, three beeps sound from the left or right, depending on the direction of the detected vehicle.

Assistance Systems for Driving

If equipped, when driving the vehicle in a forward gear, Forward Collision Alert (FCA), Lane Departure Warning (LDW), Lane Keep Assist (LKA), Side Blind Zone Alert (SBZA), Lane Change Alert (LCA), Forward Automatic Braking (FAB), and/or the Front Pedestrian Braking (FPB) System can help to avoid a crash or reduce crash damage.



Forward Collision Alert (FCA) System

If equipped, the FCA system may help to avoid or reduce the harm caused by front-end crashes. When approaching a vehicle ahead too quickly, FCA provides a red flashing alert on the windshield and rapidly beeps. FCA also lights an amber visual alert if following another vehicle much too closely. FCA detects vehicles within a distance of approximately 60 m (197 ft) and operates at speeds above 8 km/h (5 mph).

Warning

FCA is a warning system and does not apply the brakes. When approaching a slower-moving or stopped vehicle ahead too rapidly, or when following a vehicle too closely, FCA may not provide a warning with enough time to help avoid a crash. It also may not provide any warning at all. FCA

(Continued)

Warning (Continued)

does not warn of pedestrians, animals, signs, guardrails, bridges, construction barrels, or other objects. Be ready to take action and apply the brakes.

Detecting the Vehicle Ahead



FCA warnings will not occur unless the FCA system detects a vehicle ahead. When a vehicle is detected, the vehicle ahead indicator will display green. Vehicles may not be detected on curves, highway exit ramps, or hills, due to poor visibility; or if a vehicle ahead is partially blocked by pedestrians or other objects. FCA will not detect another vehicle ahead until it is completely in the driving lane.

Warning

FCA does not provide a warning to help avoid a crash, unless it detects a vehicle. FCA may not detect a vehicle ahead if the FCA sensor is blocked by dirt, snow, or ice, or if the windshield is damaged. It may also not detect a vehicle on winding or hilly roads, or in conditions that can limit visibility such as fog, rain, or snow, or if the headlamps or windshield are not cleaned or in proper condition. Keep the windshield, headlamps, and FCA sensors clean and in good repair.

Collision Alert



When your vehicle approaches another detected vehicle too rapidly, the red FCA display will flash on the windshield. Also, eight rapid high-pitched beeps will sound from the front. When this Collision Alert occurs, the brake system may prepare for driver braking to occur more rapidly which can cause a brief, mild deceleration. Continue to apply the brake pedal as the driving situation dictates. Cruise control may be disengaged when the Collision Alert occurs.

Tailgating Alert

The vehicle ahead indicator will display amber when you are following a detected vehicle ahead much too closely.

Selecting the Alert Timing

The Collision Alert control is on the steering wheel. Press  to set the FCA timing to far, medium, near, or off. The first button press shows the current control setting on the DIC. Additional button presses will change this setting. The chosen

setting will remain until it is changed and will affect the timing of both the Collision Alert and the Tailgating Alert features. The timing of both alerts will vary based on vehicle speed. The faster the vehicle speed, the farther away the alert will occur. Consider traffic and weather conditions when selecting the alert timing. The range of selectable alert timing may not be appropriate for all drivers and driving conditions.

Following Distance Indication

The following distance to a moving vehicle you are following is indicated in following time in seconds on the Driver Information Center (DIC).

The minimum following time is 0.5 seconds away. If there is no vehicle detected ahead, or the vehicle ahead is out of sensor range, dashes will be displayed.

Unnecessary Alerts

FCA may provide unnecessary alerts to turning vehicles, vehicles in other lanes, objects that are not

vehicles, or shadows. These alerts are normal operation and the vehicle does not need service.

Cleaning the System

If the FCA system does not seem to operate properly, this may correct the issue:

- Clean the outside of the windshield in front of the rearview mirror.
- Clean the entire front of the vehicle.
- Clean the headlamps.

Forward Automatic Braking (FAB)

If the vehicle has Forward Collision Alert (FCA), it also has FAB, which includes Intelligent Brake Assist (IBA). When the system detects a vehicle ahead in your path that is traveling in the same direction that you may be about to crash into, it can provide a boost to braking or automatically brake the vehicle. This can help avoid or lessen the severity of crashes when

driving in a forward gear. Depending on the situation, the vehicle may automatically brake moderately or hard. This forward automatic braking can only occur if a vehicle is detected. This is shown by the FCA vehicle ahead indicator being lit. See *Forward Collision Alert (FCA) System* ⇨ 225.

The system works when driving in a forward gear between 8 km/h (5 mph) and 80 km/h (50 mph). It can detect vehicles up to approximately 60 m (197 ft).

Warning

FAB is an emergency crash preparation feature and is not designed to avoid crashes. Do not rely on FAB to brake the vehicle. FAB will not brake outside of its operating speed range and only responds to detected vehicles.

(Continued)

Warning (Continued)

FAB may not:

- Detect a vehicle ahead on winding or hilly roads.
- Detect all vehicles, especially vehicles with a trailer, tractors, muddy vehicles, etc.
- Detect a vehicle when weather limits visibility, such as in fog, rain, or snow.
- Detect a vehicle ahead if it is partially blocked by pedestrians or other objects.

Complete attention is always required while driving, and you should be ready to take action and apply the brakes and/or steer the vehicle to avoid crashes.

FAB may slow the vehicle to a complete stop to try to avoid a potential crash. If this happens, FAB may engage the Electric Parking

Brake (EPB) to hold the vehicle at a stop. Release the EPB or firmly press the accelerator pedal.

 **Warning**

FAB may automatically brake the vehicle suddenly in situations where it is unexpected and undesired. It could respond to a turning vehicle ahead, guardrails, signs, and other non-moving objects. To override FAB, firmly press the accelerator pedal, if it is safe to do so.

Intelligent Brake Assist (IBA)

IBA may activate when the brake pedal is applied quickly by providing a boost to braking based on the speed of approach and distance to a vehicle ahead.

Minor brake pedal pulsations or pedal movement during this time is normal and the brake pedal should continue to be applied as needed.

IBA will automatically disengage only when the brake pedal is released.

 **Warning**

IBA may increase vehicle braking in situations when it may not be necessary. You could block the flow of traffic. If this occurs, take your foot off the brake pedal and then apply the brakes as needed.

FAB and IBA can be disabled through vehicle personalization. See “Collision/Detection Systems” under *Vehicle Personalization* ⇨ 143.

A system unavailable message may display if:

- The front of the vehicle or windshield is not clean.
- Heavy rain or snow is interfering with object detection.
- There is a problem with the StabiliTrak system.

The FAB system does not need service.

Front Pedestrian Braking (FPB) System

If equipped, the FPB system may help avoid or reduce the harm caused by front-end crashes with nearby pedestrians when driving in a forward gear. FPB displays an amber indicator, , when a nearby pedestrian is detected directly ahead. When approaching a detected pedestrian too quickly, FPB provides a red flashing alert on the windshield and rapidly beeps. FPB can provide a boost to braking or automatically brake the vehicle. This system includes Intelligent Brake Assist (IBA), and the Forward Automatic Braking (FAB) System may also respond to pedestrians. See *Forward Automatic Braking (FAB)* ⇨ 227.

The FPB system can detect and alert to pedestrians in a forward gear at speeds between 8 km/h (5 mph) and 80 km/h (50 mph). During daytime driving, the system detects pedestrians up to a distance

of approximately 40 m (131 ft). During nighttime driving, system performance is very limited.

Warning

FPB does not provide an alert or automatically brake the vehicle, unless it detects a pedestrian. FPB may not detect pedestrians, including children:

- When the pedestrian is not directly ahead, fully visible, or standing upright, or when part of a group.
- Due to poor visibility, including nighttime conditions, fog, rain, or snow.
- If the FPB sensor is blocked by dirt, snow, or ice.
- If the headlamps or windshield are not cleaned or in proper condition.

(Continued)

Warning (Continued)

Be ready to take action and apply the brakes. For more information, see *Defensive Driving* ⇨ 194. Keep the windshield, headlamps, and FPB sensor clean and in good repair.

FPB can be set to Off, Alert, or Alert and Brake through vehicle personalization. See “Collision/Detection Systems” under *Vehicle Personalization* ⇨ 143.

Detecting the Pedestrian Ahead



FPB alerts and automatic braking will not occur unless the FPB system detects a pedestrian. When a nearby pedestrian is detected

directly in front of the vehicle, the pedestrian ahead indicator will display amber.

Front Pedestrian Alert



When the vehicle approaches a pedestrian ahead too rapidly, the red FPB alert display will flash on the windshield. Eight rapid high-pitched beeps will sound from the front. When this Pedestrian Alert occurs, the brake system may prepare for driver braking to occur more rapidly which can cause a brief, mild deceleration. Continue to apply the brake pedal as needed. Cruise control may be disengaged when the Front Pedestrian Alert occurs.

Automatic Braking

If FPB detects it is about to crash into a pedestrian directly ahead, and the brakes have not been applied, FPB may automatically brake moderately or brake hard. This can help to avoid some very low speed pedestrian crashes or reduce pedestrian injury. FPB can automatically brake to detected pedestrians between 8 km/h (5 mph) and 80 km/h (50 mph). Automatic braking levels may be reduced under certain conditions, such as higher speeds.

If this happens, Automatic Braking may engage the Electric Parking Brake (EPB) to hold the vehicle at a stop. Release the EPB. A firm press of the accelerator pedal will also release Automatic Braking and the EPB.

Warning

FPB may alert or automatically brake the vehicle suddenly in situations where it is unexpected and undesired. It could falsely alert or brake for objects similar in shape or size to pedestrians, including shadows. This is normal operation and the vehicle does not need service. To override Automatic Braking, firmly press the accelerator pedal, if it is safe to do so.

Automatic Braking can be disabled through vehicle personalization. See “Front Pedestrian Detection” in “Collision/Detection Systems” under *Vehicle Personalization* ⇨ 143.

Cleaning the System

If FPB does not seem to operate properly, cleaning the outside of the windshield in front of the rearview mirror may correct the issue.

Side Blind Zone Alert (SBZA)

If equipped, the SBZA system is a lane-changing aid that assists drivers with avoiding crashes that occur with moving vehicles in the side blind zone (or spot) areas. When the vehicle is in a forward gear, the left or right side mirror display will light up if a moving vehicle is detected in that blind zone. If the turn signal is activated and a vehicle is also detected on the same side, the display will flash as an extra warning not to change lanes. Since this system is part of the Lane Change Alert (LCA) system, read the entire LCA section before using this feature.

Lane Change Alert (LCA)

If equipped, the LCA system is a lane-changing aid that assists drivers with avoiding lane change crashes that occur with moving vehicles in the side blind zone (or spot) areas or with vehicles rapidly approaching these areas from

behind. The LCA warning display will light up in the corresponding outside mirror and will flash if the turn signal is on.

Warning

LCA does not alert the driver to vehicles outside of the system detection zones, pedestrians, bicyclists, or animals. It may not provide alerts when changing lanes under all driving conditions. Failure to use proper care when changing lanes may result in injury, death, or vehicle damage. Before making a lane change, always check mirrors, glance over your shoulder, and use the turn signals.

LCA Detection Zones

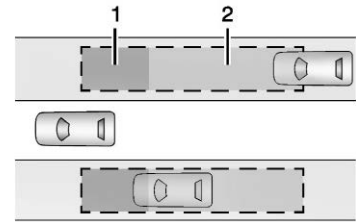

1. SBZA Detection Zone
2. LCA Detection Zone

The LCA sensor covers a zone of approximately one lane over from both sides of the vehicle, or 3.5 m (11 ft). The height of the zone is approximately between 0.5 m (1.5 ft) and 2 m (6 ft) off the ground. The Side Blind Zone Alert (SBZA) warning area starts at approximately the middle of the vehicle and goes back 5 m (16 ft). Drivers are also warned of vehicles rapidly approaching from up to 25 m (82 ft) behind the vehicle.

How the System Works

The LCA symbol lights up in the side mirrors when the system detects a moving vehicle in the next lane over that is in the side blind zone or rapidly approaching that zone from behind. A lit LCA symbol indicates it may be unsafe to change lanes. Before making a lane change, check the LCA display, check mirrors, glance over your shoulder, and use the turn signals.



Left Side Mirror Display **Right Side Mirror Display**

When the vehicle is started, both outside mirror LCA displays will briefly come on to indicate the system is operating. When the vehicle is in a forward gear, the left or right side mirror display will light up if a moving vehicle is detected in the next lane over in that blind zone

or rapidly approaching that zone. If the turn signal is activated in the same direction as a detected vehicle, this display will flash as an extra warning not to change lanes.

LCA can be disabled through vehicle personalization. See "Collision/Detection Systems" under *Vehicle Personalization* ⇨ 143. If LCA is disabled by the driver, the LCA mirror displays will not light up.

When the System Does Not Seem to Work Properly

The LCA system requires some driving for the system to calibrate to maximum performance. This calibration may occur more quickly if the vehicle is driven on a straight highway road with traffic and roadside objects (e.g., guardrails, barriers).

LCA displays may not come on when passing a vehicle quickly or for a stopped vehicle. LCA may alert to objects attached to the vehicle, such as a bicycle, or object extending out to either side of the vehicle. Attached objects may also

interfere with the detection of vehicles. This is normal system operation; the vehicle does not need service.

LCA may not always alert the driver to vehicles in the next lane over, especially in wet conditions or when driving on sharp curves. The system does not need to be serviced. The system may light up due to guardrails, signs, trees, shrubs, and other non-moving objects. This is normal system operation; the vehicle does not need service.

LCA may not operate when the LCA sensors in the left or right corners of the rear bumper are covered with mud, dirt, snow, ice, or slush, or in heavy rainstorms. For cleaning instructions, see "Washing the Vehicle" under *Exterior Care* ⇨ 311. If the DIC still displays the system unavailable message after cleaning both sides of the vehicle toward the rear corners of the vehicle, see your dealer.

If the LCA displays do not light up when moving vehicles are in the side blind zone or rapidly

approaching this zone and the system is clean, the system may need service. Take the vehicle to your dealer.

Lane Departure Warning (LDW)

If equipped, LDW may help avoid crashes due to unintentional lane departures. It may provide a warning if the vehicle is crossing a detected lane marking without using a turn signal in the lane departure direction. Since this system is part of the Lane Keep Assist (LKA) system, read the entire LKA section before using this feature.

Lane Keep Assist (LKA)

If equipped, LKA may help avoid crashes due to unintentional lane departures. It may assist by gently turning the steering wheel if the vehicle approaches a detected lane marking without using a turn signal in that direction. It may also provide a Lane Departure Warning (LDW) system alert as the lane marking is

crossed. The LKA system will not assist or provide an LDW alert if it detects that you are actively steering. Override LKA by turning the steering wheel. LKA uses a camera to detect lane markings between 60 km/h (37 mph) and 155 km/h (96 mph).

Warning

The LKA system does not continuously steer the vehicle. It may not keep the vehicle in the lane or give a Lane Departure Warning (LDW) alert, even if a lane marking is detected. The LKA and LDW systems may not:

- Provide an alert or enough steering assist to avoid a lane departure or crash.
- Detect lane markings under poor weather or visibility conditions. This can occur if the windshield or headlamps are blocked by dirt, snow, or ice, if they are

(Continued)

Warning (Continued)

not in proper condition, or if the sun shines directly into the camera.

- Detect road edges.
- Detect lanes on winding or hilly roads.

If LKA only detects lane markings on one side of the road, it will only assist or provide an LDW alert when approaching the lane on the side where it has detected a lane marking. Even with LKA and LDW, you must steer the vehicle. Always keep your attention on the road and maintain proper vehicle position within the lane, or vehicle damage, injury, or death could occur. Always keep the windshield, headlamps, and camera sensors clean and in good repair. Do not use LKA in bad weather conditions.



Warning

Using LKA on slippery roads could cause loss of control of the vehicle and a crash. Turn the system off.

How the System Works

The LKA camera sensor is on the windshield ahead of the rearview mirror.

To turn LKA on and off, press  on the steering wheel.

When on,  is green if LKA is available to assist and provide LDW alerts. It may assist by gently turning the steering wheel and display  as amber if the vehicle approaches a detected lane marking without using a turn signal in that direction. It may also provide an LDW alert by flashing  amber as the lane marking is crossed.

Additionally, there may be three beeps on the right or left, depending on the lane departure direction.

The LKA system does not continuously steer the vehicle. If LKA does not detect active driver steering, an alert and chime may be provided. Move the steering wheel to dismiss.

When the System Does Not Seem to Work Properly

The system performance may be affected by:

- Close vehicles ahead.
- Sudden lighting changes, such as when driving through tunnels.
- Banked roads.
- Roads with poor lane markings, such as two-lane roads.

If the LKA system is not functioning properly when lane markings are clearly visible, cleaning the windshield may help.

LKA assistance and/or LDW alerts may occur due to tar marks, shadows, cracks in the road, temporary or construction lane markings, or other road imperfections. This is normal system operation; the vehicle does not need service. Turn LKA off if these conditions continue.

Charging

When to Charge

When the high voltage battery is getting low, charging messages may display.

The CHARGE VEHICLE SOON message indicates that the driving range is low and the vehicle needs to be charged soon. As the charge level drops, the PROPULSION POWER IS REDUCED message is displayed and the accelerator pedal response is reduced. In addition, the remaining range value will change to LOW indicating the vehicle should be charged immediately.

When the energy is fully depleted, the OUT OF ENERGY, CHARGE VEHICLE NOW message displays and the vehicle slows to a stop. Brake and steering assist will still operate. Once the vehicle has stopped, turn the vehicle off.

Plug-In Charging

This section explains the process for charging the high voltage battery. Do not allow the vehicle to remain in temperature extremes for long periods without being driven or plugged in. It is recommended that the vehicle be plugged in when temperatures are below 0 °C (32 °F) and above 32 °C (90 °F) to maximize high voltage battery life.

When using a 120-volt AC electrical outlet, it will take approximately 50 hours to charge the vehicle from a fully depleted battery with the 12 amp AC current setting, allowing approximately 6 km (4 mi) for every hour of charging.

When using a 240-volt charging station, it will take approximately 9.5 hours to charge the vehicle with the 32 amp setting, allowing approximately 40 km (25 mi) for every hour of charging.

Charge times will vary based on battery condition, charge level, and outside temperature. See *Programmable Charging* ⇨ 131 for charge mode selection.

If equipped, the vehicle can be charged using DC charging equipment typically found at service stations and other public locations.

When using a DC charging station with at least 80 kW of available power, it will take approximately 30 minutes to recharge from a depleted battery to an estimated 145 km (90 mi) of driving range. This time estimate is applicable to nominal temperature ranges. In extreme hot or cold conditions, this time may be lengthened. A full charge will take additional time.

The charging system may run fans and pumps that result in sounds from the vehicle while it is turned off. Additionally, clicking sounds may be caused by the electrical devices used while charging.

The vehicle does not require indoor charging area ventilation before, during, or after charging.

The vehicle cannot be driven while the charge cord is plugged into the vehicle.

Charging Override

A CHARGING OVERRIDE/ INTERRUPTION OCCURRED message may display to indicate that a charging override or interruption has occurred due to one or more of the following events:

- Override of the charge settings by the owner.
- Unintended interruption of AC power at the vehicle's charge port.
- Interruption of charging by the utility company.

There are several screens that will display depending on the current charging status. See *Programmable Charging* ⇨ 131.

A loss of AC power alert may sound for a short time if AC power is lost for over one minute. This sound alert can be turned off. See *Vehicle Personalization* ⇨ 143.

AC Charging



AC Charge Cord Vehicle Plug

Start Charge

1. Make sure the vehicle is parked.



2. Push the rearward edge of the charge port door and release to open the door.

In cold weather conditions, ice may form around the charge port door. Remove ice from the area before attempting to open or close the charge port door.



3. Open the liftgate, lift the load floor cover, and remove the charge cord.
4. Plug the charge cord into the electrical outlet. Verify the charge cord status and select the appropriate charge level. See *Electrical Requirements for Battery Charging* ⇨ 251. See *Charge Cord* ⇨ 243. See “Charge Current Limit Selection” under *Programmable Charging* ⇨ 131.



5. Plug in the AC vehicle plug of the charge cord into the charge port on the vehicle. Make sure the AC vehicle plug is fully connected to the AC charge port. If it is not properly seated, the charge may not occur.
6. Verify that the Charging Status Indicator illuminates on top of the instrument panel and an audible chirp occurs. See *Charging Status Feedback* ⇨ 240.
7. To arm the charge cord theft alert, lock the vehicle twice with the RKE transmitter. To disarm

this feature, see “Energy Settings” under *Energy Information* ⇨ 138.

End Charge

1. Unlock the vehicle with the RKE transmitter to disarm the charge cord theft alert.
2. Unplug the vehicle plug of the charge cord from the vehicle. Unlock the vehicle plug of the charge cord from the vehicle by pressing the button on the top of the charge cord plug.
3. Close the charge port door by pressing firmly in the center until it latches.
4. Unplug the charge cord from the electrical outlet.
5. Place the charge cord into the storage compartment.

DC Charging (If Equipped)

DC Charging Station Hardware

Check the charge station DC vehicle plug for compatibility with the DC charge port on this vehicle. When recharging at a DC fast

charge station, the power cable connected to the vehicle must be less than 10 m (33 ft) in length.

Follow the steps listed on the charging station to perform a DC vehicle charge.

If for any reason DC charging does not begin or is interrupted, check the DC charge station display for messages. Unplug to restart the DC charge process.

Start Charge

1. Make sure the vehicle is parked.
2. Push the rearward edge of the charge port door and release to open the door.

In cold weather conditions, ice may form around the charge port door. The charge port door may not open on the first attempt. Remove ice from the area and repeat attempting to open the charge port door.

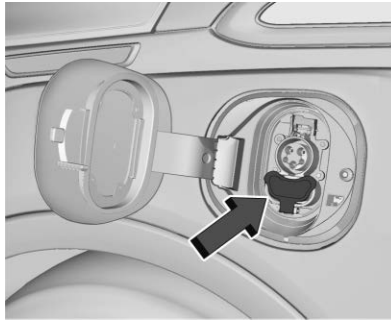

3. Unlatch the DC charging dust cover and lower it fully.
4. Plug in the DC vehicle plug into the DC charge port on the vehicle. Make sure that the DC vehicle plug is fully connected to the DC charge port. If it is not properly seated then the charge may not occur. Proper plug connection can be checked by information on the DIC.
5. Follow the steps listed on the charging station to start charging. The Electric Parking

Brake will automatically apply once the charge process has been started.

6. Once charging, the DC vehicle plug will be locked to the DC charge port and cannot be disconnected while charging is active.
7. Verify that the Charging Status Indicator illuminates on top of the instrument panel and an audible chirp occurs. See *Charging Status Feedback* ⇨ 240.

Caution

Do not attempt to disconnect the DC vehicle plug while charging is active. This action may damage vehicle or charging station hardware.

Stop Charge

Controls on the charging station can be used to stop the charge process at any time.

To stop the charge when inside the vehicle, you may use the stop charging button on the Charging screen. See *Programmable Charging* ⇨ 131.

There is also an available mobile app with several charging functions. See *KeyPass* ⇨ 45.

Stop Charge — Automatic

When the vehicle no longer needs to use power from the charging station, it will stop charging and the DC vehicle plug will be unlocked from the DC charge port.

Energy can still be consumed from the charging station when the vehicle's displays and indicators show that the battery is fully charged. This is to ensure the battery is in optimal temperature operating range to maximize vehicle range. See *Programmable Charging* ⇨ 131.

End Charge

1. Wait until the charging process has been fully stopped, the vehicle plug is unlocked, and the Charging Status Indicator is solid green or off.

If the vehicle plug does not unlock from the vehicle charge port after a charge, contact Roadside Assistance for assistance. See *Roadside Assistance Program* ⇨ 336.

2. Unplug the DC vehicle plug from the DC charge port on the vehicle and close the dust cover.
3. Close the charge port door by pressing firmly in the center until it latches.
4. The Electric Parking Brake should be manually disengaged before driving the vehicle.
5. To start another DC charge, remove the DC vehicle plug and reconnect.

Delayed Charging Override

To temporarily override a delayed charge event, unplug the charge cord from the charge port and then plug it back in within five seconds. A single audible chirp will sound and charging will begin immediately.

To cancel a temporary override, unplug the charge cord, wait for 10 seconds, and then plug the charge cord back in. A double audible chirp will sound and charging will be delayed.

See *Programmable Charging* ⇨ 131 for advanced charge scheduling options.

Charging Status Feedback

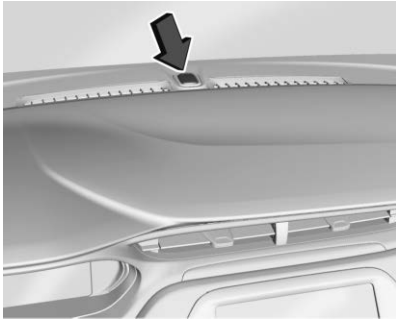

The vehicle has a Charging Status Indicator (CSI) at the center of the instrument panel near the windshield. When the vehicle is plugged in and the vehicle power is off, the CSI indicates the following:

- Short Flashing Green – Vehicle is plugged in. Battery is not fully charged. Flash rate increases from one to four flashes as battery charges.

- Long Flashing Green – Vehicle is plugged in. Battery is not fully charged. Battery charging is delayed.
- Solid Green – Vehicle is plugged in. Battery is fully charged.
- Solid Yellow – Vehicle is plugged in. It is normal for the CSI to turn yellow for a few seconds after plugging in a compatible charge cord. The solid yellow may be extended depending on the vehicle and if there is a total utility interruption. See *Utility Interruption of Charging* ⇨ 250. This may also indicate that the charging system has detected a fault and will not charge the battery. See “Charge Cord Status Indicators” in *Charge Cord* ⇨ 243.

If the vehicle is plugged in and vehicle power is on, the CSI will flash or will be solid green, depending on the charge level.

If the vehicle is plugged in and the CSI is off, a total utility interruption or a charging fault has been detected. See *Utility Interruption of Charging* ⇨ 250 or “Charge Cord Status Indicators” in *Charge Cord* ⇨ 243.

A message displays if the vehicle is not able to charge.

Following is the vehicle feedback when the charge cord is plugged in.

Charging Status Indicator	Sound	Action/Reason
Short Flashing Green (Flash rate increases from one to four as the battery charges)	One audible chirp	Vehicle is charging.
Long Flashing Green	Two audible chirps	Charging is delayed by Programmable Charging or, if the vehicle is equipped accordingly, by a total utility interruption. Charging will begin later. See <i>Utility Interruption of Charging</i> ⇨ 250.
Short Flashing Green (From one to four flashes depending on charge level)	Two audible chirps	Vehicle is charging but will delay by Programmable Charging at least once before the charge is complete.
Solid Green	None	Charging is complete.
Yellow (Upon Plug-in)	None	Charge cord is OK and the vehicle is preparing to charge.

242 Driving and Operating

Charging Status Indicator	Sound	Action/Reason
Yellow (For Extended Time Period after Plug-in)	None	Charge cord is OK, but the vehicle is not charging. This may be due to a total utility interruption and charging will begin later. This may also occur if the vehicle has detected a high voltage charging system fault. <i>See Utility Interruption of Charging ⇨ 250 or Service Vehicle Soon Light ⇨ 126.</i>
Short Flashing Green (From one to four flashes depending on charge level) or Long Flashing Green	Four audible chirps	Insufficient time to fully charge by departure time due to the selected rate preference. To increase the battery state of charge at the departure time perform a delayed charging override. <i>See Delayed Charging Override ⇨ 239.</i>
None (Upon Plug-in)	None	Charge cord connection should be checked.
None (After Green or Yellow CSI Indication Observed)	None	Charge cord connection should be checked. If connection is good, this may be due to a power failure or a total utility interruption and charging will begin later. This may also occur if the vehicle has detected a high voltage charging system fault. <i>See Utility Interruption of Charging ⇨ 250 or Service Vehicle Soon Light ⇨ 126.</i>

Charging Status Indicator	Sound	Action/Reason
None	Repeated audible chirps	Electricity has been interrupted before charging was complete. Repeated chirps will stop if power is restored within 90 seconds.
None	Three audible chirps	Charge port door is open.

To disable this feature, see “Charge Power Loss Alert” in *Energy Information* ⇨ 138.

To stop this alert, do one of the following:

- Unplug the charge cord.
- Press  on the RKE transmitter.

- Press and hold  on the RKE transmitter, then press again to stop the panic alarm.
- Press the horn pad.

Charge Cord

IMPORTANT SAFETY INSTRUCTIONS



This symbol indicates risk of electrical shock if misused.

See *Radio Frequency Statement* ⇨ 342.

244 Driving and Operating

A portable charge cord used to charge the vehicle high voltage battery is stored under the load floor in the rear cargo area.

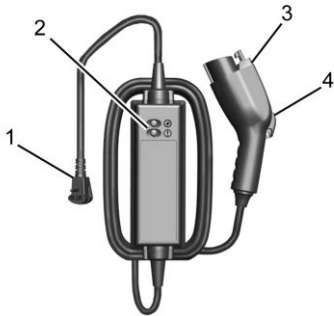

1. Wall Plug
2. Status Indicators
3. Vehicle Plug
4. Release Button

Important Information about Portable Electric Vehicle Charging

- Charging an electric vehicle can stress a building's electrical system more than a typical household appliance.
- Before plugging into any electrical outlet, have a qualified electrician inspect and verify the electrical system (electrical outlet, wiring, junctions, and protection devices) for heavy-duty service at a 12 amp continuous load.
- Electrical outlets may wear out with normal usage or may be damaged over time, making them unsuitable for electric vehicle charging.
- Check the electrical outlet/plug while charging and discontinue use if the electrical outlet/plug is hot, then have the electrical outlet serviced by a qualified electrician.
- When outdoors, plug into an electrical outlet that is weatherproof while in use.
- Mount the charge cord to reduce strain on the electrical outlet/plug.
- Do not place the charge cord in a position where it is expected to be submerged in water.

Danger

Improper use of portable electric vehicle charge cords may cause a fire, electrical shock, or burns, and may result in damage to property, serious injury, or death.

(Continued)

Danger (Continued)

- Do not use extension cords, multi-outlet power strips, splitters, grounding adaptors, surge protectors, or similar devices.
- Do not use an electrical outlet that is worn or damaged, or will not hold the plug firmly in place.
- Do not use an electrical outlet that is not properly grounded.
- Do not use an electrical outlet that is on a circuit with other electrical loads.

 **Warning**

When using electric products, basic precautions should always be followed, including the following:

- Read all the safety warnings and instructions before using this product. Failure to follow the warnings and the instructions may result in electric shock, fire, and/or serious injury.
- Never leave children unattended near the vehicle while the vehicle is charging and never allow children to play with the charge cord.
- If the plug provided does not fit the electrical outlet, do not modify the plug. Arrange for a qualified electrician to inspect the electrical outlet.
- Do not put fingers into the electric vehicle connector.

 **Warning**

- To reduce the risk of fire, installations shall comply with the requirements of National Electric Code, ANSI/NFPA 70 (USA), Canadian Electrical Code CSA 22.1 and IEC 60364 – Electrical installations in buildings, depending on the region in which the unit is being installed. The installer shall comply with any additional local requirements mandated by the country and/or municipality.
- Do not use this product if the flexible power cord or the electric vehicle cable is frayed, has broken insulation, or shows any other signs of damage.
- For Canada only: Not for use in commercial garages.

(Continued)

Warning (Continued)

- Do not use this product if the enclosure or the vehicle plug is broken, cracked, open, or shows any other indication of damage.
- The plug must be plugged into an appropriate electrical outlet that is properly installed in accordance with all local codes and ordinances. Do not modify the plug provided with the product. If the plug does not fit the electrical outlet, have a proper electrical outlet installed by a qualified electrician. If ground is missing, the charge cord indicators will indicate an electrical system fault and the vehicle may not charge.



Charge Cord Status Indicators

After plugging in the charge cord, it will perform a quick self test.

Verify the charge cord status. When the ⚡ indicator is lit solid green, the charge cord is ready to charge the vehicle.

The charge cord utilizes a combination of the ⚡ and ⚠ indicators to display the status of the charge cord per the following table.

⊗	⓪	Symbol	Fault/Condition/Event
● Solid Green	○ Off (No Light)	✓	No Faults: The charge cord is receiving power from the electrical outlet and is ready to supply it to the vehicle.
⊗ Flashing Green	● Solid Red	X ⊕ ⚡	Electrical Outlet/Plug Fault: The charge cord has detected that the electrical outlet/plug overheated. Electrical outlets may wear out with normal usage or may be damaged over time, making them unsuitable for electric vehicle charging. Do not use an electrical outlet that is worn, damaged, or one that will not hold the plug firmly in place. Use another electrical outlet or have the electrical outlet serviced by a qualified electrician. Reset the charge cord by unplugging the charge cord from the electrical outlet and re-plugging it.
○ Off (No Light)	● Solid Red	X ⚡	Electrical System Fault: The charge cord has detected a missing or improper ground within the building's electrical system. Do not use an electrical outlet that is not properly grounded. Use another electrical outlet or have a qualified electrician inspect and verify the building's electrical system.

⚡	ⓘ	Symbol	Fault/Condition/Event
○ Off (No Light)	● Flashing Red	X 	Vehicle Fault: The charge cord ground-fault circuit interrupter (GFCI) has tripped. Ensure that there is no physical damage to the charge cord, and that the vehicle plug is seated completely and making a good connection. Reset the charge cord by unplugging it from the electrical outlet and re-plugging it. If the fault remains, see an authorized dealer for service.
● Solid Green	● Flashing Red	X 	Charge Cord Fault: The charge cord has detected a potential problem with the charge cord. Reset the charge cord by unplugging it from the electrical outlet and re-plugging it. If the fault remains, see an authorized dealer for service.

If no status indicators are lit, ensure the electrical outlet is powered.

Charge Limit Selection

Charge level selection can be made using the Charge Mode tab on the Charging screen on the infotainment display. See “Charge Current Limit Selection” under *Programmable Charging* ⇨ 131.

Warning

Using a charge level that exceeds the electrical circuit or electrical outlet capacity may start a fire or damage the electrical circuit. Use the lowest charge level until a qualified electrician inspects the electrical circuit capacity. Use the

(Continued)

Warning (Continued)

lowest charge level if the electrical circuit or electrical outlet capacity is not known.

Grounding Instructions

The charge circuit must be grounded. If this charge circuit should malfunction or break down, grounding provides a path of least resistance for electric current to reduce the risk of electric shock. This product is equipped with a cord that has an equipment grounding conductor and a grounding plug. The plug must be plugged into an appropriate outlet that is properly installed and grounded in accordance with all local codes and ordinances.

Warning

Improper connection of the charge cord ground may cause electrical shock. Check with a qualified electrician if there is doubt as to whether the charge circuit is properly grounded. Do not modify the plug provided with the product. If it will not fit the

(Continued)

Warning (Continued)

electrical outlet, have a proper electrical outlet installed by a qualified electrician.

Mounting Instructions

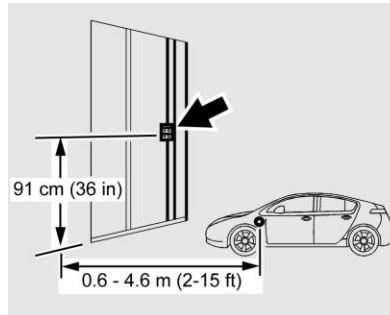

1. Identify an appropriate location for the charge cord.
2. Locate a mounting support, such as a wall stud.

The appropriate height for mounting the charge cord is 91 cm (36 in) from the floor.

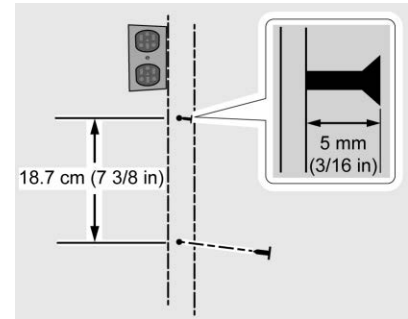

3. Mark and drill the mounting holes in a wall stud or suitable structure. Stay away from any power source.
Space the holes 18.7 cm (7 3/8 in) apart.
4. Install the mounting screws in the wall surface leaving the head of the screws 5 mm (3/16 in) from the surface.

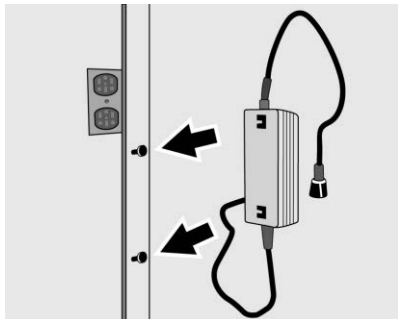

5. Securely mount the charge cord on to the screws.
6. Connect the wall plug to the electrical outlet.
7. Connect the vehicle plug to the charge port.

Lock Feature

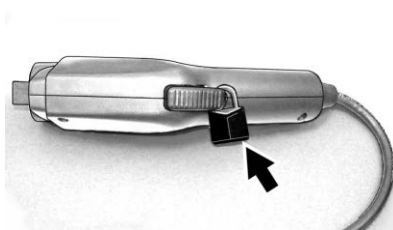

A lock can be added to the vehicle plug for additional security.

FCC Information

See *Radio Frequency Statement*
⇨ 342.

Utility Interruption of Charging

This vehicle will respond to requests through the utility company to limit or completely block electrical power grid usage. This feature is inactive during DC charging. A utility interruption of charging will lengthen the vehicle charge time.

When electrical grid power is completely blocked, the vehicle will delay charging until the utility interruption has expired. The vehicle should be left plugged in so that the vehicle can automatically begin charging.

Changing the charge mode to Immediate or performing a delayed charging override will not disable a utility interruption.

A pop-up will appear in the infotainment display while starting the vehicle following any utility interruption. See “Charging Interrupted or Overridden Pop-Up” under *Programmable Charging*
⇨ 131.

A message will display on the instrument cluster indicating that a utility interruption has occurred.

Charging Station Troubleshooting

If the vehicle does not charge after being plugged in to a residential 240-volt charging station:

1. Verify that the charge mode is set to Immediate.
2. Verify that the charging station's circuit breaker has not been tripped.
3. Plug the portable charge cord into the wall outlet, verify that the indicator light on the charge cord is solid green, and connect it to the vehicle. See "Charge Cord Status Indicators" in *Charge Cord* ⇨ 243.
4. If the vehicle charges with the portable charge cord, there may be a problem with the charging station. Try to charge the vehicle with a different 240-volt charging station, such as a public station. If both attempts charge the vehicle, contact the charging station manufacturer.

Electrical Requirements for Battery Charging

This vehicle is capable of being charged with most standard vehicle charging equipment that complies with one or more of the following:

- SAE J1772
- SAE J2847-2
- IEC 61851-1
- IEC 61851-22
- IEC 61851-23
- IEC 61851-24
- IEC 62196-1
- IEC 62196-2
- IEC 62196-3
- ISO 15118

The portable charge cord requires a minimum circuit capacity of 120 volts and 15 amps.

Caution

Do not use portable or stationary backup generating equipment to charge the vehicle. This may cause damage to the vehicle's charging system. Only charge the vehicle from utility supplied power.

Trailer Towing

General Towing Information

The vehicle is neither designed nor intended to tow a trailer.

Conversions and Add-Ons

Add-On Electrical Equipment

Warning

The Data Link Connector (DLC) is used for vehicle service and Emission Inspection/Maintenance testing. See *Service Vehicle Soon Light* ⇨ 126. A device connected to the DLC — such as an aftermarket fleet or driver-behavior tracking device — may interfere with vehicle systems. This could affect vehicle operation and cause a crash. Such devices may also access information stored in the vehicle's systems.

Caution

Some electrical equipment can damage the vehicle or cause components to not work and would not be covered by the vehicle warranty. Always check with your dealer before adding electrical equipment.

Add-on equipment can drain the vehicle's 12-volt battery, even if the vehicle is not operating.

When adding electrical equipment, it should only be connected using the accessory power outlets. The maximum power that can be supplied by one accessory power outlet or spread across all three is 200 watts or 15 amps. Exceeding 200 watts or 15 amps may cause erratic vehicle operation.

The vehicle has an airbag system. Before attempting to add anything electrical to the vehicle, see *Servicing the Airbag-Equipped Vehicle* ⇨ 81 and *Adding Equipment to the Airbag-Equipped Vehicle* ⇨ 81.

Vehicle Care

General Information

General Information	255
California Proposition 65 Warning	255
California Perchlorate Materials Requirements	256
Accessories and Modifications	256

Vehicle Checks

Doing Your Own Service Work	256
Hood	257
Underhood Compartment Overview	259
Cooling System	260
Washer Fluid	261
Brakes	262
Brake Fluid	263
Battery - North America	264
Wiper Blade Replacement	266
Windshield Replacement	267
Gas Strut(s)	267

Headlamp Aiming

Headlamp Aiming	269
-----------------------	-----

Bulb Replacement

Bulb Replacement	269
Halogen Bulbs	269
High Intensity Discharge (HID) Lighting	269
LED Lighting	269
Taillamps, Turn Signal, Stoplamps, and Back-Up Lamps	270
License Plate Lamp	270

Electrical System

High Voltage Devices and Wiring	271
Electrical System Overload ...	271
Fuses and Circuit Breakers ...	272
Underhood Compartment Fuse Block	272
Instrument Panel Fuse Block	276

Wheels and Tires

Tires	278
All-Season Tires	279
Winter Tires	279
Self-Sealing Tires	279
Tire Sidewall Labeling	280
Tire Designations	281
Tire Terminology and Definitions	282
Tire Pressure	284

Tire Pressure Monitor System	285
Tire Pressure Monitor Operation	286
Tire Inspection	289
Tire Rotation	290
When It Is Time for New Tires	291
Buying New Tires	291
Different Size Tires and Wheels	293
Uniform Tire Quality Grading	293
Wheel Alignment and Tire Balance	295
Wheel Replacement	295
Tire Chains	296
If a Tire Goes Flat	296
Tire Sealant and Compressor Kit	297
Storing the Tire Sealant and Compressor Kit	303

Jump Starting

Jump Starting - North America	304
--	-----

Towing the Vehicle

Towing the Vehicle	307
Recreational Vehicle Towing	309

Appearance Care

Exterior Care 311
 Interior Care 316
 Floor Mats 319

General Information

For service and parts needs, visit your dealer. You will receive genuine GM parts and GM-trained and supported service people.

Genuine GM parts have one of these marks:



California Proposition 65 Warning



Most motor vehicles, including this one, as well as many of its service parts and fluids, contain and/or emit chemicals known to the State of California to cause cancer and birth defects or other reproductive harm. Engine exhaust, many parts and systems, many fluids, and some component wear by-products contain and/or emit these chemicals. For more information go to www.P65Warnings.ca.gov/passenger-vehicle.

See *Battery - North America* ⇨ 264 and *Jump Starting - North America* ⇨ 304 and the back cover.

California Perchlorate Materials Requirements

Certain types of automotive applications, such as airbag initiators, seat belt pretensioners, and lithium batteries contained in Remote Keyless Entry transmitters, may contain perchlorate materials. Special handling may be necessary. For additional information, see www.dtsc.ca.gov/hazardouswaste/perchlorate.

Accessories and Modifications

Adding non-dealer accessories or making modifications to the vehicle can affect vehicle performance and safety, including such things as airbags, braking, stability, ride and handling, emissions systems, aerodynamics, durability, and electronic systems like antilock brakes, traction control, and stability control. These accessories or modifications could even cause malfunction or damage not covered by the vehicle warranty.

Damage to suspension components caused by modifying vehicle height outside of factory settings will not be covered by the vehicle warranty.

Damage to vehicle components resulting from modifications or the installation or use of non-GM certified parts, including control module or software modifications, is not covered under the terms of the vehicle warranty and may affect remaining warranty coverage for affected parts.

GM Accessories are designed to complement and function with other systems on the vehicle. See your dealer to accessorize the vehicle using genuine GM Accessories installed by a dealer technician.

Also, see *Adding Equipment to the Airbag-Equipped Vehicle* ⇨ 81.

Vehicle Checks

Doing Your Own Service Work

 **Warning**

Never try to do your own service on high voltage battery components. You can be injured and the vehicle can be damaged if you try to do your own service work. Service and repair of these high voltage battery components should only be performed by a trained dealer technician with the proper knowledge and tools.

Exposure to high voltage can cause shock, burns, and even death. The high voltage components in the vehicle can only be serviced by technicians with special training.

(Continued)

Warning (Continued)

High voltage components are identified by labels. Do not remove, open, take apart, or modify these components. High voltage cable or wiring has orange covering. Do not probe, tamper with, cut, or modify high voltage cable or wiring.

⚠ Warning

It can be dangerous to work on your vehicle if you do not have the proper knowledge, service manual, tools, or parts. Always follow owner's manual procedures and consult the service manual for your vehicle before doing any service work.

If doing some of your own service work, use the proper service manual. It tells you much more about how to service the vehicle than this manual can. To order the

proper service manual, see *Service Publications Ordering Information* ⇨ 341.

This vehicle has an airbag system. Before attempting to do your own service work, see *Servicing the Airbag-Equipped Vehicle* ⇨ 81.

Keep a record with all parts receipts and list the mileage and the date of any service work performed. See *Maintenance Records* ⇨ 329.

Hood

To open the hood:



1. Pull the release handle with this symbol. It is below the instrument panel outboard of the steering wheel.

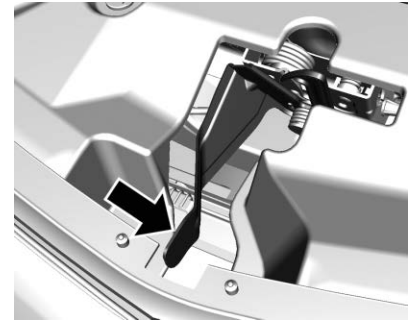

2. Go to the front of the vehicle and locate the secondary release lever under the front center of the hood. Push the secondary hood release lever to the right to disengage.

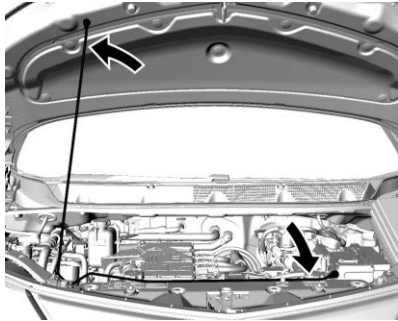

3. Lift the hood and release the hood prop rod from its retainer above the radiator support. Place the prop rod securely into the slot in the hood.

To close the hood:

1. Before closing the hood, check that all filler caps are properly installed. Then, lift the hood to relieve pressure on the hood prop.
2. Remove the hood prop from the slot in the hood and return it to its retainer above the radiator support. The prop rod

must lock into place when returning it to the retainer to prevent hood damage.

3. Lower the hood 20 cm (8 in) above the vehicle and release it so it fully latches. Check to make sure the hood is firmly closed. Repeat the process if necessary.

Underhood Compartment Overview

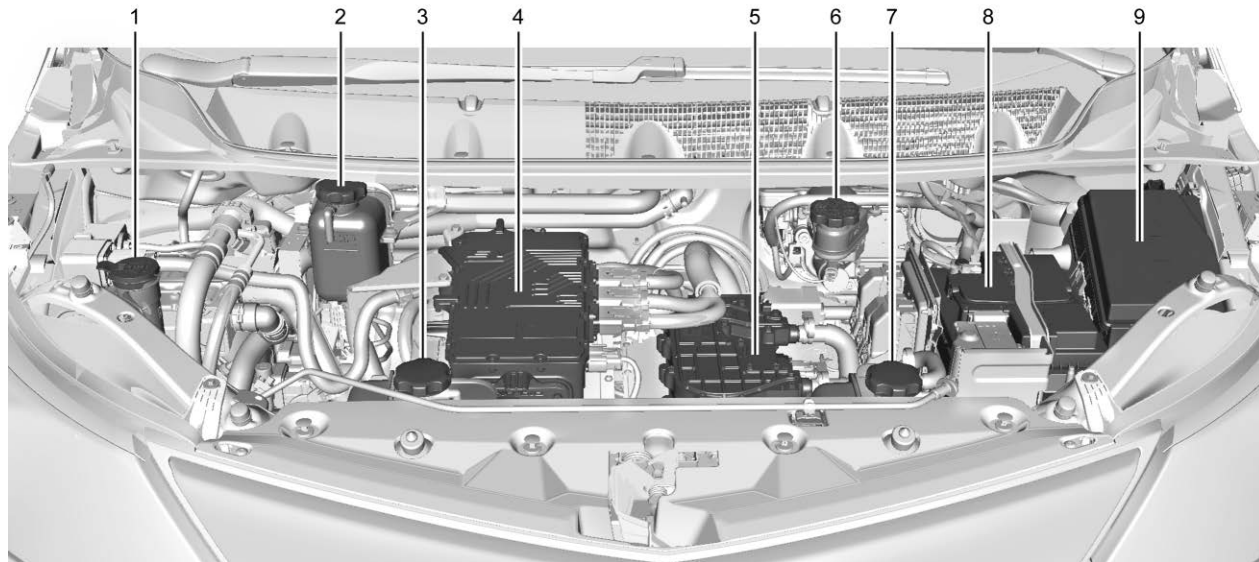

1. Windshield Washer Fluid Reservoir. See *Washer Fluid* ⇨ 261.
2. Cabin Heating Coolant Reservoir. See *Cooling System* ⇨ 260.
3. High Voltage Battery Coolant Reservoir. See *Cooling System* ⇨ 260.
4. HPDM (High Power Distribution Module).
5. APM (Accessory Power Module), OBCM (On-Board Charging Module).
6. Brake Fluid Reservoir. See *Brake Fluid* ⇨ 263.
7. SPIM, APM, and Charger Module Coolant Reservoir. See *Cooling System* ⇨ 260.
8. Battery. See *Battery - North America* ⇨ 264.
9. Underhood Compartment Fuse Block. *Underhood Compartment Fuse Block* ⇨ 272.

Cooling System

It is not necessary to regularly check coolant unless a leak is suspected or an unusual noise is heard. A coolant loss could indicate a problem. Have it inspected and repaired by your dealer.

The following explains the cooling systems and how to check coolant levels.

- High Voltage Battery
- Single Power Inverter Module (SPIM), Accessory Power Module (APM), and Charger Module
- Cabin Heating

High Voltage Battery

During vehicle operation and also during charging, the high voltage battery cells in the vehicle are kept within a normal operating temperature range. If the temperature rises above this temperature, the battery cooling system turns on the air conditioning compressor and cools the coolant

until the correct temperature is reached. If the temperature falls below this temperature, a high voltage heater, located outside the battery on a cradle, heats the coolant until the correct temperature is reached.

Single Power Inverter Module (SPIM), Accessory Power Module (APM), and Charger Module

The SPIM, APM, and charger module are cooled using a separate coolant loop. These modules are kept below a maximum temperature. If the temperature rises above this temperature, the electric cooling fan will turn on to cool the coolant.

Cabin Heating

Cabin heating is maintained by coolant heated by the Coolant Heater Control Module (CHCM), separate from the power electronics and battery coolant loops. This module heats the coolant based on temperature inputs from the cabin climate control systems.

Hybrid Cooling System Pressure Caps

The hybrid cooling system reservoirs have tamper resistant pressure caps. The coolant should only be serviced by a qualified technician.

Checking Coolant

The coolant needs to be replaced at the appropriate interval. See *Maintenance Schedule* ⇨ 322.

The coolant reservoirs are in the underhood compartment. See *Underhood Compartment Overview* ⇨ 259.

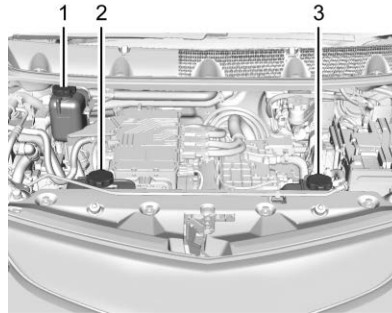

1. Cabin Heating Coolant Reservoir
 2. High Voltage Battery Coolant Reservoir
 3. SPIM, APM, and Charger Module Coolant Reservoir
1. Park on a level surface and turn the vehicle off.
 2. After the system has completely cooled, check that the coolant level is at the cold fill mark on the reservoirs.
 3. If the coolant level is not visible or needs to be adjusted within the reservoirs, contact your dealer.



Washer Fluid

What to Use

When windshield washer fluid is needed, be sure to read the manufacturer's instructions before use. If operating the vehicle in an area where the temperature may fall below freezing, use a fluid that has sufficient protection against freezing.

Adding Washer Fluid

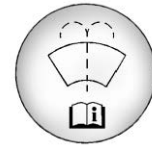

Open the cap with the washer symbol on it. Add washer fluid until the tank is full. See *Underhood Compartment Overview* ⇨ 259 for reservoir location.

Caution

- Do not use washer fluid that contains any type of water repellent coating. This can cause the wiper blades to chatter or skip.
- Do not use engine coolant (antifreeze) in the windshield washer. It can damage the windshield washer system and paint.
- Do not mix water with ready-to-use washer fluid. Water can cause the solution to freeze and damage the washer fluid tank and other parts of the washer system.
- When using concentrated washer fluid, follow the manufacturer instructions for adding water.
- Fill the washer fluid tank only three-quarters full when it is very cold. This allows

(Continued)

Caution (Continued)

for fluid expansion if freezing occurs, which could damage the tank if it is completely full.

Brakes

Disc brake pads have built-in wear indicators that make a high-pitched warning sound when the brake pads are worn and new pads are needed. The sound can come and go or can be heard all the time when the vehicle is moving, except when applying the brake pedal firmly.

Warning

The brake wear warning sound means that soon the brakes will not work well. That could lead to a crash. When the brake wear warning sound is heard, have the vehicle serviced.

Caution

Continuing to drive with worn-out brake pads could result in costly brake repair.

Some driving conditions or climates can cause a brake squeal when the brakes are first applied or lightly applied. This does not mean something is wrong with the brakes.

Properly torqued wheel nuts are necessary to help prevent brake pulsation. When tires are rotated, inspect brake pads for wear and evenly tighten wheel nuts in the proper sequence to torque specifications. See *Capacities and Specifications* ⇨ 331.

Brake pads should be replaced as complete sets.

Brake Pedal Travel

See your dealer if the brake pedal does not return to normal height, or if there is a rapid increase in pedal travel. This could be a sign that brake service may be required.

Replacing Brake System Parts

Always replace brake system parts with new, approved replacement parts. If this is not done, the brakes may not work properly. The braking performance expected can change in many other ways if the wrong replacement brake parts are installed or if parts are improperly installed.

Brake Fluid



The brake master cylinder reservoir is filled with GM approved DOT 3 brake fluid as indicated on the reservoir cap. See *Underhood Compartment Overview* ⇨ 259 for the location of the reservoir.

Checking Brake Fluid

With the vehicle in P (Park) on a level surface, the brake fluid level should be between the minimum and maximum marks on the brake fluid reservoir.

There are only two reasons why the brake fluid level in the reservoir may go down:

- Normal brake lining wear. When new linings are installed, the fluid level goes back up.
- A fluid leak in the brake hydraulic system. Have the brake hydraulic system fixed. With a leak, the brakes will not work well.

Always clean the brake fluid reservoir cap and the area around the cap before removing it.

Do not top off the brake fluid. Adding fluid does not correct a leak. If fluid is added when the linings are worn, there will be too much fluid when new brake linings are

installed. Add or remove fluid, as necessary, only when work is done on the brake hydraulic system.

When the brake fluid falls to a low level, the brake warning light comes on. See *Brake System Warning Light* ⇨ 126.

Brake fluid absorbs water over time which degrades the effectiveness of the brake fluid. Replace brake fluid at the specified intervals to prevent increased stopping distance. See *Maintenance Schedule* ⇨ 322.

What to Add

Use only GM approved DOT 3 brake fluid from a clean, sealed container. See *Recommended Fluids and Lubricants* ⇨ 327.

Warning

The wrong or contaminated brake fluid could result in damage to the brake system. This could result in the loss of braking leading to a possible injury. Always use the proper GM approved brake fluid.

Caution

If brake fluid is spilled on the vehicle's painted surfaces, the paint finish can be damaged. Immediately wash off any painted surface.

Battery - North America

The original equipment battery is maintenance free. Do not remove the cap and do not add fluid.

This vehicle has a high voltage battery and a standard 12-volt battery.

Warning

Damage to the high voltage battery or high voltage system can create a risk of electric shock, overheating, or fire.

If the vehicle is damaged from a moderate to severe crash, flood, fire, or other event, the vehicle

(Continued)

Warning (Continued)

should be inspected as soon as possible. Until the vehicle has been inspected, store it outside at least 15 m (50 ft) from any structure or anything that can burn. Ventilate the vehicle by opening a window or a door.

Contact Customer Assistance as soon as possible to determine whether an inspection is needed. See *Customer Assistance Offices* ⇨ 334.

If the vehicle is in a crash, the sensing system may shut down the high voltage system. When this occurs, the high voltage battery is disconnected and the vehicle will not start. The SERVICE VEHICLE SOON message in the Driver Information Center (DIC) will be displayed. Before the vehicle can be operated again, it must be serviced at your dealer.

See "If a Crash Occurs" under *Collision Damage Repair* ⇨ 339 for additional information. If an airbag has inflated, see *What Will You See after an Airbag Inflates?* ⇨ 75.

Only a trained service technician with the proper knowledge and tools should inspect, test, or replace the high voltage battery. See your dealer if either the 12-volt or high voltage battery needs service. The dealer has information on how to recycle the high voltage battery. There is also information available at <http://www.recyclemybattery.com>.

Keep the vehicle plugged in, even when fully charged, to keep the high voltage battery temperature ready for the next drive. This is important when outside temperatures are extremely hot or cold.

Propulsion power may be reduced in extremely cold temperatures, or if the high voltage battery is too cold. BATTERY TOO COLD, PLUG IN TO WARM will display.

A vehicle cover, which can reduce sun loading on the vehicle and improve high voltage battery life, is available from your dealer.

Refer to the replacement number shown on the original battery label when a new 12-volt battery is needed. The vehicle has an Absorbed Glass Mat (AGM) 12-volt battery. Installation of a standard 12-volt battery will result in reduced 12-volt battery life.

When using a 12-volt battery charger on the 12-volt AGM battery, some chargers have an AGM battery setting on the charger. If available, use the AGM setting on the charger, to limit charge voltage to 14.8 volts.

 **Warning**

WARNING: Battery posts, terminals, and related accessories contain lead and lead compounds, chemicals known to the State of California to cause

(Continued)

Warning (Continued)

cancer and birth defects or other reproductive harm. Batteries also contain other chemicals known to the State of California to cause cancer. **WASH HANDS AFTER HANDLING.** For more information go to www.P65Warnings.ca.gov/passenger-vehicle.

See *California Proposition 65 Warning* ⇨ 255 and the back cover.

Vehicle Storage

 **Warning**

Batteries have acid that can burn you and gas that can explode. You can be badly hurt if you are not careful. See *Jump Starting - North America* ⇨ 304 for tips on working around a battery without getting hurt.



Up to Four Weeks

- Plug in the charge cord.

Four Weeks to 12 Months

- Discharge the high voltage battery until two or three bars remain on the battery range indicator (Battery symbol) on the instrument cluster.
- Do not plug in the charge cord.
- Remove the black negative (-) cable from the 12-volt battery and attach a trickle charger to the battery terminals or keep the 12-volt battery cables connected and trickle charge from the underhood remote positive (+) and negative (-) terminals. See *Jump Starting - North America* ⇨ 304 for the location of these terminals.

Caution

The vehicle is equipped with an AGM/VRLA 12-volt battery, which can be damaged by using the

(Continued)

Caution (Continued)

incorrect type of trickle charger. An AGM/VRLA-compatible charger must be used, with the appropriate setting selected. Follow the trickle charger manufacturer instructions.

After the battery cable is reconnected, it is possible that the vehicle may not operate. If this happens, the high voltage battery may need to be charged.

Wiper Blade Replacement

Front Wiper Blade Replacement

Windshield wiper blades should be inspected for wear and cracking. See the *Maintenance Schedule* ⇨ 322.

Replacement blades come in different types and are removed in different ways. For proper type and length, see *Maintenance Replacement Parts* ⇨ 328.

Caution

Allowing the wiper arm to touch the windshield when no wiper blade is installed could damage the windshield. Any damage that occurs would not be covered by the vehicle warranty. Do not allow the wiper arm to touch the windshield.

To replace the windshield wiper blade:

1. Pull the windshield wiper assembly away from the windshield.

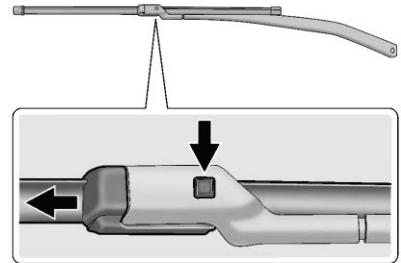

2. Press the button in the middle of the wiper arm connector, and pull the wiper blade away from the arm connector.
3. Remove the wiper blade.
4. Reverse Steps 1–3 for wiper blade replacement.

Rear Wiper Blade Replacement

The rear wiper blade and wiper arm have a cover for protection. The cover must be removed before the wiper blade can be replaced.

To remove the cover:



1. Slide a plastic tool under the cover and push upward to unsnap.
2. Slide the cover toward the wiper blade tip to unhook it from the blade assembly.
3. Remove the cover.
4. After wiper blade replacement, ensure that the cover hook slides into the slot in the blade assembly.
5. Snap the cover down to secure.

To replace the wiper blade:

1. Lift the wiper arm away from the windshield.

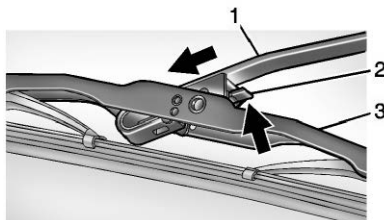

2. Push the release lever (2) to disengage the hook and push the wiper arm (1) out of the blade assembly (3).
3. Push the new blade assembly securely on the wiper arm until the release lever clicks into place.
4. Replace the wiper cover.

Windshield Replacement

Driver Assistance Systems

If the windshield needs to be replaced and the vehicle is equipped with a front camera sensor for the Driver Assistance Systems, a GM replacement windshield is recommended. The replacement windshield must be installed

according to GM specifications for proper alignment. If it is not, these systems may not work properly, they may display messages, or they may not work at all. See your dealer for proper windshield replacement.

Gas Strut(s)

This vehicle is equipped with gas strut(s) to provide assistance in lifting and holding open the hood/trunk/liftgate system in full open position.

Warning

If the gas struts that hold open the hood, trunk, and/or liftgate fail, you or others could be seriously injured. Take the vehicle to your dealer for service immediately. Visually inspect the gas struts for signs of wear, cracks, or other damage periodically. Check to make sure the hood/trunk/liftgate is held open with enough force. If struts are failing to hold the

(Continued)

Warning (Continued)

hood/trunk/liftgate, do not operate. Have the vehicle serviced.

Caution

Do not apply tape or hang any objects from gas struts. Also do not push down or pull on gas struts. This may cause damage to the vehicle.

See *Maintenance Schedule* ⇨ 322.



Hood



Liftgate

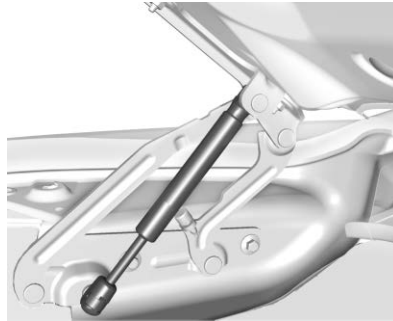

Trunk

Headlamp Aiming

Headlamp aim has been preset and should need no further adjustment.

If the vehicle is damaged in a crash, the headlamp aim may be affected. If adjustment to the headlamps is necessary, see your dealer.

Bulb Replacement

For the proper type of replacement bulbs, or any bulb changing procedure not listed in this section, contact your dealer.

Halogen Bulbs

Warning

Halogen bulbs have pressurized gas inside and can burst if you drop or scratch the bulb. You or others could be injured. Be sure to read and follow the instructions on the bulb package.

High Intensity Discharge (HID) Lighting

Warning

The High Intensity Discharge (HID) lighting system operates at a very high voltage. If you try to

(Continued)

Warning (Continued)

service any of the system components, you could be seriously injured. Have your dealer or a qualified technician service them.

This vehicle has several HID lamps.

For replacement of any HID lighting assembly, contact your dealer.

After an HID headlamp bulb has been replaced, the beam might be a slightly different shade than it was originally. This is normal.

LED Lighting

This vehicle has several LED lamps.

For replacement of any LED lighting assembly, contact your dealer.

Taillamps, Turn Signal, Stoplamps, and Back-Up Lamps

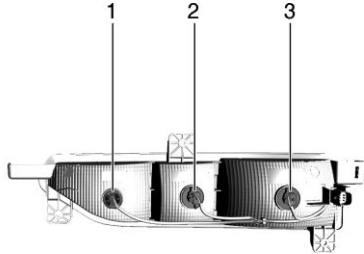

1. Back-up Lamp
2. Turn Signal Lamp
3. Stoplamp/Taillamp

To access the bulbs, reach up behind the rear bumper. To replace a back-up bulb, turn signal lamp, taillamp, or stoplamp:

1. Turn the bulb socket counterclockwise and remove it from the socket. The lamps are in the rear bumper.

2. Press the new bulb in and turn clockwise to install the bulb into the socket.
3. Turn the bulb socket clockwise to reinstall.

License Plate Lamp

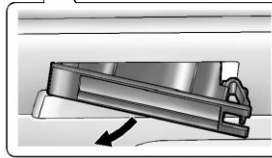
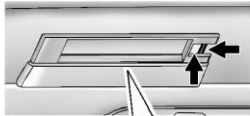

1. Press the spring clip on the right end of the lamp assembly to the left to unlock the lamp assembly.
2. Pull down on the lamp assembly to remove it from the fascia.

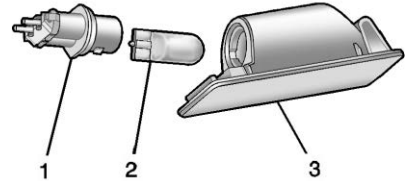

4. Turn the bulb socket (1) counterclockwise to remove it from the lamp assembly (3).
5. Pull the bulb (2) straight out of the bulb socket (1).
6. Push the replacement bulb straight into the bulb socket (1) and turn the bulb socket (1) clockwise to install it into the lamp assembly (3).
7. Reinstall the lamp assembly (3) into the fascia by inserting the left side first.
8. Push the spring clip into place.

Electrical System

High Voltage Devices and Wiring

Warning

Exposure to high voltage can cause shock, burns, and even death. The high voltage components in the vehicle can only be serviced by technicians with special training.

High voltage components are identified by labels. Do not remove, open, take apart, or modify these components. High voltage cable or wiring has orange covering or labels. Do not probe, tamper with, cut, or modify high voltage cable or wiring.

Electrical System Overload

The vehicle has fuses and circuit breakers to protect against an electrical system overload.

When the current electrical load is too heavy, the circuit breaker opens and closes, protecting the circuit until the current load returns to normal or the problem is fixed. This greatly reduces the chance of circuit overload and fire caused by electrical problems.

Fuses and circuit breakers protect the following in the vehicle:

- Headlamp wiring
- Windshield wiper motor
- Power windows and other power accessories

Replace a bad fuse with a new one of the identical size and rating.

If there is a problem on the road and a fuse needs to be replaced, the same amperage fuse can be

borrowed. Choose some feature of the vehicle that is not needed to use and replace it as soon as possible.

Headlamp Wiring

An electrical overload may cause the lamps to go on and off, or in some cases to remain off. Have the headlamp wiring checked right away if the lamps go on and off or remain off.

Windshield Wipers

If the wiper motor overheats due to heavy snow or ice, the windshield wipers will stop until the motor cools and the wiper control is turned off. After removal of the blockage, the wiper motor will restart when the control is then moved to the desired operating position.

Although the circuit is protected from electrical overload, overload due to heavy snow or ice, may cause wiper damage. Always clear ice and heavy snow from the windshield before using the windshield wipers.

If the overload is caused by an electrical problem and not snow or ice, be sure to get it fixed.

Fuses and Circuit Breakers

The wiring circuits in the vehicle are protected from short circuits by a combination of fuses and circuit breakers. This greatly reduces the chance of damage caused by electrical problems.

Danger

Fuses and circuit breakers are marked with their ampere rating. Do not exceed the specified amperage rating when replacing fuses and circuit breakers. Use of an oversized fuse or circuit breaker can result in a vehicle fire. You and others could be seriously injured or killed.

To check a fuse, look at the silver-colored band inside the fuse. If the band is broken or melted, replace the fuse. Be sure to replace a bad fuse with a new one of the identical size and rating.

Fuses of the same amperage can be temporarily borrowed from another fuse location, if a fuse goes out. Replace the fuse as soon as possible.

Underhood Compartment Fuse Block

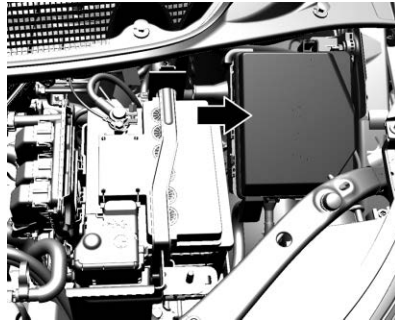

To open the fuse block cover, press the clips at the side and back and pull the cover up.

Caution

Spilling liquid on any electrical component on the vehicle may damage it. Always keep the covers on any electrical component.

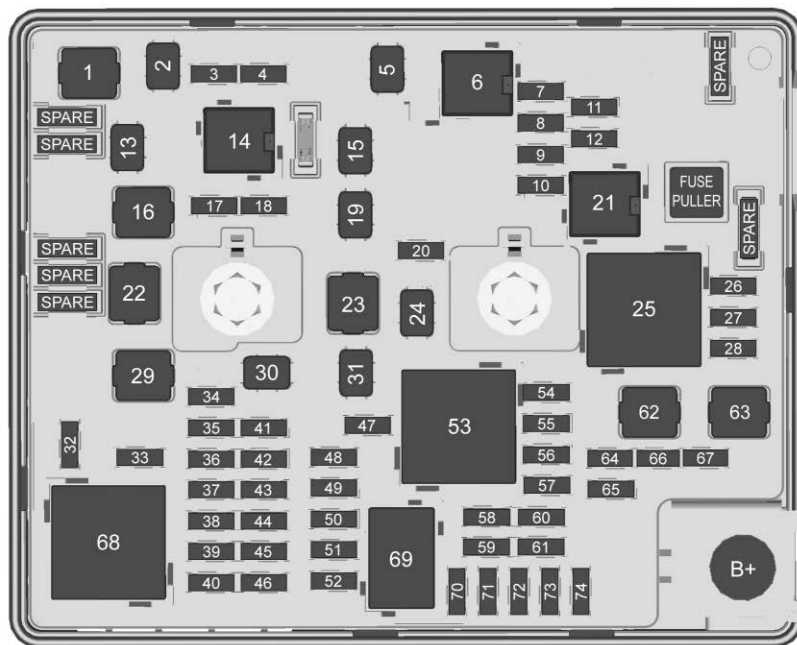

274 Vehicle Care

A fuse puller is in the underhood compartment fuse block.

The vehicle may not be equipped with all of the fuses, relays, and features shown.

Fuses	Usage
1	–
2	Power window rear
3	–
4	Rechargeable energy storage system 1
5	–
6	–
7	Left high-beam headlamp
8	Right high-beam headlamp
9	Left low-beam headlamp
10	Right low-beam headlamp
11	Horn
12	–

Fuses	Usage
13	Front wiper motor driver
14	Liftgate
15	Front wiper motor co-driver
16	Electronic brake control module supply electronics
17	Rear wiper
18	Liftgate
19	Seat module front
20	Washer
21	HID lamp
22	Linear power module
23	Electronic brake control module supply motor
24	Seat module rear
25	Powertrain
26	Transmission range control module
27	Aeroshutter

Fuses	Usage
28	Auxiliary oil pump
29	Electric brake boost motor source
30	Front power windows
31	In-panel bussed electrical center
32	Rear window defogger
33	Heated exterior rearview mirror
34	Pedestrian friendly alert function
35	–
36	–
37	Current sensor
38	Rain sensor
39	–
40	Electric brake boost (ECU)
41	Power line communication module

Fuses	Usage	Fuses	Usage	Fuses	Usage
42	Automatic occupant sensing	56	–	72	Transmission range control module
43	Window switch	57	Power electronics coolant pump	73	Single power inverter module
44	Rechargeable energy storage system	58	Engine control module	74	–
45	Vehicle integration control module	59	Electric steering column lock		
46	Integrated chassis control module	60	HVAC electric heater		
47	Headlamp leveling	61	On-board charging module		
48	Integrated chassis control module	62	Transmission range control module 1		
49	Interior rearview mirror	63	Electric cooling fan		
50	–	64	Engine control module		
51	Electric brake boost	65	Auxiliary heater pump		
52	Rear camera	66	Powertrain relay		
53	Run/Crank relay	67	Drive unit controller		
54	A/C control module	68	Rear window defogger		
55	Rechargeable energy storage system coolant pump	69	Second run/Crank relay		
		70	A/C control module		
		71	–		

Instrument Panel Fuse Block

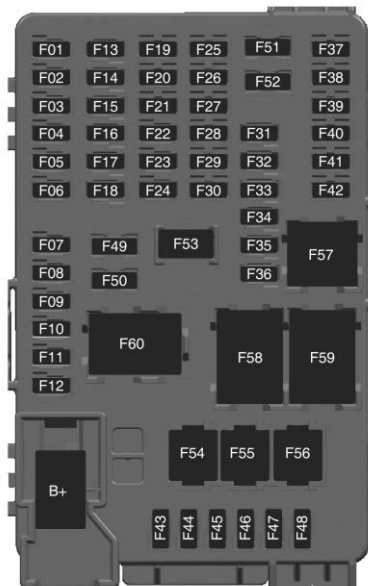

The instrument panel fuse block is on the left side of the instrument panel. To access the fuses, open the fuse panel door by pulling out.

To reinstall the door, insert the top tab first, then push the door back into its original location.

Fuses

Usage

F01	Video processing module
F02	Indicator light solar sensor
F03	Side blind zone alert
F04	Passive entry, passive start
F05	CGM
F06	Body control module 4
F07	Body control module 3
F08	Body control module 2
F09	Body control module 1
F10	Trailer interface module 1
F11	Amplifier
F12	Body control module 8

Fuses

Usage

F13	Data link connector 1
F14	Automatic parking assist
F15	-
F16	Single power inverter module 1
F17	Body control module 6
F18	Body control module 5
F19	-
F20	-
F21	-
F22	-
F23	USB
F24	Wireless charging module
F25	Reflected LED alert display
F26	Heated steering wheel
F27	-
F28	Instrument cluster 2

Fuses	Usage
F29	Trailer interface module 2
F30	Headlamp leveling device
F31	OnStar
F32	–
F33	Heating, ventilation, and air conditioning module
F34	–
F35	Instrument cluster 1
F36	Radio
F37	–
F38	–
F39	–
F40	–
F41	–
F42	–
F43	Body control module 7

Fuses	Usage
F44	Sensing and diagnostic module
F45	Front camera module
F46	Vehicle integration control module
F47	Single power inverter module 2
F48	Electric steering column lock
F49	Auxiliary jack
F50	Steering wheel controls
F51	Steering wheel controls backlighting
F52	Smartphone remote function module
F53	Auxiliary power outlet
F54	–
F55	Logistic
F56	–

Fuses	Usage
F57	–
F58	Logistics relay
F59	–
F60	Accessory/Retained accessory power relay

Wheels and Tires

Tires

Every new GM vehicle has high-quality tires made by a leading tire manufacturer. See the warranty manual for information regarding the tire warranty and where to get service. For additional information refer to the tire manufacturer.

Warning

- Poorly maintained and improperly used tires are dangerous.
- Overloading the tires can cause overheating as a result of too much flexing. There could be a blowout and a serious crash. See *Vehicle Load Limits* ⇨ 200.

(Continued)

Warning (Continued)

- Underinflated tires pose the same danger as overloaded tires. The resulting crash could cause serious injury. Check all tires frequently to maintain the recommended pressure. Tire pressure should be checked when the tires are cold.
- Overinflated tires are more likely to be cut, punctured, or broken by a sudden impact — such as when hitting a pothole. Keep tires at the recommended pressure.
- Worn or old tires can cause a crash. If the tread is badly worn, replace them.

(Continued)

Warning (Continued)

- Replace any tires that have been damaged by impacts with potholes, curbs, etc.
- Improperly repaired tires can cause a crash. Only the dealer or an authorized tire service center should repair, replace, dismount, and mount the tires.
- Do not spin the tires in excess of 56 km/h (35 mph) on slippery surfaces such as snow, mud, ice, etc. Excessive spinning may cause the tires to explode.

All-Season Tires

This vehicle may come with all-season tires. These tires are designed to provide good overall performance on most road surfaces and weather conditions. Original equipment tires designed to GM's specific tire performance criteria have a TPC specification code molded onto the sidewall. Original equipment all-season tires can be identified by the last two characters of this TPC code, which will be "MS."

Consider installing winter tires on the vehicle if frequent driving on snow or ice-covered roads is expected. All-season tires provide adequate performance for most winter driving conditions, but they may not offer the same level of traction or performance as winter tires on snow or ice-covered roads. See *Winter Tires* ⇨ 279.

Winter Tires

This vehicle was not originally equipped with winter tires. Winter tires are designed for increased traction on snow and ice-covered roads. Consider installing winter tires on the vehicle if frequent driving on ice or snow covered roads is expected. See your dealer for details regarding winter tire availability and proper tire selection. Also, see *Buying New Tires* ⇨ 291.

With winter tires, there may be decreased dry road traction, increased road noise, and shorter tread life. After changing to winter tires, be alert for changes in vehicle handling and braking.

If using winter tires:

- Use tires of the same brand and tread type on all four wheel positions.
- Use only radial ply tires of the same size, load range, and speed rating as the original equipment tires.

Winter tires with the same speed rating as the original equipment tires may not be available for H, V, W, Y, and ZR speed rated tires. If winter tires with a lower speed rating are chosen, never exceed the tire's maximum speed capability.

Self-Sealing Tires

This vehicle may have self-sealing tires. These tires have a material inside that can seal punctures up to 6 mm (0.25 in) in the tread area. The tire may lose air pressure if the sidewall is damaged or the tread puncture is too large. If the Tire Pressure Monitor System indicates the tire pressure is low, inspect the tire for damage and inflate it to the recommended pressure. If the tire is unable to maintain the recommended pressure, contact the nearest authorized GM servicing facility immediately for inspection and repair or replacement. To locate the nearest GM servicing facility, call GM Customer Assistance.

Caution

Do not drive on a deflated self-sealing tire as this could damage the tire. Make sure the tire is inflated to the recommended pressure or have it immediately repaired or replaced.

When tire replacement is needed replace with a self-sealing tire, because the vehicle does not come with a spare tire or tire changing equipment.

Tire Sidewall Labeling

Useful information about a tire is molded into its sidewall. The examples show a typical passenger tire sidewall.

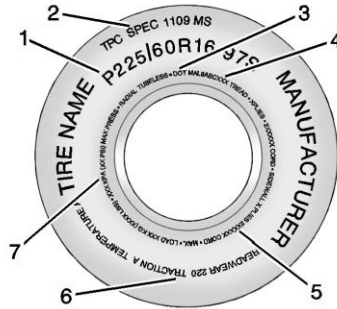
**Passenger (P-Metric) Tire Example**

(1) Tire Size : The tire size is a combination of letters and numbers used to define a particular tire's width, height, aspect ratio, construction type, and service description. See the "Tire Size" illustration later in this section for more detail.

(2) TPC Spec (Tire Performance Criteria Specification) : Original equipment tires designed to GM's specific tire performance criteria have a TPC specification

code molded onto the sidewall. GM's TPC specifications meet or exceed all federal safety guidelines.

(3) DOT (Department of Transportation) : The Department of Transportation (DOT) code indicates that the tire is in compliance with the U.S. Department of Transportation Motor Vehicle Safety Standards.

DOT Tire Date of Manufacture : The last four digits of the TIN indicate the tire manufactured date. The first two digits represent the week (01-52) and the last two digits, the year. For example, the third week of the year 2010 would have a four-digit DOT date of 0310.

(4) Tire Identification Number (TIN) : The letters and numbers following the DOT code are the Tire Identification Number (TIN).

The TIN shows the manufacturer and plant code, tire size, and date the tire was manufactured. The TIN is molded onto both sides of the tire, although only one side may have the date of manufacture.

(5) Tire Ply Material : The type of cord and number of plies in the sidewall and under the tread.

(6) Uniform Tire Quality Grading (UTQG) : Tire manufacturers are required to grade tires based on three performance factors: treadwear, traction, and temperature resistance. For more information see *Uniform Tire Quality Grading* ⇨ 293.

(7) Maximum Cold Inflation Load Limit : Maximum load that can be carried and the maximum pressure needed to support that load.

Tire Designations

Tire Size

The following is an example of a typical passenger vehicle tire size.

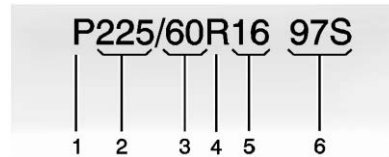

(1) Passenger (P-Metric) Tire : The United States version of a metric tire sizing system. The letter P as the first character in the tire size means a passenger vehicle tire engineered to standards set by the U.S. Tire and Rim Association.

(2) Tire Width : The three-digit number indicates the tire section width in millimeters from sidewall to sidewall.

(3) Aspect Ratio : A two-digit number that indicates the tire height-to-width measurements. For example, if the tire size aspect ratio is 60, as shown in item 3 of the illustration, it would mean that the tire's sidewall is 60 percent as high as it is wide.

(4) Construction Code : A letter code is used to indicate the type of ply construction in the tire. The letter R means radial ply construction; the letter D means diagonal or bias ply construction; and the letter B means belted-bias ply construction.

(5) Rim Diameter : Diameter of the wheel in inches.

(6) Service Description : These characters represent the load index and speed rating of the tire. The load index represents the load carrying capacity a tire

is certified to carry. The speed rating is the maximum speed a tire is certified to carry a load.

Tire Terminology and Definitions

Air Pressure : The amount of air inside the tire pressing outward on each square inch of the tire. Air pressure is expressed in kPa (kilopascal) or psi (pounds per square inch).

Accessory Weight : The combined weight of optional accessories. Some examples of optional accessories are, electric drive unit, power windows, power seats, and air conditioning.

Aspect Ratio : The relationship of a tire's height to its width.

Belt : A rubber coated layer of cords that is located between the plies and the tread. Cords may be made from steel or other reinforcing materials.

Bead : The tire bead contains steel wires wrapped by steel cords that hold the tire onto the rim.

Bias Ply Tire : A pneumatic tire in which the plies are laid at alternate angles less than 90 degrees to the centerline of the tread.

Cold Tire Pressure : The amount of air pressure in a tire, measured in kPa (kilopascal) or psi (pounds per square inch) before a tire has built up heat from driving. See *Tire Pressure* ⇨ 284.

Curb Weight : The weight of a motor vehicle with standard and optional equipment including the

maximum capacity of fuel, oil, and coolant, but without passengers and cargo.

DOT Markings : A code molded into the sidewall of a tire signifying that the tire is in compliance with the U.S. Department of Transportation (DOT) Motor Vehicle Safety Standards. The DOT code includes the Tire Identification Number (TIN), an alphanumeric designator which can also identify the tire manufacturer, production plant, brand, and date of production.

GAWR FRT : Gross Axle Weight Rating for the front axle. See *Vehicle Load Limits* ⇨ 200.

GAWR RR : Gross Axle Weight Rating for the rear axle. See *Vehicle Load Limits* ⇨ 200.

GVWR : Gross Vehicle Weight Rating. See *Vehicle Load Limits* ⇨ 200.

Intended Outboard Sidewall :

The side of an asymmetrical tire, that must always face outward when mounted on a vehicle.

Kilopascal (kPa) : The metric unit for air pressure.

Light Truck (LT-Metric) Tire : A tire used on light duty trucks and some multipurpose passenger vehicles.

Load Index : An assigned number ranging from 1 to 279 that corresponds to the load carrying capacity of a tire.

Maximum Inflation Pressure : The maximum air pressure to which a cold tire can be inflated. The maximum air pressure is molded onto the sidewall.

Maximum Load Rating : The load rating for a tire at the maximum permissible inflation pressure for that tire.

Maximum Loaded Vehicle

Weight : The sum of curb weight, accessory weight, vehicle capacity weight, and production options weight.

Normal Occupant Weight : The number of occupants a vehicle is designed to seat multiplied by 68 kg (150 lbs). See *Vehicle Load Limits* ⇨ 200.

Occupant Distribution : Designated seating positions.

Outward Facing Sidewall : The side of an asymmetrical tire that has a particular side that faces outward when mounted on a vehicle. The side of the tire that contains a whitewall, bears white lettering, or bears manufacturer, brand, and/or model name molding that is higher or deeper than the same moldings on the other sidewall of the tire.

Passenger (P-Metric) Tire : A tire used on passenger cars and some light duty trucks and multipurpose vehicles.

Recommended Inflation Pressure : Vehicle manufacturer's recommended tire inflation pressure as shown on the tire placard. See *Tire Pressure* ⇨ 284 and *Vehicle Load Limits* ⇨ 200.

Radial Ply Tire : A pneumatic tire in which the ply cords that extend to the beads are laid at 90 degrees to the centerline of the tread.

Rim : A metal support for a tire and upon which the tire beads are seated.

Sidewall : The portion of a tire between the tread and the bead.

Speed Rating : An alphanumeric code assigned to a tire indicating the maximum speed at which a tire can operate.

Traction : The friction between the tire and the road surface. The amount of grip provided.

Tread : The portion of a tire that comes into contact with the road.

Treadwear Indicators : Narrow bands, sometimes called wear bars, that show across the tread of a tire when only 1.6 mm (1/16 in) of tread remains. See *When It Is Time for New Tires* ⇨ 291.

UTQGS (Uniform Tire Quality Grading Standards) : A tire information system that provides consumers with ratings for a tire's traction, temperature, and treadwear. Ratings are determined by tire manufacturers using

government testing procedures. The ratings are molded into the sidewall of the tire. See *Uniform Tire Quality Grading* ⇨ 293.

Vehicle Capacity Weight : The number of designated seating positions multiplied by 68 kg (150 lbs) plus the rated cargo load. See *Vehicle Load Limits* ⇨ 200.

Vehicle Maximum Load on the Tire : Load on an individual tire due to curb weight, accessory weight, occupant weight, and cargo weight.

Vehicle Placard : A label permanently attached to a vehicle showing the vehicle's capacity weight and the original equipment tire size and recommended inflation pressure. See "Tire and Loading Information Label" under *Vehicle Load Limits* ⇨ 200.

Tire Pressure

Tires need the correct amount of air pressure to operate effectively.

Caution

Neither tire underinflation nor overinflation is good. Underinflated tires, or tires that do not have enough air, can result in:

- Tire overloading and overheating which could lead to a blowout.
- Premature or irregular wear.
- Poor handling.
- Reduced battery-electric range.

(Continued)

Caution (Continued)

Overinflated tires, or tires that have too much air, can result in:

- Unusual wear.
- Poor handling.
- Rough ride.
- Needless damage from road hazards.

The Tire and Loading Information label on the vehicle indicates the original equipment tires and the correct cold tire inflation pressures. The recommended pressure is the minimum air pressure needed to support the vehicle's maximum load carrying capacity. See *Vehicle Load Limits* ⇨ 200.

How the vehicle is loaded affects vehicle handling and ride comfort. Never load the vehicle with more weight than it was designed to carry.

When to Check

Check the tires once a month or more.

How to Check

Use a good quality pocket-type gauge to check the tire pressure. Proper tire inflation cannot be determined by looking at the tire. Check the tire inflation pressure when the tires are cold, meaning the vehicle has not been driven for at least three hours or no more than 1.6 km (1 mi).

Remove the valve cap from the tire valve stem. Press the tire gauge firmly onto the valve to get the pressure measurement. If the cold tire inflation pressure matches the recommended

pressure on the Tire and Loading Information label, no further adjustment is necessary.

If the inflation pressure is low, add air until the recommended pressure is reached. If the inflation pressure is high, press on the metal stem in the center of the tire valve to release air. Re-check the tire pressure with the tire gauge.

Put the valve caps back on the valve stems to keep out dirt and moisture and prevent leaks. Use only valve caps designed for the vehicle by GM. TPMS sensors could be damaged and would not be covered by the vehicle warranty.

Tire Pressure Monitor System

The Tire Pressure Monitor System (TPMS) uses radio and sensor technology to check tire pressure levels. The TPMS sensors monitor

the air pressure in your tires and transmit tire pressure readings to a receiver located in the vehicle.

Each tire, including the spare (if provided), should be checked monthly when cold and inflated to the inflation pressure recommended by the vehicle manufacturer on the vehicle placard or tire inflation pressure label. (If your vehicle has tires of a different size than the size indicated on the vehicle placard or tire inflation pressure label, you should determine the proper tire inflation pressure for those tires.)

As an added safety feature, your vehicle has been equipped with a tire pressure monitoring system (TPMS) that illuminates a low tire pressure telltale when one or more of your tires is significantly under-inflated.

Accordingly, when the low tire pressure telltale illuminates, you should stop and check your tires as soon as possible, and inflate them to the proper pressure. Driving on a significantly under-inflated tire causes the tire to overheat and can

lead to tire failure. Under-inflation also reduces fuel efficiency and tire tread life, and may affect the vehicle's handling and stopping ability.

Please note that the TPMS is not a substitute for proper tire maintenance, and it is the driver's responsibility to maintain correct tire pressure, even if under-inflation has not reached the level to trigger illumination of the TPMS low tire pressure telltale.

Your vehicle has also been equipped with a TPMS malfunction indicator to indicate when the system is not operating properly. The TPMS malfunction indicator is combined with the low tire pressure telltale. When the system detects a malfunction, the telltale will flash for approximately one minute and then remain continuously illuminated. This sequence will continue upon subsequent vehicle start-ups as long as the malfunction exists.

When the malfunction indicator is illuminated, the system may not be able to detect or signal low tire

pressure as intended. TPMS malfunctions may occur for a variety of reasons, including the installation of replacement or alternate tires or wheels on the vehicle that prevent the TPMS from functioning properly. Always check the TPMS malfunction telltale after replacing one or more tires or wheels on your vehicle to ensure that the replacement or alternate tires and wheels allow the TPMS to continue to function properly.

See *Tire Pressure Monitor Operation* ⇨ 286.

See *Radio Frequency Statement* ⇨ 342.

Tire Pressure Monitor Operation

This vehicle may have a Tire Pressure Monitor System (TPMS). The TPMS is designed to warn the driver when a low tire pressure condition exists. TPMS sensors are mounted onto each tire and wheel assembly, excluding the spare tire and wheel assembly. The TPMS

sensors monitor the air pressure in the tires and transmits the tire pressure readings to a receiver located in the vehicle.



When a low tire pressure condition is detected, the TPMS illuminates the low tire pressure warning light located on the instrument cluster. If the warning light comes on, stop as soon as possible and inflate the tires to the recommended pressure shown on the Tire and Loading Information label. See *Vehicle Load Limits* ⇨ 200.

A message to check the pressure in a specific tire displays in the Driver Information Center (DIC). The low tire pressure warning light and the DIC warning message come on at each ignition cycle using POWER ⏻ until the tires are inflated to the correct inflation pressure. Using the

DIC, tire pressure levels can be viewed. For additional information and details about the DIC operation and displays see *Driver Information Center (DIC)* ⇨ 141.

The low tire pressure warning light may come on in cool weather when the vehicle is first started, and then turn off as the vehicle is driven. This could be an early indicator that the air pressure is getting low and needs to be inflated to the proper pressure.

A Tire and Loading Information label, attached to your vehicle, shows the size of the original equipment tires and the correct inflation pressure for the tires when they are cold. See *Vehicle Load Limits* ⇨ 200, for an example of the Tire and Loading Information label and its location. Also see *Tire Pressure* ⇨ 284.

The TPMS can warn about a low tire pressure condition but it does not replace normal tire maintenance. See *Tire Inspection* ⇨ 289, *Tire Rotation* ⇨ 290 and *Tires* ⇨ 278.

Caution

Tire sealant materials are not all the same. A non-approved tire sealant could damage the TPMS sensors. TPMS sensor damage caused by using an incorrect tire sealant is not covered by the vehicle warranty. Always use only the GM approved tire sealant available through your dealer or included in the vehicle.

Factory-installed Tire Inflator Kits use a GM-approved liquid tire sealant. Using non-approved tire sealants could damage the TPMS sensors. See *Tire Sealant and Compressor Kit* ⇨ 297 for information regarding the inflator kit materials and instructions.

TPMS Malfunction Light and Message

The TPMS will not function properly if one or more of the TPMS sensors are missing or inoperable. When the system detects a malfunction, the

low tire warning light flashes for about one minute and then stays on for the remainder of the ignition cycle using POWER \cup . A DIC warning message also displays. The malfunction light and DIC warning message come on at each ignition cycle using POWER \cup until the problem is corrected. Some of the conditions that can cause these to come on are:

- One of the road tires has been replaced with the spare tire. The spare tire does not have a TPMS sensor. The malfunction light and DIC message should go off after the road tire is replaced and the sensor matching process is performed successfully. See "TPMS Sensor Matching Process" later in this section.
- The TPMS sensor matching process was not done or not completed successfully after rotating the tires. The malfunction light and the DIC message should go off after successfully completing the

sensor matching process. See "TPMS Sensor Matching Process" later in this section.

- One or more TPMS sensors are missing or damaged. The malfunction light and the DIC message should go off when the TPMS sensors are installed and the sensor matching process is performed successfully. See your dealer for service.
- Replacement tires or wheels do not match the original equipment tires or wheels. Tires and wheels other than those recommended could prevent the TPMS from functioning properly. See *Buying New Tires* \diamond 291.
- Operating electronic devices or being near facilities using radio wave frequencies similar to the TPMS could cause the TPMS sensors to malfunction.

If the TPMS is not functioning properly it cannot detect or signal a low tire condition. See your dealer

for service if the TPMS malfunction light and DIC message comes on and stays on.

TPMS Sensor Matching Process

Each TPMS sensor has a unique identification code. The identification code needs to be matched to a new tire/wheel position after rotating the vehicle's tires or replacing one or more of the TPMS sensors. The TPMS sensor matching process should also be performed after replacing a spare tire with a road tire containing the TPMS sensor. The malfunction light and the DIC message should go off at the next ignition cycle using POWER \cup . The sensors are matched to the tire/wheel positions, using a TPMS relearn tool, in the following order: driver side front tire, passenger side front tire, passenger side rear tire, and driver side rear. See your dealer for service or to purchase a relearn tool. A TPMS relearn tool can also be purchased. See Tire Pressure Monitor Sensor Activation

Tool at www.gmtoolsandequipment.com or call 1-800-GM TOOLS (1-800-468-6657).

There are two minutes to match the first tire/wheel position, and five minutes overall to match all four tire/wheel positions. If it takes longer, the matching process stops and must be restarted.

The TPMS sensor matching process is:

1. Set the parking brake.
2. Press POWER  to start the vehicle. See *Power Button* ⇨ 204.
3. Make sure the Tire Pressure info page option is turned on. The info pages on the DIC can be turned on and off through the Settings menu. See *Driver Information Center (DIC)* ⇨ 141.
4. Use the DIC controls on the right side of the steering wheel to scroll to the Tire Pressure screen under the DIC info page.

5. Press and hold ✓ in the center of the DIC controls.

The horn sounds twice to signal the receiver is in relearn mode and the TIRE LEARNING ACTIVE message displays on the DIC screen.

6. Start with the driver side front tire.
7. Place the relearn tool against the tire sidewall, near the valve stem. Then press the button to activate the TPMS sensor. A horn chirp confirms that the sensor identification code has been matched to this tire and wheel position.
8. Proceed to the passenger side front tire, and repeat the procedure in Step 7.
9. Proceed to the passenger side rear tire, and repeat the procedure in Step 7.
10. Proceed to the driver side rear tire, and repeat the procedure in Step 7. The horn sounds two times to indicate the sensor

identification code has been matched to the driver side rear tire, and the TPMS sensor matching process is no longer active. The TIRE LEARNING ACTIVE message on the DIC display screen goes off.

11. Turn the vehicle off.
12. Set all four tires to the recommended air pressure level as indicated on the Tire and Loading Information label.

Tire Inspection

We recommend that the tires, including the spare tire, if the vehicle has one, be inspected for signs of wear or damage at least once a month.

Replace the tire if:

- The indicators at three or more places around the tire can be seen.
- There is cord or fabric showing through the tire's rubber.

- The tread or sidewall is cracked, cut, or snagged deep enough to show cord or fabric.
- The tire has a bump, bulge, or split.
- The tire has a puncture, cut, or other damage that cannot be repaired well because of the size or location of the damage.

Tire Rotation

Tires should be rotated every 12 000 km (7,500 mi). See *Maintenance Schedule* ⇨ 322.

Tires are rotated to achieve a uniform wear for all tires. The first rotation is the most important.

Anytime unusual wear is noticed, rotate the tires as soon as possible, check for proper tire inflation pressure, and check for damaged tires or wheels. If the

unusual wear continues after the rotation, check the wheel alignment.

See *When It Is Time for New Tires* ⇨ 291 and *Wheel Replacement* ⇨ 295.

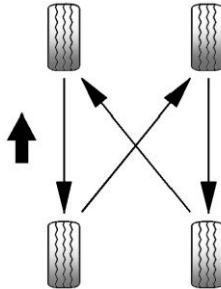

Use this rotation pattern when rotating the tires.

If the vehicle has a compact spare tire, do not include it in the tire rotation.

Adjust the front and rear tires to the recommended inflation pressure on the Tire and

Loading Information label after the tires have been rotated. See *Tire Pressure* ⇨ 284 and *Vehicle Load Limits* ⇨ 200.

Reset the Tire Pressure Monitor System. See *Tire Pressure Monitor Operation* ⇨ 286.

Check that all wheel nuts are properly tightened. See “Wheel Nut Torque” under *Capacities and Specifications* ⇨ 331.

Warning

Rust or dirt on a wheel, or on the parts to which it is fastened, can make wheel nuts become loose after time. The wheel could come off and cause an accident. When changing a wheel, remove any rust or dirt from places where the wheel attaches to the vehicle. In an emergency, a cloth or a paper towel can be used; however, use a scraper or wire brush later to remove all rust or dirt.

Lightly coat the center of the wheel hub with wheel bearing grease after a wheel change or tire rotation to prevent corrosion or rust build-up. Do not get grease on the flat wheel mounting surface or on the wheel nuts or bolts.

When It Is Time for New Tires

Factors such as maintenance, temperatures, driving speeds, vehicle loading, and road conditions affect the wear rate of the tires.

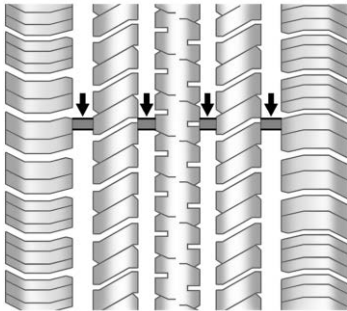

Treadwear indicators are one way to tell when it is time for new tires. Treadwear indicators appear when the tires have only 1.6 mm (1/16 in) or less of tread remaining. See *Tire Inspection* ⇨ 289 and *Tire Rotation* ⇨ 290.

The rubber in tires ages over time. This also applies to the spare tire, if the vehicle has one, even if it is never used. Multiple factors including temperatures, loading conditions, and inflation pressure maintenance affect how fast aging takes place. GM recommends that tires, including the spare if equipped, be replaced after six years, regardless of tread wear. The tire manufacture date is the last four digits of the DOT Tire Identification Number (TIN) which is molded into one side of the tire sidewall. The first two digits represent the week (01–52) and the last two digits, the year. For example, the third week of the year 2010 would have a four-digit DOT date of 0310.



Vehicle Storage

Tires age when stored normally mounted on a parked vehicle. Park a vehicle that will be stored for at least a month in a cool, dry, clean area away from direct sunlight to slow aging. This area should be free of grease, gasoline, or other substances that can deteriorate rubber.

Parking for an extended period can cause flat spots on the tires that may result in vibrations while driving. When storing a vehicle for at least a month, remove the tires or raise the vehicle to reduce the weight from the tires.

Buying New Tires

GM has developed and matched specific tires for the vehicle. The original equipment tires installed were designed to meet General Motors Tire Performance Criteria Specification (TPC Spec) system rating. When replacement tires are needed,

GM strongly recommends buying tires with the same TPC Spec rating.

GM's exclusive TPC Spec system considers over a dozen critical specifications that impact the overall performance of the vehicle, including brake system performance, ride and handling, traction control, and tire pressure monitoring performance. GM's TPC Spec number is molded onto the tire's sidewall near the tire size. If the tires have an all-season tread design, the TPC Spec number will be followed by MS for mud and snow. See *Tire Sidewall Labeling* ⇨ 280, for additional information.

GM recommends replacing worn tires in complete sets of four. Uniform tread depth on all tires will help to maintain the performance of the vehicle. Braking and handling

performance may be adversely affected if all the tires are not replaced at the same time. If proper rotation and maintenance have been done, all four tires should wear out at about the same time. See *Tire Rotation* ⇨ 290 for information on proper tire rotation. However, if it is necessary to replace only one axle set of worn tires, place the new tires on the rear axle.

Winter tires with the same speed rating as the original equipment tires may not be available for H, V, W, and ZR speed rated tires. Never exceed the winter tire's maximum speed capability when using winter tires with a lower speed rating.

 Warning
Tires could explode during improper service. Attempting to mount or dismount a tire

(Continued)



Warning (Continued)
could cause injury or death. Only your dealer or authorized tire service center should mount or dismount the tires.

 Warning
Mixing tires of different sizes (other than those originally installed on the vehicle), brands, or types may cause loss of control of the vehicle, resulting in a crash or other vehicle damage. Use the correct size, brand, and type of tire on all four wheels.

 Warning
Using bias-ply tires on the vehicle may cause the wheel rim flanges to develop cracks
(Continued)

Warning (Continued)

after many miles of driving. A tire and/or wheel could fail suddenly and cause a crash. Use only radial-ply tires with the wheels on the vehicle.

If the vehicle tires must be replaced with a tire that does not have a TPC Spec number, make sure they are the same size, load range, speed rating, and construction (radial) as the original tires.

Vehicles that have a tire pressure monitoring system could give an inaccurate low-pressure warning if non-TPC Spec rated tires are installed. See *Tire Pressure Monitor Operation* ⇨ 286.

The Tire and Loading Information label indicates the original equipment tires on the vehicle. See *Vehicle Load Limits* ⇨ 200.

Different Size Tires and Wheels

If wheels or tires are installed that are a different size than the original equipment wheels and tires, vehicle performance, including its braking, ride and handling characteristics, stability, and resistance to rollover may be affected. If the vehicle has electronic systems such as antilock brakes, rollover airbags, traction control, electronic stability control, or All-Wheel Drive, the performance of these systems can also be affected.

⚠ Warning

If different sized wheels are used, there may not be an acceptable level of performance and safety if

(Continued)

Warning (Continued)

tires not recommended for those wheels are selected. This increases the chance of a crash and serious injury. Only use GM specific wheel and tire systems developed for the vehicle, and have them properly installed by a GM certified technician.

See *Buying New Tires* ⇨ 291 and *Accessories and Modifications* ⇨ 256.

Uniform Tire Quality Grading

The following information relates to the system developed by the United States National Highway Traffic Safety Administration (NHTSA), which grades tires by treadwear, traction, and temperature performance. This applies only to vehicles sold in the United States. The grades are molded on the sidewalls of

most passenger car tires. The Uniform Tire Quality Grading (UTQG) system does not apply to deep tread, winter tires, compact spare tires, tires with nominal rim diameters of 10 to 12 inches (25 to 30 cm), or to some limited-production tires.

While the tires available on General Motors passenger cars and light trucks may vary with respect to these grades, they must also conform to federal safety requirements and additional General Motors Tire Performance Criteria (TPC) standards.

Quality grades can be found where applicable on the tire sidewall between tread shoulder and maximum section width. For example:

Treadwear 200 Traction AA Temperature A

All Passenger Car Tires Must Conform to Federal Safety Requirements In Addition To These Grades.

Treadwear

The treadwear grade is a comparative rating based on the wear rate of the tire when tested under controlled conditions on a specified government test course. For example, a tire graded 150 would wear one and one-half (1½) times as well on the government course as a tire graded 100. The relative performance of tires depends upon the actual conditions of their use, however, and may depart significantly from the norm due to variations in driving habits, service practices and differences in road characteristics and climate.

**Traction**

The traction grades, from highest to lowest, are AA, A, B, and C. Those grades represent the tire's ability to stop on wet pavement as measured under controlled conditions on specified government test surfaces of asphalt and concrete. A tire marked C may have poor traction performance. Warning: The traction grade assigned to this tire is based on straight-ahead braking traction tests, and does not include acceleration, cornering, hydroplaning, or peak traction characteristics.

Temperature

The temperature grades are A (the highest), B, and C, representing the tire's resistance to the generation of heat and its ability to dissipate heat when tested under controlled conditions on a specified indoor

laboratory test wheel. Sustained high temperature can cause the material of the tire to degenerate and reduce tire life, and excessive temperature can lead to sudden tire failure. The grade C corresponds to a level of performance which all passenger car tires must meet under the Federal Motor Safety Standard No. 109. Grades B and A represent higher levels of performance on the laboratory test wheel than the minimum required by law. Warning: The temperature grade for this tire is established for a tire that is properly inflated and not overloaded. Excessive speed, underinflation, or excessive loading, either separately or in combination, can cause heat buildup and possible tire failure.

Wheel Alignment and Tire Balance

The tires and wheels were aligned and balanced at the factory to provide the longest tire life and best overall performance. Adjustments to wheel alignment and tire balancing are not necessary on a regular basis. Consider an alignment check if there is unusual tire wear or the vehicle is significantly pulling to one side or the other. Some slight pull to the left or right, depending on the crown of the road and/or other road surface variations such as troughs or ruts, is normal. If the vehicle is vibrating when driving on a smooth road, the tires and wheels may need to be rebalanced. See your dealer for proper diagnosis.

Wheel Replacement

Replace any wheel that is bent, cracked, or badly rusted or corroded. If wheel nuts keep coming loose, the wheel, wheel bolts, and wheel nuts should be replaced. If the wheel leaks air, replace it.

Some aluminum wheels can be repaired. See your dealer if any of these conditions exist.

Your dealer will know the kind of wheel that is needed.

Each new wheel should have the same load-carrying capacity, diameter, width, offset, and be mounted the same way as the one it replaces.

Replace wheels, wheel bolts, wheel nuts, or Tire Pressure Monitor System (TPMS) sensors with new GM original equipment parts.

Warning

Using the wrong replacement wheels, wheel bolts, or wheel nuts can be dangerous. It could affect the braking and handling of the vehicle. Tires can lose air, and cause loss of control, causing a crash. Always use the correct wheel, wheel bolts, and wheel nuts for replacement.

Caution

The wrong wheel can also cause problems with bearing life, brake cooling, speedometer or odometer calibration, headlamp aim, bumper height, vehicle ground clearance, and tire or tire chain clearance to the body and chassis.

Used Replacement Wheels **Warning**

Replacing a wheel with a used one is dangerous. How it has been used or how far it has been driven may be unknown. It could fail suddenly and cause a crash. When replacing wheels, use a new GM original equipment wheel.

Tire Chains **Warning**

Do not use tire chains. There is not enough clearance. Tire chains used on a vehicle without the proper amount of clearance can cause damage to the brakes, suspension, or other vehicle parts. The area damaged by the tire chains could cause loss of control and a crash.

Use another type of traction device only if its manufacturer recommends it for the vehicle's tire size combination and road conditions. Follow that manufacturer's instructions. To avoid vehicle damage, drive slow and readjust or remove the traction device if it contacts the vehicle. Do not spin the wheels. If traction devices are used, install them on the front tires.

If a Tire Goes Flat

This vehicle has self-sealing tires. See *Self-Sealing Tires* ⇨ 279. Tread punctures typically will not cause tires to lose air. However, if the vehicle does get a flat tire, there is no spare tire, tire changing equipment, or place to store a tire. Contact Roadside Assistance for help.

It is unusual for a tire to blow out, especially if the tires are maintained properly. If air goes out of a tire, it is much more likely to leak out slowly. See *Tires* ⇨ 278. But if there is ever a blowout, here are a few tips about what to expect and what to do.

If a front tire fails, the flat tire will create a drag that pulls the vehicle toward that side. Take your foot off the accelerator pedal and grip the steering wheel firmly. Steer to maintain lane position, and then gently brake to a stop, well off the road, if possible.

A rear blowout, particularly on a curve, acts much like a skid and may require the same correction as

used in a skid. Stop pressing the accelerator pedal and steer to straighten the vehicle. It may be very bumpy and noisy. Gently brake to a stop, well off the road, if possible.

Warning

Lifting a vehicle and getting under it to do maintenance or repairs is dangerous without the appropriate safety equipment and training. If a jack is provided with the vehicle, it is designed only for changing a flat tire. If it is used for anything else, you or others could be badly injured or killed if the vehicle slips off the jack. If a jack is provided with the vehicle, only use it for changing a flat tire.

If a tire goes flat, avoid further tire and wheel damage by driving slowly to a level place, well off the road, if possible.

1. Turn on the hazard warning flashers. See *Hazard Warning Flashers* ⇨ 153.
2. Set the parking brake firmly.
3. Put an automatic transmission in P (Park) or a manual transmission in 1 (First) or R (Reverse).
4. Turn off the ignition.
5. Inspect the flat tire.

Warning

Driving on a flat tire will cause permanent damage to the tire. Re-inflating a tire after it has been driven on while severely underinflated or flat may cause a blowout and a serious crash. Never attempt to re-inflate a tire that has been driven on while severely underinflated or flat. Have your dealer or an authorized tire service center repair or replace the flat tire as soon as possible.



If this vehicle has a tire sealant kit and the tire has been separated from the wheel, has damaged sidewalls, or has a puncture larger than 6 mm (0.25 in), the tire is too severely damaged for the tire sealant and compressor kit to be effective. If the tire has a puncture less than 6 mm (0.25 in) in the tread area of the tire, see *Tire Sealant and Compressor Kit* ⇨ 297.

Tire Sealant and Compressor Kit

Warning

Overinflating a tire could cause the tire to rupture and you or others could be injured. Be sure to read and follow the tire sealant and compressor kit instructions and inflate the tire to its recommended pressure. Do not exceed the recommended pressure.

Warning

Storing the tire sealant and compressor kit or other equipment in the passenger compartment of the vehicle could cause injury. In a sudden stop or collision, loose equipment could strike someone. Store the tire sealant and compressor kit in its original location.

If this vehicle has a tire sealant and compressor kit, there may not be a spare tire or tire changing equipment, and on some vehicles there may not be a place to store a tire.

The tire sealant and compressor can be used to temporarily seal punctures up to 6 mm (0.25 in) in the tread area of the tire. It can also be used to inflate an underinflated tire.

For vehicles with self-sealing tires, try to inflate the tire without sealant first. See “Using the Tire Sealant

and Compressor Kit without Sealant to Inflate a Tire (Not Punctured)” below.

If the tire has been separated from the wheel, has damaged sidewalls, or has a large puncture, the tire is too severely damaged for the tire sealant and compressor kit to be effective. See *Roadside Assistance Program* ⇨ 336.

Read and follow all of the tire sealant and compressor kit instructions.

The kit includes:

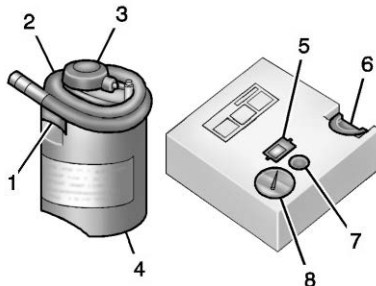

1. Sealant Canister Inlet Valve

2. Sealant/Air Hose
3. Base of Sealant Canister
4. Tire Sealant Canister
5. On/Off Button
6. Slot on Top of Compressor
7. Pressure Deflation Button
8. Pressure Gauge

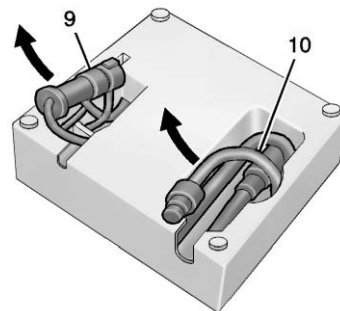

9. Power Plug
10. Air Only Hose

Tire Sealant

Read and follow the safe handling instructions on the label adhered to the tire sealant canister (4).

Check the tire sealant expiration date on the tire sealant canister. The tire sealant canister (4) should be replaced before its expiration date. Replacement tire sealant canisters are available at your local dealer.

There is only enough sealant to seal one tire. After usage, the tire sealant canister must be replaced.

Using the Tire Sealant and Compressor Kit to Temporarily Seal and Inflate a Punctured Tire

When using the tire sealant and compressor kit during cold temperatures, warm the kit in a heated environment for five minutes. This will help to inflate the tire faster.

If a tire goes flat, avoid further tire and wheel damage by driving slowly to a level place. Turn on the hazard warning flashers. See *Hazard Warning Flashers* ⇨ 153.

See *If a Tire Goes Flat* ⇨ 296 for other important safety warnings.

Do not remove any objects that have penetrated the tire.

1. Remove the tire sealant canister (4) and compressor from its storage location. See *Storing the Tire Sealant and Compressor Kit* ⇨ 303.
2. Remove the air only hose (10) and the power plug (9) from the bottom of the compressor.
3. Place the compressor on the ground near the flat tire.

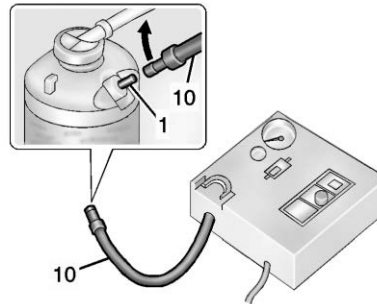

4. Attach the air only hose (10) to the sealant canister inlet valve (1) by turning it clockwise until tight.

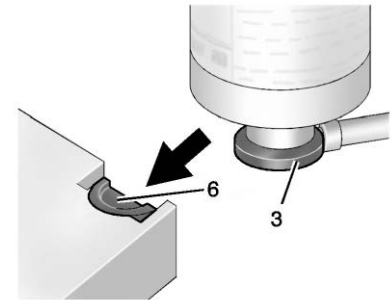

5. Slide the base of the tire sealant canister (3) into the slot on the top of the compressor (6) to hold it upright.

Make sure the tire valve stem is positioned close to the ground so the hose will reach it.

6. Remove the valve stem cap from the flat tire by turning it counterclockwise.

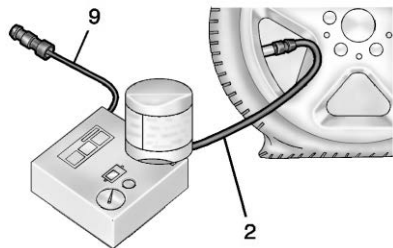

7. Attach the sealant/air hose (2) to the tire valve stem by turning it clockwise until tight.
8. Plug the power plug (9) into the accessory power outlet in the vehicle. Unplug all items from other accessory power outlets. See *Power Outlets* ⇨ 114.

If the vehicle has an accessory power outlet, do not use the cigarette lighter.

If the vehicle only has a cigarette lighter, use the cigarette lighter.

Do not pinch the power plug cord in the door or window.

9. Start the vehicle. The vehicle must be running while using the air compressor.
10. Press the on/off button (5) to turn the tire sealant and compressor kit on.

The compressor will inject sealant and air into the tire.

The pressure gauge (8) will initially show a high pressure while the compressor pushes the sealant into the tire. Once the sealant is completely dispersed into the tire, the pressure will quickly drop and start to rise again as the tire inflates with air only.

11. Inflate the tire to the recommended inflation pressure using the pressure gauge (8). The recommended inflation pressure can be found on the Tire and Loading Information label. See *Tire Pressure* ⇨ 284.

The pressure gauge (8) may read higher than the actual tire pressure while the compressor

is on. Turn the compressor off to get an accurate pressure reading. The compressor may be turned on/off until the correct pressure is reached.

Caution

If the recommended pressure cannot be reached after approximately 25 minutes, the vehicle should not be driven farther. The tire is too severely damaged and the tire sealant and compressor kit cannot inflate the tire. Remove the power plug from the accessory power outlet and unscrew the inflating hose from the tire valve. See *Roadside Assistance Program* ⇨ 336.

12. Press the on/off button (5) to turn the tire sealant and compressor kit off.

The tire is not sealed and will continue to leak air until the vehicle is driven and the sealant is distributed in the tire.

Therefore, Steps 13–21 must be done immediately after Step 12.

Be careful while handling the tire sealant and compressor kit as it could be warm after usage.

13. Unplug the power plug (9) from the accessory power outlet in the vehicle.
14. Turn the sealant/air hose (2) counterclockwise to remove it from the tire valve stem.
15. Replace the tire valve stem cap.
16. Remove the tire sealant canister (4) from the slot on top of the compressor (6).
17. Turn the air only hose (10) counterclockwise to remove it from the tire sealant canister inlet valve (1).
18. Turn the sealant/air hose (2) clockwise onto the sealant canister inlet valve (1) to prevent sealant leakage.

19. Return the air only hose (10) and power plug (9) back to their original storage location.



20. If the flat tire was able to inflate to the recommended inflation pressure, remove the maximum speed label from the sealant canister and place it in a highly visible location.
Do not exceed the speed on this label until the damaged tire is repaired or replaced.
21. Return the equipment to its original storage location in the vehicle.
22. Immediately drive the vehicle 8 km (5 mi) to distribute the sealant in the tire.
23. Stop at a safe location and check the tire pressure. Refer to Steps 1–10 under “Using the

Tire Sealant and Compressor Kit without Sealant to Inflate a Tire (Not Punctured).”

If the tire pressure has fallen more than 68 kPa (10 psi) below the recommended inflation pressure, stop driving the vehicle. The tire is too severely damaged and the tire sealant cannot seal the tire. See *Roadside Assistance Program* ⇨ 336.

If the tire pressure has not dropped more than 68 kPa (10 psi) from the recommended inflation pressure, inflate the tire to the recommended inflation pressure.

24. Wipe off any sealant from the wheel, tire, or vehicle.
25. Dispose of the used tire sealant canister (4) at a local dealer or in accordance with local state codes and practices.
26. Replace it with a new canister available from your dealer.

302 Vehicle Care

27. After temporarily sealing a tire using the tire sealant and compressor kit, take the vehicle to an authorized dealer to have the tire replaced.

Using the Tire Sealant and Compressor Kit without Sealant to Inflate a Tire (Not Punctured)

The kit includes:

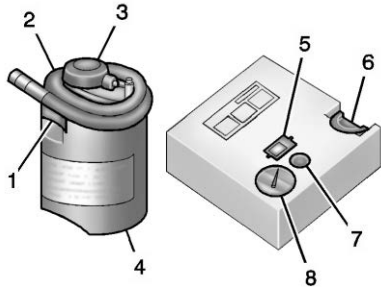

1. Sealant Canister Inlet Valve
2. Sealant/Air Hose
3. Base of Sealant Canister
4. Tire Sealant Canister

5. On/Off Button
6. Slot on Top of Compressor
7. Pressure Deflation Button
8. Pressure Gauge

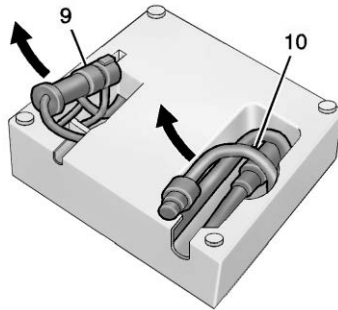

9. Power Plug
10. Air Only Hose

If a tire goes flat, avoid further tire and wheel damage by driving slowly to a level place. Turn on the hazard warning flashers. See *Hazard Warning Flashers* ⇨ 153.

See *If a Tire Goes Flat* ⇨ 296 for other important safety warnings.

1. Remove the compressor from its storage location. See *Storing the Tire Sealant and Compressor Kit* ⇨ 303.
2. Remove the air only hose (10) and the power plug (9) from the bottom of the compressor.
3. Place the compressor on the ground near the flat tire.

Make sure the tire valve stem is positioned close to the ground so the hose will reach it.

4. Remove the valve stem cap from the flat tire by turning it counterclockwise.
5. Attach the air only hose (10) to the tire valve stem by turning it clockwise until tight.
6. Plug the power plug (9) into the accessory power outlet in the vehicle. Unplug all items from other accessory power outlets. See *Power Outlets* ⇨ 114.

If the vehicle has an accessory power outlet, do not use the cigarette lighter.

If the vehicle only has a cigarette lighter, use the cigarette lighter.

Do not pinch the power plug cord in the door or window.

7. Start the vehicle. The vehicle must be running while using the air compressor.
8. Press the on/off button (5) to turn the tire sealant and compressor kit on.

The compressor will inflate the tire with air only.

9. Inflate the tire to the recommended inflation pressure using the pressure gauge (8). The recommended inflation pressure can be found on the Tire and Loading Information label. See *Tire Pressure* ⇨ 284.

The pressure gauge (8) may read higher than the actual tire pressure while the compressor is on. Turn the compressor off to get an accurate pressure

reading. The compressor may be turned on/off until the correct pressure is reached.

Caution

If the recommended pressure cannot be reached after approximately 25 minutes, the vehicle should not be driven farther. The tire is too severely damaged and the tire sealant and compressor kit cannot inflate the tire. Remove the power plug from the accessory power outlet and unscrew the inflating hose from the tire valve. See *Roadside Assistance Program* ⇨ 336.

10. Press the on/off button (5) to turn the tire sealant and compressor kit off.

Be careful while handling the compressor as it could be warm after usage.

11. Unplug the power plug (9) from the accessory power outlet in the vehicle.

12. Turn the air only hose (10) counterclockwise to remove it from the tire valve stem.
13. Replace the tire valve stem cap.
14. Return the air only hose (10) and power plug (9) back to their original storage location.
15. Return the equipment to its original storage location in the vehicle.

The tire sealant and compressor kit has accessory adapters located in a compartment on the bottom of its housing that can be used to inflate air mattresses, balls, etc.

Storing the Tire Sealant and Compressor Kit

To access the tire sealant and compressor kit:

1. Open the liftgate. See *Liftgate* ⇨ 47.
2. Remove the load floor.

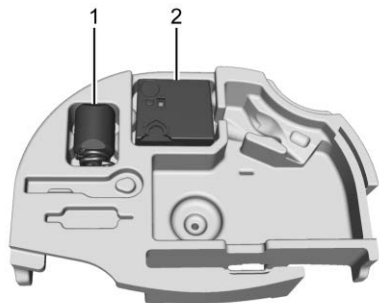

3. Remove the tire sealant canister (1) and the compressor (2).

To store the tire sealant canister and the compressor, reverse the steps.

Jump Starting

Jump Starting - North America

For more information about the vehicle battery, see *Battery - North America* ⇨ 264.

If the 12-volt battery has run down, try to use another vehicle and some jumper cables to start your vehicle. Be sure to use the following steps to do it safely.

Warning

The high voltage battery cannot be jump started either with another vehicle or battery charger. Personal injury, death, or damage to the vehicle could result.

Warning

WARNING: Battery posts, terminals, and related accessories contain lead and lead compounds, chemicals known to the State of California to cause cancer and birth defects or other reproductive harm. Batteries also contain other chemicals known to the State of California to cause cancer. **WASH HANDS AFTER HANDLING.** For more information go to www.P65Warnings.ca.gov/passenger-vehicle.

See *California Proposition 65 Warning* ⇨ 255 and the back cover.

Warning

Batteries can hurt you. They can be dangerous because:

- They contain acid that can burn you.
- They contain gas that can explode or ignite.
- They contain enough electricity to burn you.

If you do not follow these steps exactly, some or all of these things can hurt you.

Caution

Ignoring these steps could result in costly damage to the vehicle that would not be covered by the vehicle warranty. Trying to start the vehicle by pushing or pulling it will not work, and it could damage the vehicle.

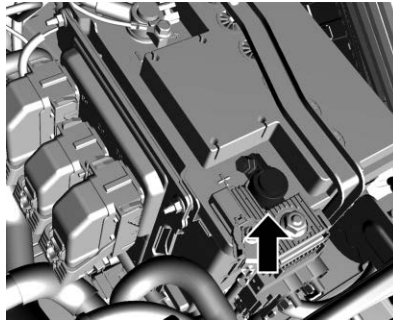

Discharged Battery Positive Terminal

The jump start positive terminal is on the discharged battery on the driver side of the vehicle.

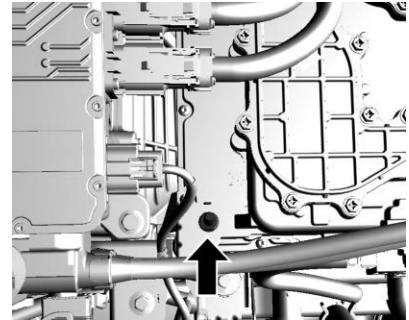

Discharged Battery Negative Terminal

The jump start negative grounding point is a stud on a bracket located near the Accessory Power Module (APM).

The jump start positive terminal and jump start negative terminal are on the battery of the vehicle providing the jump start.

306 Vehicle Care

The positive jump start connection for the discharged battery is under a trim cover. Open the cover to expose the terminal.

1. Check the other vehicle.
It must have a 12-volt battery with a negative ground system.

Caution

If the other vehicle does not have a 12-volt system with a negative ground, both vehicles can be damaged. Only use a vehicle that has a 12-volt system with a negative ground for jump starting.

2. Position the two vehicles so that they are not touching.
3. Set the parking brake and shift into P (Park). See *Shifting Into Park* ⇨ 206.

Caution

If any accessories are left on or plugged in during the jump starting procedure, they could be damaged. The repairs would not be covered by the vehicle warranty. Whenever possible, turn off or unplug all accessories on either vehicle when jump starting.

4. Turn the vehicle off. Turn off all lights and accessories in both vehicles, except the hazard warning flashers if needed.

Warning

An electric fan can start up even when the propulsion system is not operating and can injure you. Keep hands, clothing and tools away from any underhood electric fan.

Warning

Using a match near a battery can cause battery gas to explode. People have been hurt doing this, and some have been blinded. Use a flashlight if you need more light.

Battery fluid contains acid that can burn you. Do not get it on you. If you accidentally get it in your eyes or on your skin, flush the place with water and get medical help immediately.

Warning

Fans or other moving propulsion system parts can injure you badly. Keep your hands away from moving parts once the propulsion system is operating.

5. Connect one end of the red positive (+) cable to the positive (+) terminal on the discharged battery.
6. Connect the other end of the red positive (+) cable to the positive (+) terminal of the good battery.
7. Connect one end of the black negative (-) cable to the negative (-) terminal of the good battery.
8. Connect the other end of the black negative (-) cable to the negative (-) grounding point for the discharged battery.
9. Start the vehicle with the good battery.
10. Try to start the vehicle with the dead battery. If it will not start after a few tries, it probably needs service.

Caution

If the jumper cables are connected or removed in the wrong order, electrical shorting may occur and damage the vehicle. The repairs would not be covered by the vehicle warranty. Always connect and remove the jumper cables in the correct order, making sure that the cables do not touch each other or other metal.

Jumper Cable Removal

Reverse the sequence exactly when removing the jumper cables.

Towing the Vehicle

Caution

Incorrectly towing a disabled vehicle may cause damage. The damage would not be covered by the vehicle warranty.

Do not lash or hook to suspension components. Use the proper straps around the tires to secure the vehicle.

Use only a flatbed tow truck for towing a disabled vehicle. Never use a sling type lift or damage will occur. Use ramps to help reduce approach angles if necessary. A towed vehicle should have its drive wheels off the ground.

Consult a professional towing service if the disabled vehicle must be towed.

Caution

Improper use of the tow eye can cause vehicle damage. Use caution and low speeds to prevent damage to the vehicle.

If the vehicle is equipped with a tow eye, only use the tow eye to pull the vehicle onto a flatbed car carrier from a flat road surface. Do not use the tow eye to pull the vehicle from snow, mud, or sand.

The tow eye is located underneath the load floor, near the spare tire or the compressor kit, if equipped.

Front Tow Eye Attachment Point

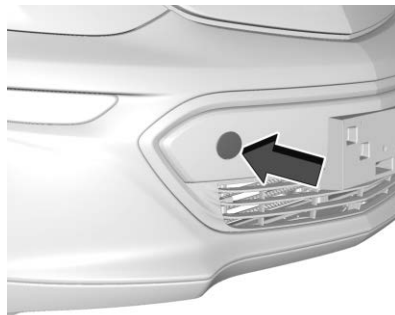

Carefully open the cover in the fascia by using the small notch that conceals the tow eye socket.



Install the tow eye into the socket and turn it until it is fully tightened. When the tow eye is removed, reinstall the cover with the notch in the original position.

Rear Tow Eye Attachment Point



Carefully open the cover in the fascia by using the small notch that conceals the tow eye socket.



Install the tow eye into the socket and turn it until it is fully tightened. When the tow eye is removed, reinstall the cover with the notch in the original position.

Recreational Vehicle Towing

Recreational vehicle towing means towing the vehicle behind another vehicle, such as behind a motor home. The two most common types of recreational vehicle towing are known as dinghy towing and dolly towing. Dinghy towing is towing the vehicle with all four wheels on the

ground. Dolly towing is towing the vehicle with two wheels on the ground and two wheels up on a device known as a dolly.

Here are some important things to consider before recreational vehicle towing:

- What is the towing capacity of the towing vehicle? Be sure to read the tow vehicle manufacturer's recommendations.
- How far will the vehicle be towed? Some vehicles have restrictions on how far and how long they can tow.
- Does the vehicle have the proper towing equipment? See your dealer or trailering professional for additional advice and equipment recommendations.
- Is the vehicle ready to be towed? Just as preparing the vehicle for a long trip, make sure the vehicle is prepared to be towed.

Caution

Use of a shield mounted in front of the vehicle grille could restrict airflow and cause damage to the electric drive unit. The repairs would not be covered by the vehicle warranty. If using a shield, only use one that attaches to the towing vehicle.

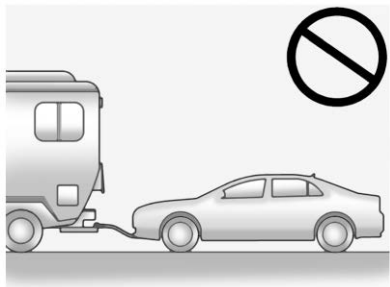
Dinghy Towing**Caution**

If the vehicle is towed with all four wheels on the ground, the drivetrain components could be damaged. The repairs would not be covered by the vehicle warranty. Do not tow the vehicle with all four wheels on the ground.

The vehicle was not designed to be towed with all four wheels on the ground. If the vehicle must be towed, a dolly should be used. See “Dolly Towing” following.

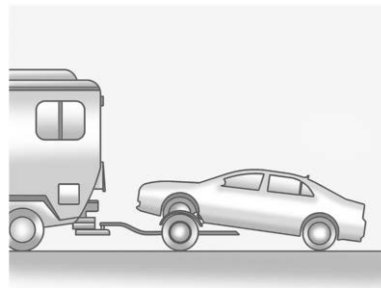
Dolly Towing

Tow the vehicle with the two rear wheels on the ground and the front wheels on a dolly.

To tow the vehicle from the front with the rear wheels on the ground:

1. Put the front wheels on the dolly.
2. Shift the transmission to P (Park). See *Shifting Into Park* ⇨ 206.
3. Set the parking brake.
4. Secure the vehicle to the dolly.

5. Follow the dolly manufacturer's instructions for preparing the vehicle and dolly for towing.
6. Release the parking brake.
7. Turn the vehicle off.
8. Open the hood.
9. Wait two minutes.
10. Disconnect the negative (-) terminal connector from the 12-volt battery.
11. Close and latch the hood.

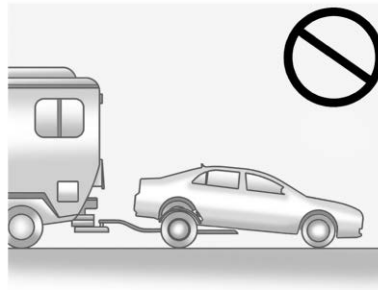

Caution
Towing the vehicle from the rear could damage it. Also, repairs would not be covered by the vehicle warranty. Never have the vehicle towed from the rear.

Appearance Care

Exterior Care

Locks

Locks are lubricated at the factory. Use a de-icing agent only when absolutely necessary, and have the locks greased after using.

Washing the Vehicle

To preserve the vehicle's finish, wash it often and out of direct sunlight.

Caution
Do not use petroleum-based, acidic, or abrasive cleaning agents as they can damage the vehicle's paint, metal, or plastic parts. If damage occurs, it would not be covered by the vehicle warranty. Approved cleaning products can be obtained from your dealer. Follow all manufacturer directions regarding
(Continued)

Caution (Continued)

correct product usage, necessary safety precautions, and appropriate disposal of any vehicle care product.

Caution

Avoid using high-pressure washes closer than 30 cm (12 in) to the surface of the vehicle. Use of power washers exceeding 8,274 kPa (1,200 psi) can result in damage or removal of paint and decals.

Caution

Do not power wash any component under the hood that has this  symbol.

(Continued)

Caution (Continued)

This could cause damage that would not be covered by the vehicle warranty.

If using an automatic car wash, follow the car wash instructions. The windshield wiper and rear window wiper, if equipped, must be off. Remove any accessories that may be damaged or interfere with the car wash equipment.

Rinse the vehicle well, before washing and after, to remove all cleaning agents completely. If they are allowed to dry on the surface, they could stain.

Dry the finish with a soft, clean chamois or an all-cotton towel to avoid surface scratches and water spotting.

Finish Care

Application of aftermarket clearcoat sealant/wax materials is not recommended. If painted surfaces are damaged, see your dealer to

have the damage assessed and repaired. Foreign materials such as calcium chloride and other salts, ice melting agents, road oil and tar, tree sap, bird droppings, chemicals from industrial chimneys, etc., can damage the vehicle's finish if they remain on painted surfaces. Wash the vehicle as soon as possible. If necessary, use non-abrasive cleaners that are marked safe for painted surfaces to remove foreign matter.

Occasional hand waxing or mild polishing should be done to remove residue from the paint finish. See your dealer for approved cleaning products.

Do not apply waxes or polishes to uncoated plastic, vinyl, rubber, decals, simulated wood, or flat paint as damage can occur.

Caution

Machine compounding or aggressive polishing on a basecoat/clearcoat paint finish may damage it. Use only non-abrasive waxes and polishes that are made for a basecoat/clearcoat paint finish on the vehicle.

To keep the paint finish looking new, keep the vehicle garaged or covered whenever possible.

Protecting Exterior Bright Metal Moldings**Caution**

Failure to clean and protect the bright metal moldings can result in a hazy white finish or pitting. This damage would not be covered by the vehicle warranty.

The bright metal moldings on the vehicle are aluminum or stainless steel. To prevent damage always follow these cleaning instructions:

- Be sure the molding is cool to the touch before applying any cleaning solution.
- Use a cleaning solution approved for aluminum or stainless steel. Some cleaners are highly acidic or contain alkaline substances and can damage the moldings.
- Always dilute a concentrated cleaner according to the manufacturer's instructions.
- Do not use chrome cleaners.
- Do not use cleaners that are not intended for automotive use.
- Use a nonabrasive wax on the vehicle after washing to protect and extend the molding finish.

Cleaning Exterior Lamps/ Lenses, Emblems, Decals, and Stripes

Use only lukewarm or cold water, a soft cloth, and a car washing soap to clean exterior lamps, lenses, emblems, decals and stripes. Follow instructions under "Washing the Vehicle" previously in this section.

Lamp covers are made of plastic, and some have a UV protective coating. Do not clean or wipe them while they are dry.

Do not use any of the following on lamp covers:

- Abrasive or caustic agents.
- Washer fluids and other cleaning agents in higher concentrations than suggested by the manufacturer.
- Solvents, alcohols, fuels, or other harsh cleaners.
- Ice scrapers or other hard items.

314 Vehicle Care

- Aftermarket appearance caps or covers while the lamps are illuminated, due to excessive heat generated.

Caution

Failure to clean lamps properly can cause damage to the lamp cover that would not be covered by the vehicle warranty.

Caution

Using wax on low gloss black finish stripes can increase the gloss level and create a non-uniform finish. Clean low gloss stripes with soap and water only.

Air Intakes

Clear debris from the air intakes, between the hood and windshield, when washing the vehicle.

Windshield and Wiper Blades

Clean the outside of the windshield with glass cleaner.

Clean rubber blades using a lint-free cloth or paper towel soaked with windshield washer fluid or a mild detergent. Wash the windshield thoroughly when cleaning the blades. Bugs, road grime, sap, and a buildup of vehicle wash/wax treatments may cause wiper streaking.

Replace the wiper blades if they are worn or damaged. Damage can be caused by extreme dusty conditions, sand, salt, heat, sun, snow, and ice.

Weatherstrips

Apply weatherstrip lubricant on weatherstrips to make them last longer, seal better, and not stick or squeak. Lubricate weatherstrips at least once a year. Hot, dry climates may require more frequent application. Black marks from rubber material on painted surfaces can be removed by rubbing with a clean cloth.

Tires

Use a stiff brush with tire cleaner to clean the tires.

Caution

Using petroleum-based tire dressing products on the vehicle may damage the paint finish and/or tires. When applying a tire dressing, always wipe off any overspray from all painted surfaces on the vehicle.

Wheels and Trim — Aluminum or Chrome

Use a soft, clean cloth with mild soap and water to clean the wheels. After rinsing thoroughly with clean water, dry with a soft, clean towel. A wax may then be applied.

Caution

Chrome wheels and other chrome trim may be damaged if the vehicle is not washed after driving on roads that have been sprayed with magnesium, calcium, or sodium chloride. These chlorides are used on roads for conditions such as ice and dust. Always wash the chrome with soap and water after exposure.

Caution

To avoid surface damage, do not use strong soaps, chemicals, abrasive polishes, cleaners, brushes, or cleaners that contain acid on aluminum or chrome-plated wheels. Use only approved cleaners. Also, never drive a vehicle with aluminum or chrome-plated wheels through an automatic car wash that uses silicone carbide tire cleaning brushes. Damage could occur and the repairs would not be covered by the vehicle warranty.

Brake System

Visually inspect brake lines and hoses for proper hook-up, binding, leaks, cracks, chafing, etc. Inspect disc brake pads for wear and rotors for surface condition. Inspect drum brake linings/shoes for wear or cracks. Inspect all other brake parts.

Steering, Suspension, and Chassis Components

Visually inspect steering, suspension, and chassis components for damaged, loose, or missing parts or signs of wear at least once a year.

Inspect power steering for proper attachment, connections, binding, leaks, cracks, chafing, etc.

Visually check constant velocity joint boots and axle seals for leaks.

Body Component Lubrication

Lubricate all key lock cylinders, hood hinges, liftgate hinges, steel charge port door, and power assist step hinges, unless the components are plastic. Applying silicone grease on weatherstrips with a clean cloth will make them last longer, seal better, and not stick or squeak.

Underbody Maintenance

At least twice a year, spring and fall, use plain water to flush any corrosive materials from the underbody. Take care to thoroughly clean any areas where mud and other debris can collect.

Sheet Metal Damage

If the vehicle is damaged and requires sheet metal repair or replacement, make sure the body repair shop applies anti-corrosion material to parts repaired or replaced to restore corrosion protection.

Original manufacturer replacement parts will provide the corrosion protection while maintaining the vehicle warranty.

Finish Damage

Quickly repair minor chips and scratches with touch-up materials available from your dealer to avoid corrosion. Larger areas of finish damage can be corrected in your dealer's body and paint shop.

Chemical Paint Spotting

Airborne pollutants can fall upon and attack painted vehicle surfaces causing blotchy, ring-shaped discolorations, and small, irregular dark spots etched into the paint surface. See "Finish Care" previously in this section.

Interior Care

To prevent dirt particle abrasions, regularly clean the vehicle's interior. Immediately remove any soils. Newspapers or dark garments can transfer color to the vehicle's interior.

Use a soft bristle brush to remove dust from knobs and crevices on the instrument cluster. Using a mild soap solution, immediately remove hand lotions, sunscreen, and insect repellent from all interior surfaces or permanent damage may result.

Use cleaners specifically designed for the surfaces being cleaned to prevent permanent damage. Apply all cleaners directly to the cleaning cloth. Do not spray cleaners on any switches or controls. Remove cleaners quickly.

Before using cleaners, read and follow all safety instructions on the label. While cleaning the interior, open the doors and windows to get proper ventilation.

To prevent damage, do not clean the interior using the following cleaners or techniques:

- Never use a razor or any other sharp object to remove soil from any interior surface.
- Never use a brush with stiff bristles.

- Never rub any surface aggressively or with too much pressure.
- Do not use laundry detergents or dishwashing soaps with degreasers. For liquid cleaners, use approximately 20 drops per 3.8 L (1 gal) of water. A concentrated soap solution will create streaks and attract dirt. Do not use solutions that contain strong or caustic soap.
- Do not heavily saturate the upholstery when cleaning.
- Do not use solvents or cleaners containing solvents.

Interior Glass

To clean, use a terry cloth fabric dampened with water. Wipe droplets left behind with a clean dry cloth. If necessary, use a commercial glass cleaner after cleaning with plain water.

Caution

To prevent scratching, never use abrasive cleaners on automotive glass. Abrasive cleaners or aggressive cleaning may damage the rear window defogger.

Cleaning the windshield with water during the first three to six months of ownership will reduce tendency to fog.

Speaker Covers

Vacuum around a speaker cover gently, so that the speaker will not be damaged. Clean spots with water and mild soap.

Coated Moldings

Coated moldings should be cleaned.

- When lightly soiled, wipe with a sponge or soft, lint-free cloth dampened with water.
- When heavily soiled, use warm soapy water.

Fabric/Carpet/Suede

Start by vacuuming the surface using a soft brush attachment. If a rotating vacuum brush attachment is being used, only use it on the floor carpet. Before cleaning, gently remove as much of the soil as possible:

- Gently blot liquids with a paper towel. Continue blotting until no more soil can be removed.
- For solid soils, remove as much as possible prior to vacuuming.

To clean:

1. Saturate a clean, lint-free colorfast cloth with water. Microfiber cloth is recommended to prevent lint transfer to the fabric or carpet.
2. Remove excess moisture by gently wringing until water does not drip from the cleaning cloth.

3. Start on the outside edge of the soil and gently rub toward the center. Fold the cleaning cloth to a clean area frequently to prevent forcing the soil in to the fabric.
4. Continue gently rubbing the soiled area until there is no longer any color transfer from the soil to the cleaning cloth.
5. If the soil is not completely removed, use a mild soap solution followed only by plain water.

If the soil is not completely removed, it may be necessary to use a commercial upholstery cleaner or spot lifter. Test a small hidden area for colorfastness before using a commercial upholstery cleaner or spot lifter. If ring formation occurs, clean the entire fabric or carpet.

After cleaning, use a paper towel to blot excess moisture.

Cleaning High Gloss Surfaces and Vehicle Information and Radio Displays

Use a microfiber cloth on high gloss surfaces or vehicle displays. First, use a soft bristle brush to remove dirt that can scratch the surface. Then gently clean by rubbing with a microfiber cloth. Never use window cleaners or solvents. Periodically hand wash the microfiber cloth separately, using mild soap. Do not use bleach or fabric softener. Rinse thoroughly and air dry before next use.

Caution

Do not attach a device with a suction cup to the display. This may cause damage and would not be covered by the vehicle warranty.

Instrument Panel, Leather, Vinyl, Other Plastic Surfaces, Low Gloss Paint Surfaces, and Natural Open Pore Wood Surfaces

Use a soft microfiber cloth dampened with water to remove dust and loose dirt. For a more thorough cleaning, use a soft microfiber cloth dampened with a mild soap solution.

Caution

Soaking or saturating leather, especially perforated leather, as well as other interior surfaces, may cause permanent damage. Wipe excess moisture from these surfaces after cleaning and allow them to dry naturally. Never use heat, steam, or spot removers. Do not use cleaners that contain silicone or wax-based products. Cleaners containing these solvents can permanently change

(Continued)

Caution (Continued)

the appearance and feel of leather or soft trim, and are not recommended.

Do not use cleaners that increase gloss, especially on the instrument panel. Reflected glare can decrease visibility through the windshield under certain conditions.

Caution

Use of air fresheners may cause permanent damage to plastics and painted surfaces. If an air freshener comes in contact with any plastic or painted surface in the vehicle, blot immediately and clean with a soft cloth dampened with a mild soap solution. Damage caused by air fresheners would not be covered by the vehicle warranty.

Cargo Cover and Convenience Net

If equipped, wash with warm water and mild detergent. Do not use chlorine bleach. Rinse with cold water, and then dry completely.

Care of Seat Belts

Keep belts clean and dry.

Warning

Do not bleach or dye seat belt webbing. It may severely weaken the webbing. In a crash, they might not be able to provide adequate protection. Clean and rinse seat belt webbing only with mild soap and lukewarm water. Allow the webbing to dry.

Floor Mats**Warning**

If a floor mat is the wrong size or is not properly installed, it can interfere with the pedals. Interference with the pedals can cause unintended acceleration and/or increased stopping distance which can cause a crash and injury. Make sure the floor mat does not interfere with the pedals.

Use the following guidelines for proper floor mat usage:

- The original equipment floor mats were designed for your vehicle. If the floor mats need replacing, it is recommended that GM certified floor mats be purchased. Non-GM floor mats may not fit properly and may interfere with the pedals. Always check that the floor mats do not interfere with the pedals.

320 Vehicle Care

- Do not use a floor mat if the vehicle is not equipped with a floor mat retainer on the driver side floor.
- Use the floor mat with the correct side up. Do not turn it over.
- Do not place anything on top of the driver side floor mat.
- Use only a single floor mat on the driver side.
- Do not place one floor mat on top of another.

Removing and Replacing the Floor Mats

Pull up on the rear of the floor mat to unlock each retainer and remove.

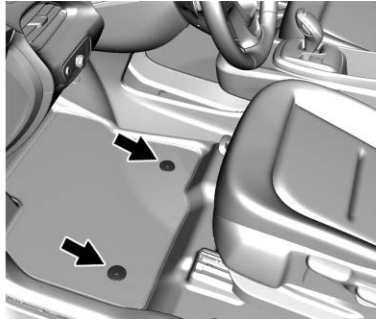

Reinstall by lining up the floor mat retainer openings over the carpet retainers and snap into position.

Make sure the floor mat is properly secured in place.

Verify the floor mat does not interfere with the pedals.

Service and Maintenance

- General Information**
- General Information 321
- Maintenance Schedule**
- Maintenance Schedule 322
- Owner Checks and Services**
- Owner Checks and Services 324
- Additional Maintenance and Care**
- Additional Maintenance and Care 325
- Recommended Fluids, Lubricants, and Parts**
- Recommended Fluids and Lubricants 327
- Maintenance Replacement Parts 328
- Maintenance Records**
- Maintenance Records 329

General Information

Your vehicle is an important investment. This section describes the required maintenance for the vehicle. Follow this schedule to help protect against major repair expenses resulting from neglect or inadequate maintenance. It may also help to maintain the value of the vehicle if it is sold. It is the responsibility of the owner to have all required maintenance performed.

Your dealer has trained technicians who can perform required maintenance using genuine replacement parts. They have up-to-date tools and equipment for fast and accurate diagnostics. Many dealers have extended evening and Saturday hours, courtesy transportation, and online scheduling to assist with service needs.

Your dealer recognizes the importance of providing competitively priced maintenance and repair services. With trained technicians, the dealer is the place

for routine maintenance such as tire rotations and additional maintenance items like tires, brakes, batteries, and wiper blades.

Caution

Damage caused by improper maintenance can lead to costly repairs and may not be covered by the vehicle warranty. Maintenance intervals, checks, inspections, recommended fluids, and lubricants are important to keep the vehicle in good working condition.

Do not have chemical flushes that are not approved by GM performed on the vehicle. The use of flushes, solvents, cleaners, or lubricants that are not approved by GM could damage the vehicle, requiring expensive repairs that are not covered by the vehicle warranty.



The Tire Rotation and Required Services are the responsibility of the vehicle owner. It is recommended to have your dealer perform these services every 12 000 km/7,500 mi. Proper vehicle maintenance helps to keep the vehicle in good working condition.

The Additional Required Services are for vehicles that:

- Carry passengers and cargo within recommended limits on the Tire and Loading Information label. See *Vehicle Load Limits* ⇨ 200.
- Are driven on reasonable road surfaces within legal driving limits.

Refer to the information in the Maintenance Schedule Additional Required Services chart.

Warning

Performing maintenance work can be dangerous and can cause serious injury. Perform maintenance work only if the required information, proper tools, and equipment are available. If they are not, see your dealer to have a trained technician do the work. See *Doing Your Own Service Work* ⇨ 256.

Maintenance Schedule

Owner Checks and Services

Once a Month

- Check the tire inflation pressures. See *Tire Pressure* ⇨ 284.
- Inspect the tires for wear. See *Tire Inspection* ⇨ 289.
- Check the windshield washer fluid level. See *Washer Fluid* ⇨ 261.

Tire Rotation and Required Services Every 12 000 km/7,500 mi

Rotate the tires, if recommended for the vehicle, and perform the following services. See *Tire Rotation* ⇨ 290.

- Check coolant level. See *Cooling System* ⇨ 260.
- Check windshield washer fluid level. See *Washer Fluid* ⇨ 261.

- Visually inspect windshield wiper blades for wear, cracking, or contamination. See *Exterior Care* ⇨ 311. Replace worn or damaged wiper blades. See *Wiper Blade Replacement* ⇨ 266.
- Check tire inflation pressures. See *Tire Pressure* ⇨ 284.
- Inspect tire wear. See *Tire Inspection* ⇨ 289.
- Visually check for fluid leaks.
- Inspect brake system. See *Exterior Care* ⇨ 311.
- Visually inspect steering, suspension, and chassis components for damaged, loose, or missing parts or signs of wear. See *Exterior Care* ⇨ 311.
- Check restraint system components. See *Safety System Check* ⇨ 69.
- Lubricate body components. See *Exterior Care* ⇨ 311.
- Check accelerator pedal for damage, high effort, or binding. Replace if needed.
- Visually inspect gas strut for signs of wear, cracks, or other damage. Check the hold open ability of the strut. If the hold open ability is low, service the gas strut. See *Gas Strut(s)* ⇨ 267.
- Check tire sealant expiration date, if equipped. See *Tire Sealant and Compressor Kit* ⇨ 297.

Maintenance Schedule Additional Required Services	12 000 km/7,500 mi	24 000 km/15,000 mi	36 000 km/22,500 mi	48 000 km/30,000 mi	60 000 km/37,500 mi	72 000 km/45,000 mi	84 000 km/52,500 mi	96 000 km/60,000 mi	108 000 km/67,500 mi	120 000 km/75,000 mi	132 000 km/82,500 mi	144 000 km/90,000 mi	156 000 km/97,500 mi	168 000 km/105,000 mi	180 000 km/112,500 mi	192 000 km/120,000 mi	204 000 km/127,500 mi	216 000 km/135,000 mi	228 000 km/142,500 mi	240 000 km/150,000 mi
Rotate tires and perform Required Services.	✓	✓	✓	✓	✓	✓	✓	✓	✓	✓	✓	✓	✓	✓	✓	✓	✓	✓	✓	✓
Replace passenger compartment air filter. (1)			✓			✓			✓			✓			✓			✓		
Drain and fill vehicle coolant circuits. (2)																				✓
Replace brake fluid. (3)																				

Footnotes — Maintenance Schedule Additional Required Services

(1) Or every two years, whichever comes first. More frequent passenger compartment air filter replacement may be needed if driving in areas with heavy traffic, poor air quality, high dust levels, or environmental allergens. Passenger compartment air filter replacement may also be needed if there is reduced airflow, window fogging, or odors. Your GM dealer can help determine when to replace the filter.

(2) Or every five years, whichever comes first. See *Cooling System* ⇨ 260.

(3) Replace brake fluid every five years. See *Brake Fluid* ⇨ 263.

Owner Checks and Services

- At least twice a year, have underbody flushing service performed. See "Underbody Maintenance" in *Exterior Care* ⇨ 311.

Additional Maintenance and Care

Your vehicle is an important investment and caring for it properly may help to avoid future costly repairs. To maintain vehicle performance, additional maintenance services may be required. It is recommended that your dealer perform these services — their trained dealer technicians know your vehicle best. Your dealer can also perform a thorough assessment with a multi-point inspection to recommend when your vehicle may need attention. The following list is intended to explain the services and conditions to look for that may indicate services are required.

Battery

The battery supplies power to operate any additional electrical accessories.

- To avoid break-down or failure, maintain a battery with full power.

- Trained dealer technicians have the diagnostic equipment to test the battery and ensure that the connections and cables are corrosion-free.

Brakes

Brakes stop the vehicle and are crucial to safe driving.

- Signs of brake wear may include chirping, grinding, or squealing noises, or difficulty stopping.
- Trained dealer technicians have access to tools and equipment to inspect the brakes and recommend quality parts engineered for the vehicle.

Fluids

Proper fluid levels and approved fluids protect the vehicle's systems and components. See *Recommended Fluids and Lubricants* ⇨ 327 for GM approved fluids.

- Keep the windshield washer fluid reservoir filled.

- Instrument cluster lights may come on to indicate that fluids may be low and need to be filled.

Hoses

Hoses transport fluids and should be regularly inspected to ensure that there are no cracks or leaks. With a multi-point inspection, your dealer can inspect the hoses and advise if replacement is needed.

Lamps

Properly working headlamps, taillamps, and brake lamps are important to see and be seen on the road.

- Signs that the headlamps need attention include dimming, failure to light, cracking, or damage. The brake lamps need to be checked periodically to ensure that they light when braking.
- With a multi-point inspection, your dealer can check the lamps and note any concerns.

Shocks and Struts

Shocks and struts help aid in control for a smoother ride.

- Signs of wear may include steering wheel vibration, bounce/sway while braking, longer stopping distance, or uneven tire wear.
- As part of the multi-point inspection, trained dealer technicians can visually inspect the shocks and struts for signs of leaking, blown seals, or damage, and can advise when service is needed.

Tires

Tires need to be properly inflated, rotated, and balanced. Maintaining the tires can save money and reduce the risk of tire failure.

- Signs that the tires need to be replaced include three or more visible treadwear indicators; cord or fabric showing through the rubber; cracks or cuts in the tread or sidewall; or a bulge or split in the tire.

- Trained dealer technicians can inspect and recommend the right tires. Your dealer can also provide tire/wheel balancing services to ensure smooth vehicle operation at all speeds. Your dealer sells and services name brand tires.

Vehicle Care

To help keep the vehicle looking like new, vehicle care products are available from your dealer. For information on how to clean and protect the vehicle's interior and exterior, see *Interior Care* ⇨ 316 and *Exterior Care* ⇨ 311.

Wheel Alignment

Wheel alignment is critical for ensuring that the tires deliver optimal wear and performance.

- Signs that the alignment may need to be adjusted include pulling, improper vehicle handling, or unusual tire wear.
- Your dealer has the required equipment to ensure proper wheel alignment.

Windshield

For safety, appearance, and the best viewing, keep the windshield clean and clear.

- Signs of damage include scratches, cracks, and chips.
- Trained dealer technicians can inspect the windshield and recommend proper replacement if needed.

Wiper Blades

Wiper blades need to be cleaned and kept in good condition to provide a clear view.

- Signs of wear include streaking, skipping across the windshield, and worn or split rubber.
- Trained dealer technicians can check the wiper blades and replace them when needed.

Recommended Fluids, Lubricants, and Parts

Recommended Fluids and Lubricants

Usage	Fluid/Lubricant
Electric Drive Unit	See your dealer.
Hydraulic Brake System	DOT 3 Hydraulic Brake Fluid (GM Part No. 19353126, in Canada 19299819).
Key Lock Cylinders, Hood and Liftgate Hinges	Multi-Purpose Lubricant, Superlube (GM Part No. 12346241, in Canada 10953474).
Vehicle Coolant Circuits	Use Only Premix DEX-COOL Coolant (GM Part No. 12378390, in Canada 10953456). See <i>Cooling System</i> ⇨ 260.
Weatherstrip Conditioning	Weatherstrip lubricant (GM Part No. 3634770, in Canada 10953518) or equivalent.
Windshield Washer	Automotive windshield washer fluid that meets regional freeze protection requirements.

Maintenance Replacement Parts

Replacement parts identified below by name, part number, or specification can be obtained from your dealer.

Part	GM Part Number	ACDelco Part Number
Passenger Compartment Air Filter	13508023	CF185
Wiper Blades		
Driver Side – 68 cm (26.8 in)	42341754	—
Passenger Side – 68 cm (26.8 in)	42341756	—
Rear – 30 cm (11.8 in)	84215609	—

Maintenance Records

After the scheduled services are performed, record the date, odometer reading, who performed the service, and the type of services performed in the boxes provided. Retain all maintenance receipts.

Date	Odometer Reading	Serviced By	Services Performed

Technical Data

Vehicle Identification

Vehicle Identification Number (VIN)	330
Service Parts Identification Label	330

Vehicle Data

Capacities and Specifications	331
--	-----

Vehicle Identification

Vehicle Identification Number (VIN)



This legal identifier is in the front corner of the instrument panel, on the driver side of the vehicle. It can be seen through the windshield from outside. The Vehicle Identification Number (VIN) also appears on the Vehicle Certification and Service Parts labels and certificates of title and registration.

Engine Identification

The eighth character in the VIN is the engine code. This code identifies the vehicle's engine, specifications, and replacement

parts. See “Engine Specifications” under *Capacities and Specifications* ⇨ 331 for the vehicle's engine code.

Service Parts Identification Label

There may be a label on the inside of the trunk that contains the following information:

- Vehicle Identification Number (VIN)
- Model designation
- Paint information
- Production options and special equipment

If there is no label, there is a barcode on the certification label on the center (B) pillar to scan for this same information.

Vehicle Data

Capacities and Specifications

The following approximate capacities are given in metric and English conversions.

Refer to *Recommended Fluids and Lubricants* ⇨ 327 for more information.

Application	Capacities	
	Metric	English
Air Conditioning Refrigerant	For the air conditioning system refrigerant charge type and amount, see the refrigerant label under the hood. See your dealer for more information.	
Cooling Systems		
High Voltage Battery	7.0 L	7.4 qt
Power Electronics	3.8 L	4.0 qt
Heater	2.0 L	2.1 qt
Wheel Nut Torque	140 N•m	100 lb ft
All capacities are approximate. When adding, be sure to fill to the approximate level, as recommended in this manual. Recheck fluid level after filling.		

Customer Information

Customer Information

Customer Satisfaction Procedure	332
Customer Assistance Offices	334
Customer Assistance for Text Telephone (TTY) Users	335
Online Owner Center	335
GM Mobility Reimbursement Program	336
Roadside Assistance Program	336
Scheduling Service Appointments	338
Courtesy Transportation Program	338
Collision Damage Repair	339
Service Publications Ordering Information	341
Radio Frequency Statement	342

Reporting Safety Defects

Reporting Safety Defects to the United States Government	342
Reporting Safety Defects to the Canadian Government	343
Reporting Safety Defects to General Motors	343

Vehicle Data Recording and Privacy

Vehicle Data Recording and Privacy	344
Event Data Recorders	344
OnStar	345

Customer Information

Customer Satisfaction Procedure

Your satisfaction and goodwill are important to your dealer and to Chevrolet. Normally, any concerns with the sales transaction or the operation of the vehicle will be resolved by your dealer's sales or service departments. Sometimes, however, despite the best intentions of all concerned, misunderstandings can occur. If your concern has not been resolved to your satisfaction, the following steps should be taken:

STEP ONE : Discuss your concern with a member of dealership management. Normally, concerns can be quickly resolved at that level. If the matter has already been reviewed with the sales, service, or parts manager, contact the owner of your dealership or the general manager.

STEP TWO : If after contacting a member of dealership management, it appears your concern cannot be

resolved by your dealership without further help, in the U.S., call the Chevrolet Customer Assistance Center at 1-877-486-5846. In Canada, call General Motors of Canada Customer Care Centre at 1-800-263-3777 (English), or 1-800-263-7854 (French).

We encourage you to call the toll-free number in order to give the inquiry prompt attention. Have the following information available to give the Customer Assistance representative:

- Vehicle Identification Number (VIN). This is available from the vehicle registration or title, or the plate at the top left of the instrument panel and visible through the windshield.
- Dealership name and location.
- Vehicle delivery date and present mileage.

When contacting Chevrolet, remember that your concern will likely be resolved at a dealer's facility. That is why we suggest following Step One first.

STEP THREE — U.S. Owners :

Both General Motors and your dealer are committed to making sure you are completely satisfied with the new vehicle. However, if you continue to remain unsatisfied after following the procedure outlined in Steps One and Two, you can file with the Better Business Bureau (BBB) Auto Line Program to enforce your rights.

The BBB Auto Line Program is an out-of-court program administered by the Council of Better Business Bureaus to settle automotive disputes regarding vehicle repairs or the interpretation of the New Vehicle Limited Warranty. Although you may be required to resort to this informal dispute resolution program prior to filing a court action, use of the program is free of charge and your case will generally be heard within 40 days. If you do not agree with the decision given in your case, you may reject it and proceed with any other venue for relief available to you.



You may contact the BBB Auto Line Program using the toll-free telephone number or write them at the following address:

BBB Auto Line Program
Council of Better Business Bureaus, Inc.
3033 Wilson Boulevard
Suite 600 , Arlington, VA 22201
Telephone: 1-800-955-5100
<http://www.bbb.org/council/programs-services/dispute-handling-and-resolution/bbb-auto-line>

This program is available in all 50 states and the District of Columbia. Eligibility is limited by vehicle age, mileage, and other factors. General Motors reserves the right to change eligibility limitations and/or discontinue its participation in this program.

STEP THREE — Canadian

Owners : In the event that you do not feel your concerns have been addressed after following the procedure outlined in Steps One and Two, General Motors of Canada Company wants you to be aware of

its participation in a no-charge Mediation/Arbitration Program. General Motors of Canada Company has committed to binding arbitration of owner disputes involving factory-related vehicle service claims. The program provides for the review of the facts involved by an impartial third party arbiter, and may include an informal hearing before the arbiter. The program is designed so that the entire dispute settlement process, from the time you file your complaint to the final decision, should be completed in about 70 days. We believe our impartial program offers advantages over courts in most jurisdictions because it is informal, quick, and free of charge.

For further information concerning eligibility in the Canadian Motor Vehicle Arbitration Plan (CAMVAP), call toll-free 1-800-207-0685, or call the General Motors Customer Care Centre, 1-800-263-3777 (English), 1-800-263-7854 (French), or write to:

The Mediation/Arbitration Program
c/o Customer Care Centre
General Motors of Canada
Company
Mail Code: CA1-163-005
1908 Colonel Sam Drive
Oshawa, Ontario L1H 8P7

The inquiry should be accompanied by the Vehicle Identification Number (VIN).

Customer Assistance Offices

Chevrolet encourages customers to call the toll-free number for assistance. However, if a customer wishes to write or e-mail Chevrolet, the letter should be addressed to:

United States and Puerto Rico

Chevrolet Motor Division
Chevrolet Customer Assistance
Center
P.O. Box 33170
Detroit, MI 48232-5170
www.Chevrolet.com

1-877-486-5846
1-800-833-2438 (For Text
Telephone Devices (TTYs))
Roadside Assistance:
1-888-811-1926

From U.S. Virgin Islands:
1-800-496-9994

Canada

General Motors of Canada
Company
Customer Care Centre, Mail Code:
CA1-163-005
1908 Colonel Sam Drive
Oshawa, Ontario L1H 8P7
www.gm.ca

1-800-263-3777 (English)
1-800-263-7854 (French)
1-800-263-3830 (For Text

Telephone devices (TTYs))
 Roadside Assistance:
 1-800-268-6800

Overseas

Please contact the local General Motors Business Unit.

Customer Assistance for Text Telephone (TTY) Users

To assist customers who are deaf, hard of hearing, or speech-impaired and who use Text Telephones (TTYs), Chevrolet has TTY equipment available at its Customer Assistance Center. Any TTY user in the U.S. can communicate with Chevrolet by dialing: 1-800-833-2438. TTY users in Canada can dial 1-800-263-3830.

Online Owner Center

Online Owner Experience (U.S.) my.chevrolet.com

The Chevrolet online owner experience allows interaction with Chevrolet and keeps important vehicle-specific information in one place.

Membership Benefits

 : Download owner's manuals and view vehicle-specific how-to videos.

 : View maintenance schedules, alerts, and OnStar Vehicle Diagnostic Information. Schedule service appointments.

 : View and print dealer-recorded service records and self-recorded service records.

 : Select a preferred dealer and view locations, maps, phone numbers, and hours.

 : Track your vehicle's warranty information.

 : View active recalls by Vehicle Identification Number (VIN). See *Vehicle Identification Number (VIN)* ⇨ 330.

 : View GM Card, SiriusXM Satellite radio (if equipped), and OnStar account information.

 : Chat with online help representatives.

See my.chevrolet.com to register your vehicle.

Chevrolet Owner Centre (Canada) chevroletowner.ca

Visit the Chevrolet Owner Centre:

- Chat live with online help representatives.
- Locate owner resources such as lease-end, financing, and warranty information.
- Retrieve your favorite articles, quizzes, tips, and multimedia galleries organized into the Featured Articles and Auto Care Sections.
- Download owner's manuals.

- Find the Chevrolet-recommended maintenance services.

GM Mobility Reimbursement Program

GENERAL MOTORS MOBILITY



This program is available to qualified applicants for cost reimbursement, up to certain limits, of eligible aftermarket adaptive equipment required for the vehicle, such as hand controls or a wheelchair/scooter lift for the vehicle.

To learn about the GM Mobility program, see www.gmmobility.com or call the GM Mobility Assistance Center at 1-800-323-9935. Text Telephone (TTY) users, call 1-800-833-9935.

General Motors of Canada also has a Mobility program. See www.gm.ca or call 1-800-GM-DRIVE (800-463-7483) for details. TTY users call 1-800-263-3830.

Roadside Assistance Program

From the U.S., call 1-888-811-1926; Text Telephone (TTY): 1-888-889-2438.

From Canada, call 1-800-268-6800.

Service is available 24 hours a day, 365 days a year.

Calling for Assistance

When calling Roadside Assistance, have the following information ready:

- Your name, home address, and home telephone number.
- Telephone number of your location.
- Location of the vehicle.
- Model, year, color, and license plate number of the vehicle.

- Odometer reading, Vehicle Identification Number (VIN), and delivery date of the vehicle.
- Description of the problem.

Coverage

Services are provided for the duration of the vehicle's powertrain warranty.

In the U.S., anyone driving the vehicle is covered. In Canada, a person driving the vehicle without permission from the owner is not covered.

Roadside Assistance is not a part of the New Vehicle Limited Warranty. General Motors North America and Chevrolet reserve the right to make any changes or discontinue the Roadside Assistance program at any time without notification.

General Motors North America and Chevrolet reserve the right to limit services or payment to an owner or driver if they decide the claims are made too often, or the same type of claim is made many times.

Services Provided

- **Lock-Out Service:** Service to unlock the vehicle if you are locked out. A remote unlock may be available if you have OnStar. For security reasons, the driver must present identification before this service is given.
- **Emergency Tow from a Public Road or Highway:** Tow to the nearest certified Bolt EV dealer for warranty service, or if the vehicle was in a crash and cannot be driven. Assistance is not given when the vehicle is stuck in the sand, mud, or snow.

Emergency towing may be covered during the Extended Vehicle (EV) warranty.

- **Flat Tire Change:** If the tire has been separated from the wheel, has damaged sidewalls, or has a large puncture, the tire is too severely damaged for the self sealing tire to be effective and the vehicle will have to be towed. It is the owner's

responsibility for the repair or replacement of the tire if it is not covered by the warranty.

- **Battery Jump Start:** Service to jump start a dead battery.
- **Trip Interruption Benefits and Assistance:** If your trip is interrupted due to a warranty event, incidental expenses may be reimbursed within the Powertrain warranty period. Items considered are reasonable and customary hotel, meals, rental car, or a vehicle being delivered back to the customer, up to 500 miles.

Services Not Included in Roadside Assistance

- Impound towing caused by violation of any laws.
- Legal fines.
- Mounting, dismounting, or changing of snow tires, chains, or other traction devices.

Service is not provided if a vehicle is in an area that is not accessible to the service vehicle or is not a

regularly traveled or maintained public road, which includes ice and winter roads. Off-road use is not covered.

Services Specific to Canadian Vehicles

- **Lock-Out Service:** Vehicle registration is required.
- **Trip Interruption Benefits and Assistance:** Must be over 150 km (93 mi) from where the trip was started to qualify. Pre-authorization, original detailed receipts, and a copy of the repair orders are required. Once authorization has been received, the Roadside Assistance advisor will help to make arrangements and explain how to receive payment.
- **Alternative Service:** If assistance cannot be provided right away, the Roadside Assistance advisor may give permission to get local emergency road service. You will receive payment, up to \$100, after sending the original receipt

to Roadside Assistance. Mechanical failures may be covered, however any cost for parts and labor for repairs not covered by the warranty are the owner's responsibility.

Scheduling Service Appointments

When the vehicle requires warranty service, contact your dealer and request an appointment. By scheduling a service appointment and advising the service consultant of your transportation needs, your dealer can help minimize your inconvenience.

If the vehicle cannot be scheduled into the service department immediately, keep driving it until it can be scheduled for service, unless, of course, the problem is safety related. If it is, please call your dealership, let them know this, and ask for instructions.

If your dealer requests you to bring the vehicle for service, you are urged to do so as early in the work day as possible to allow for same-day repair.

Courtesy Transportation Program

To enhance your ownership experience, we and our participating dealers are proud to offer Courtesy Transportation, a customer support program for vehicles with the Bumper-to-Bumper (Base Warranty Coverage period in Canada), and extended powertrain in both the U.S. and Canada.

Several Courtesy Transportation options are available to assist in reducing inconvenience when warranty repairs are required.

Courtesy Transportation is not a part of the New Vehicle Limited Warranty. A separate booklet entitled "Limited Warranty and Owner Assistance Information"

furnished with each new vehicle provides detailed warranty coverage information.

Transportation Options

Warranty service can generally be completed while you wait. However, if you are unable to do so, your dealer may offer the following transportation options:

Shuttle Service

This includes one-way or round-trip shuttle service within reasonable time and distance parameters of your dealer's area.

Public Transportation

If overnight warranty repairs are needed, and public transportation is used, the expense must be supported by original receipts and within the maximum amount allowed by GM for shuttle service. Claim amounts should reflect actual costs and be supported by original receipts. See your dealer for information.

Courtesy Rental Vehicle

For an overnight warranty repair, the dealer may provide an available courtesy rental vehicle or provide for reimbursement of a rental vehicle. Reimbursement is limited and must be supported by original receipts as well as a signed and completed rental agreement and meet state/provincial, local, and rental vehicle provider requirements.

Requirements vary and may include minimum age requirements, insurance coverage, credit card, etc. Additional fees such as taxes, levies, usage fees, excessive mileage, or rental usage beyond the completion of the repair are also your responsibility.

It may not be possible to provide a like vehicle as a courtesy rental.

Additional Program Information

All program options, such as shuttle service, may not be available at every dealer. Contact your dealer for specific availability.

General Motors reserves the right to unilaterally modify, change, or discontinue Courtesy Transportation at any time and to resolve all questions of claim eligibility pursuant to the terms and conditions described herein at its sole discretion.

Collision Damage Repair

If the vehicle is involved in a collision and it is damaged, have the damage repaired by a qualified technician using the proper equipment and quality replacement parts. Poorly performed collision repairs diminish the vehicle resale value, and safety performance can be compromised in subsequent collisions.

Collision Parts

Genuine GM Collision parts are new parts made with the same materials and construction methods as the parts with which the vehicle was originally built. Genuine GM Collision parts are the best choice to ensure that the vehicle's designed

appearance, durability, and safety are preserved. The use of Genuine GM parts can help maintain the GM New Vehicle Limited Warranty.

Recycled original equipment parts may also be used for repair. These parts are typically removed from vehicles that were total losses in prior crashes. In most cases, the parts being recycled are from undamaged sections of the vehicle. A recycled original equipment GM part may be an acceptable choice to maintain the vehicle's originally designed appearance and safety performance; however, the history of these parts is not known. Such parts are not covered by the GM New Vehicle Limited Warranty, and any related failures are not covered by that warranty.

Aftermarket collision parts are also available. These are made by companies other than GM and may not have been tested for the vehicle. As a result, these parts may fit poorly, exhibit premature durability/corrosion problems, and may not perform properly in subsequent

collisions. Aftermarket parts are not covered by the GM New Vehicle Limited Warranty, and any vehicle failure related to such parts is not covered by that warranty.

Repair Facility

GM also recommends that you choose a collision repair facility that meets your needs before you ever need collision repairs. Your dealer may have a collision repair center with GM-trained technicians and state-of-the-art equipment, or be able to recommend a collision repair center that has GM-trained technicians and comparable equipment.

Insuring the Vehicle

Protect your investment in the GM vehicle with comprehensive and collision insurance coverage. There are significant differences in the quality of coverage afforded by various insurance policy terms. Many insurance policies provide reduced protection to the GM vehicle by limiting compensation for damage repairs by using

aftermarket collision parts. Some insurance companies will not specify aftermarket collision parts. When purchasing insurance, we recommend that you ensure that the vehicle will be repaired with GM original equipment collision parts. If such insurance coverage is not available from your current insurance carrier, consider switching to another insurance carrier.

If the vehicle is leased, the leasing company may require you to have insurance that ensures repairs with Genuine GM Original Equipment Manufacturer (OEM) parts or Genuine Manufacturer replacement parts. Read the lease carefully, as you may be charged at the end of the lease for poor quality repairs.

If a Crash Occurs

If there has been an injury, call emergency services for help. Do not leave the scene of a crash until all matters have been taken care of. Move the vehicle only if its position

puts you in danger, or you are instructed to move it by a police officer.

Give only the necessary information to police and other parties involved in the crash.

For emergency towing see *Roadside Assistance Program* ⇨ 336.

Gather the following information:

- Driver name, address, and telephone number
- Driver license number
- Owner name, address, and telephone number
- Vehicle license plate number
- Vehicle make, model, and model year
- Vehicle Identification Number (VIN)
- Insurance company and policy number
- General description of the damage to the other vehicle

Choose a reputable repair facility that uses quality replacement parts. See "Collision Parts" earlier in this section.

In a crash, the sensing system may shut down the high voltage system. See *Battery - North America* ⇨ 264 for important safety information. If an airbag has inflated, see *What Will You See after an Airbag Inflates?* ⇨ 75.

If the vehicle is damaged from a crash, flood, fire, or other event it may be necessary to have the vehicle inspected. See *Battery - North America* ⇨ 264 and *High Voltage Safety Information* ⇨ 22 for important safety information.

Managing the Vehicle Damage Repair Process

In the event that the vehicle requires damage repairs, GM recommends that you take an active role in its repair. If you have a pre-determined repair facility of choice, take the vehicle there, or have it towed there. Specify to the facility that any required replacement collision parts

be original equipment parts, either new Genuine GM parts or recycled original GM parts. Remember, recycled parts will not be covered by the GM vehicle warranty.

Insurance pays the bill for the repair, but you must live with the repair. Depending on your policy limits, your insurance company may initially value the repair using aftermarket parts. Discuss this with the repair professional, and insist on Genuine GM parts. Remember, if the vehicle is leased, you may be obligated to have the vehicle repaired with Genuine GM parts, even if your insurance coverage does not pay the full cost.

If another party's insurance company is paying for the repairs, you are not obligated to accept a repair valuation based on that insurance company's collision policy repair limits, as you have no contractual limits with that company. In such cases, you can have control of the repair and parts choices as long as the cost stays within reasonable limits.



Service Publications Ordering Information

Service Manuals

Service Manuals have the diagnosis and repair information on the electric drive unit, axle, suspension, brakes, electrical, steering, body, etc.

Owner Information

Owner publications are written specifically for owners and intended to provide basic operational information about the vehicle. The Owner Manual includes the Maintenance Schedule for all models.

In-Portfolio: Includes a Portfolio, Owner Manual, and Warranty Booklet.

RETAIL SELL PRICE: \$35.00 to \$40.00 (U.S.) plus handling and shipping fees.

Without Pouch: Owner Manual only.

RETAIL SELL PRICE:
\$25.00 (U.S.) plus handling and shipping fees.

Current and Past Models

Service and Owner Publications are available for many current and past model GM vehicles.

ORDER TOLL FREE:
1-800-551-4123 Monday - Friday
8:00 AM - 6:00 PM Eastern Time

For Credit Card Orders Only
(VISA-MasterCard-Discover), visit
Helm, Inc. at: www.helminc.com

Or write to:

Helm, Incorporated
Attention: Customer Service
47911 Halyard Drive
Plymouth, MI 48170

Prices are subject to change without notice and without incurring obligation. Allow ample time for delivery.

All listed prices are quoted in U.S. funds. Make checks payable in U.S. funds.

Radio Frequency Statement

This vehicle has systems that operate on a radio frequency that complies with Part 15/Part 18 of the Federal Communications Commission (FCC) rules and with Innovation, Science and Economic Development (ISED) Canada's RSP-100 / license-exempt RSS's / ICES-001.

Operation is subject to the following two conditions:

1. The device may not cause harmful interference.
2. The device must accept any interference received, including interference that may cause undesired operation of the device.

Changes or modifications to any of these systems by other than an authorized service facility could void authorization to use this equipment.

Reporting Safety Defects

Reporting Safety Defects to the United States Government

If you believe that your vehicle has a defect which could cause a crash or could cause injury or death, you should immediately inform the National Highway Traffic Safety Administration (NHTSA) in addition to notifying General Motors.

If NHTSA receives similar complaints, it may open an investigation, and if it finds that a safety defect exists in a group of vehicles, it may order a recall and remedy campaign. However, NHTSA cannot become involved in individual problems between you, your dealer, or General Motors.



To contact NHTSA, you may call the Vehicle Safety Hotline toll-free at 1-888-327-4236 (TTY: 1-800-424-9153); go to <http://www.safercar.gov>; or write to:

Administrator, NHTSA
1200 New Jersey Avenue, S.E.
Washington, D.C. 20590

You can also obtain other information about motor vehicle safety from <http://www.safercar.gov>.

Reporting Safety Defects to the Canadian Government

If you live in Canada, and you believe that the vehicle has a safety defect, notify Transport Canada immediately, and notify General Motors of Canada Company. Call Transport Canada at 1-800-333-0510; go to:

www.tc.gc.ca/recalls (English)

www.tc.gc.ca/rappels (French)

or write to:

Transport Canada
Motor Vehicle Safety Directorate
Defect Investigations and
Recalls Division
80 Noel Street
Gatineau, QC J8Z 0A1

Reporting Safety Defects to General Motors

In addition to notifying NHTSA (or Transport Canada) in a situation like this, notify General Motors.

Call 1-800-222-1020, or write:

Chevrolet Motor Division
Chevrolet Customer Assistance
Center
P.O. Box 33170
Detroit, MI 48232-5170

In Canada, call 1-800-263-3777 (English) or 1-800-263-7854 (French), or write:

General Motors of Canada
Company
Customer Care Centre, Mail Code:
CA1-163-005
1908 Colonel Sam Drive
Oshawa, Ontario L1H 8P7

In Mexico, call 01-800-466-0811.

In other Central America and Caribbean Countries, call 52-722-236-0680.



Vehicle Data Recording and Privacy

The vehicle has a number of computers that record information about the vehicle's performance and how it is driven. For example, the vehicle uses computer modules to monitor and control electric drive unit performance, to monitor the conditions for airbag deployment and to deploy them in a crash, and, if equipped, to provide antilock braking to help the driver control the vehicle. These modules may store data to help the dealer technician service the vehicle. Some modules may also store data about how the vehicle is operated, such as rate of energy consumption or average speed. These modules may retain personal preferences, such as radio presets, seat positions, and temperature settings.

Event Data Recorders

This vehicle is equipped with an event data recorder (EDR). The main purpose of an EDR is to record, in certain crash or near crash-like situations, such as an air bag deployment or hitting a road obstacle, data that will assist in understanding how a vehicle's systems performed. The EDR is designed to record data related to vehicle dynamics and safety systems for a short period of time, typically 30 seconds or less. The EDR in this vehicle is designed to record such data as:

- How various systems in your vehicle were operating;
- Whether or not the driver and passenger safety belts were buckled/fastened;
- How far (if at all) the driver was depressing the accelerator and/or brake pedal; and,
- How fast the vehicle was traveling.

These data can help provide a better understanding of the circumstances in which crashes and injuries occur.

Note

EDR data are recorded by your vehicle only if a non-trivial crash situation occurs; no data are recorded by the EDR under normal driving conditions and no personal data (e.g., name, gender, age, and crash location) are recorded. However, other parties, such as law enforcement, could combine the EDR data with the type of personally identifying data routinely acquired during a crash investigation.

To read data recorded by an EDR, special equipment is required, and access to the vehicle or the EDR is needed. In addition to the vehicle manufacturer, other parties, such as law enforcement, that have the special equipment, can read the information if they have access to the vehicle or the EDR.

GM will not access these data or share it with others except: with the consent of the vehicle owner or, if the vehicle is leased, with the consent of the lessee; in response to an official request by police or similar government office; as part of GM's defense of litigation through the discovery process; or, as required by law. Data that GM collects or receives may also be used for GM research needs or may be made available to others for research purposes, where a need is shown and the data is not tied to a specific vehicle or vehicle owner.

OnStar

If the vehicle is equipped with OnStar and has an active service plan, additional data may be collected through the OnStar system. This includes information about the vehicle's operation; collisions involving the vehicle; the use of the vehicle and its features; and, in certain situations, the location and approximate GPS speed of the vehicle. Refer to the

OnStar Terms and Conditions and Privacy Statement on the OnStar website.

See *OnStar Additional Information*
⇨ 352.

OnStar

OnStar Overview

OnStar Overview 346

OnStar Services



Emergency 347
 Security 348
 Navigation 348
 Connections 349
 Diagnostics 351

OnStar Additional Information

OnStar Additional
 Information 352

OnStar Overview



-  Voice Command Button
-  Blue OnStar Button
-  Red Emergency Button

This vehicle may be equipped with a comprehensive, in-vehicle system that can connect to an OnStar Advisor for Emergency, Security, Navigation, Connections, and Diagnostics Services. OnStar services may require a paid service plan and data plan. OnStar requires the vehicle battery and electrical system, cellular service, and GPS satellite signals to be available and operating. OnStar acts as a link to existing emergency service providers. OnStar may collect information about you and your vehicle, including location information. See OnStar User



Terms, Privacy Statement, and Software Terms for more details including system limitations at www.onstar.com (U.S.) or www.onstar.ca (Canada).

The OnStar system status light is next to the OnStar buttons. If the status light is:

- Solid Green: System is ready.
- Flashing Green: On a call.
- Red: Indicates a problem.
- Off: System is off. Press  twice to speak with an OnStar Advisor.

Press  or call 1-888-4ONSTAR (1-888-466-7827) to speak to an Advisor.

Functionality of the Voice Command button may vary by vehicle and region.

Press  to:

- Open the OnStar app on the infotainment display. See the infotainment manual for information on how to use the OnStar app.

Or

- Make a call, end a call, or answer an incoming call.
- Give OnStar Hands-Free Calling voice commands.
- Give OnStar Turn-by-Turn Navigation voice commands.
- Obtain and customize the Wi-Fi hotspot name or SSID and password, if equipped.

Press  to connect to an Advisor to:

- Verify account information or update contact information.
- Get driving directions.

- Receive a Diagnostic check of the vehicle's key operating systems.
- Receive Roadside Assistance.
- Manage Wi-Fi Settings, if equipped.

Press  to get a priority connection to an OnStar Advisor available 24/7 to:

- Get help for an emergency.
- Be a Good Samaritan or respond to an AMBER Alert.
- Get assistance in severe weather or other crisis situations and find evacuation routes.

OnStar Services

Emergency

Emergency Services require an active, OnStar service plan (excludes Basic Plan). With Automatic Crash Response, built-in sensors can automatically alert a specially trained OnStar Advisor who is immediately connected in to the vehicle to help.

Press  for a priority connection to an OnStar Advisor who can contact emergency service providers, direct them to your exact location, and relay important information.

With OnStar Crisis Assist, specially trained Advisors are available 24 hours a day, 7 days a week, to provide a central point of contact, assistance, and information during a crisis.

With Roadside Assistance, Advisors can locate a nearby service provider to help with a flat tire, a battery jump, or an empty gas tank.



Security

If equipped, OnStar provides these services:

- With Stolen Vehicle Assistance, OnStar Advisors can use GPS to pinpoint the vehicle and help authorities quickly recover it.
- With Remote Ignition Block, if equipped, OnStar can block the vehicle from being restarted.
- With Stolen Vehicle Slowdown, if equipped, OnStar can work with law enforcement to gradually slow the vehicle down.

Theft Alarm Notification

If equipped, if the doors are locked and the vehicle alarm sounds, a notification by text, e-mail, or phone call will be sent. If the vehicle is stolen, an OnStar Advisor can work with authorities to recover the vehicle.

Navigation



OnStar navigation requires a specific OnStar service plan.

Press  to receive Turn-by-Turn directions or have them sent to the vehicle's navigation screen, if equipped.

Turn-by-Turn Navigation

1. Press  to connect to an Advisor.
2. Request directions to be downloaded to the vehicle.
3. Follow the voice-guided commands.

Using Voice Commands During a Planned Route

Functionality of the Voice Command button may vary by vehicle and region. For some vehicles, press  to open the OnStar app on the infotainment display. For other vehicles press  as follows.

Cancel Route

1. Press . System responds: "OnStar ready," then a tone.
2. Say "Cancel route." System responds: "Do you want to cancel directions?"
3. Say "Yes." System responds: "OK, request completed, thank you, goodbye."

Route Preview

1. Press . System responds: "OnStar ready," then a tone.
2. Say "Route preview." System responds with the next three maneuvers.

Repeat

1. Press . System responds: "OnStar ready," then a tone.
2. Say "Repeat." System responds with the last direction given, then responds with "OnStar ready," then a tone.

Get My Destination

1. Press . System responds: “OnStar ready,” then a tone.
2. Say “Get my destination.” System responds with the address and distance to the destination, then responds with “OnStar ready,” then a tone.

Send Destination to Vehicle

Directions can be sent to the vehicle’s navigation screen, if equipped.

Press , then ask the Advisor to download directions to the vehicle’s navigation system, if equipped. After the call ends, the navigation screen will provide prompts to begin driving directions. Routes that are sent to the navigation screen can only be canceled through the navigation system.

See www.onstar.com (U.S.) or www.onstar.ca (Canada).

Connections

The following OnStar services help with staying connected.

For coverage maps, see www.onstar.com (U.S.) or www.onstar.ca (Canada).



Ensuring Security

- Change the default passwords for the Wi-Fi hotspot and myChevrolet mobile app. Make these passwords different from each other and use a combination of letters, numbers, and symbols to increase the security.
- Change the default name of the SSID (Service Set Identifier). This is your network’s name that is visible to other wireless devices. Choose a unique name and avoid family names or vehicle descriptions.

OnStar Wi-Fi Hotspot (If Equipped)

The vehicle may have a built-in Wi-Fi hotspot that provides access to the Internet and web content at

4G LTE speed. Up to seven mobile devices can be connected. A data plan is required. Use the in-vehicle controls only when it is safe to do so.

1. To retrieve Wi-Fi hotspot information, press  to open the OnStar app on the infotainment display, then select Wi-Fi Hotspot. On some vehicles, touch Wi-Fi or Settings on the screen.
2. The Wi-Fi settings will display the Wi-Fi hotspot name (SSID), password, and on some vehicles, the connection type (no Internet connection, 3G, 4G, 4G LTE), and signal quality (poor, good, excellent).
3. To change the SSID or password, press  or call 1-888-4ONSTAR to connect with an Advisor. On some vehicles, the SSID and password can be changed in the Wi-Fi Hotspot menu.

After initial set-up, your vehicle's Wi-Fi hotspot will connect automatically to your mobile devices. Manage data usage by turning Wi-Fi on or off on your mobile device, using the myChevrolet mobile app, or by contacting an OnStar Advisor. On some vehicles, Wi-Fi can also be managed from the Wi-Fi Hotspot menu.

myChevrolet Mobile App (If Available)

Download the myChevrolet mobile app to compatible Apple and Android smartphones. Chevrolet users can access the following services from a smartphone:

- Remotely start/stop the vehicle, if factory-equipped.
- Lock/unlock doors, if equipped with automatic locks.
- Activate the horn and lamps.
- Check the vehicle's energy level, range or tire pressure, if factory-equipped with the Tire Pressure Monitor System.

- Send destinations to the vehicle.
- Locate the vehicle on a map (U.S. market only).
- Turn the vehicle's Wi-Fi hotspot on/off, manage settings, and monitor data consumption, if equipped.
- Locate a dealer and schedule service.
- Request roadside assistance.
- Set a parking reminder with pin drop, take a photo, make a note, and set a timer.
- Connect with Chevrolet on social media.
- Set the climate control settings.

For myChevrolet mobile app information and compatibility, see www.my.chevrolet.com.

An active OnStar service plan, compatible device, factory-installed remote start, and power locks are required. Data rates apply. See www.onstar.com for details and system limitations.





Remote Services

Contact an OnStar Advisor to unlock the doors or sound the horn and flash the lamps.

OnStar AtYourService

OnStar Advisors can provide offers from restaurants and retailers on your route, help locate hotels, or book a room. These services vary by market.

OnStar Hands-Free Calling

Make and receive calls with the built-in wireless calling service, which requires available minutes. Functionality of the Voice Command button may vary by vehicle and region. For some vehicles, press  to open the OnStar app on the infotainment display, then select Hands-Free calling. For other vehicles press  as follows.

Make a Call

1. Press . System responds: "OnStar ready."
2. Say "Call." System responds: "Call. Please say the name or number to call."
3. Say the entire number without pausing, including a "1" and the area code. System responds: "OK, calling."

Calling 911 Emergency

1. Press . System responds: "OnStar ready."
2. Say "Call." System responds: "Call. Please say the name or number to call."
3. Say "911" without pausing. System responds: "911."
4. Say "Call." System responds: "OK, dialing 911."

Retrieve My Number

1. Press . System responds: "OnStar ready."

2. Say "My number." System responds: "Your OnStar Hands-Free Calling number is," then says the number.

End a Call

Press . System responds: "Call ended."

Verify Minutes and Expiration

Press  and say "Minutes" then "Verify" to check how many minutes remain and their expiration date.

Diagnostics

By monitoring and reporting on the vehicle's key systems, OnStar Advanced Diagnostics provides a way to keep up on maintenance. Capabilities vary by model. See www.onstar.com for details and system limitations. Message and data rates may apply.

Advanced Diagnostics requires an active OnStar paid service plan, e-mail address on file, and enrollment in Advanced Diagnostics.

Includes:

- Diagnostic Alerts: Set preferences to receive real-time e-mails, texts, or monthly reports of the vehicle's health. Or press  to have an Advisor initiate a remote diagnostic report.
- Proactive Alerts: Receive a real-time e-mail or text message regarding potential issues with key vehicle components, such as the battery, fuel system, or starter system. Alerts for potential issues appear on the infotainment display. Proactive Alerts are designed to help predict specific types of issues based on information collected from the vehicle. Other factors may affect vehicle performance. Not all issues will deliver alerts. In some cases, a dealer service check may be required to confirm the accuracy of the alerts.



- Dealer Maintenance Notification: Have the vehicle notify your preferred dealer when it is time for maintenance. Your dealer will then contact you to set up an appointment.

To begin, press  to speak to an Advisor, or see www.onstar.com.

OnStar Additional Information

OnStar Smart Driver

OnStar Smart Driver provides information about driving behavior to help maximize overall vehicle performance, reduce wear and tear, and enhance fuel efficiency. An Insurance Discounts Eligibility feature is also offered within OnStar Smart Driver. See www.onstar.com for details regarding vehicle eligibility and system limitations. OnStar, General Motors, and their affiliates are not insurance providers. Obtain insurance only from licensed insurance providers.

In-Vehicle Audio Messages

Audio messages may play important information at the following times:

- Prior to vehicle purchase.
Press  to set up an account.
- With the OnStar Basic Plan, every 60 days.



- After change in ownership and at 90 days.

Transferring Service

Press  to request account transfer eligibility information. The Advisor can cancel or change account information.

Selling/Transferring the Vehicle

Call 1-888-4ONSTAR (1-888-466-7827) immediately to terminate your OnStar services if the vehicle is disposed of, sold, transferred, or if the lease ends.

Reactivation for Subsequent Owners

Press  and follow the prompts to speak to an Advisor as soon as possible. The Advisor will update vehicle records and explain OnStar service options.

How OnStar Service Works

Automatic Crash Response, Emergency Services, Crisis Assist, Stolen Vehicle Assistance,

Advanced Vehicle Diagnostics, Remote Services, Roadside Assistance, Turn-by-Turn Navigation, and Hands-Free Calling are available on most vehicles. Not all OnStar services are available everywhere or on all vehicles. For more information, a full description of OnStar services, system limitations, and OnStar User Terms, Privacy Statement, and Software Terms:

- Call 1-888-4ONSTAR (1-888-466-7827).
- See www.onstar.com (U.S.).
- See www.onstar.ca (Canada).
- Call TTY 1-877-248-2080.
- Press  to speak with an Advisor.

OnStar services cannot work unless the vehicle is in a place where OnStar has an agreement with a wireless service provider for service in that area. The wireless service provider must also have coverage, network capacity, reception, and technology compatible with OnStar

services. Service involving location information about the vehicle cannot work unless GPS signals are available, unobstructed, and compatible with the OnStar hardware. OnStar services may not work if the OnStar equipment is not properly installed or it has not been properly maintained. If equipment or software is added, connected, or modified, OnStar services may not work. Other problems beyond the control of OnStar — such as hills, tall buildings, tunnels, weather, electrical system design and architecture of the vehicle, damage to the vehicle in a crash, or wireless phone network congestion or jamming — may prevent service.

See *Radio Frequency Statement*
 ⇨ 342.

Services for People with Disabilities

Advisors provide services to help with physical disabilities and medical conditions.

Press  to help:

- Locate a gas station with an attendant to pump gas.
- Find a hotel, restaurant, etc., that meets accessibility needs.
- Provide directions to the closest hospital or pharmacy in urgent situations.

TTY Users

OnStar has the ability to communicate to deaf, hard-of-hearing, or speech-impaired customers while in the vehicle. The available dealer-installed TTY system can provide in-vehicle access to all OnStar services, except Virtual Advisor and OnStar Turn-by-Turn Navigation.

OnStar Personal Identification Number (PIN)

A PIN is needed to access some OnStar services. The PIN will need to be changed the first time when speaking with an Advisor. To



change the OnStar PIN, contact an OnStar Advisor by pressing  or calling 1-888-4ONSTAR.

Warranty

OnStar equipment may be warranted as part of the vehicle warranty.

Languages

The vehicle can be programmed to respond in multiple languages.

Press  and ask for an Advisor. Advisors are available in English, Spanish, and French. Available languages may vary by country.

Potential Issues

OnStar cannot perform Remote Door Unlock or Stolen Vehicle Assistance after the vehicle has been off continuously for 10 days without an ignition cycle. If the vehicle has not been started for 10 days, OnStar can contact Roadside Assistance or a locksmith to help gain access to the vehicle.

Global Positioning System (GPS)

- Obstruction of the GPS can occur in a large city with tall buildings; in parking garages; around airports; in tunnels and underpasses; or in an area with very dense trees. If GPS signals are not available, the OnStar system should still operate to call OnStar. However, OnStar could have difficulty identifying the exact location.
- In emergency situations, OnStar can use the last stored GPS location to send to emergency responders.

A temporary loss of GPS can cause loss of the ability to send a Turn-by-Turn Navigation route. The Advisor may give a verbal route or may ask for a call back after the vehicle is driven into an open area.

Cellular and GPS Antennas

Cellular reception is required for OnStar to send remote signals to the vehicle. Do not place items over

or near the antenna to prevent blocking cellular and GPS signal reception.

Unable to Connect to OnStar Message

If there is limited cellular coverage or the cellular network has reached maximum capacity, this message may come on. Press  to try the call again or try again after driving a few miles into another cellular area.

Vehicle and Power Issues

OnStar services require a vehicle electrical system, wireless service, and GPS satellite technologies to be available and operating for features to function properly. These systems may not operate if the battery is discharged or disconnected.

Add-on Electrical Equipment

The OnStar system is integrated into the electrical architecture of the vehicle. Do not add any electrical equipment. See *Add-On Electrical Equipment* ⇨ 252. Added electrical

equipment may interfere with the operation of the OnStar system and cause it to not operate.

Vehicle Software Updates

OnStar or GM may remotely deliver software updates or changes to the vehicle without further notice or consent. These updates or changes may enhance or maintain safety, security, or the operation of the vehicle or the vehicle systems. Software updates or changes may affect or erase data or settings that are stored in the vehicle, such as OnStar Hands-Free Calling name tags, saved navigation destinations, or pre-set radio stations. Neither OnStar nor GM is responsible for any affected or erased data or settings. These updates or changes may also collect personal information. Such collection is described in the OnStar privacy statement or separately disclosed at the time of installation. These updates or changes may also cause a system to automatically communicate with GM servers to collect information about vehicle

system status, identify whether updates or changes are available, or deliver updates or changes. An active OnStar agreement constitutes consent to these software updates or changes and agreement that either OnStar or GM may remotely deliver them to the vehicle.

Privacy

The complete OnStar Privacy Statement may be found at www.onstar.com (U.S.), or www.onstar.ca (Canada). We recommend that you review it. If you have any questions, call 1-888-4ONSTAR (1-888-466-7827) or press  to speak with an Advisor. Users of wireless communications are cautioned that the privacy of any information sent via wireless cellular communications cannot be assured. Third parties may unlawfully intercept or access transmissions and private communications without consent.



OnStar - Software Acknowledgements

Certain OnStar components include libcurl and unzip software and other third party software. Below are the notices and licenses associated with libcurl and unzip and for other third party software please see <http://opensource.lge.com/index>

www.onstar.com/us/en/

libcurl:

COPYRIGHT AND PERMISSION NOTICE

Copyright (c) 1996 - 2010, Daniel Stenberg, <daniel@haxx.se>.

All rights reserved.

Permission to use, copy, modify, and distribute this software for any purpose with or without fee is hereby granted, provided that the above copyright notice and this permission notice appear in all copies.

THE SOFTWARE IS PROVIDED "AS IS," WITHOUT WARRANTY OF ANY KIND, EXPRESS OR

IMPLIED, INCLUDING BUT NOT LIMITED TO THE WARRANTIES OF MERCHANTABILITY, FITNESS FOR A PARTICULAR PURPOSE AND NON-INFRINGEMENT OF THIRD PARTY RIGHTS. IN NO EVENT SHALL THE AUTHORS OR COPYRIGHT HOLDERS BE LIABLE FOR ANY CLAIM, DAMAGES OR OTHER LIABILITY, WHETHER IN AN ACTION OF CONTRACT, TORT OR OTHERWISE, ARISING FROM, OUT OF OR IN CONNECTION WITH THE SOFTWARE OR THE USE OR OTHER DEALINGS IN THE SOFTWARE.

Except as contained in this notice, the name of a copyright holder shall not be used in advertising or otherwise to promote the sale, use or other dealings in this Software without prior written authorization of the copyright holder.

unzip:

This is version 2005-Feb-10 of the Info-ZIP copyright and license. The definitive version of this document

should be available at <ftp://ftp.info-zip.org/pub/infozip/license.html> indefinitely.

Copyright (c) 1990-2005 Info-ZIP. All rights reserved.

For the purposes of this copyright and license, "Info-ZIP" is defined as the following set of individuals:

Mark Adler, John Bush, Karl Davis, Harald Denker, Jean-Michel Dubois, Jean-loup Gailly, Hunter Goatley, Ed Gordon, Ian Gorman, Chris Herborth, Dirk Haase, Greg Hartwig, Robert Heath, Jonathan Hudson, Paul Kienitz, David Kirschbaum, Johnny Lee, Onno van der Linden, Igor Mandrichenko, Steve P. Miller, Sergio Monesi, Keith Owens, George Petrov, Greg Roelofs, Kai Uwe Rommel, Steve Salisbury, Dave Smith, Steven M. Schweda, Christian Spieler, Cosmin Truta, Antoine Verheijen, Paul von Behren, Rich Wales, Mike White.

This software is provided "as is," without warranty of any kind, express or implied. In no event shall Info-ZIP or its contributors be held

liable for any direct, indirect, incidental, special or consequential damages arising out of the use of or inability to use this software.

Permission is granted to anyone to use this software for any purpose, including commercial applications, and to alter it and redistribute it freely, subject to the following restrictions:

1. Redistributions of source code must retain the above copyright notice, definition, disclaimer, and this list of conditions.
2. Redistributions in binary form (compiled executables) must reproduce the above copyright notice, definition, disclaimer, and this list of conditions in documentation and/or other materials provided with the distribution. The sole exception to this condition is redistribution of a standard UnZipSFX binary (including SFXWiz) as part of a self-extracting archive; that is permitted without inclusion of this license, as long as the

- normal SFX banner has not been removed from the binary or disabled.
3. Altered versions—including, but not limited to, ports to new operating systems, existing ports with new graphical interfaces, and dynamic, shared, or static library versions—must be plainly marked as such and must not be misrepresented as being the original source. Such altered versions also must not be misrepresented as being Info-ZIP releases—including, but not limited to, labeling of the altered versions with the names “Info-ZIP” (or any variation thereof, including, but not limited to, different capitalizations), “Pocket UnZip,” “WiZ” or “MacZip” without the explicit permission of Info-ZIP. Such altered versions are further prohibited from misrepresentative use of the Zip-Bugs or Info-ZIP e-mail addresses or of the Info-ZIP URL(s).
 4. Info-ZIP retains the right to use the names “Info-ZIP,” “Zip,” “UnZip,” “UnZipSFX,” “WiZ,” “Pocket UnZip,” “Pocket Zip,” and “MacZip” for its own source and binary releases.

Index

A

- Accessories and
 - Modifications 256
- Accessory Power 206
- Add-On Electrical Equipment ... 252
- Additional Information
 - OnStar 352
- Additional Maintenance
 - and Care 325
- Agreements
 - Trademarks and License 184
- Air Conditioning 186
- Air Conditioning Regular
 - Operation 192
- Air Filter, Passenger
 - Compartment 191
- Air Intake 191
- Air Vents 190
- Airbag System
 - Check 82
 - How Does an Airbag
 - Restrain? 75
 - Passenger Sensing System ... 77
 - What Makes an Airbag
 - Inflate? 75
 - What Will You See after an
 - Airbag Inflates? 75
- Airbag System (cont'd)
 - When Should an Airbag
 - Inflate? 74
 - Where Are the Airbags? 72
- Airbags
 - Adding Equipment to the
 - Vehicle 81
 - Passenger Status Indicator ... 125
 - Readiness Light 124
 - Servicing Airbag-Equipped
 - Vehicles 81
 - System Check 71
- Alarm
 - Vehicle Security 48
- Alert
 - Lane Change 231
 - Side Blind Zone (SBZA) 231
- All-Season Tires 279
- AM-FM Radio 162
- Antenna
 - Multi-band 165
- Antilock Brake System (ABS) ... 213
 - Warning Light 127
- Appearance Care
 - Exterior 311
 - Interior 316
- Apple CarPlay and
 - Android Auto 177

Armrest
 Rear Seat64
 Assistance Program,
 Roadside 336
 Assistance Systems for
 Driving 225
 Assistance Systems for
 Parking and Backing 222
 Audio
 Bluetooth 172
 Theft-Deterrent Feature 158
 Automatic
 Climate Control System 186
 Door Locks 43
 Forward Braking 227
 Headlamp System 153
 Auxiliary
 Devices 172
B
 Battery 122
 Exterior Lighting Battery
 Saver 156
 Power Protection 156
 Battery - North America264, 304
 Battery Gauge
 High Voltage 122
 Blade Replacement, Wiper 266

Bluetooth
 Overview 175
 Bluetooth Audio 172
 Brake
 Parking, Electric 213
 System Warning Light 126
 Brakes 262
 Antilock 213
 Assist 215
 Fluid 263
 Regenerative Braking 215
 Braking 195
 Automatic Forward 227
 Braking System
 Front Pedestrian (FPB) 229
 Break-In, New Vehicle 203
 Bulb Replacement
 Halogen Bulbs 269
 Headlamp Aiming 269
 Headlamps 269
 High Intensity Discharge
 (HID) Lighting 269
 License Plate Lamps 270
 Taillamps, Turn Signal,
 Stoplamps, and Back-up
 Lamps 270
 Buying New Tires 291

C

Calibration 113
 California
 Perchlorate Materials
 Requirements 256
 California
 Proposition
 65 Warning 255, 264, 304,
 Back Cover
 Canadian Vehicle Owners 2
 Capacities and
 Specifications 331
 Carbon Monoxide
 Liftgate 47
 Winter Driving 198
 Cargo
 Cover 106
 Management System 107
 Caution, Danger, and Warning 2
 Center Console Storage 106
 Chains, Tire 296
 Charge Cord 243
 Charging
 Delay Override 239
 Electrical Requirements 251
 Plug-In 235
 Programmable 131
 Utility Interruption 250



Charging (cont'd)		Control		Data Collection	
Wireless	115	Traction and Electronic		OnStar	345
Charging Status Screens	240	Stability	217	Data Recorders, Event	344
Charging System Light	125	Control of a Vehicle	195	Daytime Running	
Child Restraints		Convex Mirrors	50	Lamps (DRL)	152
Infants and Young Children	85	Cooling	186	Defensive Driving	194
Lower Anchors and Tethers		Cooling System	260	Delayed Charging Override	239
for Children	90	Courtesy Lamps	155	Delayed Locking	43
Older Children	83	Courtesy Transportation		Devices	
Securing	99, 101	Program	338	Auxiliary	172
Systems	87	Cover		Diagnostics	
Circuit Breakers	272	Cargo	106	OnStar	351
Cleaning		Cruise Control	219	Distracted Driving	194
Exterior Care	311	Light	130	Dome Lamps	155
Interior Care	316	Cupholders	105	Door	
Climate Control Systems		Customer Assistance	335	Ajar Light	131
Automatic	186	Offices	334	Delayed Locking	43
Clock	114	Text Telephone (TTY)		Locks	41
Cluster, Instrument	118	Users	335	Power Locks	43
Collision Damage Repair	339	Customer Information		Drive Unit	
Compartment		Service Publications		Electric	208
Underhood	259	Ordering Information	341	Driver	
Compartments		Customer Satisfaction		Teen	181
Storage	105	Procedure	332	Driver Assistance Systems	221
Compass	113	D		Driver Efficiency Gauge	122
Compressor Kit, Tire Sealant ...	297	Damage Repair, Collision	339	Driver Information	
Connections		Danger, Warning, and Caution ...	2	Center (DIC)	141
OnStar	349				

Driver Selected Operating Modes	208	Electrical System (cont'd)		Folding Mirrors	50
Driving		Overload	271	Forward Automatic Braking	227
Assistance Systems	225	Emergency		Forward Collision Alert	
Defensive	194	OnStar	347	(FCA) System	225
Drunk	195	Energy Efficiency		Frequency Statement	
Hill and Mountain Roads	198	Driving	30	Radio	342
If the Vehicle is Stuck	199	Energy Information	138	Front Pedestrian Braking	
Loss of Control	196	Energy Settings	140	(FPB) System	229
Off-Road Recovery	196	Engine		Front Seats	
Vehicle Load Limits	200	Cooling System	260	Adjustment	59
Wet Roads	197	Entry Lighting	156	Heated	60
Winter	198	Event Data Recorders	344	Fuses	
Driving for Better Energy		Exit Lighting	156	Fuses and Circuit Breakers ...	272
Efficiency	30	Extended Parking	207	Instrument Panel Fuse	
E		Extender, Seat Belt	69	Block	276
Electric Drive Unit	208	Exterior Lamp Controls	150	Underhood Compartment	272
Electric Parking Brake	213	Exterior Lamps Off Reminder ...	152	G	
Electric Parking Brake Light	126	Exterior Lighting Battery		Gas Strut(s)	267
Electrical Equipment,		Saver	156	Gauges	
Add-On	252	F		Battery	122
Electrical Requirements for		Flash-to-Pass	152	Driver Efficiency	122
Battery Charging	251	Flashers, Hazard Warning	153	Odometer	121
Electrical System		Flat Tire	296	Power Indicator	123
Fuses and Circuit Breakers ...	272	Floor Mats	319	Speedometer	121
Instrument Panel Fuse		Fluid		Trip Odometer	121
Block	276	Brakes	263	Warning Lights and	
		Washer	261	Indicators	118

General Information		Heating	186	J	
Service and Maintenance	321	High Voltage Battery Gauge	122	Jump Starting - North	
Towing	252	High Voltage Devices and		America	304
Vehicle Care	255	Wiring	271	K	
GM Mobility Reimbursement		High-Beam On Light	130	Keyless Entry	
Program	336	Hill and Mountain Roads	198	Remote (RKE) System	33
H		Hill Start Assist (HSA)	215	KeyPass	45
Halogen Bulbs	269	Hood	257	Keys	32
Hands-Free Phone	178	Horn	110	L	
Hazard Warning Flashers	153	How to Wear Seat Belts		Labeling, Tire Sidewall	280
Head Restraints	57	Properly	66	Lamps	
Headlamps		HVAC	186	Courtesy	155
Aiming	269	I		Daytime Running (DRL)	152
Automatic	153	Immobilizer	48	Dome	155
Bulb Replacement	269	Indicator		Exterior Controls	150
Daytime Running		Pedestrian Ahead	128	Exterior Lamps Off	
Lamps (DRL)	152	Vehicle Ahead	128	Reminder	152
Flash-to-Pass	152	Infants and Young Children,		Exterior Lighting Battery	
High Intensity Discharge		Restraints	85	Saver	156
(HID) Lighting	269	Information		License Plate	270
High-Beam On Light	130	Energy	138	On Reminder	130
High/Low Beam Changer	152	Instrument Cluster	118	Reading	155
Lamps On Reminder	130	Instrument Panel		Lane Change Alert (LCA)	231
Heated		Storage Area	105	Lane Departure	
Rear Seats	64	Interior Rearview Mirrors	51	Warning (LDW)	233
Steering Wheel	110	Introduction	2, 157	Lane Keep Assist (LKA)	233
Heated Front Seats	60			Lane Keep Assist Light	127

Lap-Shoulder Belt 67
 LATCH System
 Replacing Parts after a
 Crash99
 LATCH, Lower Anchors and
 Tethers for Children 90
 LED Lighting 269
 Liftgate 47
 Lighting
 Entry 156
 Exit 156
 Illumination Control 154
 LED 269
 Lights
 Airbag Readiness 124
 Antilock Brake System
 (ABS) Warning 127
 Brake System Warning 126
 Charging System 125
 Cruise Control 130
 Door Ajar 131
 Electric Parking Brake 126
 Flash-to-Pass 152
 High-Beam On 130
 High/Low Beam Changer 152
 Lane Keep Assist 127
 Seat Belt Reminders 123
 Security 130

Lights (cont'd)
 Service Electric Parking
 Brake 127
 Service Vehicle Soon 126
 Sport Mode 127
 StabiliTrak OFF 128
 Tire Pressure 129
 Traction Control System
 (TCS)/StabiliTrak 129
 Traction Off 128
 Vehicle Ready 130
 Locks
 Automatic Door 43
 Delayed Locking 43
 Door 41
 Lockout Protection 44
 Power Door 43
 Safety 44
 Loss of Control 196
 Lower Anchors and Tethers
 for Children (LATCH
 System) 90

M
 Maintenance
 Air Conditioning Regular
 Operation 192
 Records 329

Maintenance and Care
 Additional 325
 Maintenance Schedule 322
 Recommended Fluids and
 Lubricants 327
 Messages
 Propulsion Power 143
 Vehicle 142
 Vehicle Speed 143
 Mirror
 Rear Camera 51
 Mirrors
 Automatic Dimming
 Rearview 51
 Convex 50
 Folding 50
 Manual Rearview 51
 Power 50
 Mirrors, Interior Rearview 51
 Mobile Applications
 KeyPass 45
 Modes
 Driver Selected 208
 Monitor System, Tire
 Pressure 285
 Multi-band Antenna 165



N		Overview	158	Phone (cont'd)	
Navigation		Underhood Compartment	259	Hands-Free	178
OnStar	348	Owner Checks and Services	324	Plug-In Charging	235
New Vehicle Break-In	203	P		Port	
O		Park		USB	166
Odometer	121	Shifting Into	206	Power	
Trip	121	Shifting Out of	207	Button	204
Off-Road		Parking		Door Locks	43
Recovery	196	Extended	207	Flows	131
Older Children, Restraints	83	Parking Assist	222	Indicator Gauge	123
Online Owner Center	335	Parking or Backing		Mirrors	50
OnStar	345	Assistance Systems	222	Outlets	114
OnStar Additional		Passenger Airbag Status		Protection, Battery	156
Information	352	Indicator	125	Retained Accessory (RAP) ...	206
OnStar Connections	349	Passenger Compartment Air		Windows	53
OnStar Diagnostics	351	Filter	191	Pregnancy, Using Seat Belts	69
OnStar Emergency	347	Passenger Sensing System	77	Privacy	
OnStar Navigation	348	Pedestrian Ahead Indicator	128	Vehicle Data Recording	344
OnStar Overview	346	Pedestrian Safety Signal	110	Program	
OnStar Security	348	Perchlorate Materials		Courtesy Transportation	338
OnStar System	175	Requirements, California	256	Programmable Charging	131
Operation		Personalization		Proposition	
Infotainment System	159	Vehicle	143	65 Warning,	
Ordering		Phone		California	255, 264, 304,
Service Publications	341	Apple CarPlay and		Back Cover	
Outlets		Android Auto	177	Propulsion Power Messages ...	143
Power	114	Bluetooth	175		

R			
Radio Frequency Statement	342	Replacement Parts	
Radios		Airbags	82
AM-FM Radio	162	Maintenance	328
Satellite	164	Replacing Airbag System	82
Reading Lamps	155	Replacing LATCH System	
Ready Indicator	130	Parts after a Crash	99
Rear Camera Mirror	51	Replacing Seat Belt System	
Rear Seat Armrest	64	Parts after a Crash	70
Rear Seats	62	Reporting Safety Defects	
Heated	64	Canadian Government	343
Rear Vision Camera (RVC)	222	General Motors	343
Rear Window Washer/Wiper	112	U.S. Government	342
Rearview Mirrors	51	Requirements	
Automatic Dimming	51	Electrical Battery Charging	251
Reclining Seatbacks	59	Restraints	
Recommended Fluids and		Where to Put	89
Lubricants	327	Retained Accessory	
Records		Power (RAP)	206
Maintenance	329	Roads	
Recreational Vehicle Towing	309	Driving, Wet	197
Regenerative Braking	215	Roadside Assistance	
Reimbursement Program,		Program	336
GM Mobility	336	Rotation, Tires	290
Remote Keyless Entry (RKE)			
System	33	S	
Remote Start	39	Safety Defects Reporting	
		Canadian Government	343
		General Motors	343
		Safety Defects Reporting (cont'd)	
		U.S. Government	342
		Safety Locks	44
		Safety Signal	
		Pedestrian	110
		Safety System Check	69
		Satellite Radio	164
		Scheduling Appointments	338
		Sealant Kit, Tire	297
		Seat Belts	65
		Care	70
		Extender	69
		How to Wear Seat Belts	
		Properly	66
		Lap-Shoulder Belt	67
		Reminders	123
		Replacing after a Crash	70
		Use During Pregnancy	69
		Seats	
		Adjustment, Front	59
		Head Restraints	57
		Heated Front	60
		Heated, Rear	64
		Rear	62
		Reclining Seatbacks	59
		Securing Child Restraints	99, 101
		Security	
		Light	130

Security (cont'd)		Software Updates	161	Storing the Tire Sealant and Compressor Kit	303
OnStar	348	Specifications and Capacities	331	Struts	
Vehicle	48	Speedometer	121	Gas	267
Vehicle Alarm	48	Sport Mode Light	127	Stuck Vehicle	199
Self-Sealing Tires	279	StabiliTrak		Sun Visors	55
Service	192	OFF Light	128	Symbols	3
Accessories and Modifications	256	Start		System	
Doing Your Own Work	256	Remote	39	Forward Collision Alert (FCA)	225
Maintenance Records	329	Start Assist, Hill	215	Systems	
Maintenance, General Information	321	Starting and Stopping the Vehicle	205	Driver Assistance	221
Parts Identification Label	330	Status Screens			
Publications Ordering Information	341	Charging	240	T	
Scheduling Appointments	338	Steering	195	Taillamps	
Vehicle Soon Light	126	Heated Wheel	110	Bulb Replacement	270
Service Electric Parking		Wheel Adjustment	109	Teen Driver	181
Brake Light	127	Wheel Controls	109	Text Telephone (TTY) Users	335
Servicing the Airbag	81	Stoplamps and Back-up Lamps		Theft-Deterrent Systems	49
Settings	180	Bulb Replacement	270	Immobilizer	48
Energy	140	Storage Areas		Time	114
Shifting		Cargo Cover	106	Tires	278
Into Park	206	Cargo Management		All-Season	279
Out of Park	207	System	107	Buying New Tires	291
Side Blind Zone Alert (SBZA)	231	Center Console	106	Chains	296
Signals, Turn and		Instrument Panel	105	Designations	281
Lane-Change	154	Storage Compartments	105	Different Size	293
				If a Tire Goes Flat	296

Tires (cont'd)	
Inspection	289
Pressure	284
Pressure Light	129
Pressure Monitor Operation ..	286
Pressure Monitor System	285
Rotation	290
Sealant and	
Compressor Kit	297
Sealant and Compressor	
Kit, Storing	303
Self-Sealing	279
Sidewall Labeling	280
Terminology and Definitions ..	282
Uniform Tire Quality	
Grading	293
Wheel Alignment and Tire	
Balance	295
Wheel Replacement	295
When It Is Time for New	
Tires	291
Winter	279
Towing	
General Information	252
Recreational Vehicle	309
Vehicle	307

Traction	
Control System (TCS)/	
StabiliTrak Light	129
Off Light	128
Traction Control/Electronic	
Stability Control	217
Trademarks and License	
Agreements	184
Transportation Program,	
Courtesy	338
Trip Odometer	121
Turn and Lane-Change	
Signals	154
Turn Signal	
Bulb Replacement	270
U	
Underhood Compartment	
Fuse Block	272
Underhood Compartment	
Overview	259
Uniform Tire Quality Grading ...	293
Updates	
Software	161
USB Port	166
Using This Manual	2
Utility Interruption of	
Charging	250

V

Vehicle	
Alarm System	48
Canadian Owners	2
Control	195
Identification Number (VIN) ...	330
Load Limits	200
Messages	142
Personalization	143
Security	48
Service Soon Light	126
Speed Messages	143
Starting and Stopping	205
Towing	307
Vehicle Ahead Indicator	128
Vehicle Care	
Storing the Tire Sealant	
and Compressor Kit	303
Tire Pressure	284
Vehicle Data Recording and	
Privacy	344
Vehicle Ready Light	130
Ventilation, Air	190
Visors	55
Voltage Devices and Wiring	271

W

Warning
 Brake System Light 126
 Caution and Danger 2
 Lane Departure (LDW) 233
 Warning Lights, Gauges, and
 Indicators 118
 Warnings
 Hazard Flashers 153
 Washer Fluid 261
 Wheels
 Alignment and Tire Balance .. 295
 Different Size 293
 Replacement 295
 When It Is Time for New
 Tires 291
 When to Charge 235
 Where to Put the Restraint 89
 Wi-Fi 349
 Windows
 Power 53
 Windshield
 Replacement 267
 Wiper/Washer 111
 Winter
 Driving 198
 Winter Tires 279
 Wiper Blade Replacement 266

Wipers
 Rear Washer 112
 Wireless Charging 115
 Wiring, High Voltage Devices ... 271





WARNING

Operating, servicing and maintaining a passenger vehicle or off-road vehicle can expose you to chemicals including engine exhaust, carbon monoxide, phthalates, and lead, which are known to the State of California to cause cancer and birth defects or other reproductive harm. To minimize exposure, avoid breathing exhaust, do not idle engine except as necessary, service your vehicle in a well-ventilated area and wear gloves or wash your hands frequently when servicing your vehicle. For more information go to www.P65Warnings.ca.gov/passenger-vehicle.



U.S. Only



84486646 B

DEP
DEALER ePROCESS

