

CLARITY

HONDA
The Power of Dreams



**2018 ELECTRIC
OWNER'S MANUAL**

⚠ WARNING

California Proposition 65 Warning

Operating, servicing and maintaining a passenger vehicle or off-road vehicle can expose you to chemicals including engine exhaust, carbon monoxide, phthalates, and lead, which are known to the State of California to cause cancer and birth defects or other reproductive harm. To minimize exposure, avoid breathing exhaust, do not idle the engine except as necessary, service your vehicle in a well-ventilated area and wear gloves or wash your hands frequently when servicing your vehicle. For more information go to www.P65Warnings.ca.gov/passenger-vehicle.

Event Data Recorders

This vehicle is equipped with an event data recorder (EDR).

The main purpose of an EDR is to record, in certain crash or near crash-like situations, such as an air bag deployment or hitting a road obstacle, data that will assist in understanding how a vehicle's systems performed. **The EDR is designed to record data related to vehicle dynamics and safety systems for a short period of time, typically 30 seconds or less. The EDR in this vehicle is designed to record such data as:**

- **How various systems in your vehicle were operating;**
- **Whether or not the driver and passenger safety belts were buckled/fastened;**

- **How far (if at all) the driver was depressing the accelerator and/or brake pedal; and,**
- **How fast the vehicle was traveling.**

These data can help provide a better understanding of the circumstances in which crashes and injuries occur. NOTE: EDR data are recorded by your vehicle only if a non-trivial crash situation occurs; no data are recorded by the EDR under normal driving conditions and no personal data (e.g., name, gender, age, and crash location) are recorded. However, other parties, such as law enforcement, could combine the EDR data with the type of personally identifying data routinely acquired during a crash investigation.

To read data recorded by an EDR, special equipment is required, and access to the vehicle or the EDR is needed. In addition to the vehicle manufacturer, other parties, such as law enforcement, that have the special equipment, can read the information if they have access to the vehicle or the EDR.

The data belongs to the vehicle owner and may not be accessed by anyone else except as legally required or with the permission of the vehicle owner.

Service Diagnostic Recorders

This vehicle is equipped with service-related devices that record information about powertrain performance. The data can be used to verify emissions law requirements and/or help technicians diagnose and solve service problems. It may also be combined with data from other sources for research purposes, but it remains confidential. Some diagnostic and maintenance information is uploaded to Honda upon vehicle start up.

California Perchlorate Contamination Prevention Act

The airbags, seat belt tensioners, and CR type batteries in this vehicle may contain perchlorate materials - special handling may apply. See www.dtsc.ca.gov/hazardouswaste/perchlorate/

As you read this manual, you will find information that is preceded by a **NOTICE** symbol. This information is intended to help you avoid damage to your vehicle, other property, or the environment.

Software End User License Agreement

Your vehicle comes equipped with software, which is governed by the End User License Agreement in Owner's Manual, and which contains a binding arbitration clause. Please refer to the End User License Agreement for the terms and conditions governing your use of the installed software, as well as the applications, services, functions, and content provided through the software. Your use of the installed software will serve as your consent to the terms and conditions of the End User License Agreement.

You may opt out within 30 days of your initial use of the Software by sending a signed, written notice to HONDA at American Honda Motor Co., Inc. Honda Automobile Customer Services Mail Stop 100-5E-8A, 1919 Torrance Blvd. Torrance, CA 90501-2746.

Privacy Notice

This vehicle may share location and usage information. To manage this setting, visit www.hondalink.com/vehicle-data-choices.



High-Voltage Battery Monitoring System

This vehicle is equipped with a monitoring system that compiles data about your vehicle and driving conditions and transmits that data to Honda at regular intervals as determined at the discretion of Honda. This data includes information on but not limited to the following:

- Vehicle location, distance driven, warning indicators and messages, and vehicle speed
- High-Voltage Battery system control and power generation

The system does not record audio or images.

Data collected is used for the sole purposes of technical diagnoses, preventive maintenance, research and vehicle development.

Neither Honda nor any third party receiving data will use the data for any other purpose without first obtaining customer authorization.



A Few Words About Safety

Your safety, and the safety of others, is very important. And operating this vehicle safely is an important responsibility.

To help you make informed decisions about safety, we have provided operating procedures and other information on labels and in this manual. This information alerts you to potential hazards that could hurt you or others.

Of course, it is not practical or possible to warn you about all the hazards associated with operating or maintaining your vehicle. You must use your own good judgment.

You will find this important safety information in a variety of forms, including:

- **Safety Labels** - on the vehicle.
- **Safety Messages** - preceded by a safety alert symbol  and one of three signal words: **DANGER**, **WARNING**, or **CAUTION**. These signal words mean:

DANGER

You **WILL** be **KILLED** or **SERIOUSLY HURT** if you don't follow instructions.

WARNING

You **CAN** be **KILLED** or **SERIOUSLY HURT** if you don't follow instructions.

CAUTION

You **CAN** be **HURT** if you don't follow instructions.

- **Safety Headings** - such as Important Safety Precautions.
- **Safety Section** - such as Safe Driving.
- **Instructions** - how to use this vehicle correctly and safely.

This entire book is filled with important safety information - please read it carefully.

This owner's manual should be considered a permanent part of the vehicle and should remain with the vehicle when it is sold.

This owner's manual covers all models of your vehicle. You may find descriptions of equipment and features that are not on your particular model.

Images throughout this owner's manual (including the front cover) represent features and equipment that are available on some, but not all, models. Your particular model may not have some of these features.

The information and specifications included in this publication were in effect at the time of approval for printing. Honda Motor Co., Ltd. reserves the right, however, to discontinue or change specifications or design at any time without notice and without incurring any obligation.

➤ Safe Driving P. 39

For Safe Driving P. 40 Seat Belts P. 44 Airbags P. 52

➤ Instrument Panel P. 81

Indicators P. 82 Gauges and Driver Information Interface P. 116

➤ Controls P. 129

Clock P. 130 Locking and Unlocking the Doors P. 131
Operating the Switches Around the Steering Wheel P. 152
Interior Lights/Interior Convenience Items P. 176

➤ Features P. 195

Audio System P. 196 Audio System Basic Operation P. 202
Customized Features P. 296 HomeLink® Universal Transceiver P. 322

➤ Driving P. 359

Before Driving P. 360 Towing a Trailer P. 365
Multi-View Rear Camera P. 438 Charging P. 440

➤ Maintenance P. 457

Before Performing Maintenance P. 458 Maintenance Minder™ P. 461
Checking and Maintaining Wiper Blades P. 472
Climate Control System Maintenance P. 487 Cleaning P. 488

➤ Handling the Unexpected P. 497

If a Tire Goes Flat P. 498 Handling of the Jack P. 510
Indicator, Coming On/Blinking P. 518 Fuses P. 524
When You Cannot Disengage the Charging Connector P. 533

➤ Information P. 535

Specifications P. 536 Identification Numbers P. 538
Warranty Coverages P. 541 Authorized Manuals P. 543

Contents

Child Safety P. 67

Safety Labels P. 80

Opening and Closing the Trunk P. 144
Adjusting the Mirrors P. 167
Climate Control System P. 186

Security System P. 147
Adjusting the Seats P. 169

Opening and Closing the Windows P. 150

Audio Error Messages P. 274
Bluetooth® HandsFreeLink® P. 325

General Information on the Audio System P. 278

When Driving P. 366
Energy Economy P. 456

Braking P. 420

Parking Your Vehicle P. 436

Maintenance Under the Hood P. 465
Checking and Maintaining Tires P. 475
Accessories and Modifications P. 494

Replacing Light Bulbs P. 470
12-Volt Battery P. 484

Remote Transmitter Care P. 486

Power System Won't Start P. 511
Emergency Towing P. 531
When You Cannot Open the Trunk P. 534

Jump Starting P. 514
Overheating P. 517
When You Cannot Open the Charge Lid P. 532

Devices that Emit Radio Waves P. 539
Customer Service Information P. 544

Reporting Safety Defects P. 540

Quick Reference Guide P. 6

Safe Driving P. 39

Instrument Panel P. 81

Controls P. 129

Features P. 195

Driving P. 359

Maintenance P. 457

Handling the Unexpected P. 497

Information P. 535

Index P. 546



Visual Index

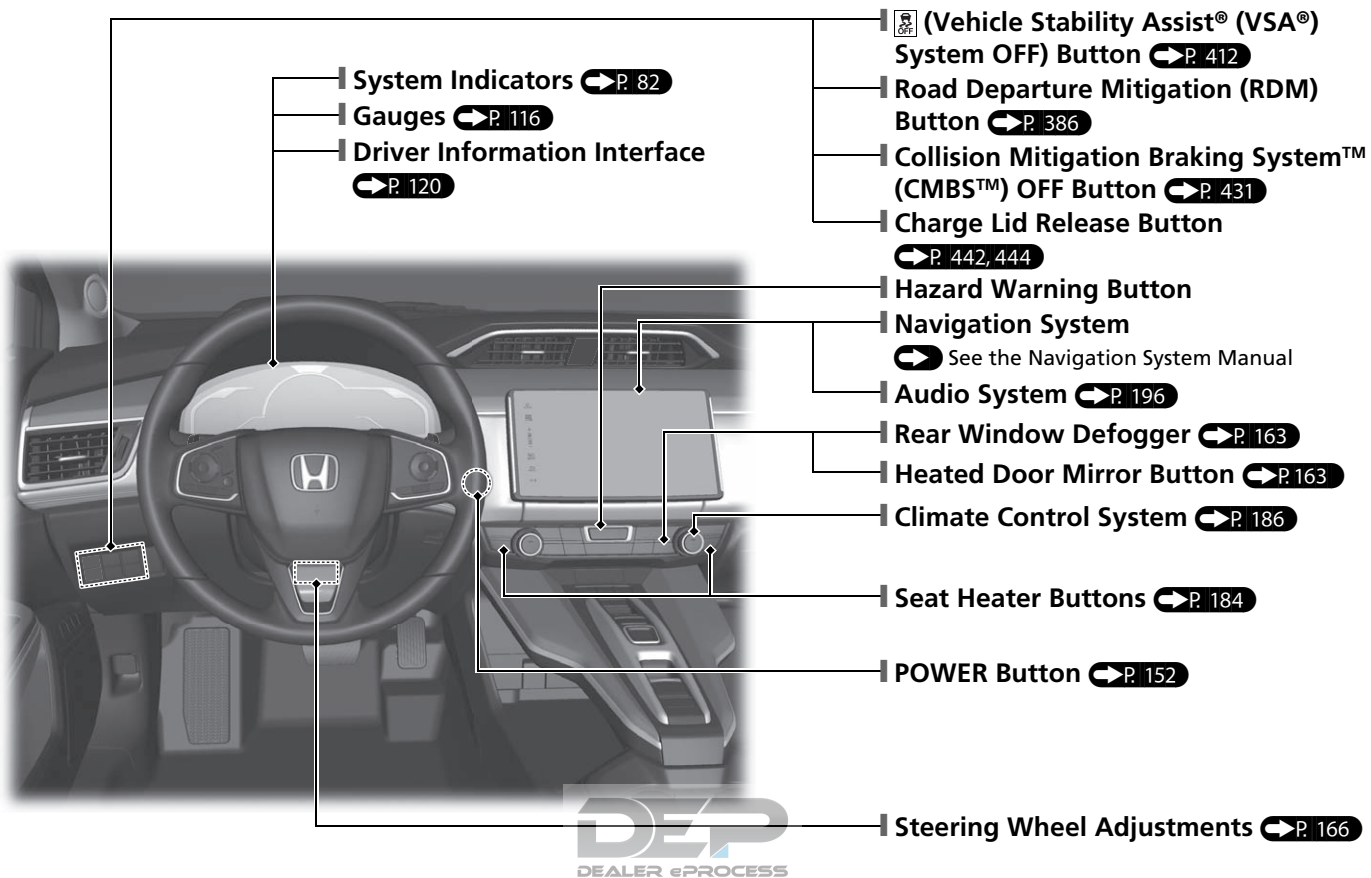

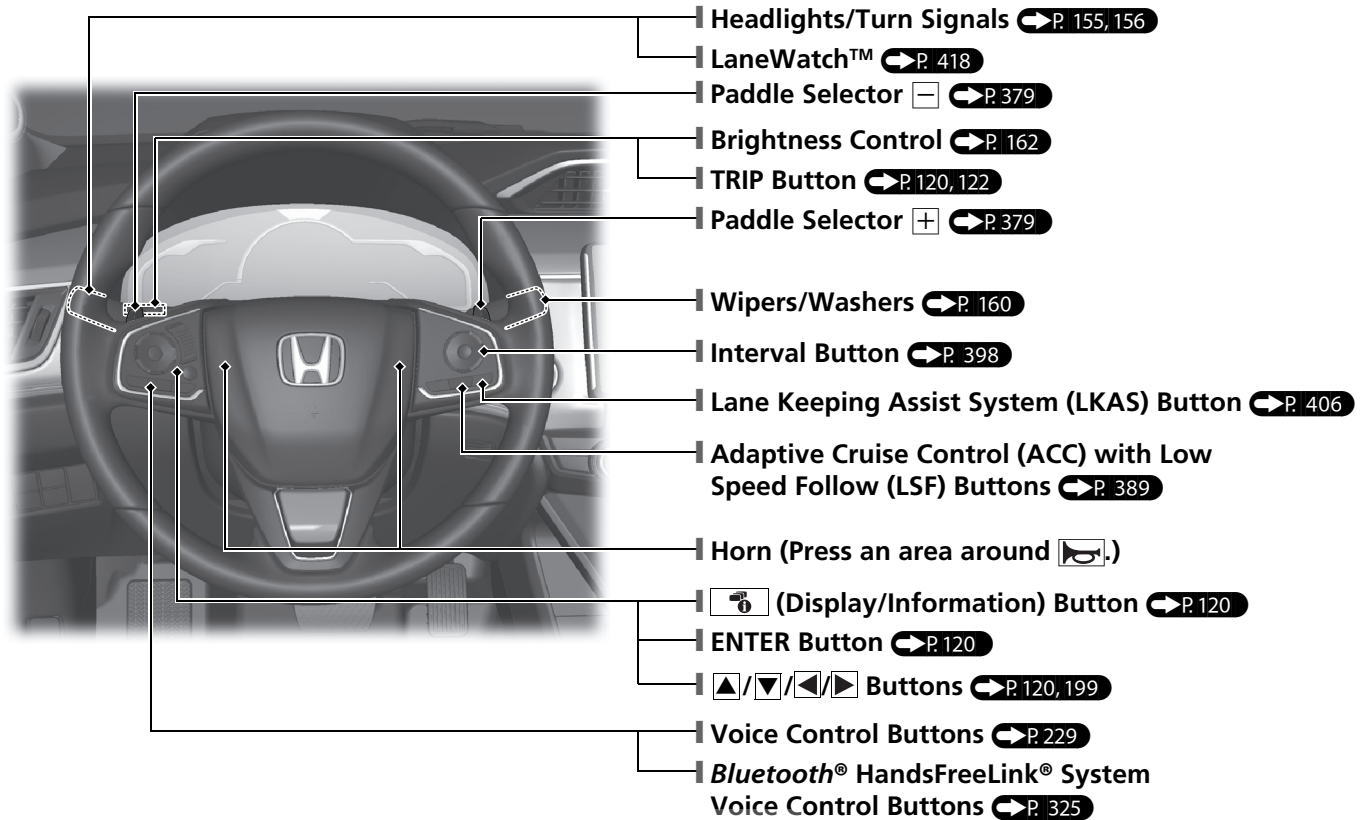

Visual Index

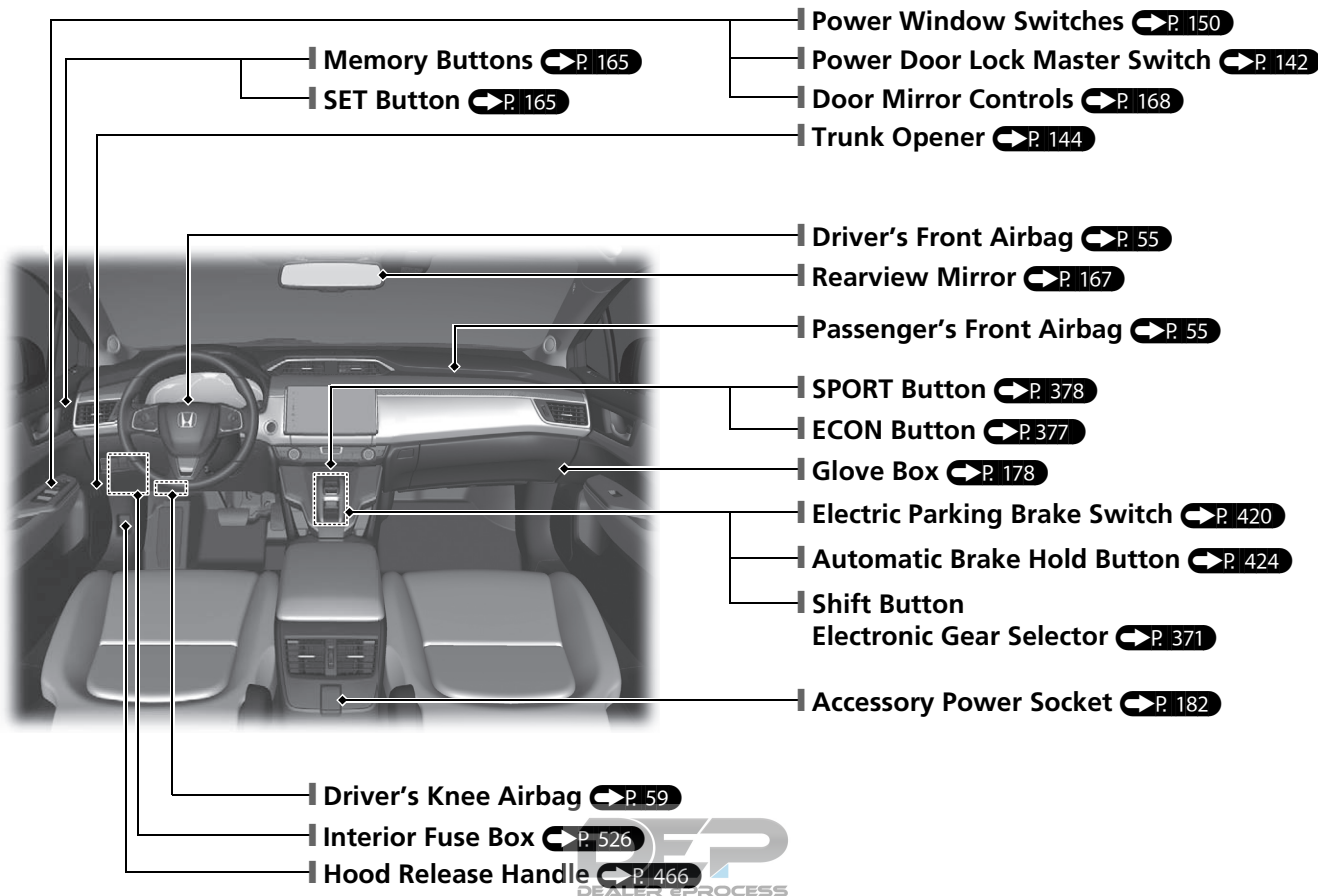

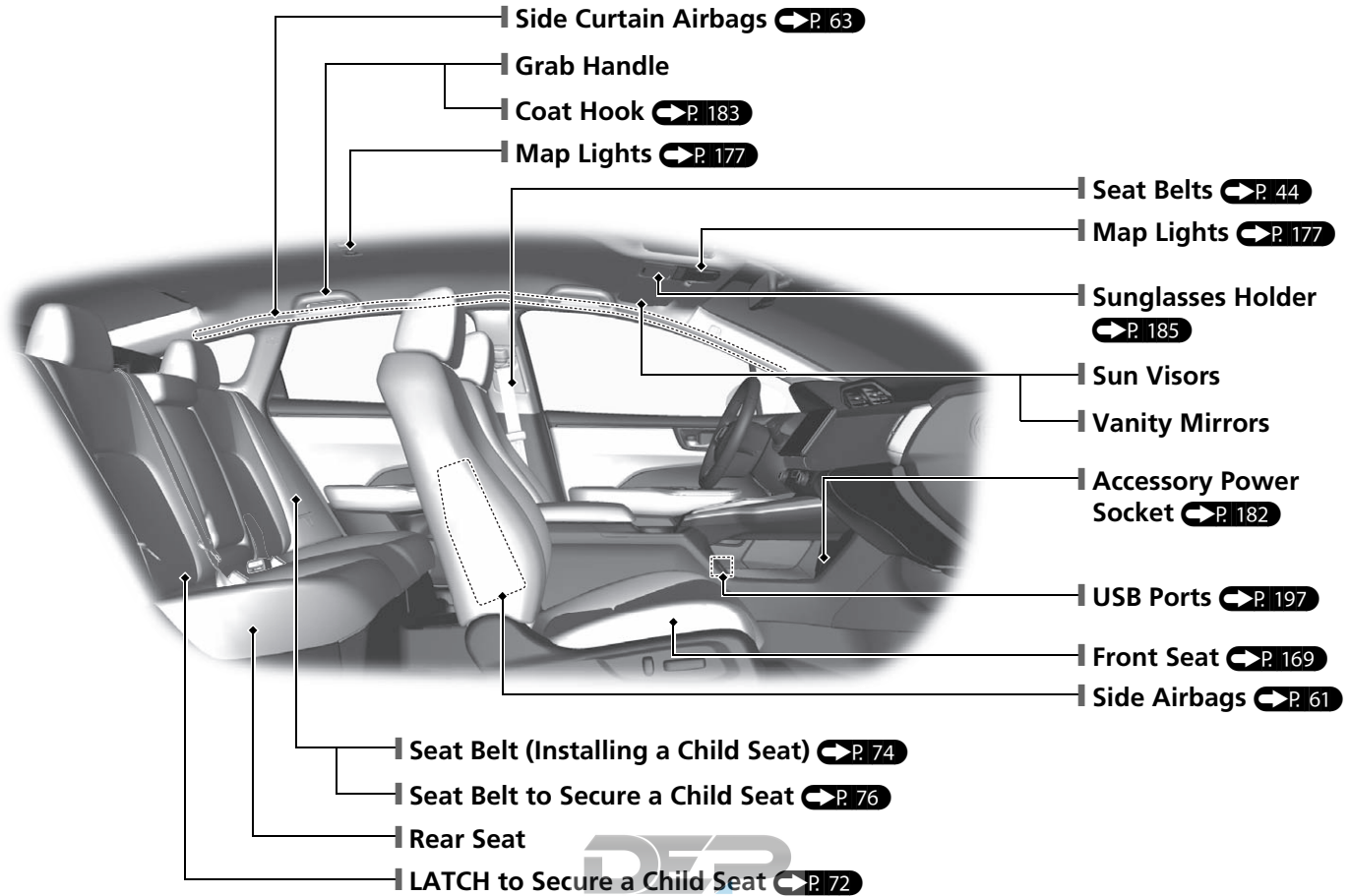

Visual Index

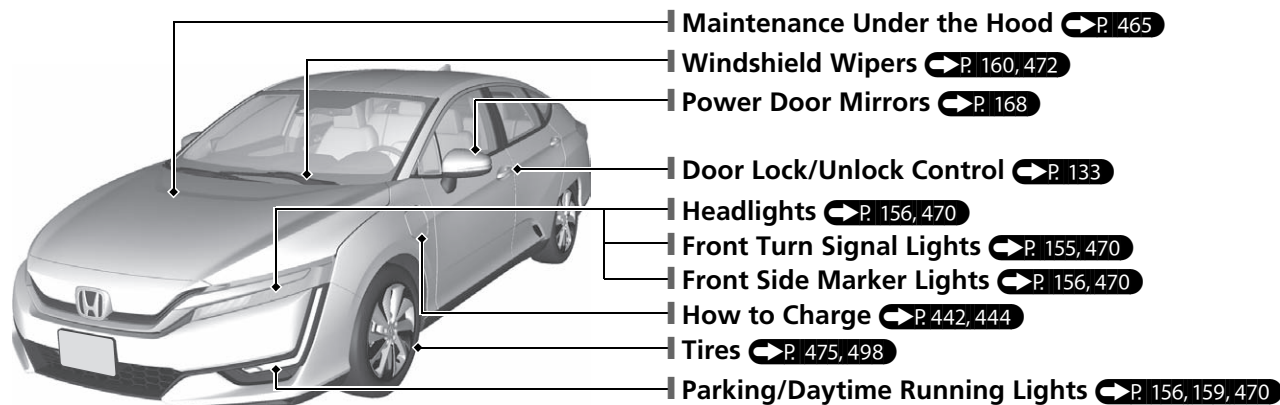

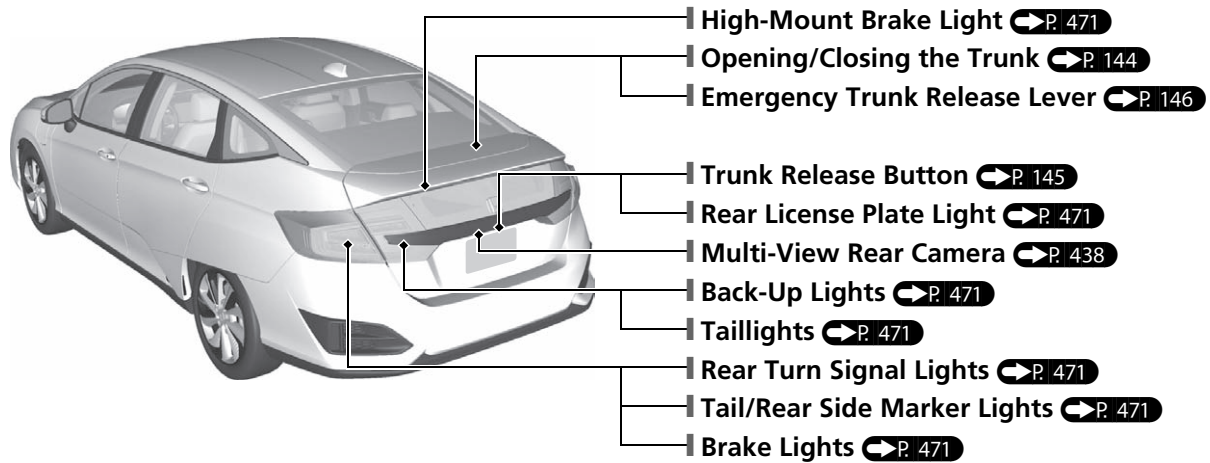

Making Good Use of Your Honda Electric Vehicle



Charging at Home

Your Honda electric vehicle can be charged with an appropriately configured household outlet. If a timer has been set, charging automatically starts and ends.

- **Charging** P. 440
- **Using a Timer** P. 454

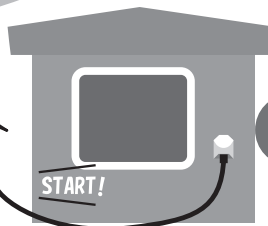



Parking

There are several things you need to know when parking your Honda electric vehicle.

➤ **High Voltage Battery** P. 453



How the electric vehicle works

An electric motor propels your Honda electric vehicle.

➤ **How the Electric Vehicle Works**
P. 14



How the Electric Vehicle Works

Instead of using gasoline to power an internal combustion engine, your vehicle uses stored electricity to power an electric propulsion motor. As with a gasoline powered vehicle, the efficiency of an electric vehicle (and the vehicle's range) is most impacted by the driver's driving style. Climate control system usage also has a strong impact with heavy usage negatively affecting the vehicle's range.

There are two types of batteries used in this vehicle, a standard 12-volt battery that powers the airbags, the interior and exterior lights, and other standard 12-volt systems, and a high voltage lithium ion battery that is used to power the propulsion motor and recharge the 12-volt battery.

Charging the High Voltage Battery

You can recharge the High Voltage battery using a standard household outlet or at a public charging station.

➔ P. 440

While the vehicle is charging or is parked after running, the compressor may operate to melt any frost that has formed on the climate control system.

Water from the melted frost drains out through the front section of the vehicle, near the undercover.



Electric Vehicle Precautions

High Voltage Components, High Voltage Cables and High Temperature Components

Electric vehicles have high voltage components (about 500 V maximum) such as the power control unit, High Voltage battery, high voltage cables (identified by their orange covers), electric motor, and high temperature parts such as the radiator. Labels with handling warnings are attached to these components.

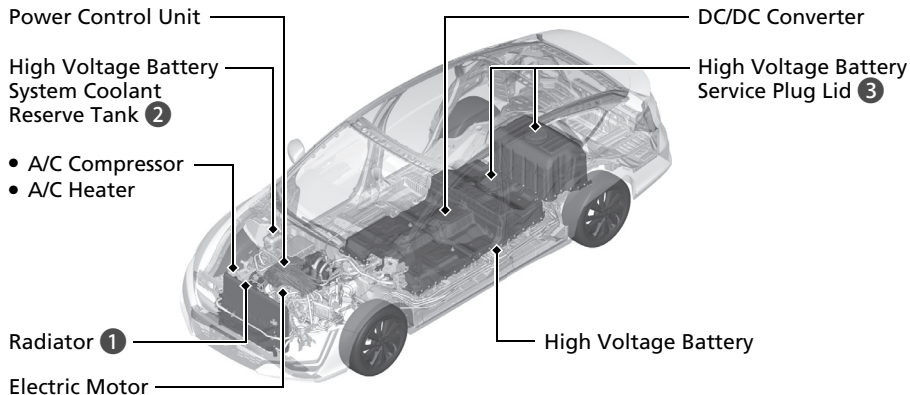

⚠ WARNING

This vehicle has high voltage circuits and parts. Failure to observe the following precautions can result in burns or electric shock.

- Do not remove, disassemble, or replace the high voltage parts, cables (orange) or their connectors.
- Never touch the High Voltage battery service plugs.

In an emergency or during maintenance or repair, the service plugs are removed to cut off the electric flow from the battery. These plugs are in contact with the battery and can cause severe electric shock if not handled properly.

Only a qualified technician should handle any electrical equipment. For inspection and repair, consult an authorized Honda Clarity Electric dealer.

Label

1 Radiator Cap

2 High Voltage Battery System Coolant Reserve Tank Cap

3 High Voltage Battery Service Plug Lid

DEP DEALER ePROCESS

High Voltage Battery

The High Voltage battery gradually discharges when the vehicle is not in use. If allowed to discharge too much, the battery may become damaged.

If your vehicle is parked for an extended period of time, during storage for example, periodically recharge the battery to maintain sufficient charge levels. At least once every three months, recharge the High Voltage battery.

Excessive heat can also damage the battery. On hot, sunny days, try to avoid parking your vehicle under direct sunlight.

If the High Voltage battery becomes fully discharged or damaged and you are unable to start the power system as a result, consult an authorized Honda Clarity Electric dealer.

Temperature

When storing the vehicle, make sure not to expose it to extremely low temperatures: If the temperature of the High Voltage battery drops to -22°F (-30°C) or below, the power system may not start. Wait for the High Voltage battery to warm up, or warm it up by plugging in the vehicle.

If the temperature of the High Voltage battery drops to -31°F (-35°C) or below, the power system will not start. Wait for the High Voltage battery to warm up or move the vehicle to a warmer location. Note plugging the vehicle in will not help in this case.



Maintenance, Repair, and Disposal

Always consult an authorized Honda Clarity Electric dealer regarding maintenance, repair, and disposal.

High Voltage batteries that have been removed from disposed vehicles are collected through authorized Honda Clarity Electric dealers. Do not dispose of those batteries yourself.

In Case of a Crash

- Be careful of electric shock hazard.
 - ▶ If a severe crash damaged your vehicle's High Voltage system, there is a possibility of electrical shock due to exposed High Voltage components or wires. If this happens, do not touch any of the High Voltage system components or any of its orange wires.
- Avoid contact with High Voltage battery fluid.
 - ▶ The High Voltage battery contains a flammable electrolyte that could leak as a result of a severe crash. Avoid any skin or eye contact with the electrolyte as it is corrosive. If you accidentally touch it, flush your eyes or skin with a large quantity of water for at least five minutes, and seek medical attention immediately.
- Use a fire extinguisher for an electrical fire.
 - ▶ Attempting to extinguish an electrical fire with a small quantity of water, from a garden hose for instance, can be dangerous.
- Anytime the vehicle is damaged in an accident, have it repaired by an authorized Honda Clarity Electric dealer.

Emergency Shutdown System for the High Voltage System

The emergency shutdown system may activate when the vehicle is impacted by a crash or a collision. When this system activates, the High Voltage system automatically shuts down, and your vehicle no longer moves.

To return the High Voltage system to normal operation, consult an authorized Honda Clarity Electric dealer.



⚠ WARNING

High voltage parts and/or the cables (orange) connecting them may be exposed as a result of a crash. Stay clear of these parts as you may be electrocuted.

If High Voltage battery fluid leaks, be careful not to touch the fluid. It can harm your eyes and skin. If it comes in contact with your eyes and skin; flush the affected area with clean water immediately for a few minutes, and seek immediate medical attention.

Regenerative Energy and Regenerative Braking

When decelerating or while driving downhill, the electric motor acts as a generator that recovers a portion of the electrical energy that was used to accelerate the vehicle.

In the following situations, the vehicle generates electricity while decelerating.

- The accelerator pedal is released with the gear position in **[D]**.
- The brake pedal is depressed with the gear position in **[D]**.
 - ▶ When the High Voltage battery is fully charged or its temperature is too cold/hot, or another factor or factors are affecting the condition of the battery, the regenerative braking system may not be activated.
- The deceleration paddle selector is used with the gear position in **[D]**.
 - ▶ You can control the rate of deceleration by using the deceleration paddle selector.

Electricity Consumption and Driving Range

Driving range is dependent on driving conditions and climate control system use. Since the climate control system in this vehicle runs on electricity, it will consume electricity when in use. The climate control system requires more electricity for heating than it does for cooling; therefore, when you use the heating function, especially when ambient temperatures are very low, the distance that you can travel on the remaining power will be shortened.

The meter below shows the driving range as well as the amount of electricity that has been consumed by the motor and the climate control system.

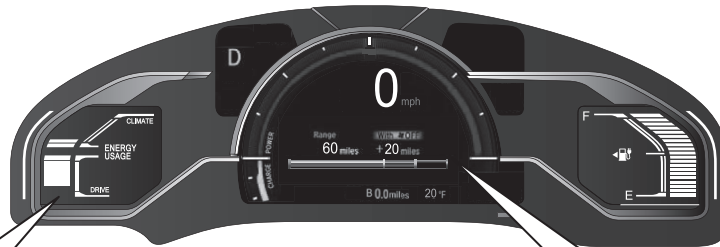

Electricity Consumption Indicator (ENERGY USAGE)

The meter shows the ratio between the energy which has been consumed by the climate control system (CLIMATE) and the energy which has been consumed by the motor (DRIVE).

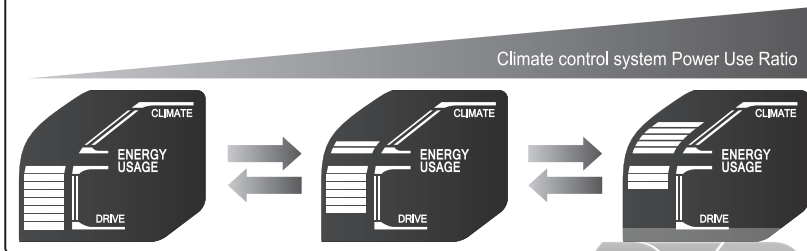

Range Display

Displays the estimated driving range as well as the estimated additional driving range if the climate control system is turned off.

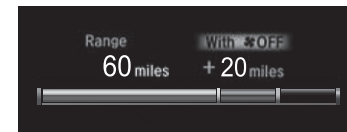

To turn the climate control system off, press the **ON/OFF** button.

Climate Control System **P. 186**



Eco Assist® System

Ambient Meter

- Changes color to reflect how energy-efficiently you are driving.
 - Green: Slow acceleration or deceleration (good energy economy)
 - White-green: Moderate acceleration or deceleration (moderate energy economy)
 - White: Aggressive acceleration or deceleration (poor energy economy)
- The indicator remains red as long as **SPORT** mode is activated.

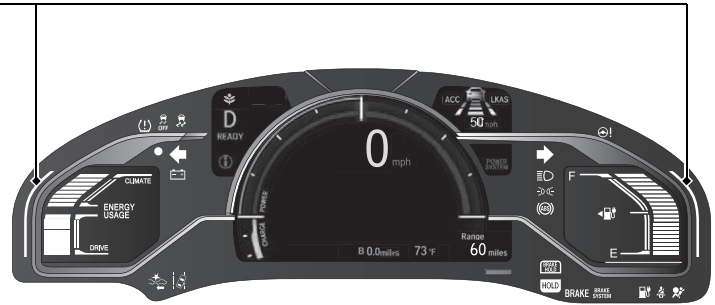

ECON Mode Indicator [↔ P.95](#)
Comes on when the **ECON** button is pressed.



The message is displayed for a few seconds when the **ECON** button is pressed.



ECON Button [↔ P.377](#)
Helps maximize energy economy.

Drive Cycle Score/Lifetime Points

- Appears when the power mode is in VEHICLE OFF (LOCK).

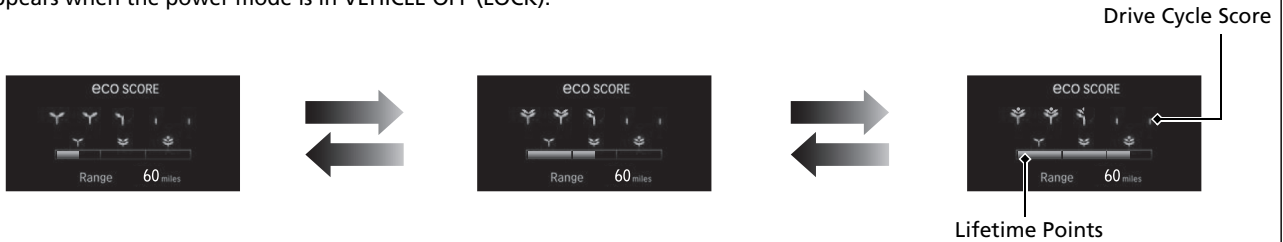

Eco Drive Display [P. 126](#)

The vehicle icon in the display moves forward and back.

- When you accelerate and decelerate, the icon moves forward and back respectively. The greater the acceleration or deceleration, the greater the icon moves.
- You can maintain better energy efficiency by keeping the icon in the center.

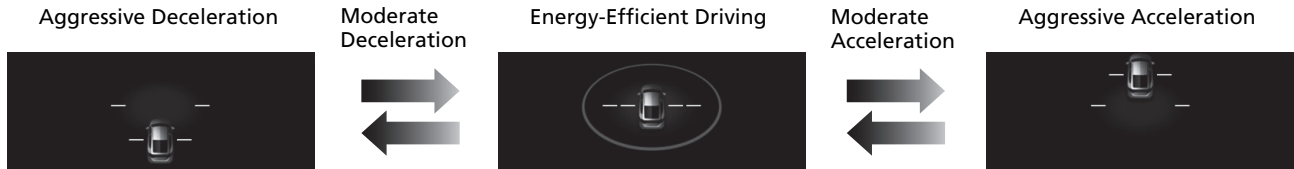

Safe Driving P. 39

Airbags P. 52

- Your vehicle is fitted with airbags to help protect you and your passengers during a moderate-to-severe collision.

Child Safety P. 67

- All children 12 and younger should be seated in the rear seat.
- Smaller children should be properly restrained in a forward-facing child seat.
- Infants must be properly restrained in a rear-facing child seat.

Seat Belts P. 44

- Fasten your seat belt and sit upright well back in the seat.
- Check that your passengers are wearing their seat belts correctly.

Before Driving Checklist P. 43

- Before driving, check that the front seats, head restraints, steering wheel, and mirrors have been properly adjusted.

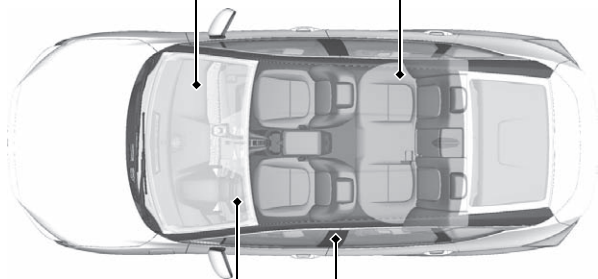











Fasten your lap belt as low as possible.



Instrument Panel P. 81



Gauges P. 116 / Driver Information Interface P. 120 / System Indicators P. 82

System Indicators

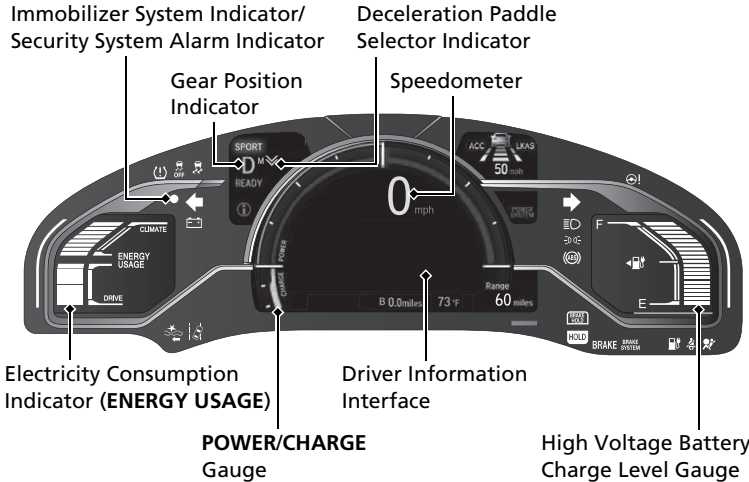





-  **SPORT** SPORT Mode Indicator
-  **ECON** Mode Indicator
- READY** **READY** Indicator
-  Vehicle Stability Assist® (VSA®) System Indicator
-  **VSA® OFF** Indicator
-  **!** Low Tire Pressure/TPMS Indicator
-  **i** System Message Indicator
-  **B+** 12-Volt Battery Charging System Indicator
-  **BRAKE HOLD** Automatic Brake Hold System Indicator
-  **HOLD** Automatic Brake Hold Indicator
-  **RDM** Road Departure Mitigation (RDM) Indicator
-  **CMBS** Collision Mitigation Brake System™ (CMBS™) Indicator



Lights Indicators

-  **Lights On** Indicator
-  **High Beam** Indicator

System Indicators

-  **!** Electric Power Steering (EPS) System Indicator
- ACC** Adaptive Cruise Control (ACC) with Low Speed Follow (LSF) Indicator
- LKAS** Lane Keeping Assist System (LKAS) Indicator
-  **↔** Turn Signal and Hazard Warning Indicators
-  **SRS** Supplemental Restraint System Indicator
-  **(ABS)** Anti-lock Brake System (ABS) Indicator
- BRAKE** Parking Brake and Brake System Indicator (Red)
- BRAKE SYSTEM** Parking Brake and Brake System Indicator (Amber)
-  **!** Seat Belt Reminder Indicator
- POWER SYSTEM** **!** POWER SYSTEM Indicator
-  **!** Low Charge Indicator





Controls P. 129

Clock P. 130

The navigation system receives signals from GPS satellites, updating the clock automatically.

You can also adjust the time manually.



- 1 Select the  (Home) icon, then select **Settings**.
- 2 Select **Clock**, then **Clock Adjustment**.
- 3 Touch the respective / icon to adjust the hours or minutes up or down.
- 4 Select **OK**.

POWER Button P. 152

Press the button to change the vehicle's power mode.

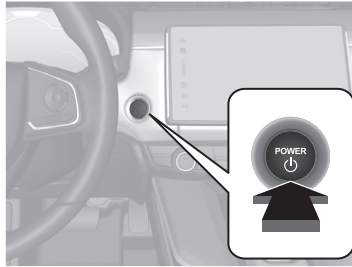

Turn Signals P. 155

Turn Signal Control Lever

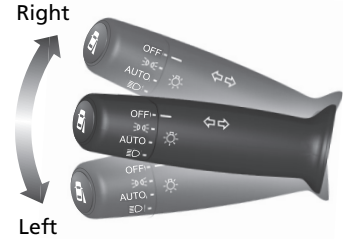

Lights P. 156

Light Control Switches

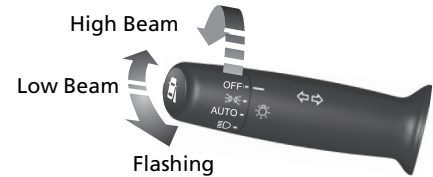

Wipers and Washers

➔ P. 160

Wiper/Washer Control Lever

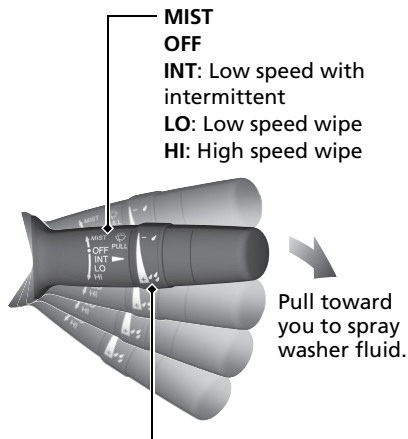

Adjustment Ring

- ⚡: Lower speed, fewer sweeps
- ⚡⚡: Higher speed, more sweeps

Steering Wheel ➔ P. 166

- To adjust, push the adjustment lever down, adjust to the desired position, then lock the lever back in place.

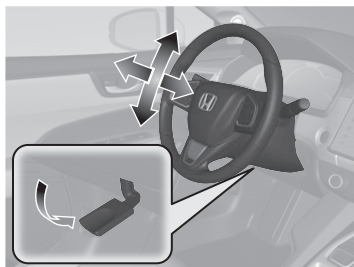

Unlocking the Front Doors from the Inside

➔ P. 141

- Pull either front door inner handle to unlock and open it in one motion.

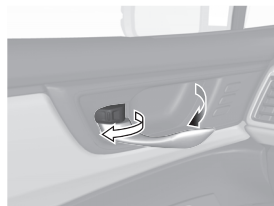

- Unlocking and opening the driver's door from the inner handle unlocks all the other doors.

DEP
DEALER ePROCESS

Trunk ➔ P. 144

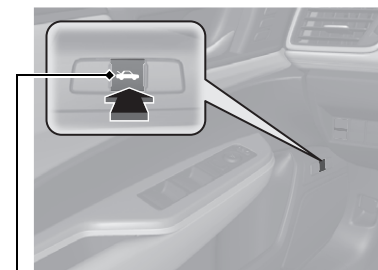

Trunk Opener

- To unlock and open the trunk:
 - Press the trunk opener on the driver's door.
 - Press the trunk release button on the smart entry remote.
 - Press the trunk release button on the trunk lid.

Power Door Mirrors

➔ P. 168

- With the power mode in ON, move the selector switch to L or R.
- Push the appropriate edge of the adjustment switch to adjust the mirror.

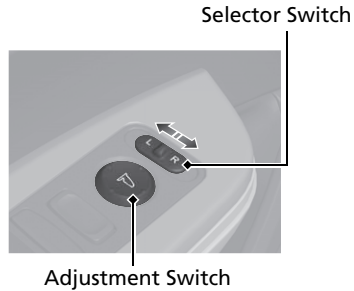

Power Windows ➔ P. 150

- With the power mode in ON, open and close the power windows.
- If the power window lock button is in the off position, each passenger's window can be opened and closed with its own switch.
- If the power window lock button is in the on position (indicator on), each passenger's window switch is disabled.

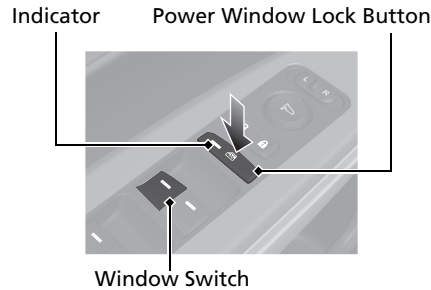

Climate Control System P. 186

- Press the **AUTO** button to activate the climate control system.
- Press the **ON/OFF** button to turn the system on or off.
- Press the button to defrost the windshield.

The climate control system is voice operable. P. 229

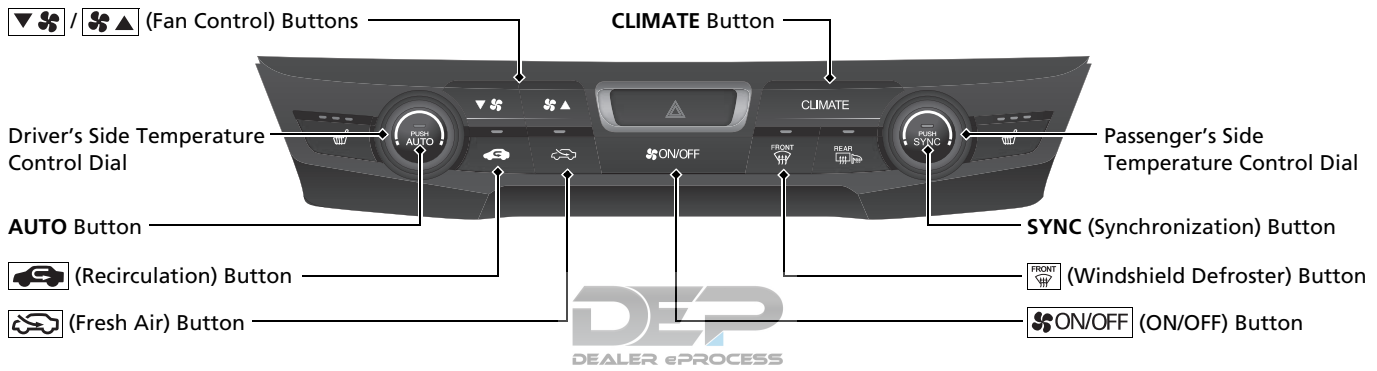
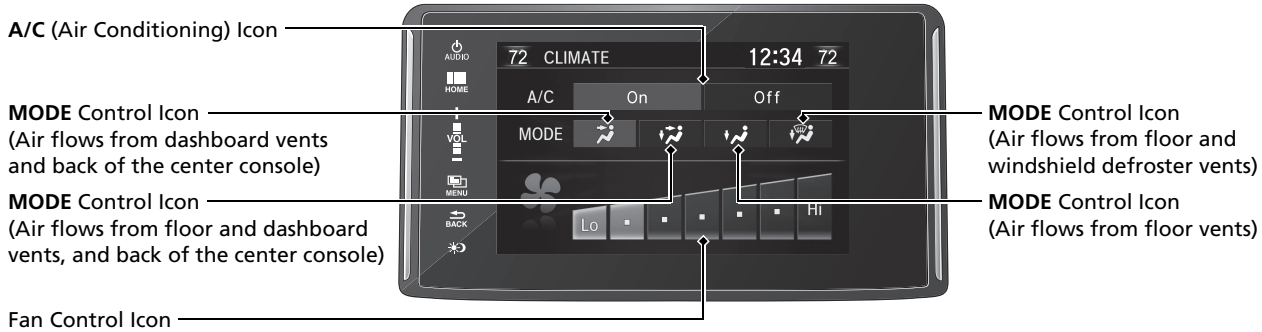

Features P. 195

Audio Remote Controls

 P. 199

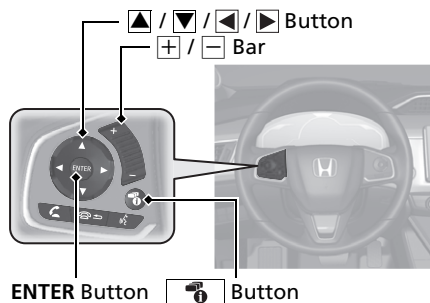

- + / - Bar
Press to adjust the volume up/down.
- ▲ / ▼ Button
Press ▲ or ▼ to cycle through the audio mode as follows:
FM→AM→SiriusXM®→USB→iPod®→
Bluetooth® Audio→Pandora®→Apple
CarPlay/Android Auto

- **ENTER** Button
- When listening to the radio and SiriusXM®

- 1 Press **ENTER** to switch the display to a preset list you stored in the preset buttons.
- 2 Press ▲ or ▼ to select a preset, then press **ENTER**.

- When listening to a USB flash drive

- 1 Press **ENTER** to display the folder list.
- 2 Press ▲ or ▼ to select a folder.
- 3 Press **ENTER** to display a list of tracks in that folder.
- 4 Press ▲ or ▼ to select a track, then press **ENTER**.

- When listening to an iPod®

- 1 Press **ENTER** to display the iPod® music list.
- 2 Press ▲ or ▼ to select a category.
- 3 Press **ENTER** to display a list of items in the category.
- 4 Press ▲ or ▼ to select an item, then press **ENTER**.
▶ Press **ENTER** and press ▲ or ▼ repeatedly until a desired item you want to listen is displayed.

- When listening to Pandora®

- 1 Press **ENTER** to display the station list.
- 2 Press ▲ or ▼ to select an item, then press **ENTER**.

- When listening to Bluetooth® Audio

- 1 Press **ENTER** to display the track list.
- 2 Press ▲ or ▼ to select a track, then press **ENTER**.

-  Button

Radio: Press to change the preset station.
Press and hold to select the next or previous strong station.

USB device:

Press to skip to the beginning of the next song or return to the beginning of the current song.
Press and hold to change a folder.



Button:

Press to change contents.

 **Driver Information Interface**  P. 120

Audio System P. 196

For navigation system operation  See the Navigation System Manual



Driver Information Interface

 AUDIO (Power/Audio) Icon

 (Home) Icon

VOL (Volume) Icons

 (Menu) Icon

 (Back) Icon

 (Day/Night) Icon

Audio/Information Screen

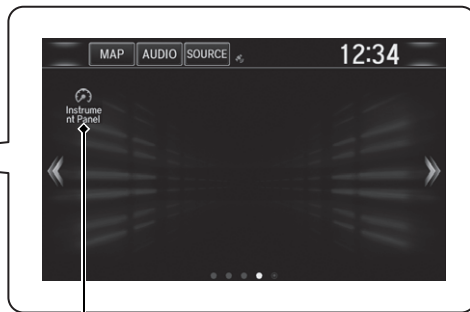

 (Instrument Panel) Icon



Driving P. 359

Electronic Gear Selector P. 371

- Select **P** and depress the brake pedal when turning on the power.

Gear selection

Gear Position Indicator

The gear position indicator and the shift button indicator indicate the current gear selection.



Gear Position Indicator

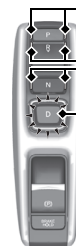
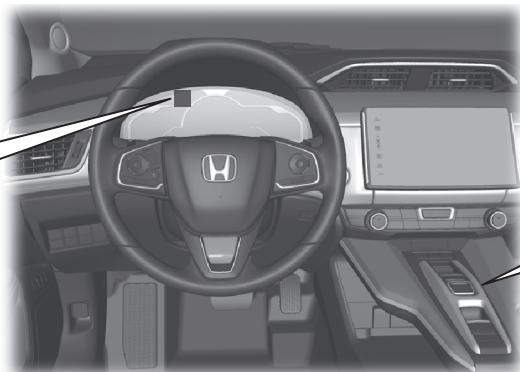

Shift Button Indicator

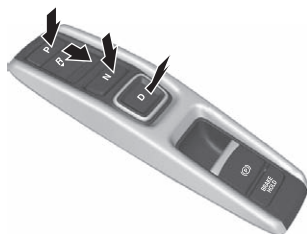

P

Park

Press the **P** button.

Used when parking or before turning the power on or off.
Transmission is locked.

R

Reverse

Press back the **R** button.

Used when reversing.

N

Neutral

Press the **N** button.

Transmission is not locked.

D

Drive

Press the **D** button.

Used for normal driving.

The deceleration paddle selector can be used temporarily.

The deceleration paddle selector can be used when SPORT mode is on.

Deceleration Paddle Selector P. 379

When you release the accelerator pedal, you can control the rate of deceleration without releasing your hands from the steering wheel. Using the deceleration paddle selector situated on the steering wheel, you can sequentially shift through four stages of deceleration.

Pull the selector for a few seconds when you want to cancel the deceleration paddle selector.

- **When SPORT mode is OFF**

If you pull back the paddle selector, the rate of deceleration will change temporarily, and the stage will appear in the instrument panel.

- **When SPORT mode is ON**

If you pull back the paddle selector, the rate of deceleration will change and the stage along with **M** will appear in the instrument panel.

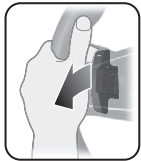

Paddle Selector



Paddle Selector

When SPORT mode is OFF, the deceleration stage appears.



Deceleration stage

When SPORT mode is ON, The deceleration stage and **M** appear.

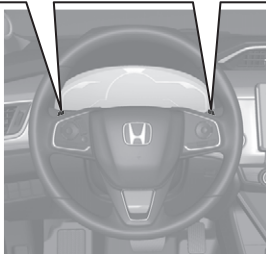
**VSA® On and Off** P. 412

- The Vehicle Stability Assist® (VSA®) system helps stabilize the vehicle during cornering and helps maintain traction while accelerating on loose or slippery road surfaces.
- VSA® comes on automatically every time you turn on the power system.
- To partially disable or fully restore VSA® function, press and hold the button until you hear a beep.

CMBS™ On and Off

P. 431

- When a possible collision is likely unavoidable, the CMBS™ can help you to reduce the vehicle speed and the severity of the collision.
- The CMBS™ is turned on every time you start the power system.
- To turn the CMBS™ on or off, press and hold the button until you hear a beep.

Tire Pressure Monitoring System (TPMS) P. 414

- Detects a change in tire conditions and overall dimensions due to decrease in tire pressures.
- The TPMS is turned on automatically every time you turn on the power system.
- A calibration procedure must be performed when certain conditions arise.

Honda Sensing®

Honda Sensing® is a driver support system which employs the use of two distinctly different kinds of sensors, a radar sensor located in the front grille and a front sensor camera located to the interior side of the windshield, behind the rearview mirror.

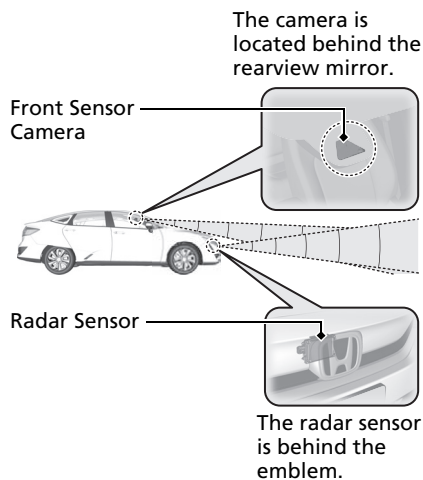

Adaptive Cruise Control (ACC) with Low Speed Follow (LSF) P. 389

Helps maintain a constant vehicle speed and a set following-interval behind a vehicle detected ahead of yours and, if the detected vehicle comes to a stop, can decelerate and stop your vehicle, without you having to keep your foot on the brake or the accelerator.

Road Departure Mitigation (RDM) System P. 385

Alerts and helps to assist you when the system detects a possibility of your vehicle unintentionally crossing over detected lane markings and/or leaving the roadway altogether.

Lane Keeping Assist System (LKAS) P. 404

Provides steering input to help keep the vehicle in the middle of a detected lane and provides tactile and visual alerts if the vehicle is detected drifting out of its lane.



Collision Mitigation Braking System™ (CMBS™) P. 428

Can assist you when there is a possibility of your vehicle colliding with a vehicle or a pedestrian detected in front of yours. The CMBS™ is designed to alert you when a potential collision is determined, as well as to reduce your vehicle speed to help minimize collision severity when a collision is deemed unavoidable.

Maintenance P. 457

Under the Hood P. 465

- Check coolants and windshield washer fluid. Add when necessary.
- Check brake fluid.
- Check the 12-volt battery condition monthly.

- 1 Pull the hood release handle under the corner of the dashboard.

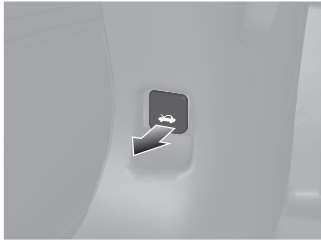

- 2 Locate the hood latch lever, push it to the side, and then raise the hood. Once you have raised the hood slightly, you can release the lever.

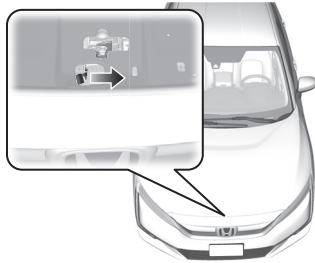

- 3 When finished, close the hood and make sure it is firmly locked in place.

Wiper Blades P. 472

- Replace blades if they leave streaks across the windshield.

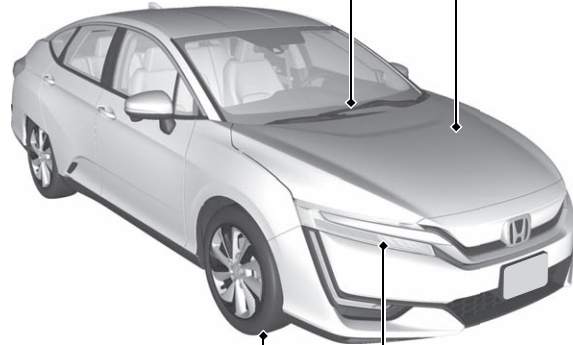

Tires P. 475

- Inspect tires and wheels regularly.
- Check tire pressures regularly.
- Install snow tires for winter driving.

Lights P. 470

- Inspect all lights regularly.

Handling the Unexpected P. 497

Flat Tire P. 498

- Park in a safe location and repair the flat tire using the temporary tire repair kit.



Power System Won't Start P. 511

- If the 12-volt battery is dead, jump start using a booster battery.

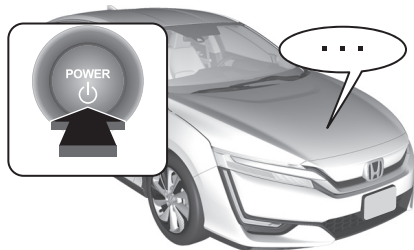

Overheating P. 517

- Park in a safe location. If you do not see steam under the hood, open the hood, and let the power system cool down.



Indicators Come On P. 518

- Identify the indicator and consult the owner's manual.

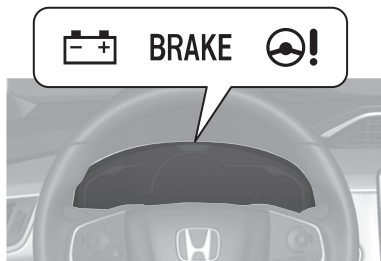

Blown Fuse P. 524

- Check for a blown fuse if an electrical device does not operate.

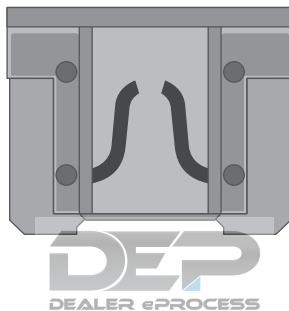

Emergency Towing P. 531

- Call a professional towing service if you need to tow your vehicle.



What to Do If

Q Why do I hear an operating noise when applying the brakes?

A This can occur when the ABS activates and does not indicate a problem. Apply firm, steady pressure on the brake pedal. Never pump the brake pedal.

➤ Anti-lock Brake System (ABS) ➔ P.426

Q The rear door cannot be opened from inside the vehicle. Why?

A Check if the childproof lock is in the lock position. If so, open the rear door with the outside door handle.

To cancel this function, slide the lever up to the unlock position.

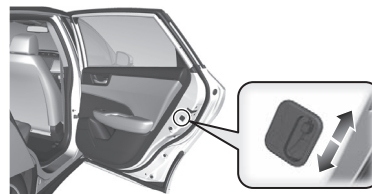

Q Why do the doors lock after I unlocked the doors?

A If you do not open the doors within 30 seconds, the doors are relocked automatically for security.

Q Why does the beeper sound when I open the driver's door?

A The beeper sounds when:

- The power mode is in ACCESSORY.
- The exterior lights are left on.

Q Why does a beeper sound when I walk away from the vehicle after I close the door?

A The beeper sounds if you move outside the walk away auto lock operating range before the door completely closes.
❏ Locking the doors and trunk (Walk away auto lock) ➔ P. 134

Q Why does the beeper sound when I start driving?

A The beeper sounds when the driver and/or front passenger are not wearing their seat belts.

Q Pressing the electric parking brake switch does not release the parking brake. Why?

A Press the electric parking brake switch with the brake pedal depressed.

Q I'm seeing an amber indicator of a tire with an exclamation point. What is that?

A The Tire Pressure Monitoring System (TPMS) needs attention. If you recently inflated or changed a tire, you have to recalibrate the system.
▶ TPMS Calibration ➔ P. 414

Q Depressing the accelerator pedal does not release the parking brake automatically. Why?

A

- Fasten the driver's seat belt.
- Check if the transmission is in **P** or **N**. If so, select any other position.



Why does the gear position automatically change to **P** when I open the driver's door to check for parking space lines when reversing?



- Fasten the driver's seat belt.
 - Close the driver's door and manually change the gear position.
- ▶ When opening the driver's door  **P 374**



Why do I hear a screeching sound when I apply the brake pedal?



The brake pads may need to be replaced. Have your vehicle inspected by an authorized Honda Clarity Electric dealer.

Safe Driving

You can find many safety recommendations throughout this chapter, and throughout this manual.

For Safe Driving

Important Safety Precautions	40
Your Vehicle's Safety Features.....	42
Safety Checklist	43

Seat Belts

About Your Seat Belts.....	44
Fastening a Seat Belt.....	47
Seat Belt Inspection.....	51

Airbags

Airbag System Components.....	52
Types of Airbags	55
Front Airbags (SRS)	55

Driver's Knee Airbag	59
Side Airbags	61
Side Curtain Airbags	63
Airbag System Indicators.....	64
Airbag Care	66

Child Safety

Protecting Child Passengers	67
Safety of Infants and Small Children ..	69
Safety of Larger Children	78

Safety Labels

Label Locations	80
-----------------------	----

The following pages explain your vehicle's safety features and how to use them properly. The safety precautions below are ones that we consider to be among the most important.

Important Safety Precautions

■ Always wear your seat belt

A seat belt is your best protection in all types of collisions. Airbags are designed to supplement seat belts, not replace them. So even though your vehicle is equipped with airbags, make sure you and your passengers always wear your seat belts, and wear them properly.

■ Restrain all children

Children ages 12 and under should ride properly restrained in a back seat, not the front seat. Infants and small children should be restrained in a child seat. Larger children should use a booster seat and a lap/shoulder seat belt until they can use the belt properly without a booster seat.

■ Be aware of airbag hazards

While airbags can save lives, they can cause serious or fatal injuries to occupants who sit too close to them, or are not properly restrained. Infants, young children, and short adults are at the greatest risk. Be sure to follow all instructions and warnings in this manual.

■ Don't drink and drive

Alcohol and driving don't mix. Even one drink can reduce your ability to respond to changing conditions, and your reaction time gets worse with every additional drink. So don't drink and drive, and don't let your friends drink and drive, either.

▣ Important Safety Precautions

Some states and territories prohibit the use of cell phones other than hands-free devices by the driver while driving.

■ Pay appropriate attention to the task of driving safely

Engaging in cell phone conversation or other activities that keep you from paying close attention to the road, other vehicles, and pedestrians could lead to a crash. Remember, situations can change quickly, and only you can decide when it is safe to divert some attention away from driving.

■ Control your speed

Excessive speed is a major factor in crash injuries and deaths. Generally, the higher the speed, the greater the risk, but serious injuries can also occur at lower speeds. Never drive faster than is safe for current conditions, regardless of the maximum speed posted.

■ Keep your vehicle in safe condition

Having a tire blowout or a mechanical failure can be extremely hazardous. To reduce the possibility of such problems, check your tire pressures and condition frequently, and perform all regularly scheduled maintenance.

■ Do not leave children unattended in the vehicle

Children left unattended in the vehicle may be injured if they activate one or more of the vehicle controls. They may also cause the vehicle to move, resulting in a crash in which the children and/or another person(s) can be injured or killed. Also, depending on the ambient temperature, the temperature of the interior may reach extreme levels, which can result in injury or death.

Even if the climate control system is on, never leave children in the vehicle unattended as the climate control system can shut off at any time.

■ Handle high-voltage with care

Familiarize yourself with the charging instructions and warnings supplied in this manual and on the quick reference card. If using a public charger, also observe the charging station manufacturer's instructions.



Your Vehicle's Safety Features

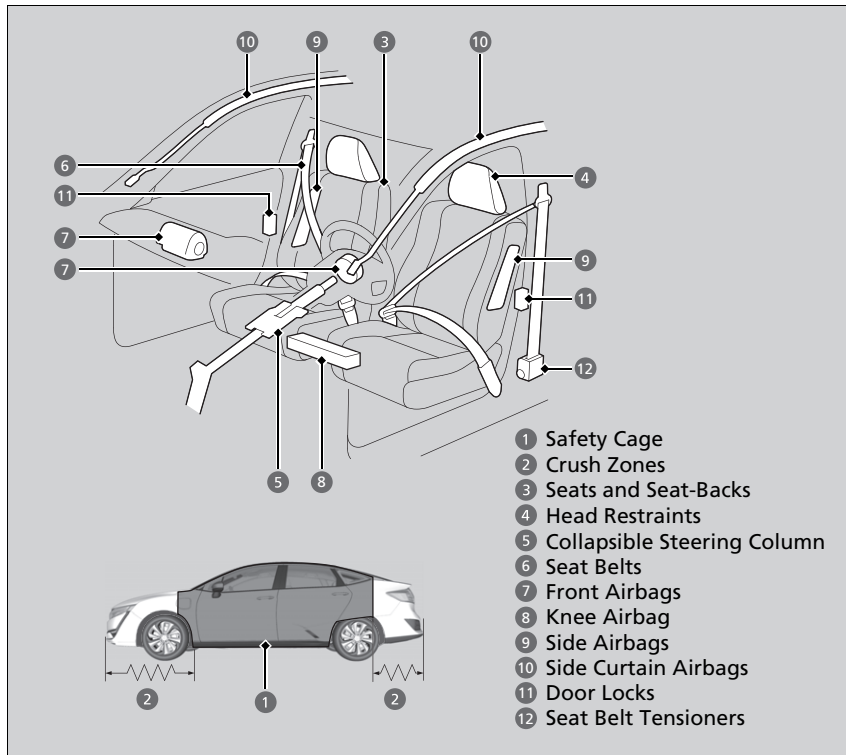

The following checklist will help you take an active role in protecting yourself and your passengers.



► Your Vehicle's Safety Features

Your vehicle is equipped with many features that work together to help protect you and your passengers during a crash.

Some features do not require any action on your part. These include a strong steel framework that forms a safety cage around the passenger compartment, front and rear crush zones, a collapsible steering column, and tensioners that tighten the front seat belts in a sufficient crash.

However, you and your passengers cannot take full advantage of these features unless you remain seated in the correct position and always wear your seat belts. In fact, some safety features can contribute to injuries if they are not used properly.

Safety Checklist

For the safety of you and your passengers, make a habit of checking these items each time before you drive. Check if the charging cable is connected to the vehicle and disconnect it if it is. The vehicle will not operate with the cable connected.

- After everyone has entered the vehicle, be sure all doors are closed and locked. Locking the doors helps prevent an occupant from being ejected and an outsider from unexpectedly opening a door.
 - **Locking/Unlocking the Doors from the Inside** P. 140
- Adjust your seat to a position suitable for driving. Be sure the front seats are adjusted as far to the rear as possible while allowing the driver to control the vehicle. Sitting too close to a front airbag can result in serious or fatal injury in a crash.
 - **Adjusting the Seats** P. 169
- Adjust head restraints to the proper position. Head restraints are most effective when the center of the head restraint aligns with the center of your head. Taller persons should adjust their head restraint to the highest position.
 - **Adjusting the Front Head Restraints Positions** P. 171
- Always wear your seat belt, and make sure you wear it properly. Confirm that any passengers are properly belted as well.
 - **Fastening a Seat Belt** P. 47
- Protect children by using seat belts or child seats according to a child's age, height and weight.
 - **Child Safety** P. 67

☒ Safety Checklist

If the door and/or trunk open message appears on the driver information interface, a door and/or the trunk is not completely closed. Close all doors and the trunk tightly until the message disappears.

➤ **Driver Information Interface Warning and Information Messages** P. 108



About Your Seat Belts

Seat belts are the single most effective safety device because they keep you connected to the vehicle so that you can take advantage of many built-in safety features. They also help keep you from being thrown against the inside of the vehicle, against any passengers, or out of the vehicle. When worn properly, seat belts also keep your body properly positioned in a crash so that you can take full advantage of the additional protection provided by the airbags.

In addition, seat belts help protect you in almost every type of crash, including:

- frontal impacts
- side impacts
- rear impacts
- rollovers

■ Lap/shoulder seat belts

All five seating positions are equipped with lap/shoulder seat belts with emergency locking retractors. In normal driving the retractor lets you move freely while keeping some tension on the belt. During a collision or sudden stop the retractor locks to restrain your body.

The front passenger's and rear seat belts also have a lockable retractor for use with child seats.

➤ **Installing a Child Seat with a Lap/Shoulder Seat Belt** P. 74

➤ About Your Seat Belts

⚠ WARNING

Not wearing a seat belt properly increases the chance of serious injury or death in a crash, even though your vehicle has airbags.

Be sure you and your passengers always wear seat belts and wear them properly.

Seat belts cannot completely protect you in every crash. But in most cases, seat belts can reduce your risk of serious injury.

Most states and territories require you to wear seat belts.

If you extend the seat belt too quickly, it will lock in place. If this happens, slightly retract the seat belt, then extend it slowly.

■ Proper use of seat belts

Follow these guidelines for proper use:

- All occupants should sit upright, well back in the seat, and remain in that position for the duration of the trip. Slouching and leaning reduce the effectiveness of the belt and can increase the chance of serious injury in a crash.
- Never place the shoulder part of a lap/shoulder seat belt under your arm or behind your back. This could cause very serious injuries in a crash.
- Two people should never use the same seat belt. If they do, they could be very seriously injured in a crash.
- Do not put any accessories on the seat belts. Devices intended to improve comfort or reposition the shoulder part of a seat belt can reduce the protective capability and increase the chance of serious injury in a crash.

▣ About Your Seat Belts

If a rear seat passenger moves around and extends the seat belt, the lockable retractor may activate. If this happens, release the retractor by unfastening the seat belt and allow the belt to retract completely. Then refasten the belt.



Continued

■ Seat Belt Reminder



The seat belt system includes an indicator on the instrument panel to remind the driver or a front passenger or both to fasten their seat belts.

If you set the power mode to ON and a seat belt is not fastened, a beeper will sound and the indicator will blink. After a few seconds, the beeper will stop and the indicator will come on and remain illuminated until the seat belt is fastened.

The beeper will periodically sound and the indicator will blink while the vehicle is moving until the driver's and/or the front passenger's seat belt is fastened.

■ Automatic Seat Belt Tensioners

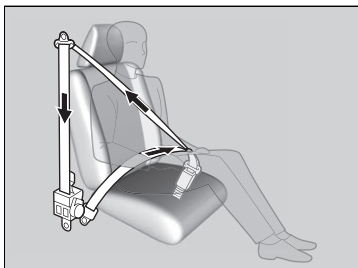

The front seats are equipped with automatic seat belt tensioners to enhance safety.

The tensioners automatically tighten the front seat belts during a moderate-to-severe frontal collision, sometimes even if the collision is not severe enough to inflate the front airbags or the driver's knee airbag.



❏ Seat Belt Reminder

The indicator will also come on if a front passenger does not fasten their seat belt within six seconds after the power mode is set to ON.

When no one is sitting in the front passenger's seat, the indicator will not come on and the beeper will not sound.

The indicator also may not come on and the beeper may not sound when the occupant is not heavy enough to trigger the weight sensor. Such occupants (e.g., infants and smaller children) should be moved to the rear seat as a deploying front airbag likely will injure or kill them.

➤ **Protecting Child Passengers** P. 67

❏ Automatic Seat Belt Tensioners

The seat belt tensioners can only operate once. If a tensioner is activated, the SRS indicator will come on. Have an authorized Honda Clarity Electric dealer replace the tensioner and thoroughly inspect the seat belt system as it may not offer protection in a subsequent crash.

During a moderate-to-severe side impact, the tensioner on that side of the vehicle also activates.

Fastening a Seat Belt

After adjusting a front seat to the proper position, and while sitting upright and well back in the seat:

🔧 **Adjusting the Seats** P. 169

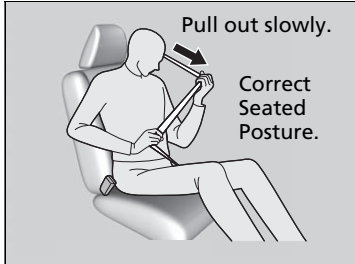

1. Pull the seat belt out slowly.

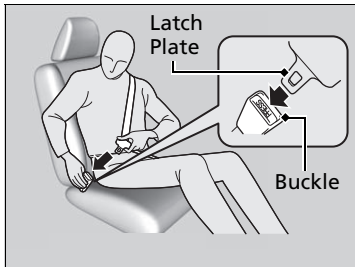

2. Insert the latch plate into the buckle, then tug on the belt to make sure the buckle is secure.

▶ Make sure that the belt is not twisted or caught on anything.

🔧 Fastening a Seat Belt

No one should sit in a seat with an inoperative seat belt or one that does not appear to be working correctly. Using a seat belt that is not working properly may not protect the occupant in a crash. Have an authorized Honda Clarity Electric dealer check the belt as soon as possible.

Never insert any foreign objects into the buckle or retractor mechanism.



3. Position the lap part of the belt as low as possible across your hips, then pull up on the shoulder part of the belt so the lap part fits snugly. This lets your strong pelvic bones take the force of a crash and reduces the chance of internal injuries.
4. If necessary, pull up on the belt again to remove any slack, then check that the belt rests across the center of your chest and over your shoulder. This spreads the forces of a crash over the strongest bones in your upper body.

Fastening a Seat Belt

WARNING

Improperly positioning the seat belts can cause serious injury or death in a crash.

Make sure all seat belts are properly positioned before driving.

To release the belt, push the red **PRESS** button and then guide the belt by hand until it has retracted completely.

When exiting the vehicle, be sure the belt is properly stowed so that it will not get caught in the closing door.

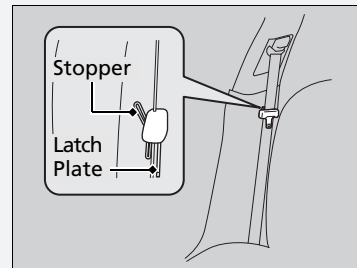

When stowing the seat belt, make sure the latch plate is resting on the stopper.

■ Adjusting the Shoulder Anchor

The front seats have adjustable shoulder anchors to accommodate taller and shorter occupants.

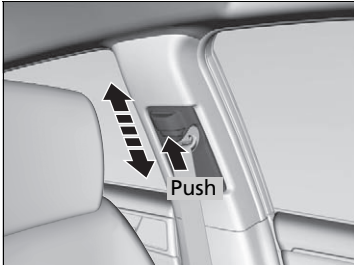

1. Move the anchor up and down while holding the release button.
2. Position the anchor so that the belt rests across the center of your chest and over your shoulder.

▣ Adjusting the Shoulder Anchor

The shoulder anchor height can be adjusted to four levels. If the belt contacts your neck, lower the height one level at a time.

After an adjustment, make sure that the shoulder anchor position is secure.

■ Advice for Pregnant Women

If you are pregnant, the best way to protect yourself and your unborn child when driving or riding in a vehicle is to always wear a seat belt and keep the lap part of the belt as low as possible across the hips.

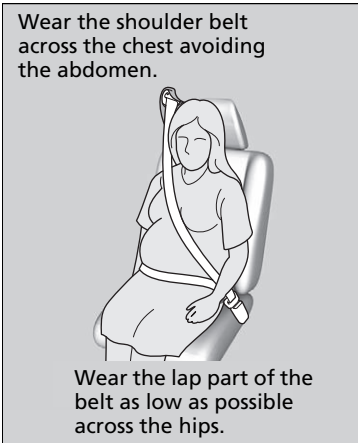

▣ Advice for Pregnant Women

Each time you have a checkup, ask your doctor if it is okay for you to drive.

To reduce the risk of injuries to both you and your unborn child that can be caused by an inflating front airbag:

- When driving, sit upright and adjust the seat as far back as possible while allowing full control of the vehicle.
- When sitting in the front passenger's seat, adjust the seat as far back as possible.



Seat Belt Inspection

Regularly check the condition of your seat belts as follows:

- Pull each belt out fully, and look for frays, cuts, burns, and wear.
- Check that the latch plates and buckles work smoothly and the belts retract easily.
 - ▶ If a belt does not retract easily, cleaning the belt may correct the problem. Only use a mild soap and warm water. Do not use bleach or cleaning solvents. Make sure the belt is completely dry before allowing it to retract.

Any belt that is not in good condition or working properly will not provide proper protection and should be replaced as soon as possible.

A belt that has been worn during a crash may not provide the same level of protection in a subsequent crash. Have your seat belts inspected by an authorized Honda Clarity Electric dealer after any collision.

Seat Belt Inspection

⚠ WARNING

Not checking or maintaining seat belts can result in serious injury or death if the seat belts do not work properly when needed.

Check your seat belts regularly and have any problem corrected as soon as possible.

Airbag System Components

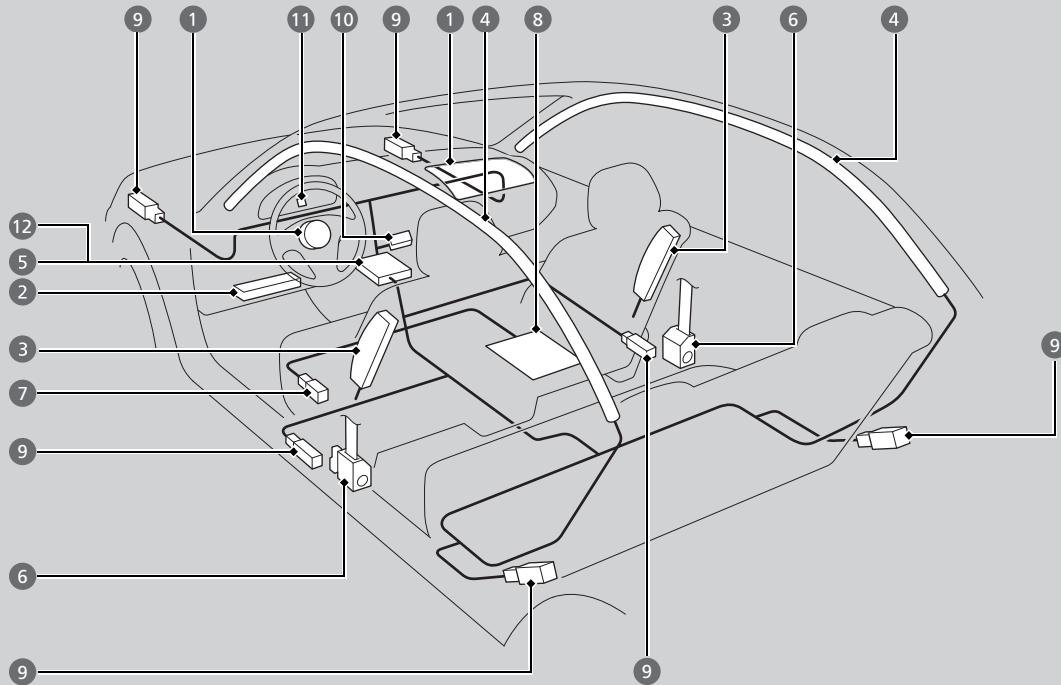

The front, driver's knee, front side, and side curtain airbags are deployed according to the direction and severity of impact. Both side curtain airbags are deployed in a rollover. The airbag system includes:

- 1 Two SRS (Supplemental Restraint System) front airbags. The driver's airbag is stored in the center of the steering wheel; the front passenger's airbag is stored in the dashboard. Both are marked **SRS AIRBAG**.
- 2 Driver's knee airbag. The knee airbag is stored under the steering column. It is marked **SRS AIRBAG**.
- 3 Two side airbags, one for the driver and one for a front passenger. The airbags are stored in the outer edges of the seat-backs. Both are marked **SIDE AIRBAG**.
- 4 Two side curtain airbags, one for each side of the vehicle. The airbags are stored in the ceiling, above the side windows. The front and rear pillars are marked **SIDE CURTAIN AIRBAG**.
- 5 An electronic control unit that, when the vehicle is on, continually monitors information about the various impact sensors, seat and buckle sensors, rollover sensor, airbag activators, seat belt tensioners, seat weight sensor, seat position sensor, passenger airbag OFF indicator, and other vehicle information. During a crash event the unit can record such information.
- 6 Automatic front seat belt tensioners. In addition, the driver's and front passenger's seat belt buckles incorporate sensors that detect whether or not the belts are fastened.
- 7 A driver's seat position sensor. This sensor determines the optimal force at which the airbag will deploy in a crash.
- 8 Weight sensors in the front passenger's seat. The front passenger's airbag will be turned off if the weight on the seat is approximately 65 lbs (29 kg) or less (the weight of an infant or small child).
- 9 Impact sensors that can detect a moderate-to-severe front or side impact.
- 10 An indicator on the dashboard that alerts you that the front passenger's front airbag has been turned off.
- 11 An indicator on the instrument panel that alerts you to a possible problem with your airbag system or seat belt tensioners.
- 12 A rollover sensor that can detect if your vehicle is about to roll over and signal the control unit to deploy both side curtain airbags.



■ Important Facts About Your Airbags

Airbags can pose serious hazards. To do their job, airbags must inflate with tremendous force. So, while airbags help save lives, they can cause burns, bruises, and other minor injuries, sometimes even fatal ones if occupants are not wearing their seat belts properly and sitting correctly.

What you should do: Always wear your seat belt properly, and sit upright and as far back from the steering wheel as possible while allowing full control of the vehicle. A front passenger should move their seat as far back from the dashboard as possible.

Remember, however, that no safety system can prevent all injuries or deaths that can occur in a severe crash, even when seat belts are properly worn and the airbags deploy.

Do not place hard or sharp objects between yourself and a front airbag.

Carrying hard or sharp objects on your lap, or driving with a pipe or other sharp object in your mouth, can result in injuries if your front airbag inflates.

Do not attach or place objects on the front and driver's knee airbag covers.

Objects on the covers marked **SRS AIRBAG** could interfere with the proper operation of the airbags or be propelled inside the vehicle and hurt someone if the airbags inflate.

▣ Important Facts About Your Airbags

Do not attempt to deactivate your airbags. Together, airbags and seat belts provide the best protection.

When driving, keep hands and arms out of the deployment path of the front airbag by holding each side of the steering wheel. Do not cross an arm over the airbag cover.



Types of Airbags

Your vehicle is equipped with four types of airbags:

- **Front airbags:** Airbags in front of the driver's and front passenger's seats.
- **Driver's knee airbag:** Airbag under the steering column.
- **Side airbags:** Airbags in the driver's and front passenger's seat-backs.
- **Side curtain airbags:** Airbags above the side windows.

Each is discussed in the following pages.

Front Airbags (SRS)

The front SRS airbags inflate in a moderate-to-severe frontal collision to help protect the head and chest of the driver and/or front passenger.

SRS (Supplemental Restraint System) indicates that the airbags are designed to supplement seat belts, not replace them. Seat belts are the occupant's primary restraint system.

Housing Locations

The front airbags are housed in the center of the steering wheel for the driver, and in the dashboard for the front passenger. Both airbags are marked **SRS AIRBAG**.

Types of Airbags

The airbags can inflate whenever the power mode is in ON.

After an airbag inflates in a crash, you may see a small amount of smoke. This is from the combustion process of the inflator material and is not harmful. People with respiratory problems may experience some temporary discomfort. If this occurs, get out of the vehicle as soon as it is safe to do so.

Front Airbags (SRS)

During a frontal crash severe enough to cause one or both front airbags to deploy, the airbags can inflate at different rates, depending on the severity of the crash, whether or not the seat belts are latched, and/or other factors. Frontal airbags are designed to supplement the seat belts to help reduce the likelihood of head and chest injuries in frontal crashes.



Continued

■ Operation

Front airbags are designed to inflate during moderate-to-severe frontal collisions. When the vehicle decelerates suddenly, the sensors send information to the control unit which signals one or both front airbags to inflate.

A frontal collision can be either head-on or angled between two vehicles, or when a vehicle crashes into a stationary object, such as a concrete wall.

■ How the Front Airbags Work

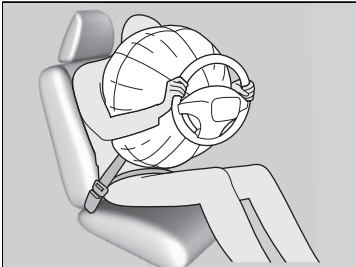

While your seat belt restrains your torso, the front airbag provides supplemental protection for your head and chest.

The front airbags deflate immediately so that they won't interfere with the driver's visibility or the ability to steer or operate other controls.

The total time for inflation and deflation is so fast that most occupants are not aware that the airbags deployed until they see them lying in front of them.

☒ How the Front Airbags Work

Although the driver's and front passenger's airbags normally inflate within a split second of each other, it is possible for only one airbag to deploy. This can happen if the severity of a collision is at the margin, or threshold that determines whether or not the airbags will deploy. In such cases, the seat belt will provide sufficient protection, and the supplemental protection offered by the airbag would be minimal.

■ When front airbags should not deploy

Minor frontal crashes: Front airbags were designed to supplement seat belts and help save lives, not to prevent minor scrapes, or even broken bones that might occur during a less than moderate-to-severe frontal crash.

Side impacts: Front airbags can provide protection when a sudden deceleration causes a driver or front passenger to move towards the front of the vehicle. Side airbags and side curtain airbags have been specifically designed to help reduce the severity of injuries that can occur during a moderate-to-severe side impact which can cause the driver or passenger to move towards the side of the vehicle.

Rear impacts: Head restraints and seat belts are your best protection during a rear impact. Front airbags cannot provide any significant protection and are not designed to deploy in such collisions.

Rollovers: In a rollover, your best form of protection is a seat belt or, if your vehicle is equipped with a rollover sensor, both a seat belt and a side curtain airbag. Front airbags, however, are not designed to deploy in a rollover as they would provide little if any protection.

■ When front airbags deploy with little or no visible damage

Because the airbag system senses sudden deceleration, a strong impact to the vehicle framework or suspension might cause one or more of the airbags to deploy. Examples include running into a curb, the edge of a hole, or other low fixed object that causes a sudden deceleration in the vehicle chassis. Since the impact is underneath the vehicle, damage may not be readily apparent.

■ When front airbags may not deploy, even though exterior damage appears severe

Since crushable body parts absorb crash energy during an impact, the amount of visible damage does not always indicate proper airbag operation. In fact, some collisions can result in severe damage but no airbag deployment because the airbags would not have been needed or would not have provided protection even if they had deployed.



Continued

Advanced Airbags

The airbags have advanced features to help reduce the likelihood of airbag related injuries to smaller occupants.

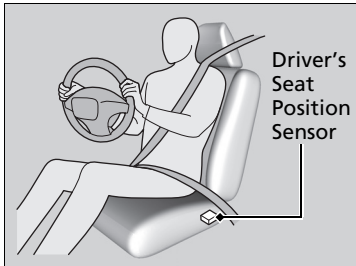

The driver's advanced airbag system includes a seat position sensor.

Based on information from this sensor and the severity of the impact, the advanced airbag system determines the optimal deployment of the driver's airbag.

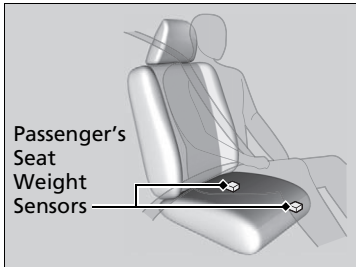

The front passenger's advanced airbag system has weight sensors.

We advise against allowing a child age 12 or under to ride in the front passenger's seat. However, ***if you do allow a child age 12 or under to ride in the front passenger's seat***, note that the system will automatically turn off the front passenger's airbag if the sensors detect that the child is approximately 65 lbs (29 kg) or less.

Advanced Airbags

If there is a problem with the driver's seat position sensor, the SRS indicator will come on, and in the event of a crash, the airbag will deploy (regardless of the driver's seating position) with a force corresponding to the severity of the impact.

For the advanced airbags to work properly:

- Do not spill any liquid on or under the seats.
- Do not put any object under the passenger's seat.
- Make sure any objects are positioned properly on the floor. Improperly positioned objects can interfere with the advanced airbag sensors.
- All occupants should sit upright and wear their seat belts properly.
- Do not cover the passenger's side dashboard with a cloth, towel, cover, etc.

▶ **Passenger Front Airbag Off Indicator** P. 65

Make sure the floor mat behind the front passenger's seat is hooked to the floor mat anchor. An improperly placed mat can interfere with the advanced airbag sensors.

▶ **Floor Mats** P. 489

Driver's Knee Airbag

The driver's knee SRS airbag inflates in a moderate-to-severe frontal collision to help keep the driver in the proper position and to help maximize the benefit provided by the vehicle's other safety features.

SRS (Supplemental Restraint System) indicates that the airbag is designed to supplement seat belts, not replace them. Seat belts are the occupant's primary restraint system.

Housing Locations

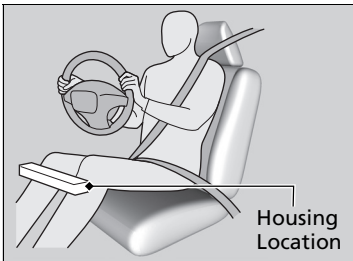

The driver's knee airbag is housed under the steering column.

The airbag is marked **SRS AIRBAG**.

Operation

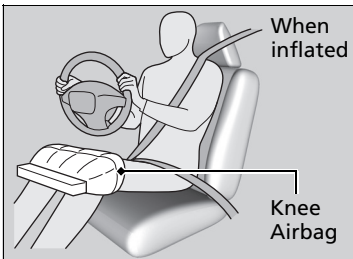

When the driver's front airbag inflates, the driver's knee airbag also inflates.

Even if the collision is not severe enough to deploy the front airbag, the knee airbag may inflate alone.



Continued

Driver's Knee Airbag

Do not attach accessories on or near the driver's knee airbag. They can interfere with the proper operation of the airbag, or hurt someone if an airbag inflates.

The driver should not store any items under the seat or behind their feet. The items can interfere with proper airbag deployment in the event of a moderate to severe frontal collision and may result in inadequate protection.

■ **When driver's knee airbag deploys with little or no visible damage**

Because the airbag system senses sudden deceleration, a strong impact to the vehicle framework or suspension might cause one or more of the airbags to deploy. Examples include running into a curb, the edge of a hole, or other low fixed object that causes a sudden deceleration in the vehicle chassis. Since the impact is underneath the vehicle, damage may not be readily apparent.

■ **When driver's knee airbag may not deploy, even though exterior damage appears severe**

Since crushable body parts absorb crash energy during an impact, the amount of visible damage does not always indicate proper airbag operation. In fact, some collisions can result in severe damage but no airbag deployment because the airbags would not have been needed or would not have provided protection even if they had deployed.



Side Airbags

The side airbags help protect the torso and pelvis of the driver or a front passenger during a moderate-to-severe side impact.

Housing Locations

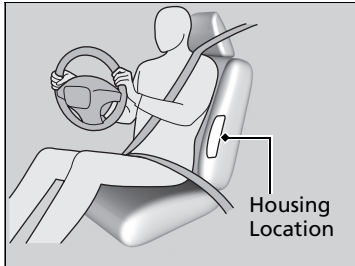

The side airbags are housed in the outside edge of the driver's and passenger's seat-backs.

Both are marked **SIDE AIRBAG**.

Operation

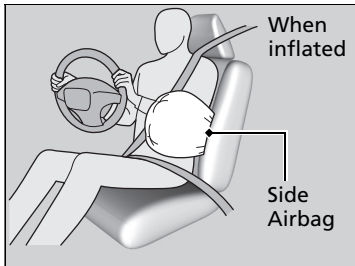

When the sensors detect a moderate-to-severe side impact, the control unit signals the side airbag on the impact side to immediately inflate.

Side Airbags

Make sure you and your front seat passenger always sit upright. Leaning into the path of a side airbag can prevent the airbag from deploying properly and increases your risk of serious injury.

Do not attach accessories on or near the side airbags. They can interfere with the proper operation of the airbags, or hurt someone if an airbag inflates.

Do not cover or replace the front seat-back covers without consulting an authorized Honda Clarity Electric dealer.

Improperly replacing or covering front seat-back covers can prevent your side airbags from properly deploying during a side impact.



Continued

■ **When a side airbag deploys with little or no visible damage**

Because the airbag system senses sudden acceleration, a strong impact to the side of the vehicle's framework can cause a side airbag to deploy. In such cases, there may be little or no damage, but the side impact sensors detected a severe enough impact to deploy the airbag.

■ **When a side airbag may not deploy, even though visible damage appears severe**

It is possible for a side airbag to not deploy during an impact that results in apparently severe damage. This can occur when the point of impact was toward the far front or rear of the vehicle, or when the vehicle's crushable body parts absorbed most of the crash energy. In either case, the side airbag would not have been needed nor provided protection even if it had deployed.



Side Curtain Airbags

The side curtain airbags help protect the heads of the driver and passengers in the outer seating positions during a moderate-to-severe side impact. The side curtain airbags equipped in this vehicle are also designed to help reduce the likelihood of partial and complete ejection of vehicle occupants through side windows in crashes, particularly rollover crashes.

■ Housing Locations

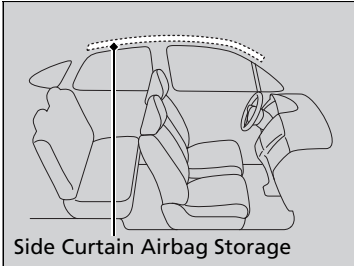

Side Curtain Airbag Storage

The side curtain airbags are located in the ceiling above the side windows on both sides of the vehicle.

■ Operation

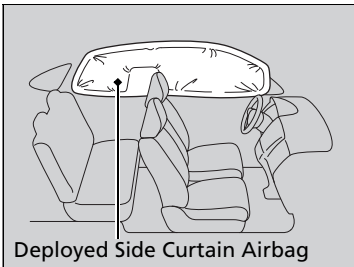

Deployed Side Curtain Airbag

The side curtain airbag is designed to deploy in a rollover or a moderate-to-severe side impact.

▶ Side Curtain Airbags

If the SRS control unit senses that your vehicle is about to rollover, it immediately deploys both side curtain airbags and activates both front seat belt tensioners.

If the impact is on the passenger's side, the passenger's side curtain airbag deploys even if there are no occupants on that side of the vehicle.

To get the best protection from the side curtain airbags, occupants should wear their seat belts properly and sit upright and well back in their seats.

Do not attach any objects to the side windows or roof pillars as they can interfere with the proper operation of the side curtain airbags.



Continued

■ **When side curtain airbags deploy in a frontal collision**

One or both side curtain airbags may also inflate in a moderate-to-severe angled frontal collision.

Airbag System Indicators

If a problem occurs in the airbag system, the SRS indicator will come on and a message appears on the driver information interface.

■ Supplemental Restraint System (SRS) Indicator



■ **When the power mode is set to ON**

The indicator comes on for a few seconds, then goes off. This tells you the system is working properly.

If the indicator comes on at any other time, or does not come on at all, have the system checked by an authorized Honda Clarity Electric dealer as soon as possible. If you don't, your airbags and seat belt tensioners may not work properly when they are needed.

⌘ Supplemental Restraint System (SRS) Indicator

⚠ WARNING

Ignoring the SRS indicator can result in serious injury or death if the airbag systems or tensioners do not work properly.

Have your vehicle checked by an authorized Honda Clarity Electric dealer as soon as possible if the SRS indicator alerts you to a possible problem.



Passenger Front Airbag Off Indicator

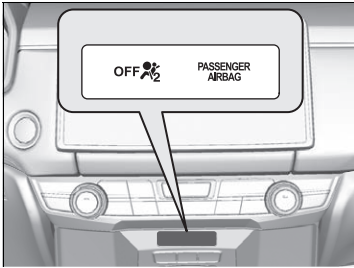

■ When the passenger front airbag off indicator comes on

The indicator comes on to alert you that the passenger's front airbag has been turned off.

This occurs when the weight sensors detect about 65 lbs (29 kg) or less, the weight of an infant or small child, on the seat.

Children age 12 or under should always ride properly restrained in a back seat.

📄 **Child Safety** P. 67

If the front passenger's seat is empty, the passenger's front airbag will not deploy and the indicator will come on.

📄 Passenger Front Airbag Off Indicator

To ensure the passenger is detected properly, confirm that:

- There is no child seat or other object pressing against the rear of the seat-back.
- There is no rear passenger pushing or pulling on the back of the front passenger's seat.
- The front seat or seat-back is not forced back against an object on the seat or floor behind it.
- There is no object placed under or beside the front passenger's seat.
- The occupant is sitting in an upright position and the seat back is not excessively reclined.
- The occupant is not leaning against the door or center console.
- The occupant's feet are placed on the floor in front of them.
- There are no objects hanging from the front passenger's seat.
- Only small, lightweight objects are in the seat-back pocket.

The passenger front airbag off indicator may come on and go off periodically if the total weight on the seat is near the airbag cutoff threshold.

Have your vehicle checked by an authorized Honda Clarity Electric dealer as soon as possible if:

- All of the above conditions are met, and the indicator comes on with an adult seated in the front passenger seat.
- The seat is empty and the indicator is off.

Do not allow an adult passenger to ride in the front seat when the indicator is on.

Airbag Care

You do not need to, and should not, perform any maintenance on or replace any airbag system components yourself. However, you should have your vehicle inspected by an authorized Honda Clarity Electric dealer in the following situations:

■ When the airbags have deployed

If an airbag has inflated, the control unit and other related parts must be replaced. Similarly, once an automatic seat belt tensioner has been activated, it must be replaced.

■ When the vehicle has been in a moderate-to-severe collision

Even if the airbags did not inflate, have your authorized Honda Clarity Electric dealer inspect the following: the driver's seat position sensor, weight sensors in the passenger's seat, front seat belt tensioners, and each seat belt that was worn during the crash.

■ Do not remove or modify a front seat without consulting an authorized Honda Clarity Electric dealer

This would likely disable or affect the proper operation of the driver's seat position sensor or the weight sensors in the passenger's seat. If it is necessary to remove or modify a front seat to accommodate a person with disabilities, contact an authorized Honda Clarity Electric dealer, or American Honda Automobile Customer Service at 1-800-999-1009.

✎ Airbag Care

We recommend against the use of salvaged airbag system components, including the airbag, tensioners, sensors, and control unit.



Protecting Child Passengers

Each year, many children are injured or killed in vehicle crashes because they are either unrestrained or not properly restrained. In fact, vehicle crashes are the number one cause of death of children ages 12 and under.

To reduce the number of child deaths and injuries, every state and territory requires that infants and children be properly restrained when they ride in a vehicle.

Children should sit properly restrained in a rear seat. This is because:

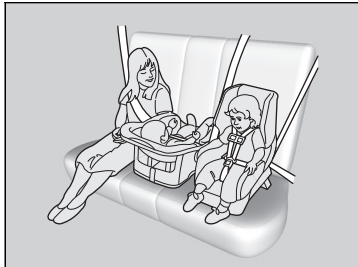

- An inflating front or side airbag can injure or kill a child sitting in the front seat.
- A child in the front seat is more likely to interfere with the driver's ability to safely control the vehicle.
- Statistics show that children of all sizes and ages are safer when they are properly restrained in a rear seat.

Protecting Child Passengers

⚠ WARNING

Children who are unrestrained or improperly restrained can be seriously injured or killed in a crash.

Any child too small for a seat belt should be properly restrained in a child seat. A larger child should be properly restrained with a seat belt, using a booster seat if necessary.

The National Highway Traffic Safety Administration recommend that all children ages 12 and under be properly restrained in a rear seat. Some states or territories have laws restricting where children may ride.

- Any child who is too small to wear a seat belt correctly must be restrained in an approved child seat that is properly secured to the vehicle using either the seat belt or the lower anchors of the LATCH system.
- Never hold a child on your lap because it is impossible to protect them in the event of a collision.
- Never put a seat belt over yourself and a child. During a crash, the belt would likely press deep into the child and cause serious or fatal injuries.
- Never let two children use the same seat belt. Both children could be very seriously injured in a crash.
- Do not allow children to operate the doors, windows or seat adjustments.
- Do not leave children in the vehicle unattended, especially in hot weather when the inside of the vehicle can get hot enough to kill them. They could also activate vehicle controls causing it to move unexpectedly.

► Protecting Child Passengers

⚠ WARNING

Allowing a child to play with a seat belt or wrap one around their neck can result in serious injury or death.

Instruct children not to play with any seat belt and make sure any unused seat belt a child can reach is buckled, fully retracted, and locked.

To deactivate a lockable retractor, release the buckle and allow the seat belt to wind up all the way.

To remind you of the passenger's front airbag hazards and child safety, your vehicle has warning labels on the dashboard (U.S. models) and on the front visors. Please read and follow the instructions on these labels.

► **Safety Labels** P. 80



Safety of Infants and Small Children

■ Protecting Infants

An infant must be properly restrained in a rear-facing, reclining child seat until the infant reaches the seat manufacturer's weight or height limit for the seat, and the infant is at least one year old.

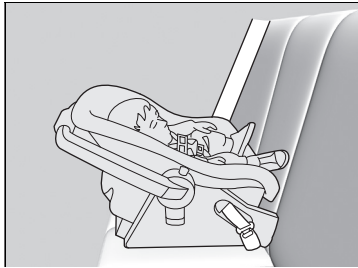

■ Positioning a rear-facing child seat

Child seats must be placed and secured in a rear seating position.

When properly installed, a rear-facing child seat may prevent the driver or a front passenger from moving their seat all the way back, or from locking their seat-back in the desired position. Make sure that there is no contact between the child seat and the seat in front of it.

It can also interfere with proper operation of the passenger's advanced front airbag system.

▶ **Airbags** P. 52

If this occurs, we recommend that you install the child seat directly behind the front passenger's seat, move the seat as far forward as needed, and leave it unoccupied. Or, you may wish to get a smaller rear-facing child seat.



Continued

▶▶ Protecting Infants

⚠ WARNING

Placing a rear-facing child seat in the front seat can result in serious injury or death during a crash.

Always place a rear-facing child seat in the rear seat, not the front.

Many experts recommend use of a rear-facing seat for a child up to two years old if the child's height and weight are appropriate for a rear-facing seat.

Rear-facing child seats should never be installed in a forward facing position.

Always refer to the child seat manufacturer's instructions before installation.

Do not allow a front seat to rest against a child seat installed in a rear seating position:
The weight sensor in the front seat may not correctly detect the actual weight of the occupant.

■ Protecting Smaller Children

If a child is at least one year old and has exceeded the weight and height limitations of a rearward facing child seat, the child should be properly restrained in a firmly secured forward facing child seat until they exceed the weight and height limitations for the forward facing child seat.

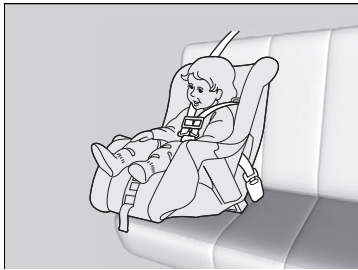

■ Forward-facing child seat placement

We strongly recommend placing a forward-facing child seat in a rear seating position.

Placing a forward-facing child seat in the front seat can be hazardous, even with advanced front airbags that automatically turn the passenger's front airbag off. A rear seat is the safest place for a child.

►► Protecting Smaller Children

⚠ WARNING

Placing a forward-facing child seat in the front seat can result in serious injury or death if the front airbag inflates.

If you must place a forward-facing child seat in front, move the vehicle seat as far back as possible, and properly restrain the child.

Educate yourself about the laws and regulations regarding child seat use where you are driving, and follow the child seat manufacturer's instructions.

■ Selecting a Child Seat

Most child seats are LATCH-compatible (Lower Anchors and Tethers for CHildren). Some have a rigid-type connector while others have a flexible-type connector. Both are equally easy to use. Some existing and previously owned child seats can only be installed using the seat belt. Whichever type you choose, follow the child seat manufacturer's use and care instructions including recommended expiration dates as well as the instructions in this manual. Proper installation is key to maximizing your child's safety.

In seating positions and vehicles not equipped with LATCH, a LATCH-compatible child seat can be installed using the seat belt and a top tether for added security. This is because all child seats are required to be designed so that they can be secured with a lap belt or the lap part of a lap/shoulder belt. In addition, the child seat manufacturer may advise that a seat belt be used to attach a LATCH-compatible seat once a child reaches a specified weight. Please read the child seat owner's manual for proper installation instructions.

■ Important consideration when selecting a child seat

Make sure the child seat meets the following three requirements:

- The child seat is the correct type and size for the child.
- The child seat is the correct type for the seating position.
- The child seat is compliant with Federal Motor Vehicle Safety Standard 213.

▶▶ Selecting a Child Seat

Installation of a LATCH-compatible child seat is simple.

LATCH-compatible child seats have been developed to simplify the installation process and reduce the likelihood of injuries caused by incorrect installation.



Continued

■ Installing a LATCH-Compatible Child Seat

A LATCH-compatible child seat can be installed in either of the two outer rear seats. A child seat is attached to the lower anchors with either the rigid or flexible type of connectors.

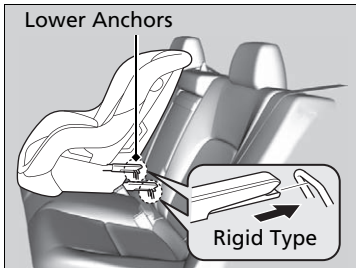
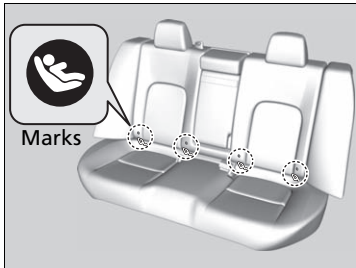

1. Locate the lower anchors under the marks.

2. Place the child seat on the vehicle seat, then attach the child seat to the lower anchors according to the instructions that came with the child seat.

► When installing the child seat, make sure that the lower anchors are not obstructed by the seat belt or any other object.

►► Installing a LATCH-Compatible Child Seat

⚠ WARNING

Never attach two child seats to the same anchor. In a collision, one anchor may not be strong enough to hold two child seat attachments and may break, causing serious injury or death.

For your child's safety, when using a child seat installed using the LATCH system, make sure that the child seat is properly secured to the vehicle. A child seat that is not properly secured will not adequately protect a child in a crash and may cause injury to the child or other vehicle occupants.

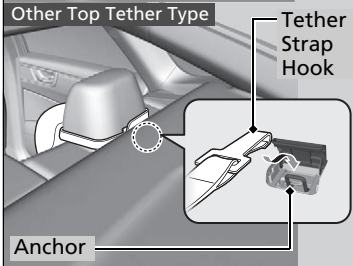
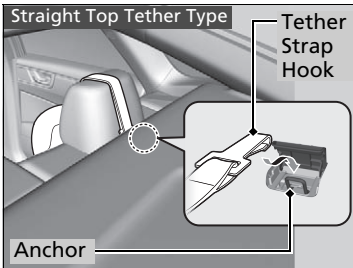
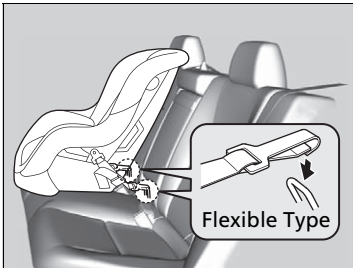

3. Open the tether anchor cover behind the head restraint.

4. Straight Top Tether Type

Route the tether strap over the top of the head restraint and secure the tether strap hook to the anchor.

Other Top Tether Type

Route the tether strap around the head restraint and secure the tether strap hook to the anchor.

5. Tighten the tether strap as instructed by the child seat manufacturer.

6. Make sure the child seat is firmly secured by rocking it forward and back and side to side; little movement should be felt.

7. Make sure any unused seat belt that a child can reach is buckled, the lockable retractor is activated, and the belt is fully retracted and locked.



Continued

▶▶ Installing a LATCH-Compatible Child Seat

⚠ WARNING

Do not use the lower inner anchors of the outer rear seats to secure a LATCH-compatible child seat to the rear center seat, unless the manufacturer's instructions for that system permit the use of inner anchors with the stated spacing.

Installing a LATCH-compatible child seat in the rear center seat

Each outer rear seat is equipped with a pair of lower anchors which are used to secure a LATCH-compatible child seat. The rear center seat, however, is not equipped with anchors of any kind.

The inner and outer anchors are spaced apart at a standard distance of 11 inches (280 mm). The distance between the two inner anchors is 15.7 inches (400 mm).

LATCH-compatible restraint systems that are fitted with rigid-type attachments cannot be installed in the rear center seat. However, a system fitted with flexible-type attachments can be installed in the center seat, provided that the manufacturer's instructions for that system permit the use of the inner anchors with the stated spacing.

Before seating a child, make sure that the system is properly attached to both the lower anchors and tether anchors.

■ Installing a Child Seat with a Lap/Shoulder Seat Belt

A child seat can be installed with a lap/shoulder belt in any rear seat or, if absolutely necessary, the front passenger seat.

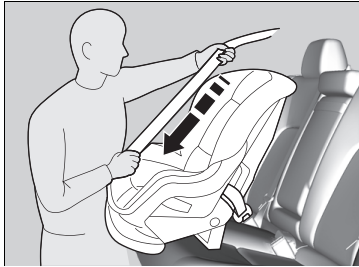
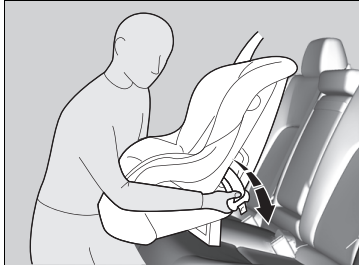

1. Place the child seat on the vehicle seat.
2. Route the seat belt through the child seat according to the seat manufacturer's instructions, and insert the latch plate into the buckle.
 - Insert the latch plate fully until it clicks.
3. Slowly pull the shoulder part of the belt all the way out until it stops. This activates the lockable retractor.
4. Let the seat belt retract a few inches and check that the retractor has switched modes by pulling on the webbing. It should not pull out again until it is reset by removing the latch plate from the buckle.
 - If you are able to pull the shoulder belt out, the lockable retractor is not activated. Slowly pull the seat belt all the way out, and repeat steps 3 – 4.

▣ Installing a Child Seat with a Lap/Shoulder Seat Belt

A child seat that is not properly secured will not adequately protect a child in a crash and may cause injury to the child or other vehicle occupants.



5. Grab the shoulder part of the seat belt near the buckle, and pull up to remove any slack from the lap part of the belt.

▶ When doing this, place your weight on the child seat and push it into the vehicle seat.

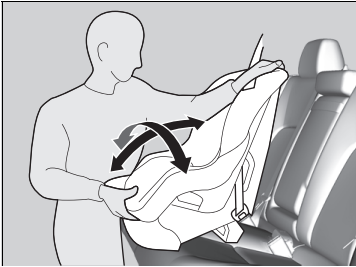

6. Make sure the child seat is firmly secured by rocking it forward and back and side to side; less than one inch of movement should occur near the seat belt.

7. Make sure any unused seat belt that a child can reach is buckled, the lockable retractor is activated, and the belt is fully retracted and locked.

▶▶ Installing a Child Seat with a Lap/Shoulder Seat Belt

To deactivate a lockable retractor, release the buckle and allow the seat belt to wind up all the way.



Continued

■ Adding Security with a Tether

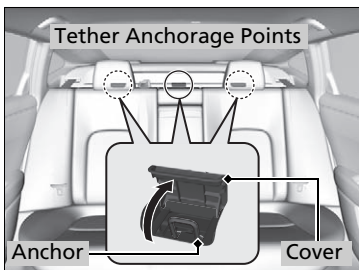

A tether anchorage point is provided behind each rear seating position. If you have a child restraint system that comes with a tether but can be installed with a seat belt, the tether may be used for additional security.

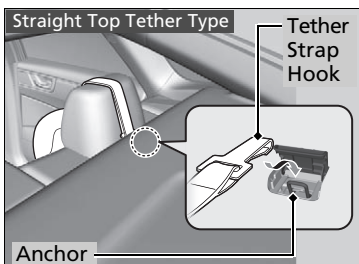

■ Using an outer anchor

1. Locate the appropriate tether anchorage point and lift the cover.

2. Straight Top Tether Type

Route the tether strap over the head restraint. Make sure the strap is not twisted.

Other Top Tether Type

Route the tether strap around the head restraint. Make sure the strap is not twisted.

3. Secure the tether strap hook to the anchor.

4. Tighten the tether strap as instructed by the child seat manufacturer.

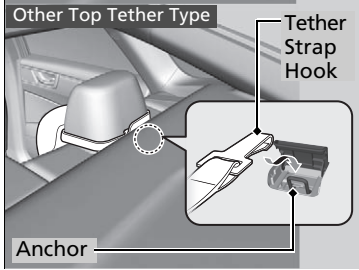

►► Adding Security with a Tether

Always use a tether for forward facing child seats when using the seat belt or lower anchors.



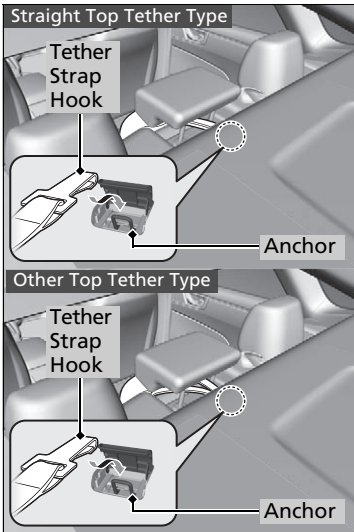

■ Using the center anchor

1. Locate the appropriate tether anchorage point and lift the cover.
2. Raise the head restraint to its highest position, then route the tether strap through the head restraint legs. Make sure the strap is not twisted.
3. Secure the tether strap hook to the anchor.
4. Tighten the tether strap as instructed by the child seat manufacturer.

Safety of Larger Children

■ Protecting Larger Children

The following pages give instructions on how to check proper seat belt fit, what kind of booster seat to use if one is needed, and important precautions for a child who must sit in front.

■ Checking Seat Belt Fit

When a child is too big for a child seat, secure the child in a rear seat using the lap/shoulder seat belt. Have the child sit upright and all the way back, then answer the following questions.



■ Checklist

- Do the child's knees bend comfortably over the edge of the seat?
- Does the shoulder belt cross between the child's neck and arm?
- Is the lap part of the seat belt as low as possible, touching the child's thighs?
- Will the child be able to stay seated like this for the whole trip?

If you answer yes to all these questions, the child is ready to wear the lap/shoulder seat belt correctly. If you answer no to any question, the child needs to ride on a booster seat until the seat belt fits properly without a booster seat.

▶ Safety of Larger Children

⚠ WARNING

Allowing a child age 12 or under to sit in front can result in injury or death if the passenger's front airbag inflates.

If a larger child must ride in front, move the vehicle seat as far to the rear as possible, have the child sit up properly and wear the seat belt properly, using a booster seat if needed.

Booster Seats



If a lap/shoulder seat belt cannot be used properly, position the child in a booster seat in the rear seat. For the child's safety, check that the child meets the booster seat manufacturer's recommendations.

Protecting Larger Children-Final Checks

Your vehicle has a rear seat where children can be properly restrained. If you ever have to carry a group of children, and a child must ride in front:

- Make sure you read and fully understand the instructions and safety information in this manual.
- Move the front passenger seat as far back as possible.
- Have the child sit upright and well back in the seat.
- Check that the seat belt is properly positioned so that the child is secure in the seat.

Monitoring child passengers

We strongly recommend that you keep an eye on child passengers. Even older, more mature children sometimes need to be reminded to fasten their seat belts and sit up properly.



Booster Seats

When installing a booster seat, make sure to read the instructions that came with it, and install the seat accordingly.

There are high- and low-type booster seats. Choose a booster seat that allows the child to wear the seat belt correctly.

Some U.S. states require children to use a booster seat until they reach a given age or weight (e.g. 6 years or 60 lbs). Be sure to check current laws in the state where you intend to drive.

Label Locations

These labels are in the locations shown. They warn you of potential hazards that can cause serious injury or death. Read these labels carefully.

If a label comes off or becomes hard to read (except for the U.S. dashboard label which may be removed by the owner), contact an authorized Honda Clarity Electric dealer for a replacement.

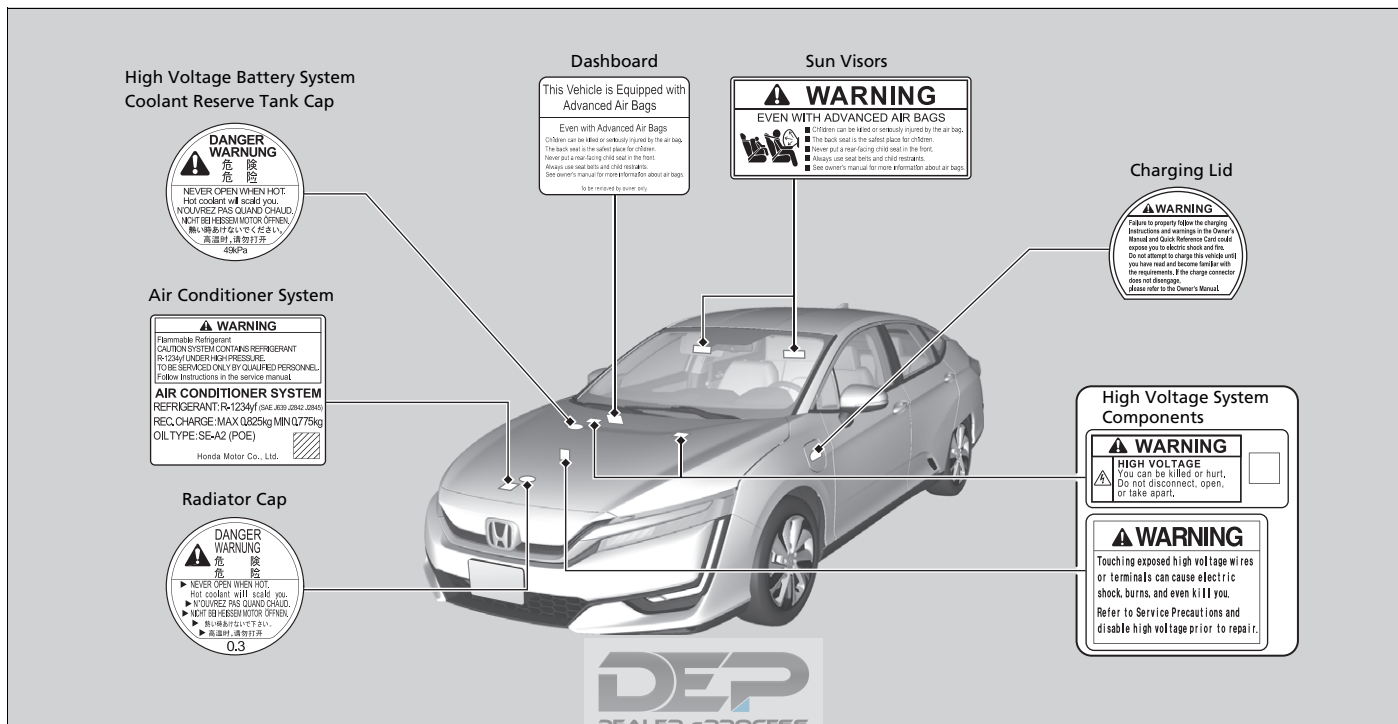





Instrument Panel

This chapter describes the buttons, indicators, and gauges that are used while driving.

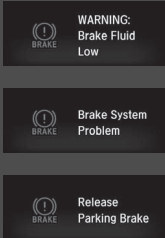

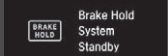

Indicators	82
Driver Information Interface Warning and Information Messages	100
Gauges and Driver Information Interface	116
Gauges	116
Driver Information Interface	120

Indicator	Name	On/Blinking	Explanation	Message
BRAKE	Parking Brake and Brake System Indicator (Red)	<ul style="list-style-type: none"> • Comes on for a few seconds when you set the power mode to ON, then goes off if the parking brake has been released. • Comes on when the parking brake is applied, and goes off when it is released. • Comes on when the brake fluid level is low. • Comes on if there is a problem with the brake system. • The beeper sounds and the indicator comes on if you drive with the parking brake not fully released. 	<ul style="list-style-type: none"> • Comes on while driving - Make sure the parking brake is released. Check the brake fluid level. <ul style="list-style-type: none"> ➤ What to do when the indicator comes on while driving P. 519 • Comes on along with the parking brake and brake system indicator (amber) - Immediately stop in a safe place. Contact an authorized Honda Clarity Electric dealer for repair. The brake pedal becomes harder to operate. Depress the pedal further than you normally do. • Comes on along with the ABS indicator - Have your vehicle checked by an authorized Honda Clarity Electric dealer. <ul style="list-style-type: none"> ➤ If the Brake System Indicator (Red) Comes On or Blinks P. 519 	



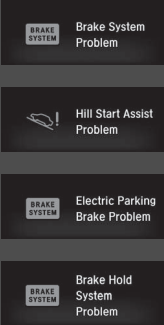

Indicator	Name	On/Blinking	Explanation	Message
	Parking Brake and Brake System Indicator (Red)	<ul style="list-style-type: none"> • Comes on for about 15 seconds when you push the electric parking brake switch while the power mode is in VEHICLE OFF. • Stays on for about 15 seconds when you set the power mode to VEHICLE OFF while the electric parking brake is set. 	<ul style="list-style-type: none"> • Blinks and the parking brake and brake system indicator (amber) comes on at the same time - There is a problem with the electric parking brake system. The parking brake may not be set. Avoid using the parking brake and have your vehicle checked by an authorized Honda Clarity Electric dealer immediately. <ul style="list-style-type: none"> ▶ If the Brake System Indicator (Red) Comes On or Blinks at the Same Time When the Brake System Indicator (Amber) Comes On P. 521 	—
	Automatic Brake Hold System Indicator	<ul style="list-style-type: none"> • Comes on for a few seconds when you set the power mode to ON, then goes off. • Comes on when the automatic brake hold system is on. 	<ul style="list-style-type: none"> ▶ Automatic Brake Hold P. 424 	
	Automatic Brake Hold Indicator	<ul style="list-style-type: none"> • Comes on for a few seconds when you set the power mode to ON, then goes off. • Comes on when the automatic brake hold is activated. 	<ul style="list-style-type: none"> ▶ Automatic Brake Hold P. 424 	—

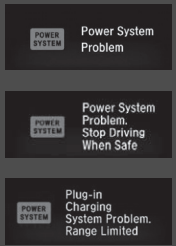



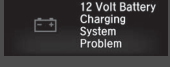

Indicator	Name	On/Blinking	Explanation	Message
	Parking Brake and Brake System Indicator (Amber)	<ul style="list-style-type: none"> • Comes on for a few seconds when you set the power mode to ON, then goes off. • Comes on if there is a problem with a system related to braking other than the conventional brake system. • Comes on if there is a problem with the cooperative control with regenerative braking, the electric servo brake system, or the hill start assist system. • Comes on if there is a problem with the electric parking brake system or the automatic brake hold system. 	<ul style="list-style-type: none"> • Comes on while driving - Avoid using the parking brake and have your vehicle checked by an authorized Honda Clarity Electric dealer immediately. • Stays on constantly - Avoid high speeds and sudden braking. Take the vehicle to an authorized Honda Clarity Electric dealer immediately. • With this indicator on, your vehicle still has normal braking ability. 	



Indicator	Name	On/Blinking	Explanation	Message
	<p>POWER SYSTEM Indicator</p>	<ul style="list-style-type: none"> • Comes on for a few seconds when you set the power mode to ON, then goes off. • Comes on if there is a problem with the electric vehicle system or plug-in charging system. 	<ul style="list-style-type: none"> • Comes on while driving - Have your vehicle checked by an authorized Honda Clarity Electric dealer. • Comes on when you set the power mode to ON after having charged your vehicle - Have your vehicle checked by an authorized Honda Clarity Electric dealer. 	







Indicator	Name	On/Blinking	Explanation	Message
	READY Indicator	<ul style="list-style-type: none"> Comes on when the vehicle is ready to drive. 	<ul style="list-style-type: none"> May go off if the POWER SYSTEM or transmission system indicator comes on. <ul style="list-style-type: none"> ☒ Turning on the Power P. 366 	
	12-Volt Battery Charging System Indicator	<ul style="list-style-type: none"> Comes on when you set the power mode to ON, and goes off when the power system is on. Comes on when the 12-volt battery is not charging. 	<ul style="list-style-type: none"> Comes on while driving - Turn off the climate control system and rear defogger in order to reduce electricity consumption. <ul style="list-style-type: none"> ☒ If the 12-Volt Battery Charging System Indicator Comes On P. 518 	
	Low Charge Indicator	<ul style="list-style-type: none"> Comes on when the high voltage battery is running low. 	<ul style="list-style-type: none"> Comes on - There is a decrease in acceleration performance. Recharge the high voltage battery as soon as possible. 	



Indicator	Name	On/Blinking	Explanation	Message
	Gear Position Indicator	<ul style="list-style-type: none"> Indicates the current gear selection. 	<p>➤ Shifting P. 371</p>	—
	Transmission System Indicator	<ul style="list-style-type: none"> All the gear positions comes on for a few seconds when you set the power mode to ON, then goes off. 	—	—
		<ul style="list-style-type: none"> The indicated current gear selection blinks if there is a problem with the transmission system. 	<ul style="list-style-type: none"> Avoid sudden start and acceleration, and stop in a safe place immediately. Have your vehicle checked by an authorized Honda Clarity Electric dealer. 	
		<ul style="list-style-type: none"> The indicated current gear selection or all the gear positions blink if you cannot select P due to a transmission system failure. 	<ul style="list-style-type: none"> The power system can be activated as a temporary measure. ➤ If the Transmission System Indicator Blinks along with the Warning Message P. 523 Set the parking brake when parking. Have your vehicle checked by an authorized Honda Clarity Electric dealer immediately. 	



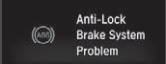



Indicator	Name	On/Blinking	Explanation	Message
	Deceleration Paddle Selector Indicator	<ul style="list-style-type: none"> • Comes on when the paddle selector is pulled. • Blinks when deceleration does not occur while pulling the paddle selector. • Comes on with M when SPORT mode is selected and pulling the paddle selector. 	 Deceleration Paddle Selector P. 379	—

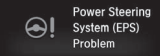

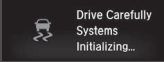

Indicator	Name	On/Blinking	Explanation	Message
	Seat Belt Reminder Indicator	<ul style="list-style-type: none"> • Comes on and the beeper sounds if you are not wearing a seat belt when you set the power mode to ON. • If the front passenger is not wearing a seat belt, the indicator comes on a few seconds later. • Blinks while driving if either you and/or the front passenger has not fastened a seat belt. The beeper sounds and the indicator blinks at regular intervals. 	<ul style="list-style-type: none"> • The beeper stops and the indicator goes off when the driver or the driver and the front passenger fasten their seat belts. • Stays on after you and/or the front passenger has fastened the seat belt(s) - A detection error may have occurred in the sensor. Have your vehicle checked by an authorized Honda Clarity Electric dealer. <ul style="list-style-type: none"> ▶ Seat Belt Reminder P. 46 	 
	Anti-lock Brake System (ABS) Indicator	<ul style="list-style-type: none"> • Comes on for a few seconds when you set the power mode to ON, then goes off. • If it comes on at any other time, there is a problem with the ABS. 	<ul style="list-style-type: none"> • Stays on constantly - Have your vehicle checked by an authorized Honda Clarity Electric dealer. With this indicator on, your vehicle still has normal braking ability but no anti-lock function. <ul style="list-style-type: none"> ▶ Anti-lock Brake System (ABS) P. 426 	

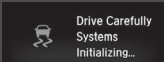





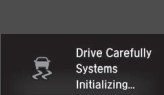

Indicator	Name	On/Blinking	Explanation	Message
	Supplemental Restraint System Indicator	<ul style="list-style-type: none"> • Comes on for a few seconds when you set the power mode to ON, then goes off. • Comes on if a problem with any of the following is detected: <ul style="list-style-type: none"> - Supplemental restraint system - Side airbag system - Side curtain airbag system - Seat belt tensioner 	<ul style="list-style-type: none"> • Stays on constantly or does not come on at all - Have your vehicle checked by an authorized Honda Clarity Electric dealer. 	
	Electric Power Steering (EPS) System Indicator	<ul style="list-style-type: none"> • Comes on when you set the power mode to ON, and goes off when the power system is on. • Comes on if there is a problem with the EPS system. 	<ul style="list-style-type: none"> • Stays on constantly or does not come on at all - Have your vehicle checked by an authorized Honda Clarity Electric dealer. <ul style="list-style-type: none"> ▣ If the Electric Power Steering (EPS) System Indicator Comes On P. 520 	







Indicator	Name	On/Blinking	Explanation	Message
	Vehicle Stability Assist® (VSA®) System Indicator	<ul style="list-style-type: none"> • Comes on for a few seconds when you set the power mode to ON, then goes off. • Blinks when VSA® is active. • Comes on if there is a problem with the VSA® system. 	<ul style="list-style-type: none"> • Stays on constantly - Have your vehicle checked by an authorized Honda Clarity Electric dealer. <ul style="list-style-type: none"> ➤ Vehicle Stability Assist® (VSA®), aka Electronic Stability Control (ESC), System P. 411 	
		<ul style="list-style-type: none"> • Comes on if the VSA® system is deactivated temporarily after the battery has been disconnected, then re-connected. 	<ul style="list-style-type: none"> • Drive a short distance at more than 12 mph (20 km/h). The indicator should go off. If it does not, have your vehicle checked by an authorized Honda Clarity Electric dealer. 	
	Vehicle Stability Assist® (VSA®) OFF Indicator	<ul style="list-style-type: none"> • Comes on for a few seconds when you set the power mode to ON, then goes off. • Comes on when you partially disable VSA®. 	<ul style="list-style-type: none"> ➤ VSA® On and Off P. 412 	
		<ul style="list-style-type: none"> • Comes on if the VSA® system is deactivated temporarily after the battery has been disconnected, then re-connected. 	<ul style="list-style-type: none"> • Drive a short distance at more than 12 mph (20 km/h). The indicator should go off. If it does not, have your vehicle checked by an authorized Honda Clarity Electric dealer. 	



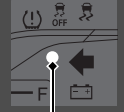



Indicator	Name	On/Blinking	Explanation	Message
	Low Tire Pressure/TPMS Indicator	<ul style="list-style-type: none"> • Comes on for a few seconds when you set the power mode to ON. • May come on briefly if the power mode is set to ON and the vehicle is not moved within 45 seconds, to indicate the calibration process is not yet complete. • Comes on and stays on when: <ul style="list-style-type: none"> - One or more tires' pressures are determined to be significantly low. - The system has not been calibrated. 	<ul style="list-style-type: none"> • Comes on while driving - Stop in a safe place, check tire pressures, and inflate the tire(s) if necessary. • Stays on after the tires are inflated to the recommended pressures - The system needs to be calibrated.  TPMS Calibration P. 414 	
		<ul style="list-style-type: none"> • Blinks for about one minute, and then stays on if there is a problem with the TPMS. 	<ul style="list-style-type: none"> • Blinks and remains on - Have your vehicle checked by an authorized Honda Clarity Electric dealer. 	
		<ul style="list-style-type: none"> • Comes on if the TPMS is deactivated temporarily after the battery has been disconnected, then re-connected. 	<ul style="list-style-type: none"> • Drive a short distance at more than 12 mph (20 km/h). The indicator should go off. If it does not, have your vehicle checked by an authorized Honda Clarity Electric dealer. 	

Indicator	Name	On/Blinking	Explanation	Message
	System Message Indicator	<ul style="list-style-type: none"> Comes on along with a beep when a problem is detected. A system message on the driver information interface appears at the same time. 	<ul style="list-style-type: none"> While the indicator is on, press the  (display/information) button to see the message again. Refer to the Indicators information in this chapter when a system message appears on the driver information interface. Take the appropriate action for the message. The driver information interface does not return to the normal screen unless the warning is canceled, or the  button is pressed. 	—

Indicator	Name	On/Blinking	Explanation	Message
	Turn Signal and Hazard Warning Indicators	<ul style="list-style-type: none"> • Blinks when you operate the turn signal lever. • Blinks along with all turn signals when you press the hazard warning button. 	<ul style="list-style-type: none"> • Does not blink or blinks rapidly - Have your vehicle checked by an authorized Honda Clarity Electric dealer immediately. 	—
	High Beam Indicator	<ul style="list-style-type: none"> • Comes on when the high beam headlights are on. 	—	—
	Lights On Indicator	<ul style="list-style-type: none"> • Comes on when the light switch in a position other than OFF or when the switch is set to AUTO and the exterior lights come on. 	<ul style="list-style-type: none"> • If you set the power mode to ACCESSORY or VEHICLE OFF while the exterior lights are on, a chime sounds when the driver's door is opened. 	—
 Indicator	Immobilizer System Indicator	<ul style="list-style-type: none"> • Blinks if the immobilizer system cannot recognize the key information. 	<ul style="list-style-type: none"> • Blinks - You cannot start the power system. Set the power mode to VEHICLE OFF, then select the ON mode again. • Repeatedly blinks - The system may be malfunctioning. Have your vehicle checked by an authorized Honda Clarity Electric dealer. • Do not attempt to alter this system or add other devices to it. Electrical problems can occur. 	—

Indicator	Name	On/Blinking	Explanation	Message
 <p>Indicator</p>	<p>Security System Alarm Indicator</p>	<ul style="list-style-type: none"> Blinks when the security system alarm has been set. 	<p>➤ Security System Alarm P. 147</p>	
	<p>SPORT Mode Indicator</p>	<ul style="list-style-type: none"> Comes on when you press the SPORT button. 	<p>➤ SPORT Mode P. 378</p>	
	<p>ECON Mode Indicator</p>	<ul style="list-style-type: none"> Comes on when ECON mode is on. 	<p>➤ ECON Mode P. 377</p>	



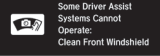

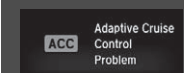
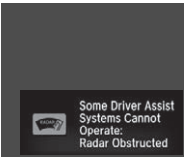
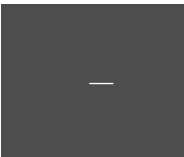

Indicator	Name	On/Blinking	Explanation	Message
	Road Departure Mitigation (RDM) Indicator	<ul style="list-style-type: none"> • Comes on for a few seconds when you set the power mode to ON, then goes off. • Comes on if there is a problem with the RDM system. 	<ul style="list-style-type: none"> • Stays on constantly - Have your vehicle checked by an authorized Honda Clarity Electric dealer. 	
		<ul style="list-style-type: none"> • Comes on when the RDM system shuts itself off. 	<ul style="list-style-type: none"> • Stays on - The temperature inside the camera is too high. Use the climate control system to cool down the camera. The system activates when the temperature inside the camera cools down sufficiently.  Front Sensor Camera P. 383 	
			<ul style="list-style-type: none"> • Stays on - The area around the camera is blocked by dirt, mud, etc. Stop your vehicle in a safe place, and wipe it off with a soft cloth. • Have your vehicle checked by an authorized Honda Clarity Electric dealer if the indicator and message come back on after you cleaned the area around the camera.  Front Sensor Camera P. 383 	



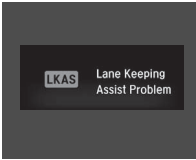

Indicator	Name	On/Blinking	Explanation	Message
ACC	Adaptive Cruise Control (ACC) with Low Speed Follow (LSF) Indicator (Amber)	<ul style="list-style-type: none"> Comes on for a few seconds when you set the power mode to ON, then goes off. Comes on if there is a problem with ACC with LSF. 	<ul style="list-style-type: none"> Comes on while driving - Have your vehicle checked by an authorized Honda Clarity Electric dealer. 	
		<ul style="list-style-type: none"> Comes on if anything covers the radar sensor cover and prevents the sensor from detecting a vehicle in front. May come on when driving in bad weather (rain, snow, fog, etc.) ACC with LSF has been automatically canceled. 	<ul style="list-style-type: none"> When the radar sensor gets dirty, stop your vehicle in a safe place, and then clean the sensor using a soft cloth. Have your vehicle checked by an authorized Honda Clarity Electric dealer if the indicator does not disappear, even after you clean the sensor cover. 	
ACC	Adaptive Cruise Control (ACC) with Low Speed Follow (LSF) Indicator (Green)	<ul style="list-style-type: none"> Comes on when you press the MAIN button. 	<p>➤ Adaptive Cruise Control (ACC) with Low Speed Follow (LSF) P. 389</p>	

Instrument Panel

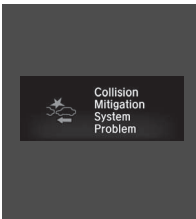
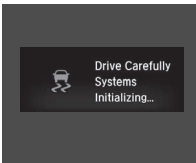

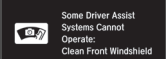





Indicator	Name	On/Blinking	Explanation	Message
	Lane Keeping Assist System (LKAS) Indicator (Amber)	<ul style="list-style-type: none"> Comes on for a few seconds when you set the power mode to ON, then goes off. Comes on if there is a problem with the LKAS. 	<ul style="list-style-type: none"> Stays on constantly - Have your vehicle checked by an authorized Honda Clarity Electric dealer. 	
	Lane Keeping Assist System (LKAS) Indicator (Green)	<ul style="list-style-type: none"> Comes on when you press the MAIN button. 	<ul style="list-style-type: none"> ➤ Lane Keeping Assist System (LKAS) P. 404 	
	Collision Mitigation Braking System™ (CMBS™) Indicator	<ul style="list-style-type: none"> Comes on for a few seconds when you set the power mode to ON, then goes off. Comes on when you deactivate the CMBS™. Comes on if there is a problem with the CMBS™. 	<ul style="list-style-type: none"> Stays on constantly without the CMBS™ off - Have your vehicle checked by an authorized Honda Clarity Electric dealer. <ul style="list-style-type: none"> ➤ Collision Mitigation Braking System™ (CMBS™) P. 428 	
		<ul style="list-style-type: none"> Comes on if the CMBS™ is deactivated temporarily after the battery has been disconnected, then re-connected. 	<ul style="list-style-type: none"> Drive a short distance at more than 12 mph (20 km/h). The indicator should go off. If it does not, have your vehicle checked by an authorized Honda Clarity Electric dealer. 	





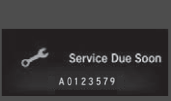

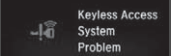
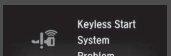
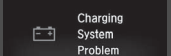
Indicator	Name	On/Blinking	Explanation	Message
	Collision Mitigation Braking System™ (CMBS™) Indicator	<ul style="list-style-type: none"> Comes on when the CMBS™ system shuts itself off. 	<ul style="list-style-type: none"> Stays on - The area around the camera is blocked by dirt, mud, etc. Stop your vehicle in a safe place, and wipe it off with a soft cloth. ➤ Front Sensor Camera P. 383 	
			<ul style="list-style-type: none"> When the radar sensor gets dirty, stop your vehicle in a safe place, and then clean the sensor using a soft cloth. Have your vehicle checked by an authorized Honda Clarity Electric dealer if the message does not disappear even after you clean the sensor cover. ➤ Collision Mitigation Braking System™ (CMBS™) P. 428 	
			<ul style="list-style-type: none"> Stays on - The temperature inside the camera is too high. Use the climate control system to cool down the camera. The system activates when the temperature inside the camera cools down sufficiently. ➤ Front Sensor Camera P. 383 	

Instrument Panel

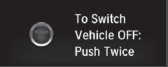

Driver Information Interface Warning and Information Messages

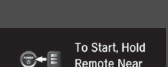

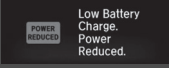
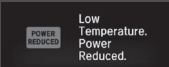

The following messages appear only on the driver information interface. Press the  (display/information) button to see the message again with the system message indicator on.

Message	Condition	Explanation
 Critical Failure Detected. Stop Driving When Safe	<ul style="list-style-type: none"> Appears when the vehicle is no longer able to run due to a malfunction. 	<ul style="list-style-type: none"> Immediately stop in a safe place.
 Service Due Soon A 0123579	<ul style="list-style-type: none"> Appears when the scheduled maintenance is due soon. Consequently, Service Due Now and Service Past Due follow. 	<p> Warning Message and Maintenance Minder Information on the Driver Information Interface P. 462</p>
 Keyless Access System Problem  Keyless Start System Problem	<ul style="list-style-type: none"> Appears as soon as a problem is detected in the smart entry system or push button starting system. 	<ul style="list-style-type: none"> Appears constantly - Have your vehicle checked by an authorized Honda Clarity Electric dealer.
 Charging System Problem	<ul style="list-style-type: none"> Appears when there is a problem with the sensor on the 12-volt battery. Appears along with the battery charging system indicator when the battery is not charging. 	<ul style="list-style-type: none"> Have your vehicle checked by an authorized Honda Clarity Electric dealer.  Checking the 12-Volt Battery P. 484 Turn off the climate control system and rear defogger to reduce electricity consumption.  If the 12-Volt Battery Charging System Indicator Comes On P. 518

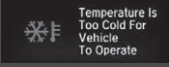

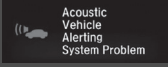
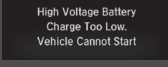

Message	Condition	Explanation
	<ul style="list-style-type: none"> Appears after the driver's door is opened when the power mode is in ACCESSORY. 	<ul style="list-style-type: none"> Press the POWER button twice with your foot off the brake pedal to change the power mode to VEHICLE OFF.
	<ul style="list-style-type: none"> Appears when the power mode is in ACCESSORY. 	—
	<ul style="list-style-type: none"> Appears when you close the door with the power mode in ON without the smart entry remote inside the vehicle. 	<ul style="list-style-type: none"> Disappears when you bring the smart entry remote back inside the vehicle and close the door. <ul style="list-style-type: none"> ► Smart Entry Remote Reminder P. 154
	<ul style="list-style-type: none"> Appears when the smart entry remote battery becomes weak. 	<ul style="list-style-type: none"> Replace the battery as soon as possible. <ul style="list-style-type: none"> ► Replacing the Button Battery P. 486
	<ul style="list-style-type: none"> Appears if the smart entry remote's battery is too weak to turn on the power system or the smart entry remote is not within operating range to turn on the power system. A beeper sounds six times. 	<ul style="list-style-type: none"> Bring the back of the smart entry remote into contact with the POWER button. <ul style="list-style-type: none"> ► If the Smart Entry Remote Battery is Weak P. 512
	<ul style="list-style-type: none"> Appears when you set the power mode to ACCESSORY or ON. 	<ul style="list-style-type: none"> ► Turning on the Power P. 366



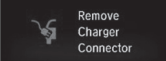

Message	Condition	Explanation
	<ul style="list-style-type: none"> Appears when the power system temperature is high. 	<ul style="list-style-type: none"> Your vehicle has less ability to accelerate and may be harder to start on an incline.
	<ul style="list-style-type: none"> Appears when the high voltage battery charge level is extremely low. 	<ul style="list-style-type: none"> Caused by the low battery charge level - Immediately charge the high voltage battery.
	<ul style="list-style-type: none"> Appears when the power system temperature is low. 	<ul style="list-style-type: none"> Your vehicle has less ability to accelerate and may be harder to start on an incline. In extremely cold climates, keep the vehicle stored in a garage or connect the charging connector. <ul style="list-style-type: none"> ☑ Charge the High Voltage battery using a Level 1, 2 or SAE J1772 DC charger P. 441
	<ul style="list-style-type: none"> Appears when the high voltage battery temperature is too low to operate (approx. -22°F [-30°C] or below). 	<ul style="list-style-type: none"> Charge the high voltage battery.
	<ul style="list-style-type: none"> Appears when the high voltage battery and other system control temperatures are too low to operate (approx. -31°F [-35°C] or below). 	<ul style="list-style-type: none"> You must wait for an increase in the ambient temperature or move the vehicle to a warmer location. Consult an authorized Honda Clarity Electric dealer.

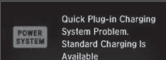
Message	Condition	Explanation
 <p>Hybrid System Problem. Power May Be Reduced.</p>	<ul style="list-style-type: none"> Appears if the power system is in diagnostic mode. 	<ul style="list-style-type: none"> You may notice a decrease in available power. Have your vehicle checked by an authorized Honda Clarity Electric dealer immediately. As a result of diagnostics, the POWER SYSTEM indicator may come on. <ul style="list-style-type: none"> ➤ POWER SYSTEM Indicator P. 85
 <p>12 Volt Battery Charging System Problem. Power Reduced.</p>	<ul style="list-style-type: none"> Appears after the 12-volt battery charging system indicator comes on. 	<ul style="list-style-type: none"> Your vehicle has less ability to accelerate and may be harder to start on an incline. Contact an authorized Honda Clarity Electric dealer immediately.
 <p>Acoustic Vehicle Alerting System Problem</p>	<ul style="list-style-type: none"> Appears if there is a problem with the acoustic vehicle alerting system. 	<ul style="list-style-type: none"> Have your vehicle checked by an authorized Honda Clarity Electric dealer immediately.
 <p>High Voltage Battery Charge Too Low. Vehicle Cannot Start</p>	<ul style="list-style-type: none"> Appears when the high voltage battery is running extremely low. 	<ul style="list-style-type: none"> Charge the high voltage battery. <ul style="list-style-type: none"> ➤ Charge the High Voltage battery using a Level 1, 2 or SAE J1772 DC charger P. 441
 <p>Plug-in Charging System Problem. Range Limited</p>	<ul style="list-style-type: none"> Appears when there is a problem with the standard and quick plug-in charging system or the charging station outlet. 	<ul style="list-style-type: none"> This message only - There may be a problem with the charging station outlet. Refer to the instructions provided at the station or consult a qualified technician. If the outlet works properly, have the vehicle checked by an authorized Honda Clarity Electric dealer. Comes on with the POWER SYSTEM indicator - Have your vehicle checked by an authorized Honda Clarity Electric dealer.



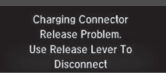

Message	Condition	Explanation
 <p>Remove Charger Connector</p>	<ul style="list-style-type: none"> Appears when the charging connector is connected to the inlet. 	<ul style="list-style-type: none"> The vehicle does not move while the charging connector is plugged into the inlet.
 <p>Standard Plug-in Charging System Problem. Quick Charging Is Available</p>	<ul style="list-style-type: none"> Appears when there is a problem with the standard plug-in charging system or the charging station outlet. 	<ul style="list-style-type: none"> This message only - There may be a problem with the charging station outlet. Refer to the instructions provided at the station or consult a qualified technician. If the outlet works properly, have the vehicle checked by an authorized Honda Clarity Electric dealer. Comes on with the POWER SYSTEM indicator - Have your vehicle checked by an authorized Honda Clarity Electric dealer.
 <p>Quick Plug-in Charging System Problem. Standard Charging Is Available</p>	<ul style="list-style-type: none"> Appears when there is a problem with the quick plug-in charging system or the charging station outlet. 	<ul style="list-style-type: none"> This message only - There may be a problem with the charging station outlet. Refer to the instructions provided at the station or consult a qualified technician. If the outlet works properly, have your vehicle checked by an authorized Honda Clarity Electric dealer. Comes on with the POWER SYSTEM indicator - Have your vehicle checked by an authorized Honda Clarity Electric dealer.
 <p>Charge Lid Open</p>	<ul style="list-style-type: none"> Appears when the charge lid is open. 	<ul style="list-style-type: none"> Close the charge lid.  Charging P. 440

Message	Condition	Explanation
 <p>Charging Connector Release Problem. Use Release Lever To Disconnect</p>	<ul style="list-style-type: none"> • Appears when the charging connector has failed. 	<ul style="list-style-type: none"> • Disconnect the charging connector using the release cord. ➤ When You Cannot Disengage the Charging Connector P. 533
 <p>Low Ambient Temperature. Charge Connection Recommended</p>	<ul style="list-style-type: none"> • Appears after you set the power mode to VEHICLE OFF without connecting the charging connector while the ambient temperature is low. 	<ul style="list-style-type: none"> • Connecting the charging connector improves cold startability.

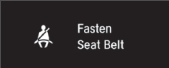
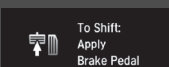
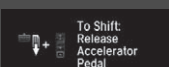

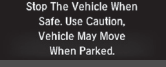
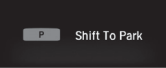
Message	Condition	Explanation
 <p>Fasten Seat Belt</p>	<ul style="list-style-type: none"> • Appears when you set the power mode to ON without fastening the driver's seat belt. • Appears if the gear position has been automatically changed to P and the driver attempts to take the vehicle out of P but does not have his or her seatbelt fastened. 	<ul style="list-style-type: none"> • Fasten the seat belt properly before you start to drive. <ul style="list-style-type: none"> ► Shift Operation P. 373
 <p>To Shift: Apply Brake Pedal</p>	<ul style="list-style-type: none"> • Appears when you try to change the gear position without depressing the brake pedal while the transmission is in P or N. 	<ul style="list-style-type: none"> • Depress the brake pedal, then select a shift button.
 <p>To Shift: Release Accelerator Pedal</p>	<ul style="list-style-type: none"> • Appears when you try to change the gear position without releasing your foot off the accelerator pedal while the transmission is in P or N. 	<ul style="list-style-type: none"> • Release your foot off the accelerator pedal, then select a shift button.

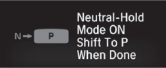



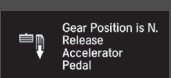
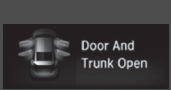
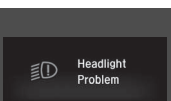

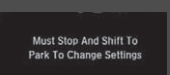
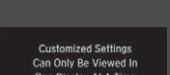
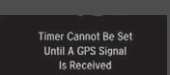
Message	Condition	Explanation
	<ul style="list-style-type: none"> • Appears when the parking button is pressed while the vehicle is moving. • Appears if you change the gear position to R while the vehicle is moving forward, or to D while the vehicle is reversing. 	<ul style="list-style-type: none"> • Make sure that the vehicle comes to a stop before operating the select button.
	<ul style="list-style-type: none"> • Appears if there is a problem with the electric system. • Appears when you set the power mode to OFF while driving. 	<ul style="list-style-type: none"> • Immediately stop in a safe place and set the parking brake. • Resume driving if the message disappears. • If there is a problem with the transmission system, the transmission system indicator comes on. <ul style="list-style-type: none"> ► Transmission System Indicator P. 87
	<ul style="list-style-type: none"> • Appears when the vehicle is stopped with the driver's seat belt unfastened and there is a chance that the vehicle may roll unintentionally. 	<ul style="list-style-type: none"> • Press the P button before releasing the brake pedal when idling, parking, or exiting the vehicle. <ul style="list-style-type: none"> ► Shift Operation P. 373
	<ul style="list-style-type: none"> • Appears for a few seconds if you have not pressed the N button long enough to initiate Neutral-Hold mode. 	<ul style="list-style-type: none"> ► If you want to keep the transmission in N position [car wash mode] P. 375
	<ul style="list-style-type: none"> • Appears when you press and hold N button for more than 2 seconds. 	<ul style="list-style-type: none"> • Disappears when you set the gear position to other than N. <ul style="list-style-type: none"> ► If you want to keep the transmission in N position [car wash mode] P. 375







Message	Condition	Explanation
 <p>Gear Unavailable. Try Again After Awhile</p>	<ul style="list-style-type: none"> Appears when the transmission system temperature is too high. 	<ul style="list-style-type: none"> Park in a safe place, and allow the system to cool down sufficiently.
 <p>Gear Position is N. Release Accelerator Pedal</p>	<ul style="list-style-type: none"> Appears when you depress the accelerator pedal while the transmission is in N. 	<ul style="list-style-type: none"> Release the accelerator pedal. Depress the brake pedal, then select a shift button to start driving.
 <p>Door And Trunk Open</p>	<ul style="list-style-type: none"> Appears if any door or the trunk is not completely closed. Appears if any door or the trunk is opened while driving. The beeper sounds. 	<ul style="list-style-type: none"> Goes off when all doors and the trunk are closed.
 <p>Headlight Problem</p>	<ul style="list-style-type: none"> Appears when there is a problem with the headlights. 	<ul style="list-style-type: none"> Appears while driving - The headlights may not be on. When conditions allow you to drive safely, have your vehicle checked by an authorized Honda Clarity Electric dealer as soon as possible.



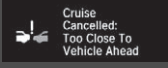

Message	Condition	Explanation
 <p>Must Stop And Shift To Park To Change Settings</p>	<ul style="list-style-type: none"> Appears while you are customizing the settings and the shift lever is moved out of P. 	<p>➤ Customized Features P. 296</p>
 <p>Customized Settings Can Only Be Viewed In One Display At A Time</p>	<ul style="list-style-type: none"> Appears if you try to go to vehicle settings from the driver information interface while the audio/information screen shows the same menu. 	<ul style="list-style-type: none"> Select either display to customize a setting. You cannot have vehicle settings displayed on the driver information interface and audio/information screen simultaneously. <p>➤ Customized Features P. 296</p>
 <p>Timer Cannot Be Set Until A GPS Signal Is Received</p>	<ul style="list-style-type: none"> Appears if you try to go to Charge Timer Setup while the time is incorrect. 	<p>➤ Customized Features P. 296</p>

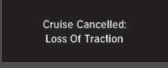

Message	Condition	Explanation
 <p>Brake Hold Disabled Apply Brake Pedal</p>	<ul style="list-style-type: none"> • Appears if the automatic brake hold is automatically canceled while it is in operation. • The beeper may sound. 	<ul style="list-style-type: none"> • Immediately depress the brake pedal.
 <p>BRAKE HOLD System OFF</p>	<ul style="list-style-type: none"> • Appears when the automatic brake hold system is turned off. 	<p>➤ Automatic Brake Hold P. 424</p>
 <p>To Enable Brake Hold: Seat Belt + Push</p>	<ul style="list-style-type: none"> • Appears when the automatic brake hold button is pressed without wearing the driver's seat belt. 	<ul style="list-style-type: none"> • Fasten the driver's seat belt. ➤ Automatic Brake Hold P. 424
 <p>To Disable Brake Hold: Brake + Push</p>	<ul style="list-style-type: none"> • Appears when the automatic brake hold button is pressed without depressing the brake pedal while the automatic brake hold is in operation. 	<ul style="list-style-type: none"> • Press the automatic brake hold button with the brake pedal depressed. ➤ Automatic Brake Hold P. 424
 <p>Parking Brake Engaged</p>	<ul style="list-style-type: none"> • Appears when the parking brake is applied automatically while it is in operation. 	<p>➤ Automatic Brake Hold P. 424 ➤ Parking Brake P. 420</p>
 <p>To Release Parking Brake: Brake + Push</p>	<ul style="list-style-type: none"> • Appears when the electric parking brake switch is pressed without depressing the brake pedal while the electric parking brake is in operation. 	<ul style="list-style-type: none"> • Appears while driving - Press the electric parking brake switch with the brake pedal depressed. ➤ Parking Brake P. 420

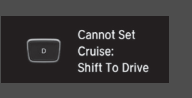
Message	Condition	Explanation
	<ul style="list-style-type: none"> Flashes when the system senses a likely collision with a vehicle in front of you. 	<ul style="list-style-type: none"> Take the appropriate means to prevent a collision (apply the brakes, change lanes, etc.) <ul style="list-style-type: none"> ► Collision Mitigation Braking System™ (CMBS™) P. 428 ► Adaptive Cruise Control (ACC) with Low Speed Follow (LSF) P. 389
	<ul style="list-style-type: none"> Appears when ACC with LSF has been automatically canceled. 	<ul style="list-style-type: none"> You can resume the set speed after the condition that caused ACC with LSF to cancel improves. Press the RES/+ or -/SET switch up. <ul style="list-style-type: none"> ► Adaptive Cruise Control (ACC) with Low Speed Follow (LSF) P. 389
	<ul style="list-style-type: none"> Appears when the distance between your vehicle and the vehicle ahead of you is too close while ACC with LSF is in operation. 	<ul style="list-style-type: none"> ACC with LSF has been automatically canceled. <ul style="list-style-type: none"> ► Adaptive Cruise Control (ACC) with Low Speed Follow (LSF) P. 389
	<ul style="list-style-type: none"> Appears when pressing the RES/+ or -/SET switch down while the distance between your vehicle and the vehicle ahead of you is too close. 	<ul style="list-style-type: none"> ACC with LSF cannot be set. <ul style="list-style-type: none"> ► Adaptive Cruise Control (ACC) with Low Speed Follow (LSF) P. 389
	<ul style="list-style-type: none"> Appears when pressing the RES/+ or -/SET switch down while the driver's seat belt is unfastened. 	<ul style="list-style-type: none"> ACC with LSF cannot be set. <ul style="list-style-type: none"> ► Adaptive Cruise Control (ACC) with Low Speed Follow (LSF) P. 389
	<ul style="list-style-type: none"> Appears if the VSA® or traction control function operates while ACC is in operation. 	<ul style="list-style-type: none"> ACC has been automatically canceled. <ul style="list-style-type: none"> ► Adaptive Cruise Control (ACC) with Low Speed Follow (LSF) P. 389

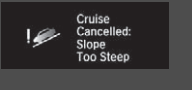

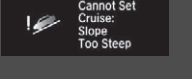
Message	Condition	Explanation
 <p>Cannot Set Cruise: Shift To Drive</p>	<ul style="list-style-type: none"> Appears when pressing the RES/+ or -/SET switch down while the transmission is not in D. 	<ul style="list-style-type: none"> ACC with LSF cannot be set. <ul style="list-style-type: none"> ▶ Adaptive Cruise Control (ACC) with Low Speed Follow (LSF) P. 389
 <p>Cruise Cancelled: Slope Too Steep</p>  <p>Cruise Cancelled: Slope Too Steep</p>	<ul style="list-style-type: none"> Appears when the vehicle is stopped on a very steep slope while ACC with LSF is in operation. 	<ul style="list-style-type: none"> ACC with LSF has been automatically canceled. <ul style="list-style-type: none"> ▶ Adaptive Cruise Control (ACC) with Low Speed Follow (LSF) P. 389
 <p>Cannot Set Cruise: Slope Too Steep</p>  <p>Cannot Set Cruise: Slope Too Steep</p>	<ul style="list-style-type: none"> Appears when pressing the RES/+ or -/SET switch down while the vehicle is stopped on a very steep slope. 	<ul style="list-style-type: none"> ACC with LSF cannot be set. <ul style="list-style-type: none"> ▶ Adaptive Cruise Control (ACC) with Low Speed Follow (LSF) P. 389

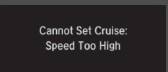
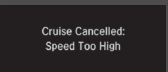
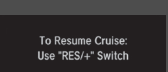
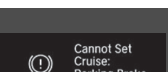
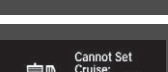
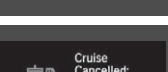
Message	Condition	Explanation
	<ul style="list-style-type: none"> Appears when the speed of the vehicle is too high for you to set ACC with LSF. 	<ul style="list-style-type: none"> Reduce the speed, then set ACC with LSF. <ul style="list-style-type: none"> ➤ Adaptive Cruise Control (ACC) with Low Speed Follow (LSF) P. 389
	<ul style="list-style-type: none"> Appears when ACC with LSF is cancelled due to excessive vehicle speed. 	<ul style="list-style-type: none"> Reduce the speed, then reset ACC with LSF. <ul style="list-style-type: none"> ➤ Adaptive Cruise Control (ACC) with Low Speed Follow (LSF) P. 389
	<ul style="list-style-type: none"> Appears when the vehicle ahead of you resumes driving, after your vehicle has been stopped automatically by ACC with LSF. 	<ul style="list-style-type: none"> Press the RES/+ or -/SET switch or depress the accelerator pedal to resume. <ul style="list-style-type: none"> ➤ Adaptive Cruise Control (ACC) with Low Speed Follow (LSF) P. 389
	<ul style="list-style-type: none"> Appears when pressing the RES/+ or -/SET switch down while the parking brake is applied. 	<ul style="list-style-type: none"> ACC with LSF cannot be set. <ul style="list-style-type: none"> ➤ Adaptive Cruise Control (ACC) with Low Speed Follow (LSF) P. 389 ➤ Parking Brake P. 420
	<ul style="list-style-type: none"> Appears when pressing the RES/+ or -/SET switch down while the vehicle is moving and the brake pedal is depressed. 	<ul style="list-style-type: none"> ACC with LSF cannot be set. <ul style="list-style-type: none"> ➤ Adaptive Cruise Control (ACC) with Low Speed Follow (LSF) P. 389
	<ul style="list-style-type: none"> Appears if ACC with LSF is canceled while your vehicle is automatically stopped by ACC with LSF. 	<ul style="list-style-type: none"> Immediately depress the brake pedal.

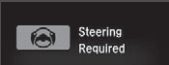
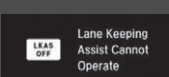

Message	Condition	Explanation
	<p>Lane Keeping Assist System (LKAS)</p> <ul style="list-style-type: none"> • Appears when the vehicle is driving out of a detected lane. The steering wheel vibrates rapidly. <p>Road Departure Mitigation (RDM) System</p> <ul style="list-style-type: none"> • Appears when the vehicle is driving out of a detected lane. <p>When you selected Warning Only</p> <ul style="list-style-type: none"> - The steering wheel vibrates rapidly when the vehicle is drifting out of a detected lane. <p>When you selected Normal or Wide</p> <ul style="list-style-type: none"> - The steering wheel vibrates rapidly when the vehicle is drifting out of a detected lane. The system also steers the vehicle to help you remain within your driving lane. 	<ul style="list-style-type: none"> • Keep the vehicle within the lane you are driving. <ul style="list-style-type: none"> ➤ Road Departure Mitigation (RDM) System P. 385 ➤ Lane Keeping Assist System (LKAS) P. 404 • You can change the setting for the road departure mitigation system. Normal, Wide, and Warning Only can be selected. <ul style="list-style-type: none"> ➤ Customized Features P. 296
	<ul style="list-style-type: none"> • Blinks when you fail to steer the vehicle. The beeper sounds simultaneously. 	<ul style="list-style-type: none"> • Operate the steering wheel to resume the LKAS.
	<ul style="list-style-type: none"> • Appears when the LKAS is in operation, or the LKAS button is pressed, but there is a problem with a system related to the LKAS. The LKAS cancels automatically. The beeper sounds simultaneously. 	<ul style="list-style-type: none"> • If the VSA®, ABS, or brake system indicator or another indicator comes on, take appropriate action. <ul style="list-style-type: none"> ➤ Indicators P. 82

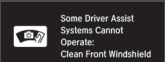
Message	Condition	Explanation
 <p>Some Driver Assist Systems Cannot Operate: Camera Temperature Too High</p>	<ul style="list-style-type: none"> • Appears when the temperature inside the camera is too high. 	<ul style="list-style-type: none"> • Use the climate control system to cool down the camera. • Goes off - The camera has been cooled down. Pressing the LKAS button can resume the system. <ul style="list-style-type: none"> ▶ Adaptive Cruise Control (ACC) with Low Speed Follow (LSF) P. 389 ▶ Lane Keeping Assist System (LKAS) P. 404 ▶ Front Sensor Camera P. 383
 <p>Some Driver Assist Systems Cannot Operate: Clean Front Windshield</p>	<ul style="list-style-type: none"> • Appears when the area around the camera is blocked by dirt, mud, etc. Stop your vehicle in a safe place, and wipe it off with a soft cloth. • May appear when driving in bad weather (rain, snow, fog, etc.). 	<ul style="list-style-type: none"> • Have your vehicle checked by an authorized Honda Clarity Electric dealer if the message does not disappear, even after you clean the area around the camera. <ul style="list-style-type: none"> ▶ Adaptive Cruise Control (ACC) with Low Speed Follow (LSF) P. 389 ▶ Lane Keeping Assist System (LKAS) P. 404 ▶ Front Sensor Camera P. 383

Gauges

Gauges include the speedometer, **POWER/CHARGE** gauge, high voltage battery charge level gauge, and related indicators. They are displayed when the power mode is in ON.



Speedometer

Displays your driving speed in mph or km/h.

Range

Shows the estimated distance you can travel on the remaining power. This estimate is based on the energy consumption of your previous trips.

Gauges

Press the  (display/information) button repeatedly until the  icon is shown on the driver information interface. Press **ENTER**, then press and hold it again. The speedometer reading and the displayed measurements will switch between mph and km/h.

■ POWER/CHARGE Gauge

■ Electric motor

The degree to which the electric motor is being powered is displayed by the readings on the **POWER** side.

■ Battery charge in progress

The degree to which the high voltage battery is being charged is displayed by the readings on the **CHARGE** side.



Continued

■ High Voltage Battery Charge Level Gauge

Shows the remaining high voltage battery charge level.

⊠ High Voltage Battery Charge Level Gauge

The high voltage battery charge level may decrease under the following conditions:

- When the 12-volt battery has been replaced.
- When the 12-volt battery has been disconnected.
- When the high voltage battery control system corrects its reading.

The charge level reading will be corrected automatically while driving.

Changes in the temperature of the high voltage battery can increase or decrease the battery's charging capacity. If temperature changes cause the battery's capacity to change, the number of indicators in the battery charge level gauge may also change, even if the amount of charging remains the same.

Electricity Consumption Indicator (ENERGY USAGE)

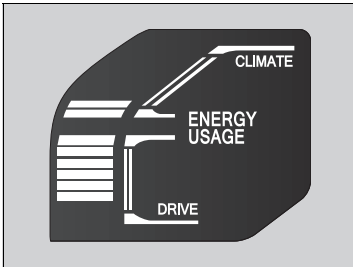

The meter shows the ratio between the energy which has been consumed by the climate control system (**CLIMATE**) and the energy which has been consumed by the motor (**DRIVE**).

As the climate control system consumes more power, bars in the **CLIMATE** section increase as bars in the **DRIVE** section decrease. Likewise, as the motor consumes more power, bars in the **DRIVE** section increase as bars in the **CLIMATE** section decrease.



Electricity Consumption Indicator (ENERGY USAGE)

Every few minutes the electricity consumption indicator adjusts the readings by one bar at a time. If the energy consumption ratio is minimal, the readings may not change. If climate control system use is low, the **CLIMATE** section may not display any bars.

Driver Information Interface

The driver information interface shows the odometer, trip meter, outside temperature indicator, and other gauges. It also displays important messages such as warnings and other helpful information.

Switching the Display

Press the  (display/information) button and press  or  to change the display. Press **ENTER** to see detailed information.

Switching the Display

You can edit, add, or delete the meter contents using the audio/information screen.

 **Customizing the Meter** P. 209

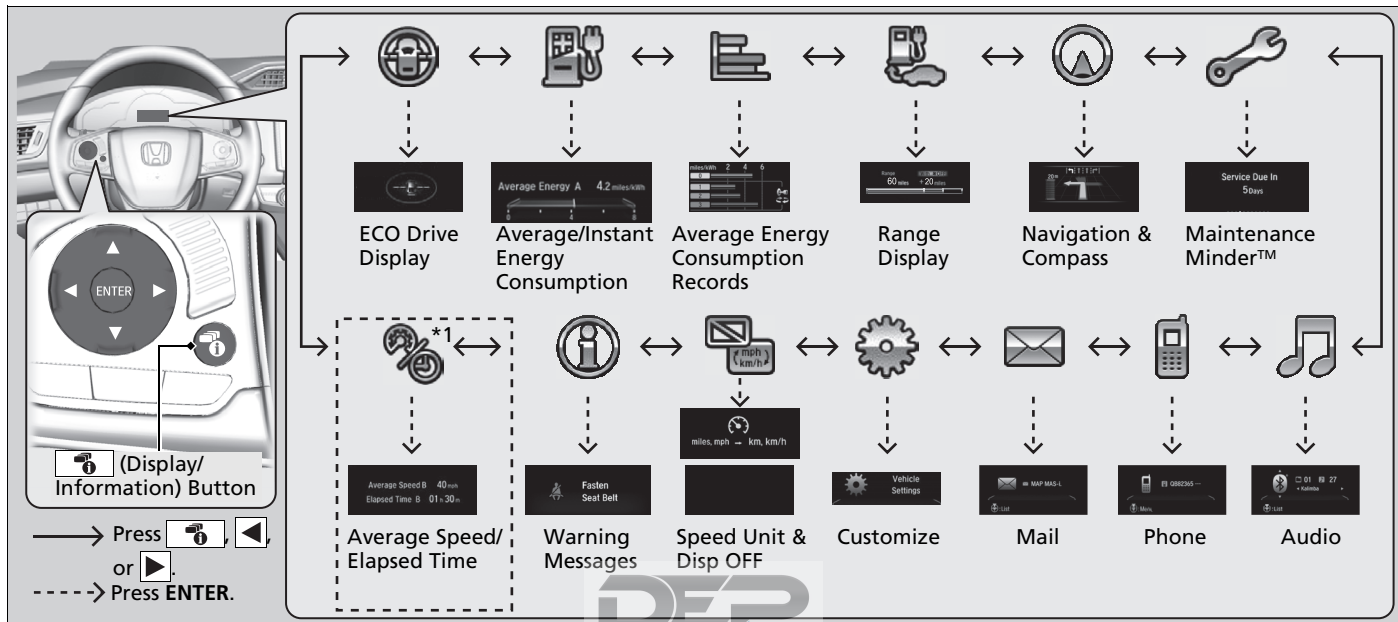

*1: You can add the content using the audio/information screen.

Press the **TRIP** button to change the display.

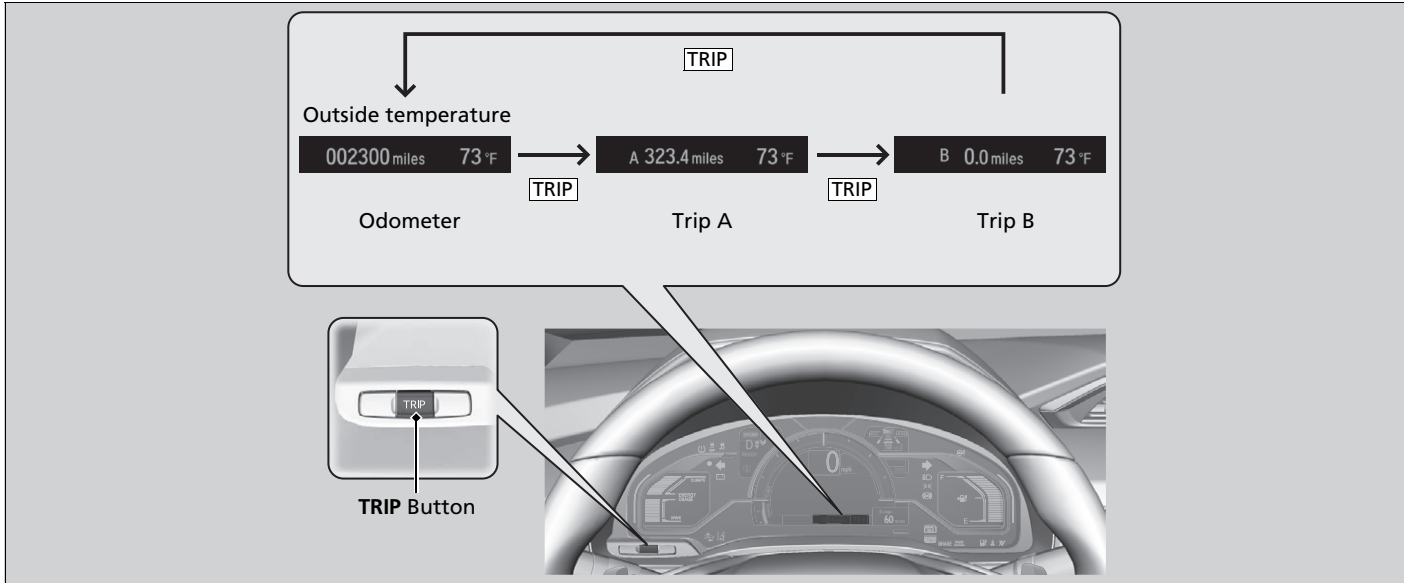

■ Odometer

Shows the total number of miles or kilometers that your vehicle has accumulated.

■ Trip Meter

Shows the total number of miles or kilometers driven since the last reset. Meters A and B can be used to measure two separate trips.

■ Resetting a trip meter

To reset a trip meter, display it, then press and hold the **TRIP** button. The trip meter is reset to **0.0**.

■ Outside Temperature

Shows the outside temperature in Fahrenheit.

■ Adjusting the outside temperature display

Adjust the temperature reading up to $\pm 5^\circ\text{F}$ if the temperature reading seems incorrect.

■ Average Energy Consumption

Shows the estimated average energy consumption of each trip meter in miles/kWh or km/kWh. The display is updated at set intervals. When a trip meter is reset, the average energy consumption is also reset.

☒ Trip Meter

Switch between trip meter A and trip meter B by pressing the **TRIP** button.

☒ Outside Temperature

The temperature sensor is in the front bumper. Road heat and exhaust from another vehicle can affect the temperature reading when your vehicle speed is less than 19 mph (30 km/h).

It may take several minutes for the display to be updated after the temperature reading has stabilized.

Use the audio/information screen's customized features to correct the temperature.

☒ **Customized Features** P. 296

☒ Average Energy Consumption

You can change when to reset the average energy consumption.

☒ **Customized Features** P. 296



■ Instant Energy Consumption

Shows the instant energy consumption as a bar graph in miles/kWh or km/kWh.

■ Elapsed Time

Shows the time elapsed since Trip A or Trip B was reset.

■ Average Speed

Shows the average speed in mph or km/h since Trip A or Trip B was reset.

■ Turn-by-Turn Directions

Shows you turn-by-turn driving directions to your destination linked with the navigation system.

➤ **Refer to the Navigation System Manual**

⌘ Elapsed Time

You can change when to reset the elapsed time.

➤ **Customized Features** P. 296

⌘ Average Speed

You can change when to reset the average speed.

➤ **Customized Features** P. 296

⌘ Turn-by-Turn Directions

The driver information interface shows a compass when the route guidance is not used.

You can select whether the turn-by-turn display comes on or not during the route guidance.

➤ **Customized Features** P. 296



Continued

■ Maintenance Minder™

Shows the Maintenance Minder™.

➤ **Maintenance Minder™** P. 461

■ Audio

Shows the current audio information.

➤ **Audio System Basic Operation** P. 202

■ Mail

Shows the current mail information.

➤ **Bluetooth® HandsFreeLink®** P. 325

■ Phone

Shows the current phone information.

➤ **Bluetooth® HandsFreeLink®** P. 325

Range Display

Shows the estimated distance you can travel on the remaining power. This estimate is based on the energy consumption of your previous trips and the remaining charge of the high voltage battery.

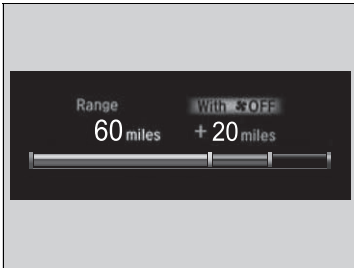

You can increase the driving range by turning off the climate control system. The distance displayed under **"With OFF"** is the additional estimated distance that the vehicle can drive if the climate control system is turned off.

Average Energy Consumption Records

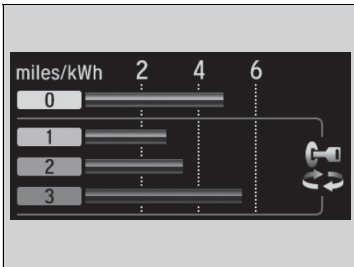

Shows the average energy consumption for the last three driving cycles (1 – 3), and the current driving cycle (0) in miles/kWh or km/kWh.

Each time you set the power mode to ON, the display is updated, and the oldest record is deleted.

Range Display

The driving range displayed is only an estimate and may differ to the actual distance the vehicle can travel.



■ Eco Drive Display/Drive Cycle Score/Lifetime Points

■ Eco Drive Display

The vehicle icon on the display moves forward or backward while driving.

The more aggressive the acceleration is, the further the icon moves forward.

The more aggressive the deceleration is, the further the icon moves backward.

Keep the icon near the center of the circle for better energy economy while driving.

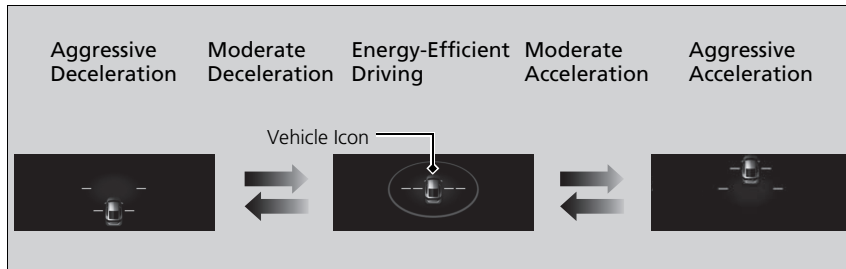

■ Drive Cycle Score/Lifetime Points

Appear for a few seconds when you set the power mode to VEHICLE OFF (LOCK). Each has three stages. Depending on your driving style, the leaf icon(s) and the gauge increase or decrease to indicate that you have reached a different stage of energy economy.

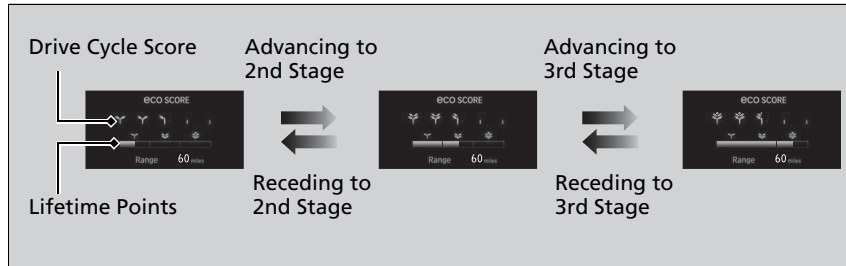

■ Resetting the Drive Cycle Score

1. Make sure the transmission is in **[P]**. Turn the power mode to ON.
2. If ECON mode is on, press the **ECON** button to turn it off.
3. Turn the power mode to VEHICLE OFF (LOCK).
4. Turn the power mode to ON again.
 - ▶ Make sure to complete steps from 4 through 6 within 30 seconds.
5. Depress the brake pedal twice.
 - ▶ The color of the ambient meter will change from white to green.
 - ▶ When the **Fuel Efficiency Backlight** setting on the audio/information display is off, the color stays white.
6. Press the **ECON** button twice.
 - ▶ The color of the ambient meter will turn to monochrome.
7. Turn the power mode to VEHICLE OFF (LOCK).



Continued

■ Customized Features

- Shows the customized feature (charge timer).
 - **Using a Timer** P. 454
- Use the audio/information screen to customize certain features.
 - **Customized Features** P. 296

■ Telematics Control Unit

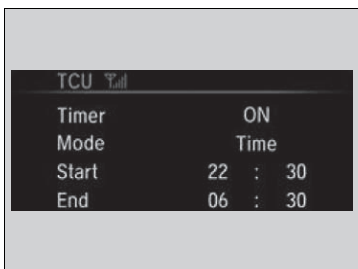

Sends and receives information between your vehicle and smartphones.

When you set the power mode to VEHICLE OFF, the telematics control unit signal strength and high voltage battery charge timer setting appear on the driver information interface.

➤ Telematics Control Unit

If you are planning to use a smartphone, check the telematics control unit signal strength before leaving the vehicle.

Controls

This chapter explains how to operate the various controls necessary for driving.

Clock	130	Security System Alarm.....	147	Adjusting the Steering Wheel	166
Locking and Unlocking the Doors		Opening and Closing the Windows ...	150	Adjusting the Mirrors	167
Key Types and Functions	131	Operating the Switches Around the		Interior Rearview Mirror	167
Low Smart Entry Remote Signal Strength..	132	Steering Wheel		Power Door Mirrors	168
Locking/Unlocking the Doors from the		POWER Button.....	152	Adjusting the Seats	169
Outside	133	Turn Signals.....	155	Front Seats	169
Locking/Unlocking the Doors from the		Light Switches.....	156	Interior Lights/Interior Convenience	
Inside	140	Daytime Running Lights	159	Items	176
Childproof Door Locks	142	Wipers and Washers	160	Interior Lights	176
Auto Door Locking/Unlocking	143	Brightness Control	162	Interior Convenience Items	178
Opening and Closing the Trunk	144	Rear Defogger/Heated Door Mirror		Climate Control System	186
Security System	147	Button.....	163	Using Automatic Climate Control	186
Immobilizer System	147	Driving Position Memory System	164	Automatic Climate Control Sensors...	194



Adjusting the Clock

The clock is automatically updated through the navigation system, so the time does not need to be adjusted.

You can also adjust the time manually in the audio/information screen, with the power mode in ON.

Adjusting the Time

Using the Settings menu on the audio/information screen



1. Select **Settings**.
2. Select **Clock**.
3. Select **Clock Adjustment**.
4. Select ▲ or ▼ to change hour.
5. Select ▲ or ▼ to change minute, then select **OK**.

Adjusting the Clock

You can customize the clock display to show the 12 hour clock or 24 hour clock.

➤ **Customized Features** P. 296

You can turn the clock display in the audio/information screen on and off.

➤ **Customized Features** P. 296

You cannot adjust the time while the vehicle is moving.

You can also adjust the clock by touching the clock displayed on the upper right corner of the display.

1. Touch the clock on the display.
2. Select **Clock Adjustment**.
3. Select ▲ or ▼ to change hour.
4. Select ▲ or ▼ to change minute, then select **OK**.

Key Types and Functions

This vehicle comes with the following keys:



Use the keys to turn on and off the power system, and to lock and unlock the doors and to open the trunk. You can also use the remote transmitter to lock and unlock the doors and trunk, and open the charge lid.

Built-in Key

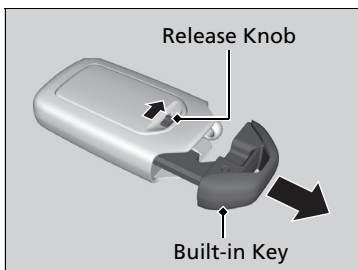

The built-in key can be used to lock/unlock the doors when the smart entry remote battery becomes weak and the power door lock/unlock operation is disabled.

To remove the built-in key, slide the release knob and then pull out the key. To reinstall the built-in key, push the built-in key into the smart entry remote until it clicks.

Key Types and Functions

All the keys have an immobilizer system. The immobilizer system helps to protect against vehicle theft.

Immobilizer System P. 147

Follow the advice below to prevent damage to the keys:

- Do not leave the keys in direct sunlight, or in locations with high temperature or high humidity.
- Do not drop the keys or set heavy objects on them.
- Keep the keys away from liquids, dust and sand.
- Do not take the keys apart except for replacing the battery.

If the circuits in the keys are damaged, the power system may not activate, and the remote transmitter may not work.

If the keys do not work properly, have them inspected by an authorized Honda Clarity Electric dealer.

■ Key Number Tag

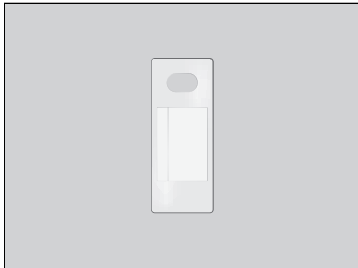

Contains a number that you will need if you purchase a replacement key.

☒ Key Number Tag

Keep the key number tag separate from the key in a safe place outside of your vehicle. If you wish to purchase an additional key, contact an authorized Honda Clarity Electric dealer.

If you lose your key and you cannot activate the power system, contact an authorized Honda Clarity Electric dealer.

Low Smart Entry Remote Signal Strength

The vehicle transmits radio waves to locate the smart entry remote when locking/unlocking the doors, opening the trunk, or to activate the power system.

In the following cases, locking/unlocking the doors, opening the trunk, or activating the power system may be inhibited or operation may be unstable:

- Strong radio waves are being transmitted by nearby equipment.
- You are carrying the smart entry remote together with telecommunications equipment, laptop computers, cell phones, or wireless devices.
- A metallic object is touching or covering the smart entry remote.

☒ Low Smart Entry Remote Signal Strength

Communication between the smart entry remote and the vehicle consumes the smart entry remote's battery.

Battery life is about two years, but this varies depending on regularity of use.

The battery is consumed whenever the smart entry remote is receiving strong radio waves. Avoid placing it near electrical appliances such as televisions and personal computers.

Locking/Unlocking the Doors from the Outside

■ Using the Smart Entry with Push Button Start System

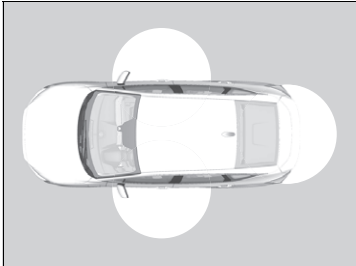

When you carry the smart entry remote, you can lock/unlock the doors and open the trunk. You can lock/unlock the doors within a radius of about 32 inches (80 cm) of the outside door handle or trunk release button.

■ Locking the doors and trunk

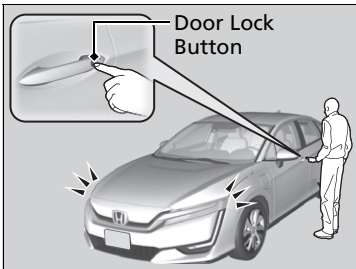

Press the door lock button on the front door.

- ▶ Some exterior lights flash; the beeper sounds; all the doors lock; and the security system sets.

☒ Locking/Unlocking the Doors from the Outside

If the interior light switch is in the door activated position, the interior light comes on when you unlock the doors.

No doors opened: The light fades out after 30 seconds.

Doors relocked: The light goes off immediately.

☒ **Interior Lights** P. 176

☒ Using the Smart Entry with Push Button Start System

If you do not open a door within 30 seconds of unlocking the vehicle with the smart entry system, the doors will automatically relock.

You can lock or unlock doors using the smart entry system only when the power mode is in VEHICLE OFF.



Continued

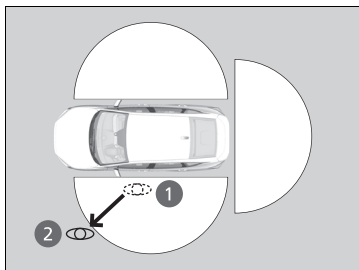
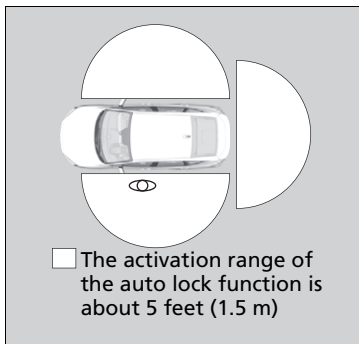

■ Locking the doors and trunk (Walk away auto lock)

When you walk away from the vehicle while carrying the smart entry remote, the doors will automatically lock.

The auto lock function activates when all doors are closed, and the smart entry remote is within about 5 feet (1.5 m) radius of the outside door handle.

Exit vehicle while carrying smart entry remote and close door(s).

1. While within about 5 feet (1.5 m) radius of the vehicle.
 - ▶ The beeper sounds; the auto lock function will be activated.
2. Carry the smart entry remote beyond about 5 feet (1.5 m) from the vehicle and remain outside this range for 2 or more seconds.
 - ▶ Some exterior lights flash; the beeper sounds; all doors will then lock.

▶ Locking the doors and trunk (Walk away auto lock)

The auto lock function is set to OFF as the factory default setting. The auto lock function can be set to ON using the audio/information screen.

If you set the auto lock function to ON using the audio/information screen, only the remote transmitter that was used to unlock the driver's door prior to the setting change can activate auto lock.

▶ **Customized Features** P. 296

After the auto lock function has been activated, when you stay within the locking/unlocking operation range, the indicator on the smart entry remote will continue to flash until the doors are locked.

When you stay beside the vehicle within the operation range, the doors will automatically lock approximately 30 seconds after the auto lock function activating beeper sounds.

When you open a door after the auto lock function activating beeper sounds, the auto lock function will be delayed until all doors are closed.

When all doors have been closed and the smart entry remote is inside the vehicle, or if the smart entry remote is not detected within about 5 feet (1.5 m) of the vehicle, auto lock function will not be activated.



To temporarily deactivate the function:

1. Set the power mode to OFF.
2. Open the driver's door.
3. Using the master door lock switch, operate the lock as follows:
Lock → Unlock → Lock → Unlock.
▶ The beeper sounds and the function is deactivated.

To restore the function:

- Set the power mode to ON.
- Lock the vehicle without using the auto lock function.
- With the smart entry remote on you, move out of the auto lock function operation range.
- Open any door.

⊗ Locking the doors and trunk (Walk away auto lock)

The auto lock function does not operate when any of the following conditions are met.

- The smart entry remote is inside the vehicle.
- A door or the hood is not closed.
- The power mode is set to any mode other than OFF.
- The smart entry remote is not located within a radius of about 5 feet (1.5 m) from the vehicle when you get out of the vehicle and close the doors.

Auto lock function operation stop beeper

After the auto lock function has been activated, the auto lock operation stop beeper sounds for approximately two seconds in the following cases.

- The smart entry remote is put inside the vehicle through a window.
- You are located too close to the vehicle.
- The smart entry remote is put inside the trunk.

If the warning beeper sounds, check that you are carrying the smart entry remote. Then, open/close a door and confirm the auto lock activation beeper sounds once.



Continued

■ Unlocking the doors and trunk

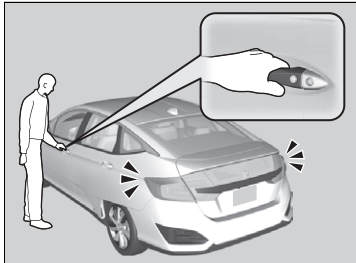

- Grab the driver's door handle:
- ▶ The driver's door unlocks.
 - ▶ Some exterior lights flash twice and the beeper sounds twice.

- Grab the front passenger's door handle:
- ▶ All doors unlock.
 - ▶ Some exterior lights flash twice and the beeper sounds twice.

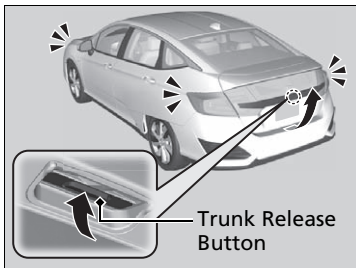

- Press the trunk release button:
- ▶ The trunk unlocks and opens.
 - ▶ Some exterior lights flash and the beeper sounds.

▶ **Using the Trunk Release Button** P. 145

▶ Using the Smart Entry with Push Button Start System

- Do not leave the smart entry remote in the vehicle when you get out. Carry it with you.
- Even if you are not carrying the smart entry remote, you can lock/unlock the doors while someone else with the remote is within range.
- The door may be unlocked if the door handle is covered with water in heavy rain or in a car wash if the smart entry remote is within range.
- If you grip a front door handle wearing gloves, the door sensor may be slow to respond or may not respond by unlocking the doors.
- After locking the door, you have up to two seconds during which you can pull the door handle to confirm whether the door is locked. If you need to unlock the door immediately after locking it, wait at least two seconds before gripping the handle, otherwise the door will not unlock.
- The door might not open if you pull it immediately after gripping the door handle. Grip the handle again and confirm that the door is unlocked before pulling the handle.
- Even within the 32 inches (80 cm) radius, you may not be able to lock/unlock the doors with the smart entry remote if it is above or below the outside handle.
- The smart entry remote may not operate if it is too close to the door and door glass.

The light flash, beep and door unlock mode settings can be customized using the audio/information screen.

▶ **Customized Features** P. 296

■ Using the Remote Transmitter

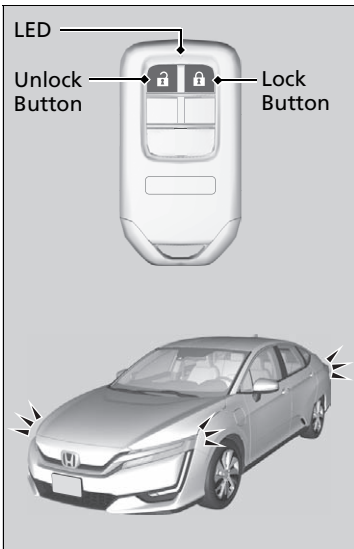

■ Locking the doors

Press the lock button.

Once:

- ▶ Some exterior lights flash, all the doors lock, and the security system sets.

Twice (within five seconds after the first push):

- ▶ The beeper sounds and verifies the security system is set.

■ Unlocking the doors

Press the unlock button.

Once:

- ▶ Some exterior lights flash twice, and the driver's door unlocks.

Twice:

- ▶ The remaining doors unlock.

▣ Using the Remote Transmitter

If you do not open a door within 30 seconds of unlocking the vehicle with the remote transmitter, the doors will automatically relock.

You can change the relock timer setting.

▣ **Customized Features** P. 296

You can lock or unlock doors using the remote transmitter only when the power mode is in VEHICLE OFF.

The remote transmitter uses low-power signals, so the operating range may vary depending on the surroundings.

The remote will not lock the vehicle when a door is open.

If the distance at which the remote transmitter works varies, the battery is probably low.

If the LED does not come on when you press a button, the battery is dead.

▣ **Replacing the Button Battery** P. 486

You can customize the door unlock mode setting.

▣ **Customized Features** P. 296



Continued

■ Locking/Unlocking the Doors Using a Key

If the lock or unlock button of the smart entry remote does not work, use the key instead.

➤ **Replacing the Button Battery** P. 486

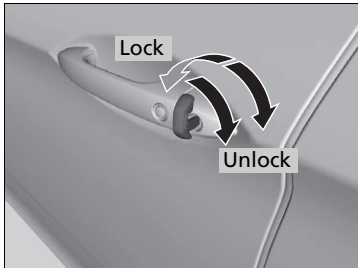

Fully insert the key and turn it.

☒ Locking/Unlocking the Doors Using a Key

When you lock the driver's door with a key, all the other doors lock at the same time. When unlocking, the driver's door unlocks first. Turn the key a second time within a few seconds to unlock the remaining doors.

You can customize the door unlock mode setting.

➤ **Customized Features** P. 296

■ Locking a Door Without Using a Key

If you do not have the key on you, or if for some reason you cannot lock a door using the key, you can lock the door without it.

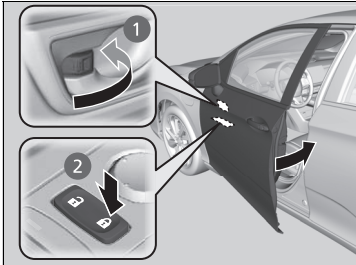

■ Locking the front doors

Push the lock tab forward **1** or push the master door lock switch in the lock direction **2**, and close the door.

■ Locking the rear doors

Push the lock tab forward and close the door.

■ Lockout prevention system

The doors cannot be locked when the smart entry remote is inside the vehicle.

⌘ Locking a Door Without Using a Key

When you lock the driver's door, all the other doors lock at the same time.
Before locking a door, make sure that the key is not inside the vehicle.

Locking/Unlocking the Doors from the Inside

■ Using the Lock Tab

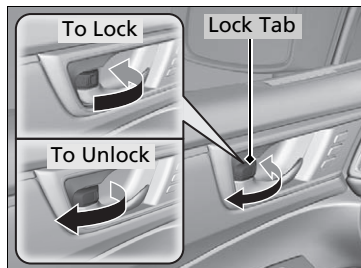

■ **Locking a door**
Push the lock tab forward.

■ **Unlocking a door**
Pull the lock tab rearward.

☒ Using the Lock Tab

When you lock the door using the lock tab on the driver's door, all of the other doors lock at the same time.

When you unlock the door using the lock tab on the driver's door, only the driver's door will unlock.

■ Unlocking Using the Front Door Inner Handle

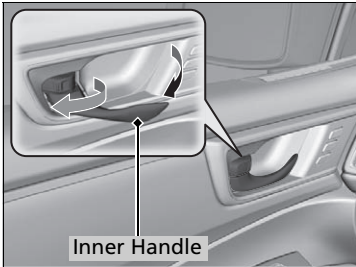

Pull the front door inner handle.

- ▶ The door unlocks and opens in one motion.

Unlocking and opening the driver's door from the inner handle unlocks all the other doors.

To avoid all the doors to be unlocked, use the lock tab on the driver's door to unlock, then lock again before opening the door.

- ▶ This setting works for one time only. If you do not want all the doors to be unlocked all the time, customize the **Auto Door Unlock** setting to **Off** using the audio/information screen.

▣ Unlocking Using the Front Door Inner Handle

The front door inner handles are designed to allow front seat occupants to open the door in one motion. However, this feature requires that front seat occupants never pull a front door inner handle while the vehicle is in motion.

Children should always ride in a rear seat where childproof door locks are provided.

▶ **Childproof Door Locks** P. 142



Continued

■ Using the Master Door Lock Switch

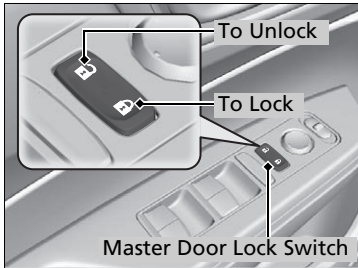

Press the master door lock switch in as shown to lock or unlock all the doors.

☒ Using the Master Door Lock Switch

When you lock/unlock either front door using the master door lock switch, all the other doors lock/unlock at the same time.

Childproof Door Locks

The childproof door locks prevent the rear doors from being opened from the inside regardless of the position of the lock tab.

☒ Childproof Door Locks

To open the door from the inside when the childproof door lock is on, put the lock tab in the unlock position, lower the rear window, put your hand out of the window, and pull the outside door handle.

■ Setting the Childproof Door Locks

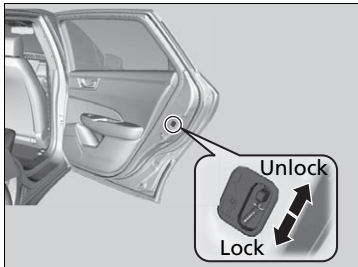

Slide the lever in the rear door to the lock position, and close the door.

■ When opening the door

Open the door using the outside door handle.



Auto Door Locking/Unlocking

Your vehicle locks or unlocks all doors automatically when a certain condition is met.

■ Auto Door Locking

■ Drive lock mode

All doors lock when the vehicle's speed reaches about 10 mph (15 km/h).

■ Auto Door Unlocking

■ Driver's door open mode

All doors unlock when the driver's door is opened.

☒ Auto Door Locking/Unlocking

You can turn off or change to another auto door locking/unlocking setting using the audio/information screen.

☒ **Customized Features** P. 296

Precautions for Opening/Closing the Trunk

■ Opening the trunk

Open the trunk all the way.

- ▶ If it is not fully opened, the trunk lid may begin to close under its own weight.

■ Closing the trunk

Keep the trunk lid closed while driving to:

- ▶ Avoid possible damage.

Using the Trunk Opener

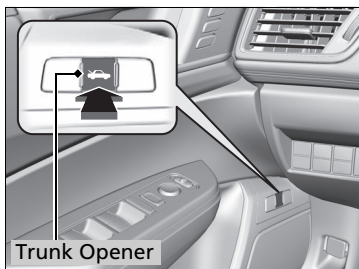

Pressing the trunk opener on the driver's door unlocks and opens the trunk.

➤ **When You Cannot Open the Trunk** P. 534

Using the Trunk Release Button

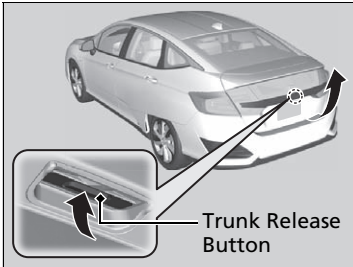

Push up the release button on the trunk lid after the doors are unlocked.

🚫 **When You Cannot Open the Trunk** P. 534

Even if the trunk is locked, you can open the trunk if you carry the smart entry remote.

▶ Some exterior lights flash and the beeper sounds.

Using the Remote Transmitter

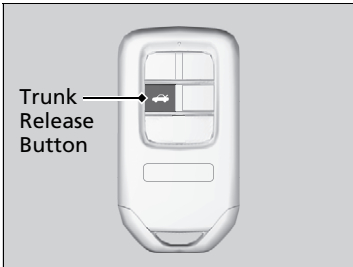

Press the trunk release button for approximately one second to unlock and open the trunk.

🚫 Using the Trunk Release Button

- If you forget the remote inside, the beeper will sound and the trunk will not close.
- A person who is not carrying the smart entry remote can unlock the trunk if a person who is carrying it is within range.
- If the beeper sounds after you close the trunk, move the smart entry remote away from the trunk and close again.
- The smart entry remote may not operate if it is too close to the trunk.

🚫 Using the Remote Transmitter

If the driver's door is locked, the trunk will automatically lock when you close it. Otherwise, you will have to lock it manually.

Emergency Trunk Opener



The trunk release lever allows you to open the trunk from inside for your safety.

Slide the release lever in the direction of the arrow.

Emergency Trunk Opener

Parents should decide if their children should be shown how to use this feature.

Immobilizer System

The immobilizer system prevents a key that has not been pre-registered from starting the power system. Each key contains electronic transmitters that use electronic signals to verify the key.

Pay attention to the following when pressing the **POWER** button:

- Do not allow objects that emit strong radio waves near the **POWER** button.
- Make sure the key is not covered by or touching a metal object.
- Do not bring a key from another vehicle's immobilizer system near the **POWER** button.
- Do not put the key near magnetic items. Electronic devices, such as televisions and audio systems emit strong magnetic fields. Note that even a key chain can become magnetic.

Security System Alarm

The security system alarm activates when the trunk, hood or doors are forcibly opened. The alarm does not activate if the trunk or doors are opened with the key, remote transmitter or smart entry system.

However, the alarm activates if a door is opened with the key and then the hood is opened before the power mode is set to ON.

■ When the security system alarm activates

The horn sounds intermittently and some exterior lights flash.

■ To deactivate the security system alarm

Unlock the vehicle using the key, remote transmitter or smart entry system. The system, along with the horn and flashing lights, is deactivated.



☒ Immobilizer System

NOTICE

Leaving the key in the vehicle can result in theft or accidental movement of the vehicle. Always take the key with you whenever you leave the vehicle unattended.

Do not alter the system or add other devices to it. Doing so may damage the system and make your vehicle inoperable.

☒ Security System Alarm

Do not alter the system or add other devices to it. Doing so may damage the system and make your vehicle inoperable.

The security alarm continues for a maximum of two minutes until the security system alarm deactivates.

■ Setting the security system alarm

The security system alarm automatically sets when the following conditions have been met:

- The power mode is set to VEHICLE OFF (LOCK).
- The hood is closed.
- All doors and the trunk are locked from outside with the key, remote transmitter or smart entry system.

■ When the security system alarm sets

The security system alarm indicator in the instrument panel blinks. When the blinking interval changes after about 15 seconds, the security system alarm is set.

■ To cancel the security system alarm

The security system alarm is canceled when the vehicle is unlocked using the remote transmitter, smart entry system, or the power mode is set to ON. The security system alarm indicator goes off at the same time.

☒ Security System Alarm

Do not set the security system alarm when someone is in the vehicle or a window is open. The system can accidentally activate when:

- Unlocking the door with the lock tab.
- Opening the trunk with the trunk opener or the emergency trunk opener.
- Opening the hood with the hood release.

If the 12-volt battery goes dead after you have set the security system alarm, the security alarm may go off once the 12-volt battery is recharged or replaced. If this occurs, deactivate the security system alarm by unlocking a door using the key, remote transmitter or smart entry system.

■ Panic Mode

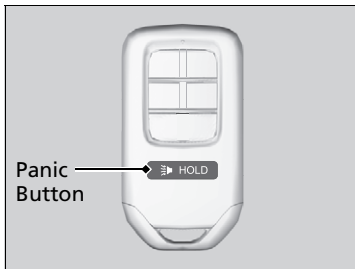

■ The panic button on the remote transmitter

If you press the panic button for approximately one second, the following will occur for about 30 seconds:

- The horn sounds.
- Some exterior lights flash.

■ Canceling panic mode

Press any button on the remote transmitter, or set the power mode to ON.

Opening/Closing the Power Windows

The power windows can be opened and closed when the power mode is in ON, using the switches on the doors.

The driver's side switches can be used to open and close all the windows. The power window lock button on the driver's side must be switched off (indicator off) to open and close the windows from anywhere other than the driver's seat.

When the power window lock button is pressed, the indicator comes on and you can only operate the driver's window. Turn the power window lock button on if a child is in the vehicle.

Opening/Closing Windows with Auto-Open/Close Function

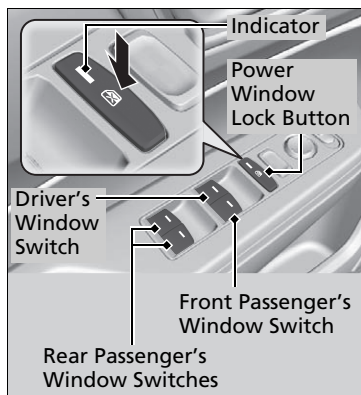

Manual operation

To open: Push the switch down lightly, and hold it until the desired position is reached.

To close: Pull the switch up lightly, and hold it until the desired position is reached.

Automatic operation

To open: Push the switch down firmly.

To close: Pull the switch up firmly.

The window opens or closes completely. To stop the window at any time, push or pull the switch briefly.

Opening/Closing the Power Windows

WARNING

Closing a power window on someone's hands or fingers can cause serious injury.

Make sure your passengers are away from the windows before closing them.

The power windows can be operated for up to 10 minutes after you set the power mode to VEHICLE OFF (LOCK). Opening either front door cancels this function.

Auto Reverse

If a power window senses resistance when closing automatically, it will stop closing and reverse direction.

The driver's window auto reverse function is disabled when you continuously pull up the switch.

The auto reverse function stops sensing when the window is almost closed to ensure that it fully closes.

■ Opening the Windows with the Remote

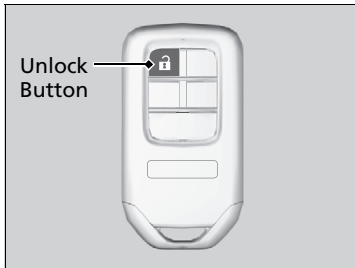

To open: Press the unlock button, and then within 10 seconds, press it again and hold it.

If the windows stop midway, repeat the procedure.

■ Opening/Closing the Windows with the Key

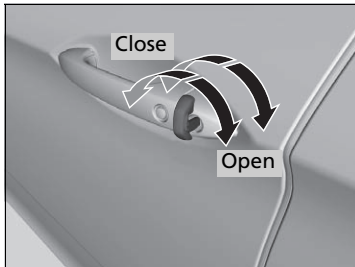

To open: Unlock the driver's door with the key. Within 10 seconds of returning the key to the central position, turn the key in the unlock direction and hold it there.

To close: Lock the driver's door with the key. Within 10 seconds of returning the key to the central position, turn the key in the lock direction and hold it there.

Release the key to stop the windows at the desired position. If you want further adjustment, repeat the same operation.



POWER Button

■ Changing the Power Mode

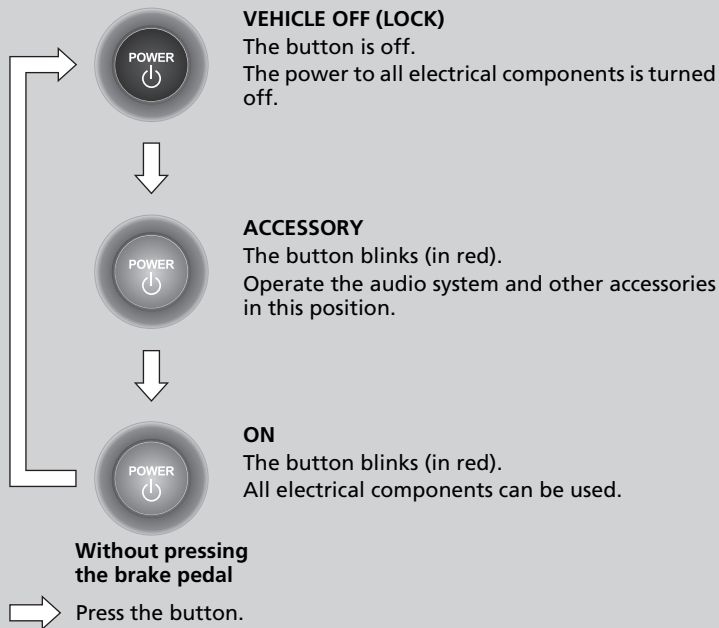

▶ POWER Button

POWER Button Operating Range

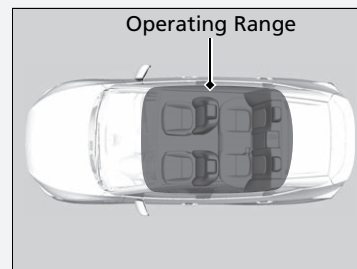

You can start the power system when the smart entry remote is inside the vehicle.

The power system may also start if the smart entry remote is close to the door or window, even if it is outside the vehicle.

ON mode:

The **POWER** button is on (in red), if the power system is on.

If the battery of the smart entry remote is getting low, the power system may not start when you press the **POWER** button. If the power system does not start, refer to the following link.

▶ **If the Smart Entry Remote Battery is Weak**
P. 512

Do not leave the power mode in ACCESSORY or ON when you get out.

■ Automatic Power Off

If you leave the vehicle for 30 to 60 minutes with the transmission in **P** and the power mode in ACCESSORY, the vehicle automatically goes into the mode to VEHICLE OFF (LOCK) to avoid draining the 12-volt battery.

■ Power Mode Reminder

If you open the driver's door when the power mode is set to ACCESSORY, a warning beep sounds.



Continued

Smart Entry Remote Reminder

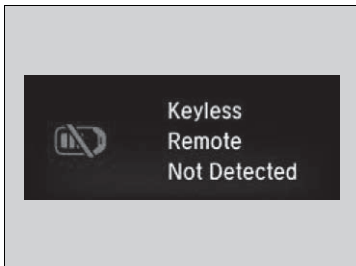

Warning buzzers may sound from inside and/or outside the vehicle to remind you that the smart entry remote is out of the vehicle. If the buzzer continues even after the remote is put back inside, place it to be within its operational range.

■ When the power mode is in ON

If the smart entry remote is taken out of the vehicle, and the driver's door is closed, a warning buzzer sounds from both inside and outside the vehicle. A warning message on the driver information interface notifies the driver inside that the remote outside of the vehicle.

■ When the power mode is in ACCESSORY

If the smart entry remote is taken out of the vehicle, and the driver's door is closed, a warning buzzer sounds from outside the vehicle.

Smart Entry Remote Reminder

When the smart entry remote is within the system's operational range, and the driver's door is closed, the warning function cancels.

If the smart entry remote is taken out of the vehicle after the power system has been turned on, you can turn the power system off, but you can no longer use ACCESSORY mode or restart the vehicle. Always make sure if the remote is in your vehicle when you operate the **POWER** button.

Removing the smart entry remote from the vehicle through a window does not activate the warning buzzer.

Do not put the smart entry remote on the dashboard or in the glove box. It may cause the warning buzzer to go off. Under some other conditions that can prevent the vehicle from locating the remote, the warning buzzer may also go off even if the remote is within the system's operational range.

Turn Signals

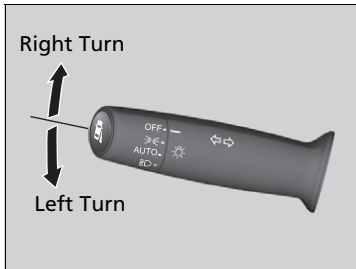

The turn signals can be used when the power mode is in ON.

■ One-touch turn signal

When you lightly push up or down and release the turn signal lever, the exterior turn signals and turn signal indicator blink three times.

This feature can be used when signaling for a lane change.

Light Switches

Manual Operation

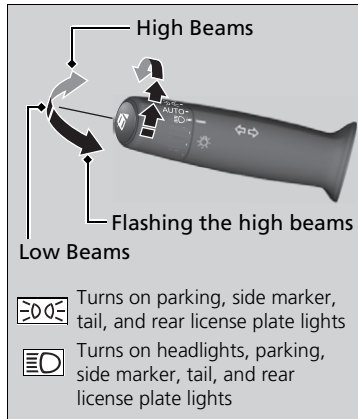

Rotating the light switch turns the lights on and off, regardless of the power mode setting.

High beams

Push the lever forward until you hear a click.

Low beams

When in high beams, pull the lever back to return to low beams.

Flashing the high beams

Pull the lever back, and release it.

Light Switches

If you leave the power mode in VEHICLE OFF (LOCK) while the lights are on, a chime sounds when the driver's door is opened.

When the lights are on, the lights on indicator in the instrument panel will be on.

Lights On Indicator P. 94

Do not leave the lights on when the power system is off because it will cause the 12-volt battery to discharge.

If you sense that the level of the headlights is abnormal, have the vehicle inspected by an authorized Honda Clarity Electric dealer.

Automatic Operation (automatic lighting control)



Automatic lighting control can be used when the power mode is in ON.

When you turn the light switch to **AUTO**, the headlights and other exterior lights will switch on and off automatically depending on the ambient brightness.

You can change the auto light sensitivity setting.

▶ **Customized Features** P. 296

The headlights comes on when you unlock a door in dark areas with the headlight switch in **AUTO**.

- ▶ Once you lock the door, the headlights will go off.

Automatic Operation (automatic lighting control)

We recommend that you turn on the lights manually when driving at night, in a dense fog, or in dark areas such as long tunnels or parking facilities.

The light sensor is in the location shown below. Do not cover this light sensor with anything; otherwise, the automatic lighting system may not work properly.

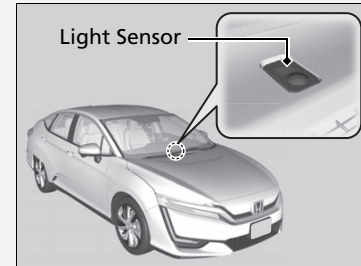

Adjust the auto light sensitivity as follows:

Setting	The exterior lights come on when the ambient light is at	
Max		Bright
High		
Mid		
Low		
Min		Dark



Continued

■ Headlight Integration with Wipers

The headlights automatically come on when the wipers are used several times within a certain number of intervals with the headlight switch in **AUTO**. The headlights automatically go off a few minutes later if the wipers are stopped.

■ Automatic Lighting Off Feature

The headlights, all other exterior lights, and the instrument panel lights turn off 15 seconds after you set the power mode to VEHICLE OFF (LOCK), take the remote with you, and close the driver's door.

If you set the power mode to VEHICLE OFF (LOCK) with the headlight switch on, but do not open the door, the lights turn off after 10 minutes (3 minutes, if the switch is in the **AUTO** position).

The lights turn on again when you unlock or open the driver's door. If you unlock the door, but do not open it within 15 seconds, the lights go off. If you open the driver's door, you will hear a lights on reminder chime.



☒ Headlight Integration with Wipers

This feature activates while the headlights are off in **AUTO**. The instrument panel brightness does not change when the headlights come on.

At dark ambient light levels, the automatic lighting control feature turns on the headlights, regardless of the number of wiper sweeps.

You can turn the headlight integration with wipers function on and off.

☒ **Customized Features** P. 296

☒ Automatic Lighting Off Feature

You can change the headlight auto off timer setting.

☒ **Customized Features** P. 296

Daytime Running Lights

The daytime running lights come on when the following conditions have been met:

- The power mode is in ON.
- The headlight switch is **AUTO**, or **OFF**.
- The parking brake is released.

The lights remain on even if you set the parking brake.

Setting the power mode to VEHICLE OFF (LOCK) will turn off the daytime running lights.

The daytime running lights are off once the headlight switch is turned on, or when the headlight switch is in **AUTO** and it is getting darker outside.



Wipers and Washers

■ Windshield Wipers/Washers

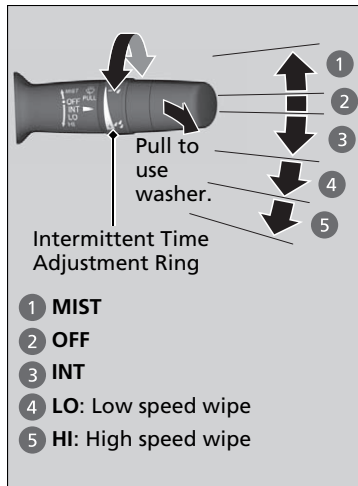

The windshield wipers and washers can be used when the power mode is in ON.

■ MIST

The wipers run at high speed until you release the lever.

■ Wiper switch (OFF, INT, LO, HI)

Move the lever up or down to change the wiper settings.

■ Adjusting wiper operation

Turn the adjustment ring to adjust the wiper operation.

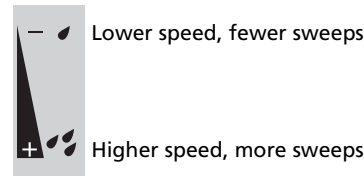

■ Washer

Sprays while you pull the lever toward you. When you release the lever for more than one second, the spray stops, the wipers sweep two or three more times to clear the windshield, then stop.

» Wipers and Washers

NOTICE

Do not use the wipers when the windshield is dry. The windshield will get scratched, or the rubber blades will get damaged.

Turn the washers off if no washer fluid comes out. The pump may get damaged.

When the wiper motor is kept running under heavy load for extended periods of time, this protection feature is activated, and the wiper speed may decrease or motor operation may stop temporarily. This function will be canceled within a few minutes once the load has been reduced; the wiper operation returns to normal.

If the vehicle speeds up while the wipers are operating intermittently, the length of the wipe interval shortens.

When the vehicle speeds up, the wiper operation's shortest delay setting (LO) and the LO setting become the same.

NOTICE

In cold weather, the blades may freeze to the windshield.

Operating the wipers in this condition may damage the wipers. Use the defroster to warm the windshield, then turn the wipers on.

▶ Wipers and Washers

If the wipers stop operating due to an obstacle such as the build-up of snow, park the vehicle in a safe place.

Rotate the wiper switch to **OFF**, and set the power mode to ACCESSORY or VEHICLE OFF (LOCK), then remove the obstacle.

The washer jets are in the location shown below.

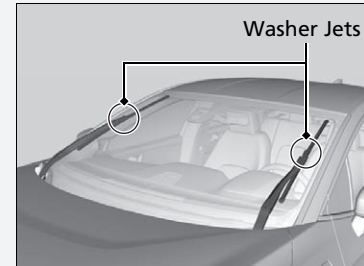

Brightness Control

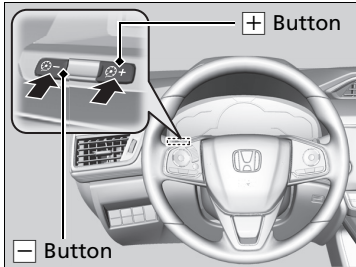

When the power mode is in ON, you can use the **+** or **-** button to adjust instrument panel brightness.

Brighten: Press the **+** button.

Dim: Press the **-** button.

You will hear a beep when the brightness reaches minimum or maximum. Several seconds after adjusting the brightness, you will be returned to the previous display.

■ Brightness level indicator

The brightness level is shown on the display while you are adjusting it.

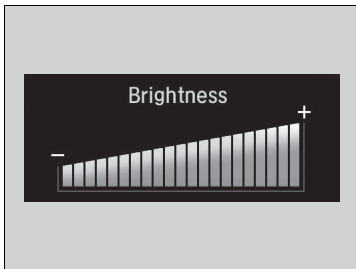

▶▶ Brightness Control

Instrument panel brightness varies, depending on whether the exterior lights are on or off. The instrument panel dims to reduce glare when they are on.

When it is bright outside and the headlight integration with the wiper is activated, the instrument panel brightness does not change.

To cancel the reduced instrument panel brightness when the exterior lights are on, press the **+** button until the brightness display is up to max, the beeper sounds.

The brightness can be set differently for when the exterior lights are on, and when they are off.

Rear Defogger/Heated Door Mirror Button

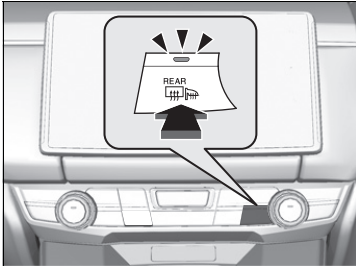

Press the rear defogger and heated door mirror button to defog the rear window and mirrors when the power mode is in ON.

The rear defogger and heated door mirrors automatically switch off after 10-30 minutes depending on the outside temperature.

However, if the outside temperature is 32°F (0°C) or below, it does not automatically switch off.

⊠ Rear Defogger/Heated Door Mirror Button

NOTICE

When cleaning the inside of the rear window, be careful not to damage the heating wires. It is critical to wipe the window from side to side along the defogger heating wires.

This system consumes a lot of power, so turn it off when the window has been defogged. Also, do not use the system for a long time while the power system is stopped. This may weaken the 12-volt battery, making it difficult to turn the power system on.

When the outside temperature is below 41°F (5°C), the heated door mirror may activate automatically for 10 minutes when you set the power mode to ON.

Driving Position Memory System

You can store two driver's seat with the driving position memory system.

When you unlock and open the driver's door with a remote transmitter, or smart entry system, the seat adjusts automatically to one of the two preset positions.

- **DRIVER 1** transmitter is linked to memory button 1.
- **DRIVER 2** transmitter is linked to memory button 2.



▶▶ Driving Position Memory System

Using the audio/information screen, you can disable the automatic seat adjustment function.

▶ **Customized Features** P. 296

■ Storing a Position in Memory

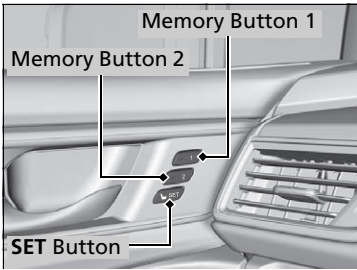

1. Set the power mode to ON. Adjust the driver's seat to the desired position.
2. Press the **SET** button.
 - ▶ You will hear the beeper, and the memory button indicator light will blink.
3. Press and hold memory button **1** or **2** within five seconds of pressing the **SET** button.
 - ▶ Once the seat position has been memorized, the indicator light on the button you pressed stays on and you will hear the double-beep.

■ Recalling the Stored Position

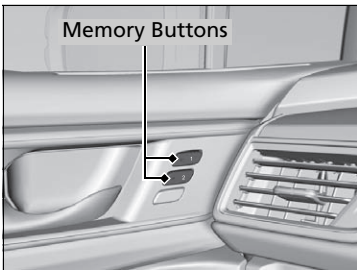

1. Put the transmission into **P**.
2. Apply the parking brake.
3. Press a memory button (**1** or **2**).
 - ▶ You will hear the beeper, and the indicator light will blink.

The seat will automatically move to the memorized position. When it has finished moving, you will hear the beeper, and the indicator light stays on.



☒ Storing a Position in Memory

After you press the **SET** button, the storing operation will be canceled when:

- You do not press the memory button within five seconds.
- You readjust the seat position before the double-beep.
- You set the power mode to any position except ON.

☒ Recalling the Stored Position

The seat will stop moving if you:

- Press the **SET** button or memory button **1** or **2**.
- Adjust the seat position.
- Put the transmission into a position other than **P**.

Adjusting the Steering Wheel

The steering wheel height and distance from your body can be adjusted so that you can comfortably grip the steering wheel in an appropriate driving posture.

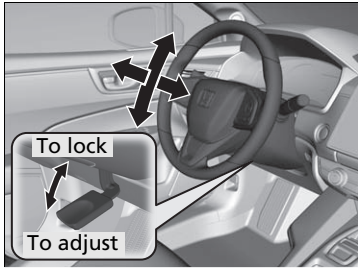

1. Push the steering wheel adjustment lever down.
 - ▶ The steering wheel adjustment lever is under the steering column.
2. Move the steering wheel up or down, and in or out.
 - ▶ Make sure you can see the instrument panel gauges and indicators.
3. Pull the steering wheel adjustment lever up to lock the steering wheel in position.
 - ▶ After adjusting the position, make sure you have securely locked the steering wheel in place by trying to move it up, down, in, and out.

Adjusting the Steering Wheel

⚠ WARNING

Adjusting the steering wheel position while driving may cause you to lose control of the vehicle and be seriously injured in a crash.

Adjust the steering wheel only when the vehicle is stopped.

Adjusting the Mirrors

Interior Rearview Mirror

Adjust the angle of the rearview mirror when you are sitting in the correct driving position.

Automatic Dimming Rearview Mirror

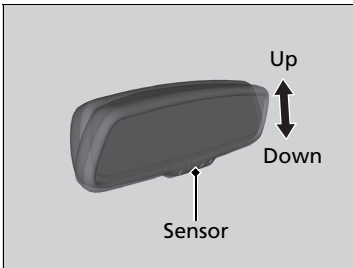

When you are driving after dark, the automatic dimming rearview mirror reduces the glare from headlights behind you, based on inputs from the mirror sensor. This feature is always active.

Adjusting the Mirrors

Keep the inside and outside mirrors clean and adjusted for best visibility.

Adjust the mirrors before you start driving.

➤ **Front Seats** P. 169

Automatic Dimming Rearview Mirror

The auto dimming function cancels when the transmission is in **R**.

Power Door Mirrors

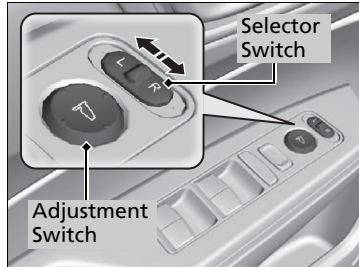

You can adjust the door mirrors when the power mode is in ON.

■ Mirror position adjustment

L/R selector switch: Select the left or right mirror. After adjusting the mirror, return the switch to the center position.

Mirror position adjustment switch: Press the switch left, right, up, or down to move the mirror.

■ Expanded View Driver's Mirror

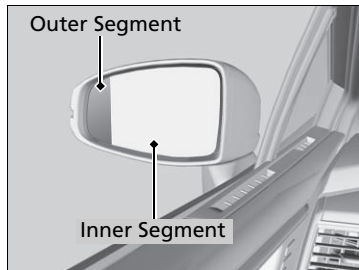

The driver's side door mirror has outer and inner segments. The outer segment is slightly curved to provide a wider angle view than a standard flat mirror. This wider view may help you check areas that are not visible using a standard door mirror.

▶ Expanded View Driver's Mirror

Objects visible in the outer segment of the driver's side door mirror appear smaller than objects in the rest of the mirror. But in fact, they are closer than they appear.

Do not rely on your mirrors. Always look to the side and behind your vehicle before changing lanes.

Adjusting the Seats

Front Seats

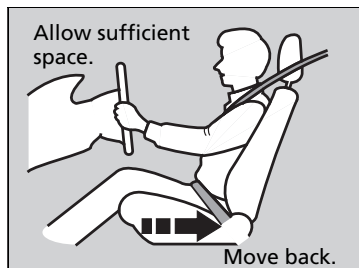

Adjust the driver's seat as far back as possible while allowing you to maintain full control of the vehicle. You should be able to sit upright, well back in the seat and be able to adequately press the pedals without leaning forward, and grip the steering wheel comfortably. The passenger's seat should be adjusted in a similar manner, so that it is as far back from the front airbag in the dashboard as possible.

Adjusting the Seats

⚠ WARNING

Sitting too close to a front airbag can result in serious injury or death if the front airbags inflate.

Always sit as far back from the front airbags as possible while maintaining control of the vehicle.

The National Highway Traffic Safety Administration recommends that drivers allow at least 10 inches (25 cm) between the center of the steering wheel and the chest.

Always make seat adjustments before driving.

Adjusting the Seat Positions

Adjusting the front power seats

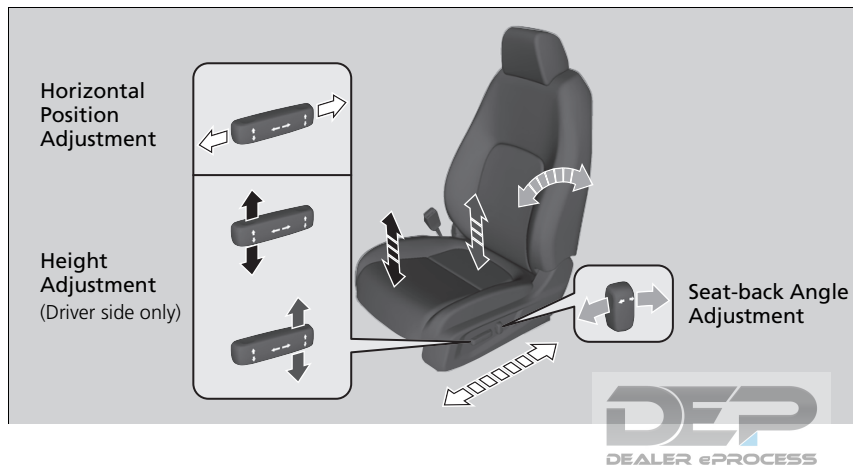

Continued

■ Adjusting the Seat-Backs

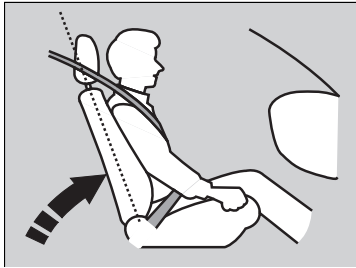

Adjust the driver's seat-back to a comfortable, upright position, leaving ample space between your chest and the airbag cover in the center of the steering wheel.

The front seat passenger should also adjust their seat-back to a comfortable, upright position.

Reclining a seat-back so that the shoulder part of the belt no longer rests against the occupant's chest reduces the protective capability of the belt. It also increases the chance of sliding under the belt in a crash and being seriously injured. The farther a seat-back is reclined, the greater the risk of injury.

► Adjusting the Seat-Backs

⚠ WARNING

Reclining the seat-back too far can result in serious injury or death in a crash.

Adjust the seat-back to an upright position, and sit well back in the seat.

Do not put a cushion, or other object, between the seat-back and your back. Doing so may interfere with proper seat belt or airbag operation.

If you cannot get far enough away from the steering wheel and still reach the controls, we recommend that you investigate whether some type of adaptive equipment may help.

Head Restraints

Your vehicle is equipped with head restraints in all seating positions.

■ Adjusting the Front Head Restraints Positions

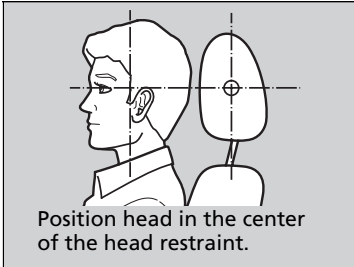

Head restraints are most effective for protection against whiplash and other rear-impact crash injuries when the center of the back of the occupant's head rests against the center of the restraint. The tops of the occupant's ears should be level with the center height of the restraint.

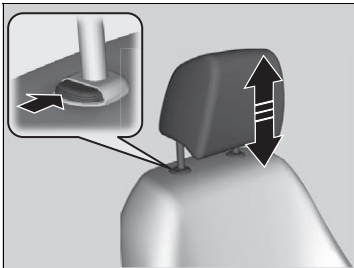

To raise the head restraint:

Pull it upward.

To lower the head restraint:

Push it down while pressing the release button.

⊠ Head Restraints

⚠ WARNING

Improperly positioning head restraints reduces their effectiveness and increases the likelihood of serious injury in a crash.

Make sure head restraints are in place and positioned properly before driving.

In order for the head restraint system to work properly:

- Do not hang any items on the head restraints, or from the restraint legs.
- Do not place any objects between an occupant and the seat-back.
- Install each restraint in its proper location.

■ Changing the Rear Center Seat Head Restraint Positions

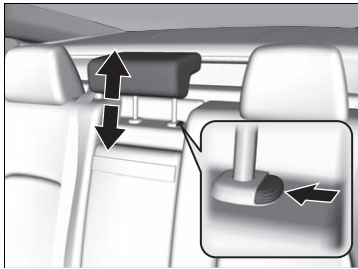

A passenger sitting in the center back seating position should adjust the height of their head restraint to an appropriate position before the vehicle begins moving.

To raise the head restraint:

Pull it upward.

To lower the head restraint:

Push it down while pressing the release button.

Front and rear center head restraints

■ Removing and Reinstalling the Head Restraints

Head restraints can be removed for cleaning or repair.

To remove a head restraint:

Pull the restraint up as far as it will go. Then push the release button, and pull the restraint up and out.

To reinstall a head restraint:

Insert the legs back in place, then adjust the head restraint to an appropriate height while pressing the release button. Pull up on the restraint to make sure it is locked in position.

✎ Removing and Reinstalling the Head Restraints

⚠ WARNING

Failure to reinstall, or correctly reinstall, the head restraints can result in severe injury during a crash.

Always replace the head restraints before driving.

Maintain a Proper Sitting Position

After all occupants have adjusted their seats and head restraints, and put on their seat belts, it is very important that they continue to sit upright, well back in their seats, with their feet on the floor, until the vehicle is safely parked and the power system is off.

Sitting improperly can increase the chance of injury during a crash. For example, if an occupant slouches, lies down, turns sideways, sits forward, leans forward or sideways, or puts one or both feet up, the chance of injury during a crash is greatly increased.

In addition, an occupant who is out of position in the front seat can be seriously or fatally injured in a crash by striking interior parts of the vehicle or being struck by an inflating front airbag.

ⓘ Maintain a Proper Sitting Position

⚠ WARNING

Sitting improperly or out of position can result in serious injury or death in a crash.

Always sit upright, well back in the seat, with your feet on the floor.

Rear Seats

■ 60/40 Split Folding Down the Rear Seats

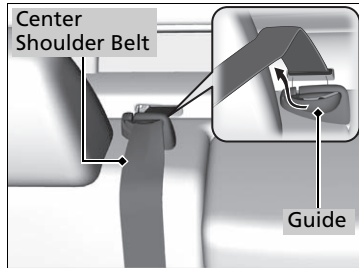

1. Remove the center shoulder belt from the guide.

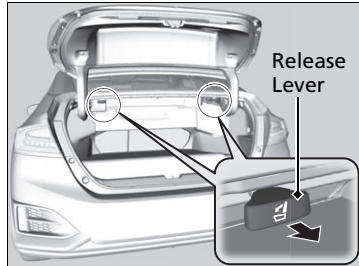

2. Pull the release lever in the trunk to release the lock.

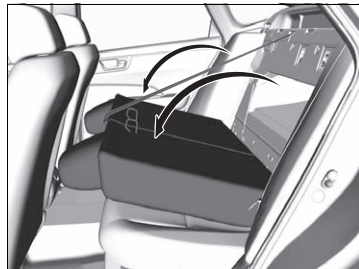

3. Fold the seat-back down.

▣ 60/40 Split Folding Down the Rear Seats

The rear seat-back(s) can be folded down to accommodate bulkier items in the trunk.

To lock the seat-back upright, push it backwards until it locks.

When returning a seat-back to its original position, push it firmly back. Also, make sure all rear shoulder belts are positioned in front of the seat-back, and the center shoulder belt is re-positioned in the guide.

Make sure that the folded seat-back does not press against the front passenger seat, as this can cause the weight sensors in the front passenger seat to work improperly.

▣ **Passenger Front Airbag Off Indicator** P. 65

Also make sure all items in the trunk or items extending through the opening into the rear seats are properly secured. Loose items can fly forward if you have to brake hard.

The front seat(s) must be far enough forward so they do not interfere with the rear seats as they fold down.



Armrest

■ Using the Front Seat Armrest

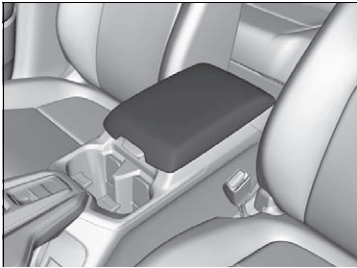

The console lid can be used as an armrest.

■ Using the Rear Seat Armrest



Pull down the armrest in the center backrest.

Interior Lights

Interior Light Switches

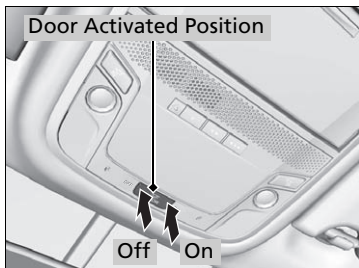

■ ON

The interior lights come on regardless of whether the doors are open or closed.

■ Door activated

The interior lights come on in the following situations:

- When any of the doors are opened.
- You unlock the driver's door.
- When the power mode is set to VEHICLE OFF (LOCK).

■ OFF

The interior lights remain off regardless of whether the doors are open or closed.

Interior Light Switches

In the door activated position, the interior lights fade out and go off about 30 seconds after the doors are closed.

The lights go off after about 30 seconds in the following situations:

- When you unlock the driver's door but do not open it.
- When you set the power mode to VEHICLE OFF (LOCK) but do not open a door.

You can change the interior lights dimming time.

➤ **Customized Features** P. 296

The interior lights go off immediately in the following situations:

- When you lock the driver's door.
- When you close the driver's door in ACCESSORY mode.
- When you set the power mode to ON.

To avoid draining the 12-volt battery, do not leave the interior light on for an extended length of time when the power system is off.

If you leave any of the doors open in VEHICLE OFF (LOCK) mode, the interior lights go off after about 15 minutes.

Map Lights

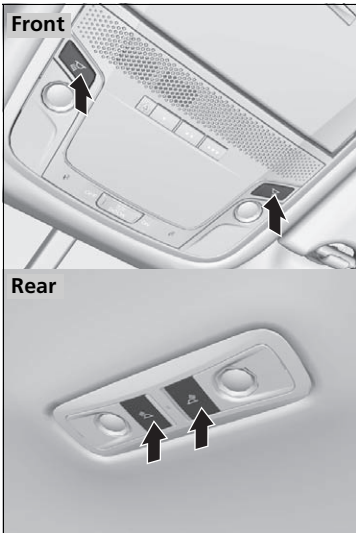

The map lights can be turned on and off by pressing the  (map light) button.

Map Lights

When the interior light switch is in the door activated position and any door is open, the rear map light will not go off when you press the  (map light) button.

Interior Convenience Items

■ Glove Box

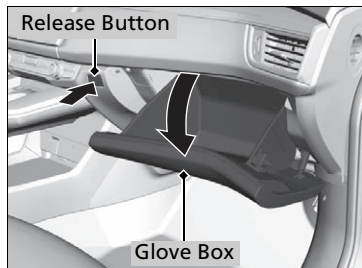

Press the release button to open the glove box.

☞ Glove Box

⚠ WARNING

An open glove box can cause serious injury to your passenger in a crash, even if the passenger is wearing the seat belt.

Always keep the glove box closed while driving.

The glove box light comes on when the parking lights are on.

■ Console Compartment

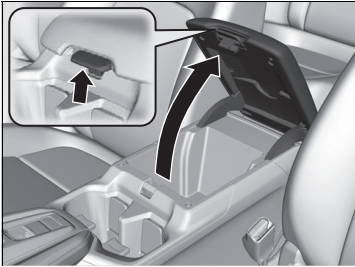

Pull the handle to open the console compartment.

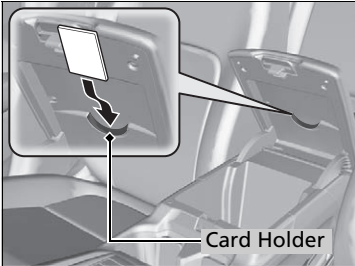

You can use the card holder located in the console compartment lid.



Continued

■ Beverage Holders

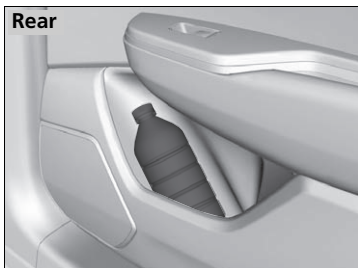
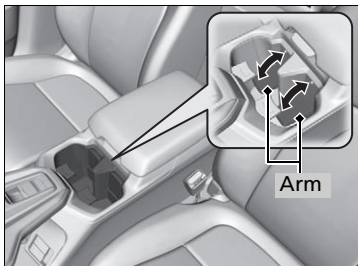

■ Front seat beverage holders

The beverage holders have two bases, an adjustable upper base and a fixed lower base.

For short cups, flip the upper base into position by lowering the arm. For tall cups, reverse the procedure.

■ Door side beverage holders

Are located on the both of the front and rear door side pockets.

► Beverage Holders

NOTICE

Spilled liquids can damage the upholstery, carpeting, and electrical components in the interior.

Be careful when you are using the beverage holders. Hot liquid can scald you.



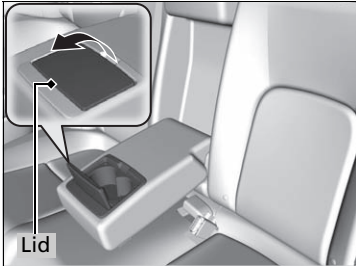

■ **Rear seat beverage holders**

Pull down the armrest in the center backrest and open the lid to use it.



Continued

■ Accessory Power Sockets

The accessory power sockets can be used when the power mode is in ACCESSORY or ON.

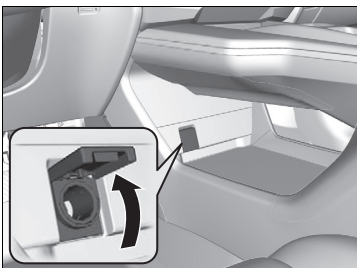

■ Accessory power socket (console panel)

Open the cover to use it.



■ Accessory power socket (back of the console compartment)

Open the cover to use it.

» Accessory Power Sockets

NOTICE

Do not insert an automotive type cigarette lighter element. This can overheat the power socket.

The accessory power sockets are designed to supply power for 12-volt DC accessories that are rated 180 watts (15 amps) or less.

To prevent 12-volt battery drain, only use the power socket with the power system on.

■ Coat Hook

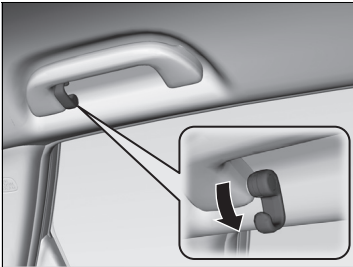

There is a coat hook on the rear left grab handle. Pull it down to use it.

■ Under-Floor Storage Area

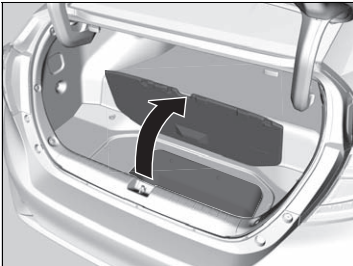

Pull up the cargo area floor lid.

☒ Coat Hook

The coat hook is not designed for large or heavy items.

Seat Heaters

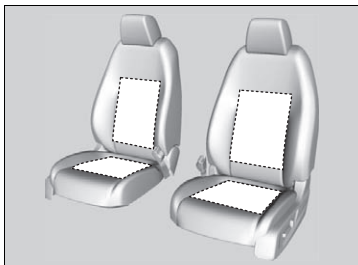

The power mode must be in ON to use the seat heaters.

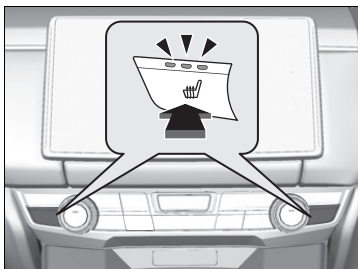

Press the seat heater button:

Once - The HI setting (three indicators on)

Twice - The MID setting (two indicators on)

Three times - The LO setting (one indicator on)

Four times - The OFF setting (no indicators on)

Seat Heaters

WARNING

Heat induced burns are possible when using seat heaters.

Persons with a diminished ability to sense temperature (e.g., persons with diabetes, lower-limb nerve damage, or paralysis) or with sensitive skin should not use seat heaters.

Avoid using seat heaters when the 12-volt battery charge is low. The vehicle may be difficult to start.

After a certain period of time, the strength setting for the seat heaters will automatically be reduced by one level at a time until the seat heaters shuts off. The elapsed time varies according to the interior environment.

When the ECON mode is active, the driver's side seat heater functions according to the status of the climate control system. If you want to use only the climate control system, press the seat heater button to OFF.

Sunglasses Holder

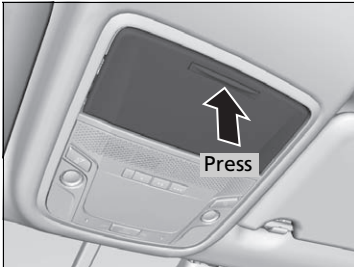

To open the sunglasses holder, press and release the indent. To close, press it again until it latches.

You can store eyeglasses and other small items in this holder.

☒ Sunglasses Holder

Keep the holder closed while driving except when accessing stored items.

Using Automatic Climate Control

The automatic climate control system maintains the interior temperature you select. The system also selects the proper mix of heated or cooled air that raises or lowers the interior temperature to your preference as quickly as possible.

Using Automatic Climate Control

Press the **CLIMATE** button to display **A/C, MODE**, fan control information on the audio/information screen to operate manually. Select icon to turn on or off **A/C**, change the vent mode, or change the fan speed.

If any buttons/icons are pressed while using the climate control system in auto, the function of the button/icon that was pressed will take priority. The **AUTO** indicator will go off, but functions unrelated to the button/icon that was pressed will be controlled automatically.

To prevent cold air from blowing in from outside, the fan may operate at low speed for a while after the **AUTO** button has been pressed.

If the interior is very warm, you can cool it down more rapidly by partially opening the windows, turning the system on auto, and setting the temperature to low. Change the fresh air mode to recirculation mode until the temperature cools down.

When you set the temperature to the lower or upper limit, **Lo** or **Hi** is displayed.

Pressing the **ON/OFF** button switches the climate control system between on and off. When turned on, the system returns to your last selection.



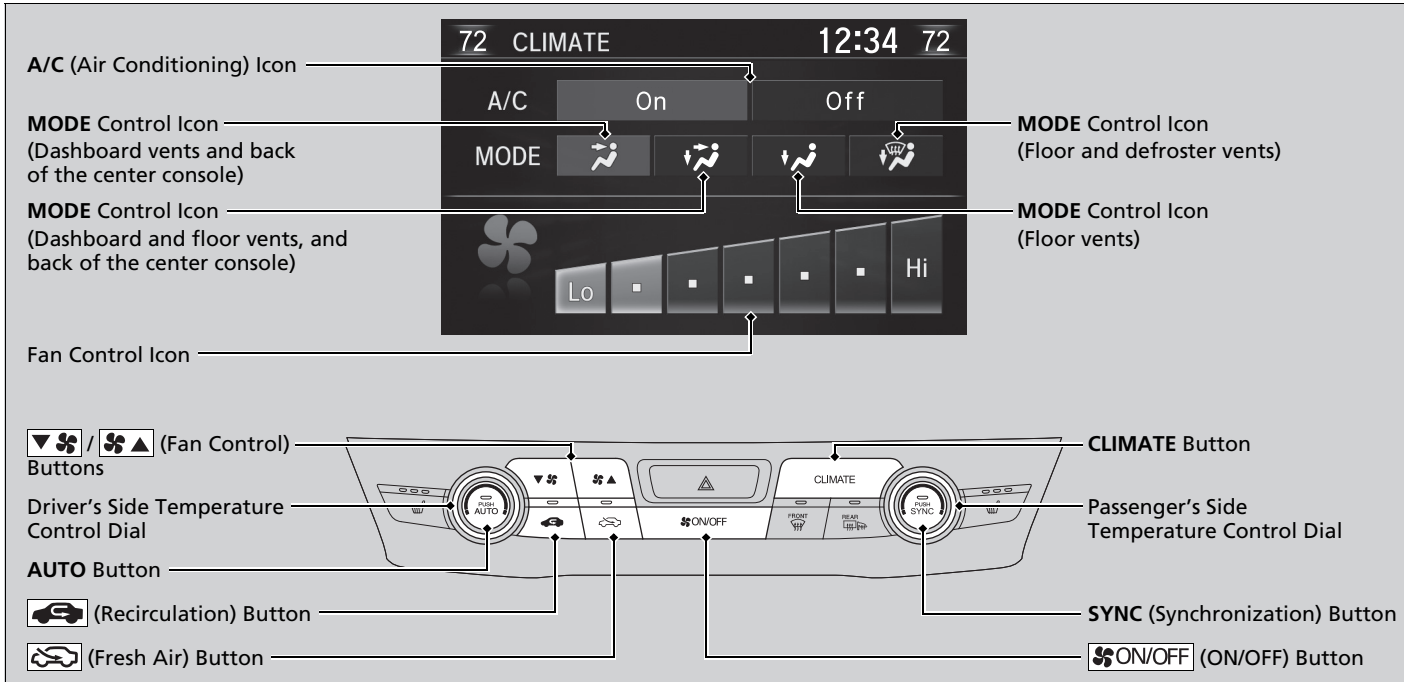

Use the system when the power system is on.

1. Press the **AUTO** button.
2. Adjust the interior temperature using the driver's side or passenger's side temperature control dial.
3. Press the **ON/OFF** (ON/OFF) button to cancel.



■ Switching the vent mode

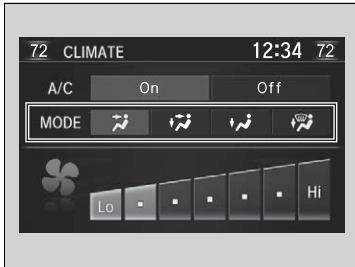

1. Press the **CLIMATE** button.
2. Select a desired vent mode icon.

■ A/C on and off

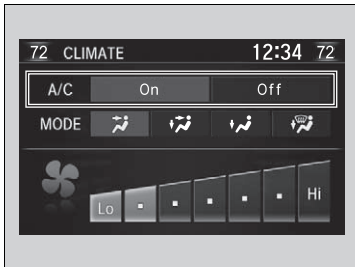

1. Press the **CLIMATE** button.
2. Select **On** or **Off**.

►► Using Automatic Climate Control

When you unlock the doors with your remote, the driver's ID (**DRIVER 1** or **DRIVER 2**) is detected, and the climate control settings are turned to the respective mode automatically when you set the power mode to ON.

The High Voltage battery level being low may reduce the climate control system performance.



If any icons are not selected within several seconds after the display is switched, it returns to the previous screen. In this case, press the **CLIMATE** button again.

You can change the length of time the climate control display stays on.

► **Customized Features** P. 296

While ECON mode is active, the climate control system may have reduced cooling performance.

■ Switching between the recirculation and fresh air modes

Press the  (recirculation) or  (fresh air) button to switch the mode depending on environmental conditions.

 Recirculation mode (indicator on): Recirculates air from the vehicle's interior through the system.

 Fresh air mode (indicator on): Maintains outside ventilation. Keep the system in fresh air mode in normal situations.



■ Defrosting the Windshield and Windows

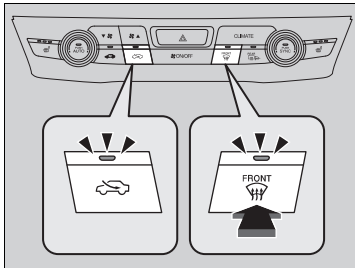

Pressing the  button turns the air conditioning system on and automatically switches the system to fresh air mode.

Press the  button again to turn off, the system returns to the previous settings.

■ To rapidly defrost the windows

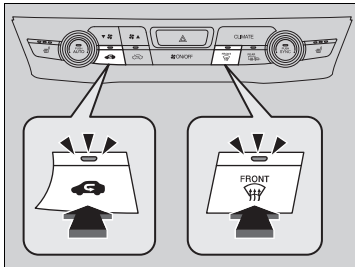

1. Press the  button.
2. Press the  button.

►► Defrosting the Windshield and Windows

For your safety, make sure you have a clear view through all the windows before driving.

Do not set the temperature near the upper or lower limit.

When cold air hits the windshield, the outside of the windshield may fog up.

If the side windows fog up, adjust the vents so that the air hits the side windows.

►► To rapidly defrost the windows

After defrosting the windows, switch over to fresh air mode.

If you keep the system in recirculation mode, the windows may fog up from humidity. This impedes visibility.

Synchronization Mode

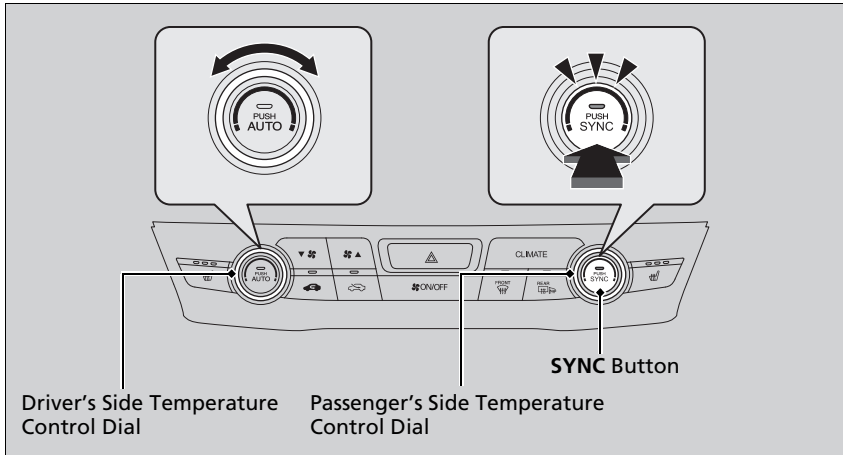

You can set the temperature synchronously for the driver's side and the passenger's side in synchronization mode.

1. Press the **SYNC** button.
 - The system switches to synchronization mode.
2. Adjust the temperature using the driver's side temperature control dial.

To return to dual mode, you can either press the **SYNC** button again or turn the dial of the passenger's side temperature control unit.

Synchronization Mode

When you press the  button, the system changes to synchronization mode.

When the system is in dual mode, the driver's side temperature and the passenger's side temperature can be set separately.

■ Turning the Climate Control System On and Off with the Remote

You can operate the climate control system from outside the vehicle.

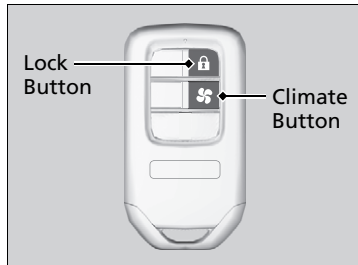

■ To turn on the system

1. Press the lock button.
 - ▶ Some exterior lights flash.
2. Within about five seconds, press and hold the climate button.
 - ▶ Some exterior lights flash.
 - ▶ After a few seconds, some exterior lights flash six times and the climate control system is turned on.

■ To turn off the system

Press and hold the climate button.

- ▶ Some exterior lights flash and the climate control system is turned off.

▶▶ Turning the Climate Control System On and Off with the Remote

⚠ WARNING

Make sure that no one is inside the vehicle when you use the remote climate control system. After a certain period of time has elapsed, the system shuts off temporarily. During this time, the interior of the vehicle may heat up or cool down depending on ambient temperatures. If a child is left inside the vehicle, extreme temperature exposure can result in death or serious injury of the child.

The climate control system does not operate when any of the following conditions are met.

- A door or the hood is not closed.
- The power mode is set to any mode other than OFF.
- The brake pedal is being depressed.
- The High Voltage battery level is low.

Make sure you use level 2 (240 volt) or DC fast charging when you activate the climate control system during vehicle charging.

☒ Turning the Climate Control System On and Off with the Remote

The climate control system automatically turned off when any of the following conditions are met.

- The system has been operated for more than 30 minutes.
- The High Voltage battery level becomes low.
- A door or the hood is opened.
- The power mode is set to any mode other than OFF.
- The brake pedal is being depressed.

If the charging connector is unplugged, the High Voltage battery is used to power the climate control system.

Automatic Climate Control Sensors

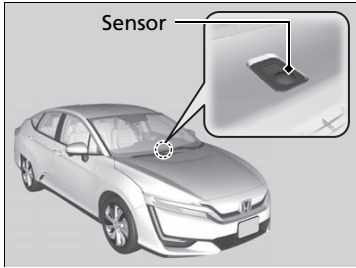

The automatic climate control system is equipped with sensors. Do not cover or spill any liquid on them.

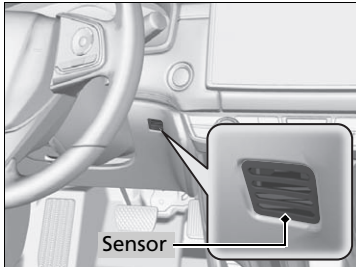

Features

This chapter describes how to operate technology features.

Audio System

About Your Audio System	196
USB Ports	197
Audio System Theft Protection	198
Audio Remote Controls	199
Audio System Basic Operation	202
Audio/Information Screen	203
Adjusting the Sound	226
Display Setup	227
Voice Control Operation	229
Playing AM/FM Radio	233
Playing SiriusXM® Radio	237

Playing an iPod	245
Song By Voice™ (SBV)	248
Playing Pandora®	252
Playing a USB Flash Drive	254
Playing <i>Bluetooth</i> ® Audio	257
HondaLink®	259
Wi-Fi Connection	264
Siri Eyes Free	266
Apple CarPlay	267
Android Auto	270
Audio Error Messages	274

General Information on the Audio

System	278
Customized Features	296
HomeLink® Universal Transceiver	322
<i>Bluetooth</i>® HandsFreeLink®	325



About Your Audio System

The audio system features AM/FM radio and SiriusXM® Radio service. It can also play USB flash drives, and iPod®, iPhone® and *Bluetooth*® devices.

You can operate the audio system from the buttons and switches on the panel, the remote controls on the steering wheel, or the icons on the touchscreen interface.

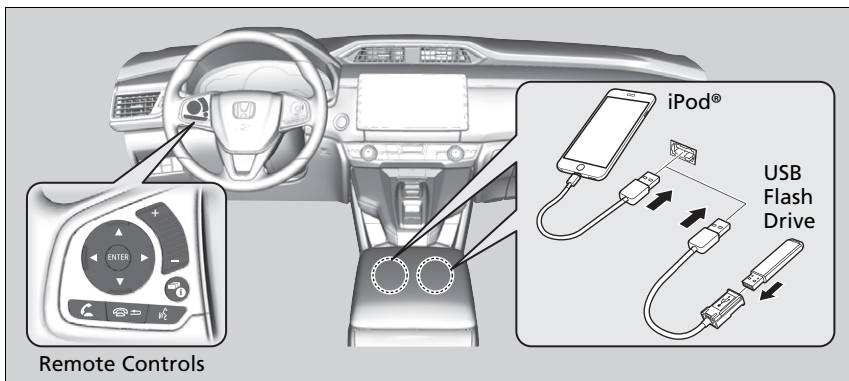

▣ About Your Audio System

SiriusXM® Radio is available on a subscription basis only. For more information on SiriusXM® Radio, contact an authorized Honda Clarity Electric dealer.

▣ **General Information on the Audio System** P. 278

SiriusXM® Radio is available in the United States and Canada, except Hawaii, Alaska, and Puerto Rico.

SiriusXM® is a registered trademark of SiriusXM Radio, Inc.

iPod®, iPhone® and iTunes® are trademarks of Apple Inc.

State or local laws may prohibit the operation of handheld electronic devices while operating a vehicle.

USB Ports

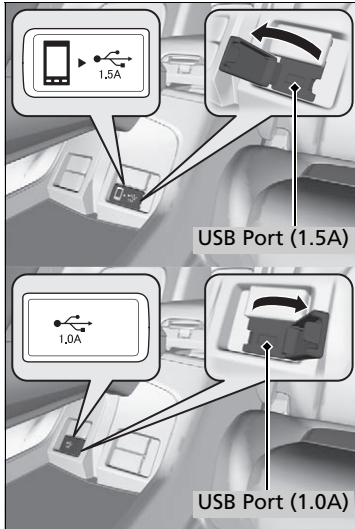

Install the device USB connector or the USB flash drive to the USB port.

- ▶ The USB port (1.5A) is for charging devices, playing audio files and connecting compatible phones with Apple CarPlay or Android Auto.
- ▶ The USB port (1.0A) is for playing audio files on the USB flash drive and connecting a cellular phone and charging device.

USB Ports

- Do not leave the iPod or USB flash drive in the vehicle. Direct sunlight and high temperatures may damage it.
- We recommend using an extension cable with the USB port.
- Do not connect the iPod or USB flash drive using a hub.
- Do not use a device such as a card reader or hard disk drive, as the device or your files may be damaged.
- We recommend backing up your data before using the device in your vehicle.
- Displayed messages may vary depending on the device model and software version.

If the audio system does not recognize the iPod, try reconnecting it a few times or reboot the device. To reboot, follow the manufacturer's instructions provided with the iPod or visit www.apple.com/ipod.

USB charge

The USB port can supply up to 1.0A or 1.5A of power. It does not output 1.0A or 1.5A unless requested by the device.

For amperage details, read the operating manual of the device that needs to be charged.

Turn the power mode to ACCESSORY or ON first.

Under certain conditions, a device connected to the port may generate noise in the radio you are listening to.

Audio System Theft Protection

The audio system is disabled when it is disconnected from the power source, such as when the 12-volt battery is disconnected or goes dead. In certain conditions, the system may display a code entry screen. If this occurs, reactivate the audio system.

■ Reactivating the audio system

1. Set the power mode to ON.
2. Turn on the audio system.
3. Select and hold the audio system power icon for more than two seconds.
 - ▶ The audio system is reactivated when the audio control unit establishes a connection with the vehicle control unit. If the control unit fails to recognize the audio unit, you must go to an authorized Honda Clarity Electric dealer and have the audio unit checked.

Audio Remote Controls

Allow you to operate the audio system while driving. The information is shown on the driver information interface.

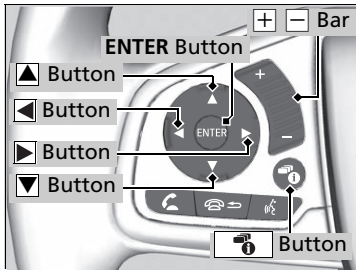

▲ ▼ Buttons

Press ▲ or ▼ to cycle through the audio mode as follows:

FM→AM→SiriusXM®→USB→iPod
→Bluetooth® Audio→Pandora®→Apple
CarPlay/Android Auto

ENTER Button

- When listening to the radio and SiriusXM®
 1. Press **ENTER** to switch the display to a preset list you stored in the preset buttons.
 2. Press ▲ or ▼ to select a preset, then press **ENTER**.
- When listening to a USB flash drive
 1. Press **ENTER** to display the folder list.
 2. Press ▲ or ▼ to select a folder.
 3. Press **ENTER** to display a list of tracks in that folder.
 4. Press ▲ or ▼ to select a track, then press **ENTER**.

Audio Remote Controls

Some modes appear only when an appropriate device or medium is used.

Depending on the Bluetooth® device you connect, some functions may not be available.

Press the  (Hang-up/back) button to go back to the previous command or cancel a command.

Press the  button to switch display.

▶ **Switching the Display** P. 203





Continued



- When listening to an iPod
 1. Press **ENTER** to display the iPod music list.
 2. Press ▲ or ▼ to select a category.
 3. Press **ENTER** to display a list of items in the category.
 4. Press ▲ or ▼ to select an item, then press **ENTER**.
 - ▶ Press **ENTER** and press ▲ or ▼ repeatedly until the desired mode you want to listen to is displayed.
- When listening to Pandora®
 1. Press **ENTER** to display the station list.
 2. Press ▲ or ▼ to select an item, then press **ENTER**.
- When listening to *Bluetooth*® Audio
 1. Press **ENTER** to display the track list.
 2. Press ▲ or ▼ to select a track, then press **ENTER**.

+ - (Volume) Bar**Press** : To increase the volume.**Press** : To decrease the volume.**◀ ▶ Buttons**

- When listening to the radio

Press : To select the next preset radio station.**Press** : To select the previous preset radio station.**Press and hold** : To select the next strong station.**Press and hold** : To select the previous strong station.



- When listening to an iPod, USB flash drive, or *Bluetooth*® Audio

Press : To skip to the next song.**Press** : To go back to the beginning of the current or previous song.

- When listening to a USB flash drive

Press and hold : To skip to the next folder.**Press and hold** : To go back to the previous folder.

- When listening to Pandora®

Press : To skip to the next track.**Press and hold** : To select the next station.**Press and hold** : To select the previous station.

To use the audio system function, the power mode must be in ACCESSORY or ON.

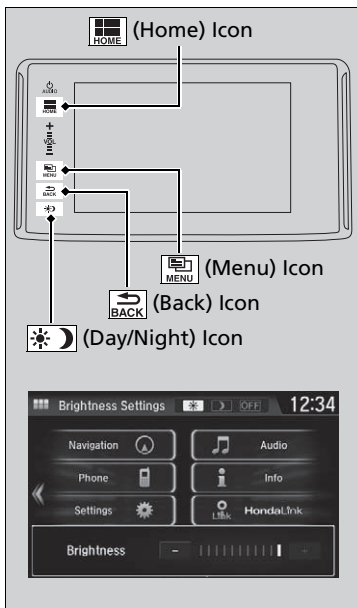

Select to go to the home screen.

▶ Using the audio/information screen

P. 204



Select to display available options including **Sound**, **View Radio Text**, **Music Search**, and playback modes.



Select to go back to the previous screen when the icon is illuminated.



(Day/Night): Select to change the audio/information screen brightness. Select once and select or to make an adjustment.

- ▶ Each time you select , the mode switches among the daytime mode, nighttime mode and off mode.

▶ Audio System Basic Operation

Audio Menu Items

- ▶ **Station List** P. 234, 235
- ▶ **Music Search List** P. 246, 255
- ▶ **Scan** P. 235, 236, 244, 256
- ▶ **Play Mode** P. 247, 256

Audio/Information Screen

Displays the audio status and wallpaper. From this display, you can go to various setup options.

Switching the Display

Using the button

Press the  (display) button to change the display.

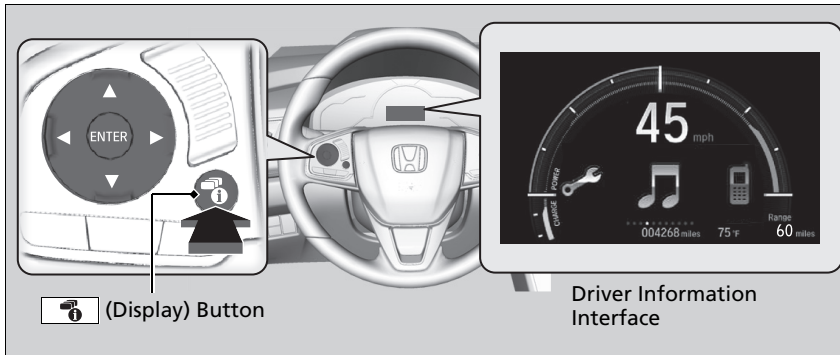



Using the button

You can edit, add, and delete the contents shown on the driver information interface.

Customizing the Meter P. 209

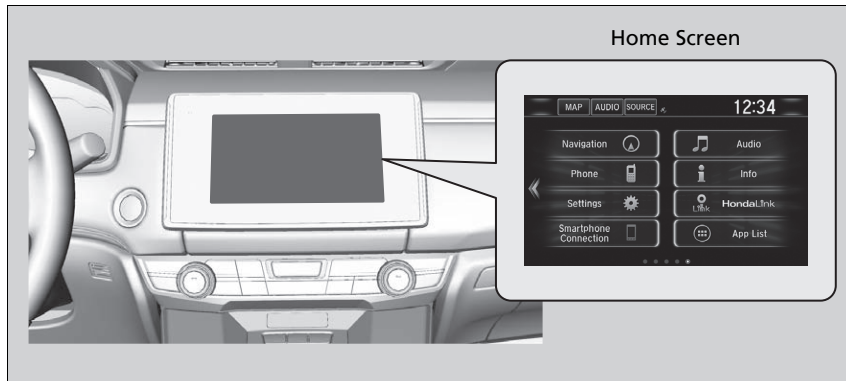
■ Using the audio/information screen



Select  to go to the home screen.

Select **Phone**, **Info**, **Audio**, **Settings**, **Navigation**, **HondaLink**, **Smartphone Connection** (Apple CarPlay, Android Auto), **App List**, or **Instrument Panel**.

■ Phone

Displays the HFL information.

➤ **Bluetooth® HandsFreeLink®** P. 325

■ Info

Displays **Trip Computer** or **Clock/Wallpaper**. Select  on the **Info Menu** screen to see all available options: **Trip Computer**, **Voice Info**, **Clock/Wallpaper**, **System/Device Information** and **Vehicle energy**.

Trip Computer:

- **Current Drive** tab: Displays the current trip information.
- **History of Trip A** tab: Displays information for the three previous drives. The information is stored every time you reset Trip A.
To delete the history manually, select **Delete history** on the **History of Trip A** tab. The confirmation message appears on the screen, then select **Yes**.

Voice Info: Displays a list of all voice commands.

Clock/Wallpaper: Displays the clock and wallpaper.

System/Device Information:

- **System Info:** Displays the software version of the audio system.
- **USB Info:** Displays the memory usage of the USB device.

Vehicle energy:

Displays the energy flow screen.

 **Energy flow screen** P. 207

■ Audio

Displays the current audio information.

Audio/Information Screen

Touchscreen operation

- Use simple gestures - including touching, swiping and scrolling - to operate certain audio functions.
- Some items may be grayed out during driving to reduce the potential for distraction.
- You can select them when the vehicle is stopped or use voice commands.
- Wearing gloves may limit or prevent touchscreen response.

You can change the touchscreen sensitivity setting.

 **Customized Features** P. 296



Continued

■ Settings

Enters the customizing menu screen.

➤ **Customized Features** P. 296

■ Navigation

Displays the navigation screen.

➤ **Refer to the Navigation System Manual**

■ HondaLink®

Displays the Hondalink® screen.

➤ **HondaLink®** P. 259

■ Smartphone Connection

Displays the Apple CarPlay or Android Auto.

➤ **Apple CarPlay** P. 267

➤ **Android Auto** P. 270

■ App List

Adds or removes apps or widgets on the Home screen.

➤ **Home Screen** P. 215

■ Instrument Panel

Selects from three customizable settings for the driver information interface.

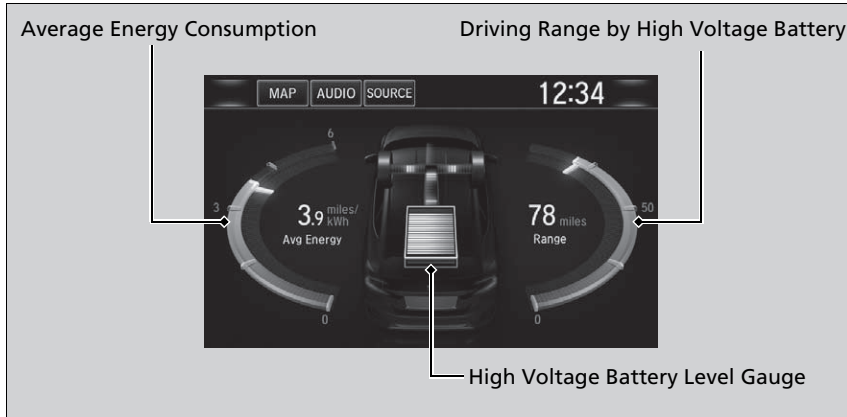

■ Energy flow screen

The energy flow screen shows the vehicle's power flow, average energy consumption, and range.



Shows the High Voltage battery power flow, indicating what is supplying power to the vehicle and/or charging the battery.

- ▶ The indicator for the power transmission appears in blue, and for the battery charging operation, in green.

Display	Color of indicators	Vehicle's Condition
	Blue	While Driving: Power is being supplied by the High Voltage battery.
	Green	While Decelerating: High Voltage battery is being charged by regenerative braking.
	—	When Stopped: The vehicle is idle (standby state).



Changing the Home Screen Icon Layout



1. Select .
2. Select and hold an icon.
 - ▶ The screen switches to the customization screen.
3. Drag and drop the icon to where you want it to be.
4. Select **OK**.
 - ▶ The screen will return to the home screen.

Customizing the Meter

You can edit, add, or delete the meter contents on the driver information interface.

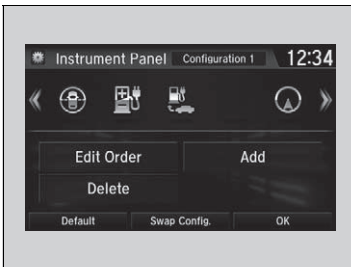

1. .
2. **Settings**
3. **System**
4. **Configuration of Instrument Panel**

Customizing the Meter

You can store up to three customized configurations. To select or customize a configuration, press **Swap Config.**

When you select **Swap Config.** during customization, the settings you changed will be saved.

When you select  during customization, the settings you changed will not be saved and you will be returned to the **Configuration of Instrument Panel** screen.

■ Editing order

To change the order of the icons on the driver information interface, first select:

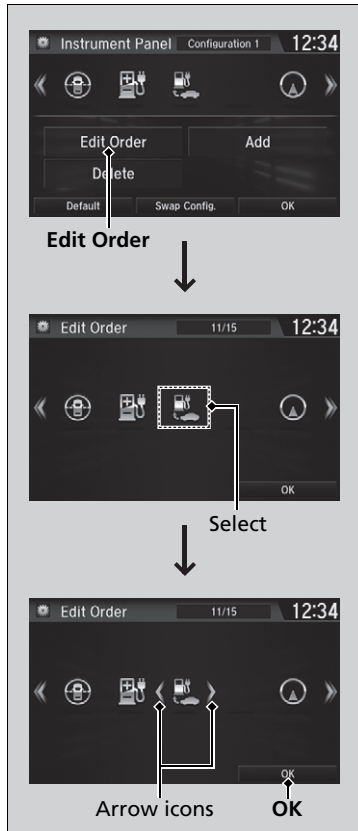

1. Edit Order

2. Select the icon you want to move.

- ▶ You will see arrows on both sides of the selected icon.

3. Select the left or right arrow repeatedly to move the icon to your desired position.

4. Select **OK**.

- ▶ The screen will return to the **Configuration of Instrument Panel** screen.



▶▶ Editing order

You can use an alternative method to change the order of the icons. First select:

1. **Edit Order**

2. Select and hold the icon you want to move.
3. Drag and drop the icon to where you want it to be.
4. Select **OK**.

- ▶ The screen will return to the **Configuration of Instrument Panel** screen.

■ Adding contents

You can add icons to the driver information interface. To add icons, first select:

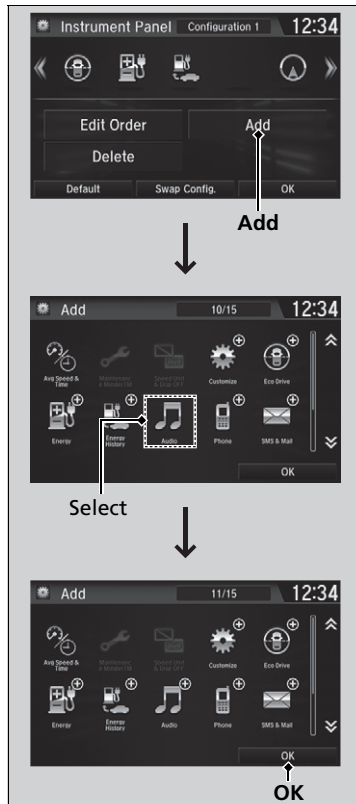

1. Add

2. Select an icon you want to add.

- ▶ You will see a plus mark on the upper right hand corner of the selected icon.

3. Select **OK**.

- ▶ The screen will return to the **Configuration of Instrument Panel** screen.



Continued

▶▶ Adding contents

Icons that are grayed out cannot be selected.

If an icon has a plus mark in the upper-right corner, it means that the icon has already been added.

■ Deleting contents

To delete contents on the driver information interface, first select:

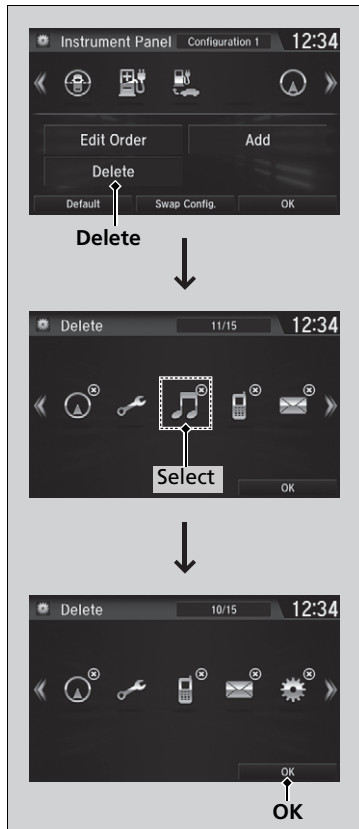

1. Delete

2. Select an icon you want to delete.

- ▶ The icon with an **X** on the upper right hand corner can be deleted.

3. Select **OK**.

- ▶ The screen will return to the **Configuration of Instrument Panel** screen.

▶▶ Deleting contents

You can also delete contents by selecting:

1. **Delete** or **Edit Order**

2. Select and hold an icon you want to delete.
3. Drag and drop the icon to the trash icon.
4. Select **OK**.

- ▶ The screen will return to the **Configuration of Instrument Panel** screen.



Wallpaper Setup

You can change, store, and delete the wallpaper on the audio/information screen.

Import wallpaper

You can import up to five images, one at a time, for wallpaper from a USB flash drive.

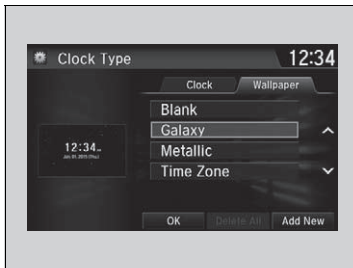

1. Connect the USB flash drive to the USB port.
 ▶ **USB Ports** P. 197
2. Select **Settings**.
3. Select **Clock**.
4. Select **Clock/Wallpaper Type**, then open the **Wallpaper** tab.
5. Select **Add New**.
 ▶ The picture name is displayed on the list.
6. Select a desired picture.
 ▶ The preview is displayed on the left side on the screen.
7. Select **Start Import** to save the data.
 ▶ The display will return to the wallpaper list.

Wallpaper Setup

The wallpaper you set up on **Clock Wallpaper/Type** cannot be displayed on the driver information interface.

- When importing wallpaper files, the image must be in the USB flash drive's root directory. Images in a folder cannot be imported.
- The file name must be fewer than 64 characters.
- The file format of the image that can be imported is BMP (bmp) or JPEG (jpg).
- The individual file size limit is 5 MB.
- The maximum image size is 4,096 × 4,096 pixels. If the image size is less than 800 × 480 pixels, the image is displayed in the middle of the screen with the extra area appearing in black.
- If the USB flash drive does not have any pictures, the **No files detected** message appears.

After changing the screen interface design, you can change the wallpaper by following procedure.

1. Select .
2. Select and hold empty space on the home screen. The pop-up menu appears on the screen.
3. Select **Change wallpaper**.
4. Select **Gallery**, **Live wallpapers**, or **Wallpapers**.

■ Select wallpaper

1. Select **Settings**.
2. Select **Clock**.
3. Select **Clock/Wallpaper Type**, then open the **Wallpaper** tab.
 - ▶ The screen changes to the wallpaper list.
4. Select a desired wallpaper.
 - ▶ The preview is displayed on the left side on the screen.
 - ▶ The pop-up menu appears on the screen.
5. Select **Set**.
 - ▶ The display will return to the wallpaper list.

■ To view wallpaper once it is set

1. Select .
2. Select **Info**.
3. Select .
4. Select **Clock/Wallpaper**.

■ Delete wallpaper

1. Select **Settings**.
2. Select **Clock**.
3. Select **Clock/Wallpaper Type**, then open the **Wallpaper** tab.
 - ▶ The screen changes to the wallpaper list.
4. Select a wallpaper that you want to delete.
 - ▶ The preview is displayed on the left side on the screen.
 - ▶ The pop-up menu appears on the screen.
5. Select **Delete**.
 - ▶ A confirmation message appears on the screen.
6. Select **Yes** to delete completely.
 - ▶ The display will return to the wallpaper list.



▶▶ Wallpaper Setup

From the pop-up menu, select **Preview** to see a preview at full-size screen.

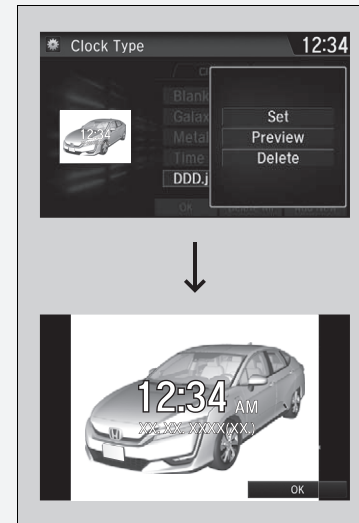

To go back to the previous screen, select **OK**, or select .

When the file size is large, it takes a while to be previewed.

To delete all wallpapers you add, select **Delete All**, then **Yes**.

Home Screen

■ To change to a next screen

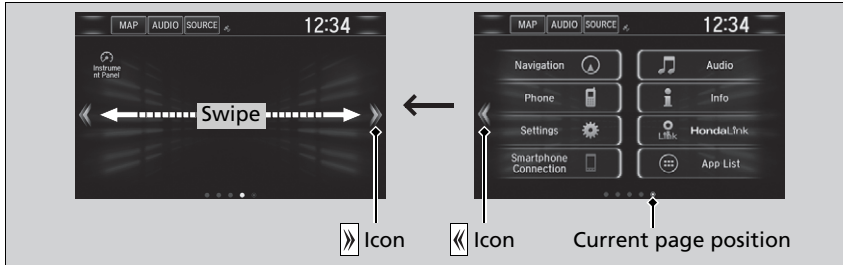

Selecting or , or swiping the screen left or right changes to the next screen.

Home Screen

The home screen has 5 pages (fixed). You cannot add any more pages.

Select to go directly back to the first page of the home screen from any page.

■ To use apps or widgets



1. Select .
2. Select **App List**.
▶ The **App** screen appears.
3. Select the app or widget you want to use.

Preinstall app list:

- **Browser:** Displays the web browser utilized by smartphone and Wi-Fi connection.
- **Calculator:** Displays Calculator.
- **Gallery:** Displays images.
- **Downloads:** Displays the data downloaded from the web browser and so on.
- **App Installer:** Check with a Honda dealer for apps that are available for installation.
- **Search:** Displays various retrieval screen.

▶▶ To use apps or widgets

Select and hold a selected app or widget to add that app's or widget's shortcut on the home screen.

Pre-installed apps may not start up normally. If this occurs, you need to reset the system.

▶▶ **Defaulting All the Settings** P. 321

If you perform **Factory Data Reset**, it may reset all the settings to their factory default.

▶▶ **Defaulting All the Settings** P. 321

In case those apps still do not startup normally even after **Factory Data Reset**, contact an authorized Honda Clarity Electric dealer.

There is a possibility that a browser is shut down in the situation of the use. In that situation, the screen will return to before the browser startup.

Do not install apps other than those confirmed by a Honda dealer. Installation of unauthorized apps may introduce data corruption risks to your vehicle's information and your privacy.

You can delete user installed apps by the following procedure.

1. Select .
2. Select **Settings**.
3. Select **System**.
4. Select the **Others** tab.
5. Select **Detail Information**.
6. Select **Apps**.
7. Select an app that you want to delete.
8. Select **Delete**.

Pre-installed apps cannot be deleted.



■ To add app or widget icons on the home screen

App or widget icons can be added on the home screen.

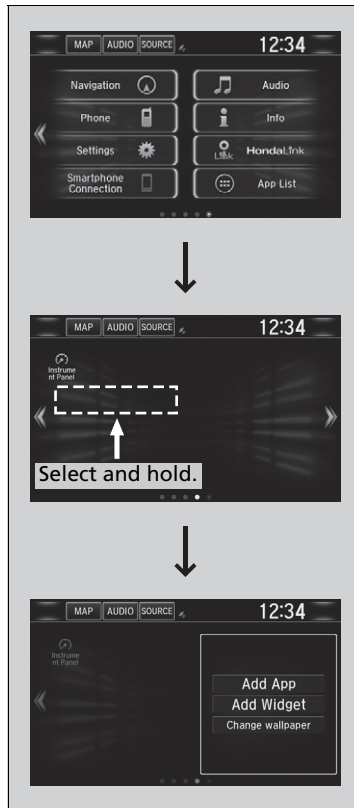

1. Select .
2. Select .
3. Select and hold empty space on the home screen.
 - ▶ The pop-up menu appears on the screen.
4. Select **Add App** or **Add Widget**.
 - ▶ The **App/Widget** screen appears.

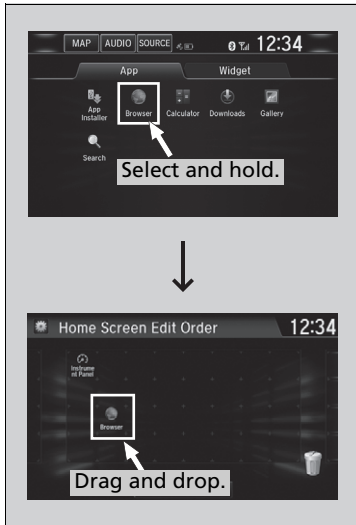

5. Select and hold an app or widget icon you want to add.
 - ▶ The screen switches to the customization screen.
6. Drag and drop the icon to where you want it to be.
7. Select **OK**.
 - ▶ The screen will return to the home screen.

■ To move icons on the home screen

You can change location on the home screen.

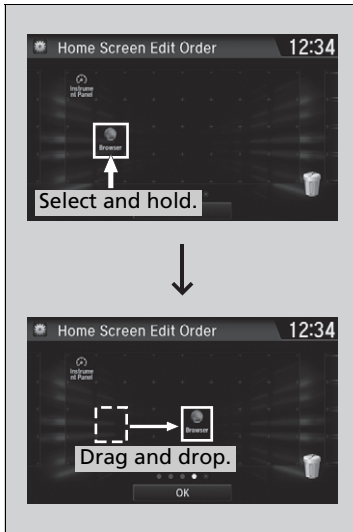

1. Select and hold an icon.
 - ▶ The screen switches to the customization screen.
2. Drag and drop the icon to where you want it to be.
3. Select **OK**.
 - ▶ The screen will return to the home screen.

☒ To move icons on the home screen

You can also move the **Phone, Info, Audio, Settings, Navigation, HondaLink, Smartphone Connection, App List, and Instrument Panel** icons in the same manner.

■ To remove icons on the home screen

You can delete the icons on the home screen.

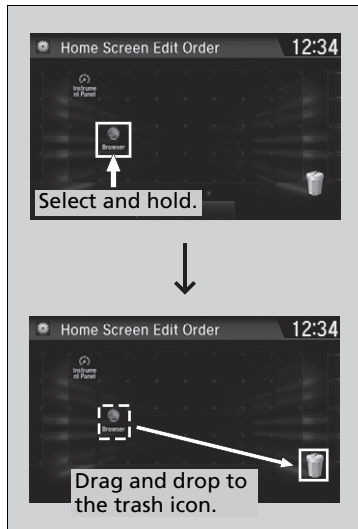

1. Select and hold an icon.
 - ▶ The screen switches to the customization screen.
2. Drag and drop the icon you want to remove to the trash icon.
 - ▶ The icon is removed from the home screen.
3. Select **OK**.
 - ▶ The screen will return to the home screen.

✎ To remove icons on the home screen

You cannot delete the **Phone, Info, Audio, Settings, Navigation, HondaLink, Smartphone Connection, App List, and Instrument Panel** icons.

Apps or widgets will not be deleted by deleting the icon on the home screen.

■ To change the home screen wallpaper

You can change a wallpaper of the home screen.

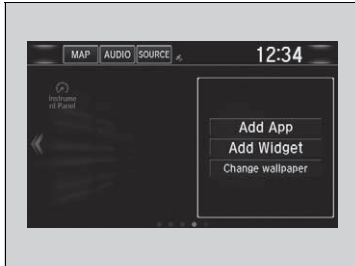

1. Select and hold empty space on the home screen.
 - ▶ The pop-up menu appears on the screen.
2. Select **Change wallpaper**.
 - ▶ The pop-up menu appears on the screen.

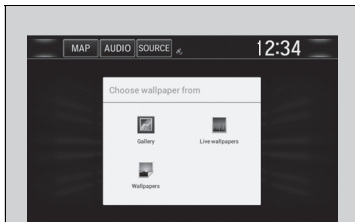

3. Select an app for selecting wallpapers.
4. Select the wallpaper you want to change.
5. Select **Set wallpaper**.
 - ▶ The wallpaper is changed, then the screen will return to the home screen.



Continued

Status Area



1. Swipe the upper area of the screen.
 - ▶ The status area appears.
2. Select an item to see the details.
3. Select **BACK** or swipe up the bottom bar to close the area.

Changing the Screen Interface

You can change the screen interface design.

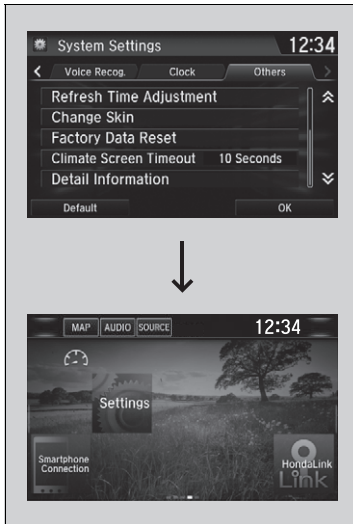

1. Select .
2. Select **Settings**.
3. Select **System**.
4. Select the **Others** tab.
5. Select **Change Skin**.
6. A confirmation message appears on the screen. Select **Yes**.

Changing the Screen Interface

After changing the screen interface design, you can change the wallpaper by following procedure.

1. Select .
2. Select and hold empty space on the home screen. The pop-up menu appears on the screen.
3. Select **Change wallpaper**.
4. Select **Gallery**, **Live wallpapers**, or **Wallpapers**.

If you change the screen interface, some of the setting items will change.

 **Customized Features P. 296**

Menu Customize

You can change menu icons on the right side of **Audio**, **Phone**, and **Info** screen.

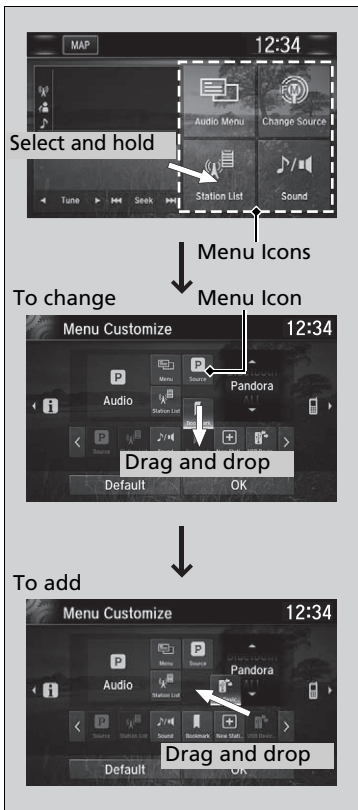

1. Select and hold menu icon.

2. Select ◀ or ▶ icon, then **Audio**, **Phone**, or **Info** from **Menu Customize**.

3. Select and hold the menu icon you want to change, then drag and drop the icon to the bottom.

4. Select and hold the menu icon you want to add, then drag and drop the icon to above.

5. Select **OK**.

Menu Customize

You can also use the method below to change menu icon:

Select **Settings**→**System**→**Home** tab→**Menu Icon Position**



■ Closing Apps

You can close specific apps running in the background on the system.

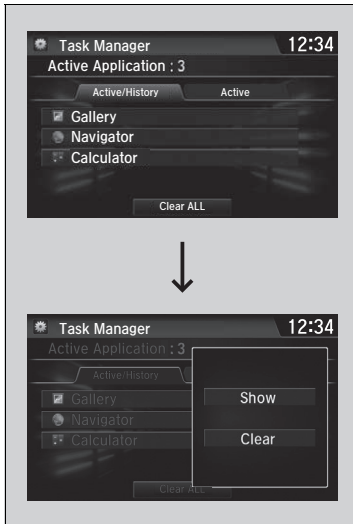

1. Select and hold .
2. Select the **Active** tab.
 - ▶ If you select the **Active/History** tab, you can close the apps that are currently running and delete the app activity history simultaneously.
3. Select an app you want to close.
4. Select **Clear**.
 - ▶ The display will return to the app list.

☒ Closing Apps

If you have a number of apps running in the background and something goes wrong with the audio system, some of those apps may not work properly. If this happens, close all the apps and re-launch the app/apps that you want to use.

To close all apps on the system, select **Clear All**, then **Yes**.

You cannot close the HondaLink® and Garmin apps.

Adjusting the Sound



1. Select .
2. Select **Audio**.
3. Select .
4. Select **Sound**.

Select a tab from the following choices:

- **BAS-MID-TRE:** Bass, Middle, Treble
- **FAD-BAL:** Fader, Balance
- **SVC:** Speed Volume Compensation

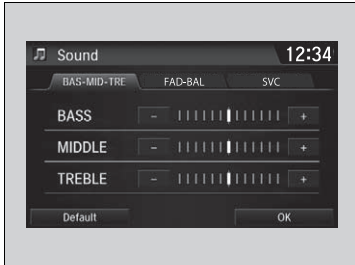

▶▶ Adjusting the Sound

The SVC has four modes: **Off**, **Low**, **Mid**, and **High**. SVC adjusts the volume level based on the vehicle speed. As you go faster, audio volume increases. As you slow down, audio volume decreases.

Display Setup

You can change the brightness or color theme of the audio/information screen.

Changing the Screen Brightness

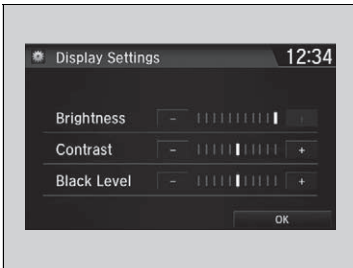

1. Select **HOME**.
2. Select **Settings**.
3. Select **System**.
4. Select the **Display** tab.
5. Select **Display Settings**.
6. Select the setting you want.
7. Select **OK**.

Changing the Screen's Color Theme



1. Select **HOME**.
2. Select **Settings**.
3. Select **System**.
4. Select the **Display** tab.
5. Select **Background Color**.
6. Select the setting you want.
7. Select **OK**.

Changing the Screen Brightness

You can change the **Contrast** and **Black Level** settings in the same manner.

■ Selecting an Audio Source

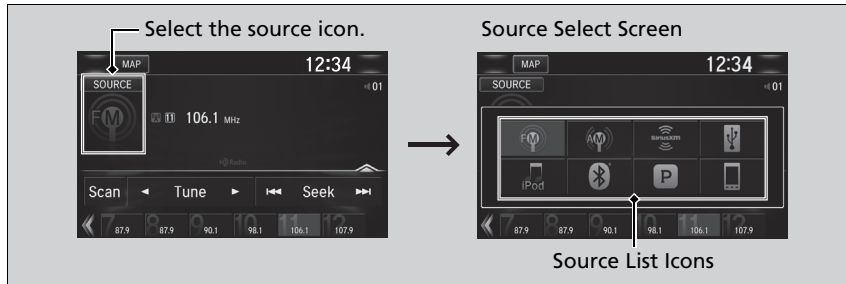



Select the current source icon, then select an icon on the source list to switch the audio source.

■ Limitations for Manual Operation

Certain manual functions are disabled or inoperable while the vehicle is in motion. You cannot select a grayed-out option until the vehicle is stopped.

Voice Control Operation

Your vehicle has a voice control system that allows hands-free operation.

The voice control system uses the  (Talk) and  (hang-up/back) buttons on the steering wheel and a microphone near the map lights in the ceiling.

Voice Recognition

To achieve optimum voice recognition when using the voice control system:



- Make sure the correct screen is displayed for the voice command that you are using.

The system recognizes only certain commands.

Available voice command P. 230

- Close the windows.
- Adjust the dashboard and side vents so air does not blow onto the microphone in the ceiling.
- Speak clearly in a natural speaking voice without pausing between words.
- Reduce any background noise if possible. The system may misinterpret your command if more than one person is speaking at the same time.

Voice Control Operation

When you press the  button, a helpful prompt asks what you would like to do. Press and release the  button again to bypass this prompt and give a command.

Voice Recognition

The voice control system can only be used from the driver's seat because the microphone unit removes noises from the front passenger's side.



Continued

Voice Portal Screen

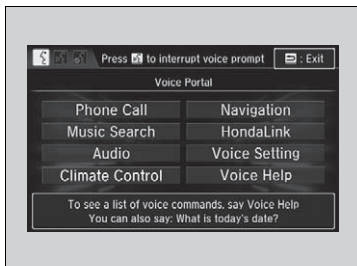

When the  (Talk) button is pressed, available voice commands appear on the screen.

For a complete list of commands, say "Voice Help" after the beep or select **Voice Help**.

You can see the list of commands in **Voice Info** on the **Info Menu** screen. Select **Info**, then select .

The system only recognizes the commands on the following pages, at certain screens. Free form voice commands are not recognized.

Phone Call

This can be only used when the phone is connected. When the system recognizes the *Phone call* command, the screen will change to the voice recognition screen for phone commands.

- Dial by Number
- Call History
- Redial
- Call <Your contact Name>
- Call <Phone Number>
- Call Police
- Call 911

Phone Call commands are not available if using Apple CarPlay.

Music Search

This can be only used when the iPod or USB device is connected.

Climate Control

When the system recognizes the *Climate Control* command, the screen will change the dedicated screen to the climate control voice recognition screen.

➤ **Climate Control Commands** P. 232



Audio

When the system recognizes the *Audio* command, the screen will change to the audio voice recognition screen.

- Audio On*¹
- Audio Off*¹
- Radio FM
- Radio AM
- Radio SXM
- PANDORA
- iPod
- USB
- Other Sources

Pandora® cannot be used while Android Auto is active.

Navigation

The screen changes to the navigation screen.

➤ **Refer to the Navigation System Manual**

HondaLink®

This can be only used when the phone is connected.

*1: These commands toggle the function on and off, so the command may not match your intended action.

■ Voice Setting

The screen changes to the **Voice Recog.** tab on the **System Settings** screen.

■ Voice Help

You can see a list of the available commands on the screen.

- *Useful Commands*
- *Phone Commands*
- *Audio Commands*
- *On Screen Commands*
- *Music Search Commands*
- *General Commands*
- *Climate Control Commands*

■ Useful Commands

The system accepts these commands on the voice portal top screen.

- *Call <Phone Number>*
- *Call <Your contact Name>*
- *What time is it?*
- *What is today's date?*

■ Phone Commands

The system accepts these commands on the dedicated screen for the voice recognition of the phone.

- *Call by number*
- *Call by name*
- *Call <Phone Number>*
- *Call <Your contact Name>*

■ Audio Commands

The system accepts these commands on the dedicated screen for the voice recognition of the audio.

■ Radio FM Commands

- *Radio tune to <87.7-107.9> FM*
- *Radio tune to <87.7 -107.9> HD <1-8> FM*
- *Preset <1-12>*

■ Radio AM Commands

- *Radio tune to <530-1710> AM*
- *Preset <1-6>*

■ Radio SXM Commands

- *SXM channel <1-999>*
- *SXM channel <channel name, category name, traffic and weather city name, sports team name>*
- *SXM preset <1-12>*

■ Pandora Commands

- *PANDORA play*

■ iPod Commands

- *iPod play*
- *iPod play track <1-30>*
- *Music Search*
- *What album is this?*
- *What am I listening to?*

■ USB Commands

- *USB play*
- *USB play track <1-30>*
- *Music Search*
- *What album is this?*
- *What am I listening to?*



■ **Bluetooth® audio Commands**

- *Bluetooth® audio play*

NOTE:

Bluetooth® Audio commands may not work on some phones or *Bluetooth®* Audio devices.

■ **On Screen Commands**

When **On Screen Commands** is selected, the explanation screen is displayed.

■ **Music Search Commands**

The system accepts these commands on the **Music Search** screen.

■ **Using Song By Voice**

Song By Voice™ is a feature that allows you to select music from your iPod or USB device using Voice Commands. To activate this mode, you must push the talk switch and say: "Music search".

■ **Song By Voice Commands**

- *What am I listening to?*
- *Who am I listening to?*
- *Who is this?*
- *What's playing?*
- *Who's playing?*
- *What album is this?*

■ **Play Commands**

- *Play artist <Name>*
- *Play track/song <Name>*
- *Play album <Name>*
- *Play genre/category <Name>*
- *Play playlist <Name>*
- *Play composer <Name>*

■ **List Commands**

- *List artist <Name>*
- *List album <Name>*
- *List genre/category <Name>*
- *List playlist <Name>*
- *List composer <Name>*

■ **General Commands**

- *What time is it?*
- *What is today's date?*



■ **Climate Control Commands**

- *Climate Control On*¹*
- *Climate Control Off*¹*
- *Fan speed <1-7>*
- *Temperature max heat*
- *Temperature max cool*
- *Temperature <57-87> degrees*
- *Defrost On*¹*
- *Defrost Off*¹*
- *Air conditioner On*¹*
- *Air conditioner Off*¹*
- *More*
- *Climate Control Automatic*
- *Vent*
- *Dash and floor*
- *Fan speed up*
- *Fan speed down*
- *Floor vents*
- *Floor and Defrost*
- *Temperature up*
- *Temperature down*

*1: These commands toggle the function on and off, so the command may not match your intended action.

Playing AM/FM Radio

Driver Information Interface

Audio/Information Screen

Power/Audio Icon
Select to turn the audio system on and off.

VOL (Volume) Icons
Select to adjust the volume.

(Menu) Icon
Select to display the menu items.

(Back) Icon
Select to go back to the previous display.

Scan Icon
Select to scan each station with a strong signal.

Tune Icons
Select ◀ or ▶ to tune the radio frequency.

Open/Close Icon*1
Displays/hides the detailed information.

Preset Icons
Tune the preset radio frequency. Select and hold the preset icon to store that station. Select >> to display preset 7 onwards.

Seek Icons
Select ▶▶ or ◀◀ to search the selected band up or down for a station with a strong signal.

*1:Some or all of the lists may not be displayed.



■ Preset Memory

To store a station:

1. Tune to the selected station.
2. Select and hold the preset number for the station you want to store.

You can also store a preset station by the following procedure.

1. Tune to the selected station.
2. Select the open/close icon to display a list.
3. Select the **Preset** tab.
4. Select and hold the preset number for the station you want to store.

■ Station List

Lists the strongest stations on the selected band.

1. Select the open/close icon to display a list.
2. Select the **Station List** tab.
3. Select the station.

■ Manual update

Updates your available station list at any time.

1. Select the open/close icon to display a list.
2. Select the **Station List** tab.
3. Select **Refresh**.

▶▶ Playing AM/FM Radio

The **ST** indicator appears on the display indicating stereo FM broadcasts. Stereo reproduction in AM is not available.

Switching the Audio Mode

Press the ▲ or ▼ button on the steering wheel or select **SOURCE** on the screen.

▶▶ **Audio Remote Controls** P. 199

You can store 6 AM stations and 12 FM stations into preset memory.

HD Radio Technology manufactured under license from iBiquity Digital Corporation. U.S. and Foreign Patents. HD Radio™ and the HD, HD Radio, and "Arc" logos are proprietary trademarks of iBiquity Digital Corp.



■ Scan

Samples each of the strongest stations on the selected band for 10 seconds. To turn off scan, select **Cancel** or .

■ HD Subchannel

Displays the subchannel list when an HD Radio™ station is selected while listening to an FM station.

1. Select .
2. Select **HD Radio Subchannel**.
3. Select the channel number.

■ Radio Data System (RDS)

Provides text data information related to your selected RDS-capable FM station.

■ To find an RDS station from Station List

1. Select the open/close icon to display a list while listening to an FM station.
2. Select the **Station List** tab.
3. Select the station.

■ Manual update

Updates your available station list at any time.

1. Select the open/close icon to display a list while listening to an FM station.
2. Select the **Station List** tab.
3. Select **Refresh**.

▣ Radio Data System (RDS)

When you select an RDS-capable FM station, the RDS automatically turns on, and the frequency display changes to the station name. However, when the signals of that station become weak, the display changes from the station name to the frequency.



Continued

■ Radio text

Displays the radio text information of the selected RDS station.

1. Select .
2. Select **View Radio Text**.

■ Scan

Samples each of the strongest stations on the selected band for 10 seconds.

To turn off scan, select **Cancel** or .

Playing SiriusXM® Radio

Channel Icons
 Select ◀◀ or ▶▶ to the previous or next channel.
 Select and hold to rapidly skip 10 channels at a time.

Driver Information Interface

Album Art

Audio/Information Screen

Station Art

Open/Close Icon^{*1}
 Displays/hides the detailed information.

Preset Icons
 Tune the preset radio station. Select and hold the preset icon to store that station. Select >> to display preset 7 onwards.

Skip Icons
 Select ◀◀ or ▶▶ to change section in the channel.
 Select and hold to move rapidly within the section.

Power/Audio Icon
 Press to turn the audio system on and off.

VOL (Volume) Icons
 Select to adjust the volume.

(Menu) Icon
 Select to display the menu items.

(Back) Icon
 Select to go back to the previous display.

Scan Icon
 Select to scan each channel.

Category Icons
 Select ◀ or ▶ to display and select a SiriusXM® Radio category.

*1:Some or all of the lists may not be displayed.



■ To Change the Tune Mode

1. Select .
2. Select **Tune Mode**.
3. Select **Channel Mode** or **Category Mode**.



▶▶ Playing SiriusXM® Radio

In the channel mode, all available channels are selectable. In the category mode, you can select a channel within a category (Jazz, Rock, Classical, etc.).

There may be instances when SiriusXM® Radio does not broadcast all the data fields (artist name, title). This does not indicate a problem with your audio system.

SiriusXM® Radio stations load in ascending order, which can take about a minute. Once they have loaded you will be able to scroll up or down to make your selections.

Switching the Audio Mode

Press the  or  button on the steering wheel or select **SOURCE** on the screen.

▶ **Audio Remote Controls** P. 199

Tune Start:

When you change to a preset channel, a song being played on that channel restarts from the beginning with this function. This can be turned on or off from the **Audio settings** screen.

▶ **Customized Features** P. 296

■ Preset Memory

To store a channel:

1. Tune to the selected channel.
2. Press and hold the preset number for the station you want to store.
 - ▶ If **Multiple Channel Mix Preset** setting to **On**, then select **Replace**.

You can also store a channel by the following procedure.

1. Tune to the selected channel.
2. Select the open/close icon to display a list.
3. Select the **Preset** tab.
4. Select and hold the preset number for the station you want to store.

■ Multi-channel preset (for music channels only)

You can store up to five of your preferred music channels to preset numbers.



1. Tune a station.
2. Select the open/close icon to display a list.
3. Select the **Preset** tab.
4. Select and hold the preset number you want to add a music channel.
 - ▶ A message appears if there are no available presets.
5. Select **Combine**.

▶▶ Playing SiriusXM® Radio

You can store 12 SiriusXM® channels into the preset memory.

▶▶ Multi-channel preset (for music channels only)

To store a multi-channel preset, you need to setup the **Multiple Channel Mix Preset** setting to **On**.

▶ **Customized Features** P. 296

■ Listening to Featured Channels

Suggested channel listing received from SiriusXM® can be displayed and selected.

1. Select the open/close icon to display a channel list.
2. Select the **Channel** tab.
3. Select the featured channel list title you want to listen to.
 - ▶ The selected channel list of the title is displayed.
4. Select the channel.

▶▶ Listening to Featured Channels

Up to three featured channels by SiriusXM® can be displayed.





Featured channel lists are at the top of the channel list.

Replay Function

The system can record up to the last 60 minutes of your currently tuned channel's broadcast, as well as the last 30 minutes of your preset channel's broadcast, starting from the moment you turn the vehicle on. If you tuned to a preset channel, the system records up to 60 minutes of a broadcast instead of up to 30 minutes. You can rewind and replay the last 30 or 60 minutes of a broadcast.

1. Select .
2. Select **Playback**.
3. Move the time marker to the position you want to replay.

The following items are available on the pop-up screen:

-  (Skip Down): Skips to the previously stored channel. Select and hold to fast-rewind the current selection.
 -  (Skip Up): Skips to the next channel. Select and hold to fast-forward the current selection.
 -  (15sec Back): Select to skip back 15 seconds in the current selection. Select and hold to fast-rewind the current selection.
 -  (15sec Skip): Select to skip forward 15 seconds in the current selection. Select and hold to fast-forward the current selection.
- ▶ Select **OK** to close the pop-up menu. Replay in playback mode continues.

To play or pause on playback mode:

1. Select .
2. Select **Play/Pause**.



Continued

Replay Function

The system starts storing broadcast in memory when the power mode is turned ON. You can go back to the program from that point.

You can no longer replay any program once the power mode is turned off as it erases memory. You can check how long the program has been stored in memory from the audio/information screen.

After 30 or 60 minutes of recording the system will automatically start deleting the oldest data.

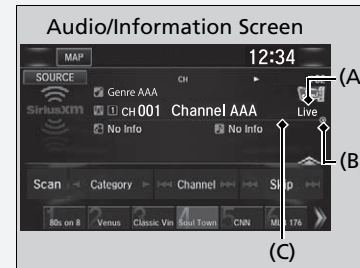

- (A): Shows how much time the replayed segment is behind the real-time broadcast
- (B): Replayed segment
- (C): Length stored in memory

When you listen a multi-channel preset while at the playback mode, the replayed segment is not displayed.

■ Returning to real-time broadcast

1. Select .
2. Select **Go to Live**.

■ Live Sports Alert

While listening to other channels, you can receive sports alerts such as scores from the games of your favorite teams.

■ To set up a favorite team



1. Select .
2. Select **Settings**.
3. Select **Audio**.
4. Select **SportsFlash Setup**.
5. Select **Favorite Team**.
6. Select a team.

■ To set up an alert message

1. Select .
2. Select **Settings**.
3. Select **Audio**.
4. Select **SportsFlash Setup**.
5. Select **Interrupt**.
6. Select **On(One Time)** or **On(Continue)**.

▶▶ Live Sports Alert

The sports alert function is available in SiriusXM® mode only.

▶▶ To set up a favorite team

Sports alerts cut in only when SiriusXM® mode is on. Selecting **On(One Time)** from the customized settings disables the alert feature next time you turn the power mode to ON.

▶▶ **Customized Features** P. 296

You can also set up a favorite team by the following procedure.

1. Select **Audio**.
2. Select .
3. Select **Setting**.
4. Select **SportsFlash Setup**.

■ To set up an alert beep

1. Select .
2. Select **Settings**.
3. Select **Audio**.
4. Select **SportsFlash Setup**.
5. Select **Interrupt Beep**.
6. Select **On**.

■ Receiving a sports alert

1. A pop-up appears and notifies you of a sports alert.
2. Select **Listen**.
 - ▶ You can use the same items as the playback mode pop-up screen.

 **Replay Function** P. 241

To go back to the previous screen, select **Back**.

■ Listening to a missed sports alert

If you have missed a sports alert:

1. Select .
2. Select **SportsFlash List**.
3. Select alert.

▶▶ To set up an alert beep

You can also set up an alert beep by the following procedure.

1. Select **Audio**.
2. Select .
3. Select **Setting**.
4. Select **SportsFlash Setup**.

■ Traffic and Weather Information

You can receive traffic and weather information.

■ To set up a traffic & weather information

1. Select .
2. Select **Settings**.
3. Select **Audio**.
4. Select **Traffic & Weather Setup**.
5. Select the region.
 - ▶ When you do not want to receive the information, select **Unregistered**.

■ Listening a traffic and weather information

1. Select .
2. Select **Traffic & Weather**.
 - ▶ Play mode can also use the any items same as playback mode.
 - ▶ **Replay Function** P. 241
 - To go back to the previous screen, select **OK**.

■ Scan

Sample each channel on the selected mode for 10 seconds.

1. Select **Scan**.
2. Select **Scan Channels**.
 - ▶ You can select the desired channel by songs using **Scan Song in Preset**.

To turn off scan, select **Cancel**.



▶▶ Traffic and Weather Information

The traffic and weather information function at SiriusXM® mode only.

You can also set up the traffic and weather information by the following procedure.

1. Select **Audio**.
2. Select .
3. Select **Setting**.
4. Select **Traffic & Weather Setup**.

Traffic & Weather Now are registered trademarks of SiriusXM® Radio, Inc.

▶▶ Scan

The “Scan Songs in Preset” function is based on TuneScan™ technology of SiriusXM®.

The “Featured Channels” function is based on Featured Favorites™ technology of SiriusXM®.

TuneScan™ and Featured Favorites™ are registered trademarks of SiriusXM® Radio, Inc.

Playing an iPod

Connect the iPod using your USB connector to the USB port, then select the iPod mode.

 **USB Ports** P. 197

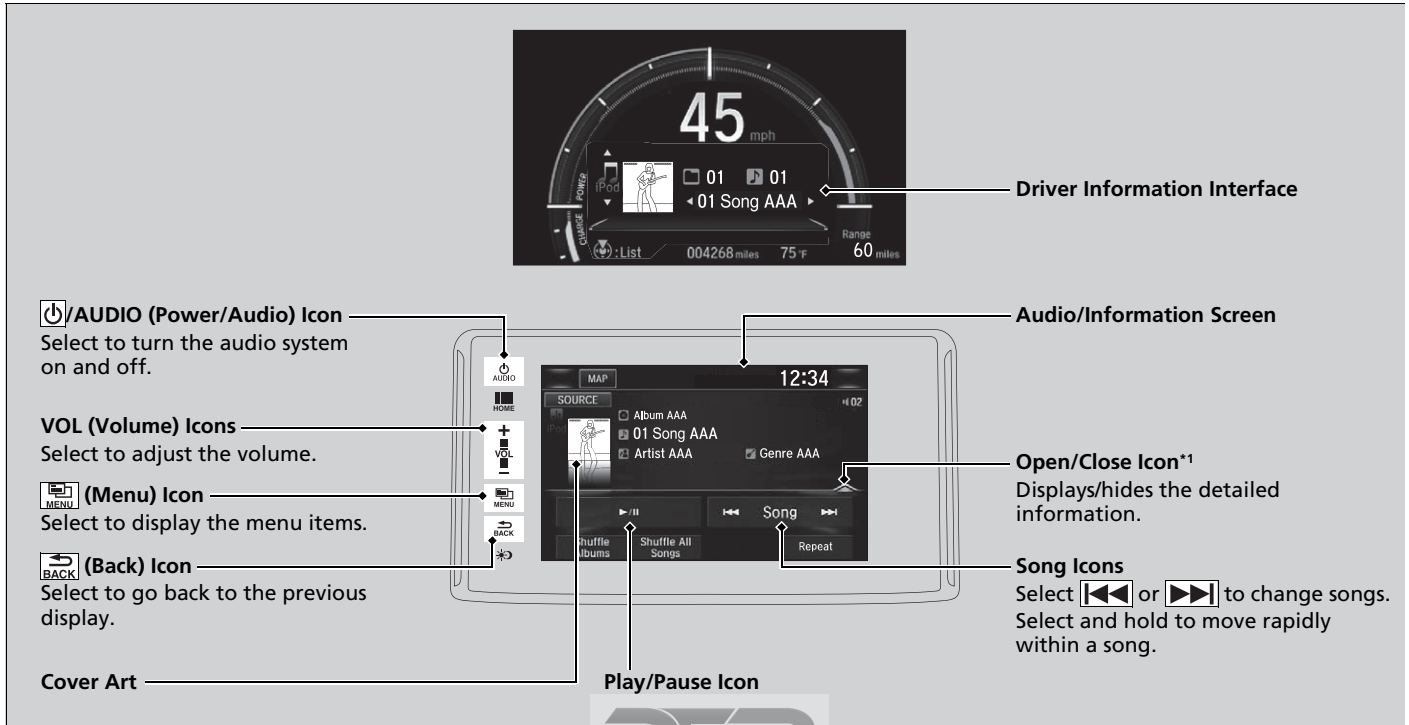

Driver Information Interface

Audio/Information Screen

Power/Audio (Power/Audio) Icon
Select to turn the audio system on and off.



VOL (Volume) Icons
Select to adjust the volume.

(Menu) Icon
Select to display the menu items.

(Back) Icon
Select to go back to the previous display.

Cover Art

Open/Close Icon*1
Displays/hides the detailed information.

Song Icons
Select  or  to change songs. Select and hold to move rapidly within a song.

Play/Pause Icon

DEP DEALER ePROCESS

*1: Some or all of the lists may not be displayed.

How to Select a Song from the Music Search List

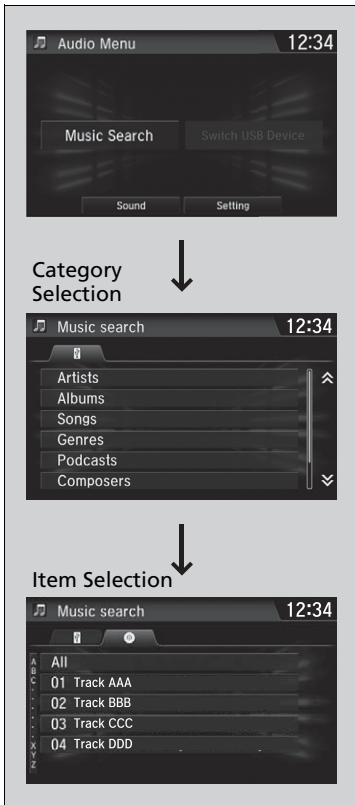

1. Select  and select **Music Search**.

2. Select the items on that menu.

▶▶ Playing an iPod

Available operating functions vary on models or versions. Some functions may not be available on the vehicle's audio system.

If there is a problem, you may see an error message on the audio/information screen.

 **iPod/USB Flash Drive** P. 274

If you operate any music app on your iPhone/iPod while the phone is connected to the audio system, you may no longer be able to operate the same app on the audio/information screen. Reconnect the device if necessary.



How to Select a Play Mode

You can select shuffle and repeat modes when playing a file.

Select a play mode.

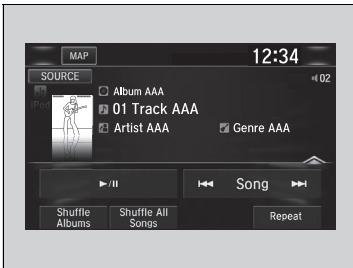

To turn off a play mode

Select the mode you want to turn off.

How to Select a Play Mode

Play Mode Menu Items

Shuffle Albums: Plays all available albums in a selected list (playlists, artists, albums, songs, podcasts, genres, composers, or audiobooks) in random order.

Shuffle All Songs: Plays all available files in a selected list (playlists, artists, albums, songs, podcasts, genres, composers, or audiobooks) in random order.

Repeat: Repeats the current track.

Song By Voice™ (SBV)

Use SBV to search for and play music from your USB flash drive or iPod using voice commands.

■ To enable SBV

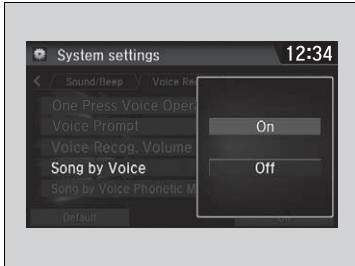

1. Select .
2. Select **Settings**.
3. Select **System**.
4. Select the **Voice Recog.** tab.
5. Select **Song by Voice**.
6. Select **On** or **Off**.



▶▶ Song By Voice™ (SBV)

Setting options:

- **On** (factory default): Song By Voice™ commands are available.
- **Off**: Disable the feature.

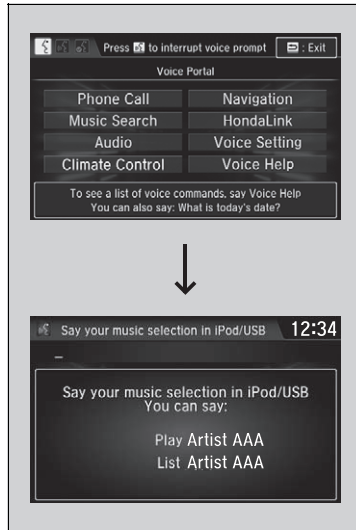
■ Searching for music using SBV



1. Set the **Song by Voice** setting to **On**.
2. Press the  (Talk) button and say "Music Search" to activate the SBV feature for the USB flash drive and iPod.
3. Then, say a next command.
 - ▶ Example 1: Say "(List) 'Artist A'" to view a list of songs by that artist. Select the desired song to start playing.
 - ▶ Example 2: Say "Play 'Artist A'" to start playing songs by that artist.
4. To cancel SBV, press the  (hang-up/back) button on the steering wheel. The selected song continues playing.

Once you have canceled this mode, you need to press the  button and say "Music Search" again to re-activate this mode.

▶▶ Searching for music using SBV

Song By Voice™ Commands List

▶ **Song By Voice Commands** P. 232

NOTE:

Song By Voice™ commands are available for tracks stored on the USB flash drive or iPod.

You can add phonetic modifications of difficult words so that it is easier for SBV to recognize artists, songs, albums, and composers in voice commands.

▶ **Phonetic Modification** P. 250



Continued

Phonetic Modification

Add phonetic modifications of difficult or foreign words so that it is easier for SBV to recognize artists, songs, albums, and composers in voice commands when searching for music on the USB flash drive or iPod.



1. Select **[HOME]**.
2. Select **Settings**.
3. Select **System**.
4. Select the **Voice Recog.** tab.
5. Select **Song by Voice Phonetic Modification**.
6. Select **New Modification**.
7. Select **USB** or **iPod**.

Phonetic Modification

Song by Voice Phonetic Modification function is not available when **Song by Voice** is set to **Off**.

You can store up to 2,000 phonetic modification items.

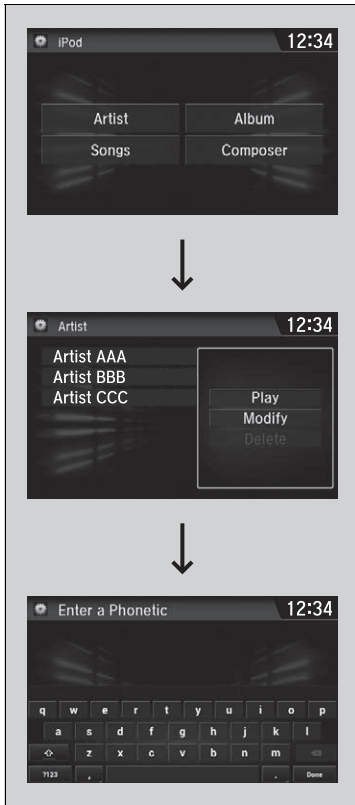

8. Select the item to modify (e.g., **Artist**).

- ▶ The list of the selected item appears on the screen.

9. Select an entry to modify.

- ▶ The pop-up menu appears on the screen.
- ▶ To listen to the current phonetic modification, select **Play**.
- ▶ To delete the current phonetic modification, select **Delete**.

10. Select **Modify**.

- 11.** Select the phonetic spelling you want to use (e.g., "Artist A") when prompted.

12. Select **OK**.

- ▶ The artist "No Name" is phonetically modified to "Artist A." When in the SBV mode, you can press the  (Talk) button and use the voice command "Play 'Artist A'" to play songs by the artist "No Name."

Playing Pandora®

Your audio system allows you to listen to music from the Pandora® app on a compatible smartphone.

This function is available when the phone is paired and connected to the vehicle's *Bluetooth®* HandsFreeLink® (HFL) system, or with an iPhone, you can connect using your USB cable to the USB port.

▶ **Phone Setup** P. 333

▶ **USB Ports** P. 197

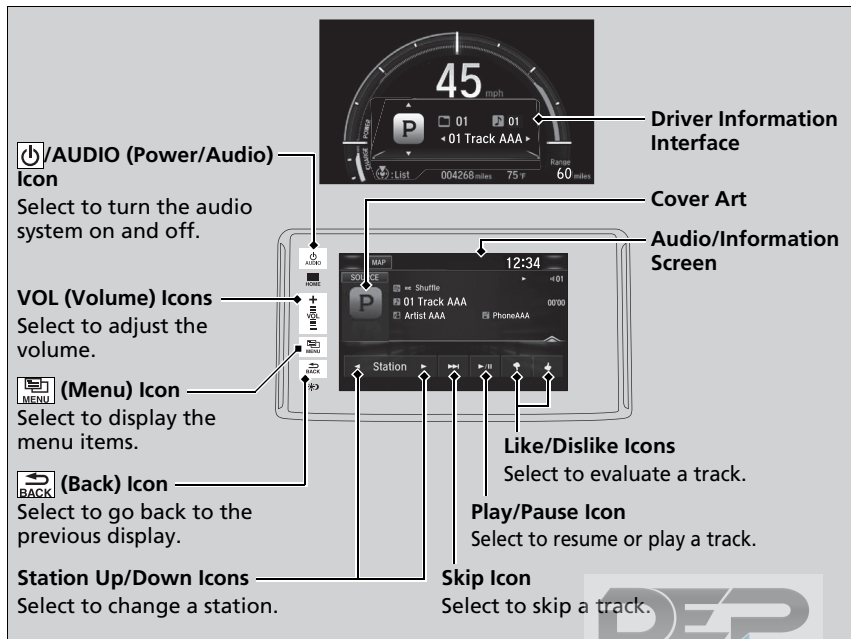

▶▶ Playing Pandora®

Pandora®, the Pandora logo, and the Pandora trade dress are trademarks or registered trademarks of Pandora Media, Inc., used with permission. Pandora is only available in certain countries. Visit the Pandora website for more information.

To find out if your phone is compatible with this feature, visit automobiles.honda.com/handsfreelink/, or call 1-888-528-7876.

To use this service in your vehicle, the Pandora® app must first be installed on your phone. Visit www.pandora.com for more information.

Pandora® is free, personalized radio that plays music and comedy you'll love. Just start with the name of one of your favorite artists, tracks, comedians or composers and Pandora® will create a custom station that plays similar tracks. Pandora® also features hundreds of genre stations ranging from Dubstep to Smooth Jazz to Power Workout.

If you cannot operate Pandora® through the audio system, it may be streaming through *Bluetooth®* Audio. Make sure Pandora® mode on your audio system is selected.

If your phone is connected to Android Auto, Pandora® is only available through the Android Auto interface. Visit the Android Auto website to check compatibility.

Pandora® Menu

You can operate some of the Pandora® menu items from your vehicle's audio system. The available items are:

- **Bookmark**
- **Station List**
- **New Station**
- **Switch USB device**
- **Sound**
- **Setting**

■ Operating a menu item

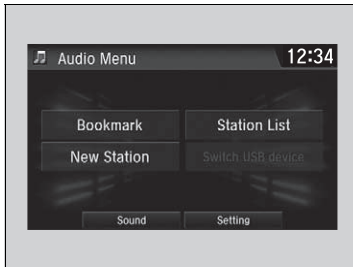

1. Select .
2. Select an item.

▶▶ Pandora® Menu

Available operating functions vary on software versions. Some functions may not be available on the vehicle's audio system.

If there is a problem, you may see an error message on the audio/information screen.

▶ **Pandora®** P. 276

Pandora® may limit the total number of skips allowed on the service. If you dislike a track after the skip limit has been reached, your feedback will be saved but the current track will continue to play.

To change stations, activate the Pandora® menu, select **Station List**, and then select a new station. It also changes stations on the main Pandora® screen.

Playing a USB Flash Drive

Your audio system reads and plays sound files on a USB flash drive in either MP3, WMA, or AAC*1 format.

Connect your USB flash drive to the USB port, then select the USB mode.

➤ **USB Ports** P. 197

Driver Information Interface

Audio/Information Screen

Power/Audio (Power/Audio) Icon
Select to turn the audio system on and off.

VOL (Volume) Icons
Select to adjust the volume.

(Menu) Icon
Select to display the menu items.

(Back) Icon
Select to go back to the previous display.

Folder Icons
Select to skip to the next folder, and to skip to the beginning of the previous folder.

Open/Close Icon*2
Displays/hides the detailed information.

Track Icons
Select or to change files. Select and hold to move rapidly within a track.

*1: Only AAC format files recorded with iTunes are playable on this unit.

*2: Some or all of the lists may not be displayed.

How to Select a File from the Music Search List

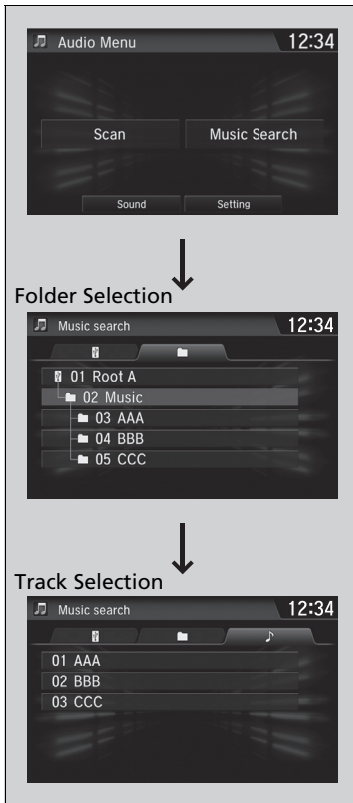

1. Select  and select **Music Search**.
2. Select **Music**.

3. Select a folder.

4. Select a track.

▶▶ Playing a USB Flash Drive

Use the recommended USB flash drives.

- ▶ **General Information on the Audio System**
P. 278

WMA files protected by digital rights management (DRM) cannot be played.

The audio system displays **Unplayable File**, then skips to the next file.

If there is a problem, you may see an error message on the audio/information screen.

- ▶ **iPod/USB Flash Drive** P. 274

■ How to Select a Play Mode

You can select scan, repeat, and random modes when playing a file.

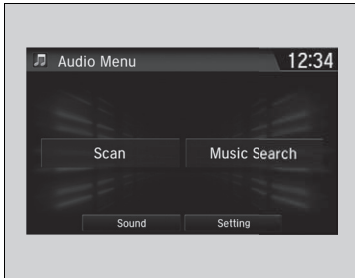

■ Scan

1. Select .
2. Select **Scan**.
3. Select a play mode.

■ Random/Repeat

Select a play mode.

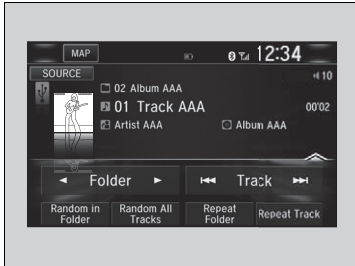

■ To turn off a play mode

To turn off Scan, select  or **Cancel**.

To turn off **Random/Repeat**, select the mode again.

▶▶ How to Select a Play Mode

Play Mode Menu Items

Scan

Scan Folders: Provides 10-second sampling of the first file in each of the main folders.

Scan Tracks: Provides 10-second sampling of all files in the current folder.

Random/Repeat

Random in Folder: Plays all files in the current folder in random order.

Random All Tracks: Plays all files in random order.

Repeat Folder: Repeats all files in the current folder.

Repeat Track: Repeats the current file.

Playing *Bluetooth*® Audio

Your audio system allows you to listen to music from your *Bluetooth*-compatible phone.

This function is available when the phone is paired and connected to the vehicle's *Bluetooth*® HandsFreeLink® (HFL) system.

🔧 **Phone Setup** P. 333

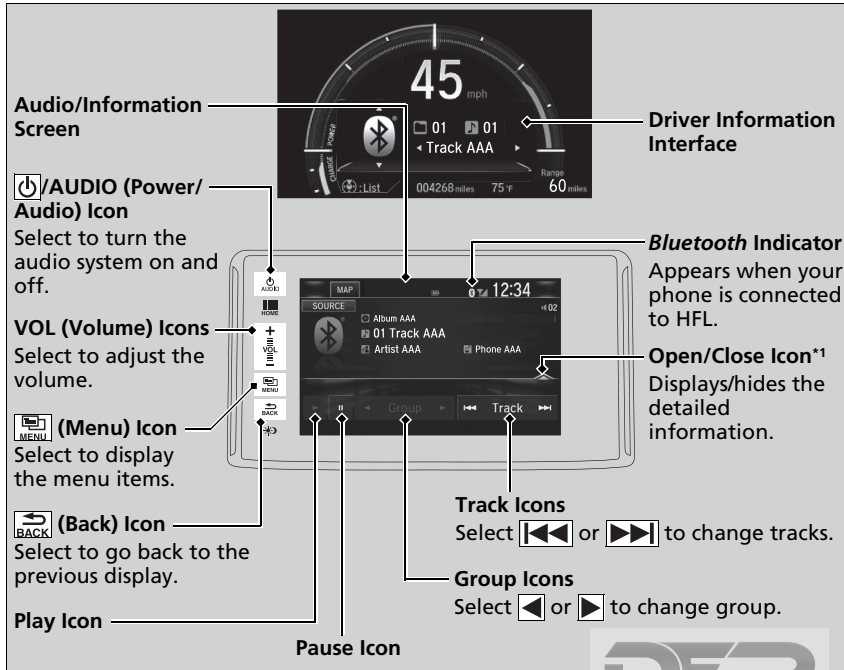

*1: Depending on the *Bluetooth*® device you connect, some or all of the lists may not be displayed.

▶▶ Playing *Bluetooth*® Audio

Not all *Bluetooth*-enabled phones with streaming audio capabilities are compatible.

To check if your phone is compatible, visit automobiles.honda.com/handsfreelink/.

It may be illegal to perform some data device functions while driving.

Only one phone can be used with HFL at a time. When there are more than two paired phones in the vehicle, the first paired phone the system finds is automatically connected.

The connected phone for *Bluetooth*® Audio can be different.

If more than one phone is paired to the HFL system, there may be a delay before the system begins to play.

In some cases, the name of the artist, album, or track may not appear correctly.

Some functions may not be available on some devices.

If a phone is currently connected via Apple CarPlay or Android Auto, *Bluetooth*® Audio from that phone is unavailable. However, a second previously paired phone can stream *Bluetooth*® Audio from that phone by selecting **Connect** 🎵 from the **Bluetooth Device List**.

🔧 **Phone Setup** P. 333

■ To Play *Bluetooth*® Audio Files

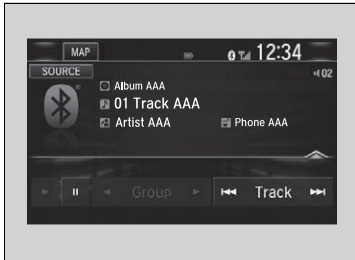

1. Make sure that your phone is paired and connected to the system.

▶ **Phone Setup** P. 333

2. Select the *Bluetooth*® Audio mode.

If the phone is not recognized, another HFL-compatible phone, which is not compatible for *Bluetooth*® Audio, may already be connected.

■ To pause or resume a file

Select the play icon or pause icon.

■ Searching for Music

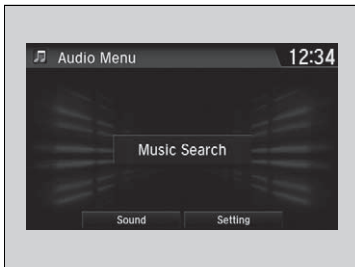

1. Select .

2. Select **Music Search**.

3. Select a search category (e.g., Albums).

4. Select an item.

▶ The selection begins playing.

▶▶ To Play *Bluetooth*® Audio Files

To play the audio files, you may need to operate your phone. If so, follow the phone maker's operating instructions.

Switching to another mode pauses the music playing from your phone.

You can change the connected phone in the *Bluetooth*® settings on the **Audio Menu** screen by the following procedure.

1. Select .

2. Select **Setting**.

▶▶ Searching for Music

Depending on the *Bluetooth*® device you connect, some or all of the lists may not be displayed.

HondaLink®

HondaLink® connects you to the latest information from Honda. You can connect your phone wirelessly through Wi-Fi or *Bluetooth®*.

➤ **Wi-Fi Connection** P. 264

➤ **Phone Setup** P. 333

HondaLink® Menu

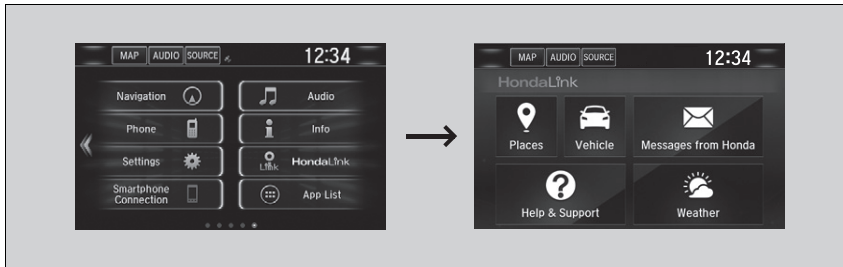

■ Places

Displays restaurants, Honda dealer, and so on. You can also navigate to the found locations via the navigation.

■ Vehicle

Displays instruction messages when the vehicle needs service.

■ Help & Support

Displays tips for vehicle usage, and get support via road side or customer service center.



Continued

▶▶ HondaLink®

The HondaLink® connect app is compatible with most iPhone and Android phones.

Some cell phone carriers charge for tethering and smartphone data use. Check your phone's data subscription package.

When Apple CarPlay or Android Auto is connected to the audio system, HondaLink® can be accessed even without a Wi-Fi connection.

■ Messages from Honda

Displays helpful and important information from Honda.

■ Weather

Displays a weekly five-day weather forecast for any location you want. You can change the ZIP Code at any time.

■ To Set Up to Connect HondaLink® Service

Use the following procedure to connect to HondaLink® service.

■ To enable the HondaLink® service

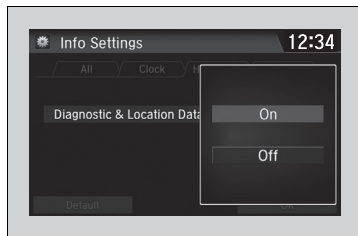

1. Select .
2. Select **Settings**.
3. Select **Info**.
4. Select the **HondaLink** tab.
5. Select **Diagnostic & Location Data**.
6. Select **On**.

You need to allow the consent of the location service to enable the HondaLink® service.

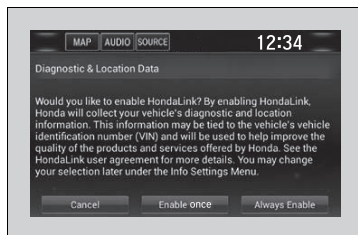

Enable once: Allows only one time. (Prompt shows again next time.)

Always Enable: Allows anytime. (Prompt does not show again.)

Cancel: Does not allow this consent.



■ To link with HondaLink®

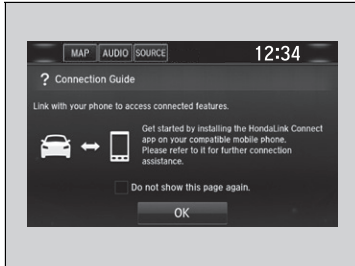

You can see the **Connection Guide** screen after launching HondaLink®. If you do not need this guide, select check-box and select **OK**.

■ Vehicle Information and Message from Honda Tips

You can check the messages that are received quickly in the shortcut operation.

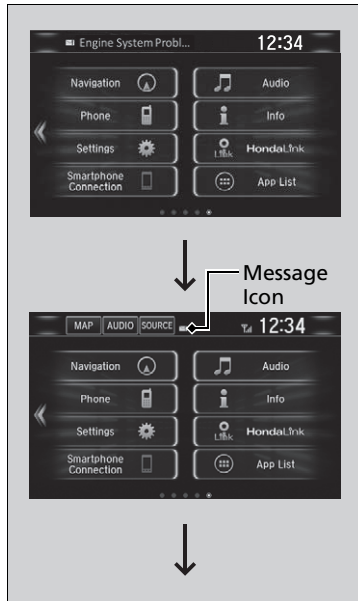

1. A message appears and notifies you of a new message on the header area.
 - ▶ When the message is received, a notification ring can be heard.

2. A message icon is continuously displayed in the header area until the new message is read.



3. From the top of the screen, swipe down to see the messages.

4. Select a new message to open.

Wi-Fi Connection



You can connect the Display Audio to the Internet using Wi-Fi and browse websites or use online services on the audio/information screen. If your phone has wireless hotspot capabilities, the system can be tethered to the phone. Use the following steps to setup.

Wi-Fi mode (setting for the first time)



1. Select .
2. Select **Settings**.
3. Select **Bluetooth/Wi-Fi**.
4. Select the **Wi-Fi** tab.
5. Select **Wi-Fi On/Off Status**, then **On**.
6. Select **Wi-Fi Device List**.
 - ▶ Make sure your phone's Wi-Fi setting is in access point (tethering) mode.
 - ▶ Select the phone you want to connect to the system.
 - ▶ If you do not find the phone you want to connect in the list, select **Scan**.



7. Select **Connect**.
 - ▶ If needed, enter a password for your phone and select **OK**.
 - ▶ When the connection is successful, the  icon is displayed on the top of the screen.
8. Select  to go back to the home screen.

Wi-Fi mode (setting for the first time)

You cannot go through the setting procedure while a vehicle is moving. Park in a safe place to setup the Wi-Fi connection.

Some cell phone carriers charge for tethering and smartphone data use. Check your phone's data subscription package.

Check your phone manual to find out if the phone has Wi-Fi connectivity.

You can confirm whether Wi-Fi connection is on or off with the  icon on **Wi-Fi Device List**. Network speed will not be displayed on this screen.

■ Wi-Fi mode (after the initial setting has been made)

Make sure your phone's Wi-Fi setting is in access point (tethering) mode.

▶▶ Wi-Fi mode (after the initial setting has been made)

iPhone users

You may need to go through an initial setup for Wi-Fi connection again after you boot your phone.

Siri Eyes Free

You can talk to Siri using the  (Talk) button on the steering wheel when your iPhone is paired to the *Bluetooth*® HandsFreeLink® (HFL) system.

➔ **Phone Setup** P. 333

❏ Siri Eyes Free

Siri is a trademark of Apple Inc.

Check Apple Inc. website for features available for Siri.

We recommend against using Siri other than in Siri Eyes Free while operating a vehicle.

❏ Using Siri Eyes Free

Some commands work only on specific phone features or apps.

■ Using Siri Eyes Free

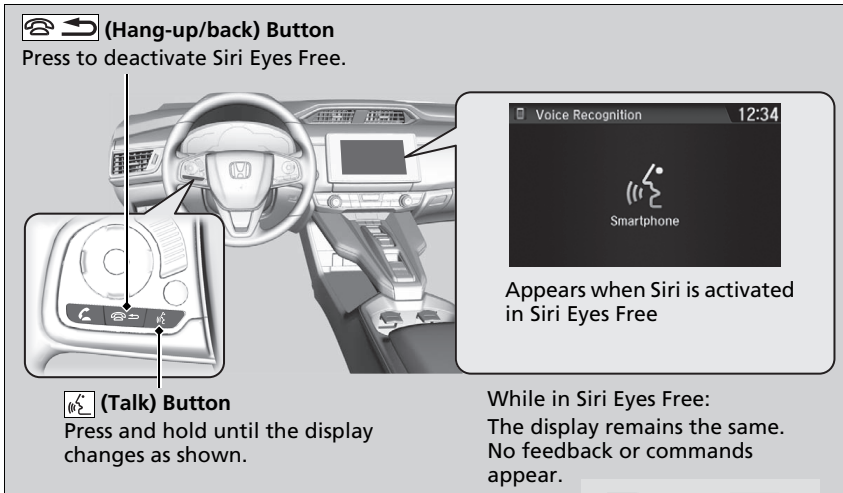

 **(Hang-up/back) Button**
Press to deactivate Siri Eyes Free.

 **(Talk) Button**
Press and hold until the display changes as shown.

Appears when Siri is activated in Siri Eyes Free

While in Siri Eyes Free:
The display remains the same. No feedback or commands appear.



Apple CarPlay

If you connect an Apple CarPlay-compatible iPhone to the system via the 1.5A USB port, you can use the audio/information screen, instead of the iPhone display, to make a phone call, listen to music, view maps (navigation), and access messages.

📖 **USB Ports** P. 197

Apple CarPlay Menu

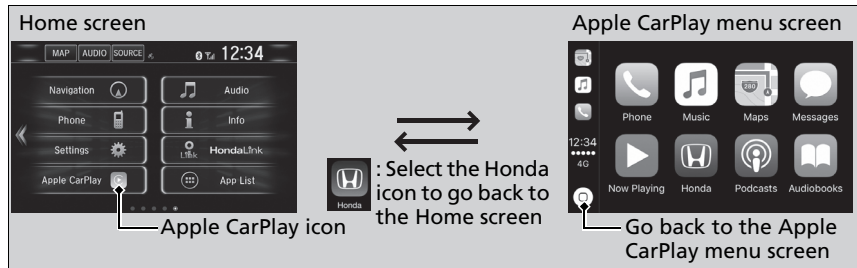

Phone

Access the contact list, make phone calls, or listen to voice mail.

Messages

Check and reply to text messages, or have messages read to you.

Music

Play music stored on your iPhone.

Apple CarPlay

Only iPhone 5 or newer versions with iOS 8.4 or later are compatible with Apple CarPlay.

Park in a safe place before connecting your iPhone to Apple CarPlay and when launching any compatible apps.

To use Apple CarPlay, connect the USB cable to the USB port (1.5A). The USB port (1.0A) will not enable Apple CarPlay operation.

📖 **USB Ports** P. 197

To directly access the Apple CarPlay phone function, press **Phone** on the home screen. While connected to Apple CarPlay, calls are only made through Apple CarPlay. If you want to make a call with *Bluetooth*® HandsFreeLink®, turn Apple CarPlay OFF or detach the USB cable from your iPhone.

📖 **Setting Up Apple CarPlay** P. 268

When your iPhone is connected to Apple CarPlay, it is not possible to use the *Bluetooth*® Audio or *Bluetooth*® HandsFreeLink®. However, other previously paired phones can stream audio via *Bluetooth*® while Apple CarPlay is connected.

📖 **Phone Setup** P. 333

For details on countries and regions where Apple CarPlay is available, as well as information pertaining to function, refer to the Apple homepage.



Continued

■ Maps

Display Apple Maps and use the navigation function just as you would on your iPhone.

Only one navigation system (pre-installed navigation or Apple CarPlay) can give directions at a time. When you are using one system, directions to any prior destination set on the other system will be canceled, and the system you are currently using will direct you to your destination.

■ Setting Up Apple CarPlay

After you have connected your iPhone to the system via the 1.5A USB port, use the following procedure to set up Apple CarPlay. Use of Apple CarPlay will result in the transmission of certain user and vehicle information (such as vehicle location, speed, and status) to your iPhone to enhance the Apple CarPlay experience. You will need to consent to the sharing of this information on the Display Audio Screen.

■ Enabling Apple CarPlay

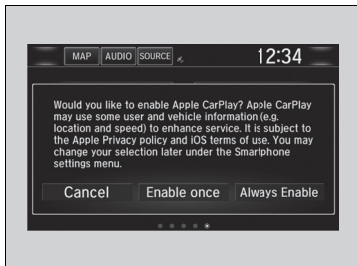

Enable once: Allows only once. (Prompt shows again next time.)

Always Enable: Allows anytime. (Prompt does not show again.)

Cancel: Does not allow this consent.

You may change the consent settings under the **Smartphone** settings menu.



▶▶ Apple CarPlay

Apple CarPlay Operating Requirements & Limitations

Apple CarPlay requires a compatible iPhone with an active cellular connection and data plan. Your carrier's rate plans will apply.

Changes in operating systems, hardware, software, and other technology integral to providing Apple CarPlay functionality, as well as new or revised governmental regulations, may result in a decrease or cessation of Apple CarPlay functionality and services. Honda cannot and does not provide any warranty or guarantee of future Apple CarPlay performance or functionality.

It is possible to use 3rd party apps if they are compatible with Apple CarPlay. Refer to the Apple homepage for information on compatible apps.

▶▶ Setting Up Apple CarPlay

You can also use the method below to set up Apple CarPlay:
Select HOME→Settings→Smartphone→Apple CarPlay

Use of user and vehicle information

The use and handling of user and vehicle information transmitted to /from your iPhone by Apple CarPlay is governed by the Apple iOS terms and conditions and Apple's Privacy Policy.

■ Operating Apple CarPlay with Siri

Press and hold the talk button to activate Siri.

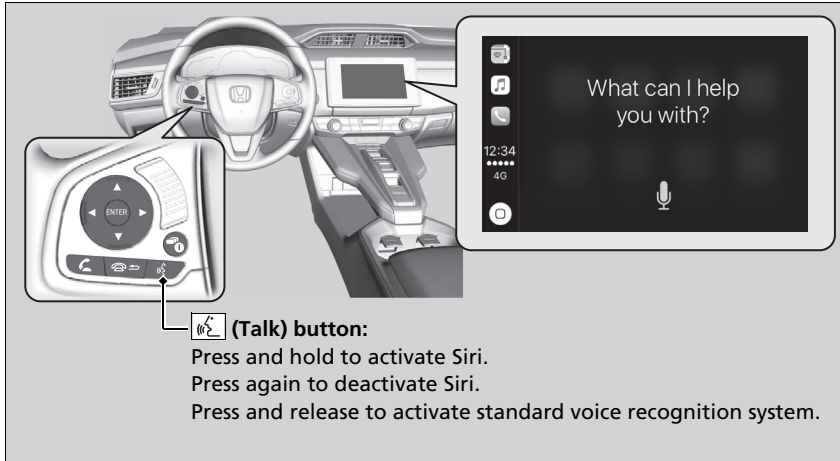

▣ Operating Apple CarPlay with Siri

Below are examples of questions and commands for Siri.

- What movies are playing today?
- Call dad at work.
- What song is this?
- How's the weather tomorrow?
- Read my latest email.
- Find a table for four tonight in Chicago.

For more information, please visit www.apple.com/ios/siri.

Android Auto

When you connect an Android phone to the Display Audio system via the 1.5A USB port, Android Auto is automatically initiated. When connected via Android Auto, you can use the audio/information screen to access the Phone, Google Maps (Navigation), Google Play Music, and Google Now functions. When you first use Android Auto, a tutorial will appear on the screen.

We recommend that you complete this tutorial while safely parked before using Android Auto.

- **USB Ports** P. 197
- **Auto Pairing Connection** P. 272

Android Auto

To use Android Auto, you need to download the Android Auto app from Google Play to your smartphone.

Only Android 5.0 (Lollipop) or later versions are compatible with Android Auto. Bluetooth A2DP cannot be used with Android Auto phone.

Park in a safe place before connecting your Android phone to Android Auto and when launching any compatible apps.

To use Android Auto, connect the USB cable to the USB port (1.5A). The USB port (1.0A) will not enable Android Auto operation.

- **USB Ports** P. 197

When your Android phone is connected to Android Auto, it is not possible to use the *Bluetooth*® Audio. However, other previously paired phones can stream audio via *Bluetooth*® while Android Auto is connected.

- **Phone Setup** P. 333

Android Auto Menu

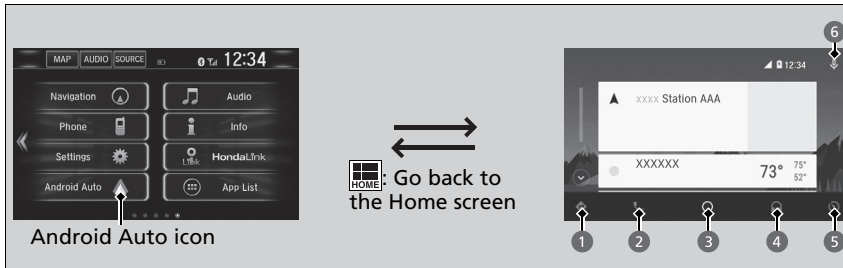

1 Maps (Navigation)

Display Google Maps and use the navigation function just as you would with your Android phone. When the vehicle is in motion, it is not possible to make keyboard entries. Stop the vehicle in a safe location to undertake a search or provide other inputs.

Only one navigation system (pre-installed navigation or Android Auto) can give directions at a time. When you are using one system, directions to any prior destination set on the other system will be canceled, and the system you are currently using will direct you to your destination. The audio/information screen shows you turn-by-turn driving directions to your destination.

2 Phone (Communication)

Make and receive phone calls as well as listen to voicemail.

3 Google Now (Home screen)

Display useful information organized by Android Auto into simple cards that appear just when they're needed.



Continued

Android Auto

For details on countries and regions where Android Auto is available, as well as information pertaining to function, refer to the Android Auto homepage.

Android Auto Operating Requirements & Limitations

Android Auto requires a compatible Android phone with an active cellular connection and data plan. Your carrier's rate plans will apply.

Changes in operating systems, hardware, software, and other technology integral to providing Android Auto functionality, as well as new or revised governmental regulations, may result in a decrease or cessation of Android Auto functionality and services. Honda cannot and does not provide any warranty or guarantee of future Android Auto performance or functionality.

It is possible to use 3rd party apps if they are compatible with Android Auto. Refer to the Android Auto homepage for information on compatible apps.

4 Music and audio

Play Google Play Music and music apps that are compatible with Android Auto. To switch between music apps, press this icon.

5 Go back to the Home Screen.

6 Voice

Operate Android Auto with your voice.

Auto Pairing Connection

When you connect an Android phone to the unit via the 1.5A USB port, Android Auto is automatically initiated.

Enabling Android Auto

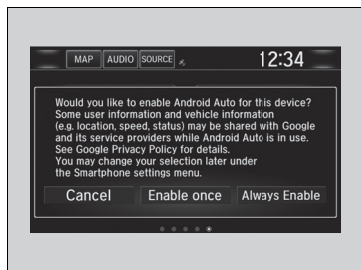

Enable once: Allows only once. (Prompt shows again next time.)

Always Enable: Allows anytime. (Prompt does not show again.)

Cancel: Does not allow this consent.

You may change the consent settings under the **Smartphone** settings menu.

Enabling Android Auto

Only initialize Android Auto when you safely parked. When Android Auto first detects your phone, you will need to set up your phone so that auto pairing is possible. Refer to the instruction manual that came with your phone.

You can use the method below to change Android Auto settings after you have completed the initial setup:
Select HOME→Settings→Smartphone→Android Auto

Use of user and vehicle information

The use and handling of user and vehicle information transmitted to /from your phone by Android Auto is governed by the Google's Privacy Policy.



■ Operating Android Auto with Voice Recognition

Press and hold the talk button to operate Android Auto with your voice.



▣ Operating Android Auto with Voice Recognition

Below are examples of commands you can give with voice recognition:

- Reply to text.
- Call my wife.
- Navigate to Honda.
- Play my music.
- Send a text message to my wife.
- Call flower shop.

For more information, please refer to the Android Auto homepage.

You can also activate the voice recognition function by pressing the  icon in the upper-right corner of the screen.

iPod/USB Flash Drive

If an error occurs while playing an iPod or USB flash drive, you may see the following error messages. If you cannot clear the error message, contact an authorized Honda Clarity Electric dealer.

Error Message	Solution
USB Error	Appears when there is a problem with the audio system. Check if the device is compatible with the audio system.
A charging error has occurred with the connected USB device. When safe please check the compatibility of the device and USB cable and try again.	Appears when an incompatible device is connected. Disconnect the device. Then turn the audio system off, and turn it on again. Do not reconnect the device that caused the error.
Unsupported Version	Appears when an unsupported iPod is connected. If it appears when a supported iPod is connected, update the iPod software to the newer version.
Connect Retry	Appears when the system does not acknowledge the iPod. Reconnect the iPod.
Unplayable File	Appears when the files in the USB flash drive are copyright protected or an unsupported format. This error message appears for about three seconds, then plays the next song.

Error Message	Solution
No Data	<p>iPod Appears when the iPod is empty.</p> <p>USB flash drive Appears when the USB flash drive is empty or there are no MP3, WMA, or AAC files in the USB flash drive.</p> <p>iPod and USB flash drive Check that compatible files are stored on the device.</p>
Unsupported	Appears when an unsupported device is connected. If it appears when a supported device is connected, reconnect the device.

Pandora®

If an error occurs while playing Pandora®, you may see the following error messages. If you cannot clear the error message, contact an authorized Honda Clarity Electric dealer.

Error Message	Solution
To begin listening, select a station from the Stations list.	Appears when there is no station list on the device. Use the device to create a station.
The maximum number of tracks that can be skipped has been reached.	Appears when you try to skip a track or select Like/Dislike over the predetermined number of times in an hour.
Unable to play PANDORA. Please try again later. Unable to rate track. Please try again. Unable to save bookmark.	Appears when the commanded operation fails. Try again later.
No Data	Appears when no data is available with Pandora® activated. Reboot the app and reconnect the device.
PANDORA App version is not supported.	Appears when Pandora® version is not supported. Update Pandora® to the latest version.
PANDORA system maintenance.	Appears when the Pandora® server is in maintenance. Try again later.
Unable to connect to PANDORA. When stopped, check your mobile phone.	Appears when Pandora® is unable to play music. Check your device.
Unable to connect to PANDORA. When stopped, check your mobile phone.	Appears when Pandora® app is not installed on your device. Install Pandora® app to your device.



Android/Apps

If an error occurs while using the audio system or apps, you may see the following error messages. If you cannot clear the error message, contact an authorized Honda Clarity Electric dealer.

Error Message* ¹	Solution
Unfortunately, **** has stopped.	Error has occurred within app, select OK on the screen to close the app.
**** is not responding. Would you like to close it?	App is not responding. Select Wait if you can wait for a response from app a little longer. If it does not respond even if you keep waiting, select OK to close the app and restart it. If the error message continues, perform Factory Data Reset . ➤ Defaulting All the Settings P. 321

*1:****part is variable characters, and will change depending upon where an error occurs.

SiriusXM® Radio Service

■ Subscribing to SiriusXM® Radio

1. You need your radio ID ready before registering for subscription. To see the ID on the screen, select **Channel 0**.
2. Have your radio ID ready, and either call SiriusXM® or visit the SiriusXM® website to subscribe.

■ Receiving SiriusXM® Radio

Switch to the SiriusXM® mode by using the ▲ or ▼ button on the steering wheel, or through the audio/information screen, and stay in this mode for about 30 minutes until the service is activated. Make sure your vehicle is in an open area with good reception.

☒ Subscribing to SiriusXM® Radio

Contact Information for SiriusXM® Radio:
SiriusXM® Radio at www.siriusxm.com/subscribe, or 1-866-635-2349

☒ Receiving SiriusXM® Radio

The SiriusXM® satellites are in orbit over the equator; therefore, objects south of the vehicle may cause satellite reception interruptions. Satellite signals are more likely to be blocked by tall buildings and mountains the farther north you travel from the equator.

You may experience reception problems under the following circumstances:

- In a location with an obstruction to the south of your vehicle.
- In tunnels
- On the lower level of a multi-tiered road
- Large items carried on the roof rack

■ SiriusXM® Radio Display Messages

Requested Channel Not Subscribed:

You are not subscribed to the channel selected.

Channel Off Air:

The channel is not currently broadcasting.

Channel unauthorized:

SiriusXM® is loading the audio or program information.

Subscription Updated.:

SiriusXM® radio is receiving information update from the network.

Channel Not Available:

No such channel exists, or the artist or title information is unavailable.

No Signal:

The signal is too weak in the current location.

Check Antenna:

There is a problem with the SiriusXM® antenna. Contact an authorized Honda Clarity Electric dealer.

Check Tuner:

There is a problem with the SiriusXM® tuner. Contact an authorized Honda Clarity Electric dealer.



Compatible iPod, iPhone, and USB Flash Drives

■ iPod and iPhone Model Compatibility

Model
iPod (5th generation)
iPod classic 80GB/160GB (launch in 2007)
iPod classic 120GB (launch in 2008)
iPod classic 160GB (launch in 2009)
iPod nano (1st to 7th generation) released between 2005 and 2012
iPod touch (1st to 6th generation) released between 2007 and 2012
iPhone 3G/iPhone 3GS/iPhone 4/iPhone 4s/iPhone 5/iPhone 5c/iPhone 5s/iPhone 6/ iPhone 6 Plus/iPhone 6s/iPhone 6s Plus/iPhone SE/iPhone 7/iPhone 7 Plus

■ USB Flash Drives

- A USB flash drive of 256 MB or higher is recommended.
- Some digital audio players may not be compatible.
- Some USB flash drives (e.g., a device with security lockout) may not work.
- Some software files may not allow for audio play or text data display.
- Some versions of MP3, WMA, or AAC formats may be unsupported.

⌘ iPod and iPhone Model Compatibility

This system may not work with all software versions of these devices.

⌘ USB Flash Drives

Files on the USB flash drive are played in their stored order. This order may be different from the order displayed on your PC or device.



Honda App License Agreement

END USER LICENSE AGREEMENT

PLEASE CAREFULLY READ THIS END USER LICENSE AGREEMENT (THIS "AGREEMENT") WHICH GOVERNS YOUR USE OF THE SOFTWARE INSTALLED ON YOUR HONDA OR ACURA VEHICLE (YOUR "VEHICLE") AS WELL AS THE APPLICATIONS, SERVICES, FUNCTIONS, AND CONTENT PROVIDED THROUGH THE SOFTWARE (COLLECTIVELY, THE "SERVICES"). YOUR USE OF THE SOFTWARE OR SERVICES WILL SERVE AS YOUR CONSENT TO THE TERMS OF THIS AGREEMENT. THE SOFTWARE IS OWNED (OR LICENSED), PROVIDED, AND/OR OPERATED BY AMERICAN HONDA MOTOR CO. INC., ("HONDA," "US," "WE," OR "OUR"), WITH ITS BUSINESS ADDRESS AT 1919 TORRANCE BLVD., TORRANCE, CA 90501. REFERENCE TO "HONDA" IN THIS AGREEMENT INCLUDES HONDA'S PARENT COMPANY AND ITS AFFILIATES AND DESIGNATED AGENTS. THE SERVICES ARE OWNED (OR LICENSED), PROVIDED, AND/OR OPERATED BY HONDA OR A THIRD-PARTY SERVICE PROVIDER (A "PROVIDER"). REFERENCE TO A "PROVIDER" IN THIS AGREEMENT INCLUDES SUCH PROVIDER'S PARENT COMPANY, AFFILIATES, AND DESIGNATED AGENTS.

A. Description of the Software. The SOFTWARE includes the software, firmware and the like, installed and executing on your VEHICLE during manufacture, and thereafter updated from time to time by HONDA, you or an authorized HONDA dealer (a "DEALER"). The SOFTWARE allows you to access and use a variety of SERVICES, including but not limited to: (a) HONDA applications, services, and content provided through the SOFTWARE (together, "HONDA SERVICES"); and (b) PROVIDER applications, services, and content provided through the SOFTWARE (together, "PROVIDER SERVICES"), each of which may provide access to various information, media, content, and services.

B. SOFTWARE Licensing and Intellectual Property.

1. SOFTWARE. This AGREEMENT grants you a non-exclusive, limited, and revocable license to use the SOFTWARE and SERVICES solely (a) as installed on your VEHICLE by HONDA, (b) as updated on your Vehicle by HONDA, you (but only as and when directed by HONDA), or a DEALER and (c) as permitted under the terms of this AGREEMENT.

2. HONDA Services. The SOFTWARE may provide you with access to various HONDA SERVICES. Installation, activation, or use of HONDA SERVICES may require your consent to additional terms, conditions, and privacy policies applicable to those HONDA SERVICES (the "HONDA TERMS"). You acknowledge and agree that any collection, use, sharing of data generated by your VEHICLE or your use of your VEHICLE, and your use of the HONDA SERVICES shall be subject to this AGREEMENT and any additional HONDA TERMS that may be specifically applicable to such HONDA SERVICES or data generation. The HONDA SERVICES may collect, use, and share such data while you are using the SOFTWARE.



3. Open-Source Software. The SOFTWARE and SERVICES may incorporate software licensed to HONDA under free or open-source licenses which govern HONDA's distribution and your use of such software. HONDA and the third-party authors, licensors, and distributors of such software disclaim all warranties and all liability arising from any and all use or distribution of the software. To the extent such software is provided under terms that differ from the applicable free or open-source licenses, those terms are offered by HONDA alone. Additional information regarding free and open-source software incorporated in the SOFTWARE and SERVICES is available in this manual or within the SOFTWARE.

4. Provider Services. The SOFTWARE may provide you with access to various PROVIDER SERVICES. Installation or use of such PROVIDER SERVICES may require your consent to additional terms, conditions, and privacy policies of the applicable PROVIDER (the "PROVIDER TERMS"). This AGREEMENT restricts the manner in which you can install and use PROVIDER SERVICES but does not grant you a license or permission to use such PROVIDER SERVICES. Your permission to use PROVIDER SERVICES is limited and subject to any license grants, conditions, and limitations included in the PROVIDER TERMS. You acknowledge that any collection, use, sharing of your information, targeted advertising practices by PROVIDERS, and your use of the PROVIDER SERVICES shall be subject to both this AGREEMENT and any applicable PROVIDER TERMS. The PROVIDER SERVICES may collect, use, and share such information while you are using the SOFTWARE.

5. License Limitations and Restrictions on Use.

(a) Limited License. You understand and agree that the SOFTWARE and SERVICES are licensed, not sold, to you solely for use in accordance with this AGREEMENT and any applicable PROVIDER TERMS, and any documentation for the VEHICLE made available to you by HONDA (any "DOCUMENTATION"). HONDA and its licensors reserve all rights in the SOFTWARE and HONDA SERVICES not expressly granted to you under this AGREEMENT. PROVIDERS and their licensors reserve all rights in the PROVIDER SERVICES not expressly granted to you under the applicable PROVIDER TERMS.



(b) Restrictions on Use. The licenses granted under this AGREEMENT do not permit you to use the SOFTWARE or SERVICES on a device other than your VEHICLE. As a condition of using the SOFTWARE and SERVICES, you agree that you may not and will not:

- (1) copy, download, distribute, modify, publish, sell, rent, lease, lend, license, sublicense, reuse, or create derivative works of the SOFTWARE or SERVICES or any of the content or other material within the SOFTWARE or SERVICES, including without limitation, HONDA or PROVIDER names, logos, or any other trademarks of HONDA or PROVIDERS or used in association with the SOFTWARE or any SERVICES, except as required to use the SOFTWARE or SERVICES in accordance with this AGREEMENT, any applicable PROVIDER TERMS, and the DOCUMENTATION;
- (2) access or use the SOFTWARE or SERVICES in any manner intended to damage or impair the operation of the SOFTWARE or SERVICES or interfere with anyone else's use and enjoyment of the SOFTWARE or SERVICES;
- (3) access or attempt to access any system or server on which the SOFTWARE or SERVICES is hosted or modify or alter the SOFTWARE or SERVICES in any way;
- (4) use the SOFTWARE or SERVICES for any unlawful purpose, or in violation of any third party rights;
- (5) use the SOFTWARE or SERVICES in violation of any applicable traffic regulations, rules or laws, including but not limited to any driver distraction laws, rules or regulations;
- (6) violate the terms of this AGREEMENT, any HONDA TERMS, any PROVIDER TERMS or other applicable third-party terms, conditions, and privacy policies; or
- (7) reverse engineer, decompile, disassemble, attempt to derive the source code of, nor permit others to reverse engineer, decompile, or disassemble, or attempt to derive the source code of the SOFTWARE or SERVICES, except and only to the extent that such activity is expressly permitted (a) by applicable law notwithstanding this limitation or (b) the terms of applicable free or opensource software licenses.

6. Intellectual Property Rights. All title and intellectual property rights in and to the SOFTWARE and SERVICES, the accompanying DOCUMENTATION, and all copies of the SOFTWARE or SERVICES are owned by HONDA, PROVIDERS, or their suppliers or licensors. This AGREEMENT does not grant you any rights in connection with any trademarks or service marks of HONDA, PROVIDERS, or their licensors, affiliates, or suppliers.



7. Export Restrictions: You acknowledge that the SOFTWARE and SERVICES are subject to U.S., European Union, and other export jurisdictions. You agree to comply with all applicable international and national laws that apply to the SOFTWARE and SERVICES, including the U.S. Export Administration Regulations, as well as end-user, end-use, and destination restrictions issued by the U.S. and other governments.

C. SOFTWARE Operation

1. HONDA reserves the right to suspend or terminate your access to and use of the SOFTWARE or SERVICES if you are found to be in violation of this AGREEMENT or as reasonably deemed necessary by HONDA.

2. Eligibility/Registration/Activation. The SOFTWARE is intended for and available to individuals who (a) are of legal age of majority in their jurisdiction of residence (and at least 18 years of age), or are younger than 18 years of age and possess a valid driver's license issued by their jurisdiction of residence, and (b) own or have permissive access to a compatible VEHICLE. We do not knowingly collect any information, including personal information, from children under 13. If we learn or are notified that we have collected personal information of a child under 13, we will immediately take steps to delete such information.

3. Use of PROVIDER SERVICES through the SOFTWARE. Certain PROVIDER SERVICES made available through the SOFTWARE may require that you register or otherwise have an account with the PROVIDER and agree to PROVIDER TERMS. Any use of any of such PROVIDER SERVICES within the SOFTWARE is subject to this AGREEMENT and the applicable PROVIDER TERMS. HONDA does not exercise control over such PROVIDER SERVICES and is not responsible or liable for the availability, security, or content of such PROVIDER SERVICES, and the inclusion of any PROVIDER SERVICES does not imply a referral from, the approval of, or the endorsement by HONDA of such PROVIDER SERVICES. HONDA is not responsible or liable, directly or indirectly, for any damage relating to or resulting from your use of the PROVIDER SERVICES.

4. Links to Third Party Sites: The SOFTWARE may provide you with the ability to access third-party sites and content through the use of the SOFTWARE or SERVICES. The third-party sites and content are not under the control of HONDA. HONDA is not responsible or liable, directly or indirectly, for such third-party websites and their content or for any damage relating to or resulting from your access or use of such websites and content.



5. Unauthorized Use and Abuse. You are responsible for ensuring your (and any authorized third parties') use of the SOFTWARE and SERVICES remains in compliance with this AGREEMENT and all other applicable HONDA TERMS and PROVIDER TERMS. You acknowledge and agree that any use of the SOFTWARE or SERVICES occurring through your VEHICLE will be deemed your actions and that HONDA and PROVIDERS may rely upon such actions. You agree to immediately notify us if you suspect fraudulent or abusive activity involving the SOFTWARE or SERVICES. If you so notify us or if we otherwise suspect fraudulent or abusive activity, you agree to cooperate with us in any fraud investigation and to use any fraud prevention measures we prescribe. Your failure to immediately notify us or cooperate to use such measures will result in your liability for all fraudulent usage or abusive activity associated with your VEHICLE.

6. SOFTWARE Updates. The SOFTWARE and SERVICES may be updated when your VEHICLE is serviced by a DEALER or remotely, over-the-air, by HONDA from time to time; such updates may occur with or without further notice or your future consent. The SOFTWARE may be updated at HONDA's discretion and for any purpose including, without limitation, to patch or otherwise improve the SOFTWARE or SERVICES functionality, security, or stability. All updates to the SOFTWARE and SERVICES are subject to this AGREEMENT and any other applicable HONDA TERMS and PROVIDER TERMS.

7. Uninstalling, Removing, and Replacing the SOFTWARE. Replacing SOFTWARE or HONDA SERVICES with software or firmware not provided and installed by HONDA or a DEALER will render all representations and warranties for the SOFTWARE, HONDA SERVICES, and VEHICLE functionality reliant upon the SOFTWARE or HONDA SERVICES null and void.

D. SOFTWARE Operational Notices and Warnings

1. Vehicle Geolocation Information. You acknowledge that your VEHICLE may be equipped with certain traffic and map features. The traffic feature will automatically collect and transmit, through GPS technology, your Vehicle's current location (longitude and latitude), travel direction and speed ("VEHICLE GEOLOCATION INFORMATION") to HONDA and PROVIDERS. The VEHICLE GEOLOCATION INFORMATION is used by HONDA and PROVIDERS to provide traffic and navigation-related information to you, but may also be used to provide other SERVICES or offers to you. HONDA will not use such VEHICLE GEOLOCATION INFORMATION for its own marketing efforts, or provide such information to unaffiliated third parties for their own purposes, without your express consent.



2. Potential Map Inaccuracy and Route Safety. Maps used by this system may be inaccurate because of changes in roads, traffic controls, routing, or driving conditions. Always use good judgment and common sense when following suggested routes. Do not follow the route suggestions if doing so would result in an unsafe or illegal driving maneuver, if you would be placed in an unsafe situation, or if you would be directed into an area that you consider unsafe. Do not rely on any navigation features included in the system to route you to emergency services. Not all emergency services such as police, fire stations, hospitals, or clinics are likely to be contained in the map database for such navigation features. Ask local authorities or an emergency services operator for such locations and routes. The driver is ultimately responsible for the safe operation of the vehicle and therefore, must evaluate whether it is safe to follow the suggested directions. Any navigation features are provided only as an aid. Make your driving decisions based on your observations of local conditions and existing traffic regulations. Navigation features are not a substitute for your personal judgment. Any route suggestions made by the SOFTWARE or SERVICES should never replace any local traffic regulations or your personal judgment or knowledge of safe driving practices.

3. Speech Recognition: You acknowledge and understand that HONDA and PROVIDERS may record, retain, and use voices commands when you use the speech recognition components of the SOFTWARE or SERVICES. You and all VEHICLE operators and passengers (a) consent to the recording and retention of voice commands in support of providing speech recognition components and (b) release HONDA and PROVIDERS from all claims, liabilities, and losses that may result from any use of such recorded voice commands. Recognition errors are inherent in speech recognition. It is your responsibility to monitor any speech recognition functions included in the system and address any errors. Neither HONDA nor PROVIDERS will be liable for any damages arising out of errors in the speech recognition process.

4. Distraction Hazards. Navigation features may require manual (non-verbal) input or setup. Attempting to perform such set-up or insert data while driving can seriously distract your attention and could cause a crash or other serious consequences; the ability to undertake such interactions may also be limited by state or local law, which laws you are responsible to know and follow. Even occasional short scans of the screen may be hazardous if your attention has been diverted away from your driving at a critical time. Pull over and stop the vehicle in a safe and legal manner before attempting to access a function of the system requiring prolonged attention. Do not raise the volume excessively. Keep the volume at a level where you can still hear outside traffic and emergency signals while driving. Driving while unable to hear these sounds could result in a crash.



E. Information Collection and Storage

1. Information Collection, Use, Transmission and Storage of Data. Consent to Use of Data: You agree that HONDA and PROVIDERS may collect and use your information gathered in any manner as part of product support services related to the SOFTWARE or related services. HONDA may share such information with third parties, including, without limitation, PROVIDERS, third party software and services suppliers, their affiliates and/or their designated agents, solely to improve their products or to provide services or technologies to you. HONDA, third party software and systems suppliers, their affiliates and/or their designated agent may disclose this information to others, but not in a form that personally identifies you.

2. Information Storage. Depending on the type of multimedia system you have in your VEHICLE, certain information may be stored for ease of use of the SOFTWARE including, without limitation, search history, location history in certain applications, previous and saved destinations, map locations within certain applications, and device numbers and contact information.

(a) Vehicle Health Information. Your VEHICLE may remotely transmit information regarding the status and health of your VEHICLE (“VEHICLE INFORMATION”) to HONDA without notification to you. VEHICLE INFORMATION may contain VEHICLE maintenance and malfunction status that is derived from VEHICLE diagnostic data and includes, but is not limited to, status of powered doors and windows, battery life data, battery charging data, VEHICLE speed, coolant temperature, air compressor revolution, output power, warning codes, diagnostic trouble codes, fuel injection volume, and engine rotations per minute. VEHICLE HEALTH INFORMATION may be used by HONDA for research and development, to deliver HONDA SERVICES and information to you, and to contact you, and is retained only for a period of time necessary to fulfill these goals.

(b) VEHICLE Geolocation Data (non-navigation/map based). If you opt-in to geolocation-based SERVICES, your vehicle’s geolocation data (latitude and longitude) will be automatically sent from your VEHICLE to HONDA and PROVIDERS.

(c) You understand that the inputting or uploading of information to your VEHICLE’s multimedia system or the SOFTWARE or SERVICES is at your own risk and that HONDA is not responsible for unauthorized access to or use of any personal or other information. All information uploaded to the SOFTWARE and SERVICES may be stored on your VEHICLES’s multimedia system and you understand that the security and safety of your VEHICLE’s multimedia system is your sole responsibility.



F. NO WARRANTY. You understand and agree that your use of the SOFTWARE and SERVICES are solely at your own risk and that you will be solely responsible for any damage to your VEHICLE's multimedia system or any other equipment or any loss of data that may result from your use of the SOFTWARE or SERVICES. THE SOFTWARE AND SERVICES ARE PROVIDED ON AN "AS IS" AND "AS AVAILABLE" BASIS WITHOUT ANY WARRANTY OF ANY KIND, EXPRESSED, IMPLIED OR STATUTORY. WE SPECIFICALLY DISCLAIM ANY IMPLIED WARRANTIES OF MERCHANTABILITY, FITNESS FOR A PARTICULAR PURPOSE, AND NON-INFRINGEMENT. HONDA makes no warranties that the SOFTWARE or SERVICES will meet your requirements, or that the SOFTWARE or SERVICES will be uninterrupted, timely, secure, non-infringing or error free. You understand and agree that you are responsible for any and all charges, costs or expenses associated with your use of the SOFTWARE or SERVICES. Advice or information, whether oral or written, obtained by you from us or through the SOFTWARE or SERVICES are provided for informational purposes only and will not create any warranty not expressly made herein. You should not rely on any such information or advice. We assume no liability or responsibility for any errors or omissions in the SOFTWARE or SERVICES. We do not make any warranty or representation that your use of the material displayed on, or obtained through, the SOFTWARE or SERVICES is non-infringing of any rights of any third party. Any decision or action taken by you on the basis of information or content provided via the application is at your sole discretion and risk. HONDA and PROVIDERS are not responsible or liable for any such decision, or for the accuracy, completeness, usefulness, or availability of any content or information displayed, transmitted, or otherwise made available via the SOFTWARE or SERVICES. To the extent jurisdictions do not allow the exclusion of certain warranties, some of the above exclusions may not apply to you.

G. LIMITATIONS ON LIABILITY. You and HONDA are each waiving important rights.

1. Limitations on YOUR liability. HONDA cannot recover from you any consequential, indirect, incidental, or special damages, or attorney's fees in connection with your use of the SOFTWARE or HONDA SERVICES. HONDA WAIVES TO THE FULLEST EXTENT ALLOWED BY LAW ANY CLAIM FOR DAMAGES OTHER THAN DIRECT, COMPENSATORY DAMAGES AS LIMITED IN THIS AGREEMENT.



2. Limitation on HONDA and PROVIDER liability. Neither HONDA nor PROVIDERS will be liable to you or any other party for consequential, indirect, incidental, special, or punitive damages (including without limitation lost profits) in connection with your use of the SOFTWARE or SERVICES, even if HONDA or PROVIDERS are aware of the possibility of such damages. These limitations apply to all claims, including, without limitation, claims in contract and tort (such as negligence, product liability and strict liability). To the extent that a jurisdiction does not permit the exclusion or limitation of liability as set forth herein our liability is limited to the maximum extent permitted by law in such states. If HONDA or PROVIDERS are found liable to you for any reason, you agree that the aggregate liability of all these parties to you for any claim is limited to ten U.S. dollars (US \$10.00). Neither HONDA nor any PROVIDER would have agreed to provide the SOFTWARE or SERVICES to you if you did not agree to this limitation. This amount is the sole and exclusive liability of HONDA and PROVIDERS to you, and is payable as liquidated damages and not as a penalty. Except where prohibited by law, you may not bring any claim against HONDA or any third-party beneficiary more than two (2) years after the claim arises. We do not have any liability for SOFTWARE or SERVICES interruptions of any length.

(a) **Release of HONDA and PROVIDERS** For yourself and anyone else claiming under you, you agree to release and discharge HONDA, PROVIDERS, their respective officers, directors, and employees, and each third-party beneficiary from all claims, liabilities and losses in connection with the SOFTWARE or SERVICES, including, but not limited to claims for personal injury or property damage arising from the total or partial failure of performance of the SOFTWARE or SERVICES, even if caused by or based upon the negligence, gross negligence, strict products liability, Deceptive Trade Practices Act violations, bad faith, or breach of warranty of us or the malfunction of the SOFTWARE or SOFTWARE SERVICES. YOU AGREE TO WAIVE TO THE FULLEST EXTENT ALLOWED BY LAW, ANY CLAIM FOR DAMAGES OTHER THAN DIRECT, COMPENSATORY DAMAGES AS LIMITED IN THIS AGREEMENT. YOU HEREBY RELEASE AND DISCHARGE HONDA AND ITS LICENSORS AND CONTRACTORS (INCLUDING ANY THIRD PARTIES PROVIDING ALL OR PART OF THE SOFTWARE OR SERVICES) FROM AND AGAINST ANY CLAIMS, DAMAGES, EXPENSES AND LIABILITY ARISING FROM OR RELATED TO ANY INJURIES, DAMAGES, OR LOSSES TO ANY PERSON (INCLUDING DEATH) OR PROPERTY OF ANY KIND RESULTING IN WHOLE OR PART, DIRECTLY OR INDIRECTLY, FROM YOUR USE OF THE SOFTWARE OR SERVICES.

H. Survival. You agree that the limitations of liability and indemnities in this AGREEMENT will survive even after the AGREEMENT has ended. These limitations of liability apply not only to you, but to anyone using the SOFTWARE or SERVICES via your VEHICLE, to anyone making a claim on your behalf, and to any claims made by your family, employees, customers, or others arising out of or relating to your VEHICLE, the SOFTWARE, or SERVICES.



I. Availability/Interruption. The SOFTWARE and certain SERVICES are made available through your VEHICLE's compatible multimedia system when the VEHICLE is turned on. Certain SERVICES may be available only through your compatible mobile device when it is within the operating range of the VEHICLE and a wireless carrier. The availability of the SOFTWARE and SERVICES may be subject to transmission limitation or interruption, including but not limited to technical obsolescence or sunset of the hardware, software or firmware, inside of or external to the Vehicle, required for data transmission or receipt. HONDA does not guarantee that the SOFTWARE, SERVICES, or any portion thereof will be available at all times or in all areas. You acknowledge and agree that HONDA is not responsible for performance degradation, interruption or delays. You acknowledge that HONDA shall not be liable to you if the SOFTWARE or SERVICES in a given location are not available. If the SOFTWARE or SERVICES are not available within your intended location, you agree that your sole remedy shall be to cease using the SOFTWARE and SERVICES.

J. PRODUCT SUPPORT: Product support for the SOFTWARE is provided by HONDA. For product support, please refer to HONDA instructions provided in the DOCUMENTATION. Should you have any questions concerning this AGREEMENT, or if you desire to contact HONDA for any other reason, please refer to the HONDA contact information provided in the DOCUMENTATION.

K. Termination and Transfer.

1. Termination. This AGREEMENT is effective until terminated by you or US. WE may terminate this AGREEMENT for any or no reason, and with or without notice to you. Your rights under this AGREEMENT will terminate automatically without notice from US if you fail to comply with any term of this AGREEMENT. Upon termination of this AGREEMENT, you shall cease all use of the SOFTWARE and SERVICES.

2. Transfer: You may permanently transfer your rights under this AGREEMENT only as part of a sale or transfer of the VEHICLE, provided you retain no copies, you transfer all of the SOFTWARE and HONDA SERVICES (including all component parts, the media and printed materials, and any upgrades), and the recipient agrees to the terms of this AGREEMENT. You agree to notify HONDA upon the sale or transfer of the VEHICLE. To contact HONDA, please refer to the HONDA contact information provided in the DOCUMENTATION.



L. Changes to the SOFTWARE or SERVICES. WE may change, modify, or update the SOFTWARE or SERVICES from time to time. Unless explicitly stated otherwise, any new features or services that augment or enhance the SOFTWARE or SERVICES in the future shall respectively be considered part of the SOFTWARE or SERVICES and subject to this AGREEMENT. WE reserve the right at any time and from time to time to interrupt, restrict, modify, suspend, discontinue, temporarily or permanently, the SOFTWARE or SERVICES (or any portion thereof), with or without notice to you, and you agree that HONDA shall not be liable to you or to any third party for any modification, suspension or discontinuance of the SOFTWARE or SERVICES.

M. ARBITRATION:

PLEASE READ THIS ARBITRATION PROVISION CAREFULLY TO UNDERSTAND YOUR RIGHTS. YOU AGREE THAT ANY CLAIM THAT YOU MAY HAVE IN THE FUTURE MUST BE RESOLVED THROUGH BINDING ARBITRATION. YOU WAIVE THE RIGHT TO HAVE YOUR DISPUTE HEARD IN COURT AND WAIVE THE RIGHT TO BRING CLASS CLAIMS. YOU UNDERSTAND THAT DISCOVERY AND APPEAL RIGHTS ARE MORE LIMITED IN ARBITRATION.

Arbitration is a method of resolving a claim, dispute or controversy without filing a lawsuit. By agreeing to arbitrate, the right to go to court is waived and instead claims, disputes or controversies are submitted to binding arbitration. This provision sets forth the terms and conditions of our agreement. YOU and HONDA agree and acknowledge that this Agreement affects interstate commerce and the Federal Arbitration Act (“FAA”) applies. By using the Software, Vehicle, or Services, YOU elect to have disputes resolved by arbitration. YOU, HONDA or any involved third party may pursue a Claim. “Claim” means any dispute between YOU, HONDA, or any involved third party relating to your use of the Software, the Vehicle, or the Services, this Agreement, or our relationship, including any representations, omissions or warranties. “Claim” does not include personal injury or wrongful death claims. YOU or HONDA may seek remedies in small claims court or provisional judicial remedies without arbitrating. In addition, notwithstanding anything herein to the contrary, YOU or HONDA may seek equitable relief in a court of competent jurisdiction.

YOU or HONDA may select arbitration with American Arbitration Association, JAMS or National Arbitration and Mediation. Contact these sponsors for their rules. The hearing will be in the federal district where YOU reside. If agreed, it may be by telephone or written submissions. Filing and arbitrator fees to be paid per the sponsor rules. You may contact the sponsor for a fee waiver. If no fee waivers, HONDA will pay filing and arbitrator fees up to \$5,000, unless law requires more. Each party is responsible for other fees. Arbitrator may award costs or fees to prevailing party, if permitted by law. HONDA will not seek fees, unless the claims are frivolous.



Arbitrator shall be an attorney or current or retired judge familiar with automotive or consumer software. The arbitrator shall follow substantive law, statute of limitations and decide all issues relating to the interpretation, construction, enforceability and applicability of this provision. The arbitrator may order relief permitted by law. This provision is governed and enforceable by the FAA. An award shall include a written opinion and be final, subject to appeal by the FAA.

This provision survives termination of this Agreement or relationship, bankruptcy, assignment or transfer. If part of this provision is unenforceable, the remainder remains in effect. If unenforceability allows arbitration as a class action, then this provision is entirely unenforceable. YOU may opt out within 30 days of your initial use of the Software by sending a signed, written notice to HONDA at Honda Financial Services, P.O. Box 165007, Irving, TX 75016. HONDA reserves the right to make changes to this provision after providing written notice and an opportunity to opt out.

N. Miscellaneous: You may not assign this AGREEMENT without HONDA's prior written consent. This AGREEMENT and any additional HONDA TERMS and PROVIDER TERMS represents the entire agreement between you and US. HONDA may amend the terms of this AGREEMENT by providing you with notices of such updated terms. If you do not consent to be bound by the updated terms, your sole remedy will be to cease using the SOFTWARE and SERVICES. If any part of this AGREEMENT is found invalid, void, or unenforceable, the balance of the AGREEMENT will remain valid and enforceable according to its terms. To the fullest extent permitted by law, and except as explicitly provided otherwise, this AGREEMENT and any disputes arising out of or relating to it will be governed by the laws of the State of California, except that California laws concerning choice of law or conflicts shall not apply if they would cause the substantive law of another jurisdiction to apply. Notwithstanding the foregoing, Section M shall be governed by the Federal Arbitration Act and the laws of the State of California, as applicable, as set forth therein. The failure to enforce any term of this AGREEMENT on one occasion shall not prevent enforcement on any other occasion or the enforcement of any other term. Headings and captions shall not be considered included for purposes of interpretation or application hereof, but are for convenience only.



Legal Information on Apple CarPlay/Android Auto

■ OWNER'S MANUAL LICENSE/LIABILITY STATEMENTS

USE OF APPLE CARPLAY IS SUBJECT TO YOUR AGREEMENT TO THE CARPLAY TERMS OF USE, WHICH ARE INCLUDED AS PART OF THE APPLE iOS TERMS OF USE. IN SUMMARY, THE CARPLAY TERMS OF USE DISCLAIM APPLE AND ITS SERVICE PROVIDERS' LIABILITY IF THE SERVICES FAIL TO PERFORM CORRECTLY OR ARE DISCONTINUED, STRICTLY LIMIT APPLE AND ITS SERVICE PROVIDERS' OTHER LIABILITIES, DESCRIBE THE KINDS OF USER INFORMATION (INCLUDING, FOR EXAMPLE, VEHICLE LOCATION, VEHICLE SPEED, AND VEHICLE STATUS) BEING GATHERED AND STORED BY APPLE AND ITS SERVICE PROVIDERS, AND DISCLOSE CERTAIN POSSIBLE RISKS ASSOCIATED WITH THE USE OF CARPLAY, INCLUDING THE POTENTIAL FOR DRIVER DISTRACTION. SEE APPLE'S PRIVACY POLICY FOR DETAILS REGARDING APPLE'S USE AND HANDLING OF DATA UPLOADED BY CARPLAY.

USE OF ANDROID AUTO IS SUBJECT TO YOUR AGREEMENT TO THE ANDROID AUTO TERMS OF USE WHICH MUST BE AGREED TO WHEN THE ANDROID AUTO APPLICATION IS DOWNLOADED TO YOUR ANDROID PHONE. IN SUMMARY, THE ANDROID AUTO TERMS OF USE DISCLAIM GOOGLE AND ITS SERVICE PROVIDERS' LIABILITY IF THE SERVICES FAIL TO PERFORM CORRECTLY OR ARE DISCONTINUED, STRICTLY LIMIT GOOGLE AND ITS SERVICE PROVIDERS' OTHER LIABILITIES, DESCRIBE THE KINDS OF USER INFORMATION (INCLUDING, FOR EXAMPLE, VEHICLE LOCATION, VEHICLE SPEED, AND VEHICLE STATUS) BEING GATHERED AND STORED BY GOOGLE AND ITS SERVICE PROVIDERS, AND DISCLOSE CERTAIN POSSIBLE RISKS ASSOCIATED WITH THE USE OF ANDROID AUTO, INCLUDING THE POTENTIAL FOR DRIVER DISTRACTION. SEE GOOGLE'S PRIVACY POLICY FOR DETAILS REGARDING GOOGLE'S USE AND HANDLING OF DATA UPLOADED BY ANDROID AUTO.



DISCLAIMER OF WARRANTIES; LIMITATION ON LIABILITY

YOU EXPRESSLY ACKNOWLEDGE AND AGREE THAT USE OF APPLE CARPLAY OR ANDROID AUTO (“THE APPLICATIONS”) IS AT YOUR SOLE RISK AND THAT THE ENTIRE RISK AS TO SATISFACTORY QUALITY, PERFORMANCE, ACCURACY AND EFFORT IS WITH YOU TO THE MAXIMUM EXTENT PERMITTED BY APPLICABLE LAW, AND THAT THE APPLICATIONS AND INFORMATION ON THE APPLICATIONS IS PROVIDED “AS IS” AND “AS AVAILABLE,” WITH ALL FAULTS AND WITHOUT WARRANTY OF ANY KIND, AND HONDA HEREBY DISCLAIMS ALL WARRANTIES AND CONDITIONS WITH RESPECT TO THE APPLICATIONS AND INFORMATION ON THE APPLICATIONS, EITHER EXPRESS, IMPLIED OR STATUTORY, INCLUDING, BUT NOT LIMITED TO, THE IMPLIED WARRANTIES AND/OR CONDITIONS OF MERCHANTABILITY, SATISFACTORY QUALITY, FITNESS FOR A PARTICULAR PURPOSE, ACCURACY, QUIET ENJOYMENT, AND NON-INFRINGEMENT OF THIRD PARTY RIGHTS. NO ORAL OR WRITTEN INFORMATION OR ADVICE GIVEN BY HONDA OR AN AUTHORIZED REPRESENTATIVE SHALL CREATE A WARRANTY. AS EXAMPLES, AND WITHOUT LIMITATION, HONDA DISCLAIMS ANY WARRANTY REGARDING THE ACCURACY OF DATA PROVIDED BY THE APPLICATIONS, SUCH AS THE ACCURACY OF DIRECTIONS, ESTIMATED TRAVEL TIME, SPEED LIMITS, ROAD CONDITIONS, NEWS, WEATHER, TRAFFIC, OR OTHER CONTENT PROVIDED BY APPLE, GOOGLE, THEIR AFFILIATES, OR THIRD PARTY PROVIDERS; HONDA DOES NOT GUARANTEE AGAINST LOSS OF APPLICATION DATA, WHICH MAY BE LOST AT ANY TIME; HONDA DOES NOT GUARANTEE THAT THE APPLICATIONS OR ANY SERVICES PROVIDED THROUGH THEM WILL BE PROVIDED AT ALL TIMES OR THAT ANY OR ALL SERVICES WILL BE AVAILABLE AT ANY PARTICULAR TIME OR LOCATION. FOR EXAMPLE, SERVICES MAY BE SUSPENDED OR INTERRUPTED WITHOUT NOTICE FOR REPAIR, MAINTENANCE, SECURITY FIXES, UPDATES, ETC., SERVICES MAY BE UNAVAILABLE IN YOUR AREA OR LOCATION, ETC. IN ADDITION, YOU UNDERSTAND THAT CHANGES IN THIRD PARTY TECHNOLOGY OR GOVERNMENT REGULATION MAY RENDER THE SERVICES AND/OR APPLICATIONS OBSOLETE AND/OR UNUSABLE.

TO THE EXTENT NOT PROHIBITED BY LAW, IN NO EVENT SHALL HONDA OR ITS AFFILIATES BE LIABLE FOR PERSONAL INJURY, OR ANY INCIDENTAL, SPECIAL, INDIRECT OR CONSEQUENTIAL DAMAGES WHATSOEVER, INCLUDING, WITHOUT LIMITATION, DAMAGES FOR LOSS OF PROFITS, CORRUPTION OR LOSS OF DATA, FAILURE TO TRANSMIT OR RECEIVE ANY DATA, BUSINESS INTERRUPTION OR ANY OTHER COMMERCIAL DAMAGES OR LOSSES, ARISING OUT OF OR RELATED TO THE APPLICATIONS OR YOUR USE OF OR INABILITY TO USE THE APPLICATIONS OR INFORMATION ON THE APPLICATIONS, HOWEVER CAUSED, REGARDLESS OF THE THEORY OF LIABILITY (CONTRACT, TORT OR OTHERWISE) AND EVEN IF HONDA WERE ADVISED OF THE POSSIBILITY OF SUCH DAMAGES. SOME STATES AND JURISDICTIONS DISALLOW THE EXCLUSION OR LIMITATION OF LIABILITY FOR DAMAGES, SO THESE LIMITATIONS AND EXCLUSIONS MAY NOT APPLY TO YOU. IN NO EVENT SHALL HONDA’S TOTAL LIABILITY TO YOU FOR ALL DAMAGES (OTHER THAN AS MAY BE REQUIRED BY APPLICABLE LAW IN CASES INVOLVING PERSONAL INJURY) EXCEED THE AMOUNT OF FIVE DOLLARS (\$5.00). THE FOREGOING LIMITATIONS WILL APPLY EVEN IF THE ABOVE STATED REMEDY FAILS OF ITS ESSENTIAL PURPOSE.

About Open Source Licenses

To see the open source license information, follow these steps.

1. Select .
2. Select **Settings**.
3. Select **System**.
4. Select the **Others** tab.
5. Select **Detail Information**.
6. Select **About device**.
7. Select **Legal information**.
8. Select **Open source licenses**.

Use the audio/information screen to customize certain features.

■ How to customize

While the vehicle is at a complete stop with the power mode in ON, select , and **Settings**, then select a setting item.

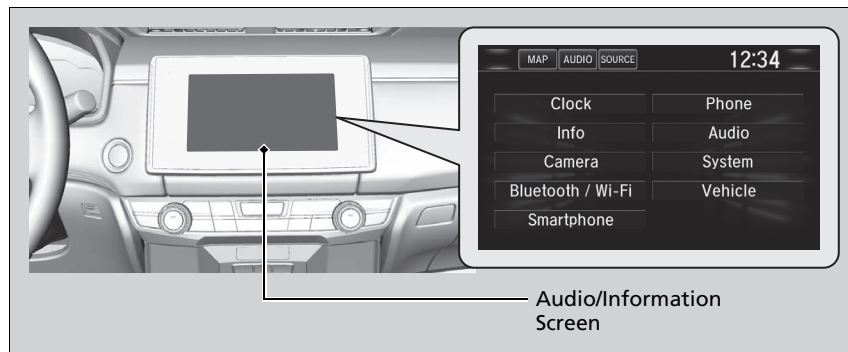

▶ Customized Features

When you customize setting, make sure that the vehicle is at a complete stop and **P** is selected.

To customize other features, select **Settings**.

▶ **List of customizable options** P. 304

■ Customization flow

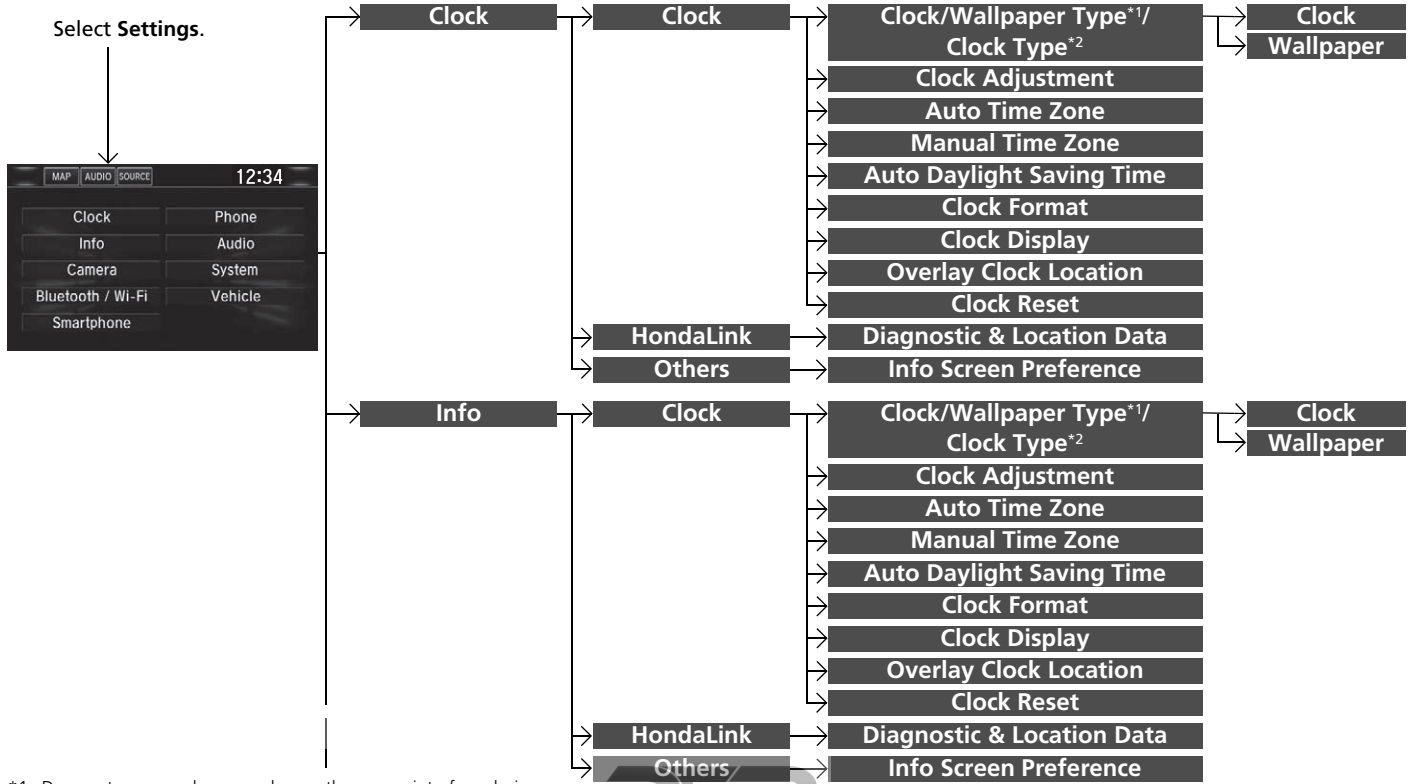

*1: Does not appear when you change the screen interface design.

*2: Appears only when you change the screen interface design.



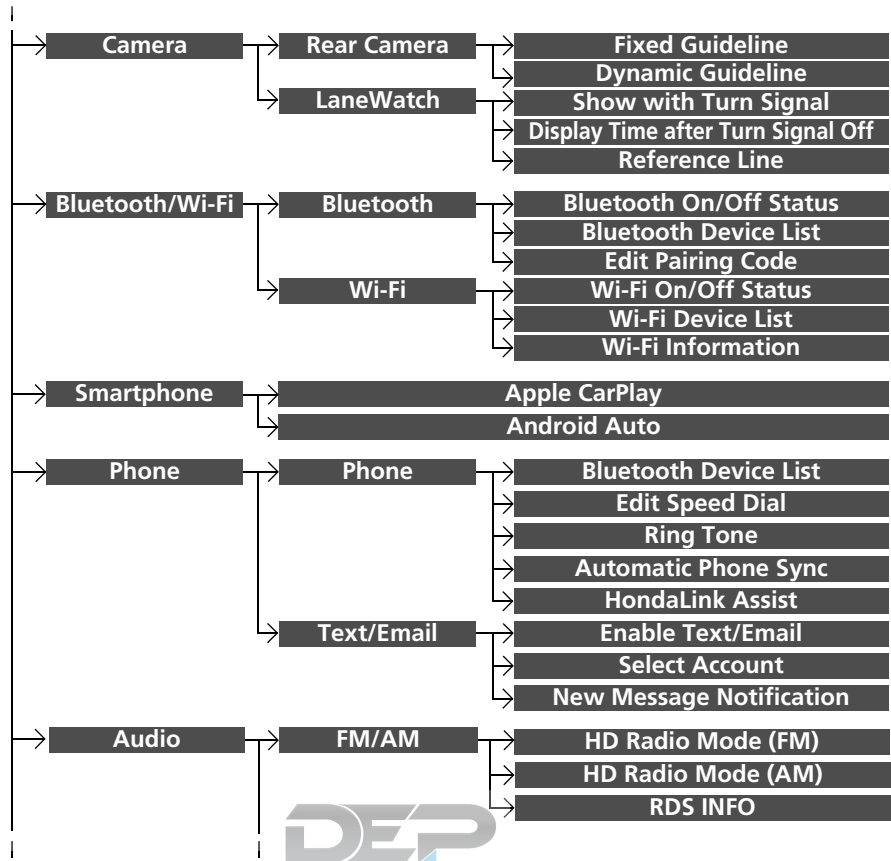

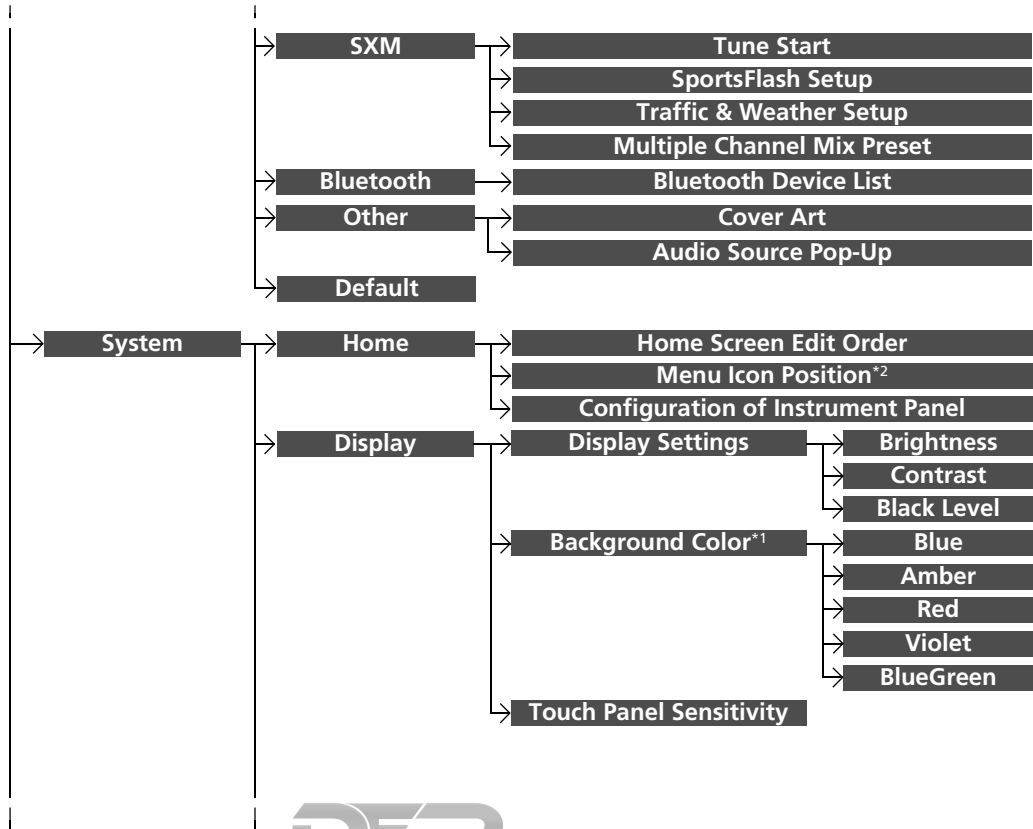

Features

*1: Does not appear when you change the screen interface design.

*2: Appears only when you change the screen interface design.



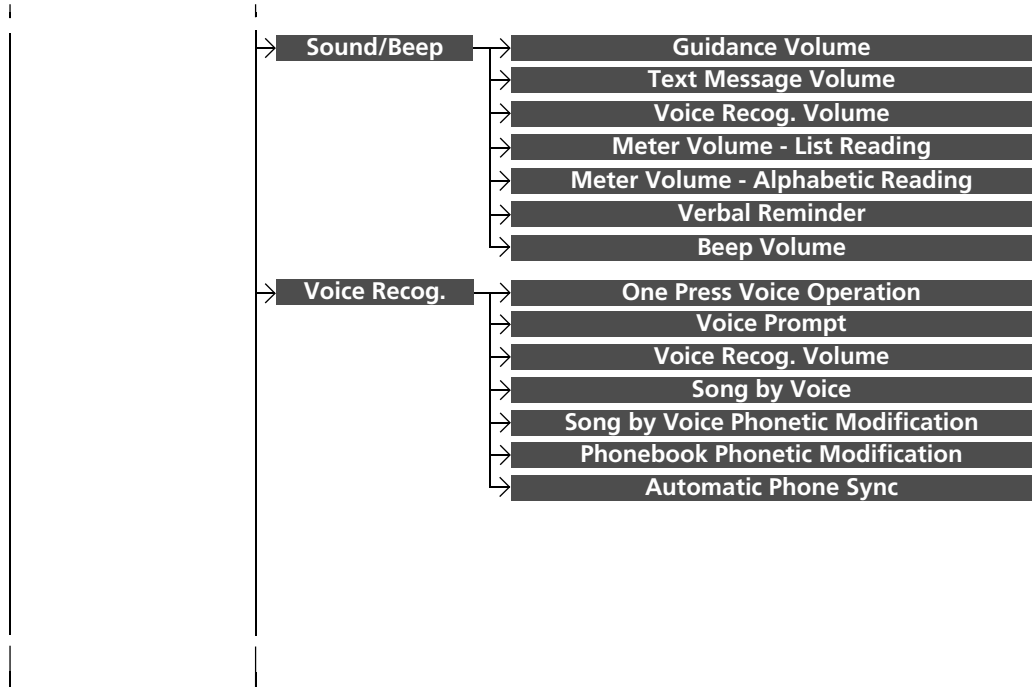

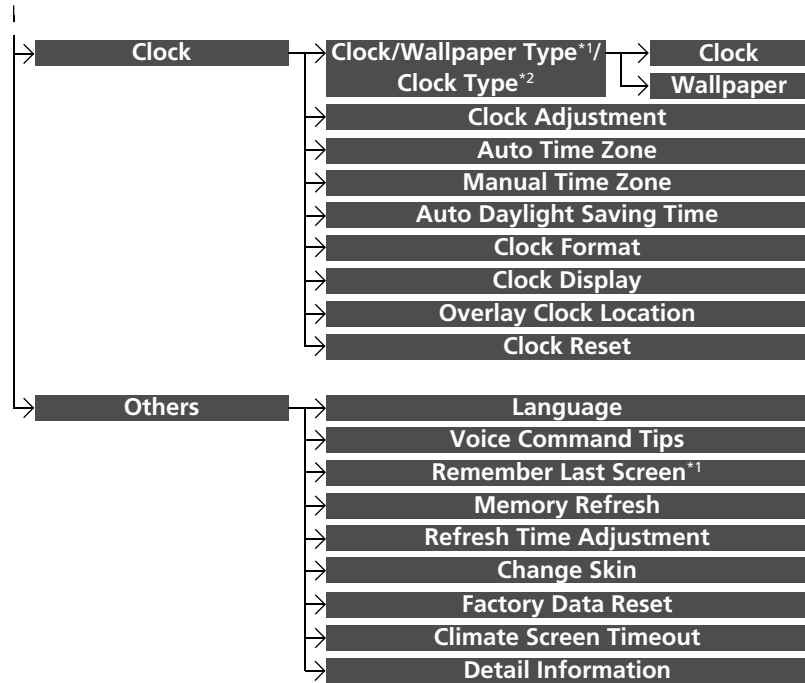

Features

*1: Does not appear when you change the screen interface design.

*2: Appears only when you change the screen interface design.



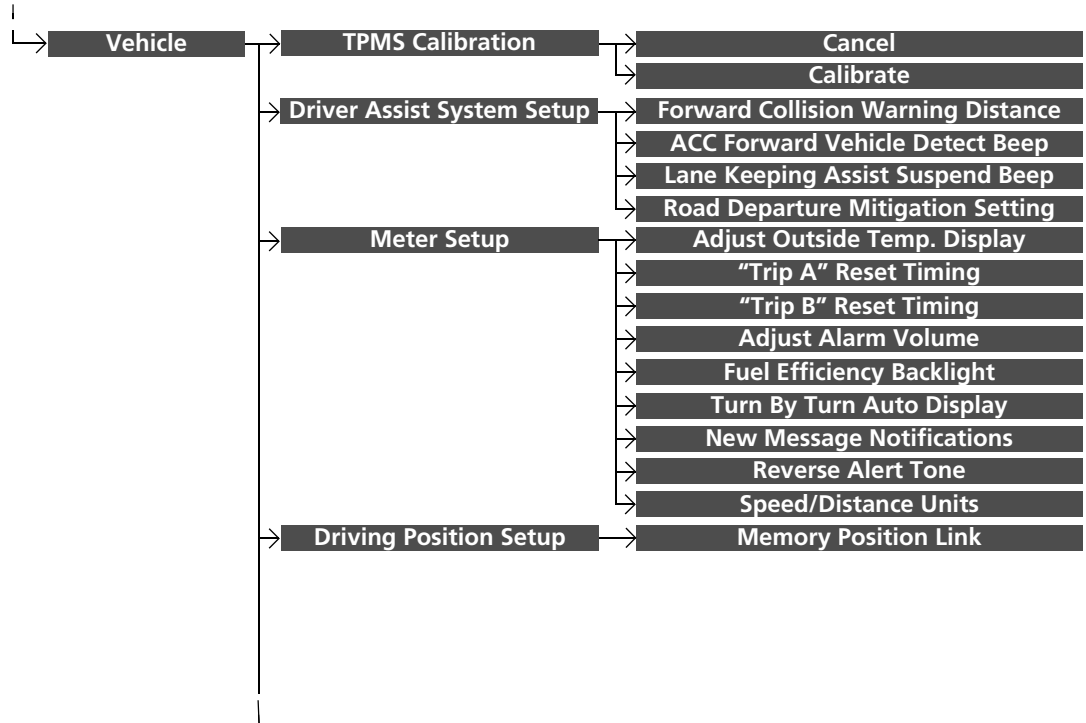

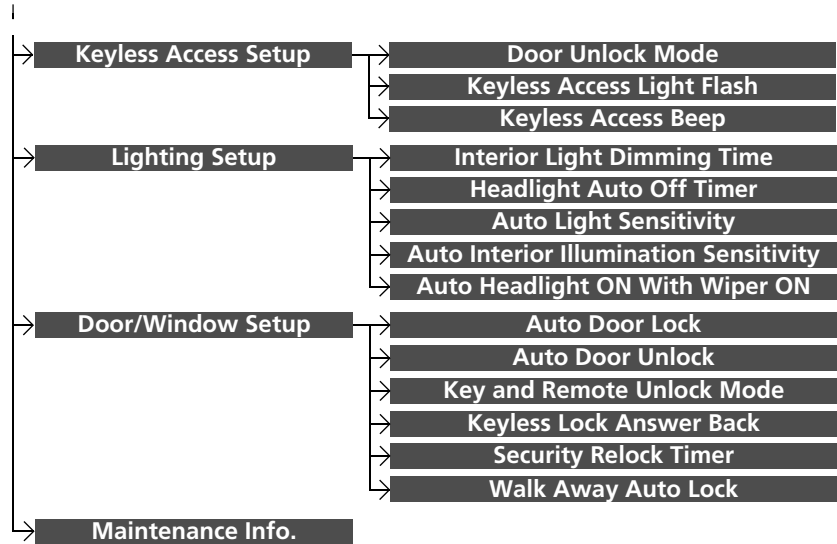

Features

■ List of customizable options

Setup Group	Customizable Features	Description	Selectable Settings	
Clock	Clock/ Wallpaper Type* ¹ / Clock Type* ²	Clock Wallpaper		
	Clock Adjustment			
	Auto Time Zone			
	Manual Time Zone			
	Auto Daylight Saving Time		See Info on P. 305	
	Clock Format			
	Clock Display			
	Overlay Clock Location			
	Clock Reset			
	HondaLink	Diagnostic & Location Data		
	Others	Info Screen Preference		

*1: Does not appear when you change the screen interface design.

*2: Appears only when you change the screen interface design.



Setup Group	Customizable Features	Description	Selectable Settings	
Info	Clock	Clock/ Wallpaper Type^{*2/} Clock	Changes the clock display type.	Analog/Digital^{*1/} Small Digital/Off
		Clock Type^{*3} Wallpaper	<ul style="list-style-type: none"> • Changes the wallpaper type. • Imports an image file for a new wallpaper. • Deletes an image file for a wallpaper. 	Blank/Galaxy^{*1/} Metallic/Time Zone
		Clock Adjustment	Adjusts Clock.	—
		Auto Time Zone	Automatically adjusts the clock when driving through different time zones.	On^{*1/}Off
		Manual Time Zone	Changes the time zone manually.	—
		Auto Daylight Saving Time	Select On to have the GPS automatically adjust the clock to daylight savings time. Select Off to cancel this function.	On^{*1/}Off
		Clock Format	Selects the digital clock display from 12H to 24H.	12H^{*1/}24H
		Clock Display	Selects whether the clock display comes on.	On^{*1/}Off
		Overlay Clock Location	Changes the clock display layout.	Upper Right^{*1/}Upper Left/Lower Right/ Lower Left/Off
		Clock Reset	Resets the clock settings to the factory default.	Yes/No

*1:Default Setting

*2:Does not appear when you change the screen interface design.

*3:Appears only when you change the screen interface design.



Setup Group	Customizable Features	Description	Selectable Settings	
Info	HondaLink	Diagnostic & Location Data	Turns HondaLink® on and off.	On ^{*1} /Off
	Others	Info Screen Preference	Selects the top menu when the Info is selected. <ul style="list-style-type: none"> • Info Top- A brief menu pops up. • Info Menu- A full menu pops up. • Off- A menu does not pop up. 	Info Top/Info Menu ^{*1} /Off

*1: Default Setting

Setup Group	Customizable Features	Description	Selectable Settings
Camera	Rear Camera	Fixed Guideline Selects whether the fixed guidelines come on the rear camera monitor. ▶ Multi-View Rear Camera P. 438	On ^{*1} /Off
		Dynamic Guideline Selects whether the guidelines adjust to the movement of the steering wheel. ▶ Multi-View Rear Camera P. 438	On ^{*1} /Off
		Default Cancels/Resets all customized items in the Rear Camera setting group as default.	Yes/No
	LaneWatch	Show with Turn Signal Selects whether the LaneWatch display comes on when you move the turn signal lever to indicate a right turn.	On ^{*1} /Off
		Display Time after Turn Signal Off Changes the length of time the LaneWatch display stays on after the turn signal lever returns to the center.	0 second ^{*1} / 2 seconds
		Reference Line Selects whether the reference lines come on the LaneWatch monitor.	On ^{*1} /Off
		Default Cancels/Resets all customized items in the LaneWatch group as default.	Yes/No



*1:Default Setting



Setup Group	Customizable Features	Description	Selectable Settings
Bluetooth/ Wi-Fi	Bluetooth On/Off Status	Changes the <i>Bluetooth</i> ® status.	On*¹/Off
	Bluetooth	Pairs a new phone to HFL, edits or deletes a paired phone. ☑ Phone Setup P. 333	—
	Edit Pairing Code	Edits a pairing code. ☑ To change the pairing code setting P. 334	Random/Fixed*¹
	Wi-Fi On/Off Status	Changes the Wi-Fi mode.	On/Off*¹
	Wi-Fi	Wi-Fi Device List Connects, disconnects, or deletes the Wi-Fi device.	—
		Wi-Fi Information Shows the Wi-Fi information of the head unit.	—
	Default	Cancels/Resets all customized items in the Bluetooth/Wi-Fi group as default.	Yes/No
Smartphone	Apple CarPlay	Sets up the Apple CarPlay connection.	—
	Android Auto	Sets up the Android Auto connection.	—
	Default	Cancels/Resets all customized items in the Smartphone group as default.	Yes/No

*1:Default Setting



Setup Group	Customizable Features	Description	Selectable Settings
Phone	Bluetooth Device List	Pairs a new phone to HFL, connects or disconnects a paired phone.  Phone Setup P. 333	—
	Edit Speed Dial	Edits, adds or deletes a speed dial entry.  Speed Dial P. 339	—
	Ring Tone	Selects the ring tone.	Fixed/Mobile Phone * ¹
	Automatic Phone Sync	Sets a phonebook and call history data to be automatically imported when a phone is paired to HFL.	On * ¹ / Off
	HondaLink Assist	Turns HondaLink Assist on and off.	On/Off * ¹
	Enable Text/Email	Turns the text/e-mail message function on and off.	On * ¹ / Off
	Select Account	Selects a text or e-mail message account.	—
	New Message Notification	Selects whether a pop-up alert comes on the screen when HFL receives a new text/e-mail message.	On/Off
Default	Cancels/Resets all customized items in the Phone settings group as default.		Yes/No

*1:Default Setting



Setup Group	Customizable Features	Description	Selectable Settings	
Audio	<div style="background-color: #cccccc; padding: 2px;">FM/AM mode</div> FM/AM	HD Radio Mode	Selects whether the audio system automatically switches to the digital radio waves or receives the analog waves only.	Auto^{*1}/Analog Only
		RDS INFO	Turns on and off the RDS information.	On^{*1}/Off
		Tune Start	Turns on and off, starts the song from the beginning as you change preset stations.	On^{*1}/Off
		Interrupt	Turns on and off the sports alert function.	Off/On(One Time)/On(Continue)^{*1}
	<div style="background-color: #cccccc; padding: 2px;">SiriusXM[®] mode</div> SXM	SportsFlash Setup	Favorite Team Selects your favorite sports teams. 📺 Live Sports Alert P. 242	—
		Interrupt Beep	Causes the system to beep when the sports alert is notified.	On^{*1}/Off
		Traffic & Weather Setup	Selects the region you want to receive the information.	—
		Multiple Channel Mix Preset	Turns multiple channel mix preset on and off.	On/Off^{*1}

*1:Default Setting



Setup Group	Customizable Features	Description	Selectable Settings
Audio	Bluetooth <i>Bluetooth® mode</i>	Bluetooth Device List Pairs a new phone to HFL, edits or deletes a paired phone. ☑ Phone Setup P. 333	—
	Other	<i>iPod or USB mode</i> [Your selected media] Cover Art	Turns the cover art display on and off. On*/Off
		Audio Source Pop-Up	Selects whether the list of selectable audio source comes on when Audio is selected on the home screen. On/Off*1
	Default		Cancels/Resets all customized items in the Audio settings group as default. Yes/No
System	Home	Home Screen Edit Order	Changes the HOME screen icon layout. —
		Menu Icon Position*2	Changes the position of the menu icons on the Audio, Phone, and Info screen. —
		Configuration of Instrument Panel	Changes the Instrument Panel screen icon layout. —

*1:Default Setting

*2:Appears only when you change the screen interface design.





Setup Group	Customizable Features	Description	Selectable Settings		
System	Display	Brightness	Changes the brightness of the audio/information screen.	—	
		Display Settings	Contrast	Changes the contrast of the audio/information screen.	—
			Black Level	Changes the black level of the audio/information screen.	—
	Background Color ^{*2}	Changes the background color of the audio/information screen.	Blue ^{*1} / Amber/Red/Violet/BlueGreen		
	Touch Panel Sensitivity	Sets the sensitivity of the touch panel screen.	High/Low ^{*1}		
	Sound/Beep	Guidance Volume	Changes the sound volume. Adjusts the guidance volume of the navigation system.	00~06 ^{*1} ~ 11	
Text Message Volume		Changes the text/e-mail message reading volume.	01~06 ^{*1} ~ 11		

*1:Default Setting

*2:Does not appear when you change the screen interface design.



Setup Group	Customizable Features	Description	Selectable Settings	
Sound/ Beep	Voice Recog. Volume	Changes the volume of the voice prompt.	01~06*1~11	
	Meter Volume - List Reading	Changes the list reading volume.	01~06*1~11	
	Meter Volume - Alphabetic Reading	Changes the alphabetic reading volume.	01~06*1~11	
	Verbal Reminder	Turns the verbal reminders on and off.	On*1/Off	
	Beep Volume	Changes the beep volume.	Off/1/2*1/3	
System	One Press Voice Operation	Changes the setting of the  (Talk) button operation when using the voice operation.	On*1/Off	
	Voice Prompt	Turns the voice prompt on and off.	On*1/Off	
	Voice Recog. Volume	Changes the volume of the voice prompt.	01~06*1~11	
	Song by Voice	Turns the Song By Voice™ on and off.	On*1/Off	
	Voice Recog.	Song by Voice Phonetic Modification	Modifies a voice command for music stored in the USB flash drive or an iPod/iPhone.  Phonetic Modification P. 250	—
		Phonebook Phonetic Modification	Modifies a voice command for the phonebook.  Phonebook Phonetic Modification P. 342	—
		Automatic Phone Sync	Sets phonebook and call history data to be automatically imported when a phone is paired to HFL.	On/Off

*1:Default Setting



Setup Group	Customizable Features	Description	Selectable Settings
System	Clock/ Wallpaper Type* ² / Clock Type* ³	Clock Wallpaper	
	Clock Adjustment		
	Auto Time Zone		
	Manual Time Zone	See Info on P. 305	
	Auto Daylight Saving Time		
	Clock Format		
	Clock Display		
	Overlay Clock Location		
	Clock Reset		
	Others	Language	Change the display language.

*1:Default Setting

*2:Does not appear when you change the screen interface design.

*3:Appears only when you change the screen interface design.



Setup Group	Customizable Features	Description	Selectable Settings
System Others	Voice Command Tips	Alerts you when manual control of the system is disabled to prevent distraction while driving. Only voice commands are available.	On*¹/Off
	Remember Last Screen ^{*2}	Selects whether the device remembers the last screen.	On/Off ^{*1}
	Memory Refresh	Turns on the audio system automatically and restores the fragmentation of a memory when the power mode is in VEHICLE OFF.	On*¹/Off
	Refresh Time Adjustment	Sets the time for Memory Refresh .	—
	Change Skin	Changes the screen interface design.	Yes/No
	Factory Data Reset	Resets all the settings to their factory default. <input checked="" type="checkbox"/> Defaulting All the Settings P. 321	Yes/No

*1:Default Setting

*2:Does not appear when you change the screen interface design.



Setup Group	Customizable Features	Description	Selectable Settings	
System	Others	Climate Screen Timeout	Changes the length of time the climate control display stays on when you press the CLIMATE button.	Never/5 Seconds/10 Seconds*¹/20 Seconds
		Detail Information	Displays the details of the head unit and operating system information.	
	Default		Cancels /Resets all customized items in the System group as default.	Yes/No
Vehicle		TPMS Calibration	Cancels/Calibrates the TPMS.	Cancel/Calibrate
	Driver Assist System Setup	Forward Collision Warning Distance	Changes the distance at which CMBS™ alerts.	Long/Normal*¹/Short
		ACC Forward Vehicle Detect Beep	Causes the system to beep when the system detects a vehicle, or when the vehicle goes out of the ACC with LSF range.	On/Off*¹
		Lane Keeping Assist Suspend Beep	Causes the system to beep when LKAS is suspended.	On/Off*¹
		Road Departure Mitigation Setting	Changes the setting for the road departure mitigation system.	Normal*¹/Wide/Warning Only

*1:Default Setting



Setup Group	Customizable Features	Description	Selectable Settings
Vehicle Meter Setup	Adjust Outside Temp. Display	Adjusts the temperature reading by a few degrees.	-5°F ~ ±0°F*1 ~ +5°F
	“Trip A” Reset Timing	Changes the setting of how to reset trip meter A, average energy consumption A, average speed A, and elapsed time A.	When Charged/IGN Off/Manually Reset*1
	“Trip B” Reset Timing	Changes the setting of how to reset trip meter B, average energy consumption B, average speed B, and elapsed time B.	When Charged/IGN Off/Manually Reset*1
	Adjust Alarm Volume	Changes the alarm volume, such as buzzers, warnings, turn signal sound, and so on.	High/Mid*1/Low
	Fuel Efficiency Backlight	Turns the ambient meter feature on and off.	On*1/Off
	Turn By Turn Auto Display	Selects whether the turn-by-turn display comes on during the route guidance.	On*1/Off
	New Message Notifications	Used to select whether a pop-up alert comes on the screen when HFL receives a new text/e-mail message.	On*1/Off

*1:Default Setting



Setup Group	Customizable Features	Description	Selectable Settings	
Vehicle	Meter Setup	Reverse Alert Tone	Causes the beeper to sound once when the transmission is put into R .	On^{*1}/Off
		Speed/Distance Units	Selects the trip computer units.	km/h·km/ mph·miles^{*1}
	Driving Position Setup	Memory Position Link	Turns the driving position memory system on and off.	On^{*1}/Off
		Keyless Access Setup	Door Unlock Mode	Changes which doors unlock when you grab the driver's door handle.
	Keyless Access Light Flash		Causes some exterior lights to flash when you unlock/lock the doors.	On^{*1}/Off
	Keyless Access Beep		Causes the beeper to sound when you unlock/lock the doors.	On^{*1}/Off

*1:Default Setting



Setup Group	Customizable Features	Description	Selectable Settings
Vehicle Lighting Setup	Interior Light Dimming Time	Changes the length of time the interior lights stay on after you close the doors.	15seconds/ 30seconds*¹/ 60seconds
	Headlight Auto Off Timer	Changes the length of time the exterior lights stay on after you close the driver's door.	0seconds/ 15seconds*¹/ 30seconds/ 60seconds
	Auto Light Sensitivity	Changes the timing for the headlights to come on.	Max/High/Mid*¹/ Low/Min
	Auto Interior Illumination Sensitivity	Changes the sensitivity of the brightness of the instrument panel when the headlight switch is in the AUTO position.	Max/High/Mid*¹/ Low/Min
	Auto Headlight ON With Wiper ON	Changes the settings for the wiper operation when the headlights automatically come on while the headlight switch is in the AUTO position.	On*¹/Off

*1:Default Setting



Setup Group	Customizable Features	Description	Selectable Settings	
Vehicle	Door/ Window Setup	Auto Door Lock	Used to change the setting for when the doors automatically lock.	With Vehicle Speed^{*1}/Shift from P/ Off
		Auto Door Unlock	Changes the setting for when the doors unlock automatically.	All Doors When Driver's Door Opens^{*1}/All Doors When Shifted to Park/All Doors When Ignition Switched Off/Off
		Key and Remote Unlock Mode	Sets up the driver's door or all the doors to unlock on the first push of the remote.	Driver Door^{*1}/All Doors
		Keyless Lock Answer Back	LOCK/UNLOCK- The exterior lights flash. LOCK (2nd push)- The beeper sounds.	On^{*1}/Off
		Security Relock Timer	Changes the time it takes for the doors to relock and the security system to set after you unlock the vehicle without opening any door.	90seconds/ 60seconds/ 30seconds^{*1}
		Walk Away Auto Lock	Changes the settings for the auto lock function when you walk away from the vehicle.	On/Off^{*1}
	Maintenance Info.	Resets the Maintenance Minder™ display when you have performed the maintenance service.	—	

*1: Default Setting



Defaulting All the Settings

Reset all the menu and customized settings as the factory defaults.

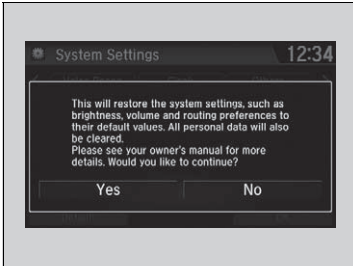

1. Select .
2. Select **Settings**.
3. Select **System**.
4. Select the **Others** tab.
5. Select **Factory Data Reset**.
 - A confirmation message appears on the screen.
6. Select **Yes** to reset the settings.
7. Select **Yes** again to reset the settings.
 - A confirmation message appears on the screen. Select **OK**.
 - After selecting **OK**, the system will reboot.

Defaulting All the Settings

When you transfer the vehicle to a third party, reset all settings to default and delete all personal data.

If you perform **Factory Data Reset**, it will reset the preinstalled apps to their factory default.

If you perform **Factory Data Reset**, you cannot use the HondaLink® because it becomes off line.

 **HondaLink®** P. 259

The HomeLink® Universal Transceiver can be programmed to operate up to three remote controlled devices around your home, such as garage doors, lighting, or home security systems.

■ Important Safety Precautions

Refer to the safety information that came with your garage door opener to test that the safety features are functioning properly. If you do not have the safety information, contact the manufacturer.

Before programming HomeLink, make sure that people and objects are out of the way of the garage or gate to prevent potential injury or damage.

When programming a garage door opener, park just outside the garage door's path.

⌘ HomeLink® Universal Transceiver

Before programming HomeLink to operate a garage door opener, confirm that the opener has an external entrapment protection system, such as an "electronic eye," or other safety and reverse stop features. If it does not, HomeLink may not be able to operate it.

Training HomeLink

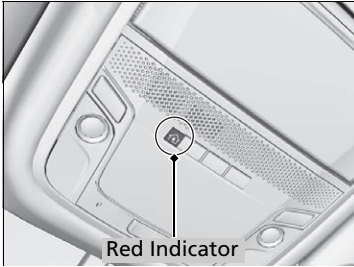

If it is necessary to erase a previously entered learned code:

- Press and hold the two outside buttons for about 20 seconds, until the red indicator blinks. Release the buttons, and proceed to step 1.
- If you are training the second or third button, go directly to step 1.

The instructions on the next page should work for most gate or garage openers, but may not work for all. For detailed instructions about your specific remote opener, visit <http://www.homelink.com> or call (800) 355-3515.



Continued

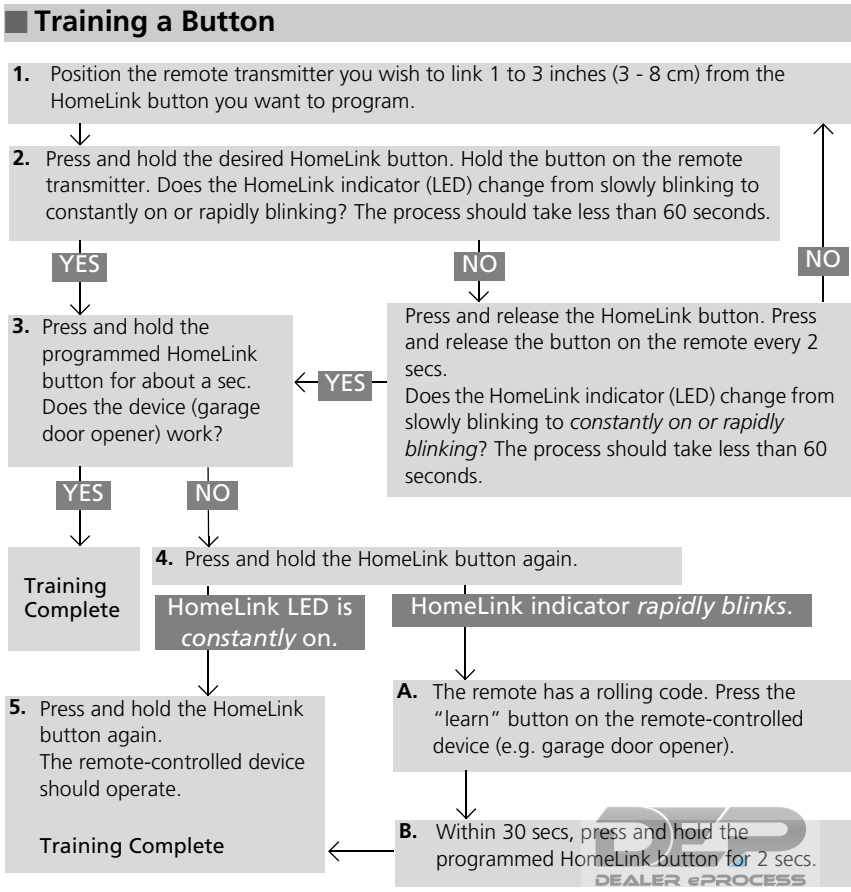

▶▶ Training HomeLink

Retraining a Button
 If you want to retrain a programmed button for a new device, you do not have to erase all button memory. You can replace the existing memory code using this procedure:

- Press and hold the desired HomeLink button until the HomeLink indicator begins to blink.
 - Standard transmitter**
Indicator remains on for about 25 secs.
 - Rolling code transmitter**
Indicator remains on for about 25 secs.
- Quickly release the HomeLink button and follow steps 1 - 3 under "Training a Button." You do not need to press and release the HomeLink button again in step 2.

Erasing Codes
 To erase all the codes, press and hold the two outside buttons until the HomeLink indicator begins to blink (about 10 to 20 secs). You should erase all codes before selling the vehicle.

If you have any problems, see the device's instructions, visit www.homelink.com, or call HomeLink at (800) 355-3515.

HomeLink® is a registered trademark of Gentex Corporation.

Bluetooth® HandsFreeLink® (HFL) allows you to place and receive phone calls using your vehicle's audio system, without handling your cell phone.

Using HFL

HFL Buttons

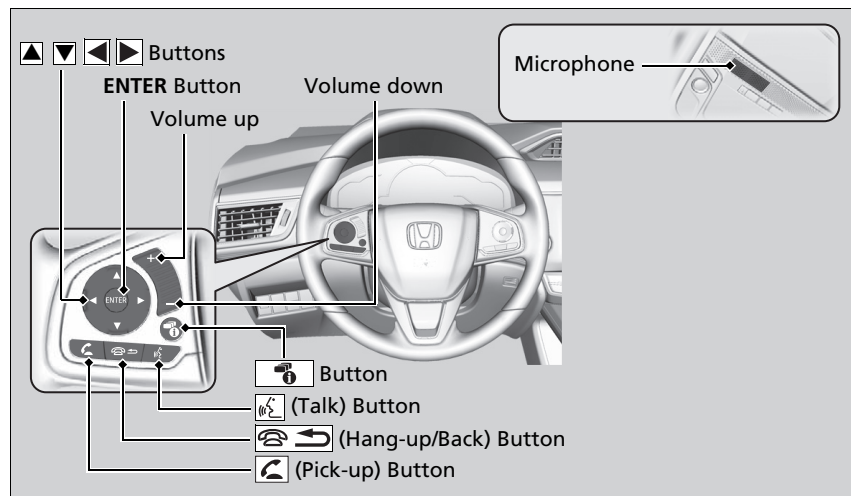

Bluetooth® HandsFreeLink®

Place your phone where you can get good reception.

To use HFL, you need a *Bluetooth*-compatible cell phone. For a list of compatible phones, pairing procedures, and special feature capabilities, visit automobiles.honda.com/handsfreelink/, or call 1-888-528-7876.

To use the system, the **Bluetooth On/Off Status** setting must be **On**. If there is an active connection to Apple CarPlay, HFL is unavailable.

➤ **How to customize** P. 296

Voice control tips

- Aim the vents away from the ceiling and close the windows, as noise coming from them may interfere with the microphone.
- Press the  button when you want to call a number using a stored voice tag. Speak clearly and naturally after a beep.
- If the microphone picks up voices other than yours, the command may be misinterpreted.
- To change the volume level, select the audio system's **VOL** (Volume) or use the remote audio controls on the steering wheel.

Up to five speed dial entries can be displayed among a total of 20 that can be entered.

➤ **Speed Dial** P. 339

Up to five previous calls can be displayed at a time among a total of 20 that can be entered. If there is no call history, Call History is disabled.



Continued



 **(Pick-up) button:** Press to go directly to the phone menu on the driver information interface, or to answer an incoming call.

 **(Hang-up/back) button:** Press to end a call, go back to the previous command, or cancel a command.



 **(Talk) button:** Press to access Voice Portal.

 **buttons:** Press to select an item displayed on the phone menu in the driver information interface.

ENTER button: Press to call a number listed in the selected item on the phone menu in the driver information interface.

 **button:** Select  and press **ENTER** to display **Speed Dial, Call History, or Phonebook** on the phone menu in the driver information interface.

To go to the **Phone Menu** screen:

1. Select .
2. Select **Phone** to switch the display to the phone screen.
3. Select .

Bluetooth® HandsFreeLink®

Bluetooth® Wireless Technology

The *Bluetooth®* word mark and logos are registered trademarks owned by Bluetooth SIG, Inc., and any use of such marks by Honda Motor Co., Ltd., is under license. Other trademarks and trade names are those of their respective owners.

HFL Limitations

An incoming call on HFL will interrupt the audio system when it is playing. It will resume when the call is ended.

■ HFL Status Display

The audio/information screen notifies you when there is an incoming call.

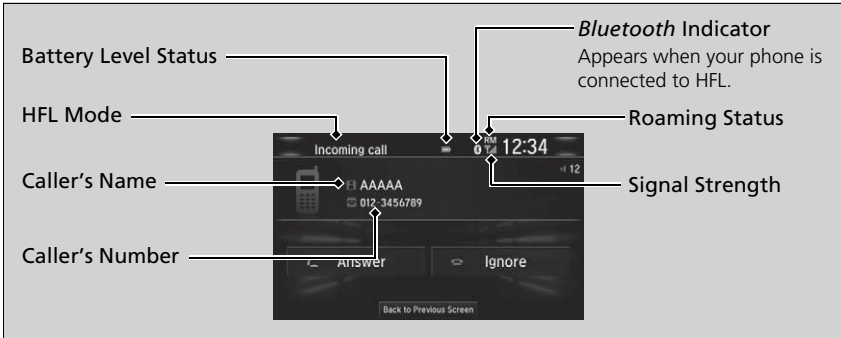

■ Limitations for Manual Operation

Certain manual functions are disabled or inoperable while the vehicle is in motion. You cannot select a grayed-out option until the vehicle is stopped.

Only previously stored speed dial entries with voice tags, phonebook names, or numbers can be called using voice commands while the vehicle is in motion.

▶ **Speed Dial** P. 339

▶▶ HFL Status Display

The information that appears on the audio/information screen varies between phone models.

You can change the system language.

▶ **How to customize** P. 296



HFL Menus

The power mode must be in ACCESSORY or ON to use HFL.

■ Phone Settings screen



1. Select .
2. Select **Settings**.
3. Select **Phone**.

▶ HFL Menu

To use HFL, you must first pair your *Bluetooth*-compatible cell phone to the system while the vehicle is parked.

Some functions are limited while driving.

Features

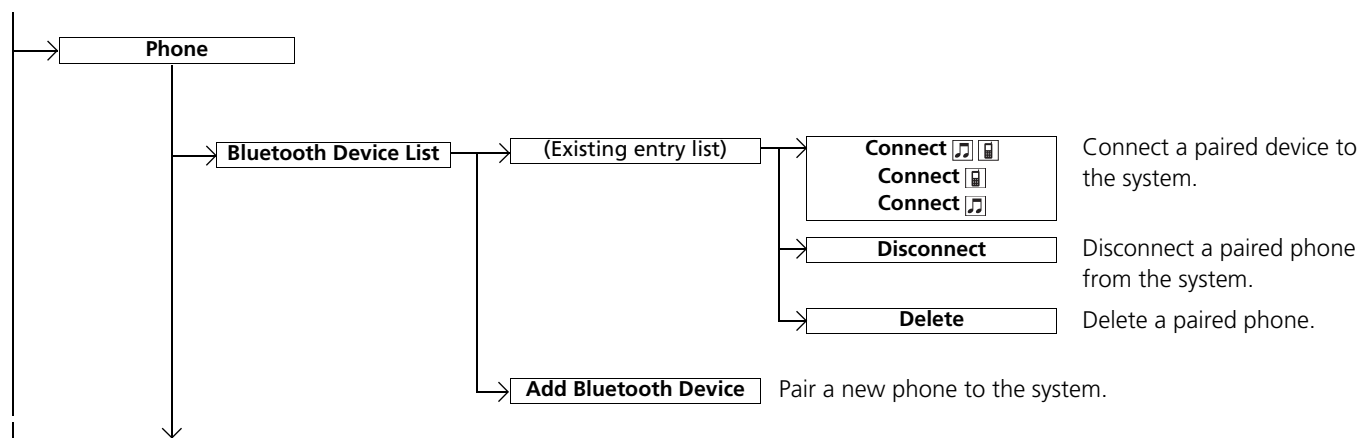

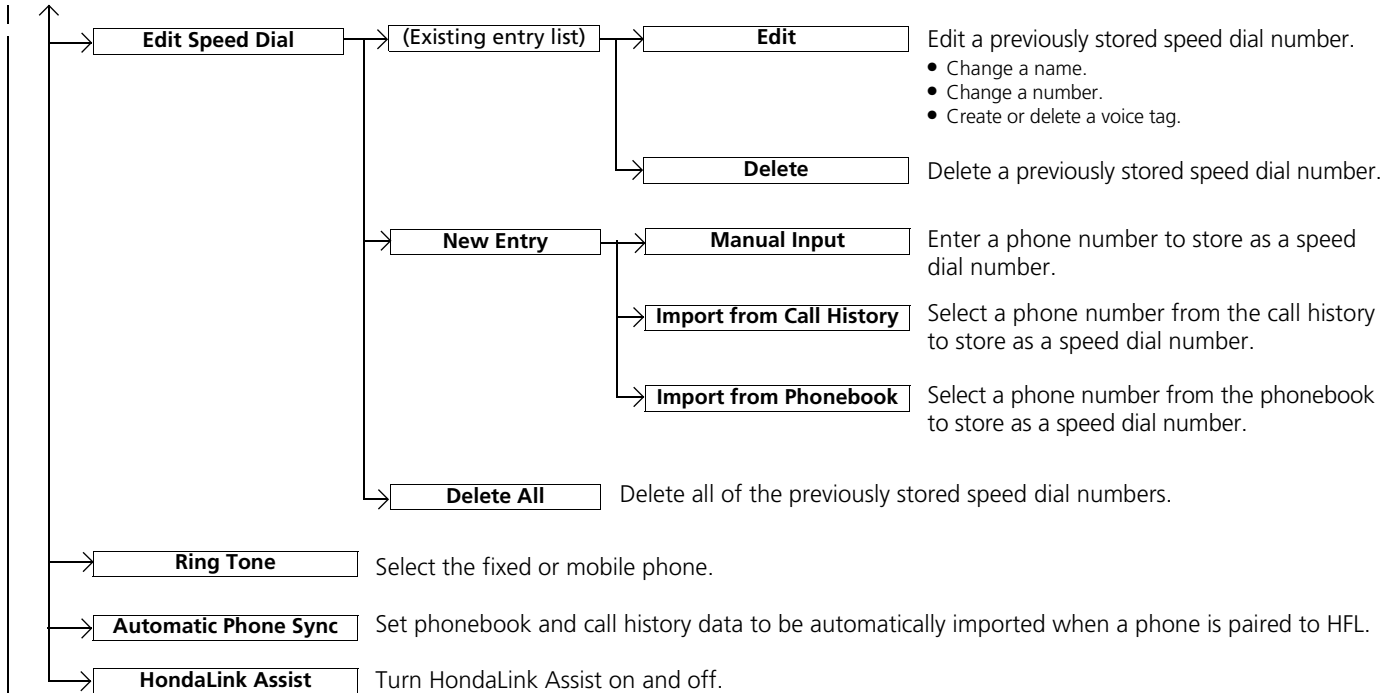

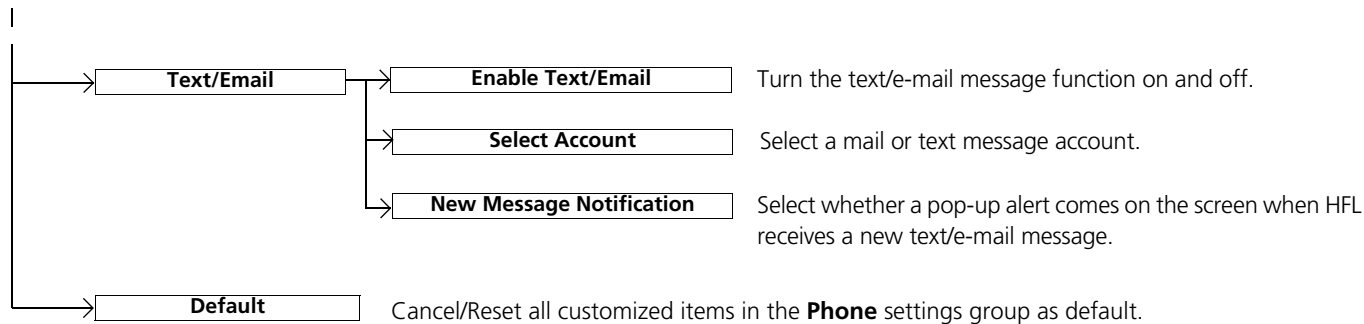

■ Phone Menu screen



1. Select .
2. Select **Phone**.
3. Select .

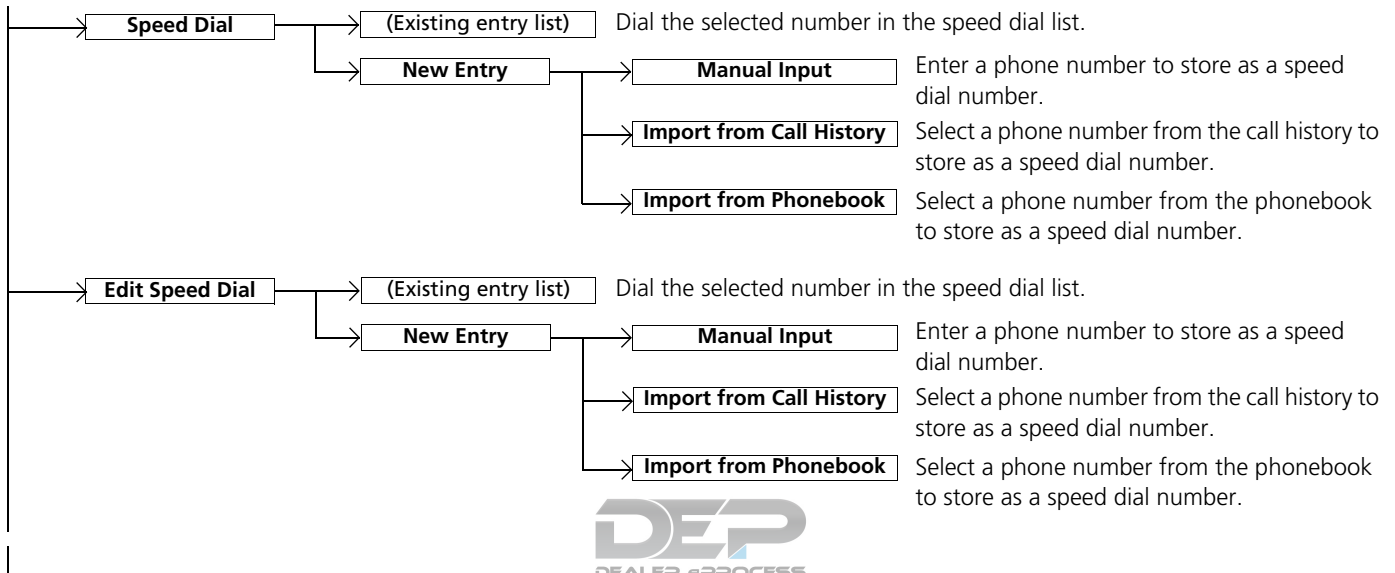

Continued

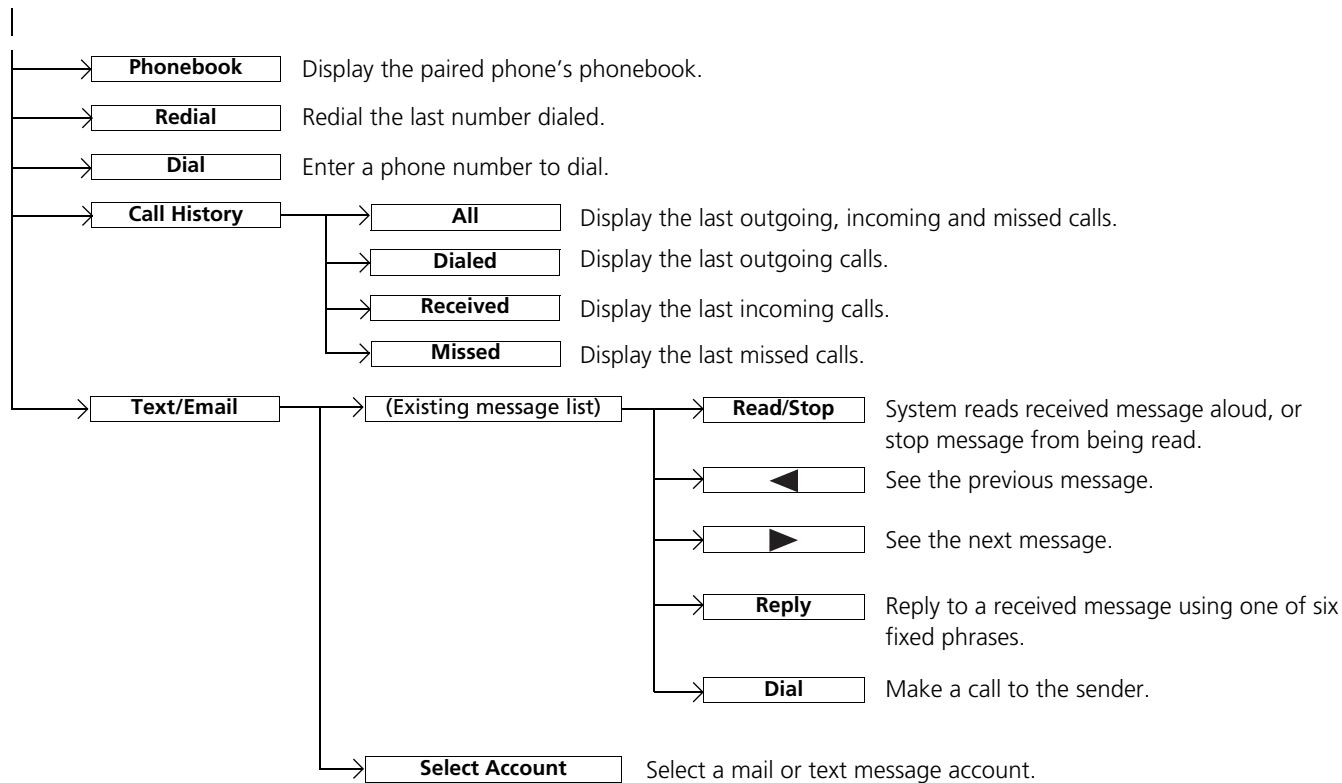

Phone Setup

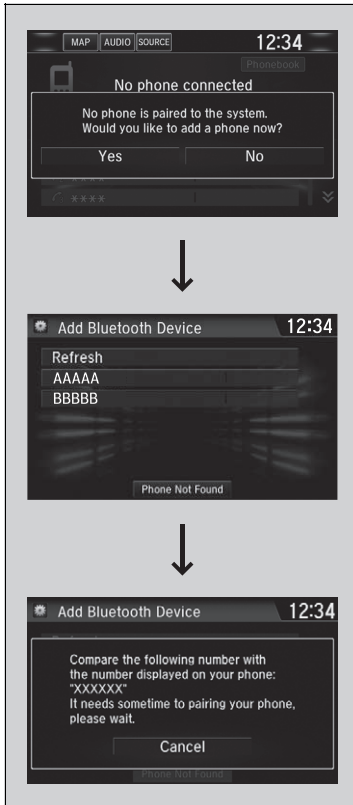

■ To pair a cell phone (when there is no phone paired to the system)

1. Select **Phone**.
2. Select **Yes**.
3. Make sure your phone is in search or discoverable mode, then select **Continue**.
 - ▶ HFL automatically searches for a *Bluetooth*® device.
4. Select your phone when it appears on the list.
 - ▶ If your phone does not appear, you can select **Refresh** to search again.
 - ▶ If your phone still does not appear, select **Phone Not Found** and search for *Bluetooth*® devices using your phone. From your phone, search for **HandsFreeLink**.
5. The system gives you a pairing code on the audio/information screen.
 - ▶ Confirm if the pairing code on the screen and your phone match. This may vary by phone.



Continued

☒ Phone Setup



Your *Bluetooth*-compatible phone must be paired to the system before you can make and receive hands-free calls.

Phone Pairing Tips:

- You cannot pair your phone while the vehicle is moving.
- Up to six phones can be paired.
- Your phone's battery may drain faster when it is paired to the system.
- If your phone is not ready for pairing or not found by the system within three minutes, the system will time out and return to idle.

Once you have paired a phone, you can see it displayed on the screen with one or two icons on the right side.





These icons indicate the following:

- : The phone can be used with HFL.
- : The phone is compatible with *Bluetooth*® Audio.

If there is an active connection to Apple CarPlay, pairing of additional *Bluetooth*-compatible devices is unavailable and **Add Bluetooth Device** is grayed out from the **Bluetooth Device List** screen.



■ **To change the currently paired phone**

1. Go to the **Phone Settings** screen.
 - ▶ **Phone Settings screen** P. 328
2. Select **Bluetooth Device List**.
3. Select a phone to connect.
 - ▶ HFL disconnects the connected phone and starts searching for another paired phone.
4. Select **Connect**  , **Connect** , or **Connect** .

■ **To change the pairing code setting**

1. Select .
2. Select **Settings**.
3. Select **Bluetooth/Wi-Fi**.
4. Select the **Bluetooth** tab.
5. Select **Edit Pairing Code**.
6. Select **Random** or **Fixed**.

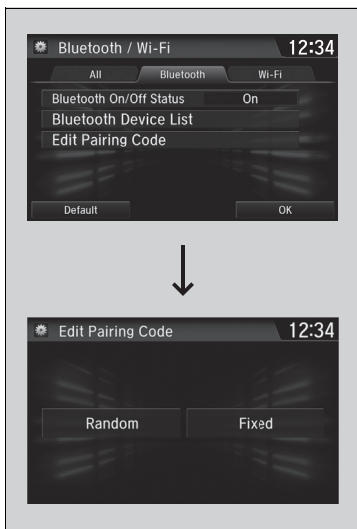

▶▶ To change the currently paired phone

If no other phones are found or paired when trying to switch to another phone, HFL will inform you that the original phone is connected again.

To pair other phones, select **Add Bluetooth Device** from the **Bluetooth Device List** screen.

▶▶ To change the pairing code setting

The default pairing code is **0000** until you change the setting.
To create your own, select **Fixed**, and delete the current code, then enter a new one.

For a randomly generated pairing code each time you pair a phone, select **Random**.



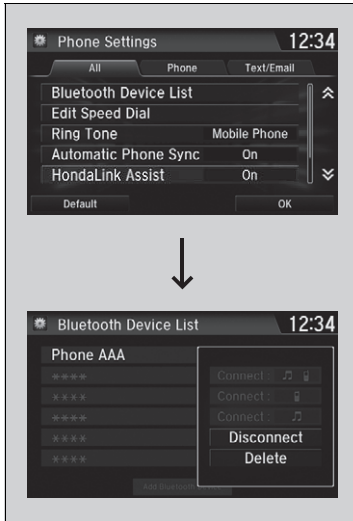

■ **To delete a paired phone**

1. Go to the **Phone Settings** screen.
 ▶ **Phone Settings** screen P. 328
2. Select **Bluetooth Device List**.
3. Select a phone you want to delete.
4. Select **Delete**.
5. A confirmation message appears on the screen. Select **Yes**.



■ To Set Up Text/E-mail Message Options

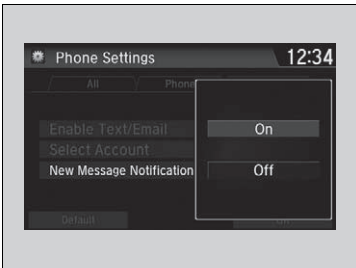
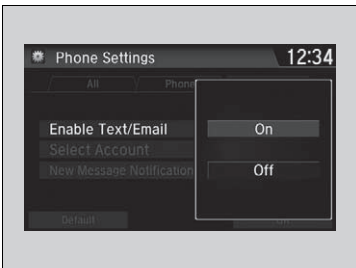

■ To turn on or off the text/e-mail message function

1. Go to the **Phone Settings** screen.
 - ▶ **Phone Settings screen** P. 328
2. Select the **Text/Email** tab, then **Enable Text/Email**.
 - ▶ A pop-up menu appears on the screen.
3. Select **On** or **Off**.

■ To turn on or off the text/e-mail message notice

1. Go to the **Phone Settings** screen.
 - ▶ **Phone Settings screen** P. 328
2. Select the **Text/Email** tab, then **New Message Notification**.
 - ▶ A pop-up menu appears on the screen.
3. Select **On** or **Off**.

▶▶ To Set Up Text/E-mail Message Options

To use the text/e-mail message function, it may be necessary to set up on your phone.

Some text/e-mail message features may not be available depending on a cellular phone.

▶▶ To turn on or off the text/e-mail message notice

On: A pop-up notification comes on every time you receive a new message.

Off: The message you receive is stored in the system without notification.



Ring Tone

You can change the ring tone setting.

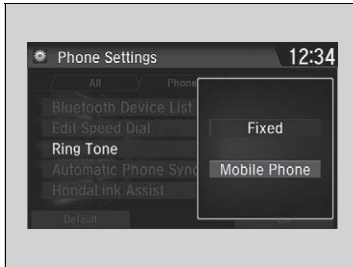

1. Go to the **Phone Settings** screen.
 ▶ **Phone Settings** screen P. 328
2. Select **Ring Tone**.
3. Select **Fixed** or **Mobile Phone**.

Ring Tone

Fixed: The fixed ring tone sounds from the speakers.
Mobile Phone: For certain connected phones, the ring tone stored in the phone sounds from the speakers.

■ Automatic Import of Cellular Phonebook and Call History

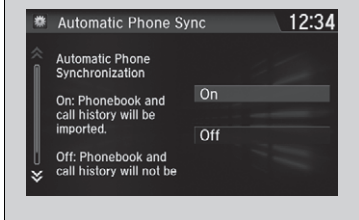
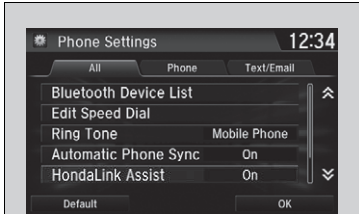
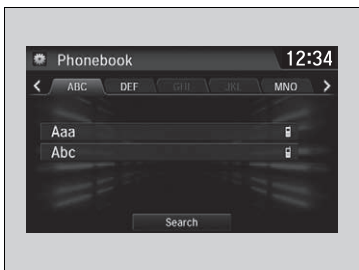

■ **When Automatic Phone Sync is set to On:**
 When your phone is paired, the contents of its phonebook and call history are automatically imported to the system.

- **Changing the Automatic Phone Sync setting**
1. Go to the **Phone Settings** screen.
 ▶ **Phone Settings screen** P. 328
 2. Select **Automatic Phone Sync**.
 3. Select **On** or **Off**.

▶ Automatic Import of Cellular Phonebook and Call History

When you select a name from the list in the cellular phonebook, you can see up to three category icons. The icons indicate what types of numbers are stored for that name.

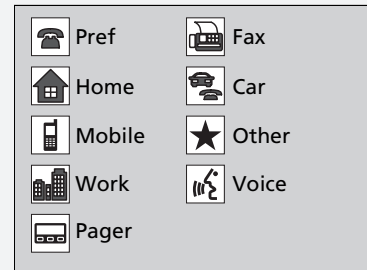

On some phones, it may not be possible to import the category icons to the system.

The phonebook is updated after every connection. Call history is updated after every connection or call.



Speed Dial

Up to 20 speed dial numbers can be stored per phone.

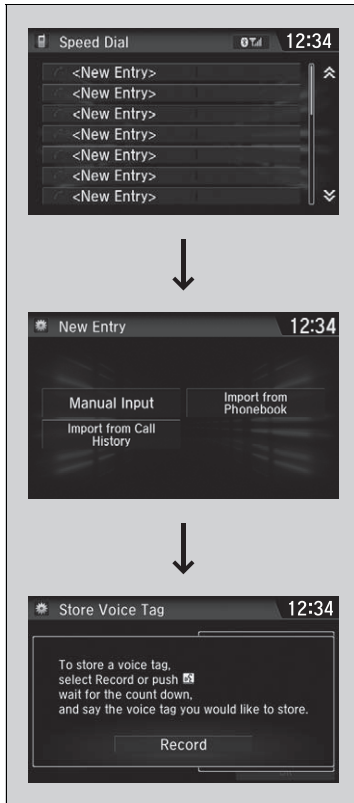

To store a speed dial number:

1. Go to the **Phone Menu** screen.

➤ **Phone Menu screen** P. 331

2. Select **Speed Dial**.

3. Select **New Entry**.

From **Import from Call History**:

▶ Select a number from the call history.

From **Manual Input**:

▶ Input the number manually.

From **Import from Phonebook**:

▶ Select a number from the connected cell phone's imported phonebook.

4. When the speed dial is successfully stored, you are asked to create a voice tag for the number. Select **Yes** or **No**.

5. Select **Record**, or use the [RECORD] button and follow the prompts to complete the voice tag.



Continued

Speed Dial

When a voice tag is stored, press the [RECORD] button to call the number using the voice tag. Say the voice tag name.

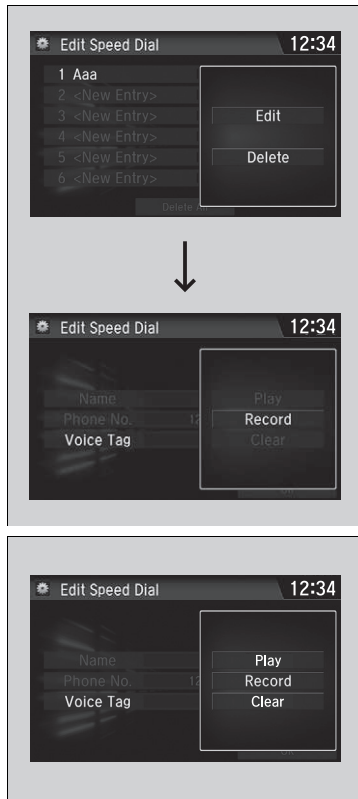

■ To add a voice tag to a stored speed dial number

1. Go to the **Phone Settings** screen.
 - ▶ **Phone Settings screen** P. 328
2. Select **Edit Speed Dial**.
3. Select an existing speed dial entry.
 - ▶ From the pop-up menu, select **Edit**.
4. Select **Voice Tag**.
 - ▶ From the pop-up menu, select **Record**.
5. Select **Record**, or use the  button and follow the prompts to complete the voice tag.

■ To delete a voice tag

1. Go to the **Phone Settings** screen.
 - ▶ **Phone Settings screen** P. 328
2. Select **Edit Speed Dial**.
3. Select an existing speed dial entry.
 - ▶ From the pop-up menu, select **Edit**.
4. Select **Voice Tag**.
 - ▶ From the pop-up menu, select **Clear**.
5. A confirmation message appears on the screen. Select **Yes**.



▶▶ Speed Dial

Avoid using duplicate voice tags.
 Avoid using "home" as a voice tag.
 It is easier for the system to recognize a longer name.
 For example, use "John Smith" instead of "John."

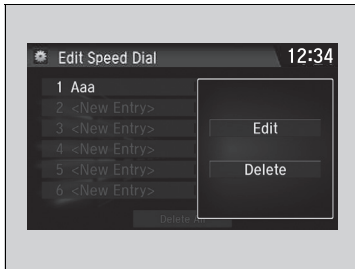

■ To edit a speed dial

1. Go to the **Phone Settings** screen.
 - ▶ **Phone Settings screen** P. 328
2. Select **Edit Speed Dial**.
3. Select an existing speed dial entry.
 - ▶ From the pop-up menu, select **Edit**.
4. Select a setting you want.

■ To delete a speed dial

1. Go to the **Phone Settings** screen.
 - ▶ **Phone Settings screen** P. 328
2. Select **Edit Speed Dial**.
3. Select an existing speed dial entry.
 - ▶ From the pop-up menu, select **Delete**.
4. A confirmation message appears on the screen. Select **Yes**.



■ Phonebook Phonetic Modification

Add phonetic modifications or a new voice tag to the phone's contact name so that it is easier for HFL to recognize voice commands.

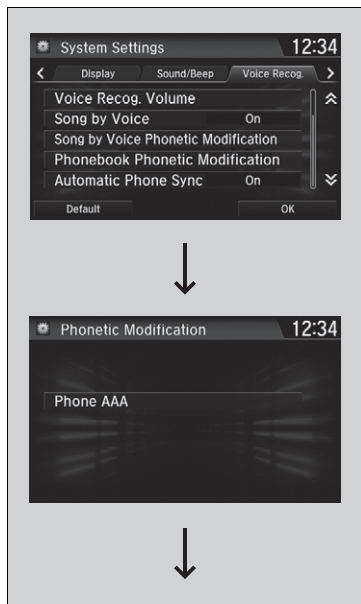



■ To add a new voice tag

1. Select .
2. Select **Settings**.
3. Select **System**.
4. Select the **Voice Recog.** tab.
5. Select **Phonebook Phonetic Modification**.
6. Select the phone you want to add phonetic modification to.

▶▶ Phonebook Phonetic Modification

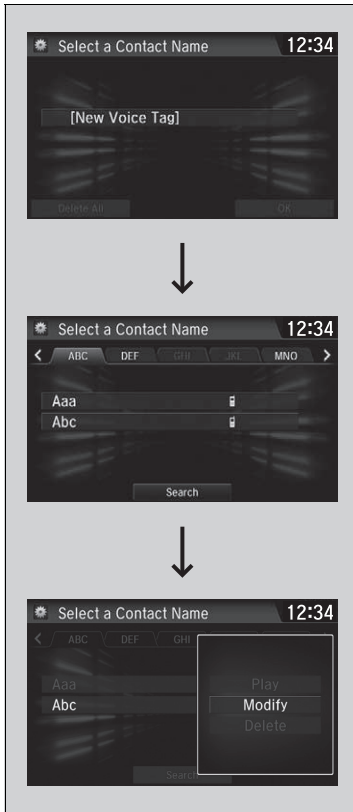

You can store up to 20 phonetic modification items.

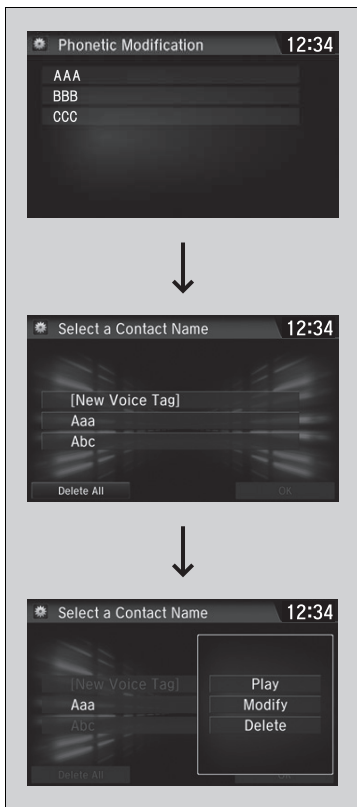

7. Select **New Voice Tag**.
8. Select a contact name you want to add to.
 - ▶ The pop-up menu appears on the screen.
9. Select **Modify**.
10. Using **Record** or the  button, follow the prompts to complete the voice tag.
11. You will receive a confirmation message on the screen, then select **OK**.



■ **To modify a voice tag**

1. Select .
2. Select **Settings**.
3. Select **System**.
4. Select the **Voice Recog.** tab.
5. Select **Phonebook Phonetic Modification**.
6. Select the phone you want to modify phonetic modification.
7. Select a contact name you want to modify.
 - ▶ The pop-up menu appears on the screen.
8. Select **Modify**.
9. Using **Record** or the  button, follow the prompts to complete the voice tag.
10. You will receive a confirmation message on the screen, then select **OK**.

▶▶ Phonebook Phonetic Modification

You can only modify or delete contact names for the currently connected phone.



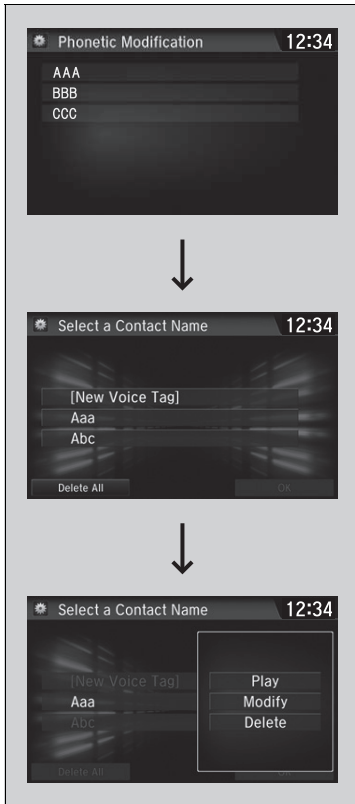

■ **To delete a modified voice tag**

1. Select .
2. Select **Settings**.
3. Select **System**.
4. Select the **Voice Recog.** tab.
5. Select **Phonebook Phonetic Modification**.
6. Select the phone you want to delete phonetic modification.
7. Select a contact name you want to delete.
 - ▶ The pop-up menu appears on the screen.
8. Select **Delete**.
 - ▶ The selected contact name has been selected.
9. Select **OK**.



Continued

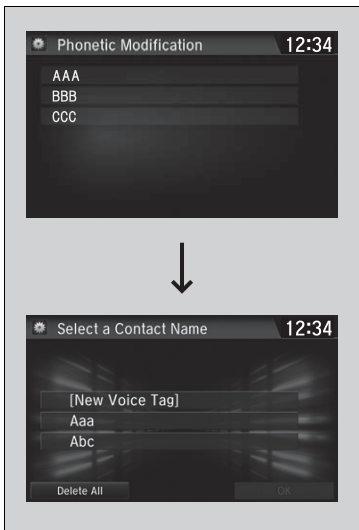

■ To delete all modified voice tags

1. Select .
2. Select **Settings**.
3. Select **System**.
4. Select the **Voice Recog.** tab.
5. Select **Phonebook Phonetic Modification**.
6. Select the phone you want to delete phonetic modification.
 - ▶ The contact name list appears.
7. Select **Delete All**.
8. You will receive a confirmation message on the screen, then select **Yes**.

■ Making a Call

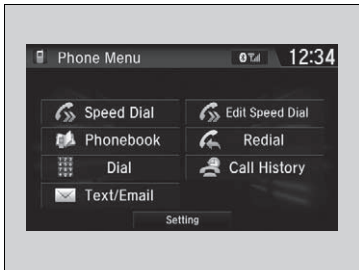

You can make calls by inputting any phone number, or by using the imported phonebook, call history, speed dial entries, or redial.

⊗ Making a Call

Any voice-tagged speed dial entry can be dialed by voice from most screens.

Press the  button and say the voice tag name.

Once a call is connected, you can hear the voice of the person you are calling through the audio speakers.

While there is an active connection with Apple CarPlay, phone calls cannot be made with HandsFreeLink® and are only made from Apple CarPlay.





■ **To make a call using the imported phonebook**

1. Go to the **Phone Menu** screen.
 - ▶ **Phone Menu screen** P. 331
2. Select **Phonebook**.
3. Select a name.
 - ▶ You can also search by letter. Select **Search**.
 - ▶ Use the keyboard on the touch screen for entering a name, if multiple numbers exist select a number.
4. Select a number.
 - ▶ Dialing starts automatically.

■ **To make a call using a phone number**

1. Go to the **Phone Menu** screen.
 - ▶ **Phone Menu screen** P. 331
2. Select **Dial**.
3. Select a number.
 - ▶ Use the keyboard on the touch screen for entering numbers.
4. Select .
 - ▶ Dialing starts automatically.



Continued

☒ **To make a call using the imported phonebook**

You can call a stored voice-tagged speed dial number using voice commands.
 ▶ **Speed Dial** P. 339

☒ **To make a call using a phone number**

You can call a stored voice-tagged speed dial number using voice commands.
 ▶ **Speed Dial** P. 339



■ **To make a call using redial**

1. Go to the **Phone Menu** screen.
 - ▶ **Phone Menu screen** P. 331
2. Select **Redial**.
 - ▶ Dialing starts automatically.

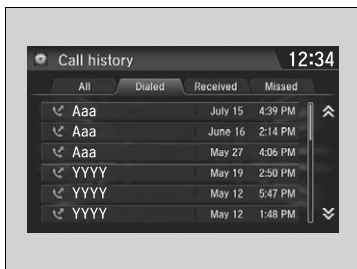

■ **To make a call using the Call History**

Call history is stored by **All**, **Dialed**, **Received**, and **Missed**.

1. Go to the **Phone Menu** screen.
 - ▶ **Phone Menu screen** P. 331
2. Select **Call History**.
3. Select **All**, **Dialed**, **Received**, or **Missed**.
4. Select a number.
 - ▶ Dialing starts automatically.



■ **To make a call using a Speed Dial entry**

1. Go to the **Phone Menu** screen.
 - ▶ **Phone Menu screen** P. 331
2. Select **Speed Dial**.
3. Select a number.
 - ▶ Dialing starts automatically.

☒ **To make a call using the Call History**

The call history displays the last 20 all, dialed, received, or missed calls. (Appears only when a phone is connected to the system.)

☒ **To make a call using a Speed Dial entry**

When a voice tag is stored, press the  button to call the number using the voice tag.

▶ **Speed Dial** P. 339

Any voice-tagged speed dial entry can be dialed by voice from any screen.



Press the  button and follow the prompts.

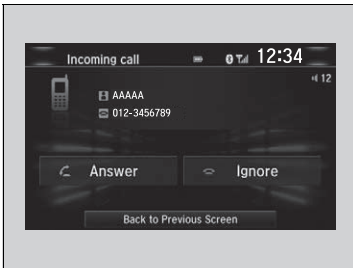

Receiving a Call



When there is an incoming call, an audible notification sounds (if activated) and the **Incoming call** screen appears.

Press the  button to answer the call.
Press the  button to decline or end the call.

Options During a Call

The following options are available during a call.

Mute: Mute your voice.

Transfer: Transfer a call from the system to your phone.

Touch Tones: Send numbers during a call. This is useful when you call a menu-driven phone system.

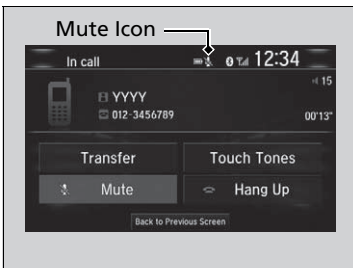

The available options are shown on the lower half of the screen.

Select the option.

- ▶ The mute icon appears when **Mute** is selected. Select **Mute** again to turn it off.



Continued

Receiving a Call



Call Waiting

Press the  button to put the current call on hold to answer the incoming call.

Press the  button again to return to the current call.

Select **Ignore** to ignore the incoming call if you do not want to answer it.

Press the  button if you want to hang up the current call.

You can select the icons on the audio/information screen instead of the  and  buttons.

Options During a Call

Touch Tones: Available on some phones.

You can select the icons on the audio/information screen.

■ Receiving a Text/E-mail Message

HFL can display newly received text or e-mail messages as well as 20 of the most recently received messages on a linked cell phone. Each received message can be read aloud and replied to using a fixed common phrase.



1. A pop-up appears and notifies you of a new text or e-mail message.
2. Select **Read** to listen to the message.
 - ▶ The text or e-mail message is displayed. The system automatically starts reading out the message.
3. To discontinue the message read-out, select **Stop**.

▣ Receiving a Text/E-mail Message

The system does not display any received messages while you are driving. You can only hear them read aloud.

The system can only receive messages that are sent as text (SMS) messages. Messages sent using data services will not be displayed in the list.

With some phones, you may be able to display up to 20 most recent text and e-mail messages.

State or local laws may limit your use of the HFL text/e-mail message feature. Only use the text/e-mail message feature when conditions allow you to do so safely.

When you receive a text or e-mail message for the first time since the phone is paired to HFL, you are asked to turn the **New Message Notification** setting to **On**.

- ▣ **To turn on or off the text/e-mail message notice** P. 336

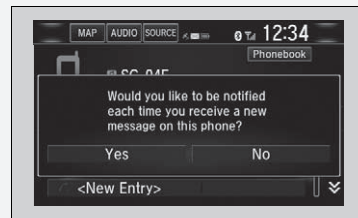

Selecting a Mail Account

If a paired phone has text message or mail accounts, you can select one of them to be active and receive notifications.

1. Go to the **Phone Settings** screen.
 ▶ **Phone Settings screen** P. 328
2. Select the **Text/Email** tab, then **Select Account**.
 ▶ A pop-up menu appears on the screen.
3. Select **Text Messages** or an e-mail message account you want.

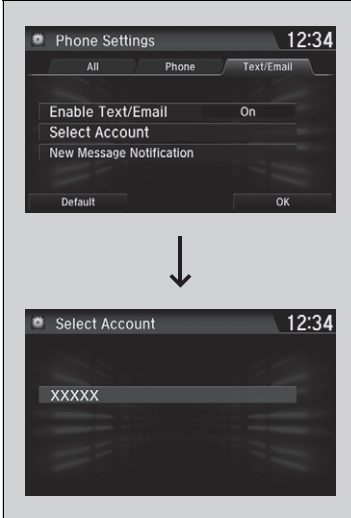

Selecting a Mail Account

You can also select a mail account from the folder list screen or the message list screen.

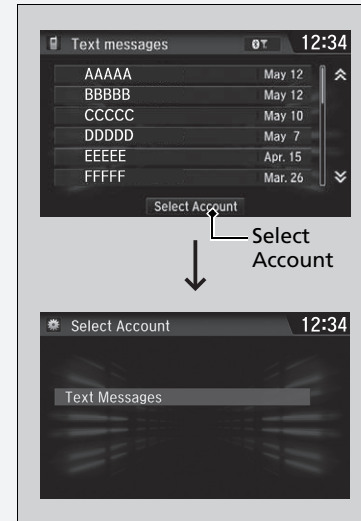

You can only receive notifications from one text message or mail account at a time.

■ Displaying Messages

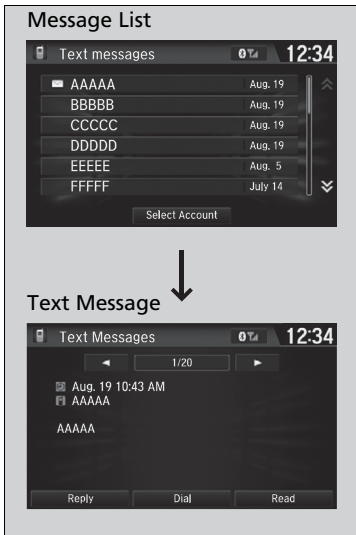



■ Displaying text messages

1. Go to the **Phone Menu** screen.
 - ▶ **Phone Menu screen** P. 331
2. Select **Text/Email**.
 - ▶ Select account if necessary.
3. Select a message.
 - ▶ The text message is displayed. The system automatically starts reading the message aloud.

» Displaying Messages

The  icon appears next to an unread message.

If you delete a message on the phone, the message is also deleted in the system. If you send a message from the system, the message goes to your phone's mailbox.

To see the previous or next message, select  (previous) or  (next) on the message screen.

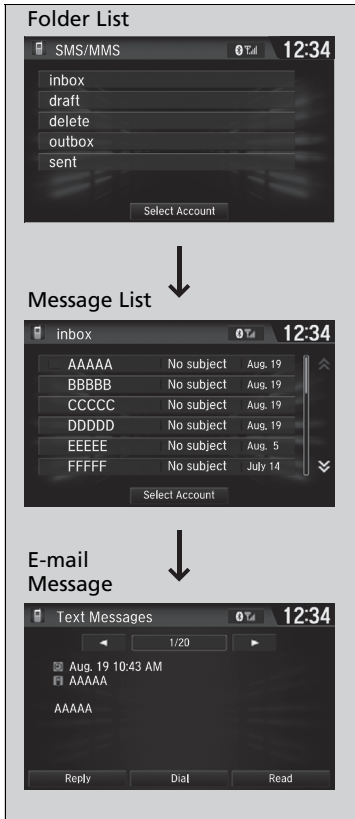

■ Displaying e-mail messages

1. Go to the **Phone Menu** screen.
 - ▶ **Phone Menu screen** P. 331
2. Select **Text/Email**.
 - ▶ Select **Select Account** if necessary.
3. Select a folder.
 - ▶ Select a message.
4. Select a message.
 - ▶ The e-mail message is displayed. The system automatically starts reading the message aloud.



Continued



■ Read or Stop reading a message

1. Go to the text or e-mail message screen.
 - ▶ The system automatically starts reading the message aloud.
 - ☑ **Displaying Messages** P. 352
2. Select **Stop** to stop reading.
 - Select **Read** again to start reading the message from the beginning.

■ Reply to a message

1. Go to the text or e-mail message screen.
 - ▶ The system automatically starts reading the message aloud.
 - ☑ **Displaying Messages** P. 352
2. Select **Reply**.
3. Select the reply message.
 - ▶ The pop-up menu appears on the screen.
4. Select **Send** to send the message.
 - ▶ **Message sent** appears on the screen when the reply message was successfully sent.

☒ Reply to a message

The available fixed reply messages are as follows:

- **Talk to you later, I'm driving.**
- **I'm on my way.**
- **I'm running late.**
- **OK**
- **Yes**
- **No**

You cannot add, edit, or delete reply messages.

Only certain phones receive and send messages when paired and connected. For a list of compatible phones, visit automobiles.honda.com/handsfreelink/, or call 1-888-528-7876.



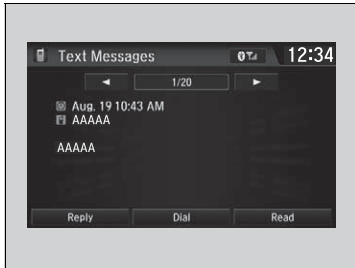

■ **Making a call to a sender**

1. Go to the text message screen.
2. Select **Dial**.



■ In Case of Emergency

■ Automatic collision notification

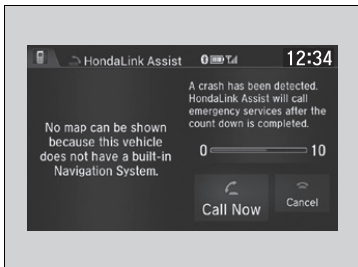

If your vehicle's airbags deploy or if the unit detects that the vehicle is severely impacted, your vehicle automatically will attempt to connect to the HondaLink operator. If connected, information about your vehicle, its location, and its condition can be sent to the operator*1; you also can speak to the operator when connected.

IMPORTANT: For vehicles equipped with HondaLink Assist, owner activation constitutes authorization for Honda to collect information from your vehicle needed to provide the service, and agreement to the Terms of Use at www.hondalink.com/TermsAndConditions. In a crash, HondaLink Assist will attempt to notify emergency services but NEITHER Honda-PRO NOR ITS SERVICE PROVIDERS GUARANTEE THAT SUCH NOTIFICATION WILL OCCUR.

Honda reserves the right to terminate HondaLink Assist services at any time or for any reason, and in the future may not be able to provide services due to changes in, or obsolescence of, technology integral to the service or changes in governmental regulation.

*1: Depending on your phone and adequate cellular coverage, your vehicle's location may not be sent to the operator.



⌘ In Case of Emergency

Your vehicle may not be able to connect to the operator if the 12-volt battery level is low, the line is disconnected, or you do not have adequate cellular coverage.

You cannot use this emergency service when:

- You travel outside the HondaLink service coverage areas.
- There is a problem with the connecting devices, such as the microphones, speakers, or the unit itself.

You cannot operate other phone-related functions using the screen while talking to the operator. Select **Hang Up** to terminate the connection to your vehicle.

⌘ Automatic collision notification

If the unit fails to connect to the operator, it repeatedly tries until it succeeds.

■ To enable notification

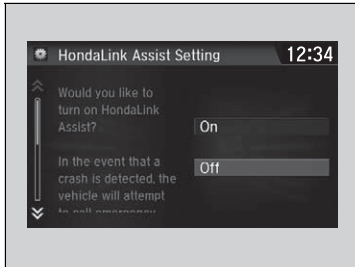

1. Go to the **Phone Settings** screen.
 - ▶ **Phone Settings screen** P. 328
2. Select the **Phone** tab, then **HondaLink Assist**.
 - ▶ A pop-up menu appears on the screen.
3. Select **On** or **Off**.

☒ To enable notification

Setting options:

- **On:** Notification is available.
- **Off:** Disable the feature.



Driving

This chapter discusses driving and charging.



Before Driving	360
Towing a Trailer	365
When Driving	
Turning on the Power	366
Precautions While Driving.....	369
Transmission	370
Shifting	371
ECON Mode	377
SPORT Mode.....	378
Deceleration Paddle Selector	379
Acoustic Vehicle Alerting System.....	382
Front Sensor Camera	383
Road Departure Mitigation (RDM) System	385

Adaptive Cruise Control (ACC) with Low Speed Follow (LSF)	389
Lane Keeping Assist System (LKAS).....	404
Vehicle Stability Assist® (VSA®), aka Electronic Stability Control (ESC), System	411
Agile Handling Assist	413
Tire Pressure Monitoring System (TPMS)..	414
Tire Pressure Monitoring System (TPMS) - Required Federal Explanation	416
LaneWatch™.....	418

Braking

Brake System	420
Anti-lock Brake System (ABS)	426



Brake Assist System	427
Collision Mitigation Braking System™ (CMBS™)	428
Parking Your Vehicle When Stopped	436
Multi-View Rear Camera	438
Charging	440
Before Charging	440
Charge the High Voltage battery using a Level 1, 2 or SAE J1772 DC charger ...	441
Control Box	448
High Voltage Battery.....	453
Using a Timer	454
Energy Economy	456

Driving Preparation

Check the following items before you start driving.

Exterior Checks

- Make sure there are no obstructions on the windows, door mirrors, exterior lights, or other parts of the vehicle.
 - ▶ Remove any frost, snow, or ice.
 - ▶ Remove any snow on the roof, as this can slip down and obstruct your field of vision while driving. If frozen solid, remove ice once it has softened.
 - ▶ When removing ice from around the wheels, be sure not to damage the wheel or wheel components.
- Make sure the hood is securely closed.
 - ▶ If the hood opens while driving, your front view will be blocked.
- Make sure the tires are in good condition.
 - ▶ Check air pressures, and check for damage and excessive wear.
 - ✦ **Checking and Maintaining Tires** P. 475
- Make sure there are no people or objects behind or around the vehicle.
 - ▶ There are blind spots from the inside.
- Disconnect the charging cable.

Exterior Checks

NOTICE

When doors are frozen shut, use warm water around the door edges to melt any ice. Do not try to force them open, as this can damage the rubber trim around the doors. When done, wipe dry to avoid further freezing.

Do not pour warm water into the key cylinder. You will be unable to insert the key if the water freezes in the hole.

Heat from the power system can ignite flammable materials left under the hood, causing a fire. If you've parked your vehicle for an extended period, inspect and remove any debris that may have collected, such as dried grass and leaves that have fallen or have been carried in for use as a nest by a small animal. Also check under the hood for leftover flammable materials after you or someone else has performed maintenance on your vehicle.

Interior Checks

- Store or secure all items on board properly.
 - ▶ Carrying too much cargo, or improperly storing it, can affect your vehicle's handling, stability, stopping distance, and tires, and make it unsafe.
 - ✦ **Maximum Load Limit** P. 363
- Do not pile items higher than the seat height.
 - ▶ They can block your view and may be thrown forward in the event of sudden braking.
- Do not place anything in the front seat footwells. Make sure to secure the floor mat.
 - ▶ An object or unsecured floor mat can interfere with your brake and accelerator pedal operation while driving.
- If you have any animals on board, do not let them move around in the vehicle.
 - ▶ They may interfere with driving and a crash could occur.
- Securely close and lock all doors and the trunk.
 - ✦ **Locking/Unlocking the Doors from the Inside** P. 140
- Adjust your seating position properly.
 - ▶ Adjust the head restraint, too.
 - ✦ **Adjusting the Seats** P. 169
 - ✦ **Adjusting the Front Head Restraints Positions** P. 171
- Adjust the mirrors and steering wheel properly for your driving.
 - ▶ Adjust them while sitting in the proper driving position.
 - ✦ **Adjusting the Mirrors** P. 167
 - ✦ **Adjusting the Steering Wheel** P. 166

Interior Checks

The headlight aim is set by the factory, and does not need to be adjusted. However, if you regularly carry heavy items in the trunk, have the aiming readjusted at an authorized Honda Clarity Electric dealer or by a qualified technician.



Continued

- Be sure items placed on the floor behind the front seats cannot roll under the seats.
 - ▶ They can interfere with the driver's ability to operate the pedals, the operation of the seats, or the operation of the sensors under the seats.
- Everyone in the vehicle must fasten their seat belt.
 - ▶ **Fastening a Seat Belt** P. 47
- Make sure that the indicators in the instrument panel come on when you start the vehicle, and go off soon after.
 - ▶ Always have an authorized Honda Clarity Electric dealer check the vehicle if a problem is indicated.
 - ▶ **Indicators** P. 82

Maximum Load Limit

The maximum load for your vehicle is 850 lbs (385 kg). See the Tire and Loading Information label attached to the driver's doorjamb.

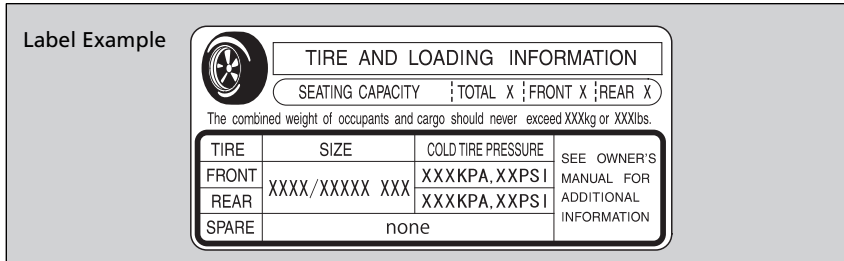

This figure includes the total weight of all occupants, cargo, and accessories, and the tongue load if you are towing a trailer.

Steps for Determining Correct Load Limit -

- (1) Locate the statement "The combined weight of occupants and cargo should never exceed XXX kg or XXX lbs." on your vehicle's placard.
- (2) Determine the combined weight of the driver and passengers that will be riding in your vehicle.
- (3) Subtract the combined weight of the driver and passengers from XXX kg or XXX lbs.
- (4) The resulting figure equals the available amount of cargo and luggage load capacity. For example, if the "XXX" amount equals 1,400 lbs. and there will be five 150 lb. passengers in your vehicle, the amount of available cargo and luggage load capacity is 650 lbs.
(1,400 - 750 (5 x 150) = 650 lbs.)



Continued

Maximum Load Limit

⚠ WARNING

Overloading or improper loading can affect handling and stability and cause a crash in which you can be hurt or killed.

Follow all load limits and other loading guidelines in this manual.

Gross Vehicle Weight Rating (GVWR):
The maximum allowable weight of the vehicle, all occupants, all accessories and all cargo.

➤ Specifications P. 536



Gross Axle Weight Rating (GAWR):
The maximum allowable weight of the vehicle axle.



➤ Specifications P. 536

- (5) Determine the combined weight of luggage and cargo being loaded on the vehicle. That weight may not safely exceed the available cargo and luggage load capacity calculated in step 4.
- (6) If your vehicle will be towing a trailer, load from your trailer will be transferred to your vehicle. Consult this manual to determine how this reduces the available cargo and luggage load capacity of your vehicle.

In addition, the total weight of the vehicle, all occupants, accessories, cargo, and trailer tongue load must not exceed the Gross Vehicle Weight Rating (GVWR) or the Gross Axle Weight Rating (GAWR). Both are on a label on the driver's doorjamb.

Load Limits Example

<p>Example 1</p>  <p>Max Load 850 lbs (385 kg)</p>	\geq		<p>+</p>	
		<p>Passenger Weight 150 lbs x 2 = 300 lbs (68 kg x 2 = 136 kg)</p>		<p>Cargo Weight 550 lbs (249 kg)</p>

<p>Example 2</p>  <p>Max Load 850 lbs (385 kg)</p>	\geq		<p>+</p>	
		<p>Passenger Weight 150 lbs x 5 = 750 lbs (68 kg x 5 = 340 kg)</p>		<p>Cargo Weight 100 lbs (45 kg)</p>

DEALER ePROCESS

Your vehicle is not designed to tow a trailer. Attempting to do so can void your warranties.

Towing Your Vehicle

Your vehicle is not designed to be towed behind a motor home. If your vehicle needs to be towed in an emergency, refer to the emergency towing information.

➤ **Emergency Towing** P. 531



Turning on the Power



1. Make sure the parking brake is applied.

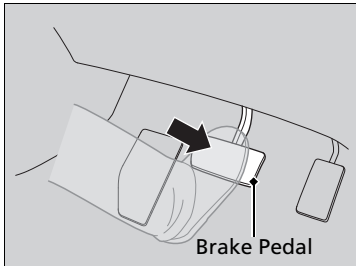

2. Depress the brake pedal.

Turning on the Power

Keep your foot firmly on the brake pedal when starting the power system.

When turning on the power system in cold weather, turn off all electrical accessories such as the lights, climate control system, and rear defogger in order to reduce 12-volt battery drain.

If the temperature of the High Voltage battery drops to -22°F (-30°C) or below, the power system may not start. Wait for the High Voltage battery to warm up, or warm it up by plugging in the vehicle.

If the temperature of the High Voltage battery drops to -31°F (-35°C) or below, the power system will not start. Wait for the High Voltage battery to warm up or move the vehicle to a warmer location. Note plugging the vehicle in will not help in this case. Store the vehicle in a garage or take another measure to insure that temperature of the High Voltage battery does not fall below this temperature. If necessary, consult an authorized Honda Clarity Electric dealer.

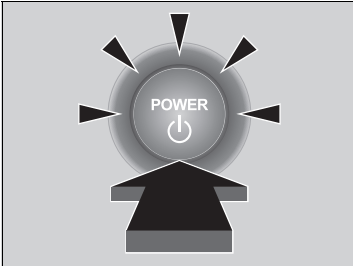

3. Press the **POWER** button without depressing the accelerator pedal.
 - ▶ The **Ready To Drive** message appears on the driver information interface.
 - ▶ When the ambient temperature is extremely low, the vehicle does not move until certain conditions are met. A warning message appears instead of **Ready To Drive**.
 - ▣ **Driver Information Interface Warning and Information Messages**
P. 100

■ Stopping the Power System

You can turn the power system off when the vehicle is completely stopped.

1. Put the transmission into **P**.
2. Press the **POWER** button.

▣ Turning on the Power

The immobilizer system protects your vehicle from theft.

If an improperly coded device is used, the power system does not activate.

▣ **Immobilizer System** P. 147

When you set the power mode to ON, you may feel as if the brake pedal is sinking down. This is normal.

Bring the smart entry remote close to the **POWER** button if the battery in the smart entry remote is weak.

▣ **If the Smart Entry Remote Battery is Weak**
P. 512

The power system may not activate if the smart entry remote is subjected to strong radio waves.



Continued

■ Starting to Drive

1. Keeping your right foot on the brake pedal, press the **[D]** button. Select **[R]** when reversing.
2. With the parking brake applied, release the brake pedal and gently depress the accelerator pedal.
 - ▶ Make sure the parking brake and brake system indicator (red) goes off.
❏ **Parking Brake P.** 420

■ Hill Start Assist System

Hill start assist keeps the brake engaged briefly to help prevent the vehicle from rolling on inclines as you move your foot from the brake pedal to the accelerator.

Change to **[D]** when facing uphill, or **[R]** when facing downhill, then release the brake pedal.

❏ Starting to Drive

You can also release the parking brake by pressing the electric parking brake switch while depressing the brake pedal.

When facing downhill, you can start your vehicle more smoothly by manually releasing it with the electric parking brake switch than by releasing it with the accelerator pedal.

❏ Hill Start Assist System

Hill start assist may not prevent the vehicle from rolling downhill on a very steep or slippery slope, and will not operate on small inclines.

Hill start assist is not a replacement for the parking brake.



Precautions While Driving

In Rain

Avoid driving in deep water and on flooded roads. This can damage the power system or driveline, or cause electrical component failure.



Continued

Precautions While Driving

NOTICE

Do not select a shift button while pressing the accelerator pedal.

NOTICE

The following can damage the rear frames and rear suspensions. Be careful when driving.

- Backing up the vehicle into a space with a parking block or road shoulder
- Driving up or down to a different surface level (such as a road shoulder)
- Driving on a road with potholes

NOTICE

If you repeatedly turn the steering wheel at an extremely low speed, or hold the steering wheel in the full left or right position for a while, the electric power steering (EPS) system heats up. The system goes into a protective mode, and limits its performance. The steering wheel becomes harder and harder to operate. Once the system cools down, the EPS system is restored.

Repeated operation under these conditions can eventually damage the system.

If the power mode is set to ACCESSORY while driving, the power system will shut down and all steering and brake power assist functions will stop, making it difficult to control the vehicle.

■ Other Precautions

If there is a strong impact with something under the vehicle, stop in a safe location. Check the underside of the vehicle for damage or any fluid leaks, and contact an authorized Honda Clarity Electric dealer.

Transmission

■ Creeping

As with a conventional gasoline-powered vehicle with an automatic transmission, this vehicle will creep. Keep the brake pedal firmly depressed when stopped.

⌘ Precautions While Driving

Do not press the **[N]** button, as you will lose regenerative braking (and acceleration) performance.

Avoid hard braking for the first 200 miles (300 km). You should also follow this when the brake pads are replaced.

Shifting

Change the gear position in accordance with your driving needs.

■ Shift button positions



- P** **Park**
Used when parking, before turning off or starting the power system
- R** **Reverse**
Used when reversing
- N** **Neutral**
Transmission is not locked
- D** **Drive**
Used for:
Normal driving
- The deceleration paddle selector can be used temporarily.
The deceleration paddle selector can be used when SPORT mode is on.

▶▶ Shifting

⚠ WARNING

The vehicle can roll away if left unattended without confirming that Park is engaged.

A vehicle that rolls away could cause a crash resulting in serious injury or death.

Always keep your foot on the brake pedal until you have confirmed that **P** is shown on the gear position indicator.

To prevent malfunction and unintended engagement:

- Do not spill any liquids on or around shift buttons.
- Do not place or drop any objects on or around shift buttons.
- Do not let passengers or children operate the shift buttons.

■ **P (parking) button**

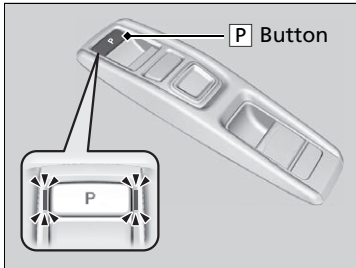

The gear position changes to **P** when you press the **P** button while the vehicle is parked with the power mode in ON. The indicators on the sides of the **P** button come on.

▶▶ Shifting

The beeper sounds and the message appears on the driver information interface when you depress the accelerator pedal with the gear position in **N**. Change the gear position to **D** or **R** with the brake pedal depressed.

Shift Operation

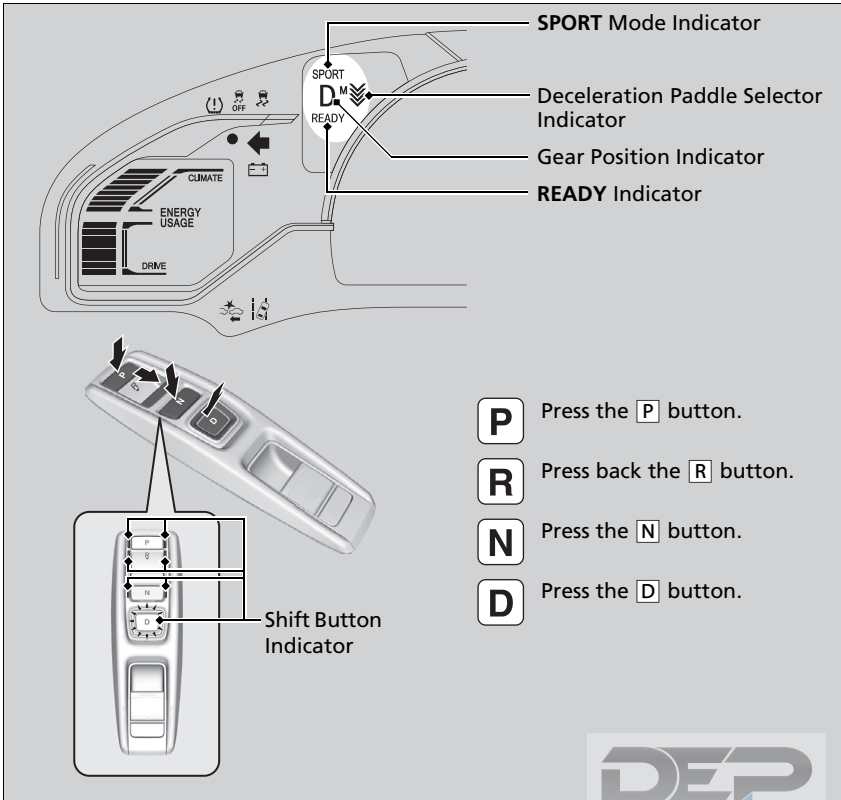

Continued

Shift Operation

NOTICE

When you change **D** to **R** and vice versa, come to a complete stop and keep the brake pedal depressed. Operating the shift button before the vehicle has come to a complete standstill can damage the transmission.

Use the gear position indicator and the shift button indicator to check the gear position before and after selecting a shift button.

If the indicator of the currently selected gear position, or all the gear position indicators are blinking simultaneously, there is a problem with the transmission.

Avoid sudden acceleration and have the transmission checked by an authorized Honda Clarity Electric dealer as soon as possible.

The beeper sounds once when you change to **R**.

■ When opening the driver's door

If you open the driver's door under the following conditions, the gear position automatically changes to **P**.

- The vehicle is in stationary with the power mode in ON, or moving at 1 mph (2 km/h) or slower.
- The transmission is in other than **P**.
- You have unfastened the driver side seat belt.
 - ▶ If you manually change the gear position from **P** with the brake pedal depressed, the gear position will automatically return to **P** once you release the brake pedal.

■ When turning off the power mode

If you turn the power system off while the vehicle is stationary, and the transmission is in other than **P**, the gear position automatically changes to **P**.

⌘ When opening the driver's door

While the system is designed to automatically change the gear position to **P** under the described conditions, in the interest of safety you should always select **P** before opening the driver's door. Make sure to park the vehicle in a safe place.

➤ When Stopped P. 436

If you want to drive the vehicle after the gear position has automatically changed to **P** under the described conditions, close the door, fasten the seat belt, depress the brake pedal, then change the gear position.

If you leave the vehicle, turn off the power system and lock the doors.

■ If you want to keep the transmission in **[N]** position [car wash mode]

With the power system on:

1. Depress the brake pedal.
2. Make sure the **READY** indicator is on.
3. Press **[N]**. Within six seconds press and hold **[N]** for two seconds.
 - ▶ This puts the vehicle in car wash mode which must be used when your vehicle is pulled through a conveyor type automatic car wash where you or an attendant do not remain in the vehicle.

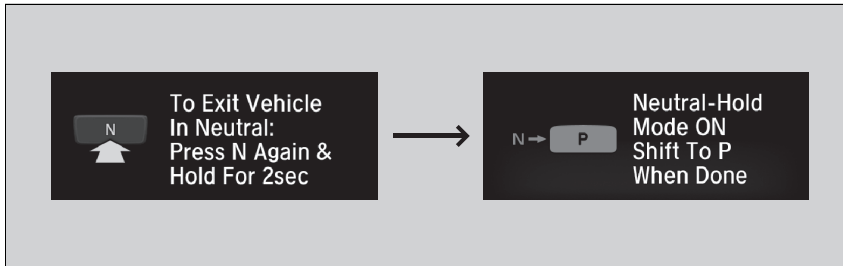

If you want to cancel car wash mode, select a position other than **[N]**.

If you want to reduced energy consumption in car wash mode:

Press the **POWER** button during car wash mode.

- ▶ Make sure the **READY** indicator is off.
- ▶ The gear position remains in **[N]** with the power mode in ACCESSORY for 15 minutes, then, it automatically changes to **[P]** and the power mode changes to OFF.

Manually changing to **[P]** cancels ACCESSORY mode. The **[P]** indicator comes on and the power mode changes to OFF. You must always shift to **[P]** when car wash mode is no longer needed.



Continued

☒ If you want to keep the transmission in **[N]** position [car wash mode]

To keep the vehicle in **[N]** position, you can also follow this procedure:

While the power system is on, select **[N]**, and then within five seconds, press the **POWER** button. Note that the transmission may not stay in **[N]** position while any of the following indicators is on:

- **POWER SYSTEM** indicator
- Transmission system indicator
- 12-volt battery charging system indicator

■ Restriction on selecting a gear position

You cannot select a gear position under certain circumstances that may lead to a crash.

When the transmission is in:	1. Under the circumstances of that:	2. You cannot select:	3. The gear position remains in/changes to:	How to change the gear position		
P	The brake pedal is not depressed.	Other gear position	P	Release the accelerator pedal and depress the brake pedal.		
	The accelerator pedal is depressed.					
N	The vehicle is moving at low speed without the brake pedal depressed.		N			
	The vehicle is moving at low speed with the accelerator pedal depressed.					
N or D	The vehicle is moving forward.		R		N	Park your vehicle in a safe place.
R or N	The vehicle is moving backward.		D			
R , N , or D	The vehicle is moving.	P				
P or N	The READY indicator is not on.	A gear position other than P or N	P or N	Make sure that the READY indicator comes on.		

Driving



ECON Mode

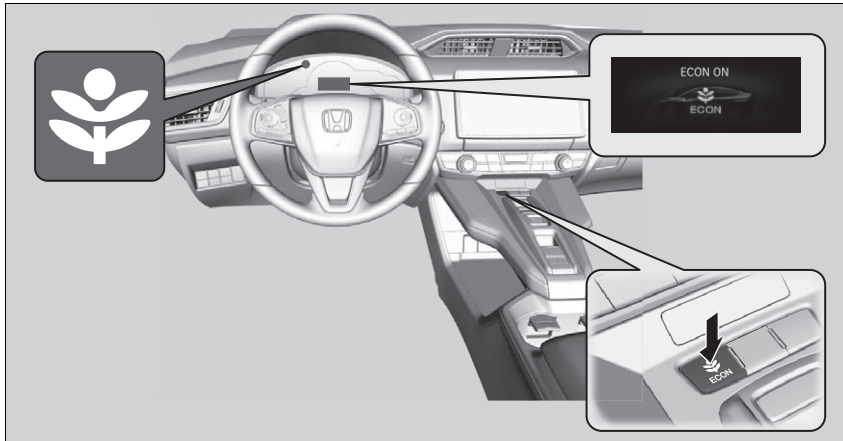

The **ECON** button turns the ECON mode on and off.

The ECON mode helps you improve your energy economy by adjusting the performance of the climate control system.

▶▶ ECON Mode

While in the ECON mode, the climate control system has greater temperature fluctuations.

When the ECON mode is active, the driver's side seat heater functions according to the status of the climate control system. If you want to use only the climate control system, press the seat heater button to OFF.

SPORT Mode

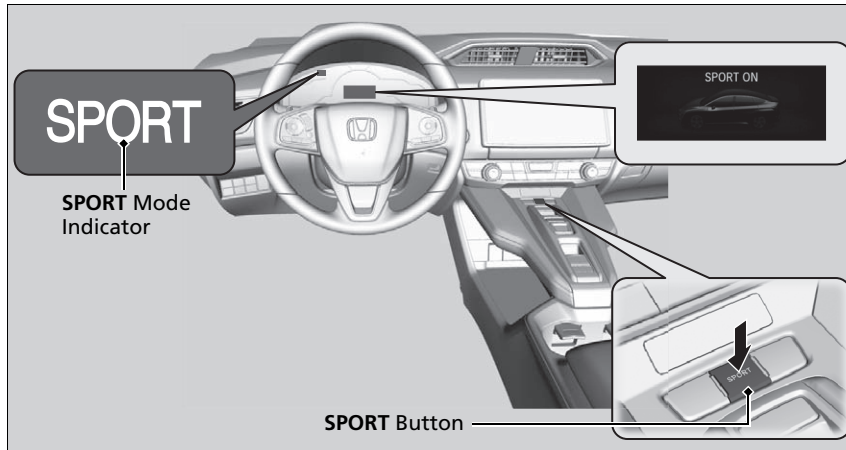

To turn the SPORT mode on and off, press the **SPORT** button.

The SPORT mode delivers crisp agility and quick responsiveness. This mode is suitable for driving on hills or through curves on mountain roads.

The SPORT mode is turned off every time you start the power system, even if you turned it on the last time you drove the vehicle.

Deceleration Paddle Selector

When you release the accelerator pedal, you can control the rate of deceleration without releasing your hands from the steering wheel. Using the deceleration paddle selector situated on the steering wheel, you can sequentially shift through four stages of deceleration.

When descending a hill, you can use the deceleration paddle selector to help maintain the rate of deceleration, thereby allowing you to keep a safe distance between your vehicle and the vehicle ahead as well as utilize regenerative braking.

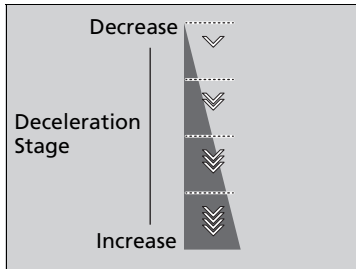

The default deceleration stage is . Each paddle selector operation makes a single stage deceleration change.

- ▶ The deceleration stage may not change if you keep the paddle selector pulled back.

To select the different stages of deceleration:

- Pull back the selector (right side) to decrease the deceleration stage.
- Pull back the selector (left side) to increase the deceleration stage.

Pull the selector for a few seconds when you want to cancel the deceleration paddle selector.

Deceleration Paddle Selector

CAUTION

Rapidly increasing the deceleration rate by quickly shifting the deceleration paddle can cause the tires to skid, resulting in a crash that could injure or kill someone.

Always maintain a reasonable rate of deceleration.

If you are descending a hill when you select stage , the vehicle may enter stage .

If you pull back right and left paddle selector at the same time, the deceleration stage may not change.



Continued

When to use

Gear position is in D

When SPORT mode is OFF, the deceleration stage appears.

Deceleration Stage

When SPORT mode is ON, the deceleration stage and **M** appear.

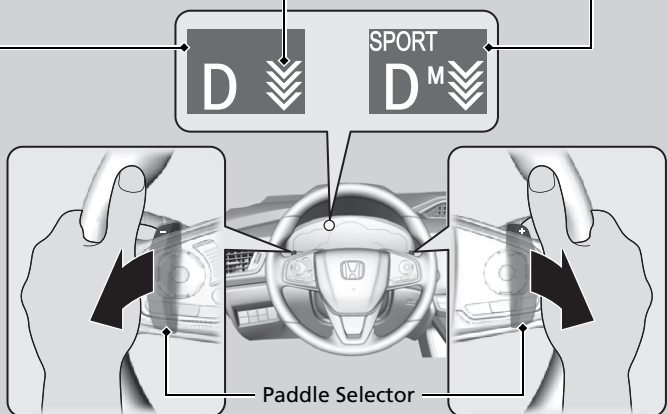

Paddle Selector

Increase the deceleration stage when pulling the - paddle selector (left side)

Decrease the deceleration stage when pulling the + paddle selector (right side)

▶▶ Deceleration Paddle Selector

In the following situations, the stage may not change and the stage icon will blink even if you pull back the selector. The deceleration stage may decrease or cancel automatically:

- The high voltage battery is fully charged or its temperature is too cold or too hot.
- The speed of the vehicle is beyond the deceleration range with SPORT mode off.
- Power system protection is needed.
- The paddle selector is operated while your vehicle is stopped automatically by ACC with LSF.

If either paddle selector is operated, ACC with LSF will cancel automatically.

■ When SPORT mode is OFF

If you pull back the paddle selector, the rate of deceleration will change temporarily, and the stage will appear in the driver information interface.

When you want to cancel the deceleration paddle selector, pull the  selector (right side) for a few seconds.

The deceleration paddle selector will cancel automatically and deceleration stage in the driver information interface disappear when you drive with constant speed, situations of acceleration and decelerate just before stopping your vehicle.

■ When SPORT mode is ON

If you pull back the paddle selector, the rate of deceleration will change and the stage along with **M** will appear in the driver information interface. The deceleration stage is not cancel automatically while SPORT mode is ON.

When you want to cancel the deceleration paddle selector, turn the SPORT mode OFF, or pull the  selector (right side) for a few seconds. When canceled, deceleration stage in the driver information interface disappear.



Acoustic Vehicle Alerting System

Alerts pedestrians that a vehicle is approaching when the vehicle speed is around 12 mph (20 km/h) or less.

Front Sensor Camera

The camera, used in systems such as LKAS, RDM, ACC with LSF, and CMBS™, is designed to detect an object that triggers any of the systems to operate its functions.

Camera Location and Handling Tips

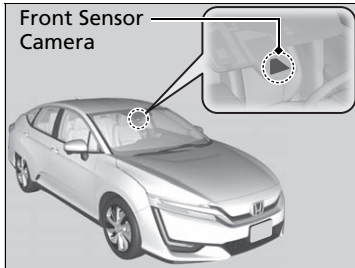

This camera is located behind the rearview mirror.

To help reduce the likelihood that high interior temperatures will cause the camera's sensing system to shut off, when parking, find a shady area or face the front of the vehicle away from the sun. If you use a reflective sun shade, do not allow it to cover the camera housing. Covering the camera can concentrate heat on it.

Front Sensor Camera

Never apply a film or attach any objects to the windshield, hood, or front grill that could obstruct the camera's field of vision and cause the system to operate abnormally.

Scratches, nicks, and other damage to the windshield within the camera's field of vision can cause the system to operate abnormally. If this occurs, we recommend that you replace the windshield with a genuine Honda replacement windshield. Making even minor repairs within the camera's field of vision or installing an aftermarket replacement windshield may also cause the system to operate abnormally. After replacing the windshield, have an authorized Honda Clarity Electric dealer recalibrate the camera. Proper calibration of the camera is necessary for the system to operate properly.

Do not place an object on the top of the instrument panel. It may reflect onto the windshield and prevent the system from detecting lane lines properly.



Continued

Front Sensor Camera

If the **Some Driver Assist Systems Cannot Operate: Camera Temperature Too High** message appears:

- Use the climate control system to cool down the interior and, if necessary, also use defroster mode with the airflow directed towards the camera.
- Start driving the vehicle to lower the windshield temperature, which cools down the area around the camera.

If the **Some Driver Assist Systems Cannot Operate: Clean Front Windshield** message appears:

- Park your vehicle in a safe place, and clean the windshield. If the message does not disappear after you have cleaned the windshield and driven for a while, have your vehicle checked by an authorized Honda Clarity Electric dealer.



Road Departure Mitigation (RDM) System

Alerts and helps to assist you when the system detects a possibility of your vehicle unintentionally crossing over detected lane markings and/or leaving the roadway altogether.

How the System Works

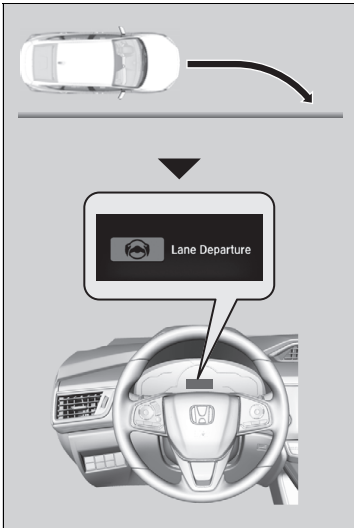

The front camera behind the rearview mirror monitors left and right lane markings (in white or yellow). If your vehicle is getting too close to detected lane markings without a turn signal activated, the system, in addition to a visual alert, applies steering torque and alerts you with rapid vibrations on the steering wheel, to help you remain within the detected lane.

▶ **Customized Features** P. 296

As a visual alert, the **Lane Departure** message appears on the driver information interface.

If the system determines that its steering input is insufficient to keep your vehicle on the roadway, it may apply braking.

▶ Braking is applied only when the lane markings are solid continuous lines.

The system cancels assisting operations when you turn the steering wheel to avoid crossing over detected lane markings.

If the system operates several times without detecting driver response, the system beeps to alert you.

⊠ Road Departure Mitigation (RDM) System

Important Safety Reminder

Like all assistance systems, the RDM system has limitations.

Over-reliance on the RDM system may result in a collision. It is always your responsibility to keep the vehicle within your driving lane.

The RDM system only alerts you when lane drift is detected without a turn signal in use. The RDM system may not detect all lane markings or lane or roadway departures; accuracy will vary based on weather, speed and lane marker condition. It is always your responsibility to safely operate the vehicle and avoid collisions.

You can read about handling information for the camera equipped with this system.

▶ **Front Sensor Camera** P. 383

The RDM system may not work properly or may work improperly under the certain conditions:

▶ **RDM Conditions and Limitations** P. 387

There are times when you may not notice RDM functions due to your operation of the vehicle, or road surface conditions.



Continued

■ How the System Activates

The system becomes ready to start searching for lane markings when all the following conditions are met:

- The vehicle is traveling between about 45 and 90 mph (72 and 145 km/h).
- The vehicle is on a straight or slightly curved road.
- The turn signals are off.
- The brake pedal is not depressed.
- The wipers are not in continuous operation.
- The vehicle is not accelerating or braking, and the steering wheel is not being turned.
- The system makes a determination that the driver is not actively accelerating, braking or steering.

■ RDM On and Off

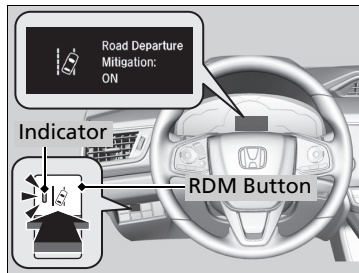

Press the RDM button to turn the system on and off.

- ▶ The indicator in the button comes on and the message appears on the driver information interface when the system is on.

▶▶ How the System Activates

The RDM system may automatically shut off and the  indicator comes and stays on.

▶▶ Indicators P. 82

RDM system function can be impacted when the vehicle is:

- Not driven within a traffic lane.
- Driven on the inside edge of a curve, or outside of a lane.
- Driven in a narrow lane.

▶▶ RDM On and Off

When you have selected **Warning Only** from the customized options using the audio/information screen, the system does not operate the steering wheel and braking.

RDM Conditions and Limitations

The system may not properly detect lane markings and the position of your vehicle under certain conditions. Some examples of these conditions are listed below.

■ Environmental conditions

- Driving in bad weather (rain, fog, snow, etc.).
- Sudden changes between light and dark, such as an entrance or exit of a tunnel.
- There is little contrast between lane lines and the roadway surface.
- Driving into low sunlight (e.g., at dawn or dusk).
- Strong light is reflected onto the roadway.
- Driving in the shadows of trees, buildings, etc.
- Shadows of adjacent objects are parallel to lane markings.
- Roadway objects or structures are misinterpreted as lane markers.
- Reflections on the interior of the windshield.



Continued

■ Roadway conditions

- Driving on a snowy or wet roadway (obscured lane marking, vehicle tracks, reflected lights, road spray, high contrast).
- Driving on a road with temporary lane markings.
- Faint, multiple, or varied lane markings are visible on the roadway due to road repairs or old lane markings.
- The roadway has merging, split, or crossing lines (e.g., such as at an intersection or crosswalk).
- The lane markings are extremely narrow, wide, or changing.
- The vehicle in front of you is driving near the lane lines.
- The road is hilly or the vehicle is approaching the crest of a hill.
- Driving on rough or unpaved roads, or over bumpy surfaces.
- When objects on the road (curb, guard rail, pylons, etc.) are recognized as white lines (or yellow lines).
- Driving on roads with double lines.

■ Vehicle conditions

- Headlight lenses are dirty or the headlights are not properly adjusted.
- The outside of the windshield is streaked or blocked by dirt, mud, leaves, wet snow, etc.
- The inside of the windshield is fogged.
- The camera temperature gets too high.
- An abnormal tire or wheel condition (wrong sized, varied size or construction, improperly inflated tire, etc.).
- The vehicle is tilted due to a heavy load or suspension modifications.
- When tire chains are installed.



Adaptive Cruise Control (ACC) with Low Speed Follow (LSF)

Helps maintain a constant vehicle speed and a set following-interval behind a vehicle detected ahead of yours and, if the detected vehicle comes to a stop, can decelerate and stop your vehicle, without you having to keep your foot on the brake or the accelerator.

When ACC with LSF slows your vehicle by applying the brakes, your vehicle's brake lights will illuminate.

When to use

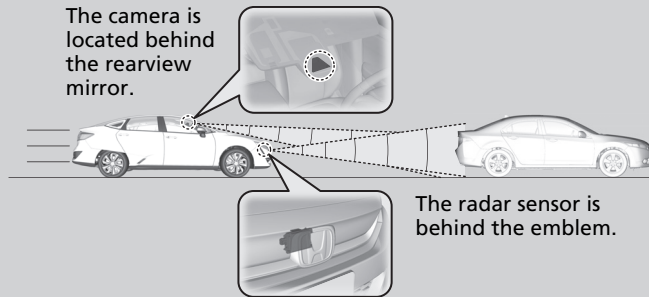

- Vehicle speed for ACC with LSF: A vehicle is detected ahead within ACC with LSF range – ACC with LSF operates at speeds up to 90 mph (145 km/h).
No vehicle is detected within ACC with LSF range – ACC with LSF operates at the speed of 25 mph (40 km/h) or above.
- Gear position for ACC with LSF: In **D**.



Continued

Adaptive Cruise Control (ACC) with Low Speed Follow (LSF)

⚠ WARNING

Improper use of ACC with LSF can lead to a crash.

Use ACC with LSF only when driving on expressways or freeways and in good weather conditions.

⚠ WARNING

ACC with LSF has limited braking capability and may not stop your vehicle in time to avoid a collision with a vehicle that quickly stops in front of you.

Always be prepared to apply the brake pedal if the conditions require.

Important Reminder

As with any system, there are limits to ACC with LSF. Use the brake pedal whenever necessary, and always keep a safe interval between your vehicle and other vehicles.

Be careful not to severely impact the radar sensor cover.

■ How to activate the system

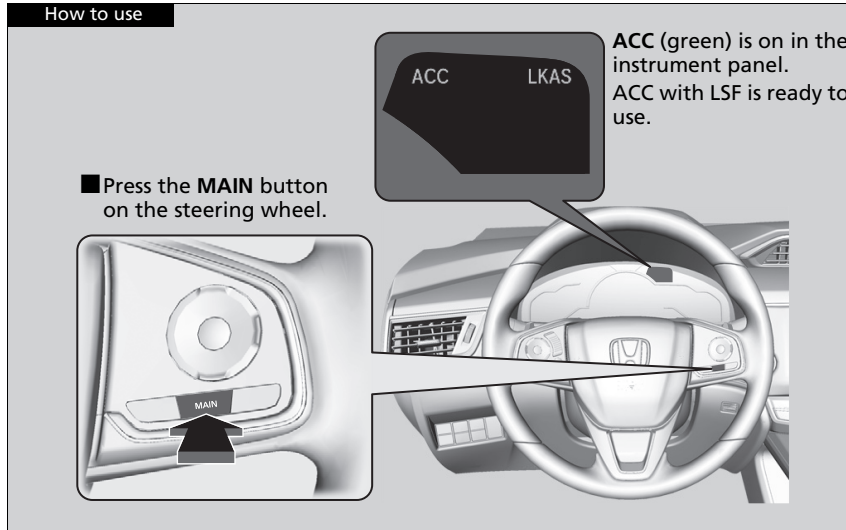

▶ Adaptive Cruise Control (ACC) with Low Speed Follow (LSF)

When the **MAIN** button is pressed, both ACC with LSF and the Lane Keeping Assist System (LKAS) are either turned on or off.

ACC with LSF may not work properly under certain conditions.

▶ **ACC with LSF Conditions and Limitations**
P. 395

When not using ACC with LSF: Turn off adaptive cruise by pressing the **MAIN** button. This also will turn off the Lane Keeping Assist System (LKAS).

Do not use ACC with LSF under the following conditions:

- On roads with heavy traffic or while driving in continuous stop and go traffic.
- On roads with sharp turns.
- On roads with steep downhill sections, as the set vehicle speed can be exceeded by coasting. In such cases, ACC with LSF will not apply the brakes to maintain the set speed.
- On roads with toll collection facilities or other objects between lanes of traffic, or in parking areas, or facilities with drive through access.

■ To Set the Vehicle Speed

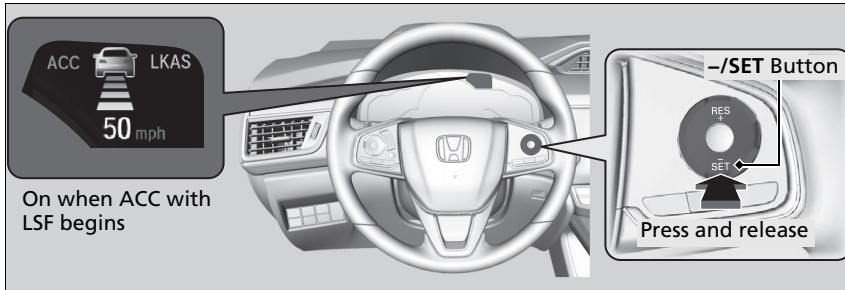

When driving at about 25 mph (40 km/h) or above: Take your foot off the pedal and press the **-/SET** button when you reach the desired speed. The moment you release the button, the set speed is fixed, and ACC with LSF begins.

When driving at slower than about 25 mph (40 km/h): If the vehicle is moving and the brake pedal is not depressed, pressing the button fixes the set speed to about 25 mph (40 km/h) regardless of current vehicle speed. If your vehicle is stationary, you can set the vehicle speed even with the brake pedal depressed.

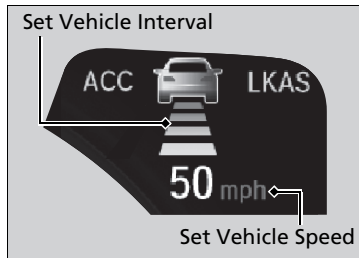

When ACC with LSF starts operating, the vehicle icon, interval bars and set speed appear on the driver information interface.

When you use ACC with LSF, Straight Driving Assist (a feature of the Electric Power Steering system) is activated.

By enabling the steering system to automatically compensate for natural steering pull, Straight Driving Assist makes it easier for you to keep your vehicle in a straight line.

■ When in Operation

■ There is a vehicle ahead

ACC with LSF monitors if a vehicle ahead of you enters the ACC with LSF range. If a vehicle is detected doing so, the ACC with LSF system maintains or decelerates your vehicle's set speed in order to keep the vehicle's set following-interval from the vehicle ahead.

📖 **To Set or Change Following-Interval** P. 398

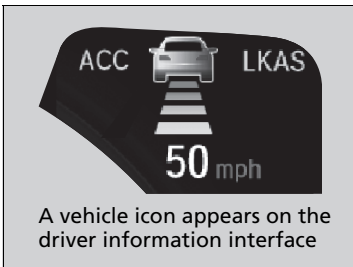
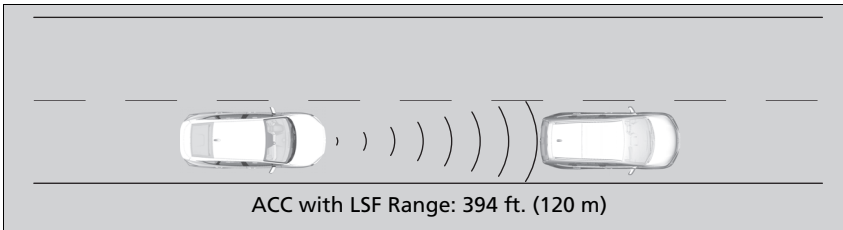

When a vehicle whose speed is slower than your set speed is detected in front of you, your vehicle starts to slow down.



Continued

📖When in Operation

If the vehicle ahead of you slows down abruptly, or if another vehicle is detected cutting in front of you, the beeper sounds, a message appears on the driver information interface.

Depress the brake pedal, and keep an appropriate interval from the vehicle ahead.

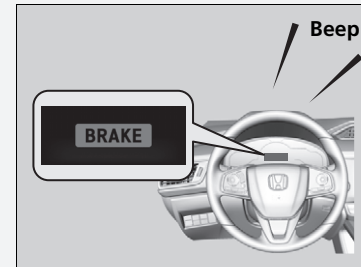

Even if the interval between your vehicle and the vehicle detected ahead is short, ACC with LSF may start accelerating your vehicle under the following circumstances:

- The vehicle ahead of you is going at almost the same speed as, or faster than, your vehicle.
- A vehicle that cuts in front of you is going faster than your vehicle, gradually increasing the interval between the vehicles.

You can also set the system to beep when a vehicle detected in front of you comes in and goes out of the ACC with LSF detecting range. Change the **ACC Forward Vehicle Detect Beep** setting.

📖 **Customized Features** P. 296

■ There is no vehicle ahead

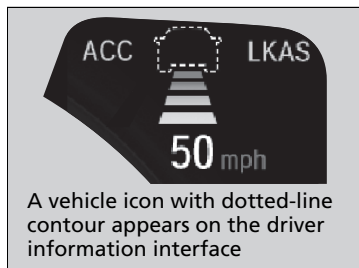

Your vehicle maintains the set speed without having to keep your foot on the brake or accelerator pedal.

If there previously was a vehicle detected ahead that kept your vehicle from traveling at the set speed, ACC with LSF accelerates your vehicle to the set speed, and then maintains it.

■ When you depress the accelerator pedal

You can temporarily increase the vehicle speed. In this case, there is no audible or visual alert even if a vehicle is in the ACC with LSF range.

ACC with LSF stays on unless you cancel it. Once you release the accelerator pedal, the system resumes an appropriate speed for keeping the following-interval while a vehicle ahead is within the ACC with LSF range.

■ A vehicle detected ahead is within ACC with LSF range and slows to a stop



Your vehicle also stops, automatically. The **Stopped** message appears on the driver information interface.

When the vehicle ahead of you starts again, the vehicle icon on the driver information interface blinks. If you press the **RES/+** or **-/SET** button, or depress the accelerator pedal, ACC with LSF operates again within the prior set speed.



▶▶ When in Operation

⚠ WARNING

Exiting a vehicle that has been stopped while the ACC with LSF system is operating can result in the vehicle moving without operator control.

A vehicle that moves without operator control can cause a crash, resulting in serious injury or death.

Never exit a vehicle when the vehicle is stopped by ACC with LSF.

Limitations

You may need to use the brake to maintain a safe interval when using ACC with LSF. Additionally, ACC with LSF may not work properly under certain conditions.

▶ **ACC with LSF Conditions and Limitations**
P. 395

▶▶ When you depress the accelerator pedal

While the accelerator pedal is depressed, the system does not apply the brakes to keep the following interval, as well as the **BRAKE** message on the driver information interface does not appear.

■ ACC with LSF Conditions and Limitations

The system may automatically shut off and the **ACC** indicator will come on under certain conditions. Some examples of these conditions are listed below. Other conditions may reduce some of the ACC functions.

➤ **Front Sensor Camera** P. 383

■ Environmental conditions

Driving in bad weather (rain, fog, snow, etc.).

■ Roadway conditions

Driving on a snowy or wet roadway (obscured lane marking, vehicle tracks, reflected lights, road spray, high contrast).

■ Vehicle conditions

- The outside of the windshield is blocked by dirt, mud, leaves, wet snow, etc.
- An abnormal tire or wheel condition (Wrong sized, varied size or construction, improperly inflated tire, etc.).
- The camera temperature gets too high.
- The parking brake is applied.
- When the front grille is dirty.
- The vehicle is tilted due to a heavy load or suspension modifications.
- When tire chains are installed.



Continued

▣ ACC with LSF Conditions and Limitations

The radar sensor for ACC with LSF is shared with the collision mitigation braking system™ (CMBS™).

➤ **Collision Mitigation Braking System™ (CMBS™)** P. 428

You can read about handling information for the camera equipped with this system.

➤ **Front Sensor Camera** P. 383

Always keep the radar sensor cover clean.

Never use chemical solvents or polishing powder for cleaning the sensor cover. Clean it with water or a mild detergent.

Do not put a sticker on the radar sensor cover or replace the radar sensor cover.

If you need the radar sensor to be repaired, or removed, or the radar sensor cover is strongly impacted, turn off the system by pressing the **MAIN** button and take your vehicle to an authorized Honda Clarity Electric dealer.

Have your vehicle checked by an authorized Honda Clarity Electric dealer if you find any unusual behavior of the system (e.g., the warning message appears too frequently).

■ Detection limitations

- A vehicle suddenly crosses in front of you.
- The interval between your vehicle and the vehicle ahead of you is too short.
- A vehicle cuts in front of you at a slow speed, and it brakes suddenly.
- When you accelerate rapidly and approach the vehicle ahead of you at high speed.
- The vehicle ahead of you is a motorcycle, bicycle, mobility scooter, or other small vehicle.
- When there are animals in front of your vehicle.
- When you drive on a curved or winding or undulating road that makes it difficult for the sensor to properly detect a vehicle in front of you.
- The speed difference between your vehicle and a vehicle in front of you is significantly large.
- An oncoming vehicle suddenly comes in front of you.
- Your vehicle abruptly crosses over in front of an oncoming vehicle.
- When driving through a narrow iron bridge.
- When the vehicle ahead of you brakes suddenly.
- When the vehicle ahead of you has a unique shape.
- When your vehicle or the vehicle ahead of you is driving on one edge of the lane.

▣ ACC with LSF Conditions and Limitations

If the front of the vehicle is impacted in any of the following situations, the radar sensor may not work properly. Have your vehicle checked by an authorized Honda Clarity Electric dealer:

- The vehicle mounted onto a bump, curb, chock, embankment, etc.
- You drive the vehicle where the water is deep.
- Your vehicle has a frontal collision.

■ To Adjust the Vehicle Speed

Increase or decrease the vehicle speed using the **RES/+** or **-/SET** button on the steering wheel.

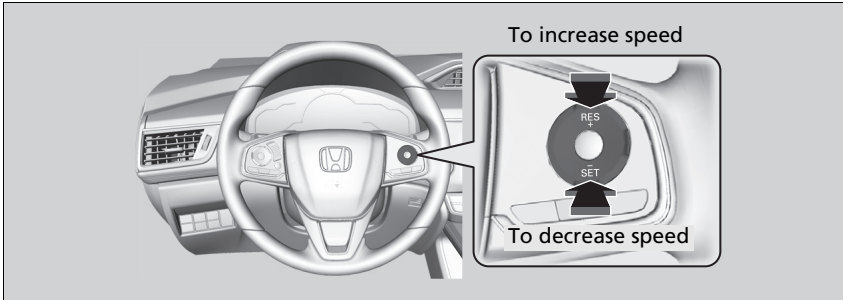

- Each time you press the **RES/+** or **-/SET** button, the vehicle speed is increased or decreased by about 1 mph or 1 km/h accordingly.
- If you press and hold the **RES/+** or **-/SET** button, the vehicle speed increases or decreases by about 5 mph or 5 km/h accordingly.

▣ To Adjust the Vehicle Speed

If a vehicle detected ahead is going at a speed slower than your increased set speed, ACC with LSF may not accelerate your vehicle. This is to maintain the set interval between your vehicle and the vehicle ahead.

You can switch the displayed set speed measurements on the driver information interface between mph and km/h.

▣ **Gauges** P. 116

■ To Set or Change Following-Interval

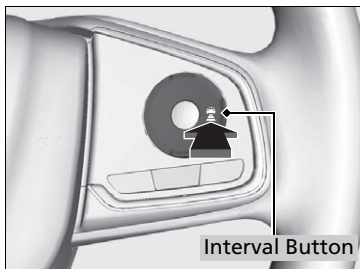





Press the  (interval) button to change the ACC with LSF following-interval.

Each time you press the button, the following-interval (the interval behind a vehicle detected ahead of you) setting cycles through extra long, long, middle, and short following-intervals.

Determine the most appropriate following-interval setting based on your specific driving conditions. Be sure to adhere to any following-interval requirements set by local regulation.

The higher your vehicle's following-speed is, the longer the short, middle, long or extra long following-interval becomes. See the following examples for your reference.

Following-interval		When the Set Speed is:	
		50 mph (80 km/h)	65 mph (104 km/h)
Short		83 feet 25 meters 1.1 sec	100 feet 31 meters 1.1 sec
Middle		110 feet 33 meters 1.5 sec	142 feet 43 meters 1.5 sec
Long		154 feet 47 meters 2.1 sec	200 feet 61 meters 2.1 sec
Extra Long		204 feet 62 meters 2.8 sec	265 feet 81 meters 2.8 sec

When your vehicle stops automatically because a vehicle detected ahead of you has stopped, the interval between the two vehicles will vary based on the ACC with LSF interval setting.



Continued

■ To Cancel

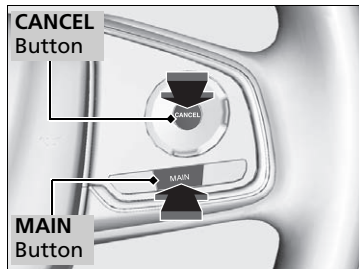

To cancel ACC with LSF, do any of the following:

- Press the **CANCEL** button.
- Press the **MAIN** button.
 - ▶ ACC with LSF indicator goes off.
- Depress the brake pedal.
 - ▶ When the LSF function has stopped the vehicle, you cannot cancel ACC with LSF by depressing the brake pedal.

▶▶ To Cancel

Resuming the prior set speed: After you have canceled ACC with LSF, you can resume the prior set speed while it is still displayed. Press the **RES/+** button.

The set speed cannot be set or resumed when ACC with LSF has been turned off using the **MAIN** button. Press the **MAIN** button to activate the system, then set the desired speed.

■ Automatic cancellation

The beeper sounds and a message appears on the driver information interface when ACC with LSF is automatically canceled. Any of these conditions may cause the ACC with LSF to automatically cancel:

- Bad weather (rain, fog, snow, etc.)
- When the radar sensor in the front grille gets dirty.
- An abnormal tire condition is detected, or the tires are skidding.
- Driving on a mountainous road, or driving off road for extended periods.
- Abrupt steering wheel movement.
- When the ABS, VSA® or CMBS™ is activated.
- When the ABS or VSA® system indicator comes on.
- When the vehicle is stopped on a very steep slope.
- When you manually apply the parking brake.
- When the detected vehicle within the ACC with LSF range is too close to your vehicle.
- The camera behind the rearview mirror, or the area around the camera, including the windshield, gets dirty.

The ACC with LSF automatic cancellation can be also triggered by the following causes. In these cases, the parking brake will be automatically applied.

- The driver's seat belt is unfastened when the vehicle is stationary.
- The vehicle stops for more than 10 minutes.
- The power system is turned off.

⌘ Automatic cancellation

Even though ACC with LSF has been automatically canceled, you can still resume the prior set speed. Wait until the condition that caused ACC with LSF to cancel improves, then press the **RES/+** button.



Continued

■ To Switch ACC with LSF to Cruise Control

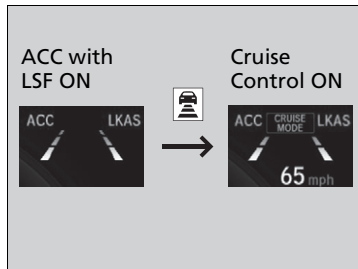

Press and hold the  (interval) button for one second. **Cruise Mode Selected** appears on the driver information interface for two seconds, and then the mode switches to Cruise.

To switch back to ACC with LSF, press and hold the  button again for one second. **ACC Mode Selected** appears on the driver information interface for two seconds.

■ When to use

Desired speed in a range above roughly 25 mph (40 km/h) ~.

■ To Set the Vehicle Speed

Take your foot off the pedal and press the **-/SET** button when you reach the desired speed.

The moment you release the **-/SET** button, the set speed is fixed, and cruise control begins. The **CRUISE CONTROL** indicator comes on.

▶▶ To Switch ACC with LSF to Cruise Control

Always be aware which mode you are in. When you are driving in Cruise mode, the system will not assist you to maintain a following-interval from a vehicle ahead of you.

You can switch the displayed set speed measurements on the driver information interface between mph and km/h.

▶ **Gauges** P. 116

■ To Adjust the Vehicle Speed

Each time you press the **RES/+** or **-/SET** button, the vehicle speed is increased or decreased by about 1 mph (1.6 km/h).

If you keep the **RES/+** or **-/SET** button pressed, the vehicle speed increases or decreases until you release it. This speed is then set.

When you use cruise control, Straight Driving Assist (a feature of the Electric Power Steering system) is activated.

By enabling the steering system to automatically compensate for natural steering pull, Straight Driving Assist makes it easier for you to keep your vehicle in a straight line.

■ To Cancel

To cancel cruise control, do any of the following:

- Press the **CANCEL** button.
- Press the **MAIN** button.
- Depress the brake pedal.

The **CRUISE CONTROL** indicator goes off.

☒ To Cancel

Resuming the prior set speed:

After cruise control has been canceled, you can still resume the prior set speed by pressing the **RES/+** button while driving at a speed of at least 25 mph (40 km/h) or more.

You cannot set or resume in the following situations:

- When vehicle speed is less than 25 mph (40 km/h).
- When the **MAIN** button is turned off.

At vehicle speeds of 22 mph (35 km/h) or less, cruise control canceled automatically.



Lane Keeping Assist System (LKAS)

Provides steering input to help keep the vehicle in the middle of a detected lane and provides tactile and visual alerts if the vehicle is detected drifting out of its lane.

■ Steering input assist
The system applies torque to the steering to keep the vehicle between the left and right lane lines. The applied torque becomes stronger as the vehicle gets closer to either of the lane lines.

■ Front Sensor Camera
Monitors the lane lines

■ Tactile and visual alerts
Rapid vibrations on the steering wheel and a warning display alert you that the vehicle is drifting out of a detected lane.

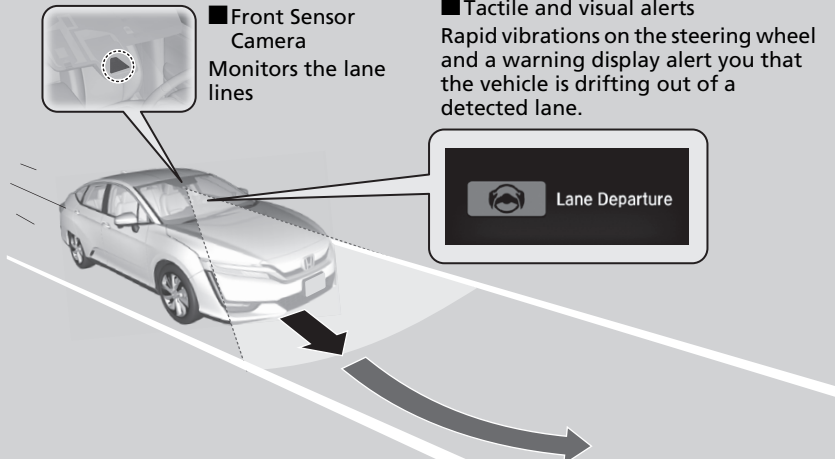

When you operate the turn signals to change lanes, the system is suspended, and resumes after the signals are off.
If you make a lane change without operating the turn signals, the LKAS alerts activate, and torque is applied to the steering.



☒ Lane Keeping Assist System (LKAS)

Important Safety Reminders

The LKAS is for your convenience only. It is not a substitute for your vehicle control. The system does not work if you take your hands off the steering wheel or fail to steer the vehicle.

☒ Driver Information Interface Warning and Information Messages P. 114

Do not place objects on the instrument panel. Objects may reflect on the windshield and prevent correct detection of the traffic lanes.

The LKAS only alerts you when lane drift is detected without a turn signal in use. The LKAS may not detect all lane markings or lane departures; accuracy will vary based on weather, speed, and lane marker condition. It is always your responsibility to safely operate the vehicle and avoid collisions.

The LKAS is convenient when it is used on freeways.

The LKAS may not work properly or may work improperly under the certain conditions:

☒ LKAS Conditions and Limitations P. 409

You can read about handling information for the camera equipped with this system.

☒ Front Sensor Camera P. 383

The LKAS may not function as designed while driving in frequent stop and go traffic, or on roads with sharp curves.

■ Lane Keep Support Function

Provides assistance to keep the vehicle in the center of the lane, when the vehicle nears a white or yellow line, steering force of the electric power steering will become stronger.

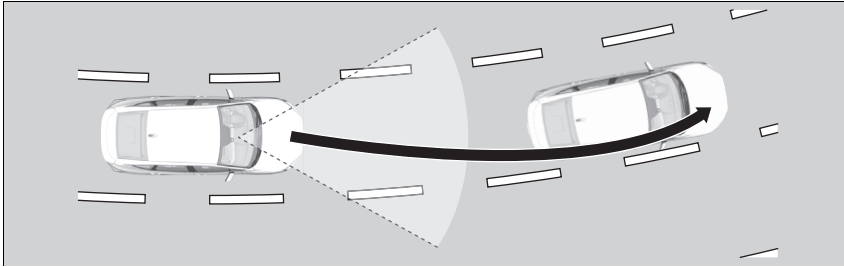

■ Lane Departure Warning Function

When the vehicle enters the warning area, the LKAS alerts you with slight steering wheel vibration as well as a warning display.

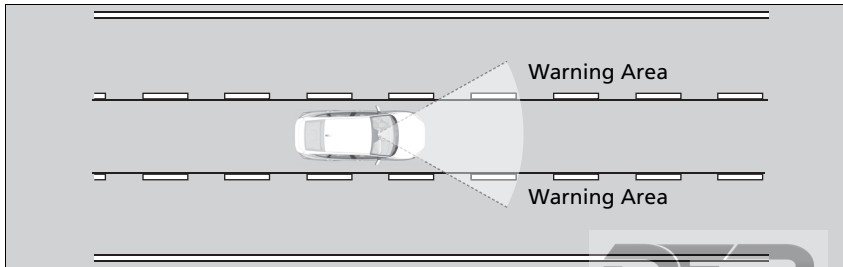

Continued

☒ Lane Keeping Assist System (LKAS)

When it fails to detect lanes, the system will temporarily be canceled. When a lane is detected, the system will recover automatically.

■ When the System can be Used

The system can be used when the following conditions are met.

- The lane in which you are driving has detectable lane markers on both sides, and your vehicle is in the center of the lane.
- The vehicle speed is between 45 and 90 mph (72 and 145 km/h).
- You are driving on a straight or slightly curved road.
- The turn signals are off.
- The brake pedal is not depressed.
- The wipers are not in continuous operation.

■ How to activate the system

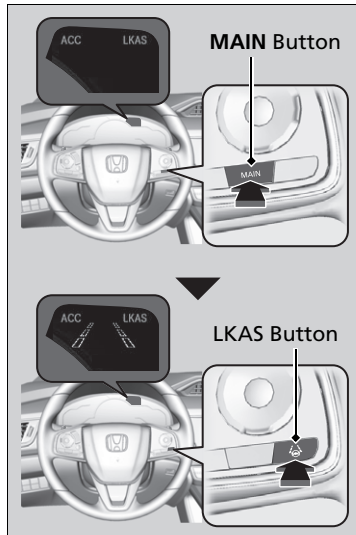

1. Press the **MAIN** button.
 - ▶ The LKAS (green) is on in the driver information interface.
The system is ready to use.
2. Press the LKAS button.
 - ▶ Lane outlines appear on the driver information interface.
The system is activated.



▶▶ When the System can be Used

If the vehicle drifts toward either left or right lane line due to the system applying torque, turn off the LKAS and have your vehicle checked by an authorized Honda Clarity Electric dealer.

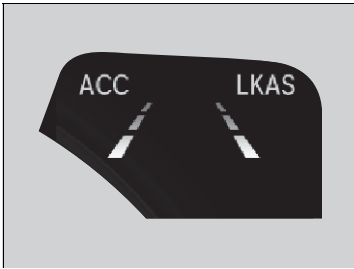

3. Keep your vehicle near the center of the lane while driving.
 - ▶ The dotted outer lines change to solid ones once the system starts operating after detecting the left and right lane markings.

To Cancel

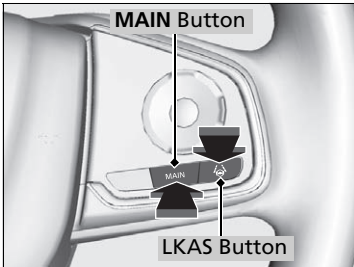

To cancel the LKAS:
Press the **MAIN** or LKAS button.

The LKAS is turned off every time you turn the power system off, even if you turned it on the last time you drove the vehicle.

To Cancel

Pressing the **MAIN** button also turns ACC with LSF on and off.



Continued

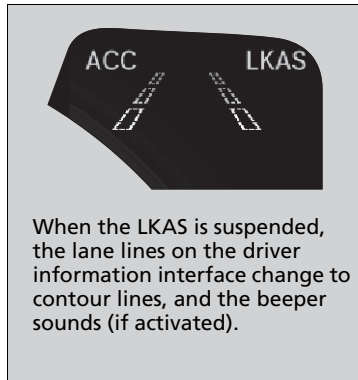

■ **The system operation is suspended if you:**

- Set the wipers to continuous operation.
 - ▶ Turning the wipers off resumes the LKAS.
- Decrease the vehicle speed to about 40 mph (64 km/h) or less.
 - ▶ Increasing the vehicle speed to about 45 mph (72 km/h) or more resumes the LKAS.
- Depress the brake pedal.
 - ▶ The LKAS resumes and starts detecting the lane lines again once you release the brake pedal.

■ **The LKAS may automatically be suspended when:**

- The system fails to detect lane lines.
- The steering wheel is quickly turned.
- You fail to steer the vehicle.
- Driving through a sharp curve.
- Driving at a speed in excess of approximately 90 mph (145 km/h).

Once these conditions no longer exist, the LKAS automatically resumes.

■ The LKAS may automatically be canceled when:

- The camera temperature gets extremely high or low.
- The camera behind the rearview mirror, or the area around the camera, including the windshield, gets dirty.
- The ABS or VSA® system engages.

The beeper sounds if the LKAS is automatically canceled.

■ LKAS Conditions and Limitations

The system may not detect lane markings and therefore may not keep the vehicle in the middle of a lane under certain conditions, including the following:

■ Environmental conditions

- Driving in bad weather (rain, fog, snow, etc.).
- Sudden changes between light and dark, such as an entrance or exit of a tunnel.
- There is little contrast between lane lines and the roadway surface.
- Driving into low sunlight (e.g., at dawn or dusk).
- Strong light is reflected onto the roadway.
- Driving in the shadows of trees, buildings, etc.
- Shadows of adjacent objects are parallel to lane markings.
- Roadway objects or structures are misinterpreted as lane markers.
- Reflections on the interior of the windshield.



Continued

■ Roadway conditions

- Driving on a snowy or wet roadway (obscured lane marking, vehicle tracks, reflected lights, road spray, high contrast).
- Driving on a road with temporary lane markings.
- Faint, multiple, or varied lane markings are visible on the roadway due to road repairs or old lane markings.
- The roadway has merging, split, or crossing lines (e.g., such as at an intersection or crosswalk).
- The lane markings are extremely narrow, wide, or changing.
- The vehicle in front of you is driving near the lane lines.
- The road is hilly or the vehicle is approaching the crest of a hill.
- Driving on rough or unpaved roads, or over bumpy surfaces.
- When objects on the road (curb, guard rail, pylons, etc.) are recognized as white lines (or yellow lines).
- Driving on roads with double lines.

■ Vehicle conditions

- Headlight lenses are dirty or the headlights are not properly adjusted.
- The outside of the windshield is streaked or blocked by dirt, mud, leaves, wet snow, etc.
- The inside of the windshield is fogged.
- The camera temperature gets too high.
- An abnormal tire or wheel condition (wrong sized, varied size or construction, improperly inflated tire, etc.).
- The vehicle is tilted due to a heavy load or suspension modifications.



Vehicle Stability Assist® (VSA®), aka Electronic Stability Control (ESC), System

VSA® helps to stabilize the vehicle during cornering if the vehicle turns more or less than what was intended. It also assists in maintaining traction on slippery surfaces. It does so by regulating motor output and selectively applying the brakes.

■ VSA® Operation

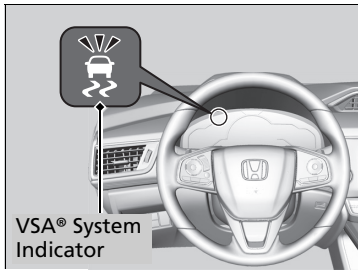

When VSA® activates, you may notice that the motor do not respond to the accelerator. You may also notice some noise from the hydraulic system. You will also see the indicator blink.

▣ Vehicle Stability Assist® (VSA®), aka Electronic Stability Control (ESC), System

The VSA® may not function properly if tire type and size are mixed. Make sure to use the same size and type of tire, and the air pressures as specified.

When the VSA® system indicator comes on and stays on while driving, there may be a problem with the system. While this may not interfere with normal driving, have your vehicle checked by an authorized Honda Clarity Electric dealer immediately.

The indicators for the Vehicle Stability Assist® (VSA®) System, Vehicle Stability Assist® (VSA®) OFF, low tire Pressure/TPMS and Collision Mitigation Braking System™ (CMBS™) may come on along with a message in the driver information interface after re-connecting the 12-volt battery. Drive a short distance at more than 12 mph (20 km/h). The indicator should go off. If it does not, have your vehicle checked by an authorized Honda Clarity Electric dealer.

VSA® cannot enhance stability in all driving situations and does not control the entire braking system. You still need to drive and corner at speeds appropriate for the conditions and always leave a sufficient margin of safety.

The main function of the VSA® system is generally known as Electronic Stability Control (ESC). The system also includes a traction control function.



Continued

■ VSA® On and Off

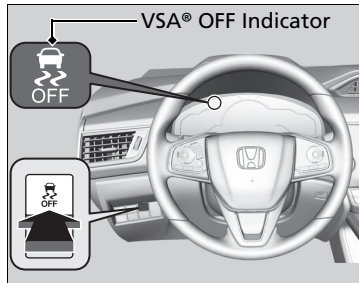

This button is on the driver side control panel. To partially disable VSA® functionality/features, press and hold it until you hear a beep.

Your vehicle will have normal braking and cornering ability, but traction control function will be less effective.

To restore VSA® functionality/features, press the  (VSA® OFF) button until you hear a beep.

VSA® is turned on every time you turn the power system on, even if you turned it off the last time you drove the vehicle.

▶▶ Vehicle Stability Assist® (VSA®), aka Electronic Stability Control (ESC), System

In certain unusual conditions when your vehicle gets stuck in shallow mud or fresh snow, it may be easier to free it with the VSA® temporarily switched off.

When the  button is pressed, the traction control function becomes less effective. This allows for the wheels to spin more freely at low speed. You should only attempt to free your vehicle with the VSA® off if you are not able to free it when the VSA® is on.

Immediately after freeing your vehicle, be sure to switch VSA® on again. We do not recommend driving your vehicle with the VSA® system switched off.

You may hear a motor sound coming from the motor compartment while system checks are being performed immediately after turning the power system on or while driving. This is normal.

Agile Handling Assist

Lightly brakes the front wheels, as needed, when you turn the steering wheel, and helps support the vehicle's stability and performance during cornering.

Agile Handling Assist

The agile handling assist cannot enhance stability in all driving situations. You still need to drive and corner at speeds appropriate for the conditions and always leave a sufficient margin of safety.

When the VSA® system indicator comes on and stays on while driving, the agile handling assist does not activate.

You may hear a sound coming from the motor compartment while the agile handling assist is activated. This is normal.

Tire Pressure Monitoring System (TPMS)

Instead of directly measuring the pressure in each tire, the TPMS on this vehicle monitors and compares the rolling radius and rotational characteristics of each wheel and tire while you are driving to determine if one or more tires are significantly under-inflated. This will cause the low tire pressure/TPMS indicator to come on and a message to appear on the driver information interface.

TPMS Calibration

You must start TPMS calibration every time you:

- Adjust the pressure in one or more tires.
- Rotate the tires.
- Replace one or more tires.

Before calibrating the TPMS:

- Set the cold tire pressure in all four tires.
 - ▶ **Checking Tires** P. 475

Make sure:

- The vehicle is at a complete stop.
- The gear position is in **P**.
- The power mode is in ON.

▶▶ Tire Pressure Monitoring System (TPMS)

The system does not monitor the tires when driving at low speed.

Conditions such as low ambient temperature and altitude change directly affect tire pressure and can trigger the low tire pressure/TPMS indicator to come on.

Tire pressure checked and inflated in:

- Warm weather can become under-inflated in colder weather.
- Cold weather can become over-inflated in warmer weather.

The low tire pressure/TPMS indicator will not come on as a result of over inflation.

The TPMS may not function properly if tire type and size are mixed. Make sure to use the same size and type of tire.

- ▶▶ **Checking and Maintaining Tires** P. 475

The low tire pressure/TPMS indicator may come on with a delay or may not come on at all when:

- You rapidly accelerate, decelerate, or turn the steering wheel.
- You drive on snowy or slippery roads.
- Tire chains are used.

The low tire pressure/TPMS indicator may come on under the following conditions:

- There is a heavier and uneven load on the tires than the condition at calibration.
- Tire chains are used.



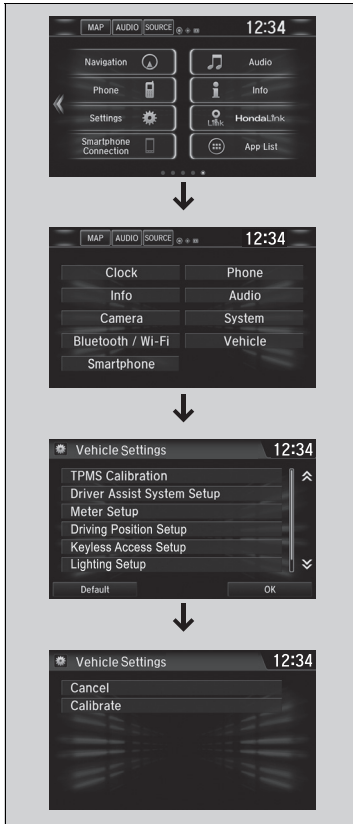

You can calibrate the system from the customized feature on the audio/information screen.

1. Set the power mode to ON.
2. Select **HOME**.
3. Select **Settings**.
4. Select **Vehicle**.
5. Select **TPMS Calibration**.
6. Select **Cancel** or **Calibrate**.
 - ▶ When the calibration is complete, the display returns to the customization menu screen.

- If the **Calibration Failed To Start** message appears, repeat steps 4-6.
- The calibration process finishes automatically.

▶▶ TPMS Calibration

- The calibration process requires approximately 30 minutes of cumulative driving at speeds between 30-65 mph (48-105 km/h).
- During this period, if the power system is turned on and the vehicle is not moved within 45 seconds, you may notice the low tire pressure/TPMS indicator comes on briefly. This is normal and indicates that the calibration process is not yet complete.

If tire chains are installed, remove them before calibrating the TPMS.

If the low tire pressure/TPMS indicator comes on even when the properly inflated specified regular tires are installed, have your vehicle checked by an authorized Honda Clarity Electric dealer.

We recommend that the tires be replaced with the same brand, model, and size as the originals. Ask an authorized Honda Clarity Electric dealer for details.

The indicators for the Vehicle Stability Assist® (VSA®) System, Vehicle Stability Assist® (VSA®) OFF, low tire Pressure/TPMS and Collision Mitigation Braking System™ (CMBS™) may come on along with a message in the driver information interface after re-connecting the 12-volt battery. Drive a short distance at more than 12 mph (20 km/h). The indicator should go off. If it does not, have your vehicle checked by an authorized Honda Clarity Electric dealer.

Tire Pressure Monitoring System (TPMS) - Required Federal Explanation

Each tire, including the spare (if provided), should be checked monthly when cold and inflated to the inflation pressure recommended by the vehicle manufacturer on the vehicle placard or tire inflation pressure label.

(If your vehicle has tires of a different size than the size indicated on the vehicle placard or tire inflation pressure label, you should determine the proper tire inflation pressure for those tires.)

As an added safety feature, your vehicle has been equipped with a tire pressure monitoring system (TPMS) that illuminates a low tire pressure telltale



when one or more of your tires is significantly under-inflated.

Accordingly, when the low tire pressure telltale illuminates, you should stop and check your tires as soon as possible, and inflate them to the proper pressure.

Driving on a significantly under-inflated tire causes the tire to overheat and can lead to tire failure. Under-inflation also reduces energy efficiency and tire tread life, and may affect the vehicle's handling and stopping ability.



Please note that the TPMS is not a substitute for proper tire maintenance, and it is the driver's responsibility to maintain correct tire pressure, even if under-inflation has not reached the level to trigger illumination of the TPMS low tire pressure telltale.

Your vehicle has also been equipped with a TPMS malfunction indicator to indicate when the system is not operating properly. The TPMS malfunction indicator is combined with the low tire pressure telltale. When the system detects a malfunction, the telltale will flash for approximately one minute and then remain continuously illuminated. This sequence will continue upon subsequent vehicle start-ups as long as the malfunction exists.

When the malfunction indicator is illuminated, the system may not be able to detect or signal low tire pressure as intended.

TPMS malfunctions may occur for a variety of reasons, including the installation of replacement or alternate tires or wheels on the vehicle that prevent the TPMS from functioning properly.

Always check the TPMS malfunction telltale after replacing one or more tires or wheels on your vehicle to ensure that the replacement or alternate tires and wheels allow the TPMS to continue to function properly.



LaneWatch™

LaneWatch is an assistance system that allows you to check the passenger side rear areas displayed on the audio/information screen when the turn signal is activated to the passenger's side. A camera in the passenger side door mirror monitors these areas and allows you to check for vehicles, in addition to your visual check and use of the passenger door mirror. You can also keep the system on for your convenience while driving.

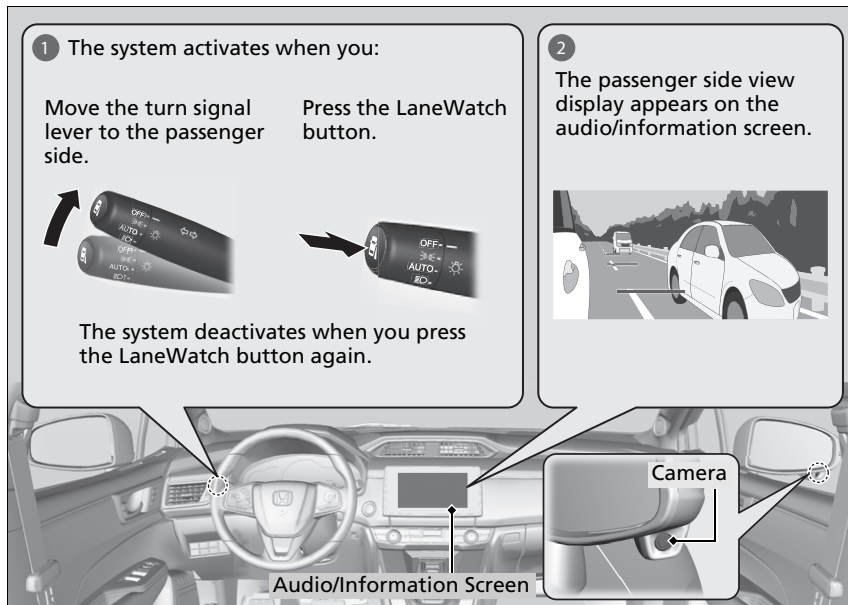

▶ LaneWatch™

⚠ WARNING

Failure to visually confirm that it is safe to change lanes before doing so may result in a crash and serious injury or death.

Do not rely only on LaneWatch while driving.

Always look in your mirrors, to either side of your vehicle, and behind you for other vehicles before changing lanes.

Important Safety Reminder

Like all assistance systems, LaneWatch has limitations. Over reliance on LaneWatch may result in a collision.

The LaneWatch function can be affected by weather, lighting (including headlights and low sun angle), ambient darkness, camera condition, and loading.

The LaneWatch may not provide the intended display of traffic to the side and rear under the following conditions:

- Your vehicle's suspension has been altered, changing the height of the vehicle.
- Your tires are over or under inflated.
- Your tires or wheels are of varied size or construction.



■ Customizing the LaneWatch settings

You can customize the following items using the audio/information screen.

- **Show with Turn Signal:** Selects whether LaneWatch monitor comes on when you operate the turn signal light lever.
- **Display Time after Turn Signal Off:** Changes the length of time the LaneWatch display stays on after you pull the turn signal lever back.
- **Reference Line:** Selects whether the reference lines appear on the LaneWatch monitor.
- **Display:** Allows for display adjustments of items, such as brightness, contrast and black level. This setting is part of the **System** setup group.

📧 **Customized Features** P. 296

■ Reference Lines

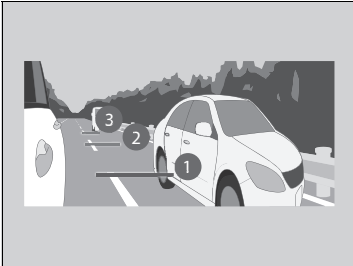

Three lines that appear on the screen can give an idea of how far the vehicles or objects on the screen are from your vehicle, respectively. If an object is near line 1 (in red), it indicates that it is close to your vehicle whereas an object near line 3 farther away.



📧 LaneWatch™

The LaneWatch camera view is restricted. Its unique lens makes objects on the screen slightly look different from what they are.

LaneWatch display does not come on when the gear position is in **[R]**.

For proper LaneWatch operation:

- The camera is located in the passenger side door mirror. Always keep this area clean. If the camera lens is covered with dirt or moisture, use a soft, moist cloth to keep the lens clean and free of debris.
- Do not cover the camera lens with labels or stickers of any kind.
- Do not touch the camera lens.

📧 Reference Lines

The area around the reference line 1 (red) is very close to your vehicle. As always, make sure to visually confirm the safety of a lane change before changing lanes.

The distance between your vehicle and lines 1, 2 and 3 on the screen vary depending on road conditions and vehicle loading. For example, the reference lines on the screen may seem to appear closer than the actual distances when the rear of your vehicle is more heavily loaded.

Consult an authorized Honda Clarity Electric dealer if:

- The passenger side door mirror, or area around it is severely impacted, resulting in changing the camera angle.
- The LaneWatch display does not come on at all.

Brake System

■ Parking Brake

Use the parking brake to keep the vehicle stationary when parked. When the parking brake is applied, you can manually or automatically release it.



■ To apply

The electric parking brake can be applied any time the vehicle has battery, no matter which position the power mode is in.

Pull the electric parking brake switch up gently and securely.

- ▶ The parking brake and brake system indicator (red) comes on.

» Brake System

When you depress the brake pedal, you may hear a whirling sound from the motor compartment. This is because the brake system is in operation, and it is normal.

» Parking Brake

You may hear the electric parking brake system motor operating from the rear wheel area when you apply or release the parking brake, or set the power mode to OFF. This is normal.

The brake pedal may slightly move due to the electric parking brake system operation when you apply or release the parking brake. This is normal.

You cannot apply or release the parking brake if the 12-volt battery goes dead.

▶ **Jump Starting** P. 514

If you pull up and hold the electric parking brake switch while driving, the brakes on all four wheels are applied by the VSA® system until the vehicle comes to a stop. The electric parking brake then applies, and the switch should be released.

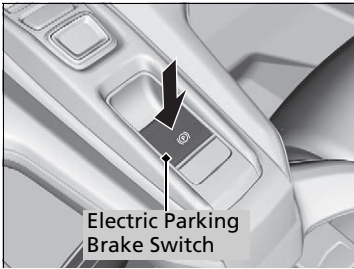

■ To release

The power mode must be in ON in order to release the electric parking brake.

1. Depress the brake pedal.
2. Press the electric parking brake switch.
 - ▶ The parking brake and brake system indicator (red) goes off.

Manually releasing the parking brake using the switch helps your vehicle start slowly and smoothly when facing down hill on steep hills.

▣ Parking Brake

In the following situations, the parking brake automatically operates.

- When the vehicle stops more than 10 minutes while ACC with LSF is activated.
- When the driver's seat belt is unfastened while your vehicle is stopped automatically by ACC with LSF.
- When the power system is turned off while ACC with LSF is activated.
- When the vehicle stops with the automatic brake hold system activated for more than 10 minutes.
- When the driver's seat belt is unfastened while your vehicle is stopped and brake hold is applied.
- When the power system is turned off while brake hold is applied.
- When there is a problem with the Brake Hold System while Brake Hold is applied.

■ To release automatically

Depressing the accelerator pedal releases the parking brake. Use the accelerator pedal to release the brake when you are starting the vehicle facing uphill, or in a traffic jam.

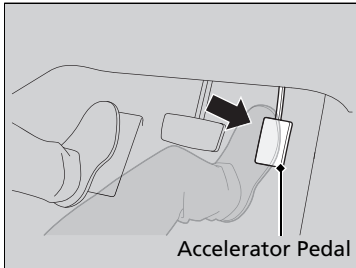

Gently depress the accelerator pedal. When on a hill, it may require more accelerator input to release.

- The parking brake and brake system indicator (red) goes off.

You can release the parking brake automatically when:

- You are wearing the driver's seat belt.
- The power system is on.
- The transmission is not in **P** or **N**.

▣ Parking Brake

If the parking brake cannot be released automatically, release it manually.

When the vehicle is traveling uphill, the accelerator pedal may need to be pressed farther to automatically release the electric parking brake.

The parking brake may not be released automatically while the following indicators are on:

- **POWER SYSTEM** indicator
- Transmission system indicator
- Parking brake and brake system indicator (amber)
- VSA® system indicator
- **ABS** indicator
- Supplemental restraint system indicator

Foot Brake

Your vehicle is equipped with disc brakes at all four wheels. The brake assist system increases the stopping force when you depress the brake pedal hard in an emergency situation. The anti-lock brake system (ABS) helps you retain steering control when braking very hard.

➤ **Brake Assist System** P. 427

➤ **Anti-lock Brake System (ABS)** P. 426

Foot Brake

Check the brakes after driving through deep water, or if there is a buildup of road surface water. If necessary, dry the brakes by lightly depressing the pedal several times.

If you hear a continuous metallic friction sound when applying the brakes, this is caused by the brake wear indicator rubbing on the brake rotor and indicates that the brake pads need to be replaced. Have the vehicle checked by an authorized Honda Clarity Electric dealer. If you hear only an occasional squeak or squeal when you initially apply the brake pedal, this may be normal and caused by high frequency vibration of the brake pads against the rotating brake disc.

Applying constant pressure to the brakes while going down a long hill can cause the brakes to heat up, resulting in a loss of stopping power. Therefore, when descending a long hill, release the accelerator pedal and allow regenerative braking to slow the vehicle down. To adjust the rate of deceleration, use the deceleration paddle selector.

When the high voltage battery is recharging, regenerative braking may not be possible.

➤ **POWER/CHARGE Gauge** P. 117

➤ **High Voltage Battery Charge Level Gauge**
P. 118

➤ **Deceleration Paddle Selector** P. 379

Do not rest your foot on the brake pedal while driving, as it will lightly apply the brakes and cause them to lose effectiveness over time and reduce pad life. It will also confuse drivers behind you.



Continued

■ Automatic Brake Hold

Keeps the brake applied after releasing the brake pedal until the accelerator pedal is pressed. You can use this system while the vehicle is temporarily stopped, like at traffic lights and in heavy traffic.

►► Automatic Brake Hold

⚠ WARNING

Activating the automatic brake hold system on steep hills or slippery roads may still allow the vehicle to move if you remove your foot from the brake pedal.

If a vehicle unexpectedly moves, it may cause a crash resulting in serious injury or death.

Never activate the automatic brake hold system or rely on it to keep a vehicle from moving when stopped on a steep hill or slippery roads.

⚠ WARNING

Using the automatic brake hold system to park the vehicle may result in the vehicle unexpectedly moving.

If a vehicle moves unexpectedly, it may cause a crash, resulting in serious injury or death.

Never leave the vehicle when braking is temporarily kept by automatic brake hold and always park the vehicle by putting the transmission in **P** and applying the parking brake.

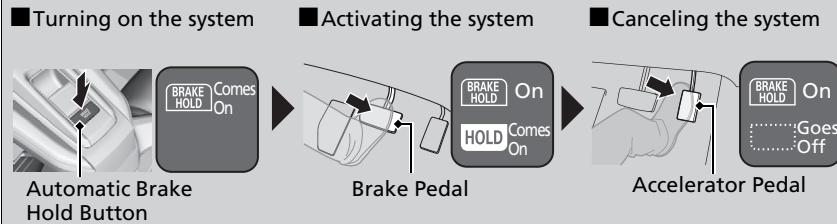

Fasten your seat belt properly, then start the power system. Press the automatic brake hold button.

- The automatic brake hold system indicator comes on. The system is turned on.

Depress the brake pedal to come to a complete stop. The transmission must be in **D** or **N**.

- The automatic brake hold indicator comes on. Braking is kept for up to 10 minutes.
- Release the brake pedal after the automatic brake hold indicator comes on.

Depress the accelerator pedal while the transmission is in **D**. The system is canceled and the vehicle starts to move.

- The automatic brake hold indicator goes off. The system continues to be on.



■ **The system automatically cancels when:**

- You depress the brake pedal and change to **P** or **R**.
- You engage the parking brake.

■ **The system automatically cancels and the parking brake is applied when:**

- Braking is kept for more than 10 minutes.
- The driver's seat belt is unfastened.
- The power system is turned off.
- **Brake Hold System Problem** appears on the driver information interface.

■ **Turning off the automatic brake hold system**

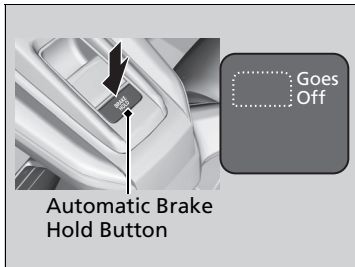

While the system is on, press the automatic brake hold button again.

- ▶ The automatic brake hold system indicator goes off.

If you want to turn off automatic brake hold while the system is in operation, press the automatic brake hold button with the brake pedal depressed.

⊠ Automatic Brake Hold

While the system is activated, you can turn off the power system or park the vehicle through the same procedure as you normally do.

⊠ **When Stopped** P. 436

Whether the system is on, or the system is activated, the automatic brake hold turns off once the power system is off.

⊠ Turning off the automatic brake hold system

Make sure to turn off the automatic brake hold system before using an automated car wash.

You may hear an operating noise if the vehicle moves while the automatic brake hold system is in operation.

Anti-lock Brake System (ABS)

■ ABS

Helps prevent the wheels from locking up, and helps you retain steering control by pumping the brakes rapidly, much faster than you.

The electronic brake distribution (EBD) system, which is part of the ABS, also balances the front-to-rear braking distribution according to vehicle loading.

You should never pump the brake pedal. Let the ABS work for you by always keeping firm, steady pressure on the brake pedal. This is sometimes referred to as “stomp and steer.”

■ ABS operation

You may hear an operating noise when the ABS is working. Keep holding the pedal firmly down. On dry pavement, you will need to press on the brake pedal very hard before the ABS activates. However, you may feel the ABS activate immediately if you are trying to stop on snow or ice.

ABS may activate when you depress the brake pedal when driving on:

- Wet or snow covered roads.
- Roads paved with stone.
- Roads with uneven surfaces, such as potholes, cracks, manholes, etc.

When the vehicle speed goes under 6 mph (10 km/h), the ABS stops.

►► Anti-lock Brake System (ABS)

NOTICE

The ABS may not function correctly if you use a tire of the wrong size or type.

If the **ABS** indicator comes on while driving, there may be a problem with the system. While normal braking will not be affected, there is a possibility that the ABS will not be operating. Have your vehicle checked by an authorized Honda Clarity Electric dealer immediately.

The ABS is not designed for the purpose of reducing the time or distance it takes for a vehicle to stop: It is designed to limit brake lockup which can lead to skidding and loss of steering control.

In the following cases, your vehicle may need more distance to stop than a vehicle without the ABS:

- You are driving on rough or uneven road surfaces, such as gravel or snow.
- The tires are equipped with tire chains.

The following may be observed with the ABS system:

- Motor sounds coming from the motor compartment when the brakes are applied, or when system checks are being performed after the power system has been turned on and while vehicle accelerates.
- Brake pedal and/or the vehicle body vibration when ABS activates.

These vibrations and sounds are normal to ABS systems and are no cause for concern.



Brake Assist System

Designed to assist the driver by generating greater braking force when you depress the brake pedal hard during emergency braking.

■ Brake assist system operation

Press the brake pedal firmly for more powerful braking.

Collision Mitigation Braking System™ (CMBS™)

Can assist you when there is a possibility of your vehicle colliding with a vehicle or a pedestrian detected in front of yours. The CMBS™ is designed to alert you when a potential collision is determined, as well as to reduce your vehicle speed to help minimize collision severity when a collision is deemed unavoidable.

■ How the system works

When to use

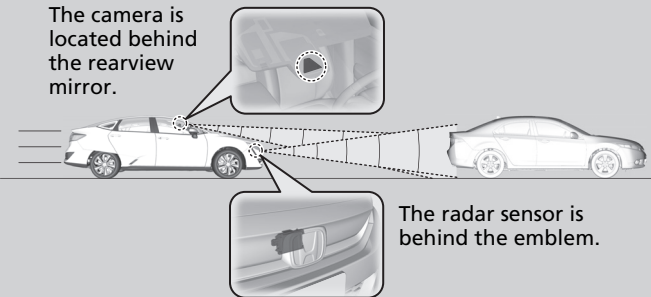

The camera is located behind the rearview mirror.

The radar sensor is behind the emblem.

The system starts monitoring the roadway ahead when your vehicle speed is about 3 mph (5 km/h) and there is a vehicle in front of you.

The CMBS™ activates when:

- The speed difference between your vehicle and a vehicle or pedestrian detected in front of you becomes about 3 mph (5 km/h) and over with a chance of a collision.
- Your vehicle speed is about 62 mph (100 km/h) or less and there is a chance of a collision with an oncoming detected vehicle or a pedestrian in front of you.



► Collision Mitigation Braking System™ (CMBS™)

Important Safety Reminder

The CMBS™ is designed to reduce the severity of an unavoidable collision. It does not prevent a collision nor stop the vehicle automatically. It is still your responsibility to operate the brake pedal and steering wheel appropriately according to the driving conditions.

The CMBS™ may not activate or may not detect a vehicle in front of your vehicle under certain conditions:

► **CMBS™ Conditions and Limitations** P. 432

You can read about handling information for the camera equipped with this system.

► **Front Sensor Camera** P. 383

Be careful not to severely impact the radar sensor cover.

► How the system works

Rapid vibrations on the steering wheel alert you when the your vehicle speed is between 19 and 62 mph (30 and 100 km/h) with an oncoming vehicle detected in front of you.

When the CMBS™ activates, it may automatically apply the brake. It will be canceled when your vehicle stops or a potential collision is not determined.

■ When the system activates

The system provides visual, audible and tactile alerts of a possible collision, and stops if the collision is avoided.

- ▶ Take appropriate action to prevent a collision (apply the brakes, change lanes, etc.)

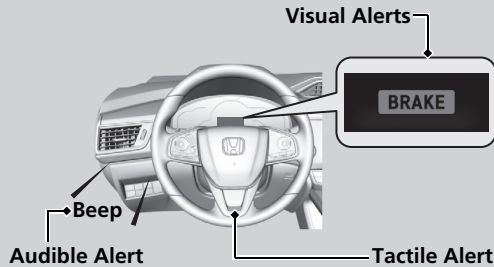

At system's earliest collision alert stage, you can change the distance (**Long/Normal/Short**) between vehicles at which alerts will come on through audio/information screen setting options.

- ▶ **Customized Features** P. 296

■ Vibration alert on the steering wheel

When a potential collision to an oncoming detected vehicle is determined, the system alerts you with rapid vibration on the steering wheel, in addition to visual and audible alerts.

- ▶ Take appropriate action to prevent a collision (apply the brakes, operate the steering wheel, etc.).



Continued

▶▶ When the system activates

The camera in the CMBS™ is also designed to detect pedestrians.

However, this pedestrian detection feature may not activate or may not detect a pedestrian in front of your vehicle under certain conditions. Refer to the ones indicating the pedestrian detection limitations from the list.

- ▶ **CMBS™ Conditions and Limitations** P. 432

▶▶ Vibration alert on the steering wheel

Vibration alert function is disabled when the electric power steering (EPS) system indicator comes on.

- ▶ **Electric Power Steering (EPS) System Indicator** P. 90

■ Collision Alert Stages

The system has three alert stages for a possible collision. However, depending on circumstances, the CMBS™ may not go through all of the stages before initiating the last stage.

Distance between vehicles		CMBS™			
		The sensor detects a vehicle	Audible & Visual WARNINGS	Steering Wheel	Braking
Stage one		There is a risk of a collision with the vehicle ahead of you.	When in Long , visual and audible alerts come on at a longer distance from a vehicle ahead than in Normal setting, and in Short , at a shorter distance than in Normal .	In case of an oncoming vehicle detected, rapid vibration is provided.	—
Stage two		The risk of a collision has increased, time to respond is reduced.	Visual and audible alerts.	—	Lightly applied
Stage three		The CMBS™ determines that a collision is unavoidable.			Forcefully applied

Driving



■ CMBS™ On and Off

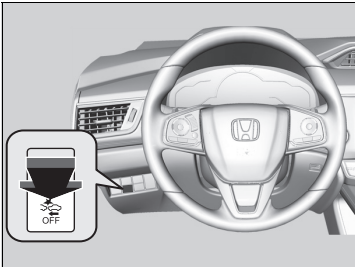

Press and hold the button until the beeper sounds to switch the system on or off.

When the CMBS™ is off:

- The CMBS™ indicator in the instrument panel comes on.
- A message on the driver information interface reminds you that the system is off.

The CMBS™ is turned on every time you start the power system, even if you turned it off the last time you drove the vehicle.

▣ Collision Mitigation Braking System™ (CMBS™)

The CMBS™ may automatically shut off, and the CMBS™ indicator will come and stay on under certain conditions:

▣ **CMBS™ Conditions and Limitations** P. 432

The indicators for the Vehicle Stability Assist® (VSA®) System, Vehicle Stability Assist® (VSA®) OFF, low tire Pressure/TPMS and Collision Mitigation Braking System™ (CMBS™) may come on along with a message in the driver information interface after re-connecting the 12-volt battery. Drive a short distance at more than 12 mph (20 km/h). The indicator should go off. If it does not, have your vehicle checked by an authorized Honda Clarity Electric dealer.



Continued

■ CMBS™ Conditions and Limitations

The system may automatically shut off and the CMBS™ indicator will come on under certain conditions. Some examples of these conditions are listed below. Other conditions may reduce some of the CMBS™ functions.

➤ **Front Sensor Camera** P. 383

■ Environmental conditions

- Driving in bad weather (rain, fog, snow, etc.).
- Sudden changes between light and dark, such as an entrance or exit of a tunnel.
- There is little contrast between objects and the background.
- Driving into low sunlight (e.g., at dawn or dusk).
- Strong light is reflected onto the roadway.
- Driving in the shadows of trees, buildings, etc.
- Roadway objects or structures are misinterpreted as vehicles and pedestrians.
- Reflections on the interior of the windshield.
- Driving at night or in a dark condition such as a tunnel.

■ Roadway conditions

- Driving on a snowy or wet roadway (obscured lane marking, vehicle tracks, reflected lights, road spray, high contrast).
- Driving on curvy, winding, or undulating roads.
- The road is hilly or the vehicle is approaching the crest of a hill.

⌘ CMBS™ Conditions and Limitations

If you need the radar sensor to be repaired, or removed, or the radar sensor cover is strongly impacted, turn off the system by pressing the CMBS™ off button and take your vehicle to an authorized Honda Clarity Electric dealer.



■ Vehicle conditions

- Headlight lenses are dirty or the headlights are not properly adjusted.
- The outside of the windshield is blocked by dirt, mud, leaves, wet snow, etc.
- The inside of the windshield is fogged.
- An abnormal tire or wheel condition (wrong sized, varied size or construction, improperly inflated tire, etc.).
- When tire chains are installed.
- The vehicle is tilted due to a heavy load or suspension modifications.
- The camera temperature gets too high.
- Driving with the parking brake applied.
- When the radar sensor in the front grille gets dirty.

■ Detection limitations

- A vehicle or pedestrian suddenly crosses in front of you.
- The distance between your vehicle and the vehicle or pedestrian ahead of you is too short.
- A vehicle cuts in front of you at a slow speed, and it brakes suddenly.
- When you accelerate rapidly and approach the vehicle or pedestrian ahead of you at high speed.
- The vehicle ahead of you is a motorcycle, bicycle, mobility scooter or other small vehicle.
- When there are animals in front of your vehicle.
- When you drive on a curved, winding or undulating road that makes it difficult for the sensor to properly detect a vehicle in front of you.
- The speed difference between your vehicle and a vehicle or pedestrian in front of you is significantly large.
- An oncoming vehicle suddenly comes in front of you.
- Another vehicle suddenly comes in front of you at an intersection, etc.
- Your vehicle abruptly crosses over in front of an oncoming vehicle.
- When driving through a narrow iron bridge.
- When the lead vehicle suddenly slows down.



Continued

Limitations applicable to pedestrian detection only

- When there is a group of people in front of your vehicle walking together side by side.
- Surrounding conditions or belongings of the pedestrian alter the pedestrian's shape, preventing the system from recognizing that the person is a pedestrian.
- When the pedestrian is shorter than about 3.3 feet (1 meter) or taller than about 6.6 feet (2 meters) in height.
- When a pedestrian blends in with the background.
- When a pedestrian is bent over or squatting, or when their hands are raised or they are running.
- When several pedestrians are walking ahead in a group.
- When the camera cannot correctly identify that a pedestrian is present due to an unusual shape (holding luggage, body position, size).

■ **Automatic shutoff**

The CMBST™ may automatically shut itself off and the CMBST™ indicator comes and stays on when:

- The temperature inside the system is high.
- You drive off-road or on a mountain road, or curved and winding road for an extended period.
- An abnormal tire condition is detected (wrong tire size, flat tire, etc.).
- The camera behind the rearview mirror, or the area around the camera, including the windshield, gets dirty.

Once the conditions that caused the CMBST™ to shut off improve or are addressed (e.g., cleaning), the system comes back on.

■ With Little Chance of a Collision

The CMBS™ may activate even when you are aware of a vehicle ahead of you, or when there is no vehicle ahead. Some examples of this are:

■ When Passing

Your vehicle approaches another vehicle ahead of you and you change lanes to pass.

■ At an intersection

Your vehicle approaches or passes another vehicle that is making a left or right turn.

■ On a curve

When driving through curves, your vehicle comes to a point where an oncoming vehicle is right in front of you.

■ Through a low bridge at high speed

You drive under a low or narrow bridge at high speed.

■ Speed bumps, road work sites, train tracks, roadside objects, etc.

You drive over speed bumps, steel road plates, etc., or your vehicle approaches train tracks or roadside objects [such as a traffic sign and guard rail] on a curve or, when parking, stationary vehicles and walls.

☒ Collision Mitigation Braking System™ (CMBS™)

For the CMBS™ to work properly:

Always keep the radar sensor cover clean.

Never use chemical solvents or polishing powder for cleaning the sensor cover. Clean it with water or a mild detergent.

Do not paint, or apply any coverings or paint to radar sensor area. This can impact CMBS™ operation.

Have your vehicle checked by an authorized Honda Clarity Electric dealer if you find any unusual behavior of the system (e.g., the warning message appears too frequently).

If the front of the vehicle is impacted in any of the following situations, the radar sensor may not work properly. Have your vehicle checked by an authorized Honda Clarity Electric dealer:

- The vehicle mounted onto a bump, curb, chock, embankment, etc.
- You drive the vehicle where the water is deep.
- Your vehicle has a frontal collision.



When Stopped

1. Depress the brake pedal firmly.
2. With the brake pedal depressed, pull up the electric parking brake switch slowly, but fully.
3. Change the gear position to **P**.
4. Turn off the power system.

» Parking Your Vehicle

⚠ WARNING

The vehicle can roll away if left unattended without confirming that Park is engaged.

A vehicle that rolls away could cause a crash resulting in serious injury or death.

Always keep your foot on the brake pedal until you have confirmed that **P** is shown on the gear position indicator.

» When Stopped

NOTICE

The following can damage the driveline:

- Depressing the accelerator and brake pedals simultaneously.
- Changing into **P** before the vehicle stops completely.

When facing uphill, do not hold the vehicle by depressing the accelerator pedal.

Doing so may cause the power system to overheat and fail.

Always confirm the electric parking brake is set, in particular if you are parked on an incline.

⌘ When Stopped

In extremely cold temperatures, the parking brake may freeze up if applied. If such temperatures are expected, do not apply the parking brake but, if parking on a slope, either turn the front wheels so they will contact the curb if the vehicle rolls down the slope or block the wheels to keep the vehicle from moving. If you do not take either precaution, the vehicle may roll unexpectedly, leading to a crash.

About Your Multi-View Rear Camera

The audio/information screen can display your vehicle's rear view. The display automatically changes to the rear view when the transmission is put into **R**.

Multi-View Rear Camera Display Area

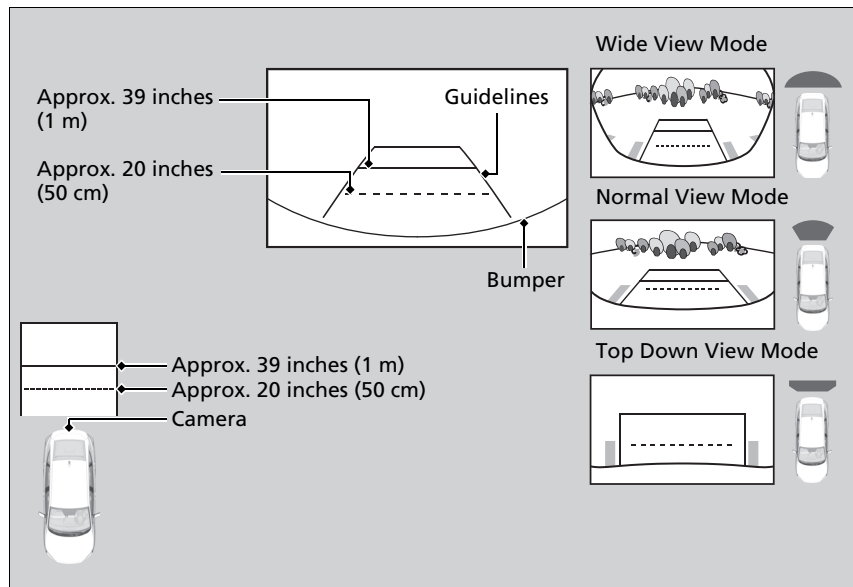

About Your Multi-View Rear Camera

The rear camera view is restricted. You cannot see the corner ends of the bumper or what is underneath the bumper. Its unique lens also makes objects appear closer or farther than they actually are.

Visually confirm that it is safe to drive before backing up. Certain conditions (such as weather, lighting, and high temperatures) may also restrict the rear view. Do not rely on the rearview display which does not give you all information about conditions at the back of your vehicle.

If the camera lens is covered with dirt or moisture, use a soft, moist cloth to keep the lens clean and free of debris.

You can change the **Fixed Guideline** and **Dynamic Guideline** settings.

➤ **Customized Features** P. 296

Fixed Guideline

On: Guidelines appear when you put the transmission into **R**.

Off: Guidelines do not appear.

Dynamic Guideline

On: Guidelines move according to the steering wheel direction.

Off: Guidelines do not move.

You can view three different camera modes on the rearview display. Touch the appropriate icon to switch the mode.

: Wide view mode

: Normal view mode

: Top down view mode

- If the last used viewing mode was Wide or Normal view mode, the same mode is selected the next time you put the transmission into **R**.
- If Top down view mode was last used before you turned off the power system, Wide view mode is selected next time you turn the power on and put the transmission into **R**.
- If Top down view mode was last used more than 10 seconds after you change from **R**, Wide view mode is selected the next time you put the transmission into **R**.

Before Charging

Check the following items before you start charging your vehicle.

Safety Checklist

- The 120 volt charger draws approximately 12 amps. Make sure to use a dedicated and properly grounded circuit that can supply 12 amps continuously.
 - ▶ Have an electrician inspect the outlet you are using to see if it meets these criteria.
- Make sure you plug the charging cable directly into the wall outlet dedicated to vehicle charging.
 - ▶ Do not use extension cords, adaptors, or multi-outlet plugs between the charging cable and the outlet.
- Make sure the charging cable is fully uncoiled before use.
- Make sure the control box, charging connector, and charging cable are free from any damage, including cracks or frays.
 - ▶ If you find any damage to the devices, contact an authorized Honda Clarity Electric dealer.
- Make sure the charging connector and inlet are clean.
 - ▶ If you find any contamination or foreign object in the connector or inlet, contact an authorized Honda Clarity Electric dealer.
- Make sure the charging cable is dry.
 - ▶ Check that there is no water in the immediate area, and that your hands are dry.

Note: Outlet needs to be in good shape. Worn or damaged outlet will not make good contact with the plug. Ensure that the plug is fully inserted and does not come out of the outlet after installation. A loose connection will cause excessive heat build up within the plug and damage it.

Charging

WARNING

Using a 120 volt wall outlet that is rated less than 12 amps or one that is powering other devices can cause a fire, seriously injuring you or others.

When using the 120 volt charger, use a dedicated and properly grounded circuit rated 12 amps or more. Consult an electrician if you are not sure.

Charge the High Voltage battery using a Level 1, 2 or SAE J1772 DC charger

There are three ways to charge the High Voltage battery; by using the Level 1 120 volt (12 amp) charger supplied with the vehicle plugged into a standard three-prong wall outlet, or by using a professionally installed Level 2 240 volt (32 amp) or SAE J1772 DC (125 amp) charger.

Charging with	Suggested charging time
SAE J1772 DC	30 minutes (80% charge)* ¹
AC 240 V (Level 2)	3.5 hours (full charge)* ¹
AC 120 V (Level 1)	19 hours (full charge)* ¹

*¹: Charging time varies depending on conditions, such as the remaining battery level and the ambient temperature.

The suggested full charging time in this table indicates the hours it may likely take for the High Voltage battery to be fully charged from the moment the low charge indicator comes on with the ambient temperature at 77°F (25°C).



Continued

Charging

⚠ WARNING

Improper usage and handling of the 120 volt charger can cause a fire, seriously injuring you or others.

- Always insert the plug fully into a properly rated and grounded the wall outlet.
- Plug the charging cable directly to the wall outlet. Do not use extension cords or multi-plug adapters.
- Prevent the vehicle charging connector from becoming contaminated. Clean if necessary.

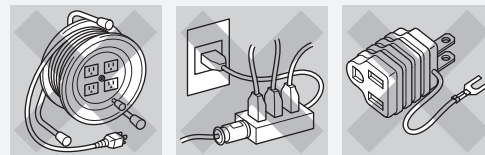

When the battery warming system is activated, the battery may take longer to charge.

When the 12-volt battery is disconnected, vehicle charging is not possible. After reconnecting the battery, turn the power system on, then turn it off. Confirm that charging is possible.

▶ **Turning on the Power** P. 366

■ How to Charge (Level 1)

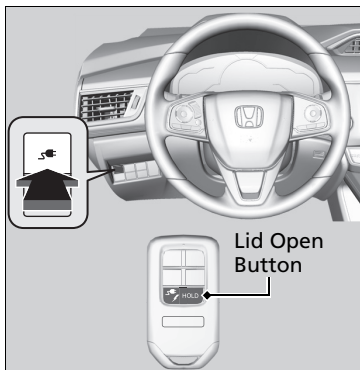

1. Put the transmission into **P** and set the power mode to OFF.
2. Press and hold the lid open button on the remote transmitter, or press and hold the charge lid release button on the dashboard.
 - ▶ The lid opens.
 - ▶ The illumination lamp inside the charge lid comes on for a few minutes.

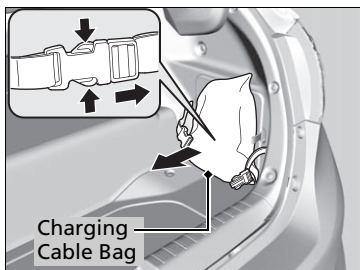

3. Open the trunk, and remove the bag.
4. Open the bag, and take the charging cable out.
 - ▶ Do not tie or coil the cable when in use.

⚡ Charging

⚠ WARNING

Charging the High Voltage battery under the following conditions is a potential source of electric shock and fire, which can result in serious injury or death:

- Charging the battery during an electric storm.
- Using the charging cable near water or handling with wet hands.
- Using a charger, whose case is broken or cracked or whose cable is frayed or damaged.

Never charge the vehicle in any of the above situations.

⚠ WARNING

Using a charger that is damaged or modified can cause electrical shock and fire, which can result in serious injury or death.

Never disassemble or modify the charger. If the charger becomes damaged, stop using it and consult an authorized Honda Clarity Electric dealer.

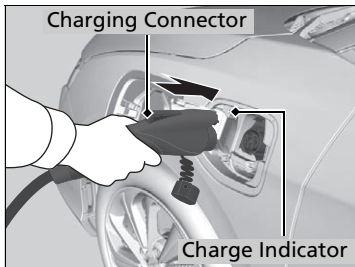
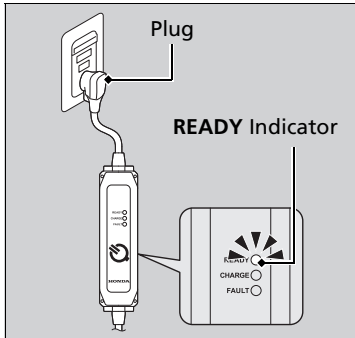
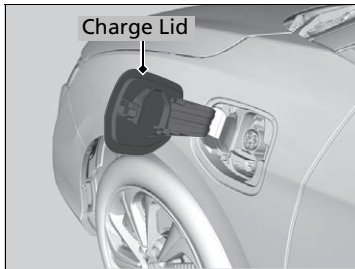

5. Open the vehicle's charge lid.

6. Insert the plug into a 120 volt wall outlet.

▶ Insert the plug completely until it stops.

7. Check that the **READY** indicator on the control box comes on.

8. Remove the cover from the charging connector. Align and insert the charging connector into the vehicle's inlet until you hear a click.

▶ The charge indicator stops blinking, and stays on when charging starts.



⌘ Charging

NOTICE

Do not charge the vehicle with a vehicle cover on. It can cause a malfunction and damage the vehicle or charging components.

The 120 volt charger requires a properly grounded and dedicated circuit that is protected by a 15 amp or greater over-current protection device (circuit breaker). For more information consult an authorized Honda Clarity Electric dealer.

We recommend that a GFCI (ground-fault circuit interrupter) protected outlet be used to charge the vehicle. Follow the GFCI maker's installation instructions, or consult an electrician if you are not sure about installation requirements.

Inspect the charging cable plug and charging connector, as well as the vehicle's charge inlet, before use. If the plug or connector are dirty or otherwise contaminated, carefully clean them with a dry clean cloth before use. Do not wipe the metal part of the inlet and the charging connector. Also, if you are unable to clean the plug or connector, if the inlet is dirty, or if any are damaged or corroded, take the charging cable and vehicle to an authorized Honda Clarity Electric dealer for inspection and possible repair.

Before using a vehicle charging cable, inspect the cable for damage such as scratches, cracks, or tears. If you find any damage, do not use the charging cable; instead, take it to an authorized Honda Clarity Electric dealer for inspection.

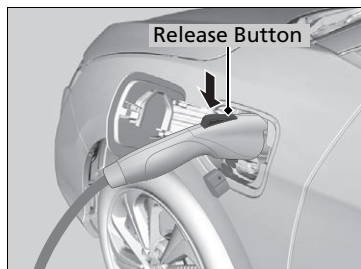

■ When charging is completed

Press the release button on the charging connector to disengage it from the inlet. The charge indicator goes off once charging is completed.

■ How to Charge (Level 2)

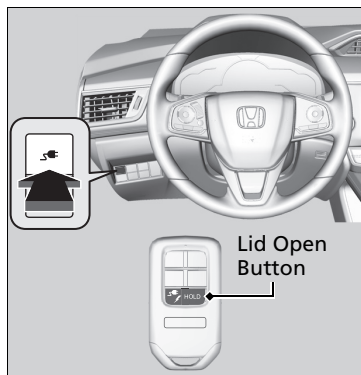

1. Stop your vehicle at a station specific for electric vehicles. Park with the charge lid closest to the charge plug, just in front of the driver's door.
2. Put the transmission into **P**.
3. Turn off the power system.
4. Press and hold the charge lid release button.
 - ▶ The lid opens.
 - ▶ The illumination lamp inside the charge lid comes on for a few minutes.

☒ Charging

If a blackout or other electrical interruption occurs during vehicle charging, the vehicle will automatically resume charging once power is restored.

To avoid damage to the charger, take these precautions:

- Do not hit the charging connector components with a hard object or drop them on the ground.
- Do not pull, twist, tangle, drag or step on the charging cable.
- Do not use or store near any sources of heat.
- Do not expose to liquids or use harsh chemicals to clean.

☒ How to Charge (Level 1)

The charge speed slows down towards the completion of the battery charging.

The High Voltage battery may not be charged even if the charging connector is properly connected to the vehicle's inlet when the charging timer is set but the timer has not yet started.

If you unplug the charging connector from the inlet, charging cancels automatically.

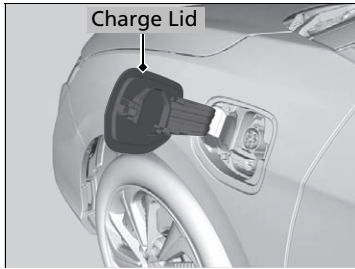

5. Open the charge lid.

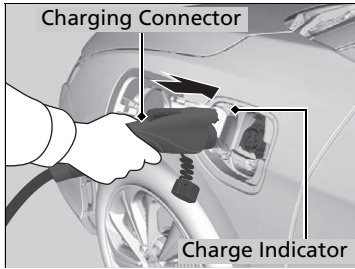

6. To connect the cable to the vehicle, push the cable's charging connector until it clicks to the charge lid.

▶ The charge indicator on the charge lid stays on.

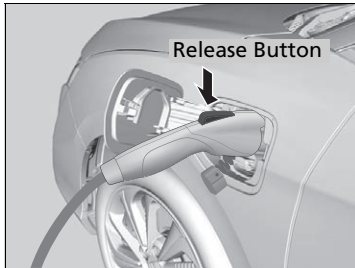

■ When charging is completed

Press the release button on the charging connector to disengage it from the inlet. The charge indicator goes off once charging is completed.

⌘ How to Charge (Level 2)

The charge speed slows down towards the completion of the battery charging.

The charge lid can open by remote transmitter.

The High Voltage battery may not be charged even if the charge connector is properly connected to the vehicle's inlet when the charging timer is set but the timer has not yet started.

Be sure to follow the instructions and safety precautions provided with the Level 2 charging equipment.

While the vehicle is charging or is parked after running, the compressor may operate to melt any frost that has formed on the climate control system. Water from the melted frost drains out through the front section of the vehicle, near the undercover.

If you unplug the charging connector from the inlet, charging cancels automatically.



Continued

■ How to Charge (DC)

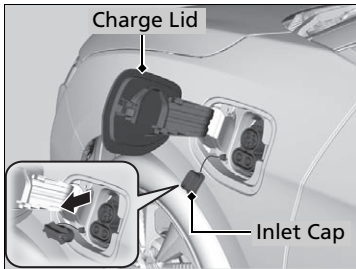
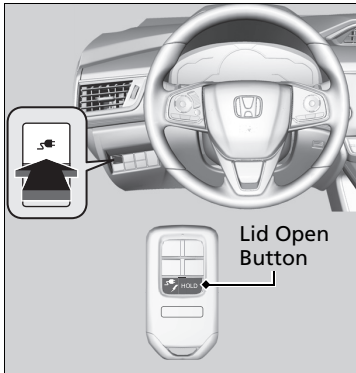

1. Stop your vehicle at a station specific for electric vehicles. Park with the charge lid closest to the charge plug, just in front of the driver's door.
2. Put the transmission into **P**.
3. Turn off the power system.
4. Press and hold the charge lid release button.
 - ▶ The lid opens.
 - ▶ The illumination lamp inside the charge lid comes on for a few minutes.
5. Open the charge lid.
6. Remove the inlet cap.

☒ How to Charge (DC)

The charge speed slows down towards the completion of the battery charging.

The charge lid can open by remote transmitter.

Be sure to follow the instructions and safety precautions provided with the SAE J1772 DC charger equipment.

While the vehicle is charging or is parked after running, the compressor may operate to melt any frost that has formed on the climate control system. Water from the melted frost drains out through the front section of the vehicle, near the undercover.

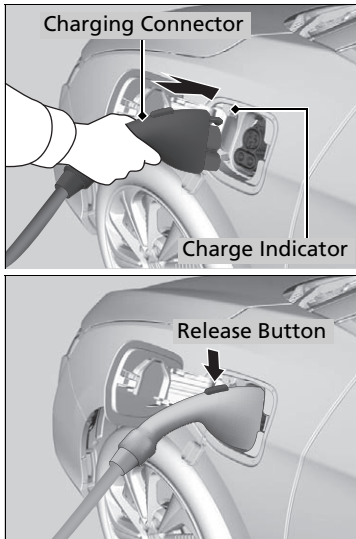

7. To connect the cable to the vehicle, push the cable's charging connector until it clicks to the charge lid.
 - ▶ The charge indicator on the charge lid stays on.

■ When charging is completed

Press the release button on the charging connector to disengage it from the inlet.

- ▶ Make sure to put the cover back on the inlet before you close the lid.

The charge indicator goes off once charging is completed.

⌘ How to Charge (DC)

If the charging connector does not disengage, do not engage it forcefully, and follow the procedures mentioned in the following page.

⌘ When You Cannot Disengage the Charging Connector P. 533

Control Box

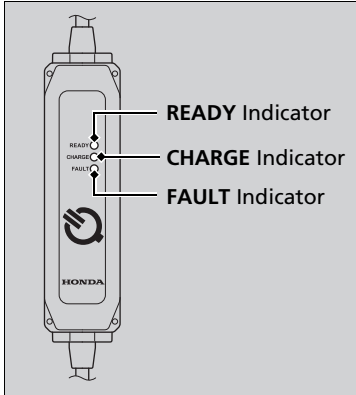

Charging Status	Control Box LED Status Indicator			Charge Indicator	Explanatory notes ● Goes off ○ Stays on ☼ Blinking
	READY	CHARGE	FAULT		
Initializing	○	○	○	●	Initial processing
Stand by	○	●	●	☼ Slowly	Ready and waiting for the timer
Charge	○	○	●	○	Comes on during charge.
Completion	○	●	●	●	Charge end

Timer On	Control Box LED Status Indicator			Charge Indicator	Explanatory notes ● Goes off ○ Stays on ☼ Blinking
	READY	CHARGE	FAULT		
Fault	☼	☼	☼	○	Inappropriately grounded circuit or configured wall outlet may cause the plug to over-heat. The system can continue charging the vehicle with the reduced supply of electricity, but for your safety, unplug the cable and have the vehicle and the control box inspected at an authorized Honda Clarity Electric dealer.
	☼	●	☼	●	Plug over-heated and charge rate was reduced. Contact an authorized Honda Clarity Electric dealer. You don't have to charge before contacting the dealer. Inappropriately grounded circuit or configured wall outlet may cause the plug to over-heat. Do not charge the vehicle until you have the vehicle and the control box inspected at an authorized Honda Clarity Electric dealer.
	☼	●	●		Ground wire in the wall outlet is open. Consult an electrician.
	○	●	☼		Short circuit. Stop using immediately and see an authorized Honda Clarity Electric dealer.
	○	●	○		Comes on if there is a problem with the charging cable. Stop using the cable immediately, and contact an authorized Honda Clarity Electric dealer.
	●	●	●		There could be a problem with the electric supply or an internal failure. First try a known good outlet.



■ What to do when you cannot start charging

If charging does not start, even if the **READY** indicator comes on, and the charging connector is plugged in, perform one of the following solutions.

Cause	Solution
<p>Charging with AC 120 V (Level 1) or AC 240 V (Level 2) The timer has been set, but the start time is in the future.</p>	<p>Start charging using the smart entry remote. Press and hold the charge lid release button on the smart entry remote. ▶ The charge indicator on the charge lid comes on when charging starts.</p> <p>Change the customized setting of the charge timer to OFF using the driver information interface. ▶ The timer setting will be canceled. 🗨 Using a Timer P. 454</p>
The 12-volt battery is weaken.	Check the 12-volt battery condition. If necessary, charge the battery.
The power mode is set to ON.	Set the power mode to ACCESSORY or VEHICLE OFF (LOCK).
The charging connector is not properly attached to the vehicle's inlet.	Disengage the connector from the inlet. Align and insert the connector into the inlet until you hear a click.

Note: The charging equipment provided with this vehicle has been tested and found to comply with the limits for a Class B digital device, pursuant to part 15 of the FCC Rules.

These limits are designed to provide reasonable protection against harmful interference in a residential installation.

This equipment generates, uses and can radiate radio frequency energy and, if not installed and used in accordance with the instructions, may cause harmful interference to radio communications.

However, there is no guarantee that interference will not occur in a particular installation.

If this equipment does cause harmful interference to radio or television reception, which can be determined by turning the equipment off and on, the user is encouraged to try to correct the interference by one or more of the following measures:

- Reorient or relocate the receiving antenna.
- Increase the separation between the equipment and receiver.
- Connect the equipment into an outlet on a circuit different from that to which the receiver is connected.
- Consult the dealer or an experienced radio/TV technician for help.



Continued

■ Charge Indicator on the Vehicle Side

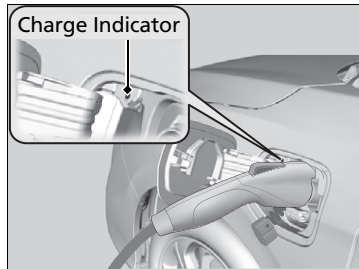

Shows the High Voltage battery charging status.

If it blinks for a while, then stays on after the charging connector is plugged in, it indicates that the battery is being charged.

Indicator status	Explanation
Blinks slowly	<ul style="list-style-type: none"> • The charger is ready to charge the battery. • Charging is programmed to start using the timer. <ul style="list-style-type: none"> ▶ The indicator goes off after about 15 seconds.
Stays on	<ul style="list-style-type: none"> • The battery is being charged. • The climate control system is activated with the remote while the charging cable is plugged in.
Goes off	<ul style="list-style-type: none"> • Charging is complete.
Blinks once after staying on for a few seconds.	<ul style="list-style-type: none"> • The battery has been fully charged and the battery heating system has been activated.
Blinks rapidly	<ul style="list-style-type: none"> • When the 12-volt battery is disconnected. <ul style="list-style-type: none"> ▶ After reconnecting the battery, turn the power system on, then turn it off. The charging connector is replugged in. Confirm that charging is possible. • There is a problem with the charging system. <ul style="list-style-type: none"> ▶ The indicator goes off after 15 seconds. Charging does not start.

High Voltage Battery

The High Voltage battery gradually discharges even if the vehicle is not in use. As a result, if your vehicle is parked for an extended period of time, the battery level may get low. Keeping your vehicle's battery level low can shorten the battery life, negatively affecting the vehicle's range. To maintain the battery while the vehicle is not in use, recharge the battery at least once every three months.

The High Voltage battery life can also be affected by ambient temperature. In particular, when it is cold outside, the vehicle's driving range can be reduced, and a longer battery charging time is required. In addition, parking in extremely hot or cold environments can accelerate battery drain.

To help extend the lifespan of the battery, it is recommended that you fully charge the battery each time prior to driving.

■ Battery Warming System

Designed to prevent the temperature of the battery from dropping when outside temperatures drop, thereby maintaining starting and running efficiency.

If the vehicle is plugged in when outside temperatures are low, the battery warming system will use the power from the charging equipment to maintain the temperature of the battery until the next time the vehicle is driven.

⌘ High Voltage Battery

The High Voltage battery drains over time, and under some conditions, drains faster. When the battery life is shortened, this changes the vehicle's driving distance.

⌘ Battery Warming System

If the vehicle is left unplugged in cold temperatures, the temperature of the battery will drop, possibly resulting in a loss of running efficiency.

If left for an extended period of time in extremely cold temperatures, the vehicle may not start. We recommend that you plug in your vehicle when you are parking or storing your vehicle in cold temperatures.



Using a Timer

You can set the timer for the High Voltage battery charge using the driver information interface's customization feature.

The vehicle automatically begins charging at the scheduled time when the charging connector is connected to the vehicle.

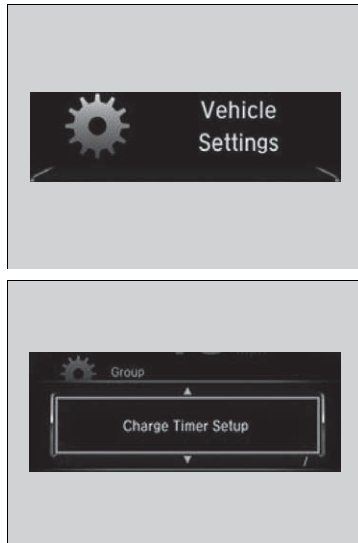
Driver Information Interface



1. Press the  (display/information) button and press  or  until **Vehicle Settings** appears on the display, then press the **ENTER** button.

2. Select **Charge Timer Setup**, then press the **ENTER** button.

Using a Timer

When the battery warming system is activated, it may not sufficiently charge within the charging period that you have set.

Driver Information Interface

Timer: Select **ON** or **OFF**.

Mode: When **Timer** is **ON**, select the charging mode, **Full** or **Time**.



Full: Charging will continue until the battery is fully charged.

Time: The battery will be charged between the time you have designated to start and end.

Start: Set the time when to start the High Voltage battery charge.

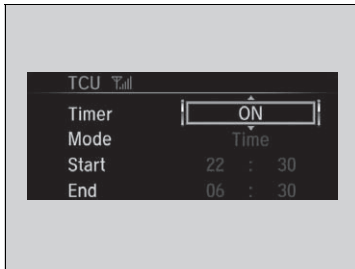
End: Set the time when to end the High Voltage battery charging. You cannot set this when the **Full** mode is selected.



3. Press the **ENTER** button to select the item you want to set.
4. Press the / button to select when to start and end the charging, and the charging mode.
5. Press the **ENTER** button again.

Improving Energy Economy

Achieving energy economy is dependent on several factors, including driving conditions, load weight, driving habits, and vehicle condition.

Depending on these and other factors, you may not achieve the rated energy economy of this vehicle.

Maintenance and Energy Economy

You can optimize your energy economy with proper maintenance of your vehicle. Always maintain your vehicle in accordance with the messages displayed on the driver information interface.

- Maintain the specified tire pressure.
- Do not load the vehicle with excess cargo.
- Keep your vehicle clean. A buildup of snow or mud on your vehicle's underside adds weight and increases wind resistance.

Maintenance

This chapter discusses basic maintenance.



Before Performing Maintenance

Inspection and Maintenance	458
Safety When Performing Maintenance...	459
Parts and Fluids Used in Maintenance	
Service	460

Maintenance Minder™..... 461

Maintenance Under the Hood

Maintenance Items Under the Hood..	465
Opening the Hood	466
Cooling System	467
Transmission Fluid	468
Brake Fluid	468

Refilling Window Washer Fluid.....	469
Replacing Light Bulbs	470
Checking and Maintaining Wiper	
Blades	472
Checking and Maintaining Tires	
Checking Tires	475
Tire and Loading Information Label..	476
Tire Labeling	476
DOT Tire Quality Grading (U.S. Vehicles)..	478
Wear Indicators.....	480
Tire Service Life.....	480
Tire and Wheel Replacement.....	481

Tire Rotation	482
Winter Tires	483
12-Volt Battery	484
Remote Transmitter Care	
Replacing the Button Battery	486
Climate Control System Maintenance ..	487
Cleaning	
Interior Care	488
Exterior Care.....	490
Accessories and Modifications	494



Inspection and Maintenance

For your safety, perform all listed inspections and maintenance to keep your vehicle in good condition. If you become aware of any abnormality (noise, smell, insufficient brake fluid, fluid residue on the ground, etc.), have your vehicle inspected by an authorized Honda Clarity Electric dealer. (Note, however, that service at an authorized Honda Clarity Electric dealer is not mandatory to keep your warranties in effect.)

Types of Inspection and Maintenance

■ Daily inspections

Perform inspections before long distance trips, when washing the vehicle, or when charging.

■ Periodic inspections

- Check the brake fluid level monthly.
 - **Brake Fluid** P. 468
- Check the tire pressure monthly. Examine the tread for wear and foreign objects.
 - **Checking and Maintaining Tires** P. 475
- Check the operation of the exterior lights monthly.
 - **Replacing Light Bulbs** P. 470
- Check the condition of the wiper blades at least every six months.
 - **Checking and Maintaining Wiper Blades** P. 472

▣ Inspection and Maintenance

At this time, maintenance involving the high-voltage system should only be performed at an authorized Honda Clarity Electric dealer.

All maintenance services should be performed in accordance with the intervals indicated by the driver information interface.

➤ **Maintenance Service Items** P. 463

If you want to perform basic maintenance yourself, make sure that you have the necessary tools and skills first.

After performing maintenance, update the records in the separate maintenance booklet.

Safety When Performing Maintenance

Some of the most important safety precautions are given here. However, we cannot warn you of every conceivable hazard that can arise in performing maintenance. Only you can decide whether you should perform a given task.

Maintenance Safety

- To reduce the possibility of fire or explosion, keep cigarettes, sparks, and flames away from the 12-volt battery and all High Voltage system related parts.
- Never leave rags, towels, or other flammable objects under the hood.
 - ▶ Heat from the motor or the surrounding parts can ignite them, causing a fire.
- To clean parts, use a commercially available degreaser or parts cleaner, not gasoline.
- Wear eye protection and protective clothing when working with the 12-volt battery or compressed air.

Vehicle Safety

- The vehicle must be in a stationary condition.
 - ▶ Make sure your vehicle is parked on level ground, the parking brake is set, and the power system is turned off.
- Be aware that hot parts can burn you.
 - ▶ Make sure to let the power system cool thoroughly before touching vehicle parts.
- Be aware that moving parts can injure you.
 - ▶ Do not activate the power system unless instructed to do so. Keep your hands and limbs away from moving parts.



⚠ Safety When Performing Maintenance

⚠ WARNING

Improperly maintaining this vehicle or failing to correct a problem before driving can cause a crash in which you can be seriously hurt or killed.

Always follow the inspection and maintenance recommendations according to the schedules in this owner's manual.

⚠ WARNING

Failure to properly follow maintenance instructions and precautions can cause you to be seriously hurt or killed.

Always follow the procedures and precautions in this owner's manual.



Parts and Fluids Used in Maintenance Service

The use of Honda genuine parts and fluids is recommended when maintaining and servicing your vehicle. Honda genuine parts are manufactured according to the same high quality standards used in Honda vehicles.

If the vehicle has maintenance items due within 30 days, you will see the Maintenance Minder messages appear on the driver information interface every time you set the power mode to ON. The messages notify you when to bring your vehicle to an authorized Honda Clarity Electric dealer for indicated maintenance services.

To Use Maintenance Minder™

■ Displaying the Maintenance Minder Information

1. Set the power mode to ON.
2. Press the  (display/ information) button.
3. Press the  button to select the  icon, and press the **ENTER** button.

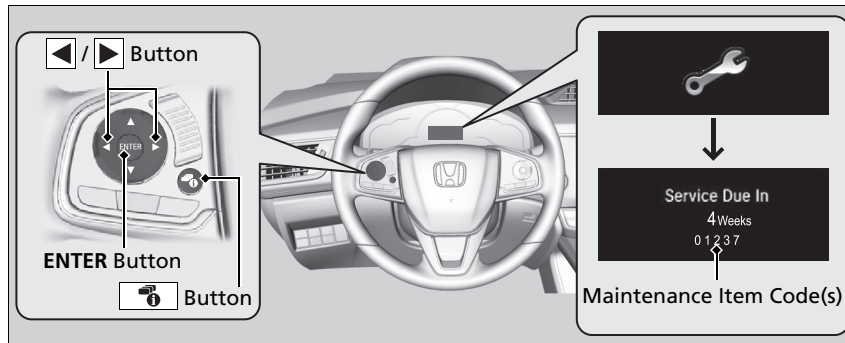

▣ Displaying the Maintenance Minder Information

There is a list of maintenance service items you can view on the driver information interface.

▣ **Maintenance Service Items** P. 463

Warning Message and Maintenance Minder Information on the Driver Information Interface

Warning Message	Maintenance Minder Information	Explanation	Information
<p>Service Due Soon</p>		<p>One or more of the service items are required in less than 30 days. Press the button to switch to another display.</p>	<p>The remaining days will be counted down per day.</p>
<p>Service Due Now</p>		<p>One or more of the service items are required in less than 10 days. Press the button to switch to another display.</p>	<p>Have the indicated service performed as soon as possible.</p>
<p>Service Past Due</p>		<p>The indicated maintenance service is still not done after the remaining time reaches 0. Press the button to switch to another display.</p>	<p>Your vehicle has passed the service required point. Immediately have the service performed and make sure to reset the Maintenance Minder™.</p>

The system message indicator (i) comes on along with the Maintenance Minder message.

Maintenance Service Items



CODE	Maintenance Items
0	<ul style="list-style-type: none"> • Inspect front and rear brakes • Check expiration date for Temporary Tire Repair Kit • Inspect these items: <ul style="list-style-type: none"> • Tie rod ends, steering gear box, and boots • Suspension components • Driveshaft boots • Brake hoses and lines (including ABS/VSA) • All fluid levels and condition of fluids • Stay RR, RR Subframe • Under body battery cover
1	<ul style="list-style-type: none"> • Rotate tires

CODE	Maintenance Items
2	<ul style="list-style-type: none"> • Replace dust and pollen filter*¹
3	<ul style="list-style-type: none"> • Replace transmission fluid*²
7	<ul style="list-style-type: none"> • Replace brake fluid*³

*1: If you drive primarily in urban areas that have high concentrations of soot in the air from industry and from diesel-powered vehicles, replace the dust and pollen filter every 15,000 miles.

*2: Driving in mountainous areas at very low vehicle speeds results in higher transmission temperatures. This requires transmission fluid changes more frequently than recommended by the Maintenance Minder. If you regularly drive your vehicle under these conditions, have the transmission fluid changed every 31,250 miles.





*3: If a Maintenance Minder message does not appear more than 3 years after the display for item 7 is reset, change the brake fluid and replace air cleaner element every 3 years.

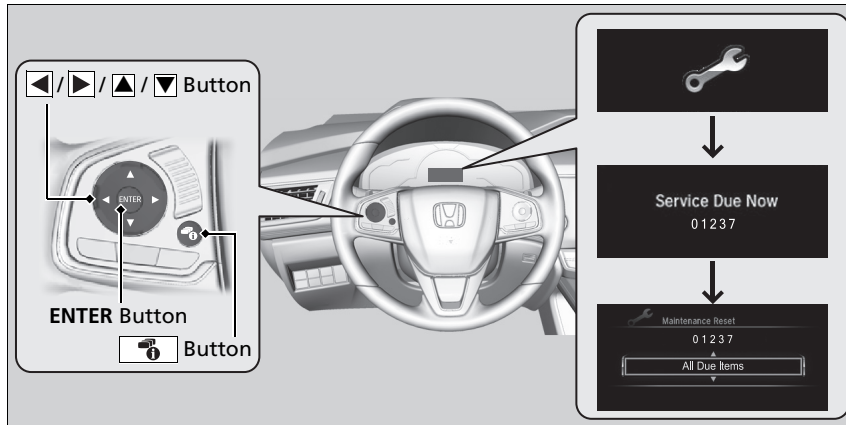

■ Resetting the Display

Reset the maintenance minder information display if you have performed the maintenance service.



1. Set the power mode to ON.
2. Press the  (display/information) button.
3. Press the  button to select the , and press the **ENTER** button.
4. Press and hold the **ENTER** button for about 10 seconds to enter the reset mode.
5. Press  /  to select a maintenance item to reset, or to select **All Due Items** (You can also select **Cancel** to end the process).
6. Press the **ENTER** button to reset the selected item.
7. Repeat from step 4 for other items you wish to reset.

▶▶ Resetting the Display

NOTICE

Failure to reset the Maintenance Minder™ display after a maintenance service results in the system showing incorrect maintenance intervals, which can lead to serious mechanical problems.

The authorized Honda Clarity Electric dealer will reset the Maintenance Minder™ display after completing the required maintenance service. If someone other than an authorized Honda Clarity Electric dealer performs maintenance service, reset the Maintenance Minder™ display yourself.

You can reset the Maintenance Minder™ display using the audio/information screen.

 **Customized Features** P. 296



Maintenance Items Under the Hood

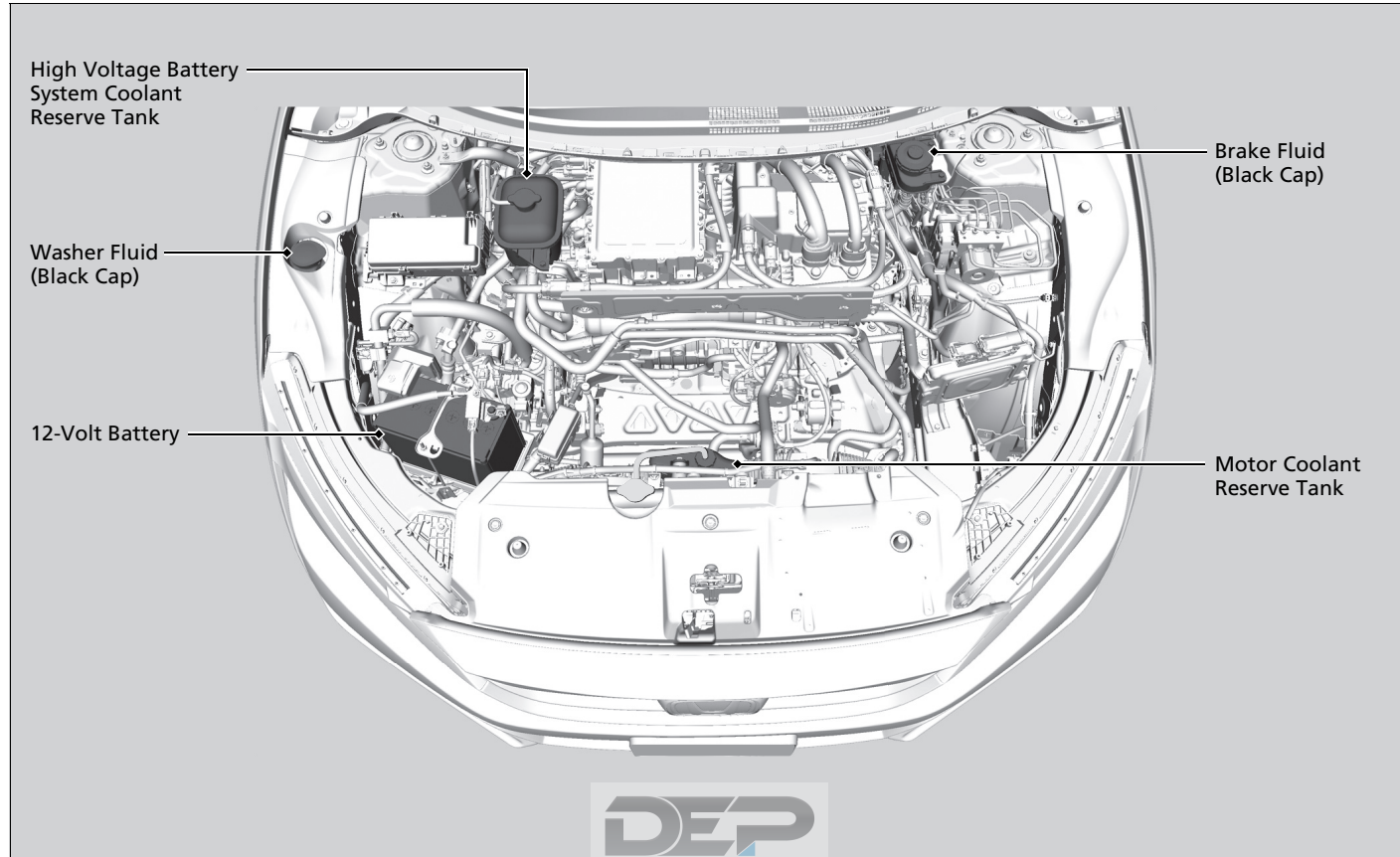

Opening the Hood

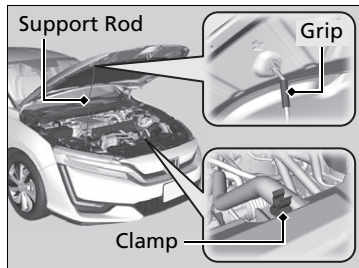
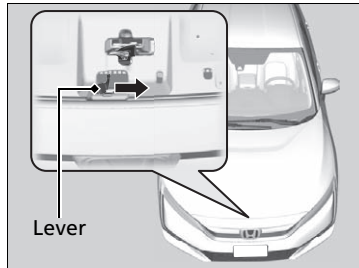
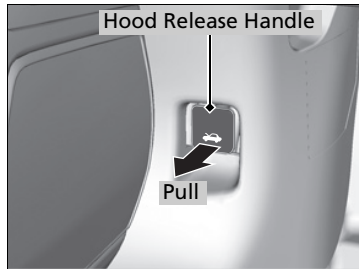

1. Park the vehicle on a level surface, and set the parking brake.
2. Pull the hood release handle under the driver's side lower corner of the dashboard.
► The hood will pop up slightly.
3. Push the hood latch lever (located under the front edge of the hood to the center) to the side and raise the hood. Once you have raised the hood slightly, you can release the lever.
4. Remove the support rod from the clamp using the grip. Mount the support rod in the hood.

When closing, remove the support rod, and stow it in the clamp, then gently lower the hood. Remove your hand at a height of approximately 12 inches (30 cm) and let the hood close.

►► Opening the Hood

NOTICE

Do not open the hood when the wiper arms are raised. The hood will strike the wipers, resulting in possible damage to the hood and/or the wipers.

When closing the hood, check that the hood is securely latched.

If the hood latch lever moves stiffly, or if you can open the hood without lifting the lever, the latch mechanism should be cleaned and lubricated.

The radiator fans and the climate control system will not operate, when the hood is open and any of the following conditions are met.

- The climate control system is turned on with the remote transmitter.
- The compressor operates to melt any frost that has formed on the climate control system.



Cooling System

Specified coolant: Honda Long Life Antifreeze/Coolant Type 2

Coolant is used to reduce the temperature of the high voltage battery, motor and related parts. When checking the coolant level, make sure to follow the procedures listed below. If the coolant level is below the **MIN** mark, have your vehicle inspected by an authorized Honda Clarity Electric dealer.

■ Checking the Coolant Level for the Motor and Related Parts

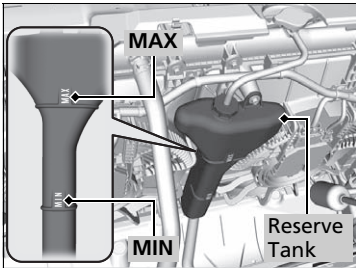

1. Check the fluid level in the tank.
2. If the coolant level has dropped below the **MIN** level, have your vehicle serviced at an authorized Honda Clarity Electric dealer.
 - Only a properly trained technician can refill the coolant and check the system for leaks.

■ Checking the Coolant Level for the High Voltage Battery and Related Parts

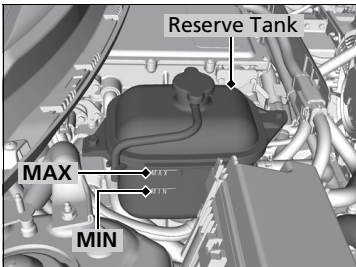

1. Check the fluid level in the tank.
2. If the coolant level has dropped below the **MIN** level, have your vehicle serviced at an authorized Honda Clarity Electric dealer.
 - Only a properly trained technician can refill the coolant and check the system for leaks.



Transmission Fluid

■ Transmission Fluid

Specified fluid: Honda ATF DW-1 (automatic transmission fluid)

Have an authorized Honda Clarity Electric dealer check the fluid level and replace if necessary.

Do not attempt to check or change the transmission fluid yourself.

Brake Fluid

Specified fluid: Honda Heavy Duty Brake Fluid DOT 3

■ Checking the Brake Fluid

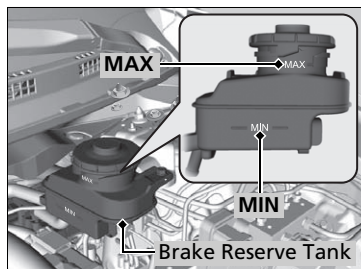

The fluid level should be between the **MIN** and **MAX** marks on the side of the reserve tank.



►► Transmission Fluid

NOTICE

Do not mix Honda ATF DW-1 with other transmission fluids.

Using a transmission fluid other than Honda ATF DW-1 may adversely affect the operation and durability of your vehicle's transmission, and damage the transmission.

Any damage caused by using a transmission fluid that is not equivalent to Honda ATF DW-1 is not covered by Honda's new vehicle limited warranty.

►► Brake Fluid

NOTICE

Brake fluid marked DOT 5 is not compatible with your vehicle's braking system and can cause extensive damage.

If the specified brake fluid is not available, you should use only DOT 3 or DOT 4 fluid from a sealed container as a temporary replacement.

Using any non-Honda brake fluid can cause corrosion and decrease the longevity of the system. Have the brake system flushed and refilled with Honda Heavy Duty Brake Fluid DOT 3 as soon as possible.

If the brake fluid level is at or below the **MIN** mark, have an authorized Honda Clarity Electric dealer inspect the vehicle for leaks or worn brake pads as soon as possible.

Refilling Window Washer Fluid

Check the amount of window washer fluid using the washer fluid level gauge on the cap.

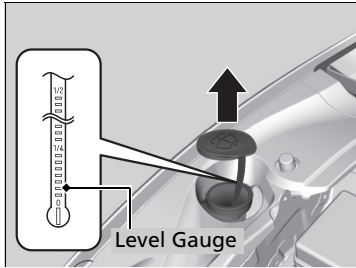

If the level is low, fill the washer reservoir.

Pour the washer fluid carefully. Do not overflow the reservoir.

▣ Refilling Window Washer Fluid

NOTICE

Do not use motor antifreeze or a vinegar/water solution in the windshield washer reservoir. Antifreeze can damage your vehicle's paint. A vinegar/water solution can damage the windshield washer pump. Use only commercially available windshield washer fluid. Avoid prolonged use of hard water to prevent lime scale build up.

Headlights

Headlights are LED type. Have an authorized Honda Clarity Electric dealer inspect and replace the light assembly.

Front Turn Signal and Front Side Marker Lights

Front turn signal and front side marker lights are LED type. Have an authorized Honda Clarity Electric dealer inspect and replace the light assembly.

Parking/Daytime Running Lights

Parking/daytime running lights are LED type. Have an authorized Honda Clarity Electric dealer inspect and replace the light assembly.

Headlights

The headlight aim is set by the factory, and does not need to be adjusted. However, if you regularly carry heavy items in the trunk, have the aiming readjusted at an authorized Honda Clarity Electric dealer or by a qualified technician.

Taillights/Rear Side Marker, Brake and Rear Turn Signal Lights

Taillights/rear side marker, brake and rear turn signal lights are LED type. Have an authorized Honda Clarity Electric dealer inspect and replace the light assembly.

Taillights and Back-Up Lights

Taillights and back-up lights are LED type. Have an authorized Honda Clarity Electric dealer inspect and replace the light assembly.

Rear License Plate Light

Rear license plate light is LED type. Have an authorized Honda Clarity Electric dealer inspect and replace the light assembly.

High-Mount Brake Light

High-mount brake light is LED type. Have an authorized Honda Clarity Electric dealer inspect and replace the light assembly.



Checking Wiper Blades

If the wiper blade rubber has deteriorated, it will leave streaks and the hard surfaces of the blade may scratch the window glass.

Changing the Wiper Blade Rubber

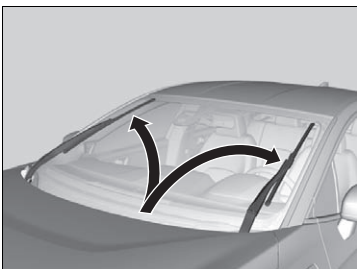

1. Set the power mode to VEHICLE OFF (LOCK).
2. While holding the wiper switch in the **MIST** position, set the power mode to ON, then to VEHICLE OFF (LOCK).
 - ▶ Both wiper arms are set to the maintenance position as shown in the image.

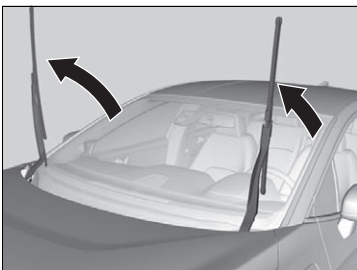

3. Lift both wiper arms.

Changing the Wiper Blade Rubber

NOTICE

Avoid dropping the wiper arm onto the windshield, it may damage the wiper arm and/or the windshield.

When you raise a wiper arm, you may inadvertently alter the position of the arm by applying undue force. If you notice that an arm is not in its proper return position, activate the wipers once and they will automatically reset.

🔧 **Wipers and Washers** P. 160

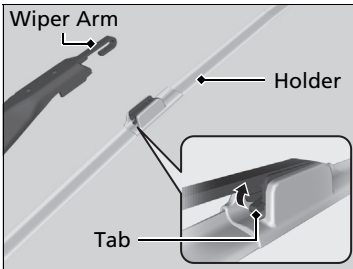

4. Press and hold the tab, then slide the holder off the wiper arm.

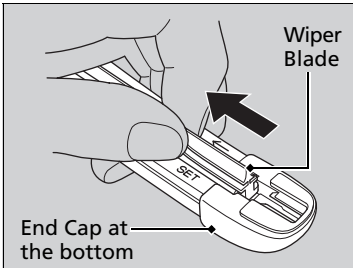

5. Pull the end of the wiper blade in the direction of the arrow in the image until it is out of the holder's end cap.

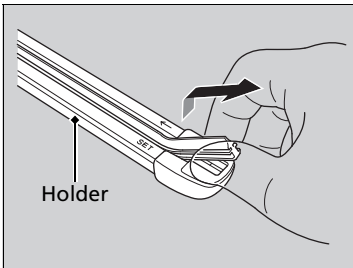

6. Pull the wiper blade in the opposite direction to slide it out of the holder.



Continued

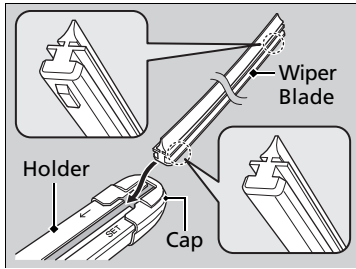

7. Insert the flat side of the new wiper blade onto the bottom part of the holder. Insert the blade all the way.
8. Install the end of the wiper blade into the cap.
9. Slide the holder onto the wiper arm until it locks.
10. Lower both wiper arms.
11. Set the power mode to ON and hold the wiper switch in the **MIST** position until both wiper arms return to the standard position.

Checking Tires

To safely operate your vehicle, your tires must be of the proper type and size, in good condition with adequate tread, and properly inflated.

■ Inflation guidelines

Properly inflated tires provide the best combination of handling, tread life, and comfort. Refer to the driver's doorjamb label or specifications page for the specified pressure.

Underinflated tires wear unevenly, adversely affect handling and energy economy, and are more likely to fail from overheating.

Overinflated tires make your vehicle ride harshly, are more prone to road hazards, and wear unevenly.

Every day before you drive, look at each of the tires. If one looks lower than the others, check the pressure with a tire gauge.

At least once a month or before long trips, use a gauge to measure the pressure in all tires. Even tires in good condition can lose 1–2 psi (10–20 kPa, 0.1–0.2 kgf/cm²) per month.

■ Inspection guidelines

Every time you check inflation, also examine the tires and valve stems.

Look for:

- Bumps or bulges on the side or in the tread. Replace the tire if you find any cuts, splits, or cracks in the side of the tire. Replace it if you see fabric or cord.
- Remove any foreign objects and inspect for air leaks.
- Uneven tread wear. Have an authorized Honda Clarity Electric dealer check the wheel alignment.
- Excessive tread wear.
 - **Wear Indicators** P. 480
- Cracks or other damage around valve stem.



☒ Checking Tires

⚠ WARNING

Using tires that are excessively worn or improperly inflated can cause a crash in which you can be seriously hurt or killed.

Follow all instructions in this owner's manual regarding tire inflation and maintenance.

Measure the air pressure when tires are cold. This means the vehicle has been parked for at least three hours, or driven less than 1 mile (1.6 km). If necessary, add or release air until the specified pressure is reached.

If checked when hot, tire pressure can be as much as 4–6 psi (30–40 kPa, 0.3–0.4 kgf/cm²) higher than if checked when cold.

Whenever tire pressure is adjusted, you must calibrate the TPMS.

➤ **TPMS Calibration** P. 414

Have an authorized Honda Clarity Electric dealer check the tires if you feel a consistent vibration while driving. New tires and any that have been removed and reinstalled should be properly balanced.

Tire and Loading Information Label

The label attached to the driver’s doorjamb provides necessary tire and loading information.

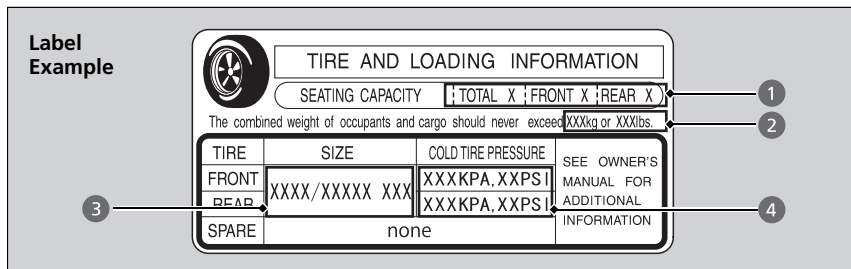

▶▶ Tire and Loading Information Label

The tire and loading information label attached to the driver’s doorjamb contains:

- 1 The number of people your vehicle can carry.
- 2 The total weight your vehicle can carry. Do not exceed this weight.
- 3 The original tire sizes for front, rear, and spare, if equipped.
- 4 The proper cold tire pressure for front, rear, and spare, if equipped.

Tire Labeling

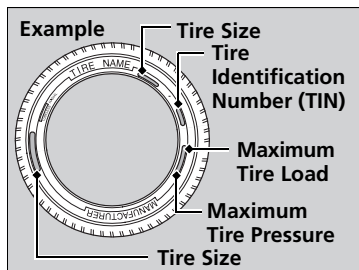

The tires that came on your vehicle have a number of markings. Those you should be aware of are described as shown.

▶▶ Tire Sizes

Following is an example of tire size with an explanation of what each component means.

235/45R18 94V

235: Tire width in millimeters.

45: Aspect ratio (the tire’s section height as a percentage of its width).

R: Tire construction code (R indicates radial).

18: Rim diameter in inches.

94: Load index (a numerical code associated with the maximum load the tire can carry).

V: Speed symbol (an alphabetical code indicating the maximum speed rating).

Tire Sizes

Whenever tires are replaced, they should be replaced with tires of the same size.



■ Tire Identification Number (TIN)

The tire identification number (TIN) is a group of numbers and letters that look like the example in the side column. TIN is located on the sidewall of the tire.

■ Glossary of Tire Terminology

Cold Tire Pressure – The tire air pressure when the vehicle has been parked for at least three hours or driven less than 1 mile (1.6 km).

Load Rating – Means the maximum load that a tire is rated to carry for a given inflation pressure.

Maximum Inflation Pressure – The maximum tire air pressure that the tire can hold.

Maximum Load Rating – Means the load rating for a tire at the maximum permissible inflation pressure for that tire.

Recommended Inflation Pressure – The cold tire inflation pressure recommended by the manufacturer.

Treadwear Indicators (TWI) – Means the projections within the principal grooves designed to give a visual indication of the degrees of wear of the tread.

☒ Tire Identification Number (TIN)

DOT B97R FW6X 2209

DOT: This indicates that the tire meets all requirements of the U.S. Department of Transportation.

B97R: Manufacturer's identification mark.

FW6X: Tire type code.

22 09: Date of manufacture.

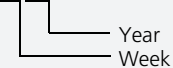

DOT Tire Quality Grading (U.S. Vehicles)

The tires on your vehicle meet all U.S. Federal Safety Requirements. All tires are also graded for treadwear, traction, and temperature performance according to Department of Transportation (DOT) standards. The following explains these gradings.

■ Uniform Tire Quality Grading

Quality grades can be found where applicable on the tire sidewall between tread shoulder and maximum section width.

■ Treadwear

The treadwear grade is a comparative rating based on the wear rate of the tire when tested under controlled conditions on a specified government test course. For example, a tire graded 150 would wear one and one-half (1 1/2) times as well on the government course as a tire graded 100. The relative performance of tires depends upon the actual conditions of their use, however, and may depart significantly from the norm due to variations in driving habits, service practices and differences in road characteristics and climate.

▣ Uniform Tire Quality Grading

For example:
Treadwear 200
Traction AA
Temperature A

All passenger car tires must conform to Federal Safety Requirements in addition to these grades.



■ Traction

The traction grades, from highest to lowest, are AA, A, B, and C. Those grades represent the tire's ability to stop on wet pavement as measured under controlled conditions on specified government test surfaces of asphalt and concrete. A tire marked C may have poor traction performance.

■ Temperature

The temperature grades are A (the highest), B, and C, representing the tire's resistance to the generation of heat and its ability to dissipate heat when tested under controlled conditions on a specified indoor laboratory test wheel. Sustained high temperature can cause the material of the tire to degenerate and reduce tire life, and excessive temperature can lead to sudden tire failure. The grade C corresponds to a level of performance which all passenger car tires must meet under the Federal Motor Vehicle Safety Standard No. 109. Grades B and A represent higher levels of performance on the laboratory test wheel than the minimum required by law.

⌘ Traction

Warning: The traction grade assigned to this tire is based on straight-ahead braking traction tests, and does not include acceleration, cornering, hydroplaning, or peak traction characteristics.

⌘ Temperature

Warning: The temperature grade for this tire is established for a tire that is properly inflated and not overloaded. Excessive speed, underinflation, or excessive loading, either separately or in combination, can cause heat buildup and possible tire failure.

Wear Indicators

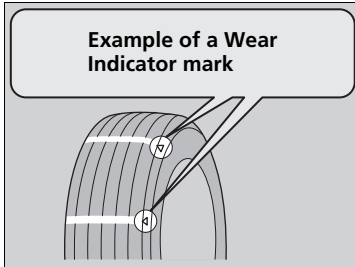

The groove where the wear indicator is located is 1/16 inch (1.6 mm) shallower than elsewhere on the tire. If the tread has worn so that the indicator is exposed, replace the tire.

Worn out tires have poor traction on wet roads.

Tire Service Life

The life of your tires is dependent on many factors, including driving habits, road conditions, vehicle loading, inflation pressure, maintenance history, speed, and environmental conditions (even when the tires are not in use).

In addition to regular inspections and inflation pressure maintenance, it is recommended that you have annual inspections performed once the tires reach five years old. All tires should be removed from service after 10 years from the date of manufacture, regardless of their condition or state of wear.

Tire and Wheel Replacement

Replace your tires with radials of the same size, load range, speed rating, and maximum cold tire pressure rating (as shown on the tire's sidewall). Using tires of a different size or construction can cause certain vehicle systems such as the ABS and Vehicle Stability Assist® (VSA®) system to work incorrectly.

It is best to replace all four tires at the same time. If that isn't possible, replace the front or rear tires in pairs.

Make sure that the wheel's specifications match those of the original wheels.

ⓘ Tire and Wheel Replacement

⚠ WARNING

Installing improper tires on your vehicle can affect handling and stability. This can cause a crash in which you can be seriously hurt or killed.

Always use the size and type of tires recommended in this owner's manual.



Tire Rotation

Rotating tires according to the maintenance messages on the driver information interface helps to distribute wear more evenly and increase tire life.

■ Tires without rotation marks

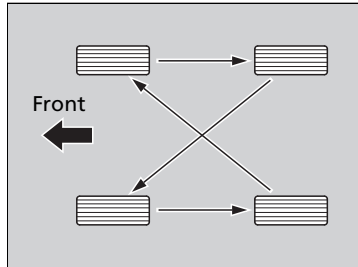

Rotate the tires as shown here.

■ Tires with rotation marks

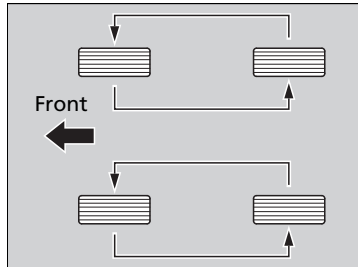

Rotate the tires as shown here.

▶▶ Tire Rotation

Tires with directional tread patterns should only be rotated front to back (not from one side to the other). Directional tires should be mounted with the rotation indication mark facing forward, as shown below.

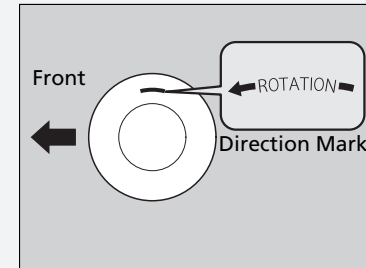

Whenever tires are rotated, you must calibrate the TPMS.

▶▶ **TPMS Calibration** P. 414

Winter Tires

If driving on snowy or frozen roads, mount all season marked **M+S** tires, snow tires, or tire chains; reduce speed; and maintain sufficient distance between vehicles when driving.

Be particularly careful when operating the steering wheel or brakes to prevent skidding.

Use tire chains, snow tires, or all season tires when necessary or according to the law.

When mounting, refer to the following points.

For winter tires:

- Select the size and load ranges that are the same as the original tires.
- Mount the tires to all four wheels.

For tire chains:

- Install them on the front tires only.
- Because your vehicle has limited tire clearance, we strongly recommend using the chains listed below:

Cable-type: SCC Radial Chain SC1040

- Follow the chain manufacturer's instruction when installing. Mount them as tightly as you can.
- Check that the chains do not touch the brake lines or suspension.
- Drive slowly.



❗ Winter Tires

⚠ WARNING

Using the wrong chains, or not properly installing chains, can damage the brake lines and cause a crash in which you can be seriously injured or killed.

Follow all instructions in this owner's manual regarding the selection and use of tire chains.

NOTICE

Traction devices that are the wrong size or improperly installed can damage your vehicle's brake lines, suspension, body, and wheels. Stop driving if they are hitting any part of the vehicle.

When tire chains are mounted, follow the chain manufacturer's instructions regarding vehicle operational limits.

If your vehicle is equipped with summer tires, be aware that these tires are not designed for winter driving conditions. For more information, contact an authorized Honda Clarity Electric dealer.

Checking the 12-Volt Battery

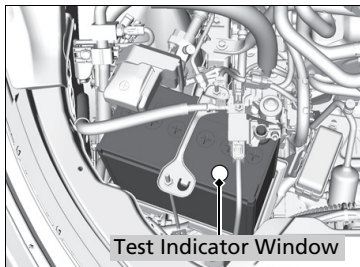

Check the battery condition monthly. Look at the test indicator window and check the terminals for corrosion.

The battery condition is monitored by the sensor on the negative terminal. If there is a problem with the sensor, the warning message on the driver information interface will let you know. Have your vehicle checked by an authorized Honda Clarity Electric dealer.

If your vehicle's battery is disconnected or goes dead:

- The audio system is disabled.
 - **Reactivating the audio system** P. 198
- The clock resets.
 - **Clock** P. 130
- The vehicle cannot be charged. After reconnecting the battery, turn the power system on, then turn it off. Confirm that charging is possible.
 - **Turning on the Power** P. 366
 - **Charging** P. 440

12-Volt Battery

⚠ WARNING

The battery gives off explosive hydrogen gas during normal operation.

A spark or flame can cause the battery to explode with enough force to kill or seriously hurt you.

When conducting any battery maintenance, wear protective clothing and a face shield, or have a skilled technician do it.

WARNING: Battery post, terminals, and related accessories contain lead and lead compounds.

Wash your hands after handling.

The test indicator's color information is on the battery.

When you find corrosion, clean the battery terminals by applying a baking powder and water solution. Clean the terminals with a damp towel. Cloth/towel dry the battery. Coat the terminals with grease to help prevent future corrosion.

Charging the 12-Volt Battery

Disconnect both battery cables to prevent damaging your vehicle's electrical system. Always disconnect the negative (-) cable first, and reconnect it last.

12-Volt Battery

When replacing the battery, the replacement must be of the same specifications. Consult an authorized Honda Clarity Electric dealer for more information.

The indicators for the Vehicle Stability Assist® (VSA®) system, VSA® OFF, Collision Mitigation Braking System™ (CMBS™), and low tire pressure/Tire Pressure Monitoring System (TPMS) may come on along with a message in the driver information interface when you turn the power system on after reconnecting the battery.

Drive a short distance at 12 mph (20 km/h). The indicator should go off. If it does not, have your vehicle checked by an authorized Honda Clarity Electric dealer.



Replacing the Button Battery

If the indicator does not come on when the button is pressed, replace the battery.



Battery type: CR2032

1. Remove the built-in key.
2. Remove the upper half of the cover by carefully prying on the edge with a coin.
 - ▶ Remove carefully to avoid losing the buttons.
 - ▶ Wrap a coin with a cloth to prevent scratching the smart entry remote.
3. Make sure to replace the battery with the correct polarity.

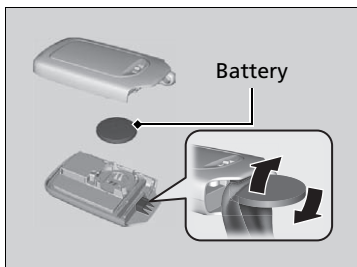

Replacing the Button Battery

WARNING

CHEMICAL BURN HAZARD

The battery that powers the remote transmitter can cause severe internal burns and can even lead to death if swallowed. Keep new and used batteries away from children.

If you suspect that a child has swallowed the battery, seek medical attention immediately.

NOTICE

An improperly disposed of battery can damage the environment. Always confirm local regulations for battery disposal.

Replacement batteries are commercially available or at an authorized Honda Clarity Electric dealer.

Air Conditioning

To ensure proper and safe operation, the Society of Automotive Engineers (SAE J2845) recommends that the refrigerant system only be serviced by trained and certified technicians.

Never repair or replace the air conditioning evaporator (cooling coil) with one removed from a used or salvaged vehicle.

New replacement mobile air conditioning evaporators must be certified (and labeled) as meeting SAE Standard J2842.

Dust and Pollen Filter

The climate control system is equipped with a dust and pollen filter that collects pollen, dust, and other debris in the air. The Maintenance Minder™ messages will let you know when to replace the filter.

We recommend that you replace the dust and pollen filter sooner when using your vehicle in areas with high concentrations of dust.



Climate Control System Maintenance

NOTICE

Vented refrigerant is harmful to the environment. To avoid refrigerant from venting, never replace the evaporator with one removed from a used or salvaged vehicle.

Refrigerant in your vehicle's air conditioning system is flammable and can be ignited during servicing if proper procedures are not followed.

The air conditioner label is found under the hood:

➤ **Safety Labels** P. 80

➤ **Specifications** P. 536

Dust and Pollen Filter

If the airflow from the climate control system deteriorates noticeably, and the windows fog up easily, the filter may need to be replaced. Please contact an authorized Honda Clarity Electric dealer for replacement.

Interior Care

Use a damp cloth with a mixture of mild detergent and warm water to remove dirt. Use a clean cloth to remove detergent residue.

Cleaning Seat Belts

Use a soft brush with a mixture of mild soap and warm water to clean the seat belts. Let the belts air dry. Wipe the openings of the seat belt anchors using a clean cloth.

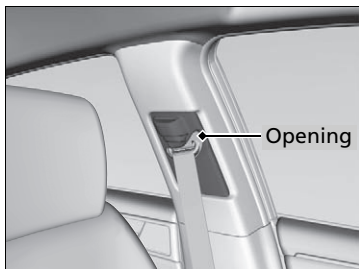

Interior Care

Do not spill liquids inside the vehicle. Electrical devices and systems may malfunction if liquids are splashed on them.

Do not use silicone based sprays on electrical devices such as audio devices and switches. Doing so may cause the items to malfunction or cause a fire inside the vehicle.

If a silicone based spray is inadvertently used on electrical devices, consult an authorized Honda Clarity Electric dealer.

Depending on their composition, chemicals and liquid aromatics may cause discoloration, wrinkles, and cracking to resin-based parts and textiles. Do not use alkali solvents or organic solvents such as benzene or gasoline.

After using chemicals, make sure to gently wipe them away using a dry cloth.

Do not place used cloths on top of resin based parts or textiles for long periods of time without washing.

■ Cleaning the Window

Wipe using a glass cleaner.

■ Floor Mats

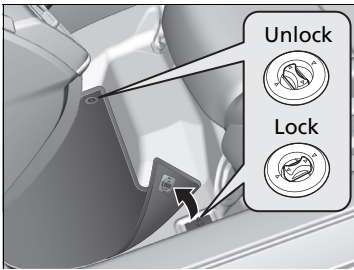

The front and rear floor mats hook over floor anchors, which keep them from sliding forward. To remove a mat for cleaning, turn the anchor knobs to the unlock position. When reinstalling the mat after cleaning, turn the knobs to the lock position.

Do not put additional floor mats on top of the anchored mats.

■ Control Box

When the control box gets dirty, wipe the dirt with a soft cloth.

■ Maintaining Genuine Leather

To properly clean leather:

1. Use a vacuum or soft dry cloth first to remove any dirt or dust.
2. Clean the leather with a soft cloth dampened with a solution comprised of 90% water and 10% neutral soap.
3. Wipe away any soap residue with a clean damp cloth.
4. Wipe away residual water and allow leather to air dry in the shade.



⊗ Cleaning the Window

Wires are mounted to the inside of the rear window. Wipe along the same direction as the wires with a soft cloth so as not to damage them.

Be careful not to spill fluids, such as water or glass cleaner, on or around the cover of both the front sensor camera and the light sensor.

➤ **Automatic Operation (automatic lighting control)** P. 157

➤ **Front Sensor Camera** P. 383

⊗ Floor Mats

If you use any floor mats that were not originally provided with your vehicle, make sure they are designed for your specific vehicle, fit correctly, and are securely anchored by the floor anchors. Position the rear seat floor mats properly. If they are not properly positioned, the floor mats can interfere with the front seat functions.

⊗ Maintaining Genuine Leather

It is important to clean or wipe away dirt or dust as soon as possible. Spills can soak into leather resulting in stains. Dirt or dust can cause abrasions in the leather. In addition, please note that some dark colored clothing can rub onto the leather seats resulting in discoloration or stains.

Exterior Care

Dust off the vehicle body after you drive. Regularly inspect your vehicle for scratches on painted surfaces. A scratch on a painted surface can result in body rust. If you find a scratch, promptly repair it.

■ Washing the Vehicle

Wash the vehicle regularly. Wash more frequently when driving in the following conditions:

- If driving on roads with road salt.
- If driving in coastal areas.
- If tar, soot, bird droppings, insects, or tree sap are stuck to painted surfaces.

■ Using an Automated Car Wash

- Make sure to follow the instructions indicated on the automated car wash.
- Fold in the door mirrors.

► Washing the Vehicle

Do not spray water into the air intake vents. It can cause a malfunction.

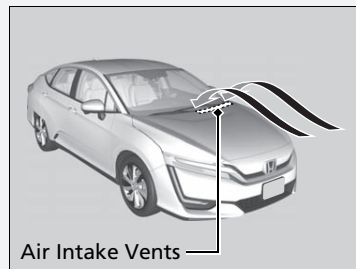

If you need to lift the wiper arms away from the windshield, first set the wiper arms to the maintenance position.

► **Changing the Wiper Blade Rubber** P. 472

► Using an Automated Car Wash

When using an automated car wash that pulls the vehicle through with a conveyor, make sure vehicle is in car wash mode.

► **If you want to keep the transmission in N position [car wash mode]** P. 375

■ Using High Pressure Cleaners

- Keep sufficient distance between the cleaning nozzle and the vehicle body.
- Take particular care around the windows. Standing too close may cause water to enter the vehicle interior.
- Do not spray high pressure water directly into the motor compartment. Instead, use low pressure water.
- Do not spray water under the hood where the electric motor and other high voltage system components are located. It could cause a malfunction.
- Do not spray water directly at the charging port.

■ Applying Wax

A good coat of automotive body wax helps protect your vehicle's paint from the elements. Wax will wear off over time and expose your vehicle's paint to the elements, so reapply as necessary.

■ Maintaining the Bumpers and Other Resin Coated Parts

If you get coolant or battery fluid on resin coated parts, they may be stained or the coating may peel. Promptly wipe it away using a soft cloth and clean water.

■ Cleaning the Window

Wipe using a glass cleaner.

▶▶ Applying Wax

NOTICE

Chemical solvents and strong cleaners can damage the paint, metal, and plastic on your vehicle. Wipe away spills immediately.

▶▶ Maintaining the Bumpers and Other Resin Coated Parts

Ask an authorized Honda Clarity Electric dealer about the correct coating material when you want to repair the painted surface of the parts made of resin.

▶▶ Cleaning the Window

When you raise a wiper arm, you may inadvertently alter the position of the arm by applying undue force. If you notice that an arm is not in its proper return position, active the wipers once and they will automatically reset.

▶▶ Wipers and Washers P. 160



Continued

■ Maintaining Aluminum Wheels

Aluminum is susceptible to deterioration caused by salt and other road contaminants. When necessary, as early as possible use a sponge and mild detergent to wipe away these contaminants. Do not use a stiff brush or harsh chemicals (including some commercial wheel cleaners). These can damage the protective finish on aluminum alloy wheels, resulting in corrosion. Depending on the type of finish, the wheels also may lose their luster or appear burnished. To avoid water stains, wipe the wheels dry with a cloth while they are still wet.

■ Fogged Exterior Light Lenses

The inside lenses of exterior lights (headlights, brake lights, etc.) may fog temporarily if you have driven in the rain, or after the vehicle has been run through a car wash. Dew condensation also may build up inside the lenses when there is a significant enough difference between the ambient and inside lens temperatures (similar to vehicle windows fogging up in rainy conditions). These conditions are natural processes, not structural design problems in the exterior lights. Lens design characteristics may result in moisture developing on the light lens frame surfaces. This also is not a malfunction.

However, if you see large amounts of water accumulation, or large water drops building up inside the lenses, have your vehicle inspected by an authorized Honda Clarity Electric dealer.

■ Painting the Vehicle

Refer to the temperature notice label affixed to the driver's doorjamb before painting the vehicle.

▶▶ Painting the Vehicle

NOTICE

High temperature may damage the high-voltage battery used to power the electric motor. When drying paint in a heated paint booth, make sure the temperature does not exceed 150°F(65°C).



Accessories

When installing accessories, check the following:

- Do not install accessories on the windshield. They can obstruct your view and delay your reaction to driving conditions. In addition, they may become projectiles in a crash.
- Do not install any accessories over areas marked SRS Airbag, on the sides or backs of the front seats, on front or side pillars, or near the side windows. Accessories installed in these areas may interfere with proper operation of the vehicle's airbags or may be propelled into you or another occupant if the airbags deploy.
- Be sure electronic accessories do not overload electrical circuits or interfere with proper operation of your vehicle.
 - **Fuses** P. 524
- Before installing any electronic accessory, have the installer contact an authorized Honda Clarity Electric dealer for assistance. If possible, have an authorized Honda Clarity Electric dealer inspect the final installation.

Accessories and Modifications

⚠ WARNING

Improper accessories or modifications can affect your vehicle's handling, stability, and performance, and cause a crash in which you can be seriously hurt or killed.

Follow all instructions in this owner's manual regarding accessories and modifications.

⚠ WARNING

Use of improperly designed, engineered or manufactured high-voltage battery assemblies could cause a fire in your vehicle.

A vehicle fire could result in a crash or injury.

Only use a genuine Honda high-voltage battery assembly, or its equivalent, in your vehicle.

Honda Genuine accessories are recommended to ensure proper operation on your vehicle.



Modifications

Do not modify your vehicle in a manner that may affect its handling, stability, or reliability, or install non-genuine Honda parts or accessories that may have a similar effect.

Even minor modifications to vehicle systems can affect overall vehicle performance. Always make sure all equipment is properly installed and maintained, and do not make any modification to your vehicle or its systems that might cause your vehicle to no longer meet federal, state, province, territory, and local regulations.

The on-board diagnostic port (OBD-II/SAE J1962 connector) installed on this vehicle is intended to be used with automobile system diagnostic devices or with other devices that Honda has approved. Use of any other type of device may adversely affect the vehicle's electronic systems or allow them to be compromised, possibly resulting in a system malfunction, drained battery, or other unexpected problems.

Do not modify or attempt to repair your vehicle's high-voltage power system or otherwise modify vehicle electrical systems. Disassembling or modifying electrical equipment can result in a crash or a fire.

If you ever need to replace your vehicle's high-voltage battery assembly outside of warranty coverage, we highly recommend that you only use a genuine Honda high-voltage battery assembly. Genuine Honda high-voltage battery assemblies are designed to work with your vehicle's power system and have been designed, engineered and manufactured to avoid overcharging situations. Non-genuine high-voltage battery assemblies may not have been similarly designed, engineered and manufactured, and installation of such assemblies could result in overcharging, fires, loss of power, or other conditions that may increase the likelihood of a crash or injury.





Handling the Unexpected

This chapter explains how to handle unexpected troubles.

If a Tire Goes Flat	
Temporarily Repairing a Flat Tire.....	498
Handling of the Jack	510
Power System Won't Start	
Checking the Procedure.....	511
If the Smart Entry Remote Battery is Weak.....	512
Emergency Power System Off.....	513
Jump Starting	514
Overheating	
How to Handle Overheating.....	517

Indicator, Coming On/Blinking	
If the 12-Volt Battery Charging System Indicator Comes On.....	518
If the Brake System Indicator (Red) Comes On or Blinks.....	519
If the Electric Power Steering (EPS) System Indicator Comes On.....	520
If the Brake System Indicator (Red) Comes On or Blinks at the Same Time When the Brake System Indicator (Amber) Comes On.....	521
If the Low Tire Pressure/TPMS Indicator Comes On or Blinks.....	522

If the Transmission System Indicator Blinks along with the Warning Message....	523
Fuses	
Fuse Locations.....	524
Inspecting and Changing Fuses.....	530
Emergency Towing	531
When You Cannot Open the Charge Lid	532
When You Cannot Disengage the Charging Connector	533
When You Cannot Open the Trunk ..	534

DEALER ePROCESS

Temporarily Repairing a Flat Tire

If the tire has a large cut or is otherwise severely damaged, you will need to have the vehicle towed. If the tire only has a small puncture, from a nail for instance, you can use the temporary tire repair kit so that you can drive to the nearest service station for a more permanent repair.

If a tire goes flat while driving, grasp the steering wheel firmly, and brake gradually to reduce speed. Then stop in a safe place.

1. Park the vehicle on a firm, level, and non-slippery surface and apply the parking brake.
2. Change the gear position to **P**.
3. Turn on the hazard warning lights and set the power mode to VEHICLE OFF (LOCK).

Temporarily Repairing a Flat Tire

The kit should not be used in the following situations. Instead, contact an authorized Honda Clarity Electric dealer or a roadside assistance to have the vehicle towed.

- The tire sealant has expired.
- More than one tire is punctured.
- The puncture or cut is larger than 3/16 inch (4 mm).
- The tire side wall is damaged or the puncture is outside the contact area.

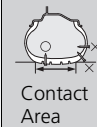

When the puncture is:	Kit Use
Smaller than 3/16 inch (4 mm)	Yes
Larger than 3/16 inch (4 mm)	No

- Damage has been caused by driving with the tires extremely under inflated.
- The tire bead is no longer seated.
- The rim is damaged.

Do not remove a nail or screw that punctured the tire. If you remove it from the tire, you may not be able to repair the puncture using the kit.

Getting Ready to Temporarily Repair the Flat Tire

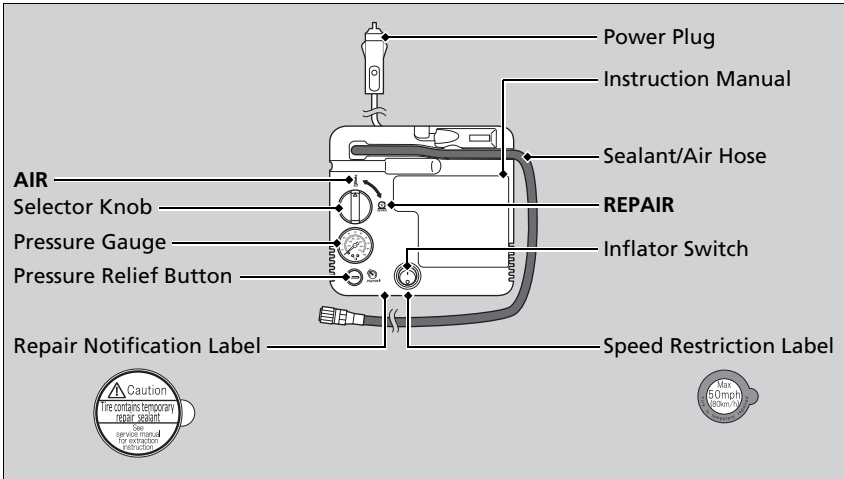

Getting Ready to Temporarily Repair the Flat Tire

Repair notification label and speed restriction label are applied to the side of temporary tire repair kit.

When making a temporary repair, carefully read the instruction manual provided with the kit.

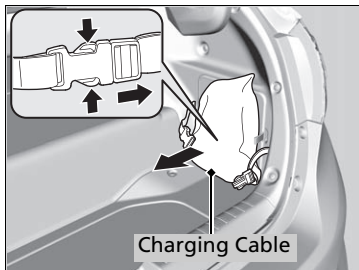

1. Remove the charging cable by releasing the belt.

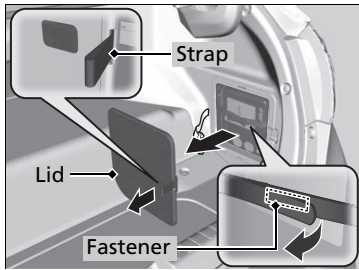

2. Pull the strap on the right side of the trunk and open the lid.
3. Open the fastener and take the kit out of the trunk.
4. Place the kit face up, on flat ground near the flat tire, and away from traffic. Do not place the kit on its side.

Injecting Sealant and Air

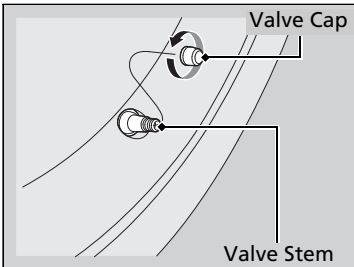

1. Remove the valve cap from the tire valve stem.

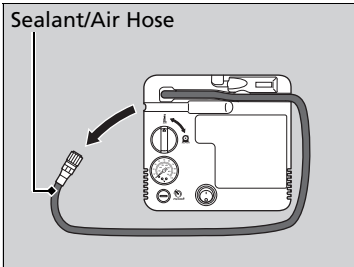

2. Remove the sealant/air hose from the packaging.

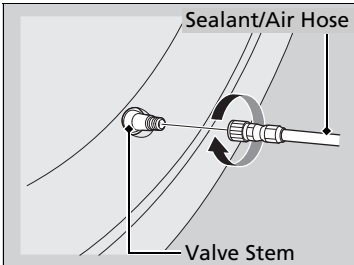

3. Attach the sealant/air hose onto the tire valve stem. Screw it until it is tight.

Injecting Sealant and Air

⚠ WARNING

Tire sealant contains substances that are harmful and can be fatal if swallowed.

If accidentally swallowed, do not induce vomiting. Drink plenty of water and get medical attention immediately.

For skin or eye contact, flush with cool water and get medical attention if necessary.

In cold temperatures, the sealant may not flow easily. In this situation, warm it up for five minutes before using.

The sealant can permanently stain clothing and other materials. Be careful during handling and wipe away any spills immediately.



Continued

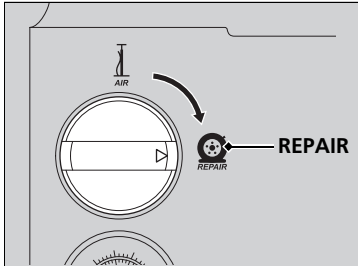
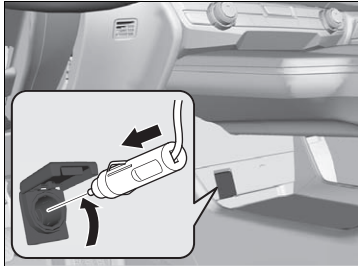

4. Plug in the compressor to the accessory power socket.
 - ▶ Be careful not to pinch the cord in a door or window.
 - ▶ Do not plug any other electric devices into other accessory power sockets.
 - **Accessory Power Sockets** P. 182
5. Turn the power system on.
 - ▶ Keep the power system on while injecting sealant and air.
6. Turn the selector knob to **REPAIR**.

▶▶ Injecting Sealant and Air

NOTICE

Do not operate the temporary tire repair kit compressor for more than 15 minutes. The compressor can overheat and become permanently damaged.

There are two accessory power sockets:

- In the back of the console compartment
- In the console panel

➤ **Accessory Power Sockets** P. 182

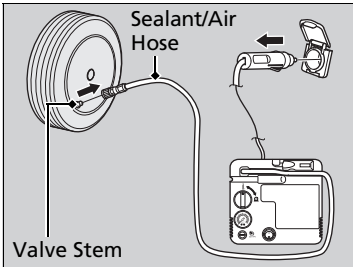
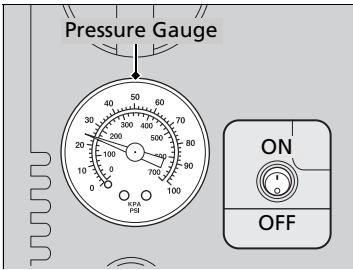

7. Press the inflator switch to turn on the compressor.
 - ▶ The compressor starts injecting sealant and air into the tire.
 - ▶ When the sealant injection is complete, continue to add air.
8. After the air pressure reaches front: 36 psi (250 kPa)/rear: 38 psi (260 kPa), turn off the kit.
 - ▶ To check the pressure, occasionally turn off the compressor, and read the gauge.
9. Unplug the power plug from the accessory power socket.
10. Unscrew the sealant/air hose from the tire valve stem. Reinstall the valve cap.
11. Press the pressure relief button until the gauge returns 0 psi (0 kPa).

✘ Injecting Sealant and Air

Until the sealant injection is complete, the pressure shown on the pressure gauge will appear higher than actual. After the sealant injection is complete the pressure will drop and then begin to rise again as the tire is inflated with air. This is normal. To accurately measure the air pressure using the gauge, turn the air compressor off only after the sealant injection is complete.

If the required air pressure is not reached within 10 minutes, the tire may be too severely damaged for the kit to provide the necessary seal, and your vehicle will need to be towed.

See an authorized Honda Clarity Electric dealer for a replacement sealant bottle and proper disposal of an empty bottle.



Continued

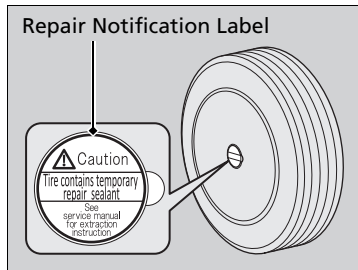

12. Apply the repair notification label to the flat surface of the wheel.
 - The wheel surface must be clean to ensure the label adheres properly.

■ Distributing the Sealant in the Tire

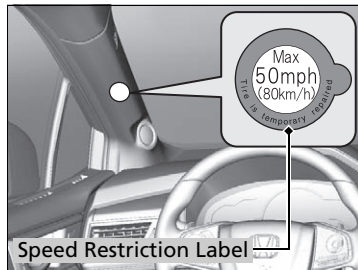

1. Apply the speed restriction label to the location as shown.
2. Drive the vehicle for about 10 minutes.
 - Do not exceed 50 mph (80 km/h).
3. Stop the vehicle in a safe place.

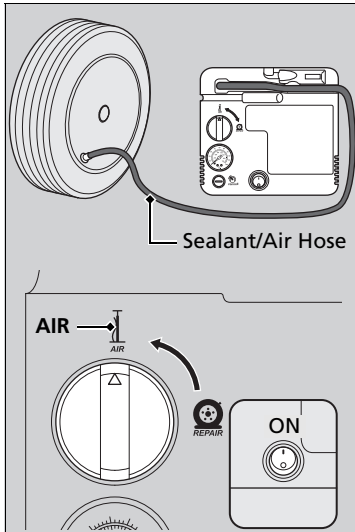

4. Recheck the air pressure using the sealant/air hose on the compressor.

5. Turn the selector knob to **AIR**.

▶ Do not turn the air compressor on to check the pressure.

➤ **Inflating an Under-inflated Tire** P. 507

6. If the air pressure is

- Less than 25 psi (175 kPa):

Do not add air or continue driving. The leak is too severe. Call for help and have your vehicle towed.

➤ **Emergency Towing** P. 531

- Front: 36 psi (250 kPa)/rear: 38 psi (260 kPa) or more:

Continue driving for another 10 minutes or until you reach the nearest service station, whichever is sooner. Do not exceed 50 mph (80 km/h). If you have not reached a service station after 10 minutes, stop in a safe place and check the tire pressure.

▶ If the air pressure does not go down after the 10 minute driving, you do not need to check the pressure any more.



Continued

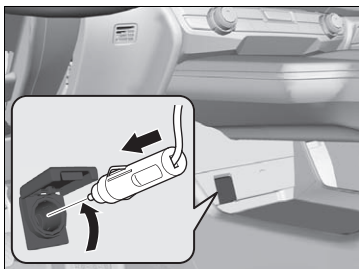

- Greater than 25 psi (175 kPa), but less than front: 36 psi (250 kPa)/rear: 38 psi (260 kPa):

Turn the air compressor on to inflate the tire until the tire pressure reaches front: 36 psi (250 kPa)/rear: 38 psi (260 kPa).

► **Inflating an Under-inflated Tire** P. 507

Then drive carefully for 10 more minutes or until you reach the nearest service station, whichever is sooner. Do not exceed 50 mph (80 km/h). If you have not reached a service station after 10 minutes, stop in a safe place and check the tire pressure.

► You should repeat this procedure as long as the air pressure is within this range.

7. Unscrew the sealant/air hose from the tire valve stem. Reinstall the valve cap.
8. Press the pressure relief button until the gauge returns 0 psi (0 kPa).
9. Repackage and properly stow the kit.

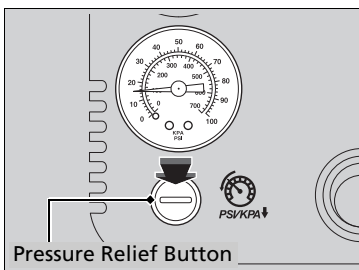

■ Inflating an Under-inflated Tire

You can use the kit to inflate a non-punctured under-inflated tire.

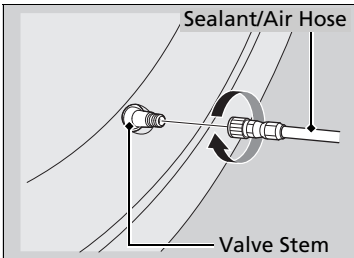
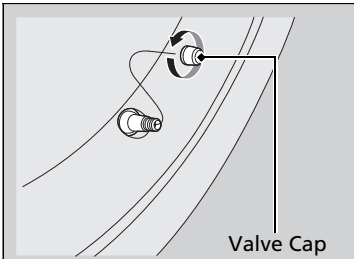
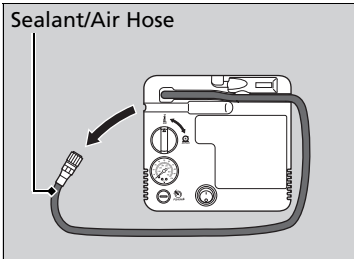

1. Open the trunk floor lid.
 - **Getting Ready to Temporarily Repair the Flat Tire** P. 499
2. Remove the kit from the case.
3. Place the kit, face up, on flat ground near the flat tire, away from traffic. Do not place the kit on its side.
4. Remove the Sealant/Air hose from the kit.
5. Remove the valve cap.
6. Attach the Sealant/Air hose onto the tire valve stem. Screw it until it is tight.

▣ Inflating an Under-inflated Tire

NOTICE

Do not operate the temporary tire repair kit compressor for more than 15 minutes. The compressor can overheat and become permanently damaged.



Continued

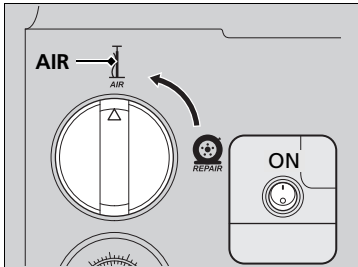
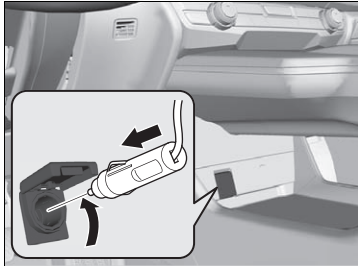

7. Plug in the kit to the accessory power socket.
 - ▶ Be careful not to pinch the cord in a door or window.
 - ▶ Do not plug any other electronic devices into other accessory power sockets.
 - ▶ **Accessory Power Sockets** P. 182
8. Turn the power system on.
 - ▶ Keep the power system on while injecting air.
9. Turn the selector knob to **AIR**.
10. Press the inflator switch to turn on the kit.
 - ▶ The compressor starts to inject air into the tire.
11. Inflate the tire to the specified air pressure.

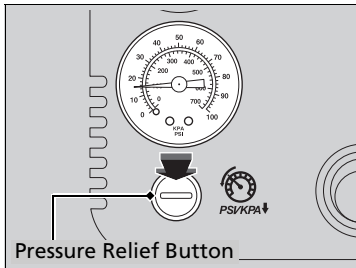

12. Turn off the kit.
 - Check the pressure gauge on the air compressor.
 - If overinflated, press the pressure relief button.
13. Unplug the kit from the accessory power socket.
14. Unscrew the Sealant/Air hose from the tire valve stem. Reinstall the valve cap.
15. Press the pressure relief button until the gauge returns 0 psi (0 kPa).
16. Repackage and properly stow the kit.

Handling of the Jack

Your vehicle has jacking points as shown.

When replacing your tires, consult an authorized Honda Clarity Electric dealer.

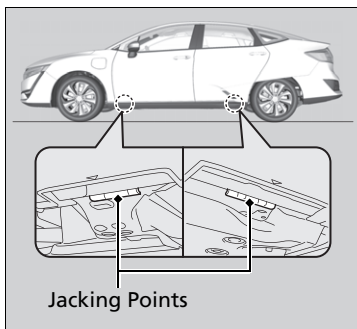

Checking the Procedure

When the **READY** indicator does not come on and the **Ready To Drive** message does not appear on the driver information interface, check the following items and take appropriate action.

☒ Checking the Procedure

If you must start the vehicle immediately, use an assisting vehicle or booster battery to jump start it.

☒ **Jump Starting** P. 514

Checklist	Condition	What to Do
Check if the related indicator or driver information interface messages come on.	The Remove Charger Connector message appears	Removing a charge connector. Set the power mode to ACCESSORY, then to ON.
	The Low Battery Charge. Power Reduced. message appears	Charge the High Voltage battery. ☒ Charging P. 440
	The Temperature Is Too Cold For Vehicle To Operate message appears.	☒ Driver Information Interface Warning and Information Messages P. 100
	The To Start, Hold Remote Near Start Button message appears. ▶ Make sure the smart entry remote is in its operating range. ☒ POWER Button Operating Range P. 152	☒ If the Smart Entry Remote Battery is Weak P. 512
	The POWER SYSTEM indicator comes on.	Have your vehicle checked by an authorized Honda Clarity Electric dealer.
Check the brightness of the interior lights.	The transmission system indicator blinks and Transmission Problem Apply Parking Brake When Parked message appears.	The power system can be activated as a temporary measure. ☒ If the Transmission System Indicator Blinks along with the Warning Message P. 523
	The interior lights are dim or do not come on at all.	Have the 12-volt battery checked by an authorized Honda Clarity Electric dealer.
Check the Security System Alarm indicator.	The interior lights come on normally.	Check all fuses, or have your vehicle checked by an authorized Honda Clarity Electric dealer. ☒ Inspecting and Changing Fuses P. 530
	When the Security System Alarm indicator is blinking, the power system cannot be turned on.	☒ Security System Alarm P. 147



If the Smart Entry Remote Battery is Weak

If the beeper sounds, the **To Start, Hold Remote Near Start Button** message appears on the driver information interface, and the **POWER** button flashes, the **READY** indicator does not come on.

Turn on the power system as follows:

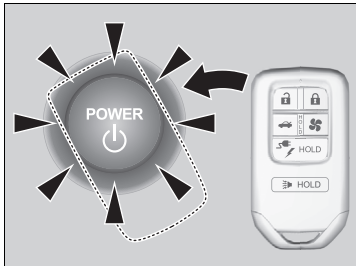

1. Touch the center of the **POWER** button with the **H** logo on the smart entry remote while the **POWER** button is flashing. The buttons on the smart entry remote should be facing you.

▶ The **POWER** button flashes for about 30 seconds.

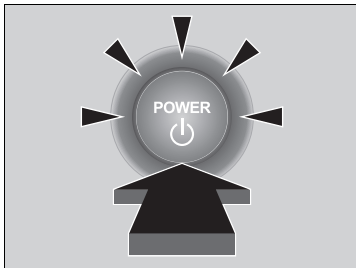

2. Depress the brake pedal and press the **POWER** button within 10 seconds after the beeper sounds and the **POWER** button changes from flashing to on.

▶ If you do not depress the pedal, the mode will change to **ACCESSORY**.

Emergency Power System Off

The **POWER** button may be used to turn the power system off due to an emergency situation even while driving. If you must turn the power system off, do either of the following operations:

- Press and hold the **POWER** button for about two seconds.
- Firmly press the **POWER** button three times.

The steering wheel will not lock. However, because turning off the power system disables the power assist the power system provides to the steering and braking systems, it will require significantly more physical effort and time to steer and slow the vehicle. Use both feet on the brake pedal to slow down the vehicle and stop immediately in a safe place.

The gear position automatically changes to **P** after the vehicle comes to a complete stop. Then, the power mode changes to VEHICLE OFF.

⚠ Emergency Power System Off

Do not press the button while driving unless it is absolutely necessary for the power system to be turned off.



Jump Starting Procedure

Turn off the power to electric devices, such as audio and lights. Turn off the power system, then open the hood.

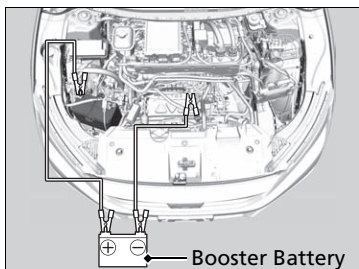

1. Connect the first jumper cable to your vehicle's 12-volt battery \oplus terminal.
2. Connect the other end of the first jumper cable to the booster battery \oplus terminal.
 - ▶ If you use a booster battery, only use a 12-volt booster battery.
 - ▶ When using an automotive battery charger, select a charging voltage lower than 15-volt. Check the charger manual for the proper setting.
3. Connect the second jumper cable to the booster battery \ominus terminal.

Jump Starting

⚠ WARNING

A 12-volt battery can explode if you do not follow the correct procedure, seriously injuring anyone nearby.

Keep all sparks, open flames, and smoking materials away from the 12-volt battery.

Securely attach the jumper cables clips so that they do not come off when the power system vibrates. Also be careful not to tangle the jumper cables or allow the cable ends to touch each other while attaching or detaching the jumper cables.

12-volt Battery performance degrades in cold conditions and may prevent the power system from starting.

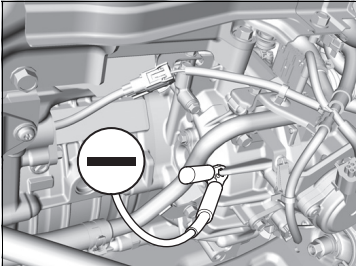

4. Connect the other end of the second jumper cable to the motor/gear case as shown. Do not connect this jumper cable to any other part of the vehicle.
5. If your vehicle is connected to another vehicle, start the assisting vehicle's engine, and increase its rpm slightly.
6. Attempt to start your vehicle's power system. If it isn't turn on, check that the jumper cables have good metal-to-metal contact.

■ What to Do After the Power System Starts

Once your vehicle's power system has started, remove the jumper cables in the following order.

1. Disconnect the jumper cable from your vehicle's ground.
2. Disconnect the other end of the jumper cable from the booster battery ⊖ terminal.
3. Disconnect the jumper cable from your vehicle's 12-volt battery ⊕ terminal.
4. Disconnect the other end of the jumper cable from the booster battery ⊕ terminal.

Have your vehicle inspected by a nearby service station or an authorized Honda Clarity Electric dealer.

▣ What to Do After the Power System Starts

The indicators for the Vehicle Stability Assist® (VSA®) system, VSA® OFF, Collision Mitigation Braking System™ (CMBS™), and low tire pressure/Tire Pressure Monitoring System (TPMS) may come on along with a message in the driver information interface when you turn the power system on after reconnecting the battery.

Drive a short distance at 12 mph (20 km/h). The indicator should go off. If it does not, have your vehicle checked by an authorized Honda Clarity Electric dealer.



How to Handle Overheating

The **High Temperature. Power Reduced.** message appears on the driver information interface when the power system temperature is high.

📄 **Driver Information Interface Warning and Information Messages** P. 100

1. Immediately park the vehicle in a safe place.
 - ▶ Change the gear position to **P** and set the parking brake. Turn off all accessories and turn on the hazard warning lights.
2. Keep the power mode on, and wait until the message goes off.
 - ▶ If the message does not go off, have the vehicle inspected at an authorized Honda Clarity Electric dealer.

If the 12-Volt Battery Charging System Indicator Comes On



■ Reasons for the indicator to come on

Comes on when the 12-volt battery is not being charged.

■ What to do when the indicator comes on

Turn off the climate control system, rear defogger, and other electrical systems, and immediately contact an authorized Honda Clarity Electric dealer for repairs.

ⓘ If the 12-Volt Battery Charging System Indicator Comes On

If you need to stop temporarily, do not turn off the power system. Restarting the power system may rapidly discharge the battery.

The power system uses the 12-volt battery to activate.

You may not be able to turn the power system on again if you have turned it off with this indicator on.

If the Brake System Indicator (Red) Comes On or Blinks

BRAKE

■ Reasons for the indicator to come on

- The brake fluid is low.
- There is a malfunction in the brake system.

■ What to do when the indicator comes on while driving

Depress the brake pedal lightly to check pedal pressure.

- If normal, check the brake fluid level the next time you stop.
- If abnormal, take immediate action. If necessary, slow the vehicle using the deceleration paddle selector.

■ Reason for the indicator to blink

- There is a problem with the electric parking brake system.

■ What to do when the indicator blinks

Avoid using the parking brake and have your vehicle checked by an authorized Honda Clarity Electric dealer immediately.

▶▶ If the Brake System Indicator (Red) Comes On or Blinks

Have your vehicle repaired immediately.

It is dangerous to drive with low brake fluid. If there is no resistance from the brake pedal, stop immediately in a safe place. If necessary, downshift the gears.

If the brake system indicator and **ABS** indicator come on simultaneously, the electronic brake distribution system is not working. This can result in vehicle instability under sudden braking.

Have your vehicle inspected by an authorized Honda Clarity Electric dealer immediately.

If the brake system indicator (red) blinks at the same time when the brake system indicator (amber) comes on, the parking brake may not work.

Avoid using the parking brake and have your vehicle checked by an authorized Honda Clarity Electric dealer immediately.

- ▶▶ **If the Brake System Indicator (Red) Comes On or Blinks at the Same Time When the Brake System Indicator (Amber) Comes On**
P. 521

If the Electric Power Steering (EPS) System Indicator Comes On



■ Reasons for the indicator to come on

- Comes on when there is a problem with the EPS system.
- If you depress the accelerator pedal repeatedly to increase the motor speed while the motor is idling, the indicator comes on, and sometimes the steering wheel becomes harder to operate.
- Comes on when the EPS steering angle center point memory is lost. This could be due to a number of problems including: battery disconnection, main fuse blow, low battery causing the reset of the EPS system, wire damage to EPS harness. Vehicle Stability Assist® (VSA®), VSA® OFF, Collision Mitigation Braking System™ (CMBS™), and low tire pressure/TPMS indicators come on along with a message in the driver information interface.

■ What to do when the indicator comes on

- Stop the vehicle in a safe place, turn off the power system, and turn on the power system again.
If the indicator re-appears and stays on, immediately have your vehicle inspected by an authorized Honda Clarity Electric dealer.

- If VSA® indicator, VSA® OFF indicator, CMBS™ indicator, and low tire pressure/TPMS indicator come on along with a message in the driver information interface, you need to calibrate the VSA and EPS systems. Drive a short distance at more than 12 mph (20 km/h) to calibrate the VSA and EPS systems.

If the indicators come on and stay on, park your vehicle in a safe place, turn off and turn on the power system, then repeat the above operation.

If the indicators still come on and stay on, immediately have your vehicle inspected by an authorized Honda Clarity Electric dealer.



If the Brake System Indicator (Red) Comes On or Blinks at the Same Time When the Brake System Indicator (Amber) Comes On

BRAKE

- **If the brake system indicator (red) comes on or blinks at the same time when the brake system indicator (amber) comes on, release the parking brake manually or automatically.**

**BRAKE
SYSTEM**

➤ **Parking Brake** P. 420

- If the brake system indicator (red) continuously comes on or blinks at the same time when the brake system indicator (amber) comes on, stop the vehicle in a safe place, and have it inspected by an authorized Honda Clarity Electric dealer immediately.
 - ▶ Prevents the vehicle from moving gear position to **[P]**.
- If only the Brake System Indicator (Red) is turned off, avoid using the parking brake, and have your vehicle checked by an authorized Honda Clarity Electric dealer immediately.

☒ If the Brake System Indicator (Red) Comes On or Blinks at the Same Time When the Brake System Indicator (Amber) Comes On

If you apply the parking brake, you may not be able to release it.

If the brake system indicator (red) and the brake system indicator (amber) come on at the same time, the parking brake is working.

If the brake system indicator (red) blinks at the same time when the brake system indicator (amber) comes on, the parking brake may not work because it is checking the system.

If the Low Tire Pressure/TPMS Indicator Comes On or Blinks



■ Reasons for the indicator to come on or blink

A tire pressure is significantly low, or the TPMS has not been calibrated. If there is a problem with the TPMS, the indicator blinks for about one minute, and then stays on.

■ What to do when the indicator comes on

Drive carefully and avoid abrupt cornering and hard braking. Stop your vehicle in a safe place. Check the tire pressure and adjust the pressure to the specified level. The specified tire pressure is on a label on the driver side doorjamb.

▶ Calibrate the TPMS after the tire pressure is adjusted.

■ What to do when the indicator blinks, then remains on

Have the tire inspected by an authorized Honda Clarity Electric dealer as soon as possible.

▶▶ If the Low Tire Pressure/TPMS Indicator Comes On or Blinks

NOTICE

Driving on an extremely underinflated tire can cause it to overheat. An overheated tire can fail. Always inflate your tires to the prescribed level.

If the Transmission System Indicator Blinks along with the Warning Message



Transmission
Problem Apply
Parking Brake
When Parked

■ Reasons for the indicator to blink

The transmission is malfunctioning.

■ What to do when the indicator blinks

- Immediately have your vehicle inspected by an authorized Honda Clarity Electric dealer.
- Change the gear position to **N** after turning the power system on.
 - ▶ Check if the **N** position in the instrument panel and the indicator on the **N** button light/blink.
 - ▶ The power system cannot be turned on unless the parking brake is set.
 - **Turning on the Power** P. 366

ⓘ If the Transmission System Indicator Blinks along with the Warning Message

You may not be able to turn on the power system.

Make sure to set the parking brake when parking your vehicle.

Call a professional towing service if you need to tow your vehicle.

➤ **Emergency Towing** P. 531

Fuse Locations

If any electrical devices are not working, set the power mode to VEHICLE OFF (LOCK), and check to see if any applicable fuse is blown.

Motor Compartment Fuse Box

There are two fuse boxes in the motor compartment.

Fuse locations are shown on the fuse box cover. Locate the fuse in question by the fuse number and box cover number.

Located near the windshield washer reservoir. Push the tabs to open the box.

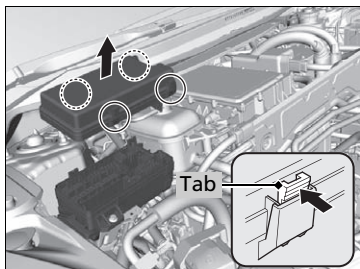

■ Circuit protected and fuse rating

	Circuit Protected	Amps
1	BATTERY	175 A
	EPS	70 A
	ESB	40 A
	IG MAIN (SMART)	30 A
2	ABS/VSA MOTOR	40 A
	WIPER MOTOR 1	30 A
	ABS/VSA FSR	40 A
	–	30 A
3	–	30 A
	SUB FUSE BOX 2-1	30 A
	SUB FUSE BOX 3-2	30 A
4	IG MAIN 2	30 A
	–	–
5	H/L LO MAIN	15 A
6	HP VLV	10 A
7	DTWP	10 A
8	–	–
9	VBU	10 A
10	STOP LIGHT	7.5 A
11	–	–

	Circuit Protected	Amps	
12	FUSE BOX MAIN 1	60 A	
	FUSE BOX MAIN 2	40 A	
	FUSE BOX MAIN 3	50 A	
	H/L HI MAIN	30 A	
	SMALL MAIN	20 A	
	SUB FUSE BOX 4	30 A	
	–	30 A	
	WIPER MOTOR 2	30 A	
	–	30 A	
	–	30 A	
	13	HEATER MOTOR	40 A
	14	REAR DEFROSTER	40 A
15	–	–	
16	BATT SNSR	7.5 A	
17	ES EWP	15 A	
18	A/C MAIN/DRL	10 A	
19	ES VLV	7.5 A	
20	HORN	10 A	
21	BACK UP	10 A	
22	AUDIO	15 A	
23	–	–	
24	R H/L LO	7.5 A	
25	L H/L LO	7.5 A	
26	–	–	

■ Fuse box B

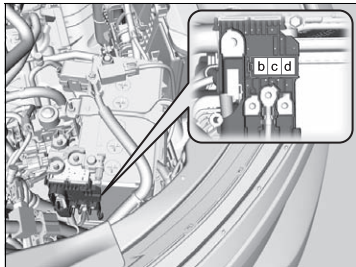
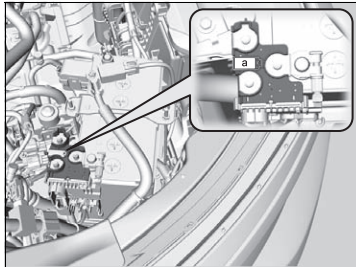
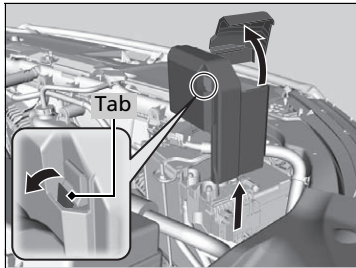

Pull up the cover on the ⊕ terminal, then remove it while pulling out the tab as shown.

Replacement of motor compartment fuses should be done by an authorized Honda Clarity Electric dealer.

■ Circuit protected and fuse rating

	Circuit Protected	Amps
a	–	–
b	–	–
c	SUB FUSE BOX 1	80 A
d	–	–



■ Driver's Side Interior Fuse Box

There are four fuse boxes on the driver's side.

■ Fuse Box A

Located under the dashboard.

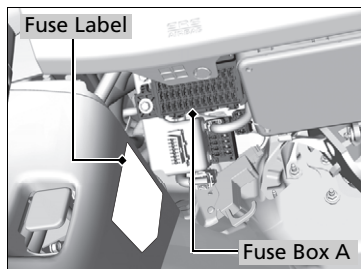

Fuse locations are shown on the label on the under panel.

Locate the fuse in question by the fuse number and label number.

■ Circuit protected and fuse rating

	Circuit Protected	Amps
1	ACC	7.5 A
2	–	–
3	–	–
4	SHIFTER	7.5 A
5	OPTION MAIN	15 A
6	SRS OPTION	10 A
7	METER	10 A
8	FUEL PUMP (BATTERY ECU)	7.5 A
9	OPTION	7.5 A
10	CTR ACC SOCKET	20 A
11	–	–
12	R SIDE DOOR LOCK	10 A
13	L SIDE DOOR UNLOCK	10 A
14	RR L P/W	20 A
15	AS P/W	20 A
16	DOOR LOCK	20 A
17	P-DRV	7.5 A
18	–	–
19	WASHER	15 A
20	–	–

	Circuit Protected	Amps
21	ACG	10 A
22	DRL	7.5 A
23	–	–
24	FR SENSOR CAMERA	5 A
25	DR DOOR LOCK	10 A
26	R SIDE DOOR UNLOCK	10 A
27	RR R P/W	20 A
28	DR P/W	20 A
29	FR ACC SOCKET	20 A
30	INTERIOR LIGHT	7.5 A
31	DR P/SEAT REC	20 A
32	FR SEAT HEATER	20 A
33	DR P/SEAT SLI	20 A
34	ABS/VSA	7.5 A
35	SRS	10 A
36	–	–
37	LID ACT	10 A
38	L SIDE DOOR LOCK	10 A
39	DR DOOR UNLOCK	10 A

■ Fuse Box B

Located under the fuse box A.

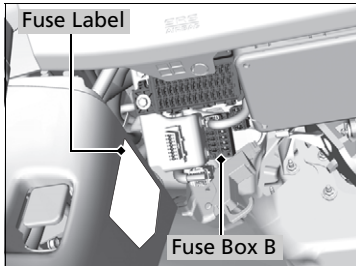

Fuse locations are shown on the label on the under panel.

Locate the fuse in question by the fuse number and label number.

■ Circuit protected and fuse rating

	Circuit Protected	Amps
c	QC CNT	(10 A)
d	R H/L HI	7.5 A
e	L H/L HI	7.5 A
f	IGC	10 A
g	HAZARD	10 A
h	IGB	15 A
i	SMART	10 A
j	IGA	10 A



■ **Fuse Box C**

Located on the right side of fuse box B.

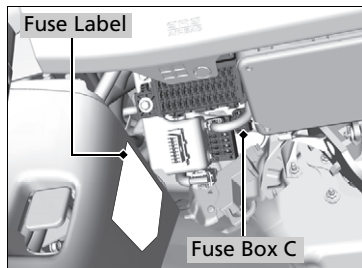

Fuse locations are shown on the label on the under panel.

Locate the fuse in question by the fuse number and label number.

■ **Circuit protected and fuse rating**

	Circuit Protected	Amps
k	AS P/SEAT REC	(20 A)
l	AS P/SEAT SLIDE	(20 A)
m	ILLUMI	7.5 A
n	SMALL	7.5 A

■ Fuse Box D

Located inside the driver's side outer panel.

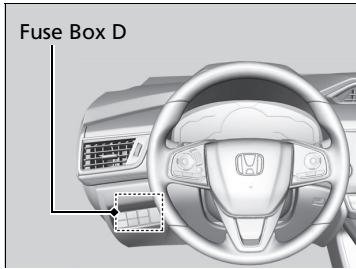

Replacement of fuses in the driver's side outer panel should be done by an authorized Honda Clarity Electric dealer.

■ Circuit protected and fuse rating

	Circuit Protected	Amps
p	COMBO	(10 A)
q	IGMG	(7.5 A)
r	SHIFTER	7.5 A
s	P-ACT DRV	7.5 A
t	–	–
u	EPP	(7.5 A)
v	OPTION	7.5 A
w	ESB	7.5 A



Inspecting and Changing Fuses

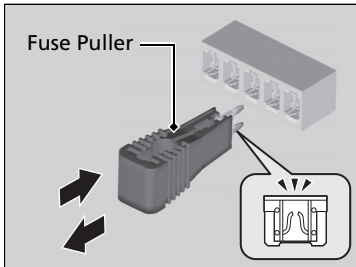
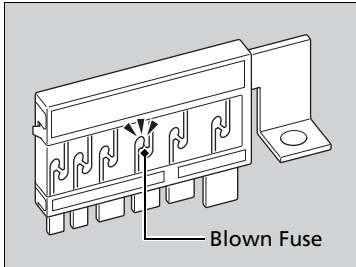
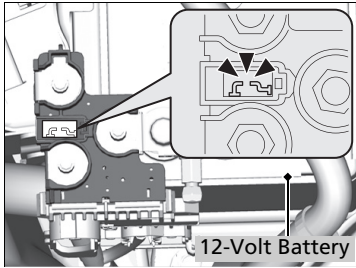

1. Set the power mode to VEHICLE OFF (LOCK). Turn headlights and all accessories off.
2. Check the fuses on the battery in the motor compartment.
 - If the fuse is blown, have it replaced by an authorized Honda Clarity Electric dealer.
3. Remove the fuse box cover.
4. Check the large fuse in the motor compartment.
 - If the fuse is blown, use a Phillips-head screwdriver to remove the screw, and replace it with a new one.
5. Inspect the small fuses in the motor compartment and the vehicle interior.
 - If there is a blown fuse, remove it with the fuse puller, and replace it with a new one.

Inspecting and Changing Fuses

NOTICE

Replacing a fuse with one that has a higher rating greatly increases the chances of damaging the electrical system.

Replace the fuse with a spare fuse of the same specified amperage. Confirm the specified amperage using the charts on P. 524 to 529.

There is a fuse puller on the back of the cover of the motor compartment fuse box A.

Emergency Towing

Call a professional towing service if you need to tow your vehicle.

■ Flat bed equipment

The operator loads your vehicle on the back of a flat bed truck.

This is the only way you can safely transport your vehicle.

Any other towing method will damage the vehicle's drive system.



» Emergency Towing

NOTICE

Trying to lift or tow your vehicle by the bumpers will cause serious damage. The bumpers are not designed to support the vehicle's weight.

NOTICE

Improper towing, such as towing behind a motorhome or other motor vehicle can damage the transmission.

Never tow your vehicle with just a rope or chain. It is very dangerous, since ropes or chains may shift from side to side or break.

Do not use the hook on the rear of your vehicle for the towing of other vehicles or emergency removal of your vehicle. The hook may break.

If your vehicle needs to be towed backward, contact an authorized Honda Clarity Electric dealer or a professional towing service.

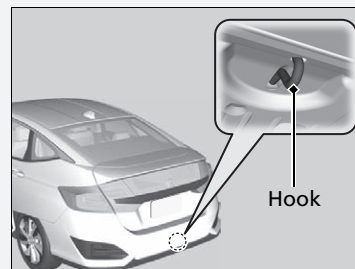

What to Do When Unable to Open the Charge Lid

If you cannot open the charge lid, use the following procedure.

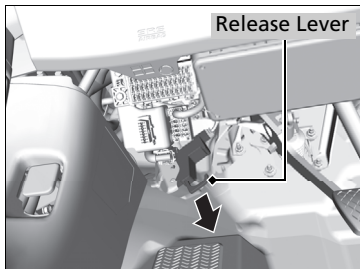

1. Pull the release lever under the lower left corner of the dashboard.
 - ▶ The lid will pop up slightly.

When You Cannot Open the Charge Lid

After taking this step, contact an authorized Honda Clarity Electric dealer to have the vehicle checked.

What to Do When Unable to Disengage the Charging Connector

The **Charging Connector Release Problem. Use Release Lever To Disconnect** message appears on the driver information interface when you cannot disengage the charging connector.

Disengage the charging connector as follows.

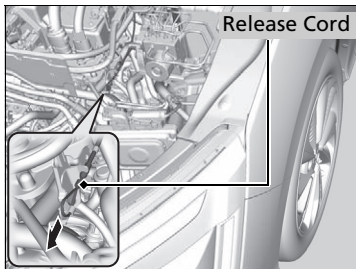

1. Make sure that charging is completed correctly.
2. Open the hood.
3. Pull the release cord toward you.
 - ▶ The release cord returns to its original position at the next charging.
4. Press the release button on the charging connector to disengage it from the inlet.

When You Cannot Disengage the Charging Connector

If the problem that you cannot disengage the charging connector occurs repeatedly, contact an authorized Honda Clarity Electric dealer to have the vehicle checked.

What to Do When Unable to Open the Trunk

If you cannot open the trunk, use the following procedure.

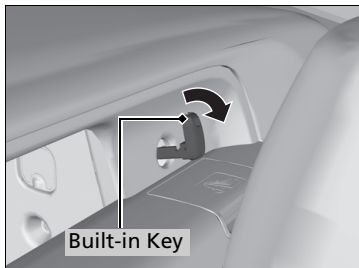

1. Insert the built-in key into the cylinder and turn the key clockwise (as shown).
▶ The trunk unlocks and opens.

Following up:

After taking these steps, contact an authorized Honda Clarity Electric dealer to have your vehicle checked.

Information

This chapter includes your vehicle's specifications, locations of identification numbers, and other information required by regulation.

Specifications	536
Identification Numbers	
Vehicle Identification Number (VIN), Motor Number, and Transmission Number ..	538
Devices that Emit Radio Waves	539
Reporting Safety Defects	540
Warranty Coverages	541
Authorized Manuals	543
Customer Service Information	544



■ Vehicle Specifications

Model	CLARITY ELECTRIC
No. of Passengers:	
Front	2
Rear	3
Total	5
Weights:	
Gross Vehicle Weight Rating	4,921 lbs (2,232 kg)
Gross Axle Weight Rating (Front)	2,383 lbs (1,081 kg)
Gross Axle Weight Rating (Rear)	2,610 lbs (1,184 kg)

■ Air Conditioning

Refrigerant Type	HFO-1234yf (R-1234yf)
Charge Quantity	27.3 – 29.1 oz (775 – 825 g)
Lubricant Type	SE-A2 (POE)
Quantity	7.63 – 9.46 cu-in (125 – 155 cc)

■ Washer Fluid

Tank Capacity	1.43 US qt (1.35 L)
---------------	---------------------

■ Light Bulbs

Headlights (Low Beam)	LED
Headlights (High Beam)	LED
Front Turn Signal Lights	LED
Front Side Marker Lights	LED
Parking/Daytime Running Lights	LED
Taillights/Rear Side Marker Lights	LED
Brake Lights	LED
Taillights	LED
Back-Up Lights	LED
Rear Turn Signal Lights	LED
High-Mount Brake Light	LED
Rear License Plate Light	LED
Interior Lights	
Front and Rear Map Lights	LED
Front and Rear Ambient Lights	LED
Vanity Mirror Lights	1.4 W
Center Console Light	LED
Glove Box Light	LED
Front Foot Lights	LED
Trunk Light	LED
Charge Indicator Light	LED



■ Brake Fluid

Specified	Honda Heavy Duty Brake Fluid DOT 3
-----------	------------------------------------

■ Transmission Fluid

Specified	Honda Automatic Transmission Fluid ATF DW-1	
Capacity	Change	1.85 US qt (1.75 L)

■ Coolant

Specified	Honda Long Life Antifreeze/Coolant Type2
-----------	--

■ Tire

	Size	235/45R18 94V	
Regular	Pressure psi (kPa [kgf/cm ²])	Front	36 (250 [2.5])
		Rear	38 (260 [2.7])
Wheel Size	Regular	18 x 8J	



Vehicle Identification Number (VIN), Motor Number, and Transmission Number

Your vehicle has a 17-digit vehicle identification number (VIN) used to register your vehicle for warranty purposes, for licensing, and insuring your vehicle. The locations of your vehicle's VIN, motor number, and transmission number are shown as follows:

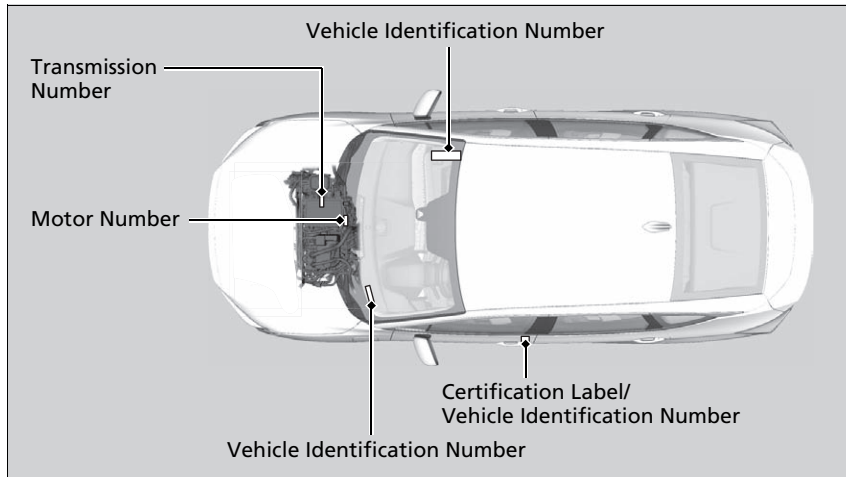

Vehicle Identification Number (VIN), Motor Number, and Transmission Number

The vehicle identification number (VIN) is located under the cover.

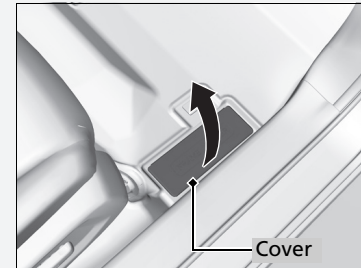

Devices that Emit Radio Waves

The following products and systems on your vehicle emit radio waves when in operation.

Adaptive Cruise Control (ACC) with Low Speed Follow (LSF)

Audio System

Bluetooth® Audio

Bluetooth® HandsFreeLink®

Charging Cable

Collision Mitigation Braking System™

HomeLink® Universal Transceiver

Immobilizer System

Smart Entry System

Wi-Fi

Each of the above complies with the appropriate requirements or the required standards of FCC (Federal Communications Commission) described below:

As required by the FCC:

This device complies with Part 15 of the FCC rules. Operation is subject to the following two conditions: (1) This device may not cause harmful interference, and (2) this device must accept any interference received, including interference that may cause undesired operation.

Changes or modifications not expressly approved by the party responsible for compliance could void the user's authority to operate the equipment.



In the U.S.

If you believe that your vehicle has a defect which could cause a crash or could cause injury or death, you should immediately inform the National Highway Traffic Safety Administration (NHTSA) in addition to notifying American Honda Motor Co., Inc.

If NHTSA receives similar complaints, it may open an investigation, and if it finds that a safety defect exists in a group of vehicles, it may order a recall and remedy campaign. However, NHTSA cannot become involved in individual problems between you, your dealer, or American Honda Motor Co., Inc.

To contact NHTSA, you may call the Vehicle Safety Hotline toll-free at 1-888-327-4236 (TTY: 1-800-424-9153); go to <http://www.safercar.gov>; or write to: Administrator, NHTSA, 1200 New Jersey Avenue, SE., Washington, DC 20590. You can also obtain other information about motor vehicle safety from <http://www.safercar.gov>.

■ U.S. Owners

Your new vehicle is covered by these warranties:

New Vehicle Limited Warranty – covers your new vehicle against defects in materials and workmanship.

Powertrain Limited Warranty – the powertrain in your new Honda is covered by a limited warranty. The duration of warranty coverage may vary. Please read your warranty booklet for details.

High Voltage Battery Capacity Warranty – gradual capacity loss of the high voltage battery is expected and not covered under warranty. Greater than normal degradation is covered and can be determined by an authorized Honda Clarity Electric dealer. Please read your warranty booklet for details.

Tire Warranty – the original tires are warranted by their manufacturer. Your Honda automobile dealer will be glad to assist you in contacting the tire's manufacturer, if needed. Please read your warranty booklet for details.

Seat Belt Limited Warranty – a seat belt that fails to function properly is covered by a limited warranty. Please read your warranty booklet for details.

Rust Perforation Limited Warranty – all exterior body panels are covered against rusting from the inside out for the specified time period, regardless of mileage.

Accessory Limited Warranty – Honda accessories are covered under this warranty. Time and mileage limits depend on the type of accessory and other factors. Please read your warranty booklet for details.



Continued

Replacement Parts Limited Warranty – covers all Honda replacement parts against defects in materials and workmanship.

Replacement 12-Volt Battery Limited Warranty – provides prorated coverage for a replacement battery purchased from an authorized Honda Clarity Electric dealer.

Restrictions and exclusions apply to all these warranties. Please read the Honda warranty information booklet that came with your vehicle for precise information on warranty coverages. Your vehicle's original tires are covered by their manufacturer. Tire warranty information is in a separate booklet.

■ Service Express

For electronic copies of service publications, you can purchase a subscription to Service Express. Visit www.techinfo.honda.com for pricing and options.

■ For U.S. Owners

Manuals can be purchased from Helm Incorporated. You can order a manual by phone at 1 (800) 782-4356 (credit card orders only), or online at www.helminc.com.



Honda dealership personnel are trained professionals who should be able to deal with any problems you may encounter with your vehicle. If, however, you are faced with a problem that they cannot resolve to your satisfaction, contact Honda Customer Services.

U.S. Owners

American Honda Motor Co., Inc.
Honda Automobile Customer Services
Mail Stop 100-5E-8A
1919 Torrance Blvd.
Torrance, CA 90501-2746
Tel: 1 (800) 999-1009

Customer Service Information

When you call or write, please give us the following information:

- Vehicle Identification Number
 - **Vehicle Identification Number (VIN), Motor Number, and Transmission Number P. 538**
- Date of purchase
- Odometer reading of your vehicle
- Your name, address, and telephone number
- A detailed description of the problem
- Name of the dealer who sold the vehicle to you

Disclaimer of Pandora®

Requirements to access Pandora®

- Latest version of the Pandora app installed on your Android, Blackberry, or iPhone.
- Registered Pandora account (you can create a free account at www.pandora.com <<http://www.pandora.com>> or on your smartphone)
- Connection to the internet via Wi-Fi or cellular data network.

Limitations

- Access to Pandora requires an active internet connection
- Ability to access Pandora through this system is subject to change without notice
- Certain functionality of Pandora service is not available when accessing the service through this system including, but not limited to, creating new stations, deleting stations, emailing current stations, buying tracks, viewing additional text information, logging in to Pandora, and adjusting Cell Network Audio Quality. Pandora internet radio is a music service not affiliated with HONDA. More information is available at <http://www.pandora.com> <<http://www.pandora.com>>. Pandora, the Pandora logo, and the Pandora trade dress are trademarks or registered trademarks of Pandora Media, Inc., used with permission.
- Mobile access requires a smartphone with an active data plan. Standard data rates may apply.
- Pandora is only available in the United States.



Numbers

120V AC (AC Level 1)	442
12-Volt Battery Charging System	
Indicator	86
240V AC (AC Level 2)	444

A

ABS (Anti-lock Brake System)	426
Accessories and Modifications	494
Accessory Power Sockets	182
Acoustic Vehicle Alerting System	382
Adaptive Cruise Control (ACC) with	
Low Speed Follow (LSF)	97, 389
Additives	
Washer	469
Adjusting	
Armrest	175
Front Seats	169
Head Restraints	171
Mirrors	167
Steering Wheel	166
Temperature	122
Agile Handling Assist	413
Air Conditioning System (Climate Control	
System)	186
Changing the Mode	188
Defrosting the Windshield and	
Windows	190
Dust and Pollen Filter	487
Sensors	194

Synchronization Mode	191
Using Automatic Climate Control	186
Air Pressure	476, 537
Airbags	52
Advanced Airbags	58
Airbag Care	66
Driver's Knee Airbag	59
Event Data Recorder	0
Front Airbags (SRS)	55
Indicator	64, 90
Passenger Front Airbag Off Indicator	65
Sensors	52
Side Airbags	61
Side Curtain Airbags	63
AM/FM Radio	233
Android Auto	270
Anti-lock Brake System (ABS)	426
Indicator	89
Apple CarPlay	267
Armrest	175
Audio Remote Controls	199
Audio System	196, 202
Adjusting the Sound	226
Audio/Information Screen	203
Changing the Home Screen Icon Layout ..	209
Changing the Screen Interface	223
Closing Apps	225
Customizing the Meter	209
Display Setup	227
Error Messages	274
General Information	278

Home Screen	215
Limitations for Manual Operation	228
Menu Customize	224
MP3/WMA/AAC	254
Reactivating	198
Recommended Devices	280
Remote Controls	199
Security Code	198
Selecting an Audio Source	228
Status Area	222
Theft Protection	198
USB Flash Drives	280
USB Port	197
Wallpaper Setup	213
Audio/Information Screen	203
Authorized Manuals	543
Auto Door Locking/Unlocking	143
Automatic Brake Hold	424
Indicator	83, 424
Automatic Brake Hold System	
Indicator	83, 424
Automatic Lighting	157
Average Energy Consumption	122, 125
Average Speed	123

B

Battery

12-Volt	484
12-Volt Battery Charging System	
Indicator	86, 518

Charging	440	Parking/Daytime Running Lights	470	Child Safety	67
Charging (12-Volt Battery)	485	Rear License Plate Lights	471	Childproof Door Locks.....	142
Energy Economy	456	Taillights and Back-Up Lights	471	Child Seat	67
High Voltage.....	453	Taillights/Rear Side Marker, Brake and		Booster Seats	79
Jump Starting	514	Rear Turn Signal Lights	471	Child Seat for Infants.....	69
Maintenance (Checking the 12-Volt		Bulb Specifications	536	Child Seat for Small Children.....	70
Battery)	484			Installing a Child Seat with a Lap/Shoulder	
Maintenance (Replacing).....	486			Seat Belt.....	74
Safety Checklist	440			Larger Children	78
Belts (Seat)	44	C		Rear-facing Child Seat	69
Beverage Holders	180	Carrying Cargo	361, 363	Selecting a Child Seat.....	71
Bluetooth® Audio	257	Certification Label	538	Using a Tether.....	76
Bluetooth® HandsFreeLink®	325	Changing Bulbs	470	Childproof Door Locks	142
Booster Seats (For Children)	79	Charge Lid	443, 445	Cleaning the Exterior	490
Brake System	420	Charge Lid Release Button	442, 444	Cleaning the Interior	488
Anti-lock Brake System (ABS)	426	Charge Timer Setting	454	Climate Control System	186
Automatic Brake Hold.....	424	Charging	440	Changing the Mode	188
Brake Assist System.....	427	120V AC (AC Level 1).....	442	Defrosting the Windshield and	
Fluid	468	240V AC (AC Level 2).....	444	Windows.....	190
Foot Brake	423	Cannot Start Charging	450	Dust and Pollen Filter.....	487
Indicator (Red)	521	Charge Indicator (vehicle side)	452	Sensors	194
Parking Brake.....	420	Charge Lid.....	443, 445	Using Automatic Climate Control	186
Brake System (Amber)		Charging Connector.....	443	Clock	130
Indicator	84	Control Box.....	448	CMBS™ (Collision Mitigation Braking	
Brake System (Red)		DC Charge	446	System™).....	428
Indicator	82, 83, 519	High Voltage Battery	453	Coat Hook	183
Bulb Replacement	470	Timer.....	454	Collision Mitigation Braking System™	
Front Turn Signal and Front Side Marker		Unable to Disengage the Charging		(CMBS™)	428
Lights.....	470	Connector	533	Console Compartment	179
Headlights	470	Charging Connector	443	Controls	129
High-Mount Brake Light.....	471	Charging System Indicator	518		

Coolant.....	467
Overheating.....	517
Creeping (Transmission).....	370
Cup Holders.....	180
Customer Service Information.....	544
Customized Features.....	128, 296

D

Daytime Running Lights.....	159
Dead Battery (12-Volt).....	514
Deceleration Paddle Selector.....	379
Defrosting the Windshield and Windows.....	190
Devices that Emit Radio Waves.....	539
Dimming	
Headlights.....	156
Rearview Mirror.....	167
Directional Signals (Turn Signal).....	155
Display Button.....	203
Door Mirrors.....	168
Doors.....	131
Auto Door Locking.....	143
Auto Door Unlocking.....	143
Door Open Message.....	43
Keys.....	131
Locking/Unlocking the Doors from the Inside.....	25, 140
Locking/Unlocking the Doors from the Outside.....	133
Lockout Prevention System.....	139

DOT Tire Quality Grading.....	478
Driver Information Interface.....	120
Driver's Knee Airbag.....	59
Driving.....	359
Braking.....	420
Shifting Gear.....	371
Transmission.....	370
Turning on the Power.....	366
Driving Position Memory System.....	164
Dust and Pollen Filter.....	487

E

Eco Assist® System.....	20
Eco Drive Display/Drive Cycle Score/ Lifetime Points.....	126
ECON Mode.....	377
Elapsed Time.....	123
Electric Power Steering (EPS) System Indicator.....	90, 520
Electric Vehicle Precautions.....	15
Electricity Consumption and Driving Range.....	19
Electricity Consumption Indicator (ENERGY USAGE).....	119
Electronic Stability Control (ESC).....	411
Emergency.....	531
Energy	
Instant Energy Economy.....	123
Range.....	116
Energy Economy.....	456

EPS (Electric Power Steering) System.....	90
Expanded View Driver's Mirror.....	168
Exterior Care (Cleaning).....	490
Exterior Mirrors.....	168

F

Features.....	195
Filters	
Dust and Pollen.....	487
Flat Tire.....	498
Floor Mats.....	489
Fluids	
Brake.....	468
Coolant.....	467
Transmission.....	468
Windshield Washer.....	469
FM/AM Radio.....	233
Foot Brake.....	423
Front Airbags (SRS).....	55
Front Seat Heaters.....	184
Front Seats.....	169
Adjusting.....	169
Front Sensor Camera.....	383
Fuses.....	524
Inspecting and Changing.....	530
Locations.....	524, 526

G

Gauges.....	116
-------------	-----

Gear Position Indicator	87, 373
Gear Shift Positions	
Transmission	371
Glass (care)	489, 491
Glove Box	178

H

Handling the Unexpected	497
HandsFreeLink® (HFL)	325
Automatic Import of Cellular Phonebook and Call History.....	338
Displaying Messages	352
HFL Buttons	325
HFL Menus.....	328
HFL Status Display.....	327
In Case of Emergency	356
Limitations for Manual Operation.....	327
Making a Call	346
Options During a Call.....	349
Phone Setup	333
Phonebook Phonetic Modification.....	342
Receiving a Call.....	349
Receiving a Text Message/E-mail	350
Ring Tone	337
Selecting a Mail Account.....	351
Speed Dial	339
To Set Up Text Message/E-mail Options ..	336
Hazard Warning Button	6
HD Radio™	233
Head Restraints	171

Headlights	156
Aiming	470
Automatic Operation	157
Dimming	156, 159
Operating.....	156
Heated Door Mirror	163
Heaters (Seat)	184
HFL (HandsFreeLink®).....	325
High Beam Indicator	94
High Voltage Battery	453
Charging	440
Energy Economy.....	456
High Voltage Battery Charge Level	
Gauge	118
Hill Start Assist System	368
HomeLink® Universal Transceiver	322
Honda App License Agreement.....	281
Honda Sensing®	33
HondaLink®	259

I

Identification Numbers	
Motor, and Transmission	538
Vehicle Identification	538
Immobilizer System	147
Indicator	94
Indicators	82
12-Volt Battery Charging System	86, 518
Adaptive Cruise Control (ACC) with	
Low Speed Follow (LSF).....	97, 389

Anti-lock Brake System (ABS).....	89
Automatic Brake Hold	83, 424
Automatic Brake Hold System	83, 424
Collision Mitigation Braking System™ (CMBS™).....	98, 99
Deceleration Paddle Selector	88
ECON Mode.....	95
Electric Power Steering (EPS) System..	90, 520
Gear Position.....	87
High Beam	94
Immobilizer System	94
Lane Keeping Assist System (LKAS)....	98, 406
Lights On	94
Low Charge	86
Low Tire Pressure/TPMS.....	92, 414, 416
Parking Brake and Brake System (Amber) ..	84
Parking Brake and Brake	
System (Red).....	82, 83, 519, 521
POWER SYSTEM.....	85
READY	86
Road Departure Mitigation (RDM)	96
Seat Belt Reminder	46, 89
Security System Alarm	95
SPORT Mode.....	95, 378
Supplemental Restraint System.....	64, 90
System Message.....	93
Transmission System.....	87
Turn Signal and Hazard Warning	94
Vehicle Stability Assist® (VSA®)	
System	91, 411
VSA® OFF	91, 412

Information.....	535
Instant Energy Consumption	123
Instrument Panel	81
Interior Lights	176
Interior Rearview Mirror	167
Inverter Coolant.....	467
Adding to the Reserve Tank	467
Overheating.....	517
iPod.....	245

J

Jacking Points	510
Jump Starting.....	514

K

Key Number Tag.....	132
Keyless Lockout Prevention	139
Keys	131
Lockout Prevention	139
Number Tag	132
Rear Door Won't Open	142
Remote Transmitter	137
Types and Functions	131

L

Lane Keeping Assist System (LKAS)	404
LaneWatch™.....	418
Language (HFL).....	327
LATCH (Child Seats).....	72

Lights.....	156, 470
Automatic.....	157
Bulb Replacement	470
Daytime Running Lights.....	159
High Beam Indicator.....	94
Interior.....	176
Light Switches	156
Lights On Indicator.....	94
Turn Signals	155

Load Limits	363
--------------------------	-----

Locking/Unlocking	131
Auto Door Locking/Unlocking.....	143
Childproof Door Locks.....	142
From Inside	140
From Outside	133
Keys	131
Using a Key	138

Lockout Prevention System	139
--	-----

Low Battery Charge (12-Volt)	518
---	-----

Low Smart Entry Remote Signal Strength	132
---	-----

Lower Anchors	72
----------------------------	----

Luggage (Maximum Load Limit)	363
---	-----

M

Maintenance	457
12-Volt Battery.....	484
Brake Fluid.....	468
Cleaning	488
Climate Control System.....	487

Coolant	467
Maintenance Minder™.....	461
Precautions	458
Remote Transmitter	486
Replacing Light Bulbs	470
Safety	459
Service Items.....	463
Tires.....	475
Transmission Fluid.....	468
Under the Hood	465

Making Good Use of Your Honda Electric Vehicle	12
---	----

Map Lights	177
-------------------------	-----

Maximum Load Limit	363
---------------------------------	-----

Meters, Gauges	116
-----------------------------	-----

Mirrors	167
----------------------	-----

Adjusting.....	167
Door	168
Exterior	168
Interior Rearview.....	167

Modifications (and Accessories)	494
--	-----

Motor	538
--------------------	-----

Coolant	467
Jump Starting	514

MP3	254
------------------	-----

Multi-View Rear Camera	438
-------------------------------------	-----

N

Numbers (Identification)	538
---------------------------------------	-----

O

Odometer	122
Open Source Licences	295
Opening	
Trunk	534
Opening/Closing	
Hood	466
Power Windows.....	150
Trunk.....	144
Operating the Switches Around the Steering Wheel.....	152
Outside Temperature Display	122
Overheating	517

P

Painting the Vehicle	493
Pandora®	252
Panic Mode.....	149
Parking	436
Parking Brake.....	420
Parking Brake and Brake System Indicator (Red).....	521
Passenger Front Airbag Off Indicator.....	65
Passing Indicators.....	156
Playing <i>Bluetooth</i> ® Audio	257
POWER Button	152
Power System	
Turning on.....	366
POWER SYSTEM Indicator	85
Power Windows.....	150

POWER/CHARGE Gauge	117
Precautions While Driving	
Rain.....	369
Pregnant Women	50
Puncture (Tire).....	498

R

Radio (FM/AM).....	233
Radio (SiriusXM®)	237
Radio Data System (RDS).....	235
Range	116
Range Display	125
RDS (Radio Data System).....	235
READY Indicator	86
Rear Defogger Button.....	163
Rear Seats.....	174
Rearview Mirror.....	167
Regenerative Energy and Regenerative Braking	18
Regulations	416, 451, 478, 539
Remote Transmitter	137
Replacement	
Battery	486
Bulbs	470
Fuses	524, 526
Tires	481
Wiper Blade Rubber.....	472
Reporting Safety Defects	540
Resetting a Trip Meter	122

Road Departure Mitigation (RDM)	385
On and Off.....	386

S

Safe Driving	39
Safety Checklist	43
Safety Labels.....	80
Safety Message.....	3
Seat Belts	44
Adjusting the Shoulder Anchor.....	49
Automatic Seat Belt Tensioners	46
Checking.....	51
Fastening	47
Installing a Child Seat with a Lap/Shoulder Seat Belt.....	74
Pregnant Women	50
Reminder	46, 89
Warning Indicator	46, 89
Seat Heaters.....	184
Seats	169
Adjusting	169
Front Seats.....	169
Rear Seats	174
Seat Heaters.....	184
Security System.....	147
Immobilizer System Indicator.....	94
Security System Alarm Indicator.....	95
Selecting a Child Seat.....	71
Setting the Clock.....	130



- Shift Button..... 31, 371
 - Operation 373
 - Shifting (Transmission) 31, 371
 - Shoulder Anchor..... 49
 - Side Airbags 61
 - Side Curtain Airbags..... 63
 - Siri Eyes Free 266
 - SiriusXM® Radio 237
 - Smart Entry System 133
 - Snow Tires 483
 - Song By Voice™ (SBV) 248
 - Spare Tire (Optional) 537
 - Specifications 536
 - SPORT Mode 378
 - SPORT Mode Indicator 95, 378
 - SRS Airbags (Airbags) 55
 - Steering Wheel
 - Adjusting..... 166
 - Stopping..... 436
 - Summer Tires 483
 - Supplemental Restraint System (SRS) 55
 - Switches (Around the Steering Wheel) 6, 7, 152
 - Synchronization Mode 191
 - System Message Indicator 93
- T**
- Telematics Control Unit..... 128
 - Temperature Sensor 194
 - Temporary Tire Repair Kit..... 499
 - Time (Setting) 130
 - Timer 454
 - Tire Pressure Monitoring System (TPMS) 414
 - Indicator..... 92, 522
 - Tires 475
 - Air Pressure 476, 537
 - Chains..... 483
 - Checking and Maintaining 475
 - Flat Tire (Puncture) 498
 - Inspection 475
 - Labeling 476
 - Regulations 478
 - Rotation 482
 - Spare (Optional) 537
 - Summer 483
 - Temporary Tire Repair Kit 499
 - Wear Indicators 480
 - Winter..... 483
 - Towing a Trailer 365
 - Towing Your Vehicle..... 365
 - Emergency 531
 - TPMS (Tire Pressure Monitoring System) 414
 - Transmission 31, 370, 371
 - Creeping 370
 - Fluid..... 468
 - Gear Position Indicator 87, 373
 - Number..... 538
 - Operating the Shift Button 31, 373
 - Shifting 371
 - Trip Meter 122
 - Troubleshooting 497
 - Blown Fuse 524, 526
 - Brake Pedal Vibrates 36
 - Buzzer Sounds When Opening Door 36
 - Cannot Start Charging..... 450
 - Emergency Towing 531
 - Flat Tire/Puncture 498
 - Noise When Braking 38
 - Overheating..... 517
 - Power System Won't Start 511
 - Rear Door Won't Open 36, 142
 - Warning Indicators..... 82
 - Trunk 144
 - Lid 144
 - Light Bulbs..... 536
 - Unable to Open 534
 - Turn Signals 155
 - Indicators (Instrument Panel) 94
 - Turn-by-Turn Directions 123
 - Turning on the Power 366
 - Does Not Activate 511
 - Jump Starting 514
- U**
- Under-Floor Storage Area 183
 - Unlocking the Doors..... 133
 - Unlocking the Front Doors from the Inside..... 25, 140
 - USB Flash Drives 254, 280

USB Ports	197
Using the Smart Entry with Push Button Start System	133

V

Vanity Mirrors	9
Vehicle Identification Number	538
Vehicle Monitoring System	2
Vehicle Stability Assist® (VSA®)	411
Off Button	412
Off Indicator	91, 412
System Indicator	91, 411
Voice Control Operation	229
Audio Commands	231
Climate Control Commands	232
General Commands	232
Music Search Commands	232
On Screen Commands	232
Phone Commands	231
Useful Commands	231
Voice Portal Screen	230
Voice Recognition	229
VSA® (Vehicle Stability Assist®)	411

W

Wallpaper	213
Warning and Information Messages	100
Warning Indicator On/Blinking	518
Warning Labels	80

Warranties (Warranty Manual provided separately)	541
Watts	536
Wear Indicators (Tire)	480
Wi-Fi Connection	264
Window Washers	160
Adding/Refilling Fluid	469
Switch	160
Windows (Opening and Closing)	150
Windshield	
Cleaning	489, 491
Defrosting/Defogging	190
Washer Fluid	469
Wiper Blades	472
Wipers and Washers	160
Winter Tires	
Snow Tires	483
Tire Chains	483
Wipers and Washers	160
Checking and Replacing Wiper Blades	472
WMA	254
Worn Tires	475











HONDA

31TRV611
OM-08507
00X31-TRV-6110

owners.honda.com (U.S.)

myhonda.ca (Canada)

2018 Honda Clarity Electric Owner's Manual
©2018 Honda Motor Co., Ltd. All Rights Reserved

DEALER ePROCESS

Printed in U.S.A.