



Leviton Integrated Networks™
HOME SYSTEM

Leviton Integrated Networks Home Systems

Structured
Media™ Systems,
Home Control &
Security,
Lighting Controls,
Power Quality and
Special Needs
Groups

Table of Contents

■ The Leviton Company & Leviton Integrated Networks	1
■ Structured Media Systems Group	2
System Packages:	
Value Platform	2
Essential Platform	2
Enhanced Platform	3
Advanced Entertainment Platform	3
Networked Home Upgrade	3
Broadband Home Upgrade	3
Multimedia Home Upgrade	4
Home Video Monitoring Upgrade	4
Guidelines For Leviton's Certified Installer Partner Program	5
Builder Programs	5
■ Components and Accessories	6-59
■ Home Control and Security Group	60-63
System Packages:	
Smarter Home Package	61
Welcome Home Package	61
House Sitter Package	62
Night Sentinel Package	63
■ Lighting Controls Group	64-68
Traditional Lighting Group	64
System Packages:	
Traditional Living & Entertainment Director Package	65
Bed & Bath Ambience Package	65
Decora Lighting Group	66
System Packages	67-68
Decora Living & Entertainment Package	66
Decora Bed & Bath Ambience Package	66
Decora Lighting Magic Package	66
Designer Lighting Group	67
System Packages:	
Designer Living & Entertainment Director Package	67
Designer Bed & Bath Lighting Ambience Package	68
Designer Lighting Package	68
Cinema Style Package	68
■ Power Quality Group	69-70
System Packages:	
Whole-House Electrical "Networked" Surge Protection Package	70
Whole-House Low-Voltage & Electrical Power Quality Protection Package	70
■ Special Needs Group	71-72
System Packages:	
Child Safety Package	71
Universal Design Package	72
■ Components and Accessories	73-74
■ Appendix	75-78
LIN Frequently Asked Questions	75-76
Structural Cabling Certification	77-78
■ Catalog Number Index	79-80

Introduction

LEVITON THE COMPANY

Since its inception at the beginning of the electrical age, the name *Leviton* has been synonymous with quality electrical products for every conceivable commercial and residential need. Today, Leviton is one of the world's most extensive and diversified electrical manufacturing companies, with some thirty facilities dedicated to engineering, manufacturing and distribution of over 25,000 products for nearly every connectivity need—from electrical receptacles to optical fiber components.

Leviton Integrated Networks™

The information and communication revolution will have as much impact on America's



Leviton Integrated Networks™

homes and businesses as did the electrical revolution of the 20th Century. To fully enable the modern home, Leviton has developed **Leviton Integrated Networks** as the upgrade path to the future.

From simple coaxial cable to optical fiber, **Leviton Integrated Networks' Structured Media™** components and systems deliver the bandwidth and speed that today's and tomorrow's information and entertainment technologies will demand. **Power Quality** products provide essential protection for the sensitive electronic components and systems that are now standard in today's homes and businesses.



Lighting Control systems bring out a home's personality by adding warmth and ambience, and deliver value by making the home more efficient as well. **Home Control and Security** systems raise a home's IQ level, making it more secure and responsive to the needs of its owner. **Special Needs** systems make a home more accessible and safer for all its occupants. Leviton Integrated Networks even includes the core wiring devices that every home needs, selected from Leviton's highest-grade offerings, to upgrade to a quality level that every homeowner can appreciate.

As the only company that can supply every conceivable connectivity need, Leviton remains the industry's reference point for product quality and installation support—and the company responsible for setting the standards that all others ultimately meet.

The Industry Leader in Quality, Support and Service

Leviton has been instrumental in influencing, developing and establishing a myriad of industry standards and codes. An **ISO-9000** certified manufacturer fully resourced to support its substantial customer base, Leviton provides long-term reliability and the highest level of quality across its broad product line. **Six Sigma** is an integral part of Leviton's commitment to continuous improvement in productivity and customer satisfaction. Leviton also maintains an extensive support network dedicated to providing the best, most up-to-date product and systems assistance possible.



Call us at: **800-722-2082** for tech support, **800-922-6229** for product literature and **800-323-8920** for the Leviton representative nearest you.

Structured Media™ Systems Group

STRUCTURED MEDIA™ SYSTEMS GROUP

New Advanced Home System Options for Every Homeowner—Homeowners' expectations are evolving as new communication and entertainment products and technologies transform their homes and their lives. The wired home, once considered a luxury, is now viewed as a necessity in the digital age. The challenge to building the wired home lies in creating an infrastructure with category-rated cabling and components that meet today's needs while laying the groundwork for the whole-house media system of the future. Leviton meets this challenge head-on by offering a single source for all applications.



Innovative Technology Blends Multiple Options Into One System—Leviton Integrated Networks takes the concept of structured cabling, as practiced in demanding commercial applications, and combines it with multimedia. This blending accommodates the convergence of telephone communications, computer and Internet services, audio/video, and much more. An innovative series of modules and media centers—set up as either pre-configured essential platforms or more customized enhanced platforms—manage and distribute voice, data, audio and video in flexible configurations and typical packages that best suit each homeowner's individual requirements. These requirements can range from something as simple as cable TV and telephone in several rooms, to a local area network (LAN) for a small office or home-based business.



SYSTEM PACKAGES

Value Platform

The Value Package ensures a multi-dwelling unit or home unit is wired for today's technologies. It can handle up to four separate telephone lines and distribute them to wall outlets. The system also distributes cable and broadcast video to 4 outlets and can support DSL or cable modems.



Type	Cat No.	Description
Structured Media Center	47605-14W	14" Enclosure acts as distribution center for voice, data and video. Supports up to 4 additional modules
Compact Telephone and Video Panel (1GHZ)	47603-1G4	Supports distribution of up to 4 separate phone lines to nine locations and cable and broadcast video to 4 locations
Quickport® Cat 5 Jacks	41108-R*5	Provide Cat 5 data and telephone connectivity
Quickport® F-Type Connectors	41084	F-connector provides cable/satellite/HDTV/DVD video and high-speed broadband cable modem connectivity at wallplates

Essential Platform

The Essential Package ensures a home is wired for the connected future. It can handle up to four separate telephone or data lines and distributes them to wall outlets. The system also distributes cable TV and off-air antenna to six outlets and can support DSL or cable modems.



Type	Cat No.	Description
Structured Media Center	47605-14W	14" Enclosure acts as distribution center for voice, data and video. Supports up to 4 additional modules
Basic Telephone and Video Panel (2GHZ)	47606-BTV	Supports distribution of up to 4 separate phone lines to nine locations and video to 6 locations
Quickport® Cat 5 Connectors	41108-R*5	Provide Cat 5 data and telephone connectivity
Quickport® F-Type Connectors	41084	F-connector provides cable/satellite/HDTV/DVD video and high-speed broadband cable modem connectivity at wallplates
Surge Protected AC Power Receptacle	47605-ACS	Surge protected duplex receptacle provides AC power

For a detailed selection of Quickport® modules, connectors and wallplates refer to pages 29–39.

For additional Structured Media options refer to Leviton's T600 Structured Cabling Systems brochure or visit our website at www.leviton.com/lin

Structured Media™ Systems Group

Enhanced Platform

The Enhanced Platform provides a larger enclosure and features advanced adaptable architecture for increased connectivity options. For example, it permits quickly changing a spare bedroom into a home office. It includes a security interface and can support additional voice/data outlets.

Type	Part No.	Description
Structured Media Center	47605-28W	28" Enclosure acts as a distribution center for voice, data and video. Supports up to 7 additional modules.
Advanced Telephone and 2GHZ Video Panel	47606-AHT	Supports distribution of up to 4 separate phone lines up to 19 locations (with expansion boards) and video to 6 locations
Quickport® Cat 5e GigaMax™ Connectors	5G108-R*5	Provide Cat 5e data and telephone connectivity
Quickport® F-Type Connectors	41084-FWF	Connects to coaxial cable infrastructure to distribute video entertainment and broadband services.
Dual Surge Protected AC Power Receptacles	47605-DP	Two surge protected receptacles provide AC power



Advanced Entertainment Platform

The Advanced Entertainment Platform provides the core capabilities to distribute voice, data and video to multiple locations throughout the entire home. It incorporates Leviton's Premium 42" Structured Media Enclosure to ensure an easy upgrading via the Networked Home, Broadband Home or Multimedia Home Upgrade Packages.

Type	Cat No.	Description
Structured Media Center	47605-42W	42" Enclosure acts as a distribution center for voice, data and video. Supports up to 12 modules.
24 Port Structured Media Panel	47603-24P	Supports distribution of up to 4 phone lines through up to 19 telephone locations and/or 24 data locations.
3x8 Enhanced Bi-Directional RF Distribution Module, 2GHz	47690-G3Y	Distributes and amplifies cable TV, satellite, video security camera, DVD and VCR signals to multiple TV's and supports bi-directional signaling such as cable modem/cable box communications
DC Power Distribution Module	48212-DCS	Transformer powers multiple DC powered devices
Dual Surge Protected AC Power Receptacles	47605-DP	2 Surge-protected receptacles provide AC power



For a detailed selection of Quickport® modules, connectors and wallplates refer to pages 29–39.

For additional Structured Media options refer to Leviton's T700 Structured Cabling Systems brochure or visit our website at www.leviton.com/lin

For additional audio/video options refer to pages 15–17 and 22–28

Networked Home Upgrade

Adds the convenience of networking PCs and other equipment at 5 locations.

Type	Cat No.	Description
Networking Switch	47611-5PT	10/100 Mbps 5 port Ethernet Switch for sharing data and peripheral devices among 5 computers (cascade additional switches to add more computers)
Cat 5e Expansion Board	47605-C5B	Provides up to six additional telephone/data outlets



Broadband Home Upgrade

Connect to a Category 5e network at either 10 or 100Mbps at 4 locations to share data and peripherals. Plus, it provides Internet sharing with firewall protection for multiple PCs.

Type	Cat No.	Description
Internet Gateway	47611-GTA	Provides Internet access sharing with firewall protection plus sharing of data and peripheral devices between four PC's in remote locations around the house. Cascade with additional hubs and switches to support a total of up to 253 devices
Cat 5e Expansion Board	47605-C5B	Provides up to six additional telephone/data outlets



For a detailed selection of Quickport® modules, connectors and wallplates refer to pages 29–39.

Structured Media™ Systems Group



Multimedia Home Upgrade

Note: Advanced Entertainment Platform recommended

Type	Cat No.	Description
Decora Digital™ Chopin™ Volume Control Kit	48211-*VK	Digital volume control provides high-quality sound and Decora styling
Decora Digital Volume Control Wall Unit	48211-*VC	Interface hub provides technologically advanced volume control
Decora Strauss Stereo Volume Control	40888-72W	Impedance-matching analog stereo volume control with ON-OFF Switch
Decora Media System Hub with Power Supply	48210-MCH	DMS permits whole-house distribution of VCR, DVD, Media cable TV, MP3, etc. signals over Cat 5 cable
Decora Media System Send Unit with Power Supply	48210-MSU	DMS Send Unit is used to send information from its source to the DMS Hub or to a DMS Receive Unit
Decora Media System Receive Unit	48210-MRU	DMS Receive Unit is used to send source information from the DMS Hub or DMS Send Unit to an A/V output device
1X6 Passive Audio Module	48211-6A	Distributes centralized stereo to up to six pairs of speakers
Decora Media Systems Send and Receive Unit Pair with Power Supply	48210-SRU	Point-to-Point model where Send and Receive Units are linked directly together
100 Watt In-Wall Flush Mount Speaker	40890-WS	High-quality 100 watt 8" woofer, 1/2" Polydome Tweeter, 90dB, 8 Ω, paintable grill and frame, 9 5/8" x 6 1/4" wall opening
100 Watt Ceiling Mount Round Speaker	40896-W	High-quality 100 watt 6 1/2" woofer, 1" Polydome Tweeter, 90dB, 8 Ω, paintable grill and frame, 8 1/2" diameter ceiling opening
Desktop Stereo Modulator	48210-DSM	Combines A/V signals from source such as DVD Player and converts it to RF for distribution
IR Repeater System Target	46721-CMS	Receives IR Signal and converts it to low-voltage DC
IR Repeater System Emitter	47621-MIE	Converts DC signal to RF to control device
1x9 Bridged Telephone Module without bracket	47603-110	Permits multiple emitter configurations
DC Power Distribution Module	48212-DCS	Transformer powers multiple DC powered devices
Internet Gateway	47611-GT4	Provides Internet access sharing with firewall protection plus sharing of data and peripheral devices between four PC's in remote locations around the house. Cascade with additional switches to support a total of up to 253 devices

For a detailed selection of Quickport® modules, connectors and wallplates refer to pages 29–39.



Home Video Monitoring Upgrade

Gives homeowners the ability to keep an eye on home entry areas or family members with video security cameras using an in-home (CCTV) system. The cameras monitor four locations and allow homeowners to see the images on a dedicated "security" channel in sequence as the view changes from one camera to the next.

Note: Advanced Entertainment Platform recommended

Type	Cat No.	Description
Indoor Camera	48213-*DC	Decora-styled indoor monitoring camera provides high-quality color video output
Outdoor Camera	48213-ECC	Low-light sensitive, ruggedly-constructed, outdoor monitoring camera provides high-quality color video output
3x8 Enhanced RF Distribution Module, 2GHz	47690-G3Y	Distributes and amplifies cable TV, satellite, video security camera, DVD and VCR signals to multiple TV's and supports bi-directional signaling such as cable modem/cable box communications
Video Modulator	48213-VMA	Modulates signal on to one unused cable TV channel
Video Sequencer	48213-CVS	Allows sequential monitoring of up to four cameras
Notch Filter	47690-NFA	Blocks pre-assigned channel on your cable TV, allowing use for video monitoring

*Colors: (I) Ivory, (W) White, (A) Almond

Structured Media™ Systems Group

GUIDELINES FOR LEVITON'S CERTIFIED INSTALLER PARTNER PROGRAM

Leviton Integrated Networks offers installers the opportunity to gain a competitive advantage in their business through a Comprehensive Certification Program. This program includes seminars to improve job planning and installation skills and adds a limited 15 Year Extended

Warranty on passive structured media component systems that have been tested and registered with the company. For details, please see warranty information in the Installation Manual. Superior technical support and effective marketing support tools are also provided. For more information on taking advantage of this program for your business, contact your distributor, your Leviton representative or call 1-800-323-8920.



BUILDER PROGRAMS

These programs provide the marketing and training support that helps everyone understand the benefits of home systems. This includes the education of builder sales people plus the availability of consumer-friendly displays and consumer literature. Leviton Integrated Networks can even provide discounted products to qualified parties as part of the Model Home Program. Speak to your Leviton representative or see the Builder section of our website at www.Leviton.com/lin.

Structured Media™ Centers

FEATURES

- Accommodates up to two full-width Pre-Configured Structured Cabling Panels—delivering audio/video, voice and data to any room of the home or office.
- Positive “stops” on housing sidewalls prevent the enclosure from falling through studs during installation.
- One piece white steel unit holds full and half-width expansion modules.
- Can be surface-mounted or recessed. Ideal for new installations or retrofits.
- Mounting guides on the cover align screw-holes and reduce the chances of dropping during attachment.
- Powder-coated white cover features a 3/4" overlap to hide irregular drywall cuts.
- Combine two or more enclosures for larger installations or future expansion.
- Multiple knock-outs on top and bottom including two new 2" knockouts on top, facilitate cable entry and routing.
- Cut-out in base of enclosure for mounting single gang J-Box kit
- Six 3" square self-healing foam grommets accommodate cable bundles

Series 140 Structured Media Enclosure

This 14" professional-grade whole-house media enclosure creates one distribution point in the home for all low voltage cables. The SMC-140 is ideal for MDU's (Multiple Dwelling Units, such as condos and apartments) or more modest homes requiring limited audio/video/voice and data configurations. It will accommodate two Pre-Configured Structured Cabling Panels. The sturdy design and functionality facilitate installation, reducing job-site labor costs, and making it ideal for essential home networking.



Cat. Nos. 47605-14W Panel enclosure
47606-BTV Basic Telephone and Video Panel
For more information about this sample configuration and components see pages 2 and 10.

Series 140 Structured Media Enclosure

Specifications	
Dimensions:	
Enclosure:	14.38"H.x 14.38"W.x 3.60"D.
Cover:	16.10"H.x 16.10"W.
Materials: .White, powder-coated 18 gauge steel	
Standards Compliance: .ACA and cULus Listed. UL Listed for fire and burglary	

Series 140 Structured Media Enclosures and Covers

Cat No.	Description
47605-14W	Series140 Enclosure and Flush-Mount Cover, empty
47605-14N	Series140 Enclosure only
47605-F14	Series 140 Flush Mount Cover
47605-H14	Series 140 Hinged Cover

For more information on Pre-Configured Cabling Panels, please see pages 10 – 11.

Structured Media™ Centers

Series 280 and 420 Structured Media Enclosures

Command central for home media

convergence, Leviton's SMC-280 and SMC-420 home technology enclosures put the home or small office on the cutting edge of the Information Age. By bringing every conceivable technology distribution point together in one place, they make running cable and managing media both simple and more cost-effective. Designed to incorporate a hospital-grade power quality module for maximum protection from line surges, the 28" and 42" high units accommodate all the latest in functions such as home networking, fax, internet (including high speed services such as DSL, cable modems and ISDN), multi-line telephones, security camera, coaxial cable and satellite video distribution, and speaker and volume controls, when equipped with the correct accessories.

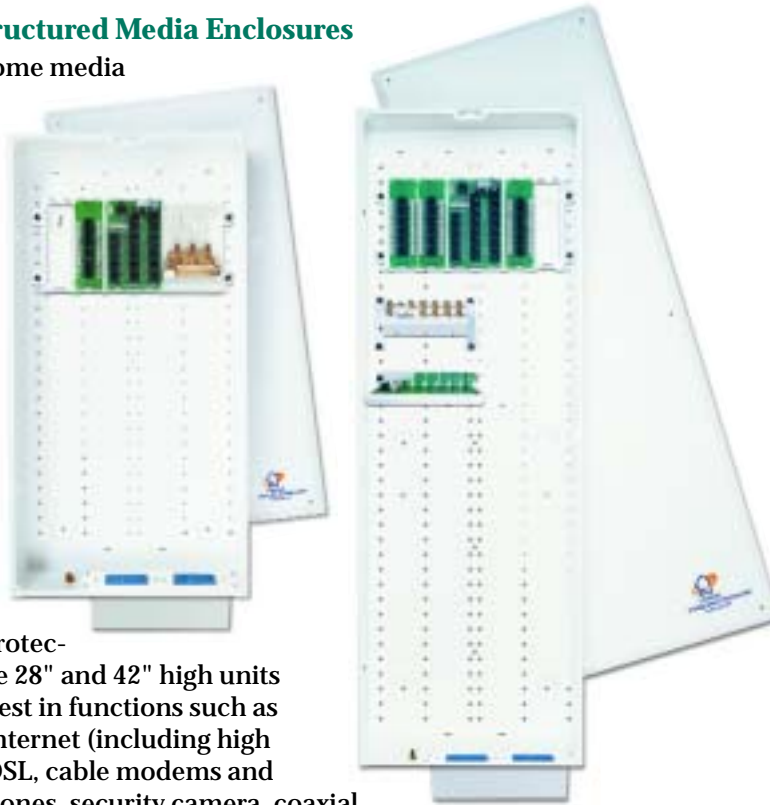

The Series 280 enclosure can comfortably accommodate up to 8 different Distribution Modules, depending on selection and density, and the 420 enclosure, with its generous size and capacity for up to 12 modules, can simultaneously manage many diverse functions. Perfect for home office and home entertainment. Make sure you plan all modules before starting the project, and specify the correct size media center.

*Module count will depend on the type used; some are larger than others.

Series 280 and 420 Structured Media Enclosures

Specifications	
Dimensions:	
SMC-280 Enclosure:28"H.x 14.38"W. x 3.00"D.
SMC-280 Cover:29.25"H.x 15.62"W.
SMC-420 Enclosure:42"H.x 14.38"W. x 3.60"D.
SMC-420 Cover:43.25"H.x 15.62"W.
Materials:White, powder-coated 18 gauge steel
Standards Compliance:ACA and CULUS Listed. UL Listed for fire and burglary

Series 280 and 420 Structured Media Enclosures

Cat No.	Description
47605-28W	Series 280 Enclosure and Flush-mount Cover, empty
47605-28N	Series 280 Enclosure, empty, no cover
47605-F28	Series 280 Flush Mount Cover
47605-H28	Series 280 Hinged Cover
47605-F42	Series 420 Flush Mount Cover
47605-42N	Series 420 Enclosure, empty, no cover
47605-H42	Series 420 Hinged Cover
47605-42W	Series 420 Enclosure and Flush-mount Cover, empty

FEATURES

- Multiple knock-outs (up to 2") on top, bottom, sides and back, including two new 2" knock-outs on top, facilitate cable entry and routing from every desired room.
- Six 3" square self-healing foam grommets accommodate cable bundles and protect them from being cut
- Sturdy, one-piece white steel construction.
- Combine two or more enclosures for larger installations or future expansions.
- Holds ¼, ½ and full-width expansion modules with the ability to mount most modules vertically or horizontally.
- Large capacity provides multiple functionality for "wired" homes.
- Powder-coated white cover features a ¾" overlap to hide irregular drywall cuts.
- Mounting hooks on the cover align screw-holes and reduce the chances of dropping during attachment.
- Holds a broad range of current and future distribution modules, delivering audio, video, voice, data, security, and more to any room of the home or office.
- Threaded inserts added to enclosure to ensure accurate threading of screws when mounting cover
- Can be surface-mounted or recessed. Ideal for new installations or retrofits.
- Knock-out in base of enclosure for mounting of either a single gang J-Box kit or an AC power module
- Designed to accommodate safe, high-quality hospital-grade power module with surge suppression.

Structured Media™ Centers

FEATURES

- Eight 1" or 1.5" conduit fittings on top and bottom facilitate cable entry and routing.
- Wall-mount or recess. Ideal for new installations or retrofits.
- Securible door provides maximum protection from dust and abuse.
- Plywood backing allows open architecture for customizing layout and can accommodate a wide variety of Structured Media Distribution Modules.

Media Versatile™ Panel—For Custom Retrofits and Remodeling

Ideal for custom retrofits and remodeling applications, the Media Versatile™ Panel with 3/8" plywood backing allows an open architecture for consolidating low voltage electronics and distribution components for phone, fax/modem, data, home networking, audio, video and home control. The 24" high cold-rolled steel panel with securible door will accommodate a wide variety of Structured Media Distribution Modules by simply removing the Push-Lock Pins and attaching directly to the plywood backing. The sturdy construction is built to industrial-grade standards, and the panel can be surface mounted or recessed in the wall. (Optional mounting brackets may be used for non-standard stud spacing). Ideal for custom retrofits and remodeling applications. Available in black powder coat finish. UL Listed.



Media Versatile Panel

Specifications	
Dimensions:24"H.x 14"W. x 6"D.
Materials:Powder-coated 18 gauge steel with 3/8" plywood backing
Standards Compliance:UL Listed.

Media Versatile Panel

Cat No.	Description
47602-24E	Media Versatile Panel
47602-BKE	Mounting Brackets—(set of 4)









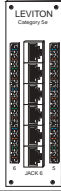

Structured Media™ Panels/Modules

PRE-CONFIGURED STRUCTURED CABLING PANELS

Route telephone, data and video services throughout your home or office with one simple panel. Leviton's Pre-configured Structured Cabling Panels combine some of our most popular voice, data and RF modules to create an economical one-stop home and office media distribution point. See the following pages for available configurations. Some modules are available in expansion styles to fill unused panel slots (see this page). Choose the pre-configured combination that best meets your needs, and enhance with expansion boards or stand-alone brackets.

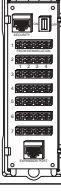
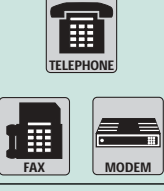
Panel Components & Expansion Boards

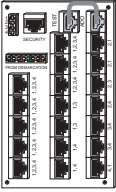
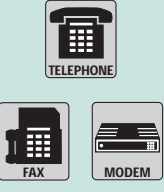
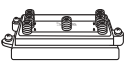
Pre-configured Panels are assembled at the factory and will contain one or more of the following distribution modules.

Components	Application	Features	Available As
 <p>1x9 Bridged Telephone Board</p> <p>Basic telephone distribution</p>		<ul style="list-style-type: none"> • Bridge up to 4 telephone lines to 9 locations • Connect up to 9 separate telephones per line • Printed circuit board module • 4-pair 110-type IDC punchdowns 	<ul style="list-style-type: none"> • Part of a Pre-configured Panel • Stand-alone module with bracket • Expansion board without bracket
 <p>Category 5e Voice & Data Board</p> <p>Basic home networking</p>		<ul style="list-style-type: none"> • Patch phone or data connections to 6 locations • Combine with a TLDM, key system, or network hubs for additional applications • Printed circuit board module • 4-pair 110-type IDC punchdowns and 6 CAT 5e RJ-45 ports* 	<ul style="list-style-type: none"> • Part of a Pre-configured Panel • Stand-alone module with bracket • Expansion board without bracket
 <p>Telephone Patching Board</p> <p>Expanded 4-line telephone distribution</p>		<ul style="list-style-type: none"> • Bridge up to 4 telephone lines to 7 locations • Printed circuit board module • One incoming 4-pair 110-type IDC punchdown and 7 outgoing RJ-45 jack connections • Combine with a Category 5e Board to route telephone to remote locations 	<ul style="list-style-type: none"> • Part of a Pre-configured Panel • Expansion board without bracket
 <p>Telephone Security Board</p> <p>Route simple telephone with security interface</p>		<ul style="list-style-type: none"> • Bridge up to 4 telephone lines to 6 locations • Connect up to 6 separate telephones per line • Connect to security system • Printed circuit board module • 4-pair 110-type IDC punchdowns 	<ul style="list-style-type: none"> • Stand-alone module with bracket
 <p>DSL Filter Board</p> <p>Filters DSL signal from telephone line</p>		<ul style="list-style-type: none"> • Filters DSL signal from phone line before distribution throughout a home or office. • Eliminates need for individual filters at each wallplate. • Use with any phone distribution module. • Printed circuit board module with RJ-45 jack and 110 punchdowns 	<ul style="list-style-type: none"> • Stand-alone module with bracket • Expansion board without bracket
 <p>Telephone Line Distribution Module (TLDM)</p> <p>Enhanced telephone distribution</p>		<ul style="list-style-type: none"> • 19 multi-line telephone connections in combinations of 2 or 4 lines • Bridge "Line 1" service to 12 locations and 4-line service to 8 locations • Connect to CAT 5e Voice & Data Board(s) or additional panels for more connections and easier adds/moves/changes • Independent RJ-45 jack and punchdown security interface to accommodate alarm systems 	<ul style="list-style-type: none"> • Part of a Pre-configured Panel ONLY
 <p>Video Splitters</p> <p>Basic video distribution</p>		<ul style="list-style-type: none"> • Cable TV or off-air antenna signals • 4-way or 6-way RF Splitter • Die-cast housing • Available in 1GHz and 2GHz models 	<ul style="list-style-type: none"> • Part of a Pre-configured Panel • Stand-alone module with bracket

Structured Media™ Panels

PRE-CONFIGURED STRUCTURED CABLING PANELS — FULL SIZE

Leviton has a Pre-Configured Structured Cabling Panel to fit any application. See opposite for explanations of individual boards. Use the Panels as they are, expand with easy snap-in Expansion Boards, or combine with other Panels or Stand-alone Modules to create a Structured Media solution tailored to your specific needs. Ideal for all installations, from basic to high-end. The new non-conductive synthetic bracket features a rugged construction and a “shelf-style” design with enhanced cable management and easier installation. Boards quickly snap on and off for easy adds/moves/changes.

Pre-Configured Structured Cabling Panels

	Cat No.	Description	Consists of:
A	47606-BTV	A –Basic Telephone and Video Panel (BTV)	<ul style="list-style-type: none"> • (1) 1x9 Bridged Telephone Board • (1) 6-way 2GHz Video Splitter • Bridge up to 4 telephone lines to 9 locations • Route video to 6 locations
B	47606-BNP	B –Basic Home Networking Plus Panel (BNP)	<ul style="list-style-type: none"> • (1) Telephone Patching Board • (1) Category 5e Voice & Data Module • (1) 6-way 2GHz Video Splitter • 6 4-line telephone connections • Route video to 6 locations • Patch data or telephone service to 6 remote locations • Comes with 6 8-inch 8p8c Flat Patch Cords
C	47606-AHT	C –Advanced Home Telephone & Video Panel (AHT)	<ul style="list-style-type: none"> • (1) Telephone Line Distribution Module • (1) Category 5e Voice & Data Board • (1) 6-way 2GHz Video Splitter • 19 multi-line telephone connections (in various combinations of 2 or 4 lines) • Route video to 6 locations • Patch data or telephone service to 6 remote locations • Comes with 6 8-inch 8p8c Flat Patch Cords
D	47603-PTE	D –12-Port Structured Media Panel (12P)	<ul style="list-style-type: none"> • (1) Telephone Line Distribution Module • (2) Category 5e Voice & Data Boards • 19 multi-line telephone connections (in various combinations of 2 or 4 lines) • Patch data or telephone service to 12 remote locations • Comes with 12 8-inch 8p8c Flat Patch Cords
E	47603-18P	E –18-Port Structured Media Panel (18P)	<ul style="list-style-type: none"> • (1) Telephone Line Distribution Module • (3) Category 5e Voice & Data Boards • 19 multi-line telephone connections (in various combinations of 2 or 4 lines) • Patch data or telephone service to 18 remote locations • Comes with 18 8-inch 8p8c Flat Patch Cords
F	47603-24P	F –24-Port Structured Media Panel (24P)	<ul style="list-style-type: none"> • (1) Telephone Line Distribution Module • (4) Category 5e Voice & Data Boards • 19 multi-line telephone connections (in various combinations of 2 or 4 lines) • Patch data or telephone service to 24 remote locations • Comes with 24 8-inch 8p8c Flat Patch Cords

Full-size panel dimensions: 6.25"H.x 13.06"W.x 2.50"D.

For detailed features and dimensions, please consult individual specification sheets at www.levitonvoicedata.com

Structured Media™ Panels

PRE-CONFIGURED STRUCTURED CABLING PANELS — COMPACT SERIES

Leviton's simple solution for basic telephone and video distribution. These compact panels, with their space-saving profile provide simple bridged telephone to 9 locations and 1GHz video to four or six locations, respectively.

Compact Series Panels are ideal for MDUs and apartments, installations with space constraints and/or installations where budget is the driving concern.

Pre-Configured Structured Cabling Panels—Compact Series

Cat No.	Description	Consists of:
47603-1G6	G —COMPACT SERIES Telephone & 6-Way Video	<ul style="list-style-type: none"> • (1) 1x9 Bridged Telephone Board • (1) 6-way 1GHz Video Splitter • Bridge up to 4 telephone lines to 9 locations • Route video to 6 locations
47603-1G4	H —COMPACT SERIES Telephone & 4-Way Video	<ul style="list-style-type: none"> • (1) 1x9 Bridged Telephone Board • (1) 4-way 1GHz Video Splitter • Bridge up to 4 telephone lines to 9 locations • Route video to 4 locations
47603-TSV	I —COMPACT SERIES Telephone Security & 6-Way Video	<ul style="list-style-type: none"> • (1) Telephone Security Board • (1) 6-way 1GHz Video Splitter • Bridge up to 4 telephone lines to 6 locations • RJ-45 Port for Security Interface • RJ-45 Expansion Port • Route video to 6 locations

Compact panel dimensions: 6.5"H.x 6.5"W.

For detailed features and dimensions, please consult individual specification sheets at www.levitonvoicedata.com

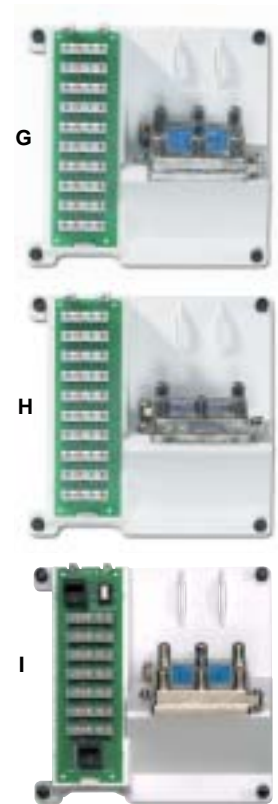

STAND-ALONE MODULES AND EXPANSION BOARDS

Stand-Alone Modules

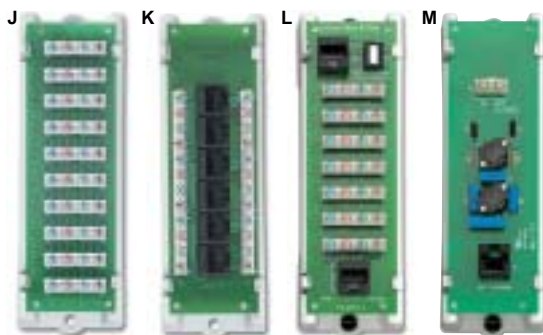

Expansion Boards

Stand-Alone Modules

Cat. No.	Description—Module w/Bracket
47689-00B	J —1x9 Bridged Telephone Module
47605-C5B	K —Category 5e Voice and Data Module
47609-TSV	L —Telephone Security Module
47616-DSB	M —DSL Filter Module
Available only as part of a Pre-configured panel	Telephone Line Distribution Mode

Expansion Boards

Cat. No.	Description—Module w/Bracket
47603-110	N —1x9 Bridged Telephone Board
47603-C5	O —Category 5e Voice and Data Board
47609-EMP	P —Telephone Patching Expansion Board
47616-DSF	Q —DSL Filter Board
Available only as part of a Pre-configured panel	Telephone Line Distribution Mode

Multimedia Adapter Bracket and Mounting Plates

Create a custom audio/video, copper or fiber mini-panel in your Structured Media Center with the Multi-Media Adapter Bracket. The bracket supports your choice of two 6-pack mounting plates, and snaps easily into any of Leviton's Structured Media Centers with push-pins. Pre-loaded mounting plates are available for BNC and F-connectors, or create a custom configuration with unloaded 6-pack QuickPort plates. QuickPort plates accept any combination of the following QuickPort adapters or connectors: BNC, F-Connector, ST, FC, SC and MT-RJ Fiber Optics, Banana Jacks, Speaker Binding Posts, RCA, S-Video, Voice Grade, and Category 5, 5e or 6. Bracket mounts vertically or horizontally.

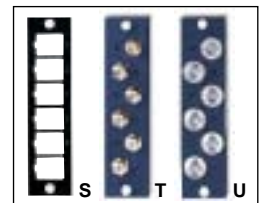

Cat No.	Description
47612-MMA	R —Multimedia Bracket
5F100-BNC	S — BNC Mounting plate, 6-pack, loaded
5F100-6VF	T — F-Connector Mounting plate, 6-pack, loaded
5F100-6QP	U — QuickPort Mounting plate, 6-pack, unloaded

Accessories

Cat. No.	Description
42400-8FG	8-Conductor Flat Telephone Patch Cord, 8' long ((1 each)

Media Center Power

SURGE-PROTECTIVE AND STANDARD AC POWER MODULES AND J-BOX KITS

Surge AC Power Module or J-Box kit models add clean, safe power to the Series 280 or 420 Structured Media Enclosures (Series 140 enclosure only accepts J-Box kits). Two non-surge protected AC Power Module or J-Box kit units offer an economical method of providing power to distribution modules and, except for built-in surge suppression, offer the same features as the respective surge-protected units. In extremely excessive surge conditions, an alarm will sound to warn the user that power is unprotected. Consists of one (J-Box kit) or two (AC Power Module) 15 Amp Hospital Grade duplex receptacles housed in a powder-coated steel enclosure. They feature EMI/RFI filtering and meet UL 1449 standards.

FEATURES

- Hospital grade surge-protected units provide greater protection for line-voltage modules, including multi-stage defense (L-N, L-G, N-G)
- Non-surge suppressor units provide an economical method of providing power to active components
- Available with one (J-Box kits) or two (AC Power Modules) 15 Amp duplex receptacles
- Safety clips protect outlets against dust, dirt and debris
- One (J-Box kits) or two (AC Power Modules) cable knock-outs on bottom for power service connection
- Saves valuable real estate by mounting on outside of Structured Media Enclosures
- Meets UL 1449 standards

AC Power Modules for 280 and 420 Series Structured Media Enclosures

Specifications	
Dimensions:	10"H.x 2.8"W.x 2.3"D.
Standards Compliance (Surge model only):	UL 1449
Input:	.2 @ 15A 120V AC

AC Power Modules for 280 and 420 Series Structured Media Enclosures

Cat No.	Description
47605-DP	Surge AC Power Module, Two Duplex Receptacle
47605-NDP	Non-Surge AC Power Module, Two Duplex Receptacles

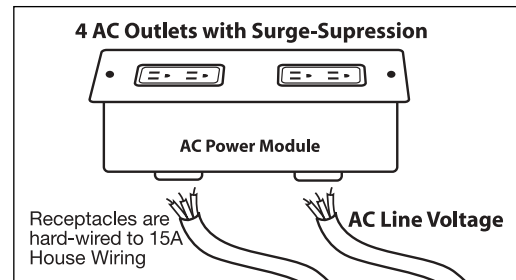

Cat. No. 47605-ACN
Non-Surge J-Box Kit

J-Box Kits for 140, 280 and 420 Series Structured Media Enclosures

Specifications	
Dimensions:	3"H.x 2"W.x 2.5"D.
Standards Compliance (Surge model only):	UL 1449
Input:	.1 @ 15A 120V AC

J-Box Kits for 140, 280 and 420 Series Structured Media Enclosures

Cat. No.	Description
47605-ACS	Surge J-Box Kit, One Duplex Receptacle
47605-ACN	Non-Surge J-Box Kit, One Duplex Receptacle



Cat. No. 47605-PSB
Universal Mini DC Power Supply

UNIVERSAL MINI DC POWER SUPPLY

This compact unit is designed specifically to fit into Leviton's Series 140, 280 and 420 Structured Media enclosures. It is compatible with any incoming AC voltage in the range of 90 to 264V. Three 12VDC connectors provide up to 10 watts of power while providing short circuit overload and surge protection as well as EMI/RFI filtering to connected equipment. Three DC cables are included to connect modules to the power supply. (UL 1950, cULus listed, NOM, ACA and China)

Universal Mini Power Supply

Cat. No.	Description
47605-PSB	Universal Mini DC Power Supply

Media Center Power

Snap-In Modules for Structured Media Enclosure Surge Module Bracket

Leviton's snap-in surge protective modules provide customized surge protection for all low-voltage communication and data lines in the Structured Media Enclosure. All Series 5950 modules can snap-in to the Cat. No. 3950-BKT Surge Module Bracket. The bracket, allows you to add and change modules to fit specific protection needs. Choose from a selection of protection modules for Digital Satellite Systems, Ethernet systems, Cable TV, Telephone/Fax/Modem and DSL/ADSL equipment. All devices attached to the modules are covered under the Leviton \$50,000 Connected Equipment Warranty.



Snap-In Surge Protection Modules

Cat No.	Description
Beige—5951-SA Gray—5951-SAT Ice—5951-SAC	Satellite System/Cable TV Protection Module —4 Standard F-connectors. 3-Amp fuse for over-current. Max. line voltage: 75V DC. Breakdown Voltage Range: 70.4-110 Volts/Sec
Beige—5952-ET Gray—5952-ETH Ice—5952-ETC	Ethernet Protection Module (10 Base-T Applications) —Two RJ45 connectors to protect two pair of transmit/receive lines. 10-Amp automatic Resettable PTC fuses. Max. operating voltage: 16.6V DC. Breakdown Voltage Range: 2.62-19.2 Volts/Sec
Beige—5953-PC Gray—5953-PCG Ice—5953-PCC	Cable TV System Protection Module —Two Standard F-type connectors. 3-Amp fuse for over-current. Max. line voltage: 75V DC. Breakdown Voltage Range: 70.4-110 Volts/Sec
Beige—5954-AT4 Gray—5954-PT4 Ice—5954-CT4	Telephone/Fax/Modem Protection Module —Three RJ11, 4-wire/2-pair connectors. 3-Position splitter allows for connection to a common line. 3-Amp fuse for over-current protection. Max. operating voltage: 150V rms (including ring voltage). Breakdown Voltage Range: 162-331 Volts/Sec
Beige—5955-DT Gray—5955-DTG Ice—5955-DTC	DSL/ADSL Subscriber Equipment Protection Module —Three RJ11, 4-wire/2pair connectors. 3-Amp fuse for over-current protection. Max. operating voltage: 150V rms (including ring voltage). Breakdown Voltage Range: 162-331 Volts/Sec

FEATURES

- Interchangeable modules accommodate changing surge protection needs
- All modules easily snap in to the Cat. No. 3950 Surge Module Bracket
- User-friendly design—no wiring required
- Telephone/Fax/Modem Module acts as a splitter, allowing the connection of two devices

DC Power Distribution Module

The DC Power Distribution Module is a unique solution to the need for high quality electrical power for the separate DC-powered components in the Structured Media Enclosure. This module reduces clutter and opens-up space in the Structured Media Enclosure by eliminating the need for multiple DC transformers. Powered by a single DC power supply, the Power Distribution module provides fully-regulated 12 VDC power for up to 6 devices.



FEATURES

- Contains six removable double screw terminal jacks.
- One F-type output for use with cable amplifiers.
- Each jack utilizes slot-drive screws.
- Shipped with 6 wires containing 18 gauge connectors and 2.1 mm power plugs.
- Fully regulated (12 volt DC regulated output).

DC Power Distribution Module

Specifications
Input:110V AC
Output:Provides 13V DC power for up to 6 devices 1500mA
Compliance (Surge model only):UL 1449
Dimensions:6.58"H.x 2.5"W.x 1.5"D.
Wire Gauge:Up to 12 gauge

DC Power Distribution Module

Cat No.	Description
48212-DCS	DC Power Distribution Module

Networking and Internet Sharing

FEATURES

- Connects up to 4 devices directly (up to 253 computers via a series of cascaded devices) to the Internet using a single shared high-speed DSL, cable modem, or Satellite connection
- Allows fast Internet access at up to 100 Mbps
- Permits creation of a private high-speed home area network (HAN) or local area network (LAN) in small office/home office (SOHO) environments for all connected computers with its fast, integral 10/100Mbps auto-sensing Ethernet ports
- High performance suitable for demanding home office and telecommuting applications, including sharing of high-speed and high-capacity devices such as storage devices and back-up systems.
- Network Address Translation technology (NAT) creates a firewall that securely cloaks the private network from outside access
- Pass-through IPSEC and ISAKMP protocols allow attached LAN users to implement secure Virtual Private Network (VPN) communication applications on their PC's.
- Built-in DHCP server for easy setup and allocation of IP addresses on the LAN.
- Connections are made by running cable from desired locations to a Category 5e Voice and Data Module (either a stand-alone module page 16, or one of the units in the Pre-Configured Structured Cabling Panels page 17). From there, Category 5 or 5e patch cord can be used to connect the Gateway to the Category 5e Module.
- Network protocols: TCP/IP, DHCP, DNS, NAT, TFTP, HTTP, PPOE. Not PPOA



Cat. No. 47611-5PT



Cat. No. 47611-8PT

STRUCTURED MEDIA™ MODULES—INTERNET CONNECTION SHARING & MULTI-LOCATION NETWORKING

10/100 Internet Gateway Cable/DSL Broadband Router*

Leviton's 10/100Mbps Internet Gateway (a.k.a router) allows multiple users to securely share a single, protected high-speed Internet connection.

10/100 Base-T Switches*

At 10/100Mbps speeds, these units are excellent choices for networking PC's to meet a wide range of residential needs such as sharing files, printers and other peripherals.

*Networked PC's and peripherals require compatible networking cards or adapters and associated software.

10/100 Base-T Switches and 10/100 Base-T Internet Gateway Router

Specifications	10/100Base-T 5-Port (or 8-Port) Switches	10/100 Base-T Internet Gateway Router
Data Transfer Rate	10/100 Mbps	
Connectors	5 (or 8) ports, 1 AC Power Adapter Jack	4 LAN ports, 1 WAN port, 1 Uplink port, 1 AC Power Adapter Jack
Cabling Requirements	Standard Cat 5/5e UTP	
LED Indicators	One Power Indicator, 5 (or 8) Link/Activity and 5 (or 8) 100Mbps	One Power Indicator, one Diagnostic Indicator, five Link/Activity, five FDX/Col and five 10/100Mbps
Power Supply	12VDC, 1000mA	
Dimensions	5.85" x 3.2" x 1.03"	5.54" x 3.92" x 1.05"
Standards Compliance	IEEE 802.3 10 Base-T Ethernet IEEE 802.3u 100 Base-TX Fast Ethernet, and FCC Class B	

10/100 Base-T Switches and 10/100 Base-T Internet Gateway Router

Cat. No.	Description
47611-5PT	10/100 Base-T 5-Port Ethernet Switch, with Power Adapter
47611-8PT	10/100 Base-T 8-Port Ethernet Switch, with Power Adapter
47611-GT4	10/100 Base-T Internet Gateway Router, with Power Adapter

Cable Distribution—Modem Outside the Structured Media Center

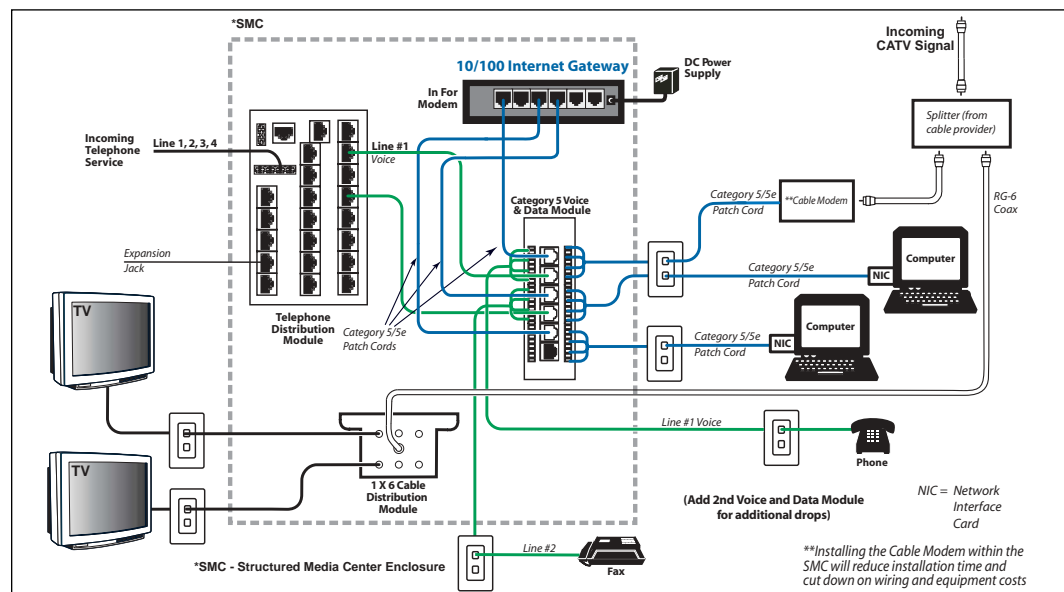

Cat No. 47611-GT4
10/100Mbps Internet
Gateway Router

Video Distribution

ENHANCED RF VIDEO DISTRIBUTION MODULES

Cable service providers are converting to digital systems. These new systems will squeeze hundreds of channels plus Internet service onto the coax line. Leviton's high-performance video modules can support these new systems while limiting noise and other artifacts. Modules can distribute standard inputs such as CATV and antennas, and modulated inputs such as VCR's, DVD's and security camera/CCTV on coaxial cable throughout the house. Signals can be precisely controlled through the modules' built-in amplifier/attenuator (-5 to +15db) to compensate for variations in incoming signal strength for the clearest possible reception*.



Incorporates state-of-the-art bi-directional signal paths to support cable modem or cable box communications throughout a home or office. The outlet ports are isolated and do not require any termination caps. Choose from one or three-input models; both come with 8 outputs. One and three-input models come in both 1 and 2 GHz versions. Dimensions: 3.55"H.x 6.57"W.x 3.29"D. Connector: F-Type. Impedance: 75 Ohm. Power Input: 12 VDC, 500 mA (1x8 & 3x8); 12 VDC, 1000 mA (4x16).

*Not for use in-line between DBS satellite dish (LNB) and DBS satellite TV receiver.

1x8 and 3x8 Enhanced RF Distribution Modules (1 GHz)

ITEM	GAIN (dB)			RETURN LOSS (dB)		ISOLATION (dB)			
	FORWARD		REVERSE	FOR.	REV. (ANY OUTPUT)	AUX-AUX	CABLE-AUX	OUT-OUT	
	54-1000 MHz	1.0-1.4 GHz	10-40 MHz						
1x 8 RF Module	+15 +/-2*	+9 +/- 5	0 +/-2	11 Typ.	12 Typ.	N/A	N/A	25	
3 x 8 RF Module	CATV	+15 +/-2*	+9 +/- 5	0 +/-2	11 Typ.	12 Typ.	18	30	25
	AUX 1	+12 +/-2*	+6 +/- 5	N/A	11 Typ.				
	AUX 2	+12 +/-2*	+6 +/- 5	N/A	11 Typ.				

*Note: Tilt specification for all units is less than +/- 3 dB to 1 GHz

1x8 and 3x8 Enhanced RF Distribution Modules (2 GHz)

ITEM	GAIN (dB)			RETURN LOSS (dB)		ISOLATION (dB)		
	FORWARD		REVERSE	FOR.	REV. (ANY OUTPUT)	AUX-AUX	CABLE-AUX	OUT-OUT
	1.0-2.0 GHz		10-40 MHz					
1x 8 RF Module	+4 +/-6	0 +/-2	11 Typ.	12 Typ.	N/A	N/A	25	
3 x 8 RF Module	CATV	+4 +/-6	0 +/-2	11 Typ.	12 Typ.	18	30	25
	AUX 1	+1 +/-6	N/A	11 Typ.				
	AUX 2	+1 +/-6	N/A	11 Typ.				

*Note: Tilt specification for all units is less than +/- 5 dB to 2 GHz

Enhanced RF Distribution Modules

Cat No.	Description
47690-ESM	1x8 Enhanced RF Module, 1 GHz
47690-GSM	1x8 Enhanced RF Module, 2 GHz
47690-3BY	3x8 Enhanced RF Module, 1 GHz
47690-G3Y	3x8 Enhanced RF Module, 2 GHz
47690-4BY	4x16 Enhanced RF Module, 1 GHz
47690-G4Y	4x16 Enhanced RF Module, 2 GHz

Video Distribution

Enhanced Bi-Directional RF Amplifier

This unit offers extremely low noise for 1 CATV/Antenna input and 1 coaxial output to boost CATV (or other RF service) signal strength. It incorporates a variable attenuator (0 to +20dB for precise amplification for the clearest signal possible. Cable TV or other RF signals can be run through this Enhanced Bi-Directional RF Amplifier before splitting and distributing them throughout a home or office. Dimensions: 3.55"H.x 6.57"W.x 3.29"D. Connector Type: F Impedance: 75 Ohm. Power Input: 12 VDC, 200 mA.

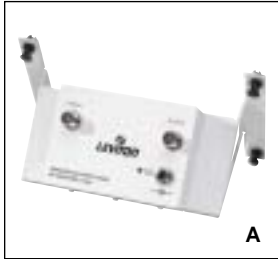

Enhanced Bi-Directional RF Amplifier-1 GHz

ITEM	GAIN (dB)		RETURN LOSS (dB)		ISOLATION (dB)		
	FORWARD	REVERSE	FOR.	REV. (ANY OUTPUT)	AUX-AUX	CABLE-AUX	OUT-OUT
	54 -1000MHz	10-40MHz					
Enhanced RF Amp.	19 +/-2*	0 +/-2	11 Typ.	12 Typ.	N/A	N/A	N/A

*NOTE: Tilt specification for all units is less than +/- 3 dB to 1 GHz

Enhanced Bi-Directional RF Amplifier-2 GHz

ITEM	GAIN (dB)		RETURN LOSS (dB)		ISOLATION (dB)		
	FORWARD	REVERSE	FOR.	REV. (ANY OUTPUT)	AUX-AUX	CABLE-AUX	OUT-OUT
	1.0-2.0 GHz	10-40MHz					
Enhanced RF Amp.	19 +/-2*	0 +/-2	11 Typ.	12 Typ.	N/A	N/A	N/A

*NOTE: Tilt specification for all units is less than +/- 5 dB to 2 GHz

FEATURES

- Variable attenuator enables precise amplification for the clearest signal possible.
- Run cable TV or other video signals through the Video Amplifier before splitting and distributing throughout the home or office.
- Boost signal strength by up to 20 dB.

Enhanced Bi-Directional RF Amplifiers

Cat No.	Description
47690-BVA	A-Enhanced Bi-Directional Amplifier, 1 GHz
47690-GVA	Enhanced Bi-Directional Amplifier, 2 GHz



Video Amplifier

Run cable TV and other video service signals, such as antenna or other modulated input through this Video Amplifier Module and boost video signal strength up to 25 dB. Features a variable attenuator for signal amplification level setting, and an FM trap to eliminate unwanted FM interference.

FEATURES

- Run cable TV or other video signals through the Video Amplifier before splitting and distributing throughout the home or office.
- Boost signal strength by up to 25 dB.

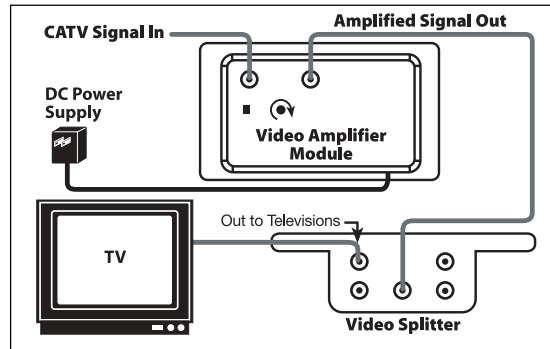

Video Amplifier

Specifications
Dimensions:6.58"H.x 3.67"W. x 4.4"D.
Frequency Range MHz:50-1000
Gain Control Range dB:10-25dB
FM Trap dB:25
Impedance:75 Ohm
Connector Type:F-type
Power Source:12 VDC 500 mA

Video Amplifier

Cat. No.	Description
48210-VA	B-Video Amplifier Module

Video Distribution

PASSIVE COMPONENTS

1x4, 1x6, 1x8 Passive Video Splitters

Use 4-, 6- and 8-way Passive Video Splitters to split digital cable (2.05 GHz units), quality cable TV and off-air antenna signals to 4, 6, or 8 televisions throughout the home or office. They feature die-cast housing and printed circuit board construction. Use with the Video Amplifier for increased signal strength.



2 GHz Modules

1x4, 1x6, 1x8 Passive Video Splitters

Item	Cat No.	Dimension	Range	Insertion Loss (dB)	Return Loss (dB)	Isolation (dB)
1x4	47690-4C	6.58"H.x 2.14"W.x 1.4"D.	1 GHz	7.0 dB – 8.1 dB	7.7 dB – 8.1 dB	28.3 dB – 48.5 dB
	47690-4C2	6.58"H.x 2.14"W.x 1.4"D.	2 GHz	7.7 dB – 10.5 dB	9.5 dB – 21.0 dB	24.0 dB – 30.0 dB
1x6	47690-6C	6.58"H.x 3.0"W.x 1.4"D.	1 GHz	10.0 dB – 12.1 dB	6.5 dB – 23.5 dB	28.9 dB – 37.5 dB
	47690-6C2	6.58"H.x 3.0"W.x 1.4"D.	2 GHz	11.0 dB – 14.0 dB	11.5 dB – 23.5 dB	35.0 dB – 39.5 dB
1x8	47690-8C	6.58"H.x 3.0"W.x 1.4"D.	1 GHz	11.5 dB – 13.0 dB	6.2 dB – 20.1 dB	34.0 dB – 65.0 dB
	47690-8C2	6.58"H.x 3.0"W.x 1.4"D.	2 GHz	11.9 dB – 15.7 dB	9.9 dB – 30.0 dB	32.0 dB – 39.2 dB

1x4, 1x6, 1x8 Passive Video Splitters

Cat No.	Description
47690-4C	1x4 Passive Video Splitter Module (1 GHz)
47690-6C	1x6 Passive Video Splitter Module (1 GHz)
47690-8C	1x8 Passive Video Splitter Module (1 GHz)
47690-4C2	1x4 Passive Video Splitter Module (2.05 GHz)
47690-6C2	1x6 Passive Video Splitter Module (2.05 GHz)
47690-8C2	1x8 Passive Video Splitter Module (2.05 GHz)

3x4 Multi-Switch

The 3x4 Multi-Switch distributes satellite signals to up to 4 TV's. It combines signals from dual incoming LNB (low noise block) digital satellite systems with transmission from an off-air antenna for distribution on a single coaxial cable. The module incorporates a separate input to receive TV antenna signals which is best used in combination with a video amplifier.



3x4 Multi-Switch

Specifications	
Dimensions: 4.766"H.x 6.576"W.x 2.366"D.
Frequency Range:TV Antenna 40-860 MHzDual LNB 950-2150 MHzReceiver Output 40-2150 MHz
Impedance:75 Ohm
Connector Type:F-type
LNB Selection Voltage:LNBA: 13/14VLNBB: 12/18V
Insertion Loss:40-860 MHz:-7dB (typical) 950-2150 MHz:-3dB (typical)
Return Loss:40-860 MHz:-10dB (typical) 950-2150 MHz:-10dB (typical)
Isolation:Output to Opposite Input-22dB (typical)
DC Power Passing:RX-LNB500Ma (max.) RX-RXNoneLNB-RXNone ANT-RXNoneRX-ANTNone

3x4 Multi-Switch

Cat No.	Description
47691-3MS	3x4 Multi-Switch

FEATURES

- Splits video signals. Outputs for up to 4, 6 or 8 televisions.
- Provide digital cable, cable TV and other video services, via coaxial cable, to any room in the house.
- Die-cast housing and printed circuit board.
- Use with the Video Amplifier for increased signal strength.
- Units come with mounting bracket.
- Gold-flashed contacts on 2.05 GHz units provide lowest conductive resistance.

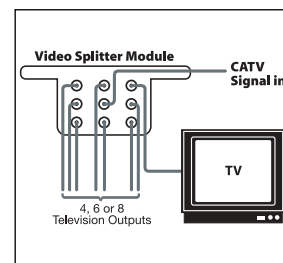

FEATURES

- Distributed digital satellite signals to up to 4 TV's.
- Combines signals from digital satellite with off-air antenna onto single coax cable.

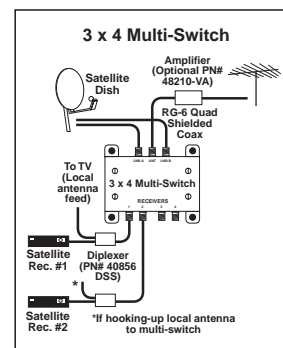

Home Security Monitoring

HOME SECURITY

Decora® Camera

A high-tech addition to the attractive Decora family, the Decora Camera provides high-quality color video output that will run through the Structured Media Enclosure and connect to a monitor anywhere in the home or office—instantly turning a home media center into a home security center.

Combine multiple cameras with a Leviton Video Sequencer to create one signal that steps through the different views. Then add a Leviton Modulator and Notch Filter to route its signal not only to a dedicated monitor, but also over a whole-house pre-assigned “security channel” between 75-80 (when used with a notch filter).

The Decora Camera produces clear and reliable CMOS-based video with a wide angle lens that eliminates the need for constant re-adjustment. It features a self-contained video differential amp for increased clarity of signal. A manual horizontal pan feature allows you to easily aim the camera. Power is indicated with a green LED indicator on the front of the faceplate. The Decora Camera does not have audio capability.

The Decora Camera has a terminal block output. An RCA/F adapter is provided for use with coaxial cable (shipped with one RCA female, 2-wire adapter and two male RCA to female F-connector adapters). Powered over separate cable. Connect power at your Structured Media Enclosure with a Leviton DC Power Distribution Module. Video signal is carried on coaxial cable. Power is supplied via a Cat 5 cable.

Shipped with one RCA female 2-wire adapter and two RCA male to female F-connector adapters.

This stylish camera is complemented by a Decora wallplate (available separately).



FEATURES

- Self-contained video differential amp provide increased clarity of signal.
- CMOS-based wide angle color video camera in one compact Decora-style unit.
- Features terminal block output connections.
- Power is indicated by a green LED on faceplate.

Decora® Camera

Specifications	
Dimensions: 4.1"H.x 1.4"W.x 2.2"D.
Connection: 4-position, removable screw terminal.
Camera: CMOS imager: 1/3" 310 TV lines, NTSC with S/N ratio 38 dB min. Minimum illumination 5 lux
Transmission Total Harmonic Distortion:	. . . -75 dBc
Power: 12-VDC @35mA typical 50mA max; green Power On LED

Decora® Camera

Cat. No.	Description
48213-*DC	Decora Camera

*Colors: (I) Ivory, (W) White, (A) Almond

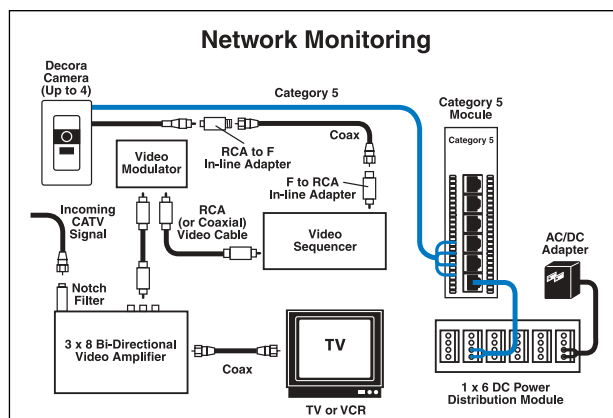
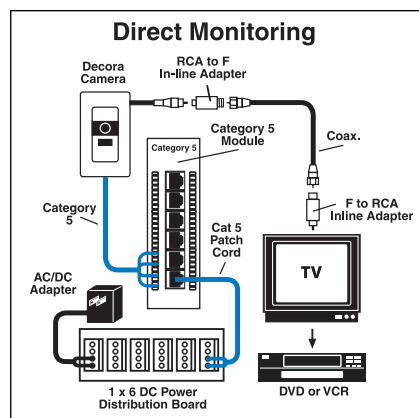

For special and custom video installations, refer to Leviton's Custom Installation Products section, starting on page 40

Home Security Monitoring

Outdoor camera

Incorporating the same advanced video technology as the Decora Camera, the Outdoor Camera allows monitoring of front doors, back yards, and anywhere an extra eye is desirable. With the Video Sequencer, up to four Decora Cameras or Outdoor Cameras in any combination may be monitored sequentially.

Used in conjunction with a Modulator and Notch Filter to view audio and video output not only on a dedicated monitor, but all over your home via a preassigned channel in your cable line-up.

The Outdoor Camera is designed to withstand temperature and environmental extremes when mounted in a suitable location.* Its high-tech housing and manual tilt-and-pan bracket assembly mount quickly and easily. The Outdoor Camera has a terminal block output. An RCA/F adapter is provided for use with coaxial cable. The camera requires one coaxial cable and one Cat 5 cable. Connect power at your Structured Media Enclosure, with a Leviton DC Power Distribution Module, or included power transformer.

*Recommended mounting is in a sheltered location such as under an eave or overhang and away from direct exposure to rain and snow.

Outdoor Camera

Specifications	
Dimensions:
Power:12 VDC 55mA typical 70mA max.
Connection:One connecting block
Camera:CCD imager: 1/3" 310 TV lines, NTSC with S/N ratio 38 dB min.Minimum illumination 10 luxLens is 3.5mm with swivel mount, adjustable focusOutput electronically balanced
Transmission Bandwidth:50 M Hz @-3 dB
Transmission Total:
Harmonic Distortion:-75 dBc
Transmission Slew Rate:800 V/us

Outdoor Camera

Cat No.	Description
48213-ECC	Outdoor Camera

Video Sequencer

The Structured Media Video Sequencer, which automatically switches between video cameras, is a security product engineered for long-term home use. With the Video Sequencer, up to four Decora Cameras or Outdoor Cameras, in any combination, may be monitored sequentially. The Sequencer allows a variable time-interval setting from 1-30 seconds on each camera to allow thorough surveillance of any perimeter or interior.

The Video Sequencer has four composite RCA audio/video inputs and two sets of RCA outputs to connect with a monitor or modulator. It snaps into a 280 or 420 Structured Media Center.

Video Sequencer

Specifications	
Dimensions:7.4"H.x 4.75"W.x 2"D.
Power:12 VDC @ 300mA
Inputs:Four RCA video; Eight RCA left/right audio
Outputs:2 RCA video and 4 RCA left/right audio
Time interval:1-30 seconds, variable/adjustable
Signal to Noise Ratio:<1.2dB
Bandwidth:5MHz

Video Sequencer

Cat No.	Description
48213-CVS	Video Sequencer



FEATURES

- Self-contained video differential amp provides increased clarity of signal.
- CCD-based wide angle color video camera optimized for a wide variety of lighting conditions (black and white under low-light conditions).
- Features a terminal block output connection.
- Features audio output.



FEATURES

- Inputs for up to four video cameras and audio sources.
- Automatic switching between cameras.
- 1-30 second variable time setting between cameras.
- RCA composite audio/video inputs and outputs.

Home Security Monitoring



FEATURES

- RCA video and stereo audio inputs.
- F-Connector output (channels 14-35 UHF and 54-86 CATV).
- DC power supply.

Media Center Modulator

The Media Center Modulator takes the signal from a video device such as a security camera (or multiple cameras using the Video Sequencer) and modulates the signal to one unused cable TV channel, which can then be combined with the CATV signal to multiple locations anywhere in the home, effectively providing a whole-house security channel.

Select the broadcast channel to be programmed via dip-switch button programming. The modulator provides 0, 10, 20 or 30 dBmV RF output.

Note: Modulator broadcasts mono audio only. In a Structured Media System, when used with Structured Media Video Distribution modules, the Modulator must be used with a Leviton Notch Filter (PN 47690-NFA) to clear the target cable channel and avoid interference.



Media Center Modulator

Specifications	
Dimensions:	3.2"H.x 2.25"W.x 1"D.
Inputs:	1 RCA video, 2 RCA left/right audio
Outputs:	1 F connector for RF signal
Operational channels:	14-69 UHF; 70-94, 100-125 CATV
Bandwidth:	.50MHZ-860MHZ
Power:	.12V DC 400mA

Media Center Modulator

Cat No.	Description
48213-VMA	Media Center Modulator



RF Notch Filter

The RF Notch Filter is an essential element of Home Security Monitoring and Multi-Room Video. It blocks incoming cable TV channels 75-80, allowing the Media Center Modulator or Component Modulator to broadcast an in-house "security" or "entertainment" channel over the coaxial cable system without interference. The Notch Filter simply couples to the coaxial cable TV input on either a splitter or an active video distribution device. Once installed, it filters out six cable channels to make room for any home security or entertainment video application. It also blocks outgoing signals, such as cameras, from being broadcast outside the home.

RF Notch Filter

Specifications	
Dimensions/Weight:	3"L.x .9"W.-2lbs
Type:	Passive RF filter
Bandwidth:	CATV channels 75-80
Input:	Female F-connector
Output:	Male F-connector

RF Notch Filter

Cat No.	Description
47690-NFA	RF Notch Filter

Home Security Monitoring

Desktop Stereo Modulator

The Stereo Modulator is a desktop-style device designed to work with audio/video components such as DVD players and home theater receivers. It combines composite audio and video signals from a source such as a DVD player, DSS receiver, or VCR, converts the signals to radio frequency and creates a television channel, which can then be broadcast over the whole-house coaxial network to multiple televisions on one unused cable channel, effectively setting-up an in-home entertainment channel.

The "frequency agile" modulator allows the selected broadcast channel to be programmed via push buttons. The modulator outputs on any UHF channel between 14 and 69 or CATV channel between 54 and 94 and 100 and 125 (channels 75-80 are recommended with the Notch Filter; see below note).

Note: The Desktop Stereo Modulator broadcasts in stereo. When used with Structured Media Video Distribution modules such as Leviton's 3x8 RF Video Module (Cat. No. 47690-3BY), the Desktop Stereo Modulator must be used with a Leviton Notch Filter (Cat. No. 47690-NFA) to clear the cable channel and avoid interference.

Desktop Stereo Modulator

Specifications	
Dimensions:	7.8"W.x 2.4"H.x 7"D.
Inputs:	1 RCA video, 2 RCA left/right audio
Outputs:	1 F connector for RF signal (1 RCA video, 2 RCA left/right audio) loop through
Operational channels:	14-69 UHF; 54-94 and 100-125 CATV (76-80 recommended with Notch Filter)
S/N ratio:	>60dB
Separation @1KHz:	>25dB
Bandwidth:	.50MHz-860MHz
Power:	.12V DC @300mA

Desktop Stereo Modulator

Cat No.	Description
48210-DSM	A—Media Center Modulator

Multi-Room Infrared (IR) Repeater System

The IR Repeater System consists of three pieces: an IR Target, IR Emitter and a distribution block for distributing control signals to multiple emitters. The IR Target takes the signal from a remote control for an audio/video component, such as a DVD player or home theater receiver, and converts it to a low-voltage electrical signal for use over long distances and in different rooms. The electrical signal is converted back at the component to be controlled by the IR emitter. With such a set-up, a user can control a DVD player down in the family room from an upstairs bedroom, for example. The IR Repeater System is highly useful with multi-room audio/video distribution using the Component Modulator or Decora Media™ System.

The IR Target easily installs in a ceiling or wall, and connects with Category 5 cable to the IR Emitter. A separate IR Emitter is used for each controlled A/V component, through the distribution block in the Structured Media Enclosure. Distribution block (Cat. No. 47689-B) available separately.

IR Repeater System

Specifications	
Dimensions:	.2"L.x 1"W.
Power:	.12V DC @200mA
Target Output:	.4 signal leads
Target Input:	.2 power leads (DC + and -)
Emitter Output:	.Infrared to control source component
Emitter Input:	.2 signal leads
Power Supply:	.12V DC @5mA

IR Repeater System

Cat No.	Description
47621-CMS	B—Target
47621-MIE	C—Emitter
47603-110	D—1x9 Bridged Telephone Module, w/o bracket. Indiv. boxed unit pack, rack pack carton.

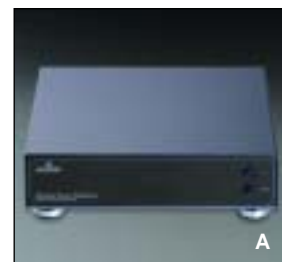

FEATURES

- Patented MTS stereo surround sound technology for the best modulated sound.
- Patent pending DVD compatible technology delivers better sound from DVD players.
- Digital read out for easy channel selection.
- Memory retention for power outages.
- Digital phase lock loop (PLL) tuning eliminates channel drift.

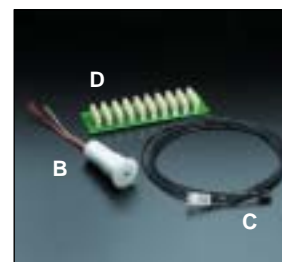

FEATURES

- Low-profile, flush-mount Target design.
- Two signal connections and two power connections.
- Emitter features adhesive surface for easy installation on audio/video components.
- Distribution block for multiple Emitter configurations.
- DC power supply.

Multi-Room Video

AUDIO/VIDEO DISTRIBUTION

Decora Media™ System

Distribute audio and video signals anywhere in the home using Category 5 cable and Leviton's Decora Media System (DMS). Send VCR, DVD library, CD, MP3 and Internet radio signals through up to 1,000 feet (300 meters) of cable with no discernible audio or video distortion and better performance than the more expensive, specialized "designer" cables.



FEATURES

- Panel can be attached vertically or horizontally in Structured Media Enclosures.
- Cascade hub units to distribute audio/video signals to over 20 locations.
- Send and Receive units are equipped with RJ-45 jacks and 110 punchdown blocks for maximum flexibility in installation.
- Composite RCA inputs for connectivity directly from A/V source.
- Send and Receive units fit standard wallboxes and Decora wallplates.
- Advanced circuitry with automatic equalization streams analog audio and video signals over long distances with less distortion.
- Stereo audio input/output handles Dolby® ProLogic™ surround signals.
- Send VCR, DVD, cable TV, satellite and security camera signals through Category 5 cable.
- RJ-45 input for Send unit.

DMS is comprised of: a Send Unit for transmitting audio/video signals, a Receive Unit for receiving signals and a Media Hub for whole house distribution.

The DMS utilizes advanced active electronics to operate with several different topologies: a star wiring scheme, with peripheral components sending and receiving critical information via Send and Receive units and the centralized data-communications hub; a Hub-to-Receive model, where information is sent to the hub—and from the hub to remote Receive units; and a Point-to-Point model, where Send and Receive units are linked directly together.

Send and receive units run on 12VDC, hub runs on 15VDC and can be powered independently or through the Media Hub.

For Category 5 and 5e patch cords, see page 46.

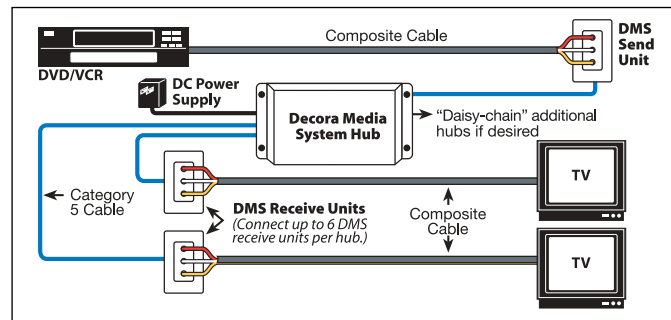

Decora Media™ System

Specifications	Send Unit	Receive Unit	Media Hub
Dimensions:	4.1"H.x 1.4"W.x 2.0"D.	4.1"H.x 1.4"W.x 2.0"D.	6.5"H.x 3.4"W.x 1.75"D.
Video Bandwidth:	50 M Hz @ -3 dB	50 M Hz @ -3 dB	50 M Hz @ -3 dB
Video THD:	75 dBc	-75 dBc	-75 dBc
Video Input:	—	0.5V to 2V composite	0.5V to 2V composite
Video Output:	0.5V to 2V composite	—	—
Slew Rate:	800/Vus	800/Vus	800/Vus
Audio Input Impedance:	—	20k Ohms, max 3Vp-p	20k Ohms, max 3Vp-p
Audio Output Impedance:	51 Ohms, max 2Vp-p	—	—
Audio Freq. Response:	5 Hz-100k Hz, ±3 dB	5 Hz-100k Hz, ±3 dB	5 Hz-100k Hz, ±3 dB
Audio THD:	0.002% 20 Hz-20k Hz	0.004% 20 Hz-20k Hz	0.002% 20 Hz-20k Hz
Audio S/N Ratio:	100 dB typical, 80 dB min 20 Hz-20k Hz	100 dB typical, 80 dB min 20 Hz-20k Hz	100 dB typical, 80 dB min 20 Hz-20k Hz
Input Noise:	4.5nV/(Hz), 1/2 typical @ 1k Hz	6nV/(Hz), 1/2 typical @ 1k Hz	4.5nV/(Hz), 1/2 typical @ 1k Hz
Input and Outputs:	3 RCA input jacks 1 set RJ-45 in/out jacks 1 110 punchdown out 1 DC power input	3 RCA output jacks 1 set RJ-45 in/out jacks 1 110 punchdown out 1 DC power input	3 RCA input jacks 1 RJ-45 input jack 6 RJ-45 output jacks 1 DC power input
Power:	12VDC	12VDC	15VDC

Decora Media™ System

Cat No.	Description
48210-MCH	Decora Media System Media Hub with Power Supply
48210-SRU	Decora Media System Send and Receive Unit Pair with Power Supply
48210-MSU	Decora Media System Send Unit with Power Supply
48210-MRU	Decora Media System Receive Unit

Multi-Location Stereo

AUDIO/VIDEO DISTRIBUTION

1x6 Passive Audio Module

Easy, centralized audio system distribution module connects up to six pairs of speakers from an entertainment center or amplifier. Just run speaker wire to this passive bridging module and fill multiple rooms with high-quality music or sound. Supports up to six pairs of speakers; ideal for multi-room sound systems. Note: To ensure a correct impedance match with an amplifier, only use the passive audio module with impedance matched volume controls or a system matching device.

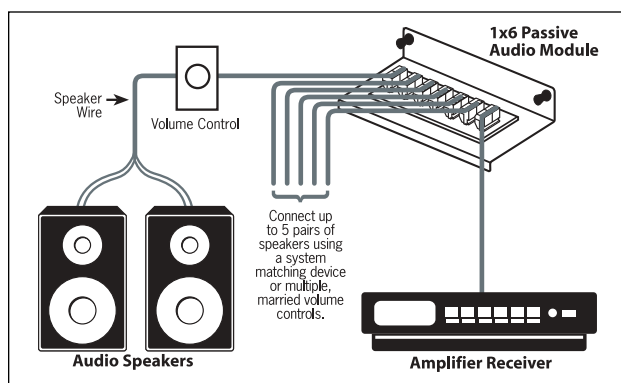

FEATURES

- Supports up to six pairs of speakers.
- Combine with Decora Volume Controls to control up to six pairs of speakers from one amplifier or receiver.
- Parallel connection scheme insures the best sound quality.
- User-removable connectors facilitate installation.
- Connects with standard fire-rated speaker wire.

1x6 Passive Audio Module

Specifications	
Dimensions:	6.58H.x 2.89W.x 1.42D.
Wire Gauge:	.18–14 AWG
Requirements:	Product should be used with impedance-matched volume controls or controller

1x6 Passive Audio Module

Cat No.	Description
48211-6A	1x6 Passive Audio Module

Multi-Location Stereo

COMPOSER SERIES AUDIO AND SPEAKER CONTROLS

Leviton's Composer Series controls are built to a single quality standard, which means system designers can specify them for any distributed sound application with total confidence. (Leviton's Chopin Digital Volume control uses the same heat-dissipation technology used on the space shuttle and resistive switching to achieve ruler-flat frequency response.) On the rotary analog controls, tapped auto-transformer design provides a stable interface between high-current amplification and speakers of virtually any type while resisting contamination from dust and dirt.

All analog audio power ratings are UL referenced. All volume controls feature screw connectors for long-term connection integrity.

FEATURES

- Connects to Interface Module with a single RJ-45 connection. No direct speaker/amplifier connections required at the controller.
- Microprocessor-controlled relays for silent switching.
- Provides impedance matching with speakers from 4–16 Ohms.
- Terminates all amplifier and speaker connections using high-quality audio connection block.
- Digital, transformer-free design uses aerospace-quality cermet resistors for proper heat dissipation and superior performance.
- Each audio zone requires one Digital Volume Control module.
- Each Digital Volume Control module can support up to three volume control units.
- Each Digital Volume Control module can control up to 4 pairs of speakers.
- Tap mute feature activated when center of rocker panel is pressed.

Decora Digital™ Chopin™ Volume Control

Fill a home with high-quality audio at the touch of a button, replacing traditional transformers and rotary controls with this advanced interface module and one-touch Decora Chopin™ Rocker-Switch Wall Unit. Attractive Decora styling and transformer-less design bring simplicity and superior sound-quality to this advanced audio delivery system. The Volume Control mounts in a standard wall box or low-voltage mounting bracket and connects via Category 5 cable to the Interface Module in the Structured Media Enclosure. Decora Chopin Wall Units are a perfect match with Decora Mural™ lighting controls, fit in all Decora wallplates and accommodate up to 4 pairs of speakers if wired in a series/parallel configuration.

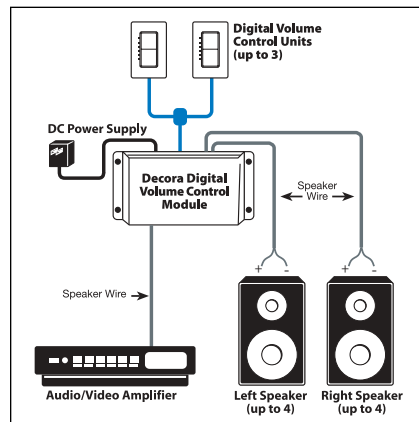

Decora Digital Volume Control Systems

Specifications	
Peak RMS Power Rating:	.200 Watts per channel
Continuous Power Rating:	.100 Watts RMS per channel
Frequency Response, all rated power levels, +/-0.1 dB:	.DC-50,000 Hz
Speaker Impedance:	.4-16 Ohms nominal
Speaker/Amplifier Connection:	.Removable, snap-in audio monoblock w/screw terminals
Power Requirements:	.12 Volts DC, 200 mA

Decora Digital Volume Control Systems

Cat No.	Description
48211-*VK	Decora Digital Volume Control Kit (Includes Interface Module and Wall Unit with Power Supply)
48211-*VC	Decora Digital Volume Control Wall Unit

Multi-Location Stereo

COMPOSER SERIES ANALOG AUDIO CONTROLS

Brahms™ Stereo Volume Controls—75 Watt Audio

The 75 Watt Brahms series (25 Watts RMS) of volume controls is ideal for low to moderate power installations in the home and for use with dedicated multi-room amplifiers and mini-systems. The units accommodate 4, 8 or 16 Ohm speakers and amplifiers up to 75 Watts. All controls facilitate impedance matching.

Attenuation: -34 dB in 12 steps. Attenuator Type: Tapped auto transformer. Power Rating: UL Listed @ 75 Watts audio, 25 Watts RMS continuous. Frequency Response: 35 Hz-20 kHz. Screw type connections, 12 position rotary switch.

Decora® Brahms™ Stereo Volume Controls

Control stereo volume from convenient wall-mounted location.

Cat No.—Ivory	Cat No.—White	Cat No.—Almond	Description
40841-DI	40841-DW	40841-DA	A—Decora® Brahms Stereo Volume Control, 75 Watt, 25 Watt RMS with insert, knob and plate. Boxed unit pack, rack pack carton



Brahms Dual Stereo Volume Controls

Control two stereo systems at one location.

Cat No.—Ivory	Cat No.—White	Description
40899-I	40899-W	B—Brahms Dual Stereo Volume Controls, 75 Watt, 25 Watt RMS on two-gang plate. Boxed unit pack, rack pack carton

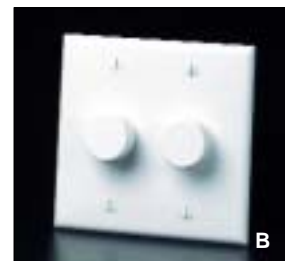

Decora® Brahms Stereo Volume Control with ON/OFF Switch

Convenience of ON/OFF, as well as volume control.

Cat No.—Ivory	Cat No.—White	Description
40905-25I	40905-25W	C—Decora® Brahms Stereo Volume Control, 75 Watt, 25 Watt RMS with insert, knob and plate. Boxed unit pack, rack pack carton



Outdoor Stereo Volume Control

Enables the control of stereo volume from an outside location. Weatherproof with gasket.

Cat No.—Gray ONLY	Description
40853-OVC	D—25 Watt RMS with weather resistant enclosure. Boxed unit pack, rack pack carton



Multi-Location Stereo

COMPOSER SERIES ANALOG AUDIO CONTROLS

Strauss™ Stereo Volume Controls—216 Watt Audio

The 216 Watt Audio (72 Watt RMS) Strauss volume control series is ideal for higher power installations in the home, and for use with home theater receivers and separate power amplifiers. Their heavy-duty autoformer construction is designed to resist saturation and degradation even after years of high-volume use while maintaining signal purity. The units accommodate 4, 8 or 16 Ohm speakers and amplifier systems rated up to 216 Watts. All controls facilitate impedance matching.

Attenuation: -34 dB in 12 steps. Attenuator Type: Tapped auto transformer. Power Rating: UL Listed @ 216 Watts Audio, 72 Watts RMS continuous. Frequency Response: 35 Hz–20 kHz. Screw type connectors, 12 position rotary switch.

Decora® Strauss Stereo Volume Controls

Control stereo volume from convenient wall-mounted location.

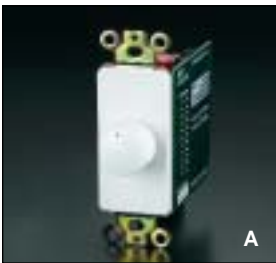

Cat No.-Ivory	Cat No.-White	Description
40901-DI	40901-DW	A—Decora® Strauss™ Stereo Volume Control, 216 Watt, 72 Watt RMS with insert, knob and plate. Boxed unit pack, rack pack carton

Strauss Dual Stereo Volume Controls

Control two stereo systems at one location.

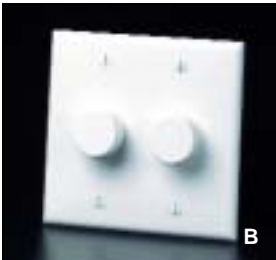

Cat No.-Ivory	Cat No.-White	Description
40864-DI	40864-DW	B—Strauss Dual Stereo Volume Controls , 216 Watt, 72 Watt RMS on two- gang plate. Boxed unit pack, rack pack carton

Decora® Strauss Stereo Volume Control with ON/OFF Switch

Convenience of ON/OFF, as well as volume control.

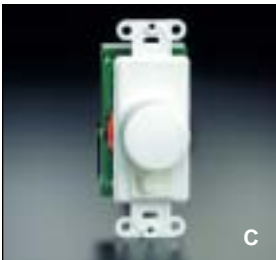

Cat No.-Ivory	Cat No.-White	Description
40888-72I	40888-72W	C—Decora® Strauss Stereo Volume Control, 216 Watt, 72 Watt RMS with two-gang plate. Boxed unit pack, rack pack carton

Decora® Strauss Stereo A/B Selector Switch

2 stereo source inputs, 1 stereo speaker pair output. Provides the ability to choose between two separate sources, such as a receiver or an amplifier.



Cat No.-Ivory	Cat No.-White	Description
40911-DI	40911-DW	D—Decora® Strauss Stereo A/B Selector Switch, 900 Watt audio, 300 Watt RMS. Boxed unit pack, rack pack carton

Multi-Location Stereo

SPECIALIZED AUDIO/VIDEO WALLPLATES

Single Spring Clip Wallplate

Equipped with spade terminals. Mounted on break resistant polymer wallplate.

Cat No.-Ivory	Cat No.-White	Description
40951-1PI	40951-1PW	A—Single Spring Clip Wallplate. Carded unit pack, rack pack carton



Double Spring Clip Wallplate

Equipped with spade terminals. Mounted on break resistant polymer wallplate.

Cat No.-Ivory	Cat No.-White	Description
40952-2PI	40952-2PW	B—Double Spring Clip Wallplate. Carded unit pack, rack pack carton

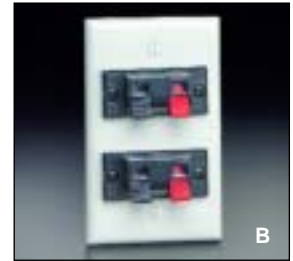

RCA to Coax Connector Wallplate

Converts coax to RCA connector. Mounted on break resistant polymer wallplate.

Cat No.-Ivory	Cat No.-White	Description
40953-ADI	40953-ADW	C—RCA to Coax Connector Wallplate. Carded unit pack, rack pack carton



Single S-Video Decora® Insert

Metal insert requires Decora wallplate for mounting.

Cat No.-Ivory	Cat No.-White	Description
40954-DMI	40954-DMW	D—Single S-Video Decora® Insert. Carded unit pack, rack pack carton



Multi-Location Stereo

SPEAKERS

In-Wall and Ceiling Flush-Mount Speaker Series

Acoustically-optimized and architecturally-designed, Leviton's series of in-wall and ceiling speakers is ideal for use in anything from foreground music systems to fully-equipped home theaters. Manufactured in the same facility as some prestigious "audiophile" types and with specifications verified through independent audio lab testing, Leviton speakers bring new meaning to the old phrase "value and performance."

All Leviton in-wall and ceiling series speakers incorporate long-throw, high-output woofers and ultralight polydome tweeters for exceptional clarity, detail and impact, and a low-loss precision crossover network for smooth, linear response. Leviton speakers have paintable grilles and frames for an aesthetic match with any décor and come with mounting frames for easy installation. Each speaker is acoustically engineered, or "voiced," for optimum performance when installed in walls or soffits. All are nominally rated at 8 Ohms impedance and 90dB sensitivity.

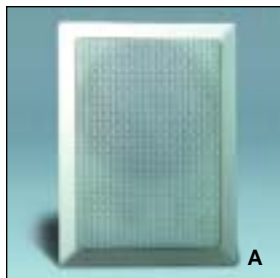

100 Watt In-Wall Flush Mount Speaker

Paintable grill and frame. 8" Woofer, 1" Polydome tweeter, 90 dB sensitivity, 8 Ohm impedance, 5,000Hz crossover frequency, 50-20,000Hz frequency response. Includes mounting bracket. 13' x 9" wall opening.

Cat No.-White ONLY	Description
40890-WS	A-100 Watt In-Wall Flush Mount Speaker, white. Boxed unit pack

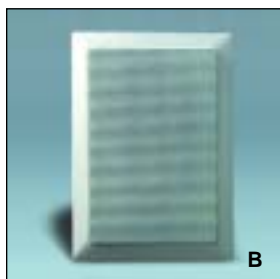

60 Watt In-Wall Flush Mount Speaker

Paintable grill and frame. 6½" woofer, ½" Polydome tweeter, 90 dB sensitivity, 8 Ohm impedance, 6,000Hz crossover frequency, 50-20,000Hz frequency response. Includes mounting bracket. 9½" x 6¼" wall opening.

Cat No.-White ONLY	Description
40890-W	B-60 Watt In-Wall Flush Mount Speaker, white. Boxed unit pack

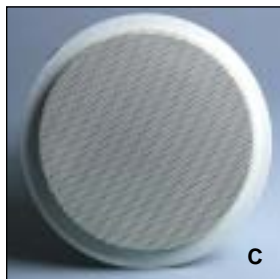

100 Watt Ceiling Mount Round Speaker

Paintable grill and frame. 6½" woofer, ½" Polydome tweeter, 90 db sensitivity, 8 Ohm impedance, 6,000Hz crossover frequency, 50-20,000Hz frequency response, 8½" diameter ceiling opening.

Cat No.-White ONLY	Description
40896-W	C-100 Watt Ceiling Mount Round Speaker, white. Boxed unit pack

OUTDOOR SPEAKERS

For stealth installations, these Leviton speakers blend into the landscape and bring high-fidelity sound to gardens, pools, atriums, and other environments. Each speaker incorporates exotic technology materials to withstand environmental extremes including heat and humidity. All come complete with 50 feet of Direct Bury 16-gauge speaker wire. Rated nominally at 8 Ohms impedance.

100 Watt Outdoor Rock Speaker

8" Woofer, 2" dome tweeter with crossover, 77 dB Sensitivity, 8 Ohm impedance, 50-20,000Hz frequency response. Includes 50 ft. of direct bury 16/2 gauge speaker wire

Cat No.-Dark Gray	Cat No.-Lava	Description
40827-G	40827-L	D-100 Watt Outdoor Rock Speaker, single. Boxed unit pack



60 Watt Outdoor Rock Speaker

6½" woofer, ½" tweeter, 77 dB sensitivity, 8 Ohm impedance, 50-20,000Hz frequency response. Includes 50 ft. of direct bury 16/2 gauge speaker wire.



Cat No.-Light Gray ONLY	Description
40828-G	E-60 Watt Outdoor Rock Speaker, Single. Boxed unit pack



QuickPort® Modules and Wallplates

QuickPort® Snap-In Connectors

The cornerstone of our superior copper structured cabling systems—GigaMax™ 5e, Category 5 and Voice Grade Snap-In Connectors feature dual-color-coded wiring labels with both T568A and T568B wiring patterns for dual flexibility in a single connector, plus fast, accurate termination of station wiring. All connectors meet or exceed industry standards. All category-rated connectors are fully compliant with published TIA-568-A and 570-A requirements. All other QuickPort connectors are UL certified, fully compliant with NEC® Article 800, and meet FCC Part 68. Communication wiring interfaces can be tailored to support the user's exact requirements for voice, data, video, audio and security applications.

Cat No.	Description	
5G108-R*5	A —Category 5e GigaMax™ 8-Conductor Channel-rated Connector <i>Permanently laser-engraved with "Cat 5e"</i>	
41108-R*5	B —Category 5 8-Conductor Connector <i>Permanently engraved with "Cat 5"</i>	
41108-K*5	B —Category 5 8-conductor connector, keyed <i>Permanently laser-engraved with "Cat 5"</i>	
41108-R*3	C —Category 3 8-Conductor Connector	
41106-R*6	D —Voice-Grade 6-Conductor USOC Connector	
41108-R*8	D —Voice-Grade 8-Conductor USOC Connector	

*Color choices for Category & Voice Grade Connectors: Ivory(I), White(W), Grey(G), Black(E), Orange(O), Blue(L), Crimson Red(C), Yellow(Y), Green(V), Purple(P), Almond(A), Brown(B), and Dark Red(R). Choose from the color chart below.
**S-Video color choices: White(W), Ivory(I), Almond(A), Black(E)



QuickPort® Snap-In Connectors Colors

Your choice of 13 connector colors—the largest selection in the industry— provides many options for color-coded port ID.



QuickPort® Modules and Wallplates

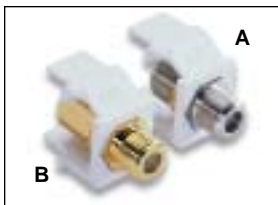

QuickPort® Snap-In Connectors for Audio/Video Cable Types

These F-type bulkhead modules are for TV, VCR, DVD, satellite and home theater applications where RG6 coaxial cable is used (“F” plug termination required). Each unit pack includes one gold-plated female-to-female, front and rear screw-on connector. They require no soldering and connections can be made with standard industry tools.

Cat No.– Ivory	Cat No.– White	Cat No.– Almond	Description
41084-FIF	41084-FWF	41084-FAF	A – F-Type Bulkhead Module
40831-BI	40831-BW	40831-BA	B – Gold-plated F-Type Bulkhead Module Individual polybag pack

FEATURES

- Each modular jack’s patented “cutting ledge” trims the wire during termination when used with the high impact punchdown tool.
- Audio and video connectors require no soldering; connections can be made with easy-to-use tools.
- All jacks feature color-coded wiring labels for fast, accurate terminations.
- F-Type, RCA, Binding Posts, BNC and Banana jacks are available gold-plated. F-Type, and BNC jacks are also available nickel-plated.
- Modules are listed in accordance and fully compliant with NEC Article 800.
- Category 5 and 5e jacks are certified to meet TIA/EIA-568-A and FCC Part 68 requirements.



QuickPort® RCA-110 Connector

Leviton’s RCA-110 QuickPort® Connector transmits audio/video signals over standard Category 5, 5e or 6 UTP cabling, and features 110-style IDC punchdowns on the rear for simple, fast installation. This simple connector is ideal in environments (like classrooms) that have frequent adds, moves and changes, or where coaxial cable runs aren’t an option. The front of the connector features a gold-plated contact surface for a better connection, and its oversized cavity readily accommodates male RCA plugs. To indicate different media types, connector inserts are offered in four colors, including Right Line Level Audio (red), Left Line Level Audio (white), Composite Video (yellow) and PCM Audio (orange). Part of the QuickPort family of connectors, Leviton’s RCA-110 Connectors are compatible with any QuickPort housing or panel.



Cat No.	Description
40735-RR*	C –RCA 110-Type QuickPort Audio Right Red Insert
40735-RW*	D –RCA 110-Type QuickPort Audio Left White Insert
40735-RO*	E –RCA 110-Type QuickPort PCM Audio Orange Insert
40735-RY*	F –RCA 110-Type QuickPort Video Yellow Insert

*Colors: White(W), Ivory (I), Almond (A), Grey (G), Black (E)



QuickPort® Modules and Wallplates

QuickPort® Snap-In Connectors for a Variety of Applications

These various connectors can be used with UTP copper cable and audio/video cable types to create a customized multi-media center in your single- or dual-gang wallplate. They require no soldering and connections can be made with standard industry tools.

Cat No.– Ivory	Cat No.– White	Cat No.– Almond	Description
40832-BI 40832-I 40832-IR	40832-BW 40832-W 40832-WR	40832-BA _____ 40832-AR	A– Gold-plated BNC Bulkhead Module Individual polybag pack Carded pack, standard carton Carded pack, rack pack carton
41084-BI	41084-BW	41084-BA	B– Standard BNC Bulkhead Module, Polybag Pack
40830-BIE 40830-BIR 40830-BIY 40830-I	40830-BWE 40830-BWR 40830-BWY 40830-W	40830-BWE 40830-BAR 40830-BAY _____ 40830-AR	C– Gold-plated RCA Bulkhead Module, Solderless Connection Black stripe on connector, individual polybag pack Red stripe on connector, individual polybag pack Yellow stripe on connector, individual polybag pack One black/one red stripe pair per carded unit pack, standard carton One black/one red stripe pair per carded unit pack, rack pack carton
40837-BIE 40837-BIR 40837-I	40837-BWE 40837-BWR 40837-W	40837-BAE 40837-BAR _____ 40837-AR	D– Gold-plated Banana Jack Module, Solderless Connection Black stripe on connector, individual polybag pack Red stripe on connector, individual polybag pack One black/one red stripe pair per carded unit pack, standard carton One black/one red stripe pair per carded unit pack, rack pack carton
40833-BIE 40833-BIR 40833-I	40833-BWE 40833-BWR 40833-W	40833-BAE 40833-BAR _____ 40833-AR	E– Gold-plated Binding Post Module, Solderless Connection Black stripe on connector, individual polybag pack Red stripe on connector, individual polybag pack One black/one red stripe pair per carded unit pack, standard carton One black/one red stripe pair per carded unit pack, rack pack carton
40734-SVI	40734-SVW	40734-SVA	F– S-Video Connector, 110 Style IDC Punchdowns on Rear of Connector, Individual polybag pack
40859-BI 40859-I 40859-IR	40859-BW 40859-W 40859-WR	40859-BA _____ 40859-AR	G– Snap-in Blank Module Individual unit, 10 units per polybag pack 4 per carded unit pack, standard carton 4 per carded pack, rack pack carton

FEATURES

- Each modular jack's patented "cutting ledge" trims the wire during termination when used with the high impact punchdown tool.
- Audio and video connectors require no soldering; connections can be made with easy-to-use tools.
- All jacks feature color-coded wiring labels for fast, accurate terminations.
- F-Type, RCA, Binding Posts, BNC and Banana jacks are available gold-plated. F-Type, and BNC jacks are also available nickel-plated.
- Modules are listed in accordance and fully compliant with NEC Article 800.
- Category 5 and 5e jacks are certified to meet TIA/EIA-568-A and FCC Part 68 requirements.



QuickPort® Modules and Wallplates

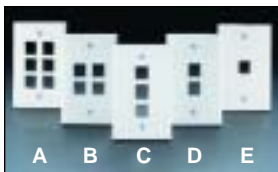

QuickPort® Flush-Mount Wallplates

Flush mount wallplates offer field-configurability in an attractive single-piece housing. All versions include color-matched mounting screws.

Note: Midway size plates are also available in plastic and high-impact nylon.

Cat No.– Ivory	Cat No.– White	Cat No.– Almond	Description
40806-BI 40806-IBR 40806-I	40806-BW 40806-WBR 40806-W	40806-BA 40806-ABR	A– 6-Port Flush Mount Individual polybag pack, standard carton Individual polybag pack, rack pack carton Carded pack, standard carton
40804-BI 40804-IBR 40804-I	40804-BW 40804-WBR 40804-W	40804-BA 40804-ABR	B– 4-Port Flush Mount Individual polybag pack, standard carton Individual polybag pack, rack pack carton Carded pack, standard carton
40803-BI 40803-IBR 40803-I	40803-BW 40803-WBR 40803-W	40803-BA 40803-ABR	C– 3-Port Flush Mount Individual polybag pack, standard carton Individual polybag pack, rack pack carton Carded pack, standard carton
40702-BI	40702-BW	40702-BA	D– 2-Port Flush Mount, individual polybag pack, standard carton
40701-BI	40701-BW	40701-BA	E– 1-Port Flush Mount, individual polybag pack, standard carton

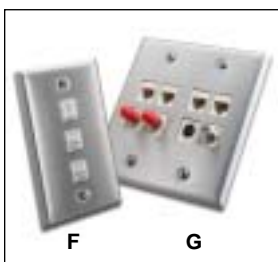

QuickPort® Stainless Steel Wallplates—Single and Dual-Gang

Leviton's QuickPort Stainless Steel Wallplates offer designer styling and a durable, easy-to-clean solution. They support a number of commercial and residential applications with single-gang and dual-gang versions in a variety of port configurations.

Cat No.	Description
43080-1S1	F– 1-Port Single-Gang Wallplate
43080-1S2	2-Port Single-Gang Wallplate
43080-1S3	3-Port Single-Gang Wallplate
43080-1S4	4-Port Single-Gang Wallplate
43080-1S5	5-Port Single-Gang Wallplate
43080-1S6	6-Port Single-Gang Wallplate
43080-2S2	G– 2-Port Dual-Gang Wallplate
43080-2S4	4-Port Dual-Gang Wallplate
43080-2S6	6-Port Dual-Gang Wallplate
43080-2S8	8-Port Dual-Gang Wallplate
43080-2S12	12-Port Dual-Gang Wallplate
4108W-1SP	Wall Phone Plate—Recessed
4108W-0SP	Wall Phone Plate—Flush



QuickPort® Angled Wallplates

Available in single-gang 4-port and dual-gang 8-port versions, these wallplates feature angled ports to relieve stress on equipment cords plugged into the device. The bottom opening is a duplex port which can be partitioned with a divider (included) to hold two individual QuickPort snap-in modules. All versions include mounting screws.

Cat No.– Ivory	Cat No.– White	Cat No.– Almond	Description
40807-BI 40807-IR 40807-I	40807-BW 40807-WR 40807-W	———— 40807-AR ————	H– Angled 4-Port with 2 angled ports Individual polybag pack, standard carton Individual polybag pack, rack pack carton Carded pack, standard carton
40807-B2I	40807-B2W	————	I– Angled 8-Port with 4 angled ports Individual polybag pack, standard carton

QuickPort® Modules and Wallplates

QuickPort® Multimedia Wallplate Inserts

Bring voice, data, audio and video together in one wallplate. Decora multimedia wallplate inserts match multimedia outlets to wallplates for electrical or lighting systems. Mix and match QuickPort Snap-In modules in combinations of two, three, four or six. Compatible with the full line of standard Decora wallplates, Decora Plus snap-on wallplates with hidden mounting screws and Leviton sectional wallplates (sold separately). The insert fits standard NEMA wallboxes and includes sturdy steel nuts on mounting tabs to ensure secure wallplate mounting without stripping.

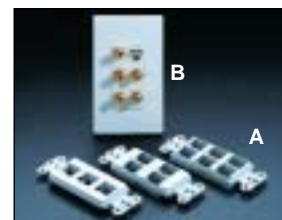

Cat No.– Ivory	Cat No.– White	Cat No.– Almond	Description
40850-BI	40850-BW	40850-BA	A– QuickPort Decora Multimedia Insert, 2-Port Insert, polybag standard carton 2-Port Insert, polybag rack pack carton 3-Port Insert, polybag standard carton 4-Port Insert, polybag standard carton 6-Port Insert, polybag standard carton
40850-IBR	40850-WBR	40850-ABR	
40753-BI	40753-BW	40753-BA	
40754-BI	40754-BW	40754-BA	
40756-BI	40756-BW	40756-BA	
80401-I	80401-W	80401-A	B– Decora Wallplates: 1-Gang 2-Gang
80409-I	80409-W	80409-A	

QuickPort® Shutters

These field-installable shutters protect connectors with a one-piece hinged door that keeps dust and contamination out. They work in any QuickPort housing and fit on USOC 8-position, Category 3, Category 5, Category 5e and Category 6 connectors.

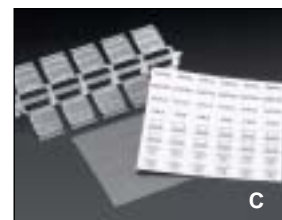

QuickPort® Shutters and Accessories

Cat No.	Description
51084-ICN	C– QuickPort Shutter Kit w/Leviton logo and miscellaneous icons
51084-XLB	Accessory Kit w/pre-printed icons on white paper
51084-CLB	Color Label Kit w/pre-printed icons on colored paper (Color Label Kit includes: brown, green, orange, red, blue, gray, purple)

4x4 Breakout Module

This unique telephone distribution module provides easy plug-and-play access to all incoming lines by using one outlet connector. The 4x4 Breakout Module allows you to divide an incoming four-line telephone connection into four individual lines for use on one- or two-line output connectors. The module provides six, eight-position RJ-45 voice grade connectors. This module is for use on 568A wiring sequenced systems.



4x4 Breakout Module

Cat No.	Description
47609-4X4	4x4 Breakout Module

Connectors and Wallplates

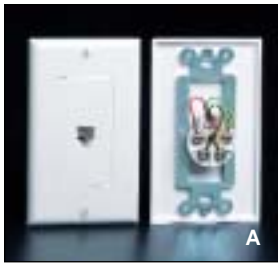

Decora® Modular Wall Jack

This single flush mount jack is designed to match Leviton's popular Decora line of decorator electrical devices. Screw Terminals. Furnished with Decora wallplate.

Cat No.-Ivory	Cat No.-White	Description
C2449-I	C2449-W	A – Decora Modular Wall Jack 6-Position, 4-Conductor Carded unit pack
40949-ID	40949-WD	Individual polybag pack

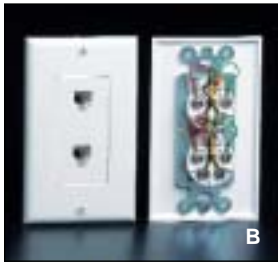

Decora® Duplex Modular Wall Jacks

This single flush mount jack is designed to match Leviton's popular Decora line of decorator electrical devices. Screw Terminals. Furnished with Decora wallplate.

Cat No.-Ivory	Cat No.-White	Description
C2447-ICP	C2447-WCP	B – Decora Duplex Modular Wall Jacks 6-Position, 4-Conductor Contractor pack, 3 per unit, rack pack carton
C2447-I	C2447-W	Carded unit pack
40944-ID	40944-WD	Individual polybag pack



Decora®TV/Phone Combination Wall Jacks

Combination jack with 4-conductor modular jack for phone connections and F-connector for video connections. Furnished with Decora wallplate.

Cat No.-Ivory	Cat No.-White	Description
40959-ID	40959-WD	C – Decora TV/Phone Combination Jacks 6-Position, 4-Conductor Individual polybag pack

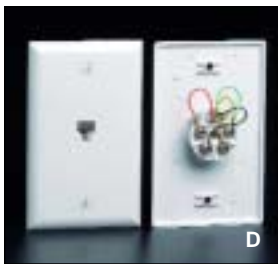

Flush Mount Modular Wall Jack

One-piece construction, single outlet telephone wallplate.

Cat No.-Ivory	Cat No.-White	Cat No.-Almond	Description
C0249-ICP	C0249-WCP	—	D – Flush Mount Modular Wall Jack, 6-Position, 4-Conductor Contractor pack, 5 per unit, rack pack carton
C0249-I	C0249-W	—	Carded unit pack
40949-I	40949-W	40949-A	Individual polybag pack in carton
C2675-I	C2675-W	—	Flush Mount Modular Wall Jack, 6-Position, 6-Conductor Carded unit pack



Flush Mount Duplex Wall Jack

These smooth finish units include two jacks, a plate and mounting hardware. They can be wired to provide the same dial tone on both jacks (e.g., for phone and answering machine combination) or separate line on each jack. Screw terminals. UL Listed and CSA Certified.

Cat No.-Ivory	Cat No.-White	Description
C0254-I	C0254-W	E – Flush Mount Duplex Wall Jack, 6-Position, 4-Conductor Carded unit pack
40944-I	40944-W	Individual polybag pack in carton
C2676-I	C2676-W	Flush Mount Duplex Wall Jack, 6-Position, 6-Conductor Carded unit pack

Connectors and Wallplates

Flush Mount TV/Phone Wallplate

Connect phone lines and incoming video signals from a single antenna, cable TV or DSS.

Cat No.–Ivory	Cat No.–White	Description
C2450-I 40959-I	C2450-W 40959-W	A– Flush Mount TV/Phone Wallplate, 6-Position, 4-Conductor Carded unit pack Individual polybag pack



Round Flush Mount Wallplate

One-piece construction installs easily in a Type 63A mounting ring or 63C junction box. Includes jack plate, ring and mounting screws. Four-conductor jack for use with 4-conductor modular line cord. Screw terminals.

Cat No.–Ivory	Cat No.–White	Description
C0229-I	C0229-W	B– Round Flush Mount Wallplate, 6-Position, 4-Conductor Carded unit pack



Wall Phone Jack

Accommodates all standard style wall phones. Four color-coded screw-down connections.

Cat No.–Ivory	Cat No.–White	Cat No.–Almond	Description
C0253-ICP C0253-I 40914-I	C0253-WCP C0253-W 40914-W	— — 40914-A	C– Wall Phone Jack, 6-Position, 4-Conductor Contractor pack, 3 per pack, rack pack carton Carded unit pack Individual polybag pack



Stainless Steel Wall Phone Jack

Stainless steel cover with quick-connect, punch-down wire connections. Four color-coded screw-down connections provided.

Cat No.	Description
C0256-SS	D– Stainless Steel Wall Phone Jack Individual polybag pack, rack pack carton



Wall Phone Jack

Single outlet telephone wall phone jack with quick-connect, punch-down terminals.

Cat No.–Ivory	Cat No.–White	Description
C2682-I	C2682-W	E– Wall Phone Jack, 6-Position, 6-Conductor Carded unit pack



Surface Mount Wall Phone Jack with 2 Extra Jacks

Offers two additional jacks. Ideal for use with answering machines or computer modems. One jack each side. Holds all standard style wall phones.

Cat No.–Ivory	Cat No.–White	Description
C2455-I	C2455-W	F– Surface Mount Wall Phone Jack with 2 Extra Jacks, 6-Position, 4-Conductor Carded unit pack
C2655-I	C2655-W	Surface Mount Wall Phone Jack with 2 Extra Jacks, 6-Position, 6-Conductor Carded unit pack



Connectors and Wallplates

Standard Flush Mount Jacks—Smooth Finish

Flush mount jacks are available in smooth finish single-jack or duplex models and Decora Styles. All feature one-piece construction and install easily in standard electrical boxes. Many are available in both standard plate sizes (2¾"W.x4½"H.x3/16"D.) and Midway plate sizes (3/8" greater in height and width), in a variety of colors.



Type 625B4 Modular Wall Jack—Smooth Finish U R

Includes jack, plate and mounting hardware. Fits standard NEMA wallboxes. Screw terminals. UL Listed and CSA Certified.

Cat No.— Ivory	Cat No.— White	Cat No.— Brown	Cat No.— Almond	Description
40249-I*	40249-W*	40249*	40249-A*	A —Type 625B4 Modular Wall Jack, 6-Position, 4-Conductor, Standard Plate Individual polybag pack
40238-I*	40238-W*	———	———	B —Type 625B4 Modular Wall Jack, 6-Position, 6-Conductor, Standard Plate Individual polybag pack
40280-I	40280-W	———	———	C —Type 625B4 Modular Wall Jack, 8-Position, 8-Conductor, Standard Plate Individual polybag pack
40549-I*	40549-W*	40549*	———	D —Type 625B4 Modular Wall Jack, 6-Position, 4-Conductor, Midway Plate Individual polybag pack
40538-I*	40538-W*	———	———	E —Type 625B4 Modular Wall Jack, 6-Position, 6-Conductor, Midway Plate Individual polybag pack
40580-I	40580-W	———	———	F —Type 625B4 Modular Wall Jack, 8-Position, 8-Conductor, Midway Plate Individual polybag pack
40539-PMI	40539-PMW	40539-PMB	40539-PMA	Type 625B4 Modular Wall Jack, 6-Position, 4-Conductor, Nylon Midway Plate Individual polybag pack

*These products are UL Listed



Type 625B4 Modular Wall Jack—Smooth Finish, alternate construction (not shown) U R

Includes jack, plate and mounting hardware. Fits standard NEMA wallboxes. Screw terminals. UL Listed and CSA Certified.

Cat No.— Ivory	Cat No.— White	Cat No.— Gray	Cat No.— Brown	Cat No.— Almond	Description
4625B-44I	4625B-44W	4625B-44G	4625B-44	4625B-44A	G —Type 625B4 Modular Wall Jack, 6-Position, 4-Conductor, Standard Plate Individual polybag pack
4625B-46I	4625B-46W	4625B-46G	———	———	H —Type 625B4 Modular Wall Jack, 6-Position, 6-Conductor, Standard Plate Individual polybag pack
4625B-48I	4625B-48W	———	———	———	I —Type 625B4 Modular Wall Jack, 8-Position, 8-Conductor, Standard Plate Individual polybag pack

Connectors and Wallplates

Type 625B3 Duplex Wall Jack U R

These smooth finish units include two jacks, a plate and mounting hardware. They can be wired to provide the same dial tone on both jacks (e.g., for phone and answering machine combination) or separate line on each jack. Screw terminals. UL Listed and CSA Certified.

Cat No.— Ivory	Cat No.— White	Cat No.— Brown	Cat No.— Almond	Description
40244-I	40244-W	40244	40244-A	A—Type 625B3 Duplex Wall Jack, 6-Position, 4-Conductor, Standard Plate Individual polybag pack
40266-I	40266-W	_____	_____	B—Type 625B3 Duplex Wall Jack, 6-Position, 6-Conductor, Standard Plate Individual polybag pack
40544-I	40544-W	_____	_____	C—Type 625B3 Duplex Wall Jack, 6-Position, 4-Conductor, Midway Plate Individual polybag pack
40566-I	40566-W	_____	_____	D—Type 625B3 Duplex Wall Jack, 6-Position, 6-Conductor, Midway Plate Individual polybag pack
40588-I	40588-W	_____	_____	E—Type 625B3 Duplex Wall Jack, 8-Position, 8-Conductor, Midway Plate Individual polybag pack



Type 625D Combination Wall Jacks and F-Connector Wallplates U R

The Type 625D includes one modular jack (with screw terminals) for voice and one F-connector for cable TV or other video applications using RG6 or RG59 coax. UL Listed and CSA Certified.

Cat No.— Ivory	Cat No.— White	Cat No.— Gray	Cat No.— Almond	Description
40259-I	40259-W	40259-G	40259-A	F—Type 625D Combination Wall Jacks, 6-Position, 4-Conductor and F-Connector Individual polybag pack
40258-I	40258-W	_____	_____	G—Type 625D Combination Wall Jacks, 6-Position, 6-Conductor and F-Connector Individual polybag pack



Type 625 Decora Modular Wall Jacks U R

This single flush mount jack is designed to match Leviton's popular Decora line of decorator electrical devices. Use with Decora Plus wallplates and mount in any standard electrical box. Gangable in multiple-gang box. Screw terminals. UL Listed and CSA Certified.

Cat No.— Brown	Cat No.— Ivory	Cat No.— White	Cat No.— Gray	Cat No.— Almond	Cat No.— Black	Description
40649	40649-I	40649-W	40649-GY	40649-A	40649-E	H—Type 625 Decora Modular Wall Jacks, 6-Position, 4-Conductor Individual polybag pack
40638	40638-I	40638-W	40638-GY	40638-A	40638-E	I—Type 625 Decora Modular Wall Jacks, 6-Position, 6-Conductor Individual polybag pack
40680	40680-I	40680-W	40680-GY	_____	_____	J—Type 625 Decora Modular Wall Jacks, 8-Position, 8-Conductor Individual polybag pack



Connectors and Wallplates

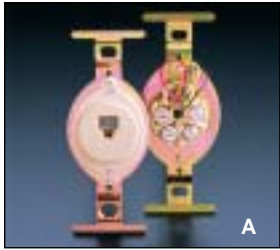

Type 625B Round Modular Jack U R

A 4-conductor jack with Type 43A mounting bracket attached. Mounts in any standard electrical box; slotted holes facilitate alignment when electrical box has been mounted crooked or askew. Can be used indoors or outdoors with corresponding Leviton wallplate (see below). For use with 4-conductor modular line cord. Screw terminals. UL Listed and CSA Certified.

Cat No.-Ivory	Description
40201-I	A- Type 625B Round Modular Jack Individual polybag pack



Round Modular Jack Wallplate U R

Standard size plate in non-combustible, smooth-finish plastic. UL Listed and CSA Certified.

Cat No.-Ivory	Description
86004	B- Round Modular Jack Wallplate Individual polybag pack



Flush Mount Outdoor Wallplate U R

Rugged plate made of die-cast zinc with a corrosion-resistant gray baked enamel finish. For use with surface-mounted, outdoor-type outlet boxes or flush-mounted wallboxes. Includes mounting screws and rubber gasket. UL Listed and CSA Certified.

Cat No.-Ivory	Description
4925-2	C- Flush Mount Outdoor Wallplate Individual polybag pack



1 and 2 Gang Wallplate Mounting Brackets

Mounting a flush-mount wallplate without a back box is easy. Brackets insert into wall opening, flexible tabs bend up to secure the bracket to the opening. Standard screw holes accept all wallplate configurations.

Cat No.	Description
C0224-CP C0224	D- Wallplate Mounting Brackets, 1-Gang Contractor pack, 10 per unit pack, rack pack carton 2 per carded unit pack
C0225-CP C0225	E- Wallplate Mounting Brackets, 2-Gang Contractor pack, 5 per unit pack, rack pack carton Individual polybag pack, rack pack carton

Connectors and Wallplates

Flush Mount 75 Ohm Decora Wallplate

75 Ohm twist-on connections for input and output.

Cat No.–Ivory	Cat No.–White	Description
C2448-I	C2448-W	A– Flush mount 75-Ohm Decora Wallplate, Carded unit pack
40981-ID	40981-WD	Decora Single F-Connector Wall Jack with Wallplate Individual polybag pack

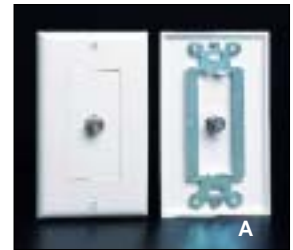

75 Ohm Wallplate

Twist-on connector on both sides.

Cat No.–Ivory	Cat No.–White	Cat No.–Almond	Description
C5256-ICP C5256-I	C5256-WCP C5256-W		B– Surface Mount 75 Ohm Wallplate Contractor pack, 5/box Carded unit pack
40981-I	40981-W	40981-A	Single Flush Mount F-Connector Wall Jack Individual polybag pack

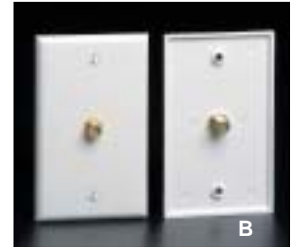

Duplex 75 Ohm Wallplate

75 Ohm twist-on connections on both sides. Can be used as two inputs, one input and one output, or two outputs.

Cat No.–Ivory	Cat No.–White	Description
C2456-I	C2456-W	C– Duplex Flush Mount 75 Ohm Wall Plate Carded unit pack
40982-I	40982-W	D– Duplex Flush Mounted F-Connector Wallplate Carded unit pack

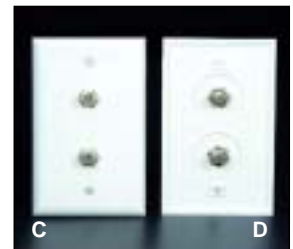

F-Connector Wallplates

The F-Connector is for cable TV or other video applications using RG6 or RG59 coaxial cabling. F-connector wallplates have one or two F-connectors. These wallplates have a smooth finish. UL Listed and CSA Certified.

Cat No.–Ivory	Cat No.–White	Cat No.–Almond	Description
80781-I	80781-W	80781-A	E– Flush Mount Single F-Connector
80782-I	80782-W	80782-A	F– Flush Mount Duplex F-Connector



Decora F-Connector Wall Jacks U R

Flush mount unit provides single or duplex standard bulkhead F-connector for CATV or other video applications. UL Listed and CSA Certified.

Cat No.–Brown	Cat No.–Ivory	Cat No.–White	Cat No.–Gray	Cat No.–Almond	Description
40681	40681-I	40681-W	40681-GY	40681-A	G– Single F-Connector, polybag
40682	40682-I	40682-W	40682-GY	40682-A	Duplex F-Connector, polybag



Midway Coax Wallplates

Nylon midway size wallplates without F-connector

Cat No.–Ivory	Cat No.–White	Cat No.–Brown	Cat No.–Almond	Description
40539-OMI	40539-OMW	40539-OMB	40539-OMA	H– Single F-Connector Wallplate
40539-HMI	40539-HMW	40539-HMB	40539-HMA	Hex Hole Wallplate —No Connector



Custom Video, Cabling & Distribution

CUSTOM INSTALLATION PRODUCTS

Leviton Custom Installation products are designed for large-premise and retrofit applications, where a high degree of customization is required and installation space may be at a premium. Custom Video includes in-wall modulators, multi-room distribution and IR signal control over coaxial cable for making the most out of an existing cable infrastructure. Cable Distribution offers the same voice & data communications connection and patching products proven in demanding commercial applications. Optical Fiber is based on Leviton's renowned Thread-Lock® technology, the first "residential-friendly" fiber termination system through its time-saving installation procedure and reusable design.

CUSTOM VIDEO

DSS 75 Ohm and 2.0GHz Combiner/Duplexer with DC Blocking

Connects one antenna/cable TV input and one DSS 2.1 GHz input, to one combined output.

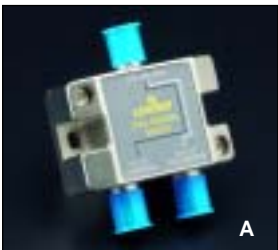

Cat No.	Description
40856-DSS	A- DSS 75 Ohm and 2.0GHz Combiner/Duplexer, gold plated, carded unit pack

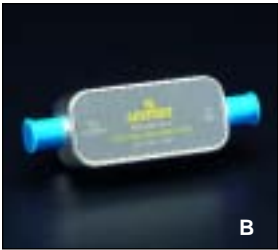

DSS Signal Amplifier

Provides 12 dB in-line signal amplification.

Cat No.	Description
40866-DSS	B- DSS Signal Amplifier, gold plated, carded unit pack



Coaxial Surge Suppressor

Maximum surge current of 5000 Amps. 0.3 dB maximum insertion loss at 5 MHz-1000 MHz.

Cat No.	Description
47690-6S	C- Coaxial Surge Suppressor, carded unit pack

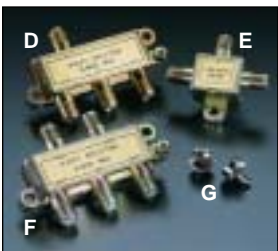

Splitters and Termination Cap for F-Connector Jacks

Splits 75 Ohm CATV signal into 2, 3, or 4 signals. Standard F-connector input and outputs. Die-cast body is configured with mounting tabs and ground screw.

2-, 3- and 4-Way Splitters

Cat No.	Description
C5002-CP	D- 2-Way Splitter, contractor pack, 12/box
C5002	2-Way Splitter, carded unit pack
C5002-GO	2-Way Splitter, gold plated, carded unit pack
40987-2	2-Way Splitter, gold plated, individual polybag pack
C5003	E- 3-Way Splitter, carded unit pack
40987-3	3-Way Splitter, gold plated, individual polybag pack
C5004	F- 4-Way Splitter, carded unit pack
C5004-GO	4-Way Splitter, gold plated, carded unit pack
40987-4	4-Way Splitter, gold plated, individual polybag pack
40984	G- Termination cap for F-connector jacks (bag of 25)

Custom Video, Cabling & Distribution

Push-On Male F-Connectors for 75 Ohm Coaxial Cable

Available in Quick and Universal styles, Leviton's Push-On F-Connectors are an easy-to-use, cost-effective solution for termination of 75 Ohm RG59, RG-6 and Quad coaxial cable. Innovative Universal push-on rubber cap requires no crimping tools. F-connector style adds metal collar to the Universal rubber cap for fast and easy, adds, moves and changes. Strip tool is included.

Cat No.	Description
40985-HPC	A– Universal F-Connector (bag of 100)
40985-HPM	B– Quick F-Connector (bag of 20)



Twist-On Male F-Connectors

Terminate 75 Ohm coaxial cable with a twist-on male F-connector. No crimping tools required.

Cat No.	Description
40985-TW9 C5203 C5203-G C5203-CP	C– Twist-On F-Connector for RG-59 Bulk polybag pack, 100 connectors per polybag 2 per carded unit pack 2 per carded unit pack, gold plated Contractor pack, 25 connectors per unit, rack pack carton
40985-TW6 C5008 C5008-G C5008-CP	D– Twist-On F-Connector for RG-6 Bulk polybag pack, 100 connectors per polybag 2 per carded unit pack 2 per carded unit pack, gold plated Contractor pack, 25 connectors per unit, rackpack carton



In-Line Splice Coupler

Double female F-connector for use in splicing two cable runs together. Attaches to male F-connectors.

Cat No.	Description
40986	E– In-line splice coupler (bag of 100)

Note: Retainer nut for wallplate mounting not provided.



Residential Tool Kit

Residential Tool Kit provides everything needed to install coaxial cable and UTP wire in residential or small office installations. The kit comes with everything you need, including a High-Impact Punch-Down Tool with 110 Blade, a 2 Step Coaxial Cable Stripper, an EZ-RJ45™ Crimp Tool with 10 EZ-RJ45 connectors, a Round Wire Cable Cutter, a UTP Stripper and a 6-in-1-Head Screwdriver.

Cat No. -Ivory	Description
40812-RTK	F– Residential Tool Kit



High-Impact Wire Punchdown/Termination Tool

Versatile punchdown/termination tool makes reliable connections on a variety of wire termination blocks. Its adjustable impact setting enables wires to be terminated with less effort than with other impact tools.

Cat No.	Description
49553-814	G– High-Impact Wire Punchdown/Termination Tool (blades sold separately)
49553-110	110 IDC Blade
49553-66	66 Clip Blade



Coaxial Stripping Tool

Designed for easy, one-step cable stripping, this contractor-grade stripping tool has an adjustable blade that adapts to different cable sizes; RG-6, RG-58 and RG-59.

Cat No.	Description
C5914	H– Coaxial stripping tool



Custom Video, Cabling & Distribution

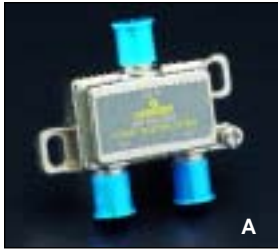

DSS 2-Way Splitter

Connects one input to two outputs. All ports 2.1 GHz

Cat No.	Description
40867-DSS	A– DSS 2-Way Splitter, gold plated, carded unit pack

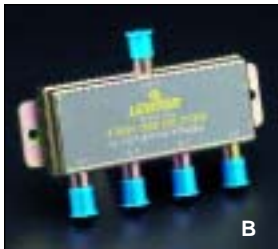

DSS 4-Way Splitter

Connects one input to four outputs. All ports 2.1 GHz.

Cat No.	Description
40868-DSS	B– DSS 4-Way Splitter, gold plated, carded unit pack



RG6 Quad Shield Cables

Digital cable, gold plated "F" plugs.

Cat No.	Description
40871-25W	C– 25' Quad shield cable, gold plated, carded unit pack
40871-50W	D– 50' Quad shield cable, gold plated, carded unit pack
40871-CW	E– 100' Quad shield cable, gold plated, carded unit pack

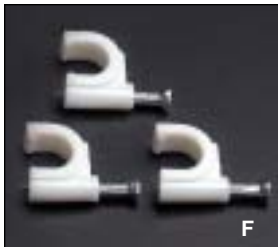

Coax Cable Clips

Nail-in clips to manage RG-59 or RG-6 coaxial cable.

Cat No.–White	Cat No.–Black	Description
C5811	C5812	F– Coax Cable Clips
C5811-WCP	_____	10 per carded unit pack Contractor pack, 50 clips per unit, rack pack carton



Video Adapter—1 F-Connector to 1 RCA Plug

Converts RCA plug to 75 Ohm F-connector connection.

Cat No.	Description
C5229	G– Video Adapter—1 "F" Jack to 1 RCA Plug



RCA to F-Type Video Adapter—1 F Jack to 1 RCA Jack

Used for connecting a 75 Ohm female jack to RCA plug connection.

Cat No.	Description
C5205	H– RCA to F-Type Video Adapter, carded unit pack

Custom Video, Cabling & Distribution

75-Ohm Push-On Connector

Converts 75 Ohm twist-on connection to 75 Ohm push-on connection.

Cat No.	Description
C5235	A- Push-on connector, 2 per carded unit pack



75-Ohm In-Line Cable Connector

Connects two cables that terminate in F plugs. Includes mounting nut.

Cat No.	Description
C5259	B- In-line cable connector, 2 per carded unit pack
C5259-GO	In-line cable connector, gold plated, 2 per carded unit pack



Indoor Matching Transformer

Converts 75-Ohm incoming signal to 300 Ohm.

Cat No.	Description
C5052	C- Indoor matching transformer, carded unit pack
C5052-GO	Indoor matching transformer, gold plated, carded unit pack



Outdoor Matching Transformer

Converts 300-Ohm incoming signal to 75 Ohm. Includes waterproof slip-on boot.

Cat No.	Description
C5053	D- Outdoor matching transformer, carded unit pack



Push-On Matching Transformer

Converts 300-Ohm incoming signal to 75 Ohm.

Cat No.	Description
C5055	E- Converts 300 Ohm incoming signal into 75 Ohm.



Deluxe Shielded Composite A/V Cable

High-quality wire and extra shielding. Gold-plated RCA plugs with strain-relief. Permits connection between A/V components.

Cat No.-Black	Description
C5822-GO	F- Stereo Dubbing Cable, carded unit pack



Custom Video, Cabling & Distribution



6' Composite A/V Cable

High-quality wire and extra shielding. Permits connection between A/V components.

Cat No.-Black	Description
C5822	A- 6' Stereo Dubbing Cable, carded unit pack



6' Composite A/V Cable, Gold-Plated

Molded gold-plated RCA plugs with strain-relief. Permits connection between A/V components.

Cat No.-Black	Description
C5856-GO	B- 6' Stereo Dubbing Cable, gold plated, carded unit pack



RCA Coax Cable

Cat No.-Black	Description
C5852-6GO	C- 6' RCA Coax Cable, gold plated, carded unit pack
C5852-12G	D- 12' RCA Coax Cable, gold plated, carded unit pack



6' S-Video Cable

Male-to-male plug. Designed for use with Super VHS video systems. Connects the SVHS TV to the SVHS VCR.

Cat No.-Black	Description
C5853-6	E- 6' SVHS Cable, carded unit pack



In-Line RCA Coupler

Connects two RCA plug audio cables together in-line.

Cat No.	Description
C5255	F- In-Line RCA Coupler, carded unit pack, nickel



RCA Y Adapter, 1 RCA Jack to 2 RCA Plugs

Splits RCA audio cable into two cables when the two cables have a plug on one end and jack on the other.

Cat No.-Black	Description
C5402	G- RCA Y Adapter, carded unit pack

Custom Video, Cabling & Distribution

RCA Y Adapter, 1 RCA Plug to 2 RCA Jacks

Splits RCA audio cable into two cables when new cables have plugs on one end and jacks on the other end or splits audio signal out of amplifier.

Cat No.—Black	Description
C5405	A— RCA Y Adapter, carded unit pack



Stereo Shielded Cable, 2 RCA Plugs to 2 RCA Plugs

Red and black plugs on both ends.

Cat No.—Black	Description
C5451-3	B— 3' Shielded Stereo Cable, carded unit pack
C5451-6	C— 6' Shielded Stereo Cable, carded unit pack
C5451-6GO	D— 6' Shielded Stereo Cable, carded unit pack, gold-plated plugs
C5451-12	E— 12' Shielded Stereo Cable, carded unit pack



RCA Patch Cable—4 RCA Plugs to RCA Plugs

Yellow, white, red and black plugs on both ends.

Cat No.—Black	Description
C-5454-3	F— Black Cable with Color-Coded Plugs (Y-W-R-B)



18/2 AWG Speaker Wire

Cat No.—Clear	Description
X3301-25C	H— 18/2 AWG Speaker Wire, 25 ft., sleeve unit pack in carton
X3301-50C	I— 18/2 AWG Speaker Wire, 50 ft., sleeve unit pack in carton
X3301-100	J— 18/2 AWG Speaker Wire, 100 ft., sleeve unit pack in carton



14/2 AWG Speaker Wire

Cat No.—Clear	Description
X3324-25C	K— 14/2 AWG Speaker Wire, 25 ft., sleeve unit pack
X3324-50C	L— 14/2 AWG Speaker Wire, 50 ft., sleeve unit pack.
X3324-100	M— 14/2 AWG Speaker Wire, 100 ft., sleeve unit pack



Custom Video, Cabling & Distribution



Category 5 Patch Cords

Leviton Category 5 patch cords are compliant with the latest standards, including TIA/EIA TSB-95, meeting and exceeding a full range of patching performance requirements. All have superior quality construction to maintain the integrity of signal transmission at the cross-connect, which is critical to the performance of the entire cabling system. They can be used to connect a number of SMC Modules, including the Decora Media System, 10/100 Switch, Internet Gateway and Category 5e Voice and Data Module.

Cat No.	Description
47620-1W	A – 1 ft Patch Cord, Individual polybag pack, white only
52455-3* 52454-3R 47620-3W	B – 3 ft Patch Cord Individual polybag pack Carded unit pack, rack pack carton, blue only Individual polybag pack, white only
52455-7* 52454-7R	C – 7 ft Patch Cord Individual polybag pack Carded unit pack, rack pack carton, blue only
52455-15* 52454-15R	D – 15 ft Patch Cord Individual polybag pack Carded unit pack, rack pack carton, blue only

*Colors: White(W), Red(R), Yellow(Y), Green(G), Blue(L), Grey(S), Black(E)



GigaMax™ Category 5e Patch Cords

Leviton GigaMax Category 5e patch cords meet the very latest TIA/EIA TSB-95 guidelines for supporting 1000 Base-T gigabit applications. Superior quality guarantees no-risk data transmission with soaring headroom over industry guidelines. They can be used to connect a number of SMC Modules, including the Decora Media System, 10/100 Switch, Internet Gateway and Category 5e Voice and Data Module.

Cat No.	Description
5G455-3* 5G454-3R	E – 3 ft Patch Cord Individual polybag pack Carded unit pack, rack pack carton, yellow only
5G455-5*	F – 5 ft Patch Cord, Individual polybag pack
5G455-7* 5G454-7R	G – 7 ft Patch Cord Individual polybag pack Carded unit pack, rack pack carton, yellow only
5G455-15* 5G454-15R	H – 15 ft Patch Cord Individual polybag pack Carded unit pack, rack pack carton, yellow only

*Colors: White(W), Red(R), Yellow(Y), Green(G), Blue(L), Grey(S), Black(E)



4- or 8-Conductor Telephone Patch Cords

Flat cordage patch cord used to connect the Telephone Distribution Module to the Category 5 Voice and Data Module, providing a dial tone instantly to any room of the home, with easy adds, moves and changes.

Cat No.	Description
42400-G	I – Flat Cordage Patch Cord, 7" long
42400-8FG	8P8C Patch Cord, 8" long

Custom Video, Cabling & Distribution

EZ-RJ45 Connectors and Crimp Tool

Connectors and EZ-RJ45 Crimp Tool provide quick, cost-effective UTP wire terminations. The high-quality connectors, terminated with our EZ-RJ45 Crimp Tool, feature openings that allow wires to be inserted and extended out the front for increased performance, wire sequence verification, and no wasted connectors, crimps, or bad terminations.

Cat No.	Description
47613-EZC	A—EZ-RJ45 Connectors (bag of 50)
47613-EZR	EZ-RJ45 Connectors (10 per clamshell)
40989-RCT	B—EZ-RJ45 Crimp Tool



1-Piece and 2-Piece Crimp-On F-Connector

Terminates 75 OHM coaxial cable with crimp-on male F-connector. A crimping tool is required. Comes in either a 2-piece version with separate crimp ring, or a 1-piece version with crimp ring attached. Both RG-59 and RG-6 versions available

Cat No.	Description
40985-Q6	One-Piece Crimp-On F-Connector for RG6 Quad Shield Bulk polybag pack, 100 connectors per pack
40985-1P9 C5307 C5307-G C5307-CP	C—One-Piece Crimp-On F-Connector for RG59 Bulk polybag pack, 100 connectors per pack 2 per carded unit pack 2 per carded unit pack, gold plated Contractor pack, 25 connectors per unit, rack pack carton
40985-1P6	D—One-Piece Crimp-On F-Connector for RG6 Bulk polybag pack, 100 connectors per pack
40985-2P9 C5009 C5009-G	E—Two-Piece Crimp-On F-Connector for RG59 Bulk polybag pack, 100 connectors per pack 4 per carded unit pack 2 per carded unit pack, gold plated
40985-2P6 C5007 C5007-CP	F—Two-Piece Crimp-On F-Connector for RG6 Bulk polybag pack, 100 connectors per pack 2 per carded unit pack Contractor pack, 25 connectors per unit, rack pack carton



Push-Lock Pins

Use Leviton Push-Lock Pins to secure Structured Media Modules into your Structured Media Enclosure. Each bag contains 20 replacement pin-and-base sets.

Cat No.	Description
47615-NYL	Push-Lock Pins—(bag of 20)

Use our Push Pins for installation of Expansion Boards on page 11



Custom Video, Cabling & Distribution

CABLING DISTRIBUTION

Leviton's cabling distribution products for residential and small office environments feature several excellent options for multimedia, 110 and 66-clip connectivity. The QuickPort® Multimedia Patch Block and 12-Port Category 5e Patch Block are ideal for small-scale network installations or additions, using twisted pair cabling where a wall-mounted or low-profile solution is required. Voice and low-speed data applications such as networks, fax machines, intercom systems and PBXs can be connected with Leviton's high-density M blocks—a well known standard for contractors and telecom professionals. Two types of patch panels are available: pre-configured Category 5e patch panels with 12 or 24 Category 5e connectors to meet the needs of high-speed data applications, or empty QuickPort® patch panels which can be configured on-site with 24 or 48 QuickPort snap-in modules (sold separately) for those high-media-density installations.

Patch Blocks and Panels

When a distribution panel enclosure doesn't provide the space or wire management necessary to support a wiring consolidation point, Leviton patch blocks can provide a customized cabling solution. Installers can lay out the products of their choice on a wall or plywood base (backboard) to build the exact configuration to meet their needs. All patch blocks fit into a standard "89D footprint" to facilitate space planning.

QuickPort® 12-Port Multimedia Patch Block

It can be field-configured with QuickPort snap-in modules to support a full range of low-voltage voice and data applications, and Category 5e and eXtreme applications. Provides custom-configurable cross-connects with all the performance of higher density products.

Snap-in module retention plates are accessible from the front side to simplify connector and cable administration. This patch block also comes with an 89D mounting bracket and port identification strips. Patch block is UL listed.



Cat No.	Description
47689-QP	A– QuickPort 12-port multimedia patch block

12-Port Universal Category 5e Patch Block

For smaller, wall-mount installations, this 12-port patch block is the ideal low-profile solution. Pre-configured with twelve Category 5e connectors, this universal block is suitable for T568A or B configurations, and comes complete with a mounting bracket and white write-on areas silkscreened beside the connectors to help identify port assignments. The patch blocks are UL Listed and fully comply with FCC Part 68. Dimensions: 10.0"H.x 2.375"W.



Cat No.	Description
5G584-U89	B– 12-port Universal Category 5e Patch Block, includes mounting bracket

QuickPort® Patch Panels

QuickPort patch panels can be field-configured with any QuickPort snap-in modules to maximize versatility, appearance, and ease of installation and upgrades. Choose from a 24-port or 48-port high-density panel for small- or large-scale network installations. Both panel versions also include a rear wire management bar. They are UL Listed and CSA Listed. Port identification kits are sold separately.

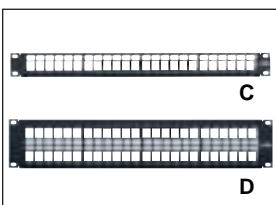

Cat No.	Description
49255-H24	C– High Density 24-Port Patch Panel w/Wire Management Bar (1.75"H.x 19"W.) Order 1 Port identification kit
49257-I24	
49255-H48	D– High Density 48-Port Patch Panel w/Wire Management Bar (3.5"H.x 19"W.) Order 2 Port identification kits
49257-I24	

Custom Video, Cabling & Distribution

Universal Category 5 and GigaMax™ 5e Patch Panels

The 12 and 24-port Category 5 and GigaMax™ 5e patch panels are pre-configured with Category 5 and 5e connectors. White write-on areas are silk-screened beside the connectors for ease of identification. The panels mount in standard 19" EIA Equipment racks and accommodate top, bottom, or side cable entry. The panels are UL Listed, meet National Electrical Code requirements and specifications for UL 1863, and fully comply with FCC Part 68 and TIA/EIA-568-B Category 5 and 5e.

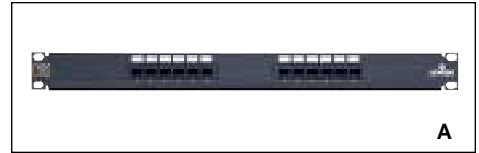

Cat No.	Configuration	Description
59484-U12	T568A/B	A- 12-Port Patch Panel-CAT 5
59484-U24	T568A/B	24-Port Patch Panel-CAT 5
5G484-U12	T568A/B	12-Port Patch Panel-CAT 5e
5G484-U24	T568A/B	24-Port Patch Panel-CAT 5e

Hinged Wall Mount Brackets

Use these brackets to mount patch panels and cable management without the use of a rack. Compatible with Category 5 patch panels and QuickPort® patch panels.



Cat No.	Description
49251-W62	B- 2-position (3.5"H.x 6.0"D.) hinged wall mount bracket
49251-W63	3-position (5.25"H.x 6.0"D.) hinged wall mount bracket
49251-W64	4-position (7.0"H.x 6.0"D.) hinged wall mount bracket

Designation Labels

Identify the services coming to and from wall outlets, distribution panels and patch blocks with these attractive, yet non-permanent designation labels. Ten sheets of clear, self-adhesive labels per unit kit, 94 labels per sheet. Printed in black ink.

Cat No.	Description
40740-BE	Designation Labels, individual polybag pack, order in increments of 10

Phone-1	Security	Video-In	Antenna-In	Bedroom-3	Garage	Speaker-1	Speaker-4
Phone-1	Security	Video-In	Antenna-In	Bedroom-3	Den	Speaker-1	Speaker-4
Phone-1	Alarm	Video-In	CableTV-In	Bedroom-4	Den	Speaker-2	Speaker-5
Phone-2	Alarm	Video-In	CableTV-In	Bedroom-4	Family Room	Speaker-2	Speaker-5
Phone-2	Printer	Video-Out	CableTV-In	Office	TV-1 In	Speaker-3	Speaker-3
Phone-2	Printer	Video-Out	CableTV-Out	Office	TV-1 Out	IN	OUT
Phone-3	Fax	Video-Out	CableTV-Out	Living Room	TV-2 In	IN	OUT
Phone-3	Fax	Video-Out	CableTV-Out	Living Room	TV-2 Out	Audio Left-In	Audio Left-Out
Bedroom-1	Modem	Remote-In	Satellite-In	Kitchen	TV-3 In	Audio Left-In	Audio Left-Out
Bedroom-1	Modem	Remote-In	Satellite-In	Kitchen	TV-3 Out	Audio Right-In	Audio Right-Out
Bedroom-2	Modem	Remote-Out	Satellite-Out	Basement	VCR-In	Audio Right-In	Audio Right-Out
Bedroom-2	Garage	Remote-Out	Satellite-Out	Basement	VCR-Out	LEVITON	OX-57819

Actual Label size
.625" x .1875"

PHONE

Custom Video, Cabling & Distribution

APPLICATION NOTE

110-Type Connections vs. 66-Clip Connections

Leviton recommends the use of products with 110-type connectors over those with 66-clips. However, many installers have different preferences, which is why Leviton offers some 66-clip products in addition to those with 110-type connectors.

66-clip blocks have been the standard for voice connections for many years. Although 66-clip blocks have been used for data, the 110 termination block may be a better choice. Both 66 and 110 blocks are insulation displacement connection (IDC) devices, which are key to reliable data connections. The 110-type connection offers: [A] higher density (more wiring in a smaller space) and [B] better control (less movement of the wires at the connection). Since more and more homes and small businesses are calling for both voice and data connections, it is easy to see why it makes sense to install 110-type devices in most situations.



110 BLOCKS

Distribution Block with 110 Connectors

50-pair 110 distribution block can be used as a termination point for all high-density voice and data cabling applications, including Category 5 Power Sum. Kit includes an 89D bracket, port identification strips, and C-4 and C-5 connectors.

Cat No.	Description
47690-110	A— Distribution Block with 110 Connectors



66-CLIP BLOCK ACCESSORIES

M Block Bracket for Jack/Connector Mounting Type 89D

Stand-off mounting bracket for 25- and 50-pair M blocks is open at top and bottom so that installers may mount bracket and lay cable, then install connecting blocks easily at a later date. Dimensions: 10"H.x 3.46"W.x 1.5"D.

Cat No.	Description
40089-D	B— M Block Bracket for Jack/Connector Mounting Type 89D Individual polybag pack
40089-DBR	Individual poly bag pack, rack pack carton



Standoff Mounting Bracket for M Blocks Type 89B

Stand-off mounting bracket for 25- and 50-pair M blocks is open at top and bottom so that installers may lay cable and mount bracket, then install connecting blocks easily at a later date. Dimensions: 10"H.x 3.41"W.x 1.5"D.

Cat No.	Description
40089-B	C— Standoff Mounting Bracket for M Blocks Type 89B



Modular Adapters

Plug into M blocks to convert 66-clip contacts to a modular jack for quick connection of equipment. These products are typically used for testing and temporary connections.

Cat No.	Description	Application
40072-T2 (Tap™-2)	D—2-position modular adapter	Converts two 66-clip contacts into a 6-position, 2-conductor modular jack.
40072-T4 (Tap™-4)	E—4-position modular adapter	Converts four contacts into a 6-position, 4-conductor modular jack.
40072-T6 (Tap™-6)	F—6-position modular adapter	Converts six contacts into a 6-position, 6 conductor modular jack.
40072-T8 (Tap™-8)	G—8-position modular adapter T568B wiring	Converts eight contacts into an 8-position, 8-conductor non-keyed modular jack

Custom Video, Cabling & Distribution

Wire Distribution Spools

Facilitate routing and fanning of cable, cross-connections, and jumper wires to any connection apparatus. Mount conveniently on backboard of distribution frame. Dimensions: 1.75" Dia. x 3"H.

Cat No.	Description
40054-DS	A— Distribution Spool without captive screw (20-A)
40054-DSS	B— Distribution Spool with captive screw (20-B)



Designation Strip for M Blocks (D-10)

Strip snaps onto fanning strips of M blocks to identify pair assignments.

Cat No.	Description
40056-DSM	C— Designation Strip for M Blocks

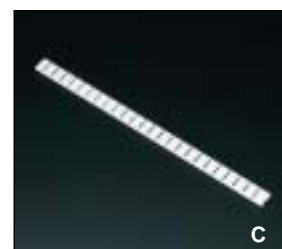

66-CLIP BLOCKS (Numbers in parentheses refer to industry product designations)

M Block: 25-pair (66M1-25)

25-pair M block contains 50 rows, each with a single clip having four slots. Incoming cable pairs (“tip” and “ring”) are connected by terminating “tip” on the leftmost slot of one row and “ring” on the leftmost slot of the next lower row. The three remaining slots in each clip are available for cross-connects. Dimensions: 10"H.x 3.31"W.x 1.19"D.

Cat No.	Description
40066-M25	D— M Block: 25-pair



Split M Block: 50-pair (66M1-50)

Split M block, like the 25-pair M block, contains 50 rows of clips, but instead of one 4-slot clip, each row contains two separate 2-slot clips. By terminating 25 incoming pairs on the slots of the left-hand clips and an additional 25 pairs on the slots of the right-hand clips, 50 cross-connects can be made. To make or eliminate connections even faster, bridging clips may be used to connect the two adjacent sets of clips together. Dimensions: 10"H.x 3.31"W.x 1.19"D.

Cat No.	Description
40066-M50	E— Split M Block: 50-pair Individual polybag pack, rack pack carton*



Bridging Clips (SA-1)

Bridging clips press onto the two center slots in any row of a Split M block. If outside cable pairs are terminated on the left-hand clips and station equipment wire is terminated on the right-hand clips, then connections can quickly be made or eliminated by simply inserting or removing the bridging clips. They can also be used on other products that use 66 clips. Made of phosphor bronze alloy, these clips provide long-term conductivity in even the most hostile environments. Because of their durability, they can easily be removed and reused for rewiring.

Cat No.	Description
40067-BC	F— Bridging Clips Bulk polybag pack, order in increments of 50
40067-CLP	Bulk polybag pack, 50 clips per unit, rack pack carton



Custom Video, Cabling & Distribution

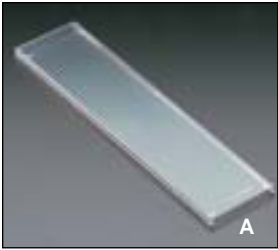

Snap-On Cover for M Blocks (66MC-4)

Durable cover snaps onto 25- and 50-pair M blocks to protect wiring from dust, dirt, and incidental shorting. Transparent plastic permits viewing of wiring and pair assignments. Dimensions: 9.94"H.x 2.31"W.x .31"D.

Cat No.-Black	Description
40050-MCV	A- Snap-On Cover for M Blocks

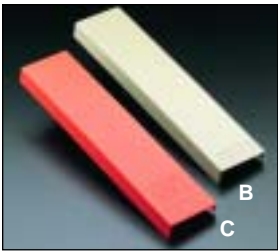

Hinged Cover for Demarc Blocks (66MC4LH-O)

Orange-colored cover allows the easy identification of the network demarcation point. It snaps onto the right side fanning strip of 25- and 50-pair M blocks to protect wiring from dust, dirt, and incidental shorting. Allows wires to be routed from both the left and right sides. Designation strip included on inside for recording pair assignments. Dimensions: 10"H.x 2.44"W.x .75"D.

Hinged Cover for M Blocks (66MC4LH-G)

Snaps onto the right side fanning strip of 25- and 50-pair M blocks to protect wiring from dust, dirt, and incidental shorting. Allows wires to be routed from both left and right sides with inside designation strip included for recording pair assignments. Dimensions: 10"H.x 2.44"W.x .75"D.

Cat No.-Black	Description
40050-MHG	B- Hinged Cover for M Blocks (grey)
40050-MHO	C- Hinged Cover for Demarc Blocks (orange)

Custom Video, Cabling & Distribution

FIBER OPTIC CONNECTORS

Thread-Lock® Connectors

Award-winning Thread-Lock Connectors, available in SC, FC and ST® styles, are reusable, field-terminable fiber optic connectors with a simple, craft-friendly installation. Bring high-speed fiber to the home or small office. Combine with a QuickPort® adapter for use in a computer workstation or home theatre, or combine with a QuickPort Mounting Plate and Multimedia Adapter in the Structured Media Center. No heat, epoxy or proprietary tools required. Silicone snap-on build-up sleeves for easy installation. Available in multimode or singlemode versions for use with 62.5/125 and 50/125 fiber cable. Each box of 50 connectors includes one tightening tool.

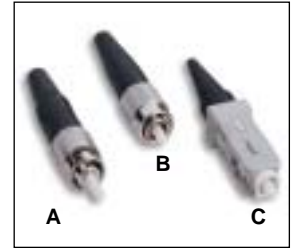

Cat No.–Singlemode	Cat No.–Multimode	Description
49884-SSC	49884-MSC	A–SC Thread-Lock Connector
49882-SST	49882-MST	B–ST® Thread-Lock Connector
49883-SFC	49883-MFC	C–FC Thread-Lock Connector
Cat No.	Description	
49884-DPC	D– SC Duplex Clip for Thread-Lock Connector, black (bag of 25)	
49886-DSC	E– SC Duplex Clip for Fast-Cure Connector, black (bag of 25)	
49886-DLS	F–LC Duplex Connector for Fast-Cure Connector, blue (bag of 25)	
49886-DLM	G– LC Duplex Clip for Fast-Cure Connector, beige (bag of 25)	



Spectro-Link® Frame Station Connector

High-density small form factor fiber connectivity for the home or office. Spectro-Link Frame-Station connectors use a cam technology to lock the fiber into a terminated position. Pair with an MT-RJ QuickPort adapter to mount in any wallplate, or combine with a QuickPort Mounting Plate and Multimedia Adapter for use in your Structured Media enclosure. Features a pre-polished ribbon fiber ferrule that eliminates polishing. Fiber can be tested and reterminated before crimping. Multimode.



Cat No.–62.5/125	Cat No.–50.0/125	Description
49888-6SF	49888-5SF	H–Spectro-Link MT-RJ Frame-Station Connector

Fast Cure Adhesive Connectors

Leviton epoxy Fast Cure connectors, available in ST®, SC and FC styles, are reliable, cost-effective fiber optic connectors with a quick, adhesive termination. Feature precision pre-radiused zirconia ferrules, high cable retention crimp, and patented non-optical disconnect spacer design. Use with a QuickPort adapter at the workstation, or combine with a QuickPort Mounting Plate and Multimedia Adapter in your Structured Media Center. Available in multimode or singlemode versions.



Cat No.–Singlemode	Cat No.–Multimode	Description
49990-SST	49990-MST	I– ST Fast-Cure Adhesive Connector
49990-SSC	49990-MSC	J– SC Fast-Cure Adhesive Connector
49990-SFC	49990-MFC	K–FC Fast-Cure Adhesive Connector
49990-SL2	49990-ML2	LC Fast-Cure Adhesive Fiber Connector with 3mm boot
49990-SDL	49990-MDL	LC Fast-Cure Adhesive Fiber Connector with 9mm boot

Small Wall Mount Panels–8.0"H.x 13.0"W.x 3.5"D. U N

Cat No.	Description
5W110-00N	L– Empty with Solid Metal Door, No Lock, boxed unit pack
5W120-00N	M– Empty with Split Metal Door and One Lock/Key, boxed unit pack
5W170-00N	N– Empty with Solid Metal Door and Lock/Key, boxed unit pack

FEATURES

- Door is L-shaped for maximum access to couplings through the open sidewall.
 - Door Options:
 - Split with single lock
 - Split with two locks (custom option)
 - Solid with single lock
 - Solid without lock
- Unique cable management ring is adjustable and stackable to simplify fiber loop installation, bend radius compliance, and future maintenance/additions. Stores 3 meters of 900 micron fiber per adapter.
- Houses two mounting plates for assorted fiber or multimedia applications, including ST, SC, FC, MT-RJ and QuickPort.
- Sidewall cutout gives completely unobstructed access to the bulkheads when door is open (covered when door is closed).



Optical Fiber



Cable Management Rings

Cable management rings can be stacked on top of existing rings for additional cable storage or management or can stand alone. Can be used with Category 5 twisted pair wire or fiber optic cable.

Cat No.	Description
5R100-0FR	A– Fiber Optic Cable Management Rings, 2 per polybag pack

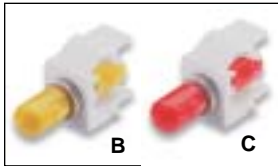

FIBER OPTIC ADAPTERS

Fiber Optic QuickPort® Adapters

Bring ST®, SC, FC or MT-RJ fiber to any outlet or media enclosure with the QuickPort® ST, FC, SC and MT-RJ Fiber Adapters. Snap-in connectors fit into any QuickPort Housing, including wallplates, wallboxes and the Multimedia Adapter bracket (for mounting in a Structured Media Enclosure).

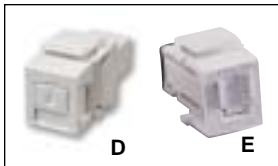

Cat No.	Description
41084-S*Z	B–ST Adapter, SM/MM, zirconia ceramic sleeve
41084-S*P	B–ST Adapter, SM/MM, phosphor bronze sleeve
41084-F*Z	C–FC Adapter, SM/MM, zirconia ceramic sleeve
41084-F*P	C–FC Adapter, SM/MM, phosphor bronze sleeve
41085-S*C	D–SC Adapter, MM, phosphor bronze sleeve
41085-M*C	D–SC Adapter, SM, zirconia ceramic sleeve
49889-QF*	E– Spectro-Link™ MT-RJ Frame-Station Adapter
41085-ML*	F–QuickPort Duplex LC Adapter, SM/MM, Phos. Bronze Sleeve
41085-SL*	G–QuickPort Duplex LC Adapter, SM/MM, Zirconia Ceramic Sleeve

*= Color: Ivory(I), White(W), Grey(G), Black(E), Almond(A). **= Colors: Ivory(I), White(W), Grey(G), and Black(E)



Fiber Optic Adapters

Cat No.	Description
49882-SAD	H– ST Adapter with Phosphor Bronze Sleeve, individual polybag pack
49884-BAD	I–SC Duplex Adapter with Phosphor Bronze Sleeve (beige) Individual polybag pack
49884-MAD	I– SC Duplex Adapter with Phosphor Bronze Sleeve (blue) Individual polybag pack
49884-SAD	SC Duplex Adapter with Zirconia Sleeve (blue), individual polybag pack
49889-MAD	J– MT-RJ Adapter (beige) Dual Polarity Multimode, individual polybag pack
5F100-DLC	K–Duplex LC Adapter with Phosphor Bronze Sleeve (beige) (Pkg. of 25)
5F100-DLZ	K–Duplex LC Adapter with Zirconia Sleeve (blue) (Pkg. of 25)
5F100-QLC	L–Quad LC Adapter with Phosphor Bronze Sleeve (beige) (Pkg. of 25)
5F100-QLZ	L–Quad LC Adapter with Zirconia Sleeve (blue) (Pkg. of 25)

Optical Fiber

FIBER OPTIC CABLE ASSEMBLIES



Leviton now offers an expanded line of low cost, high quality fiber optic cable assemblies and pigtail connectors for frame and workstation. Strenuously tested for return and insertion loss, and held to strict internal quality standards, these cords are developed to exceed TIA 568-B.3 standards. The line includes standard and hybrid combinations of connectors, as well as a selection of pre-polished pigtail fiber connectors in ST, SC, FC, LC and MT-RJ styles. We can even provide custom lengths and configurations for fiber runs, to your exact specifications—simply call Customer Service for more information.



Please Note—Custom lengths may require a waiting period. All cables are OFN-riser rated and meet all applicable TIA/EIA and industry standards.

STANDARD							
Connector Style	Density	PC Polish	SPC Polish	UPC Polish	APC Polish	50 micron	62.5 micron
MT-RJ to MT-RJ	Duplex	—	—	—	—	50DMJ-M**	62DMJ-M**
ST to ST	Duplex	PCDST-S**	SPDST-S**	UPDST-S**	—	50DST-M**	62DST-M**
ST to ST	Simplex	PCSST-S**	SPSST-S**	UPSST-S**	—	☛	☛
SC to SC	Duplex	PCDSC-S**	SPDSC-S**	UPDSC-S**	APDSC-S**	50DSC-M**	62DSC-M**
SC to SC	Simplex	PCSSC-S**	SPSSC-S**	UPSSC-S**	APSSC-S**	☛	☛
FC to FC	Duplex	☛	☛	☛	—	50DFC-M**	62DFC-M**
FC to FC	Simplex	PCSFC-S**	SPSFC-S**	UPSFC-S**	APSFC-S**	☛	☛
LC to LC	Duplex	PCDLC-S**	☛	☛	—	50DLC-M**	62DLC-M**
LC to LC	Simplex	PCSLC-S**	SPSLC-S**	UPSLC-S**	—	☛	☛
HYBRID							
Connector Style	Density	PC Polish	SPC Polish	UPC Polish	APC Polish	50 micron	62.5 micron
MT-RJ to SC	Duplex	—	—	—	—	50DCM-M**	62DCM-M**
MT-RJ to ST	Duplex	—	—	—	—	50DTM-M**	62DTM-M**
ST to SC	Duplex	PCDCT-S**	SPDCT-S**	UPDCT-S**	—	50DCT-M**	62DCT-M**
ST to SC	Simplex	PCSCT-S**	SPSCT-S**	UPSCT-S**	—	☛	☛
ST to FC	Duplex	☛	SPDTF-S**	UPDTF-S**	—	50DTF-M**	62DTF-M**
ST to FC	Simplex	PCSTF-S**	SPSTF-S**	UPSTF-S**	—	☛	☛
SC to FC	Duplex	☛	SPDCF-S**	UPDCF-S**	APDCF-S**	50DCF-M**	62DCF-M**
SC to FC	Simplex	PCSCF-S**	SPSCF-S**	UPSCF-S**	—	☛	☛
ST to LC	Duplex	PCDTL-S**	☛	☛	—	50DTL-M**	62DTL-M**
ST to LC	Simplex	PCSTL-S**	SPFTL-S**	UPSTI-S**	—	☛	☛
SC to LC	Duplex	PCDCL-S**	☛	☛	—	50DCL-M**	62DCL-M**
SC to LC	Simplex	PCSCL-S**	SPSCL-S**	UPSCLF-S**	—	☛	☛
FC to LC	Simplex	PCSFL-S**	SPSFL-S**	UPSFL-S**	—	☛	☛
PIGTAIL							
Connector Style	Density	PC Polish	SPC Polish	UPC Polish	APC Polish	50 micron	62.5 micron
MT-RJ	Duplex	—	—	—	—	50PMJ-M03	62PMJ-M03
ST	Simplex	PCPST-S03	SPPST-S03	UPPST-S03	—	50PST-M03	62PST-M03
SC	Simplex	PCPSC-S03	SPPSC-S03	UPPSC-S03	APPSC-S03	50PSC-M03	62PSC-M03
FC	Simplex	PCPFC-S03	SPPFC-S03	UPPFC-S03	APPFC-S03	☛	☛
LC	Simplex	PCPLC-S03	SPPLC-S03	UPPLC-S03	—	50PLC-M03	62PLC-M03

☛ = **Special Order**—Call Customer Service at 1-800-323-8920.

**=Length- 1 meter (01), 2 meters (02), 3 meters (03), 5 meters (05), or 10 meters (10)

All Pigtail Assemblies come standard in 3 meter lengths.

Note: To order custom lengths, please call Customer Service at 1-800-323-8920.

Optical Fiber

FIBER OPTIC TOOL KITS

6 Fiber Optic Fan Out Kits

These kits are used to safely route 250 micron fibers into 6 individual 900 micron color-coded fiber fan-out buffer tubes via a compact protective housing. The fiber can be directly terminated without the need for splicing. Offered in 24" and 36", these fan-out kits are designed to work with any Thread-Lock® connector.

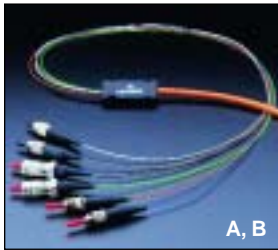

Cat No.	Description
49887-6S	A—6 Fiber Optic Fan-Out Kits with 24" Tubing, individual polybag pack
49887-6L	B—6 Fiber Optic Fan-Out Kits with 36" Tubing, individual polybag pack

Universal Tool Kit/Universal Tool Kit Plus

Singlemode and multimode compatible, and designed with the help of field technicians—Leviton's Universal Fiber Optic Tool Kits are designed for use with any Thread-Lock® connector: SC, ST or FC. The Standard Kit includes a scribe tool, while the Tool Kit Plus comes with the new Thread-Lock® Versa-Cleave® cleave tool. Leviton's state-of-the-art 200x inspection scope, which ships with both kits, has laser eye protection and is suitable for both singlemode and multimode applications.



Fast Cure Tool Kit

Designed for use with any Fast Cure epoxy connector: SC, ST, FC or LC. Comprised of a full complement of quality fiber tools, including a Crimp Tool, LC Scope Adapter and LC Polishing Puck. Suitable for both singlemode and multimode applications. Comes with Versa-Cleave™ Tool.



Spectro-Link MT-RJ Fiber Optic Tool Kit

Suitable for installing Spectro-Link MT-RJ connectors, this kit comes complete with Buffer Removers (2), Jacket Strippers, Scissors, Piano Wire, Safety Glasses, Gauge, Marking Pen, Opt-X™ 20/20 lenses, Lead-In Crimp Tool, Frame-Station Assembly Tool, Thread-Lock® Versa-Cleave™ Tool and 2 Spectro-Link MT-RJ adapters for the Thread-Lock® Versa-Cleave™ tool (for Workstation and Frame-Station connectors).



Accessory Kits

Accessory kits provide additional tools for installing Leviton Spectro-Link™ MT-RJ™ connectors or Fast Cure Epoxy connectors to expand an existing Universal Fiber Optic Tool Kit or Tool Kit Plus.

All Tool Kits and Accessory Kits come in their own compact lightweight cases. Individual Fiber Optic Tools and Components sold separately.



Cat No.	Description
49800-UTK	C—Universal Fiber Optic Tool Kit
49800-UTP	D—Universal Tool Kit Plus
49800-SLT	E— Spectro-Link MT-RJ Fiber Optic Tool Kit
49800-SLA	F— Spectro-Link MT-RJ Fiber Optic Accessory Kit
49800-FTP	Fast Cure Tool Kit Plus
49800-202	Hardner Primer Kit

Optical Fiber

FIBER OPTIC CONSUMABLES

Universal Consumable Kit

Leviton's Universal Consumable Kit contains everything you need to clean and polish singlemode and multimode ThreadLock connectors. The kit includes polyester wipes, alcohol pads, music wire, and 12-, 3- and 0.3 micron lapping film.

Fast Cure Consumable Kit

Leviton's Fast Cure Consumable Kit contains everything you need to clean and polish singlemode and multimode Fast Cure epoxy connectors. The kit includes polyester wipes, alcohol pads, Hardner/Primer Kit, replacement needles, syringes and 12-, 3- and 0.3 micron lapping film.

Hardner/Primer Kit

Contains a set of one bottle each Hardner and Primer, and one needle for epoxy connector terminations.

Cat No.	Description
49800-CON	A— Universal Consumable Kit
49800-FAC	B— Fast Cure Consumable Kit
49880-202	Adhesive/Primer Kit
49886-SYR	Syringes, 25/pack
49886-FCN	Replacement Needles, 25/pack
49886-12F	Lapping Film, 12 Micron Alum. Oxide, 100/pack
49886-03F	Lapping Film, 3.0 Micron Alum. Oxide, 100/pack
49886-X3F	Lapping Fil, 0.3 Micron Alum. Oxide, 100/pack



FIBER OPTIC TOOLS

Crimp Tool

Cat No.	Description
49886-FCT	Crimp Tool

SC Duplex Clip

Cat No.	Description
49884-DPC	C— SC Duplex Clip, bag of 25



Thread-Lock® Versa Cleave Tool™

Leviton's Versa-Cleave™ tool for mechanical or epoxy connectors features a unique cutting blade for a quality fiber cleave every time, eliminating the need for a complicated scribe and break procedure. The ergonomic stop-watch design fits comfortably in the hand and features a convenient integrated debris cup to catch and retain dangerous fiber debris until it can be safely discarded. 2.5mm and 1.25mm Ferrule Guide Tabs allow Versa-Cleave to cut to the perfect length for ST, FC, SC or LC connectors. Add a Workstation or Frame-Station Adapter to cleave fiber for Leviton MT-RJ connectors. Comes with removable Tungsten Carbide Blade Unit. Order Versa-Cleave on its own, or as part of a Fast Cure, Spectro-Link or Universal Tool Kit Plus.

Cat No.	Description
49886-TVC	D— Versa-Cleave Tool, individual polybag pack
49886-VWA	Versa-Cleave Adapter for Spectro-Link MT-RJ Workstation Connector
49886-VFA	Versa-Cleave Adapter for Spectro-Link MT-RJ Frame-Station Connector
49886-VSA	Versa-Cleave Adapter Kit for Spectro-Link MT-RJ (includes 49886-VWA and -VFA)



Thread-Lock® Tightening Tools

Available in two styles, FC and Combination SC/ST, tightening tools help simplify Thread-Lock connectorization by providing a wider gripping area to make it easier to tighten the connector plug. Use the jacket stripper (Claus WS-6) included in Leviton installation kits as a small pliers to hold the nylon sleeve head while the tool grips and rotates the metal connector plug. The tightening tools also protect the exposed fiber during the tightening process. The Combination tightening tool has an SC-style end and an ST-style end, for greater convenience and flexibility.

Cat No.	Description
49886-CTT	SC/ST Combination Tightening Tool, individual polybag pack (must be ordered in increments of 10)
49883-FCT	E— FC Tightening Tool, individual polybag pack (must be ordered in increments of 10)



Wallplates

PLASTIC WALLPLATES

Decora Standard Size Smooth Plastic Wallplates



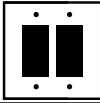
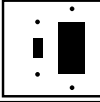
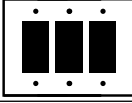
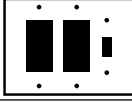
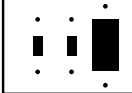

Cat No.*	Description
80401 	1-GANG
80409 	2-GANG
80405 	A- 2-GANG 1-Decora 1-Toggle
80411 	3-GANG
80431 	3-GANG 2-Decora 1-Toggle
80421 	3-GANG 2-Toggles 1-Decora

*For color selections, add suffix to the catalog number as follows Ivory (-I), White (W), Black (-E) and Almond (-A)

Decora Plus Standard Size Screwless Snap-On Thermoplastic Wallplates

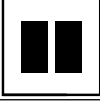

Cat No.*	Description
80301 	B- 1-GANG
80309 	2-GANG
80311 	3-GANG

*For color selections, add suffix to the catalog number as follows Ivory (-I), White (W), Black (-E) and Almond (-A)

Decora Midway Size Smooth Plastic Wallplates

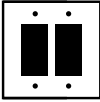
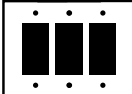

Decora Midway/Standard wallplate size comparison (3/8" wider and longer), 80401 in front of 80601.

Cat No.*	Description
80601 	C- 1-GANG
80609 	2-GANG
80611 	3-GANG





*For color selections, add suffix to the catalog number as follows Ivory (-I), White (W), Black (-E) and Almond (-A)

Many other sizes and types available—see Leviton D-503 Catalog

Wallplates

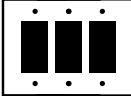

METAL WALLPLATES

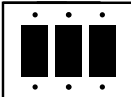
Decora Metal Wallplates

Cat No.		Description
81401		1-GANG (Brush Brass Satin finish)
81409		2-GANG (Brush Brass Satin finish)
81411		3-GANG (Brush Brass Satin finish)
83401		A- 1-GANG (Aluminum Satin finish)
83409		2-GANG (Aluminum Satin finish)
83411		3-GANG ((Aluminum Satin finish)





Standard Size Metal Duplex Receptacle Wallplates

Cat No.		Description
84003		B- 1-GANG (430 S/S)
84003-40		1-GANG (302 S/S)



WALLPLATE ACCESSORIES

Decora Standard Size Plastic Wallplate Adapters

Cat No.		Description
80414*		C- Blank (no hole)
6197**		Wallbox Adapter Extends shallow wallbox to fit GFCI/Decora devices

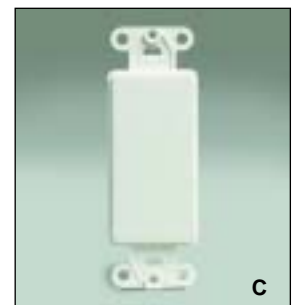

*For color selections, add suffix to the catalog number as follows Ivory (-I), White (W), Black (-E) and Almond (-A)

**For color selections, add suffix to the catalog number as follows Ivory (-I), White (W)

Home Control & Security Group

HOME CONTROL & SECURITY GROUP

A home smart enough to keep up with its owners.

Safety and security are a high priority with everyone today. Security experts are unanimous on the fact that making a home safer means first making it look “lived in.” Leviton’s Home Control and Security Group (including Decora Home Controls–DHC) makes a home more convenient, secure and comfortable.

The base-level *Smarter Home* package option brings timed ON/OFF switching to selected exterior lighting locations and motion-sensor activation at strategic outside points. The *Welcome Home* package means homeowners never have to come home to a dark house



again. Exterior and entry lights can be turned ON and OFF from the safety of a locked car in the driveway using keychain transmitters, effectively reducing the “window of opportunity” for suspicious activity outside the home.

The *House Sitter* package activates exterior and interior lights according to preset time commands, and can even turn ON appliances such as coffee and bread-makers to help everyone start the day. The entire system is controlled from a simple wall-mounted whole-house programmable controller that's as easy to use as a clock radio. This package also includes an ALL LIGHTS ON panic mode for added security, and has a SECURITY setting to randomize ON/OFF light timing while everyone is away to make the home look totally lived-in.

The *Night Sentinel* package adds total safety and convenience with four elements: **photocell control** that activates selected lighting at dawn and dusk, **outdoor**

motion sensing that can turn an entire lighting perimeter ON (and can even activate selected interior lighting for a full alert), **bedside control** to enable users to turn all Home Control devices ON and OFF without leaving their bedroom, and an **alarm interface** that integrates the smart lighting and control system to a low-voltage security system (not included) so that lights flash ON and OFF during an alarm.

Most Home Control and Security packages incorporate Leviton’s award-winning Decora Home Controls (DHC) product line, which combines superior quality with state-of-the-art electronic technology to form an



ultra-reliable home control network that’s also extremely easy to use. The system is also

simple to install and configure because it uses a wiring network that’s already built-into the home: the power-line itself. Core DHC products are equipped with Leviton’s exclusive Intellisense™ Technology to perform reliably even where electrical “noise” exists on the powerline. Leviton’s DHC Coupler/Repeater Module ensures proper signal integrity throughout the entire home.



DHC systems can be expanded to automate sprinkler systems, motorized blinds and curtains, heating systems, skylights, garage doors, motorized gates and nearly anything else the homeowner desires.

Important: *The Home Control and Security Group should only be installed in conjunction with a Leviton Power Quality network protection system for maximum reliability. Welcome Home is a prerequisite for House Sitter, and House Sitter is a prerequisite for Night Sentinel.*



Home Control & Security Group

SYSTEM PACKAGES

Smarter Home Package

A simple yet effective level of control for exterior lighting and interior pathways. *Smarter Home* uses powerful, programmable Decora LCD timers that can assign up to 48 ON/OFF intervals over a 24-hour period - perfect for setting outside lights to turn ON/OFF early in the morning, and then again at night. Residential-grade outdoor motion sensors turn lights ON/OFF in back yards and driveways, while occupancy/motion passive-infrared (PIR) sensors illuminate walk-through/walk-in paths inside the home for added security and convenience.



Type	Cat No.	Description
Decora Wall Switch PIR Occupancy Sensor, 10A	ODS10-ID	Automatic light switch turns incandescent or fluorescent lights ON and OFF in response to occupancy
Self-Contained PIR Ceiling Mount Occupancy Sensor	ODC0S-I1W	Automatically turns incandescent or fluorescent lights ON and OFF in response to occupancy, 1000W/VA
Single-Pole & 3-Way Wall-Mount Occupancy Sensor (PIR)	6800	Automatic light switch turns incandescent or fluorescent lights ON and OFF in response to occupancy, 500W/VA
Outdoor Motion Sensor	RS110-10	Outdoor sensor turns lights ON and OFF in response to motion, 500W/VA
Decora Plus Programmable Electronic Timer Switch	6124H	24-hour programmable timer for ON/OFF scheduling

Welcome Home Package

Dark driveways and doorways are a thing of the past with Leviton's *Welcome Home* package. *Welcome Home* puts control of outside and entryway lights into the palm of a homeowner's hand with a small command transmitter that fits right on a key chain. Simply push a button to turn outside lights and inside entry lights ON, all from the safety of a locked car. Because it operates from up to 75 feet away, *Welcome Home* can be a welcome deterrent in dealing with any unwelcome presence lurking near the home. It's also a more convenient way to come home after a long day. *Welcome Home* can even turn OFF power to a garage door opener (with an extra control module) for added security during extended vacations.



Type	Cat No.	Description
Key Chain Transmitter	HCKKR	Key chain remote control (RF) turns lights ON and OFF from a maximum distance of 75 feet
Transceiver	HCPRF	RF receiver/transmitter receives key chain signal and relays signal to the DHC network
Universal Remote Control	HCCUV	Provides RF Control of DHC switches and receptacles and IR control of home entertainment components (e.g., TV, cable, etc.)
DHC Single-Pole (One Location) Receiver Switch	6291-WI	Receiver responds to transmitter by turning light ON and OFF. Also, functions as a standard switch using manual override
DHC 3-Way (Multi-Location) Receiver Switch	6293-WI	Provides manual and remote ON/OFF control when used with one or more 6294 Remote Switches
3-Way and 4-Way Remote Receiver Switch	6294	Provides remote switching when used with Cat. No. 6293
DHC Single-Pole or 3-Way Dimming Receiver Switch with Scene Control	HCM06-1TW	Switch receives signals for ON/OFF or dimming. Also, functions using manual override
DHC Single-Pole or 3-Way Switch with Scene Control	HCC10-1TW	Provides manual and remote ON/OFF switching for incandescent, fluorescent and low-voltage lighting, 10A 1200W/VA
DHC One-Address ALL ON/ALL OFF Controller	HCC1A-1TW	One ON/OFF rocker transmits ON/OFF remote commands to one address
DHC 3-Way & 4-Way (Multi-Location) Remote Dimming Switch	MS00R-10	For use as a remote switch for the HCM06-1SW & HCS10-1SW
DHC Signal Amplifier/Coupler/Repeater	HCA02-10E	Ensures system reliability
DHC Split Duplex Receptacle	6227	Top outlet provides ON/OFF control, bottom outlet is continuously live

Home Control & Security Group



House Sitter Package

Leviton's *House Sitter* package makes a home smart enough to turn its inside and outside lights ON and OFF at pre-selected times, making it look like someone is always at home. *House Sitter* lets users leave their home with a greater sense of confidence—in fact, they'll never have to worry about whether they left the lights on again. *House Sitter* turns them ON and OFF automatically.

House Sitter's Wall Programmer/Controller is as easy to preset and use as a clock radio. It assigns up to eight different timed events for front, side and backyard lights, as well as entryway lights and selected lamps inside the house. The Wall Programmer/Controller can also turn ON a coffeemaker at a pre-selected time in the morning. Features include an ALL LIGHTS ON control for "panic" situations, an ALL UNITS OFF control, a BRIGHT/DIM control for dimmers (such as the entryway) and a SECURITY mode to randomize lights and enhance the "lived in" look.

Note: *House Sitter* may require additional DHC-enabled receivers (switches, receptacles and lighting controls) listed in the Welcome Home package.

Type	Cat No.	Description
Programmable Controller	6312	Basic Programmer provides automatic control plus security mode random light switching and ALL-LIGHTS-ON control
DHC Toscana™ Deluxe Programmer	HCCPG-1TW	One-touch access to up to 64 lighting scenes and direct remote control of up to 256 devices. Automatically turns appliances ON/OFF and lights ON/OFF/DIM/BRIGHT. Run timed events on recurring basis
Three-Address Dimming ALL LIGHTS ON/ALL OFF Wall Switch Controller	HCC4A-1TW	Multi-button transmitter sends signals to 3 receiver addresses for switching and dimming plus ALL LIGHTS ON/ALL OFF and GROUP DIM/BRIGHT control
One-Address ON/OFF Wall Switch Controller	HCC10-1TW	One ON/OFF rocker transmits ON/OFF commands to one address
One-Address Dimming Wall Switch Controller	HCC1D-1TW	One ON/OFF rocker transmits ON/OFF commands to one address while a built-in arrow-shaped rocker transmits BRIGHT/DIM commands to the same address.
Two-Address Dimming Wall Switch Controller	HCC2D-1TW	Two sets of ON/OFF buttons transmit ON/OFF commands to two sequential addresses in the same letter code and one set of buttons transmits GROUP BRIGHT/DIM commands to the most recently selected address
Three-Address Dimming Wall Switch Controller	HCC3D-1TW	Three sets of ON/OFF buttons transmit ON/OFF commands to three sequential addresses in the same letter code. One set of buttons transmits GROUP BRIGHT/DIM commands to most recently selected address
Four-Address Dimming Wall Switch Controller	HCC4D-1TW	Four sets of buttons transmit ON/OFF commands to three sequential addresses of the same letter code. One set of buttons transmits GROUP BRIGHT/DIM commands to the most recently selected address.
Seven-Scene Dimming Wall Switch Controller	HCCS7-1TW	Each of SEVEN scene buttons transmits ON commands to preset levels to 12 sequential addresses of the same letter code group as the controller. Only works with scene-capable receivers. One OFF button transmits OFF command to the most recently selected scene.
System Coupler/Repeater	HCA02-10E	Ensures a strong signal throughout a residence

Home Control & Security Group

Night Sentinel Package

Night Sentinel turns a home into a smart castle. Automatically turn outside and inside lights ON at sunset and OFF at sunrise, flash inside and outside lights ON and OFF at the cue of an optional security system, turn back, side and front lights ON when anyone or anything approaches the house, or even turn lights and appliances ON and OFF from the comfort of your bedside.

The *Night Sentinel* package consists of four main elements. An Outdoor Motion Sensor/Transmitter not only controls a dedicated floodlight fixture, but all the lights included in the *Welcome Home* and *House Sitter* packages by telling them to turn ON when anything approaches the house. The Outdoor Photocell Transmitter turns selected lights and lamps OFF and ON at dawn and at dusk, eliminating the need to constantly re-adjust OFF and ON times. In conjunction with an alarm system (not included), the Alarm Interface ties that system into the home's lighting, flashing the lights in an emergency to attract attention and deter criminals. Finally, the Bedside Controller complements *House Sitter's* Wall Programmer/Controller by letting your customers command essential functions from their bedsides.

Note: *Night Sentinel* must be used in conjunction with the *House Sitter* package and the *Welcome Home* package



Type	Cat No.	Description
Photocell Transmitter	6308	Outdoor photocell transmitter sends signals to switch receivers in response to dawn and dusk
Outdoor Motion Sensor	6417	Outdoor motion sensor transmitter sends signal to outdoor and indoor receivers to turn lights ON
Security Interface	6330	Alarm interface flashes lights ON/OFF in emergency
Table Top Controller	6320	Controls multiple light switches and offers ALL-LIGHTS-ON control
Universal Low Voltage Module	6337	Allows almost any low voltage device to be automated by interfacing it with a 120V AC wiring network from which it can receive ON or OFF commands from DHC Controllers
System Coupler/Repeater	HCA02-10E	Ensures a strong signal throughout a residence

Lighting Controls Group

LIGHTING CONTROLS GROUP

Setting the mood for any occasion in every room

Light defines every feature in a home, and, through variation, can even change a room's personality. By artfully controlling lighting, a room or zone can take on many levels of involvement, from intimacy to excitement.

Leviton Integrated Networks takes care of the "control" aspect by providing three levels of advanced lighting products aimed at bringing more comfort and style to



the two primary segments of the home: the living areas, and the bed and bath areas. *Living Director* upgrades kitchens, dining rooms, offices, dens and hallways, with stylish controls for lighting

fixtures and ceiling fans. *Bed & Bath* focuses on bedrooms, bathrooms, associated hallways and common areas, with controls specifically designed for these applications. Together, these two innovations transform the home into an environment suitable for entertaining, working, relaxing, and much more.

Cinema Style is an option that can equip a home theater with a theatrical-grade intelligent lighting system that's at home with any video presentation, from casual channel-surfing to feature-length films.

Lighting Magic saves time by providing "hands-free" occupancy and motion-sensing ON/OFF activation in critical walk-through and walk-in areas such as garages, laundries, hallways and closets. In garages, *Lighting Magic* also provides extra safety by turning entry lights ON before anyone gets out of the vehicle.



These Lighting Control upgrades do more than add ambience. They also add value. Even at modest settings, dimmers save energy and increase light-bulb life, while occupancy / motion sensors turn lights ON only when needed.

All Leviton Lighting Controls are inspired by the Leviton commercial and architectural lighting systems appearing in art galleries, hotels, fine restaurants and other high-profile venues. All are built to a higher level of quality, with superior on-board filtering technology, precision control features, air-gap internal switching, encapsulated gold-surfaced contacts and improved heat-dissipation design. The result is a line of lighting controls designed for the life of the home and built to withstand the rigors of everyday use.

Traditional Lighting Group



Classic and unobtrusive toggle styling hides advanced lighting technology that provides extraordinary control from ordinary-looking controls. Based on Leviton's ToggleTouch™ lighting control, the *Traditional Group* is a masterpiece of digital design in a timeless setting.

ToggleTouch uses digital electronics and Touch Pad technology to provide fingertip-control

dimming with advanced features such as preset dimming and soft-ON. Protected memory ensures that each ToggleTouch control retains its memory after power outages.

Lighting Controls Group

SYSTEM PACKAGES

Traditional Living & Entertainment Director Package

Dimmers in living room, family room, dining room, bathroom and entry area

Type	Cat No.	Description
ToggleTouch™ 600W Incandescent Dimmer (No LED locator)	TGI06-10	Controls light levels
ToggleTouch™ 600W Illuminated Incandescent Dimmer	TGI06-1L	Controls light levels—helpful in dark hallways
ToggleTouch™ 1000VA Illuminated Magnetic Low-Voltage Dimmer	TGM10-1L	Controls light levels—helpful in dark hallways



Bed & Bath Ambience Package

Dimmers in bedrooms and bathrooms, and timers in the bathrooms

Type	Cat No.	Description
ToggleTouch™ 600W Incandescent Dimmer (No LED locator)	TGI06-10	Controls light levels
ToggleTouch™ 600W Illuminated Incandescent Dimmer	TGI06-1L	Controls light levels—help in dark hallways
Lighted Toggle Switch	5501-LH	Illuminated switch helps in dark areas
3-Way Lighted Toggle Switch	5503-LH	Illuminated switch for multiple switching
Timer Switch	6230M	Timers turn OFF exhaust fan in bathrooms using factory-set time increments of 5-10-20-30 minutes



Lighting Controls Group

DECORA LIGHTING GROUP

Leviton's hallmark design is re-expressed for contemporary applications in these high-style lighting controls. Centered on Leviton's acclaimed Illumatech™ slide dimmer, the Decora Lighting Group includes innovations such as digital timers for bathroom fans (turns fans OFF after preset intervals), and Lighting Magic occupancy/motion sensors for hands-free ON/OFF switching in walk-through and walk-in areas. Proven in the hospitality industry, the Decora Lighting Group is ideal for bringing style and utility into today's homes. Features include power-failure recovery, exceptionally fluid slide control, and full compatibility with models designed for different types of lighting fixtures including fluorescent and low-voltage.

SYSTEM PACKAGES

Decora Living & Entertainment Director Package

Includes dimmers in all living areas such as living room, kitchen, family room and dining room as well as dimmers and fan timers in the bathroom.



Type	Cat No.	Description
Illumatech™ Preset 600W Incandescent Dimmer with LED Locator	IPI06-1L	Single-Pole and 3-Way preset fluid slide incandescent dimming control with LED indicator when lights are OFF
Illumatech™ Preset 400VA Electronic Low-Voltage Dimmer with LED Locator	IPE04-1L	Single-Pole and 3-Way preset fluid slide electronic low-voltage dimming control with LED indicator when lights are OFF
Illumatech™ Quiet Fan Speed Control with LED Locator	IPF01-1L	Ideal for up to 1.5 Amp preset step fan speed control with LED indicator when fan is OFF in libraries, study rooms and wherever fan noise could become distracting
Illumatech™ Incandescent Dimmer (no preset)	INI06-1L	Single-pole fluid slide incandescent dimming control with LED indicator when lights are OFF
Illumatech™ Magnetic with Low-Voltage Dimmer (no preset)	INM06-1L	Single-pole fluid slide magnetic low voltage dimming control LED indicator when lights are OFF

Decora Bed & Bath Ambience Package

Includes illuminated switches in hallways, dimmers in bedrooms and dimmers plus timers in the bathroom.



Type	Cat No.	Description
Illumatech™ Preset 600W Incandescent Dimmer with LED Locator	IPI06-1L	Single-Pole and 3-Way preset fluid slide incandescent dimming control with LED indicator when lights are OFF
Illumatech™ Preset 400VA Electronic Low-Voltage Dimmer with LED Locator	IPE04-1L	Single-Pole and 3-Way preset fluid slide electronic low-voltage dimming control with LED indicator when lights are OFF
Illumatech™ Quiet Fan Speed Control with LED Locator	IPF01-1L	Ideal for up to 1.5 Amp preset step fan speed control with LED indicator when fan is OFF to eliminate distracting fan noise
Decora Quiet Rocker Switch	5613	3-Way illuminated switch (when OFF)
Decora Quiet Rocker Switch	5611	Single-Pole Illuminated (when OFF)
Timer Switch	6230M	Fan Timers

Decora Lighting Magic Package

Provides energy savings plus convenience. Includes motion sensor light switches in areas such as the laundry room, the garage and entryways as well as a timer in the attic.



Type	Cat No.	Description
Occupancy Sensor	6800	Automatic light switch turns lights ON and OFF in response to occupancy

Lighting Controls Group

DESIGNER LIGHTING GROUP

Remote-controllable architectural-grade lighting that's equally at home in a residence as it is in art galleries and museums. The Designer Lighting Group is based on Leviton's Mural™ and TouchPoint™ digital dimmers that use advanced microprocessor circuitry for extremely precise control.

SYSTEM PACKAGES

Designer Living & Entertainment Director Package

In *Living & Entertainment Director* applications, dimmers are replaced with multiple Mural Scene Capable Dimmers that can be combined with a Scene Controller to effect flexible, preset lighting scenes with IR remote control over entire zones (such as an open kitchen/family room area).



Type	Cat No.	Description
Mural™ Decora-Style Dimmer	MSI06-1L	600W Incandescent Dimmer with LED locator is easily found in dark areas
Mural™ Decora-Style Dimmer	MDI06-1L	600W Incandescent Dimmer with LED locator and LED Brightness Display is easily found in dark areas and indicates level of illumination
Mural™ L/S (Level Set) Decora-Style Preset Digital Dimmer	MLI06-1L	600W Incandescent Dimmer with LED locator is easily found in dark areas
Mural™ L/S (Level Set) Decora-Style Preset Digital Dimmer	MRI06-1L	600W Incandescent Dimmer with LED locator is easily found in dark areas and indicates level of illumination
Mural™ Multi-Remote Unit	MS00R-10	Remote Switch permits Multi-Location Dimming
Mural™ Decora-Style Dimmer	MDM06-1L	600VA Magnetic Low-Voltage Dimmer with LED locator and LED Brightness Display is easily found in dark areas and indicates level of illumination
Mural™ L/S (Level Set) Decora-Style Preset Digital Dimmer	MLM06-1L	600VA Magnetic Low-Voltage Dimmer with LED locator and LED Brightness Display is easily found in dark areas and indicates level of illumination
Mural™ Scene Capable Decora-Style Digital Magnetic Low-Voltage Dimmer	MCM06-1L	600VA Scene Capable Incandescent Magnetic Low-Voltage Dimmer with LED locator and LED Brightness Display is easily found in dark areas and indicates level of illumination that can be set by a Scene Controller Device
Mural™ Scene Capable Decora-Style Digital Magnetic Low-Voltage Dimmer	MCM10-1L	1000VA Scene Capable Incandescent Magnetic Low-Voltage Dimmer with LED locator and LED Brightness Display is easily found in dark areas and indicates level of illumination that can be set by a Scene Controller Device
Mural™ Scene Controller	MN00C-1L	7 Lighting-Scene plus OFF and Group DIM and BRIGHT buttons provide for flexible control
Remote Control	177RC	Hand-Held IR Remote Control provides convenient lighting controls from different room locations
Remote Control Infrared Receiver	177IR-IWA	IR Receiver for 177RC Remote Control
2-Way Signal Repeater	17100-2WY	Used to control lighting on more than one circuit
Occupancy Sensor Control Bridge	177OC	Operates Scene devices in conjunction with any Leviton Occupancy Sensor

Lighting Controls Group



Designer Bed and Bath Lighting Ambience Package

Package features TouchPoint™ Touch-Pad dimmers in bedrooms and bathrooms, Decora Plus illuminated switches for welcome nighttime lighting in hallways and guest rooms and digital fan controls for turning bathroom fans OFF after preset time intervals.

Type	Cat No.	Description
Decora Switch (Lens illuminated when OFF)	5611	Single-Pole illuminated switch
Decora Switch	5613	3-way illuminated switch
Decora Switch (Lens illuminated when OFF)	5614	4-way illuminated switch
Dimmer	TPI06-1L	TouchPoint™ 600W incandescent w/LED locator
Dimmer	TPI10-1L	TouchPoint™ 1000W incandescent
Timer Switch	6230M	Turns fans OFF using factory-set time increments of 5-10-15-30 minutes



Designer Lighting Package

The Designer Lighting Group's energy-saving *Lighting Magic* package features advanced-technology Leviton passive-infrared (PIR) occupancy sensors that have a proven track record in commercial environments where reliability, efficiency and aesthetics are equally critical.

Type	Cat No.	Description
Motion Sensors	ODS10-ID	Features large coverage area and provides automatic ON and OFF light switching in response to occupancy
Timer Switch	6230M	Turns lights OFF using factory-set increments of 5-10-30 minutes



Cinema Style Package

The *Cinema Style* package brings a professional-quality, remote-controlled scene lighting system to home theaters and entertainment areas.

Type	Cat No.	Description
Dimmer	MNI10-1L	Monet™ scene capable 1000W incandescent, architectural style
Controller	MN00C-1L	Scene controller, 7 scenes
Accessory	177RC	Remote control, 4 scenes
Accessory	177IR-IWA	Infrared receiver, wall and ceiling mount
Dimmer	MNM06-1L	Monet™ scene-capable 600VA magnetic low-voltage, architectural style

Power Quality Group

POWER QUALITY GROUP

A whole-house surge protection network for residential applications

The popularity of home offices, the internet and home theaters means that there are more home electronics that are vulnerable to voltage surges than ever before. A whole-house protection plan must protect against voltage surges on both the powerline and the telephone or communication lines. Homeowners may be unaware that surges can enter their expensive electronic equipment (modems, FAX machines, answering machines, TV's and VCR's) through telephone lines and cable TV or satellite dish connections. Most surge protective devices (SPD's) designed for the AC powerline will not prevent telephone or communication line surges from damaging valuable equipment. As a result, Leviton offers a complete selection of SPD's for powerline, telephone and communication line applications.

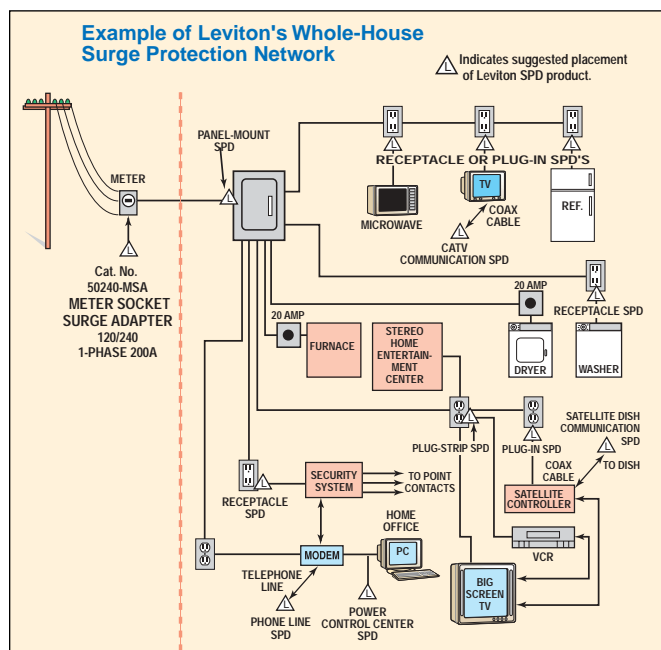

The best protection for the home is an industrial-strength solution: A Leviton Power Quality network, designed to protect mission-critical equipment in the most demanding professional environments including hospitals and laboratories.

The keyword here is "network." Because power line problems can be generated either outside (externally) or even inside the home, full protection requires a network that guards both the entire premises and each device from potentially damaging problems. The Leviton solution places an advanced-technology

transient voltage surge suppression (TVSS) device at the service entrance (either at the electrical panel or the meter), with point-of-use TVSS devices located strategically throughout the home—behind PC's and entertainment centers, in home theater rooms and at



major appliances. Because damaging electrical impulses can even enter through low-voltage lines such as cable TV and telephone, total protection includes TVSS devices designed to protect those lines as well.

From the use of hybrid-circuit design for a more advanced level of protection to Leviton's hybrid MOV (metal oxide varistor) design that delivers superior noise filtering, tighter clamping, faster response to high-speed transients and superior energy dissipation, a Leviton Integrated Networks Power Quality system is the last word in first-line defense against the damaging effects of power line surges. It should be the first choice of anyone with an electronic investment at risk.

Complete Warranty Coverage

We stand behind every Leviton Surge Protective Device. The Panel-Mount Surge Protective Devices are backed by Leviton's Limited 10-Year Warranty. Many plug-in SPD's and stand-alone and stackable low-voltage Surge Protective Devices are backed by Leviton's Lifetime Limited Warranty that covers not only the surge protective devices, but also the loads they protect up to \$25,000. Your Leviton representative can provide you with detailed information.

Power Quality Group

SYSTEM PACKAGES

Whole-House Electrical “Networked” Surge Protection Package

Includes whole-house surge protection at the electrical panel and point-of-use protection at various critical locations (home office, entertainment center, major appliances).

Type	Cat No.	Description
Whole house	51110-PTC	Panel protects AC, CATV and telephone lines at point-of-entry to home
Point-of-use	5280	Receptacle protects any plugged-in equipment (PC, stereo, microwave oven, etc.)



Whole-House Low-Voltage and Electrical Complete PQ Protection Package

Includes whole-house surge protection at the electrical panel and point-of-use protection with extra protection for low-voltage lines to protect sensitive electronics that can suffer circuit degradation. UPS's are employed for safe shutdown of home office computers when power is lost as well to protect them from power fluctuations.

Type	Cat No.	Description
Whole house	51110-PTC	Panel protects AC, CATV and telephone lines at point-of-entry to home
Point-of-use	5280	Receptacle protects any plugged-in equipment (PC, stereo, microwave oven, etc.)
Audio/Video Equipment	5505	19-inch rack-mount unit protects A/V equipment
UPS	U1000-AKP	Uninterruptible Power Supply functions as off-line power strip up to 1000VA, 5 outlets



Special Needs Group

SPECIAL NEEDS GROUP

Safer, More Accessible Home



Today, equal access is a rapidly growing residential need—not to mention a social and even legal responsibility in certain applications. Diversity in ages and abilities as well as temporary circumstances can impose special challenges in everyday life.

Leviton's Special Needs group is designed to help overcome some of those challenges by making homes safer, more accessible and more enjoyable for all users. The *Child Safety* package makes homes more secure for the littlest members of the household. The *Universal Design* package makes the home more accessible for everyone. Leviton is a pioneer in touch-operated electrical devices, with Leviton devices routinely specified in managed-care and health facilities. Exceptionally intuitive and ergonomic design combined with ease-of-use place Decora devices in the lead in this emerging field.

Leviton's Special Needs group provides nearly effortless control over a wide variety of devices and systems, placing every individual—regardless of their age, ability or mobility, more in control of their living and working environment.

SYSTEM PACKAGES

Child Safety Package

Thousands of accidents happen each year involving children and electricity. Leviton's *Child Safety* package goes a long way to making them avoidable in the home.

Instead of potentially hazardous caps in outlets, the Child Safety package starts with Leviton Kiddy Cop™ outlets which consist of two elements: a Tamper-Resistant outlet with an internal plastic shield that will not open the outlet slots up to anything except an electrical plug (resisting screwdrivers, keys and fingers), and an innovative outlet cover with spring-loaded plates that snap shut over the Tamper-Resistant outlet for a second line of defense.

Complete shock protection is assured with Leviton's innovative patent-pending SmartLock™ GFCI receptacle. It makes sure that no electrical power is provided whenever the GFCI fails to function properly for any reason.

Leviton's Anywhere Light Switches help protect children from injuries while climbing to turn ON lights by placing a second remote-controlled light switch where children can use it. The remote control can be moved as the child grows. Switch Locks prevent children from turning critical switches ON or OFF. A child's room feels more secure with a Leviton Digital Timer, which can be programmed for bedtime or naptime, letting a child fall asleep with the lights ON and turning them OFF shortly after.



Type	Cat No.	Description
Tamper-Resistant Electric Outlet	5321	Exclusive internal shutter design protects against shock due to insertion of objects in the outlet
Outlet Cover	86002	Outlet covers provide a cost-effective safety feature by blocking outlet slots
GFCI (SmartLock™) Receptacle	8599	SmartLock™ GFCI blocks power completely when ground fault prevention has been compromised
Light Switch	6690	Anywhere Light Switch allows switch location lower on wall to prevent child climbing accidents
Switch Cover	12005	Light switch lock
Timer Switch	6124H	Digital timer switch

Special Needs Group



Universal Design Package

For those with differing abilities and needs, even ordinary electrical switches can present a challenge. With the *Universal Design* package, the same Leviton electrical devices recommended by the Center for Universal Design and used in assisted-living communities throughout the country can be installed in your customers' home to make it more comfortable for loved ones in their care.

Leviton True Touch™ Digital Dimmers require the least amount of physical pressure to activate. A simple light touch turns lights ON or OFF. They are ideal for people with restricted range of motion. For those with mobility restrictions, Leviton Anywhere Dimmers provide a second remote-control point for room lighting and may be moved for convenience (next to a bed, for example). Anywhere Dimmers provide simple three-stage dimming (low, mid and high), allowing users to touch a rocker on the wall switch or use a remote (remotes may be handheld or mounted). Bathrooms and bedrooms become friendlier with Illuminated Receptacles, which provide welcome night-lighting and make it easier to locate electrical outlets. In case of an emergency, the Leviton 911 Flasher can flash a home's outside lights to signal arriving help such as police or paramedics.

Type	Cat No.	Description
Dimmer	TTI06-10	True Touch™ dimmer for easy control. 600W-120V AC incandescent only.
Illuminated Receptacle	8200-HL	Illumination helps those with reduced vision locate receptacle in darkened rooms. 15A-125V
Illuminated Switch	1201-LH	Illumination helps those with reduced vision locate switch in darkened rooms. 15A-120V AC.
Flasher Switch	911	Light Switch will flash outdoor lights to notify emergency vehicles of location (also operates as standard light switch). 500W-120V AC.
Anywhere Dimmer Switch	6698	Provides local and remote incandescent dimming

Receptacles

RECEPTACLES

Decora Plus Back and Side Wired Self-Grounding Receptacle

NEMA 5-20R , 20A/125V



Cat No.*	Description
16351*	A- Single

*For color, add suffix to the catalog number as follows Ivory (-I) and White (-W)



Decora Side Wired and Quickwire Receptacle

NEMA 5-15R, 15A/125V



Cat No.*	Description
5325*	B- Duplex

*For color selections, add suffix to the catalog number as follows Ivory (-I), White (-W), Black (-E) and Almond (-A)

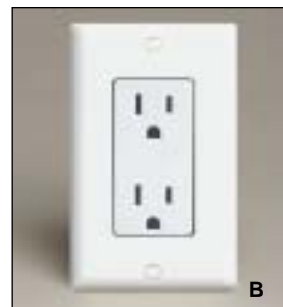

Decora Plus SmartLock™ GFCI Receptacle with Lockout Action

NEMA 5-15R , 15A/125V at Receptacle; 20A 125V Feed-Through



Cat No.*	Description
8599*	C- Duplex GFCI Receptacle with Lockout Action, No Indicator Light

*For color selections, add suffix to the catalog number as follows Ivory (-I), White (-W), Black (-E) and Almond (-A)



Straight-Blade Hospital Grade Illuminated Back and Side Wired Receptacle

NEMA 5-15R , 15A/125V



Cat No.*	Description
8200-HL*	D- Illuminated Duplex Receptacle

*For color selections, add suffix to the catalog number as follows Ivory (I) and White (W)



Switches

SWITCHES

Decora Plus AC Quiet Rocker Switches—120/277V AC; Back and Side Wired



Cat No.*	Description
5691-2*	A— Single-Pole
5693-2*	Three-Way

*For color selections, add suffix to the catalog number as follows Ivory (I), White (W), Black (E) and Almond (A)

Decora Plus AC Quiet Illuminated Rocker Switches 120V 60Hz AC Only; Back and Side Wired



Cat No.*	Description
5631-2*	B— Single-Pole
5633-2*	Three-Way

*For color selections, add suffix to the catalog number as follows Ivory (I), White (W) and Almond (A)

Decora Plus AC Quiet Pilot Light Rocker Switches 120V 60Hz AC Only; Back and Side Wired



Cat No.*	Description
5628-2*	C— Single-Pole
5638-2*	Three-Way

*For color selections, add suffix to the catalog number as follows Ivory (I), White (W) and Almond (A)

Decora AC Quiet Rocker Switches 15A/120/277V AC; Quickwire Push-In and Side Wired



Cat No.*	Description
5601*	D— Single-Pole
5603*	Three-Way

*For color selections, add suffix to the catalog number as follows Ivory (-I), White (-W), Black (-2E) and Almond (-2A)

Decora AC Quiet Rocker Switches (Lens illuminated when OFF) 15A/120/277V AC; Quickwire Push-In and Side Wired



Cat No.*	Description
5611*	E— Single-Pole
5613*	Three-Way

*For color selections, add suffix to the catalog number as follows Ivory (-I), White (-W) and Almond (-2A)

LIN Frequently Asked Questions

BASIC INFORMATION

Q. What is Leviton Integrated Networks?

A. Leviton Integrated Networks is the Leviton product line for home structured media, lighting, home control and surge protection.

Q. OK. What's a home-structured media system?

A. A system that distributes everything that isn't powered by standard electrical voltage, including Internet, cable, VCR and satellite TV, phone and fax, stereo system, home and child monitoring.

Q. When should I install a structured media system?

A. Installing one is much more economical when a house is being built, but it's also easy to install it during remodeling or when adding an addition.

LEVITON INTEGRATED NETWORKS, THE INTERNET AND HOME NETWORKING

Q. What about Leviton Integrated Networks and the Internet?

A. Whether it's for a home office or a student's room, a kitchen or a family room, Leviton Integrated Networks is capable of high-speed Internet transmission to as many rooms as you choose. (See the following question for more information on high-speed Internet.) Leviton Integrated Networks also turns homes with more than one computer into powerful home networks, for sharing of files, printers or scanners.

Q. Will Leviton Integrated Networks make my Internet downloads go faster?

A. Yes. Leviton Integrated Networks provides a large capacity pathway for downloading information from the Internet. The wiring connections allow speeds more than a hundred times faster than standard modems. But keep in mind that your Internet service provider also affects the speed of your Internet connection.

Q. Can Leviton Integrated Networks help me run an office in my home?

A. Along with Internet access, Leviton Integrated Networks puts telephones, fax/modems and other devices to work in any room of your home, because all rooms are wired and connected. Leviton Integrated Networks gives you a powerful phone network, managing distribution of multiple lines. Leviton Integrated Networks also allows you to connect to your home network just by plugging in to the data jacks in any room.

Q. Do I need anything else to set up a home network?

A. Your computer may need a networking card and software. Check your computer owner's manual.

Q. Will I need to upgrade if I add phone lines or more TVs?

A. It depends on the module you choose for your home. Basic modules can handle four phone lines and six TVs.

Q. Does Leviton Integrated Networks offer surge protection?

A. Yes. Leviton Integrated Networks helps protect sensitive and expensive electronics that can be damaged by voltage surges.

LEVITON INTEGRATED NETWORKS AND WHOLE-HOUSE VIDEO

Q. Can I get TV reception in any room in my house?

A. Yes. Any video signal (VCR, cable, satellite, DVD) can be distributed to any room in the house.

Q. Do Leviton Integrated Networks products control interior lighting?

A. Leviton Integrated Networks sets the mood for an evening's entertainment, with simplified control of room lighting.

LIN Frequently Asked Questions

LEVITON INTEGRATED NETWORKS AND HOME-WIDE STEREO

Q. Can I distribute music throughout my home?

A. Yes. Using Leviton Integrated Networks audio components, you can have music throughout your home.

Q. What if I want to play the stereo in only a couple of rooms?

A. A volume control unit in each location where speakers are present allows you to turn off the audio.

LEVITON INTEGRATED NETWORKS, CAMERA MONITORING AND SECURITY LIGHTING

Q. Can I monitor the safety of my family in a different part of the house?

A. Yes. Leviton Integrated Networks allows you to distribute a signal to any TV in the house using a camera in the kid's room.

Q. How about security lighting?

A. Leviton Integrated Networks helps create a safer, more secure environment. With features like an ALL LIGHTS ON panic button that turns all controlled lights on for "bumps in the night."

Q. What is the benefit of automatic lighting control?

A. It allows you to set a program for exterior lights to turn on and off automatically. It also increases safety by providing automatic lighting for walkways or entry areas, giving a home an occupied look when you're away.

Q. What is the benefit of "remote" lighting control?

A. Using a transmitter at your bedside, you can control lights all over your home at bedtime.

Q. How does the automated home control system work?

A. It's controlled by transmitters and receivers, which operate on either a programmed schedule or manually like conventional switches, dimmers and outlets.

TECHNICAL INFORMATION

Q. What does it mean when something is rated Category 5 (Cat 5)?

A. Cat 5 indicates a high level of performance for wire and the products that connect to it. Products that are rated Category 5 meet high performance levels, and allow the home to handle current and future technologies.

Q. What kind of cabling would I need in my home?

A. Typically, voice and data signals are transmitted through either Category 5 or Category 5e wiring, or fiber optic cabling. Each brings progressively higher speed and capability with it. RG-6 and other coaxial cable are a higher level of video and audio wire.

Structured Cabling Certification

STRUCTURED CABLING CERTIFICATION

Structured Cabling Certification is fast becoming a commonly used term, but not all Certifications are alike. The value of our certified installation depends upon the seamless combination of four elements:

1. Quality Hardware from Leviton
2. Quality Cables from Program Cable Partners
3. Quality Installation from Program Installation Partners
4. Applications Assurance and Product Warranty

The Certification Program is a carefully crafted program developed with the intent of providing real value to network users. The Certification Program brings these four elements together and offers end users security and assurance that they are getting the highest performance possible from their structured cabling system.

1. Quality Hardware from Leviton

Leviton Voice and Data Division offers a complete line of TIA/EIA-570-A compliant hardware, including one of the industry's broadest offerings of residential products for UTP, coaxial, and fiber optic cabling. This line includes products for virtually any residential application, specifically designed to assist in a proper, standards compliant installation, and manufactured to the very highest quality standards.

The Leviton Category 5 jack is fast becoming the preferred jack in the industry. The extremely compact and robust design is installer friendly, facilitates a standards compliant installation, and its electrical performance characteristics are second to none.

2. Quality Cables from Program Cable Partners

Leviton is the first company to develop a Residential Certification Program, which is open to a wide selection of compliant cables manufactured by companies participating in the Leviton program and offering a similar warranty. Leviton *does not limit the customers' options* by offering a program that only recognizes one brand of cable. Customers may choose an authorized Cable Partner to provide the cable for an installation.

3. Quality Installation from Certified Program Installation Partners

The third key to the success of this program is the installation personnel. Leviton enters into special arrangements with Certified Installation Companies, called Certification Program Installation Partners, to assist designers and users with product selection, installation, testing, and support. Certification Program Installation Partners are a select group of the best installation companies/network integrators in an area.

The Certification Program selects installation partners who meet the following selection criteria:

- Provide premises network installation and maintenance services.
- Design, install, and test in compliance with TIA/EIA Residential Building Standards.
- Maintain the highest quality and standards compliant installation practices.
- Provide engineering support for LAN design and integration.

4. Applications Assurance and Warranty

Leviton ties all these elements together with a program that offers a FIFTEEN-YEAR APPLICATIONS ASSURANCE FOR CATEGORY 5 STRUCTURED CABLING and a FIFTEEN-YEAR EXTENDED WARRANTY for Leviton passive structured cabling product in certified installations, along with a standard two-year warranty for active electronics.

The Applications Assurance provides that the Certification Program installation will support ANY CURRENT OR FUTURE APPLICATION developed for a TIA/EIA-570-A Category 5 structured cabling system for the FIFTEEN YEARS of the application, providing the installation remains as originally installed.

Leviton offers a FIFTEEN-YEAR Extended Warranty against defects in material and workmanship for all Certification Program passive structured cabling products as long as they are installed in a Certification Program installation. Leviton produces the highest quality products available and backs it with one of the strongest warranties in the industry. It is one more measure of assurance, which Leviton offers to provide real value to its customers.

Structured Cabling Certification

CERTIFICATION PROGRAM OBJECTIVE

- The objective of the Certification Program is to provide an assurance to the end user that their structured cabling system has been properly designed and installed using high quality components and installation practices and will meet or exceed system specifications.
- Leviton and its Certification Program Cable and Installation Partners guarantee that the users' systems will operate reliably and trouble free.

CERTIFICATION PROGRAM BENEFITS

- The Certification Program provides a structure in which the individual and otherwise stand-alone pieces of a structured cabling system are combined seamlessly for the end user.
- The Program benefits the end user with a quality installation and quality support.
- The Program benefits the Certification Program Installation Partner by providing access to high quality products and structured cabling installation certification, as well as factory training and technical support, to offer to its customers.

CERTIFICATION PROGRAM ADVANTAGES

The Certification Program Installation Partner receives the following competitive advantages:

- FIFTEEN-YEAR Applications Assurance for Category 5 structured cabling and FIFTEEN-YEAR Extended Warranties.
- Training in industry standards and installation practices.
- Access to the latest standards developments information.
- Technical support from Leviton applications engineers and RCDD's.
- Joint Leviton promotional materials and opportunities.
- Ability to bid jobs requiring certified installers.
- Follow-up sales for moves, adds, and changes to the certified installation.
- Promotion for the Certification Program and Certification Program Partners to end users and designers.
- Lead referrals

Index by Catalog Number

<u>Cat No.</u>	<u>Page No.</u>	<u>Cat No.</u>	<u>Page No.</u>	<u>Cat No.</u>	<u>Page No.</u>	<u>Cat No.</u>	<u>Page No.</u>	<u>Cat No.</u>	<u>Page No.</u>
C0224	38	C5405	45	TPI10-1L*	68	40682*	39	40866-DSS	40
C0224-CP	38	C5451-12	45	TTI06-10	72	40701-B*	32	40867-DSS	42
C0225	38	C5451-3	45	U1000-AKP	70	40702-B*	32	40868-DSS	42
C0225-CP	38	C5451-6	45	X3301-100	45	40734-SV*	31	40871-25W	42
C0229*	35	C5451-6GO	45	X3301-25C	45	40735-RO*	30	40871-50W	42
C0249*	34	C5454-3	45	X3301-50C	45	40735-RR*	30	40871-CW	42
C0249-CP	34	C5811	42	X3324-100	45	40735-RW*	30	40888-72*	26
C0253*	35	C5811-WCP	42	X3324-25C	45	40735-RY*	30	40888-72W	4
C0253-CP	35	C5812	42	X3324-50C	45	40740-BE	49	40890	28
C0254*	34	C5822	44	12005	71	40753-B*	33	40890-WS	4, 28
C0256-SS	35	C5822-GO	43	1201-LH	72	40754-B*	33	40896	28
C2447*	34	C5852-12G	44	16351*	73	40756-B*	33	40896-W	4
C2447-CP	34	C5852-6GO	44	17100-2WY	67	40803*	32	40899*	25
C2448*	39	C5853-6	44	1771R-IWA	67, 68	40803*BR	32	40901-D*	26
C2449*	34	C5856-GO	44	1770C	67	40803-B*	32	40905-25*	25
C2450*	35	C5914	41	177RC	67, 68	40804*	32	40911-D*	26
C2455*	35	HCA02-10E	61, 62	40050-MCV	52	40804*BR	32	40914*	35
C2456*	39	HCC10-1TW	61, 62	40050-MHG	52	40804-B*	32	40944*	34
C2655*	35	HCC1A-1TW	61	40050-MHO	52	40806*	32	40944*D	34
C2675*	34	HCC1D-1TW	62	40054-DS	51	40806*BR	32	40949*	34
C2676*	34	HCC2D-1TW	62	40054-DSS	51	40806-B*	32	40949*D	34
C2682*	35	HCC3D-1TW	62	40056-DSM	51	40807*	32	40951-1P*	27
C5002	40	HCC4A-1TW	62	40066-M25	51	40807*R	32	40952-2P*	27
C5002-CP	40	HCC4D-1TW	62	40066-M50	51	40807-B*	32	40953-AD*	27
C5002-GO	40	HCKKR	61	40067-BC	51	40807-B2*	32	40954-DM*	27
C5003	40	HCCPG-1TW	62	40067-CLP	51	40812-RTK	41	40959*	35
C5004	40	HCCS7-1TW	62	40072-T2	50	40827*	28	40959*D	34
C5004-GO	40	HCCUV	61	40072-T4	50	40828	28	40981*	39
C5007	47	HCM06-1SW	61	40072-T6	50	40830*	31	40981*D	39
C5007-CP	47	HCPRF	61	40072-T8	50	40830*R	31	40982*	39
C5008	41	INI06-1L*	66	40089-B	50	40830-B*E	31	40984	40
C5008-CP	41	INM06-1L*	66	40089-D	50	40830-B*R	31	40985-1P6	47
C5008-G	41	IPE04-1L*	66	40089-DBR	50	40830-B*Y	31	40985-1P9	47
C5009	47	IPF01-1L*	66	40201	38	40831-B*	30	40985-2P6	47
C5009-G	47	IPI06-1L*	66	40238*	36	40832*	31	40985-2P9	47
C5052	43	MCM06-1L*	67	40244*	37	40832*R	31	40985-HPC	41
C5052-GO	43	MCM10-1L*	67	40249*	36	40832-B*	31	40985-HPM	41
C5053	43	MDI06-1L*	67	40258*	37	40833*	31	40985-Q6	47
C5055	43	MDM06-1L*	67	40259*	37	40833*R	31	40985-TW6	41
C5203	41	MLI06-1L*	67	40266*	37	40833-B*E	31	40985-TW9	41
C5203-CP	41	MLM06-1L*	67	40280*	36	40833-B*R	31	40986	41
C5203-G	41	MN00C-1L*	67, 68	40538*	36	40837*	31	40987-2	40
C5205	42	MNI10-1L*	68	40539-HM*	39	40837*R	31	40987-3	40
C5229	42	MNM06-1L*	68	40539-OM*	39	40837-B*E	31	40987-4	40
C5235	43	MRI06-1L*	67	40539-PM*	36	40837-B*R	31	40989-RCT	47
C5255	44	MS00R-10*	61, 67	40544*	37	40841-D*	25	41084	2
C5256*	39	MSI06-1L*	67	40549*	36	40850*BR	33	41084-B*	31
C5256-CP	39	ODC0S-11W	61	40566*	37	40850-B*	33	41084-F*F	30
C5259	43	ODS10-ID	61, 68	40580*	36	40853-OVC	25	41084-F*P	54
C5259-GO	43	RS110-10	61	40588*	37	40856-DSS	40	41084-F*Z	54
C5307	47	TGI06-10*	65	40638*	37	40859*	31	41084-FWF	3
C5307-CP	47	TGI06-1L*	65	40649*	37	40859*R	31	41084-S*P	54
C5307-G	47	TGM10-1L*	65	40680*	37	40859-B*	31	41084-S*Z	54
C5402	44	TPI06-1L*	68	40681*	39	40864-D*	26	41085M*C	54

*= Multiple color options available

Index by Catalog Number

<u>Cat No.</u>	<u>Page No.</u>	<u>Cat No.</u>	<u>Page No.</u>	<u>Cat No.</u>	<u>Page No.</u>	<u>Cat No.</u>	<u>Page No.</u>	<u>Cat No.</u>	<u>Page No.</u>
41085-ML*	54	47606-AHT	3, 10	49251-W62	49	49990-ML2	53	5G455-5*	46
41085-S*C	54	47606-BNP	10	49251-W63	49	49990-MSC	53	5G455-7*	46
41085-SL*	54	47606-BTV	2, 10	49251-W64	49	49990-MST	53	5G484-U12	49
4108W-OSP	32	47609-4X4	33	4925-2	38	49990-SDL	53	5G484-U24	49
4108W-1SP	32	47609-EMP	11	49255-H24	48	49990-SFC	53	5G584-U89	48
41106-R*6	29	47609-TSV	11	49255-H48	48	49990-SL2	53	5R100-0FR	54
41108-K*5	29	47611-5PT	3, 14	49257-I24	48	49990-SSC	53	5W110-00N	53
41108-R*3	29	47611-8PT	14	49553-110	41	49990-SST	53	5W120-00N	53
41108-R*5	2, 29	47611-GT4	4, 14	49553-66	41	51084-CLB	33	5W170-00N	53
41108-R*8	29	47611-GTA	3	49553-814	41	51084-ICN	33	6124H	61, 71
42400-8FG	11, 46	47612-MMA	11	49800-202	56	51084-XLB	33	6197*	59
42400-G	46	47613-EZC	47	49800-CON	57	51110-PTC	70	6227	61
43080-1S1	32	47613-EZR	47	49800-FAC	57	52454-15R	46	6230M*	65, 66, 68
43080-1S2	32	47615-NYL	47	49800-FTP	56	52454-3R	46	6291-WI	61
43080-1S3	32	47616-DSB	11	49800-SLA	56	52454-7R	46	6294	61
43080-1S4	32	47616-DSF	11	49800-SLT	56	52455-15*	46	6308	63
43080-1S5	32	47620-1W	46	49800-UTK	56	52455-3*	46	6312	62
43080-1S6	32	47620-3W	46	49800-UTP	56	52455-7*	46	6320	63
43080-2S12	32	47621-CMS	21	49822-MST	53	5280	70	6330	63
43080-2S2	32	47621-MIE	4, 21	49880-202	57	5321	71	6337	63
43080-2S4	32	47689-00B	11	49882-SAD	54	5325*	77	6417	63
43080-2S6	32	47689-QP	48	49882-SST	53	5501-LH*	65	6690	71
43080-2S8	32	47690-110	50	49883-FCT	57	5503-LH*	65	6698	72
4625B-44*	36	47690-3BY	15	49883-MFC	53	5505	70	6800*	61, 66
4625B-46*	36	47690-4BY	15	49883-SFC	53	5601*	78	80301*	58
4625B-48*	36	47690-4C	17	49884-BAD	54	5603*	78	80309*	58
46721-CMS	4	47690-4C2	17	49884-DPC	53	5611*	66, 68, 74	80311*	58
47602-24E	8	47690-6C	17	49884-DPC	57	5613*	66, 68, 74	80401*	33, 58
47602-BKE	8	47690-6C2	17	49884-MAD	54	5614*	68	80405*	58
47603-110	4, 11, 21	47690-6S	40	49884-MSC	53	5628-2*	78	80409*	33, 58
47603-18P	10	47690-8C	17	49884-SAD	54	5631-2*	78	80411*	58
47603-1G4	2, 11	47690-8C2	17	49884-SSC	53	5633-2*	78	80414*	59
47603-1G6	11	47690-BVA	16	49885-SBS	53	5638-2*	78	80421*	58
47603-24P	3, 10	47690-ESM	15	49885-SLV	53	5691-2*	78	80431*	58
47603-C5	11	47690-G3Y	3, 4, 15	49886-03F	57	5693-2*	78	80601*	58
47603-PTE	10	47690-G4Y	15	49886-12F	57	59484-U12	49	80609*	58
47603-TSV	11	47690-GSM	15	49886-CTT	57	59484-U24	49	80611*	58
47605-14N	6	47690-GVA	16	49886-DLM	53	5951*	13	80781*	39
47605-14W	2, 6	47690-NFA	20	49886-DLS	53	5952*	13	80782*	39
47605-28N	7	47690-NFA	4	49886-DSC	53	5953*	13	81401	59
47605-28W	3, 7	47691-3MS	17	49886-FCN	57	5954*	13	81409	59
47605-42N	7	48210-DSM	4, 21	49886-FCT	57	5955*	13	81411	59
47605-42W	3, 7	48210-MCH	4, 22	49886-SYR	57	5F100-6QP	11	8200-HL*	72, 73
47605-ACN	12	48210-MRU	4, 22	49886-UVC	57	5F100-6VF	11	83401	59
47605-ACS	2, 12	48210-MSU	4, 22	49886-VFA	57	5F100-BNC	11	83409	59
47605-C5B	3, 11	48210-SRU	4, 22	49886-VSA	57	5F100-DLC	54	83411	59
47605-DP	3, 12	48210-VA	16	49886-VWF	57	5F100-DLZ	54	84003	59
47605-F14	6	48211-*VC	4, 23	49886-X3F	57	5F100-QLC	54	84003-40	59
47605-F28	7	48211-*VK	4, 24	49887-6L	56	5F100-QLZ	54	8599*	71, 73
47605-F42	7	48211-6A	4, 23	49887-6S	56	5G108-R*5	3, 29	86002	71
47605-H14	6	48212-DCS	3, 4, 13	49888-6SF	53	5G454-15R	46	86004	38
47605-H28	7	48213-*DC	4, 19	49889-MAD	54	5G454-3R	46	911	72
47605-H42	7	48213-CVS	4, 19	49889-QF*	54	5G454-7R	46		
47605-NDP	12	48213-ECC	4, 19	49990-MDL	53	5G455-15*	46		
47605-PSB	12	48213-VMA	4, 20	49990-MFC	53	5G455-3*	46		

*= Multiple color options available

Leviton's Complete Line of Catalogs

D-503 Wiring Devices



This catalog contains a comprehensive selection of Leviton products for Industrial, Commercial and Residential construction and maintenance, including switches, receptacles, plugs and connectors, wire mesh safety grips, lighting controls, surge protective devices (TVSS), wallplates, communications premise wiring products and more.

Power Quality Products



Virtually every educational facility has microprocessor-driven electronic equipment that is vulnerable to the disruptive and damaging effects of transient voltage surges, voltage sags and power outages. Leviton offers a full line of surge protective devices and Uninterruptible Power Supplies (UPS) to defend this equipment.

Lighting Control Products



This catalog provides a comprehensive offering of Leviton's state-of-the-art lighting control products, including our extensive line of architectural lighting control systems, box-mounted lighting and fan speed controls, occupancy sensors and DHC powerline carrier home automation products.

Decora Home Controls Technical Manual



A complete guide to Decora Home Controls Components for automated control of lighting scenes, time-set On/Off lighting control and automated appliance control, including wiring diagrams and technical information plus real-life applications for field use.

Decora Collection of Designer Devices



A comprehensive look at the Decora collection of designer-styled switches, receptacles, wallplates, lighting controls, voice, data, video and audio devices, and Decora Home Controls developed by Leviton through the merging of sleek design with the ultimate in technology to provide an elegant finishing touch to any interior.

Structured Wiring Installation Manual



This manual provides a comprehensive description of industry standards, warranties, installer certification, ordinances, tools, job planning, and system design and installation techniques for residential structured wiring.

Night and Day Decora Color Collection



Leviton offers the most complete collection of residential and commercial almond and black colored wiring, electronic and communications devices from a single source.

Home Cabling User Guide



This user guide is designed to show you the components and applications of structured wiring. It also provides suggestions and tips for the placement of TV's, computers, telephones, and other devices that will make use of structured wiring. It concludes with a glossary and section of frequently asked questions related to structured wiring.

Structured Cabling Systems



This catalog covers the wide range of structured cabling/structured media products that Leviton offers for any type of home or office cabling project, new or retrofit, from multimedia connectors to cable management to fiber optic panels and more.

FOR MORE INFORMATION ABOUT OTHER LEVITON PRODUCTS, PLEASE CALL OUR CUSTOMER SERVICE AT 1-800-323-8920



Leviton Manufacturing Co., Inc.
59-25 Little Neck Parkway, Little Neck, NY 11362-2591
Telephone: 1-800-323-8920 • FAX: 1-800-832-9538
Tech Line 1-800-722-2082 (8:30–7:30 EST, Monday–Friday)

Leviton Voice & Data Headquarters
2222–222nd St. S.E., Bothell, WA 98021-4422 USA
Telephone: 1-800-722-2082 • International: 425-486-2222

Leviton Manufacturing of Canada, Ltd.
165 Hymus Boulevard, Pointe Claire, Quebec H9R 1E9
Telephone: 1-800-469-7890 • FAX: 1-800-563-1853

Leviton S.A. de C.V.
General Arista 54-A Col. Argentina, Mexico D.F., C.P. 11270
Telephone: 011-525-386-1131, 011-525-386-2052 • FAX: 011-525-386-1797

Visit Leviton's Web site at : www.leviton.com/Lin

