

CSWS  2 - 4	CSWD  5 - 10	CLWS  11 - 13	CLNS  14 - 16	CLWD  17 - 22	CLND  23 - 28
CLNF  29 - 30	CLNU  31	CCL  32 - 37	CRAM  38	SOLDER LUGS  39	CT  40
CTL  41	CCS  42 - 43	GGA  44	GGC  45	ULT  46	ELT  47
ACL, ACN  48 - 51	2ACL, 2ACN  52 - 53	ASL  54	CPM  55 - 57	ACM  58 - 60	ACO  61 - 62
ACO-90  63	IACL  64	2IACL  65	AS  66 - 68	UCS  69	PICS  70
P840  71	AH  72	HT  73 - 74	RLT  75	ILSCONS Non-Insulated Rings  76 - 78	ILSCONS Vinyl Rings  79 - 80
ILSCONS High Temperature Rings  81	ILSCONS Non-Insulated Forks  82	ILSCONS Vinyl Forks  83	ILSCONS Non-Insulated Splices  84	ILSCONS Vinyl Splices  85	ILSCONS Disconnects and Flag Terminals  86
CRIMP 'N SEAL Rings  87	CRIMP 'N SEAL Forks, Splices, Disconnects, Bullets  88	ILSCON TOOLS  89	COMPRESSION DIE INDEX 90 - 97		

TYPE CSWS

Features

- Manufactured from high strength seamless copper tubing.
- Electro-Tin plated.
- Maximum conductivity and excellent crimping characteristics.
- Chamfered entry.
- Color coded.
- UL 486A 90°C Listed and CSA Certified for 600 Volts.
- If proper high voltage spacing and insulation techniques are used, may be used for high voltage applications up to 35KV.
- For Copper conductor only.
- IlSCO connectors are UL Listed and CSA Certified with ILSCO and other Manufacturers' tools.+
- UL File E6207

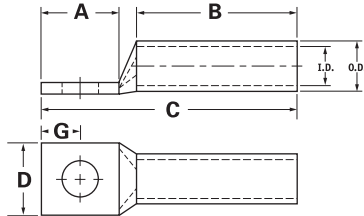

Catalog Number	Wire Size	Alt Wire Size	Expanded* Wire Range	Bolt Size	Stud Hole Dia.	Dimensions					Die Color Code	Die Index	O.D.	I.D.
						A	B	C	D	G				
CSWS-8-10	#8 AWG	#8 FLEX	-	10	0.219	0.562	0.500	1.257	0.374	0.258	Red	I-21	0.272	0.179
CSWS-8-14	#8 AWG	#8 FLEX	-	1/4	0.281	0.680	0.500	1.375	0.486	0.320	Red	I-21	0.272	0.179
CSWS-8-516	#8 AWG	#8 FLEX	-	5/16	0.343	0.875	0.500	1.570	0.532	0.352	Red	I-21	0.272	0.179
CSWS-8-38	#8 AWG	#8 FLEX	-	3/8	0.406	0.875	0.500	1.570	0.593	0.414	Red	I-21	0.272	0.179
CSWS-6-10	#6 AWG	-	-	10	0.219	0.562	0.500	1.257	0.411	0.258	Blue	I-24	0.295	0.203
CSWS-6-14	#6 AWG	-	-	1/4	0.281	0.680	0.500	1.375	0.411	0.320	Blue	I-24	0.295	0.203
CSWS-6-516	#6 AWG	-	-	5/16	0.343	0.875	0.500	1.570	0.532	0.352	Blue	I-24	0.295	0.203
CSWS-6-38	#6 AWG	-	-	3/8	0.406	0.875	0.500	1.570	0.593	0.414	Blue	I-24	0.295	0.203
CSWS-6-12	#6 AWG	-	-	1/2	0.562	1.250	0.500	1.945	0.750	0.546	Blue	I-24	0.295	0.203
CSWS-6-34	#6 AWG	-	-	3/4	0.781	1.687	0.500	2.382	0.411	0.750	Blue	I-24	0.295	0.203
CSWS-4-10	#4 AWG	#6 FLEX	4-6 AWG	10	0.219	0.562	0.500	1.296	0.486	0.258	Gray	I-29	0.343	0.250
CSWS-4-14	#4 AWG	#6 FLEX	4-6 AWG	1/4	0.281	0.680	0.500	1.414	0.486	0.320	Gray	I-29	0.343	0.250
CSWS-4-516	#4 AWG	#6 FLEX	4-6 AWG	5/16	0.343	0.875	0.500	1.609	0.486	0.352	Gray	I-29	0.343	0.250
CSWS-4-38	#4 AWG	#6 FLEX	4-6 AWG	3/8	0.406	0.875	0.500	1.609	0.593	0.414	Gray	I-29	0.343	0.250
CSWS-4-12	#4 AWG	#6 FLEX	4-6 AWG	1/2	0.562	1.250	0.500	1.984	0.750	0.546	Gray	I-29	0.343	0.250
CSWS-3-10	#3 AWG	#4 FLEX	3-6 AWG	10	0.219	0.562	0.625	1.442	0.532	0.258	White	I-29	0.375	0.275
CSWS-3-14	#3 AWG	#4 FLEX	3-6 AWG	1/4	0.281	0.680	0.625	1.560	0.532	0.320	White	I-29	0.375	0.275
CSWS-3-516	#3 AWG	#4 FLEX	3-6 AWG	5/16	0.343	0.875	0.625	1.755	0.532	0.352	White	I-29	0.375	0.275
CSWS-3-38	#3 AWG	#4 FLEX	3-6 AWG	3/8	0.406	0.875	0.625	1.755	0.593	0.414	White	I-29	0.375	0.275
CSWS-3-12	#3 AWG	#4 FLEX	3-6 AWG	1/2	0.562	1.250	0.625	2.130	0.750	0.546	White	I-29	0.375	0.275
CSWS-2-10	#2 AWG	-	2-6 AWG	10	0.219	0.562	0.625	1.473	0.599	0.258	Brown	I-33	0.421	0.312
CSWS-2-14	#2 AWG	-	2-6 AWG	1/4	0.281	0.680	0.625	1.591	0.599	0.320	Brown	I-33	0.421	0.312
CSWS-2-516	#2 AWG	-	2-6 AWG	5/16	0.343	0.875	0.625	1.786	0.599	0.352	Brown	I-33	0.421	0.312
CSWS-2-38	#2 AWG	-	2-6 AWG	3/8	0.406	0.875	0.625	1.786	0.599	0.414	Brown	I-33	0.421	0.312
CSWS-2-12	#2 AWG	-	2-6 AWG	1/2	0.562	1.250	0.625	2.161	0.750	0.546	Brown	I-33	0.421	0.312
CSWS-1-10	#1 AWG	#2 FLEX	1-6 AWG	10	0.219	0.562	0.625	1.517	0.673	0.258	Green	I-37	0.468	0.359
CSWS-1-14	#1 AWG	#2 FLEX	1-6 AWG	1/4	0.281	0.875	0.625	1.830	0.673	0.320	Green	I-37	0.468	0.359
CSWS-1-516	#1 AWG	#2 FLEX	1-6 AWG	5/16	0.343	0.875	0.625	1.830	0.673	0.352	Green	I-37	0.468	0.359
CSWS-1-38	#1 AWG	#2 FLEX	1-6 AWG	3/8	0.406	0.875	0.625	1.830	0.673	0.414	Green	I-37	0.468	0.359
CSWS-1-12	#1 AWG	#2 FLEX	1-6 AWG	1/2	0.562	1.250	0.625	2.205	0.750	0.546	Green	I-37	0.468	0.359

* When installed with specified dieless tools

+ See pages 90 to 97 for complete tooling information.

For Bent Tangs change the 4th letter to a B and add "-4" for 45 deg. or "-9" for 90 deg.

A TYPE CSWS

Features

- Manufactured from high strength seamless copper tubing.
- Electro-Tin plated.
- Maximum conductivity and excellent crimping characteristics.
- Chamfered entry.
- Color coded.
- UL 486A 90°C Listed and CSA Certified for 600 Volts.
- If proper high voltage spacing and insulation techniques are used, may be used for high voltage applications up to 35KV.
- For Copper conductor only.
- IlSCO connectors are UL Listed and CSA Certified with ILSCO and other Manufacturers' tools.*
- UL File E6207

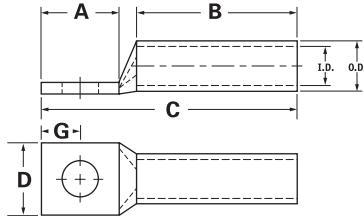

Catalog Number	Wire Size	Alt Wire Size	Expanded* Wire Range	Bolt Size	Stud Hole Dia.	Dimensions					Die Color Code	Die Index	O.D.	I.D.
						A	B	C	D	G				
CSWS-1/0-10	1/0 AWG	#1 FLEX	1/0-6 AWG	10	0.219	0.562	0.750	1.668	0.738	0.258	Pink	I-42	0.515	0.390
CSWS-1/0-14	1/0 AWG	#1 FLEX	1/0-6 AWG	1/4	0.281	0.875	0.750	1.981	0.738	0.320	Pink	I-42	0.515	0.390
CSWS-1/0-516	1/0 AWG	#1 FLEX	1/0-6 AWG	5/16	0.343	0.875	0.750	1.981	0.738	0.352	Pink	I-42	0.515	0.390
CSWS-1/0-38	1/0 AWG	#1 FLEX	1/0-6 AWG	3/8	0.406	0.875	0.750	1.981	0.738	0.414	Pink	I-42	0.515	0.390
CSWS-1/0-12	1/0 AWG	#1 FLEX	1/0-6 AWG	1/2	0.562	1.250	0.750	2.356	0.738	0.546	Pink	I-42	0.515	0.390
CSWS-2/0-10	2/0 AWG	1/0 FLEX	2/0-4 AWG	10	0.219	0.562	0.750	1.708	0.811	0.258	Black	I-45	0.562	0.437
CSWS-2/0-14	2/0 AWG	1/0 FLEX	2/0-4 AWG	1/4	0.281	0.875	0.750	2.021	0.811	0.320	Black	I-45	0.562	0.437
CSWS-2/0-516	2/0 AWG	1/0 FLEX	2/0-4 AWG	5/16	0.343	0.875	0.750	2.021	0.811	0.352	Black	I-45	0.562	0.437
CSWS-2/0-38	2/0 AWG	1/0 FLEX	2/0-4 AWG	3/8	0.406	0.875	0.750	2.021	0.811	0.414	Black	I-45	0.562	0.437
CSWS-2/0-12	2/0 AWG	1/0 FLEX	2/0-4 AWG	1/2	0.562	1.250	0.750	2.396	0.811	0.546	Black	I-45	0.562	0.437
CSWS-3/0-10	3/0 AWG	2/0 FLEX	3/0-2 AWG	10	0.219	0.562	0.750	1.751	0.885	0.258	Orange	I-50	0.609	0.484
CSWS-3/0-14	3/0 AWG	2/0 FLEX	3/0-2 AWG	1/4	0.281	0.875	0.750	2.064	0.885	0.320	Orange	I-50	0.609	0.484
CSWS-3/0-516	3/0 AWG	2/0 FLEX	3/0-2 AWG	5/16	0.343	0.875	0.750	2.064	0.885	0.352	Orange	I-50	0.609	0.484
CSWS-3/0-38	3/0 AWG	2/0 FLEX	3/0-2 AWG	3/8	0.406	0.875	0.750	2.064	0.885	0.414	Orange	I-50	0.609	0.484
CSWS-3/0-12	3/0 AWG	2/0 FLEX	3/0-2 AWG	1/2	0.562	1.250	0.750	2.439	0.885	0.546	Orange	I-50	0.609	0.484
CSWS-4/0-14	4/0 AWG	3/0 FLEX	4/0-1 AWG	1/4	0.281	0.875	0.875	2.241	0.999	0.320	Purple	I-54	0.687	0.546
CSWS-4/0-516	4/0 AWG	3/0 FLEX	4/0-1 AWG	5/16	0.343	0.875	0.875	2.241	0.999	0.352	Purple	I-54	0.687	0.546
CSWS-4/0-38	4/0 AWG	3/0 FLEX	4/0-1 AWG	3/8	0.406	0.875	0.875	2.241	0.999	0.414	Purple	I-54	0.687	0.546
CSWS-4/0-12	4/0 AWG	3/0 FLEX	4/0-1 AWG	1/2	0.562	1.250	0.875	2.616	0.999	0.546	Purple	I-54	0.687	0.546
CSWS-250-516	250kcmil	4/0 FLEX	250kcmil - 1/0 AWG	5/16	0.343	0.875	1.063	2.469	1.088	0.352	Yellow	I-62	0.750	0.593
CSWS-250-38	250kcmil	4/0 FLEX	250kcmil - 1/0 AWG	3/8	0.406	0.875	1.063	2.469	1.088	0.414	Yellow	I-62	0.750	0.593
CSWS-250-12	250kcmil	4/0 FLEX	250kcmil - 1/0 AWG	1/2	0.562	1.250	1.063	2.844	1.088	0.546	Yellow	I-62	0.750	0.593
CSWS-300-516	300kcmil	250 G,H FLEX	300kcmil - 2/0 AWG	5/16	0.343	0.875	1.063	2.525	1.189	0.352	White	I-66	0.812	0.660
CSWS-300-38	300kcmil	250 G,H FLEX	300kcmil - 2/0 AWG	3/8	0.406	0.875	1.063	2.525	1.189	0.414	White	I-66	0.812	0.660
CSWS-300-12	300kcmil	250 G,H FLEX	300kcmil - 2/0 AWG	1/2	0.562	1.250	1.063	2.900	1.189	0.546	White	I-66	0.812	0.660
CSWS-300-58	300kcmil	250 G,H FLEX	300kcmil - 2/0 AWG	5/8	0.656	1.437	1.063	3.087	1.189	0.671	White	I-66	0.812	0.660
CSWS-350-38	350kcmil	250 I,K,M FLEX 262.2 DLO	350kcmil - 3/0 AWG	3/8	0.406	0.875	1.063	2.561	1.291	0.414	Red	I-71	0.890	0.703
CSWS-350-12	350kcmil	250 I,K,M FLEX 262.2 DLO	350kcmil - 3/0 AWG	1/2	0.562	1.250	1.063	2.936	1.291	0.546	Red	I-71	0.890	0.703
CSWS-350-58	350kcmil	250 I,K,M FLEX 262.2 DLO	350kcmil - 3/0 AWG	5/8	0.656	1.437	1.063	3.123	1.291	0.671	Red	I-71	0.890	0.703
CSWS-400-38	400kcmil	300 G,H,I,K,M FLEX 313.1 DLO	400kcmil - 4/0 AWG	3/8	0.406	0.875	1.188	2.730	1.365	0.414	Blue	I-76	0.937	0.750
CSWS-400-12	400kcmil	300 G,H,I,K,M FLEX 313.1 DLO	400kcmil - 4/0 AWG	1/2	0.562	1.250	1.188	3.105	1.365	0.546	Blue	I-76	0.937	0.750
CSWS-400-58	400kcmil	300 G,H,I,K,M FLEX 313.1 DLO	400kcmil - 4/0 AWG	5/8	0.656	1.437	1.188	3.292	1.365	0.671	Blue	I-76	0.937	0.750

* When installed with specified dieless tools + See pages 90 to 97 for complete tooling information. For Bent Tangs change the 4th letter to a B and add "-4" for 45 deg. or "-9" for 90 deg.

TYPE CSWS

Features

- Manufactured from high strength seamless copper tubing.
- Electro-Tin plated.
- Maximum conductivity and excellent crimping characteristics.
- Chamfered entry.
- Color coded.
- UL 486A 90°C Listed and CSA Certified for 600 Volts.
- If proper high voltage spacing and insulation techniques are used, may be used for high voltage applications up to 35KV.
- For Copper conductor only.
- IlSCO connectors are UL Listed and CSA Certified with ILSCO and other Manufacturers' tools.+
- UL File E6207

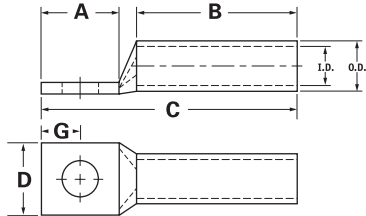

Catalog Number	Wire Size	Alt Wire Size	Expanded* Wire Range	Bolt Size	Stud Hole Dia.	Dimensions					Die Color Code	Die Index	O.D.	I.D.
						A	B	C	D	G				
CSWS-500-12	500kcmil	350 G,H,I,K,M FLEX 373.7 DLO	500kcmil - 250kcmil	1/2	0.562	1.250	1.300	3.282	1.535	0.414	Brown	I-87	1.062	0.828
CSWS-500-38	500kcmil	350 G,H,I,K,M FLEX 373.7 DLO	500kcmil - 250kcmil	3/8	0.406	0.875	1.300	2.907	1.535	0.546	Brown	I-87	1.062	0.828
CSWS-500-58	500kcmil	350 G,H,I,K,M FLEX 373.7 DLO	500kcmil - 250kcmil	5/8	0.656	1.437	1.300	3.469	1.535	0.671	Brown	I-87	1.062	0.828
CSWS-600-38	600kcmil	400 G,H,I,K,M FLEX 444.4 DLO	600kcmil - 250kcmil	3/8	0.406	0.875	1.375	3.059	1.712	0.414	Green	I-94	1.187	0.920
CSWS-600-12	600kcmil	400 G,H,I,K,M FLEX 444.4 DLO	600kcmil - 250kcmil	1/2	0.562	1.250	1.375	3.434	1.712	0.546	Green	I-94	1.187	0.920
CSWS-600-58	600kcmil	400 G,H,I,K,M FLEX 444.4 DLO	600kcmil - 250kcmil	5/8	0.656	1.437	1.375	3.621	1.712	0.671	Green	I-94	1.187	0.920
CSWS-650-516	650kcmil	500 G,H,I,K,M FLEX 535.3 DLO	650kcmil - 350kcmil	1/32	0.343	0.875	1.375	3.119	1.764	0.352	Pink	I-99	1.217	0.958
CSWS-650-38	650kcmil	500 G,H,I,K,M FLEX 535.3 DLO	650kcmil - 350kcmil	3/8	0.406	0.875	1.375	3.119	1.764	0.414	Pink	I-99	1.217	0.958
CSWS-650-12	650kcmil	500 G,H,I,K,M FLEX 535.3 DLO	650kcmil - 350kcmil	1/2	0.562	1.25	1.375	3.494	1.764	0.546	Pink	I-99	1.217	0.958
CSWS-650-58	650kcmil	500 G,H,I,K,M FLEX 535.3 DLO	650kcmil - 350kcmil	5/8	0.656	1.437	1.375	3.681	1.764	0.671	Pink	I-99	1.217	0.958
CSWS-700-38	700kcmil	500 G,H,I,K,M FLEX 535.3 DLO	700kcmil - 350kcmil	3/8	0.406	0.875	1.375	3.119	1.816	0.414	Pink	I-99	1.250	0.991
CSWS-700-12	700kcmil	500 G,H,I,K,M FLEX 535.3 DLO	700kcmil - 350kcmil	1/2	0.562	1.250	1.375	3.494	1.816	0.546	Pink	I-99	1.250	0.991
CSWS-700-58	700kcmil	500 G,H,I,K,M FLEX 535.3 DLO	700kcmil - 350kcmil	5/8	0.656	1.437	1.375	3.681	1.816	0.671	Pink	I-99	1.250	0.991
CSWS-750-38	750kcmil	600 G,H,I,M FLEX 646.4 DLO	750 kcmil - 500kcmil	3/8	0.406	0.875	1.500	3.277	1.901	0.414	Black	I-106	1.313	1.031
CSWS-750-12	750kcmil	600 G,H,I,M FLEX 646.4 DLO	750kcmil - 500kcmil	1/2	0.562	1.250	1.500	3.652	1.901	0.546	Black	I-106	1.313	1.031
CSWS-750-58	750kcmil	600 G,H,I,M FLEX 646.4 DLO	750kcmil - 500kcmil	5/8	0.656	1.437	1.500	3.839	1.901	0.671	Black	I-106	1.313	1.031
CSWS-1000-38	1000kcmil	750 G,H,I FLEX 777.7 DLO	1000kcmil - 750kcmil	3/8	0.406	0.875	1.625	3.525	2.169	0.414	White	I-125	1.500	1.172
CSWS-1000-12	1000kcmil	750 G,H,I FLEX 777.7 DLO	1000kcmil - 750kcmil	1/2	0.562	1.250	1.625	3.900	2.169	0.546	White	I-125	1.500	1.172
CSWS-1000-58	1000kcmil	750 G,H,I FLEX 777.7 DLO	1000kcmil - 750kcmil	5/8	0.656	1.437	1.625	4.087	2.169	0.671	White	I-125	1.500	1.172

* When installed with specified dieless tools

+ See pages 90 to 97 for complete tooling information.

For Bent Tangs change the 4th letter to a B and add "-4" for 45 deg. or "-9" for 90 deg.

A

TYPE CSWD

Features

- Manufactured from high strength seamless copper tubing.
- Electro-Tin plated.
- Maximum conductivity and excellent crimping characteristics.
- Chamfered entry.
- Color coded.
- UL 486A 90°C Listed and CSA Certified for 600 Volts.
- If proper high voltage spacing and insulation techniques are used, may be used for high voltage applications up to 35KV.
- For Copper conductor only.
- IlSCO connectors are UL Listed and CSA Certified with ILSCO and other Manufacturers' tools.†
- UL File E6207

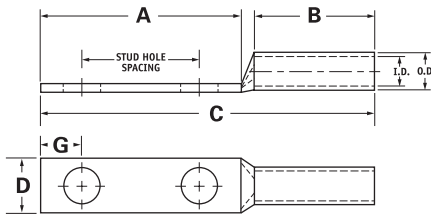

Catalog Number	Wire Size	Alt Wire Size	Expanded* Wire Range	Bolt Size	Stud Hole Dia.	Stud Hole Spacing	Dimensions					Die Color Code	Die Index	O.D.	I.D.
							A	B	C	D	G				
CSWD-8-10-58	#8 AWG	#8 FLEX	-	10	0.219	0.625	1.250	0.500	1.945	0.374	0.258	Red	I-21	0.272	0.179
CSWD-8-10-34	#8 AWG	#8 FLEX	-	10	0.219	0.750	1.437	0.500	2.132	0.374	0.258	Red	I-21	0.272	0.179
CSWD-8-14-58	#8 AWG	#8 FLEX	-	1/4	0.281	0.625	1.437	0.500	2.132	0.486	0.320	Red	I-21	0.272	0.179
CSWD-8-14-34	#8 AWG	#8 FLEX	-	1/4	0.281	0.750	1.437	0.500	2.132	0.486	0.320	Red	I-21	0.272	0.179
CSWD-8-14-1	#8 AWG	#8 FLEX	-	1/4	0.281	1.000	1.687	0.500	2.382	0.486	0.320	Red	I-21	0.272	0.179
CSWD-8-38-1	#8 AWG	#8 FLEX	-	3/8	0.406	1.000	1.937	0.500	2.632	0.593	0.414	Red	I-21	0.272	0.179
CSWD-6-10-12	#6 AWG	-	-	10	0.219	0.500	1.250	0.500	1.945	0.411	0.258	Blue	I-24	0.295	0.203
CSWD-6-10-58	#6 AWG	-	-	10	0.219	0.625	1.250	0.500	1.945	0.411	0.258	Blue	I-24	0.295	0.203
CSWD-6-10-1116	#6 AWG	-	-	10	0.219	0.687	1.250	0.500	1.945	0.411	0.258	Blue	I-24	0.295	0.203
CSWD-6-10-34	#6 AWG	-	-	10	0.219	0.750	1.437	0.500	2.132	0.411	0.258	Blue	I-24	0.295	0.203
CSWD-6-14-12	#6 AWG	-	-	1/4	0.281	0.500	1.250	0.500	1.945	0.411	0.320	Blue	I-24	0.295	0.203
CSWD-6-14-58	#6 AWG	-	-	1/4	0.281	0.625	1.437	0.500	2.132	0.411	0.320	Blue	I-24	0.295	0.203
CSWD-6-14-34	#6 AWG	-	-	1/4	0.281	0.750	1.437	0.500	2.132	0.411	0.320	Blue	I-24	0.295	0.203
CSWD-6-14-1	#6 AWG	-	-	1/4	0.281	1.000	1.687	0.500	2.382	0.411	0.320	Blue	I-24	0.295	0.203
CSWD-6-516-34	#6 AWG	-	-	5/16	0.343	0.750	1.687	0.500	2.382	0.532	0.352	Blue	I-24	0.295	0.203
CSWD-6-516-1	#6 AWG	-	-	5/16	0.343	1.000	1.937	0.500	2.632	0.532	0.352	Blue	I-24	0.295	0.203
CSWD-6-38-34	#6 AWG	-	-	3/8	0.406	0.750	1.687	0.500	2.382	0.593	0.414	Blue	I-24	0.295	0.203
CSWD-6-38-78	#6 AWG	-	-	3/8	0.406	0.875	1.937	0.500	2.632	0.593	0.414	Blue	I-24	0.295	0.203
CSWD-6-38-1	#6 AWG	-	-	3/8	0.406	1.000	1.937	0.500	2.632	0.593	0.414	Blue	I-24	0.295	0.203
CSWD-6-12-134	#6 AWG	-	-	1/2	0.562	1.750	3.000	0.500	3.695	0.750	0.546	Blue	I-24	0.295	0.203

* When installed with specified dieless tools

+ See pages 90 to 97 for complete tooling information.

For Bent Tangs change the 4th letter to a B and add "-4" for 45 deg. or "-9" for 90 deg.

TYPE CSWD

Features

- Manufactured from high strength seamless copper tubing.
- Electro-Tin plated.
- Maximum conductivity and excellent crimping characteristics.
- Chamfered entry.
- Color coded.
- UL 486A 90°C Listed and CSA Certified for 600 Volts.
- If proper high voltage spacing and insulation techniques are used, may be used for high voltage applications up to 35KV.
- For Copper conductor only.
- IlSCO connectors are UL Listed and CSA Certified with ILSCO and other Manufacturers' tools.+
- UL File E6207

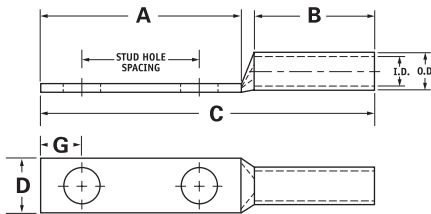

Catalog Number	Wire Size	Alt Wire Size	Expanded* Wire Range	Bolt Size	Stud Hole Dia.	Stud Hole Spacing	Dimensions					Die Color Code	Die Index	O.D.	I.D.
							A	B	C	D	G				
CSWD-4-10-58	#4 AWG	#6 FLEX	4-6 AWG	10	0.219	0.625	1.250	0.500	1.984	0.486	0.258	Gray	I-29	0.343	0.250
CSWD-4-10-34	#4 AWG	#6 FLEX	4-6 AWG	10	0.219	0.750	1.437	0.500	2.171	0.486	0.258	Gray	I-29	0.343	0.250
CSWD-4-10-1	#4 AWG	#6 FLEX	4-6 AWG	10	0.219	1.000	1.687	0.500	2.421	0.486	0.258	Gray	I-29	0.343	0.250
CSWD-4-14-58	#4 AWG	#6 FLEX	4-6 AWG	1/4	0.281	0.625	1.437	0.500	2.171	0.486	0.320	Gray	I-29	0.343	0.250
CSWD-4-14-34	#4 AWG	#6 FLEX	4-6 AWG	1/4	0.281	0.750	1.437	0.500	2.171	0.486	0.320	Gray	I-29	0.343	0.250
CSWD-4-14-1	#4 AWG	#6 FLEX	4-6 AWG	1/4	0.281	1.000	1.687	0.500	2.421	0.486	0.320	Gray	I-29	0.343	0.250
CSWD-4-516-1	#4 AWG	#6 FLEX	4-6 AWG	1/4	0.343	1.000	1.937	0.500	2.671	0.486	0.320	Gray	I-29	0.343	0.250
CSWD-4-38-34	#4 AWG	#6 FLEX	4-6 AWG	3/8	0.406	0.750	1.687	0.500	2.421	0.593	0.414	Gray	I-29	0.343	0.250
CSWD-4-38-1	#4 AWG	#6 FLEX	4-6 AWG	3/8	0.406	1.000	1.937	0.500	2.671	0.593	0.414	Gray	I-29	0.343	0.250
CSWD-4-12-134	#4 AWG	#6 FLEX	4-6 AWG	1/2	0.562	1.750	3.000	0.500	3.734	0.750	0.546	Gray	I-29	0.343	0.250
CSWD-3-14-58	#3 AWG	#4 FLEX	3-6 AWG	1/4	0.281	0.625	1.437	0.625	2.317	0.532	0.320	White	I-29	0.375	0.275
CSWD-3-14-34	#3 AWG	#4 FLEX	3-6 AWG	1/4	0.281	0.750	1.437	0.625	2.317	0.532	0.320	White	I-29	0.375	0.275
CSWD-3-516-1	#3 AWG	#4 FLEX	3-6 AWG	5/16	0.343	1.000	1.937	0.625	2.817	0.532	0.352	White	I-29	0.375	0.275
CSWD-3-38-34	#3 AWG	#4 FLEX	3-6 AWG	3/8	0.406	0.750	1.687	0.625	2.567	0.593	0.414	White	I-29	0.375	0.275
CSWD-3-38-1	#3 AWG	#4 FLEX	3-6 AWG	3/8	0.406	1.000	1.937	0.625	2.817	0.593	0.414	White	I-29	0.375	0.275
CSWD-3-12-134	#3 AWG	#4 FLEX	3-6 AWG	1/2	0.562	1.750	3.000	0.625	3.880	0.750	0.546	White	I-29	0.375	0.275

* When installed with specified dieless tools

+ See pages 90 to 97 for complete tooling information.

For Bent Tangs change the 4th letter to a B and add "-4" for 45 deg. or "-9" for 90 deg.

A

TYPE CSWD

Features

- Manufactured from high strength seamless copper tubing.
- Electro-Tin plated.
- Maximum conductivity and excellent crimping characteristics.
- Chamfered entry.
- Color coded.
- UL 486A 90°C Listed and CSA Certified for 600 Volts.
- If proper high voltage spacing and insulation techniques are used, may be used for high voltage applications up to 35KV.
- For Copper conductor only.
- IlSCO connectors are UL Listed and CSA Certified with ILSCO and other Manufacturers' tools.†
- UL File E6207

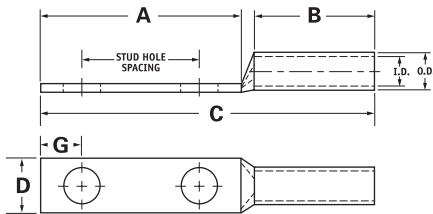

Catalog Number	Wire Size	Alt Wire Size	Expanded* Wire Range	Bolt Size	Stud Hole Dia.	Stud Hole Spacing	Dimensions					Die Color Code	Die Index	O.D.	I.D.
							A	B	C	D	G				
CSWD-2-10-34	#2 AWG	-	2-6 AWG	10	0.219	0.750	1.437	0.625	2.348	0.599	0.258	Brown	I-33	0.421	0.312
CSWD-2-14-58	#2 AWG	-	2-6 AWG	1/4	0.281	0.625	1.437	0.625	2.348	0.599	0.320	Brown	I-33	0.421	0.312
CSWD-2-14-34	#2 AWG	-	2-6 AWG	1/4	0.281	0.750	1.437	0.625	2.348	0.599	0.320	Brown	I-33	0.421	0.312
CSWD-2-14-1	#2 AWG	-	2-6 AWG	1/4	0.281	1.000	1.687	0.625	2.598	0.599	0.320	Brown	I-33	0.421	0.312
CSWD-2-516-34	#2 AWG	-	2-6 AWG	5/16	0.343	0.750	1.687	0.625	2.598	0.599	0.352	Brown	I-33	0.421	0.312
CSWD-2-516-1	#2 AWG	-	2-6 AWG	5/16	0.343	1.000	1.937	0.625	2.848	0.599	0.352	Brown	I-33	0.421	0.312
CSWD-2-38-34	#2 AWG	-	2-6 AWG	3/8	0.406	0.750	1.687	0.625	2.598	0.599	0.414	Brown	I-33	0.421	0.312
CSWD-2-38-78	#2 AWG	-	2-6 AWG	3/8	0.406	0.875	1.937	0.625	2.848	0.599	0.414	Brown	I-33	0.421	0.312
CSWD-2-38-1	#2 AWG	-	2-6 AWG	3/8	0.406	1.000	1.937	0.625	2.848	0.599	0.414	Brown	I-33	0.421	0.312
CSWD-2-38-134	#2 AWG	-	2-6 AWG	3/8	0.406	1.750	2.625	0.625	3.536	0.599	0.414	Brown	I-33	0.421	0.312
CSWD-2-12-134	#2 AWG	-	2-6 AWG	1/2	0.562	1.750	3.000	0.625	3.911	0.750	0.546	Brown	I-33	0.421	0.312
CSWD-1-14-58	#1 AWG	#2 FLEX	1-6 AWG	1/4	0.281	0.625	1.437	0.625	2.392	0.673	0.320	Green	I-37	0.468	0.359
CSWD-1-14-34	#1 AWG	#2 FLEX	1-6 AWG	1/4	0.281	0.750	1.437	0.625	2.392	0.673	0.320	Green	I-37	0.468	0.359
CSWD-1-14-1	#1 AWG	#2 FLEX	1-6 AWG	1/4	0.281	1.000	1.687	0.625	2.642	0.673	0.320	Green	I-37	0.468	0.359
CSWD-1-516-78	#1 AWG	#2 FLEX	1-6 AWG	5/16	0.343	0.875	1.687	0.625	2.642	0.673	0.352	Green	I-37	0.468	0.359
CSWD-1-516-1	#1 AWG	#2 FLEX	1-6 AWG	5/16	0.343	1.000	1.937	0.625	2.892	0.673	0.352	Green	I-37	0.468	0.359
CSWD-1-38-1	#1 AWG	#2 FLEX	1-6 AWG	3/8	0.406	1.000	1.937	0.625	2.892	0.673	0.414	Green	I-37	0.468	0.359
CSWD-1-12-134	#1 AWG	#2 FLEX	1-6 AWG	1/2	0.562	1.750	3.000	0.625	3.955	0.750	0.546	Green	I-37	0.468	0.359
CSWD-1/0-14-58	1/0 AWG	#1 FLEX	1/0-6 AWG	1/4	0.281	0.625	1.437	0.750	2.543	0.738	0.320	Pink	I-42	0.515	0.390
CSWD-1/0-14-34	1/0 AWG	#1 FLEX	1/0-6 AWG	1/4	0.281	0.750	1.437	0.750	2.543	0.738	0.320	Pink	I-42	0.515	0.390
CSWD-1/0-14-1	1/0 AWG	#1 FLEX	1/0-6 AWG	1/4	0.281	1.000	1.687	0.750	2.793	0.738	0.320	Pink	I-42	0.515	0.390
CSWD-1/0-516-34	1/0 AWG	#1 FLEX	1/0-6 AWG	5/16	0.343	0.750	1.687	0.750	2.793	0.738	0.352	Pink	I-42	0.515	0.390
CSWD-1/0-516-78	1/0 AWG	#1 FLEX	1/0-6 AWG	5/16	0.343	0.875	1.687	0.750	2.793	0.738	0.352	Pink	I-42	0.515	0.390
CSWD-1/0-516-1	1/0 AWG	#1 FLEX	1/0-6 AWG	5/16	0.343	1.000	1.937	0.750	3.043	0.738	0.352	Pink	I-42	0.515	0.390
CSWD-1/0-38-1	1/0 AWG	#1 FLEX	1/0-6 AWG	3/8	0.406	1.000	1.937	0.750	3.043	0.738	0.414	Pink	I-42	0.515	0.390
CSWD-1/0-38-134	1/0 AWG	#1 FLEX	1/0-6 AWG	3/8	0.406	1.750	2.625	0.750	3.731	0.738	0.414	Pink	I-42	0.515	0.390
CSWD-1/0-12-1	1/0 AWG	#1 FLEX	1/0-6 AWG	1/2	0.562	1.000	2.125	0.750	3.231	0.738	0.546	Pink	I-42	0.515	0.390
CSWD-1/0-12-134	1/0 AWG	#1 FLEX	1/0-6 AWG	1/2	0.562	1.750	3.000	0.750	4.106	0.738	0.546	Pink	I-42	0.515	0.390

* When installed with specified dieless tools + See pages 90 to 97 for complete tooling information.
 For Bent Tangs change the 4th letter to a B and add "-4" for 45 deg. or "-9" for 90 deg.

TYPE CSWD

Features

- Manufactured from high strength seamless copper tubing.
- Electro-Tin plated.
- Maximum conductivity and excellent crimping characteristics.
- Chamfered entry.
- Color coded.
- UL 486A 90°C Listed and CSA Certified for 600 Volts.
- If proper high voltage spacing and insulation techniques are used, may be used for high voltage applications up to 35KV.
- For Copper conductor only.
- IlSCO connectors are UL Listed and CSA Certified with ILSCO and other Manufacturers' tools.†
- UL File E6207

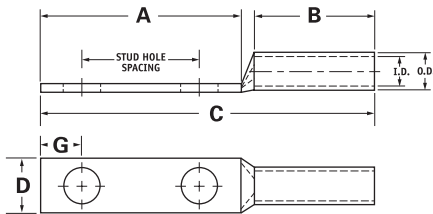

Catalog Number	Wire Size	Alt Wire Size	Expanded* Wire Range	Bolt Size	Stud Hole Dia.	Stud Hole Spacing	Dimensions					Die Color Code	Die Index	O.D.	I.D.
							A	B	C	D	G				
CSWD-2/0-14-58	2/0 AWG	1/0 FLEX	2/0-4 AWG	1/4	0.281	0.625	1.437	0.750	2.583	0.811	0.320	Black	I-45	0.562	0.437
CSWD-2/0-14-34	2/0 AWG	1/0 FLEX	2/0-4 AWG	1/4	0.281	0.750	1.437	0.750	2.583	0.811	0.320	Black	I-45	0.562	0.437
CSWD-2/0-14-1	2/0 AWG	1/0 FLEX	2/0-4 AWG	1/4	0.281	1.000	1.687	0.750	2.833	0.811	0.320	Black	I-45	0.562	0.437
CSWD-2/0-516-78	2/0 AWG	1/0 FLEX	2/0-4 AWG	5/16	0.343	0.875	1.687	0.750	2.833	0.811	0.352	Black	I-45	0.562	0.437
CSWD-2/0-516-1	2/0 AWG	1/0 FLEX	2/0-4 AWG	5/16	0.343	1.000	1.937	0.750	3.083	0.811	0.352	Black	I-45	0.562	0.437
CSWD-2/0-38-1	2/0 AWG	1/0 FLEX	2/0-4 AWG	3/8	0.406	1.000	1.937	0.750	3.083	0.811	0.414	Black	I-45	0.562	0.437
CSWD-2/0-38-134	2/0 AWG	1/0 FLEX	2/0-4 AWG	3/8	0.406	1.750	2.625	0.750	3.771	0.811	0.414	Black	I-45	0.562	0.437
CSWD-2/0-12-1	2/0 AWG	1/0 FLEX	2/0-4 AWG	1/2	0.562	1.000	2.125	0.750	3.271	0.811	0.546	Black	I-45	0.562	0.437
CSWD-2/0-12-134	2/0 AWG	1/0 FLEX	2/0-4 AWG	1/2	0.562	1.750	3.000	0.750	4.146	0.811	0.546	Black	I-45	0.562	0.437
CSWD-3/0-14-58	3/0 AWG	2/0 FLEX	3/0-2 AWG	1/4	0.281	0.625	1.437	0.750	2.626	0.885	0.320	Orange	I-50	0.609	0.484
CSWD-3/0-14-34	3/0 AWG	2/0 FLEX	3/0-2 AWG	1/4	0.281	0.750	1.437	0.750	2.626	0.885	0.320	Orange	I-50	0.609	0.484
CSWD-3/0-516-1	3/0 AWG	2/0 FLEX	3/0-2 AWG	5/16	0.343	1.000	1.937	0.750	3.126	0.885	0.352	Orange	I-50	0.609	0.484
CSWD-3/0-38-1	3/0 AWG	2/0 FLEX	3/0-2 AWG	3/8	0.406	1.000	1.937	0.750	3.126	0.885	0.414	Orange	I-50	0.609	0.484
CSWD-3/0-12-134	3/0 AWG	2/0 FLEX	3/0-2 AWG	1/2	0.562	1.750	3.000	0.750	4.189	0.885	0.546	Orange	I-50	0.609	0.484
CSWD-4/0-14-58	4/0 AWG	3/0 FLEX	4/0-1 AWG	1/4	0.281	0.625	1.437	0.875	2.803	0.999	0.320	Purple	I-54	0.687	0.546
CSWD-4/0-14-34	4/0 AWG	3/0 FLEX	4/0-1 AWG	1/4	0.281	0.750	1.437	0.875	2.803	0.999	0.320	Purple	I-54	0.687	0.546
CSWD-4/0-14-1	4/0 AWG	3/0 FLEX	4/0-1 AWG	1/4	0.281	1.000	1.687	0.875	3.053	0.999	0.320	Purple	I-54	0.687	0.546
CSWD-4/0-516-34	4/0 AWG	3/0 FLEX	4/0-1 AWG	5/16	0.343	0.750	1.687	0.875	3.053	0.999	0.352	Purple	I-54	0.687	0.546
CSWD-4/0-516-1	4/0 AWG	3/0 FLEX	4/0-1 AWG	5/16	0.343	1.000	1.937	0.875	3.303	0.999	0.352	Purple	I-54	0.687	0.546
CSWD-4/0-516-134	4/0 AWG	3/0 FLEX	4/0-1 AWG	5/16	0.343	1.750	2.500	0.875	3.866	0.999	0.352	Purple	I-54	0.687	0.546
CSWD-4/0-38-1	4/0 AWG	3/0 FLEX	4/0-1 AWG	3/8	0.406	1.000	1.937	0.875	3.303	0.999	0.414	Purple	I-54	0.687	0.546
CSWD-4/0-38-134	4/0 AWG	3/0 FLEX	4/0-1 AWG	3/8	0.406	1.750	2.625	0.875	3.991	0.999	0.414	Purple	I-54	0.687	0.546
CSWD-4/0-12-1	4/0 AWG	3/0 FLEX	4/0-1 AWG	1/2	0.562	1.000	2.125	0.875	3.491	0.999	0.546	Purple	I-54	0.687	0.546
CSWD-4/0-12-114	4/0 AWG	3/0 FLEX	4/0-1 AWG	1/2	0.562	1.250	2.500	0.875	3.866	0.999	0.546	Purple	I-54	0.687	0.546
CSWD-4/0-12-134	4/0 AWG	3/0 FLEX	4/0-1 AWG	1/2	0.562	1.750	3.000	0.875	4.366	0.999	0.546	Purple	I-54	0.687	0.546

* When installed with specified dieless tools

+ See pages 90 to 97 for complete tooling information.

For Bent Tangs change the 4th letter to a B and add "-4" for 45 deg. or "-9" for 90 deg.

A

TYPE CSWD

Features

- Manufactured from high strength seamless copper tubing.
- Electro-Tin plated.
- Maximum conductivity and excellent crimping characteristics.
- Chamfered entry.
- Color coded.
- UL 486A 90°C Listed and CSA Certified for 600 Volts.
- If proper high voltage spacing and insulation techniques are used, may be used for high voltage applications up to 35KV.
- For Copper conductor only.
- IlSCO connectors are UL Listed and CSA Certified with ILSCO and other Manufacturers' tools.+
- UL File E6207

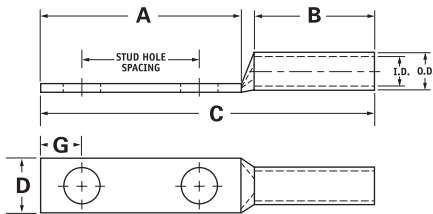

Catalog Number	Wire Size	Alt Wire Size	Expanded* Wire Range	Bolt Size	Stud Hole Dia.	Stud Hole Spacing	Dimensions					Die Color Code	Die Index	O.D.	I.D.
							A	B	C	D	G				
CSWD-250-14-34	250kcmil	4/0 FLEX	250kcmil - 1/0 AWG	1/4	0.281	0.750	1.437	1.063	3.031	1.088	0.320	Yellow	I-62	0.750	0.593
CSWD-250-38-1	250kcmil	4/0 FLEX	250kcmil - 1/0 AWG	3/8	0.406	1.00	1.937	1.063	3.531	1.088	0.414	Yellow	I-62	0.750	0.593
CSWD-250-38-134	250kcmil	4/0 FLEX	250kcmil - 1/0 AWG	3/8	0.406	1.750	2.625	1.063	4.219	1.088	0.414	Yellow	I-62	0.750	0.593
CSWD-250-12-114	250kcmil	4/0 FLEX	250kcmil - 1/0 AWG	1/2	0.562	1.250	2.500	1.063	4.094	1.088	0.546	Yellow	I-62	0.750	0.593
CSWD-250-12-134	250kcmil	4/0 FLEX	250kcmil - 1/0 AWG	1/2	0.562	1.750	3.000	1.063	4.594	1.088	0.546	Yellow	I-62	0.750	0.593
CSWD-300-38-1	300kcmil	250 G,H FLEX	300kcmil - 2/0 AWG	3/8	0.406	1.000	1.937	1.063	3.587	1.189	0.414	White	I-66	0.812	0.660
CSWD-300-12-134	300kcmil	250 G,H FLEX	300kcmil - 2/0 AWG	1/2	0.562	1.750	3.000	1.063	4.650	1.189	0.546	White	I-66	0.812	0.660
CSWD-350-14-34	350kcmil	250 I,K,M FLEX 262.2 DLO	350kcmil - 3/0 AWG	1/4	0.281	0.750	1.437	1.063	3.123	1.291	0.320	Red	I-71	0.890	0.703
CSWD-350-516-134	350kcmil	250 I,K,M FLEX 262.2 DLO	350kcmil - 3/0 AWG	5/16	0.343	1.750	2.500	1.063	4.186	1.291	0.352	Red	I-71	0.890	0.703
CSWD-350-38-1	350kcmil	250 I,K,M FLEX 262.2 DLO	350kcmil - 3/0 AWG	3/8	0.406	1.000	1.937	1.063	3.623	1.291	0.414	Red	I-71	0.890	0.703
CSWD-350-12-114	350kcmil	250 I,K,M FLEX 262.2 DLO	350kcmil - 3/0 AWG	1/2	0.562	1.250	2.500	1.063	4.186	1.291	0.546	Red	I-71	0.890	0.703
CSWD-350-12-134	350kcmil	250 I,K,M FLEX 262.2 DLO	350kcmil - 3/0 AWG	1/2	0.562	1.750	3.000	1.063	4.686	1.291	0.546	Red	I-71	0.890	0.703
CSWD-400-38-1	400kcmil	300 G,H,I,K,M FLEX 313.1 DLO	400kcmil - 4/0 AWG	3/8	0.406	1.000	1.937	1.188	3.792	1.365	0.414	Blue	I-76	0.937	0.750
CSWD-400-38-116	400kcmil	300 G,H,I,K,M FLEX 313.1 DLO	400kcmil - 4/0 AWG	3/8	0.406	1.062	1.937	1.188	3.792	1.365	0.414	Blue	I-76	0.937	0.750
CSWD-400-12-134	400kcmil	300 G,H,I,K,M FLEX 313.1 DLO	400kcmil - 4/0 AWG	1/2	0.562	1.750	3.000	1.188	4.855	1.365	0.546	Blue	I-76	0.937	0.750
CSWD-500-14-34	500kcmil	350 G,H,I,K,M FLEX 373.7 DLO	500kcmil - 250kcmil	1/4	0.281	0.750	1.437	1.300	3.469	1.535	0.320	Brown	I-87	1.062	0.828
CSWD-500-38-1	500kcmil	350 G,H,I,K,M FLEX 373.7 DLO	500kcmil - 250kcmil	3/8	0.406	1.000	1.937	1.300	3.969	1.535	0.414	Brown	I-87	1.062	0.828
CSWD-500-12-114	500kcmil	350 G,H,I,K,M FLEX 373.7 DLO	500kcmil - 250kcmil	1/2	0.562	1.250	2.500	1.300	4.532	1.535	0.546	Brown	I-87	1.062	0.828
CSWD-500-12-134	500kcmil	350 G,H,I,K,M FLEX 373.7 DLO	500kcmil - 250kcmil	1/2	0.562	1.750	3.000	1.300	5.032	1.535	0.546	Brown	I-87	1.062	0.828

* When installed with specified dieless tools + See pages 90 to 97 for complete tooling information.
 For Bent Tangs change the 4th letter to a B and add "-4" for 45 deg. or "-9" for 90 deg.

TYPE CSWD

Features

- Manufactured from high strength seamless copper tubing.
- Electro-Tin plated.
- Maximum conductivity and excellent crimping characteristics.
- Chamfered entry.
- Color coded.
- UL 486A 90°C Listed and CSA Certified for 600 Volts.
- If proper high voltage spacing and insulation techniques are used, may be used for high voltage applications up to 35KV.
- For Copper conductor only.
- IlSCO connectors are UL Listed and CSA Certified with ILSCO and other Manufacturers' tools.+
- UL File E6207

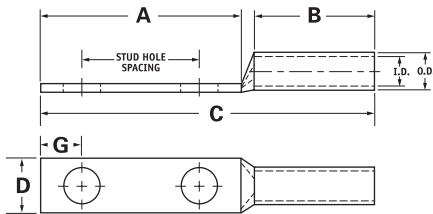

Catalog Number	Wire Size	Alt Wire Size	Expanded* Wire Range	Bolt Size	Stud Hole Dia.	Stud Hole Spacing	Dimensions					Die Color Code	Die Index	O.D.	I.D.
							A	B	C	D	G				
CSWD-600-38-1	600kcmil	400 G,H,I,K,M FLEX 444.4 DLO	600kcmil - 250kcmil	3/8	0.406	1.000	1.937	1.375	4.121	1.712	0.414	Green	I-94	1.187	0.920
CSWD-600-12-134	600kcmil	400 G,H,I,K,M FLEX 444.4 DLO	600kcmil - 250kcmil	1/2	0.562	1.750	3.000	1.375	5.184	1.712	0.546	Green	I-94	1.187	0.920
CSWD-650-12-134	650kcmil	500 G,H,I,K,M FLEX 535.3 DLO	650kcmil - 350kcmil	1/2	0.562	1.75	3	1.375	5.244	1.764	0.546	Pink	I-99	1.217	0.958
CSWD-650-12-114	650kcmil	500 G,H,I,K,M FLEX 535.3 DLO	650kcmil - 350kcmil	1/2	0.562	1.25	2.5	1.375	4.744	1.764	0.546	Pink	I-99	1.217	0.958
CSWD-650-38-1	650kcmil	500 G,H,I,K,M FLEX 535.3 DLO	650kcmil - 350kcmil	3/8	0.406	1	1.937	1.375	4.181	1.764	0.414	Pink	I-99	1.217	0.958
CSWD-650-38-118	650kcmil	500 G,H,I,K,M FLEX 535.3 DLO	650kcmil - 350kcmil	3/8	0.406	1.125	2.125	1.375	4.369	1.764	0.414	Pink	I-99	1.217	0.958
CSWD-650-516-1	650kcmil	500 G,H,I,K,M FLEX 535.3 DLO	650kcmil - 350kcmil	1/32	0.343	1	1.937	1.375	4.181	1.764	0.352	Pink	I-99	1.217	0.958
CSWD-700-38-1	700kcmil	500 G,H,I,K,M FLEX 535.3 DLO	700kcmil - 350kcmil	3/8	0.406	1.000	1.937	1.375	4.181	1.816	0.414	Pink	I-99	1.250	0.991
CSWD-700-12-114	700kcmil	500 G,H,I,K,M FLEX 535.3 DLO	700kcmil - 350kcmil	1/2	0.562	1.250	2.500	1.375	4.744	1.816	0.546	Pink	I-99	1.250	0.991
CSWD-700-12-134	700kcmil	500 G,H,I,K,M FLEX 535.3 DLO	700kcmil - 350kcmil	1/2	0.562	1.750	3.000	1.375	5.244	1.816	0.546	Pink	I-99	1.250	0.991
CSWD-700-12-178	700kcmil	500 G,H,I,K,M FLEX 535.3 DLO	700kcmil - 350kcmil	1/2	0.562	1.875	3.000	1.375	5.244	1.816	0.546	Pink	I-99	1.250	0.991
CSWD-750-38-1	750kcmil	600 G,H,I,M FLEX 646.4 DLO	750kcmil - 500kcmil	3/8	0.406	1.000	1.937	1.500	4.339	1.901	0.414	Black	I-106	1.313	1.031
CSWD-750-38-118	750kcmil	600 G,H,I,M FLEX 646.4 DLO	750kcmil - 500kcmil	3/8	0.406	1.125	2.125	1.500	4.527	1.901	0.414	Black	I-106	1.313	1.031
CSWD-750-12-112	750kcmil	600 G,H,I,M FLEX 646.4 DLO	750kcmil - 500kcmil	1/2	0.562	1.500	2.625	1.500	5.027	1.901	0.546	Black	I-106	1.313	1.031
CSWD-750-12-134	750kcmil	600 G,H,I,M FLEX 646.4 DLO	750kcmil - 500kcmil	1/2	0.562	1.750	3.000	1.500	5.402	1.901	0.546	Black	I-106	1.313	1.031
CSWD-750-58-112	750kcmil	600 G,H,I,M FLEX 646.4 DLO	750kcmil - 500kcmil	5/8	0.562	1.500	3.000	1.500	5.402	1.901	0.671	Black	I-106	1.313	1.031
CSWD-1000-38-1	1000kcmil	750 G,H,I FLEX 777.7 DLO	1000kcmil - 750kcmil	3/8	0.406	1.000	1.937	1.625	4.587	2.169	0.414	White	I-125	1.500	1.172
CSWD-1000-12-114	1000kcmil	750 G,H,I FLEX 777.7 DLO	1000kcmil - 750kcmil	1/2	0.562	1.250	2.500	1.625	5.150	2.169	0.546	White	I-125	1.500	1.172
CSWD-1000-12-134	1000kcmil	750 G,H,I FLEX 777.7 DLO	1000kcmil - 750kcmil	1/2	0.562	1.750	3.000	1.625	5.650	2.169	0.546	White	I-125	1.500	1.172
CSWD-1000-58-112	1000kcmil	750 G,H,I FLEX 777.7 DLO	1000kcmil - 750kcmil	5/8	0.562	1.500	3.000	1.625	5.650	2.169	0.671	White	I-125	1.500	1.172

* When installed with specified dieless tools + See pages 90 to 97 for complete tooling information. For Bent Tangs change the 4th letter to a B and add "-4" for 45 deg. or "-9" for 90 deg.

A

TYPE CLWS

Features

- Manufactured from high strength seamless copper tubing.
- Electro-Tin plated.
- Maximum conductivity and excellent crimping characteristics.
- Long barrel length with chamfered entry.
- Color coded.
- UL 486A 90°C Listed and CSA Certified for 600 Volts.
- If proper high voltage spacing and insulation techniques are used, may be used for high voltage applications up to 35KV.
- For Copper conductor only.
- IlSCO connectors are UL Listed and CSA Certified with ILSCO and other Manufacturers' tools.+
- UL File E6207

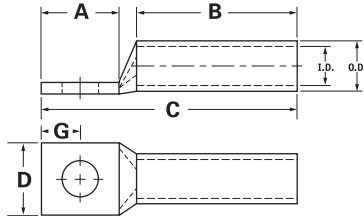

Catalog Number	Wire Size	Alt Wire Size	Expanded* Wire Range	Bolt Size	Stud Hole Dia.	Dimensions					Die Color Code	Die Index	O.D.	I.D.
						A	B	C	D	G				
CLWS-8-10	#8 AWG	#8 FLEX	-	10	0.219	0.562	0.812	1.569	0.374	0.258	Red	I-21	0.272	0.179
CLWS-8-14	#8 AWG	#8 FLEX	-	1/4	0.281	0.680	0.812	1.687	0.486	0.320	Red	I-21	0.272	0.179
CLWS-8-516	#8 AWG	#8 FLEX	-	5/16	0.343	0.875	0.812	1.882	0.532	0.352	Red	I-21	0.272	0.179
CLWS-8-38	#8 AWG	#8 FLEX	-	3/8	0.406	0.875	0.812	1.882	0.593	0.414	Red	I-21	0.272	0.179
CLWS-6-10	#6 AWG	-	-	10	0.219	0.562	1.125	1.882	0.411	0.258	Blue	I-24	0.295	0.203
CLWS-6-14	#6 AWG	-	-	1/4	0.281	0.680	1.125	2.000	0.411	0.320	Blue	I-24	0.295	0.203
CLWS-6-516	#6 AWG	-	-	5/16	0.343	0.875	1.125	2.195	0.532	0.352	Blue	I-24	0.295	0.203
CLWS-6-38	#6 AWG	-	-	3/8	0.406	0.875	1.125	2.195	0.593	0.414	Blue	I-24	0.295	0.203
CLWS-6-12	#6 AWG	-	-	1/2	0.562	1.250	1.125	2.570	0.750	0.546	Blue	I-24	0.295	0.203
CLWS-6-34	#6 AWG	-	-	3/4	0.781	1.687	1.125	3.007	0.411	0.750	Blue	I-24	0.295	0.203
CLWS-4-10	#4 AWG	#6 FLEX	4-6 AWG	10	0.219	0.562	1.125	1.921	0.486	0.258	Gray	I-29	0.343	0.250
CLWS-4-14	#4 AWG	#6 FLEX	4-6 AWG	1/4	0.281	0.680	1.125	2.039	0.486	0.320	Gray	I-29	0.343	0.250
CLWS-4-516	#4 AWG	#6 FLEX	4-6 AWG	5/16	0.343	0.875	1.125	2.234	0.486	0.352	Gray	I-29	0.343	0.250
CLWS-4-38	#4 AWG	#6 FLEX	4-6 AWG	3/8	0.406	0.875	1.125	2.234	0.593	0.414	Gray	I-29	0.343	0.250
CLWS-4-12	#4 AWG	#6 FLEX	4-6 AWG	1/2	0.562	1.250	1.125	2.609	0.750	0.546	Gray	I-29	0.343	0.250
CLWS-3-10	#3 AWG	#4 FLEX	3-6 AWG	10	0.219	0.562	1.125	1.942	0.532	0.258	White	I-29	0.375	0.275
CLWS-3-14	#3 AWG	#4 FLEX	3-6 AWG	1/4	0.281	0.680	1.125	2.060	0.532	0.320	White	I-29	0.375	0.275
CLWS-3-516	#3 AWG	#4 FLEX	3-6 AWG	5/16	0.343	0.875	1.125	2.255	0.532	0.352	White	I-29	0.375	0.275
CLWS-3-38	#3 AWG	#4 FLEX	3-6 AWG	3/8	0.406	0.875	1.125	2.255	0.593	0.414	White	I-29	0.375	0.275
CLWS-3-12	#3 AWG	#4 FLEX	3-6 AWG	1/2	0.562	1.250	1.125	2.630	0.750	0.546	White	I-29	0.375	0.275
CLWS-2-10	#2 AWG	-	2-6 AWG	10	0.219	0.562	1.125	1.973	0.599	0.258	Brown	I-33	0.421	0.312
CLWS-2-14	#2 AWG	-	2-6 AWG	1/4	0.281	0.680	1.125	2.091	0.599	0.320	Brown	I-33	0.421	0.312
CLWS-2-516	#2 AWG	-	2-6 AWG	5/16	0.343	0.875	1.125	2.286	0.599	0.352	Brown	I-33	0.421	0.312
CLWS-2-38	#2 AWG	-	2-6 AWG	3/8	0.406	0.875	1.125	2.286	0.599	0.414	Brown	I-33	0.421	0.312
CLWS-2-12	#2 AWG	-	2-6 AWG	1/2	0.562	1.250	1.125	2.661	0.750	0.546	Brown	I-33	0.421	0.312
CLWS-1-10	#1 AWG	#2 FLEX	1-6 AWG	10	0.219	0.562	1.375	2.267	0.673	0.258	Green	I-37	0.468	0.359
CLWS-1-14	#1 AWG	#2 FLEX	1-6 AWG	1/4	0.281	0.875	1.375	2.580	0.673	0.320	Green	I-37	0.468	0.359
CLWS-1-516	#1 AWG	#2 FLEX	1-6 AWG	5/16	0.343	0.875	1.375	2.580	0.673	0.352	Green	I-37	0.468	0.359
CLWS-1-38	#1 AWG	#2 FLEX	1-6 AWG	3/8	0.406	0.875	1.375	2.580	0.673	0.414	Green	I-37	0.468	0.359
CLWS-1-12	#1 AWG	#2 FLEX	1-6 AWG	1/2	0.562	1.250	1.375	2.955	0.750	0.546	Green	I-37	0.468	0.359

* When installed with specified dieless tools

+ See pages 90 to 97 for complete tooling information.

For Bent Tangs change the 4th letter to a B and add "-4" for 45 deg. or "-9" for 90 deg.

TYPE CLWS

Features

- Manufactured from high strength seamless copper tubing.
- Electro-Tin plated.
- Maximum conductivity and excellent crimping characteristics.
- Long barrel length with chamfered entry.
- Color coded.
- UL 486A 90°C Listed and CSA Certified for 600 Volts.
- If proper high voltage spacing and insulation techniques are used, may be used for high voltage applications up to 35KV.
- For Copper conductor only.
- IlSCO connectors are UL Listed and CSA Certified with ILSCO and other Manufacturers' tools.*
- UL File E6207

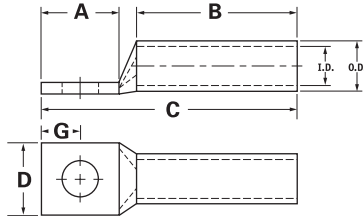

Catalog Number	Wire Size	Alt Wire Size	Expanded* Wire Range	Bolt Size	Stud Hole Dia.	Dimensions					Die Color Code	Die Index	O.D.	I.D.
						A	B	C	D	G				
CLWS-1/0-10	1/0 AWG	#1 FLEX	1/0-6 AWG	10	0.219	0.562	1.500	2.418	0.738	0.258	Pink	I-42	0.515	0.390
CLWS-1/0-14	1/0 AWG	#1 FLEX	1/0-6 AWG	1/4	0.281	0.875	1.500	2.731	0.738	0.320	Pink	I-42	0.515	0.390
CLWS-1/0-516	1/0 AWG	#1 FLEX	1/0-6 AWG	5/16	0.343	0.875	1.500	2.731	0.738	0.352	Pink	I-42	0.515	0.390
CLWS-1/0-38	1/0 AWG	#1 FLEX	1/0-6 AWG	3/8	0.406	0.875	1.500	2.731	0.738	0.414	Pink	I-42	0.515	0.390
CLWS-1/0-12	1/0 AWG	#1 FLEX	1/0-6 AWG	1/2	0.562	1.250	1.500	3.106	0.738	0.546	Pink	I-42	0.515	0.390
CLWS-2/0-10	2/0 AWG	1/0 FLEX	2/0-4 AWG	10	0.219	0.562	1.500	2.458	0.811	0.258	Black	I-45	0.562	0.437
CLWS-2/0-14	2/0 AWG	1/0 FLEX	2/0-4 AWG	1/4	0.281	0.875	1.500	2.771	0.811	0.320	Black	I-45	0.562	0.437
CLWS-2/0-516	2/0 AWG	1/0 FLEX	2/0-4 AWG	5/16	0.343	0.875	1.500	2.771	0.811	0.352	Black	I-45	0.562	0.437
CLWS-2/0-38	2/0 AWG	1/0 FLEX	2/0-4 AWG	3/8	0.406	0.875	1.500	2.771	0.811	0.414	Black	I-45	0.562	0.437
CLWS-2/0-12	2/0 AWG	1/0 FLEX	2/0-4 AWG	1/2	0.562	1.250	1.500	3.146	0.811	0.546	Black	I-45	0.562	0.437
CLWS-3/0-10	3/0 AWG	2/0 FLEX	3/0-2 AWG	10	0.219	0.562	1.500	2.501	0.885	0.258	Orange	I-50	0.609	0.484
CLWS-3/0-14	3/0 AWG	2/0 FLEX	3/0-2 AWG	1/4	0.281	0.875	1.500	2.814	0.885	0.320	Orange	I-50	0.609	0.484
CLWS-3/0-516	3/0 AWG	2/0 FLEX	3/0-2 AWG	5/16	0.343	0.875	1.500	2.814	0.885	0.352	Orange	I-50	0.609	0.484
CLWS-3/0-38	3/0 AWG	2/0 FLEX	3/0-2 AWG	3/8	0.406	0.875	1.500	2.814	0.885	0.414	Orange	I-50	0.609	0.484
CLWS-3/0-12	3/0 AWG	2/0 FLEX	3/0-2 AWG	1/2	0.562	1.250	1.500	3.189	0.885	0.546	Orange	I-50	0.609	0.484
CLWS-4/0-14	4/0 AWG	3/0 FLEX	4/0-1 AWG	1/4	0.281	0.875	1.500	2.866	0.999	0.320	Purple	I-54	0.687	0.546
CLWS-4/0-516	4/0 AWG	3/0 FLEX	4/0-1 AWG	5/16	0.343	0.875	1.500	2.866	0.999	0.352	Purple	I-54	0.687	0.546
CLWS-4/0-38	4/0 AWG	3/0 FLEX	4/0-1 AWG	3/8	0.406	0.875	1.500	2.866	0.999	0.414	Purple	I-54	0.687	0.546
CLWS-4/0-12	4/0 AWG	3/0 FLEX	4/0-1 AWG	1/2	0.562	1.250	1.500	3.241	0.999	0.546	Purple	I-54	0.687	0.546
CLWS-250-516	250kcmil	4/0 FLEX	250kcmil - 1/0 AWG	5/16	0.343	0.875	1.688	3.094	1.088	0.352	Yellow	I-62	0.750	0.593
CLWS-250-38	250kcmil	4/0 FLEX	250kcmil - 1/0 AWG	3/8	0.406	0.875	1.688	3.094	1.088	0.414	Yellow	I-62	0.750	0.593
CLWS-250-12	250kcmil	4/0 FLEX	250kcmil - 1/0 AWG	1/2	0.562	1.250	1.688	3.469	1.088	0.546	Yellow	I-62	0.750	0.593
CLWS-300-516	300kcmil	250 G,H FLEX	300kcmil - 2/0 AWG	5/16	0.343	0.875	2.000	3.462	1.189	0.352	White	I-66	0.812	0.660
CLWS-300-38	300kcmil	250 G,H FLEX	300kcmil - 2/0 AWG	3/8	0.406	0.875	2.000	3.462	1.189	0.414	White	I-66	0.812	0.660
CLWS-300-12	300kcmil	250 G,H FLEX	300kcmil - 2/0 AWG	1/2	0.562	1.250	2.000	3.837	1.189	0.546	White	I-66	0.812	0.660
CLWS-350-38	350kcmil	250 I,K,M FLEX 262.2 DLO	350kcmil - 3/0 AWG	3/8	0.406	0.875	2.000	3.498	1.291	0.414	Red	I-71	0.890	0.703
CLWS-350-12	350kcmil	250 I,K,M FLEX 262.2 DLO	350kcmil - 3/0 AWG	1/2	0.562	1.250	2.000	3.873	1.291	0.546	Red	I-71	0.890	0.703
CLWS-350-58	350kcmil	250 I,K,M FLEX 262.2 DLO	350kcmil - 3/0 AWG	5/8	0.656	1.437	2.000	4.060	1.291	0.671	Red	I-71	0.890	0.703
CLWS-400-38	400kcmil	300 G,H,I,K,M FLEX 313.1 DLO	400kcmil - 4/0 AWG	3/8	0.406	0.875	2.125	3.667	1.365	0.414	Blue	I-76	0.937	0.750
CLWS-400-12	400kcmil	300 G,H,I,K,M FLEX 313.1 DLO	400kcmil - 4/0 AWG	1/2	0.562	1.250	2.125	4.042	1.365	0.546	Blue	I-76	0.937	0.750
CLWS-400-58	400kcmil	300 G,H,I,K,M FLEX 313.1 DLO	400kcmil - 4/0 AWG	5/8	0.656	1.437	2.125	4.229	1.365	0.671	Blue	I-76	0.937	0.750

* When installed with specified dieless tools + See pages 90 to 97 for complete tooling information.
For Bent Tangs change the 4th letter to a B and add "-4" for 45 deg. or "-9" for 90 deg.

A

TYPE CLWS

Features

- Manufactured from high strength seamless copper tubing.
- Electro-Tin plated.
- Maximum conductivity and excellent crimping characteristics.
- Long barrel length with chamfered entry.
- Color coded.
- UL 486A 90°C Listed and CSA Certified for 600 Volts.
- If proper high voltage spacing and insulation techniques are used, may be used for high voltage applications up to 35KV.
- For Copper conductor only.
- IlSCO connectors are UL Listed and CSA Certified with ILSCO and other Manufacturers' tools.+
- UL File E6207

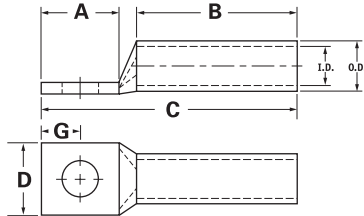

Catalog Number	Wire Size	Alt Wire Size	Expanded* Wire Range	Bolt Size	Stud Hole Dia.	Dimensions					Die Color Code	Die Index	O.D.	I.D.
						A	B	C	D	G				
CLWS-500-38	500kcmil	350 G,H,I,K,M FLEX 373.7 DLO	500kcmil - 250kcmil	3/8	0.406	0.875	2.250	3.857	1.535	0.414	Brown	I-87	1.062	0.828
CLWS-500-12	500kcmil	350 G,H,I,K,M FLEX 373.7 DLO	500kcmil - 250kcmil	1/2	0.562	1.250	2.250	4.232	1.535	0.546	Brown	I-87	1.062	0.828
CLWS-500-58	500kcmil	350 G,H,I,K,M FLEX 373.7 DLO	500kcmil - 250kcmil	5/8	0.656	1.437	2.250	4.419	1.535	0.671	Brown	I-87	1.062	0.828
CLWS-600-38	600kcmil	400 G,H,I,K,M FLEX 444.4 DLO	600kcmil - 250kcmil	3/8	0.406	0.875	2.687	4.371	1.712	0.414	Green	I-94	1.187	0.920
CLWS-600-12	600kcmil	400 G,H,I,K,M FLEX 444.4 DLO	600kcmil - 250kcmil	1/2	0.562	1.250	2.687	4.746	1.712	0.546	Green	I-94	1.187	0.920
CLWS-600-58	600kcmil	400 G,H,I,K,M FLEX 444.4 DLO	600kcmil - 250kcmil	5/8	0.656	1.437	2.687	4.933	1.712	0.671	Green	I-94	1.187	0.920
CLWS-650-516	650kcmil	500 G,H,I,K,M FLEX 535.3 DLO	650kcmil - 350kcmil	1/32	0.343	0.875	2.687	4.431	1.764	0.352	Pink	I-99	1.217	0.958
CLWS-650-38	650kcmil	500 G,H,I,K,M FLEX 535.3 DLO	650kcmil - 350kcmil	3/8	0.406	0.875	2.687	4.431	1.764	0.414	Pink	I-99	1.217	0.958
CLWS-650-12	650kcmil	500 G,H,I,K,M FLEX 535.3 DLO	650kcmil - 350kcmil	1/2	0.562	1.25	2.687	4.806	1.764	0.546	Pink	I-99	1.217	0.958
CLWS-650-58	650kcmil	500 G,H,I,K,M FLEX 535.3 DLO	650kcmil - 350kcmil	5/8	0.656	1.437	2.687	4.993	1.764	0.671	Pink	I-99	1.217	0.958
CLWS-700-38	700kcmil	500 G,H,I,K,M FLEX 535.3 DLO	700kcmil - 350kcmil	3/8	0.406	0.875	2.687	4.431	1.816	0.414	Pink	I-99	1.250	0.991
CLWS-700-12	700kcmil	500 G,H,I,K,M FLEX 535.3 DLO	700kcmil - 350kcmil	1/2	0.562	1.250	2.687	4.806	1.816	0.546	Pink	I-99	1.250	0.991
CLWS-700-58	700kcmil	500 G,H,I,K,M FLEX 535.3 DLO	700kcmil - 350kcmil	5/8	0.656	1.437	2.687	4.993	1.816	0.671	Pink	I-99	1.250	0.991
CLWS-750-38	750kcmil	600 G,H,I,M FLEX 646.4 DLO	750kcmil - 500kcmil	3/8	0.406	0.875	2.875	4.652	1.901	0.414	Black	I-106	1.313	1.031
CLWS-750-12	750kcmil	600 G,H,I,M FLEX 646.4 DLO	750kcmil - 500kcmil	1/2	0.562	1.250	2.875	5.027	1.901	0.546	Black	I-106	1.313	1.031
CLWS-750-58	750kcmil	600 G,H,I,M FLEX 646.4 DLO	750kcmil - 500kcmil	5/8	0.656	1.437	2.875	5.214	1.901	0.671	Black	I-106	1.313	1.031
CLWS-1000-38	1000kcmil	750 G,H,I FLEX 777.7 DLO	1000kcmil - 750kcmil	3/8	0.406	0.875	3.000	4.900	2.169	0.414	White	I-125	1.500	1.172
CLWS-1000-12	1000kcmil	750 G,H,I FLEX 777.7 DLO	1000kcmil - 750kcmil	1/2	0.562	1.250	3.000	5.275	2.169	0.546	White	I-125	1.500	1.172
CLWS-1000-58	1000kcmil	750 G,H,I FLEX 777.7 DLO	1000kcmil - 750kcmil	5/8	0.656	1.437	3.000	5.462	2.169	0.671	White	I-125	1.500	1.172

* When installed with specified dieless tools

+ See pages 90 to 97 for complete tooling information.

For Bent Tangs change the 4th letter to a B and add "-4" for 45 deg. or "-9" for 90 deg.

TYPE CLNS

Features

- Manufactured from high strength seamless copper tubing.
- Electro-Tin plated.
- Maximum conductivity and excellent crimping characteristics.
- Long barrel length with chamfered entry.
- Color coded.
- UL 486A 90°C Listed and CSA Certified for 600 Volts.
- If proper high voltage spacing and insulation techniques are used, may be used for high voltage applications up to 35KV.
- For Copper conductor only.
- IlSCO connectors are UL Listed and CSA Certified with ILSCO and other Manufacturers' tools.+
- UL File E6207

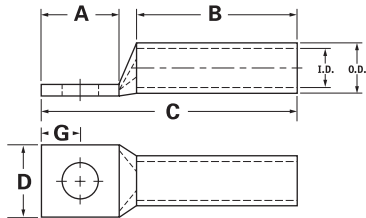

Catalog Number	Wire Size	Alt Wire Size	Expanded* Wire Range	Bolt Size	Stud Hole Dia.	Dimensions					Die Color Code	Die Index	O.D.	I.D.
						A	B	C	D	G				
CLNS-8-10	#8 AWG	#8 FLEX	-	10	0.219	0.562	0.812	1.569	0.374	0.258	Red	I-21	0.272	0.179
CLNS-8-14	#8 AWG	#8 FLEX	-	1/4	0.281	0.680	0.812	1.687	0.486	0.320	Red	I-21	0.272	0.179
CLNS-8-516	#8 AWG	#8 FLEX	-	5/16	0.343	0.875	0.812	1.882	0.532	0.352	Red	I-21	0.272	0.179
CLNS-8-38	#8 AWG	#8 FLEX	-	3/8	0.406	0.875	0.812	1.882	0.593	0.414	Red	I-21	0.272	0.179
CLNS-6-10	#6 AWG	-	-	10	0.219	0.562	1.125	1.882	0.411	0.258	Blue	I-24	0.295	0.203
CLNS-6-14	#6 AWG	-	-	1/4	0.281	0.680	1.125	2.000	0.411	0.320	Blue	I-24	0.295	0.203
CLNS-6-516	#6 AWG	-	-	5/16	0.343	0.875	1.125	2.195	0.532	0.352	Blue	I-24	0.295	0.203
CLNS-6-38	#6 AWG	-	-	3/8	0.406	0.875	1.125	2.195	0.593	0.414	Blue	I-24	0.295	0.203
CLNS-6-12	#6 AWG	-	-	1/2	0.562	1.250	1.125	2.570	0.750	0.546	Blue	I-24	0.295	0.203
CLNS-4-10	#4 AWG	#6 FLEX	4-6 AWG	10	0.219	0.562	1.125	1.921	0.486	0.258	Gray	I-29	0.343	0.250
CLNS-4-14	#4 AWG	#6 FLEX	4-6 AWG	1/4	0.281	0.680	1.125	2.039	0.486	0.320	Gray	I-29	0.343	0.250
CLNS-4-516	#4 AWG	#6 FLEX	4-6 AWG	5/16	0.343	0.875	1.125	2.234	0.486	0.352	Gray	I-29	0.343	0.250
CLNS-4-38	#4 AWG	#6 FLEX	4-6 AWG	3/8	0.406	0.875	1.125	2.234	0.593	0.414	Gray	I-29	0.343	0.250
CLNS-4-12	#4 AWG	#6 FLEX	4-6 AWG	1/2	0.562	1.250	1.125	2.609	0.750	0.546	Gray	I-29	0.343	0.250
CLNS-3-10	#3 AWG	#4 FLEX	3-6 AWG	10	0.219	0.562	1.125	1.942	0.532	0.258	White	I-29	0.375	0.275
CLNS-3-14	#3 AWG	#4 FLEX	3-6 AWG	1/4	0.281	0.680	1.125	2.060	0.532	0.320	White	I-29	0.375	0.275
CLNS-3-516	#3 AWG	#4 FLEX	3-6 AWG	5/16	0.343	0.875	1.125	2.255	0.532	0.352	White	I-29	0.375	0.275
CLNS-3-38	#3 AWG	#4 FLEX	3-6 AWG	3/8	0.406	0.875	1.125	2.255	0.593	0.414	White	I-29	0.375	0.275
CLNS-3-12	#3 AWG	#4 FLEX	3-6 AWG	1/2	0.562	1.250	1.125	2.630	0.750	0.546	White	I-29	0.375	0.275
CLNS-2-10	#2 AWG	-	2-6 AWG	10	0.219	0.562	1.125	1.973	0.599	0.258	Brown	I-33	0.421	0.312
CLNS-2-14	#2 AWG	-	2-6 AWG	1/4	0.281	0.680	1.125	2.091	0.599	0.320	Brown	I-33	0.421	0.312
CLNS-2-516	#2 AWG	-	2-6 AWG	5/16	0.343	0.875	1.125	2.286	0.599	0.352	Brown	I-33	0.421	0.312
CLNS-2-38	#2 AWG	-	2-6 AWG	3/8	0.406	0.875	1.125	2.286	0.599	0.414	Brown	I-33	0.421	0.312
CLNS-2-12	#2 AWG	-	2-6 AWG	1/2	0.562	1.250	1.125	2.661	0.750	0.546	Brown	I-33	0.421	0.312
CLNS-1-10	#1 AWG	#2 FLEX	1-6 AWG	10	0.219	0.562	1.375	2.267	0.673	0.258	Green	I-37	0.468	0.359
CLNS-1-14	#1 AWG	#2 FLEX	1-6 AWG	1/4	0.281	0.875	1.375	2.580	0.673	0.320	Green	I-37	0.468	0.359
CLNS-1-516	#1 AWG	#2 FLEX	1-6 AWG	5/16	0.343	0.875	1.375	2.580	0.673	0.352	Green	I-37	0.468	0.359
CLNS-1-38	#1 AWG	#2 FLEX	1-6 AWG	3/8	0.406	0.875	1.375	2.580	0.673	0.414	Green	I-37	0.468	0.359
CLNS-1-12	#1 AWG	#2 FLEX	1-6 AWG	1/2	0.562	1.250	1.375	2.955	0.750	0.546	Green	I-37	0.468	0.359

* When installed with specified dieless tools

+ See pages 90 to 97 for complete tooling information.

For Bent Tangs change the 4th letter to a B and add "-4" for 45 deg. or "-9" for 90 deg.

A TYPE CLNS

Features

- Manufactured from high strength seamless copper tubing.
- Electro-Tin plated.
- Maximum conductivity and excellent crimping characteristics.
- Long barrel length with chamfered entry.
- Color coded.
- UL 486A 90°C Listed and CSA Certified for 600 Volts.
- If proper high voltage spacing and insulation techniques are used, may be used for high voltage applications up to 35KV.
- For Copper conductor only.
- IlSCO connectors are UL Listed and CSA Certified with ILSCO and other Manufacturers' tools.*
- UL File E6207

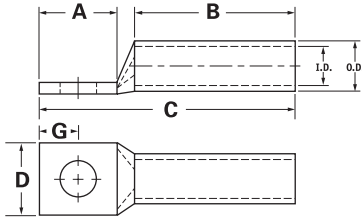

Catalog Number	Wire Size	Alt Wire Size	Expanded* Wire Range	Bolt Size	Stud Hole Dia.	Dimensions					Die Color Code	Die Index	O.D.	I.D.
						A	B	C	D	G				
CLNS-1/0-10	1/0 AWG	#1 FLEX	1/0-6 AWG	10	0.219	0.562	1.500	2.418	0.738	0.258	Pink	I-42	0.515	0.390
CLNS-1/0-14	1/0 AWG	#1 FLEX	1/0-6 AWG	1/4	0.281	0.875	1.500	2.731	0.738	0.320	Pink	I-42	0.515	0.390
CLNS-1/0-516	1/0 AWG	#1 FLEX	1/0-6 AWG	5/16	0.343	0.875	1.500	2.731	0.738	0.352	Pink	I-42	0.515	0.390
CLNS-1/0-38	1/0 AWG	#1 FLEX	1/0-6 AWG	3/8	0.406	0.875	1.500	2.731	0.738	0.414	Pink	I-42	0.515	0.390
CLNS-1/0-12	1/0 AWG	#1 FLEX	1/0-6 AWG	1/2	0.562	1.250	1.500	3.106	0.738	0.546	Pink	I-42	0.515	0.390
CLNS-2/0-10	2/0 AWG	1/0 FLEX	2/0-4 AWG	10	0.219	0.562	1.500	2.458	0.811	0.258	Black	I-45	0.562	0.437
CLNS-2/0-14	2/0 AWG	1/0 FLEX	2/0-4 AWG	1/4	0.281	0.875	1.500	2.771	0.811	0.320	Black	I-45	0.562	0.437
CLNS-2/0-516	2/0 AWG	1/0 FLEX	2/0-4 AWG	5/16	0.343	0.875	1.500	2.771	0.811	0.352	Black	I-45	0.562	0.437
CLNS-2/0-38	2/0 AWG	1/0 FLEX	2/0-4 AWG	3/8	0.406	0.875	1.500	2.771	0.811	0.414	Black	I-45	0.562	0.437
CLNS-2/0-12	2/0 AWG	1/0 FLEX	2/0-4 AWG	1/2	0.562	1.250	1.500	3.146	0.811	0.546	Black	I-45	0.562	0.437
CLNS-3/0-10	3/0 AWG	2/0 FLEX	3/0-2 AWG	10	0.219	0.562	1.500	2.501	0.885	0.258	Orange	I-50	0.609	0.484
CLNS-3/0-14	3/0 AWG	2/0 FLEX	3/0-2 AWG	1/4	0.281	0.875	1.500	2.814	0.885	0.320	Orange	I-50	0.609	0.484
CLNS-3/0-516	3/0 AWG	2/0 FLEX	3/0-2 AWG	5/16	0.343	0.875	1.500	2.814	0.885	0.352	Orange	I-50	0.609	0.484
CLNS-3/0-38	3/0 AWG	2/0 FLEX	3/0-2 AWG	3/8	0.406	0.875	1.500	2.814	0.885	0.414	Orange	I-50	0.609	0.484
CLNS-3/0-12	3/0 AWG	2/0 FLEX	3/0-2 AWG	1/2	0.562	1.250	1.500	3.189	0.885	0.546	Orange	I-50	0.609	0.484
CLNS-4/0-14	4/0 AWG	3/0 FLEX	4/0-1 AWG	1/4	0.281	0.875	1.500	2.866	0.999	0.320	Purple	I-54	0.687	0.546
CLNS-4/0-516	4/0 AWG	3/0 FLEX	4/0-1 AWG	5/16	0.343	0.875	1.500	2.866	0.999	0.352	Purple	I-54	0.687	0.546
CLNS-4/0-38	4/0 AWG	3/0 FLEX	4/0-1 AWG	3/8	0.406	0.875	1.500	2.866	0.999	0.414	Purple	I-54	0.687	0.546
CLNS-4/0-12	4/0 AWG	3/0 FLEX	4/0-1 AWG	1/2	0.562	1.250	1.500	3.241	0.999	0.546	Purple	I-54	0.687	0.546
CLNS-250-516	250kcmil	4/0 FLEX	250kcmil - 1/0 AWG	5/16	0.343	0.875	1.688	3.094	1.088	0.352	Yellow	I-62	0.750	0.593
CLNS-250-38	250kcmil	4/0 FLEX	250kcmil - 1/0 AWG	3/8	0.406	0.875	1.688	3.094	1.088	0.414	Yellow	I-62	0.750	0.593
CLNS-250-12	250kcmil	4/0 FLEX	250kcmil - 1/0 AWG	1/2	0.562	1.250	1.688	3.469	1.088	0.546	Yellow	I-62	0.750	0.593
CLNS-300-516	300kcmil	250 G,H FLEX	300kcmil - 2/0 AWG	5/16	0.343	0.875	2.000	3.462	1.189	0.352	White	I-66	0.812	0.660
CLNS-300-38	300kcmil	250 G,H FLEX	300kcmil - 2/0 AWG	3/8	0.406	0.875	2.000	3.462	1.189	0.414	White	I-66	0.812	0.660
CLNS-300-12	300kcmil	250 G,H FLEX	300kcmil - 2/0 AWG	1/2	0.562	1.250	2.000	3.837	1.189	0.546	White	I-66	0.812	0.660
CLNS-350-38	350kcmil	250 I,K,M FLEX 262.2 DLO	350kcmil - 3/0 AWG	3/8	0.406	0.875	2.000	3.498	1.291	0.414	Red	I-71	0.890	0.703
CLNS-350-12	350kcmil	250 I,K,M FLEX 262.2 DLO	350kcmil - 3/0 AWG	1/2	0.562	1.250	2.000	3.873	1.291	0.546	Red	I-71	0.890	0.703
CLNS-350-58	350kcmil	250 I,K,M FLEX 262.2 DLO	350kcmil - 3/0 AWG	5/8	0.656	1.437	2.000	4.060	1.291	0.671	Red	I-71	0.890	0.703
CLNS-400-38	400kcmil	300 G,H,I,K,M FLEX 313.1 DLO	400kcmil - 4/0 AWG	3/8	0.406	0.875	2.125	3.667	1.365	0.414	Blue	I-76	0.937	0.750
CLNS-400-12	400kcmil	300 G,H,I,K,M FLEX 313.1 DLO	400kcmil - 4/0 AWG	1/2	0.562	1.250	2.125	4.042	1.365	0.546	Blue	I-76	0.937	0.750
CLNS-400-58	400kcmil	300 G,H,I,K,M FLEX 313.1 DLO	400kcmil - 4/0 AWG	5/8	0.656	1.437	2.125	4.229	1.365	0.671	Blue	I-76	0.937	0.750

* When installed with specified dieless tools + See pages 90 to 97 for complete tooling information.
For Bent Tangs change the 4th letter to a B and add "-4" for 45 deg. or "-9" for 90 deg.

TYPE CLNS

Features

- Manufactured from high strength seamless copper tubing.
- Electro-Tin plated.
- Maximum conductivity and excellent crimping characteristics.
- Long barrel length with chamfered entry.
- Color coded.
- UL 486A 90°C Listed and CSA Certified for 600 Volts.
- If proper high voltage spacing and insulation techniques are used, may be used for high voltage applications up to 35KV.
- For Copper conductor only.
- IlSCO connectors are UL Listed and CSA Certified with ILSCO and other Manufacturers' tools.+
- UL File E6207

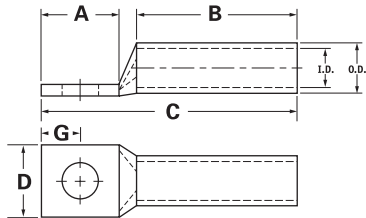

Catalog Number	Wire Size	Alt Wire Size	Expanded* Wire Range	Bolt Size	Stud Hole Dia.	Dimensions					Die Color Code	Die Index	O.D.	I.D.
						A	B	C	D	G				
CLNS-500-38	500kcmil	350 G,H,I,K,M FLEX 373.7 DLO	500kcmil - 250kcmil	3/8	0.406	0.875	2.250	3.857	1.535	0.414	Brown	I-87	1.062	0.828
CLNS-500-12	500kcmil	350 G,H,I,K,M FLEX 373.7 DLO	500kcmil - 250kcmil	1/2	0.562	1.250	2.250	4.232	1.535	0.546	Brown	I-87	1.062	0.828
CLNS-500-58	500kcmil	350 G,H,I,K,M FLEX 373.7 DLO	500kcmil - 250kcmil	5/8	0.656	1.437	2.250	4.419	1.535	0.671	Brown	I-87	1.062	0.828
CLNS-600-38	600kcmil	400 G,H,I,K,M FLEX 444.4 DLO	600kcmil - 250kcmil	3/8	0.406	0.875	2.687	4.371	1.712	0.414	Green	I-94	1.187	0.920
CLNS-600-12	600kcmil	400 G,H,I,K,M FLEX 444.4 DLO	600kcmil - 250kcmil	1/2	0.562	1.250	2.687	4.746	1.712	0.546	Green	I-94	1.187	0.920
CLNS-600-58	600kcmil	400 G,H,I,K,M FLEX 444.4 DLO	600kcmil - 250kcmil	5/8	0.656	1.437	2.687	4.933	1.712	0.671	Green	I-94	1.187	0.920
CLNS-650-516	650kcmil	500 G,H,I,K,M FLEX 535.3 DLO	650kcmil - 350kcmil	1/32	0.343	0.875	2.687	4.431	1.764	0.352	Pink	I-99	1.217	0.958
CLNS-650-38	650kcmil	500 G,H,I,K,M FLEX 535.3 DLO	650kcmil - 350kcmil	3/8	0.406	0.875	2.687	4.431	1.764	0.414	Pink	I-99	1.217	0.958
CLNS-650-12	650kcmil	500 G,H,I,K,M FLEX 535.3 DLO	650kcmil - 350kcmil	1/2	0.562	1.25	2.687	4.806	1.764	0.546	Pink	I-99	1.217	0.958
CLNS-650-58	650kcmil	500 G,H,I,K,M FLEX 535.3 DLO	650kcmil - 350kcmil	5/8	0.656	1.437	2.687	4.993	1.764	0.671	Pink	I-99	1.217	0.958
CLNS-700-38	700kcmil	500 G,H,I,K,M FLEX 535.3 DLO	700kcmil - 350kcmil	3/8	0.406	0.875	2.687	4.431	1.816	0.414	Pink	I-99	1.250	0.991
CLNS-700-12	700kcmil	500 G,H,I,K,M FLEX 535.3 DLO	700kcmil - 350kcmil	1/2	0.562	1.250	2.687	4.806	1.816	0.546	Pink	I-99	1.250	0.991
CLNS-700-58	700kcmil	500 G,H,I,K,M FLEX 535.3 DLO	700kcmil - 350kcmil	5/8	0.656	1.437	2.687	4.993	1.816	0.671	Pink	I-99	1.250	0.991
CLNS-750-38	750kcmil	600 G,H,I,M FLEX 646.4 DLO	750kcmil - 500kcmil	3/8	0.406	0.875	2.875	4.652	1.901	0.414	Black	I-106	1.313	1.031
CLNS-750-12	750kcmil	600 G,H,I,M FLEX 646.4 DLO	750kcmil - 500kcmil	1/2	0.562	1.250	2.875	5.027	1.901	0.546	Black	I-106	1.313	1.031
CLNS-750-58	750kcmil	600 G,H,I,M FLEX 646.4 DLO	750kcmil - 500kcmil	5/8	0.656	1.437	2.875	5.214	1.901	0.671	Black	I-106	1.313	1.031
CLNS-1000-38	1000kcmil	750 G,H,I FLEX 777.7 DLO	1000kcmil - 750kcmil	3/8	0.406	0.875	3.000	4.900	2.169	0.414	White	I-125	1.500	1.172
CLNS-1000-12	1000kcmil	750 G,H,I FLEX 777.7 DLO	1000kcmil - 750kcmil	1/2	0.562	1.250	3.000	5.275	2.169	0.546	White	I-125	1.500	1.172
CLNS-1000-58	1000kcmil	750 G,H,I FLEX 777.7 DLO	1000kcmil - 750kcmil	5/8	0.656	1.437	3.000	5.462	2.169	0.671	White	I-125	1.500	1.172

* When installed with specified dieless tools

+ See pages 90 to 97 for complete tooling information.

For Bent Tangs change the 4th letter to a B and add "-4" for 45 deg. or "-9" for 90 deg.

A

TYPE CLWD

Features

- Manufactured from high strength seamless copper tubing.
- Electro-Tin plated.
- Maximum conductivity and excellent crimping characteristics.
- Long barrel length with chamfered entry.
- Color coded.
- UL 486A 90°C Listed and CSA Certified for 600 Volts.
- If proper high voltage spacing and insulation techniques are used, may be used for high voltage applications up to 35KV.
- For Copper conductor only.
- IlSCO connectors are UL Listed and CSA Certified with ILSCO and other Manufacturers' tools.†
- UL File E6207

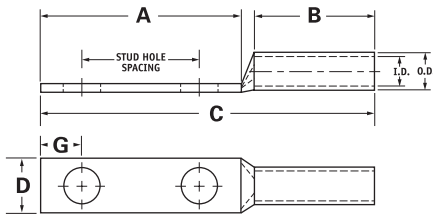

Catalog Number	Wire Size	Alt Wire Size	Expanded* Wire Range	Bolt Size	Stud Hole Dia.	Stud Hole Spacing	Dimensions					Die Color Code	Die Index	O.D.	I.D.
							A	B	C	D	G				
CLWD-8-10-58	#8 AWG	#8 FLEX	-	10	0.219	0.625	1.250	0.812	2.257	0.374	0.258	Red	I-21	0.272	0.179
CLWD-8-10-34	#8 AWG	#8 FLEX	-	10	0.219	0.750	1.437	0.812	2.444	0.374	0.258	Red	I-21	0.272	0.179
CLWD-8-14-58	#8 AWG	#8 FLEX	-	1/4	0.281	0.625	1.437	0.812	2.444	0.486	0.320	Red	I-21	0.272	0.179
CLWD-8-14-34	#8 AWG	#8 FLEX	-	1/4	0.281	0.750	1.437	0.812	2.444	0.486	0.320	Red	I-21	0.272	0.179
CLWD-8-14-1	#8 AWG	#8 FLEX	-	1/4	0.281	1.000	1.687	0.812	2.694	0.486	0.320	Red	I-21	0.272	0.179
CLWD-8-38-1	#8 AWG	#8 FLEX	-	3/8	0.406	1.000	1.937	0.812	2.944	0.593	0.414	Red	I-21	0.272	0.179
CLWD-6-10-12	#6 AWG	-	-	10	0.219	0.500	1.250	1.125	2.570	0.411	0.258	Blue	I-24	0.295	0.203
CLWD-6-10-58	#6 AWG	-	-	10	0.219	0.625	1.250	1.125	2.570	0.411	0.258	Blue	I-24	0.295	0.203
CLWD-6-10-1116	#6 AWG	-	-	10	0.219	0.687	1.250	1.125	2.570	0.411	0.258	Blue	I-24	0.295	0.203
CLWD-6-10-34	#6 AWG	-	-	10	0.219	0.750	1.437	1.125	2.757	0.411	0.258	Blue	I-24	0.295	0.203
CLWD-6-14-12	#6 AWG	-	-	1/4	0.281	0.500	1.250	1.125	2.570	0.411	0.320	Blue	I-24	0.295	0.203
CLWD-6-14-58	#6 AWG	-	-	1/4	0.281	0.625	1.437	1.125	2.757	0.411	0.320	Blue	I-24	0.295	0.203
CLWD-6-14-34	#6 AWG	-	-	1/4	0.281	0.750	1.437	1.125	2.757	0.411	0.320	Blue	I-24	0.295	0.203
CLWD-6-14-1	#6 AWG	-	-	1/4	0.281	1.000	1.687	1.125	3.007	0.411	0.320	Blue	I-24	0.295	0.203
CLWD-6-516-34	#6 AWG	-	-	5/16	0.343	0.750	1.687	1.125	3.007	0.532	0.352	Blue	I-24	0.295	0.203
CLWD-6-516-1	#6 AWG	-	-	5/16	0.343	1.000	1.937	1.125	3.257	0.532	0.352	Blue	I-24	0.295	0.203
CLWD-6-38-34	#6 AWG	-	-	3/8	0.406	0.750	1.687	1.125	3.007	0.593	0.414	Blue	I-24	0.295	0.203
CLWD-6-38-78	#6 AWG	-	-	3/8	0.406	0.875	1.937	1.125	3.257	0.593	0.414	Blue	I-24	0.295	0.203
CLWD-6-38-1	#6 AWG	-	-	3/8	0.406	1.000	1.937	1.125	3.257	0.593	0.414	Blue	I-24	0.295	0.203
CLWD-6-12-134	#6 AWG	-	-	1/2	0.562	1.750	3.000	1.125	4.320	0.750	0.546	Blue	I-24	0.295	0.203
CLWD-4-10-58	#4 AWG	#6 FLEX	4-6 AWG	10	0.219	0.625	1.250	1.125	2.609	0.486	0.258	Gray	I-29	0.343	0.250
CLWD-4-10-34	#4 AWG	#6 FLEX	4-6 AWG	10	0.219	0.750	1.437	1.125	2.796	0.486	0.258	Gray	I-29	0.343	0.250
CLWD-4-10-1	#4 AWG	#6 FLEX	4-6 AWG	10	0.219	1.000	1.687	1.125	3.046	0.486	0.258	Gray	I-29	0.343	0.250
CLWD-4-14-58	#4 AWG	#6 FLEX	4-6 AWG	1/4	0.281	0.625	1.437	1.125	2.796	0.486	0.320	Gray	I-29	0.343	0.250
CLWD-4-14-34	#4 AWG	#6 FLEX	4-6 AWG	1/4	0.281	0.750	1.437	1.125	2.796	0.486	0.320	Gray	I-29	0.343	0.250
CLWD-4-14-1	#4 AWG	#6 FLEX	4-6 AWG	1/4	0.281	1.000	1.687	1.125	3.046	0.486	0.320	Gray	I-29	0.343	0.250
CLWD-4-516-58	#4 AWG	#6 FLEX	4-6 AWG	5/16	0.343	0.625	1.437	1.125	2.796	0.486	0.352	Gray	I-29	0.343	0.250
CLWD-4-516-34	#4 AWG	#6 FLEX	4-6 AWG	5/16	0.343	0.750	1.687	1.125	3.046	0.486	0.352	Gray	I-29	0.343	0.250
CLWD-4-516-1	#4 AWG	#6 FLEX	4-6 AWG	5/16	0.343	1.000	1.937	1.125	3.296	0.486	0.352	Gray	I-29	0.343	0.250
CLWD-4-38-34	#4 AWG	#6 FLEX	4-6 AWG	3/8	0.406	0.750	1.687	1.125	3.046	0.593	0.414	Gray	I-29	0.343	0.250
CLWD-4-38-1	#4 AWG	#6 FLEX	4-6 AWG	3/8	0.406	1.000	1.937	1.125	3.296	0.593	0.414	Gray	I-29	0.343	0.250
CLWD-4-12-134	#4 AWG	#6 FLEX	4-6 AWG	1/2	0.562	1.750	3.000	1.125	4.359	0.750	0.546	Gray	I-29	0.343	0.250

* When installed with specified dieless tools + See pages 90 to 97 for complete tooling information.
 For Bent Tangs change the 4th letter to a B and add "-4" for 45 deg. or "-9" for 90 deg.

TYPE CLWD

Features

- Manufactured from high strength seamless copper tubing.
- Electro-Tin plated.
- Maximum conductivity and excellent crimping characteristics.
- Long barrel length with chamfered entry.
- Color coded.
- UL 486A 90°C Listed and CSA Certified for 600 Volts.
- If proper high voltage spacing and insulation techniques are used, may be used for high voltage applications up to 35KV.
- For Copper conductor only.
- IlSCO connectors are UL Listed and CSA Certified with ILSCO and other Manufacturers' tools.+
- UL File E6207

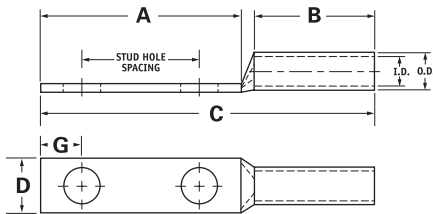

Catalog Number	Wire Size	Alt Wire Size	Expanded* Wire Range	Bolt Size	Stud Hole Dia.	Stud Hole Spacing	Dimensions					Die Color Code	Die Index	O.D.	I.D.
							A	B	C	D	G				
CLWD-3-14-58	#3 AWG	#4 FLEX	3-6 AWG	1/4	0.281	0.625	1.437	1.125	2.817	0.532	0.320	White	I-29	0.375	0.275
CLWD-3-14-34	#3 AWG	#4 FLEX	3-6 AWG	1/4	0.281	0.750	1.437	1.125	2.817	0.532	0.320	White	I-29	0.375	0.275
CLWD-3-516-58	#3 AWG	#4 FLEX	3-6 AWG	5/16	0.343	0.625	1.437	1.125	2.817	0.532	0.352	White	I-29	0.375	0.275
CLWD-3-516-1	#3 AWG	#4 FLEX	3-6 AWG	5/16	0.343	1.000	1.937	1.125	3.317	0.532	0.352	White	I-29	0.375	0.275
CLWD-3-38-34	#3 AWG	#4 FLEX	3-6 AWG	3/8	0.406	0.750	1.687	1.125	3.067	0.593	0.414	White	I-29	0.375	0.275
CLWD-3-38-1	#3 AWG	#4 FLEX	3-6 AWG	3/8	0.406	1.000	1.937	1.125	3.317	0.593	0.414	White	I-29	0.375	0.275
CLWD-3-12-134	#3 AWG	#4 FLEX	3-6 AWG	1/2	0.562	1.750	3.000	1.125	4.380	0.750	0.546	White	I-29	0.375	0.275
CLWD-2-10-34	#2 AWG	-	2-6 AWG	10	0.219	0.750	1.437	1.125	2.848	0.599	0.258	Brown	I-33	0.421	0.312
CLWD-2-14-58	#2 AWG	-	2-6 AWG	1/4	0.281	0.625	1.437	1.125	2.848	0.599	0.320	Brown	I-33	0.421	0.312
CLWD-2-14-34	#2 AWG	-	2-6 AWG	1/4	0.281	0.750	1.437	1.125	2.848	0.599	0.320	Brown	I-33	0.421	0.312
CLWD-2-14-1	#2 AWG	-	2-6 AWG	1/4	0.281	1.000	1.687	1.125	3.098	0.599	0.320	Brown	I-33	0.421	0.312
CLWD-2-516-58	#2 AWG	-	2-6 AWG	5/16	0.343	0.625	1.687	1.125	3.098	0.599	0.352	Brown	I-33	0.421	0.312
CLWD-2-516-34	#2 AWG	-	2-6 AWG	5/16	0.343	0.750	1.687	1.125	3.098	0.599	0.352	Brown	I-33	0.421	0.312
CLWD-2-516-1	#2 AWG	-	2-6 AWG	5/16	0.343	1.000	1.937	1.125	3.348	0.599	0.352	Brown	I-33	0.421	0.312
CLWD-2-38-58	#2 AWG	-	2-6 AWG	3/8	0.406	0.625	1.687	1.125	3.098	0.599	0.414	Brown	I-33	0.421	0.312
CLWD-2-38-34	#2 AWG	-	2-6 AWG	3/8	0.406	0.750	1.687	1.125	3.098	0.599	0.414	Brown	I-33	0.421	0.312
CLWD-2-38-78	#2 AWG	-	2-6 AWG	3/8	0.406	0.875	1.937	1.125	3.348	0.599	0.414	Brown	I-33	0.421	0.312
CLWD-2-38-1	#2 AWG	-	2-6 AWG	3/8	0.406	1.000	1.937	1.125	3.348	0.599	0.414	Brown	I-33	0.421	0.312
CLWD-2-38-134	#2 AWG	-	2-6 AWG	3/8	0.406	1.750	2.625	1.125	4.036	0.599	0.414	Brown	I-33	0.421	0.312
CLWD-2-12-134	#2 AWG	-	2-6 AWG	1/2	0.562	1.750	3.000	1.125	4.411	0.750	0.546	Brown	I-33	0.421	0.312
CLWD-1-14-58	#1 AWG	#2 FLEX	1-6 AWG	1/4	0.281	0.625	1.437	1.375	3.142	0.673	0.320	Green	I-37	0.468	0.359
CLWD-1-14-34	#1 AWG	#2 FLEX	1-6 AWG	1/4	0.281	0.750	1.437	1.375	3.142	0.673	0.320	Green	I-37	0.468	0.359
CLWD-1-14-1	#1 AWG	#2 FLEX	1-6 AWG	1/4	0.281	1.000	1.687	1.375	3.392	0.673	0.320	Green	I-37	0.468	0.359
CLWD-1-516-78	#1 AWG	#2 FLEX	1-6 AWG	5/16	0.343	0.875	1.687	1.375	3.392	0.673	0.352	Green	I-37	0.468	0.359
CLWD-1-516-1	#1 AWG	#2 FLEX	1-6 AWG	5/16	0.343	1.000	1.937	1.375	3.642	0.673	0.352	Green	I-37	0.468	0.359
CLWD-1-38-1	#1 AWG	#2 FLEX	1-6 AWG	3/8	0.406	1.000	1.937	1.375	3.642	0.673	0.414	Green	I-37	0.468	0.359
CLWD-1-12-134	#1 AWG	#2 FLEX	1-6 AWG	1/2	0.562	1.750	3.000	1.375	4.705	0.750	0.546	Green	I-37	0.468	0.359

* When installed with specified dieless tools

+ See pages 90 to 97 for complete tooling information.

For Bent Tangs change the 4th letter to a B and add "-4" for 45 deg. or "-9" for 90 deg.

A TYPE CLWD

Features

- Manufactured from high strength seamless copper tubing.
- Electro-Tin plated.
- Maximum conductivity and excellent crimping characteristics.
- Long barrel length with chamfered entry.
- Color coded.
- UL 486A 90°C Listed and CSA Certified for 600 Volts.
- If proper high voltage spacing and insulation techniques are used, may be used for high voltage applications up to 35KV.
- For Copper conductor only.
- IlSCO connectors are UL Listed and CSA Certified with ILSCO and other Manufacturers' tools.†
- UL File E6207

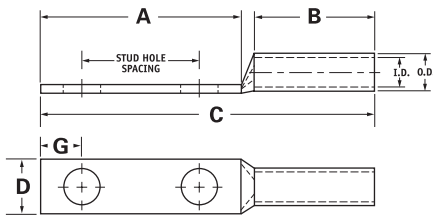

Catalog Number	Wire Size	Alt Wire Size	Expanded* Wire Range	Bolt Size	Stud Hole Dia.	Stud Hole Spacing	Dimensions					Die Color Code	Die Index	O.D.	I.D.
							A	B	C	D	G				
CLWD-1/0-14-58	1/0 AWG	#1 FLEX	1/0-6 AWG	1/4	0.281	0.625	1.437	1.500	3.293	0.738	0.320	Pink	I-42	0.515	0.390
CLWD-1/0-14-34	1/0 AWG	#1 FLEX	1/0-6 AWG	1/4	0.281	0.750	1.437	1.500	3.293	0.738	0.320	Pink	I-42	0.515	0.390
CLWD-1/0-14-1	1/0 AWG	#1 FLEX	1/0-6 AWG	1/4	0.281	1.000	1.687	1.500	3.543	0.738	0.320	Pink	I-42	0.515	0.390
CLWD-1/0-516-34	1/0 AWG	#1 FLEX	1/0-6 AWG	5/16	0.343	0.750	1.687	1.500	3.543	0.738	0.352	Pink	I-42	0.515	0.390
CLWD-1/0-516-78	1/0 AWG	#1 FLEX	1/0-6 AWG	5/16	0.343	0.875	1.687	1.500	3.543	0.738	0.352	Pink	I-42	0.515	0.390
CLWD-1/0-516-1	1/0 AWG	#1 FLEX	1/0-6 AWG	5/16	0.343	1.000	1.937	1.500	3.793	0.738	0.352	Pink	I-42	0.515	0.390
CLWD-1/0-38-1	1/0 AWG	#1 FLEX	1/0-6 AWG	3/8	0.406	1.000	1.937	1.500	3.793	0.738	0.414	Pink	I-42	0.515	0.390
CLWD-1/0-38-134	1/0 AWG	#1 FLEX	1/0-6 AWG	3/8	0.406	1.750	2.625	1.500	4.481	0.738	0.414	Pink	I-42	0.515	0.390
CLWD-1/0-12-1	1/0 AWG	#1 FLEX	1/0-6 AWG	1/2	0.562	1.000	2.125	1.500	3.981	0.738	0.546	Pink	I-42	0.515	0.390
CLWD-1/0-12-134	1/0 AWG	#1 FLEX	1/0-6 AWG	1/2	0.562	1.750	3.000	1.500	4.856	0.738	0.546	Pink	I-42	0.515	0.390
CLWD-2/0-14-58	2/0 AWG	1/0 FLEX	2/0-4 AWG	1/4	0.281	0.625	1.437	1.500	3.333	0.811	0.320	Black	I-45	0.562	0.437
CLWD-2/0-14-34	2/0 AWG	1/0 FLEX	2/0-4 AWG	1/4	0.281	0.750	1.437	1.500	3.333	0.811	0.320	Black	I-45	0.562	0.437
CLWD-2/0-14-1	2/0 AWG	1/0 FLEX	2/0-4 AWG	1/4	0.281	1.000	1.687	1.500	3.583	0.811	0.320	Black	I-45	0.562	0.437
CLWD-2/0-516-1	2/0 AWG	1/0 FLEX	2/0-4 AWG	5/16	0.343	1.000	1.937	1.500	3.833	0.811	0.352	Black	I-45	0.562	0.437
CLWD-2/0-38-1	2/0 AWG	1/0 FLEX	2/0-4 AWG	3/8	0.406	1.000	1.937	1.500	3.833	0.811	0.414	Black	I-45	0.562	0.437
CLWD-2/0-38-134	2/0 AWG	1/0 FLEX	2/0-4 AWG	3/8	0.406	1.750	2.625	1.500	4.521	0.811	0.414	Black	I-45	0.562	0.437
CLWD-2/0-12-1	2/0 AWG	1/0 FLEX	2/0-4 AWG	1/2	0.562	1.000	2.125	1.500	4.021	0.811	0.546	Black	I-45	0.562	0.437
CLWD-2/0-12-134	2/0 AWG	1/0 FLEX	2/0-4 AWG	1/2	0.562	1.750	3.000	1.500	4.896	0.811	0.546	Black	I-45	0.562	0.437
CLWD-3/0-14-58	3/0 AWG	2/0 FLEX	3/0-2 AWG	1/4	0.281	0.625	1.437	1.500	3.376	0.885	0.320	Orange	I-50	0.609	0.484
CLWD-3/0-14-34	3/0 AWG	2/0 FLEX	3/0-2 AWG	1/4	0.281	0.750	1.437	1.500	3.376	0.885	0.320	Orange	I-50	0.609	0.484
CLWD-3/0-516-1	3/0 AWG	2/0 FLEX	3/0-2 AWG	5/16	0.343	1.000	1.937	1.500	3.876	0.885	0.352	Orange	I-50	0.609	0.484
CLWD-3/0-38-1	3/0 AWG	2/0 FLEX	3/0-2 AWG	3/8	0.406	1.000	1.937	1.500	3.876	0.885	0.414	Orange	I-50	0.609	0.484
CLWD-3/0-12-134	3/0 AWG	2/0 FLEX	3/0-2 AWG	1/2	0.562	1.750	3.000	1.500	4.939	0.885	0.546	Orange	I-50	0.609	0.484

* When installed with specified dieless tools

+ See pages 90 to 97 for complete tooling information.

For Bent Tangs change the 4th letter to a B and add "-4" for 45 deg. or "-9" for 90 deg.

TYPE CLWD

Features

- Manufactured from high strength seamless copper tubing.
- Electro-Tin plated.
- Maximum conductivity and excellent crimping characteristics.
- Long barrel length with chamfered entry.
- Color coded.
- UL 486A 90°C Listed and CSA Certified for 600 Volts.
- If proper high voltage spacing and insulation techniques are used, may be used for high voltage applications up to 35KV.
- For Copper conductor only.
- IlSCO connectors are UL Listed and CSA Certified with ILSCO and other Manufacturers' tools.+
- UL File E6207

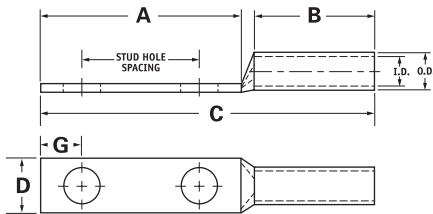

Catalog Number	Wire Size	Alt Wire Size	Expanded* Wire Range	Bolt Size	Stud Hole Dia.	Stud Hole Spacing	Dimensions					Die Color Code	Die Index	O.D.	I.D.
							A	B	C	D	G				
CLWD-4/0-14-58	4/0 AWG	3/0 FLEX	4/0-1 AWG	1/4	0.281	0.625	1.437	1.500	3.428	0.999	0.320	Purple	I-54	0.687	0.546
CLWD-4/0-14-34	4/0 AWG	3/0 FLEX	4/0-1 AWG	1/4	0.281	0.750	1.437	1.500	3.428	0.999	0.320	Purple	I-54	0.687	0.546
CLWD-4/0-14-1	4/0 AWG	3/0 FLEX	4/0-1 AWG	1/4	0.281	1.000	1.687	1.500	3.678	0.999	0.320	Purple	I-54	0.687	0.546
CLWD-4/0-516-34	4/0 AWG	3/0 FLEX	4/0-1 AWG	5/16	0.343	0.750	1.687	1.500	3.678	0.999	0.352	Purple	I-54	0.687	0.546
CLWD-4/0-516-1	4/0 AWG	3/0 FLEX	4/0-1 AWG	5/16	0.343	1.000	1.937	1.500	3.928	0.999	0.352	Purple	I-54	0.687	0.546
CLWD-4/0-516-134	4/0 AWG	3/0 FLEX	4/0-1 AWG	5/16	0.343	1.750	2.500	1.500	4.491	0.999	0.352	Purple	I-54	0.687	0.546
CLWD-4/0-38-1	4/0 AWG	3/0 FLEX	4/0-1 AWG	3/8	0.406	1.000	1.937	1.500	3.928	0.999	0.414	Purple	I-54	0.687	0.546
CLWD-4/0-38-134	4/0 AWG	3/0 FLEX	4/0-1 AWG	3/8	0.406	1.750	2.625	1.500	4.616	0.999	0.414	Purple	I-54	0.687	0.546
CLWD-4/0-12-1	4/0 AWG	3/0 FLEX	4/0-1 AWG	1/2	0.562	1.000	2.125	1.500	4.116	0.999	0.546	Purple	I-54	0.687	0.546
CLWD-4/0-12-114	4/0 AWG	3/0 FLEX	4/0-1 AWG	1/2	0.562	1.250	2.500	1.500	4.491	0.999	0.546	Purple	I-54	0.687	0.546
CLWD-4/0-12-134	4/0 AWG	3/0 FLEX	4/0-1 AWG	1/2	0.562	1.750	3.000	1.500	4.991	0.999	0.546	Purple	I-54	0.687	0.546
CLWD-250-14-34	250kcmil	4/0 FLEX	250kcmil - 1/0 AWG	1/4	0.281	0.750	1.437	1.688	3.656	1.088	0.320	Yellow	I-62	0.750	0.593
CLWD-250-38-1	250kcmil	4/0 FLEX	250kcmil - 1/0 AWG	3/8	0.406	1.000	1.937	1.688	4.156	1.088	0.414	Yellow	I-62	0.750	0.593
CLWD-250-38-134	250kcmil	4/0 FLEX	250kcmil - 1/0 AWG	3/8	0.406	1.750	2.625	1.688	4.844	1.088	0.414	Yellow	I-62	0.750	0.593
CLWD-250-12-114	250kcmil	4/0 FLEX	250kcmil - 1/0 AWG	1/2	0.562	1.250	2.500	1.688	4.719	1.088	0.546	Yellow	I-62	0.750	0.593
CLWD-250-12-134	250kcmil	4/0 FLEX	250kcmil - 1/0 AWG	1/2	0.562	1.750	3.000	1.688	5.219	1.088	0.546	Yellow	I-62	0.750	0.593
CLWD-300-38-1	300kcmil	250 G,H FLEX	300kcmil - 2/0 AWG	3/8	0.406	1.000	1.937	2.000	4.524	1.189	0.414	White	I-66	0.812	0.660
CLWD-300-12-134	300kcmil	250 G,H FLEX	300kcmil - 2/0 AWG	1/2	0.562	1.750	3.000	2.000	5.587	1.189	0.546	White	I-66	0.812	0.660

* When installed with specified dieless tools

+ See pages 90 to 97 for complete tooling information.

For Bent Tangs change the 4th letter to a B and add "-4" for 45 deg. or "-9" for 90 deg.

A TYPE CLWD

Features

- Manufactured from high strength seamless copper tubing.
- Electro-Tin plated.
- Maximum conductivity and excellent crimping characteristics.
- Long barrel length with chamfered entry.
- Color coded.
- UL 486A 90°C Listed and CSA Certified for 600 Volts.
- If proper high voltage spacing and insulation techniques are used, may be used for high voltage applications up to 35KV.
- For Copper conductor only.
- IlSCO connectors are UL Listed and CSA Certified with ILSCO and other Manufacturers' tools.*
- UL File E6207

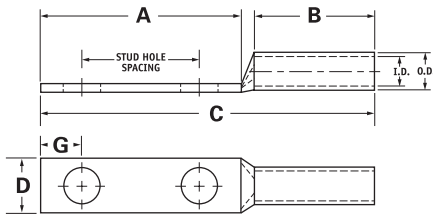

Catalog Number	Wire Size	Alt Wire Size	Expanded* Wire Range	Bolt Size	Stud Hole Dia.	Stud Hole Spacing	Dimensions					Die Color Code	Die Index	O.D.	I.D.
							A	B	C	D	G				
CLWD-350-14-34	350kcmil	250 I,K,M FLEX 262.2 DLO	350kcmil - 3/0 AWG	1/4	0.281	0.750	1.437	2.000	4.060	1.291	0.320	Red	I-71	0.890	0.703
CLWD-350-516-134	350kcmil	250 I,K,M FLEX 262.2 DLO	350kcmil - 3/0 AWG	5/16	0.343	1.750	2.500	2.000	5.123	1.291	0.352	Red	I-71	0.890	0.703
CLWD-350-38-1	350kcmil	250 I,K,M FLEX 262.2 DLO	350kcmil - 3/0 AWG	3/8	0.406	1.000	1.937	2.000	4.560	1.291	0.414	Red	I-71	0.890	0.703
CLWD-350-12-114	350kcmil	250 I,K,M FLEX 262.2 DLO	350kcmil - 3/0 AWG	1/2	0.562	1.250	2.500	2.000	5.123	1.291	0.546	Red	I-71	0.890	0.703
CLWD-350-12-134	350kcmil	250 I,K,M FLEX 262.2 DLO	350kcmil - 3/0 AWG	1/2	0.562	1.750	3.000	2.000	5.623	1.291	0.546	Red	I-71	0.890	0.703
CLWD-400-38-1	400kcmil	300 G,H,I,K,M FLEX 313.1 DLO	400kcmil - 4/0 AWG	3/8	0.406	1.000	1.937	2.125	4.729	1.365	0.414	Blue	I-76	0.937	0.750
CLWD-400-38-116	400kcmil	300 G,H,I,K,M FLEX 313.1 DLO	400kcmil - 4/0 AWG	3/8	0.406	1.062	1.937	2.125	4.729	1.365	0.414	Blue	I-76	0.937	0.750
CLWD-400-12-134	400kcmil	300 G,H,I,K,M FLEX 313.1 DLO	400kcmil - 4/0 AWG	1/2	0.562	1.750	3.000	2.125	5.792	1.365	0.546	Blue	I-76	0.937	0.750
CLWD-500-14-34	500kcmil	350 G,H,I,K,M FLEX 373.7 DLO	500kcmil - 250kcmil	1/4	0.281	0.750	1.437	2.250	4.419	1.535	0.320	Brown	I-87	1.062	0.828
CLWD-500-38-1	500kcmil	350 G,H,I,K,M FLEX 373.7 DLO	500kcmil - 250kcmil	3/8	0.406	1.000	1.937	2.250	4.919	1.535	0.414	Brown	I-87	1.062	0.828
CLWD-500-12-114	500kcmil	350 G,H,I,K,M FLEX 373.7 DLO	500kcmil - 250kcmil	1/2	0.562	1.250	2.500	2.250	5.482	1.535	0.546	Brown	I-87	1.062	0.828
CLWD-500-12-134	500kcmil	350 G,H,I,K,M FLEX 373.7 DLO	500kcmil - 250kcmil	1/2	0.562	1.750	3.000	2.250	5.982	1.535	0.546	Brown	I-87	1.062	0.828
CLWD-600-38-1	600kcmil	400 G,H,I,K,M FLEX 444.4 DLO	600kcmil - 250kcmil	3/8	0.406	1.000	1.937	2.687	5.433	1.712	0.414	Green	I-94	1.187	0.920
CLWD-600-12-134	600kcmil	400 G,H,I,K,M FLEX 444.4 DLO	600kcmil - 250kcmil	1/2	0.562	1.750	3.000	2.687	6.496	1.712	0.546	Green	I-94	1.187	0.920
CLWD-650-12-114	650kcmil	500 G,H,I,K,M FLEX 535.3 DLO	650kcmil - 350kcmil	1/2	0.562	1.25	2.5	2.687	6.056	1.764	0.546	Pink	I-99	1.217	0.958
CLWD-650-12-134	650kcmil	500 G,H,I,K,M FLEX 535.3 DLO	650kcmil - 350kcmil	1/2	0.562	1.75	3	2.687	6.556	1.764	0.546	Pink	I-99	1.217	0.958
CLWD-650-38-1	650kcmil	500 G,H,I,K,M FLEX 535.3 DLO	650kcmil - 350kcmil	3/8	0.406	1	1.937	2.687	5.493	1.764	0.414	Pink	I-99	1.217	0.958
CLWD-650-38-118	650kcmil	500 G,H,I,K,M FLEX 535.3 DLO	650kcmil - 350kcmil	3/8	0.406	1.125	2.125	2.687	5.681	1.764	0.414	Pink	I-99	1.217	0.958
CLWD-650-516-1	650kcmil	500 G,H,I,K,M FLEX 535.3 DLO	650kcmil - 350kcmil	1/32	0.343	1	1.937	2.687	5.493	1.764	0.3515	Pink	I-99	1.217	0.958

* When installed with specified dieless tools + See pages 90 to 97 for complete tooling information. For Bent Tangs change the 4th letter to a B and add "-4" for 45 deg. or "-9" for 90 deg.

TYPE CLWD

Features

- Manufactured from high strength seamless copper tubing.
- Electro-Tin plated.
- Maximum conductivity and excellent crimping characteristics.
- Long barrel length with chamfered entry.
- Color coded.
- UL 486A 90°C Listed and CSA Certified for 600 Volts.
- If proper high voltage spacing and insulation techniques are used, may be used for high voltage applications up to 35KV.
- For Copper conductor only.
- IlSCO connectors are UL Listed and CSA Certified with ILSCO and other Manufacturers' tools.+
- UL File E6207

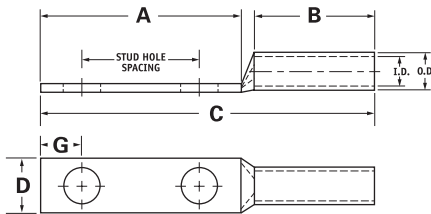

Catalog Number	Wire Size	Alt Wire Size	Expanded* Wire Range	Bolt Size	Stud Hole Dia.	Stud Hole Spacing	Dimensions					Die Color Code	Die Index	O.D.	I.D.
							A	B	C	D	G				
CLWD-700-38-1	700kcmil	500 G,H,I,K,M FLEX 535.3 DLO	700kcmil - 350kcmil	3/8	0.406	1.000	1.937	2.687	5.493	1.816	0.414	Pink	I-99	1.250	0.991
CLWD-700-38-118	700kcmil	500 G,H,I,K,M FLEX 535.3 DLO	700kcmil - 350kcmil	3/8	0.406	1.125	2.125	2.687	5.681	1.816	0.414	Pink	I-99	1.250	0.991
CLWD-700-12-112	700kcmil	500 G,H,I,K,M FLEX 535.3 DLO	700kcmil - 350kcmil	1/2	0.562	1.500	2.625	2.687	6.181	1.816	0.546	Pink	I-99	1.250	0.991
CLWD-700-12-134	700kcmil	500 G,H,I,K,M FLEX 535.3 DLO	700kcmil - 350kcmil	1/2	0.562	1.750	3.000	2.687	6.556	1.816	0.546	Pink	I-99	1.250	0.991
CLWD-700-12-178	700kcmil	500 G,H,I,K,M FLEX 535.3 DLO	700kcmil - 350kcmil	1/2	0.562	1.875	3.000	2.687	6.556	1.816	0.546	Pink	I-99	1.250	0.991
CLWD-750-38-1	750kcmil	600 G,H,I,M FLEX 646.4 DLO	750kcmil - 500kcmil	3/8	0.406	1.000	1.937	2.875	5.714	1.901	0.414	Black	I-106	1.313	1.031
CLWD-750-38-118	750kcmil	600 G,H,I,M FLEX 646.4 DLO	750kcmil - 500kcmil	3/8	0.406	1.125	2.125	2.875	5.902	1.901	0.414	Black	I-106	1.313	1.031
CLWD-750-12-112	750kcmil	600 G,H,I,M FLEX 646.4 DLO	750kcmil - 500kcmil	1/2	0.562	1.500	2.625	2.875	6.402	1.901	0.546	Black	I-106	1.313	1.031
CLWD-750-12-134	750kcmil	600 G,H,I,M FLEX 646.4 DLO	750kcmil - 500kcmil	1/2	0.562	1.750	3.000	2.875	6.777	1.901	0.546	Black	I-106	1.313	1.031
CLWD-750-58-112	750kcmil	600 G,H,I,M FLEX 646.4 DLO	750kcmil - 500kcmil	5/8	0.562	1.500	3.000	2.875	6.777	1.901	0.671	Black	I-106	1.313	1.031
CLWD-1000-38-1	1000kcmil	750 G,H,I FLEX 777.7 DLO	1000kcmil - 750kcmil	3/8	0.406	1.000	1.937	3.000	5.962	2.169	0.414	White	I-125	1.500	1.172
CLWD-1000-12-114	1000kcmil	750 G,H,I FLEX 777.7 DLO	1000kcmil - 750kcmil	1/2	0.562	1.250	2.500	3.000	6.525	2.169	0.546	White	I-125	1.500	1.172
CLWD-1000-12-134	1000kcmil	750 G,H,I FLEX 777.7 DLO	1000kcmil - 750kcmil	1/2	0.562	1.750	3.000	3.000	7.025	2.169	0.546	White	I-125	1.500	1.172
CLWD-1000-58-112	1000kcmil	750 G,H,I FLEX 777.7 DLO	1000kcmil - 750kcmil	5/8	0.562	1.500	3.000	3.000	7.025	2.169	0.671	White	I-125	1.500	1.172

* When installed with specified dieless tools

+ See pages 90 to 97 for complete tooling information.

For Bent Tangs change the 4th letter to a B and add "-4" for 45 deg. or "-9" for 90 deg.

A TYPE CLND

Features

- Manufactured from high strength seamless copper tubing.
- Electro-Tin plated.
- Maximum conductivity and excellent crimping characteristics.
- Long barrel length with chamfered entry.
- Color coded.
- UL 486A 90°C Listed and CSA Certified for 600 Volts.
- If proper high voltage spacing and insulation techniques are used, may be used for high voltage applications up to 35KV.
- For Copper conductor only.
- IlSCO connectors are UL Listed and CSA Certified with ILSCO and other Manufacturers' tools.+
- UL File E6207

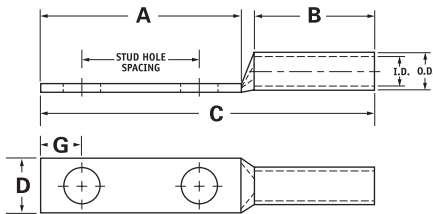

Catalog Number	Wire Size	Alt Wire Size	Expanded* Wire Range	Bolt Size	Stud Hole Dia.	Stud Hole Spacing	Dimensions					Die Color Code	Die Index	O.D.	I.D.
							A	B	C	D	G				
CLND-8-10-58	#8 AWG	#8 FLEX	-	10	0.219	0.625	1.250	0.812	2.257	0.374	0.258	Red	I-21	0.272	0.179
CLND-8-10-34	#8 AWG	#8 FLEX	-	10	0.219	0.750	1.437	0.812	2.444	0.374	0.258	Red	I-21	0.272	0.179
CLND-8-14-58	#8 AWG	#8 FLEX	-	1/4	0.281	0.625	1.437	0.812	2.444	0.486	0.320	Red	I-21	0.272	0.179
CLND-8-14-34	#8 AWG	#8 FLEX	-	1/4	0.281	0.750	1.437	0.812	2.444	0.486	0.320	Red	I-21	0.272	0.179
CLND-8-14-1	#8 AWG	#8 FLEX	-	1/4	0.281	1.000	1.687	0.812	2.694	0.486	0.320	Red	I-21	0.272	0.179
CLND-8-38-1	#8 AWG	#8 FLEX	-	3/8	0.406	1.000	1.937	0.812	2.944	0.593	0.414	Red	I-21	0.272	0.179
CLND-6-10-12	#6 AWG	-	-	10	0.219	0.500	1.250	1.125	2.570	0.411	0.258	Blue	I-24	0.295	0.203
CLND-6-10-58	#6 AWG	-	-	10	0.219	0.625	1.250	1.125	2.570	0.411	0.258	Blue	I-24	0.295	0.203
CLND-6-10-1116	#6 AWG	-	-	10	0.219	0.687	1.250	1.125	2.570	0.411	0.258	Blue	I-24	0.295	0.203
CLND-6-10-34	#6 AWG	-	-	10	0.219	0.750	1.437	1.125	2.757	0.411	0.258	Blue	I-24	0.295	0.203
CLND-6-14-12	#6 AWG	-	-	1/4	0.281	0.500	1.250	1.125	2.570	0.411	0.320	Blue	I-24	0.295	0.203
CLND-6-14-58	#6 AWG	-	-	1/4	0.281	0.625	1.437	1.125	2.757	0.411	0.320	Blue	I-24	0.295	0.203
CLND-6-14-34	#6 AWG	-	-	1/4	0.281	0.750	1.437	1.125	2.757	0.411	0.320	Blue	I-24	0.295	0.203
CLND-6-14-1	#6 AWG	-	-	1/4	0.281	1.000	1.687	1.125	3.007	0.411	0.320	Blue	I-24	0.295	0.203
CLND-6-516-34	#6 AWG	-	-	5/16	0.343	0.750	1.687	1.125	3.007	0.532	0.352	Blue	I-24	0.295	0.203
CLND-6-516-1	#6 AWG	-	-	5/16	0.343	1.000	1.937	1.125	3.257	0.532	0.352	Blue	I-24	0.295	0.203
CLND-6-38-34	#6 AWG	-	-	3/8	0.406	0.750	1.687	1.125	3.007	0.593	0.414	Blue	I-24	0.295	0.203
CLND-6-38-78	#6 AWG	-	-	3/8	0.406	0.875	1.937	1.125	3.257	0.593	0.414	Blue	I-24	0.295	0.203
CLND-6-38-1	#6 AWG	-	-	3/8	0.406	1.000	1.937	1.125	3.257	0.593	0.414	Blue	I-24	0.295	0.203
CLND-6-12-134	#6 AWG	-	-	1/2	0.562	1.750	3.000	1.125	4.320	0.750	0.546	Blue	I-24	0.295	0.203

* When installed with specified dieless tools

+ See pages 90 to 97 for complete tooling information.

For Bent Tangs change the 4th letter to a B and add "-4" for 45 deg. or "-9" for 90 deg.

TYPE CLND

Features

- Manufactured from high strength seamless copper tubing.
- Electro-Tin plated.
- Maximum conductivity and excellent crimping characteristics.
- Long barrel length with chamfered entry.
- Color coded.
- UL 486A 90°C Listed and CSA Certified for 600 Volts.
- If proper high voltage spacing and insulation techniques are used, may be used for high voltage applications up to 35KV.
- For Copper conductor only.
- IlSCO connectors are UL Listed and CSA Certified with ILSCO and other Manufacturers' tools.+
- UL File E6207

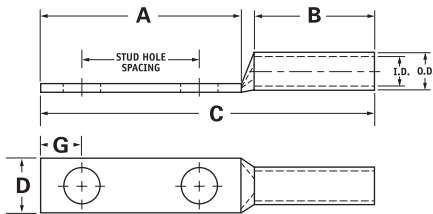

Catalog Number	Wire Size	Alt Wire Size	Expanded* Wire Range	Bolt Size	Stud Hole Dia.	Stud Hole Spacing	Dimensions					Die Color Code	Die Index	O.D.	I.D.
							A	B	C	D	G				
CLND-4-10-58	#4 AWG	#6 FLEX	4-6 AWG	10	0.219	0.625	1.250	1.125	2.609	0.486	0.258	Gray	I-29	0.343	0.250
CLND-4-10-34	#4 AWG	#6 FLEX	4-6 AWG	10	0.219	0.750	1.437	1.125	2.796	0.486	0.258	Gray	I-29	0.343	0.250
CLND-4-10-1	#4 AWG	#6 FLEX	4-6 AWG	10	0.219	1.000	1.687	1.125	3.046	0.486	0.258	Gray	I-29	0.343	0.250
CLND-4-14-58	#4 AWG	#6 FLEX	4-6 AWG	1/4	0.281	0.625	1.437	1.125	2.796	0.486	0.320	Gray	I-29	0.343	0.250
CLND-4-14-34	#4 AWG	#6 FLEX	4-6 AWG	1/4	0.281	0.750	1.437	1.125	2.796	0.486	0.320	Gray	I-29	0.343	0.250
CLND-4-516-34	#4 AWG	#6 FLEX	4-6 AWG	5/16	0.343	0.750	1.687	1.125	3.046	0.486	0.352	Gray	I-29	0.343	0.250
CLND-4-516-1	#4 AWG	#6 FLEX	4-6 AWG	5/16	0.343	1.000	1.937	1.125	3.296	0.486	0.352	Gray	I-29	0.343	0.250
CLND-4-38-34	#4 AWG	#6 FLEX	4-6 AWG	3/8	0.406	0.750	1.687	1.125	3.046	0.593	0.414	Gray	I-29	0.343	0.250
CLND-4-38-1	#4 AWG	#6 FLEX	4-6 AWG	3/8	0.406	1.000	1.937	1.125	3.296	0.593	0.414	Gray	I-29	0.343	0.250
CLND-4-12-134	#4 AWG	#6 FLEX	4-6 AWG	1/2	0.562	1.750	3.000	1.125	4.359	0.750	0.546	Gray	I-29	0.343	0.250
CLND-3-14-58	#3 AWG	#4 FLEX	3-6 AWG	1/4	0.281	0.625	1.437	1.125	2.817	0.532	0.320	White	I-29	0.375	0.275
CLND-3-14-34	#3 AWG	#4 FLEX	3-6 AWG	1/4	0.281	0.750	1.437	1.125	2.817	0.532	0.320	White	I-29	0.375	0.275
CLND-3-516-58	#3 AWG	#4 FLEX	3-6 AWG	5/16	0.343	0.625	1.437	1.125	2.817	0.532	0.352	White	I-29	0.375	0.275
CLND-3-516-1	#3 AWG	#4 FLEX	3-6 AWG	5/16	0.343	1.000	1.937	1.125	3.317	0.532	0.352	White	I-29	0.375	0.275
CLND-3-38-34	#3 AWG	#4 FLEX	3-6 AWG	3/8	0.406	0.750	1.687	1.125	3.067	0.593	0.414	White	I-29	0.375	0.275
CLND-3-38-1	#3 AWG	#4 FLEX	3-6 AWG	3/8	0.406	1.000	1.937	1.125	3.317	0.593	0.414	White	I-29	0.375	0.275
CLND-3-12-134	#3 AWG	#4 FLEX	3-6 AWG	1/2	0.562	1.750	3.000	1.125	4.380	0.750	0.546	White	I-29	0.375	0.275

* When installed with specified dieless tools

+ See pages 90 to 97 for complete tooling information.

For Bent Tangs change the 4th letter to a B and add "-4" for 45 deg. or "-9" for 90 deg.

A TYPE CLND

Features

- Manufactured from high strength seamless copper tubing.
- Electro-Tin plated.
- Maximum conductivity and excellent crimping characteristics.
- Long barrel length with chamfered entry.
- Color coded.
- UL 486A 90°C Listed and CSA Certified for 600 Volts.
- If proper high voltage spacing and insulation techniques are used, may be used for high voltage applications up to 35KV.
- For Copper conductor only.
- IlSCO connectors are UL Listed and CSA Certified with ILSCO and other Manufacturers' tools.†
- UL File E6207

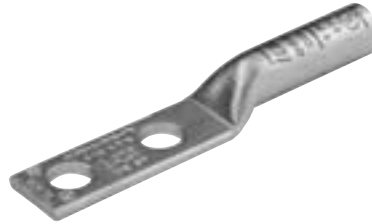
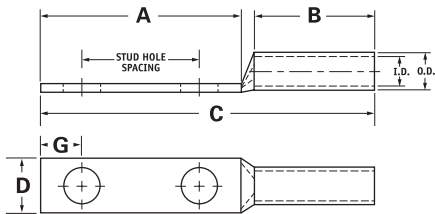

Catalog Number	Wire Size	Alt Wire Size	Expanded* Wire Range	Bolt Size	Stud Hole Dia.	Stud Hole Spacing	Dimensions					Die Color Code	Die Index	O.D.	I.D.
							A	B	C	D	G				
CLND-2-10-34	#2 AWG	-	2-6 AWG	10	0.219	0.750	1.437	1.125	2.848	0.599	0.258	Brown	I-33	0.421	0.312
CLND-2-14-58	#2 AWG	-	2-6 AWG	1/4	0.281	0.625	1.437	1.125	2.848	0.599	0.320	Brown	I-33	0.421	0.312
CLND-2-14-34	#2 AWG	-	2-6 AWG	1/4	0.281	0.750	1.437	1.125	2.848	0.599	0.320	Brown	I-33	0.421	0.312
CLND-2-14-1	#2 AWG	-	2-6 AWG	1/4	0.281	1.000	1.687	1.125	3.098	0.599	0.320	Brown	I-33	0.421	0.312
CLND-2-516-34	#2 AWG	-	2-6 AWG	5/16	0.343	0.750	1.687	1.125	3.098	0.599	0.352	Brown	I-33	0.421	0.312
CLND-2-516-1	#2 AWG	-	2-6 AWG	5/16	0.343	1.000	1.937	1.125	3.348	0.599	0.352	Brown	I-33	0.421	0.312
CLND-2-38-34	#2 AWG	-	2-6 AWG	3/8	0.406	0.750	1.687	1.125	3.098	0.599	0.414	Brown	I-33	0.421	0.312
CLND-2-38-78	#2 AWG	-	2-6 AWG	3/8	0.406	0.875	1.937	1.125	3.348	0.599	0.414	Brown	I-33	0.421	0.312
CLND-2-38-1	#2 AWG	-	2-6 AWG	3/8	0.406	1.000	1.937	1.125	3.348	0.599	0.414	Brown	I-33	0.421	0.312
CLND-2-38-134	#2 AWG	-	2-6 AWG	3/8	0.406	1.750	2.625	1.125	4.036	0.599	0.414	Brown	I-33	0.421	0.312
CLND-2-12-134	#2 AWG	-	2-6 AWG	1/2	0.562	1.750	3.000	1.125	4.411	0.750	0.546	Brown	I-33	0.421	0.312
CLND-1-14-58	#1 AWG	#2 FLEX	1-6 AWG	1/4	0.281	0.625	1.437	1.375	3.142	0.673	0.320	Green	I-37	0.468	0.359
CLND-1-14-34	#1 AWG	#2 FLEX	1-6 AWG	1/4	0.281	0.750	1.437	1.375	3.142	0.673	0.320	Green	I-37	0.468	0.359
CLND-1-14-1	#1 AWG	#2 FLEX	1-6 AWG	1/4	0.281	1.000	1.687	1.375	3.392	0.673	0.320	Green	I-37	0.468	0.359
CLND-1-516-78	#1 AWG	#2 FLEX	1-6 AWG	5/16	0.343	0.875	1.687	1.375	3.392	0.673	0.352	Green	I-37	0.468	0.359
CLND-1-516-1	#1 AWG	#2 FLEX	1-6 AWG	5/16	0.343	1.000	1.937	1.375	3.642	0.673	0.352	Green	I-37	0.468	0.359
CLND-1-38-1	#1 AWG	#2 FLEX	1-6 AWG	3/8	0.406	1.000	1.937	1.375	3.642	0.673	0.414	Green	I-37	0.468	0.359
CLND-1-12-134	#1 AWG	#2 FLEX	1-6 AWG	1/2	0.562	1.750	3.000	1.375	4.705	0.750	0.546	Green	I-37	0.468	0.359
CLND-1/0-14-58	1/0 AWG	#1 FLEX	1/0-6 AWG	1/4	0.281	0.625	1.437	1.500	3.293	0.738	0.320	Pink	I-42	0.515	0.390
CLND-1/0-14-34	1/0 AWG	#1 FLEX	1/0-6 AWG	1/4	0.281	0.750	1.437	1.500	3.293	0.738	0.320	Pink	I-42	0.515	0.390
CLND-1/0-14-1	1/0 AWG	#1 FLEX	1/0-6 AWG	1/4	0.281	1.000	1.687	1.500	3.543	0.738	0.320	Pink	I-42	0.515	0.390
CLND-1/0-516-34	1/0 AWG	#1 FLEX	1/0-6 AWG	5/16	0.343	0.750	1.687	1.500	3.543	0.738	0.352	Pink	I-42	0.515	0.390
CLND-1/0-516-78	1/0 AWG	#1 FLEX	1/0-6 AWG	5/16	0.343	0.875	1.687	1.500	3.543	0.738	0.352	Pink	I-42	0.515	0.390
CLND-1/0-516-1	1/0 AWG	#1 FLEX	1/0-6 AWG	5/16	0.343	1.000	1.937	1.500	3.793	0.738	0.352	Pink	I-42	0.515	0.390
CLND-1/0-38-1	1/0 AWG	#1 FLEX	1/0-6 AWG	3/8	0.406	1.000	1.937	1.500	3.793	0.738	0.414	Pink	I-42	0.515	0.390
CLND-1/0-38-134	1/0 AWG	#1 FLEX	1/0-6 AWG	3/8	0.406	1.750	2.625	1.500	4.481	0.738	0.414	Pink	I-42	0.515	0.390
CLND-1/0-12-1	1/0 AWG	#1 FLEX	1/0-6 AWG	1/2	0.562	1.000	2.125	1.500	3.981	0.738	0.546	Pink	I-42	0.515	0.390
CLND-1/0-12-134	1/0 AWG	#1 FLEX	1/0-6 AWG	1/2	0.562	1.750	3.000	1.500	4.856	0.738	0.546	Pink	I-42	0.515	0.390

* When installed with specified dieless tools + See pages 90 to 97 for complete tooling information.
 For Bent Tangs change the 4th letter to a B and add "-4" for 45 deg. or "-9" for 90 deg.

TYPE CLND

Features

- Manufactured from high strength seamless copper tubing.
- Electro-Tin plated.
- Maximum conductivity and excellent crimping characteristics.
- Long barrel length with chamfered entry.
- Color coded.
- UL 486A 90°C Listed and CSA Certified for 600 Volts.
- If proper high voltage spacing and insulation techniques are used, may be used for high voltage applications up to 35KV.
- For Copper conductor only.
- IlSCO connectors are UL Listed and CSA Certified with ILSCO and other Manufacturers' tools.*
- UL File E6207

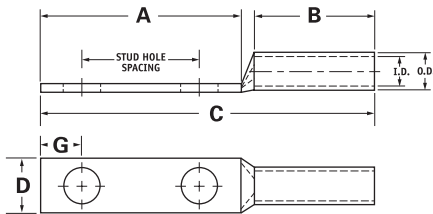

Catalog Number	Wire Size	Alt Wire Size	Expanded* Wire Range	Bolt Size	Stud Hole Dia.	Stud Hole Spacing	Dimensions					Die Color Code	Die Index	O.D.	I.D.
							A	B	C	D	G				
CLND-2/0-14-58	2/0 AWG	1/0 FLEX	2/0-4 AWG	1/4	0.281	0.625	1.437	1.500	3.333	0.811	0.320	Black	I-45	0.562	0.437
CLND-2/0-14-34	2/0 AWG	1/0 FLEX	2/0-4 AWG	1/4	0.281	0.750	1.437	1.500	3.333	0.811	0.320	Black	I-45	0.562	0.437
CLND-2/0-14-1	2/0 AWG	1/0 FLEX	2/0-4 AWG	1/4	0.281	1.000	1.687	1.500	3.583	0.811	0.320	Black	I-45	0.562	0.437
CLND-2/0-516-1	2/0 AWG	1/0 FLEX	2/0-4 AWG	5/16	0.343	1.000	1.937	1.500	3.833	0.811	0.352	Black	I-45	0.562	0.437
CLND-2/0-38-1	2/0 AWG	1/0 FLEX	2/0-4 AWG	3/8	0.406	1.000	1.937	1.500	3.833	0.811	0.414	Black	I-45	0.562	0.437
CLND-2/0-38-134	2/0 AWG	1/0 FLEX	2/0-4 AWG	3/8	0.406	1.750	2.625	1.500	4.521	0.811	0.414	Black	I-45	0.562	0.437
CLND-2/0-12-1	2/0 AWG	1/0 FLEX	2/0-4 AWG	1/2	0.562	1.000	2.125	1.500	4.021	0.811	0.546	Black	I-45	0.562	0.437
CLND-2/0-12-134	2/0 AWG	1/0 FLEX	2/0-4 AWG	1/2	0.562	1.750	3.000	1.500	4.896	0.811	0.546	Black	I-45	0.562	0.437
CLND-3/0-14-58	3/0 AWG	2/0 FLEX	3/0-2 AWG	1/4	0.281	0.625	1.437	1.500	3.376	0.885	0.320	Orange	I-50	0.609	0.484
CLND-3/0-14-34	3/0 AWG	2/0 FLEX	3/0-2 AWG	1/4	0.281	0.750	1.437	1.500	3.376	0.885	0.320	Orange	I-50	0.609	0.484
CLND-3/0-516-1	3/0 AWG	2/0 FLEX	3/0-2 AWG	5/16	0.343	1.000	1.937	1.500	3.876	0.885	0.352	Orange	I-50	0.609	0.484
CLND-3/0-38-1	3/0 AWG	2/0 FLEX	3/0-2 AWG	3/8	0.406	1.000	1.937	1.500	3.876	0.885	0.414	Orange	I-50	0.609	0.484
CLND-3/0-12-134	3/0 AWG	2/0 FLEX	3/0-2 AWG	1/2	0.562	1.750	3.000	1.500	4.939	0.885	0.546	Orange	I-50	0.609	0.484
CLND-4/0-14-58	4/0 AWG	3/0 FLEX	4/0-1 AWG	1/4	0.281	0.625	1.437	1.500	3.428	0.999	0.320	Purple	I-54	0.687	0.546
CLND-4/0-14-34	4/0 AWG	3/0 FLEX	4/0-1 AWG	1/4	0.281	0.750	1.437	1.500	3.428	0.999	0.320	Purple	I-54	0.687	0.546
CLND-4/0-14-1	4/0 AWG	3/0 FLEX	4/0-1 AWG	1/4	0.281	1.000	1.687	1.500	3.678	0.999	0.320	Purple	I-54	0.687	0.546
CLND-4/0-516-34	4/0 AWG	3/0 FLEX	4/0-1 AWG	5/16	0.343	0.750	1.687	1.500	3.678	0.999	0.352	Purple	I-54	0.687	0.546
CLND-4/0-516-1	4/0 AWG	3/0 FLEX	4/0-1 AWG	5/16	0.343	1.000	1.937	1.500	3.928	0.999	0.352	Purple	I-54	0.687	0.546
CLND-4/0-516-134	4/0 AWG	3/0 FLEX	4/0-1 AWG	5/16	0.343	1.750	2.500	1.500	4.491	0.999	0.352	Purple	I-54	0.687	0.546
CLND-4/0-38-1	4/0 AWG	3/0 FLEX	4/0-1 AWG	3/8	0.406	1.000	1.937	1.500	3.928	0.999	0.414	Purple	I-54	0.687	0.546
CLND-4/0-38-134	4/0 AWG	3/0 FLEX	4/0-1 AWG	3/8	0.406	1.750	2.625	1.500	4.616	0.999	0.414	Purple	I-54	0.687	0.546
CLND-4/0-12-1	4/0 AWG	3/0 FLEX	4/0-1 AWG	1/2	0.562	1.000	2.125	1.500	4.116	0.999	0.546	Purple	I-54	0.687	0.546
CLND-4/0-12-114	4/0 AWG	3/0 FLEX	4/0-1 AWG	1/2	0.562	1.250	2.500	1.500	4.491	0.999	0.546	Purple	I-54	0.687	0.546
CLND-4/0-12-134	4/0 AWG	3/0 FLEX	4/0-1 AWG	1/2	0.562	1.750	3.000	1.500	4.991	0.999	0.546	Purple	I-54	0.687	0.546
CLND-250-14-34	250kcmil	4/0 FLEX	250kcmil - 1/0 AWG	1/4	0.281	0.750	1.437	1.688	3.656	1.088	0.320	Yellow	I-62	0.750	0.593
CLND-250-38-1	250kcmil	4/0 FLEX	250kcmil - 1/0 AWG	3/8	0.406	1.000	1.937	1.688	4.156	1.088	0.414	Yellow	I-62	0.750	0.593
CLND-250-38-134	250kcmil	4/0 FLEX	250kcmil - 1/0 AWG	3/8	0.406	1.750	2.625	1.688	4.844	1.088	0.414	Yellow	I-62	0.750	0.593
CLND-250-12-114	250kcmil	4/0 FLEX	250kcmil - 1/0 AWG	1/2	0.562	1.250	2.500	1.688	4.719	1.088	0.546	Yellow	I-62	0.750	0.593
CLND-250-12-134	250kcmil	4/0 FLEX	250kcmil - 1/0 AWG	1/2	0.562	1.750	3.000	1.688	5.219	1.088	0.546	Yellow	I-62	0.750	0.593

* When installed with specified dieless tools + See pages 90 to 97 for complete tooling information. For Bent Tangs change the 4th letter to a B and add "-4" for 45 deg. or "-9" for 90 deg.

A TYPE CLND

Features

- Manufactured from high strength seamless copper tubing.
- Electro-Tin plated.
- Maximum conductivity and excellent crimping characteristics.
- Long barrel length with chamfered entry.
- Color coded.
- UL 486A 90°C Listed and CSA Certified for 600 Volts.
- If proper high voltage spacing and insulation techniques are used, may be used for high voltage applications up to 35KV.
- For Copper conductor only.
- IlSCO connectors are UL Listed and CSA Certified with ILSCO and other Manufacturers' tools.+
- UL File E6207

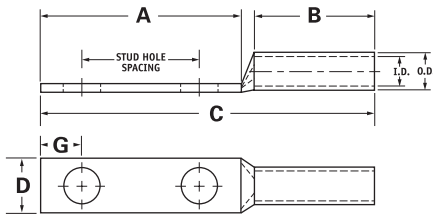

Catalog Number	Wire Size	Alt Wire Size	Expanded* Wire Range	Bolt Size	Stud Hole Dia.	Stud Hole Spacing	Dimensions					Color Code	Die Die Index	O.D.	I.D.
							A	B	C	D	G				
CLND-300-38-1	300kcmil	250 G,H FLEX	300kcmil - 2/0 AWG	3/8	0.406	1.000	1.937	2.000	4.524	1.189	0.414	White	I-66	0.812	0.660
CLND-300-12-134	300kcmil	250 G,H FLEX	300kcmil - 2/0 AWG	1/2	0.562	1.750	3.000	2.000	5.587	1.189	0.546	White	I-66	0.812	0.660
CLND-350-14-34	350kcmil	250 I,K,M FLEX 262.2 DLO	350kcmil - 3/0 AWG	1/4	0.281	0.750	1.437	2.000	4.060	1.291	0.320	Red	I-71	0.890	0.703
CLND-350-516-134	350kcmil	250 I,K,M FLEX 262.2 DLO	350kcmil - 3/0 AWG	5/16	0.343	1.750	2.500	2.000	5.123	1.291	0.352	Red	I-71	0.890	0.703
CLND-350-38-1	350kcmil	250 I,K,M FLEX 262.2 DLO	350kcmil - 3/0 AWG	3/8	0.406	1.000	1.937	2.000	4.560	1.291	0.414	Red	I-71	0.890	0.703
CLND-350-12-114	350kcmil	250 I,K,M FLEX 262.2 DLO	350kcmil - 3/0 AWG	1/2	0.562	1.250	2.500	2.000	5.123	1.291	0.546	Red	I-71	0.890	0.703
CLND-350-12-134	350kcmil	250 I,K,M FLEX 262.2 DLO	350kcmil - 3/0 AWG	1/2	0.562	1.750	3.000	2.000	5.623	1.291	0.546	Red	I-71	0.890	0.703
CLND-400-38-1	400kcmil	300 G,H,I,K,M FLEX 313.1 DLO	400kcmil - 4/0 AWG	3/8	0.406	1.000	1.937	2.125	4.729	1.365	0.414	Blue	I-76	0.937	0.750
CLND-400-38-116	400kcmil	300 G,H,I,K,M FLEX 313.1 DLO	400kcmil - 4/0 AWG	3/8	0.406	1.062	1.937	2.125	4.729	1.365	0.414	Blue	I-76	0.937	0.750
CLND-400-12-134	400kcmil	300 G,H,I,K,M FLEX 313.1 DLO	400kcmil - 4/0 AWG	1/2	0.562	1.750	3.000	2.125	5.792	1.365	0.546	Blue	I-76	0.937	0.750
CLND-500-14-34	500kcmil	350 G,H,I,K,M FLEX 373.7 DLO	500kcmil - 250kcmil	1/4	0.281	0.750	1.437	2.250	4.419	1.535	0.320	Brown	I-87	1.062	0.828
CLND-500-38-1	500kcmil	350 G,H,I,K,M FLEX 373.7 DLO	500kcmil - 250kcmil	3/8	0.406	1.000	1.937	2.250	4.919	1.535	0.414	Brown	I-87	1.062	0.828
CLND-500-12-114	500kcmil	350 G,H,I,K,M FLEX 373.7 DLO	500kcmil - 250kcmil	1/2	0.562	1.250	2.500	2.250	5.482	1.535	0.546	Brown	I-87	1.062	0.828
CLND-500-12-134	500kcmil	350 G,H,I,K,M FLEX 373.7 DLO	500kcmil - 250kcmil	1/2	0.562	1.750	3.000	2.250	5.982	1.535	0.546	Brown	I-87	1.062	0.828
CLND-600-38-1	600kcmil	400 G,H,I,K,M FLEX 444.4 DLO	600kcmil - 250kcmil	3/8	0.406	1.000	1.937	2.687	5.433	1.712	0.414	Green	I-94	1.187	0.920
CLND-600-12-134	600kcmil	400 G,H,I,K,M FLEX 444.4 DLO	600kcmil - 250kcmil	1/2	0.562	1.750	3.000	2.687	6.496	1.712	0.546	Green	I-94	1.187	0.920

* When installed with specified dieless tools

+ See pages 90 to 97 for complete tooling information.

For Bent Tangs change the 4th letter to a B and add "-4" for 45 deg. or "-9" for 90 deg.

TYPE CLND

Features

- Manufactured from high strength seamless copper tubing.
- Electro-Tin plated.
- Maximum conductivity and excellent crimping characteristics.
- Long barrel length with chamfered entry.
- Color coded.
- UL 486A 90°C Listed and CSA Certified for 600 Volts.
- If proper high voltage spacing and insulation techniques are used, may be used for high voltage applications up to 35KV.
- For Copper conductor only.
- IlSCO connectors are UL Listed and CSA Certified with ILSCO and other Manufacturers' tools.+
- UL File E6207

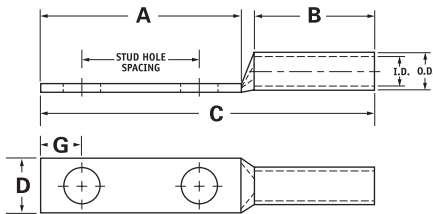

Catalog Number	Wire Size	Alt Wire Size	Expanded* Wire Range	Bolt Size	Stud Hole Dia.	Stud Hole Spacing	Dimensions					Die Color Code	Die Index	O.D.	I.D.
							A	B	C	D	G				
CLND-650-12-114	650kcmil	500 G,H,I,K,M FLEX 535.3 DLO	650kcmil - 350kcmil	1/2	0.562	1.25	2.5	2.687	6.056	1.764	0.546	Pink	I-99	1.217	0.958
CLND-650-12-134	650kcmil	500 G,H,I,K,M FLEX 535.3 DLO	650kcmil - 350kcmil	1/2	0.562	1.75	3	2.687	6.556	1.764	0.546	Pink	I-99	1.217	0.958
CLND-650-38-1	650kcmil	500 G,H,I,K,M FLEX 535.3 DLO	650kcmil - 350kcmil	3/8	0.406	1	2.125	2.687	5.493	1.764	0.414	Pink	I-99	1.217	0.958
CLND-650-38-118	650kcmil	500 G,H,I,K,M FLEX 535.3 DLO	650kcmil - 350kcmil	3/8	0.406	1.125	2.125	2.687	5.681	1.764	0.414	Pink	I-99	1.217	0.958
CLND-650-516-1	650kcmil	500 G,H,I,K,M FLEX 535.3 DLO	650kcmil - 350kcmil	1/32	0.343	1	1.937	2.687	5.493	1.764	0.3515	Pink	I-99	1.217	0.958
CLND-700-38-1	700kcmil	500 G,H,I,K,M FLEX 535.3 DLO	700kcmil - 350kcmil	3/8	0.406	1.000	1.937	2.687	5.493	1.816	0.414	Pink	I-99	1.250	0.991
CLND-700-38-118	700kcmil	500 G,H,I,K,M FLEX 535.3 DLO	700kcmil - 350kcmil	3/8	0.406	1.125	2.125	2.687	5.681	1.816	0.414	Pink	I-99	1.250	0.991
CLND-700-12-112	700kcmil	500 G,H,I,K,M FLEX 535.3 DLO	700kcmil - 350kcmil	1/2	0.562	1.500	2.625	2.687	6.181	1.816	0.546	Pink	I-99	1.250	0.991
CLND-700-12-134	700kcmil	500 G,H,I,K,M FLEX 535.3 DLO	700kcmil - 350kcmil	1/2	0.562	1.750	3.000	2.687	6.556	1.816	0.546	Pink	I-99	1.250	0.991
CLND-700-12-178	700kcmil	500 G,H,I,K,M FLEX 535.3 DLO	700kcmil - 350kcmil	1/2	0.562	1.875	3.000	2.687	6.556	1.816	0.546	Pink	I-99	1.250	0.991
CLND-750-38-1	750kcmil	600 G,H,I,M FLEX 646.4 DLO	750kcmil - 500kcmil	3/8	0.406	1.000	1.937	2.875	5.714	1.901	0.414	Black	I-106	1.313	1.031
CLND-750-38-118	750kcmil	600 G,H,I,M FLEX 646.4 DLO	750kcmil - 500kcmil	3/8	0.406	1.125	2.125	2.875	5.902	1.901	0.414	Black	I-106	1.313	1.031
CLND-750-12-112	750kcmil	600 G,H,I,M FLEX 646.4 DLO	750kcmil - 500kcmil	1/2	0.562	1.500	2.625	2.875	6.402	1.901	0.546	Black	I-106	1.313	1.031
CLND-750-12-134	750kcmil	600 G,H,I,M FLEX 646.4 DLO	750kcmil - 500kcmil	1/2	0.562	1.750	3.000	2.875	6.777	1.901	0.546	Black	I-106	1.313	1.031
CLND-750-58-112	750kcmil	600 G,H,I,M FLEX 646.4 DLO	750kcmil - 500kcmil	5/8	0.562	1.500	3.000	2.875	6.777	1.901	0.671	Black	I-106	1.313	1.031
CLND-1000-38-1	1000kcmil	750 G,H,I FLEX 777.7 DLO	1000kcmil - 750kcmil	3/8	0.406	1.000	1.937	3.000	5.962	2.169	0.414	White	I-125	1.500	1.172
CLND-1000-12-114	1000kcmil	750 G,H,I FLEX 777.7 DLO	1000kcmil - 750kcmil	1/2	0.562	1.250	2.500	3.000	6.525	2.169	0.546	White	I-125	1.500	1.172
CLND-1000-12-134	1000kcmil	750 G,H,I FLEX 777.7 DLO	1000kcmil - 750kcmil	1/2	0.562	1.750	3.000	3.000	7.025	2.169	0.546	White	I-125	1.500	1.172
CLND-1000-58-112	1000kcmil	750 G,H,I FLEX 777.7 DLO	1000kcmil - 750kcmil	5/8	0.562	1.500	3.000	3.000	7.025	2.169	0.671	White	I-125	1.500	1.172

* When installed with specified dieless tools + See pages 90 to 97 for complete tooling information.
For Bent Tangs change the 4th letter to a B and add "-4" for 45 deg. or "-9" for 90 deg.

A TYPE CLNF

Features

- Manufactured from high strength seamless copper tubing.
- Electro-Tin plated.
- Maximum conductivity and excellent crimping characteristics.
- Long barrel length with chamfered entry.
- Color coded.
- UL 486A 90°C Listed and CSA Certified for 600 Volts.
- If proper high voltage spacing and insulation techniques are used, may be used for high voltage applications up to 35KV.
- For Copper conductor only.
- IlSCO connectors are UL Listed and CSA Certified with ILSCO and other Manufacturers' tools.+
- UL File E6207

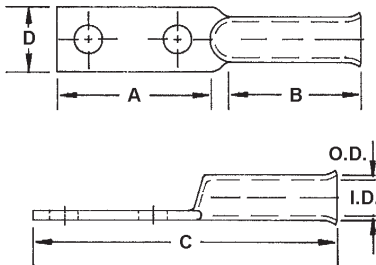

Catalog Number	Wire Size	Alt Wire Size	Expanded* Wire Range	Bolt Size	Stud Hole Dia.	Stud Hole Spacing	Dimensions					Die Color Code	Die Index	O.D.	I.D.
							A	B	C	D	G				
CLNF-2/0-12-134	2/0 AWG	1/0 FLEX	2/0-4 AWG	1/2	0.531	1.750	3.000	1.938	5.219	0.813	0.546	Black	I-45	0.562	0.437
CLNF-2/0-38	2/0 AWG	1/0 FLEX	2/0-4 AWG	3/8	0.406	-	0.875	1.938	3.094	0.813	0.414	Black	I-45	0.562	0.437
CLNF-3/0-12-134	3/0 AWG	2/0 FLEX	3/0-2 AWG	1/2	0.531	1.750	3.000	1.938	5.250	0.906	0.546	Orange	I-50	0.609	0.484
CLNF-3/0-12	3/0 AWG	2/0 FLEX	3/0-2 AWG	1/2	0.531	-	1.000	1.938	3.250	0.906	0.546	Orange	I-50	0.609	0.484
CLNF-4/0-12-134	4/0 AWG	3/0 FLEX	4/0-1 AWG	1/2	0.531	1.750	3.000	2.125	5.469	1.000	0.546	Purple	I-54	0.687	0.546
CLNF-4/0-12	4/0 AWG	3/0 FLEX	4/0-1 AWG	1/2	0.531	-	1.000	2.125	3.469	1.000	0.546	Purple	I-54	0.687	0.546
CLNF-250-12-134	250kcmil	4/0 FLEX	250kcmil-1/0 AWG	1/2	0.531	1.750	3.000	2.125	5.563	1.090	0.546	Yellow	I-62	0.750	0.593
CLNF-250-12	250kcmil	4/0 FLEX	250kcmil-1/0 AWG	1/2	0.531	-	1.125	2.125	3.688	1.090	0.546	Yellow	I-62	0.750	0.593
CLNF-300-12-134	300kcmil	250 G, H FLEX	300kcmil-2/0 AWG	1/2	0.531	1.750	3.000	2.250	5.937	1.188	0.546	White	I-66	0.812	0.660
CLNF-300-58	300kcmil	250 G, H FLEX	300kcmil-2/0 AWG	5/8	0.688	-	1.125	2.250	3.875	1.188	0.671	White	I-66	0.812	0.660
CLNF-350-12-134	350kcmil	250 I,K,M FLEX 262.2 DLO	350kcmil-3/0 AWG	1/2	0.531	1.750	3.000	2.563	6.000	1.280	0.546	Red	I-71	0.890	0.703
CLNF-350-58	350kcmil	250 I,K,M FLEX 262.2 DLO	350kcmil-3/0 AWG	5/8	0.688	-	1.125	2.563	4.125	1.280	0.671	Red	I-71	0.890	0.703
CLNF-400-12-134	400kcmil	300 G,H,I,K,M FLEX 313.1 DLO	400kcmil-4/0 AWG	1/2	0.531	1.750	3.000	2.688	6.313	1.375	0.546	Blue	I-76	0.937	0.750
CLNF-400-58	400kcmil	300 G,H,I,K,M FLEX 313.1 DLO	400kcmil-4/0 AWG	5/8	0.688	-	1.500	2.688	4.813	1.375	0.671	Blue	I-76	0.937	0.750
CLNF-500-12-134	500kcmil	350 G,H,I,K,M FLEX 373.7 DLO	500kcmil-250kcmil	1/2	0.531	1.750	3.000	2.813	6.313	1.531	0.546	Brown	I-87	1.062	0.828
CLNF-500-58	500kcmil	350 G,H,I,K,M FLEX 373.7 DLO	500kcmil-250kcmil	5/8	0.688	-	1.500	2.813	4.813	1.531	0.671	Brown	I-87	1.062	0.828

* When installed with specified dieless tools

+ See pages 90 to 97 for complete tooling information.

TYPE CLNF

Features

- Manufactured from high strength seamless copper tubing.
- Electro-Tin plated.
- Maximum conductivity and excellent crimping characteristics.
- Long barrel length with chamfered entry.
- Color coded.
- UL 486A 90°C Listed and CSA Certified for 600 Volts.
- If proper high voltage spacing and insulation techniques are used, may be used for high voltage applications up to 35KV.
- For Copper conductor only.
- IlSCO connectors are UL Listed and CSA Certified with ILSCO and other Manufacturers' tools.+
- UL File E6207

A

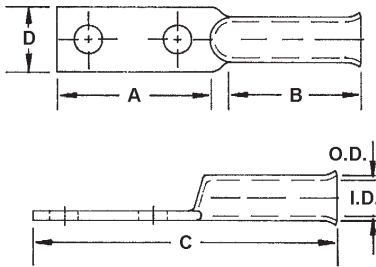

Catalog Number	Wire Size	Alt Wire Size	Expanded* Wire Range	Bolt Size	Stud Hole Dia.	Stud Hole Spacing	Dimensions					Die Color Code	Die Index	O.D.	I.D.
							A	B	C	D	G				
CLNF-600-12-134	600kcmil	400 G,H,I,K,M FLEX 444.4 DLO	600kcmil-250kcmil	1/2	0.531	1.750	3.000	2.875	6.813	1.680	0.546	Green	I-94	1.187	0.920
CLNF-600-58	600kcmil	400 G,H,I,K,M FLEX 444.4 DLO	600kcmil-250kcmil	5/8	0.688	-	1.500	2.875	5.375	1.680	0.671	Green	I-94	1.187	0.920
CLNF-700-12-134	700kcmil	500 G,H,I,K,M FLEX 535.3 DLO	700kcmil-350kcmil	1/2	0.531	1.750	3.000	2.813	6.625	1.844	0.546	Pink	I-99	1.250	0.991
CLNF-700-58	700kcmil	500 G,H,I,K,M FLEX 535.3 DLO	700kcmil-350kcmil	5/8	0.688	-	1.750	2.563	5.375	1.844	0.671	Pink	I-99	1.250	0.991
CLNF-750-12-134	750kcmil	600 G,H,I,M FLEX 646.4 DLO	750kcmil-500kcmil	1/2	0.531	1.750	3.000	2.813	6.625	1.906	0.546	Black	I-106	1.313	1.031
CLNF-750-58	750kcmil	600 G,H,I,M FLEX 646.4 DLO	750kcmil-500kcmil	5/8	0.688	-	1.938	2.813	5.563	1.906	0.671	Black	I-106	1.313	1.031
CLNF-1000-12-134	1000kcmil	750 G,H,I FLEX 777.7 DLO	1000kcmil-750kcmil	1/2	0.531	1.750	3.000	3.563	7.438	2.188	0.546	White	I-125	1.500	1.172
CLNF-1000-58	1000kcmil	750 G,H,I FLEX 777.7 DLO	1000kcmil-750kcmil	5/8	0.688	-	2.125	3.563	6.563	2.188	0.671	White	I-125	1.500	1.172
CLNF-1111-12-134	1111kcmil	-	-	1/2	0.562	1.750	3.000	3.313	7.438	2.600	0.546	White	IDT-12	1.750	1.458
CLNF-1111-58	1111kcmil	-	-	5/8	0.656	-	2.250	3.563	6.688	2.600	0.671	White	IDT-12	1.750	1.458

* When installed with specified dieless tools

+ See pages 90 to 97 for complete tooling information.

A TYPE CLNU

Features

- Manufactured from high strength seamless copper tubing.
- Electro-Tin plated.
- Maximum conductivity and excellent crimping characteristics.
- Long barrel length with chamfered entry.
- Color coded.
- UL 486A 90°C Listed and CSA Certified for 600 Volts.
- If proper high voltage spacing and insulation techniques are used, may be used for high voltage applications up to 35KV.
- For Copper conductor only.
- IlSCO connectors are UL Listed and CSA Certified with ILSCO and other Manufacturers' tools.+
- UL File E6207



Catalog Number	Wire Size	Alt Wire Size	Expanded* Wire Range	Dimensions			Die Color Code	Die Index	O.D.	I.D.
				A	B	D				
CLNU-6	6 AWG	-	-	3.000	1.130	0.760	Blue	I-24	0.295	0.203
CLNU-4	4 AWG	#6 Flex	4-6 AWG	3.000	1.130	0.760	White	I-29	0.343	0.250
CLNU-3	3 AWG	#4 Flex	3-6 AWG	3.000	1.130	0.750	White	I-29	0.375	0.275
CLNU-2	2 AWG	-	2-6 AWG	3.000	1.130	0.740	Brown	I-33	0.421	0.312
CLNU-1	1 AWG	#2 Flex	1-6 AWG	3.000	1.380	0.740	Green	I-37	0.468	0.359
CLNU-1/0	1/0 AWG	#1 Flex	1/0-6 AWG	3.000	1.500	0.740	Pink	I-42	0.515	0.390
CLNU-2/0	2/0 AWG	1/0 Flex	2/0-4 AWG	3.000	1.500	0.810	Black	I-45	0.562	0.437
CLNU-3/0	3/0 AWG	2/0 Flex	3/0-2 AWG	3.000	1.500	0.890	Orange	I-50	0.609	0.484
CLNU-4/0	4/0 AWG	3/0 Flex	4/0-1 AWG	3.000	1.500	1.000	Purple	I-54	0.687	0.546
CLNU-250	250kcmil	4/0 Flex	250kcmil-1/0 AWG	3.000	1.690	1.090	Yellow	I-62	0.750	0.593
CLNU-300	300kcmil	250 G,H Flex	300kcmil-2/0 AWG	3.000	2.000	1.190	White	I-66	0.812	0.660
CLNU-350	350kcmil	250 I,K,M Flex 262.2 DLO	350kcmil-3/0 AWG	3.000	2.000	1.290	Red	I-71	0.890	0.703
CLNU-400	400kcmil	300 G,H,I,K,M Flex 313.1 DLO	400kcmil-4/0 AWG	3.000	2.130	1.370	Blue	I-76	0.937	0.750
CLNU-500	500kcmil	350 G,H,I,K,M Flex 373.7 DLO	500kcmil-250kcmil	3.000	2.250	1.530	Brown	I-87	1.062	0.828
CLNU-600	600kcmil	400 G,H,I,K,M Flex 444.4 DLO	600kcmil-250kcmil	3.000	2.690	1.710	Green	I-94	1.187	0.920
CLNU-650	650kcmil	500 G,H,I,K,M Flex 535.3 DLO	650kcmil-350kcmil	3.000	2.690	1.760	Pink	I-99	1.217	0.958
CLNU-700	700kcmil	500 G,H,I,K,M Flex 535.3 DLO	700kcmil-350kcmil	3.000	2.690	1.820	Pink	I-99	1.250	0.991
CLNU-750	750kcmil	600 G,H,I,M Flex 646.4 DLO	750kcmil-500kcmil	3.000	2.880	1.900	Black	I-106	1.313	1.031
CLNU-1000	1000kcmil	750 G,H,I Flex 777.7 DLO	1000kcmil-750kcmil	3.000	3.000	2.170	White	I-125	1.500	1.172

* When installed with specified dieless tools

+ See pages 90 to 97 for complete tooling information.

For Bent Tangs change the 4th letter to a B and add "-4" for 45 deg. or "-9" for 90 deg.

TYPE CCL

Features

- Electro-tin plated
- Sight hole for visual inspection of proper cable insertion
- Solid seamless tang for performance and strength
- Electrolytic copper for high conductivity
- UL 486A 90° C Listed and CSA Certified
- For copper conductor only
- Installing Tool: MT-25

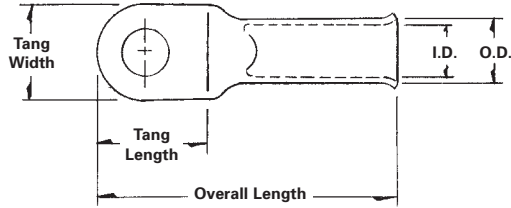

Catalog Number	Wire Size	Alt Wire Size	Bolt Size	Tang Length	Tang Width	Tang Thickness	Overall Length	Die Color Code	I.D.	O.D.
CCL-8-10	8 AWG	8 FLEX	#8-#10	0.579	0.445	0.071	1.201	RED	0.185	0.256
CCL-8-14	8 AWG	8 FLEX	1/4	0.579	0.445	0.071	1.201	RED	0.185	0.256
CCL-8-516	8 AWG	8 FLEX	5/16	0.724	0.598	0.059	1.276	RED	0.185	0.256
CCL-8-38	8 AWG	8 FLEX	3/8	0.724	0.598	0.059	1.276	RED	0.185	0.256
CCL-8-12	8 AWG	8 FLEX	1/2	0.858	0.752	0.059	1.480	RED	0.185	0.256

CONTINUED ON NEXT PAGE.

Tooling Information

Catalog Number	Standard Stranded Conductor				Color Code	
	ILSCO		Burndy	Thomas & Betts		AET
	MT-25 Hand Dieless No. of Crimps	ILC-10-N Die No. No. of Crimps	MY29-3 Hand Dieless No. of Crimps	M 5		406
CCL-8	-	Red (2)	(1)	-	-	Red

UL Listed and CSA Certified 600 volts maximum when installed with tools and dies shown above. If proper high voltage spacings and insulation techniques are used, these compression connectors can be used for high voltage applications up to 35KV.

UL File E6207

A

TYPE
CCL

Features

- Electro-tin plated
- Sight hole for visual inspection of proper cable insertion
- Solid seamless tang for performance and strength
- Electrolytic copper for high conductivity
- UL 486A 90° C Listed and CSA Certified
- For copper conductor only
- Installing Tool: MT-25

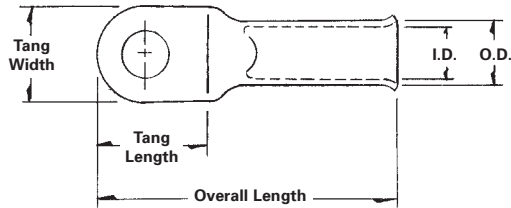

Catalog Number	Wire Size	Alt Wire Size	Bolt Size	Tang Length	Tang Width	Tang Thickness	Overall Length	Die Color Code	I.D.	O.D.
CCL-6-10	6 AWG	6 FLEX	#10	0.579	0.445	0.075	1.268	BLUE	0.232	0.299
CCL-6-14	6 AWG	6 FLEX	1/4	0.579	0.445	0.075	1.268	BLUE	0.232	0.299
CCL-6-516	6 AWG	6 FLEX	5/16	0.724	0.598	0.067	1.409	BLUE	0.232	0.299
CCL-6-38	6 AWG	6 FLEX	3/8	0.724	0.598	0.067	1.409	BLUE	0.232	0.299
CCL-6-12	6 AWG	6 FLEX	1/2	0.858	0.752	0.059	1.551	BLUE	0.232	0.299

CONTINUED ON NEXT PAGE.

Tooling Information

Catalog Number	Standard Stranded Conductor				Color Code	
	ILSCO		Burndy	Thomas & Betts		AET
	MT-25 Hand Dieless No. of Crimps	ILC-10-N Die No. No. of Crimps	MY29-3 Hand Dieless No. of Crimps	M 5		406
CCL-6	-	Blue (2)	(1)	Blue (1)	A/1	Blue

UL Listed and CSA Certified 600 volts maximum when installed with tools and dies shown above. If proper high voltage spacings and insulation techniques are used, these compression connectors can be used for high voltage applications up to 35KV.

UL File E6207

TYPE CCL

Features

- Electro-tin plated
- Sight hole for visual inspection of proper cable insertion
- Solid seamless tang for performance and strength
- Electrolytic copper for high conductivity
- UL 486A 90° C Listed and CSA Certified
- For copper conductor only
- Installing Tool: MT-25

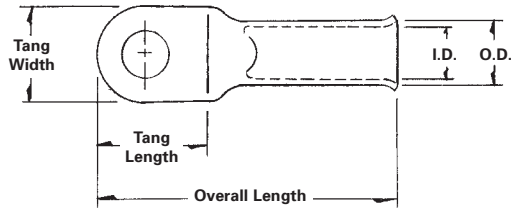

Catalog Number	Wire Size	Alt Wire Size	Bolt Size	Tang Length	Tang Width	Tang Thickness	Overall Length	Die Color Code	I.D.	O.D.
CCL-4-10	4 AWG	4 FLEX	#10	0.681	0.516	0.075	1.496	GRAY	0.283	0.362
CCL-4-14	4 AWG	4 FLEX	1/4	0.681	0.516	0.075	1.496	GRAY	0.283	0.362
CCL-4-516	4 AWG	4 FLEX	5/16	0.728	0.626	0.075	1.496	GRAY	0.283	0.362
CCL-4-38	4 AWG	4 FLEX	3/8	0.728	0.626	0.075	1.496	GRAY	0.283	0.362
CCL-4-12	4 AWG	4 FLEX	1/2	0.858	0.752	0.091	1.681	GRAY	0.283	0.362

CONTINUED ON NEXT PAGE.
Dimensions in inches – approximate.

Tooling Information

Catalog Number	Standard Stranded Conductor				Color Code	
	ILSCO		Burndy	Thomas & Betts		AET
	MT-25 Hand Dieless No. of Crimps	ILC-10-N Die No. No. of Crimps	MY29-3 Hand Dieless No. of Crimps	M 5		406
CCL-4	(1)	Grey (2)	(1)	Grey (1)	A/1	Grey

UL Listed and CSA Certified 600 volts maximum when installed with tools and dies shown above. If proper high voltage spacings and insulation techniques are used, these compression connectors can be used for high voltage applications up to 35KV.

UL File E6207

A TYPE CCL

Features

- Electro-tin plated
- Sight hole for visual inspection of proper cable insertion
- Solid seamless tang for performance and strength
- Electrolytic copper for high conductivity
- UL 486A 90° C Listed and CSA Certified
- For copper conductor only
- Installing Tool: MT-25

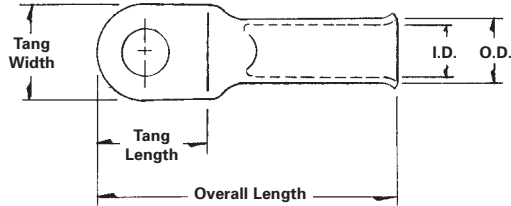

Catalog Number	Wire Size	Alt Wire Size	Bolt Size	Tang Length	Tang Width	Tang Thickness	Overall Length	Die Color Code	I.D.	O.D.
CCL-2-14	2 AWG	3 FLEX	1/4	0.728	0.598	0.094	1.606	BROWN	0.335	0.429
CCL-2-516	2 AWG	3 FLEX	5/16	0.728	0.598	0.094	1.606	BROWN	0.335	0.429
CCL-2-38	2 AWG	3 FLEX	3/8	0.728	0.598	0.094	1.606	BROWN	0.335	0.429
CCL-2-12	2 AWG	3 FLEX	1/2	0.858	0.752	0.102	1.752	BROWN	0.335	0.429
CCL-1-14	1 AWG	2 FLEX	1/4	0.858	0.650	0.098	1.720	GREEN	0.362	0.461
CCL-1-516	1 AWG	2 FLEX	5/16	0.858	0.650	0.098	1.720	GREEN	0.362	0.461
CCL-1-38	1 AWG	2 FLEX	3/8	0.858	0.650	0.098	1.720	GREEN	0.362	0.461
CCL-1-12	1 AWG	2 FLEX	1/2	0.858	0.752	0.102	1.831	GREEN	0.362	0.461

CONTINUED ON NEXT PAGE.

Tooling Information

Catalog Number	Standard Stranded Conductor				Color Code	
	ILSCO		Burndy	Thomas & Betts		AET
	MT-25 Hand Dieless No. of Crimps	ILC-10-N Die No. No. of Crimps	MY29-3 Hand Dieless No. of Crimps	M 5		406
CCL-2	(1)	Brown (2)	(1)	Brown (1)	C/1	Brown
CCL-1	(1)	Green (2)	(1)	Green (1)	C/1	Green

UL Listed and CSA Certified 600 volts maximum when installed with tools and dies shown above. If proper high voltage spacings and insulation techniques are used, these compression connectors can be used for high voltage applications up to 35KV.

UL File E6207

TYPE CCL

Features

- Electro-tin plated
- Sight hole for visual inspection of proper cable insertion
- Solid seamless tang for performance and strength
- Electrolytic copper for high conductivity
- UL 486A 90° C Listed and CSA Certified
- For copper conductor only
- Installing Tool: MT-25

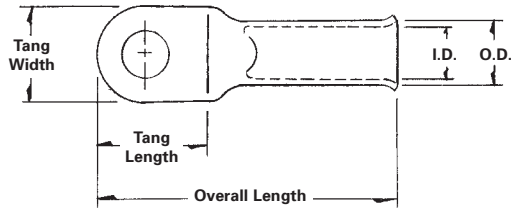

Catalog Number	Wire Size	Alt Wire Size	Bolt Size	Tang Length	Tang Width	Tang Thickness	Overall Length	Die Color Code	I.D.	O.D.
CCL-1/0-14	1/0 AWG	1 FLEX	1/4	0.791	0.713	0.110	1.831	PINK	0.406	0.516
CCL-1/0-516	1/0 AWG	1 FLEX	5/16	0.791	0.713	0.110	1.831	PINK	0.406	0.516
CCL-1/0-38	1/0 AWG	1 FLEX	3/8	0.791	0.713	0.110	1.831	PINK	0.406	0.516
CCL-1/0-12	1/0 AWG	1 FLEX	1/2	0.890	0.815	0.110	1.902	PINK	0.406	0.516
CCL-2/0-14	2/0 AWG	1/0 FLEX	1/4	0.929	0.815	0.110	2.055	BLACK	0.461	0.571
CCL-2/0-516	2/0 AWG	1/0 FLEX	5/16	0.929	0.815	0.110	2.055	BLACK	0.461	0.571
CCL-2/0-38	2/0 AWG	1/0 FLEX	3/8	0.929	0.815	0.110	2.055	BLACK	0.461	0.571
CCL-2/0-12	2/0 AWG	1/0 FLEX	1/2	0.929	0.815	0.110	2.055	BLACK	0.461	0.571

CONTINUED ON NEXT PAGE.

Tooling Information

Catalog Number	Standard Stranded Conductor				Color Code	
	ILSCO		Burndy	Thomas & Betts		AET
	MT-25 Hand Dieless No. of Crimps	ILC-10-N Die No. No. of Crimps	MY29-3 Hand Dieless No. of Crimps	M 5		406
CCL-1/0	(1)	Pink (2)	(1)	Pink (1)	B/1	Pink
CCL-2/0	(1)	-	(1)	Black (1)	B/1	Black

UL Listed and CSA Certified 600 volts maximum when installed with tools and dies shown above. If proper high voltage spacings and insulation techniques are used, these compression connectors can be used for high voltage applications up to 35KV.

UL File E6207

A TYPE CCL

Features

- Electro-tin plated
- Sight hole for visual inspection of proper cable insertion
- Solid seamless tang for performance and strength
- Electrolytic copper for high conductivity
- UL 486A 90° C Listed and CSA Certified
- For copper conductor only
- Installing Tool: MT-25

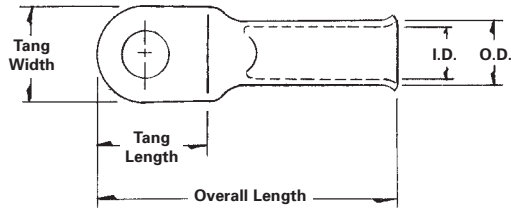

Catalog Number	Wire Size	Alt Wire Size	Bolt Size	Tang Length	Tang Width	Tang Thickness	Overall Length	Die Color Code	I.D.	O.D.
CCL-3/0-14	3/0 AWG	2/0 FLEX	1/4	0.969	0.894	0.118	2.161	ORANGE	0.512	0.630
CCL-3/0-516	3/0 AWG	2/0 FLEX	5/16	0.969	0.894	0.118	2.161	ORANGE	0.512	0.630
CCL-3/0-38	3/0 AWG	2/0 FLEX	3/8	0.969	0.894	0.118	2.161	ORANGE	0.512	0.630
CCL-3/0-12	3/0 AWG	2/0 FLEX	1/2	0.969	0.894	0.118	2.161	ORANGE	0.512	0.630
CCL-4/0-14	4/0 AWG	3/0 FLEX	1/4	1.071	1.035	0.130	2.382	PURPLE	0.591	0.720
CCL-4/0-516	4/0 AWG	3/0 FLEX	5/16	1.071	1.035	0.130	2.382	PURPLE	0.591	0.720
CCL-4/0-38	4/0 AWG	3/0 FLEX	3/8	1.071	1.035	0.130	2.382	PURPLE	0.591	0.720
CCL-4/0-12	4/0 AWG	3/0 FLEX	1/2	1.071	1.035	0.130	2.382	PURPLE	0.591	0.720

Tooling Information

Catalog Number	Standard Stranded Conductor				Color Code	
	ILSCO		Burndy	Thomas & Betts		AET
	MT-25 Hand Dieless No. of Crimps	ILC-10-N Die No. No. of Crimps	MY29-3 Hand Dieless No. of Crimps	M 5		406
CCL-3/0	(1)	-	(1)	Orange (1)	-/1	Orange
CCL-4/0	(2)	-	(1)	Purple (1)	-/1	Purple

UL Listed and CSA Certified 600 volts maximum when installed with tools and dies shown above. If proper high voltage spacings and insulation techniques are used, these compression connectors can be used for high voltage applications up to 35KV.

UL File E6207

TYPE CRAM

Features

- Electro-tin plated
- Sight hole for visual inspection
- Solid seamless tang for performance and strength
- Electrolytic copper for high conductivity
- UL 486A 90°C Listed and CSA Certified
- For copper conductor only
- Installing Tool: MT-25

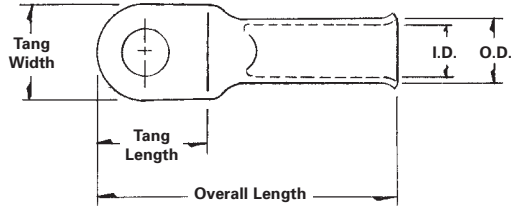

Catalog Number	Alt Wire Size	Wire Size	Bolt Size	Tang Length	Tang Width	Tang Thickness	Overall Length	Die Color Code	I.D.	O.D.
CRA-8-8/10M	8 FLEX	8 AWG	#8-#10	0.579	0.445	0.071	1.201	RED	0.185	0.256
CRA-8-14M	8 FLEX	8 AWG	1/4	0.579	0.445	0.071	1.201	RED	0.185	0.256
CRA-8-516M	8 FLEX	8 AWG	5/16	0.724	0.598	0.059	1.276	RED	0.185	0.256
CRA-8-38M	8 FLEX	8 AWG	3/8	0.724	0.598	0.059	1.276	RED	0.185	0.256
CRA-8-12M	8 FLEX	8 AWG	1/2	0.858	0.752	0.059	1.480	RED	0.185	0.256
CRA-6-10M	6 FLEX	6 AWG	#10	0.579	0.445	0.075	1.268	BLUE	0.232	0.299
CRA-6-14M	6 FLEX	6 AWG	1/4	0.579	0.445	0.075	1.268	BLUE	0.232	0.299
CRA-6-516-M	6 FLEX	6 AWG	5/16	0.724	0.598	0.067	1.409	BLUE	0.232	0.299
CRA-6-38M	6 FLEX	6 AWG	3/8	0.724	0.598	0.067	1.409	BLUE	0.232	0.299
CRA-6-12M	6 FLEX	6 AWG	1/2	0.858	0.752	0.059	1.551	BLUE	0.232	0.299
CRA-4-10M	4 FLEX	4 AWG	#10	0.681	0.516	0.075	1.496	GRAY	0.283	0.362
CRA-4-14M	4 FLEX	4 AWG	1/4	0.681	0.516	0.075	1.496	GRAY	0.283	0.362
CRA-4-516M	4 FLEX	4 AWG	5/16	0.728	0.626	0.075	1.496	GRAY	0.283	0.362
CRA-4-38M	4 FLEX	4 AWG	3/8	0.728	0.626	0.075	1.496	GRAY	0.283	0.362
CRA-4-12M	4 FLEX	4 AWG	1/2	0.858	0.752	0.091	1.681	GRAY	0.283	0.362
CRA-2-14M	2 FLEX	1 AWG	1/4	0.858	0.650	0.098	1.720	GREEN	0.362	0.461
CRA-2-516M	2 FLEX	1 AWG	5/16	0.858	0.650	0.098	1.720	GREEN	0.362	0.461
CRA-2-38M	2 FLEX	1 AWG	3/8	0.858	0.650	0.098	1.720	GREEN	0.362	0.461
CRA-2-12M	2 FLEX	1 AWG	1/2	0.858	0.752	0.102	1.831	GREEN	0.362	0.461
CRA-1-14M	1 FLEX	1/0 AWG	1/4	0.791	0.713	0.110	1.831	PINK	0.406	0.516
CRA-1-516M	1 FLEX	1/0 AWG	5/16	0.791	0.713	0.110	1.831	PINK	0.406	0.516
CRA-1-38M	1 FLEX	1/0 AWG	3/8	0.791	0.713	0.110	1.831	PINK	0.406	0.516
CRA-1-12M	1 FLEX	1/0 AWG	1/2	0.890	0.815	0.110	1.902	PINK	0.406	0.516
CRA-1/0-14M	1/0 FLEX	2/0 AWG	1/4	0.929	0.815	0.110	2.055	BLACK	0.461	0.571
CRA-1/0-516M	1/0 FLEX	2/0 AWG	5/16	0.929	0.815	0.110	2.055	BLACK	0.461	0.571
CRA-1/0-38M	1/0 FLEX	2/0 AWG	3/8	0.929	0.815	0.110	2.055	BLACK	0.461	0.571
CRA-1/0-12M	1/0 FLEX	2/0 AWG	1/2	0.929	0.815	0.110	2.055	BLACK	0.461	0.571
CRA-2/0-14M	2/0 FLEX	3/0 AWG	1/4	0.969	0.894	0.118	2.161	ORANGE	0.512	0.630
CRA-2/0-516M	2/0 FLEX	3/0 AWG	5/16	0.969	0.894	0.118	2.161	ORANGE	0.512	0.630
CRA-2/0-38-M	2/0 FLEX	3/0 AWG	3/8	0.969	0.894	0.118	2.161	ORANGE	0.512	0.630
CRA-2/0-12M	2/0 FLEX	3/0 AWG	1/2	0.969	0.894	0.118	2.161	ORANGE	0.512	0.630
CRA-3/0-38M	3/0 FLEX	4/0 AWG	3/8	1.071	1.035	0.130	2.382	PURPLE	0.591	0.720
CRA-3/0-12M	3/0 FLEX	4/0 AWG	1/2	1.071	1.035	0.130	2.382	PURPLE	0.591	0.720
CRA-4/0-38M	4/0 FLEX	250 kcmil	3/8	1.228	1.201	0.130	2.614	YELLOW	0.685	0.815
CRA-4/0-12M	4/0 FLEX	250 kcmil	1/2	1.228	1.201	0.130	2.614	YELLOW	0.685	0.815

UL File E6207

A TYPE Solder Lugs

Features

- Manufactured from high strength copper tubing
- Seamless construction
- Clearly marked with wire size
- UL Listed and CSA Certified for 600 volts, 90° C

Benefits

- Provides maximum conductivity
- Won't leak solder
- Provides easy identification
- Ensures reliability

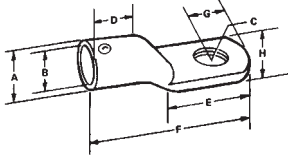

Fig. 1

Fig. 2

Catalog Number	Old Description	Figure Number	Wire Size	Dimensions								Amp Rating
				B	Bolt Size	C	D	E	F	G	H	
3/16	25A	1	10	9/64	#8	11/64	11/32	15/32	15/16	3/16	1/4	25 Amp
1/4	35A	1	8	3/16	#10	13/64	11/32	1/2	1-1/32	7/32	3/8	35 Amp
5/16	50A	1	6	15/64	#10	13/64	13/32	19/32	1-7/32	1/4	7/16	50 Amp
3/8	70A	1	4	9/32	1/4	9/32	7/16	11/16	1-3/8	9/32	17/32	70 Amp
7/16	90A	1	2	11/32	1/4	9/32	1/2	3/4	1-1/2	11/32	5/8	90 Amp
1/2	125A	1	1/0	25/64	5/16	11/32	9/16	13/16	1-3/4	13/32	3/4	125 Amp
9/16	150A	1	2/0	15/32	3/8	13/32	11/16	15/16	2	7/16	13/16	150 Amp
5/8	175A	1	3/0	33/64	3/8	13/32	25/32	1	2-1/8	1/2	29/32	175 Amp
11/16	225A	1	4/0	9/16	3/8	13/32	27/32	1-5/32	2-3/8	17/32	31/32	225 Amp
13/16	250A	1	250kcmil	43/64	3/8	13/32	31/32	1-1/4	2-21/32	5/8	1-3/16	250 Amp
1-1/8	450A	2	600kcmil	61/64	3/8	13/32	1-1/2	2-1/4	4-7/16	1	1-5/8	450 Amp
1-5/16	550A	2	800kcmil	1-3/32	1/2	17/32	1-13/16	2-1/2	5-1/16	1-1/8	1-15/16	550 Amp
1-7/16	650A	2	1000kcmil	1-7/32	7/8	29/32	2	2-1/2	5-3/8	1-3/16	2-1/8	650 Amp
1-3/4	850A	2	1500kcmil	1-15/32	1	1-1/32	2-3/8	3-1/8	6-5/8	1-7/16	2-5/8	850 Amp

Tested to UL 486A-486B, UL File E6207

TYPE CT

Features

- Manufactured from high strength seamless copper tubing.
- Electro-Tin plated.
- Maximum conductivity and excellent crimping characteristics.
- Chamfered entry.
- Color coded.
- UL 486A 90°C Listed and CSA Certified for 600 Volts.
- If proper high voltage spacing and insulation techniques are used, may be used for high voltage applications up to 35KV.
- For Copper conductor only.
- IlSCO connectors are UL Listed and CSA Certified with ILSCO or other Manufacturers' tools.
- UL File E6207

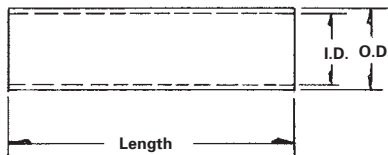

Catalog Number	Wire Size	Alt Wire Size	Expanded* Wire Range	Barrel Length	Die Color Code	Die Index	Die Catalog Number	O.D.	I.D.
CT-8	8 AWG	#8 Flex	-	1.125	Red	I-21	ILD-21	0.272	0.179
CT-6	6 AWG	-	-	1.750	Blue	I-24	ILD-24	0.295	0.203
CT-4	4 AWG	#6 Flex	4-6 AWG	1.875	Gray	I-29	ILD-29	0.343	0.250
CT-3	3 AWG	#4 Flex	3-6 AWG	1.750	White	I-29	ILD-29	0.375	0.275
CT-2	2 AWG	-	2-6 AWG	1.875	Brown	I-33	ILD-33	0.421	0.312
CT-1	1 AWG	#2 Flex	1-6 AWG	1.875	Green	I-37	ILD-37	0.468	0.359
CT-1/0	1/0 AWG	#1 Flex	1/0-6 AWG	1.875	Pink	I-42	ILD-42	0.515	0.390
CT-2/0	2/0 AWG	1/0 Flex	2/0-4 AWG	2.000	Black	I-45	ILD-45	0.562	0.437
CT-3/0	3/0 AWG	2/0 Flex	3/0-2 AWG	2.125	Orange	I-50	ILD-50	0.609	0.484
CT-4/0	4/0 AWG	3/0 Flex	4/0-1 AWG	2.125	Purple	I-54	ILD-54	0.687	0.546
CT-250	250kcmil	4/0 Flex	250kcmil-1/0 AWG	2.250	Yellow	I-62	ILD-62	0.750	0.593
CT-300	300kcmil	250 G,H Flex	300kcmil-2/0 AWG	2.250	White	I-66	ILD-66	0.812	0.660
CT-350	350kcmil	250 I,K,M Flex 262.2 DLO	350kcmil-3/0 AWG	2.375	Red	I-71	ILD-71	0.890	0.703
CT-400	400kcmil	300 G,H,I,K,M Flex 313.1 DLO	400kcmil-4/0 AWG	2.500	Blue	I-76	ILD-76	0.937	0.750
CT-500	500kcmil	350 G,H,I,K,M Flex 373.7 DLO	500kcmil-250kcmil	2.875	Brown	I-87	ILD-87	1.062	0.828
CT-600	600kcmil	400 G,H,I,K,M Flex 444.4 DLO	600kcmil-250kcmil	2.875	Green	I-94	ILD-94	1.187	0.920
CT-650	650kcmil	500 G,H,I,K,M Flex 535.3 DLO	650kcmil-350kcmil	2.875	Pink	I-99	ILD-99	1.222	0.962
CT-700	700kcmil	500 G,H,I,K,M Flex 535.3 DLO	700kcmil-350kcmil	3.375	Pink	I-99	ILD-99	1.250	0.991
CT-750	750kcmil	600 G,H,I,K,M Flex 646.4 DLO	750kcmil-500kcmil	3.375	Black	I-106	ILD-106	1.313	1.031
CT-1000	1000kcmil	750 G,H,I Flex 777.7 DLO	1000kcmil-750kcmil	3.875	White	I-125	ILD-125	1.500	1.172

* When installed with specified dieless tools
See pages 90 to 97 for complete tooling information.

A

TYPE CTL

Features

- Manufactured from high strength seamless copper tubing.
- Electro-Tin plated.
- Maximum conductivity and excellent crimping characteristics.
- Chamfered entry.
- Color coded.
- UL 486A 90°C Listed and CSA Certified for 600 Volts.
- If proper high voltage spacing and insulation techniques are used, may be used for high voltage applications up to 35KV.
- For Copper conductor only.
- IlSCO connectors are UL Listed and CSA Certified with ILSCO or other Manufacturers' tools.
- UL File E6207

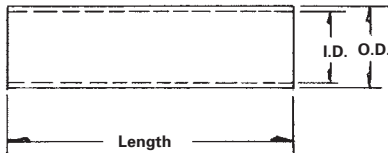

Catalog Number	Wire Size	Alt Wire Size	Expanded* Wire Range	Barrel Length	Die Color Code	Die Index	Die Catalog Number	O.D.	I.D.
CTL-8	8 AWG	-	-	1.75	Red	I-21	ILD-21	0.272	0.179
CTL-6	6 AWG	-	-	2.375	Blue	I-24	ILD-24	0.295	0.203
CTL-4	4 AWG	#6 Flex	4-6 AWG	2.375	Gray	I-29	ILD-29	0.343	0.250
CTL-3	3 AWG	#4 Flex	3-6 AWG	2.375	White	I-29	ILD-29	0.375	0.275
CTL-2	2 AWG	-	2-6 AWG	2.625	Brown	I-33	ILD-33	0.421	0.312
CTL-1	1 AWG	#2 Flex	1-6 AWG	2.875	Green	I-37	ILD-37	0.468	0.359
CTL-1/0	1/0 AWG	#1 Flex	1/0-6 AWG	2.875	Pink	I-42	ILD-42	0.515	0.390
CTL-2/0	2/0 AWG	1/0 Flex	2/0-4 AWG	3.125	Black	I-45	ILD-45	0.562	0.437
CTL-3/0	3/0 AWG	2/0 Flex	3/0-2 AWG	3.125	Orange	I-50	ILD-50	0.609	0.484
CTL-4/0	4/0 AWG	3/0 Flex	4/0-1 AWG	3.375	Purple	I-54	ILD-54	0.687	0.546
CTL-250	250kcmil	4/0 Flex	250kcmil-1/0 AWG	3.375	Yellow	I-62	ILD-62	0.750	0.593
CTL-300	300kcmil	250 G,H Flex	300kcmil-2/0 AWG	4.125	White	I-66	ILD-66	0.812	0.660
CTL-350	350kcmil	250 I,K,M Flex 262.2 DLO	350kcmil-3/0 AWG	4.125	Red	I-71	ILD-71	0.890	0.703
CTL-400	400kcmil	300 G,H,I,K,M Flex 313.1 DLO	400kcmil-4/0 AWG	4.375	Blue	I-76	ILD-76	0.937	0.750
CTL-500	500kcmil	350 G,H,I,K,M Flex 373.7 DLO	500kcmil-250kcmil	4.625	Brown	I-87	ILD-87	1.062	0.828
CTL-600	600kcmil	400 G,H,I,K,M Flex 444.4 DLO	600kcmil-250kcmil	4.625	Green	I-94	ILD-94	1.187	0.920
CTL-650	650kcmil	500 G,H,I,K,M Flex 535.3 DLO	650kcmil-350kcmil	4.625	Pink	I-99	ILD-99	1.222	0.962
CTL-700	700kcmil	500 G,H,I,K,M Flex 535.3 DLO	700kcmil-350kcmil	5.875	Pink	I-99	ILD-99	1.250	0.991
CTL-750	750kcmil	600 G,H,I,K,M Flex 646.4 DLO	750kcmil-500kcmil	5.875	Black	I-106	ILD-106	1.313	1.031
CTL-1000	1000kcmil	750 G,H,I Flex 777.7 DLO	1000kcmil-750kcmil	6.125	White	I-125	ILD-125	1.500	1.172

* When installed with specified dieless tools
See pages 90 to 97 for complete tooling information.

TYPE CCS

Features

- Manufactured from high strength copper
- Electro-tin plated
- UL Listed and CSA Certified for 600 volts, 90° C
- Color coded
- Sight hole
- Flared end

Benefits

- Provides maximum conductivity and excellent crimping characteristics
- Provides low contact resistance
- Ensures reliability for copper conductors
- Provides visual tooling recommendation for IlSCO or standard industry tools
- Allows visual cable inspection
- Easy wire insertion

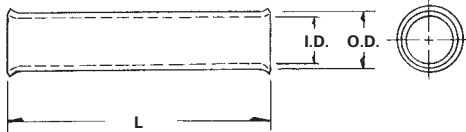

Catalog Number	Wire Size	Color Code	L	O.D.	I.D.
CCS-8	8	Red	49/64	1/4	11/64
CCS-6	6	Blue	1-1/16	5/16	15/64
CCS-4	4	Grey	1-13/64	23/64	9/32
CCS-2	2	Brown	1-23/64	7/16	21/64
CCS-1	1	Green	1-23/64	15/32	23/64

CONTINUED ON NEXT PAGE.

Tooling Information

Catalog Number	Standard Stranded Conductor				Color Code	
	ILSCO		Burndy	Thomas & Betts		AET
	MT-25 Hand Dieless No. of Crimps	ILC-10-N Die No. No. of Crimps	MY29-3 Hand Dieless No. of Crimps	M 5		406
CCS-8	-	Red (2)	(1)	-	-	Red
CCS-6	-	Blue (2)	(1)	Blue (1)	A/1	Blue
CCS-4	(1)	Grey (2)	(1)	Grey (1)	A/1	Grey
CCS-2	(1)	Brown (2)	(1)	Brown (1)	C/1	Brown
CCS-1	(1)	Green (2)	(1)	Green (1)	C/1	Green

UL Listed and CSA Certified 600 volts maximum when installed with tools and dies shown above. If proper high voltage spacings and insulation techniques are used, these compression connectors can be used for high voltage applications up to 35KV. See stuffer sheet for complete information on tooling.

UL File E158587

A

TYPE CCS

Features

- Manufactured from high strength copper
- Electro-tin plated
- UL Listed and CSA Certified for 600 volts, 90° C
- Color coded
- Sight hole
- Flared end

Benefits

- Provides maximum conductivity and excellent crimping characteristics
- Provides low contact resistance
- Ensures reliability for copper conductors
- Provides visual tooling recommendation for IlSCO or standard industry tools
- Allows visual inspection
- Easy wire insertion

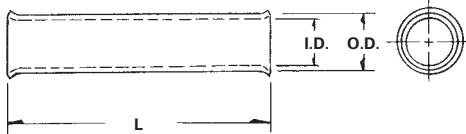

Catalog Number	Wire Size	Color Code	L	O.D.	I.D.
CCS-1/0	1/0	Pink	1-35/64	33/64	13/32
CCS-2/0	2/0	Black	1-51/64	37/64	15/32
CCS-3/0	3/0	Orange	1-29/32	5/8	33/64
CCS-4/0	4/0	Purple	2	11/16	9/16

Tooling Information

Catalog Number	Standard Stranded Conductor				Color Code	
	ILSCO		Burndy	Thomas & Betts		AET
	MT-25 Hand Dieless No. of Crimps	ILC-10-N Die No. No. of Crimps	MY29-3 Hand Dieless No. of Crimps	M 5		406
CCS-1/0	(1)	Pink (2)	(1)	Pink (1)	B/1	Pink
CCS-2/0	(1)	-	(1)	Black (1)	B/1	Black
CCS-3/0	(1)	-	(1)	Orange (1)	-/1	Orange
CCS-4/0	(2)	-	(2)	Purple (1)	-/1	Purple

UL Listed and CSA Certified 600 volts maximum when installed with tools and dies shown above. If proper high voltage spacings and insulation techniques are used, these compression connectors can be used for high voltage applications up to 35KV. See stuffer sheet for complete information on tooling.

UL File E158587

TYPE GGA

Features

- Manufactured from high strength copper alloy
- Clearly marked with wire size and die index
- Range taking
- Connector can be adjusted prior to installation
- Non-hazardous installation
- Prefilled with inhibiting compound
- Temperature Rating 90° C

Benefits

- Provides maximum conductivity and eliminates the possibility of corrosion. Suitable for direct burial.
- Provides easy identification and tooling recommendation
- Reduces inventory. Six sizes cover a wire range from 500kcmil to #6, and 1/2" to 3/4" ground rods.
- Permits adjustments to be made for misaligned cross grids
- Can be installed in all types of weather with no need for protective equipment or clothing. Does not produce heat or dangerous particles.
- Prevents oxides from forming
- Ensures reliability

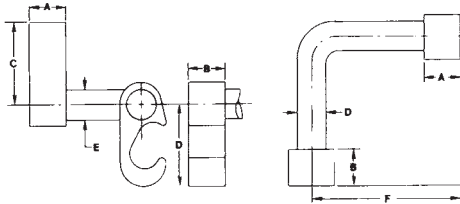

Catalog Number	Wire Range		Rod Size	Dimensions						A Die Index	B Die Index
	Main	Tap		A	B	C	D	E	F		
GGA-1	2str-6sol	2str-6sol	-	.75	.75	1.09	1.09	.313	2.50	0	0
GGA-2	250kcmil-1str	2str-6sol	1/2, 5/8	.75	.75	1.66	1.09	.313	2.50	997	0
GGA-3	250kcmil-2str	250kcmil-2str	1/2, 5/8	.75	.75	1.66	1.66	.500	2.50	997	997
GGA-4	500kcmil-250kcmil	2str-6sol	5/8, 3/4	.75	.75	2.09	1.09	.313	2.50	998	0
GGA-5	500kcmil-250kcmil	250kcmil-2str	5/8, 3/4	.75	.75	2.09	1.66	.500	2.50	998	997
GGA-6	500kcmil-250kcmil	500kcmil-250kcmil	5/8, 3/4	.75	.75	2.28	2.28	.750	2.50	999/1011	999/1011

Tested to UL 467, UL File E34440

NOTE: Hydraulic tools required on all sizes except GGA-1
Dieless tools can not be used

A TYPE GGC

Features

- Manufactured from high strength copper alloy
- Clearly marked with wire size and die index
- Range taking
- Versatile
- Non-hazardous installation
- Prefilled with inhibiting compound
- Temperature Rating 90° C

Benefits

- Provides maximum conductivity and eliminates the possibility of corrosion. Suitable for direct burial.
- Provides easy identification and tooling recommendation
- Reduces inventory. Eight sizes cover a wire range from 500kcmil to #6, and 1/2" to 3/4" ground rods.
- Can be used as a tap connector or as a lap splice connector
- Can be installed in all types of weather with no need for protective equipment or clothing. Does not produce heat or dangerous particles.
- Prevents oxides from forming
- Ensures reliability

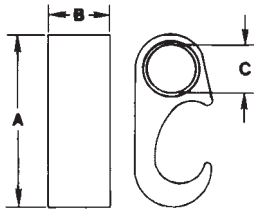

Catalog Number	Wire Range		Rod Size	Dimensions			Index
	Main	Tap		A	B	C	
GGC-1	2str-6sol	2str-6sol	-	1.4	.75	.33	0
GGC-2	250kcmil-1/0str	2str-4sol	1/2, 5/8	2.1	.75	.33	997
GGC-3	250kcmil-1/0str	2/0str-1/0str	1/2, 5/8	2.1	.75	.44	997
GGC-4	250kcmil-1/0str	250kcmil-3/0str	1/2, 5/8	2.1	.75	.61	997
GGC-5	500kcmil-250kcmil	2str-4sol	5/8, 3/4	2.6	.75	.33	998
GGC-6	500kcmil-250kcmil	2/0str-1/0str	5/8, 3/4	2.6	.75	.44	998
GGC-7	500kcmil-250kcmil	250kcmil-3/0str	5/8, 3/4	2.6	.75	.61	998
GGC-8	500kcmil-250kcmil	500kcmil-350kcmil	5/8, 3/4	2.9	.75	.84	999/1011

Tested to UL 467, UL File E34440

NOTE: Hydraulic tools required on all sizes except GGC-1
Dieless tools can not be used

ILSCO Copper C Crimps



A

TYPE ULT

Features

- Manufactured from high strength copper alloy
- Clearly marked with wire size and die index
- Range taking
- UL Listed for 600 volts, 90° C

Benefits

- Provides maximum conductivity and eliminates the possibility of corrosion
- Provides easy identification and tooling recommendation
- Reduces inventory
- Ensures reliability

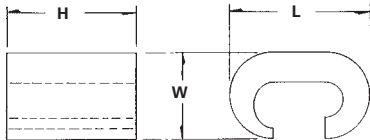

Catalog Number	Copper Wire Range		Die Index	Dimensions		
	Main	Tap		L	W	H
ULT-4-Z	4str-6sol	6str-6sol	BG or 5/8	3/4	15/32	49/64
ULT-5-Z	4str-6sol	4str-4sol	BG or 5/8	3/4	15/32	27/32
ULT-6-Z	2str-2sol	6str-8sol	C	7/8	5/8	1
ULT-7-Z	2str-2sol	2str-2sol	C	7/8	39/64	1-1/16
ULT-12-Z	4/0str-3/0str	4/0str-3/0str	F or D3	1-1/8	1	1-5/8

Tested to UL 486A-486B, UL File E6207



A

TYPE ELT

Features

- Manufactured from copper alloy
- Clearly marked with wire size and die index
- Range taking
- UL Listed and CSA Certified for grounding and bonding, rated for 600 volts
- May be used in ground grid applications

Benefits

- Provides maximum conductivity and eliminates the possibility of corrosion. Suitable for direct burial
- Provides easy identification and tooling recommendation
- Reduces inventory
- Ensures reliability
- Flexibility in application



Catalog Number	Copper Wire Range		W	Die Index
	Main	Tap		
ELT-1	2str-6sol	2str-6sol	.75	C (U Type)
ELT-4	2/0str-1str	2str-6str	.75	0 (U Type)
ELT-2	2/0str-1str	2/0str-1str	.75	0 (U Type)
ELT-5	250kcmil-3/0str	2/0str-6sol	.75	997 (U Type)
ELT-3	250kcmil-3/0str	250kcmil-3/0str	.900	997 (U Type)
ELT-6	500kcmil-300kcmil	250kcmil-3/0str	.875	1011 (U Type)

Tooling Information

Catalog Number	ILSCO		Burndy		
	ILC-12H-N, ILCB-12-N ILC-12-N Die No. No. of Crimps	ILC-15H Die No. No. of Crimps	Y-35 Die Index No. of Crimps	Y-45 Die Index No. of Crimps	Y-46 Die Index No. of Crimps
ELT-1	ILD-C (1)	-	C (U Type) (1)	C (U Type) (1)	C (U Type) (1)
ELT-4	ILD-O (1)	-	O (U Type) (1)	O (U Type) (1)	O (U Type) (1)
ELT-2	ILD-O (1)	-	O (U Type) (1)	O (U Type) (1)	O (U Type) (1)
ELT-5	ILD-U997 (1)	-	997 (U Type) (1)	997 (U Type) (1)	997 (U Type) (1)
ELT-3	ILD-U997 (1)	-	997 (U Type) (1)	997 (U Type) (1)	997 (U Type) (1)
ELT-6	ILD-U1011 (1)	ILD-P1011 (2)	-	1011 (U Type) (2)	1011 (U Type) (1)

See stuffer sheet for complete information on tooling.

Tested to UL 467, UL File E34440



TYPE ACL

Features

- Electro-tin plated
- Manufactured from high strength aluminum alloy
- Chamfered barrel
- UL 486B 90° C Listed and CSA Certified for 600 volts
- Color coded
- Clearly marked with wire size and die index for IlSCO tools, proper number and location of crimps
- Prefilled with DE-OX
- Color coded end caps inserted in barrel

Benefits

- Provides low contact resistance
- Provides maximum conductivity and excellent crimping characteristics
- Provides easy conductor insertion
- Ensures reliability for copper or aluminum conductors
- Provides visual tooling recommendation for IlSCO or standard industry tools
- Provides easy identification and tooling recommendation
- Prevents oxides from forming
- Prevents foreign materials from entering the connector prior to usage and color code identifies the proper compression die

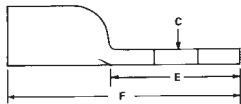

Catalog Number	Wire Size	Wire Range When Installed With IDT-12-N Tool	Die Color Code	Bolt Size	Tang Width	Dimensions			Die Index	O.D.	I.D.
						C	E	F			
ACL-8	8	8	Blue	1/4	1/2	9/32	11/16	1-7/16	2	5/16	11/64
ACN-8	8	8	Blue	#10	1/2	13/64	11/16	1-7/16	2	5/16	11/64
ACL-6	6	6	Gray	1/4	1/2	9/32	11/16	1-43/64	3	11/32	3/16
ACL-4	4	4-6	Green	1/4	9/16	9/32	23/32	1-13/16	4	7/16	1/4
ACN-4	4	4-6	Green	5/16	9/16	11/32	23/32	1-13/16	4	7/16	1/4
ACL-2	2	2-6	Pink	1/4	11/16	9/32	23/32	1-7/8	7	17/32	5/16
ACN-2	2	2-6	Pink	5/16	11/16	11/32	23/32	1-7/8	7	17/32	5/16

CONTINUED ON NEXT PAGE.

Tooling Information

Catalog Number	ILSCO								Burdyn								Thomas & Betts				Anderson	Color Code
	ILC-12-N Die No. No. of Crimps	ILCB-12-N Die No. No. of Crimps	IDTB-6 Dieless No. of Crimps	IDT-6, IDT-6H 6.2 Ton Dieless No. of Crimps	ILC-15H Die No. No. of Crimps	MT-25 Hand Dieless No. of Crimps	94285 Left /Rt. Die/Die No. of Crimps	IDT-12-N Dieless No. of Crimps	Y-48B Die Index No. of Crimps	Y-35 Die Index No. of Crimps	Y-39 Die Index No. of Crimps	Y-45 Die Index No. of Crimps	Y-46 Die Index No. of Crimps	MY29-3 Hand Dieless No. of Crimps	Y644M Dieless No. of Crimps	13642 12 Ton Die Index No. of Crimps	TBM 15 15 Ton Die Index No. of Crimps	21940 40 Ton Die Index No. of Crimps	TBM-8 Hand Tool No. of Crimps	Versa Crimp Dieless No. of Crimps		
ACL-8/ ACN-8	ILD-2 (1)	ILD-2 (1)	-	-	ILD-2 (1)	-	M/K (2)	-	-	-	-	-	-	-	24 (1)	24 (2)	-	-	-	Blue		
ACL-6	ILD-3 (1)	ILD-3 (1)	(1)	(1)	ILD-3 (1)	(1)	K/K (2)	(1)	-	346 (1)	346 (1)	346 (1)	346 (1)	-	29 (2)	29 (2)	29 (2)	(2)	(1)	Gray		
ACL-4/ ACN-4	ILD-4 (2)	ILD-4 (2)	(1)	(1)	ILD-4 (2)	(1)	H/H (3)	(1)	-	375 (1)	375 (1)	375 (1)	375 (1)	-	37 (2)	37 (2)	37 (2)	(2)	(1)	Green		
ACL-2/ ACN-2	ILD-7 (1) or ILD-6 (3)	ILD-7 (1) or ILD-6 (3)	(2)	(2)	ILD-7 (1) or ILD-6 (3)	-	E/A (3)	(1)	-	348 (1)	348 (1)	348 (1)	348 (1)	-	-	42 (1)	42H (4)	42 (2)	-	(1)	Pink	

UL Listed and CSA Certified 600 volts maximum when installed with tools and dies shown above. If proper high voltage spacings and insulation techniques are used, the aluminum compression connectors can be used for high voltage applications up to 35KV.

See stuffer sheet for complete information on tooling.

Tested to UL 486A-486B, UL File E6207

A

TYPE ACL

Features

- Electro-tin plated
- Manufactured from high strength aluminum alloy
- Chamfered barrel
- UL 486B 90° C Listed and CSA Certified for 600 volts
- Color coded
- Clearly marked with wire size and die index for IlSCO tools, proper number and location of crimps
- Prefilled with DE-OX
- Color coded end caps inserted in barrel

Benefits

- Provides low contact resistance
- Provides maximum conductivity and excellent crimping characteristics
- Provides easy conductor insertion
- Ensures reliability for copper or aluminum conductors
- Provides visual tooling recommendation for IlSCO or standard industry tools
- Provides easy identification and tooling recommendation
- Prevents oxides from forming
- Prevents foreign materials from entering the connector prior to usage and color code identifies the proper compression die

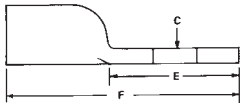

Catalog Number	Wire Size	Wire Range When Installed With IDT-12-N Tool	Die Color Code	Bolt Size	Tang Width	Dimensions			Die Index	O.D.	I.D.
						C	E	F			
ACL-1	1	1-2	Gold	1/4	3/4	9/32	29/32	2-25/64	7	35/64	23/64
ACN-1	1	1-2	Gold	5/16	3/4	11/32	29/32	2-25/64	7	35/64	23/64
ACL-1/0	1/0	1/0-1	Tan	3/8	7/8	13/32	15/16	2-9/16	8	39/64	25/64
ACN-1/0	1/0	1/0-1	Tan	5/16	7/8	11/32	15/16	2-9/16	8	39/64	25/64
ACL-2/0	2/0	2/0-1	Olive	3/8	31/32	13/32	1	2-5/8	10	43/64	7/16
ACN-2/0	2/0	2/0-1	Olive	1/2	31/32	9/16	1	2-5/8	10	43/64	7/16

CONTINUED ON NEXT PAGE.

Tooling Information

Catalog Number	ILSCO								Burdry						Thomas & Betts				Anderson	Color Code	
	ILC-12-N Die No. No. of Crimps	ILCB-12-N Die No. No. of Crimps	IDTB-6 Dieless No. of Crimps	IDT-6, IDT-6H 6.2 Ton Dieless No. of Crimps	ILC-15H Die No. No. of Crimps	MT-25 Hand Dieless No. of Crimps	94285 Left / Rt. Die / Die No. of Crimps	IDT-12-N Dieless No. of Crimps	Y-48B Die Index No. of Crimps	Y-35 Die Index No. of Crimps	Y-39 Die Index No. of Crimps	Y-45 Die Index No. of Crimps	Y-46 Die Index No. of Crimps	MY29-3 Hand Dieless No. of Crimps	Y644M Dieless No. of Crimps	13642 12 Ton Die Index No. of Crimps	TBM 15 15 Ton Die Index No. of Crimps	21940 40 Ton Die Index No. of Crimps	TBM-8 Hand Tool No. of Crimps		Versa Crimp Dieless No. of Crimps
ACL-1/ ACN-1	ILD-7 (1) or ILD-6 (4)	ILD-7 (1) or ILD-6 (4)	- (2)	- (2)	ILD-7 (1) or ILD-6 (4)	- (2)	E/A (4)	- (1)	- (1)	471 (1)	471 (1)	471 (1)	471 (1)	- (2)	- (1)	45 (3)	45 (3)	45 (3)	- (3)	- (2)	Gold
ACL-1/0/ ACN-1/0	ILD-8 (1)	ILD-8 (1)	- (2)	- (2)	ILD-8 (1)	- (2)	A/C (5)	- (1)	296 (1)	296 (1)	296 (1)	296 (1)	296 (1)	- (2)	- (1)	50 (3)	50 (3)	50 (3)	- (3)	(2)	Tan
ACL-2/0/ ACN-2/0	ILD-10 (1)	ILD-10 (1)	- (2)	- (2)	ILD-10 (1)	- (2)	A/B (4)	- (1)	297 (1)	297 (2)	297 (2)	297 (2)	297 (2)	- (2)	- (1)	54 (3)	54H (6)	54 (3)	- (3)	(2)	Olive

UL Listed and CSA Certified 600 volts maximum when installed with tools and dies shown above. If proper high voltage spacings and insulation techniques are used, the aluminum compression connectors can be used for high voltage applications up to 35KV.

See stuffer sheet for complete information on tooling.

Tested to UL 486A-486B, UL File E6207



TYPE ACL

- Features**
- Electro-tin plated
 - Manufactured from high strength aluminum alloy
 - Chamfered barrel
 - UL 486B 90° C Listed and CSA Certified for 600 volts
 - Color coded
 - Clearly marked with wire size and die index for IlSCO tools, proper number and location of crimps
 - Prefilled with DE-OX
 - Color coded end caps inserted in barrel

- Benefits**
- Provides low contact resistance
 - Provides maximum conductivity and excellent crimping characteristics
 - Provides easy conductor insertion
 - Ensures reliability for copper or aluminum conductors
 - Provides visual tooling recommendation for IlSCO or standard industry tools
 - Provides easy identification and tooling recommendation
 - Prevents oxides from forming
 - Prevents foreign materials from entering the connector prior to usage and color code identifies the proper compression die

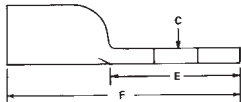

Catalog Number	Wire Size	Wire Range When Installed With IDT-12-N Tool	Die Color Code	Bolt Size	Tang Width	Dimensions			Die Index	O.D.	I.D.
						C	E	F			
ACL-3/0	3/0	3/0-1	Ruby	3/8	1-1/16	13/32	1-1/16	2-13/16	10	49/64	1/2
ACN-3/0	3/0	3/0-1	Ruby	1/2	1-1/16	9/16	1-1/16	2-13/16	10	49/64	1/2
ACL-4/0	4/0	4/0-1	White	3/8	1-1/8	13/32	1-1/16	3-3/8	12	55/64	9/16
ACN-4/0	4/0	4/0-1	White	1/2	1-1/8	9/16	1-1/16	3-3/8	12	55/64	9/16
ACL-250	250kcmil	250kcmil-1/0	Red	1/2	1-21/64	17/32	1-1/2	3-7/8	13	59/64	39/64
ACL-300	300kcmil	300kcmil-2/0	Blue	1/2	1-7/16	17/32	1-1/2	4-1/16	14	1-1/64	21/32
ACL-350	350kcmil	350kcmil-3/0	Brown	1/2	1-9/16	17/32	1-1/2	4-3/32	14	1-1/8	23/32

CONTINUED ON NEXT PAGE.

Tooling Information

Catalog Number	ILSCO							Burdly							Thomas & Betts				Anderson	Color Code	
	ILC-12-N Die No. No. of Crimps	ILCB-12-N Die No. No. of Crimps	IDTB-6 Dieless No. of Crimps	IDT-6, IDT-6H 6.2 Ton Dieless No. of Crimps	ILC-15H Die No. No. of Crimps	MT-25 Hand Dieless No. of Crimps	94285 Left/Rt. Die/Die No. of Crimps	IDT-12-N Dieless No. of Crimps	Y-48B Die Index No. of Crimps	Y-35 Die Index No. of Crimps	Y-39 Die Index No. of Crimps	Y-45 Die Index No. of Crimps	Y-46 Die Index No. of Crimps	MY29-3 Hand Dieless No. of Crimps	Y644M Dieless No. of Crimps	13642 12 Ton Die Index No. of Crimps	TBM 15 15 Ton Die Index No. of Crimps	21940 40 Ton Die Index No. of Crimps	TBM-8 Hand Tool No. of Crimps		Versa Crimp Dieless No. of Crimps
ACL-3/0 ACN-3/0	ILD-10 (2)	ILD-10 (2)	- (3)	- (3)	ILD-10 (2)	- (2)	A/A (4)	- (1)	467 (1)	467 (2)	467 (2)	467 (2)	467 (2)	- (2)	- (1)	60 (3)	60 (3)	60 (3)	- (3)	- (2)	Ruby
ACL-4/0 ACN-4/0	ILD-12 (1)	ILD-12 (1)	- (3)	- (3)	ILD-12 (1)	- (2)	- (2)	- (2)	298 (1)	298 (2)	298 (2)	298 (2)	298 (2)	- (2)	- (1)	66H (4)	66 (2)	66 (2)	- (5)	- (3)	White
ACL-250	ILD-13 (2)	ILD-13 (2)	- (3)	- (3)	ILD-13 (2)	- (2)	- (2)	- (2)	324 (1)	324 (2)	324 (2)	324 (2)	324 (2)	- (1)	- (1)	71H (4)	71H (4)	71 (2)	- (5)	- (3)	Red
ACL-300	ILD-14 (2)	ILD-14 (2)	- (4)	- (4)	ILD-14 (2)	- (2)	- (2)	- (2)	470 (1)	470 (2)	470 (2)	470 (2)	470 (2)	- (1)	- (1)	76H (4)	76 (2)	76 (2)	- (5)	- (3)	Blue
ACL-350	ILD-14 (2)	ILD-14 (2)	- (4)	- (4)	ILD-14 (2)	- (2)	- (2)	- (2)	299 (1)	299 (2)	299 (2)	299 (2)	299 (2)	- (1)	- (1)	87H (4)	87H (4)	87 (2)	- (6)	- (3)	Brown

UL Listed and CSA Certified 600 volts maximum when installed with tools and dies shown above. If proper high voltage spacings and insulation techniques are used, the aluminum compression connectors can be used for high voltage applications up to 35KV.

See stuffer sheet for complete information on tooling.

Tested to UL 486A-486B, UL File E6207

A

TYPE ACL

Features

- Electro-tin plated
- Manufactured from high strength aluminum alloy
- Chamfered barrel
- UL 486B 90° C Listed and CSA Certified for 600 volts
- Color coded
- Clearly marked with wire size and die index for IlSCO tools, proper number and location of crimps
- Prefilled with DE-OX
- Color coded end caps inserted in barrel

Benefits

- Provides low contact resistance
- Provides maximum conductivity and excellent crimping characteristics
- Provides easy conductor insertion
- Ensures reliability for copper or aluminum conductors
- Provides visual tooling recommendation for IlSCO or standard industry tools
- Provides easy identification and tooling recommendation
- Prevents oxides from forming
- Prevents foreign materials from entering the connector prior to usage and color code identifies the proper compression die

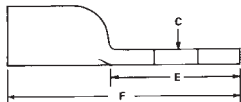

Catalog Number	Wire Size	Wire Range When Installed With IDT-12-N Tool	Die Color Code	Bolt Size	Tang Width	Dimensions			Die Index	O.D.	I.D.
						C	E	F			
ACL-400	400kcmil	400kcmil-4/0	Green	1/2	1-5/8	17/32	1-9/16	4-7/8	16	1-3/16	49/64
ACL-500	500kcmil	500kcmil-4/0	Pink	1/2	1-13/16	17/32	1-9/16	4-7/8	16A	1-21/64	55/64
ACL-600	600kcmil	600kcmil-250kcmil	Black	5/8	1-15/16	21/32	2	5-3/8	17	1-21/64	59/64
ACL-700	700kcmil	700kcmil-350kcmil	Purple	5/8	2-1/16	21/32	2-3/32	5-21/32	17	1-13/32	1
ACL-750	750kcmil	750kcmil-500kcmil	Yellow	5/8	2-3/16	21/32	2-3/32	5-21/32	18	1-29/64	1-1/32
ACL-1000	1000kcmil	1000kcmil-750kcmil	Brown	5/8	2-1/2	21/32	2-1/4	6-5/8	20	1-53/64	1-3/16

Tooling Information

Catalog Number	ILSCO						Burdny						Thomas & Betts				Anderson	Color Code
	ILC-12-N ILC-12H-N Die No. No. of Crimps	ILCB-12-N Die No. No. of Crimps	IDTB-6 Dieless No. of Crimps	IDT-6, IDT-6H 6.2 Ton Dieless No. of Crimps	ILC-15H Die No. No. of Crimps	IDT-12-N Dieless No. of Crimps	Y-48B Die Index No. of Crimps	Y-35 Die Index No. of Crimps	Y-39 Die Index No. of Crimps	Y-45 Die Index No. of Crimps	Y-46 Die Index No. of Crimps	Y644M Dieless No. of Crimps	13642 12 Ton Die Index No. of Crimps	TBM 15 40 Ton Die Index No. of Crimps	21940 Hand Die Index No. of Crimps	TBM-8 Tool No. of Crimps	Versa Crimp Dieless No. of Crimps	
ACL-400	ILD-16 (3)	ILD-16 (3)	- (4)	- (4)	ILD-16 (3)	- (2)	472 (2)	472 (4)	472 (4)	472 (4)	472 (4)	- (1)	94H (4)	94H (4)	94 (2)	- (4)	- (4)	Green
ACL-500	ILD-16A (3)	ILD-16A (3)	- (4)	- (4)	ILD-16A (3)	- (2)	300 (2)	300 (4)	300 (4)	300 (4)	300 (4)	- (1)	99H (4)	99H (4)	99 (2)	- (4)	- (4)	Pink
ACL-600	ILD-17 (4)	ILD-17 (4)	- (4)	- (4)	ILD-17 (4)	- (2)	473 (2)	473 (4)	473 (4)	473 (4)	473 (4)	- (1)	106H (4)	106 (2)	106 (2)	- (4)	- (4)	Black
ACL-700	ILD-17 (4)	ILD-17 (4)	- (4)	- (4)	ILD-17 (4)	- (2)	936 (2)	- (4)	936 (4)	936 (4)	936 (4)	- (1)	112H (4)	112H (4)	112 (2)	- (4)	- (4)	Purple
ACL-750	ILD-18 (5)	ILD-18 (5)	- (4)	- (4)	ILD-18 (5)	- (2)	936 (2)	- (4)	936 (4)	936 (4)	936 (4)	- (1)	115H (4)	115H (4)	115 (2)	- (4)	- (4)	Yellow
ACL-1000	-	-	-	-	- (3)	- (2)	302 (2)	-	-	-	-	- (1)	-	140H (4)	140 (2)	-	-	Brown

UL Listed and CSA Certified 600 volts maximum when installed with tools and dies shown above. If proper high voltage spacings and insulation techniques are used, the aluminum compression connectors can be used for high voltage applications up to 35KV.

See stuffer sheet for complete information on tooling.

Tested to UL 486A-486B, UL File E6207

TYPE 2ACL

Features

- Electro-tin plated
- Manufactured from high strength aluminum alloy
- Chamfered barrel
- UL 486B 90° C Listed and CSA Certified for 600 volts
- Color coded
- Clearly marked with wire size and die index for IlSCO tools, proper number and location of crimps
- Prefilled with DE-OX
- Color coded end caps inserted in barrel

Benefits

- Provides low contact resistance
- Provides maximum conductivity and excellent crimping characteristics
- Provides easy conductor insertion
- Ensures reliability for copper or aluminum conductors
- Provides visual tooling recommendation for IlSCO or standard industry tools
- Provides easy identification and tooling recommendation
- Prevents oxides from forming
- Prevents foreign materials from entering the connector prior to usage and color code identifies the proper compression die

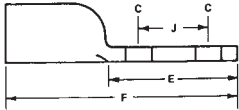

Catalog No.	Wire Size	Wire Range When Installed With IDT-12-N Tool	Die Color Code	Bolt Size	Tang Width	Dimensions				Die Index	O.D.	I.D.
						C	E	F	J			
2ACL-1/0	1/0	1/0-1	Tan	3/8 (2)	7/8	13/32(2)	1-7/8	3-15/32	1	8	39/64	25/64
2ACN-1/0	1/0	1/0-1	Tan	1/2 (2)	7/8	17/32(2)	3	4-5/8	1-3/4	8	39/64	25/64
2ACL-2/0	2/0	2/0-1	Olive	1/2 (2)	31/32	9/16(2)	3-3/8	5	1-3/4	10	43/64	7/16
2ACL-3/0	3/0	3/0-1	Ruby	1/2 (2)	1-1/16	9/16(2)	3-3/8	5-5/32	1-3/4	10	49/64	1/2
2ACL-4/0	4/0	4/0-1	White	1/2 (2)	1-1/8	9/16(2)	3-3/8	5-5/8	1-3/4	12	55/64	9/16
2ACL-250	250kcmil	250kcmil-1/0	Red	1/2 (2)	1-21/64	9/16(2)	3-3/8	5-3/4	1-3/4	13	59/64	39/64
2ACL-300	300kcmil	300kcmil-2/0	Blue	1/2 (2)	1-7/16	9/16(2)	3-3/8	5-15/16	1-3/4	14	1-1/64	21/32

CONTINUED ON NEXT PAGE.

Tooling Information

Catalog Number	ILSCO								Burdyn						Thomas & Betts				Anderson	Color Code	
	ILC-12-N Die No. No. of Crimps	ILCB-12-N Die No. No. of Crimps	IDTB-6 Die No. No. of Crimps	IDT-6, IDT-6H 6.2 Ton Dieless No. of Crimps	ILC-15H Die No. No. of Crimps	MT-25 Hand Dieless No. of Crimps	94285 Left/Rt. Die/Die No. of Crimps	IDT-12-N Dieless No. of Crimps	Y-48B Die Index No. of Crimps	Y-35 Die Index No. of Crimps	Y-39 Die Index No. of Crimps	Y-45 Die Index No. of Crimps	Y-46 Die Index No. of Crimps	MY29-3 Hand Dieless No. of Crimps	Y644M Dieless No. of Crimps	13642 12 Ton Die Index No. of Crimps	TBM 15 15 Ton Die Index No. of Crimps	21940 40 Ton Die Index No. of Crimps	TBM-8 Hand Tool No. of Crimps		Versa Crimp Dieless No. of Crimps
2ACL-1/0	ILD-8 (1)	ILD-8 (1)	- (2)	- (2)	ILD-8 (1)	- (2)	A/C (5)	- (1)	296 (1)	296 (1)	296 (1)	296 (1)	296 (1)	- (2)	- (1)	50 (3)	50 (3)	50 (3)	- (3)	- (2)	Tan
2ACN-1/0	ILD-10 (1)	ILD-10 (1)	- (2)	- (2)	ILD-10 (1)	- (2)	A/B (4)	- (1)	297 (1)	297 (2)	297 (2)	297 (2)	297 (2)	- (2)	- (1)	54 (3)	54H (6)	54 (3)	- (3)	- (2)	Olive
2ACL-3/0	ILD-10 (2)	ILD-10 (2)	- (3)	- (3)	ILD-10 (2)	- (2)	A/A (4)	- (1)	467 (1)	467 (2)	467 (2)	467 (2)	467 (2)	- (2)	- (1)	60 (3)	60 (3)	60 (3)	- (3)	- (2)	Ruby
2ACL-4/0	ILD-12 (1)	ILD-12 (1)	- (3)	- (3)	ILD-12 (1)	- (2)	-	- (2)	298 (1)	298 (2)	298 (2)	298 (2)	298 (2)	- (2)	- (1)	66H (4)	66 (2)	66 (2)	- (5)	- (3)	White
2ACL-250	ILD-13 (2)	ILD-13 (2)	- (3)	- (3)	ILD-13 (2)	-	-	- (2)	324 (1)	324 (2)	324 (2)	324 (2)	324 (2)	- (1)	- (1)	71H (4)	71H (4)	71 (2)	- (5)	- (3)	Red
2ACL-300	ILD-14 (2)	ILD-14 (2)	- (4)	- (4)	ILD-14 (2)	-	-	- (2)	470 (1)	470 (2)	470 (2)	470 (2)	470 (2)	- (1)	- (1)	76H (4)	76 (2)	76 (2)	- (5)	- (3)	Blue

UL Listed and CSA Certified 600 volts maximum when installed with tools and dies shown above. If proper high voltage spacings and insulation techniques are used, the aluminum compression connectors can be used for high voltage applications up to 35KV. See stuffer sheet for complete information on tooling.

Tested to UL 486A-486B, UL File E6207

A TYPE 2ACL

Features

- Electro-tin plated
- Manufactured from high strength aluminum alloy
- Chamfered barrel
- UL 486B 90° C Listed and CSA Certified for 600 volts
- Color coded
- Clearly marked with wire size and die index for IlSCO tools, proper number and location of crimps
- Prefilled with DE-OX
- Color coded end caps inserted in barrel

Benefits

- Provides low contact resistance
- Provides maximum conductivity and excellent crimping characteristics
- Provides easy conductor insertion
- Ensures reliability for copper or aluminum conductors
- Provides visual tooling recommendation for IlSCO or standard industry tools
- Provides easy identification and tooling recommendation
- Prevents oxides from forming
- Prevents foreign materials from entering the connector prior to usage and color code identifies the proper compression die

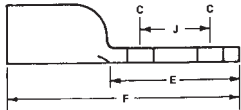

Catalog No.	Wire Size	Wire Range When Installed With IDT-12-N Tool	Die Color Code	Bolt Size	Tang Width	Dimensions				Die Index	O.D.	I.D.
						C	E	F	J			
2ACL-350	350kcmil	350kcmil-3/0	Brown	1/2 (2)	1-9/16	9/16(2)	3-3/8	5-31/32	1-3/4	14	1-1/8	23/32
2ACL-400	400kcmil	400kcmil-4/0	Green	1/2 (2)	1-5/8	9/16(2)	3-3/8	6-11/16	1-3/4	16	1-3/16	49/64
2ACL-500	500kcmil	500kcmil-4/0	Pink	1/2 (2)	1-13/16	9/16(2)	3-3/8	6-11/16	1-3/4	16A	1-21/64	55/64
2ACL-600	600kcmil	600kcmil-250kcmil	Black	1/2 (2)	1-15/16	9/16(2)	3-3/8	6-3/4	1-3/4	17	1-21/64	59/64
2ACL-700	700kcmil	700kcmil-350kcmil	Purple	1/2 (2)	2-1/16	9/16(2)	3-3/8	6-15/16	1-3/4	17	1-13/32	1
2ACL-750	750kcmil	750kcmil-500kcmil	Yellow	1/2 (2)	2-1/16	9/16(2)	3-3/8	6-15/16	1-3/4	18	1-29/64	1-1/32
2ACL-1000	1000kcmil	1000kcmil-750kcmil	Brown	1/2 (2)	2-1/2	9/16(2)	3-3/8	7-3/4	1-3/4	20	1-53/64	1-3/16

Tooling Information

Catalog Number	ILSCO								Burdry						Thomas & Betts				Anderson	Color Code	
	ILC-12-N Die No. No. of Crimps	ILCB-12-N Die No. No. of Crimps	IDTB-6 Die No. No. of Crimps	IDT-6, IDT-6H 6.2 Ton Dieless Die No. No. of Crimps	ILC-15H Die No. No. of Crimps	MT-25 Hand Dieless Die No. No. of Crimps	94285 Left/ Rt. Die/ Die No. No. of Crimps	IDT-12-N Dieless Die No. No. of Crimps	Y-48B Die Index No. of Crimps	Y-35 Die Index No. of Crimps	Y-39 Die Index No. of Crimps	Y-45 Die Index No. of Crimps	Y-46 Die Index No. of Crimps	MY29-3 Hand Dieless Die No. No. of Crimps	Y644M Dieless Die No. No. of Crimps	13642 12 Ton Die Index No. of Crimps	TBM 15 15 Ton Die Index No. of Crimps	21940 40 Ton Die Index No. of Crimps	TBM-8 Hand Tool No. of Crimps		Versa Crimp Dieless Die No. No. of Crimps
2ACL-350	ILD-14 (2)	ILD-14 (2)	- (4)	- (4)	ILD-14 (2)	-	-	- (2)	299 (1)	299 (2)	299 (2)	299 (2)	299 (2)	-	- (1)	87H (4)	87H (4)	87 (2)	87H (6)	- (3)	Brown
2ACL-400	ILD-16 (3)	ILD-16 (3)	- (4)	- (4)	ILD-16 (3)	-	-	- (2)	472 (2)	472 (4)	472 (4)	472 (4)	472 (4)	-	- (1)	94H (4)	94H (4)	94 (2)	-	- (4)	Green
2ACL-500	ILD-16A (3)	ILD-16A (3)	- (4)	- (4)	ILD-16A (3)	-	-	- (2)	300 (2)	300 (4)	300 (4)	300 (4)	300 (4)	-	- (1)	99H (4)	99H (4)	99 (2)	-	- (4)	Pink
2ACL-600	ILD-17 (4)	ILD-17 (4)	- (4)	- (4)	ILD-17 (4)	-	-	- (2)	473 (2)	473 (4)	473 (4)	473 (4)	473 (4)	-	- (1)	106H (4)	106 (2)	106 (2)	-	- (4)	Black
2ACL-700	ILD-17 (4)	ILD-17 (4)	- (4)	- (4)	ILD-17 (4)	-	-	- (2)	936 (2)	-	936 (4)	936 (4)	936 (4)	-	- (1)	112H (4)	112H (4)	112 (2)	-	-	Purple
2ACL-750	ILD-18 (5)	ILD-18 (5)	- (4)	- (4)	ILD-18 (5)	-	-	- (2)	936 (2)	-	936 (4)	936 (4)	936 (4)	-	- (1)	115H (4)	115H (4)	115 (2)	-	-	Yellow
2ACL-1000	-	-	-	-	- (3)	-	-	- (2)	302 (2)	-	-	-	-	-	-	140H (4)	140 (2)	-	-	-	Brown

UL Listed and CSA Certified 600 volts maximum when installed with tools and dies shown above. If proper high voltage spacings and insulation techniques are used, the aluminum compression connectors can be used for high voltage applications up to 35KV. See stuffer sheet for complete information on tooling.

Tested to UL 486A-486B, UL File E6207

ILSCO Stacking Adaptor For Compression Lugs



A

TYPE ASL

Features

- Electro-tin plated
- Manufactured from high strength aluminum alloy
- Two sizes cover a wire range from 750 kcmil-1/0
- Unique design
- Versatile
- UL Listed for 600 volts, 90° C

Benefits

- Provides low contact resistance
- Can be used with both aluminum and copper terminals
- Permits inventories to be kept to a minimum
- Allows vertical stacking to minimize space requirements
- Can be used with copper and/or aluminum connectors
- Ensures reliability

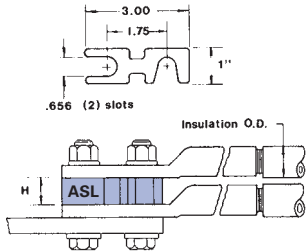

Catalog Number	Wire Range	Insulation O.D.	H
ASL-250	250kcmil-1/0	55/64	3/4
ASL-750	750 kcmil-1/0	1-3/8	1-1/4

Tested to UL 486A-486B, UL File E6207



Copper Pigtail Adaptor

Conductor Range: 3/0-#6 Copper or Aluminum



A TYPE CPM

Features

- Barrel manufactured from high strength aluminum alloy
- Pigtail manufactured from high conductivity copper
- Chamfered barrel
- UL Listed and CSA Certified for 600 volts, 90° C
- Clearly marked with wire size and die index for IlSCO tools, proper number and location of crimps
- Prefilled with DE-OX
- Color coded end caps inserted in barrel
- Supplied with insulating cover
- Rated for full ampacity of incoming conductor

Benefits

- Allows insertion into equipment supplied with either copper or aluminum connectors
- Provides maximum conductivity and excellent crimping characteristics
- Provides easy conductor insertion
- Ensures reliability for copper and aluminum conductors
- Provides easy identification and tooling recommendation
- Prevents oxides from forming
- Prevents foreign materials from entering the connector prior to usage and color code identifies the proper compression die
- Eliminates taping

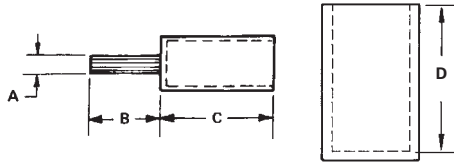

Catalog Number	Wire Size	Die Color	Copper Pin Size	Dimensions				O.D.	I.D.
				A	B	C	Cover D		
CPM-6	6	Orange	8	1/8	7/8	1-11/32	1-11/16	21/32	3/16
CPM-4	4	Orange	6	3/16	7/8	1-11/32	1-11/16	21/32	1/4
CPM-2	2	Orange	4	15/64	7/8	1-11/32	1-11/16	21/32	5/16
CPM-1	1	Orange	3	17/64	1	1-11/32	1-11/16	21/32	23/64
CPM-1/0	1/0	White	2	19/64	1-1/4	1-19/32	2-3/32	29/32	25/64
CPM-2/0	2/0	White	1	11/32	1-1/4	1-19/32	2-3/32	29/32	7/16
CPM-3/0	3/0	White	1/0	3/8	1-3/8	1-7/8	2-3/32	29/32	1/2

CONTINUED ON NEXT PAGE.

Tooling Information

Catalog Number	ILSCO			Burdny				Thomas & Betts			Color Code
	ILC-12-N ILC-12H-N Die No. No. of Crimps	ILCB-12-N Die No. No. of Crimps	ILC-15H Die No. No. of Crimps	Y-46 Die Index No. of Crimps	Y-35 Die Index No. of Crimps	Y-39 Die Index No. of Crimps	Y-45 Die Index No. of Crimps	13642 12 Ton Die Index No. of Crimps	TBM 15 15 Ton Die Index No. of Crimps	21940 40 Ton Die Index No. of Crimps	
CPM-6	ILD-9 (3)	ILD-9 (3)	ILD-9 (3)	297 (2)	297 (2)	297 (2)	297 (2)	50 (2)	50 (2)	50 (2)	Orange
CPM-4	ILD-9 (3)	ILD-9 (3)	ILD-9 (3)	297 (2)	297 (2)	297 (2)	297 (2)	50 (2)	50 (2)	87 (2)	Orange
CPM-2	ILD-9 (3)	ILD-9 (3)	ILD-9 (3)	297 (2)	297 (2)	297 (2)	297 (2)	50 (2)	50 (2)	87 (2)	Orange
CPM-1	ILD-9 (3)	ILD-9 (3)	ILD-9 (3)	297 (2)	297 (2)	297 (2)	297 (2)	50 (2)	50 (2)	87 (2)	Orange
CPM-1/0	ILD-12 (1)	ILD-12 (1)	ILD-12 (1)	324 (2)	324 (2)	324 (2)	324 (2)	76H (4)	76 (2)	76 (2)	White
CPM-2/0	ILD-12 (1)	ILD-12 (1)	ILD-12 (1)	324 (2)	324 (2)	324 (2)	324 (2)	76H (4)	76 (2)	76 (2)	White
CPM-3/0	ILD-12 (1)	ILD-12 (1)	ILD-12 (1)	324 (2)	324 (2)	324 (2)	324 (2)	76H (4)	76 (2)	76 (2)	White

UL Listed and CSA Certified 600 volts maximum when installed with tools and dies shown above. If proper high voltage spacings and insulation techniques are used, the aluminum compression connectors can be used for high voltage applications up to 35KV.

Dieless crimp tools must not be used to crimp CPM/CPML adapters. See stuffer sheet for complete information on tooling.

Tested to UL 486A-486B, UL File E62525



TYPE CPM

Features

- Barrel manufactured from high strength aluminum alloy
- Pigtail manufactured from high conductivity copper
- Chamfered barrel
- UL Listed and CSA Certified for 600 volts, 90° C
- Clearly marked with wire size and die index for IlSCO tools, proper number and location of crimps
- Prefilled with DE-OX
- Color coded end caps inserted in barrel
- Supplied with insulating cover
- Rated for full ampacity of incoming conductor

Benefits

- Allows insertion into equipment supplied with either copper or aluminum connectors
- Provides maximum conductivity and excellent crimping characteristics
- Provides easy conductor insertion
- Ensures reliability for copper and aluminum conductors
- Provides easy identification and tooling recommendation
- Prevents oxides from forming
- Prevents foreign materials from entering the connector prior to usage and color code identifies the proper compression die
- Eliminates taping

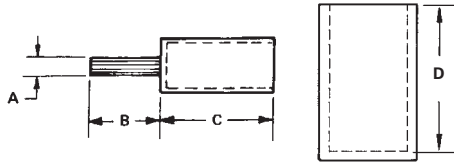

Catalog Number	Wire Size	Die Color	Copper Pin Size	Dimensions				O.D.	I.D.
				A	B	C	Cover D		
CPM-4/0	4/0	White	2/0	13/32	1-3/8	1-7/8	2-3/32	29/32	9/16
CPM-250	250kcmil	Brown	3/0	15/32	1-1/2	2-1/16	2-27/32	1-5/32	39/64
CPM-300	300kcmil	Brown	4/0	17/32	1-5/8	2-1/16	2-27/32	1-5/32	21/32
CPM-350	350kcmil	Brown	4/0	17/32	1-5/8	2-1/16	2-27/32	1-5/32	23/32
CPM-400	400kcmil	Pink	250kcmil	37/64	1-7/8	2-3/32	2-13/32	1-3/8	49/64
CPM-500	500kcmil	Pink	350kcmil	11/16	1-7/8	2-3/32	2-13/32	1-3/8	55/64
CPM-600	600kcmil	Yellow	350kcmil	11/16	1-7/8	2-3/4	3-3/32	1-1/2	59/64

CONTINUED ON NEXT PAGE.

Tooling Information

Catalog Number	ILSCO			Burdyn				Thomas & Betts			Color Code
	ILC-12-N ILC-12H-N Die No. No. of Crimps	ILCB-12-N Die No. No. of Crimps	ILC-15H Die No. No. of Crimps	Y-46 Die Index No. of Crimps	Y-35 Die Index No. of Crimps	Y-39 Die Index No. of Crimps	Y-45 Die Index No. of Crimps	13642 12 Ton Die Index No. of Crimps	TBM 15 15 Ton Die Index No. of Crimps	21940 40 Ton Die Index No. of Crimps	
CPM-4/0	ILD-12 (1)	ILD-12 (1)	ILD-12 (1)	324 (2)	324 (2)	324 (2)	324 (2)	76H (4)	76 (2)	76 (2)	White
CPM-250	ILD-14 (2*)	ILD-14 (2*)	ILD-14 (2*)	299 (2*)	299 (2*)	299 (2*)	299 (2*)	87H (2)	87H (2)	87 (1)	Brown
CPM-300	ILD-14 (2*)	ILD-14 (2*)	ILD-14 (2*)	299 (2*)	299 (2*)	299 (2*)	299 (2*)	87H (2)	87H (2)	87 (1)	Brown
CPM-350	ILD-14 (2*)	ILD-14 (2*)	ILD-14 (2*)	299 (2*)	299 (2*)	299 (2*)	299 (2*)	87H (2)	87H (2)	87 (1)	Brown
CPM-400	ILD-16A (2*)	ILD-16A (2*)	ILD-16A (2*)	300 (3)	300 (3)	300 (3)	300 (3)	106H (2)	106 (1)	106 (1)	Pink
CPM-500	ILD-16A (2*)	ILD-16A (2*)	ILD-16A (2*)	300 (3)	300 (3)	300 (3)	300 (3)	106H (2)	106 (1)	106 (1)	Pink
CPM-600	ILD-18 (3)	ILD-18 (3)	ILD-18 (3)	936 (3)	936 (3)	936 (3)	936 (3)	115H (3)	115H (3)	115 (2)	Yellow

UL Listed and CSA Certified 600 volts maximum when installed with tools and dies shown above. If proper high voltage spacings and insulation techniques are used, the aluminum compression connectors can be used for high voltage applications up to 35KV.

*Overlap Crimps Dieless crimp tools must not be used to crimp CPM/CPML adapters. See stuffer sheet for complete information on tooling.

Tested to UL 486A-486B, UL File E62525

A

TYPE
CPM
CPML

Features

- Barrel manufactured from high strength aluminum alloy
- Pigtail manufactured from high conductivity copper
- Chamfered barrel
- UL Listed and CSA Certified for 600 volts, 90° C
- Clearly marked with wire size and die index for IlSCO tools, proper number and location of crimps
- Prefilled with DE-OX
- Color coded end caps inserted in barrel
- Supplied with insulating cover
- Rated for full ampacity of incoming conductor

Benefits

- Allows insertion into equipment supplied with either copper or aluminum connectors
- Provides maximum conductivity and excellent crimping characteristics
- Provides easy conductor insertion
- Ensures reliability for copper and aluminum conductors
- Provides easy identification and tooling recommendation
- Prevents oxides from forming
- Prevents foreign materials from entering the connector prior to usage and color code identifies the proper compression die
- Eliminates taping

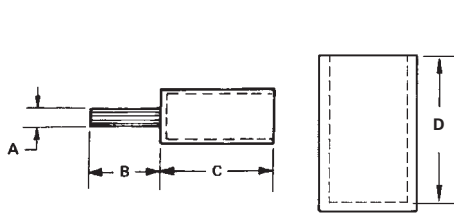

Catalog Number	Wire Range	Die Color	Copper Pin Size	Dimensions				O.D.	I.D.
				A	B	C	Cover D		
CPM-750	750kcmil-700kcmil	Yellow	500kcmil	13/16	2	2-3/4	3-3/32	1-1/2	1-1/32
CPML-500	500kcmil	Pink	350kcmil	11/16	3	2-3/32	2-13/32	1-3/8	55/64
CPML-600	600kcmil	Yellow	350kcmil	11/16	3	2-3/4	3-3/32	1-1/2	59/64
CPML-750	750kcmil-700kcmil	Yellow	500kcmil	13/16	3	2-3/4	3-3/32	1-1/2	1-1/32

Tooling Information

Catalog Number	ILSCO			Burdry				Thomas & Betts			Color Code
	ILC-12-N ILC-12H-N Die No. No. of Crimps	ILCB-12-N Die No. No. of Crimps	ILC-15H Die No. No. of Crimps	Y-46 Die Index No. of Crimps	Y-35 Die Index No. of Crimps	Y-39 Die Index No. of Crimps	Y-45 Die Index No. of Crimps	13642 12 Ton Die Index No. of Crimps	TBM 15 15 Ton Die Index No. of Crimps	21940 40 Ton Die Index No. of Crimps	
CPM-750	ILD-18 (3)	ILD-18 (3)	ILD-18 (3)	936 (3)	936 (3)	936 (3)	936 (3)	115H (3)	115H (3)	115 (2)	Yellow
CPML-500	ILD-16A (2*)	ILD-16A (2*)	ILD-16A (2*)	300 (3)	300 (3)	300 (3)	300 (3)	106H (2)	106 (1)	106 (1)	Pink
CPML-600	ILD-18 (3*)	ILD-18 (3*)	ILD-18 (3*)	936 (3)	936 (3)	936 (3)	936 (3)	115H (3)	115H (3)	115 (2)	Yellow
CPML-750	ILD-18 (3*)	ILD-18 (3*)	ILD-18 (3*)	936 (3)	936 (3)	936 (3)	936 (3)	115H (3)	115H (3)	115 (2)	Yellow

UL Listed and CSA Certified 600 volts maximum when installed with tools and dies shown above. If proper high voltage spacings and insulation techniques are used, the aluminum compression connectors can be used for high voltage applications up to 35KV.

*Overlap Crimps

Dieless crimp tools must not be used to crimp CPM/CPML adaptors.

See stuffer sheet for complete information on tooling.

Tested to UL 486A-486B, UL File E62525

TYPE ACM

Features

- Manufactured from high strength aluminum alloy
- Pin is knurled
- Chamfered barrel
- UL Listed and CSA Certified for 600 volts, 90° C
- Clearly marked with wire size and die index for IlSCO tools, proper number and location of crimps
- Prefilled with DE-OX
- Color coded end caps inserted in barrel
- Supplied with insulating cover

Benefits

- Provides maximum conductivity and excellent crimping characteristics
- Permits greater surface contact
- Provides easy conductor insertion
- Ensures reliability for aluminum or copper conductors
- Provides easy identification and tooling recommendation
- Prevents oxides from forming
- Prevents foreign materials from entering the connector prior to usage and color code identifies the proper compression die
- Eliminates taping

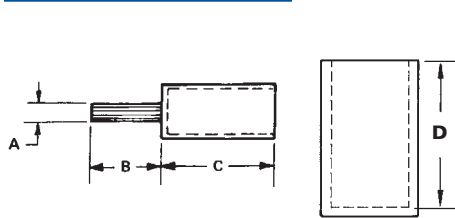

Catalog Number	Wire Size	Die Color	Pin Size	Dimensions				O.D.	I.D.
				A	B	C	D (cover)		
ACM-6	6	Tan	#4	7/32	11/16	1-13/64	1-3/4	39/64	3/16
ACM-4	4	Tan	#4	1/4	11/16	1-13/64	1-3/4	39/64	1/4
ACM-2	2	Tan	#4	1/4	11/16	1-13/64	1-3/4	39/64	5/16
ACM-1	1	Tan	#3	17/64	27/32	1-13/64	1-3/4	39/64	23/64
ACM-1/0	1/0	White	#2	19/64	27/32	1-3/8	2	55/64	25/64
ACM-2/0	2/0	White	#1	11/32	27/32	1-3/8	2	55/64	7/16

CONTINUED ON NEXT PAGE.

Tooling Information

Catalog Number	ILSCO				Burdry						Thomas & Betts		Color Code
	ILC-12-N ILC-12H-N Die No. No. of Crimps	ILCB-12-N Die No. No. of Crimps	ILC-15H Die No. No. of Crimps	IDT-12-N Die No. No. of Crimps	Y750 Family Die Index No. of Crimps	Y-35 Die Index No. of Crimps	Y-39 Die Index No. of Crimps	Y-45 Die Index No. of Crimps	Y-46 Die Index No. of Crimps	Y644M Dieless No. of Crimps	13642 12 Ton Die Index No. of Crimps	13100A 15 Ton Die Index No. of Crimps	
ACM-6	ILD-8 (1)	ILD-8 (1)	ILD-8 (1)	(1)	296 (1)	296 (1)	296 (1)	296 (1)	296 (1)	(1)	45H Gold (2)	45H Gold (2)	Tan
ACM-4	ILD-8 (1)	ILD-8 (1)	ILD-8 (1)	(1)	296 (1)	296 (1)	296 (1)	296 (1)	296 (1)	(1)	45H Gold (2)	45H Gold (2)	Tan
ACM-2	ILD-8 (1)	ILD-8 (1)	ILD-8 (1)	(1)	296 (1)	296 (1)	296 (1)	296 (1)	296 (1)	(1)	45H Gold (2)	45H Gold (2)	Tan
ACM-1	ILD-8 (1)	ILD-8 (1)	ILD-8 (1)	(1)	296 (1)	296 (1)	296 (1)	296 (1)	296 (1)	(1)	45H Gold (2)	45H Gold (2)	Tan
ACM-1/0	ILD-12 (1)	ILD-12 (1)	ILD-12 (1)	(1)	298 (2*)	298 (2*)	298 (2*)	298 (2*)	298 (2*)	(1)	66H (2)	66H (2)	White
ACM-2/0	ILD-12 (1)	ILD-12 (1)	ILD-12 (1)	(1)	298 (2*)	298 (2*)	298 (2*)	298 (2*)	298 (2*)	(1)	66H (2)	66H (2)	White

*Overlap Crimps

See stuffer sheet for complete information on tooling.

Tested to UL 486A-486B, UL File E62525

A

TYPE ACM

Features

- Manufactured from high strength aluminum alloy
- Pin is knurled
- Chamfered barrel
- UL Listed and CSA Certified for 600 volts, 90° C
- Clearly marked with wire size and die index for IlSCO tools, proper number and location of crimps
- Prefilled with DE-OX
- Color coded end caps inserted in barrel
- Supplied with insulating cover

Benefits

- Provides maximum conductivity and excellent crimping characteristics
- Permits greater surface contact
- Provides easy conductor insertion
- Ensures reliability for aluminum or copper conductors
- Provides easy identification and tooling recommendation
- Prevents oxides from forming
- Prevents foreign materials from entering the connector prior to usage and color code identifies the proper compression die
- Eliminates taping

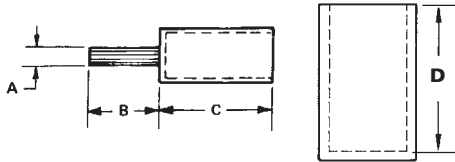

Catalog Number	Wire Size	Die Color	Pin Size	Dimensions				O.D.	I.D.
				A	B	C	D (cover)		
ACM-3/0	3/0	White	1/0	3/8	1-7/32	1-3/8	2	55/64	1/2
ACM-4/0	4/0	White	2/0	27/64	1-7/32	1-3/8	2	55/64	35/64
ACM-250	250kcmil	Brown	3/0	15/32	1-7/32	1-13/32	2-1/4	1-7/64	39/64
ACM-300	300kcmil	Brown	4/0	17/32	1-11/32	1-13/32	2-1/4	1-7/64	21/32
ACM-350	350kcmil	Brown	250kcmil	37/64	1-11/32	1-13/32	2-1/4	1-7/64	23/32
ACM-400	400kcmil	Pink	300kcmil	5/8	1-39/64	2-1/32	3-1/4	1-21/64	49/64

CONTINUED ON NEXT PAGE.

Tooling Information

Catalog Number	ILSCO				Burdny						Thomas & Betts		Color Code
	ILC-12-N ILC-12H-N Die No. No. of Crimps	ILCB-12-N Die No. No. of Crimps	ILC-15H Die No. No. of Crimps	IDT-12-N Die No. No. of Crimps	Y750 Family Die Index No. of Crimps	Y-35 Die Index No. of Crimps	Y-39 Die Index No. of Crimps	Y-45 Die Index No. of Crimps	Y-46 Die Index No. of Crimps	Y644M Dieless No. of Crimps	13642 12 Ton Die Index No. of Crimps	13100A 15 Ton Die Index No. of Crimps	
ACM-3/0	ILD-12 (1)	ILD-12 (1)	ILD-12 (1)	(1)	298 (2*)	298 (2*)	298 (2*)	298 (2*)	298 (2*)	(1)	66H (2)	66H (2)	White
ACM-4/0	ILD-12 (1)	ILD-12 (1)	ILD-12 (1)	(1)	298 (2*)	298 (2*)	298 (2*)	298 (2*)	298 (2*)	(1)	66H (2)	66H (2)	White
ACM-250	ILD-14 (1)	ILD-14 (1)	ILD-14 (1)	(1)	299 (2*)	299 (2*)	299 (2*)	299 (2*)	299 (2*)	(1)	87H (2)	87H (2)	Brown
ACM-300	ILD-14 (1)	ILD-14 (1)	ILD-14 (1)	(1)	299 (2*)	299 (2*)	299 (2*)	299 (2*)	299 (2*)	(1)	87H (2)	87H (2)	Brown
ACM-350	ILD-14 (1)	ILD-14 (1)	ILD-14 (1)	(1)	299 (2*)	299 (2*)	299 (2*)	299 (2*)	299 (2*)	(1)	87H (2)	87H (2)	Brown
ACM-400	ILD-16A (2)	ILD-16A (2)	ILD-16A (2)	(1)	300 (3)	300 (3)	300 (3)	300 (3)	300 (3)	(1)	99H (3)	99H (3)	Pink

*Overlap Crimps
See stuffer sheet for complete information on tooling.

Tested to UL 486A-486B, UL File E62525

TYPE ACM

Features

- Manufactured from high strength aluminum alloy
- Pin is knurled
- Chamfered barrel
- UL Listed and CSA Certified for 600 volts, 90° C
- Clearly marked with wire size and die index for IlSCO tools, proper number and location of crimps
- Prefilled with DE-OX
- Color coded end caps inserted in barrel
- Supplied with insulating cover

Benefits

- Provides maximum conductivity and excellent crimping characteristics
- Permits greater surface contact
- Provides easy conductor insertion
- Ensures reliability for aluminum or copper conductors
- Provides easy identification and tooling recommendation
- Prevents oxides from forming
- Prevents foreign materials from entering the connector prior to usage and color code identifies the proper compression die
- Eliminates taping

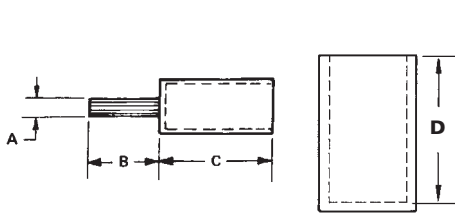

Catalog Number	Wire Size	Die Color	Pin Size	Dimensions				O.D.	I.D.
				A	B	C	D (cover)		
ACM-500	500kcmil	Pink	350kcmil	11/16	1-39/64	2-1/32	3-1/4	1-21/64	55/64
ACM-600	600kcmil	Yellow	400kcmil	47/64	1-41/64	2-1/32	3-1/4	1-15/32	59/64
ACM-750	750kcmil-700kcmil	Yellow	500kcmil	13/16	1-49/64	2-1/32	3-1/4	1-15/32	1-1/32

Tooling Information

Catalog Number	ILSCO				Burdly						Thomas & Betts		Color Code
	ILC-12-N ILC-12H-N Die No. No. of Crimps	ILCB-12-N Die No. No. of Crimps	ILC-15H Die No. No. of Crimps	IDT-12-N Die No. No. of Crimps	Y750 Family Die Index No. of Crimps	Y-35 Die Index No. of Crimps	Y-39 Die Index No. of Crimps	Y-45 Die Index No. of Crimps	Y-46 Die Index No. of Crimps	Y644M Dieless No. of Crimps	13642 12 Ton Die Index No. of Crimps	13100A 15 Ton Die Index No. of Crimps	
ACM-500	ILD-16A (2)	ILD-16A (2)	ILD-16A (2)	(1)	300 (3)	300 (3)	300 (3)	300 (3)	300 (3)	(1)	99H (3)	99H (3)	Pink
ACM-600	ILD-18 (3)	ILD-18 (3)	ILD-18 (3)	(1)	936 (3)	936 (3)	936 (3)	936 (3)	936 (3)	(1)	115H (3)	115H (3)	Yellow
ACM-750	ILD-18 (3)	ILD-18 (3)	ILD-18 (3)	(1)	936 (3)	936 (3)	936 (3)	936 (3)	936 (3)	(1)	115H (3)	115H (3)	Yellow

*Overlap Crimps
See stuffer sheet for complete information on tooling.

Tested to UL 486A-486B, UL File E62525

A TYPE ACO

Features

- Manufactured from high strength aluminum alloy
- Pin is knurled
- Pin is off center
- Chamfered barrel
- UL Listed and CSA Certified for 600 volts, 90° C
- Clearly marked with wire size and die index for IlSCO tools, proper number and location of crimps
- Prefilled with DE-OX
- Color coded end caps inserted in barrel
- Supplied with insulating cover

Benefits

- Provides maximum conductivity and excellent crimping characteristics
- Permits greater surface contact
- Allows connectors to be rotated for parallel applications. Multiple conductor lugs hole spacing does NOT permit insertion of straight pin connectors
- Provides easy conductor insertion
- Ensures reliability for aluminum or copper conductors
- Provides easy identification and tooling recommendation
- Prevents oxides from forming
- Prevents foreign materials from entering the connector prior to usage and color code identifies the proper compression die
- Eliminates taping

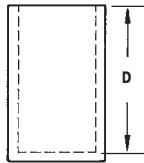
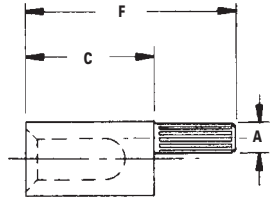

Lug Will Not Accept Straight Pin Offset Pin Design - Application

Catalog Number	Wire Size	Die Color Code	Die Index	Pin Size	Dimensions				O.D.	I.D.
					F	C	A	D (cover)		
ACO-2/0	2/0	White	12	#1	2-7/32	1-3/8	11/32	2	55/64	7/16
ACO-3/0	3/0	White	12	1/0	2-19/32	1-3/8	3/8	2	55/64	1/2
ACO-4/0	4/0	White	12	2/0	2-19/32	1-3/8	27/64	2	55/64	35/64
ACO-250	250kcmil	Brown	14	3/0	2-5/8	1-13/32	15/32	2-1/4	1-7/64	19/32
ACO-300	300kcmil	Brown	14	4/0	2-3/4	1-13/32	17/32	2-1/4	1-7/64	21/32

CONTINUED ON NEXT PAGE.

Cover and connector are packaged together (ONLY).

Tooling Information

Catalog Number	ILSCO				Burdny						Thomas & Betts		Color Code
	ILC-12-N ILC-12H-N Die No. No. of Crimps	ILCB-12-N Die No. No. of Crimps	ILC-15H Die No. No. of Crimps	IDT-12-N Die No. No. of Crimps	Y750 Family Die Index No. of Crimps	Y-35 Die Index No. of Crimps	Y-39 Die Index No. of Crimps	Y-45 Die Index No. of Crimps	Y-46 Die Index No. of Crimps	Y644M Dieless No. of Crimps	13642 12 Ton Die Index No. of Crimps	13100A 15 Ton Die Index No. of Crimps	
ACO-2/0	ILD-12 (1)	ILD-12 (1)	ILD-12 (1)	(1)	298 (2*)	298 (2*)	298 (2*)	298 (2*)	298 (2*)	(1)	66H (2)	66 (2)	White
ACO-3/0	ILD-12 (1)	ILD-12 (1)	ILD-12 (1)	(1)	298 (2*)	298 (2*)	298 (2*)	298 (2*)	298 (2*)	(1)	66H (2)	66 (2)	White
ACO-4/0	ILD-12 (1)	ILD-12 (1)	ILD-12 (1)	(1)	298 (2*)	298 (2*)	298 (2*)	298 (2*)	298 (2*)	(1)	66H (2)	66 (2)	White
ACO-250	ILD-14 (1)	ILD-14 (1)	ILD-14 (1)	(1)	299 (2*)	299 (2*)	299 (2*)	299 (2*)	299 (2*)	(1)	87H (2)	87 (2)	Brown
ACO-300	ILD-14 (1)	ILD-14 (1)	ILD-14 (1)	(1)	299 (2*)	299 (2*)	299 (2*)	299 (2*)	299 (2*)	(1)	87H (2)	87 (2)	Brown

* Overlap Crimps

See stuffer sheet for complete information on tooling.

Tested to UL 486A-486B, UL File E62525

TYPE ACO

Features

- Manufactured from high strength aluminum alloy
- Pin is knurled
- Pin is off center
- Chamfered barrel
- UL Listed and CSA Certified for 600 volts, 90° C
- Clearly marked with wire size and die index for IlSCO tools, proper number and location of crimps
- Prefilled with DE-OX
- Color coded end caps inserted in barrel
- Supplied with insulating cover

Benefits

- Provides maximum conductivity and excellent crimping characteristics
- Permits greater surface contact
- Allows connectors to be rotated for parallel applications. Multiple conductor lugs hole spacing does NOT permit insertion of straight pin connectors
- Provides easy conductor insertion
- Ensures reliability for aluminum or copper conductors
- Provides easy identification and tooling recommendation
- Prevents oxides from forming
- Prevents foreign materials from entering the connector prior to usage and color code identifies the proper compression die
- Eliminates taping

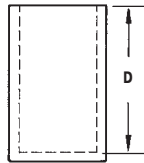
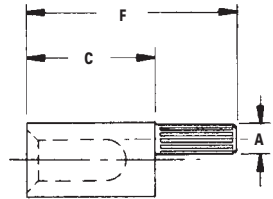

Lug Will Not Accept Straight Pin Offset Pin Design - Application

Catalog Number	Wire Range	Die Color Code	Die Index	Pin Size	Dimensions				O.D.	I.D.
					F	C	A	D (cover)		
ACO-350	350kcmil	Brown	14	250kcmil	2-3/4	1-13/32	37/64	2-1/4	1-7/64	23/32
ACO-500	500kcmil	Pink	16A	350kcmil	3-5/8	2-1/32	11/16	3-1/4	1-21/64	55/64
ACO-600	600kcmil	Yellow	18	400kcmil	3-43/64	2-1/32	47/64	3-1/4	1-15/32	59/64
ACO-750	750kcmil-700kcmil	Yellow	18	500kcmil	3-51/64	2-1/32	13/16	3-1/4	1-15/32	1-1/32
ACO-1000*	1000kcmil-750kcmil	-	-	600kcmil	4-1/32	2-1/32	29/32	-	1-45/64	1-3/16

Cover and connector are packaged together (ONLY).

* Not supplied with cover

Tooling Information

Catalog Number	ILSCO				Burdndy						Thomas & Betts		Color Code
	ILC-12-N ILC-12H-N Die No. No. of Crimps	ILCB-12-N Die No. No. of Crimps	ILC-15H Die No. No. of Crimps	IDT-12-N Die No. No. of Crimps	Y750 Family Die Index No. of Crimps	Y-35 Die Index No. of Crimps	Y-39 Die Index No. of Crimps	Y-45 Die Index No. of Crimps	Y-46 Die Index No. of Crimps	Y644M Dieless No. of Crimps	13642 12 Ton Die Index No. of Crimps	13100A 15 Ton Die Index No. of Crimps	
ACO-350	ILD-14 (1)	ILD-14 (1)	ILD-14 (1)	(1)	299 (2*)	299 (2*)	299 (2*)	299 (2*)	299 (2*)	(1)	87H (2)	87 (2)	Brown
ACO-500	ILD-16A (2)	ILD-16A (2)	ILD-16A (2)	(1)	300 (3)	300 (3)	300 (3)	300 (3)	300 (3)	(1)	99H (3)	99H (3)	Pink
ACO-600	ILD-18 (3)	ILD-18 (3)	ILD-18 (3)	(1)	936 (3)	936 (3)	936 (3)	936 (3)	936 (3)	(1)	115H (3)	115H (3)	Yellow
ACO-750	ILD-18 (3)	ILD-18 (3)	ILD-18 (3)	(1)	936 (3)	936 (3)	936 (3)	936 (3)	936 (3)	(1)	115H (3)	115H (3)	Yellow
ACO-1000	-	-	-	(1)	-	-	-	-	-	(1)	-	-	-

* Overlap Crimps

See stuffer sheet for complete information on tooling.

Tested to UL 486A-486B, UL File E62525

A

TYPE ACO-90

Features

- Manufactured from high strength aluminum alloy
- Pin is bent
- Pin is knurled
- Chamfered barrel
- UL Listed and CSA Certified for 600 volts, 90° C
- Clearly marked with wire size and die index for IlSCO tools, proper number and location of crimps
- Prefilled with DE-OX
- Color coded end caps inserted in barrel
- Supplied with insulating cover

Benefits

- Provides maximum conductivity and excellent crimping characteristics
- Eliminates the need to bend the conductor. Designed for use in tight applications where room for the required bending radius of the wire is not available
- Permits greater surface contact
- Provides easy conductor insertion
- Ensures reliability for aluminum or copper conductors
- Provides easy identification and tooling recommendation
- Prevents oxides from forming
- Prevents foreign materials from entering the connector prior to usage and color code identifies the proper compression die
- Eliminates taping

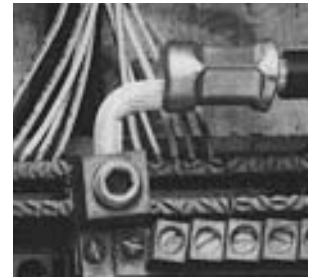
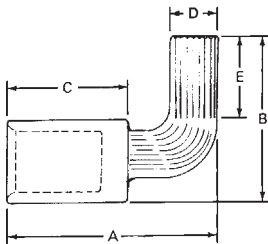

Catalog Number	Wire Range	Die Color Code	Die Index	Pin Size	A	B	C	D	E	Cover	O.D.	I.D.
ACO-90-350	350kcmil	Brown	14	250kcmil	2.49	2.68	1.41	.57	1.34	2-1/4	1-7/64	23/32
ACO-90-500	500kcmil	Pink	16A	350kcmil	3.30	3.16	2.03	.68	1.60	3-1/4	1-21/64	55/64

Cover & Connector are packaged together (ONLY).

Tooling Information

Catalog Number	ILSCO				Burdny						Thomas & Betts		Color Code
	ILC-12-N ILC-12H-N Die No. No. of Crimps	ILCB-12-N Die No. No. of Crimps	ILC-15H Die No. No. of Crimps	IDT-12-N Die No. No. of Crimps	Y750 Family Die Index No. of Crimps	Y-35 Die Index No. of Crimps	Y-39 Die Index No. of Crimps	Y-45 Die Index No. of Crimps	Y-46 Die Index No. of Crimps	Y644M Dieless No. of Crimps	13642 12 Ton Die Index No. of Crimps	13100A 15 Ton Die Index No. of Crimps	
ACO-90-350	ILD-14 (1)	ILD-14 (1)	ILD-14 (2)	(1)	299 (2*)	299 (2*)	299 (2*)	299 (2*)	299 (2*)	(1)	87H (2)	87 (2)	Brown
ACO-90-500	ILD-16A (2)	ILD-16A (2)	ILD-16A (2)	(1)	300 (3)	300 (3)	300 (3)	300 (3)	300 (3)	(1)	99H (3)	99H (3)	Pink

* Overlap Crimps

See stuffer sheet for complete information on tooling.

Tested to UL 486A-486B, UL File E62525

TYPE IACL

Features

- Manufactured from high strength aluminum alloy
- Four OD sizes accommodate a wire range from #4 to 600 kcmil
- Chamfered barrel
- Prefilled with DE-OX
- Color coded end caps inserted in barrel and ink marked with die number and number of crimps
- Electro tin plated
- UL Listed for 600 volts, 90° C
- Dual Rated

Benefits

- Provides maximum conductivity and excellent crimping characteristics
- Requires only four installation dies to crimp eleven conductor sizes. Tang width remains constant within an OD size and is designed to fit transformer pads.
- Provides easy conductor insertion
- Prevents oxides from forming
- Prevents foreign materials from entering the connector prior to usage and color code identifies the proper compression die
- Provides low contact resistance
- Ensures reliability

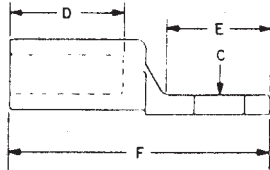

Catalog Number	Wire Size	Wire Range When Installed With IDT-12-N Tool	Tang Width	Bolt Size	Dimensions				Ilsco Die Index	Die Color Code
					D	E	F	C		
IACL-4	4	4-6	29/32	1/2	1-7/16	1-3/32	3	9/16	9	Orange
IACL-2	2	2-6	29/32	1/2	1-7/16	1-3/32	3	9/16	9	Orange
IACL-1/0	1/0	1/0-1	29/32	1/2	1-7/16	1-3/32	3	9/16	9	Orange
IACL-2/0	2/0	2/0-1	29/32	1/2	1-7/16	1-9/32	3-3/16	9/16	12	White
IACL-3/0	3/0	3/0-1	29/32	1/2	1-7/16	1-9/32	3-3/16	9/16	12	White
IACL-4/0	4/0	4/0-1	29/32	1/2	1-7/16	1-9/32	3-3/16	9/16	12	White
IACL-250	250kcmil	250kcmil-1/0	29/32	1/2	1-7/16	1-9/32	3-3/16	9/16	12	White
IACL-300	300kcmil	300kcmil-2/0	1-1/4	1/2	1-3/4	1-5/16	3-11/16	9/16	14	Blue
IACL-350	350kcmil	350kcmil-3/0	1-1/4	1/2	1-3/4	1-5/16	3-11/16	9/16	14	Blue
IACL-500	500kcmil	500kcmil-4/0	1-1/4	1/2	1-3/4	1-5/16	3-11/16	9/16	14	Blue
IACL-600	600kcmil	600kcmil-250kcmil	1-19/32	1/2	3-3/16	1-5/8	5-3/4	9/16	18	Yellow

Tooling Information

Catalog Number	Color	ILSCO					Burdly								Thomas & Betts			Anderson
		Die Index	ILC-12-N ILC-12H-N 12 Ton	ILCB-12-N	ILC-15H	IDT-12-N Dieless	Die Index	Y34A	Y35	Y39	Y45	Y46	Y48B	Y644M Dieless	Die Index	13642 12 Ton	TBM 15 15 Ton	21940 40 Ton
IACL-4	Orange	9	(3)	(3)	(2)	(1)	297	(2)	(2)	(2)	(2)	(2)	(1)	50	(2)	(2)	(2)	(2)
IACL-2	Orange	9	(3)	(3)	(2)	(1)	297	(2)	(2)	(2)	(2)	(2)	(1)	50	(2)	(2)	(2)	(2)
IACL-1/0	Orange	9	(3)	(3)	(2)	(1)	297	(2)	(2)	(2)	(2)	(2)	(1)	50	(2)	(2)	(2)	(2)
IACL-2/0	White	12	(1)	(1)	(2)	(1)	324	(2)	(2)	(2)	(2)	(2)	(1)	71	(2)	(2)	(2)	(2)
IACL-2/0	White	12	(1)	(1)	(2)	(1)	324	(2)	(2)	(2)	(2)	(2)	(1)	71	(2)	(2)	(2)	(2)
IACL-2/0	White	12	(1)	(1)	(2)	(1)	324	(2)	(2)	(2)	(2)	(2)	(1)	71	(2)	(2)	(2)	(2)
IACL-250	White	12	(1)	(1)	(2)	(1)	324	(2)	(2)	(2)	(2)	(2)	(1)	71	(2)	(2)	(2)	(2)
IACL-300	Blue	14	(2)	(2)	(2)	(1)	299	-	(2)	(2)	(2)	(2)	(1)	87	(2)	(2)	(2)	(2)
IACL-350	Blue	14	(2)	(2)	(2)	(1)	299	-	(2)	(2)	(2)	(2)	(1)	87	(2)	(2)	(2)	(2)
IACL-500	Blue	14	(2)	(2)	(2)	(1)	299	-	(2)	(2)	(2)	(2)	(1)	87	(2)	(2)	(2)	(2)
IACL-600	Yellow	18	(3)	(3)	(3)	(1)	936	-	-	(3)	(3)	(3)	(1)	115	(3)	(3)	(3)	-

* UL Listed for 600 volts maximum when installed with tools and dies shown above. If proper high voltage spacings and insulation techniques are used, these compression connectors can be used for high voltage applications up to 35KV.

See stuffer sheet for complete information on tooling. Tested to UL 486A-486B, UL File E6207

A

TYPE 2IACL

Features

- Manufactured from high strength aluminum alloy
- Four OD sizes accommodate a wire range from 1/0 to 1000 kcmil
- Chamfered barrel
- Prefilled with DE-OX
- Color coded end caps inserted in barrel and ink marked with die number and number of crimps
- Electro tin plated
- UL Listed for 600 volts, 90° C
- Dual Rated

Benefits

- Provides maximum conductivity and excellent crimping characteristics
- Requires only four installation dies to crimp eleven conductor sizes. Tang width remains constant within an OD size and is designed to fit transformer pads.
- Provides easy conductor insertion
- Prevents oxides from forming
- Prevents foreign materials from entering the connector prior to usage and color code identifies the proper compression die
- Provides low contact resistance
- Ensures reliability

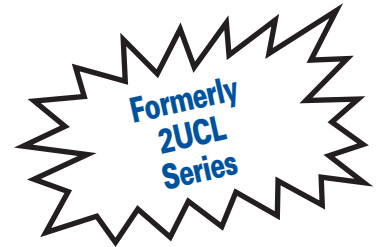
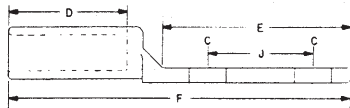

Catalog Number	Wire Size	Wire Range When Installed With IDT-12-N Tool	Tang Width	Bolt Size	Dimensions					IlSCO Die Index	Die Color Code
					D	E	F	C	J		
2IACL-1/0	1/0	1/0-1	1	1/2	1-1/2	3-1/4	5-3/16	9/16(2)	1-3/4	9	Orange
2IACL-2/0	2/0	2/0-1	1-1/4	1/2	1-7/8	3-1/4	5-3/4	9/16(2)	1-3/4	12	White
2IACL-3/0	3/0	3/0-1	1-1/4	1/2	1-7/8	3-1/4	5-3/4	9/16(2)	1-3/4	12	White
2IACL-4/0	4/0	4/0-1	1-1/4	1/2	1-7/8	3-1/4	5-3/4	9/16(2)	1-3/4	12	White
2IACL-250	250kcmil	250kcmil-1/0	1-1/4	1/2	1-7/8	3-1/4	5-3/4	9/16(2)	1-3/4	12	White
2IACL-300	300kcmil	300kcmil-2/0	1-1/4	1/2	2-3/8	3-1/4	6	9/16(2)	1-3/4	14	Blue
2IACL-350	350kcmil	350kcmil-3/0	1-1/4	1/2	2-3/8	3-1/4	6	9/16(2)	1-3/4	14	Blue
2IACL-500	500kcmil	500kcmil-4/0	1-1/4	1/2	2-3/8	3-1/4	6	9/16(2)	1-3/4	14	Blue
2IACL-600	600kcmil	600kcmil-250kcmil	1-39/64	1/2	3-3/16	3-1/4	7	9/16(2)	1-3/4	18	Yellow
2IACL-750	750kcmil	750kcmil-500kcmil	1-39/64	1/2	3-3/16	3-1/4	7-1/4	9/16(2)	1-3/4	18	Yellow
2IACL-1000	1000kcmil	1000kcmil-750kcmil	1-39/64	1/2	3-3/16	3-1/4	7-1/4	9/16(2)	1-3/4	18	Yellow

Tooling Information

Catalog Number	Color	ILSCO					Burdny								Thomas & Betts			Anderson
		Die Index	ILC-12-N ILC-12H-N 12 Ton	ILCB-12-N	ILC-15H	IDT-12-N Dieless	Die Index	Y34A	Y35	Y39	Y45	Y46	Y48B	Y644M Dieless	Die Index	13642 12 Ton	TBM 15 15 Ton	21940 40 Ton
2IACL-1/0	Orange	9	(3)	(3)	(2)	(1)	297	(2)	(2)	(2)	(2)	(2)	(1)	50	(2)	(2)	(2)	(2)
2IACL-2/0	White	12	(1)	(1)	(2)	(1)	324	(2)	(2)	(2)	(2)	(2)	(1)	71	(2)	(2)	(2)	(2)
2IACL-2/0	White	12	(1)	(1)	(2)	(1)	324	(2)	(2)	(2)	(2)	(2)	(1)	71	(2)	(2)	(2)	(2)
2IACL-250	White	12	(1)	(1)	(2)	(1)	324	(2)	(2)	(2)	(2)	(2)	(1)	71	(2)	(2)	(2)	(2)
2IACL-2/0	White	12	(1)	(1)	(2)	(1)	324	(2)	(2)	(2)	(2)	(2)	(1)	71	(2)	(2)	(2)	(2)
2IACL-300	Blue	14	(2)	(2)	(2)	(1)	299	-	(2)	(2)	(2)	(2)	(1)	87	(2)	(2)	(2)	(2)
2IACL-350	Blue	14	(2)	(2)	(2)	(1)	299	-	(2)	(2)	(2)	(2)	(1)	87	(2)	(2)	(2)	(2)
2IACL-500	Blue	14	(2)	(2)	(2)	(1)	299	-	(2)	(2)	(2)	(2)	(1)	87	(2)	(2)	(2)	(2)
2IACL-600	Yellow	18	(3)	(3)	(3)	(1)	936	-	-	(3)	(3)	(3)	(1)	115	(3)	(3)	(3)	-
2IACL-750	Yellow	18	(3)	(3)	(3)	(1)	936	-	-	(3)	(3)	(3)	(1)	115	(3)	(3)	(3)	-
2IACL-1000	Yellow	18	-	-	(3)	(1)	936	-	-	(3)	(3)	(3)	(1)	115	(3)	(3)	(3)	-

* UL Listed for 600 volts maximum when installed with tools and dies shown above. If proper high voltage spacings and insulation techniques are used, these compression connectors can be used for high voltage applications up to 35KV.

See stuffer sheet for complete information on tooling. Tested to UL 486A-486B, UL File E6207

TYPE AS

Features

- Electro-tin plated
- Manufactured from high strength aluminum alloy
- Chamfered barrel
- UL Listed and CSA Certified for 600 volts, 90° C
- Color coded
- Center wire stop
- Clearly marked with wire size and die index for IlSCO tools, proper number and location of crimps
- Prefilled with DE-OX
- Color coded end caps inserted in each end

Benefits

- Provides low contact resistance
- Provides maximum conductivity and excellent crimping characteristics
- Provides easy conductor insertion
- Ensures reliability for copper or aluminum conductors
- Provides visual tooling recommendation for IlSCO or standard industry tools
- Prevents dissimilar metals from coming into contact and insures that conductors are fully inserted
- Provides easy identification and tooling recommendation
- Prevents oxides from forming
- Prevents foreign materials from entering the connector prior to usage and color code identifies the proper compression die

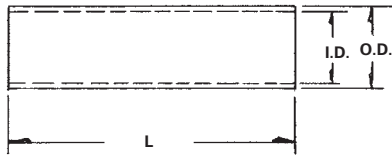

Catalog Number	Wire Size	Wire Range When Installed With IDT-12-N Tool	Die Color Code	L	Die Index	O.D.	I.D.
AS-8	8	8	Blue	1-3/16	2	5/16	5/32
AS-6	6	6	Gray	1-5/8	3	11/32	3/16
AS-4	4	4-6	Green	1-7/8	4	7/16	1/4
AS-2	2	2-6	Pink	2-3/8	7	17/32	5/16
AS-1	1	1-2	Gold	2-3/8	7	35/64	23/64
AS-1/0	1/0	1/0 - 1	Tan	2-3/8	8	39/64	25/64
AS-2/0	2/0	2/0 - 1	Olive	2-1/2	10	43/64	7/16

CONTINUED ON NEXT PAGE.

Tooling Information

Catalog Number	ILSCO								Burdny						Thomas & Betts				Anderson	Color Code
	ILC-12-N ILC-12H-N Die No. No. of Crimps	ILCB-12-N Die No. No. of Crimps	IDTB-6 Dieless No. of Crimps	IDT-6, IDT-6H 6.2 Ton Dieless No. of Crimps	ILC-15H Die No. No. of Crimps	MT-25 Hand Dieless No. of Crimps	94285 Left/ Rt. Die/Die No. of Crimps	IDT-12-N Dieless No. of Crimps	Y-35 Die Index No. of Crimps	Y-39 Die Index No. of Crimps	Y-45 Die Index No. of Crimps	Y-46 Die Index No. of Crimps	MY29-3 Hand Dieless No. of Crimps	Y644M Dieless No. of Crimps	13642 12 Ton Die Index No. of Crimps	TBM 15 15 Ton Die Index No. of Crimps	21940 40 Ton Die Index No. of Crimps	TBM-8 Hand Tool No. of Crimps	Versa Crimp Dieless No. of Crimps	
AS-8	ILD-2 (1)	ILD-2 (1)	-	-	ILD-2 (1)	-	M/K (2)	-	-	-	-	-	(1)	-	24	24 (1)	24 (2)	-	-	Blue
AS-6	ILD-3 (1)	ILD-3 (1)	(1)	(1)	ILD-3 (1)	(1)	K/K (2)	(1)	346 (1)	346 (1)	346 (1)	346 (1)	(1)	(1)	29 (2)	29 (2)	29 (2)	(2)	-	Gray
AS-4	ILD-4 (2)	ILD-4 (2)	(1)	(1)	ILD-4 (2)	(1)	H/H (3)	(1)	375 (1)	375 (1)	375 (1)	375 (1)	(1)	(1)	37 (2)	37 (2)	37 (2)	(2)	(1)	Green
AS-2	ILD-7 (1) ILD-6 (3)	ILD-7 (1) ILD-6 (3)	(2)	(2)	ILD-7 (1) ILD-6 (3)	(2)	E/A (3)	(1)	348 (1)	348 (1)	348 (1)	348 (1)	(2)	(1)	42 (2)	42H (4)	42 (2)	(2)	(1)	Pink
AS-1	ILD-7 (1) ILD-6 (4)	ILD-7 (1) ILD-6 (4)	(2)	(2)	ILD-7 (1) ILD-6 (4)	(2)	E/A (4)	(1)	471 (1)	471 (1)	471 (1)	471 (1)	(2)	(1)	45 (3)	45 (3)	45 (3)	(3)	(2)	Gold
AS-1/0	ILD-8 (1)	ILD-8 (1)	(2)	(2)	ILD-8 (1)	(2)	A/C (5)	(1)	296 (1)	296 (1)	296 (1)	296 (1)	(2)	(1)	50 (3)	50 (3)	50 (3)	(3)	(2)	Tan
AS-2/0	ILD-10 (1)	ILD-10 (1)	(2)	(2)	ILD-10 (1)	(2)	A/B (4)	(1)	297 (2)	297 (2)	297 (2)	297 (2)	(2)	(1)	54 (3)	54H (6)	54 (3)	(3)	(2)	Olive

UL Listed and CSA Certified 600 volts maximum when installed with tools and dies shown above. If proper high voltage spacings and insulation techniques are used, the aluminum compression connectors can be used for high voltage applications up to 35KV.

See stuffer sheet for complete information on tooling. Tested to UL 486A-486B, UL File E6207

A TYPE AS

Features

- Electro-tin plated
- Manufactured from high strength aluminum alloy
- Chamfered barrel
- UL Listed and CSA Certified for 600 volts, 90° C
- Color coded
- Center wire stop
- Clearly marked with wire size and die index for IlSCO tools, proper number and location of crimps
- Prefilled with DE-OX
- Color coded end caps inserted in each end

Benefits

- Provides low contact resistance
- Provides maximum conductivity and excellent crimping characteristics
- Provides easy conductor insertion
- Ensures reliability for copper or aluminum conductors
- Provides visual tooling recommendation for IlSCO or standard industry tools
- Prevents dissimilar metals from coming into contact and insures that conductors are fully inserted
- Provides easy identification and tooling recommendation
- Prevents oxides from forming
- Prevents foreign materials from entering the connector prior to usage and color code identifies the proper compression die

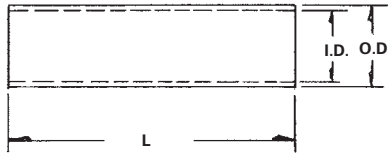

Catalog Number	Wire Size	Wire Range When Installed With IDT-12-N Tool	Die Color Code	L	Die Index	O.D.	I.D.
AS-3/0	3/0	3/0-1	Ruby	2-5/8	10	49/64	1/2
AS-4/0	4/0	4/0-1	White	3-11/16	12	55/64	9/16
AS-250	250kcmil	250kcmil-1/0	Red	3-15/16	13	59/64	39/64
AS-300	300kcmil	300kcmil-2/0	Blue	4-1/16	14	1-1/64	21/32
AS-350	350kcmil	350kcmil-3/0	Brown	5-1/16	14	1-7/64	23/32
AS-400	400kcmil	400kcmil-4/0	Green	5-1/16	16	1-3/16	49/64
AS-500	500kcmil	500kcmil-4/0	Pink	5-1/16	16A	1-5/16	55/64

CONTINUED ON NEXT PAGE.

Tooling Information

Catalog Number	ILSCO								Burdry				Thomas & Betts				Anderson	Color Code		
	ILC-12-N Die No. No. of Crimps	ILCB-12-N Die No. No. of Crimps	IDTB-6 Dieless No. of Crimps	IDT-6, IDT-6H 6.2 Ton Dieless No. of Crimps	ILC-15H Die No. No. of Crimps	MT-25 Hand Dieless No. of Crimps	94285 Left/Rt. Die/Die No. of Crimps	IDT-12-N Dieless No. of Crimps	Y-35 Die Index No. of Crimps	Y-39 Die Index No. of Crimps	Y-45 Die Index No. of Crimps	Y-46 Die Index No. of Crimps	MY29-3 Hand Dieless No. of Crimps	Y644M Dieless No. of Crimps	13642 12 Ton Die Index No. of Crimps	TBM 15 15 Ton Die Index No. of Crimps	21940 40 Ton Die Index No. of Crimps		TBM-8 Hand Tool No. of Crimps	Versa Crimp Dieless No. of Crimps
AS-3/0	ILD-10 (2)	ILD-10 (2)	- (3)	- (3)	ILD-10 (2)	- (2)	A/A (4)	- (1)	467 (2)	467 (2)	467 (2)	467 (2)	- (2)	- (1)	60 (3)	60 (3)	60 (3)	- (3)	- (2)	Ruby
AS-4/0	ILD-12 (1)	ILD-12 (1)	- (3)	- (3)	ILD-12 (1)	- (2)	-	- (2)	298 (2)	298 (2)	298 (2)	298 (2)	- (2)	- (1)	66H (4)	66 (2)	66 (2)	- (5)	- (3)	White
AS-250	ILD-13 (2)	ILD-13 (2)	- (3)	- (3)	ILD-13 (2)	-	-	- (2)	324 (2)	324 (2)	324 (2)	324 (2)	-	- (1)	71H (4)	71H (4)	71 (2)	- (5)	- (3)	Red
AS-300	ILD-14 (2)	ILD-14 (2)	- (4)	- (4)	ILD-14 (2)	-	-	- (2)	470 (2)	470 (2)	470 (2)	470 (2)	-	- (1)	76H (4)	76 (2)	76 (2)	- (5)	- (3)	Blue
AS-350	ILD-14 (2)	ILD-14 (2)	- (4)	- (4)	ILD-14 (2)	-	-	- (2)	299 (2)	299 (2)	299 (2)	299 (2)	-	- (1)	87H (4)	87H (4)	87 (2)	- (6)	- (3)	Brown
AS-400	ILD-16 (3)	ILD-16 (3)	- (4)	- (4)	ILD-16 (3)	-	-	- (2)	472 (4)	472 (4)	472 (4)	472 (4)	-	- (1)	94H (4)	94H (4)	94 (2)	-	- (4)	Green
AS-500	ILD-16A (3)	ILD-16A (3)	- (4)	- (4)	ILD-16A (3)	-	-	- (2)	300 (4)	300 (4)	300 (4)	300 (4)	-	- (1)	99H (4)	99H (4)	99 (2)	-	- (4)	Pink

UL Listed and CSA Certified 600 volts maximum when installed with tools and dies shown above. If proper high voltage spacings and insulation techniques are used, the aluminum compression connectors can be used for high voltage applications up to 35KV.

See stuffer sheet for complete information on tooling. Tested to UL 486A-486B, UL File E6207

TYPE AS

Features

- Electro-tin plated
- Manufactured from high strength aluminum alloy
- Chamfered barrel
- UL Listed and CSA Certified for 600 volts, 90° C
- Color coded
- Center wire stop
- Clearly marked with wire size and die index for IlSCO tools, proper number and location of crimps
- Prefilled with DE-OX
- Color coded end caps inserted in each end

Benefits

- Provides low contact resistance
- Provides maximum conductivity and excellent crimping characteristics
- Provides easy conductor insertion
- Ensures reliability for copper or aluminum conductors
- Provides visual tooling recommendation for IlSCO or standard industry tools
- Prevents dissimilar metals from coming into contact and insures that conductors are fully inserted
- Provides easy identification and tooling recommendation
- Prevents oxides from forming
- Prevents foreign materials from entering the connector prior to usage and color code identifies the proper compression die

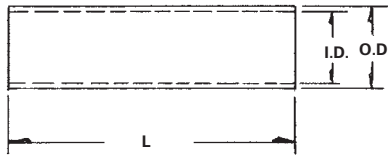

Catalog Number	Wire Size	Wire Range When Installed With IDT-12-N Tool	Die Color Code	L	Die Index	O.D.	I.D.
AS-600	600kcmil	600kcmil-250kcmil	Black	5-5/16	17	1-5/16	59/64
AS-700	700kcmil	700kcmil-350kcmil	Purple	5-13/16	17	1-13/32	1
AS-750	750kcmil	750kcmil-500kcmil	Yellow	5-13/16	18	1-29/64	1-1/32
AS-1000	1000kcmil	1000kcmil-750kcmil	Brown	7-1/8	20	1-53/64	1-3/16

Tooling Information

Catalog Number	ILSCO						Burdny					Thomas & Betts				Anderson	Color Code
	ILC-12-N ILC-12H-N Die No. No. of Crimps	ILCB-12-N Die No. No. of Crimps	IDTB-6 Dieless No. of Crimps	IDT-6, IDT-6H 6.2 Ton Dieless No. of Crimps	ILC-15H Die No. No. of Crimps	IDT-12-N Dieless No. of Crimps	Y-35 Die Index No. of Crimps	Y-39 Die Index No. of Crimps	Y-45 Die Index No. of Crimps	Y-46 Die Index No. of Crimps	Y644M Dieless No. of Crimps	13642 12 Ton Die Index No. of Crimps	TBM 15 15 Ton Die Index No. of Crimps	21940 40 Ton Die Index No. of Crimps	TBM Hand Tool No. of Crimps	Versa Crimp Dieless No. of Crimps	
AS-600	ILD-17 (4)	ILD-17 (4)	- (4)	- (4)	ILD-17 (4)	- (2)	473 (4)	473 (4)	473 (4)	473 (4)	- (1)	106H (4)	106 (2)	106 (2)	-	- (4)	Black
AS-700	ILD-17 (4)	ILD-17 (4)	- (4)	- (4)	ILD-17 (4)	- (2)	-	936 (4)	936 (4)	936 (4)	- (1)	112H (4)	112H (4)	112 (2)	-	-	Purple
AS-750	ILD-18 (5)	ILD-18 (5)	- (4)	- (4)	ILD-18 (5)	- (2)	-	936 (4)	936 (4)	936 (4)	- (1)	115H (4)	115H (4)	115 (2)	-	-	Yellow
AS-1000	-	-	-	-	- (3)	- (2)	-	-	-	-	- (1)	-	140H (4)	140 (2)	-	-	Brown

UL Listed and CSA Certified 600 volts maximum when installed with tools and dies shown above. If proper high voltage spacings and insulation techniques are used, the aluminum compression connectors can be used for high voltage applications up to 35KV. See stuffer sheet for complete information on tooling.

Tested to UL 486A-486B, UL File E6207

ILSCO Aluminum Compression Sleeves - Utility Type

A TYPE UCS

Features

- Manufactured from high strength aluminum alloy, rated for 600 volts, 90° C
- Four OD sizes accommodate a wire range from 1000kcmil to #4
- Chamfered barrel
- Prefilled with DE-OX
- Solid barrier in center
- Color coded end caps inserted in barrel

Benefits

- Provides maximum conductivity and excellent crimping characteristics
- Requires only four installation dies to crimp fourteen conductor sizes.
- Provides easy conductor insertion
- Prevents oxides from forming
- Prevents dissimilar metals from coming into contact
- Prevents foreign materials from entering the connector prior to usage and color code identifies the proper compression die



Catalog Number	Wire Range	Dimensions			Installing Dies	Die Index
		L	O.D.	I.D.		
UCS-4-Z	4	3"	41/64	9/32	BG, 5/8, 8A	9
UCS-2-Z	2	3"	41/64	11/32	BG, 5/8, 8A	9
UCS-1/0-Z	1/0	3"	41/64	27/64	BG, 5/8, 8A	9
UCS-2/0-Z	2/0	4"	29/32	7/16	249, 840, TX, 76, 11A	13
UCS-3/0-Z	3/0	4"	29/32	1/2	249, 840, TX, 76, 11A	13
UCS-4/0-Z	4/0	4"	29/32	9/16	249, 840, TX, 76, 11A	13
UCS-250-Z	250kcmil	4"	29/32	19/32	249, 840, TX, 76, 11A	13
UCS-300-Z	300kcmil	5"	1-5/32	21/32	299, 655, 705, 1-1/8, 13A	14
UCS-350-Z	350kcmil	5"	1-5/32	45/64	299, 655, 705, 96, 1-1/8, 13A	14
UCS-500-Z	500kcmil	5"	1-5/32	27/32	299, 655, 705, 96, 1-1/8, 13A	14
UCS-600-Z	600kcmil	6"	1-39/64	59/64	301, 1-1/2, 140	18
UCS-700/750-Z	750kcmil - 700kcmil	6"	1-39/64	1-1/32	301, 1-1/2, 140, 72H	18
UCS-1000-Z	1000kcmil	7"	1-39/64	1-3/16	301, 1-1/2, 140, 72H	18

ILSCO Insulated Aluminum Service Entrance Sleeves

A

TYPE PICS

Features

- Pre-insulated
- Concave polyethylene end caps
- Dual rated
- Meets ANSI C119.4 requirements
- RUS Listed
- Die Index 5/8 or BG

Benefits

- Fast, easy installation
- Seal out dirt but are easily pierced when inserting conductor
- For use with aluminum-aluminum and aluminum-copper conductors
- Ensures reliability

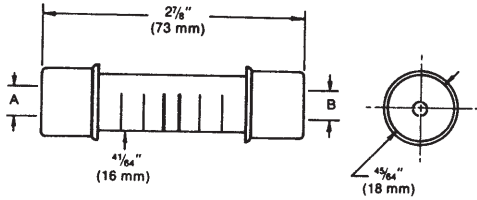

Catalog Number	End "A"					End "B"				
	Conductor Range				Color Code	Conductor Range				Color Code
	ACSR	AWG	Diameter			ACSR	AWG	Diameter		
max.			min.	max.	min.					
PICS-61	-	6 sol - 8 str	0.162	0.144	Green	-	6 sol - 8 str	0.162	0.144	Green
PICS-62	6	4 sol - 6 str	0.204	0.184	Blue	-	8 sol - 10 str	0.128	0.114	Brown
PICS-63	6	4 sol - 6 str	0.204	0.184	Blue	-	6 sol - 8 str	0.162	0.144	Green
PICS-64	6	4 sol - 6 str	0.204	0.184	Blue	6	4 sol - 6 str	0.204	0.184	Blue
PICS-65	4	2 sol - 3-4 str	0.258	0.213	Orange	-	8 sol - 10 str	0.128	0.114	Brown
PICS-66	4	2 sol - 3-4 str	0.258	0.213	Orange	-	6 sol - 8 str	0.162	0.144	Green
PICS-67	4	2 sol - 3-4 str	0.258	0.213	Orange	6	4 sol - 6 str	0.204	0.184	Blue
PICS-68	4	2 sol - 3-4 str	0.258	0.213	Orange	4	2 sol - 3-4 str	0.258	0.213	Orange
PICS-70	2	1-2 str	0.328	0.268	Red	-	6 sol - 8 str	0.162	0.144	Green
PICS-71	2	1-2 str	0.328	0.268	Red	6	4 sol - 6 str	0.204	0.184	Blue
PICS-72	2	1-2 str	0.328	0.268	Red	4	2 sol - 3-4 str	0.258	0.213	Orange
PICS-73	2	1-2 str	0.328	0.268	Red	2	1-2 str	0.328	0.268	Red
PICS-75	1/0	1/0	0.398	0.368	Yellow	6	4 sol - 6 str	0.204	0.184	Blue
PICS-76	1/0	1/0	0.398	0.368	Yellow	4	2 sol - 3-4 str	0.258	0.213	Orange
PICS-77	1/0	1/0	0.398	0.368	Yellow	2	2-1 str	0.328	0.268	Red
PICS-78	1/0	1/0	0.398	0.368	Yellow	-	1/0	0.398	0.368	Yellow



ILSCO Insulated Aluminum Service Entrance Sleeves

A

TYPE P840

Features

- Pre-insulated
- Concave polyethylene end caps
- Dual rated
- Meets ANSI C119.4 requirements
- RUS Listed
- Die Index 840

Benefits

- Fast, easy installation
- Seal out dirt but are easily pierced when inserting conductor
- For use with aluminum-aluminum and aluminum-copper conductors
- Ensures reliability

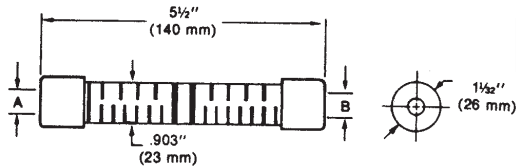

Catalog Number	End "A"					End "B"				
	Conductor Range				Color Code	Conductor Range				Color Code
	ACSR	AWG	Diameter			ACSR	AWG	Diameter		
			max.	min.			max.	min.		
PICS-834	1/0	2/0 (compact) or 1/0	0.398	0.365	Yellow	4	2 sol - 3-4 str	0.258	0.213	Orange
PICS-835	1/0	2/0 (compact) or 1/0	0.398	0.365	Yellow	2	1-2 str	0.328	0.268	Red
PICS-836	1/0	2/0 (compact) or 1/0	0.398	0.365	Yellow	1/0	2/0 (compact) or 1/0	0.398	0.365	Yellow
PICS-844	2/0	3/0 (compact) or 2/0	0.448	0.414	Gray	4	2 sol - 3-4 str	0.258	0.213	Orange
PICS-845	2/0	3/0 (compact) or 2/0	0.448	0.414	Gray	2	1-2 str	0.328	0.268	Red
PICS-846	2/0	3/0 (compact) or 2/0	0.448	0.414	Gray	1/0	2/0 (compact) or 1/0	0.398	0.365	Yellow
PICS-847	2/0	3/0 (compact) or 2/0	0.448	0.414	Gray	2/0	3/0 (compact) or 2/0	0.448	0.414	Gray
PICS-854	3/0	4/0 (compact) or 3/0	0.502	0.464	Black	4	2 sol - 3-4 str	0.258	0.213	Orange
PICS-855	3/0	4/0 (compact) or 3/0	0.502	0.464	Black	2	1-2 str	0.328	0.268	Red
PICS-856	3/0	4/0 (compact) or 3/0	0.502	0.464	Black	1/0	2/0 (compact) or 1/0	0.398	0.365	Yellow
PICS-857	3/0	4/0 (compact) or 3/0	0.502	0.464	Black	2/0	3/0 (compact) or 2/0	0.448	0.414	Gray
PICS-858	3/0	4/0 (compact) or 3/0	0.502	0.464	Black	3/0	4/0 (compact) or 3/0	0.502	0.464	Black
PICS-864	4/0	4/0	0.564	0.522	Pink	4	2 sol - 3-4 str	0.258	0.213	Orange
PICS-865	4/0	4/0	0.564	0.522	Pink	2	1-2 str	0.328	0.268	Red
PICS-866	4/0	4/0	0.564	0.522	Pink	1/0	1/0	0.398	0.365	Yellow
PICS-867	4/0	4/0	0.564	0.522	Pink	2/0	3/0 (compact) or 2/0	0.448	0.414	Gray
PICS-868	4/0	4/0	0.564	0.522	Pink	3/0	4/0 (compact) or 3/0	0.502	0.464	Black
PICS-869	4/0	4/0	0.564	0.522	Pink	4/0	4/0	0.564	0.522	Pink



TYPE AH

Features

- Prefilled with oxide inhibitor
- Color coded
- Rated for 600 Volts, 90° C
- Manufactured from high strength aluminum alloy
- UL Listed

Benefits

- Provides corrosion resistance
- Provides visual tooling recommendation for ILSCO or standard industry tools
- Can be used on any secondary splice or tap application
- Provides maximum conductivity and excellent crimping characteristics
- Ensures reliability for copper or aluminum conductors



Catalog Number	Wire Range		IlSCO Compression Tool	Die Index	L	W
	Main	Tap				
AH-1	1/0 str - 6 str	1 str - 6 str	ND-58/ND-60	0	1.62	1.78
AH-2	4/0 str - 1 str	1 str - 6 str	ND-58/ND-60	D3	1.88	2.31
AH-3	4/0 str - 3/0 str	4/0 str - 3/0 str	ND-58/ND-60	D3	2.50	2.50
AH-4	4/0 str - 1 str	2/0 str - 1 str	ND-58/ND-60	D3	2.50	2.38
AH-5	400kcmil - 4/0 str	400kcmil - 4/0 str	ILC-15H*	N	3.50	3.09
AH-6	500kcmil - 4/0 str	2/0 str - 6 str	ILC-15H*	N	2.00	2.84
AH-8	600kcmil - 350kcmil	350kcmil - 2/0 str	ILC-15H*	KR	3.50	4.50
AH-10	1000kcmil Compact - 600kcmil AL 750kcmil - 600kcmil CU	350kcmil - 2/0 str	ILC-15H*	KR	3.50	4.62
AH-11	1000kcmil Compact - 600kcmil AL 750kcmil - 600kcmil CU	600kcmil - 350kcmil	ILC-15H*	KR	4.62	4.75
AH-12	1000 Compact - 600kcmil AL 750kcmil - 600kcmil CU	1000kcmil Compact - 600kcmil AL 750kcmil - 600kcmil CU	ILC-15H*	KR	4.62	4.78

*Other hydraulic tools can be used. See stuffer sheet for complete information on tooling.

Tested to UL 486A-486B, UL File E6207

ILSCO Aluminum Compression Tap Connectors

A

**TYPE
HT**

Features

- Serrated interior
- Prefilled with oxide inhibitor
- Installed with industry standard "O" and "D" dies
- Rated for 600 Volts
- Manufactured from high strength aluminum alloy

Benefits

- Assures positive mating with cable strands when compressed
- Provides corrosion resistance
- Provides convenient die selection
- Can be used on any secondary splice or tap application
- Provides maximum conductivity and excellent crimping characteristics

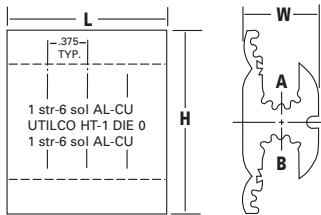

Catalog Number	Wire Range										Connector Die	No. of Crimps		Dimensions		
	Standard Wire						Compact Wire					ILSCO ND-58 Tool	ILSCO ILC-15 Tool	L	W	H
	A Groove ACSR		str		sol		A Groove ACSR		B Groove ACSR							
HT-3-Z	2/0	3/0	-	2	1	1/0	3/0	3/0	1	1	D3	5	2	1-7/8	13/16	2-3/16
	1/0	2/0	-	3	2	1	2/0	-	2	2	D3	5	2			
	-	-	-	4	3	2	-	-	4	4	D3	5	2			
	-	-	-	6	4	4	-	-	6	6	D3	5	2			
	-	-	-	-	6	6	-	-	-	-	D3	5	2			
HT-5-Z	4/0	4/0	-	2	1	1/0	266-18/1	266	1	1	D3	5	2	1-7/8	53/64	2-1/4
	3/0	-	-	3	2	1	4/0	250	2	2	D3	5	2			
	-	-	-	4	3	2	-	4/0	4	4	D3	5	2			
	-	-	-	6	4	4	-	-	6	6	D3	5	2			
	-	-	-	-	6	6	-	-	-	-	D3	5	2			
HT-6-Z	4/0	4/0	-	2/0	2/0	-	266-18/1	266	2/0	3/0	D3	7	3	2-1/4	53/64	2-3/8
	3/0	3/0	-	1/0	1/0	-	4/0	250	1/0	2/0	D3	7	3			
	-	-	-	1	-	-	3/0	4/0	-	1/0	D3	7	3			
HT-7-Z	4/0	4/0	-	4/0	4/0	-	266-18/1	266	266-18/1	266	D3	7	3	2-1/2	7/8	2-1/2
	3/0	3/0	-	3/0	3/0	-	4/0	250	4/0	250	D3	7	3			
	-	-	-	-	-	-	3/0	4/0	3/0	4/0	D3	7	3			

Consult factory for tool and die information.

ILSCO Aluminum Compression Tap Connectors



TYPE HT

Features

- Serrated interior
- Prefilled with oxide inhibitor
- Installed with industry standard "O" and "D" dies
- Rated for 600 Volts, CSA Certified
- Manufactured from high strength aluminum alloy

Benefits

- Assures positive mating with cable strands when compressed
- Provides corrosion resistance
- Provides convenient die selection
- Can be used on any secondary splice or tap application
- Provides maximum conductivity and excellent crimping characteristics

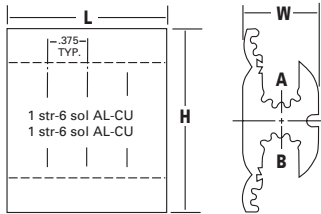

Catalog Number	Wire Range										Connector Die	No. of Crimps		Dimensions		
	Standard Wire					Compact Wire						Mech. Tool	Hyd. Tool	L	W	H
	A Groove ACSR	str	sol	B Groove ACSR	str	sol	A Groove ACSR	str	B Groove ACSR	str						
HT-6	2, 3, 4, 6, -	1, 2, 3, 4, 6	1, 2, 3, 4, 6	2, 3, 4, 6, -	1, 2, 3, 4, 6	1, 2, 3, 4, 6	1, 2, 3, 4, 6	1, 2, 3, 4, 6	1, 2, 3, 4, 6	1, 2, 3, 4, 6	O O O O O	4 4 4 4 4	2 2 2 2 2	1-1/2	23/32	1-23/32
HT-8	1/0, 1, 2, 3 -	2/0, 1/0, 1, 2	3/0, 2/0, 1/0, 1	2, 3, 4, 6	1, 2, 3, 4, 6	1/0, 1, 2, 3, 4, 6	2/0, 1/0, 1, 2	2/0, 1/0, 1, 2	1, 2, 3, 4, 6	1, 2, 3, 4, 6	O O O O O	5 5 5 5 5	2 2 2 2 2	1-1/2	45/64	1-25/32
HT-2	2/0, 1/0 -	3/0, 2/0 -	- -	2, 3, 4, 6	1, 2, 3, 4, 6	1/0, 1, 2, 4, 6	3/0, 2/0 -	3/0 -	1, 2, 4, 6	1, 2, 4, 6	D3 D3 D3 D3	5 5 5 5	2 2 2 2	1-7/8	13/16	2-3/16
HT-4	2/0, 1/0, 1	3/0, 2/0, 1/0	- -	2/0, 1/0, 1	3/0, 2/0, 1/0	- -	3/0, 2/0, 1/0	3/0, 2/0, 1/0	3/0, 2/0, 1/0	3/0, 2/0, 1/0	D3 D3 D3	6 6 6	2 2 2	1-7/8	57/64	2-17/64
HT-3	4/0, 3/0 -	4/0 -	- -	2, 3, 4, 6	1, 2, 3, 4, 6	1/0, 1, 2, 4, 6	266, 4/0 -	266, 250, 4/0 -	1, 2, 4, 6	1, 2, 4, 6	D3 D3 D3 D3	5 5 5 5	2 2 2 2	1-7/8	53/64	2-1/4
HT-5	4/0, 3/0 -	4/0, 3/0 -	- -	2/0, 1/0 -	2/0, 1/0 -	- -	266, 4/0, 3/0	266, 250, 4/0	2/0, 1/0 -	3/0, 2/0, 1/0	D3 D3 D3	7 7 7	3 3 3	2-1/4	53/64	2-3/8
HT-7	4/0, 3/0 -	4/0, 3/0 -	- -	4/0, 3/0 -	4/0, 3/0 -	- -	266, 4/0, 3/0	266, 250, 4/0	266, 4/0, 3/0	266, 250, 4/0	D3 D3 D3	7 7 7	3 3 3	2-1/2	7/8	2-1/2

Consult factory for tool and die information.



A

TYPE RLT

Features

- Prefilled with oxide inhibitor and bagged
- Clearly marked with wire size and die index
- UL Listed for 600 Volts and CSA Certified for direct burial in earth or concrete
- Range taking
- Manufactured from high strength copper alloy

Benefits

- Prevents oxides from forming
- Provides easy identification and tooling recommendation
- Ensures reliability
- Reduces inventory. Eight sizes cover a wire range of #2-500kcmil
- Provides maximum conductivity and eliminates the possibility of corrosion

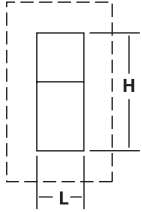

Catalog Number	Ground Rod Size	Wire Range	Die Index	Dimensions	
				H	L
RLT-2	1/2	2 (.292 Dia.) - 2/0 (.419 Dia.)	998/1011	1.94	.88
RLT-3	5/8	2 (.292 Dia.) - 2/0 (.419 Dia.)	998/1011	1.97	.88
RLT-4	3/4	2 (.292 Dia.) - 2/0 (.419 Dia.)	998/1011	2.19	.88
RLT-5	1/2	4/0 (.528 Dia.) - 250kcmil (.575 Dia.)	998/1011	1.94	.88
RLT-6	5/8	4/0 (.528 Dia.) - 250kcmil (.575 Dia.)	998/1011	2.14	.88
RLT-7	3/4	4/0 (.528 Dia.) - 250kcmil (.575 Dia.)	998/1011	2.19	.88
RLT-8	5/8	300kcmil (.630 Dia.) - 500kcmil (.813 Dia.)	998/1011	2.14	.88
RLT-9	3/4	300kcmil (.630 Dia.) - 500kcmil (.813 Dia.)	998/1011	2.44	.88

UL File E158587

ILSCO Non-Insulated Ring Terminals



TYPE ILSCONS

Features

- Manufactured from high strength copper alloy
- Electro-tin plated
- Silver solder brazed seam
- Packaged in convenient small quantities
- UL Listed and CSA Certified, 90° C

Benefits

- Provides maximum conductivity
- Provides low contact resistance
- May be crimped anywhere and will not split open, even under extreme operating stresses
- Can be displayed on merchandise racks
- Ensures reliability for copper conductor

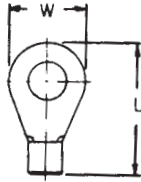

Catalog Number	Wire Range	Stud Size	Dimensions	
			L	W
44100-B20	18-22	4	.45	.20
44101-B20	18-22	6	.62	.25
44102-B20	18-22	8	.75	.31
44103-B20	18-22	10	.75	.31
44104-B20	18-22	1/4	.94	.47
44105-B20	18-22	5/16	.94	.47
44106-B20	18-22	3/8	.97	.53
44110-B20	14-16	4	.95	.25
44111-B20	14-16	6	.71	.31
44112-B20	14-16	8	.71	.31
44113-B20	14-16	10	.71	.31
44114-B20	14-16	1/4	.94	.46
44115-B20	14-16	5/16	.94	.46
44116-B20	14-16	3/8	.97	.53
44120-B20	10-12	6	.90	.37
44121-B20	10-12	8	.90	.37
44122-B20	10-12	10	.90	.37
44123-B20	10-12	1/4	1.01	.52
44124-B20	10-12	5/16	1.01	.52
44125-B20	10-12	3/8	1.01	.59
44126-B20	10-12	7/16	1.13	.71
44127-B20	10-12	1/2	1.13	.71

Can be supplied in bulk. Consult factory for part number.
UL File E158587



ILSCO Non-Insulated Ring Terminals



A

TYPE ILSCONS

Features

- Manufactured from high strength copper alloy
- Electro-tin plated
- Silver solder brazed seam
- Packaged in convenient small quantities
- UL Listed and CSA Certified, 90° C

Benefits

- Provides maximum conductivity
- Provides low contact resistance
- May be crimped anywhere and will not split open, even under extreme operating stresses
- Can be displayed on merchandise racks
- Ensures reliability for copper conductor

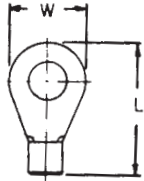

Catalog Number	Wire Range	Stud Size	Dimensions	
			L	W
44130-B10	8	10	1.20	.59
44131-B10	8	1/4	1.20	.59
44140-B10	6	10	1.18	.47
44141-B10	6	1/4	1.18	.47
44142-B10	6	5/16	1.26	.63
44143-B10	6	3/8	1.26	.63
44150-B10	4	10	1.30	.66
44151-B10	4	1/4	1.30	.66
44152-B10	4	5/16	1.30	.66
44153-B10	4	3/8	1.30	.66
44154-B10	4	7/16	1.30	.66
44155-B10	4	1/2	1.90	.88
44160-B10	2	10	1.55	.60
44161-B10	2	1/4	1.55	.60
44162-B10	2	5/16	1.55	.70
44163-B10	2	3/8	1.55	.70
44164-B10	2	7/16	1.55	.81
44165-B10	2	1/2	1.93	.81
44170-B2	1/0	1/4	1.93	.88
44171-B2	1/0	5/16	1.93	.88
44172-B2	1/0	3/8	1.93	.88
44173-B2	1/0	7/16	1.93	.88
44174-B2	1/0	1/2	1.93	.88

Can be supplied in bulk. Consult factory for part number.
UL File E158587



ILSCO Non-Insulated Ring Terminals



A

TYPE ILSCONS

Features

- Manufactured from high strength copper alloy
- Electro-tin plated
- Silver solder brazed seam
- Packaged in convenient small quantities
- UL Listed and CSA Certified, 90° C

Benefits

- Provides maximum conductivity
- Provides low contact resistance
- May be crimped anywhere and will not split open, even under extreme operating stresses
- Can be displayed on merchandise racks
- Ensures reliability for copper conductor

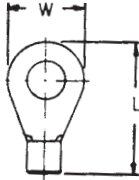

Catalog Number	Wire Range	Stud Size	Dimensions	
			L	W
44180-B2	2/0	1/4	1.93	.88
44181-B2	2/0	5/16	1.93	.88
44182-B2	2/0	3/8	1.93	.88
44183-B2	2/0	7/16	1.93	.88
44184-B2	2/0	1/2	1.93	.88
44190-B2	3/0	1/4	1.97	.93
44191-B2	3/0	5/16	1.97	.93
44192-B2	3/0	3/8	1.97	.93
44193-B2	3/0	7/16	1.97	.93
44194-B2	3/0	1/2	1.97	.93
44195-B2	4/0	5/16	2.17	1.08
44196-B2	4/0	3/8	2.17	1.08
44197-B2	4/0	7/16	2.17	1.08
44198-B2	4/0	1/2	2.17	1.08

Can be supplied in bulk. Consult factory for part number.

UL File E158587



ILSCO Vinyl Insulated Ring Terminals



A

TYPE ILSCONS

Features

- Color coded
- Manufactured from high strength copper alloy
- Electro-tin plated
- Vinyl insulation
- Packaged in convenient small quantities
- UL Listed and CSA Certified for 600 volts, 90° C

Benefits

- Provides easy wire range identification
#22-18 AWG Red
#16-14 AWG Blue
#12-10 AWG Yellow
- Provides maximum conductivity
- Provides low contact resistance
- Provides tough pliable insulative qualities to protect connectors and wire from corrosion as well as providing some strain relief
- Can be displayed on merchandise racks
- Ensures reliability for copper conductor

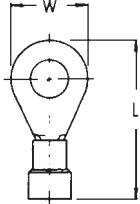

Catalog Number	Wire Range	Stud Size	Dimensions		Maximum Wire Insulated Diameter
			L	W	
44200-B10	18-22	4	.74	.22	.145
44201-B10	18-22	6	.91	.31	.145
44202-B10	18-22	8	.91	.31	.145
44203-B10	18-22	10	.91	.31	.145
44204-B10	18-22	1/4	1.10	.46	.145
44205-B10	18-22	5/16	1.14	.53	.145
44206-B10	18-22	3/8	1.14	.53	.145
44210-B10	14-16	4	.80	.25	.175
44211-B10	14-16	6	.88	.25	.175
44212-B10	14-16	8	.94	.31	.175
44213-B10	14-16	10	.94	.31	.175
44214-B10	14-16	1/4	1.06	.53	.175
44215-B10	14-16	5/16	1.06	.53	.175
44216-B10	14-16	3/8	1.06	.53	.175
44220-B10	10-12	6	.95	.28	.255
44221-B10	10-12	8	.95	.28	.255
44222-B10	10-12	10	1.00	.38	.255
44223-B10	10-12	1/4	1.22	.53	.255
44224-B10	10-12	3/8	1.33	.53	.255
44225-B10	10-12	7/16	1.46	.71	.255

Can be supplied in bulk. Consult factory for part number.

UL File E158587



ILSCO Vinyl Insulated Ring Terminals



TYPE ILSCONS

Features

- Color coded
- Manufactured from high strength copper alloy
- Electro-tin plated
- Vinyl insulation
- Packaged in convenient small quantities
- UL Listed and CSA Certified for 600 volts, 90° C

Benefits

- Provides easy wire range identification
#22-18 AWG Red
#16-14 AWG Blue
#12-10 AWG Yellow
- Provides maximum conductivity
- Provides low contact resistance
- Provides tough pliable insulative qualities to protect connectors and wire from corrosion as well as providing some strain relief
- Can be displayed on merchandise racks
- Ensures reliability for copper conductor

A

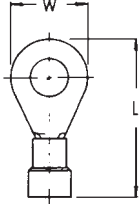

Catalog Number	Wire Range	Stud Size	Dimensions		Maximum Wire Insulated Diameter
			L	W	
44226-B10	10-12	1/2	1.52	.75	.255
44230-B5	8	10	1.28	.47	.385
44231-B5	8	1/4	1.28	.47	.385
44240-B5	6	10	1.62	.47	.440
44241-B5	6	1/4	1.62	.47	.440
44242-B5	6	5/16	1.70	.63	.440
44243-B5	6	3/8	1.70	.63	.440
44250-B5	4	10	1.81	.66	.515
44251-B5	4	1/4	1.81	.66	.515
44252-B5	4	5/16	1.81	.66	.515
44253-B5	4	3/8	1.81	.66	.515
44254-B5	4	7/16	1.81	.66	.515
44255-B5	4	1/2	2.41	.88	.515
45314-P100	14-16	10	.94	.31	.175
45315-P100	14-16	1/4	1.06	.53	.175
45316-P100	14-16	5/16	1.06	.53	.175
45316N-P100*	14-16	5/16	1.06	.53	.175
45317-P100	14-16	3/8	1.06	.53	.175
45414-P50	10-12	10	1.00	.38	.255
45415-P50	10-12	1/4	1.22	.53	.255
45416-P50	10-12	5/16	1.46	.71	.255
45417-P50	10-12	3/8	1.33	.53	.255

* Nylon Insulated Ring

Can be supplied in bulk. Consult factory for part number. UL File E158587



ILSCO High Temperature, Non-Insulated Ring Terminals



A

TYPE ILSCONS

Features

- Manufactured from high strength steel alloy
- Electro-tin plated
- Silver solder brazed seam
- Packaged in convenient small quantities
- 900° F 482° C Continuous, 1200° F 649° C Intermittent

Benefits

- Provides maximum conductivity
- Provides low contact resistance
- May be crimped anywhere and will not split open, even under extreme operating stresses
- Can be displayed on merchandise racks

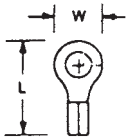

Catalog Number	Wire Range	Stud Size	Dimensions	
			L	W
44300-B20	18-22	4-6	.65	.25
44301-B20	18-22	8-10	.69	.31
44302-B20	18-22	12-1/4	.93	.56
44310-B20	14-16	4-6	.65	.25
44311-B20	14-16	8-10	.69	.31
44312-B20	14-16	12-1/4	.90	.46
44320-B20	10-12	4-6	.67	.28
44321-B20	10-12	8-10	.72	.37
44322-B20	10-12	12-1/4	.93	.53
44323-B20	10-12	5/16-3/8	.99	.60
44330-B10	8	12-1/4	.95	.47
44340-B10	6	5/16-3/8	1.22	.63

Can be supplied in bulk. Consult factory for part number.

ILSCO Non-Insulated Fork Terminals



TYPE ILSCONS

Features

- Manufactured from high strength copper alloy
- Electro-tin plated
- Silver solder brazed seam
- Packaged in convenient small quantities
- UL Listed and CSA Certified, 90° C

Benefits

- Provides maximum conductivity
- Provides low contact resistance
- May be crimped anywhere and will not split open, even under extreme operating stresses
- Can be displayed on merchandise racks
- Ensures reliability for copper conductor

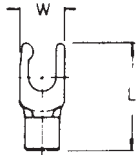

Catalog Number	Wire Range	Stud Size	Dimensions	
			L	W
44400-B20	18-22	4	.68	.25
44401-B20	18-22	6	.68	.25
44402-B20	18-22	8	.68	.30
44403-B20	18-22	10	.68	.32
44410-B20	14-16	4	.68	.25
44411-B20	14-16	6	.68	.25
44412-B20	14-16	8	.68	.25
44413-B20	14-16	10	.68	.30
44414-B20	14-16	1/4	.90	.32
44420-B20	14-16	6	.73	.28
44421-B20	10-12	8	.73	.32
44422-B20	10-12	10	.73	.32
44423-B20	10-12	1/4	.94	.43

Can be supplied in bulk. Consult factory for part number.

UL File E158587



ILSCO Vinyl Insulated Fork Terminals



A

TYPE ILSCONS

Features

- Color coded
- Manufactured from high strength copper alloy
- Electro-tin plated
- Vinyl insulation
- Packaged in convenient small quantities
- UL Listed and CSA Certified for 600 volts, 90° C

Benefits

- Provides easy wire range identification
#22-18 AWG Red
#16-14 AWG Blue
#12-10 AWG Yellow
- Provides maximum conductivity
- Provides low contact resistance
- Provides tough pliable insulative qualities to protect connectors and wire from corrosion as well as providing some strain relief
- Can be displayed on merchandise racks
- Ensures reliability for copper conductor

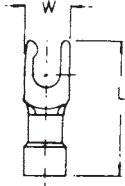

Catalog Number	Wire Range	Stud Size	Dimensions		Maximum Wire Insulated Diameter
			L	W	
44500-B10	18-22	4	.88	.25	.145
44501-B10	18-22	6	.88	.29	.145
44502-B10	18-22	8	.88	.31	.145
44503-B10	18-22	10	.88	.31	.145
44511-B10	14-16	6	.88	.29	.175
44512-B10	14-16	8	.88	.31	.175
44513-B10	14-16	10	.88	.31	.175
44514-B10	14-16	1/4	1.10	.43	.175
44520-B10	10-12	6	1.06	.28	.255
44521-B10	10-12	8	1.06	.28	.255
44522-B10	10-12	10	1.06	.28	.255
44523-B10	10-12	1/4	1.24	.43	.255
45322FL-P100*	14-16	6	.88	.29	.175
45323FL-P100*	14-16	8	.88	.31	.175
45324FL-P100*	14-16	10	.88	.31	.175
45423FL-P50*	10-12	8	1.06	.28	.255
45424FL-P50*	10-12	10	1.06	.28	.255

* Flanged Fork

Can be supplied in bulk. Consult factory for part number.

UL File E158587



ILSCO Non-Insulated Splices



TYPE ILSCONS

Features

- Manufactured from high strength copper alloy
- Electro-tin plated
- Packaged in convenient small quantities
- UL Listed and CSA Certified, 90° C

Benefits

- Provides maximum conductivity
- Provides low contact resistance
- Can be displayed on merchandise racks
- Ensures reliability for copper conductor

A



Fig. 1

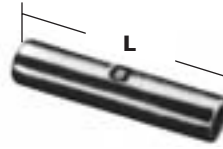

Fig. 2

Catalog Number	Figure Number	Wire Range	L
44600-B20	1	18-22	.33
44610-B20	1	14-16	.33
44620-B20	1	10-12	.33
44630-B10	1	8	.38
44640-B10	1	6	.46
44650-B10	1	4	.54
44800-B20	2	18-22	.63
44810-B20	2	14-16	.63
44820-B20	2	10-12	.82
44830-B10	2	8	.77
44840-B10	2	6	1.02
44850-B10	2	4	1.20

Can be supplied in bulk. Consult factory for part number.

UL File E158587



A

TYPE ILSCONS

Features

- Color coded
- Manufactured from high strength copper alloy
- Electro-tin plated
- Silver solder brazed seam
- Vinyl insulation
- Packaged in convenient small quantities
- UL Listed and CSA Certified for 600 volts, 90° C

Benefits

- Provides easy wire range identification
#22-18 AWG Red
#16-14 AWG Blue
#12-10 AWG Yellow
- Provides maximum conductivity
- Provides low contact resistance
- May be crimped anywhere and will not split open, even under extreme operating stresses
- Provides tough pliable insulative qualities to protect connectors and wire from corrosion as well as providing some strain relief
- Can be displayed on merchandise racks
- Ensures reliability for copper conductor



Fig. 1

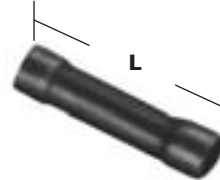

Fig. 2

Catalog Number	Figure Number	Wire Range	L	Maximum Wire Insulated Diameter	Connector Type
44700-B10	1	18-22	.76	.145	Parallel Splice
44710-B10	1	14-16	.76	.175	Parallel Splice
44720-B10	1	10-12	.83	.255	Parallel Splice
44730-B5	1	8	1.05	.385	Parallel Splice
44740-B5	1	6	1.19	.440	Parallel Splice
44750-B5	1	4	1.41	.515	Parallel Splice
44900-B10	2	18-22	.95	.145	Butt Splice
44910-B10	2	14-16	1.02	.175	Butt Splice
44920-B10	2	10-12	1.01	.255	Butt Splice
44930-B5	2	8	1.46	.385	Butt Splice
44940-B5	2	6	1.80	.440	Butt Splice
44950-B5	2	4	1.95	.515	Butt Splice
45130-P100	1	18-22	.76	.145	Vinyl Insulated Splice
45330-P100	1	14-16	.76	.175	Vinyl Insulated Splice
45430-P50	1	10-12	.83	.255	Vinyl Insulated Splice

Can be supplied in bulk. Consult factory for part number.

UL File E158587

ILSCO Disconnects and Flag Terminals

A

TYPE ILSCONS

Features

- Color coded
- Manufactured from high strength copper alloy
- Electro-tin plated
- Silver solder brazed seam
- Vinyl insulation
- Packaged in convenient small quantities
- Insulated connectors are rated for 600 volts, 90° C

Benefits

- Provides easy wire range identification
 - #22-18 AWG Red
 - #16-14 AWG Blue
 - #12-10 AWG Yellow
- Provides maximum conductivity
- Provides low contact resistance
- May be crimped anywhere and will not split open, even under extreme operating stresses
- Provides tough pliable insulative qualities to protect connectors and wire from corrosion as well as providing some strain relief
- Can be displayed on merchandise racks
- Ensures reliability for copper conductor



Fig. 1



Fig. 2



Fig. 3



Fig. 4

Catalog Number	Figure Number	Wire Range	Stud Size	Type	Width	Thickness	Length	Connector Type
45100-B10	1	18-22	-	Female	1/4	-	-	Disconnects - Insulated - Male - Female - Brass Sleeve - Vinyl Insulation
45101-B10	1	18-22	-	Male	1/4	-	-	
45110-B10	1	14-16	-	Female	1/4	-	-	Disconnects - Insulated - Male - Female - Brass Sleeve - Vinyl Insulation
45111-B10	1	14-16	-	Male	1/4	-	-	
45120-B10	1	10-12	-	Female	1/4	-	-	Disconnects - Insulated - Male - Female - Brass Sleeve - Vinyl Insulation
45121-B10	1	10-12	-	Male	1/4	-	-	
45112-B10	1	14-16	-	Female	3/16	-	-	Disconnects - Insulated - Male - Female - Brass Sleeve - Vinyl Insulation
45113-B10	1	14-16	-	Male	3/16	-	-	
45200-B10	2	18-22	-	Female	1/4	-	-	Disconnects - Uninsulated - Male - Female
45201-B10	2	18-22	-	Male	1/4	-	-	
45210-B10	2	14-16	-	Female	1/4	-	-	Disconnects - Uninsulated - Male - Female
45211-B10	2	14-16	-	Male	1/4	-	-	
45220-B10	2	10-12	-	Female	1/4	-	-	Disconnects - Uninsulated - Male - Female
45221-B10	2	10-12	-	Male	1/4	-	-	
45212-B10	2	14-16	-	Female	3/16	-	-	Disconnects - Uninsulated - Male - Female
45213-B10	2	14-16	-	Male	3/16	-	-	
45300-B10	3	18-22	10	-	21/32	-	3/8	Ring Flag Terminals - Uninsulated
45310-B10	3	14-16	10	-	11/16	-	3/8	Ring Flag Terminals - Uninsulated
45320-B10	3	10-12	10	-	11/16	-	3/8	Ring Flag Terminals - Uninsulated
45400-B10	4	18-22	-	-	.187	.016	.46	Female Quick-Slide Flag Terminals - Uninsulated
45401-B10	4	18-22	-	-	.250	.030	.50	Female Quick-Slide Flag Terminals - Uninsulated
45410-B10	4	14-16	-	-	.187	.016	.49	Female Quick-Slide Flag Terminals - Uninsulated
45411-B10	4	14-16	-	-	.250	.030	.51	Female Quick-Slide Flag Terminals - Uninsulated
45420-B10	4	10-12	-	-	.250	.030	.61	Female Quick-Slide Flag Terminals - Uninsulated
45393-P100	1	14-16	-	Female	1/4	-	-	Vinyl Insulated Disconnect
45483-P50	1	10-12	-	Male	1/4	-	-	Vinyl Insulated Disconnect
45493-P50	1	10-12	-	Female	1/4	-	-	Vinyl Insulated Disconnect

Can be supplied in bulk. Consult factory for part number.



A

TYPE CNS

Features

- Dual wall tubing
- Color coded
- Manufactured from high strength copper alloy
- Electro-tin plated
- Silver solder brazed seam
- UL Listed and CSA Certified for 600 volts, 90° C
- Serrated barrel
- Packaged in convenient small quantities

Benefits

- Irradiated, thermally stabilized, high density polyolefin has inner wall of hot melt adhesive to insure watertight seal
- Provides easy wire range identification. #22-18 AWG Red, #16-14 AWG Blue, #12-10 AWG Yellow
- Provides maximum conductivity
- Provides low contact resistance
- May be crimped anywhere and will not split open, even under extreme operating stresses
- Ensures reliability for copper conductor
- "V" grooves inside barrel securely grip wire and prevent pullout
- Can be displayed on merchandise racks



Catalog Number	Wire Range	Stud Size	Maximum Wire Insulation
31112-B10	18-22	6	.170
31113-B10	18-22	8	.170
31114-B10	18-22	10	.170
31115-B10	18-22	1/4"	.170
31312-B10	14-16	6	.190
31313-B10	14-16	8	.190
31314-B10	14-16	10	.190
31315-B10	14-16	1/4"	.190
31316-B10	14-16	5/16"	.190
31317-B10	14-16	3/8"	.190
31413-B10	10-12	8	.240
31414-B10	10-12	10	.240
31415-B10	10-12	1/4"	.240
31417-B10	10-12	3/8"	.240
31419-B10	10-12	1/2"	.240
31514-B5	8	10	.310
31515-B5	8	1/4"	.310
31517-B5	8	3/8"	.310
31519-B5	8	1/2"	.310

Can be supplied in bulk. Consult factory for part number.

UL File E158587

TYPE CNS

Features

- Dual wall tubing
- Color coded
- Manufactured from high strength copper alloy
- Electro-tin plated
- Silver solder brazed seam
- UL Listed and CSA Certified for 600 volts, 90°C
- Serrated barrel
- Packaged in convenient small quantities

Benefits

- Irradiated, thermally stabilized, high density polyolefin has inner wall of hot melt adhesive to insure watertight seal
- Provides easy wire range identification. #22-18 AWG Red, #16-14 AWG Blue, #12-10 AWG Yellow
- Provides maximum conductivity
- Provides low contact resistance
- May be crimped anywhere and will not split open, even under extreme operating stresses
- Ensures reliability for copper conductor
- "V" grooves inside barrel securely grip wire and prevent pullout
- Can be displayed on merchandise racks



Fig. 1



Fig. 2



Fig. 3



Fig. 4

Catalog Number	Fig. Number	Wire Range	Stud Size	Style	Maximum Wire Insulation	Connector Type
31122-B10	1	18-22	6	-	.170	Forks
31123-B10	1	18-22	8	-	.170	Forks
31124-B10	1	18-22	10	-	.170	Forks
31322-B10	1	14-16	6	-	.190	Forks
31323-B10	1	14-16	8	-	.190	Forks
31324-B10	1	14-16	10	-	.190	Forks
31423-B10	1	10-12	8	-	.240	Forks
31424-B10	1	10-12	10	-	.240	Forks
31425-B10	1	10-12	1/4"	-	.240	Forks
31130-B10	2	18-22	BS	-	.170	Butt Splices
31330-B10	2	14-16	BS	-	.190	Butt Splices
31430-B10	2	10-12	BS	-	.240	Butt Splices
31530-B5	2	8	BS	-	.310	Butt Splices
30187-B10	3	18-22	-	Male	.170	Quick Disconnects
30197-B10	3	18-22	-	Female	.170	Fully Insulated
30387-B10	3	14-16	-	Male	.190	Quick Disconnects
30397-B10	3	14-16	-	Female	.190	Fully Insulated
30487-B10	3	10-12	-	Male	.240	Quick Disconnects
30497-B10	3	10-12	-	Female	.240	Fully Insulated
30369-B10	4	14-16	-	Male	.190	Bullets
30379-B10	4	14-16	-	Female	.190	Bullets

Can be supplied in bulk. Consult factory for part number.

UL File E158587

A

TYPE

94130**Controlled-Cycle
Crimper****Features**

- Dieless tool
- Ratchet mechanism
- Compound action
- Cushion grip handles
- Crimps insulated wire terminals
- Wire Range: 10-22 AWG, Weight .8 lb

Benefits

- No need to purchase and maintain dies
- Assures proper crimp force every time
- Delivers maximum crimp force with minimum effort
- Provides user comfort
- Provides flexibility in use



TYPE

94140**Multi Purpose
Crimp Tool****Features**

- Heavy duty carbon steel construction
- Comfort grip handles
- Spring loaded action
- Safety lock mechanism
- Color coded crimp nest
- Crimp nest
- Wire cutter
- Machine screw cutters
- Wire stripper/wire gauge

Benefits

- Provides durable rugged reliability
- Provides user comfort
- Enables multiple crimps
- Provides for compact storage
- For insulated terminals
- For uninsulated terminals
- Easily cuts solid and stranded wire
- Cuts and rethreads 4-40, 6-32, 8-32, 10-24, and 10-32 machine screws
- 26-8 AWG



TYPE

WS-1**Wire Stripper****Features**

- Cushion grip handles
- Crimp die
- Wire strip gauge
- Plier nose
- Wire loop holes
- Wire cutter
- "Open" spring
- Metric markings
- Precision stripping
- Wire crimp range: 14-20 AWG

Benefits

- Eases pressure on hands when working for long periods or with larger conductor
- Built in crimp die allows you to crimp insulated terminals from 20AWG to 14AWG
- Convenient stamped wire strip gauge makes it easy to strip conductors to specific length consistently
- Flat plier nose allows you to conveniently punch and twist knock outs
- Built in looping holes allow you to conveniently bend eye loop into end of conductor
- Built in cutter is precision ground to cut small conductor copper intended to be stripped (Strips #10 - 18 AWG)
- Conveniently holds tool in open position to facilitate wire insertion
- Metric markings provide for use of tool on products that have been sized metrically
- Precision ground wire stripping holes provide a clean cutting and stripping action of insulation





Series CS, CL Compression Connectors for Class B/C Copper Wire Only



ILSCO TOOLS - Tooling Information

WARNING! Do Not Use with Aluminum Wire



Hydraulic Tools

Manual Hand Tools

Lug Size	Class B/C Wire Size	Color Code	Die Index	Manual Hand Tools						Hydraulic Tools					
				94285			MT-25	ILC-10-N		IDT-6, IDT-6H 6.2 Ton Dieless, IDTB-6 6.2 Ton Dieless Battery	ILC-12-N, ILC-12H-N, ILC-12, ILC-12H, ILC-14, ILC-14H 12 Ton, ILCB-12-N, ILCB-12 12 Ton Battery	IDT-12-N 15 Ton Dieless	IDT-12, IDT-12H, IDTB-12 11 Ton Dieless	ILC-15H 15 Ton, ILC-30H 30 Ton	ILC-750
				Left Die	Right Die	Crimps	Crimps	Index	Crimps						
8	8 AWG	Red	21	M	K	2	1	Red	1		1			1	1
6	6 AWG	Blue	24	K	K	2	1	Blue	2	1	1			1	1
4	4 AWG	Gray	29	K	K	2	1	Gray	2	1	1	1	1	1	1
3	3 AWG	White	29	K	K	2	1	Gray	2	1	1	1	1	1	1
2	2 AWG	Brown	33	H	H	2	2	Brown	2	1	1	1	1	1	1
1	1 AWG	Green	37	H	H	2	2	Green	2	1	1	1	1	1	1
1/0	1/0 AWG	Pink	42	E	A	2	2	Pink	4	1	1	1	1	1	1
2/0	2/0 AWG	Black	45	E	A	3	2			1	1	1	1	1	1
3/0	3/0 AWG	Orange	50	A	C	3	2			2	1	1	1	1	1
4/0	4/0 AWG	Purple	54	A	B	3	2			2	1	1	1	1	1
250	250kcmil	Yellow	62	A	A	3	2			2	1	1	1	1	1
300	300kcmil	White	66							2	2	1	1	2	2
350	350kcmil	Red	71							2	2	1	1	2	2
400	400kcmil	Blue	76							2	2	1	1	2	2
500	500kcmil	Brown	87							2	2	1	1	2	2
600	600kcmil	Green	94							2	2	1	1	2	2
700	700kcmil	Pink	99							3	2	1	1	2	2
750	750kcmil	Black	106							3	2	1	1	2	2
1000	1000kcmil	White	125								2	1	1	2	

RANGE TAKING

Lug Size	Standard Wire Size	Expanded Wire Size	No. Crimps for ILSCO IDT-12, IDT-12-N and Burndy Y644M, PAT644	No. Crimps for ILSCO IDTB-6, IDT-6 and IDT-6H
4	4 AWG	4 - 6 AWG		1
3	3 AWG	3 - 6 AWG	1	1
2	2 AWG	2 - 6 AWG	1	1
1	1 AWG	1 - 6 AWG	1	1
1/0	1/0 AWG	1/0 - 6 AWG	1	1
2/0	2/0 AWG	2/0 - 4 AWG	1	1
3/0	3/0 AWG	3/0 - 2 AWG	1	2
4/0	4/0 AWG	4/0 - 1 AWG	1	2
250	250kcmil	250kcmil - 1/0 AWG	1	2
300	300kcmil	300kcmil - 2/0 AWG	1	2
350	350kcmil	350kcmil - 3/0 AWG	1	2
400	400kcmil	400kcmil - 4/0 AWG	1	2
500	500kcmil	500kcmil - 250kcmil	1	2
600	600kcmil	600kcmil - 250kcmil	1	2
700	700kcmil	700kcmil - 350kcmil	1	3
750	750kcmil	750kcmil - 500kcmil	1	3
1000	1000kcmil	1000kcmil - 750kcmil	1	

UL Listed and CSA Certified when installed with tools and dies shown above

- Connectors are marked with color, die numbers and required number of crimps for ILSCO hydraulic tools. When using other listed tools, consult chart for crimps required. Crimps should be evenly spaced on connector.
- The ILSCO 94285, MT-25 and all dieless tools are not color coded or do not contain the die index.
- Strip Length = Barrel Length + 1/16 Inch
- For long barrel connectors double the amount of crimps indicated on chart except for 1000kcmil add only one additional crimp.



ILSCO TOOLS - Tooling Information

WARNING! Do Not Use with Aluminum Wire

Hydraulic Tools

Lug Size	Class B/C Wire Size	Color Code	Die Index	Manual Hand Tools						Hydraulic Tools				
				94285			MT-25	ILC-10-N		IDT-6, IDT-6H 6.2 Ton Dieless, IDTB-6 6.2 Ton Dieless Battery	ILC-12-N, ILC-12H, ILC-12, ILC-14, ILC-14H 12 Ton, ILCB-12-N, ILCB-12 12 Ton Battery	IDT-12-N 15 Ton Dieless	IDT-12, IDT-12H, IDTB-12 11 Ton Dieless	ILC-15H 15 Ton, ILC-30H 30 Ton
				Left Die	Right Die	Crimps	Crimps	Index	Crimps					
8	8 AWG	Red	21	M	K	2	1	Red	1		1			1
6	6 AWG	Blue	24	K	K	2	1	Blue	2	1	1		1	1
4	4 AWG	Gray	29	K	K	2	1	Gray	2	1	1	1	1	1
3	3 AWG	White	29	K	K	2	1	Gray	2	1	1	1	1	1
2	2 AWG	Brown	33	H	H	2	2	Brown	2	1	1	1	1	1
1	1 AWG	Green	37	H	H	2	2	Green	2	1	1	1	1	1
1/0	1/0 AWG	Pink	42	E	A	2	2	Pink	4	1	1	1	1	1
2/0	2/0 AWG	Black	45	E	A	3	2			1	1	1	1	1
3/0	3/0 AWG	Orange	50	A	C	3	2			2	1	1	1	1
4/0	4/0 AWG	Purple	54	A	B	3	2			2	1	1	1	1
250	250kcmil	Yellow	62	A	A	3	2			2	1	1	1	1
300	300kcmil	White	66							2	2	1	1	2
350	350kcmil	Red	71							2	2	1	1	2
400	400kcmil	Blue	76							2	2	1	1	2
500	500kcmil	Brown	87							2	2	1	1	2
600	600kcmil	Green	94							2	2	1	1	2
700	700kcmil	Pink	99							3	2	1	1	2
750	750kcmil	Black	106							3	2	1	1	2
1000	1000kcmil	White	125								2	1	1	2

UL Listed and CSA Certified when installed with tools and dies shown above

- a) Number of crimps shown on chart must be on each end of the CT splicer connectors.
- b) The CT connectors are marked with color, the die numbers and required number of crimps for ILSCO hydraulic tools. When using other listed tools, consult chart for crimps required. Crimps should be evenly spaced on connector.
- c) The ILSCO 94285, MT-25 and all dieless tools are not color coded or do not contain the die index.
- d) For long barrel (CTL) connectors add one additional crimp to each side of barrel.

ILSCO TOOLS - Tooling Information

WARNING! Do Not Use with Aluminum Wire



Hydraulic Tools

Lug Size	Fine Strand Wire Size	Approved Wire Classes	Color Code	Die Index	Manual Hand Tools					Hydraulic Tools					
					94285			ILC-10-N		IDT-6, IDT-6H 6.2 Ton Dieless, IDTB-6 6.2 Ton Dieless Battery	ILC-12-N, ILC-12H-N, ILC-12, ILC-12H, ILC-14, ILC-14H 12 Ton, ILCB-12-N, ILCB-12 12 Ton Battery	IDT-12-N 15 Ton Dieless	IDT-12H, IDTB-12 11 Ton Dieless	ILC-15H 15 Ton, ILC-30H 30 Ton	ILC-750
					Left Die	Right Die	Crimps	Index	Crimps						
8	8	G,H,I,K,M,DLO	Red	21				Red	1		1			1	1
4	6	G,H,I,K,M,DLO	Gray	29				Blue	2		1			1	1
3	4	G,H,I,K,M,DLO	White	29	K	K	2	Gray	2	1	1	1	1	1	1
1	2	G,H,I,K,M,DLO	Green	37	H	H	2	Green	2	1	1	1	1	1	1
1/0	1	G,H,I,K,M,DLO	Pink	42	H	H	2	Pink	4	1	1	1	1	1	1
2/0	1/0	G,H,I,K,M,DLO	Black	45	E	A	3			1	1	1	1	1	1
3/0	2/0	G,H,I,K,M,DLO	Orange	50	E	A	3			1	1	1	1	1	1
4/0	3/0	G,H,I,K,M,DLO	Purple	54	A	B	3			1	1	1	1	1	1
250	4/0	G,H,I,K,M,DLO	Yellow	62	A	B	3			1	1	1	1	1	1
300	250	G,H	White	66						1	2	1	1	2	2
350	250	I,K,M	Red	71						1	2	1	1	2	2
350	262	DLO	Red	71						1	2	1	1	2	2
400	300	G,H,I,K,M	Blue	76						2	2	1	1	2	2
400	313	DLO	Blue	76						2	2	1	1	2	2
500	350	G,H,I,K,M	Brown	87						2	2	1	1	2	2
500	373	DLO	Brown	87						2	2	1	1	2	2
600	400	G,H,I,K,M	Green	94						2	2	1	1	2	2
600	444	DLO	Green	94						2	2	1	1	2	2
700	500	G,H,I,K,M	Pink	99						3	2	1	1	2	2
700	535	DLO	Pink	99						3	2	1	1	2	2
750	600	G,H,I,M	Black	106						3	2	1	1	2	2
750	646	DLO	Black	106						3	2	1	1	2	2
1000	750	G,H,I	White	125							3	1	1	3	
1000	777	DLO	White	125							3	1	1	3	

UL Listed and CSA Certified when installed with tools and dies shown above

- a) Connectors are marked with color, die numbers and required number of crimps for ILSCO hydraulic tools. When using other listed tools, consult chart for crimps required. Crimps should be evenly spaced on connector.
- b) The ILSCO 94285, MT-25 and all dieless tools are not color coded or do not contain the die index.
- c) Strip Length = Barrel Length + 1/16 Inch
- d) For long barrel connectors double the amount of crimps indicated on chart except for 1000kcmil add only one additional crimp.

ILSCO TOOLS - Tooling Information

WARNING! Do Not Use with Aluminum Wire

Hydraulic Tools

Lug Size	Fine Strand Wire Size	Approved Wire Classes	Color Code	Die Index	Manual Hand Tools					Hydraulic Tools				
					94285			ILC-10-N		IDT-6, IDT-6H 6.2 Ton Dieless, IDTB-6 6.2 Ton Dieless Battery	ILC-12-N, ILC-12H-N, ILC-12H, ILC-14, ILC-14H 12 Ton, ILCB-12-N, ILCB-12 12 Ton Battery	IDT-12-N 15 Ton Dieless	IDT-12H, IDTB-12 11 Ton Dieless	ILC-15H 15 Ton, ILC-30H 30 Ton
					Left Die	Right Die	Crimps	Index	Crimps					
8	8	G,H,I,K,M,DLO	Red	21	M	K	2	Red	1		1			1
4	6	G,H,I,K,M,DLO	Gray	29	K	K	2	Blue	2		1			1
3	4	G,H,I,K,M,DLO	White	29	K	K	2	Gray	2	1	1	1	1	1
1	2	G,H,I,K,M,DLO	Green	37	H	H	2	Green	2	1	1	1	1	1
1/0	1	G,H,I,K,M,DLO	Pink	42	H	H	2	Pink	4	1	1	1	1	1
2/0	1/0	G,H,I,K,M,DLO	Black	45	E	A	3			1	1	1	1	1
3/0	2/0	G,H,I,K,M,DLO	Orange	50	E	A	3			2	1	1	1	1
4/0	3/0	G,H,I,K,M,DLO	Purple	54	A	B	3			2	1	1	1	1
250	4/0	G,H,I,K,M,DLO	Yellow	62	A	B	3			2	1	1	1	1
300	250	G,H	White	66						2	2	1	1	2
350	250	I,K,M	Red	71						2	2	1	1	2
350	262	DLO	Red	71						2	2	1	1	2
400	300	G,H,I,K,M	Blue	76						2	2	1	1	2
400	313	DLO	Blue	76						2	2	1	1	2
500	350	G,H,I,K,M	Brown	87						2	2	1	1	2
500	373	DLO	Brown	87						2	2	1	1	2
600	400	G,H,I,K,M	Green	94						2	2	1	1	2
600	444	DLO	Green	94						2	2	1	1	2
700	500	G,H,I,K,M	Pink	99						3	3	1	1	3
700	535	DLO	Pink	99						3	3	1	1	3
750	600	G,H,I,M	Black	106						3	3	1	1	3
750	646	DLO	Black	106						3	3	1	1	3
1000	750	G,H,I	White	125							3	1	1	3
1000	777	DLO	White	125							3	1	1	3

UL Listed and CSA Certified when installed with tools and dies shown above

- a) Number of crimps shown on chart must be on each end of the CT splicer connectors.
- b) The CT connectors are marked with color, the die numbers and required number of crimps for ILSCO hydraulic tools. When using other listed tools, consult chart for crimps required. Crimps should be evenly spaced on connector.
- c) The ILSCO 94285, MT-25 and all dieless tools are not color coded or do not contain the die index.
- d) For long barrel (CTL) connectors add one additional crimp to each side of barrel.

COMPETITOR'S TOOLS - Tooling Information

WARNING! Do Not Use with Aluminum Wire



Lug Size	Class B/C Wire Size	Anderson		Burdny							T&B				Greenlee					
		VC6-FT, VC6-FTR, VC6-FT-BP, VC7-FT, VC7-FTR Dieless		PAT81KFT, Y81KFT, Y81KFTMBH Dieless		‡ Y644M, PAT644 Dieless		Y35, Y35BH, Y39, Y750, Y750BH, PAT750		Y46, Y46C Requires Die Adaptor		TBM25S		13100A, TBM14M, TBM14BSCR		K111		HK06FT, RK06FT, EK06FT Dieless		1990 Dieless
		Crimps	Index	Crimps	Crimps	Crimps	Die Part	Crimps	Die Part	Crimps	Index	Crimps	Die Part	Crimps	Index	Crimps	Crimps	Crimps		
8	8 AWG	1	Red	1	1		U8CRT	1	U8CRT	1	Red	1	15520	1	Red	1				
6	6 AWG	1	Blue	1	1		U5CRT	1	U5CRT	1	Blue	1	15522	1	Blue	2	1			
4	4 AWG	1	Gray	2	1	1	U4CRT	1	U4CRT	1	Gray	2	15527-CK	1	Gray	2	1	1		
3	3 AWG	1	White	2	1	1	U3CRT	1	U3CRT	1					Gray	2	1	1		
2	2 AWG	1	Brown	2	1	1	U2CRT	1	U2CRT	1	Brown	2	15528	1	Brown	2	1	1		
1	1 AWG	1			1	1	U1CRT-1	1	U1CRT-1	1			15513-CK	1	Green	2	1	1		
1/0	1/0 AWG	1			1	1	U25RT	1	U25RT	1			15508	1	Pink	4	1	1		
2/0	2/0 AWG	1			1	1	U26RT	1	U26RT	1			15526	1			1	1		
3/0	3/0 AWG	1			1	1	U27RT	1	U27RT	1			15530	1			2	1		
4/0	4/0 AWG	1			1	1	U28RT	1	U28RT	1			15511	1			2	1		
250	250kcmil	2			2	1	U29RT	1	U29RT	1			15510-CK	1			2	1		
300	300kcmil	2			2	1	U30RT	2	U30RT	2			15534	2			2	1		
350	350kcmil	3*			2	1	U31RT	2	U31RT	2			15514-CK	2			2	1		
400	400kcmil	3*			2	1	U32RT	2	U32RT	2			15512	2			2	1		
500	500kcmil	3*			2	1	U34RT	2	U34RT	2			15506	2			2	1		
600	600kcmil	4*			2	1	U36RT	2	U36RT	2			15536-CK	2			2	1		
700	700kcmil	4*			3	1	U38RT	2	U38RT	2			15505	2			3	1		
750	750kcmil	4*			3	1	U39RT	2	U39RT	2			15515-CK	2			3	1		
1000	1000kcmil				3	1			P44RT	3			15504	2				1		

Dieless* - Crimps will overlap

UL Listed and CSA Certified when installed with tools and dies shown above

- a) Connectors are marked with color, die numbers and required number of crimps for ILSCO hydraulic tools. When using other listed tools, consult chart for crimps required. Crimps should be evenly spaced on connector.
- b) The ILSCO 94285, MT-25 and all dieless tools are not color coded or do not contain the die index.
- c) Consult manufacturers data for catalog numbers of dies for each tool.
- d) Strip Length = Barrel Length + 1/16 Inch
- e) For long barrel connectors double the amount of crimps indicated on chart except for 1000kcmil add only one additional crimp.

‡ Allows expanded wire range to be used.

A

COMPETITOR'S TOOLS - Tooling Information

WARNING! Do Not Use with Aluminum Wire

Lug Size	Fine Strand Wire Size	Approved Wire Classes	Anderson		Burdny						T&B				Greenlee							
			VC6-FT, VC6-FTR, VC6-FT-BP, VC7-FT, VC7-FTR Dieless		PAT81KFT, Y81KFT, Y81KFTMBH Dieless		‡ Y644M, PAT644 Dieless		Y35, Y35BH, Y39, Y750, Y750BH, PAT750		Y46, Y46C Requires Die Adaptor		TBM25S		13100A, TBM14M, TBM14BSCR		K111		HK06FT, RK06FT, EK06FT Dieless		1990 Dieless	
			Crimps	Index	Crimps	Crimps	Crimps	Die Part	Crimps	Die Part	Crimps	Index	Crimps	Die Part	Crimps	Index	Crimps	Crimps	Crimps	Crimps		
8	8	G,H,I,K,M,DLO	1	Red	1	1		U8CRT	1	U8CRT	1	Red	1	15520	1	Red	1					
4	6	G,H,I,K,M,DLO	1	Blue	2	1		U5CRT	1	U5CRT	1	Blue	2	15522	1	Blue	2					
3	4	G,H,I,K,M,DLO	1	Gray	2	1	1	U4CRT	1	U4CRT	1	Gray	2	15528	1	Gray	2	1	1			
1	2	G,H,I,K,M,DLO	1	Brown	2	1	1	U2CRT	1	U2CRT	1	Brown	3	15513-CK	1	Green	2	1	1			
1/0	1	G,H,I,K,M,DLO	1			1	1	U1CRT-1	1	U1CRT-1	1			15508	1	Pink	4	1	1			
2/0	1/0	G,H,I,K,M,DLO	1			1	1	U25RT	1	U25RT	1			15526	1			1	1			
3/0	2/0	G,H,I,K,M,DLO	2			2	1	U26RT	1	U26RT	1			15530	1			1	1			
4/0	3/0	G,H,I,K,M,DLO	2			2	1	U27RT	1	U27RT	1			15511	1			1	1			
250	4/0	G,H,I,K,M,DLO	2			2	1	U28RT	1	U28RT	1			15510-CK	2			1	1			
300	250	G,H	2			2	1	U29RT	2	U29RT	2			15534	2			1	1			
350	250	I,K,M	3*			2	1	U30RT	2	U30RT	2				2			1	1			
350	262	DLO	3*			2	1		2		2				2			1	1			
400	300	G,H,I,K,M	3*			2	1	U31RT	2	U31RT	2			15514-CK	2			2	1			
400	313	DLO	3*			2	1		2		2				2			2	1			
500	350	G,H,I,K,M	3*			2	1	U32RT	2	U32RT	2			15512	2			2	1			
500	373	DLO	3*			2	1		2		2			15517	2			2	1			
600	400	G,H,I,K,M	4*			2	1	U34RT	2	U34RT	2			15536-CK	2			2	1			
600	444	DLO	4*			2	1		2		2				2			2	1			
700	500	G,H,I,K,M	4*			3	1	U38XRT	2	U38XRT	2			15505	2			3	1			
700	535	DLO	4*			3	1		2		2				2			3	1			
750	600	G,H,I,M	4*			3	1	U39RT	2	U39RT	2			15515-CK	2			3	1			
750	646	DLO	4*			3	1		2		2				2			3	1			
1000	750	G,H,I				3	1			U44XRT	3			15504	3				1			
1000	777	DLO				3	1				3				3				1			

Dieless* - Crimps will overlap

UL Listed and CSA Certified when installed with tools and dies shown above

- a) Connectors are marked with color, die numbers and required number of crimps for ILSCO hydraulic tools. When using other listed tools, consult chart for crimps required. Crimps should be evenly spaced on connector.
- b) The ILSCO 94285, MT-25 and all dieless tools are not color coded or do not contain the die index.
- c) Strip Length = Barrel Length + 1/16 Inch
- d) For long barrel connectors double the amount of crimps indicated on chart except for 1000kcmil add only one additional crimp.

‡ Allows expanded wire range to be used.

COMPRESSOR DIES FOR ND-58 AND ND-60

Catalog Number	For Use With	
	Aluminum Compression Connectors	Copper Compression Connectors
ND-0	HT-1, HT-2, AH-1	GGC-1, GGA-1, GGA-2, GGA-4
ND-BG	PICS-61 thru PICS-78	ULT-4, ULT-5
ND-C		ULT-6, ULT-7
ND-K-840	UCS-2/0, UCS-3/0 UCS-4/0, UCS-250, PICS-834 thru PICS-869	

COMPRESSOR DIES FOR ILC-15, ILC-15H AND ILC-750

Catalog Number	For Use With	
	Aluminum Compression Connectors	Copper Compression Connectors
ILD-K-840*	UCS-2/0, UCS-3/0, UCS-4/0, UCS-250, PICS-834 thru PICS-869	
ILD-C*		ULT-6, ULT-7, ELT-1
ILD-D ₃ *	HT-2, HT-3, HT-4, HT-5, HT-7, AH-2, AH-3, AH-4	ULT-12
ILD-0*	HT-1, HT-6, HT-8, AH-1	GGC-1, GGA-1, GGA-2, GGA-4, ELT-2, ELT-4
ILD-N*	AH-5, AH-6, AH-7	
ILD-KR*	AH-8, AH-9, AH-10, AH-11, AH-12	
ILD-U997*		GGA-2, GGA-3, GGA-5, GGC-2, GGC-3, GGC-4, ELT-3, ELT-5
ILD-U998*		GGA-4, GGA-5, GGC-5, GGC-6, GGC-7, RLT
ILD-P998		GGA-4, GGA-5, GGC-5, GGC-6, GGC-7, RLT
+ILD-P999		GGA-6, GGC-8
ILD-U1011*		GGA-6, GGC-8, ELT-6, RLT
ILD-P1011		GGA-6, GGC-8, RLT
ILD-UBG	PICS-61 thru PICS-78	ULT-4, ULT-5

+ Consult factory for availability. * Must be used with IL-ADP when using ILC-15 tool.

DIE ADAPTOR FOR ILC-15

Catalog Number	Description
ILD-ADP	Permits IL-1 – IL-18 and standard U dies to be inserted in ILC-15 Tool

DIE ADAPTOR FOR ILC-15H

Catalog Number	Description
ILD-UADP	Permits IL-1 – IL-18 and standard U dies to be inserted in ILC-15H Tool
ILD-PADP	Permits P style dies to be inserted in ILC-15H Tool

COMPRESSOR DIES FOR IDT-12 AND IDT-12H

Catalog Number	For Use With	
	Aluminum Compression Connectors	Copper Compression Connectors
+ILD-OH	HT-1, HT-2, AH-1	GGC-1, GGA-1, GGA-2, GGA-4
+ILD-D3H	HT-3, HT-4, HT-5, HT-6, HT-7, AH-2, AH-3, AH-4	ULT-12

+ Consult factory for availability.



ILSCO Compression Die Index

A



Compressor Dies For ILC-12-N, ILC-12H-N, ILCB-12-N, ILC-15H, ILC-12, ILC-12H, ILC-14, ILC-14H, ILCB-12, ILC-15, ILC-750

Catalog Number	Wire Size		
	Aluminum Terminals and Splices	ACM and ACO Pin Connectors	CPM Pin Connectors
ILD-1			
ILD-2	8		
ILD-3	6		
ILD-4	4		
ILD-5			
ILD-6			
ILD-7	2, 1		
ILD-8	1/0	6, 4, 2, 1	
ILD-9	6, 4, 2, 1		
ILD-10	2/0, 3/0		
ILD-11			
ILD-12	4/0	1/0, 2/0, 3/0, 4/0	1/0, 2/0, 3/0, 4/0
ILD-13	250kcmil		
ILD-14	300kcmil, 350kcmil	250kcmil, 300kcmil, 350kcmil	250kcmil, 300kcmil, 350kcmil
ILD-15			
ILD-16	400kcmil		
ILD-16A	*500kcmil	400kcmil, 500kcmil	400kcmil, 500 kcmil
ILD-17	*600kcmil, *700 kcmil		
ILD-18	*700kcmil	600kcmil, 750kcmil	600 kcmil, 750 kcmil

* Cannot be used on Sleeves with ILC-12-N, ILC-12H-N, ILC-12 and ILC-12H tools



Compressor Dies For ILC-12, ILC-12-N, ILC-12H, ILC-12H-N, ILCB-12, ILCB-12-N, ILC-14, ILC-14H, ILC-15, ILC-15H, ILC-750

Catalog Number	Class B/C Copper Wire Only	Fine Strand Copper Wire Only
	Series CS, CL, CT, CTL	Series CS, CL, CT, CTL
ILD-21	8 AWG	8 FLEX CLASS G,H,I,K,M,DLO
ILD-24	6 AWG	-
ILD-29	4-3 AWG	6-4 FLEX CLASS G,H,I,K,M,DLO
ILD-33	2 AWG	-
ILD-37	1 AWG	2 FLEX CLASS G,H,I,K,M,DLO
ILD-42	1/0 AWG	1 FLEX CLASS G,H,I,K,M,DLO
ILD-45	2/0 AWG	1/0 FLEX CLASS G,H,I,K,M,DLO
ILD-50	3/0 AWG	2/0 FLEX CLASS G,H,I,K,M,DLO
ILD-54	4/0 AWG	3/0 FLEX CLASS G,H,I,K,M,DLO
ILD-62	250kcmil	4/0 FLEX CLASS G,H,I,K,M,DLO
ILD-66	300kcmil	250 G,H
ILD-71	350kcmil	250 I,K,M, 262 DLO
ILD-76	400kcmil	300 G,H,I,K,M, 313 DLO
ILD-87	500kcmil	350 G,H,I,K,M, 373 DLO
ILD-94	600kcmil	400 G,H,I,K,M, 444 DLO
ILD-99	700kcmil	500 G,H,I,K,M, 535 DLO
ILD-106	750kcmil	600 G,H,I,M, 646 DLO
ILD-125	1000kcmil	750 G,H,I, 777 DLO



**Put More Money in Your Pocket
with these Labor Savers!**

KUP-L-Tap® Insulation Piercing Connectors

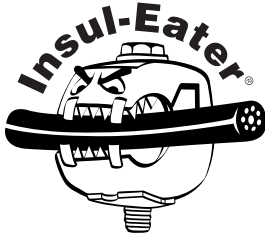

- Fully insulated – Work it Hot
- Versatile – Dual Rated
- Dependable – UL Listed, CSA Certified
- Time Saver – No stripping, no wire brushing, no oxide inhibitor, no taping
- Convenient – Wire Range 750kcmil-14

CLEAR TAP®

Insulated Multi-Tap Connectors



- Fully insulated – No taping
- Versatile – Dual Rated, Two-sided entry splice or tap
- Dependable – UL Listed
- Time Saver – Captive pressure screws in “Quick Start” position, no taping, Self-closing openings eliminate lost plugs and caps
- Convenient – Wire Range 800kcmil-14

IK  99	IK3  100	
SK  101	IKB  102	
IKS  103	AK  104	
DBA, DBA-S  105	IPC  106	
GTA  107	SPAR  108	
GTT  109	GTC  110	GT2  111
GT4T  112	GTA/GTT KIT  113	MGTT  114
PTA  115	PCT  116	

TYPE IK

B

Features

- Manufactured from high strength copper alloy.
- Precision tooled threads.
- UL 467 Listed for Grounding and Bonding 8 thru 500kcmil
- CSA certified for Grounding and Bonding 8 thru 250kcmil
- UL listed and CSA Certified for 600 volts, 90° C
- RUS Accepted 8 thru 1/0 AWG
- For use with copper conductor types: Solid, Compact, Compressed, Concentric.
- ROHS compliant.

Benefits

- Provides maximum conductivity and high breakage resistance.
- Allows maximum torque to be applied.
- Suitable for direct burial and earth and concrete.

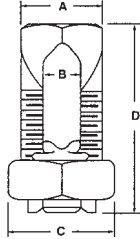

Catalog Number	Range For Equal Main & Tap	Min. Tap With One Max. Main	Max. Cond Copperweld		Rebar With 6 or 8 AWG	Wire Diameter	Dimensions				Recommended Torque (IN-LB)
			Str	Type A			A	B	C	D	
IK-10	10str - 16str	16str	-	-	N/A	.057 - .125	.125	0.344	0.500	0.719	80
IK-8	8str - 16str	16str	-	-	N/A	.057 - .145	.145	0.375	0.500	0.844	80
IK-6	6sol - 10sol	16sol	-	-	N/A	.102 - .162	.165	0.500	0.625	1.047	165
IK-4	4sol - 8sol	16sol	3 No. 12	8A	N/A	.128 - .204	.215	0.562	0.688	1.047	165
IK-3	2sol - 6sol	12sol	3 No. 9	5A	N/A	.162 - .258	.328	0.688	0.812	1.312	275
IK-2	2str - 6sol	14str	3 No. 7	3A	N/A	.162 - .292	.328	0.688	0.812	1.312	275
IK-1/0	1/0str - 4sol	14sol	3 No. 6	2A	N/A	.204 - .375	.377	0.750	0.875	1.641	385
IK-2/0	2/0str - 2sol	14str	3 No. 5	-	#3 (3/8)	.258 - .418	.420	0.812	1.000	1.812	385
IK-3/0	3/0str - 2sol	12sol	7 No. 7	-	N/A	.258 - .470	0.466	0.875	1.125	2.000	500
IK-250	250kcmil - 1/0sol	10sol	7 No. 5	-	#4 (1/2)	.325 - .575	0.579	1.000	1.312	2.078	650
IK-350	350kcmil - 4/0str	8sol	19 No. 7	-	#5 (5/8)	.528 - .682	0.746	1.500	1.625	2.625	650
IK-500	500kcmil - 250kcmil	8sol	19 No. 6	-	#6 (3/4)	.575 - .815	0.834	1.625	1.812	3.000	825
IK-750	750kcmil - 350kcmil	8sol	19 No. 5	-	N/A	.682 - .999	1.030	1.938	2.125	3.750	1000
IK-1000	1000kcmil - 500kcmil	8sol	-	-	N/A	.815 - 1.153	1.222	2.250	2.500	4.000	1100

UL File E6207

ILSCO Three Wire Copper Split Bolts



TYPE IK3

Features

- Manufactured from high strength copper alloy.
- Precision tooled threads.
- UL 467 Listed for Grounding and Bonding thru 500kcmil
- CSA certified for Grounding and Bonding thru 250kcmil
- UL listed and CSA Certified for 600 volts, 90° C
- RUS Accepted
- For use with copper conductor types: Solid, Compact, Compressed, Concentric.
- ROHS compliant.

Benefits

- Provides maximum conductivity and high breakage resistance.
- Allows maximum torque to be applied.
- Suitable for direct burial and earth and concrete.

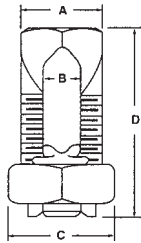

B

Catalog Number	Range For Equal Main & Tap	Min. Tap With One Max. Main	Max Cond Copperweld		Wire Diameter Range	Dimensions				Recommended Torque (IN-LB)
			Str	Type A		A	B	C	D	
IK3-8	8str - 16str	16str	-	-	.057 - .145	0.144	0.375	0.500	0.844	80
IK3-6	6sol - 10sol	16sol	-	-	.102 - .162	0.166	0.500	0.625	1.109	165
IK3-4	4sol - 8sol	16sol	3 No. 12	8A	.128 - .204	0.217	0.562	0.688	1.266	165
IK3-2	2str - 6sol	14str	3 No. 7	3A	.162 - .258	0.326	0.688	0.812	1.547	275

UL File E6207



ILSCO Tin Plated Copper Split Bolts



TYPE SK

Features

- Manufactured from high strength copper alloy.
- Electro-tin plated bolt, nut, spacer and pressure bar
- Precision tooled threads.
- UL listed and CSA Certified for 600 volts, 90° C
- SK-10, SK-8, SK3, SK-2 SK-1/0, SK-2/0 are RUS Accepted.
- For use with copper conductor types: Solid, Compact, Compressed, Concentric.
- ROHS compliant.

Benefits

- Provides maximum conductivity and high breakage resistance.
- Provides low contact resistance.
- Suitable for direct burial and earth and concrete.

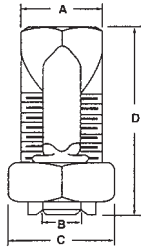

Catalog Number	Range For Equal Main & Tap	Min. Tap With One Max. Main	Max Cond Copperweld		Wire Diameter Range	Dimensions				Recommended Torque (IN-LB)
			Str	Type A		A	B	C	D	
SK-10	10str - 16str	16str	-	-	.057 - .116	.144	0.375	0.500	0.844	80
SK-8	8str - 16str	16str	-	-	.057 - .145	0.144	0.375	0.500	0.844	80
SK-6	8str - 14str	14str	-	-	.073 - .146	.166	0.500	0.625	1.109	165
SK-4	6str - 10str	10sol	3 No. 12	8A	.116 - .184	0.217	0.562	0.688	1.266	165
SK-3	4str - 8sol AL 2sol - 8sol CU	8sol AL 8sol CU	3 No. 9	5A	.128 - .258	0.326	0.688	0.812	1.547	275
SK-2	2str - 8sol	8sol	3 No. 7	3A	.128 - .316	0.326	0.688	0.812	1.547	275
SK-1/0	1/0str - 6sol	10sol	3 No. 6	-	.162 - .375	0.376	0.750	0.875	1.641	385
SK-2/0	2/0str - 6str	10sol	3 No. 5	-	.184 - .419	.420	0.812	1.000	1.812	385
SK-3/0	3/0str - 4str	6sol	7 No. 7	-	.198 - .470	0.466	0.875	1.125	2.000	500
SK-250	250kcmil - 4str	4str	7 No. 5	-	.232 - .575	0.577	1.000	1.312	2.328	650
SK-350	350kcmil - 3/0str	1sol	19 No. 7	-	.447 - .682	0.746	1.500	1.625	2.625	650
SK-500	500kcmil - 3/0str	1/0str	19 No. 6	-	.447 - .815	0.834	1.625	1.812	3.000	825
SK-750	750kcmil - 250kcmil	2/0str	19 No. 5	-	.563 - .999	1.030	1.938	2.125	3.750	1000
SK-1000	1000kcmil - 350kcmil	4/0str	-	-	.682 - 1.162	1.222	2.250	2.500	4.000	1100

UL File E12822

ILSCO Copper Two Bolt Connectors



TYPE IKB

Features

- Manufactured from high strength copper alloy
- Two bolt design
- Longer peened bolt
- UL Listed, rated for 600 volts
- For copper conductor only

Benefits

- Allows maximum conductivity and high breakage resistance
- Allows maximum pressure to be applied directly to the conductor strands
- Permits a swivel action for easier installation
- Ensures reliability

B

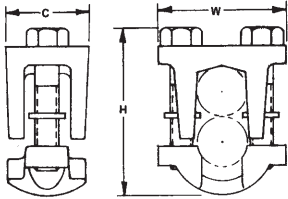

Catalog Number	Copper Wire Range		Dimensions		
	Main	Tap	C	H	W
IKB-4/0 +	1/0-4/0	4/0-10	1.10	1.97	1.72
IKB-350 +	350kcmil-250kcmil	350kcmil-10	1.38	2.48	1.12
IKB-500	500kcmil-400kcmil	500kcmil-10	1.50	2.80	2.25
IKB-800	800kcmil-400kcmil	800kcmil-3/0	1.62	3.32	2.50
IKB-1000	1000kcmil-500kcmil	1000kcmil-3/0	2.00	3.78	3.03

+ REA Listed

Tested to UL 486A-486B, UL File E6207



ILSCO Two Bolt Connectors

TYPE IKS

B

Features

- Manufactured from high strength copper alloy
- Electro-tin plated
- Two bolt design
- Longer peened bolt
- Serrated spacer bar
- For copper conductor only
- Rated for 600 volts

Benefits

- Allows maximum conductivity and high breakage resistance
- Provides low contact resistance
- Allows maximum pressure to be applied directly to the conductor strands
- Permits a swivel action for easier installation
- Makes a secure connection
- Ensures reliability

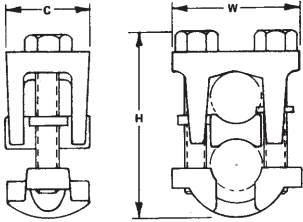

Catalog Number	Wire Range		Dimensions		
	Main	Tap	C	H	W
IKS-4/0	4/0-1/0	4/0-6	1.12	2.31	1.72
IKS-350	350kcmil-250kcmil	350kcmil-6	1.38	2.62	2.12
IKS-500	500kcmil-400kcmil	500kcmil-4	1.50	3.00	2.26
IKS-800	800kcmil-400kcmil	800kcmil-4/0	1.62	3.50	2.50
IKS-1000	1000kcmil-500kcmil	1000kcmil-4/0	2.00	4.03	3.03

ILSCO Aluminum Split Bolt - Dual Rated



TYPE AK

Features

- Manufactured from heat treated aluminum alloy
- Triangular edges
- UL Listed and CSA Certified for 600 volts, 90° C
- Electro-tin plated
- Spacer bar
- Hex Head

Benefits

- Provides maximum conductivity and strength for copper and aluminum conductors
- Bite into the conductor to break through surface oxides which eliminates wire brushing
- Ensures reliability for copper or aluminum conductors
- Provides low contact resistance
- Separates dissimilar metals which prevents galvanic corrosion
- Provides ease of installation with standard wrenches

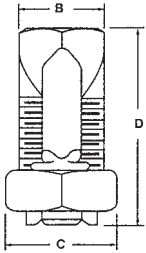

Catalog Number	Wire Range		Recommended Tightening Torque	Dimensions		
	Main	Tap		B	C	D
AK-6	6 str-10 sol	6 str-10 sol	165	.56	.75	1.88
AK-4	4 str-8 sol	4 str-10 sol	165	.62	.81	1.38
AK-2	2 str-6 str Compact	2 str-8 str	275	.69	.94	1.58
AK-1/0	1/0 str-2 str Compact	1/0 str-8 str	385	.75	1.00	1.92
AK-2/0	2/0 str-2 str Compact	2/0 str-8 str	385	.88	1.12	1.92
AK-4/0	4/0 str-2 str Compact	4/0 str-6 str	500	1.13	1.49	2.54
AK-350	350kcmil-1/0 str Compact	350kcmil-4 str	650	1.50	1.69	3.24
AK-500	500kcmil-400kcmil Compact	500kcmil-2 str Compact	825	1.73	2.00	3.62

DE-OX Inhibitor is recommended for all aluminum terminations.

UL File E9998



B

ILSCO Aluminum Two Bolt Connectors - Dual Rated

B

TYPE DBA DBA-S

Features

- Manufactured from high strength aluminum alloy
- Heat treated
- Wax plated
- Neoprene washers
- Range taking
- Re-usable
- Type DBA-S - Spacer bar
- Rated for 600 volts

Benefits

- Type DBA - Suitable for copper to copper or aluminum to aluminum conductors
- Type DBA-S - Suitable for copper and/or aluminum conductors in any combination
- Provides maximum strength
- Provides low contact resistance
- Hold the bolts captive and eliminates the possibility of loose hardware
- Permits inventories to be kept to a minimum
- Provides efficient use and flexibility in the field
- Separates dissimilar metals
- Ensures reliability

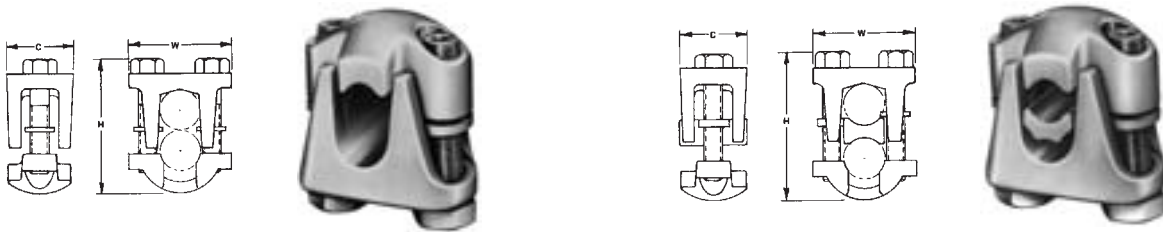

Fig. 1

Fig. 2

Catalog Number	Figure Number	Wire Range		Dimensions		
		Main	Tap	C	W	H
DBA-2/0	1	2/0-2	2/0-10	1-1/8	1-5/8	1-5/8
DBA-250	1	250kcmil-1/0	250kcmil-10	1-5/16	2	2
DBA-350	1	350kcmil-4/0	350kcmil-10	1-9/16	2-11/32	2-1/4
DBA-500	1	500kcmil-350kcmil	500kcmil-10	1-3/4	2-1/2	2-3/4
DBA-800	1	800kcmil-400kcmil	800kcmil-3/0	1-7/8	2-7/8	3
DBA-1000	1	1000kcmil-500kcmil	1000kcmil-3/0	2-1/4	3-3/16	3-1/2
DBA-2/0S	2	2/0-2	2/0-10	1-1/8	1-5/8	1-5/8
DBA-250S	2	250kcmil-1/0	250kcmil-10	1-5/16	2	2
DBA-350S	2	350kcmil-4/0	350kcmil-10	1-9/16	2-11/32	2-1/4
DBA-500S	2	500kcmil-350kcmil	500kcmil-10	1-3/4	2-1/2	2-3/4
DBA-800S	2	800kcmil-400kcmil	800kcmil-3/0	1-7/8	2-7/8	3
DBA-1000S	2	1000kcmil-500kcmil	1000kcmil-3/0	2-1/4	3-3/16	3-1/2

DE-OX Inhibitor is recommended for all aluminum terminations.

TYPE IPC



Features

- Body is molded from tough, resilient glass-filled nylon
 - Compact design
 - Tin plated copper contact teeth
 - Insulation piercing
 - Perforated end tabs
 - Pre-filled with silicone lubricant
 - Versatile
 - Increased safety
- Horizontal line grid
 - Temperature rating 90° C

Benefits

- Provides high degree of breakage resistance and long dependable use
- Saves space
- Easily penetrates most types of insulation
- No need to strip the conductor which saves installation time
- Break out easily by hand
- Prevents oxidation and moisture from entering the contact area
- Can be used as a splice or tap connector
- Contains no external energized parts. Can be installed "hot" on energized conductors providing tap conductor is not under load.
- Provides a visual guide for proper installation of conductors

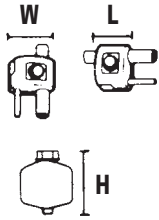

Fig. 1



Fig. 2



Fig. 3



Fig. 4

Catalog Number	Figure Number	Wire Range		Volts	Current Rating		Dimensions			Torque Ft. Lbs.	Bolt Head Size
		Main	Tap		CU	AL	L	W	H		
IPC-1/0-2	3	1/0-8	2-8	300 (480 Grounded Y System)	130	100	1-7/32	1-15/32	2-5/16	16	1/2
IPC-4/0-6	2	4/0-4	6-14	600	75	60	1-27/64	1	1-7/8	13	1/2
IPC-4/0-2/0	3	4/0-2	2/0-6	600	195	150	1-21/32	1-7/8	2-7/8	25	1/2
IPC-250-4/0	2	250kcmil-1	4/0-6	600	260	205	1-7/8	2-11/32	3-11/32	30	5/8
IPC-350-4/0	3	350kcmil-4/0	4/0-10	300 (480 Grounded Y System)	260	205	1-43/64	2-7/16	3-1/8	25	5/8
IPC-350-350	4	350kcmil-4/0	350kcmil-4/0	300 (480 Grounded Y System)	350	280	2-43/64	2-23/32	3-1/4	25	5/8
IPC-500-12	1	500kcmil-250kcmil	10-12	300 (480 Grounded Y System)	40	35	1-43/64	2-7/16	3-1/4	25	5/8
IPC-500-250	1	500kcmil-250kcmil	250kcmil-4	600	290	230	2-27/64	2-29/32	3-3/4	55	5/8-11/16
IPC-500-500	1	500kcmil-300kcmil	500kcmil-250kcmil	600	430	350	3-3/16	3-5/8	5	75	7/8-7/8
IPC-750-500	1	750kcmil-500kcmil	500kcmil-350kcmil	600	430	350	3-3/16	3-5/8	5	75	7/8-7/8

Tested to UL 486A-486B, UL File E6207

B

TYPE GTA

Features

- Manufactured from high strength 6061-T6 aluminum alloy
- Electro-tin plated
- UL Listed and CSA Certified for 600 volts, Temp. rating 90° C
- Compact design
- Range taking
- Re-usable
- Lay-in main conductor
- Insulating cover available

Benefits

- Suitable for use with either copper or aluminum conductors
- Provides low contact resistance
- Ensures reliability for copper or aluminum conductors
- Saves space and reduces installation time
- Permits inventories to be kept to a minimum
- Provides efficient use and flexibility in the field
- No need to break the feeder cable
- Eliminates taping

B

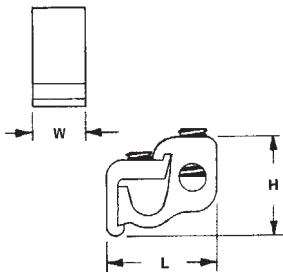

Fig. 1



Fig. 2



Catalog Number		Figure Number	Wire Range		Dimensions			Hex Size	
Connector	Cover		Main	Tap	L	W	H	Main	Tap
GTA-2-2	GTC-2	1	2-12 str	2-12 AL 2-14 CU	1-1/4	9/16	1	Slot	Slot
GTA-0-0	GTC-0	1	1/0-2	1/0-12 AL 1/0-14 CU	1-9/16	3/4	1-1/8	Slot	Slot
GTA-250-0	GTC-250-350	1	250kcmil-1/0	1/0-12 AL 1/0-14 CU	2	15/16	1-7/16	5/16	Slot
GTA-250-250	GTC-250-350	1	250kcmil-1/0	250kcmil-6	2-1/8	15/16	1-7/16	5/16	5/16
GTA-350-350	GTC-250-350	1	350kcmil-4/0	350kcmil-6	2-7/16	1	1-11/16	3/8	3/8
GTA-500-500	GTC-500	1	500kcmil-350kcmil	500kcmil-2	2-15/16	1-1/4	2	3/8	3/8
GTA-750-500	GTC-750-500	1	750kcmil-500kcmil	500kcmil-2	3-3/8	1-5/16	2-7/16	3/8	3/8
GTA-750-750	GTPC-750-750	2	750kcmil-500kcmil	750kcmil-1/0	3-3/8	2-5/8	2-7/16	1/2	1/2
GTA-1000-500	Not Available	1	1000kcmil-750kcmil	500kcmil-2	3-3/8	1-15/16	2-7/16	1/2	3/8

Insulating covers are available for most connector sizes.

See page 110 for additional information on covers

Note: If ordering with cover, add suffix w/c to catalog number.

DE-OX Inhibitor is recommended for all aluminum terminations.

Tested to UL 486A-486B, UL File E6207

TYPE SPAR

Features

- Transparent flexible insulating cover
- Range adjustable trim-to-fit tip
- Unique shape and compact design
- Connector, cover and cable tie packaged together
- UL Listed and CSA Certified for 600 volts
- Dual Rated

Benefits

- No taping and allows visual inspection of splice
- Ensures proper fit of cover to cable
- Provides ease of installation, versatility and serviceability of connections made in tight spaces
- Provides ease of ordering
- Ensures reliability
- Use with copper or aluminum conductor

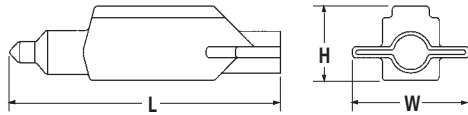

B

Catalog Number	Connector Shape	Wire Range	Dimensions			Screw Size & Shape
			L	W	H	
SPAR-4		4-14	3.30	1.55	.76	slotted
SPAR-2		2-14	3.83	1.75	.95	slotted
SPAR-1/0		1/0-14	4.80	1.94	1.14	3/16" socket head
SPAR-250		250kcmil-6	5.67	2.41	1.29	5/16" socket head
SPAR-350		350kcmil-6	6.17	3.29	1.79	5/16" socket head
SPAR-500		500kcmil-4	7.94	3.66	2.28	3/8" socket head

Not suitable for direct burial.

DE-OX Oxide Inhibitor is recommended for all aluminum terminations.

Tested to UL 486A-486B, UL File E6207

TYPE GTT

B

Features

- Manufactured from high strength 6061-T6 aluminum alloy
- Electro-tin plated
- UL Listed and CSA Certified for 600 volts, 90° C
- Compact design
- Range taking
- Re-usable
- Lay-in main conductor
- Insulating cover available

Benefits

- Suitable for use with either copper or aluminum conductors
- Provides low contact resistance
- Ensures reliability for copper or aluminum conductors
- Saves space and reduces installation time
- Permits inventories to be kept to a minimum
- Provides efficient use and flexibility in the field
- No need to break the feeder cable
- Eliminates taping

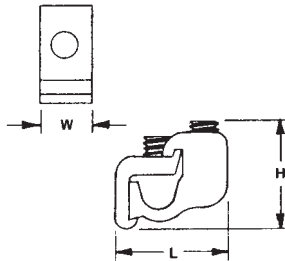

Fig. 1



Fig. 2



Catalog Number		Figure Number	Wire Range		Dimensions			Hex Size	
Connector	Cover		Main	Tap	L	W	H	Main	Tap
GTT-2-2	GTC-2	1	2-12 str	2-12 AL 2-14 CU	1-1/4	9/16	1	Slot	Slot
GTT-0-0	GTC-0	1	1/0-2	1/0-12 AL 1/0-14 CU	1-9/16	3/4	1-1/8	Slot	Slot
GTT-250-0	GTC-250-350	1	250kcmil-1/0	1/0-12 AL 1/0-14 CU	2	7/8	1-7/16	5/16	Slot
GTT-250-250	GTC-250-350	1	250kcmil-1/0	250kcmil-6	2-1/8	7/8	1-7/16	5/16	5/16
GTT-350-350	GTC-500	1	350kcmil-4/0	350kcmil-6	2-7/16	1	1-11/16	3/8	3/8
GTT-500-500	GTC-500	1	500kcmil-350kcmil	500kcmil-2	2-15/16	1-1/4	2	3/8	3/8
GTT-750-500	GTC-750-500	1	750kcmil-500kcmil	500kcmil-2	3-3/8	1-1/4	2-7/16	3/8	3/8
GTT-750-750	GTTC-750-750	2	750kcmil-500kcmil	750kcmil-600kcmil	3-3/8	2-3/8	2-7/16	1/2	EH 3/4
GTT-1000-500	Not Available	1	1000kcmil-750kcmil	500kcmil-2	3-3/8	1-1/4	2-7/16	1/2	3/8

EH-External Hex

Insulating covers are available for most connector sizes.

See page 110 for additional information on covers

Note: If ordering with cover, add suffix w/c to catalog number.

DE-OX Inhibitor is recommended for all aluminum terminations.

Tested to UL 486A-486B, UL File E6207

ILSCO Insulating Covers For GTA-GTT



TYPE GTC

Features

- Snap closure
- Color coded
- UL Listed and CSA Certified for 600 volts, 90° C except for GTPC-750-750 and GTTC-750-750

Benefits

- Installs quickly and saves labor time by eliminating taping
- Provides ease of identification in the field
- Ensures reliability

B



Fig. 1



Fig. 2



Fig. 3

Catalog Number	Figure Number	Color	Dimensions			Used with Connector
			L	W	H	
GTC-2	1	Black	2-1/4	1-13/16	1-1/4	GTA-2-2: GTT-2-2
GTC-0	1	Black	2-1/2	2-3/32	1-3/8	GTA-0-0: GTT-0-0
GTC-250-350	1	Black	3-61/64	3-1/32	2	GTA-250-0: GTA-250-250 GTA-350-350 GTT-250-0: GTT-250-250 GTT-350-350
GTC-500	1	Black	4-1/8	3-1/16	2-31/32	GTA-500-500 GTT-500-500
GTC-750-500	1	Black	4-7/8	3-1/8	2-23/32	GTA-750-500 GTT-750-500
GTPC-750-750*	2	Black	4-7/8	4	2-7/8	GTA-750-750
GTTC-750-750*	3	Black	5-3/4	4-1/4	3-1/16	GTT-750-750

* Not UL Listed or CSA Certified

Tested to UL 486A-486B, UL File E6207



TYPE GT2

B

Features

- Manufactured from high strength 6061-T6 aluminum alloy
- Electro-tin plated
- UL Listed for 600 volts, 90° C
- Compact design
- Range taking
- Re-usable
- Lay-in main conductor
- Supplied with cover

Benefits

- Suitable for use with either copper or aluminum conductors
- Provides low contact resistance
- Ensures reliability for copper or aluminum conductors
- Saves space and reduces installation time
- Permits inventories to be kept to a minimum
- Provides efficient use and flexibility in the field
- No need to break the feeder cable
- Eliminates taping

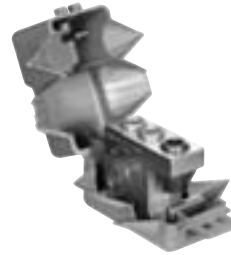
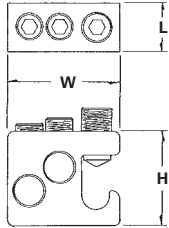

Catalog Number	Wire Range Main & Tap	No. of Taps	Dimensions			Hex Size
			L	W	H	
GT2-250-W/C	250kcmil-2	2	31/32	2-9/32	1-15/16	5/16

DE-OX Inhibitor is recommended for all aluminum terminations.

Tested to UL 486A-486B, UL File E6207

TYPE GT4T

Features

- Manufactured from high strength 6061-T6 aluminum alloy
- Electro-tin plated
- UL Listed and CSA Certified for 600 volts, 90° C
- Compact design
- Range taking
- Re-usable
- Lay-in main conductor
- Insulating cover available

Benefits

- Suitable for use with either copper or aluminum conductors
- Provides low contact resistance
- Ensures reliability for copper or aluminum conductors
- Can make up to four taps off a single main which saves space and reduces installation time
- Permits inventories to be kept to a minimum
- Provides efficient use and flexibility in the field
- No need to break the feeder cable
- Eliminates taping

B

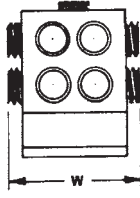
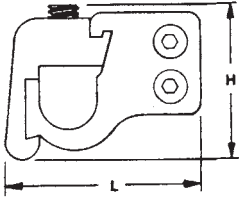

Fig. 1

Fig. 2

Catalog Number	Figure Number	Wire Range		No. of Taps	Dimensions			Hex Size	
		Main	Tap		L	W	H	Main	Tap
*GT4T-250-2-1	1	250kcmil-1/0	2-12 AL, 2-14 CU	4	2-3/16	1-1/8	1-35/64	5/16	Slot
*GT4T-250-2-2	2	250kcmil-1/0	2-12 AL, 2-14 CU	4	2-3/16	1-1/8	1-35/64	5/16	Slot
†GT4T-350-2-1	1	350kcmil-4/0	2-12 AL, 2-14 CU	4	2-17/32	1-1/8	1-17/32	3/8	Slot
*GT4T-350-2-2	2	350kcmil-4/0	2-12 AL, 2-14 CU	4	2-17/32	1-1/8	1-17/32	3/8	Slot
†GT4T-500-2-1	1	500kcmil-350kcmil	2-12 AL, 2-14 CU	4	2-31/32	1-1/4	1-11/16	3/8	Slot
†GT4T-500-2-2	2	500kcmil-350kcmil	2-12 AL, 2-14 CU	4	2-31/32	1-1/4	1-11/16	3/8	Slot
†GT4T-500-0-1	1	500kcmil-350kcmil	1/0-12 AL, 1/0-14 CU	4	2-31/32	1-1/4	1-11/16	3/8	Slot
†GT4T-500-0-2	2	500kcmil-350kcmil	1/0-12 AL, 1/0-14 CU	4	2-31/32	1-1/4	1-11/16	3/8	Slot

* GTC-250-350 Cover can be used. See page 113.

† GTC-500 can be used. See page 113.

DE-OX Inhibitor is recommended for all aluminum terminations.

Tested to UL 486A-486B, UL File E6207

ILSCO Tap Connector Kits - Dual Rated



TYPE GTA/GTT KITS

Features

- Kit includes connector, cover and 5cc DE-OX tube
- Manufactured from high strength aluminum alloy
- Cover has snap closure
- UL Listed and CSA Certified for 600 volts, 90° C

Benefits

- Saves time, convenient
- Suitable for use with copper or aluminum conductors
- Installs quickly, eliminates taping
- Ensures reliability



Fig. 1



Fig. 2

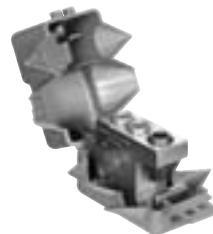

Fig. 3

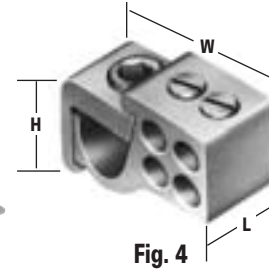

Fig. 4

Catalog Number	Figure Number	Wire Range		No. of Taps	Dimensions			Hex Size	
		Main	Tap		L	W	H	Main	Tap
GTA-0-0-KIT	1	1/0-2	1/0-12 AL, 1/0-14 CU	1	3/4	1-7/16	1-1/8	Slot	Slot
GTA-2-2-KIT	1	2-12	2-12 AL, 2-14 CU	1	9/16	1-1/8	1	Slot	Slot
GTA-250-0-KIT	1	250kcmil-1/0	1/0-12 AL, 1/0-14 CU	1	7/8	2	1-7/16	5/16	Slot
GTA-250-250-KIT	1	250kcmil-1/0	250kcmil-6	1	7/8	2	1-7/16	5/16	5/16
GTT-0-0-KIT	2	1/0-2	1/0-12 AL, 1/0-14 CU	1	3/4	1-9/16	1-1/8	Slot	Slot
GTT-2-2-KIT	2	2-12	2-12 AL, 2-14 CU	1	9/16	1-1/4	1	Slot	Slot
GTT-250-0-KIT	2	250kcmil-1/0	1/0-12 AL, 1/0-14 CU	1	7/8	2	1-7/16	5/16	Slot
GTT-250-250-KIT	2	250kcmil-1/0	250kcmil-6	1	7/8	2-1/8	1-7/16	5/16	5/16
GT2-250-KIT	3	250kcmil-2	250kcmil-2	2	1-3/4	3-1/4	2-1/2	5/16	5/16
GT4T-250-2-2-KIT	4	250kcmil-1/0	2-12 AL, 2-14 CU	4	2-1/4	1	1-11/16	5/16	Slot
GT4T-350-2-2-KIT	4	350kcmil-4/0	2-12 AL, 2-14 CU	4	2-7/16	1	1-3/4	3/8	Slot

Covers rated at 600V 90°C.

Note: Covers are for indoor use only.

Tested to UL 486A-486B, UL File E6207

Multiple Tap Connector - Dual Rated Lay-In

TYPE MGTT

Features

- Manufactured from high strength 6061-T6 aluminum alloy
- Electro-tin plated
- Dual-Rated
- Compact design
- Range taking
- Re-usable
- Lay-in main conductor
- Rated for 600 volts

Benefits

- Suitable for use with either copper or aluminum conductors
- Provides low contact resistance
- Can be used with copper and/or aluminum conductors
- Saves space and reduces installation time
- Permits inventories to be kept to a minimum
- Provides efficient use and flexibility in the field
- No need to break the feeder cable
- Ensures reliability

B

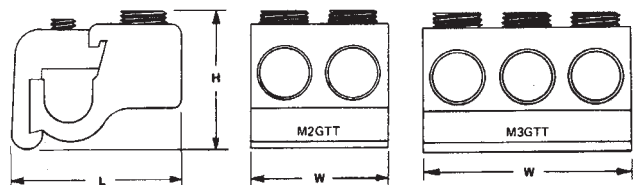

Catalog Number	Wire Range		No. of Tap Openings	Dimensions			Hex Size	
	Main	Tap		L	W	H	Main	Tap
M2GTT-250-250	250kcmil-1/0	250kcmil-6	2	2	1-3/4	1-5/8	5/16	5/16
M2GTT-350-350	350kcmil-4/0	350kcmil-6	2	2-1/4	2	1-11/16	5/16	5/16
M3GTT-350-350	350kcmil-4/0	350kcmil-6	3	2-1/4	3	1-11/16	5/16	5/16
M2GTT-500-500	500kcmil-350kcmil	500kcmil-2	2	2-3/4	2-3/8	1-13/16	3/8	3/8
M3GTT-500-500	500kcmil-350kcmil	500kcmil-2	3	2-3/4	3-1/2	1-13/16	3/8	3/8

DE-OX Inhibitor is recommended for all aluminum terminations.

ILSCO Multiple Tap Connector - Dual Rated



TYPE PTA

B

Features

- Manufactured from high strength 6061-T6 aluminum alloy
- Electro-tin plated
- UL Listed and CSA Certified for 600 volts, 90° C
- Compact design
- Range taking
- Re-usable
- Lay-in main conductors
- Supplied with insulating cover

Benefits

- Suitable for use with either copper or aluminum conductors
- Provides low contact resistance
- Ensures reliability for copper or aluminum conductors
- Saves space and reduces installation time
- Permits inventories to be kept to a minimum
- Provides efficient use and flexibility in the field
- No need to break the feeder cables
- Eliminates taping



Fig. 1



Fig. 2



Fig. 3

Catalog Number Connector	Figure Number	Main Wire Range	Bottom Tap Range	Dimensions			Hex Size	
				H	W	D	Main	Tap
PTA2-500-500-W/C	1	Two: 500kcmil-250kcmil	Two: 500kcmil-4	3-15/16	3-1/2	1-1/4	3/8	3/8
PTA2-750-500-W/C	1	Two: 750kcmil-350kcmil	Two: 500kcmil-4	3-5/8	4-3/32	1-5/16	3/8	3/8
PTA4-750-500-W/C	2	Four: 750kcmil-350kcmil	Two: 500kcmil-4	5-7/8	4-3/32	1-5/16	3/8	3/8
PTA26-500-4/0*+	3	Two: 500kcmil-4/0	Four: 4/0-6 Two: 2-14	3-15/16	3-1/2	1-1/4	3/8	5/16 Slotted

Note: W/C indicates product is supplied with insulating cover.

* Not CSA Certified.

+ Cover must be ordered separately. For non UL cover, order 1 each RO614W00A and RO615W00A.

DE-OX Inhibitor is recommended for all aluminum terminations.

Tested to UL 486A-486B, UL File E6207

ILSCO ClearTap® Insulated Multi-Tap Connectors



TYPE PCT

Features

- Transparent flexible insulating cover
- Captive pressure screws
- Self-closing openings
- Access from both sides of connector
- Broad wire range: 800kcmil-14
- UL Listed for 600 volts, 90° C
- Dual Rated

Benefits

- No taping and allows visual inspection of connection
- No wasted time finding screws
- No lost or loose caps and plugs
- Provides greater versatility
- Reduces inventory
- Ensures reliability
- For copper or aluminum conductor

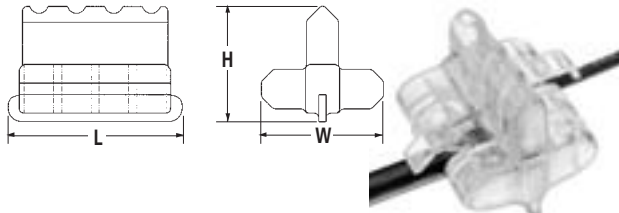

Fig. 1 (Patented)

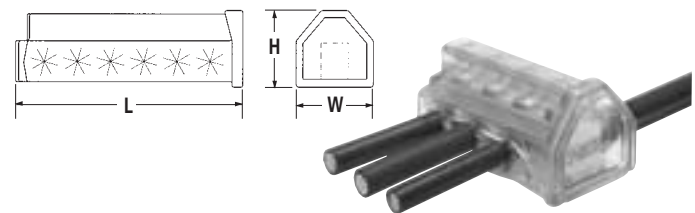

Fig. 2







































Catalog Number	Connector Shape	Figure No.	No. Of Ports	Wire Range	Ampere Rating	Dimensions			Hex Size
						L	W	H	
PCT-2-4		1	2	4-14	95	1.46	1.57	1.43	slot
PCT-4-4		1	4	4-14	95	2.46	1.57	1.43	slot
PCT-6-4		1	6	4-14	95	3.46	1.57	1.43	slot
PCT-8-4		1	8	4-14	95	4.46	1.57	1.43	slot
PCT-2-2/0		2	2	2/0-14	195	2.61	2.30	1.97	3/16
PCT-4-2/0		2	4	2/0-14	195	4.30	2.30	1.97	3/16
PCT-6-2/0		2	6	2/0-14	195	5.98	2.30	1.97	3/16
PCT-8-2/0		2	8	2/0-14	195	7.67	2.30	1.97	3/16
PCT-2-4/0		2	2	4/0-6	260	2.33	2.49	2.25	5/16
PCT-4-4/0		2	4	4/0-6	260	4.19	2.49	2.25	5/16
PCT-6-4/0		2	6	4/0-6	260	6.05	2.49	2.25	5/16
PCT-8-4/0		2	8	4/0-6	260	7.91	2.49	2.25	5/16
PCT-2-350		2	2	350 kcmil-6	350	2.75	2.69	2.65	5/16
PCT-4-350		2	4	350 kcmil-6	350	5.06	2.69	2.65	5/16
PCT-6-350		2	6	350 kcmil-6	350	7.37	2.69	2.65	5/16
PCT-8-350		2	8	350 kcmil-6	350	9.68	2.69	2.65	5/16
PCT-2-600		2	2	600 kcmil-4	475	3.17	3.20	3.27	3/8
PCT-4-600		2	4	600 kcmil-4	475	5.73	3.20	3.27	3/8
PCT-6-600		2	6	600 kcmil-4	475	8.29	3.20	3.27	3/8
PCT-8-600		2	8	600 kcmil-4	475	10.86	3.20	3.27	3/8
PCT-2-800		2	2	800kcmil-250kcmil	555	3.91	3.34	3.30	1/2
PCT-4-800		2	4	800kcmil-250kcmil	555	7.03	3.34	3.30	1/2
PCT-6-800		2	6	800kcmil-250kcmil	555	10.15	3.34	3.30	1/2

Not suitable for direct burial.

Tested to UL 486A-486B, UL File E6207



**Mechanical
Aluminum - Dual Rated**

<p>TA</p>  <p>119</p>	<p>AU</p>  <p>120</p>	<p>T3A</p>  <p>121</p>	<p>T4A4</p>  <p>122</p>	<p>PB</p>  <p>123</p>	<p>TLK</p>  <p>124</p>
<p>USGL</p>  <p>125</p>	<p>SPA</p>  <p>126</p>	<p>CA</p>  <p>127</p>	<p>GTA</p>  <p>128</p>	<p>GTT</p>  <p>129</p>	<p>GTC</p>  <p>130</p>
<p>GT2</p>  <p>131</p>	<p>GT4T</p>  <p>132</p>	<p>MGTT</p>  <p>133</p>	<p>PTA</p>  <p>134</p>	<p>LDA</p>  <p>135</p>	<p>LDB</p>  <p>135</p>
<p>PDA</p>  <p>136</p>	<p>PDC</p>  <p>136</p>	<p>PDB</p>  <p>137 - 142</p>	<p>IPC</p>  <p>143</p>	<p>AK</p>  <p>144</p>	<p>DBA/DBA-S</p>  <p>145</p>
<p>AGC</p>  <p>146</p>	<p>SGC</p>  <p>146</p>	<p>GBL</p>  <p>147</p>	<p>GBT</p>  <p>148</p>	<p>PED-Z</p>  <p>149</p>	<p>PED-X</p>  <p>150</p>
<p>PSA-Z</p>  <p>150</p>	<p>PEC</p>  <p>150</p>	<p>PED-CP</p>  <p>151</p>	<p>PET</p>  <p>152</p>	<p>PTT</p>  <p>153</p>	<p>NB</p>  <p>154</p>
<p>USPA-SS</p>  <p>155</p>	<p>DBK</p>  <p>156</p>	<p>ASK</p>  <p>156</p>	<p>SS, SSK, SSKC</p>  <p>157</p>	<p>PG</p>  <p>158</p>	<p>GRM</p>  <p>159</p>
<p>GRF</p>  <p>159</p>					

Mechanical Copper

SLU/SAU 160	SLS/SAS 160	E 161	H 161	SLUH 162	LO 163
VT/LO-S 164	XT 165	LY 165	CP 166	CO 167 - 168	COPP 169
TC 170	SX 171	2SC 172	N 173	MU 174	LU 174
CL 175 - 176	HL 177	CL 178	CL 178	H2L 179	H3L 180
CGRC 181	BGRC 182	SRC 183	GRC 184	DCGC 185	BGC 186 - 187
BGDB 188	GBL-DB 189	D167 190	CAN 191	N-174 191	IK 192
IK3 193	SK 194	IKB 195	IKS 196	TORQUE INDEX 197	

TYPE TA

Features

- Manufactured from high strength 6061-T6 aluminum alloy
- Electro-tin plated
- Chamfered wire entry
- UL Listed and CSA Certified for 600 volts, 90° C

Benefits

- Suitable for use with either copper or aluminum conductors
- Provides low contact resistance
- Provides ease of installation
- Ensures reliability for copper or aluminum conductors

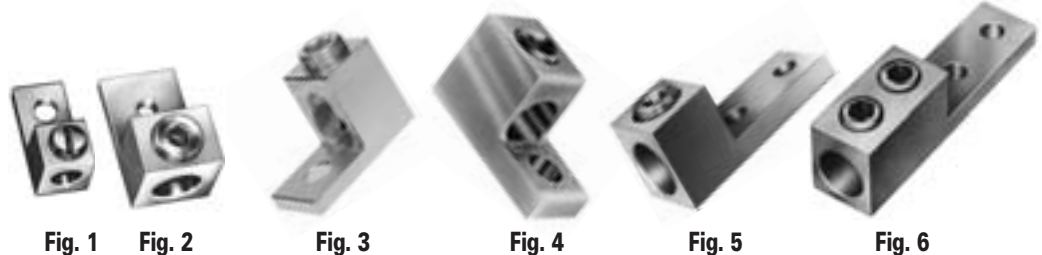
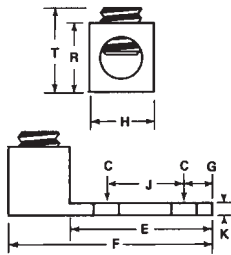

C

Catalog Number	Figure Number	Wire Range	Bolt Size	Dimensions										Hex Size
				C	E	F	G	H	J	K	R	T		
TA-6-S	1	4-14	1/4	17/64	11/16	1-1/16	1/4	1/2	-	3/32	1/2	41/64	S	
TA-2	1	2-14	1/4	17/64	11/16	1-5/32	5/16	1/2	-	7/64	9/16	3/4	S	
TA-0	1	1/0-14	1/4	17/64	27/32	1-15/32	7/16	5/8	-	3/16	25/32	29/32	S	
TA-2/0	2	2/0-14	1/4	17/64	27/32	1-15/32	7/16	5/8	-	3/16	25/32	1-1/32	3/16	
TA-250	2	250kcmil-6	5/16	21/64	1	2	15/32	1	-	1/4	1-1/8	1-21/64	5/16	
TA-300	2	300kcmil-6	1/4	9/32	1	2	1/2	55/64	-	1/4	1-1/8	1-11/32	5/16	
TA-350	2	350kcmil-6	3/8	13/32	1-1/8	2-1/4	1/2	1-1/8	-	1/4	1-1/4	1-29/64	3/8	
TA-500	2	500kcmil-4	3/8	13/32	1-19/32	2-13/16	7/8	1-1/2	-	5/16	1-13/16	1-13/16	3/8	
TA-500-S	3	One: 600kcmil-4 Two: 250kcmil-1/0	3/8	13/32	1-1/2	2-13/16	5/8	1-5/16	-	5/16	1-13/16	2-3/16	1/2	
TA-600	2	600kcmil-2	3/8	13/32	1-13/16	3-3/16	7/8	1-1/2	-	7/16	1-9/16	1-31/32	1/2	
TA-800	2	800kcmil-300kcmil	5/8	21/32	1-3/4	3-3/8	7/8	1-3/4	-	1/2	1-15/16	2-15/64	1/2	
TA-800-S	4	800kcmil-3/0	5/8	21/32	1-3/4	3-1/4	11/16	1-5/16	-	1/2	1-13/16	2-3/16	1/2	
TA-1000	2	1000kcmil-350kcmil	5/8	21/32	1-3/4	3-3/8	7/8	1-3/4	-	1/2	1-15/16	2-25/64	9/16	
TA-1000-S	4	1000kcmil-500kcmil	5/8	21/32	1-3/4	3-1/4	11/16	1-7/16	-	1/2	1-13/16	2-3/16	9/16	
TA-350-2NS	5	350kcmil-6	1/2	9/16	3	4-5/16	5/8	1-1/8	1-3/4	5/16	1-3/8	1-29/64	3/8	
TA-600-2NS	5	600kcmil-2	1/2	9/16	3-5/16	4-11/16	5/8	1-1/2	1-3/4	7/16	1-3/8	1-59/64	1/2	
TA-800-2NS	5	800kcmil-300kcmil	1/2	9/16	3-1/8	4-3/4	5/8	1-3/4	1-3/4	1/2	1-15/16	2-3/16	1/2	
TA-1000-2NS	5	1000kcmil-500kcmil	1/2	9/16	3-1/8	4-3/4	5/8	1-3/4	1-3/4	1/2	1-15/16	2-27/64	9/16	
TA-350-2N	6	350kcmil-6	1/2	9/16	3-1/4	5-1/2	5/8	1-1/4	1-3/4	3/8	1-1/2	1-21/32	(2)3/8	
TA-600-2N	6	600kcmil-2	1/2	9/16	3-1/4	5-1/2	5/8	1-3/8	1-3/4	3/8	1-1/2	1-31/32	(2)3/8	
TA-800-2N	6	800kcmil-300kcmil	1/2	9/16	3-5/8	5.97	5/8	1-1/2	1-3/4	1/2	1.813	2-15/64	(2)1/2	
TA-1000-2N	6	1000kcmil-500kcmil	1/2	9/16	3-5/8	5.97	5/8	1-5/8	1-3/4	1/2	1.813	2-25/64	(2)1/2	

DE-OX Inhibitor is recommended for all aluminum terminations.

Tested to UL 486A-486B, UL File E6207

TYPE AU

Features

- Manufactured from high strength 6061-T6 aluminum alloy
- Electro-tin plated
- Chamfered wire entry
- UL Listed and CSA Certified for 600 volts, 90° C

Benefits

- Suitable for use with either copper or aluminum conductors
- Provides low contact resistance
- Provides ease of installation
- Ensures reliability for copper or aluminum conductors

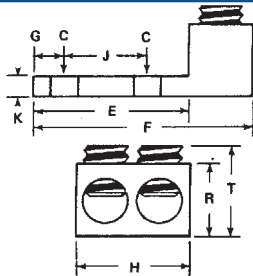

Fig. 1



Fig. 2



Fig. 3



Fig. 4

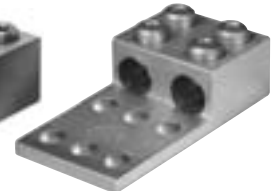

Fig. 5

Catalog Number	Figure Number	Wire Range	Bolt Size	Dimensions									Hex Size
				C	E	F	G	H	J	K	R	T	
AU-0	1	Two: 1/0-14	1/4	17/64	27/32	1-15/32	7/16	1-1/8	-	3/16	51/64	29/32	S
AU-2/0	2	Two: 2/0-14	1/4	17/64	27/32	1-15/32	27/64	1-1/4	-	3/16	51/64	1-1/32	3/16
AU-250	2	Two: 250kcmil-6	3/8	25/64	1-9/16	2-9/16	7/8	1-21/32	-	1/4	1-3/16	1-9/32	5/16
AU-350	2	Two: 350kcmil-4	1/2	9/16	1-3/4	2-7/8	7/8	1-57/64	-	1/4	1-1/4	1-3/8	5/16
AU-600	2	Two: 600kcmil-2	1/2	17/32	1-13/16	3-3/16	5/8	2-13/32	-	7/16	1-9/16	1-31/32	1/2
AU-800	2	Two: 800kcmil-300kcmil	5/8	21/32	1-3/4	3-3/8	7/8	3-3/16	-	1/2	1-15/16	2-15/64	1/2
AU-1000	2	Two: 1000kcmil-500kcmil	5/8	21/32	1-3/4	3-3/8	7/8	3-3/16	-	1/2	1-15/16	2-25/64	9/16
AU-600-2NS	3	Two: 600kcmil-2	1/2	9/16	3-5/16	4-11/16	5/8	2-13/32	1-3/4	7/16	1-3/8	2-3/64	1/2
AU-800-2NS	3	Two: 800kcmil-300kcmil	1/2	9/16	3-1/8	4-3/4	5/8	3-3/16	1-3/4	1/2	1-15/16	2-3/16	1/2
AU-1000-2NS	3	Two: 1000kcmil-500kcmil	1/2	9/16	3-1/8	4-3/4	5/8	3-3/16	1-3/4	1/2	1-5/8	2-33/64	9/16
AU-350-2N	4	Two: 350kcmil-6	1/2	9/16	3	4-5/16	5/8	2	1-3/4	5/16	1-3/8	1-29/64	5/16
AU-350-N*	5	Two: 350kcmil-6	1/2	9/16	3-1/4	5-1/2	5/8	2-3/4	1-3/4	3/8	1-1/2	1-31/32	5/16
AU-600-2N*	5	Two: 600kcmil-2	1/2	9/16	3-1/4	5-1/2	5/8	2-3/4	1-3/4	3/8	1-1/2	1-31/32	1/2
AU-800-2N*	5	Two: 800kcmil-300kcmil	1/2	9/16	3-5/8	5-31/32	5/8	3	1-3/4	1/2	1-13/16	2-15/64	1/2
AU-1000-2N*	5	Two: 1000kcmil-500kcmil	1/2	9/16	3-5/8	5-31/32	5/8	3-1/4	1-3/4	1/2	1-13/16	2-25/64	9/16

DE-OX Inhibitor is recommended for all aluminum terminations.

Tested to UL 486A-486B, UL File E6207

* Mounting hole spacing from side to side, hole to hole is .875

TYPE T3A

Features

- Manufactured from high strength 6061-T6 aluminum alloy
- Electro tin plated
- Chamfered wire entry
- UL Listed and CSA Certified for 600 volts, 90° C

Benefits

- Suitable for use with either copper or aluminum conductors
- Provides low contact resistance
- Provides ease of installation
- Ensures reliability for copper or aluminum conductors

C

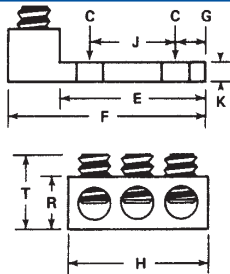

Fig. 1



Fig. 2



Fig. 3

Catalog Number	Figure Number	Wire Range	Bolt Size	Dimensions									Hex Size
				C	E	F	G	H	J	K	R	T	
T3A2-2	1	Three: 2-14	5/16	11/32	1-11/16	2-3/16	11/32	1-19/32	7/8	3/16	5/8	13/16	Slot
T3A2-0	1	Three: 1/0-14	3/8	7/16	2-5/32	2-29/32	11/32	1-15/16	1	1/4	7/8	15/16	Slot
T3A2-3/0N	1	Three: 3/0-6	1/2	9/16	3	3-7/8	5/8	2-13/16	1-3/4	5/16	1-1/8	1-1/2	5/16
T3A2-250N	1	Three: 250kcmil-6	1/2	9/16	3	4	5/8	2-13/16	1-3/4	5/16	1-3/16	1-17/32	5/16
T3A2-350N	1	Three: 350kcmil-6	1/2	9/16	3	4-5/16	5/8	3	1-3/4	5/16	1-3/8	1-17/32	5/16
T3A2-600N*	3	Three: 600kcmil-2	1/2	9/16	3-1/4	5-1/2	5/8	3-1/2	1-3/4	3/8	1-1/2	1-49/64	3/8
T3A2-800N*	3	Three: 800kcmil-350kcmil	1/2	9/16	3-5/8	5-31/32	5/8	4-1/8	1-3/4	1/2	1-13/16	2-21/64	5/16
T3A2-1000N*	3	Three: 1000kcmil-500kcmil	1/2	9/16	3-5/8	5-31/32	5/8	4-7/8	1-3/4	1/2	1-13/16	2-21/64	3/8
T3A4-2	2	Three: 2-14	5/16	11/32	1-11/16	2-3/16	11/32	1-19/32	7/8	3/16	5/8	13/16	Slot
T3A4-0	2	Three: 1/0-14	3/8	7/16	2-5/32	2-29/32	11/32	1-15/16	1	1/4	7/8	15/16	Slot
T3A4-3/0N	2	Three: 3/0-6	1/2	9/16	3	3-7/8	5/8	2-13/16	1-3/4	5/16	1-1/8	1-1/2	5/16
T3A4-250N	2	Three: 250kcmil-6	1/2	9/16	3	4	5/8	2-13/16	1-3/4	5/16	1-3/16	1-17/32	5/16
T3A4-350N	2	Three: 350kcmil-6	1/2	9/16	3	4-5/16	5/8	3	1-3/4	5/16	1-3/8	1-17/32	5/16
T3A4-600N*	3	Three: 600kcmil-2	1/2	9/16	3-1/4	5-1/2	5/8	3-1/2	1-3/4	3/8	1-1/2	1-49/64	1/2
T3A4-800N*	3	Three: 800kcmil-350kcmil	1/2	9/16	3-5/8	5-31/32	5/8	4-1/8	1-3/4	1/2	1-13/16	2-21/64	1/2
T3A4-1000N*	3	Three: 1000kcmil-500kcmil	1/2	9/16	3-5/8	5-31/32	5/8	4-7/8	1-3/4	1/2	1-13/16	2-21/64	1/2

DE-OX Inhibitor is recommended for all aluminum terminations.

Tested to UL 486A-486B, UL File E6207

* Mounting hole spacing from side to side, hole to hole is .875

TYPE T4A4

Features

- Manufactured from high strength 6061-T6 aluminum alloy
- Electro-tin plated
- Chamfered wire entry
- UL Listed and CSA Certified for 600 volts, 90° C

Benefits

- Suitable for use with either copper or aluminum conductors
- Provides low contact resistance
- Provides ease of installation
- Ensures reliability for copper or aluminum conductors

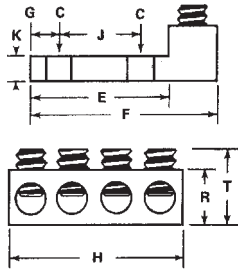

Fig. 1



Fig. 2



Fig. 3



Fig. 4

Catalog Number	Figure Number	Wire Range	Bolt Size	Dimensions									Hex Size
				C	E	F	G	H	J	K	R	T	
T4A4-250N*	1	250kcmil-6	1/2	9/16	3	4	5/8	3-49/64	1-3/4	5/16	1-3/16	1-17/32	5/16
T4A4-350N*	1	350kcmil-6	1/2	9/16	3	4-5/16	5/8	4-1/64	1-3/4	5/16	1-3/8	1-17/32	5/16
T4A4-600N*	3	600kcmil-2	1/2	9/16	3-1/4	5-1/2	5/8	5	1-3/4	3/8	1-1/2	1-7/8	1/2
T4A4-800N*	2	800kcmil-350kcmil	1/2	9/16	3-5/8	5-31/32	5/8	6	1-3/4	1/2	1-13/16	2-13/64	1/2
T4A4-1000N*	4	1000kcmil-350kcmil	1/2	9/16	3-5/8	5-31/32	5/8	6-1/2	1-3/4	1/2	1-13/16	2-13/64	1/2

DE-OX Inhibitor is recommended for all aluminum terminations.

Tested to UL 486A-486B, UL File E6207

* Mounting hole spacing from side to side, hole to hole is .875

ILSCO Aluminum Panelboard Lugs - Dual Rated



TYPE PB

Features

- Manufactured from high strength 6061-T6 aluminum alloy
- Electro-tin plated
- Chamfered wire entry
- UL Listed and CSA Certified for 600 volts, 90° C
- Stacked design

Benefits

- Suitable for use with either copper or aluminum conductors
- Provides low contact resistance
- Provides ease of installation
- Ensures reliability for copper or aluminum conductors
- Saves space and reduces installation time

C

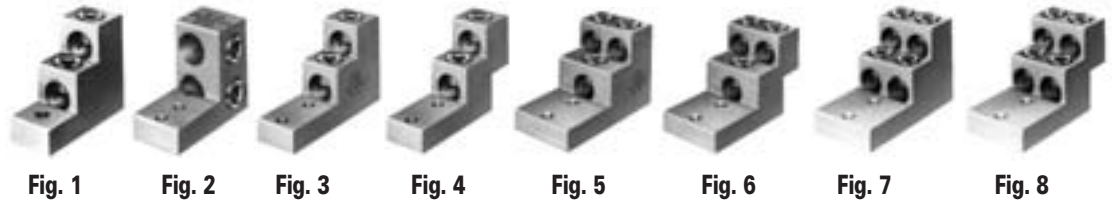
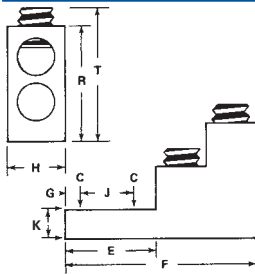

Catalog Number	Figure Number	Wire Range	Bolt Size	Dimensions									Hex Size
				C	E	F	G	H	J	K	R	T	
PB2-300	1	300kcmil-6	5/16	21/64	1	3	15/32	1	-	5/16	2	2-5/16	5/16
PB2-500	2	500kcmil-4/0	1/4	9/32	1-11/16	2-29/32	1/4	1-7/16	11/16	5/8	2-3/8	1-27/64	3/8
PB2-600	4	600kcmil-2	3/8	13/32	2-11/32	4-29/32	3/8	1-1/2	1-3/8	3/4	3	3-29/64	1/2
PB3-600	6	600kcmil-2	3/8	13/32	2-11/32	4-29/32	3/8	2-15/32	1-3/8	3/4	3	3-29/64	1/2
PB4-600	8	600kcmil-2	3/8	13/32	2-11/32	4-29/32	3/8	2-15/32	1-3/8	3/4	3	3-29/64	1/2
PB2-750	4	750kcmil-1/0	3/8	13/32	2-11/32	4-29/32	3/8	1-11/16	1-3/8	3/4	3	3-29/64	1/2
PB4-750	8	750kcmil-1/0	3/8	13/32	2-11/32	4-29/32	3/8	2-5/8	1-3/8	3/4	3	3-29/64	1/2
PB3-600-2N	5	600kcmil-2	1/2	9/16	3-1/8	5-11/16	3/8	2-15/32	1-3/4	3/4	3	3-29/64	1/2
PB2-600-2N	3	600kcmil-2	1/2	9/16	3-1/8	5-11/16	3/8	1-1/2	1-3/4	3/4	3	3-29/64	1/2
PB2-750-2N	3	750kcmil-1/0	1/2	9/16	3-1/8	5-11/16	3/8	1-11/16	1-3/4	3/4	3	3-29/64	1/2
PB4-600-2N	7	600kcmil-2	1/2	9/16	3-1/8	5-11/16	3/8	2-15/32	1-3/4	3/4	3	3-29/64	1/2
PB4-750-2N	7	750kcmil-1/0	1/2	9/16	3-1/8	5-11/16	3/8	3-1/16	1-3/4	3/4	3	3-29/64	1/2

DE-OX Inhibitor is recommended for all aluminum terminations.

Tested to UL 486A-486B, UL File E6207

ILSCO Transformer Lug Kits - Dual Rated



TYPE TLK

Features

- Connectors manufactured from high strength 6061-T6 aluminum alloy
- Electro-tin plated
- Chamfered wire entry
- UL Listed and CSA Certified for 600 volts
- Kit includes all required hardware

Benefits

- Suitable for use with either copper or aluminum conductors
- Provides low contact resistance
- Provides ease of installation
- Ensures reliability for copper or aluminum conductors



C

Catalog Number	XFMR KVA Size	Lugs in Kit	Bolts in Kit
TLK-1	15-37 1/2 1-Phase, 15-45 3-Phase	Eight TA-2, Four TA-250	Eight 1/4-20 x 3/4 Bolts, Eight 1/2-20 Flange Nuts
TLK-2	50-75 1-Phase, 75-112 1/2 3-Phase	Twelve TA-250	Eight 1/4-20 x 3/4 Bolts, Eight 1/4-20 x 1-3/4 Bolts and Sixteen 1/4-20 Flange Nuts
TLK-3	100-167 1-Phase, 150-300 3-Phase	Three TA-250 and Twenty-two TA-600	Three 1/4-20 x 3/4 Bolts, Three 1/4-20 nuts, Sixteen 3/8-16-2 Bolts, Sixteen 3/8-16 Flange Nuts, Sixteen 3/8 flat washer
TLK-4	500 3-Phase	Twenty-nine TA-600	Eighteen 3/8-16 x 2 Bolts and Eighteen 3/8-16 Flange Nuts

Dimensional data for connectors see Type TA.
DE-OX Inhibitor is recommended for all aluminum terminations.



TYPE USGL

Features

- Compact, lay-in design
- Manufactured from high strength 6061-T6 aluminum for strength and conductivity
- High strength aluminum 5/16" drive torque screw
- Clear plated coating
- Designed for installation on standard NEMA mounting holes
- UL Listed
- 1-3/4" NEMA spacing on mounting holes

Benefits

- Solves the problem of trying to bend larger size cables into place
- Dual rated for aluminum or copper conductors
- Enables range taking
- Provides low contact resistance
- Conforms to industry standards
- Ensures reliability
- Industry standard

C

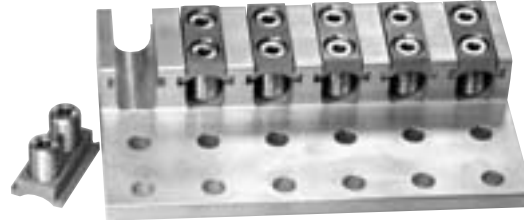
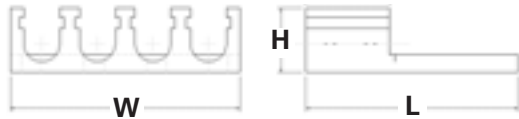

Catalog Number	Number of Mtg. Holes	Number of Ports	Wire Range	Mounting Bolt Size	Dimensions			Hex Size
					Width	Length	Height	
USGL-350R21	2	1	350 kcmil-6	1/2	1.50	4.69	1.56	5/16
USGL-350R42	4	2	350 kcmil-6	1/2	2.75	4.69	1.56	5/16
USGL-350R43	4	3	350 kcmil-6	1/2	4.00	4.69	1.56	5/16
USGL-350R64	6	4	350 kcmil-6	1/2	5.25	4.69	1.56	5/16
USGL-350R86	8	6	350 kcmil-6	1/2	7.75	4.69	1.56	5/16
USGL-350R128	12	8	350 kcmil-6	1/2	10.25	4.69	1.56	5/16
USGL-600R21	2	1	600 kcmil-2	1/2	1.68	5.35	1.69	5/16
USGL-600R42	4	2	600 kcmil-2	1/2	3.08	5.35	1.69	5/16
USGL-600R63	6	3	600 kcmil-2	1/2	4.81	5.35	1.69	5/16
USGL-600R84	8	4	600 kcmil-2	1/2	6.45	5.35	1.69	5/16
USGL-600R106	10	6	600 kcmil-2	1/2	8.69	5.35	1.69	5/16
USGL-600R148	14	8	600 kcmil-2	1/2	11.70	5.35	1.69	5/16
USGL-750R21	2	1	750 kcmil-1/0	1/2	1.76	5.97	1.81	5/16
USGL-750R42	4	2	750 kcmil-1/0	1/2	3.31	5.97	1.81	5/16
USGL-750R63	6	3	750 kcmil-1/0	1/2	4.88	5.97	1.81	5/16
USGL-750R84	8	4	750 kcmil-1/0	1/2	6.45	5.97	1.81	5/16
USGL-750R126	12	6	750 kcmil-1/0	1/2	9.95	5.97	1.81	5/16
USGL-750R148	14	8	750 kcmil-1/0	1/2	12.30	5.97	1.81	5/16
USGL-1000R21	2	1	1000 kcmil-1/0	1/2	2.00	6.19	1.88	5/16
USGL-1000R22	2	2	1000 kcmil-1/0	1/2	3.68	6.19	1.88	5/16
USGL-1000R42	4	2	1000 kcmil-1/0	1/2	3.68	6.19	1.88	5/16
USGL-1000R43	4	3	1000 kcmil-1/0	1/2	5.37	6.19	1.88	5/16
USGL-1000R63	6	3	1000 kcmil-1/0	1/2	5.37	6.19	1.88	5/16
USGL-1000R84	8	4	1000 kcmil-1/0	1/2	7.06	6.19	1.88	5/16
USGL-1000R126	12	6	1000 kcmil-1/0	1/2	10.44	6.19	1.88	5/16
USGL-1000R168	16	8	1000 kcmil-1/0	1/2	13.81	6.19	1.88	5/16

Add T for tin plated, P for Pre-filled with De-Ox

ILSCO Aluminum Splicer/Reducer - Dual Rated



TYPE SPA

Features

- Manufactured from high strength 6061-T6 aluminum alloy
- Electro-tin plated
- Chamfered wire entry
- UL Listed and CSA Certified for 600 volts, 90° C
- Rounded bottoms
- Large screw diameters
- Wire stop in center

Benefits

- Suitable for use with either copper or aluminum conductors
- Provides low contact resistance
- Provides ease of installation
- Ensures reliability for copper or aluminum conductors
- Facilitates taping
- Ensures all wire strands are held securely
- Prevents dissimilar metals coming into contact

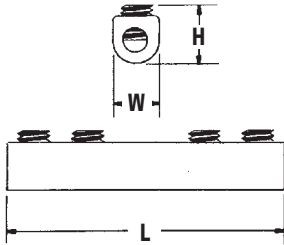

C

Catalog Number	Wire Range	Dimensions			Number of Screws	Screw Diameter	Hex Size
		L	W	H			
SPA-2	2-14	1-3/16	29/64	9/16	2	3/8	Slot
SPA-0	1/0-14	1-29/32	5/8	11/16	2	7/16	3/16
SPA-250	250kcmil-6	2-5/16	7/8	1	2	5/8	5/16
SPA-350	350kcmil-6	2-15/32	1	1-1/4	2	11/16	5/16
SPA-500	500kcmil-3/0	3-7/8	1-1/8	1-5/8	2	13/16	3/8
SPA-750	750kcmil-250kcmil	5-7/16	1-3/8	1-3/4	4	15/16	1/2
SPA-1000	1000kcmil-500kcmil	8-11/16	1-3/4	1-3/4	6	1-1/8	9/16

DE-OX Inhibitor is recommended for all aluminum terminations.

Tested to UL 486A-486B, UL File E6207



TYPE CA

Features

- Manufactured from high strength 6061-T6 aluminum alloy
- Electro-tin plated
- UL Recognized for 75° C and is CSA certified, rated for 600 volts
- Design includes bossed mounting holes

Benefits

- Suitable for use with either copper or aluminum conductors
- Provides low contact resistance
- Ensures reliability
- Acts as an anti-rotation device and prevents connector from turning

C

Fig. 1 & 2 Bottom View

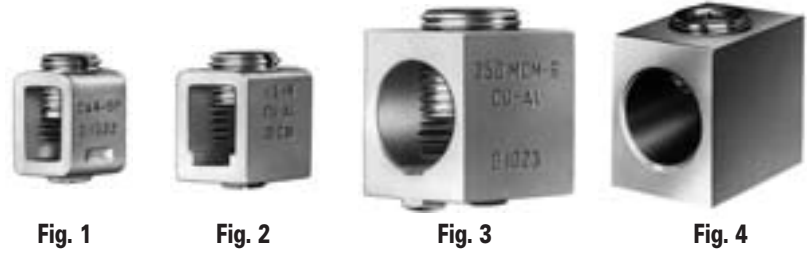
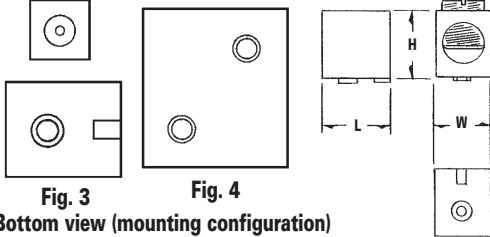

Fig. 3
Bottom view (mounting configuration)

Catalog Number	Figure Number	Wire Range	Dimensions			Style and Size of Boss	Flat Bottom	Bossed Hole Tapped	Two Mounting Holes Tapped	Hex Size
			L	W	H					
CA4SP	1	2-14 CU 2-12 AL	15/32	1/2	23/32	Sq. .229	-	10-32	-	Slot
CA4RP	1	2-14 CU 2-12 AL	15/32	1/2	23/32	Rd. .229	-	10-32	-	Slot
CA5SP	2	1/0-14 CU 1/0-12 AL	5/8	9/16	11/16	Sq. .229	-	10-32	-	Slot
CA5RP	2	1/0-14 CU 1/0-12 AL	5/8	9/16	11/16	Rd. .229	-	10-32	-	Slot
CA6RP	3	250kcmil-6	1	13/16	1	Rd. .285	-	1/4-20	-	5/16
CA7	4	500kcmil-1/0	1-3/8	1-15/64	1-13/32	-	YES	-	1/4-20	3/8
CA8	4	750kcmil-500kcmil	1-15/16	1-3/8	1-3/4	-	YES	-	5/16-18	1/2

DE-OX Oxide Inhibitor is recommended for all aluminum terminations.

Tested to UL 486A-486B, UL File E6207

TYPE GTA

Features

- Manufactured from high strength 6061-T6 aluminum alloy
- Electro-tin plated
- UL Listed and CSA Certified for 600 volts, Temp. rating 90° C
- Compact design
- Range taking
- Re-usable
- Lay-in main conductor
- Insulating cover available

Benefits

- Suitable for use with either copper or aluminum conductors
- Provides low contact resistance
- Ensures reliability for copper or aluminum conductors
- Saves space and reduces installation time
- Permits inventories to be kept to a minimum
- Provides efficient use and flexibility in the field
- No need to break the feeder cable
- Eliminates taping

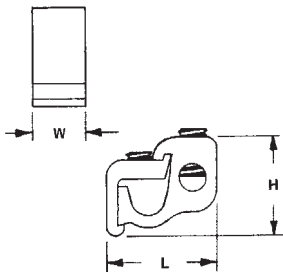

Fig. 1



Fig. 2



C

Catalog Number		Figure Number	Wire Range		Dimensions			Hex Size	
Connector	Cover		Main	Tap	L	W	H	Main	Tap
GTA-2-2	GTC-2	1	2-12 str	2-12 AL 2-14 CU	1-1/4	9/16	1	Slot	Slot
GTA-0-0	GTC-0	1	1/0-2	1/0-12 AL 1/0-14 CU	1-9/16	3/4	1-1/8	Slot	Slot
GTA-250-0	GTC-250-350	1	250kcmil-1/0	1/0-12 AL 1/0-14 CU	2	15/16	1-7/16	5/16	Slot
GTA-250-250	GTC-250-350	1	250kcmil-1/0	250kcmil-6	2-1/8	15/16	1-7/16	5/16	5/16
GTA-350-350	GTC-250-350	1	350kcmil-4/0	350kcmil-6	2-7/16	1	1-11/16	3/8	3/8
GTA-500-500	GTC-500	1	500kcmil-350kcmil	500kcmil-2	2-15/16	1-1/4	2	3/8	3/8
GTA-750-500	GTC-750-500	1	750kcmil-500kcmil	500kcmil-2	3-3/8	1-5/16	2-7/16	3/8	3/8
GTA-750-750	GTPC-750-750	2	750kcmil-500kcmil	750kcmil-1/0	3-3/8	2-5/8	2-7/16	1/2	1/2
GTA-1000-500	Not Available	1	1000kcmil-750kcmil	500kcmil-2	3-3/8	1-15/16	2-7/16	1/2	3/8

Insulating covers are available for most connector sizes.

See page 130 for additional information on covers

Note: If ordering with cover, add suffix w/c to catalog number.

DE-OX Inhibitor is recommended for all aluminum terminations.

Tested to UL 486A-486B, UL File E6207

TYPE GTT

Features

- Manufactured from high strength 6061-T6 aluminum alloy
- Electro-tin plated
- UL Listed and CSA Certified for 600 volts, Temp. rating 90° C
- Compact design
- Range taking
- Re-usable
- Lay-in main conductor
- Insulating cover available

Benefits

- Suitable for use with either copper or aluminum conductors
- Provides low contact resistance
- Ensures reliability for copper or aluminum conductors
- Saves space and reduces installation time
- Permits inventories to be kept to a minimum
- Provides efficient use and flexibility in the field
- No need to break the feeder cable
- Eliminates taping

C

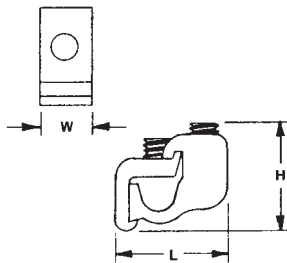

Fig. 1



Fig. 2



Catalog Number		Figure Number	Wire Range		Dimensions			Hex Size	
Connector	Cover		Main	Tap	L	W	H	Main	Tap
GTT-2-2	GTC-2	1	2-12 str	2-12 AL 2-14 CU	1-1/4	9/16	1	Slot	Slot
GTT-0-0	GTC-0	1	1/0-2	1/0-12 AL 1/0-14 CU	1-9/16	3/4	1-1/8	Slot	Slot
GTT-250-0	GTC-250-350	1	250kcmil-1/0	1/0-12 AL 1/0-14 CU	2	7/8	1-7/16	5/16	Slot
GTT-250-250	GTC-250-350	1	250kcmil-1/0	250kcmil-6	2-1/8	7/8	1-7/16	5/16	5/16
GTT-350-350	GTC-500	1	350kcmil-4/0	350kcmil-6	2-7/16	1	1-11/16	3/8	3/8
GTT-500-500	GTC-500	1	500kcmil-350kcmil	500kcmil-2	2-15/16	1-1/4	2	3/8	3/8
GTT-750-500	GTC-750-500	1	750kcmil-500kcmil	500kcmil-2	3-3/8	1-1/4	2-7/16	3/8	3/8
GTT-750-750	GTC-750-750	2	750kcmil-500kcmil	750kcmil-600kcmil	3-3/8	2-3/8	2-7/16	1/2	EH 3/4
GTT-1000-500	Not Available	1	1000kcmil-750kcmil	500kcmil-2	3-3/8	1-1/4	2-7/16	1/2	3/8

EH-External Hex

Insulating covers are available for most connector sizes.

See page 130 for additional information on covers

Note: If ordering with cover, add suffix w/c to catalog number.

DE-OX Inhibitor is recommended for all aluminum terminations.

Tested to UL 486A-486B, UL File E6207

ILSCO Insulating Covers For GTA-GTT



TYPE GTC

Features

- Snap closure
- Color coded
- UL Listed and CSA Certified for 600 volts, 90° C except for GTPC-750-750 and GTTC-750-750

Benefits

- Installs quickly and saves labor time by eliminating taping
- Provides ease of identification in the field
- Ensures reliability



Fig. 1



Fig. 2



Fig. 3

Catalog Number	Figure Number	Color	Dimensions			Used with Connector
			L	W	H	
GTC-2	1	Black	2-1/4	1-13/16	1-1/4	GTA-2-2: GTT-2-2
GTC-0	1	Black	2-1/2	2-3/32	1-3/8	GTA-0-0: GTT-0-0
GTC-250-350	1	Black	3-61/64	3-1/32	2	GTA-250-0: GTA-250-250 GTA-350-350 GTT-250-0: GTT-250-250 GTT-350-350
GTC-500	1	Black	4-1/8	3-1/16	2-31/32	GTA-500-500 GTT-500-500
GTC-750-500	1	Black	4-7/8	3-1/8	2-23/32	GTA-750-500 GTT-750-500
GTPC-750-750*	2	Black	4-7/8	4	2-7/8	GTA-750-750
GTTC-750-750*	3	Black	5-3/4	4-1/4	3-1/16	GTT-750-750

* Not UL Listed or CSA Certified

Tested to UL 486A-486B, UL File E6207

C



TYPE GT2

Features

- Manufactured from high strength 6061-T6 aluminum alloy
- Electro-tin plated
- UL Listed for 600 volts, 90° C
- Compact design
- Range taking
- Re-usable
- Lay-in main conductor
- Supplied with cover

Benefits

- Suitable for use with either copper or aluminum conductors
- Provides low contact resistance
- Ensures reliability for copper or aluminum conductors
- Saves space and reduces installation time
- Permits inventories to be kept to a minimum
- Provides efficient use and flexibility in the field
- No need to break the feeder cable
- Eliminates taping

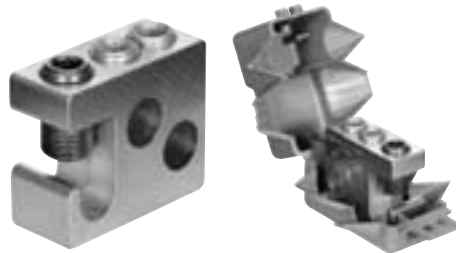
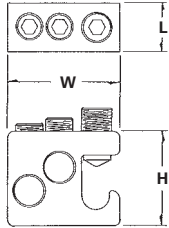

Catalog Number	Wire Range Main & Tap	No. of Taps	Dimensions			Hex Size
			L	W	H	
GT2-250-W/C	250kcmil-2	2	31/32	2-9/32	1-15/16	5/16

DE-OX Inhibitor is recommended for all aluminum terminations.

Tested to UL 486A-486B, UL File E6207

TYPE GT4T

Features

- Manufactured from high strength 6061-T6 aluminum alloy
- Electro-tin plated
- UL Listed and CSA Certified for 600 volts, 90° C
- Compact design
- Range taking
- Re-usable
- Lay-in main conductor
- Insulating cover available

Benefits

- Suitable for use with either copper or aluminum conductors
- Provides low contact resistance
- Ensures reliability for copper or aluminum conductors
- Can make up to four taps off a single main which saves space and reduces installation time
- Permits inventories to be kept to a minimum
- Provides efficient use and flexibility in the field
- No need to break the feeder cable
- Eliminates taping

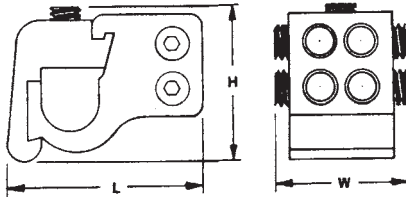

Fig. 1

Fig. 2

Catalog Number	Figure Number	Wire Range		No. of Taps	Dimensions			Hex Size	
		Main	Tap		L	W	H	Main	Tap
*GT4T-250-2-1	1	250kcmil-1/0	2-12 AL, 2-14 CU	4	2-3/16	1-1/8	1-35/64	5/16	Slot
*GT4T-250-2-2	2	250kcmil-1/0	2-12 AL, 2-14 CU	4	2-3/16	1-1/8	1-35/64	5/16	Slot
†GT4T-350-2-1	1	350kcmil-4/0	2-12 AL, 2-14 CU	4	2-17/32	1-1/8	1-17/32	3/8	Slot
*GT4T-350-2-2	2	350kcmil-4/0	2-12 AL, 2-14 CU	4	2-17/32	1-1/8	1-17/32	3/8	Slot
†GT4T-500-2-1	1	500kcmil-350kcmil	2-12 AL, 2-14 CU	4	2-31/32	1-1/4	1-11/16	3/8	Slot
†GT4T-500-2-2	2	500kcmil-350kcmil	2-12 AL, 2-14 CU	4	2-31/32	1-1/4	1-11/16	3/8	Slot
†GT4T-500-0-1	1	500kcmil-350kcmil	1/0-12 AL, 1/0-14 CU	4	2-31/32	1-1/4	1-11/16	3/8	Slot
†GT4T-500-0-2	2	500kcmil-350kcmil	1/0-12 AL, 1/0-14 CU	4	2-31/32	1-1/4	1-11/16	3/8	Slot

* GTC-250-350 Cover can be used. See page 133.

† GTC-500 Cover can be used. See page 133.

DE-OX Inhibitor is recommended for all aluminum terminations.

Tested to UL 486A-486B, UL File E6207



Multiple Tap Connector - Dual Rated Lay-In

TYPE MGTT

Features

- Manufactured from high strength 6061-T6 aluminum alloy
- Electro-tin plated
- Dual-Rated
- Compact design
- Range taking
- Re-usable
- Lay-in main conductor
- Rated for 600 volts

Benefits

- Suitable for use with either copper or aluminum conductors
- Provides low contact resistance
- Can be used with copper and/or aluminum conductors
- Saves space and reduces installation time
- Permits inventories to be kept to a minimum
- Provides efficient use and flexibility in the field
- No need to break the feeder cable
- Ensures reliability

C

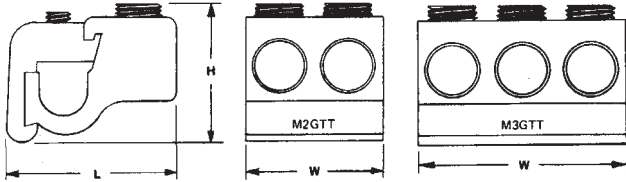

Catalog Number	Wire Range		No. of Tap Openings	Dimensions			Hex Size	
	Main	Tap		L	W	H	Main	Tap
M2GTT-250-250	250kcmil-1/0	250kcmil-6	2	2	1-3/4	1-5/8	5/16	5/16
M2GTT-350-350	350kcmil-4/0	350kcmil-6	2	2-1/4	2	1-11/16	5/16	5/16
M3GTT-350-350	350kcmil-4/0	350kcmil-6	3	2-1/4	3	1-11/16	5/16	5/16
M2GTT-500-500	500kcmil-350kcmil	500kcmil-2	2	2-3/4	2-3/8	1-13/16	3/8	3/8
M3GTT-500-500	500kcmil-350kcmil	500kcmil-2	3	2-3/4	3-1/2	1-13/16	3/8	3/8

DE-OX Inhibitor is recommended for all aluminum terminations.

ILSCO Multiple Tap Connector - Dual Rated



TYPE PTA

Features

- Manufactured from high strength 6061-T6 aluminum alloy
- Electro-tin plated
- UL Listed and CSA Certified for 600 volts, 90° C
- Compact design
- Range taking
- Re-usable
- Lay-in main conductors
- Supplied with insulating cover

Benefits

- Suitable for use with either copper or aluminum conductors
- Provides low contact resistance
- Ensures reliability for copper or aluminum conductors
- Saves space and reduces installation time
- Permits inventories to be kept to a minimum
- Provides efficient use and flexibility in the field
- No need to break the feeder cables
- Eliminates taping



Fig. 1

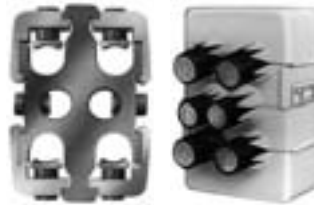

Fig. 2



Fig. 3

Catalog Number Connector	Figure Number	Main Wire Range	Bottom Tap Wire Range	Dimensions			Hex Size	
				H	W	D	Main	Tap
PTA-2-500-500-W/C	1	Two: 500kcmil-250kcmil	Two: 500kcmil-4	3-15/16	3-1/2	1-1/4	3/8	3/8
PTA-2-750-500-W/C	1	Two: 750kcmil-350kcmil	Two: 500kcmil-4	3-5/8	4-3/32	1-5/16	3/8	3/8
PTA-4-750-500-W/C	2	Four: 750kcmil-350kcmil	Two: 500kcmil-4	5-7/8	4-3/32	1-5/16	3/8	3/8
PTA-26-500-4/0*+	3	Two: 500kcmil-4/0	Four: 4/0-6 Two: 2-14	3-15/16	3-1/2	1-1/4	3/8	5/16 Slotted

Note: W/C indicates product is supplied with insulating cover.

* Not CSA Certified.

+ Cover must be ordered separately. For non UL cover, order 1 each RO614W00A and RO615W00A.

DE-OX Inhibitor is recommended for all aluminum terminations.

Tested to UL 486A-486B, UL File E6207



TYPE

LDA

LDB

Features

- Modular design
- Easy to assemble
- UL listed 90° C 600 Volts and is CSA Certified
- Electro-tin plated 6061-T6 aluminum alloy
- Clear cover
- Multiple conductor capability

Benefits

- Simplifies stocking. Combines any number of blocks with multiple conductor ranges into the specific configuration required for the job.
- Unique locking feature allows individual blocks to be combined quickly without special tools
- Ensures reliability
- Suitable for use with both copper and aluminum conductors in any combination
- Permits visual inspection
- Individual blocks supplied in a variety of configurations with one or two main cable ports and four, six, or twelve taps. All are range taking.

C



Fig. 1

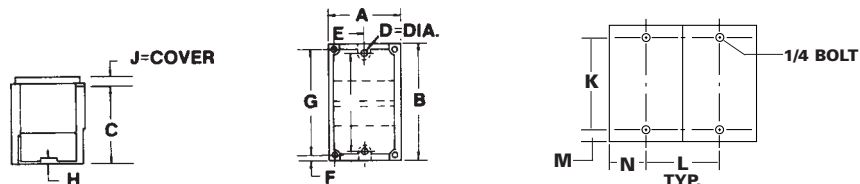

Fig. 2

Catalog Number	Figure Number	Connector		Primary			Secondary			Ampere
		Primary	Secondary	Wire Range	Openings Per Pole	Hex Size	Wire Range	Openings Per Pole	Hex Size	Rating Per Pole
LDB-112-350	1			350kcmil-6	1	3/8	4-14	12	Slot	310
LDA-112-350	2			350kcmil-6	1	3/8	4-14	12	Slot	310
LDB-112A-350	1			350kcmil-6	1	3/8	4-14	12	Slot	310
LDA-112A-350	2			350kcmil-6	1	3/8	4-14	12	Slot	310
LDB-16-350	1			350kcmil-6	1	3/8	2/0-14	6	3/16	310
LDA-16-350	2			350kcmil-6	1	3/8	2/0-14	6	3/16	310
LDB-16-500	1			500kcmil-4	1	3/8	2/0-14	6	3/16	380
LDA-16-500	2			500kcmil-4	1	3/8	2/0-14	6	3/16	380
LDB-26-350	1			350kcmil-6	2	3/8	2/0-14	6	3/16	620
LDA-26-350	2			350kcmil-6	2	3/8	2/0-14	6	3/16	620
LDB-212-4/0	1			4/0-6	2	1/4	4-14	12	Slot	460
LDA-212-4/0	2			4/0-6	2	1/4	4-14	12	Slot	460
LDB-212-500	1			500kcmil-4	2	3/8	4-14	12	Slot	760
LDA-212-500	2			500kcmil-4	2	3/8	4-14	12	Slot	760
LDB-26-500	1			500kcmil-4	2	3/8	2/0-14	6	3/16	760
LDA-26-500	2			500kcmil-4	2	3/8	2/0-14	6	3/16	760
LDB-24-500	1			500kcmil-4	2	3/8	4/0-6	4	5/16	760
LDA-24-500	2			500kcmil-4	2	3/8	4/0-6	4	5/16	760
LDB-11-500	1			500kcmil-4	1	3/8	500kcmil-4	1	3/8	380
LDA-11-500	2			500kcmil-4	1	3/8	500kcmil-4	1	3/8	380
LDB-22-350	1			350kcmil-6	2	3/8	350kcmil-6	2	3/8	620
LDA-22-350	2			350kcmil-6	2	3/8	350kcmil-6	2	3/8	620
LDB-22-500	1			500kcmil-4	2	3/8	500kcmil-4	2	3/8	760
LDA-22-500	2			500kcmil-4	2	3/8	500kcmil-4	2	3/8	760

Side Panel can be ordered separately Cat. No. LDS-1

Tested to UL 1059, UL File E112158



Dimensions

A	B	C	D=Dia.	E	F	G	H	J = Cover	K	L	M	N
3	5-1/2	3-7/16	.28 Slot	1-1/2	5/16	4-7/8	1/4	1/2	4.75	2.69	.38	1.50

TYPE

PDA

PDC

Features

- Modular design
- Easy to assemble
- UL Recognized 90° C 600 Volts and is CSA Certified
- Electro-tin plated
- Lexan* insulating base
- Manufactured from high strength 6061-T6 aluminum alloy

Benefits

- Simplifies stocking. Combines any number of blocks with multiple conductor ranges into the specific configuration required for the job.
- Unique locking feature allows individual blocks to be combined quickly without special tools
- Ensures reliability
- Provides low contact resistance
- Provides a high degree of impact resistance with superior insulating qualities
- Suitable for use with either copper or aluminum conductors



Fig. 1



Fig. 2



Fig. 3



Fig. 4

C

Catalog Number	Figure Number	Connector		Primary		Secondary		Ampere Rating Per Pole	No. of Poles	Hex Size	
		Primary	Secondary	Wire Range	Openings Per Pole	Wire Range	Openings Per Pole			Primary	Secondary
PDC-14-2/0-1	1			2/0-14	1	4-14	4	175	1	3/16	Slot
PDA-14-2/0-1	2			2/0-14	1	4-14	4	175	Adder	3/16	Slot
PDC-11-2/0-1	3			2/0-14	1	2/0-14	1	175	1	3/16	3/16
PDA-11-2/0-1	4			2/0-14	1	2/0-14	1	175	Adder	3/16	3/16

Covers available 1-10 Poles. Specify length.

*Lexan is a registered trademark of SABIC INNOVATIVE PLASTICS HOLDINGS BV.

Tested to UL 486A-486B, UL File E84782

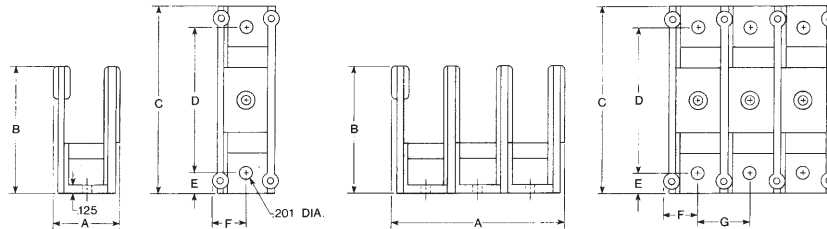

Block Size	No. of Poles	Dimensions						
		A	B	C	D	E	F	G
S	1	1.05	1.94	2.88	2.25	.31	.53	.80
S	2	1.85	1.94	2.88	2.25	.31	.53	.80

"A" Dimension increases by .80 per additional pole.

TYPE PDB

Features

- Range taking
- Valox* insulating base
- Electro-tin plated
- Manufactured from high strength 6061-T6 aluminum alloy
- UL Recognized rated 90° C and is CSA Certified, rated for 600 volts

Benefits

- Provides great flexibility in using the connector as an in line splice or to reduce conductor size
- Provides a high degree of impact resistance with superior insulating qualities
- Provides low contact resistance
- Suitable for use with either copper or aluminum conductors
- Ensures reliability

C



Catalog Number	Connector		Primary		Secondary		Ampere Rating Per Pole	Number Of Poles	Block Size	Hex Size	
	Primary	Secondary	Wire Range	Openings Per Pole	Wire Range	Openings Per Pole				Primary	Secondary
PDB-16-2/0-1			2/0-12	1	4-14	6	175	1	M	3/16	Slot
PDB-16-2/0-2			2/0-12	1	4-14	6	175	2	M	3/16	Slot
PDB-16-2/0-3			2/0-12	1	4-14	6	175	3	M	3/16	Slot
PDB-26-2/0-1			2/0-12	2	2-14	6	350	1	M	3/16	Slot
PDB-26-2/0-2			2/0-12	2	2-14	6	350	2	M	3/16	Slot
PDB-26-2/0-3			2/0-12	2	2-14	6	350	3	M	3/16	Slot
PDB-112-350-1			350kcmil-6	1	4-14	12	310	1	L	3/8	Slot
PDB-112-350-2			350kcmil-6	1	4-14	12	310	2	L	3/8	Slot
PDB-112-350-3			350kcmil-6	1	4-14	12	310	3	L	3/8	Slot
PDB-112A-350-1			350kcmil-6	1	4-14	12	310	1	M	3/8	Slot
PDB-112A-350-2			350kcmil-6	1	4-14	12	310	2	M	3/8	Slot
PDB-112A-350-3			350kcmil-6	1	4-14	12	310	3	M	3/8	Slot
PDB-14-500-1			500kcmil-4	1	2/0-14	4	380	1	M	3/8	3/16
PDB-14-500-2			500kcmil-4	1	2/0-14	4	380	2	M	3/8	3/16
PDB-14-500-3			500kcmil-4	1	2/0-14	4	380	3	M	3/8	3/16
PDB-16-350-1			350kcmil-6	1	2/0-14	6	310	1	L	3/8	3/16
PDB-16-350-2			350kcmil-6	1	2/0-14	6	310	2	L	3/8	3/16
PDB-16-350-3			350kcmil-6	1	2/0-14	6	310	3	L	3/8	3/16
PDB-162-500-1			500kcmil-4	1	2-14	6	380	1	M	3/8	Slot
PDB-162-500-2			500kcmil-4	1	2-14	6	380	2	M	3/8	Slot
PDB-162-500-3			500kcmil-4	1	2-14	6	380	3	M	3/8	Slot

* Valox® is a registered trade name of the General Electric Company.

Tested to UL 486A-486B, UL File E84782

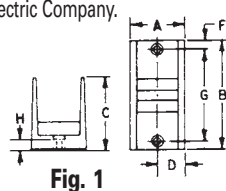

Fig. 1

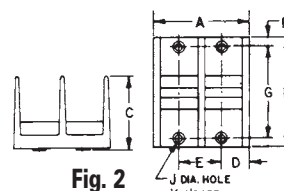

Fig. 2

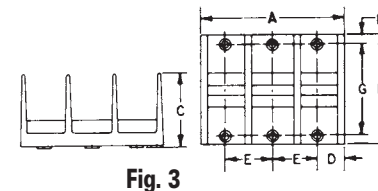

Fig. 3

Dimensions

Block Size	Number Of Poles	Figure Number	A	B	C	D	E	F	G	H	J	K
M	1	1	1-27/32	4	2-5/8	31/32	-	5/16	3-3/8	3/8	13/64	13/32
M	2	2	3-13/32	4	2-5/8	31/32	1-17/32	5/16	3-3/8	3/8	13/64	13/32
M	3	3	5	4	2-5/8	31/32	1-17/32	5/16	3-3/8	3/8	13/64	13/32
L	1	1	3	5-1/2	3-1/2	1-1/2	-	3/8	4-3/4	7/16	9/32	1/2
L	2	2	5-11/16	5-1/2	3-1/2	1-1/2	2-11/16	3/8	4-3/4	7/16	9/32	1/2
L	3	3	8-3/8	5-1/2	3-1/2	1-1/2	2-11/16	3/8	4-3/4	7/16	9/32	1/2

TYPE PDB

Features

- Range taking
- Valox* insulating base
- Electro-tin plated
- Manufactured from high strength 6061-T6 aluminum alloy
- UL Recognized rated 90° C and is CSA Certified, rated for 600 volts

Benefits

- Provides great flexibility in using the connector as an in line splice or to reduce conductor size
- Provides a high degree of impact resistance with superior insulating qualities
- Provides low contact resistance
- Suitable for use with either copper or aluminum conductors
- Ensures reliability



C

Catalog Number	Connector		Primary		Secondary		Ampere Rating Per Pole	Number Of Poles	Block Size	Hex Size	
	Primary	Secondary	Wire Range	Openings Per Pole	Wire Range	Openings Per Pole				Primary	Secondary
PDB-212-4/0-1			4/0-6	2	4-14	12	460	1	M		
PDB-212-4/0-2			4/0-6	2	4-14	12	460	2	M	3/8	Slot
PDB-212-4/0-3			4/0-6	2	4-14	12	460	3	M		
PDB-26-350-1			350kcmil-6	2	2/0-14	6	620	1	L		
PDB-26-350-2			350kcmil-6	2	2/0-14	6	620	2	L	3/8	3/16
PDB-26-350-3			350kcmil-6	2	2/0-14	6	620	3	L		
PDB-16-500-1			500kcmil-4	1	2/0-14	6	380	1	L		
PDB-16-500-2			500kcmil-4	1	2/0-14	6	380	2	L	3/8	3/16
PDB-16-500-3			500kcmil-4	1	2/0-14	6	380	3	L		
PDB-212-500-1			500kcmil-4	2	4-14	12	760	1	L		
PDB-212-500-2			500kcmil-4	2	4-14	12	760	2	L	3/8	Slot
PDB-212-500-3			500kcmil-4	2	4-14	12	760	3	L		
PDB-24-500-1			500kcmil-4	2	4/0-6	4	760	1	L		
PDB-24-500-2			500kcmil-4	2	4/0-6	4	760	2	L	3/8	5/16
PDB-24-500-3			500kcmil-4	2	4/0-6	4	760	3	L		
PDB-26-500-1			500kcmil-4	2	2/0-14	6	760	1	L		
PDB-26-500-2			500kcmil-4	2	2/0-14	6	760	2	L	3/8	3/16
PDB-26-500-3			500kcmil-4	2	2/0-14	6	760	3	L		

* Valox® is a registered trade name of the General Electric Company.

Tested to UL 486A-486B, UL File E84782

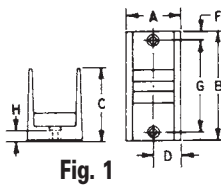

Fig. 1

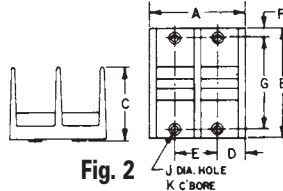

Fig. 2

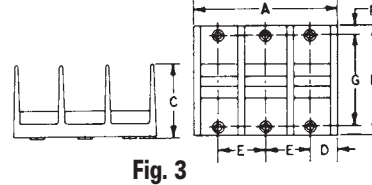

Fig. 3

Dimensions

Block Size	Number Of Poles	Figure Number	A	B	C	D	E	F	G	H	J	K
M	1	1	1-27/32	4	2-5/8	31/32	-	5/16	3-3/8	3/8	13/64	13/32
M	2	2	3-13/32	4	2-5/8	31/32	1-17/32	5/16	3-3/8	3/8	13/64	13/32
M	3	3	5	4	2-5/8	31/32	1-17/32	5/16	3-3/8	3/8	13/64	13/32
L	1	1	3	5-1/2	3-1/2	1-1/2	-	3/8	4-3/4	7/16	9/32	1/2
L	2	2	5-11/16	5-1/2	3-1/2	1-1/2	2-11/16	3/8	4-3/4	7/16	9/32	1/2
L	3	3	8-3/8	5-1/2	3-1/2	1-1/2	2-11/16	3/8	4-3/4	7/16	9/32	1/2

TYPE PDB

Features

- Multiple taps
- Range taking
- Valox® insulating base
- Electro-tin plated
- Manufactured from high strength 6061-T6 aluminum alloy
- UL Recognized rated 90° C and is CSA Certified, rated for 600 volts

Benefits

- Depending on product selected, up to twelve taps can be taken from one or two mains
- Provides tapping flexibility over a broad wire range
- Provides a high degree of impact resistance with superior insulating qualities
- Provides low contact resistance
- Suitable for use with either copper or aluminum conductors
- Ensures reliability



Catalog Number	Connector		Primary		Secondary		Ampere Rating Per Pole	Number Of Poles	Block Size	Hex Size	
	Primary	Secondary	Wire Range	Openings Per Pole	Wire Range	Openings Per Pole				Primary	Secondary
PDB-11-2/0-1			2/0-14	1	2/0-14	1	175	1	M	3/16	3/16
PDB-11-2/0-2			2/0-14	1	2/0-14	1	175	2	M		
PDB-11-2/0-3			2/0-14	1	2/0-14	1	175	3	M		
PDB-11-350-1			350kcmil-6	1	350kcmil-6	1	310	1	M	3/8	3/8
PDB-11-350-2			350kcmil-6	1	350kcmil-6	1	310	2	M		
PDB-11-350-3			350kcmil-6	1	350kcmil-6	1	310	3	M		
PDB-11-500-1			500kcmil-4	1	500kcmil-4	1	380	1	L	3/8	3/8
PDB-11-500-2			500kcmil-4	1	500kcmil-4	1	380	2	L		
PDB-11-500-3			500kcmil-4	1	500kcmil-4	1	380	3	L		
PDB-22-2/0-1			2/0-14	2	2/0-14	2	350	1	M	3/16	3/16
PDB-22-2/0-2			2/0-14	2	2/0-14	2	350	2	M		
PDB-22-2/0-3			2/0-14	2	2/0-14	2	350	3	M		
PDB-22-350-1			350kcmil-6	2	350kcmil-6	2	620	1	L	3/8	3/8
PDB-22-350-2			350kcmil-6	2	350kcmil-6	2	620	2	L		
PDB-22-350-3			350kcmil-6	2	350kcmil-6	2	620	3	L		
PDB-22-500-1			500kcmil-4	2	500kcmil-4	2	760	1	L	3/8	3/8
PDB-22-500-2			500kcmil-4	2	500kcmil-4	2	760	2	L		
PDB-22-500-3			500kcmil-4	2	500kcmil-4	2	760	3	L		

* Valox® is a registered trade name of the General Electric Company.

Tested to UL 486A-486B, UL File E84782

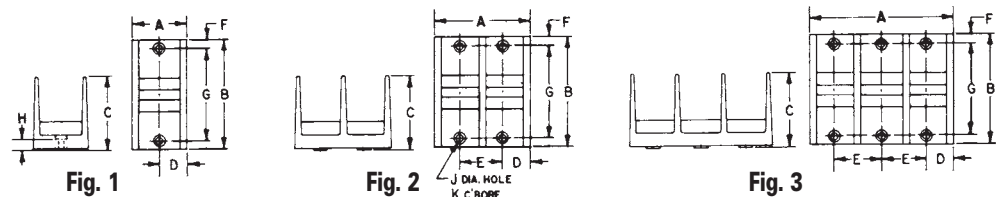

Dimensions

Block Size	Number Of Poles	Figure Number	A	B	C	D	E	F	G	H	J	K
M	1	1	1-27/32	4	2-5/8	31/32	-	5/16	3-3/8	3/8	13/64	13/32
M	2	2	3-13/32	4	2-5/8	31/32	1-17/32	5/16	3-3/8	3/8	13/64	13/32
M	3	3	5	4	2-5/8	31/32	1-17/32	5/16	3-3/8	3/8	13/64	13/32
L	1	1	3	5-1/2	3-1/2	1-1/2	-	3/8	4-3/4	7/16	9/32	1/2
L	2	2	5-11/16	5-1/2	3-1/2	1-1/2	2-11/16	3/8	4-3/4	7/16	9/32	1/2
L	3	3	8-3/8	5-1/2	3-1/2	1-1/2	2-11/16	3/8	4-3/4	7/16	9/32	1/2

TYPE PDB

Features

- Lay-In primary cable ports
- Valox insulating base
- Clear cover
- UL 1953 Listed and CSA Certified for 600 volts
- Electro-tin plated
- Manufactured from high strength 6061-T6 aluminum alloy

Benefits

- Designed for feed through of two primary conductors and up to six taps with no need to break the main feeder cable
- Provides a high degree of impact resistance with superior insulating qualities
- Permits visual inspection
- Ensures reliability
- Provides low contact resistance
- Suitable for use with either copper or aluminum conductors



C

Catalog Number	Connector		Primary		Secondary		Ampere Rating Per Pole	Number Of Poles	Hex Size	
	Primary	Secondary	Wire Range	Openings Per Pole	Wire Range	Openings Per Pole			Primary	Secondary
									PDB-26-750-1	

Tested to UL 486A-486B, UL File E112158

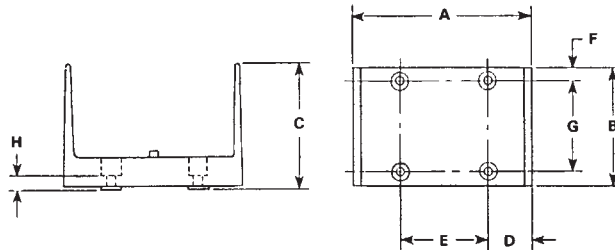

Block Size	No. of Poles	Dimensions							
		A	B	C	D	E	F	G	H
W	1	6-7/32	4	4-3/8	1-19/32	3	3/8	3-1/4	7/16

* Valox® is a registered trade name of the General Electric Company.

TYPE PDB

Features

- Manufactured from high strength 6061-T6 aluminum alloy
- Valox* insulating base
- UL 1953 Listed 90° C 600 volts
- Electro-tin plated
- Clear cover

Benefits

- Reliable use for copper conductor only
- Provides a high degree of impact resistance with superior insulating qualities
- Ensures reliability
- Provides low contact resistance
- Provides visual inspection

C



Catalog Number	Connector		Primary		Secondary		Ampere Rating Per Pole	Number Of Poles	Block Size	Hex Size	
	Primary	Secondary	Wire Range	Openings Per Pole	Wire Range	Openings Per Pole				Primary	Secondary

Valox® is a registered trade name of the General Electric Company.
A versatile tap hole, wire range 8-14 AWG included on the connector.

Tested to UL 486A-486B, UL File E112158

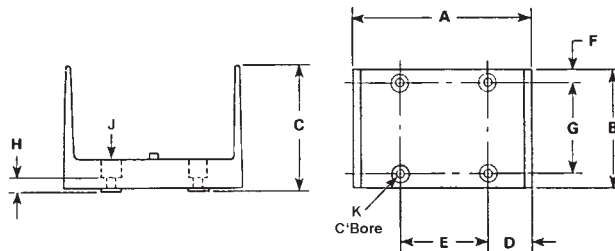

Block Size	No. of Poles	Dimensions									
		A	B	C	D	E	F	G	H	J	K
W	1	6-7/32	4	4-3/8	1-19/32	3	3/8	3-1/4	7/16	9/32	9/16

TYPE PDB

Features

- Multiple taps
- Valox® insulating base
- Clear cover
- UL 1953 Listed 90° C 600 Volts and is CSA Certified
- Electro-tin plated
- Manufactured from high strength 6061-T6 aluminum alloy

Benefits

- Three different connector configurations provide a wide range of tapping capabilities for up to four primary conductors
- Provides a high degree of impact resistance with superior insulating qualities
- Permits visual inspection
- Ensures reliability
- Provides low contact resistance
- Suitable for use with either copper or aluminum conductors



Fig. 1



Fig. 2



Fig. 3



Fig. 4

C

Catalog Number	Figure Number	Connector		Primary		Secondary		Ampere Rating Per Pole	Number of Poles	Block Size	Hex Size	
		Primary	Secondary	Wire Range	Openings Per Pole	Wire Range	Openings Per Pole				Primary	Secondary
PDB-428-500-1	1			500kcmil-4	4	4-14	28	1520	1	W	3/8	Slot
PDB-49-500-1	2			500kcmil-4	4	350kcmil-6 4/0-6	6 3	1520	1	W	3/8	3/8 5/16
‡ PDB-55-500-1	4			500kcmil-3/0	5	500kcmil-3/0	5	1600	1	W	3/8	3/8
PDB-412-500-1	3			500kcmil-4	4	4/0-6	12	1520	1	W	3/8	5/16

Valox® is a registered trade name of the General Electric Company.
 ° A versatile tap hole, wire range 8-14 AWG included on the connector.
 ‡ Not CSA Certified

Tested to UL 486A-486B, UL File E112158

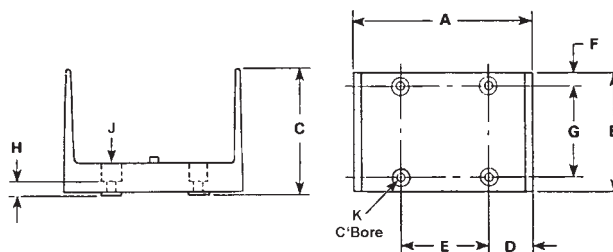

Block Size	No. of Poles	Dimensions									
		A	B	C	D	E	F	G	H	J	K
W	1	6-7/32	4	4-3/8	1-19/32	3	3/8	3-1/4	7/16	9/32	9/16

TYPE IPC



- Features**
- Body is molded from tough, resilient glass-filled nylon
 - Compact design
 - Tin plated copper contact teeth
 - Insulation piercing
 - Perforated end tabs
 - Pre-filled with silicone lubricant
 - Versatile
 - Increased safety
- Horizontal line grid
• Temperature rating 90° C

- Benefits**
- Provides high degree of breakage resistance and long dependable use
 - Saves space
 - Easily penetrates most types of insulation
 - No need to strip the conductor which saves installation time
 - Break out easily by hand
 - Prevents oxidation and moisture from entering the contact area
 - Can be used as a splice or tap connector
 - Contains no external energized parts. Can be installed "hot" on energized conductors providing tap conductor is not under load.
 - Provides a visual guide for proper installation of conductors

C

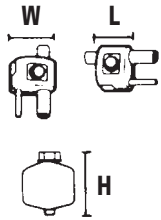

Fig. 1



Fig. 2



Fig. 3



Fig. 4

Catalog Number	Figure Number	Wire Range		Volts	Current Rating		Dimensions			Torque Ft. Lbs.	Bolt Head Size
		Main	Tap		CU	AL	L	W	H		
IPC-1/0-2	3	1/0-8	2-8	300 (480 Grounded Y System)	130	100	1-7/32	1-15/32	2-5/16	16	1/2
IPC-4/0-6	2	4/0-4	6-14	600	75	60	1-27/64	1	1-7/8	13	1/2
IPC-4/0-2/0	3	4/0-2	2/0-6	600	195	150	1-21/32	1-7/8	2-7/8	25	1/2
IPC-250-4/0	2	250kcmil-1	4/0-6	600	260	205	1-7/8	2-11/32	3-11/32	30	5/8
IPC-350-4/0	3	350kcmil-4/0	4/0-10	300 (480 Grounded Y System)	260	205	1-43/64	2-7/16	3-1/8	25	5/8
IPC-350-350	4	350kcmil-4/0	350kcmil-4/0	300 (480 Grounded Y System)	350	280	2-43/64	2-23/32	3-1/4	25	5/8
IPC-500-12	1	500kcmil-250kcmil	10-12	300 (480 Grounded Y System)	40	35	1-43/64	2-7/16	3-1/4	25	5/8
IPC-500-250	1	500kcmil-250kcmil	250kcmil-4	600	290	230	2-27/64	2-29/32	3-3/4	55	5/8-11/16
IPC-500-500	1	500kcmil-300kcmil	500kcmil-250kcmil	600	430	350	3-3/16	3-5/8	5	75	7/8-7/8
IPC-750-500	1	750kcmil-500kcmil	500kcmil-350kcmil	600	430	350	3-3/16	3-5/8	5	75	7/8-7/8

Tested to UL 486A-486B, UL File E6207

ILSCO Aluminum Split Bolt - Dual Rated



TYPE AK

Features

- Manufactured from heat treated aluminum alloy
- Triangular edges
- UL Listed and CSA Certified for 600 volts, 90° C
- Electro-tin plated
- Spacer bar
- Hex Head

Benefits

- Provides maximum conductivity and strength for copper and aluminum conductors
- Bite into the conductor to break through surface oxides which eliminates wire brushing
- Ensures reliability for copper or aluminum conductors
- Provides low contact resistance
- Separates dissimilar metals which prevents galvanic corrosion
- Provides ease of installation with standard wrenches

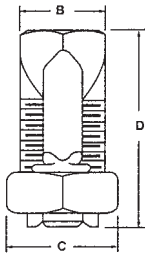

C

Catalog Number	Wire Range		Recommended Tightening Torque	Dimensions		
	Main	Tap		B	C	D
AK-6	6 str-10 sol	6 str-10 sol	165	.56	.75	1.88
AK-4	4 str-8 sol	4 str-10 sol	165	.62	.81	1.38
AK-2	2 str-6 str Compact	2 str-8 str	275	.69	.94	1.58
AK-1/0	1/0 str-2 str Compact	1/0 str-8 str	385	.75	1.00	1.92
AK-2/0	2/0 str-2 str Compact	2/0 str-8 str	385	.88	1.12	1.92
AK-4/0	4/0 str-2 str Compact	4/0 str-6 str	500	1.13	1.49	2.54
AK-350	350kcmil-1/0 str Compact	350kcmil-4 str	650	1.50	1.69	3.24
AK-500	500kcmil-400kcmil Compact	500kcmil-2 str Compact	825	1.73	2.00	3.62

DE-OX Inhibitor is recommended for all aluminum terminations.

UL File E9998



ILSCO Aluminum Two Bolt Connectors - Dual Rated

TYPE DBA DBA-S

Features

- Manufactured from high strength aluminum alloy
- Heat treated
- Wax plated
- Neoprene washers
- Range taking
- Re-usable
- Type DBA-S - Spacer bar
- Rated for 600 volts

Benefits

- Type DBA - Suitable for copper to copper or aluminum to aluminum conductors
- Type DBA-S - Suitable for copper and/or aluminum conductors in any combination
- Provides maximum strength
- Provides low contact resistance
- Hold the bolts captive and eliminates the possibility of loose hardware
- Permits inventories to be kept to a minimum
- Provides efficient use and flexibility in the field
- Separates dissimilar metals
- Ensures reliability

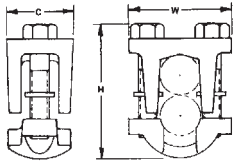

Fig. 1

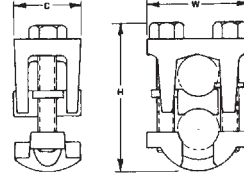

Fig. 2

Catalog Number	Figure Number	Wire Range		Dimensions		
		Main	Tap	C	W	H
DBA-2/0	1	2/0-2	2/0-10	1-1/8	1-5/8	1-5/8
DBA-250	1	250kcmil-1/0	250kcmil-10	1-5/16	2	2
DBA-350	1	350kcmil-4/0	350kcmil-10	1-9/16	2-11/32	2-1/4
DBA-500	1	500kcmil-350kcmil	500kcmil-10	1-3/4	2-1/2	2-3/4
DBA-800	1	800kcmil-400kcmil	800kcmil-3/0	1-7/8	2-7/8	3
DBA-1000	1	1000kcmil-500kcmil	1000kcmil-3/0	2-1/4	3-3/16	3-1/2
DBA-2/0S	2	2/0-2	2/0-10	1-1/8	1-5/8	1-5/8
DBA-250S	2	250kcmil-1/0	250kcmil-10	1-5/16	2	2
DBA-350S	2	350kcmil-4/0	350kcmil-10	1-9/16	2-11/32	2-1/4
DBA-500S	2	500kcmil-350kcmil	500kcmil-10	1-3/4	2-1/2	2-3/4
DBA-800S	2	800kcmil-400kcmil	800kcmil-3/0	1-7/8	2-7/8	3
DBA-1000S	2	1000kcmil-500kcmil	1000kcmil-3/0	2-1/4	3-3/16	3-1/2

DE-OX Inhibitor is recommended for all aluminum terminations.

ILSCO Dual Rated Ground Clamp



TYPE
AGC
SGC

Features

- Manufactured from high strength 6061-T6 aluminum alloy
- Clear plated
- UL Listed
- Versatile
- Range taking
- SGC Lay-In feature

Benefits

- Suitable for use with either copper or aluminum conductors
- Provides low contact resistance
- Ensures reliability
- Effectively grounds aluminum or copper conductors to copper water pipe, galvanized pipe or steel conduit
- Three sizes cover a range from 1/2" to 4" pipe with a ground wire range of 250 kcmil - #14 which reduces inventory
- Provides ease of installation for long ground wire runs

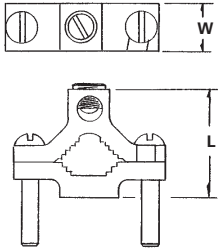

Fig. 1



Fig. 2



Fig. 3

C

Catalog Number	Figure Number	Pipe Size	Rebar Size	Ground Wire Range	Screw Type	Dimensions		Hex Size
						L	W	
AGC-1	1	1/2-3/4-1	4, 5, 6	1/0-14	Slot	2-1/4	11/16	Slot
AGC-2	2	1 1/4-1 1/2-2	-	250kcmil-6	Hex Socket	3-3/4	13/16	5/16
AGC-4	2	2 1/2-3-3 1/2-4	-	250kcmil-6	Hex Socket	6-5/16	1	5/16
SGC-1/0*	3	1/2-3/4-1"	-	1/0-14	Slot	2-1/4	11/16	Slot

DE-OX Inhibitor is recommended for all aluminum terminations.

* Typical application would be grounding computer floor room system.

UL File E34440





TYPE GBL

Features

- Manufactured from high strength 6061-T6 aluminum alloy
- Electro-tin plated
- UL Recognized for grounding and bonding
- Lay-in feature
- Rated for 600 volts

Benefits

- Suitable for use with either copper or aluminum conductors
- Provides low contact resistance
- Ensures reliability
- Provides ease of installation
- Ensures reliability

C

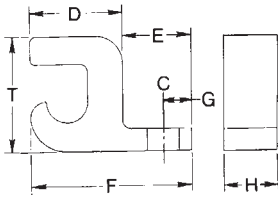

Fig. 1



Fig. 2

Catalog Number	Figure Number	Ground Wire Range	Bolt Size	Dimensions							Hex Size
				C	D	E	F	G	H	T	
*GBL-4	1	4-14	10	7/32	5/8	31/64	1-3/32	13/64	25/64	51/64	Slot
+GBL-1/0	1	1/0-14	1/4	9/32	51/64	27/32	1-5/8	7/16	5/8	1-5/32	Slot
+GBL-250	2	250kcmil-6	1/4	9/32	31/64	1	2-3/16	29/64	7/8	1-23/32	7/32

+ U.L. 467 recognized for grounding and bonding only.
DE-OX Inhibitor is recommended for all aluminum terminations.

+ UL File E34440/E6207

* UL 467 Listed

TYPE GBT

Features

- Approved for UL 467 (Grounding & Bonding)
- Lay in style
- No mounting required
- Dual rated
- 4 Taps (#2-14) stranded or solid
- Stainless steel screws
- Serrations in conductor wire way
- Patent Pending

Benefits

- Meets NEC 250.94 installation requirements.
- Eliminates the need to cut or splice into existing conductor
- Allows fast simple installation on ground conductor below meter
- For use with copper and aluminum conductors
- For bonding multiple communication systems (Phone, TV, Cable, etc.)
- For corrosion resistance
- Cuts oxidation



Fig. 1



Fig. 2

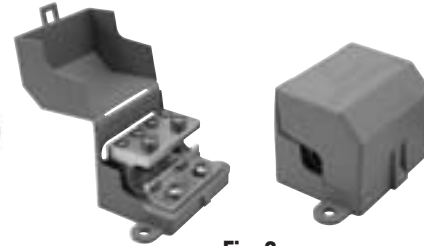
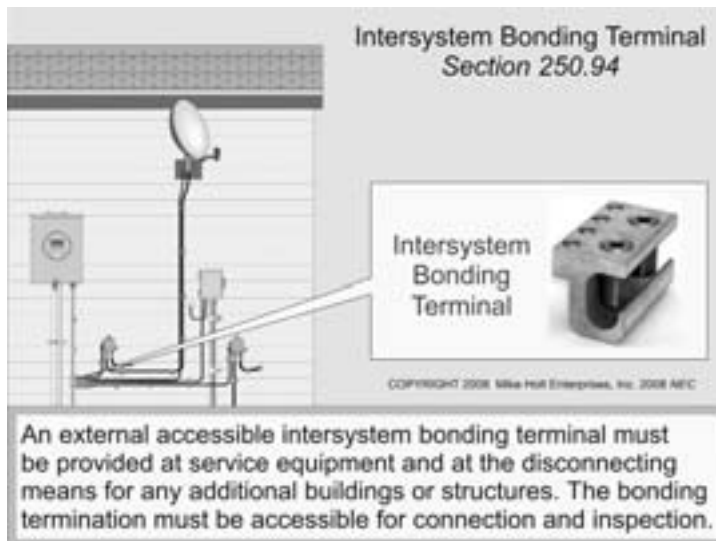

Fig. 3

Catalog Number	Figure Number	Wire Range Main	Wire Range Tap	Length	Width	Height	Hex Size	
							Main	Tap
GBT-1/0	1	1/0-8	2-14str-sol	2.250	1.125	1.160	S	S
GBT-250	1	250kcmil-8str - 1/0-8sol	2-14str-sol	2.250	1.375	1.587	7/32	S
GBT-1/0-M	2	1/0-8	2-14str-sol	2.250	1.750	1.160	S	S
GBT-1/0-M-W/C	3	1/0-8	2-14str-sol	2.730	3.930	2.110	S	S

UL File E34440



250-94 01 reproduced with approval from Mike Holt Enterprises, www.mikeholt.com

ILSCO Aluminum Multi-Tap Connectors - Dual Rated



TYPE PED-Z

Features

- Available in two, four, six, or eight conductor configurations in four wire ranges
- Manufactured from high strength 6061-T6 aluminum alloy
- UL Listed
- Compact size
- Rated for 600 volts, 90° C

Benefits

- Provides multiple conductor installation for a wide range of conductors
- Suitable for use with either copper or aluminum conductors
- Ensures reliability
- Suitable for pedestal applications
- Ensures reliability

C



Catalog Number	Connector Design	Number Of Ports	Wire Range	Dimensions			Hex Size
				L	W	H	
PED-2-2/0-Z		2	2/0-14	2.09	.56	.73	3/16
PED-4-2/0-Z		4	2/0-14	3.78	.56	.73	3/16
PED-6-2/0-Z		6	2/0-14	5.46	.56	.73	3/16
PED-8-2/0-Z		8	2/0-14	7.15	.56	.73	3/16
PED-2-4/0-Z		2	4/0-6	1.78	.75	1.00	5/16
PED-4-4/0-Z		4	4/0-6	3.64	.75	1.00	5/16
PED-6-4/0-Z		6	4/0-6	5.50	.75	1.00	5/16
PED-8-4/0-Z		8	4/0-6	7.36	.75	1.00	5/16
PED-2-350-Z		2	350kcmil-6	2.22	1.00	1.25	5/16
PED-4-350-Z		4	350kcmil-6	4.53	1.00	1.25	5/16
PED-6-350-Z		6	350kcmil-6	6.84	1.00	1.25	5/16
PED-8-350-Z		8	350kcmil-6	9.15	1.00	1.25	5/16
PED-2-600-Z		2	600kcmil-4	2.47	1.25	1.63	3/8
PED-4-600-Z		4	600kcmil-4	5.03	1.25	1.63	3/8
PED-6-600-Z		6	600kcmil-4	7.59	1.25	1.63	3/8
PED-8-600-Z		8	600kcmil-4	10.16	1.25	1.63	3/8

Covers not available.

DE-OX Inhibitor is recommended for all aluminum terminations.



ILSCO Aluminum Multi-Tap Connectors - Dual Rated

TYPE
PED-X
PSA-Z
PEC

Features

- Available in four, six, or eight conductor configurations in four wire ranges
- Plastisol insulating cover available with a nominal thickness of 156 Mils
- Manufactured from high strength 6061-T6 aluminum alloy
- Compact size
- Rated for 600 volts

Benefits

- Provides multiple conductor installation for a wide range of conductors
- Eliminates the need for taping. Plastisol covers have dielectric strength of 120 volts per Mil
- Suitable for use with either copper or aluminum conductors
- Suitable for pedestal applications
- Ensures reliability

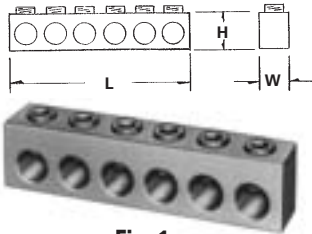

Fig. 1

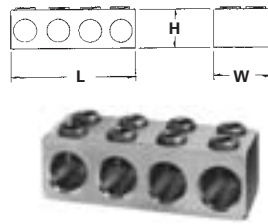

Fig. 2



Insulating Cover

Catalog Number	Figure Number	Wire Range	No. of Cond.	Dimensions			Hex Size	Recommended Torque	Insulating Cover
				L	W	H			
PED-4-350-X	1	350kcmil-6	4	3-7/8	1	1-3/8	5/16	350	PEC-4-350
PED-6-350-X	1	350kcmil-6	6	5-11/16	1	1-3/8	5/16	350	PEC-6-350
PED-8-350-X	1	350kcmil-6	8	7-1/2	1	1-3/8	5/16	350	PEC-8-350
PED-4-500-X	1	500kcmil-2	4	4-3/4	1	1-5/8	5/16	450	PEC-4-500
PED-6-500-X	1	500kcmil-2	6	7-1/4	1	1-5/8	5/16	450	PEC-6-500
PED-8-500-X	1	500kcmil-2	8	9-11/16	1	1-5/8	5/16	450	PEC-8-500
‡PSA-4-750-Z	2	750kcmil-1/0	4	6-9/16	2	2-1/2	3/8	500	PSC-4-750
‡PSA-6-750-Z	2	750kcmil-1/0	6	9-7/8	2	2-1/2	3/8	500	PSC-6-750
‡PSA-8-750-Z	2	750kcmil-1/0	8	13-3/16	2	2-1/2	3/8	500	PSC-8-750

‡ Consult factory for availability.

DE-OX Inhibitor is recommended for all aluminum terminations.

C



ILSCO Insulated Multi-Tap Connectors - Dual Rated

TYPE PED-CP

Features

- Available in three, four, five, and six conductor configurations in two wire ranges
- Connector is encapsulated in 125 Mils of clear PVC rated at 1000 amps
- Manufactured from high strength 6061-T6 aluminum alloy
- Rated for 600 volts

Benefits

- Provides multiple conductor installation for a broad wire range
- Clear cover allows visual inspection of conductors during installation. Removable caps permit easy access to conductor ports and set screws. No taping is required.
- Suitable for use with either copper or aluminum conductors.
- Ensures reliability

C

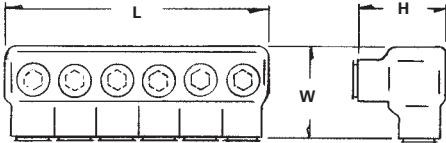

Catalog Number	Wire Range	Number of Conductors	Dimensions			Hex Size	Recommended Torque-Inch Lbs.
			L	W	H		
PED3-350-CP-Z	350kcmil-10	3	3.406	2-1/4	2-1/8	5/16	350
PED4-350-CP-Z	350kcmil-10	4	4.562	2-1/4	2-1/8	5/16	350
PED5-350-CP-Z	350kcmil-10	5	5.718	2-1/4	2-1/8	5/16	350
PED6-350-CP-Z	350kcmil-10	6	6.875	2-1/4	2-1/8	5/16	350

DE-OX Inhibitor is recommended for all aluminum terminations.

ILSCO Aluminum Spade Type Transformer Lugs - Dual Rated

TYPE PET

Features

- Available in four, six, or eight conductor configurations in four wire ranges
- Predrilled 1/2" mounting holes
- Manufactured from high strength 6061-T6 aluminum alloy
- Rated for 600 volts

Benefits

- Provides multiple conductor installation for a wide range of conductors
- Allows easy attachment. May be bolted back to back for heavy duty applications
- Suitable for use with either copper or aluminum conductors
- Ensures reliability

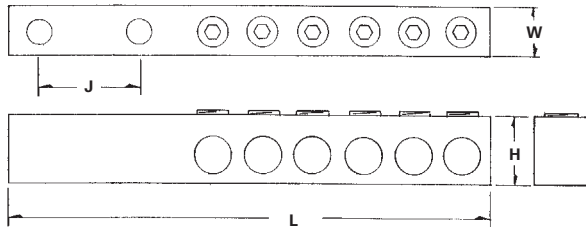

C

Catalog Number	Wire Range	Number of Conductors	Bolt Size	Diameter of Mounting Hole	Dimensions				Hex Size	Recommended Torque-Inch Lbs.
					H	J	W	L		
PET-4-350-Z	350kcmil-12	4	1/2	9/16	1-3/8	1-3/4	1	6-7/8	5/16	350
PET-6-350-Z	350kcmil-12	6	1/2	9/16	1-3/8	1-3/4	1	8-11/16	5/16	350
PET-8-350-Z	350kcmil-12	8	1/2	9/16	1-3/8	1-3/4	1	10-1/2	5/16	350
PET-4-500-Z	500kcmil-2	4	1/2	9/16	1-5/8	1-3/4	1	7-15/16	5/16	450
PET-6-500-Z	500kcmil-2	6	1/2	9/16	1-1/8	1-3/4	1	10-3/16	5/16	450
PET-8-500-Z	500kcmil-2	8	1/2	9/16	1-5/8	1-3/4	1	12-7/16	5/16	450
PET-4-750-Z	750kcmil-1/0	4	1/2	9/16	1-3/4	1-3/4	1-3/16	8-11/16	3/8	500
PET-6-750-Z	750kcmil-1/0	6	1/2	9/16	1-3/4	1-3/4	1-3/16	11-15/16	3/8	500
PET-8-750-Z	750kcmil-1/0	8	1/2	9/16	1-3/4	1-3/4	1-3/16	13-15/16	3/8	500

DE-OX Inhibitor is recommended for all aluminum terminations.



Aluminum Multi-Tap Adaptor Lugs - Dual Rated (Pole Type Transformer Lugs)

TYPE PTT

Features

- Connector manufactured from high strength 6061-T6 aluminum alloy
- Stud manufactured from electrolytic pure copper rod
- Two conductor ports
- Range taking
- Left or Right handed
- Clear Plated
- Rated for 600 volts

Benefits

- Suitable for use with either copper or aluminum conductors
- Provides maximum conductivity and can be used on equipment with copper or aluminum connectors
- Allows parallel conductors to be connected to equipment supplied with single conductor terminals
- A wide range of conductor sizes can be used in each connector
- Provides ease of installation
- Provides low contact resistance
- Ensures reliability

C

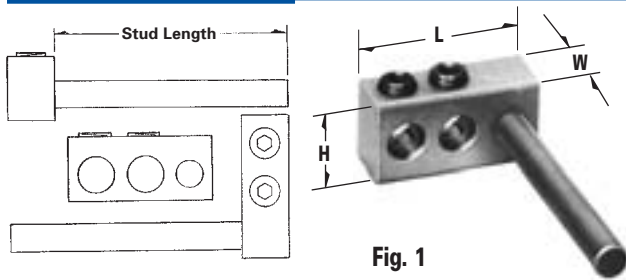

Fig. 1

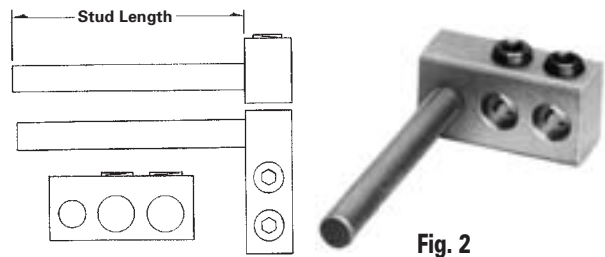

Fig. 2

Catalog Number	Figure Number	Wire Range	Number of Conductors	Copper Stud Diameter	Stud Length	Hex Size	Dimensions			Recommended Torque-Inch Lbs.
							L	W	H	
PTT-2R-0-Z	1	1/0-14	2	3/8	3"	3/16	1.87	.75	1.00	200
PTT-2L-0-Z	2	1/0-14	2	3/8	3"	3/16	1.87	.75	1.00	200
PTT-2R-250-Z	1	250kcmil-10	2	1/2	4"	5/16	2.39	.90	1.12	300
PTT-2L-250-Z	2	250kcmil-10	2	1/2	4"	5/16	2.39	.90	1.12	300
PTT-2R-350-Z	1	350kcmil-10	2	5/8	4"	5/16	3.25	1.25	1.25	350
PTT-2L-350-Z	2	350kcmil-10	2	5/8	4"	5/16	3.25	1.25	1.25	350

DE-OX Inhibitor is recommended for all aluminum terminations.

TYPE NB

Features

- Preassembled, stacked neutral bars
- Available with phenolic base
- Electro-tin plated
- Fabricated from high strength 6061-T6 aluminum alloy
- UL Recognized and CSA Certified for 600 volts, 90° C

Benefits

- Compact, space saving design offers multiple range taking flexibility and is suitable for grounding applications
- Provides insulation from mounting surface
- Provides low contact resistance
- Suitable for use with either copper or aluminum conductors
- Ensures reliability

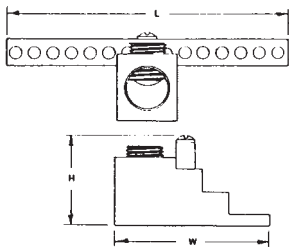

Fig. 1



Fig. 2

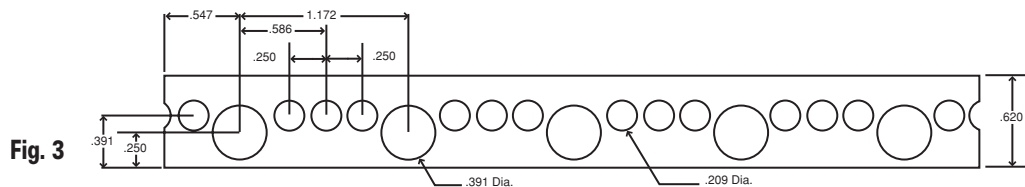

Fig. 3

Catalog Number	Figure Number	Number Of Circuit Taps	Wire Range		Dimensions			Two Tapped Mounting Holes	Hex Size	
			Circuit Taps	Line Loads	Approx. Height with Max. Wire	L	W		Main	Tap
NB-350-12	1	12	14-4	350kcmil-6	1-17/32	4-23/32	2-17/32	10-32	3/8	S
NB-350-12-W/R16*	2	12	14-4	350kcmil-6	2-17/32	4-23/32	2-17/32	10-32	3/8	S
NB-350-24	1	24	14-4	350kcmil-6	1-17/32	4-23/32	2-17/32	10-32	3/8	S
NB-350-24-W/R16*	2	24	14-4	350kcmil-6	2-17/32	4-23/32	2-17/32	10-32	3/8	S
NB-350-30	1	30	14-4	350kcmil-6	1-17/32	4-3/32	2-17/32	10-32	3/8	S
NB-350-30-W/R16*	2	30	14-4	350kcmil-6	2-17/32	4-3/32	2-17/32	10-32	3/8	S
NB-350-36	1	36	14-4	350kcmil-6	1-17/32	4-23/32	2-17/32	10-32	3/8	S
NB-350-36-W/R16*	2	36	14-4	350kcmil-6	2-17/32	4-23/32	2-17/32	10-32	3/8	S
NB-350-42	1	42	14-4	350kcmil-6	1-17/32	5-11/32	2-17/32	10-32	3/8	S
NB-350-42-W/R16*	2	42	14-4	350kcmil-6	2-17/32	5-11/32	2-17/32	10-32	3/8	S

"S" indicates slotted screw

* Part includes phenolic mounting block R-16

Tested to UL 486A-486B, UL File E81652

Catalog Number	Figure Number	Number of Outlets	Wire Range	Length
NB-120	3	120	30 outlets 1/0-14 90 outlets 6-14	3.25'

UL File E81652

ILSCO Watertight, Underground In-Line Splice



TYPE USPA-SS

Features

- Encapsulated in EPDM rubber with a nominal thickness of 125 Mils and a dielectric strength of 240 Volts per Mil
- Pre-marked end inserts
- O-Ring design screw cap inserts
- Connector is produced from high strength 6061-T6 aluminum alloy
- Connector rated for 600 volts, 90° C
- Range taking
- UL Listed and CSA Certified for direct burial in earth or concrete

Benefits

- Completely watertight in line splice. Ready for installation. (not a mold for use with mixed compounds) No taping required. No temperature or humidity restrictions.
- Simply cut end inserts to appropriate marked wire size and insert conductor into connector
- Ensures connector integrity while allowing ease of access to set screws, ensuring excellent sealing
- Suitable for use with either copper or aluminum conductors
- Ensures reliability
- Reduces inventory

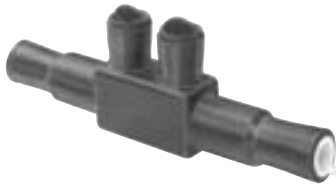

Fig. 1



Fig. 2



Fig. 3

Catalog Number	Figure Number	Wire Range		Length	Hex Size	Recommended Torque-Inch Lbs.
		Barrel A	Barrel B			
USPA-350SS-DB +	1	350kcmil-10str	350kcmil-10str	8- 5/8	5/16	350
USPA-500SS-DB*	2	500kcmil-10	500kcmil-10	9-13/16	5/16	450
USPA-750SS-DB	3	750kcmil-2	750kcmil-2	9-13/16	5/16	500

+ REA listed

* Not UL Listed

Tested to UL 486D, UL File E125087

TYPE DBK ASK

Features

- DBK-1 connectors manufactured from electrolytic copper
- All other connectors manufactured from high strength aluminum alloy
- Heavy wall heat shrink tubing with sealant
- Connector and heat shrink packaged together
- UL listed, rated for 600 volts, 90° C

Benefits

- Provides maximum conductivity for UF cable
- Provides high conductivity and can be used with either aluminum or copper conductors
- Provides watertight splice. Kits with heat shrink are designed to withstand abrasions due to direct burial in rocky soil.
- Provides ease of ordering
- Ensures reliability



Fig. 1



Fig. 2



Fig. 3

Catalog Number	Figure Number	UF Cable Range		Wire Range	Testing Certification
		Minimum	Maximum		
DBK-1	1	14/2 with Ground	8/3 with Ground	-	
DBK-2	2	-	-	2-8	
DBK-250	2	-	-	250kcmil-1	

Tested to UL 486D, UL File E125087

ABOVE GRADE SPLICE KITS

ASK-2*	3	-	-	2-8	
ASK-250*	3	-	-	250kcmil-1	

*Not UL Listed for direct burial.

Tested to UL 486A-486B, UL File E6207

C

ILSCO Watertight Underground Splice Kits

TYPE
SS
SSK
SSKC

Features

- Watertight EPDM rubber splice cover
- Tapered ends
- Ready for installation
- Type SS is cover only supplied with lubricant
- Type SSK kit is supplied with both connector and lubricant
- Connector rated for 600 volts

Benefits

- No taping required. Suitable for direct burial
- Fits a wide range of conductor sizes
- Not a mold, can be used in any type of weather. (moisture and humidity are not a factor)
- Can be used with standard aluminum or copper compression from 500kcmil - 6. Lubricant permits easy insertion of conductors into sleeve.
- Supplied with dual-rated mechanical splice connector with a wire range of 350kcmil - 6
- Ensures reliability

C



Fig. 1



Fig. 2

Catalog Number	Figure Number	Wire Range		L
		Bolted Connector	Compression Sleeves	
SSK-350-Z	1	350kcmil-6	-	5-1/2
SS-350-Z	2	350kcmil-6	500kcmil-6	5-1/2



Catalog Number	Connector Catalog Number	Wire Size	Wire Range When Installed With IDT-12 Tool
SSKC-6-Z	AS-6	6	6
SSKC-4-Z	AS-4	4	4-6
SSKC-2-Z	AS-2	2	2-6
SSKC-1/0-Z	AS-1/0	1/0	1/0-1
SSKC-2/0-Z	AS-2/0	2/0	2/0-1
SSKC-3/0-Z	AS-3/0	3/0	3/0-1
SSKC-4/0-Z	AS-4/0	4/0	4/0-1
SSKC-250-Z	AS-250	250kcmil	250kcmil-1/0

Temperature rating 90° C

ILSCO Parallel Groove Clamps - Dual Rated

TYPE PG

Features

- Manufactured from high strength 6061-T6 aluminum alloy
- Clear plated
- Range taking
- Rated for 600 volts

Benefits

- Suitable for use with either copper or aluminum conductors
- Provides low contact resistance
- Permits inventories to be kept to a minimum
- Ensures reliability

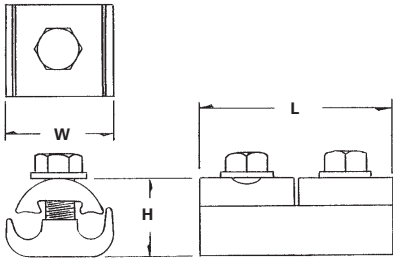

Fig. 1



Fig. 2



Fig. 3

Catalog Number	Figure Number	Wire Range Both Grooves	Type and Bolt Size	Dimensions		
				L	H	W
PG810-S-Z	1	1/0-8 sol	3/8, Steel	1-1/8	1-5/8	1-3/16
PG620-Z	2	2/0-6 sol	7/16, AL	1-3/8	1-5/8	1-1/4
PG620-S-Z	2	2/0-6 sol	3/8, Steel	1-3/16	1-5/8	1-1/8
PG620-2A-Z	3	2/0-6 sol	3/8, AL	2-7/16	1-5/8	1-1/4
PG620-2S-Z	3	2/0-6 sol	3/8, Steel	2-7/16	1-5/8	1-1/4
PG402-S-Z	2	4/0-2	3/8, Steel	1-1/2	1-3/4	1-3/8
PG402-2S-Z	3	4/0-2	3/8, Steel	3-1/16	1-3/4	1-3/8

DE-OX Inhibitor is recommended for all aluminum terminations.



ILSCO Aluminum Grounding Connectors - Dual Rated

TYPE GRM GRF

Features

- Manufactured from high strength 6061-T6 aluminum alloy
- Electro-tin plated
- Type GRM - Elongated steel stud
- Type GRF - Threaded female design

Benefits

- Suitable for use with either copper or aluminum conductors
- Provides low contact resistance
- Provides ease of grounding a single conductor to steel structures or to tap a single conductor from bus bar
- Provides ease of installation for a variety of standard stud sizes

C

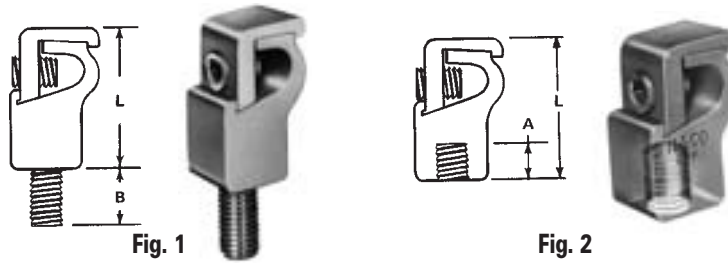

Fig. 1

Fig. 2

Catalog Number	Figure Number	Wire Range Single Cable			Dia. Thread	Dimensions			Hex Size
		Max.	Min.	Steel Strand		A	B	L	
GRM-2A	1	2str	12sol/str	5/16	1/4"-20	-	11/16	1-1/4	Slot
GRM-2B	1	2str	12sol/str	5/16	5/16"-18	-	3/8	1-1/4	Slot
GRM-2C	1	2str	12sol/str	5/16	3/8"-16	-	9/16	1-1/4	Slot
GRM-0	1	1/0str	2str	3/8	1/2"-13	-	1	1-9/16	Slot
GRM-250A	1	250kcmil	1/0	9/16	1/2"-13	-	1	2-1/8	5/16
GRM-250B	1	250kcmil	1/0	9/16	5/8"-11	-	1	2-1/8	5/16
GRM-350	1	350kcmil	4/0	-	5/8"-11	-	1	2-1/2	3/8
GRM-500	1	500kcmil	350kcmil	-	3/4"-10	-	1-3/8	2-15/16	3/8
GRM-750	1	750kcmil	500kcmil	-	3/4"-10	-	1-3/8	3-3/8	1/2
GRF-2A	2	2str	12sol/str	5/16	1/4"-20	5/16	-	1-1/4	Slot
GRF-2B	2	2str	12sol/str	5/16	5/16"-18	3/8	-	1-1/4	Slot
GRF-2C	2	2str	12sol/str	5/16	3/8"-16	7/16	-	1-1/4	Slot
GRF-0	2	1/0str	2str	3/8	1/2"-13	1/2	-	1-9/16	Slot
GRF-250A	2	250kcmil	1/0	9/16	1/2"-13	1/2	-	2-1/8	5/16
GRF-250B	2	250kcmil	1/0	9/16	5/8"-11	3/4	-	2-1/8	5/16
GRF-350	2	350kcmil	4/0	-	5/8"-11	3/4	-	2-1/2	3/8
GRF-500	2	500kcmil	350kcmil	-	3/4"-10	7/8	-	2-15/16	3/8
GRF-750	2	750kcmil	500kcmil	-	3/4"-10	7/8	-	3-3/8	1/2

DE-OX Inhibitor is recommended for all aluminum terminations.

TYPE
SLU
SLS
SAS
SAU

Features

- Manufactured from electrolytic copper tubing and strip stock
- Compact design
- Range taking
- Re-usable
- UL Listed and CSA Certified for 600 volts
- V-bottom collar
- SLU-35DB and SLU-70DB are UL 467 Listed and suitable for direct burial

Benefits

- Provides maximum conductivity and strength
- Saves space and reduces installation time
- Permits inventories to be kept to a minimum
- Provides efficient use and flexibility in the field
- Ensures reliability for copper conductor
- Wires are wedged between arched pressure bar and collar establishing positive contact and firm permanent grip

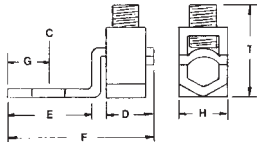

Fig. 1

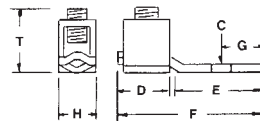

Fig. 2

Catalog Number	Screw Type	Figure Number	Wire Range Copper	Bolt Size	Dimensions							Hex Size
					C	D	E	F	G	H	T	
SLU-25	⊖	1	10-14	#6	5/32	9/32	7/16	1	3/16	5/16	21/32	Slot
SLU-35	⊖	1	6-14 & List Comb. (A)	#10	13/64	7/16	15/32	1-3/16	7/32	3/8	3/4	Slot
SLU-35DB	⊖	1	6-14 & List Comb. (A)	#10	13/64	7/16	15/32	1-3/16	7/32	3/8	3/4	Slot
SAU-70	⊖	1	4-14	1/4	17/64	7/16	17/32	1-5/16	1/4	3/8	13/16	Slot
SLU-70	⊖	1	2-8 & List Comb. (B)	1/4	17/64	1/2	21/32	1-17/32	1/4	1/2	1	Slot
SLU-70DB	⊖	1	2-8 & List Comb. (B)	1/4	17/64	1/2	21/32	1-17/32	1/4	1/2	1	Slot
SLU-125	⊖	1	1/0-6	1/4	17/64	5/8	13/16	1-31/32	7/16	5/8	1-11/32	Slot
SLU-175	⊖	1	3/0-4	3/8	13/32	3/4	15/16	2-3/16	7/16	3/4	1-9/16	3/16
SLU-225	⊖	1	4/0-2	5/16	11/32	1	1-5/32	2-5/8	1/2	1	1-13/16	7/32
SLU-300	⊖	1	350kcmil-1/0	3/8	13/32	1-1/4	1-1/2	3-3/16	1/2	1	2-5/8	5/16
SLU-400	⊖	1	500kcmil-1/0	3/8	13/32	1-1/2	1-15/16	4-14	15/16	1-1/2	2-3/4	5/16
SLU-650	⊖	1	1000kcmil-600kcmil	1/2	17/32	1-7/8	1-7/8	4-5/8	1-7/64	2	3-11/16	3/8
SLS-25	⊖	2	10-14	#6	5/32	9/32	19/32	61/64	3/16	5/16	19/32	Slot
SLS-35	⊖	2	6-14 & List Comb. (A)	#10	13/64	7/16	41/64	1-9/64	7/32	3/8	11/16	Slot
SAS-70	⊖	2	4-14	1/4	17/64	7/16	23/32	1-1/4	1/4	1/2	27/32	Slot
SLS-70	⊖	2	2-8 & List Comb. (B)	1/4	17/64	1/2	13/16	1-15/32	1/4	1/2	31/32	Slot
SLS-125	⊖	2	1/0-6	1/4	17/64	5/8	1-3/16	1-15/16	7/16	5/8	1-1/4	Slot
SLS-175	⊖	2	3/0-4	3/8	13/32	3/4	1-1/4	2-3/16	7/16	3/4	1-9/16	3/16
SLS-225	⊖	2	4/0-2	5/16	11/32	1	1-7/32	2-3/8	1/2	1	1-21/32	7/32
SLS-300	⊖	2	350kcmil-1/0	3/8	13/32	1-1/4	1-1/2	3-3/16	1/2	1	2-3/8	5/16
SLS-400	⊖	2	500kcmil-1/0	3/8	13/32	1-1/2	2-3/16	3-7/8	15/16	1-1/2	2-9/16	5/16
SLS-650	⊖	2	1000kcmil-600kcmil	1/2	17/32	1-7/8	3	5-1/8	1-3/16	2	3-11/16	3/8

(A) UL Listed wire combinations: (2) #10; (2) #12; (2) #14; (1) #12 and (1) #14; (1) #10 and (1) #12

(B) UL Listed wire combinations: (1) #8 and (1) #4; (1) #8 and (1) #6; (2) #4; (3) #8; (3) #6; (2) #8 and (1) #4; (2) #8 and (1) #6; (1) #6 and (1) #4; (2) #6

Tested to UL 486A-486B, UL File E6207

TYPE E H

Features

- Manufactured from electrolytic copper tubing and strip stock
- Compact design
- Range taking
- Re-usable
- UL Listed and CSA Certified for 600 volts
- V-bottom collar
- Two mounting holes

Benefits

- Provides maximum conductivity and strength
- Saves space and reduces installation time
- Permits inventories to be kept to a minimum
- Provides efficient use and flexibility in the field
- Ensures reliability for copper conductor
- Wires are wedged between arched pressure bar and collar establishing positive contact and firm permanent grip
- Acts as anti-rotation device and prevents turning in safety switches, control equipment etc.

C

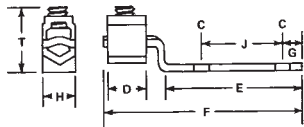

Fig. 1

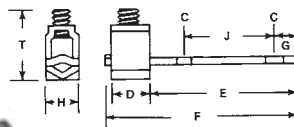

Fig. 2

Catalog Number	Figure Number	Wire Range Copper	Bolt Size	Dimensions								Hex Size
				C	D	E	F	G	H	J	T	
E-35	1	6-14 & List Comb. (A)	#10	13/64	7/16	1-1/2	2-1/4	7/32	3/8	1	3/4	Slot
E-70	1	2-8 & List Comb. (B)	1/4	17/64	1/2	1-1/2	2-7/16	1/4	1/2	1	1	Slot
E-125	1	1/0-6	1/4	17/64	5/8	1-7/8	2-15/16	7/16	5/8	1	1-11/32	Slot
E-225	1	4/0-2	5/16	11/32	1	2-5/32	3-19/32	1/2	1	1	1-13/16	7/32
E-300	1	350kcmil-1/0	3/8	13/32	1-1/4	3-11/16	5-11/16	13/16	1	1-7/8	2-5/8	5/16
E-400	1	500kcmil-1/0	3/8	13/32	1-1/2	3-13/16	6	15/16	1-1/2	1-3/4	2-3/4	5/16
E-650	1	1000kcmil-600kcmil	1/2	17/32	1-7/8	3-9/16	6-1/4	1-3/16	2	1-3/4	3-11/16	3/8
H-35	2	6-14 & List Comb. (A)	#10	13/64	7/16	1-5/8	2-1/8	7/32	3/8	1	11/16	Slot
H-70	2	2-8 & List Comb. (B)	1/4	17/64	1/2	1-7/8	2-1/2	1/4	1/2	1	31/32	Slot
H-225	2	4/0-2	5/16	11/32	1	2-7/32	3-3/8	1/2	1	1	1-21/32	7/32
H-400	2	500kcmil-1/0	3/8	13/32	1-1/2	3-15/16	5-5/8	15/16	1-1/2	1-3/4	2-9/16	5/16
H-650	2	1000kcmil-600kcmil	1/2	17/32	1-7/8	4-3/4	6-7/8	1-3/16	2	1-3/4	3-11/16	3/8

(A) UL Listed wire combinations: (2) #10; (2) #12; (2) #14; (1) #12 and (1) #14; (1) #10 and (1) #12

(B) UL Listed wire combinations: (1) #8 and (1) #4; (1) #8 and (1) #6; (2) #4; (3) #8; (3) #6; (2) #8 and (1) #4; (2) #8 and (1) #6; (1) #6 and (1) #4; (2) #6

Tested to UL 486A-486B, UL File E6207

TYPE SLUH

Features

- Manufactured from electrolytic copper tubing and strip stock
- Compact design
- Range taking
- Re-usable
- UL Listed and CSA Certified for fine stranded CU wire
- Electro-tin plated
- Captive tang
- V-bottom collar
- Rated for 600 volts

Benefits

- Provides maximum conductivity and strength
- Saves space and reduces installation time
- Permits inventories to be kept to a minimum
- Provides efficient use and flexibility in the field
- Ensures reliability for copper conductor
- Provides low contact resistance
- Suited for heavy duty applications requiring high torque to withstand vibration and high ambient heat
- Wires are wedged between arched pressure bar and collar establishing positive contact and firm permanent grip
- Ensures reliability

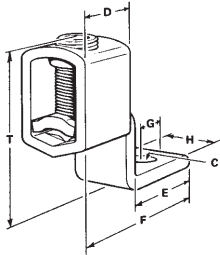

Catalog Number	Wire Range	Bolt Size	Dimensions							Hex Size
			C	D	E	F	G	H	T	
SLUH-35	6-14	#10	13/64	7/16	1/2	1-1/8	7/32	3/8	11/16	Slot
SLUH-90	2-14	1/4	17/64	9/16	5/8	1-31/64	1/4	1/2	27/32	Slot
SLUH-125	1/0-8	1/4	17/64	11/16	13/16	1-7/8	7/16	5/8	63/64	Slot
SLUH-225	250kcmil-6	5/16	11/32	1	1-5/32	2-7/16	1/2	1	1-17/64	1/4
SLUH-300	350kcmil-1/0	3/8	13/32	1-3/16	1-1/2	3-1/16	1/2	1	2-1/4	5/16
SLUH-400	500kcmil-1/0	3/8	13/32	1-3/8	1-15/16	3-13/16	15/16	1-1/2	2-15/32	5/16
SLUH-650	1000kcmil-4/0	1/2	17/32	1-57/64	1-7/8	4-5/16	1-3/16	2	3-3/32	3/8

Tested to UL 486A-486B, UL File E6207

UL Listed for use with fine stranded conductors. See chart below.

Conductor Class		B	C	G	H	I	K	M	Locomotive Cable
		-	-	14/49	-	-	14/41	14/104	14/19
		14/7	14/19	12/49	-	-	12/65	12/168	12/19
		12/7	12/19	-	-	-	-	-	-
		10/7	10/19	10/49	-	10/26	10/104	10/259	10/27
		-	-	8/49	8/133	8/41	8/168	8/420	8/37
		8/7	8/19	-	-	-	-	-	-
		6/7	6/19	-	-	-	-	-	-
		4/7	4/19	6/49	6/133	6/63	6/266	6/665	6/61
		3/7	3/19	4/49	4/133	4/105	4/420	4/1064	4/105
		2/7	2/19	3/49	3/133	3/133	3/532	3/1323	3/125
		1/19	1/37	2/49	2/133	2/161	2/665	2/1666	2/150
		1/0-19	1/0-37	1/133	1/259	1/210	1/836	1/2107	1/225
		2/0-19	2/0-37	1/0-133	1/0-259	-	-	1/0/2646	1/0/275
		3/0-19	3/0-37	2/0-133	2/0-259	1/0/266	1/0/1064	-	2/0/325
		/0-19	4/0-37	3/0-133	3/0-259	2/0/342	2/0/1323	2/0/3325	-
		250kcmil/37	250kcmil/61	-	-	3/0/418	3/0/1666	3/0/4256	3/0/450
		300kcmil/37	300kcmil/61	4/0-133	4/0-259	4/0/532	-	-	222.2kcmil/550
		350kcmil/37	350kcmil/61	250kcmil/259	250kcmil/427	250kcmil/637	4/0/2107	4/0/5320	262.6kcmil/650
		400kcmil/37	400kcmil/61	300kcmil/259	300kcmil/427	300kcmil/735	250kcmil/2499	250kcmil/6384	313.1kcmil/775
		500kcmil/37	500kcmil/61	350kcmil/259	350kcmil/427	350kcmil/882	300kcmil/2989	300kcmil/7581	-
		-	-	400kcmil/259	400kcmil/427	400kcmil/980	350kcmil/3458	350kcmil/8806	373.7kcmil/925
		600kcmil/61	600kcmil/91	-	-	-	-	-	444kcmil/1100
		700kcmil/61	700kcmil/91	500kcmil/259	500kcmil/427	500kcmil/1225	450kcmil/4522	450kcmil/11396	535.3kcmil/1325
		750kcmil/61	750kcmil/91	550kcmil/259	500kcmil/703	550kcmil/1372	500kcmil/5054	500kcmil/12691	-
		-	-	600kcmil/259	500kcmil/703	600kcmil/1470	550kcmil/5453	550kcmil/13664	646.4kcmil/1591
		1000kcmil/61	1000kcmil/91	750kcmil/259	500kcmil/703	650kcmil/1596	600kcmil/5985	600kcmil/14945	-

TYPE LO

Features

- Manufactured from electrolytic seamless copper tubing
- Compact design
- Range taking
- Re-usable
- UL Listed and CSA Certified for 600 volts

Benefits

- Provides maximum conductivity and strength
- Saves space and reduces installation time
- Permits inventories to be kept to a minimum
- Provides efficient use and flexibility in the field
- Ensures reliability for copper conductor

C

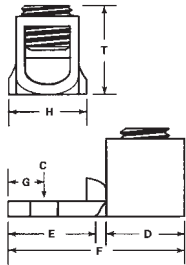

Fig. 1



Fig. 2



Fig. 3



Fig. 4

Catalog Number	Figure Number	Bolt Size	Wire Range	Dimensions							Hex Size
				C	D	E	F	G	H	T	
LO-4	1	1/4	4-14	17/64	3/4	5/8	1-3/8	9/32	1/2	25/32	Slot
LO-0	2	1/4	1/0-14	9/32	11/16	27/32	1-3/4	13/32	3/4	11/16	Slot
LO-250	4	5/16	250kcmil-6	21/64	1	1-1/4	2-9/32	7/16	63/64	7/8	3/8
LO-350SH	3	1/2	350kcmil-4	17/32	7/8	1	2-7/32	1/2	1-1/8	1-3/16	3/8
LO-350STD	3	3/8	350kcmil-4	13/32	1-1/4	1-1/8	2-5/8	1/2	1-1/8	1-1/16	3/8
LO-500	4	3/8	500kcmil-4/0	25/64	1-1/4	1-9/16	3-5/16	7/8	1-1/2	1-1/2	3/8
LO-600	4	3/8	600kcmil-1	13/32	1-7/16	1-11/16	3-5/8	7/8	1-1/2	1-1/2	3/8
LO-1000	4	1/2	1000kcmil-500kcmil	17/32	1-17/32	1-7/8	3-15/16	27/32	2	2-1/16	3/8

Tested to UL 486A-486B, UL File E6207

TYPE VT LO-S

Features

- Manufactured from electrolytic seamless copper tubing
- Compact design
- Range taking
- Re-usable
- UL Listed and CSA Certified for 600 volts

Benefits

- Provides maximum conductivity and strength
- Saves space and reduces installation time
- Permits inventories to be kept to a minimum
- Provides efficient use and flexibility in the field
- Ensures reliability for copper conductor

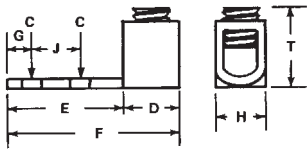

C

Catalog Number	Wire Range	Bolt Size	Dimensions								Hex Size
			C	D	E	F	G	H	J	T	
VT-4-S	4-14	#10	15/64	9/16	1	1-3/4	1/4	1/2	1/2	25/32	Slot
LO-0-S	1/0-14	1/4	9/32	11/16	1-9/16	2-1/2	3/8	3/4	7/8	19/32	Slot
LO-250-S	250kcmil-6	3/8	13/32	1	1-3/4	3-3/32	3/8	1	1	7/8	3/8
LO-350-S	350kcmil-4	3/8	7/16	7/8	2	3-1/2	3/8	1-1/8	1-1/16	1-1/4	3/8
LO-600-S	600kcmil-1	1/2	9/16	1-7/16	2	3-7/8	3/8	1-1/4	1-1/16	1-1/2	3/8
LO-1000-S	1000kcmil-500kcmil	1/2	9/16	1-9/16	2-1/2	4-1/2	3/8	1-5/8	1-3/16	2-1/16	3/8

Tested to UL 486A-486B, UL File E6207

TYPE XT LY

Features

- Manufactured from electrolytic copper tubing and strip stock
- Compact design
- Range taking
- Re-usable
- UL Listed and CSA Certified for 600 volts
- XT-6DB and XT-4DB are UL 467 Listed and suitable for direct burial

Benefits

- Provides maximum conductivity and strength
- Saves space and reduces installation time
- Permits inventories to be kept to a minimum
- Provides efficient use and flexibility in the field
- Ensures reliability for copper conductor

C

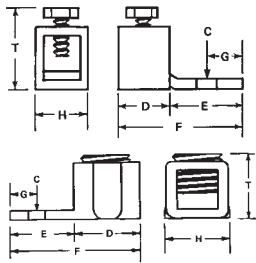

Fig. 1



Fig. 2



Fig. 3



Fig. 4

Catalog Number	Figure Number	Wire Range	Bolt Size	Dimensions							Hex Size
				C	D	E	F	G	H	T	
XT-10	3	10-14	#6	5/32	9/32	17/32	7/8	3/16	5/16	17/32	Slot
XT-6	4	6-18	#10	13/64	3/8	17/32	1	7/32	3/8	3/4	Slot
XT-6DB	3	6-14	#10	13/64	3/8	17/32	1	7/32	3/8	3/4	Slot
XT-4	3	4-14 & List Comb. (A)	1/4	17/64	1/2	5/8	1-1/8	1/4	1/2	5/8	Slot
XT-4DB	3	4-14 & List Comb. (A)	1/4	17/64	1/2	5/8	1-1/8	1/4	1/2	5/8	Slot
XT-0	3	1/0-6 & List Comb. (B)	1/4	17/64	5/8	29/32	1-17/32	7/16	5/8	1	Slot
XT-40	1	4/0-6	5/16	11/32	1	1-1/16	2-3/16	9/16	.81	1-5/8	EH 5/8
XT-500*	1	500kcmil-2/0	3/8	7/16	1-3/8	1-11/16	3-3/16	7/8	1-1/2	2-9/16	EH 3/4
LY-250-S	2	250kcmil-6	1/4	17/64	1	13/16	1-13/16	3/8	1	1	3/8
LY-600	2	600kcmil-1/0 (C)	3/8	13/32	1-7/16	1-7/8	3-5/16	7/8	1-1/2	1-3/8	3/8
LY-600-S	2	600kcmil-1/0 (C)	5/16	21/64	1-7/16	1-1/8	2-9/16	1/2	1-3/8	1-3/8	3/8

*Furnished with Pressure Plate

EH External Hex

(A) UL Listed wire combinations: (2) #14; (2) #12; (2) #10; (2) #8 and (4) #16

(B) UL Listed wire combinations: (2) #6 and (2) #8

(C) UL Listed wire combinations: (2) #4/0; (2) #3/0; (2) #2/0, and (2) #1/0

Tested to UL 486A-486B, UL File E6207

ILSCO Copper Post Connectors



TYPE CP

Features

- Manufactured from high conductivity copper alloy
- Compact design
- Range taking
- Re-usable
- UL Listed and CSA Certified for 600 volts

Benefits

- Provides long lasting reliable contact
- Saves space and reduces installation time
- Permits inventories to be kept to a minimum
- Provides efficient use and flexibility in the field
- Ensures reliability for copper conductor

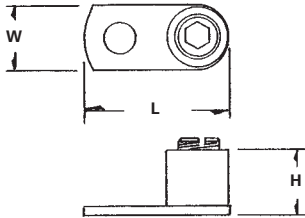

C

Catalog Number	Wire Range	Bolt Size	Stud Hole Size	Dimensions			Hex Size
				L	W	H	
CP-8	8-14	10	13/64	51/64	3/8	27/64	Slot
CP-4	4-14	1/4	17/64	1-3/32	17/32	35/64	Slot
CP-0	1/0-8	5/16	11/32	1-1/2	3/4	5/8	1/4
CP-250	250kcmil-6	3/8	13/32	1-31/32	15/16	1-1/16	1/4
CP-500*	500kcmil-4/0	1/2	17/32	2-31/32	1-3/8	1-7/16	3/8
CP-1000*	1000kcmil-500kcmil	1/2	17/32	3-31/32	2-1/32	2-3/16	1/2

* Not CSA Certified

Tested to UL 486A-486B, UL File E6207



TYPE CO

Features

- Manufactured from electrolytic seamless copper tubing
- Compact design
- Range taking
- Re-usable
- UL Recognized and CSA Certified for 600 volts
- Bossed mounting holes

Benefits

- Provides maximum conductivity and strength
- Saves space and reduces installation time
- Permits inventories to be kept to a minimum
- Provides efficient use and flexibility in the field
- Ensures reliability for copper conductor
- Acts as an anti-rotation device and prevents the connector from turning

C



Catalog Number	Figure Number	Wire Range	Dimensions							
			L	W	Height With Maximum Wire	Bossed Mounting Hole Tapped	Style Boss And Outside Dimensions	Top Hole Tapped	Top Hole And Inner Side Walls Tapped	Bottom Clearance Hole
CO3RP	1	6-14	3/8	11/32	21/32	8-32	Round .216-.220	1/4-28	-	-
CO3SP	1	6-14	3/8	11/32	21/32	10-32	Square .216-.220	1/4-28	-	-
CO4RP	2	4-14	15/32	29/64	19/32	10-32	Round .227-.231	5/16-24	-	-
CO4SP	2	4-14	15/32	29/64	19/32	10-32	Square .227-.231	5/16-24	-	-
CO4CW	3	4-14	15/32	29/64	3/4	-	-	-	3/8-27	.203
CO4CP	8	4-14	15/32	29/64	21/32	-	-	5/16-24	-	.265
CO4DD	5	4-14	29/32	29/64	19/32	10-32	Round .227-.231	5/16-24	-	-
CO4-3	6	4-14	1-29/64	29/64	19/32	10-32	Square .227-.231	5/16-24	-	-

Contact Factory for Availability and Minimum Order Requirements

Tested to UL 486A-486B, UL File E6207

TYPE CO

Features

- Manufactured from electrolytic seamless copper tubing
- Compact design
- Range taking
- Re-usable
- UL Recognized and CSA Certified for 600 volts
- Bossed mounting holes

Benefits

- Provides maximum conductivity and strength
- Saves space and reduces installation time
- Permits inventories to be kept to a minimum
- Provides efficient use and flexibility in the field
- Ensures reliability for copper conductor
- Acts as an anti-rotation device and prevents the connector from turning



Fig. 1



Fig. 2



Fig. 3



Fig. 4

Catalog Number	Figure Number	Wire Range	Dimensions							
			L	W	Height With Maximum Wire	Bossed Mounting Hole Tapped	Style Boss And Outside Dimensions	Top Hole Tapped	Top Hole And Inner Side Walls Tapped	Bottom Clearance Hole
CO5RP	1	1/0-6	5/8	9/16	29/32	10-32	Round .227-.231	3/8-27	-	-
CO5SP	1	1/0-6	5/8	9/16	29/32	10-32	Square .227-.231	3/8-27	-	-
CO5CW	1	1-14	5/8	17/32	3/4	-	-	-	7/16-20	.205
CO5SW	2	1/0-14	5/8	17/32	11/16	12-24	Square .248-.252	-	7/16-20	-
CO6RP	3	4/0-2	1	13/16	1-9/16	1/4-20	Round .2825-.2875	9/16-24	-	-
CO7	4	500kcmil-1/0	1-3/8	1-1/8	2-3/8	1/4-20	Round .3025-.3225	5/8-18	-	-
CO8	4	1000kcmil-250kcmil	1-15/16	1-33/64	3-1/2	5/16-18	Round .365-.380	3/4-16	-	-

Contact Factory for Availability and Minimum Order Requirements

Tested to UL 486A-486B, UL File E6207

TYPE CO-PP

Features

- Manufactured from electrolytic seamless copper tubing
- Compact design
- Range taking
- Re-usable
- UL Recognized and CSA Certified for 600 volts
- Bossed mounting holes
- Pressure plate
- Electro Tin Plated

Benefits

- Provides maximum conductivity and strength
- Saves space and reduces installation time
- Permits inventories to be kept to a minimum
- Provides efficient use and flexibility in the field
- Ensures reliability for copper conductor
- Acts as an anti-rotation device and prevents the connector from turning
- Prevents screw damage to the conductor
- Provides low contact resistance

C

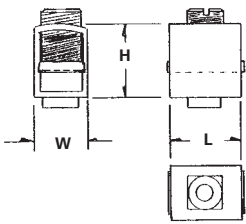

Fig. 1



Fig. 2

Catalog Number	Figure Number	Wire Range	Dimensions					
			L	W	H	Bottom Boss Size Outside	Bottom Boss Tapped	Set Screw In Top
CO4RPP*	1	4-14	9/16	29/64	41/64	Round .227-.231	10-32	5/16-24 Steel Headless
D-2742+	1	1/0-6	47/64	9/16	61/64	Round .227-.231	10-32	3/8-27 Steel Headless
D-2741+	1	1/0-6	47/64	9/16	61/64	Square .227-.231	10-32	3/8-27 Steel Headless
D-2740+	2	4/0-2	1-9/64	13/16	1-5/8	Round .2825-.2875	1/4-20	9/16-24 Steel Hex Head
D-2738+	2	500kcmil-1/0	1-21/32	1-1/8	2-3/8	Round .3025-.3225	1/4-20	5/8-18 Steel-Cap Hex Head
D-2739+	2	1000kcmil-500kcmil	2-1/4	1-33/64	3-1/2	Round .365-.380	5/16-18	3/4-16 Steel-Cap Hex Head

* UL Recognized for both aluminum and copper conductor, 75° C rating.

+ UL Recognized for copper conductors only

Tested to UL 486B, UL File E6207

TYPE TC

Features

- Manufactured from solid copper alloy
- Compact design
- Range taking
- Re-usable
- UL Listed and CSA Certified for 600 volts

Benefits

- Provides maximum conductivity and strength
- Space saving
- Permits inventories to be kept to a minimum
- Provides efficient use and flexibility in the field
- Ensures reliability for copper conductor

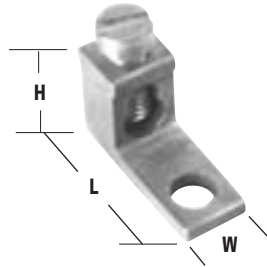

C

Catalog Number	Wire Range	Bolt Size	Hole Dia.	Dimensions			Hex Size
				L	W	H	
TC-6	6-14, (2) #8	#10	13/64	13/16	5/16	1/2	Slot

Tested to UL 486A-486B, UL File E6207

ILSCO Copper Service Entrance Mechanical Lugs

TYPE
SX

Features

- Manufactured from high strength copper tubing
- Compact design
- Versatile

Benefits

- Provides maximum conductivity for copper conductors
- Requires very little space
- Can be installed with either screwdriver, wrench, or pliers

C

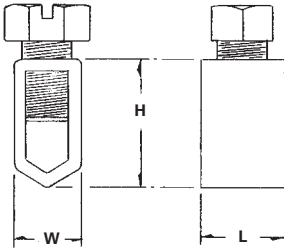

Catalog Number	Wire Range	Dimensions		
		L	W	H
SX-12	12str	9/32	1/4	3/8
SX-10-8	8-10str	5/16	1/4	31/64
SX-6+	6str	7/16	11/32	11/16
SX-4+	4str	1/2	13/32	25/32
SX-2	2str	3/4	31/64	15/16

+ REA Listed

ILSCO Copper Splicer/Reducer



TYPE 2SC

Features

- Manufactured from electrolytic seamless copper tubing
- Compact design
- Range taking
- Re-usable
- UL Listed for 600 volts
- V-bottom collar with serrations
- Two screw design

Benefits

- Provides maximum conductivity and strength
- Saves space and reduces installation time
- Permits inventories to be kept to a minimum
- Provides efficient use and flexibility in the field
- Ensures reliability for copper conductor
- Wires are held securely between set screws and v-bottom providing superior pullout strength
- For light duty applications

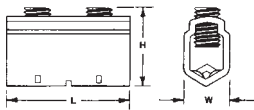

C

Catalog Number	Wire Range	Dimensions			Screw	Hex Size
		L	W	H		
2SC-35	6-14	7/8	21/64	11/16	Slotted Headless	Slot
2SC-50	4-14	7/8	3/8	3/4	Slotted Headless	Slot
2SC-70	2-4	1	15/32	29/32	Slotted Headless	Slot
2SC-125	2/0-1/0	1-1/16	39/64	13/16	Slotted Hex Head	Slot
2SC-225	250kcmil-3/0	2-5/16	49/64	1-7/16	Hex Head	7/32

Tested to UL 486A-486B, UL File E6207



TYPE N

Features

- Manufactured from electrolytic copper tubing and strip stock
- Compact design
- Range taking
- Re-usable
- UL Listed and CSA Certified for 600 volts
- V-bottom collar

Benefits

- Provides maximum conductivity and strength
- Saves space and reduces installation time
- Permits inventories to be kept to a minimum
- Provides efficient use and flexibility in the field
- Ensures reliability for copper conductor
- Wires are wedged between arched pressure bar and collar establishing positive contact and firm permanent grip

C

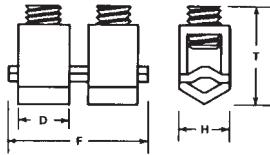

Catalog Number	Wire Range	Dimensions				Hex Size
		D	F	H	T	
N-25	10-14	9/32	13/16	1-4	19/32	Slot
N-35	6-14 & List Combination (A)	7/16	1-3/16	3/8	11/16	Slot
N-70	2-8 & List Combination (B)	1/2	1-3/8	1/2	31/32	Slot
N-125	1/0-2	5/8	1-3/4	5/8	1-1/4	Slot
N-225	4/0-2	1	2-9/16	1	1-21/32	7/32

(A) UL Listed wire combinations: (2) #10; (2) #12; (2) #14; (1) #12 and (1) #14; (1) #10 and (1) #12

(B) UL Listed wire combinations: (1) #8 and (1) #4; (1) #8 and (1) #6; (2) #4; (3) #8; (3) #6; (2) #8 and (1) #4; (2) #8 and (1) #6; (1) #6 and (1) #4; (2) #6

Tested to UL 486A-486B, UL File E6207

TYPE MU LU

Features

- Manufactured from electrolytic copper tubing and strip stock
- Compact design
- Range taking
- Re-usable
- UL Listed and CSA Certified for 600 volts
- V-bottom collar (Type LU)

Benefits

- Provides maximum conductivity and strength
- Saves space and reduces installation time
- Permits inventories to be kept to a minimum
- Provides efficient use and flexibility in the field
- Ensures reliability for copper conductor
- Wires are wedged between arched pressure bar and collar establishing positive contact and firm permanent grip

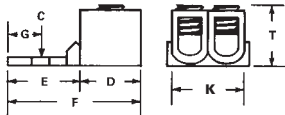

Fig. 1

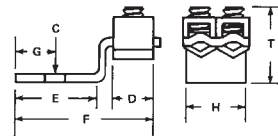

Fig. 2

Catalog Number	Figure Number	Wire Range	Bolt Size	Collar Style	Dimensions								Hex Size
					C	D	E	F	G	H	K	T	
MU-250	1	Two: 250kcmil-6	3/8	Square	25/64	1	1-9/16	2-15/16	7/8	1-1/2	1-5/8	15/16	1/4
MU-350	1	Two: 350kcmil-1/0	1/2	Round	9/16	1-9/16	1-13/16	3-5/16	7/8	1-3/4	1-7/8	1-9/16	3/8
MU-600	1	Two: 600kcmil-4/0	1/2	Round	9/16	1-1/4	1-13/16	3-5/8	7/8	2-1/4	2-1/2	1-3/4	3/8
LU-2	2	Two: 4/0-2	3/8	V-bottom	13/32	1	1-15/16	3-11/32	15/16	1-1/2	1-5/8	1-7/8	7/32
LU-4	2	Two: 350kcmil-1/0	3/8	V-bottom	13/32	1-1/4	1-3/4	3-1/2	21/32	1-3/4	2	2-7/32	5/16
LU-6	2	Two: 500kcmil-1/0	1/2	V-bottom	17/32	1-1/2	2-3/16	4-7/16	27/32	2	2-1/4	2-9/16	5/16

Tested to UL 486A-486B, UL File E6207

TYPE CL

Features

- Range taking
- Easily installed with a key wrench
- Convenient peep hole
- Re-usable
- UL Listed and CSA Certified for 600 volts

Benefits

- Permits inventories to be kept to a minimum
- Time savings
- Easy inspection
- Provides efficient use and flexibility in the field
- Ensures reliability

C

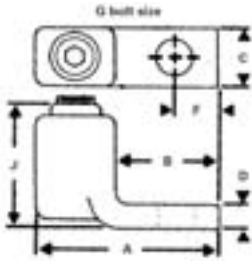

Catalog Number	Wire Range	Dimensions						
		G	A	B	C	D	J	F
CL-1-8†	8-14	1/4	1-1/8	9/16	1/2	1/8	17/32	9/32
CL-1-4†	4-8	1/4	1-1/8	5/8	1/2	1/8	17/32	9/32
CL-1-1	1-4	1/4	1-5/8	13/16	5/8	7/32	1	11/32
CL-1-2/0	2/0-1	3/8	1-15/16	1	13/16	1/4	1-3/16	7/16
CL-1-4/0	4/0-2/0	3/8	2-3/8	1-1/4	1	9/32	1-13/32	17/32
CL-1-300	300kcmil-4/0	1/2	2-3/4	1-1/2	1-3/16	5/16	1-17/32	5/8
CL-1-500	500kcmil-300kcmil	1/2	3-1/16	1-11/16	1-3/8	11/32	1-13/16	3/4
CL-1-750	750kcmil-500kcmil	1/2	3-25/32	2-3/16	1-5/8	13/32	2-1/8	1
CL-1-1000	1000kcmil-750kcmil	5/8	4-5/16	2-15/32	1-7/8	15/32	2-11/32	1-3/16

† With Filister head screw. All other, hex socket screw.
UL File E158587

TYPE CL

Features

- Range taking
- Easily installed with a key wrench
- Convenient peep hole
- Re-usable
- UL Listed and CSA Certified for 600 volts

Benefits

- Permits inventories to be kept to a minimum
- Time savings
- Easy inspection
- Provides efficient use and flexibility in the field
- Ensures reliability

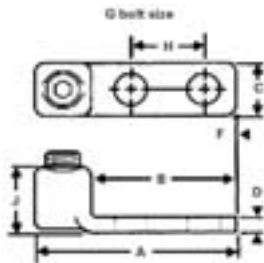

C

Catalog Number	Wire Range	Dimensions							
		G	A	B	C	D	J	F	H
CL-1-2/0N	2/0-1	1/2	3-15/16	3	1	1/4	11/16	9/16	1-3/4
CL-1-4/0N	4/0-2/0	1/2	4-1/8	3	1	9/32	1-9/32	9/16	1-3/4
CL-1-300N	300kcmil-4/0	1/2	4-3/16	3	1-3/16	5/16	1-15/32	9/16	1-3/4
CL-1-500N	500kcmil-300kcmil	1/2	4-7/8	3-1/2	1-3/8	11/32	1-13/16	9/16	1-3/4
CL-1-750N	750kcmil-500kcmil	1/2	5-3/32	3-1/2	1-3/4	13/32	2-1/8	9/16	1-3/4
CL-1-1000N	1000kcmil-750kcmil	1/2	5-1/4	3-1/2	3	15/32	2-1/8	9/16	1-3/4

Furnished with bolt holes and spacing to fit equipment supplied with NEMA type connector mounting pads.

UL File E158587

TYPE HL

Features

- Manufactured from high strength cast bronze
- Range taking
- Re-usable
- UL Listed for 600 volts
- Pressure pad/saddle

Benefits

- Provides maximum conductivity and a high degree of breakage resistance
- Permits inventories to be kept to a minimum
- Provides efficient use and flexibility in the field
- Ensures reliability for copper conductor
- Provides positive grip and low contact resistance.

C

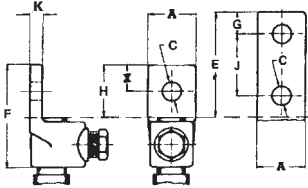

Fig. 1



Fig. 2

Catalog Number	Figure Number	Wire Range	Bolt Size	Dimensions								
				A	C	E	F	G	H	J	K	
HL4-1	1	4 str-8 sol	1/4	9/16	9/32	5/8	1-1/4	5/16	5/8	-	3/16	
HL8-1	1	1str-4 sol	1/4	3/4	9/32	11/16	1-9/16	11/32	11/16	-	7/32	
HL13-1	1	2/0 str-1 str	3/8	13/16	13/32	7/8	1-7/8	7/16	7/8	-	7/32	
HL21-1	1	4/0 str-2/0 str	3/8	1	7/16	1	2-3/16	1/2	1	-	1/4	
HL30-1	1	300kcmil-4/0 str	1/2	1-1/16	9/16	1-1/4	2-1/2	5/8	1-1/4	-	5/16	
HL35-1	1	350kcmil-250kcmil	1/2	1-3/16	9/16	1-1/4	2-9/16	5/8	1-1/4	-	5/16	
HL50-1	1	500kcmil-300kcmil	1/2	1-3/8	9/16	1-1/2	3	3/4	1-3/8	-	11/32	
HL75-1	1	750kcmil-500kcmil	5/8	1-5/8	11/16	1-3/4	3-7/16	7/8	1-3/4	-	3/8	
HL35-2N	2	350kcmil-250kcmil	1/2	1-1/2	9/16	3	4-1/4	5/8	3	1-3/4	5/16	
HL50-2N	2	500kcmil-300kcmil	1/2	1-1/2	9/16	3	4-7/16	5/8	3	1-3/4	11/32	
HL75-2N	2	750kcmil-500kcmil	1/2	1-5/8	9/16	3	4-11/16	5/8	3	1-3/4	3/8	

Contact Factory for Availability and Minimum Order Requirements
UL File E158587

TYPE CL

Features

- Range taking
- Easily installed with a key wrench
- Convenient peep hole
- Re-usable
- UL Listed and CSA Certified for 600 volts

Benefits

- Permits inventories to be kept to a minimum
- Time savings
- Easy inspection
- Provides efficient use and flexibility in the field
- Ensures reliability

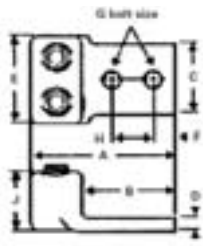

Fig. 1

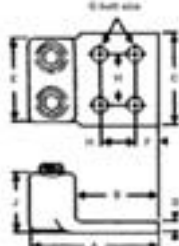

Fig. 2

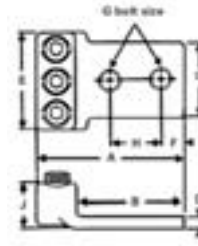

Fig. 3

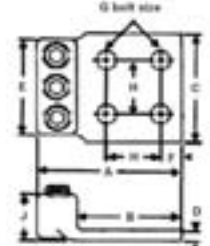

Fig. 4

C

Catalog Number	Figure Number	Wire Range	Dimensions								
			G	A	B	C	D	E	F	H	J
CL-2-8†	1	8-14	1/4	2-3/16	1-3/4	5/8	1/8	11/16	9/32	5/8	15/32
CL-2-4†	1	4-8	1/4	2-1/2	2	1	1/8	1	9/32	5/8	17/32
CL-2-1	1	1-4	3/8	2-13/16	2	1-1/4	7/32	1-1/4	7/16	1	19/32
CL-2-2/0	1	2/0-1	1/2	4-7/16	3-1/2	1-1/2	1/4	1-9/16	5/8	1-3/4	13/32
CL-2-4/0	1	4/0-2/0	1/2	4-5/8	3-1/2	1-3/4	9/32	1-3/4	5/8	1-3/4	15/16
CL-2-300	1	300kcmil-4/0	1/2	4-3/4	3-1/2	2	5/16	2-1/8	5/8	13-3/4	1-9/16
CL-2-500	1	500kcmil-300kcmil	1/2	5-3/8	3-15/16	2-1/2	11/32	2-1/2	5/8	1-3/4	1-13/16
CL-2-700	2	700kcmil-500kcmil	1/2	5-19/32	4	4	13/32	2-15/16	5/8	1-3/4	2-1/8
CL-2-1000	2	1000kcmil-750kcmil	1/2	5-27/32	4	4	15/32	3-1/4	5/8	1-3/4	2-11/32
CL-3-4/0	3	4/0-2/0	1/2	4-5/8	3-3/8	2-1/2	9/32	2-3/4	5/8	1-3/4	15/16
CL-3-300	3	300kcmil-4/0	1/2	4-3/4	3-1/2	3	5/16	3-1/4	5/8	1-3/4	1-17/32
CL-3-500	4	500kcmil-300kcmil	1/2	5-3/8	4	4	11/32	3-3/4	5/8	1-3/4	1-13/16
CL-3-750	4	750kcmil-500kcmil	1/2	5-19/32	4	4	13/32	4-3/8	5/8	1-3/4	2-1/8
CL-3-1000	4	1000kcmil-750kcmil	1/2	5-27/32	4	4	15/32	4-13/16	5/8	1-3/4	2-11/32

† With Filister Head Screw
UL File E158587

TYPE H2L

Features

- Manufactured from high strength cast bronze
- Range taking
- Re-usable
- UL Listed for 600 volts
- Compact design
- Pressure pad/saddle

Benefits

- Provides maximum conductivity and a high degree of breakage resistance
- Permits inventories to be kept to a minimum
- Provides efficient use and flexibility in the field
- Ensures reliability for copper conductor
- Requires less space than two individual connectors
- Provides positive grip and low contact resistance

C

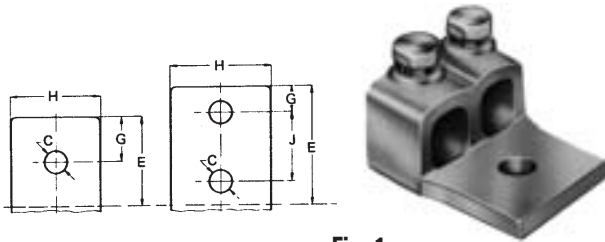

Fig. 1

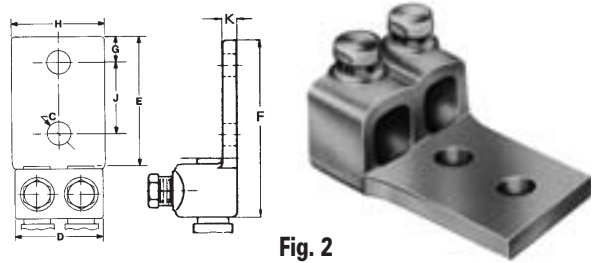

Fig. 2

Catalog Number	Figure Number	Wire Range		Bolt Size	Dimensions							
		Minimum	Maximum		C	D	E	F	G	H	J	K
H2L-13-1	1	1 str	2/0 str	1/2	9/16	1-5/8	1-1/2	2-1/2	3/4	1-5/8	-	7/32
H2L-21-1	1	2/0 str	4/0 str	1/2	9/16	1-3/4	1-3/4	2-15/16	7/8	1-7/8	-	5/16
H2L-21-2N	2	2/0 str	4/0 str	1/2	9/16	1-3/4	3	4-3/16	5/8	1-7/8	1-3/4	5/16
H2L-30-2N	2	4/0 str	300kcmil	1/2	9/16	2	3	4-3/8	5/8	2	1-3/4	5/16
H2L-35-2N	2	250kcmil	350kcmil	1/2	9/16	2-1/8	3	4-7/16	5/8	2-1/4	1-3/4	5/16
H2L-50-2N	2	300kcmil	500kcmil	1/2	9/16	2-7/16	3	4-1/2	5/8	2-1/2	1-3/4	3/8
H2L-75-2N	2	500kcmil	750kcmil	1/2	9/16	3-1/16	3	4-11/16	5/8	3	1-3/4	7/16

UL File E158587

TYPE H3L

Features

- Manufactured from high strength cast bronze
- Range taking
- Re-usable
- UL Listed for 600 volts
- Compact design
- Pressure pad/saddle

Benefits

- Provides maximum conductivity and a high degree of breakage resistance
- Permits inventories to be kept to a minimum
- Provides efficient use and flexibility in the field
- Ensures reliability for copper conductor
- Requires less space than three individual connectors
- Provides positive grip and low contact resistance

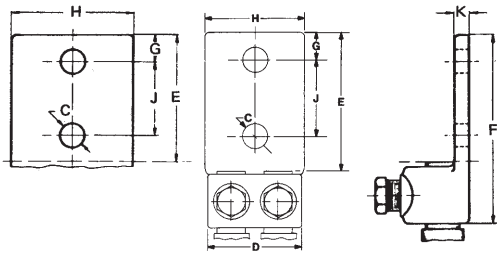

C

Catalog Number	Wire Range		Bolt Size	Dimensions							
	Minimum	Maximum		C	D	E	F	G	H	J	K
H3L-21-2N	2/0 str	4/0 str	1/2	9/16	2-5/8	3	4-3/16	5/8	1-7/8	1-3/4	5/16
H3L-30-2N	4/0 str	300kcmil	1/2	9/16	3-1/16	3	4-3/8	5/8	2-3/8	1-3/4	5/16
H3L-35-2N	250kcmil	350kcmil	1/2	9/16	3-3/16	3	4-7/16	5/8	2-3/8	1-3/4	5/16
H3L-50-2N	300kcmil	500kcmil	1/2	9/16	3-5/8	3	4-1/2	5/8	2-1/2	1-3/4	3/8

UL File E158587

ILSCO Economy Cast Bronze Ground Rod Clamps



TYPE CGRC

Features

- Manufactured from cast bronze
- Supplied with stainless steel hardware
- UL Listed and CSA Certified for 600 volts
- Suitable for grounding and bonding in applications such as swimming pools and spas

Benefits

- Ensures maximum strength and durability
- Suitable for direct burial in earth or concrete
- Ensures reliability for copper conductor

C

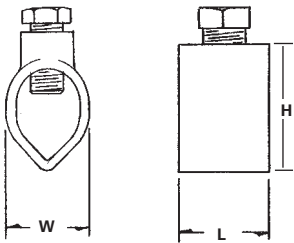

Catalog Number	Ground Rod Size	Rebar Size	Ground Rod Wire Range	Rebar Wire Range	Dimensions		
					L	W	H
CGRC-38	3/8	#3	4-10	4-10	1/2	11/16	1
CGRC-48	1/2	#4	2-10	2-10	9/16	27/32	1-3/16
CGRC-58	5/8	#5	2-10	4-10	9/16	15/16	1-9/32
CGRC-68	3/4	#6	2-10	4-10	9/16	1-1/16	1-13/32

Plain copper finish.

Tested to UL 467, UL File E34440

ILSCO Cast Bronze Ground Rod Clamps



TYPE BGRC

Features

- Manufactured from cast bronze
- Supplied with stainless steel or silicone bronze hardware
- UL Listed and CSA Certified for 600 volts

Benefits

- Ensures maximum strength and durability
- Suitable for direct burial in earth or concrete
- Ensures reliability for copper conductor

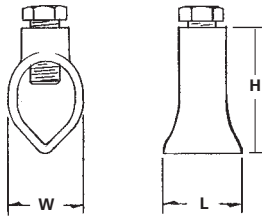

C

Catalog Number	Ground Rod Size	Rebar Size	Ground Rod Wire Range	Rebar Wire Range	Dimensions		
					L	W	H
BGRC-48	1/2	-	2-10	-	7/8	3/4	1-1/4
BGRC-58	5/8	#5	1/0-8	1/0-8	1-1/32	29/32	1-13/32
BGRC-68	3/4	-	1/0-8	-	1	1	1-5/8

Tested to UL 467, UL File E34440



ILSCO Cast Bronze Ground Rod Clamp



TYPE
SRC

Features

- Manufactured from bronze alloy
- Stainless steel bolt
- UL Listed for both copper clad and galvanized ground rods
- Range taking

Benefits

- Provides maximum strength and superior conductivity
- For direct burial
- Ensures reliability
- Reduces inventory requirement

C



Catalog Number	Ground Rod Size	Ground Rod Wire Range	Dimensions		
			L	W	H
SRC-1/0	3/8, 1/2, 5/8 3/4	10 sol - 1/0 str 8 sol - 1/0 str	13/16	1	1-1/2

UL File E198108



TYPE GRC

Features

- Manufactured from seamless bronze tubing
- Supplied with silicon bronze screw
- UL Listed and CSA Certified for 600 volts except GRC-75
- Suitable for grounding and bonding in applications such as swimming pools and spas

Benefits

- Provides maximum strength and superior conductivity
- Ground rod clamp is suitable for direct burial in earth or concrete
- Ensures reliability for copper conductor

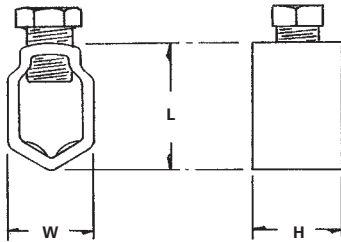

C

Catalog Number	Ground Rod Size	Ground Wire Range	Rebar Size	Rebar Wire Range	Dimensions	
					L	W
GRC-38	3/8	4-10	#3	4-10	5/8	5/8
GRC-58+	5/8	2-8	-	-	15/16	7/8
GRC-68	3/4, 5/8	2-8 for 3/4 rod, 1/0-8 for 5/8 rod	#5	1/0-8	1	1
GRC-75*	3/4	3/0-8	-	-	3/4	1-5/32

Plain copper finish.

+ REA Listed.

* Not UL Listed.

Tested to UL 467, UL File E34440

ILSCO Die Cast Ground Clamp



TYPE
DCGC

Features

- Manufactured from die cast zinc alloy
- UL Listed for 600 volts
- Assembled with zinc plated steel hardware

Benefits

- Provides maximum durability while providing economy
- Ensures reliability for copper conductor
- Provides corrosion resistance

C

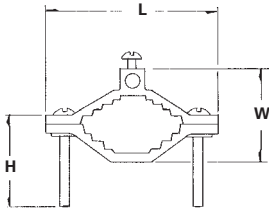

Catalog Number	Conduit Size	Ground Wire Range	L	W	H
DCGC-1	1/2, 3/4, 1	2-8	2-13/64	1-3/8	1-1/2

UL File E158587



ILSCO Cast Brass Ground Clamp



TYPE BGC

Features

- Manufactured from cast brass
- UL Listed and CSA Certified for 600 volts
- Type BGC-DB supplied with stainless steel or silicone bronze hardware

Benefits

- Provides maximum conductivity and strength
- Ensures reliability for copper conductor
- BGC-1DB and BGC-2DB are suitable for direct burial in earth or concrete. Can be used to ground swimming pools and spas.

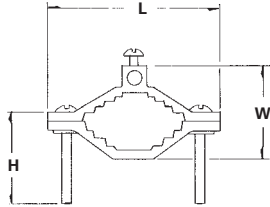

C

Catalog Number	Pipe Size	Ground Wire Range	Dimensions		
			L	W	H
BGC-1	1/2, 3/4, 1	2-10	2-9/32	2-17/32	1-1/2
BGC-2	1-1/4, 1-1/2, 2	2-10	3-9/16	2-1/4	2
BGC-1DB*	1/2, 3/4, 1	2-10	2-9/32	2-17/32	1-1/2
BGC-2DB*	1-1/4, 1-1/2, 2	2-10	3-8/16	2-1/4	2

* Suitable for direct burial in earth or concrete.

UL File E158587



TYPE BGC

Features

- Manufactured from cast bronze
- UL Listed for 600 volts
- Versatile

Benefits

- Provides maximum conductivity and strength
- Ensures reliability for copper conductor
- Type BGC supplied with conduit hub for 1/2"-1" rigid conduit; type BGC-A can be used for bare or armoured cable

C

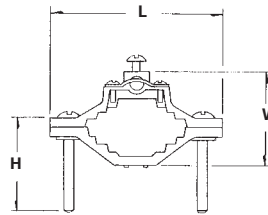
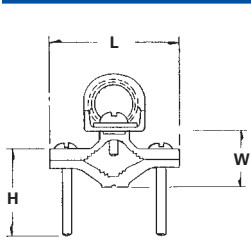

Catalog Number	Figure Number	Pipe Size	Conduit Hub Size	Wire Range	Dimensions		
					H	W	L
BGC1-50	1	1/2-1	1/2	4str-8sol	1-1/2	1-1/32	2-1/4
BGC1-75	1	1/2-1	3/4	4str-8sol	1-1/2	1-1/32	2-1/4
BGC1-10	1	1/2-1	1	4str-8sol	1-1/2	1-1/32	2-1/4
BGC2-50	1	1-1/4-2	1/2	4str-8sol	2	1-3/4	3-19/32
BGC2-75	1	1-1/4-2	3/4	4str-8sol	2	1-3/4	3-19/32
BGC2-10	1	1-1/4-2	1	4str-8sol	2	1-3/4	3-19/32
BGC-1A*	2	1/2-1	-	4str-8sol	1-1/2	1-3/8	2-1/4
BGC-2A	2	1-1/4-2	-	4str-8sol	2	2-3/32	3-19/32

* CSA Certified

UL File E158587

ILSCO Cast Bronze Ground Clamps



TYPE BGDB

Features

- Manufactured from bronze alloy
- UL Listed for direct burial in earth or concrete
- Lay-In feature

Benefits

- Ensures maximum strength and superior conductivity
- Ensures reliability
- Reduces installation time

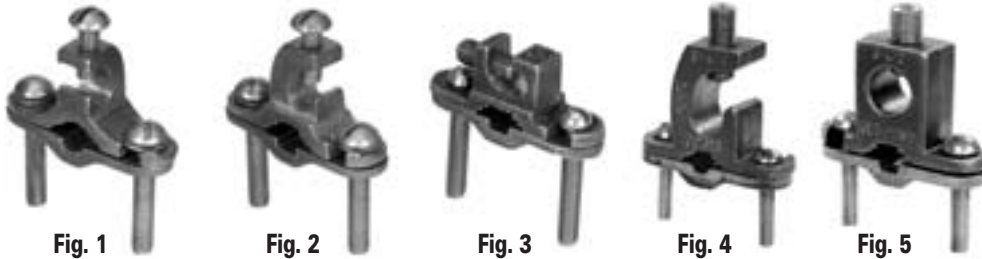

C

Catalog Number	Figure Number	Pipe Size	Rebar Size	Ground Rod Size	Ground Wire Range	Screw Material	Dimensions	
							L	W
BGC-2T-DB*	1	1/2-1	3/8-1	1/2-1	2str-10sol	silicon bronze	2-3/4	2-1/4
BGC-2P-DB*	2	1/2-1	3/8-1	1/2-1	2str-10sol	silicon bronze	2-3/4	2-1/4
BGC-2PS-DB+	3	1/2-1	3/8-1	1/4-1	2str-10sol 2 #8sol	stainless steel	2-1/4	2-1/4
BGC-4/0P-DB=	4	1/2-1	3/8-1	1/2-1	4/0-8str	stainless steel	3	2-1/4
BGC-4/0S-DB=	5	1/2-1	3/8-1	1/2-1	4/0-8str	stainless steel	2-3/4	2-1/4

* UL File E207816

+ UL File E198108

= UL File E178441



TYPE
GBL-DB

Features

- Lay-in feature
- Manufactured from high strength copper
- Stainless steel 1/4-28 torque screw
- Rated for 600 volts

Benefits

- Provides ease of installation of continuous loop grounding conductor
- Suitable for direct burial and for use with copper conductors
- Resists oxidation and corrosion in earth or concrete
- Ensures reliability

C

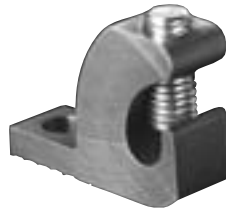
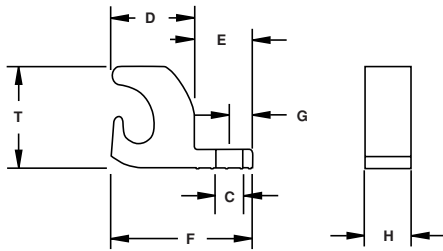

Catalog Number	Ground Wire Range	Bolt Size	Dimensions							Screw Type
			C	D	E	F	G	H	T	
GBL-4DB	4-14	10	.218	.680	.470	1.150	.190	.375	.825	Slot
GBL-4DB-14	4-14	10	.265	.680	.470	1.150	.210	.472	.825	Slot

* Add T to order tin plating

Tested to UL 467, UL File E34440

TYPE D167

Features

- Manufactured from high strength copper tubing
- Range taking
- UL Recognized for 600 volts

Benefits

- Provides maximum conductivity
- A wide range of conductor sizes can be used in the same connector
- Ensures reliability for copper conductor

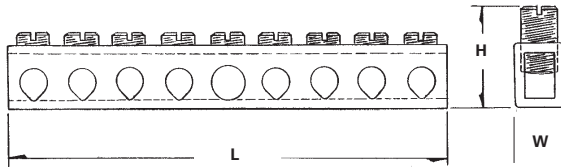

C

Catalog Number	Number Of Taps	Wire Range		Dimensions					Mounting Hole Positions	
		Main	Tap	L	Height With Maximum Wire	W	Bolt Size	Two Mounting Holes	From End Of Bar To First Mounting Hole	Distance Between Holes
D167-4	4	4-14	6-14	2-3/4	3/4	11/32	#10	13/64	.581 (2nd hole)	1.98
D167-6	6	4-14	6-14	3-1/2	3/4	11/32	#10	13/64	.978 (3rd hole)	1.98
D167-8	8	4-14	6-14	4-7/16	3/4	11/32	#10	13/64	1.375 (4th hole)	1.98
D167-10	10	4-14	6-14	5-1/8	3/4	11/32	#10	13/64	1.772 (5th hole)	1.98
D167-12	12	4-14	6-14	5-15/16	3/4	11/32	#10	13/64	2.169 (6th hole)	1.98
D167-14	14	4-14	6-14	6-23/32	3/4	11/32	#10	13/64	2.566 (7th hole)	1.98

Tested to UL 486A-486B, UL File E6207

TYPE CAN

Features

- Manufactured from high strength copper tubing
- Compact design
- Range taking
- UL Recognized and CSA Certified
- Circuit bars inserted at a 20 angle

Benefits

- Provides maximum conductivity
- Up to 42 circuit taps can be made in just 5 1/2" of space
- A wide range of conductor sizes can be used in the same connector
- Ensures reliability for copper conductor
- Provides easy wire insertion

C



Fig. 1

Fig. 2

Fig. 3

Fig. 4

Catalog Number	Figure Number	Number Of Taps	Wire Range		Dimensions			
			Main	Tap	L	Height With Maximum Wire	W	Two Tapped Mounting Holes
CAN-300	1	24	250kcmil-6	6-14	2-5/16	1-5/16	5-1/8	10-32
CAN-301	1	30	250kcmil-6	6-14	3	1-5/16	4-13/32	10-32
CAN-302	1	36	250kcmil-6	6-14	3	1-5/16	5-1/8	10-32
CAN-303	1	42	250kcmil-6	6-14	3	1-7/16	5-1/2	10-32
R-16	2	Mounting block of general purpose (phenolic black) suitable for mounting any of CAN Neutrals. 2-1/2" wide x 2-1/2" long x 1" thick.						
E-223	3	10-32 x 1/2" round head steel machine screws for fastening neutrals to mounting blocks. (Use lock washer to provide rigid assembly.)						
E-153	3	1/4-28 wire pressure screw 7/16" long. Screw is steel, zinc plated and chromate dipped.						
N-174	4	Supplied in 5' 9" lengths. Approximately 174 outlets. Wire range 14-6.						

Tested to UL 486A-486B, UL File E6207

ILSCO Copper Split Bolts



TYPE IK

Features

- Manufactured from high strength copper alloy.
- Precision tooled threads.
- UL 467 Listed for Grounding and Bonding 8 thru 500kcmil
- CSA certified for Grounding and Bonding 8 thru 250kcmil
- UL listed and CSA Certified for 600 volts, 90° C
- RUS Accepted 8 thru 1/0 AWG
- For use with copper conductor types: Solid, Compact, Compressed, Concentric.
- ROHS compliant.

Benefits

- Provides maximum conductivity and high breakage resistance.
- Allows maximum torque to be applied.
- Suitable for direct burial and earth and concrete.

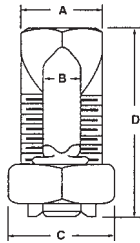

C

Catalog Number	Range For Equal Main & Tap	Min. Tap With One Max. Main	Max. Cond Copperweld		Rebar With 6 or 8 AWG	Wire Diameter	Dimensions				Recommended Torque (IN-LB)
			Str	Type A			A	B	C	D	
IK-10	10str - 16str	16str	-	-	N/A	.057 - .125	.125	0.344	0.500	0.719	80
IK-8	8str - 16str	16str	-	-	N/A	.057 - .145	.145	0.375	0.500	0.844	80
IK-6	6sol - 10sol	16sol	-	-	N/A	.102 - .162	.165	0.500	0.625	1.047	165
IK-4	4sol - 8sol	16sol	3 No. 12	8A	N/A	.128 - .204	.215	0.562	0.688	1.047	165
IK-3	2sol - 6sol	12sol	3 No. 9	5A	N/A	.162 - .258	.328	0.688	0.812	1.312	275
IK-2	2str - 6sol	14str	3 No. 7	3A	N/A	.162 - .292	.328	0.688	0.812	1.312	275
IK-1/0	1/0str - 4sol	14sol	3 No. 6	2A	N/A	.204 - .375	.377	0.750	0.875	1.641	385
IK-2/0	2/0str - 2sol	14str	3 No. 5	-	#3 (3/8)	.258 - .418	.420	0.812	1.000	1.812	385
IK-3/0	3/0str - 2sol	12sol	7 No. 7	-	N/A	.258 - .470	0.466	0.875	1.125	2.000	500
IK-250	250kcmil - 1/0sol	10sol	7 No. 5	-	#4 (1/2)	.325 - .575	0.579	1.000	1.312	2.078	650
IK-350	350kcmil - 4/0str	8sol	19 No. 7	-	#5 (5/8)	.528 - .682	0.746	1.500	1.625	2.625	650
IK-500	500kcmil - 250kcmil	8sol	19 No. 6	-	#6 (3/4)	.575 - .815	0.834	1.625	1.812	3.000	825
IK-750	750kcmil - 350kcmil	8sol	19 No. 5	-	N/A	.682 - .999	1.030	1.938	2.125	3.750	1000
IK-1000	1000kcmil - 500kcmil	8sol	-	-	N/A	.815 - 1.153	1.222	2.250	2.500	4.000	1100

UL File E6207



ILSCO Three Wire Copper Split Bolts



TYPE IK3

Features

- Manufactured from high strength copper alloy.
- Precision tooled threads.
- UL 467 Listed for Grounding and Bonding thru 500kcmil
- CSA certified for Grounding and Bonding thru 250kcmil
- UL listed and CSA Certified for 600 volts, 90° C
- RUS Accepted
- For use with copper conductor types: Solid, Compact, Compressed, Concentric.
- ROHS compliant.

Benefits

- Provides maximum conductivity and high breakage resistance.
- Allows maximum torque to be applied.
- Suitable for direct burial and earth and concrete.

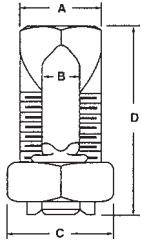

Catalog Number	Range For Equal Main & Tap	Min. Tap With One Max. Main	Max Cond Copperweld		Wire Diameter Range	Dimensions				Recommended Torque (IN-LB)
			Str	Type A		A	B	C	D	
IK3-8	8str - 16str	16str	-	-	.057 - .145	0.144	0.375	0.500	0.844	80
IK3-6	6sol - 10sol	16sol	-	-	.102 - .162	0.166	0.500	0.625	1.109	165
IK3-4	4sol - 8sol	16sol	3 No. 12	8A	.128 - .204	0.217	0.562	0.688	1.266	165
IK3-2	2str - 6sol	14str	3 No. 7	3A	.162 - .258	0.326	0.688	0.812	1.547	275

UL File E6207

ILSCO Tin Plated Copper Split Bolts



TYPE SK

Features

- Manufactured from high strength copper alloy.
- Electro-tin plated bolt, nut, spacer and pressure bar
- Precision tooled threads.
- UL listed and CSA Certified for 600 volts, 90° C
- SK-10, SK-8, SK3, SK-2 SK-1/0, SK-2/0 are RUS Accepted.
- For use with copper conductor types: Solid, Compact, Compressed, Concentric.
- ROHS compliant.

Benefits

- Provides maximum conductivity and high breakage resistance.
- Provides low contact resistance.
- Suitable for direct burial and earth and concrete.

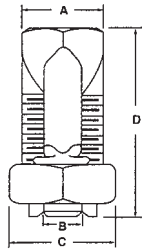

C

Catalog Number	Range For Equal Main & Tap	Min. Tap With One Max. Main	Max Cond Copperweld		Wire Diameter Range	Dimensions				Recommended Torque (IN-LB)
			Str	Type A		A	B	C	D	
SK-10	10str - 16str	16str	-	-	.057 - .116	.144	0.375	0.500	0.844	80
SK-8	8str - 16str	16str	-	-	.057 - .145	0.144	0.375	0.500	0.844	80
SK-6	8str - 14str	14str	-	-	.073 - .146	.166	0.500	0.625	1.109	165
SK-4	6str - 10str	10sol	3 No. 12	8A	.116 - .184	0.217	0.562	0.688	1.266	165
SK-3	4str - 8sol AL 2sol - 8sol CU	8sol AL 8sol CU	3 No. 9	5A	.128 - .258	0.326	0.688	0.812	1.547	275
SK-2	2str - 8sol	8sol	3 No. 7	3A	.128 - .316	0.326	0.688	0.812	1.547	275
SK-1/0	1/0str - 6sol	10sol	3 No. 6	-	.162 - .375	0.376	0.750	0.875	1.641	385
SK-2/0	2/0str - 6str	10sol	3 No. 5	-	.184 - .419	.420	0.812	1.000	1.812	385
SK-3/0	3/0str - 4str	6sol	7 No. 7	-	.198 - .470	0.466	0.875	1.125	2.000	500
SK-250	250kcmil - 4str	4str	7 No. 5	-	.232 - .575	0.577	1.000	1.312	2.328	650
SK-350	350kcmil - 3/0str	1sol	19 No. 7	-	.447 - .682	0.746	1.500	1.625	2.625	650
SK-500	500kcmil - 3/0str	1/0str	19 No. 6	-	.447 - .815	0.834	1.625	1.812	3.000	825
SK-750	750kcmil - 250kcmil	2/0str	19 No. 5	-	.563 - .999	1.030	1.938	2.125	3.750	1000
SK-1000	1000kcmil - 350kcmil	4/0str	-	-	.682 - 1.162	1.222	2.250	2.500	4.000	1100

UL File E12822



ILSCO Copper Two Bolt Connectors



TYPE IKB

Features

- Manufactured from high strength copper alloy
- Two bolt design
- Longer peened bolt
- UL Listed, rated for 600 volts
- For copper conductor only

Benefits

- Allows maximum conductivity and high breakage resistance
- Allows maximum pressure to be applied directly to the conductor strands
- Permits a swivel action for easier installation
- Ensures reliability

C

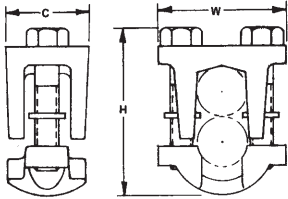

Catalog Number	Copper Wire Range		Dimensions		
	Main	Tap	C	H	W
IKB-4/0 +	1/0-4/0	4/0-10	1.10	1.97	1.72
IKB-350 +	350kcmil-250kcmil	350kcmil-10	1.38	2.48	1.12
IKB-500	500kcmil-400kcmil	500kcmil-10	1.50	2.80	2.25
IKB-800	800kcmil-400kcmil	800kcmil-3/0	1.62	3.32	2.50
IKB-1000	1000kcmil-500kcmil	1000kcmil-3/0	2.00	3.78	3.03

+ REA Listed

Tested to UL 486A-486B, UL File E6207



ILSCO Two Bolt Connectors

TYPE IKS

Features

- Manufactured from high strength copper alloy
- Electro-tin plated
- Two bolt design
- Longer peened bolt
- Serrated spacer bar
- For copper conductor only
- Rated for 600 volts

Benefits

- Allows maximum conductivity and high breakage resistance
- Provides low contact resistance
- Allows maximum pressure to be applied directly to the conductor strands
- Permits a swivel action for easier installation
- Makes a secure connection
- Ensures reliability

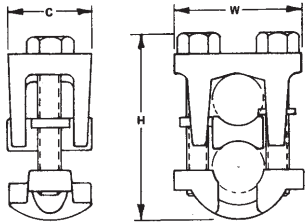

C

Catalog Number	Wire Range		Dimensions		
	Main	Tap	C	H	W
IKS-4/0	4/0-1/0	4/0-6	1.12	2.31	1.72
IKS-350	350kcmil-250kcmil	350kcmil-6	1.38	2.62	2.12
IKS-500	500kcmil-400kcmil	500kcmil-4	1.50	3.00	2.26
IKS-800	800kcmil-400kcmil	800kcmil-4/0	1.62	3.50	2.50
IKS-1000	1000kcmil-500kcmil	1000kcmil-4/0	2.00	4.03	3.03



C

TIGHTENING TORQUE VALUES FOR ILSCO MECHANICAL SCREW CONNECTORS

AWG. OR CIRCULAR MILL SIZE	TIGHTENING TORQUE IN INCH POUNDS	
	SCREW DRIVER	EXTERNAL DRIVE WRENCH
14	35	75
12	35	75
10	35	75
8	40	75
6	45	110
4	45	110
2	50	150
1	50	150
1/0	50	180
2/0	50	180
3/0		250
4/0		250
250		325
350		325
500		375
600		375
700		375
750		375
800		500
1000		500

TIGHTENING TORQUE VALUES FOR ILSCO SOCKETHEAD SCREW CONNECTORS

INTERNAL SOCKET SIZE ACROSS FLATS INCHES	TIGHTENING TORQUE IN INCH POUNDS
1/8	45
5/32	100
3/16	120
7/32	150
1/4	200
5/16	275
3/8	375
1/2	500
9/16	600

Please reference the instruction sheet included with your connector for specific torque values.

NIMBUS[®]



PBT



199

PBTO



199

PBTD



200 - 202

PBTS



203 - 205

PBTM



206 - 207

PCT



208

SPAR



209

TYPE PBT

Features

- Broad wire range: 750kcmil-14
- UL Listed and CSA Certified for 600 volts, 90° C
- Dual rated
- Cold temperature rated to -45° C
- High dielectric strength plastisol
- Black cover
- Removable plugs
- Prefilled with De-ox®

Benefits

- Flexibility in the field
- Ensures reliability
- For copper or aluminum conductor
- Application variability
- Chemical resistant
- UV Rated
- Entry port closure
- Prevents oxides from forming



Fig. 1

Fig. 2

Fig. 3

Catalog Number	Figure No.	No. Of Ports	Wire Range	Dimensions			Hex Size
				L	W	H	
PBT-1/0	1	-	1/0-14	3.11	0.94	1.44	3/16
PBT-250	1	-	250kcmil-6	4.28	1.06	2.04	5/16
PBT-350	1	-	350kcmil-6	4.75	1.31	2.43	5/16
PBT-500	1	-	500kcmil-4	5.38	1.44	3.03	3/8
PBT-750	3	-	750kcmil-250kcmil	7.25	1.75	3.31	3/8
PBTO-4	2	2	4-14	1.17	1.25	1.31	1/8
PBTO-1/0	2	2	1/0-14	1.63	1.63	1.63	3/16
PBTO-3/0	2	2	3/0-6	1.89	1.68	1.86	3/16

Per NEC Article 310-316, allowable ampacities are as follows: #4-95 Amps, 1/0-170 Amps, 3/0-225 Amps, 250-290 Amps, 350-350 Amps, 500-430 Amps, 750-535 Amps
Replacement caps & plugs available. Consult Factory

Tested to UL 486A-486B, UL File E6207

TYPE PBTD

Features

- Broad wire range: 750kcmil-14
- UL Listed and CSA Certified for 600 volts, 90° C
- Dual rated
- Cold temperature rated to -45° C
- High dielectric strength plastisol
- Black cover
- Removable plugs
- Prefilled with De-ox®

Benefits

- Flexibility in the field
- Ensures reliability
- For copper or aluminum conductor
- Application variability
- Chemical resistant
- UV Rated
- Entry port closure
- Prevents oxides from forming

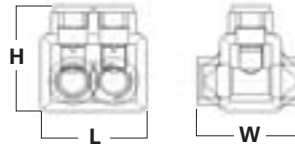

Catalog Number	No. Of Ports	Wire Range	Dimensions			Hex Size
			L	W	H	
PBTD-2-4	2	4-14	1.24	1.25	1.42	1/8
PBTD-3-4	3	4-14	1.70	1.25	1.42	1/8
PBTD-4-4	4	4-14	2.16	1.25	1.42	1/8
PBTD-5-4	5	4-14	2.61	1.25	1.42	1/8
PBTD-6-4	6	4-14	3.07	1.25	1.42	1/8
PBTD-7-4	7	4-14	3.53	1.25	1.42	1/8
PBTD-8-4	8	4-14	3.99	1.25	1.42	1/8
PBTD-9-4	9	4-14	4.45	1.25	1.42	1/8
PBTD-10-4	10	4-14	4.90	1.25	1.42	1/8
PBTD-11-4	11	4-14	5.36	1.25	1.42	1/8
PBTD-12-4	12	4-14	5.82	1.25	1.42	1/8
PBTD-13-4	13	4-14	6.28	1.25	1.42	1/8
PBTD-14-4	14	4-14	6.74	1.25	1.42	1/8
PBTD-2-1/0	2	1/0-14	1.67	1.63	1.63	3/16
PBTD-3-1/0	3	1/0-14	2.29	1.63	1.63	3/16
PBTD-4-1/0	4	1/0-14	2.92	1.63	1.63	3/16
PBTD-5-1/0	5	1/0-14	3.54	1.63	1.63	3/16
PBTD-6-1/0	6	1/0-14	4.17	1.63	1.63	3/16
PBTD-7-1/0	7	1/0-14	4.79	1.63	1.63	3/16
PBTD-8-1/0	8	1/0-14	5.42	1.63	1.63	3/16
PBTD-9-1/0	9	1/0-14	6.04	1.63	1.63	3/16
PBTD-10-1/0	10	1/0-14	6.67	1.63	1.63	3/16
PBTD-11-1/0	11	1/0-14	7.29	1.63	1.63	3/16
PBTD-12-1/0	12	1/0-14	7.92	1.63	1.63	3/16
PBTD-13-1/0	13	1/0-14	8.54	1.63	1.63	3/16
PBTD-14-1/0	14	1/0-14	9.17	1.63	1.63	3/16
PBTD-2-3/0	2	3/0-6	1.89	1.68	1.86	3/16
PBTD-3-3/0	3	3/0-6	2.65	1.68	1.86	3/16
PBTD-4-3/0	4	3/0-6	3.42	1.68	1.86	3/16
PBTD-5-3/0	5	3/0-6	4.18	1.68	1.86	3/16
PBTD-6-3/0	6	3/0-6	4.95	1.68	1.86	3/16
PBTD-7-3/0	7	3/0-6	5.71	1.68	1.86	3/16
PBTD-8-3/0	8	3/0-6	6.48	1.68	1.86	3/16
PBTD-9-3/0	9	3/0-6	7.24	1.68	1.86	3/16

Per NEC Article 310-316, allowable ampacities are as follows: #4-95 Amps, 1/0-170 Amps, 3/0-225 Amps, 250-290 Amps, 350-350 Amps, 500-430 Amps, 750-535 Amps
 Replacement caps & plugs available. Consult Factory Tested to UL 486A-486B, UL File E6207

TYPE PBTD

Features

- Broad wire range: 750kcmil-14
- UL Listed and CSA Certified for 600 volts, 90° C
- Dual rated
- Cold temperature rated to -45° C
- High dielectric strength plastisol
- Black cover
- Removable plugs
- Prefilled with De-ox®

Benefits

- Flexibility in the field
- Ensures reliability
- For copper or aluminum conductor
- Application variability
- Chemical resistant
- UV Rated
- Entry port closure
- Prevents oxides from forming

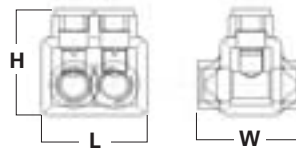

D

Catalog Number	No. Of Ports	Wire Range	Dimensions			Hex Size
			L	W	H	
PBTD-10-3/0	10	3/0-6	8.01	1.68	1.86	3/16
PBTD-11-3/0	11	3/0-6	8.77	1.68	1.86	3/16
PBTD-12-3/0	12	3/0-6	9.54	1.68	1.86	3/16
PBTD-13-3/0	13	3/0-6	10.30	1.68	1.86	3/16
PBTD-14-3/0	14	3/0-6	11.07	1.68	1.86	3/16
PBTD-2-250	2	250kcmil-6	2.17	2.13	2.17	5/16
PBTD-3-250	3	250kcmil-6	3.07	2.13	2.17	5/16
PBTD-4-250	4	250kcmil-6	3.96	2.13	2.17	5/16
PBTD-5-250	5	250kcmil-6	4.85	2.13	2.17	5/16
PBTD-6-250	6	250kcmil-6	5.75	2.13	2.17	5/16
PBTD-7-250	7	250kcmil-6	6.64	2.13	2.17	5/16
PBTD-8-250	8	250kcmil-6	7.53	2.13	2.17	5/16
PBTD-9-250	9	250kcmil-6	8.42	2.13	2.17	5/16
PBTD-10-250	10	250kcmil-6	9.32	2.13	2.17	5/16
PBTD-11-250	11	250kcmil-6	10.21	2.13	2.17	5/16
PBTD-12-250	12	250kcmil-6	11.10	2.13	2.17	5/16
PBTD-13-250	13	250kcmil-6	12.00	2.13	2.17	5/16
PBTD-14-250	14	250kcmil-6	12.89	2.13	2.17	5/16
PBTD-2-350	2	350kcmil-6	2.51	2.25	2.62	5/16
PBTD-3-350	3	350kcmil-6	3.56	2.25	2.62	5/16
PBTD-4-350	4	350kcmil-6	4.61	2.25	2.62	5/16
PBTD-5-350	5	350kcmil-6	5.67	2.25	2.62	5/16
PBTD-6-350	6	350kcmil-6	6.71	2.25	2.62	5/16
PBTD-7-350	7	350kcmil-6	7.76	2.25	2.62	5/16
PBTD-8-350	8	350kcmil-6	8.81	2.25	2.62	5/16
PBTD-9-350	9	350kcmil-6	9.86	2.25	2.62	5/16
PBTD-10-350	10	350kcmil-6	10.91	2.25	2.62	5/16
PBTD-11-350	11	350kcmil-6	11.96	2.25	2.62	5/16
PBTD-12-350	12	350kcmil-6	13.01	2.25	2.62	5/16
PBTD-13-350	13	350kcmil-6	14.06	2.25	2.62	5/16
PBTD-14-350	14	350kcmil-6	15.11	2.25	2.62	5/16
PBTD-2-500	2	500kcmil-4	2.97	2.63	3.04	3/8
PBTD-3-500	3	500kcmil-4	4.12	2.63	3.04	3/8
PBTD-4-500	4	500kcmil-4	5.28	2.63	3.04	3/8

Per NEC Article 310-316, allowable ampacities are as follows: #4-95 Amps, 1/0-170 Amps, 3/0-225 Amps, 250-290 Amps, 350-350 Amps, 500-430 Amps, 750-535 Amps
 Replacement caps & plugs available. Consult Factory Tested to UL 486A-486B, UL File E6207

TYPE PBTD

Features

- Broad wire range: 750kcmil-14
- UL Listed and CSA Certified for 600 volts, 90° C
- Dual rated
- Cold temperature rated to -45° C
- High dielectric strength plastisol
- Black cover
- Removable plugs
- Prefilled with De-ox®

Benefits

- Flexibility in the field
- Ensures reliability
- For copper or aluminum conductor
- Application variability
- Chemical resistant
- UV Rated
- Entry port closure
- Prevents oxides from forming

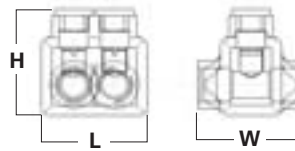

Catalog Number	No. Of Ports	Wire Range	Dimensions			Hex Size
			L	W	H	
PBTD-5-500	5	500kcmil-4	6.44	2.63	3.04	3/8
PBTD-6-500	6	500kcmil-4	7.59	2.63	3.04	3/8
PBTD-7-500	7	500kcmil-4	8.75	2.63	3.04	3/8
PBTD-8-500	8	500kcmil-4	9.90	2.63	3.04	3/8
PBTD-9-500	9	500kcmil-4	11.06	2.63	3.04	3/8
PBTD-10-500	10	500kcmil-4	12.22	2.63	3.04	3/8
PBTD-11-500	11	500kcmil-4	13.37	2.63	3.04	3/8
PBTD-12-500	12	500kcmil-4	14.53	2.63	3.04	3/8
PBTD-13-500	13	500kcmil-4	15.68	2.63	3.04	3/8
PBTD-14-500	14	500kcmil-4	16.84	2.63	3.04	3/8
PBTD-2-750	2	750kcmil-250kcmil	3.47	3.25	3.31	1/2
PBTD-3-750	3	750kcmil-250kcmil	4.89	3.25	3.31	1/2
PBTD-4-750	4	750kcmil-250kcmil	6.32	3.25	3.31	1/2
PBTD-5-750	5	750kcmil-250kcmil	7.74	3.25	3.31	1/2
PBTD-6-750	6	750kcmil-250kcmil	9.16	3.25	3.31	1/2
PBTD-7-750	7	750kcmil-250kcmil	10.58	3.25	3.31	1/2
PBTD-8-750	8	750kcmil-250kcmil	12.00	3.25	3.31	1/2
PBTD-9-750	9	750kcmil-250kcmil	13.43	3.25	3.31	1/2
PBTD-10-750	10	750kcmil-250kcmil	14.85	3.25	3.31	1/2
PBTD-11-750	11	750kcmil-250kcmil	16.27	3.25	3.31	1/2
PBTD-12-750	12	750kcmil-250kcmil	17.69	3.25	3.31	1/2
PBTD-13-750	13	750kcmil-250kcmil	19.11	3.25	3.31	1/2
PBTD-14-750	14	750kcmil-250kcmil	20.54	3.25	3.31	1/2

Per NEC Article 310-316, allowable ampacities are as follows: #4-95 Amps, 1/0-170 Amps, 3/0-225 Amps, 250-290 Amps, 350-350 Amps, 500-430 Amps, 750-535 Amps
Replacement caps & plugs available. Consult Factory

Tested to UL 486A-486B, UL File E6207

TYPE PBTS

Features

- Broad wire range: 750kcmil-14
- UL Listed and CSA Certified for 600 volts, 90° C
- Dual rated
- Cold temperature rated to -45° C
- High dielectric strength plastisol
- Black cover
- Removable plugs
- Prefilled with De-ox®

Benefits

- Flexibility in the field
- Ensures reliability
- For copper or aluminum conductor
- Application variability
- Chemical resistant
- UV Rated
- Entry port closure
- Prevents oxides from forming

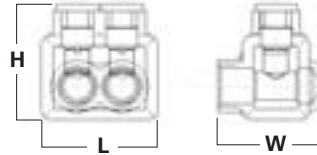

Catalog Number	No. Of Ports	Wire Range	Dimensions			Hex Size
			L	W	H	
PBTS-2-4	2	4-14	1.24	1.22	1.42	1/8
PBTS-3-4	3	4-14	1.70	1.22	1.42	1/8
PBTS-4-4	4	4-14	2.16	1.22	1.42	1/8
PBTS-5-4	5	4-14	2.61	1.22	1.42	1/8
PBTS-6-4	6	4-14	3.07	1.22	1.42	1/8
PBTS-7-4	7	4-14	3.53	1.22	1.42	1/8
PBTS-8-4	8	4-14	3.99	1.22	1.42	1/8
PBTS-9-4	9	4-14	4.45	1.22	1.42	1/8
PBTS-10-4	10	4-14	4.90	1.22	1.42	1/8
PBTS-11-4	11	4-14	5.36	1.22	1.42	1/8
PBTS-12-4	12	4-14	5.82	1.22	1.42	1/8
PBTS-13-4	13	4-14	6.28	1.22	1.42	1/8
PBTS-14-4	14	4-14	6.74	1.22	1.42	1/8
PBTS-2-1/0	2	1/0-14	1.67	1.53	1.63	3/16
PBTS-3-1/0	3	1/0-14	2.29	1.53	1.63	3/16
PBTS-4-1/0	4	1/0-14	2.92	1.53	1.63	3/16
PBTS-5-1/0	5	1/0-14	3.54	1.53	1.63	3/16
PBTS-6-1/0	6	1/0-14	4.17	1.53	1.63	3/16
PBTS-7-1/0	7	1/0-14	4.79	1.53	1.63	3/16
PBTS-8-1/0	8	1/0-14	5.42	1.53	1.63	3/16
PBTS-9-1/0	9	1/0-14	6.04	1.53	1.63	3/16
PBTS-10-1/0	10	1/0-14	6.67	1.53	1.63	3/16
PBTS-11-1/0	11	1/0-14	7.29	1.53	1.63	3/16
PBTS-12-1/0	12	1/0-14	7.92	1.53	1.63	3/16
PBTS-13-1/0	13	1/0-14	8.54	1.53	1.63	3/16
PBTS-14-1/0	14	1/0-14	9.17	1.53	1.63	3/16
PBTS-2-3/0	2	3/0-6	1.89	1.58	1.86	3/16
PBTS-3-3/0	3	3/0-6	2.65	1.58	1.86	3/16
PBTS-4-3/0	4	3/0-6	3.42	1.58	1.86	3/16
PBTS-5-3/0	5	3/0-6	4.18	1.58	1.86	3/16
PBTS-6-3/0	6	3/0-6	4.95	1.58	1.86	3/16
PBTS-7-3/0	7	3/0-6	5.71	1.58	1.86	3/16
PBTS-8-3/0	8	3/0-6	6.48	1.58	1.86	3/16
PBTS-9-3/0	9	3/0-6	7.24	1.58	1.86	3/16

Per NEC Article 310-316, allowable ampacities are as follows: #4-95 Amps, 1/0-170 Amps, 3/0-225 Amps, 250-290 Amps, 350-350 Amps, 500-430 Amps, 750-535 Amps
 Replacement caps & plugs available. Consult Factory Tested to UL 486A-486B, UL File E6207

TYPE PBTS

Features

- Broad wire range: 750kcmil-14
- UL Listed and CSA Certified for 600 volts, 90° C
- Dual rated
- Cold temperature rated to -45° C
- High dielectric strength plastisol
- Black cover
- Removable plugs
- Prefilled with De-ox®

Benefits

- Flexibility in the field
- Ensures reliability
- For copper or aluminum conductor
- Application variability
- Chemical resistant
- UV Rated
- Entry port closure
- Prevents oxides from forming

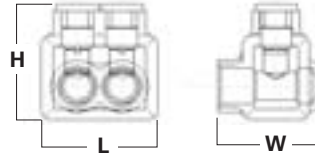

D

Catalog Number	No. Of Ports	Wire Range	Dimensions			Hex Size
			L	W	H	
PBTS-10-3/0	10	3/0-6	8.00	1.58	1.86	3/16
PBTS-11-3/0	11	3/0-6	8.77	1.58	1.86	3/16
PBTS-12-3/0	12	3/0-6	9.54	1.58	1.86	3/16
PBTS-13-3/0	13	3/0-6	10.30	1.58	1.86	3/16
PBTS-14-3/0	14	3/0-6	11.07	1.58	1.86	3/16
PBTS-2-250	2	250kcmil-6	2.17	1.91	2.17	5/16
PBTS-3-250	3	250kcmil-6	3.07	1.91	2.17	5/16
PBTS-4-250	4	250kcmil-6	3.96	1.91	2.17	5/16
PBTS-5-250	5	250kcmil-6	4.85	1.91	2.17	5/16
PBTS-6-250	6	250kcmil-6	5.75	1.91	2.17	5/16
PBTS-7-250	7	250kcmil-6	6.64	1.91	2.17	5/16
PBTS-8-250	8	250kcmil-6	7.53	1.91	2.17	5/16
PBTS-9-250	9	250kcmil-6	8.42	1.91	2.17	5/16
PBTS-10-250	10	250kcmil-6	9.32	1.91	2.17	5/16
PBTS-11-250	11	250kcmil-6	10.21	1.91	2.17	5/16
PBTS-12-250	12	250kcmil-6	11.10	1.91	2.17	5/16
PBTS-13-250	13	250kcmil-6	12.00	1.91	2.17	5/16
PBTS-14-250	14	250kcmil-6	12.89	1.91	2.17	5/16
PBTS-2-350	2	350kcmil-6	2.51	2.03	2.62	5/16
PBTS-3-350	3	350kcmil-6	3.56	2.03	2.62	5/16
PBTS-4-350	4	350kcmil-6	4.61	2.03	2.62	5/16
PBTS-5-350	5	350kcmil-6	5.66	2.03	2.62	5/16
PBTS-6-350	6	350kcmil-6	6.71	2.03	2.62	5/16
PBTS-7-350	7	350kcmil-6	7.76	2.03	2.62	5/16
PBTS-8-350	8	350kcmil-6	8.81	2.03	2.62	5/16
PBTS-9-350	9	350kcmil-6	9.86	2.03	2.62	5/16
PBTS-10-350	10	350kcmil-6	10.91	2.03	2.62	5/16
PBTS-11-350	11	350kcmil-6	11.96	2.03	2.62	5/16
PBTS-12-350	12	350kcmil-6	13.01	2.03	2.62	5/16
PBTS-13-350	13	350kcmil-6	14.06	2.03	2.62	5/16
PBTS-14-350	14	350kcmil-6	15.11	2.03	2.62	5/16
PBTS-2-500	2	500kcmil-4	2.97	2.28	3.04	3/8
PBTS-3-500	3	500kcmil-4	4.12	2.28	3.04	3/8
PBTS-4-500	4	500kcmil-4	5.28	2.28	3.04	3/8

Per NEC Article 310-316, allowable ampacities are as follows: #4-95 Amps, 1/0-170 Amps, 3/0-225 Amps, 250-290 Amps, 350-350 Amps, 500-430 Amps, 750-535 Amps
Replacement caps & plugs available. Consult Factory Tested to UL 486A-486B, UL File E6207

TYPE PBTS

Features

- Broad wire range: 750kcmil-14
- UL Listed and CSA Certified for 600 volts, 90° C
- Dual rated
- Cold temperature rated to -45° C
- High dielectric strength plastisol
- Black cover
- Removable plugs
- Prefilled with De-ox®

Benefits

- Flexibility in the field
- Ensures reliability
- For copper or aluminum conductor
- Application variability
- Chemical resistant
- UV Rated
- Entry port closure
- Prevents oxides from forming

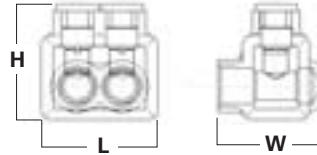

D

Catalog Number	No. Of Ports	Wire Range	Dimensions			Hex Size
			L	W	H	
PBTS-5-500	5	500kcmil-4	6.44	2.28	3.04	3/8
PBTS-6-500	6	500kcmil-4	7.59	2.28	3.04	3/8
PBTS-7-500	7	500kcmil-4	8.75	2.28	3.04	3/8
PBTS-8-500	8	500kcmil-4	9.90	2.28	3.04	3/8
PBTS-9-500	9	500kcmil-4	11.06	2.28	3.04	3/8
PBTS-10-500	10	500kcmil-4	12.22	2.28	3.04	3/8
PBTS-11-500	11	500kcmil-4	13.37	2.28	3.04	3/8
PBTS-12-500	12	500kcmil-4	14.53	2.28	3.04	3/8
PBTS-13-500	13	500kcmil-4	15.68	2.28	3.04	3/8
PBTS-14-500	14	500kcmil-4	16.84	2.28	3.04	3/8
PBTS-2-750	2	750kcmil-250kcmil	3.47	2.75	3.31	1/2
PBTS-3-750	3	750kcmil-250kcmil	4.89	2.75	3.31	1/2
PBTS-4-750	4	750kcmil-250kcmil	6.32	2.75	3.31	1/2
PBTS-5-750	5	750kcmil-250kcmil	7.74	2.75	3.31	1/2
PBTS-6-750	6	750kcmil-250kcmil	9.16	2.75	3.31	1/2
PBTS-7-750	7	750kcmil-250kcmil	10.58	2.75	3.31	1/2
PBTS-8-750	8	750kcmil-250kcmil	12.00	2.75	3.31	1/2
PBTS-9-750	9	750kcmil-250kcmil	13.43	2.75	3.31	1/2
PBTS-10-750	10	750kcmil-250kcmil	14.85	2.75	3.31	1/2
PBTS-11-750	11	750kcmil-250kcmil	16.27	2.75	3.31	1/2
PBTS-12-750	12	750kcmil-250kcmil	17.69	2.75	3.31	1/2
PBTS-13-750	13	750kcmil-250kcmil	19.11	2.75	3.31	1/2
PBTS-14-750	14	750kcmil-250kcmil	20.54	2.75	3.31	1/2

Per NEC Article 310-316, allowable ampacities are as follows: #4-95 Amps, 1/0-170 Amps, 3/0-225 Amps, 250-290 Amps, 350-350 Amps, 500-430 Amps, 750-535 Amps
Replacement caps & plugs available. Consult Factory

Tested to UL 486A-486B, UL File E6207

TYPE PBTM

Features

- Mountable
- Broad wire range: 750kcmil-6
- UL Listed and CSA Certified for 600 volts, 90° C
- Dual rated
- Cold temperature rated to -45° C
- High dielectric strength plastisol
- Black cover
- Removable plugs
- Prefilled with De-ox®

Benefits

- Isolated mounting in trough, wire way or panels
- Flexibility in the field
- Ensures reliability
- For copper or aluminum conductor
- Application variability
- Chemical resistant
- UV Rated
- Entry port closure
- Prevents oxides from forming

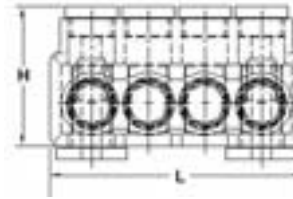

Catalog Number	No. Of Ports	Wire Range	Dimensions			Hex Size	Mounting Holes
			L	W	H		
PBTD-2-3/0-M	2	3/0-6	3.42	1.68	1.86	3/16	1/4
PBTD-3-3/0-M	3	3/0-6	4.18	1.68	1.86	3/16	1/4
PBTD-4-3/0-M	4	3/0-6	4.95	1.68	1.86	3/16	1/4
PBTD-5-3/0-M	5	3/0-6	5.71	1.68	1.86	3/16	1/4
PBTD-6-3/0-M	6	3/0-6	6.48	1.68	1.86	3/16	1/4
PBTD-7-3/0-M	7	3/0-6	7.24	1.68	1.86	3/16	1/4
PBTD-8-3/0-M	8	3/0-6	8.01	1.68	1.86	3/16	1/4
PBTD-9-3/0-M	9	3/0-6	8.77	1.68	1.86	3/16	1/4
PBTD-10-3/0-M	10	3/0-6	9.54	1.68	1.86	3/16	1/4
PBTD-11-3/0-M	11	3/0-6	10.30	1.68	1.86	3/16	1/4
PBTD-12-3/0-M	12	3/0-6	11.07	1.68	1.86	3/16	1/4
PBTD-2-250-M	2	250kcmil-6	3.96	2.13	2.17	5/16	1/4
PBTD-3-250-M	3	250kcmil-6	4.85	2.13	2.17	5/16	1/4
PBTD-4-250-M	4	250kcmil-6	5.75	2.13	2.17	5/16	1/4
PBTD-5-250-M	5	250kcmil-6	6.64	2.13	2.17	5/16	1/4
PBTD-6-250-M	6	250kcmil-6	7.53	2.13	2.17	5/16	1/4
PBTD-7-250-M	7	250kcmil-6	8.42	2.13	2.17	5/16	1/4
PBTD-8-250-M	8	250kcmil-6	9.32	2.13	2.17	5/16	1/4
PBTD-9-250-M	9	250kcmil-6	10.21	2.13	2.17	5/16	1/4
PBTD-10-250-M	10	250kcmil-6	11.10	2.13	2.17	5/16	1/4
PBTD-11-250-M	11	250kcmil-6	12.00	2.13	2.17	5/16	1/4
PBTD-12-250-M	12	250kcmil-6	12.89	2.13	2.17	5/16	1/4
PBTD-2-350-M	2	350kcmil-6	4.61	2.25	2.62	5/16	5/16
PBTD-3-350-M	3	350kcmil-6	5.67	2.25	2.62	5/16	5/16
PBTD-4-350-M	4	350kcmil-6	6.71	2.25	2.62	5/16	5/16
PBTD-5-350-M	5	350kcmil-6	7.76	2.25	2.62	5/16	5/16
PBTD-6-350-M	6	350kcmil-6	8.81	2.25	2.62	5/16	5/16
PBTD-7-350-M	7	350kcmil-6	9.86	2.25	2.62	5/16	5/16
PBTD-8-350-M	8	350kcmil-6	10.91	2.25	2.62	5/16	5/16
PBTD-9-350-M	9	350kcmil-6	11.96	2.25	2.62	5/16	5/16
PBTD-10-350-M	10	350kcmil-6	13.01	2.25	2.62	5/16	5/16
PBTD-11-350-M	11	350kcmil-6	14.06	2.25	2.62	5/16	5/16
PBTD-12-350-M	12	350kcmil-6	15.11	2.25	2.62	5/16	5/16

Per NEC Article 310-316, allowable ampacities are as follows: #4-95 Amps, 1/0-170 Amps, 3/0-225 Amps, 250-290 Amps, 350-350 Amps, 500-430 Amps, 750-535 Amps
 Replacement caps & plugs available. Consult Factory. Tested to UL 486A-486B, UL File E6207

TYPE

PBTM

Features

- Mountable
- Broad wire range: 750kcmil-6
- UL Listed and CSA Certified for 600 volts, 90° C
- Dual rated
- Cold temperature rated to -45° C
- High dielectric strength plastisol
- Black cover
- Removable plugs
- Prefilled with De-ox[®]

Benefits

- Isolated mounting in trough, wire way or panels
- Flexibility in the field
- Ensures reliability
- For copper or aluminum conductor
- Application variability
- Chemical resistant
- UV Rated
- Entry port closure
- Prevents oxides from forming

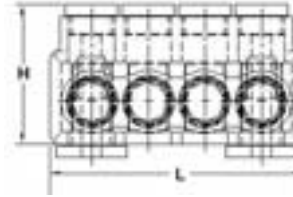

D

Catalog Number	No. Of Ports	Wire Range	Dimensions			Hex Size	Mounting Holes
			L	W	H		
PBTD-2-500-M	2	500kcmil-4	5.28	2.63	3.04	3/8	5/16
PBTD-3-500-M	3	500kcmil-4	6.44	2.63	3.04	3/8	5/16
PBTD-4-500-M	4	500kcmil-4	7.59	2.63	3.04	3/8	5/16
PBTD-5-500-M	5	500kcmil-4	8.75	2.63	3.04	3/8	5/16
PBTD-6-500-M	6	500kcmil-4	9.90	2.63	3.04	3/8	5/16
PBTD-7-500-M	7	500kcmil-4	11.06	2.63	3.04	3/8	5/16
PBTD-8-500-M	8	500kcmil-4	12.22	2.63	3.04	3/8	5/16
PBTD-9-500-M	9	500kcmil-4	13.37	2.63	3.04	3/8	5/16
PBTD-10-500-M	10	500kcmil-4	14.53	2.63	3.04	3/8	5/16
PBTD-11-500-M	11	500kcmil-4	15.68	2.63	3.04	3/8	5/16
PBTD-12-500-M	12	500kcmil-4	16.84	2.63	3.04	3/8	5/16
PBTD-2-750-M*	2	750kcmil-250kcmil	6.32	3.25	3.31	1/2	3/8
PBTD-3-750-M*	3	750kcmil-250kcmil	7.74	3.25	3.31	1/2	3/8
PBTD-4-750-M*	4	750kcmil-250kcmil	9.16	3.25	3.31	1/2	3/8
PBTD-5-750-M*	5	750kcmil-250kcmil	10.58	3.25	3.31	1/2	3/8
PBTD-6-750-M*	6	750kcmil-250kcmil	12.00	3.25	3.31	1/2	3/8
PBTD-7-750-M*	7	750kcmil-250kcmil	13.43	3.25	3.31	1/2	3/8
PBTD-8-750-M*	8	750kcmil-250kcmil	14.85	3.25	3.31	1/2	3/8
PBTD-9-750-M*	9	750kcmil-250kcmil	16.27	3.25	3.31	1/2	3/8
PBTD-10-750-M*	10	750kcmil-250kcmil	17.69	3.25	3.31	1/2	3/8
PBTD-11-750-M*	11	750kcmil-250kcmil	19.11	3.25	3.31	1/2	3/8
PBTD-12-750-M*	12	750kcmil-250kcmil	20.54	3.25	3.31	1/2	3/8

Per NEC Article 310-316, allowable ampacities are as follows: #4-95 Amps, 1/0-170 Amps, 3/0-225 Amps, 250-290 Amps, 350-350 Amps, 500-430 Amps, 750-535 Amps
Replacement caps & plugs available. Consult Factory.

* Not UL Listed

Tested to UL 486A-486B, UL File E6207

ILSCO ClearTap® Insulated Multi-Tap Connectors



TYPE PCT

Features

- Transparent flexible insulating cover
- Captive pressure screws
- Self-closing openings
- Access from both sides of connector
- Broad wire range: 800kcmil-14
- UL Listed for 600 volts, 90° C
- Dual Rated

Benefits

- No taping and allows visual inspection of connection
- No wasted time finding screws
- No lost or loose caps and plugs
- Provides greater versatility
- Reduces inventory
- Ensures reliability
- For copper or aluminum conductor

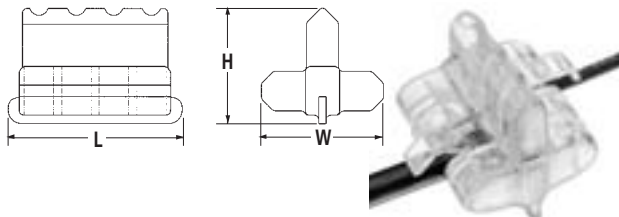

Fig. 1 (Patented)

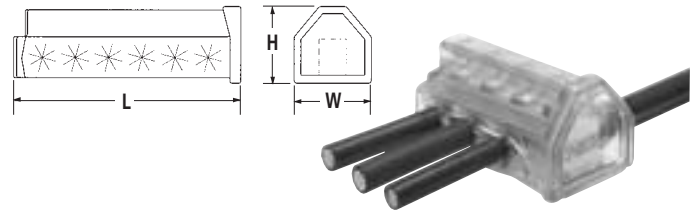

Fig. 2



Catalog Number	Connector Shape	Figure No.	No. Of Ports	Wire Range	Ampere Rating	Dimensions			Hex Size
						L	W	H	
PCT-2-4		1	2	4-14	95	1.46	1.57	1.43	slot
PCT-4-4		1	4	4-14	95	2.46	1.57	1.43	slot
PCT-6-4		1	6	4-14	95	3.46	1.57	1.43	slot
PCT-8-4		1	8	4-14	95	4.46	1.57	1.43	slot
PCT-2-2/0		2	2	2/0-14	195	2.61	2.30	1.97	3/16
PCT-4-2/0		2	4	2/0-14	195	4.30	2.30	1.97	3/16
PCT-6-2/0		2	6	2/0-14	195	5.98	2.30	1.97	3/16
PCT-8-2/0		2	8	2/0-14	195	7.67	2.30	1.97	3/16
PCT-2-4/0		2	2	4/0-6	260	2.33	2.49	2.25	5/16
PCT-4-4/0		2	4	4/0-6	260	4.19	2.49	2.25	5/16
PCT-6-4/0		2	6	4/0-6	260	6.05	2.49	2.25	5/16
PCT-8-4/0		2	8	4/0-6	260	7.91	2.49	2.25	5/16
PCT-2-350		2	2	350 kcmil-6	350	2.75	2.69	2.65	5/16
PCT-4-350		2	4	350 kcmil-6	350	5.06	2.69	2.65	5/16
PCT-6-350		2	6	350 kcmil-6	350	7.37	2.69	2.65	5/16
PCT-8-350		2	8	350 kcmil-6	350	9.68	2.69	2.65	5/16
PCT-2-600		2	2	600 kcmil-4	475	3.17	3.20	3.27	3/8
PCT-4-600		2	4	600 kcmil-4	475	5.73	3.20	3.27	3/8
PCT-6-600		2	6	600 kcmil-4	475	8.29	3.20	3.27	3/8
PCT-8-600		2	8	600 kcmil-4	475	10.86	3.20	3.27	3/8
PCT-2-800		2	2	800kcmil-250kcmil	555	3.91	3.34	3.30	1/2
PCT-4-800		2	4	800kcmil-250kcmil	555	7.03	3.34	3.30	1/2
PCT-6-800		2	6	800kcmil-250kcmil	555	10.15	3.34	3.30	1/2

Not suitable for direct burial.

Tested to UL 486A-486B, UL File E6207



TYPE SPAR

Features

- Transparent flexible insulating cover
- Range adjustable trim-to-fit tip
- Unique shape and compact design
- Connector, cover and cable tie packaged together
- UL Listed and CSA Certified for 600 volts
- Dual Rated

Benefits

- No taping and allows visual inspection of splice
- Ensures proper fit of cover to cable
- Provides ease of installation, versatility and serviceability of connections made in tight spaces
- Provides ease of ordering
- Ensures reliability
- Use with copper or aluminum conductor

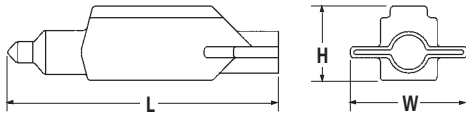

D

Catalog Number	Connector Shape	Wire Range	Dimensions			Screw Size & Shape
			L	W	H	
SPAR-4		4-14	3.30	1.55	.76	slotted
SPAR-2		2-14	3.83	1.75	.95	slotted
SPAR-1/0		1/0-14	4.80	1.94	1.14	3/16" socket head
SPAR-250		250kcmil-6	5.67	2.41	1.29	5/16" socket head
SPAR-350		350kcmil-6	6.17	3.29	1.79	5/16" socket head
SPAR-500		500kcmil-4	7.94	3.66	2.28	3/8" socket head

DE-OX Oxide Inhibitor is recommended for all aluminum terminations.

Tested to UL 486A-486B, UL File E6207

KUP-L-TAP® Insulation Piercing Connectors Save Time And Money

Tin plated, hardened copper contact teeth easily penetrate most types of conductor insulation.

Bolt tightens with just a wrench. Available in stainless steel for corrosive environments.

KUP-L-TAP® is dual-rated for copper and aluminum conductors.

End tabs knock out easily by hand.





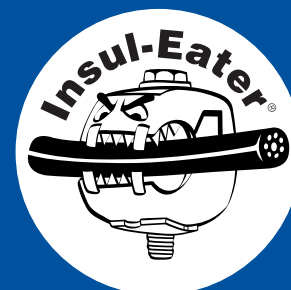

A horizontal line grid provides a visual guide for proper alignment of connector body.

KUP-L-TAP® body is molded of tough, resilient glass-filled nylon. Silicone compound acts as a blocking agent to protect connection from oxidation



ILSCO Compare: Time...Parts...Tools...Total Costs...

Save 40-50% with KUP-L-TAP®

Installed Cost Comparison:	EXAMPLE A				EXAMPLE B				EXAMPLE C			
												
Product Catalog Number	KUP-L-TAP® IPC-1/0-2		Split Bolt AK-1/0		KUP-L-TAP® IPC 250-4/0		Split Bolt AK-4/0		KUP-L-TAP® IPC 500-250		Split Bolt AK-500	
Connector Wire Range	Main	Tap	Main	Tap	Main	Tap	Main	Tap	Main	Tap	Main	Tap
Material Cost* Connector	\$12.54		\$10.73		\$27.83		\$29.16		\$67.14		\$71.04	
Insulating Material	0		1.54		0		2.97		0		5.17	
Oxide Inhibitor	0		.12		0		.14		0		.16	
TOTAL MATERIAL COST	\$12.54		\$12.39		\$27.83		\$32.27		\$67.14		\$76.37	
Installation Cost												
Stripping Insulation	0		1 Minute		0		2 Minutes		0		3 Minutes	
Wire Brush Conductor	0		1/2 Minute		0		1/2 Minute		0		1/2 Minute	
Applying Oxide Inhibitor	0		1/2 Minute		0		1/2 Minute		0		1/2 Minute	
Assemble and Tighten	1 Minute		1 Minute		1 Minute		2 Minutes		2 Minutes		3 Minutes	
Insulate Connector	0		12 Minutes		0		15 Minutes		0		25 Minutes	
Total Installation Time**	1 Minute		15 Minutes		1 Minute		20 Minutes		2 Minutes		32 Minutes	
Direct Labor Cost*** At \$60.00 per hour	\$1.00		\$15.00		\$1.00		\$20.00		\$2.00		\$32.00	
TOTAL MATERIAL & LABOR	\$13.54		\$27.39		\$28.83		\$52.27		\$69.14		\$108.37	
Work It Hot	Yes		No		Yes		No		Yes		No	

*Material cost based upon current manufacturers suggested trade price.

** Installation time based upon average for installation indoors in gutter or trough (National Electrical Contractors Association Instruction Manual of Labor Units shows respective time for split bolt installation for Example A, 1 hr., Example B, 2 hrs., Example C, 6 hrs.).

***Actual hourly rate for specific areas should be substituted.

THERE IS REALLY NO COMPARISON!

KUP-L-TAP® is your best choice for lower costs, easier installation, and increased safety.



KUP-L-TAP®, for indoor/outdoor use are dual rated for copper and aluminum wire and can be installed on energized conductors. They run cooler than the conductor yet require no cover or tape over the connectors. No need for stripping or oxide inhibitor.

Molded of tough, resilient, glass-filled nylon, KUP-L-TAP® can be used as a dead-end non-tension splice or a tap splice. Precisely designed, extra-hard copper contact teeth assure proper penetration into either copper or aluminum conductors.

KUP-L-TAP® can be installed "hot" on energized conductors.

TYPE IPC



Features

- Body is molded from tough, resilient glass-filled nylon
 - Compact design
 - Tin plated copper contact teeth
 - Insulation piercing
 - Perforated end tabs
 - Pre-filled with silicone lubricant
 - Versatile
 - Increased safety
- Horizontal line grid
 - Temperature rating 90° C

Benefits

- Provides high degree of breakage resistance and long dependable use
- Saves space
- Easily penetrates most types of insulation
- No need to strip the conductor which saves installation time
- Break out easily by hand
- Prevents oxidation and moisture from entering the contact area
- Can be used as a splice or tap connector
- Contains no external energized parts. Can be installed "hot" on energized conductors providing tap conductor is not under load.
- Provides a visual guide for proper installation of conductors

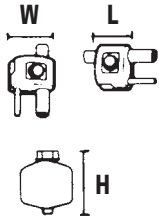

Fig. 1



Fig. 2



Fig. 3



Fig. 4

Catalog Number	Figure Number	Wire Range		Volts	Current Rating		Dimensions			Torque Ft. Lbs.	Bolt Head Size
		Main	Tap		CU	AL	L	W	H		
IPC-1/0-2	3	1/0-8	2-8	300 (480 Grounded Y System)	130	100	1-7/32	1-15/32	2-5/16	16	1/2
IPC-4/0-6	2	4/0-4	6-14	600	75	60	1-27/64	1	1-7/8	13	1/2
IPC-4/0-2/0	3	4/0-2	2/0-6	600	195	150	1-21/32	1-7/8	2-7/8	25	1/2
IPC-250-4/0	2	250kcmil-1	4/0-6	600	260	205	1-7/8	2-11/32	3-11/32	30	5/8
IPC-350-4/0	3	350kcmil-4/0	4/0-10	300 (480 Grounded Y System)	260	205	1-43/64	2-7/16	3-1/8	25	5/8
IPC-350-350	4	350kcmil-4/0	350kcmil-4/0	300 (480 Grounded Y System)	350	280	2-43/64	2-23/32	3-1/4	25	5/8
IPC-500-12 *	1	500kcmil-250kcmil	10-12	300 (480 Grounded Y System)	40	35	1-43/64	2-7/16	3-1/4	25	5/8
IPC-500-250	1	500kcmil-250kcmil	250kcmil-4	600	290	230	2-27/64	2-29/32	3-3/4	55	5/8-11/16
IPC-500-500	1	500kcmil-300kcmil	500kcmil-250kcmil	600	430	350	3-3/16	3-5/8	5	75	7/8-7/8
IPC-750-500	1	750kcmil-500kcmil	500kcmil-350kcmil	600	430	350	3-3/16	3-5/8	5	75	7/8-7/8

* Not CSA Certified

Tested to UL 486A-486B, UL File E6207



LDA/LDB

Snap Bloc®



214

PDA/PDC



215



PDB



216 - 218

PDB



219

PDB



220

PDB



221

TYPE

LDA

LDB

Features

- Modular design
- Easy to assemble
- UL listed 90° C 600 Volts and is CSA Certified
- Electro-tin plated 6061-T6 aluminum alloy
- Clear cover
- Multiple conductor capability

Benefits

- Simplifies stocking. Combines any number of blocks with multiple conductor ranges into the specific configuration required for the job.
- Unique locking feature allows individual blocks to be combined quickly without special tools
- Ensures reliability
- Suitable for use with both copper and aluminum conductors in any combination
- Permits visual inspection
- Individual blocks supplied in a variety of configurations with one or two main cable ports and four, six, or twelve taps. All are range taking.



Fig. 1

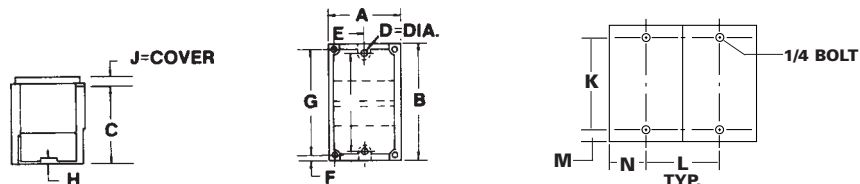

Fig. 2

Catalog Number	Figure Number	Connector		Primary			Secondary			Ampere
		Primary	Secondary	Wire Range	Openings Per Pole	Hex Size	Wire Range	Openings Per Pole	Hex Size	Rating Per Pole
LDB-112-350	1			350kcmil-6	1	3/8	4-14	12	Slot	310
LDA-112-350	2			350kcmil-6	1	3/8	4-14	12	Slot	310
LDB-112A-350	1			350kcmil-6	1	3/8	4-14	12	Slot	310
LDA-112A-350	2			350kcmil-6	1	3/8	4-14	12	Slot	310
LDB-16-350	1			350kcmil-6	1	3/8	2/0-14	6	3/16	310
LDA-16-350	2			350kcmil-6	1	3/8	2/0-14	6	3/16	310
LDB-16-500	1			500kcmil-4	1	3/8	2/0-14	6	3/16	380
LDA-16-500	2			500kcmil-4	1	3/8	2/0-14	6	3/16	380
LDB-26-350	1			350kcmil-6	2	3/8	2/0-14	6	3/16	620
LDA-26-350	2			350kcmil-6	2	3/8	2/0-14	6	3/16	620
LDB-212-4/0	1			4/0-6	2	1/4	4-14	12	Slot	460
LDA-212-4/0	2			4/0-6	2	1/4	4-14	12	Slot	460
LDB-212-500	1			500kcmil-4	2	3/8	4-14	12	Slot	760
LDA-212-500	2			500kcmil-4	2	3/8	4-14	12	Slot	760
LDB-26-500	1			500kcmil-4	2	3/8	2/0-14	6	3/16	760
LDA-26-500	2			500kcmil-4	2	3/8	2/0-14	6	3/16	760
LDB-24-500	1			500kcmil-4	2	3/8	4/0-6	4	5/16	760
LDA-24-500	2			500kcmil-4	2	3/8	4/0-6	4	5/16	760
LDB-11-500	1			500kcmil-4	1	3/8	500kcmil-4	1	3/8	380
LDA-11-500	2			500kcmil-4	1	3/8	500kcmil-4	1	3/8	380
LDB-22-350	1			350kcmil-6	2	3/8	350kcmil-6	2	3/8	620
LDA-22-350	2			350kcmil-6	2	3/8	350kcmil-6	2	3/8	620
LDB-22-500	1			500kcmil-4	2	3/8	500kcmil-4	2	3/8	760
LDA-22-500	2			500kcmil-4	2	3/8	500kcmil-4	2	3/8	760

Side Panel can be ordered separately Cat. No. LDS-1

Tested to UL 1059, UL File E112158



Dimensions

A	B	C	D=Dia.	E	F	G	H	J = Cover	K	L	M	N
3	5-1/2	3-7/16	.28 Slot	1-1/2	5/16	4-7/8	1/4	1/2	4.75	2.69	.38	1.50

TYPE PDA PDC

Features

- Modular design
- Easy to assemble
- UL Recognized 90° C 600 Volts and is CSA Certified
- Electro-tin plated
- Lexan* insulating base
- Manufactured from high strength 6061-T6 aluminum alloy

Benefits

- Simplifies stocking. Combines any number of blocks with multiple conductor ranges into the specific configuration required for the job.
- Unique locking feature allows individual blocks to be combined quickly without special tools
- Ensures reliability
- Provides low contact resistance
- Provides a high degree of impact resistance with superior insulating qualities
- Suitable for use with either copper or aluminum conductors



Fig. 1



Fig. 2



Fig. 3



Fig. 4

Catalog Number	Figure Number	Connector		Primary		Secondary		Ampere Rating Per Pole	No. of Poles	Hex Size	
		Primary	Secondary	Wire Range	Openings Per Pole	Wire Range	Openings Per Pole			Primary	Secondary
PDC-14-2/0-1	1			2/0-14	1	4-14	4	175	1	3/16	Slot
PDA-14-2/0-1	2			2/0-14	1	4-14	4	175	Adder	3/16	Slot
PDC-11-2/0-1	3			2/0-14	1	2/0-14	1	175	1	3/16	3/16
PDA-11-2/0-1	4			2/0-14	1	2/0-14	1	175	Adder	3/16	3/16

Covers available 1-10 Poles. Specify length.

*Lexan is a registered trademark of SABIC INNOVATIVE PLASTICS HOLDINGS BV.

Tested to UL 486A-486B, UL File E84782

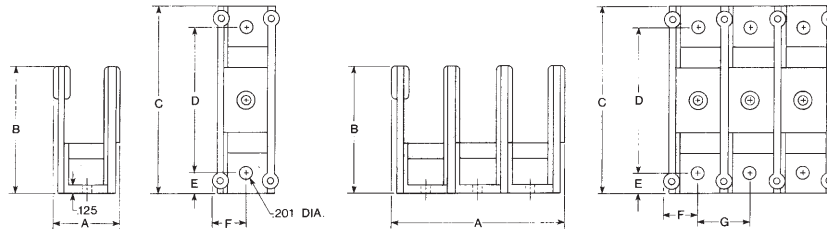

Block Size	No. of Poles	Dimensions						
		A	B	C	D	E	F	G
S	1	1.05	1.94	2.88	2.25	.31	.53	.80
S	2	1.85	1.94	2.88	2.25	.31	.53	.80

"A" Dimension increases by .80 per additional pole.

TYPE PDB

Features

- Range taking
- Valox* insulating base
- Electro-tin plated
- Manufactured from high strength 6061-T6 aluminum alloy
- UL Recognized rated 90° C and is CSA Certified, rated for 600 volts

Benefits

- Provides great flexibility in using the connector as an in line splice or to reduce conductor size
- Provides a high degree of impact resistance with superior insulating qualities
- Provides low contact resistance
- Suitable for use with either copper or aluminum conductors
- Ensures reliability



Catalog Number	Connector		Primary		Secondary		Ampere Rating Per Pole	Number Of Poles	Block Size	Hex Size	
	Primary	Secondary	Wire Range	Openings Per Pole	Wire Range	Openings Per Pole				Primary	Secondary
PDB-16-2/0-1			2/0-12	1	4-14	6	175	1	M	3/16	Slot
PDB-16-2/0-2			2/0-12	1	4-14	6	175	2	M	3/16	Slot
PDB-16-2/0-3			2/0-12	1	4-14	6	175	3	M	3/16	Slot
PDB-26-2/0-1			2/0-12	2	2-14	6	350	1	M	3/16	Slot
PDB-26-2/0-2			2/0-12	2	2-14	6	350	2	M	3/16	Slot
PDB-26-2/0-3			2/0-12	2	2-14	6	350	3	M	3/16	Slot
PDB-112-350-1			350kcmil-6	1	4-14	12	310	1	L	3/8	Slot
PDB-112-350-2			350kcmil-6	1	4-14	12	310	2	L	3/8	Slot
PDB-112-350-3			350kcmil-6	1	4-14	12	310	3	L	3/8	Slot
PDB-112A-350-1			350kcmil-6	1	4-14	12	310	1	M	3/8	Slot
PDB-112A-350-2			350kcmil-6	1	4-14	12	310	2	M	3/8	Slot
PDB-112A-350-3			350kcmil-6	1	4-14	12	310	3	M	3/8	Slot
PDB-14-500-1			500kcmil-4	1	2/0-14	4	380	1	M	3/8	3/16
PDB-14-500-2			500kcmil-4	1	2/0-14	4	380	2	M	3/8	3/16
PDB-14-500-3			500kcmil-4	1	2/0-14	4	380	3	M	3/8	3/16
PDB-16-350-1			350kcmil-6	1	2/0-14	6	310	1	L	3/8	3/16
PDB-16-350-2			350kcmil-6	1	2/0-14	6	310	2	L	3/8	3/16
PDB-16-350-3			350kcmil-6	1	2/0-14	6	310	3	L	3/8	3/16
PDB-162-500-1			500kcmil-4	1	2-14	6	380	1	M	3/8	Slot
PDB-162-500-2			500kcmil-4	1	2-14	6	380	2	M	3/8	Slot
PDB-162-500-3			500kcmil-4	1	2-14	6	380	3	M	3/8	Slot

* Valox® is a registered trade name of the General Electric Company.

Tested to UL 1059, UL File E84782

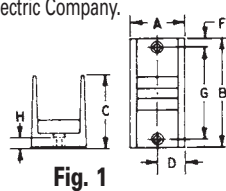

Fig. 1

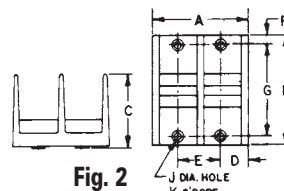

Fig. 2

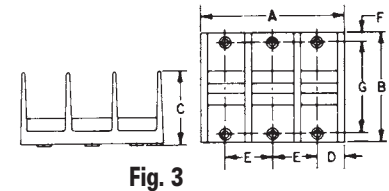

Fig. 3

Dimensions

Block Size	Number Of Poles	Figure Number	A	B	C	D	E	F	G	H	J	K
M	1	1	1-27/32	4	2-5/8	31/32	-	5/16	3-3/8	3/8	13/64	13/32
M	2	2	3-13/32	4	2-5/8	31/32	1-17/32	5/16	3-3/8	3/8	13/64	13/32
M	3	3	5	4	2-5/8	31/32	1-17/32	5/16	3-3/8	3/8	13/64	13/32
L	1	1	3	5-1/2	3-1/2	1-1/2	-	3/8	4-3/4	7/16	9/32	1/2
L	2	2	5-11/16	5-1/2	3-1/2	1-1/2	2-11/16	3/8	4-3/4	7/16	9/32	1/2
L	3	3	8-3/8	5-1/2	3-1/2	1-1/2	2-11/16	3/8	4-3/4	7/16	9/32	1/2



TYPE PDB

Features

- Range taking
- Valox* insulating base
- Electro-tin plated
- Manufactured from high strength 6061-T6 aluminum alloy
- UL Recognized rated 90° C and is CSA Certified, rated for 600 volts

Benefits

- Provides great flexibility in using the connector as an in line splice or to reduce conductor size
- Provides a high degree of impact resistance with superior insulating qualities
- Provides low contact resistance
- Suitable for use with either copper or aluminum conductors
- Ensures reliability



Catalog Number	Connector		Primary		Secondary		Ampere Rating Per Pole	Number Of Poles	Block Size	Hex Size	
	Primary	Secondary	Wire Range	Openings Per Pole	Wire Range	Openings Per Pole				Primary	Secondary
PDB-212-4/0-1			4/0-6	2	4-14	12	460	1	M		
PDB-212-4/0-2			4/0-6	2	4-14	12	460	2	M	3/8	Slot
PDB-212-4/0-3			4/0-6	2	4-14	12	460	3	M		
PDB-26-350-1			350kcmil-6	2	2/0-14	6	620	1	L		
PDB-26-350-2			350kcmil-6	2	2/0-14	6	620	2	L	3/8	3/16
PDB-26-350-3			350kcmil-6	2	2/0-14	6	620	3	L		
PDB-16-500-1			500kcmil-4	1	2/0-14	6	380	1	L		
PDB-16-500-2			500kcmil-4	1	2/0-14	6	380	2	L	3/8	3/16
PDB-16-500-3			500kcmil-4	1	2/0-14	6	380	3	L		
PDB-212-500-1			500kcmil-4	2	4-14	12	760	1	L		
PDB-212-500-2			500kcmil-4	2	4-14	12	760	2	L	3/8	Slot
PDB-212-500-3			500kcmil-4	2	4-14	12	760	3	L		
PDB-24-500-1			500kcmil-4	2	4/0-6	4	760	1	L		
PDB-24-500-2			500kcmil-4	2	4/0-6	4	760	2	L	3/8	5/16
PDB-24-500-3			500kcmil-4	2	4/0-6	4	760	3	L		
PDB-26-500-1			500kcmil-4	2	2/0-14	6	760	1	L		
PDB-26-500-2			500kcmil-4	2	2/0-14	6	760	2	L	3/8	3/16
PDB-26-500-3			500kcmil-4	2	2/0-14	6	760	3	L		

* Valox® is a registered trade name of the General Electric Company.

Tested to UL 1059, UL File E84782

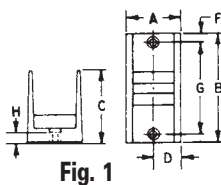

Fig. 1

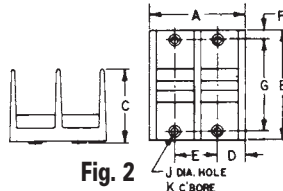

Fig. 2

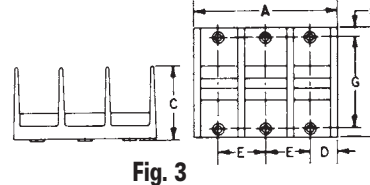

Fig. 3

Dimensions

Block Size	Number Of Poles	Figure Number	A	B	C	D	E	F	G	H	J	K
M	1	1	1-27/32	4	2-5/8	31/32	-	5/16	3-3/8	3/8	13/64	13/32
M	2	2	3-13/32	4	2-5/8	31/32	1-17/32	5/16	3-3/8	3/8	13/64	13/32
M	3	3	5	4	2-5/8	31/32	1-17/32	5/16	3-3/8	3/8	13/64	13/32
L	1	1	3	5-1/2	3-1/2	1-1/2	-	3/8	4-3/4	7/16	9/32	1/2
L	2	2	5-11/16	5-1/2	3-1/2	1-1/2	2-11/16	3/8	4-3/4	7/16	9/32	1/2
L	3	3	8-3/8	5-1/2	3-1/2	1-1/2	2-11/16	3/8	4-3/4	7/16	9/32	1/2

TYPE PDB

Features

- Multiple taps
- Range taking
- Valox* insulating base
- Electro-tin plated
- Manufactured from high strength 6061-T6 aluminum alloy
- UL Recognized rated 90° C and is CSA Certified, rated for 600 volts

Benefits

- Depending on product selected, up to twelve taps can be taken from one or two mains
- Provides tapping flexibility over a broad wire range
- Provides a high degree of impact resistance with superior insulating qualities
- Provides low contact resistance
- Suitable for use with either copper or aluminum conductors
- Ensures reliability



Catalog Number	Connector		Primary		Secondary		Ampere Rating Per Pole	Number Of Poles	Block Size	Hex Size	
	Primary	Secondary	Wire Range	Openings Per Pole	Wire Range	Openings Per Pole				Primary	Secondary
PDB-11-2/0-1			2/0-14	1	2/0-14	1	175	1	M	3/16	3/16
PDB-11-2/0-2			2/0-14	1	2/0-14	1	175	2	M		
PDB-11-2/0-3			2/0-14	1	2/0-14	1	175	3	M		
PDB-11-350-1			350kcmil-6	1	350kcmil-6	1	310	1	M	3/8	3/8
PDB-11-350-2			350kcmil-6	1	350kcmil-6	1	310	2	M		
PDB-11-350-3			350kcmil-6	1	350kcmil-6	1	310	3	M		
PDB-11-500-1			500kcmil-4	1	500kcmil-4	1	380	1	L	3/8	3/8
PDB-11-500-2			500kcmil-4	1	500kcmil-4	1	380	2	L		
PDB-11-500-3			500kcmil-4	1	500kcmil-4	1	380	3	L		
PDB-22-2/0-1			2/0-14	2	2/0-14	2	350	1	M	3/16	3/16
PDB-22-2/0-2			2/0-14	2	2/0-14	2	350	2	M		
PDB-22-2/0-3			2/0-14	2	2/0-14	2	350	3	M		
PDB-22-350-1			350kcmil-6	2	350kcmil-6	2	620	1	L	3/8	3/8
PDB-22-350-2			350kcmil-6	2	350kcmil-6	2	620	2	L		
PDB-22-350-3			350kcmil-6	2	350kcmil-6	2	620	3	L		
PDB-22-500-1			500kcmil-4	2	500kcmil-4	2	760	1	L	3/8	3/8
PDB-22-500-2			500kcmil-4	2	500kcmil-4	2	760	2	L		
PDB-22-500-3			500kcmil-4	2	500kcmil-4	2	760	3	L		

* Valox® is a registered trade name of the General Electric Company.

Tested to UL 1059, UL File E84782

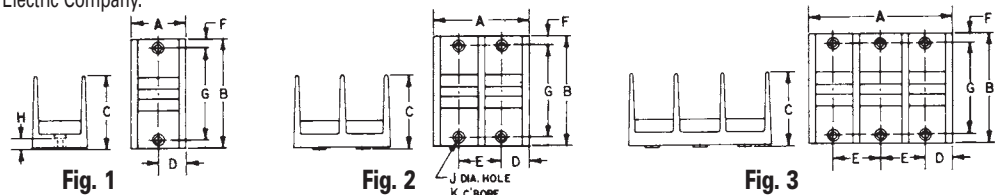

Dimensions

Block Size	Number Of Poles	Figure Number	A	B	C	D	E	F	G	H	J	K
M	1	1	1-27/32	4	2-5/8	31/32	-	5/16	3-3/8	3/8	13/64	13/32
M	2	2	3-13/32	4	2-5/8	31/32	1-17/32	5/16	3-3/8	3/8	13/64	13/32
M	3	3	5	4	2-5/8	31/32	1-17/32	5/16	3-3/8	3/8	13/64	13/32
L	1	1	3	5-1/2	3-1/2	1-1/2	-	3/8	4-3/4	7/16	9/32	1/2
L	2	2	5-11/16	5-1/2	3-1/2	1-1/2	2-11/16	3/8	4-3/4	7/16	9/32	1/2
L	3	3	8-3/8	5-1/2	3-1/2	1-1/2	2-11/16	3/8	4-3/4	7/16	9/32	1/2

TYPE PDB

Features

- Lay-In primary cable ports
- Valox insulating base
- Clear cover
- UL 1953 Listed and CSA Certified for 600 volts
- Electro-tin plated
- Manufactured from high strength 6061-T6 aluminum alloy

Benefits

- Designed for feed through of two primary conductors and up to six taps with no need to break the main feeder cable
- Provides a high degree of impact resistance with superior insulating qualities
- Permits visual inspection
- Ensures reliability
- Provides low contact resistance
- Suitable for use with either copper or aluminum conductors



Catalog Number	Connector		Primary		Secondary		Ampere Rating Per Pole	Number Of Poles	Hex Size	
	Primary	Secondary	Wire Range	Openings Per Pole	Wire Range	Openings Per Pole			Primary	Secondary
									PDB-26-750-1	

Tested to UL 1059, UL File E112158

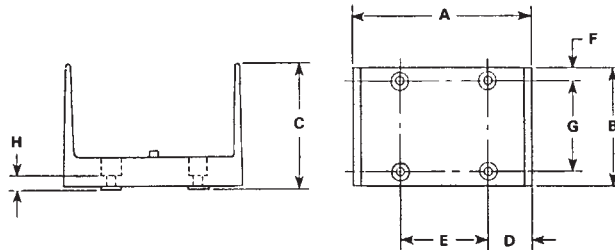

Block Size	No. of Poles	Dimensions							
		A	B	C	D	E	F	G	H
W	1	6-7/32	4	4-3/8	1-19/32	3	3/8	3-1/4	7/16

* Valox® is a registered trade name of the General Electric Company.

TYPE PDB

Features

- Manufactured from high strength 6061-T6 aluminum alloy
- Valox* insulating base
- UL 1953 Listed 90° C 600 volts
- Electro-tin plated
- Clear cover

Benefits

- Reliable use for copper conductor only
- Provides a high degree of impact resistance with superior insulating qualities
- Ensures reliability
- Provides low contact resistance
- Provides visual inspection



Catalog Number	Connector		Primary		Secondary		Ampere Rating Per Pole	Number Of Poles	Block Size	Hex Size	
	Primary	Secondary	Wire Range	Openings Per Pole	Wire Range	Openings Per Pole				Primary	Secondary
										Primary	Secondary
PDB-55-600-1			600kcmil-250kcmil	5	600kcmil-250kcmil	5	1900	1	W	3/8	3/8

Valox® is a registered trade name of the General Electric Company.
A versatile tap hole, wire range 8-14 AWG included on the connector.

Tested to UL 1059, UL File E112158

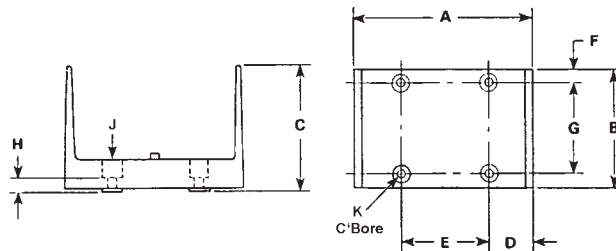

Block Size	No. of Poles	Dimensions									
		A	B	C	D	E	F	G	H	J	K
W	1	6-7/32	4	4-3/8	1-19/32	3	3/8	3-1/4	7/16	9/32	9/16

ILSCO Power Distribution Blocks - Dual Rated



TYPE PDB

Features

- Multiple taps
- Valox® insulating base
- Clear cover
- UL 1953 Listed 90° C 600 Volts and is CSA Certified
- Electro-tin plated
- Manufactured from high strength 6061-T6 aluminum alloy

Benefits

- Three different connector configurations provide a wide range of tapping capabilities for up to four primary conductors
- Provides a high degree of impact resistance with superior insulating qualities
- Permits visual inspection
- Ensures reliability
- Provides low contact resistance
- Suitable for use with either copper or aluminum conductors



Fig. 1



Fig. 2



Fig. 3

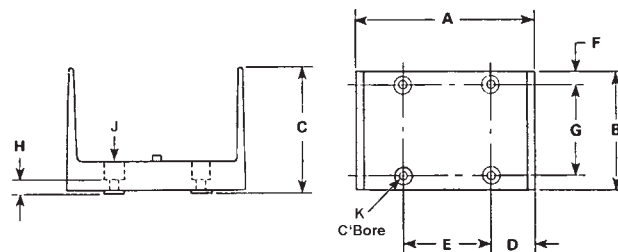

Fig. 4

Catalog Number	Figure Number	Connector		Primary		Secondary		Ampere Rating Per Pole	Number of Poles	Block Size	Hex Size	
		Primary	Secondary	Wire Range	Openings Per Pole	Wire Range	Openings Per Pole				Primary	Secondary
PDB-428-500-1	1			500kcmil-4	4	4-14	28	1520	1	W	3/8	Slot
PDB-49-500-1	2			500kcmil-4	4	350kcmil-6 4/0-6	6 3	1520	1	W	3/8	3/8 5/16
‡ PDB-55-500-1	4			500kcmil-3/0	5	500kcmil-3/0	5	1600	1	W	3/8	3/8
PDB-412-500-1	3			500kcmil-4	4	4/0-6	12	1520	1	W	3/8	5/16

Valox® is a registered trade name of the General Electric Company.
 ° A versatile tap hole, wire range 8-14 AWG included on the connector.
 ‡ Not CSA Certified

Tested to UL 1059, UL File E112158



Block Size	No. of Poles	Dimensions									
		A	B	C	D	E	F	G	H	J	K
W	1	6-7/32	4	4-3/8	1-19/32	3	3/8	3-1/4	7/16	9/32	9/16



**Bronze Ground Clamps
Type BGDB**



**ClearGround™
Intersystem Ground Tap
Type GBT**

<p>GGA</p> <p>224</p>	<p>GGC</p> <p>225</p>	<p>ULT</p> <p>226</p>
<p>ELT</p> <p>227</p>	<p>CGRC</p> <p>228</p>	<p>BGRC</p> <p>229</p>
<p>SRC</p> <p>230</p>	<p>GRC</p> <p>231</p>	<p>RLT</p> <p>232</p>
<p>DCGC</p> <p>233</p>	<p>BGC</p> <p>234</p>	<p>BGC</p> <p>235</p>
<p>BGDB</p> <p>236</p>	<p>BGCS</p> <p>237</p>	<p>SPS</p> <p>238 - 239</p>
<p>SPD</p> <p>240 - 241</p>	<p>TTGC</p> <p>242</p>	<p>GUB</p> <p>243</p>
<p>T</p> <p>244 - 251</p>	<p>GS/GSR</p> <p>252</p>	<p>D167</p> <p>253</p>
<p>GBL</p> <p>256</p>	<p>GBL-DB</p> <p>257</p>	<p>GBT</p> <p>258</p>
<p>GRM</p> <p>259</p>	<p>GRF</p> <p>259</p>	<p>NB</p> <p>260</p>

- **Pure wrought copper extrusions prevent corrosion due to dissimilar metals, have the same conductivity as copper conductors, and are pre-filled with inhibiting compound**

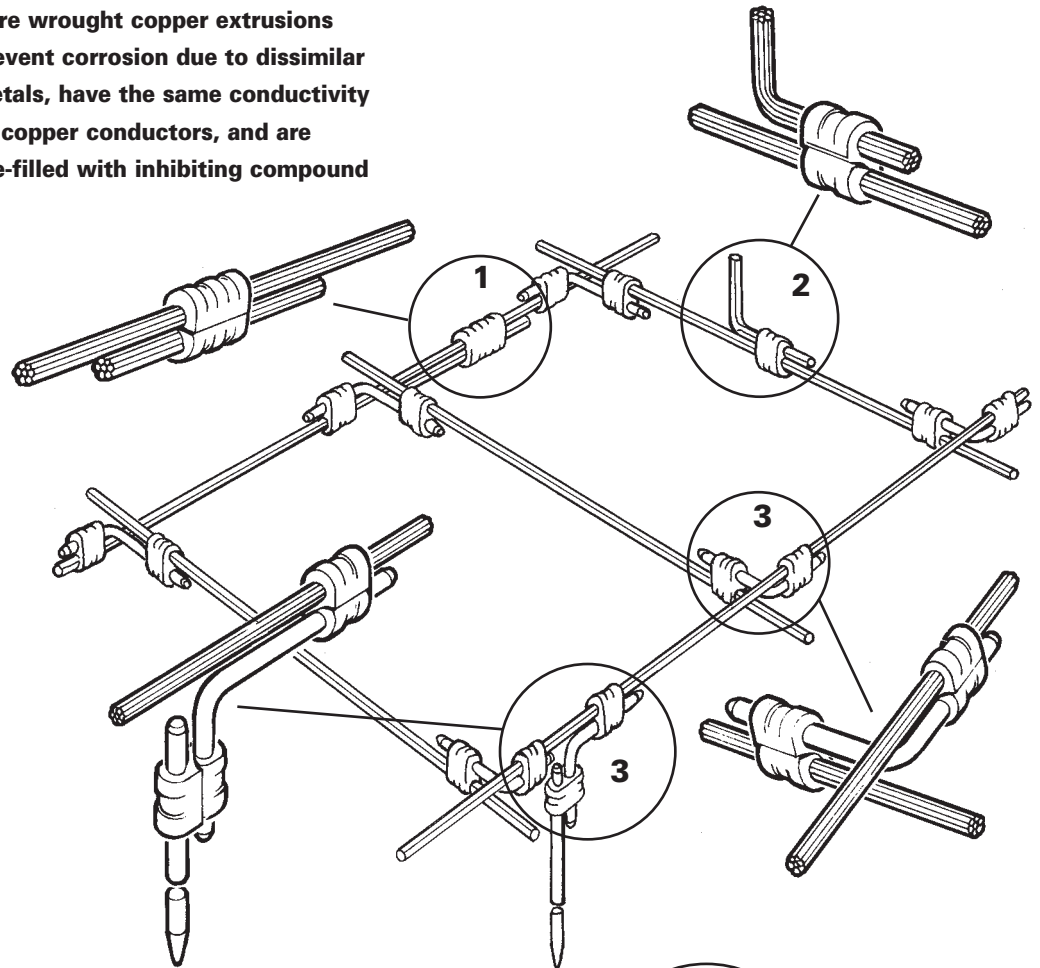

1 ULT

Compression Line Tap/C-Crimp

Applications: Tap Connector, Lap Splice Connector
 Conductor Range: #6 solid – 4/0



2 GGC

Compression Ground Tap Connector

Applications: Tap Connector, Lap Splice Connector
 Conductor Range: #6 solid – 500kcmil
 Copper Ground Rods: 1/2", 5/8", 3/4"



3 GGA

Compression Ground Grid Cross Connector

Compression elements can be rotated or adjusted prior to installation
 Applications: Cross Connector, Ground Rod Connector
 Conductor Range: #6 solid – 500kcmil
 Copper Ground Rods: 1/2", 5/8", 3/4"



ILSCO Grounding Grid Connectors



TYPE GGA

Features

- Manufactured from high strength copper alloy
- Clearly marked with wire size and die index
- Range taking
- Connector can be adjusted prior to installation
- Non-hazardous installation
- Prefilled with inhibiting compound
- Temp. Rating 90° C

Benefits

- Provides maximum conductivity and eliminates the possibility of corrosion. Suitable for direct burial in earth or concrete
- Provides easy identification and tooling recommendation
- Reduces inventory. Six sizes cover a wire range from 500kcmil to #6, and 1/2" to 3/4" ground rods.
- Permits adjustments to be made for misaligned cross grids
- Can be installed in all types of weather with no need for protective equipment or clothing. Does not produce heat or dangerous particles.
- Prevents oxides from forming
- Ensures reliability

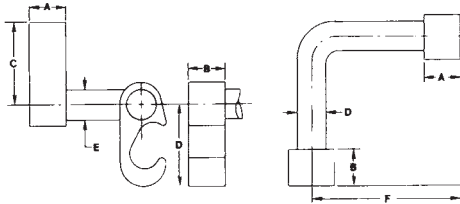

Catalog Number	Wire Range		Rod Size	Dimensions						A Die Index	B Die Index
	Main	Tap		A	B	C	D	E	F		
GGA-1	2str-6sol	2str-6sol	-	.75	.75	1.09	1.09	.313	2.50	0	0
GGA-2	250kcmil-1str	2str-6sol	1/2, 5/8	.75	.75	1.66	1.09	.313	2.50	997	0
GGA-3	250kcmil-2str	250kcmil-2str	1/2, 5/8	.75	.75	1.66	1.66	.500	2.50	997	997
GGA-4	500kcmil-250kcmil	2str-6sol	5/8, 3/4	.75	.75	2.09	1.09	.313	2.50	998	0
GGA-5	500kcmil-250kcmil	250kcmil-2str	5/8, 3/4	.75	.75	2.09	1.66	.500	2.50	998	997
GGA-6	500kcmil-250kcmil	500kcmil-250kcmil	5/8, 3/4	.75	.75	2.28	2.28	.750	2.50	999/1011	999/1011

Tested to UL 467, UL File E34440

NOTE: Hydraulic tools required on all sizes except GGA-1
 Dieless tools can not be used
 ILC-15H or similar required for GGA-4, GGA-5 and GGA-6



ILSCO Grounding Grid Connectors



TYPE GGC

Features

- Manufactured from high strength copper alloy
- Clearly marked with wire size and die index
- Range taking
- Versatile
- Non-hazardous installation
- Prefilled with inhibiting compound
- Temp. Rating 90° C

Benefits

- Provides maximum conductivity and eliminates the possibility of corrosion. Suitable for direct burial in earth or concrete
- Provides easy identification and tooling recommendation
- Reduces inventory. Eight sizes cover a wire range from 500kcmil to #6, and 1/2" to 3/4" ground rods.
- Can be used as a tap connector or as a lap splice connector
- Can be installed in all types of weather with no need for protective equipment or clothing. Does not produce heat or dangerous particles.
- Prevents oxides from forming
- Ensures reliability

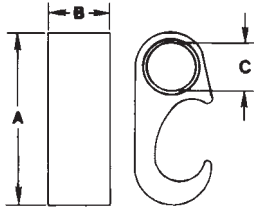

Catalog Number	Wire Range		Rod Size	Dimensions			Index
	Main	Tap		A	B	C	
GGC-1	2str-6sol	2str-6sol	-	1.4	.75	.33	0
GGC-2	250kcmil-1/0str	2str-4sol	1/2, 5/8	2.1	.75	.33	997
GGC-3	250kcmil-1/0str	2/0str-1/0str	1/2, 5/8	2.1	.75	.44	997
GGC-4	250kcmil-1/0str	250kcmil-3/0str	1/2, 5/8	2.1	.75	.61	997
GGC-5	500kcmil-250kcmil	2str-4sol	5/8, 3/4	2.6	.75	.33	998
GGC-6	500kcmil-250kcmil	2/0str-1/0str	5/8, 3/4	2.6	.75	.44	998
GGC-7	500kcmil-250kcmil	250kcmil-3/0str	5/8, 3/4	2.6	.75	.61	998
GGC-8	500kcmil-250kcmil	500kcmil-350kcmil	5/8, 3/4	2.9	.75	.84	999/1011

Tested to UL 467, UL File E34440

NOTE: Hydraulic tools required on all sizes except GGC-1

Dieless tools can not be used

ILC-15H or similar required for GGC-5, GGC-6, GGC-7 and GGC-8

TYPE ULT

Features

- Manufactured from high strength copper alloy
- Clearly marked with wire size and die index
- Range taking
- UL Listed for 600 volts, 90° C

Benefits

- Provides maximum conductivity and eliminates the possibility of corrosion
- Provides easy identification and tooling recommendation
- Reduces inventory
- Ensures reliability

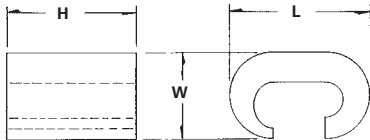

Catalog Number	Wire Range		Die Index	Dimensions		
	Main	Tap		L	W	H
ULT-4-Z	4str-6sol	6str-6sol	BG or 5/8	3/4	15/32	49/64
ULT-5-Z	4str-6sol	4str-4sol	BG or 5/8	3/4	15/32	27/32
ULT-6-Z	2str-2sol	6str-8sol	C	7/8	5/8	1
ULT-7-Z	2str-2sol	2str-2sol	C	7/8	39/64	1-1/16
ULT-12-Z	4/0str-3/0str	4/0str-3/0str	F or D3	1-1/8	1	1-5/8

Tested to UL 486A-486B, UL File E6207

G

TYPE ELT

Features

- Manufactured from copper alloy
- Clearly marked with wire size and die index
- Range taking
- UL Listed and CSA Certified for grounding and bonding, rated for 600 volts
- May be used in ground grid applications

Benefits

- Provides maximum conductivity and eliminates the possibility of corrosion. Suitable for direct burial in earth or concrete
- Provides easy identification and tooling recommendation
- Reduces inventory
- Ensures reliability
- Flexibility in application



Catalog Number	Copper Wire Range		Width	Die Index
	Main	Tap		
ELT-1	2str-6sol	2str-6sol	.75	C (U Type)
ELT-4	2/0str-1str	2str-6str	.75	0 (U Type)
ELT-2	2/0str-1str	2/0str-1str	.75	0 (U Type)
ELT-5	250kcmil-3/0str	2/0str-6sol	.75	997 (U Type)
ELT-3	250kcmil-3/0str	250kcmil-3/0str	.900	997 (U Type)
ELT-6	500kcmil-300kcmil	250kcmil-3/0str	.875	1011 (U Type)

Tooling Information

Catalog Number	ILSCO			Burndy		
	ILC-12H-N ILC-12-N Die No. No. of Crimps	ILCB-12-N Die No. No. of Crimps	ILC-15H Die No. No. of Crimps	Y-35 Die Index No. of Crimps	Y-45 Die Index No. of Crimps	Y-46 Die Index No. of Crimps
ELT-1	ILD-C (1)	ILD-C (1)	- -	C (U Type) (1)	C (U Type) (1)	C (U Type) (1)
ELT-4	ILD-O (1)	ILD-O (1)	- -	O (U Type) (1)	O (U Type) (1)	O (U Type) (1)
ELT-2	ILD-O (1)	ILD-O (1)	- -	O (U Type) (1)	O (U Type) (1)	O (U Type) (1)
ELT-5	ILD-U997 (1)	ILD-U997 (1)	- -	997 (U Type) (1)	997 (U Type) (1)	997 (U Type) (1)
ELT-3	ILD-U997 (1)	ILD-U997 (1)	- -	997 (U Type) (1)	997 (U Type) (1)	997 (U Type) (1)
ELT-6	- -	- -	ILD-P1011 (2)	- -	1011 (U Type) (2)	1011 (U Type) (1)

See stuffer sheet for complete information on tooling.

Tested to UL 467, UL File E34440

ILSCO Economy Cast Bronze Ground Rod Clamps



TYPE CGRC

Features

- Manufactured from cast bronze
- Supplied with stainless steel hardware
- UL Listed and CSA Certified for 600 volts except for CGRC-38
- Suitable for grounding and bonding in applications such as swimming pools and spas

Benefits

- Ensures maximum strength and durability
- Suitable for direct burial in earth or concrete
- Ensures reliability for copper conductor

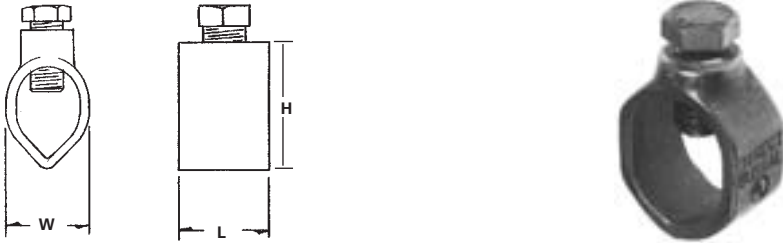

Catalog Number	Ground Rod Size	Rebar Size	Ground Rod Wire Range	Rebar Wire Range	Dimensions		
					L	W	H
CGRC-38	3/8	#3	4-10	4-10	1/2	11/16	1
CGRC-48	1/2	#4	2-10	2-10	9/16	27/32	1-3/16
CGRC-58	5/8	#5	2-10	4-10	9/16	15/16	1-9/32
CGRC-68	3/4	#6	2-10	4-10	9/16	1-1/16	1-9/32

Plain copper finish.

Tested to UL 467, UL File E34440

G



ILSCO Cast Bronze Ground Rod Clamps



TYPE BGRC

Features

- Manufactured from cast bronze
- Supplied with stainless steel hardware
- UL Listed and CSA Certified for 600 volts

Benefits

- Ensures maximum strength and durability
- Suitable for direct burial in earth or concrete
- Ensures reliability for copper conductor

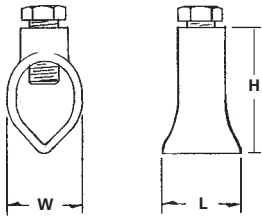

Catalog Number	Ground Rod Size	Rebar Size	Ground Rod Wire Range	Rebar Wire Range	Dimensions		
					L	W	H
BGRC-48	1/2	-	2-10	-	7/8	3/4	1-1/4
BGRC-58	5/8	#5	1/0-8	1/0-8	1-1/32	29/32	1-13/32
BGRC-68	3/4	-	1/0-8	-	1	1	1-5/8

Tested to UL 467, UL File E34440

G

ILSCO Cast Bronze Ground Rod Clamp



TYPE
SRC

Features

- Manufactured from bronze alloy
- Stainless steel bolt
- UL Listed for both copper clad and galvanized ground rods
- Range taking

Benefits

- Provides maximum strength and superior conductivity
- For direct burial
- Ensures reliability
- Reduces inventory requirement



Catalog Number	Ground Rod Size	Ground Rod Wire Range	Dimensions		
			L	W	H
SRC-1/0	3/8, 1/2, 5/8 3/4	10 sol - 1/0 str 8 sol - 1/0 str	13/16	1	1-1/2

UL File E198108

G



TYPE GRC

Features

- Manufactured from seamless bronze tubing
- Supplied with silicon bronze screw
- UL Listed and CSA Certified for 600 volts except GRC-75
- Suitable for grounding and bonding in applications such as swimming pools and spas

Benefits

- Provides maximum strength and superior conductivity
- Ground rod clamp is suitable for direct burial in earth or concrete
- Ensures reliability for copper conductor

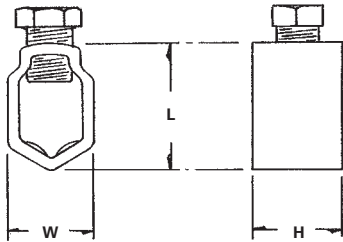

Catalog Number	Ground Rod Size	Ground Wire Range	Rebar Size	Rebar Wire Range	Dimensions	
					L	W
GRC-38	3/8	4-10	#3	4-10	5/8	5/8
GRC-58+	5/8	2-8	-	-	15/16	7/8
GRC-68	3/4, 5/8	2-8 for 3/4 rod, 1/0-8 for 5/8 rod	#5	1/0-8	1	1
GRC-75*	3/4	3/0-8	-	-	3/4	1-5/32

G

Plain copper finish.
+ REA Listed.
* Not UL Listed

Tested to UL 467, UL File E34440

TYPE RLT

Features

- Prefilled with oxide inhibitor and bagged
- Clearly marked with wire size and die index
- UL Listed for 600 Volts and CSA Certified for direct burial in earth or concrete
- Range taking
- Manufactured from high strength copper alloy

Benefits

- Prevents oxides from forming
- Provides easy identification and tooling recommendation
- Ensures reliability
- Reduces inventory. Eight sizes cover a wire range of #2-500kcmil
- Provides maximum conductivity and eliminates the possibility of corrosion

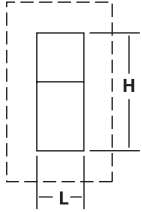

Catalog Number	Ground Rod Size	Wire Range	Die Index	Dimensions	
				H	L
RLT-2	1/2	2 (.292 Dia.) - 2/0 (.419 Dia.)	998/1011	1.94	.88
RLT-3	5/8	2 (.292 Dia.) - 2/0 (.419 Dia.)	998/1011	1.97	.88
RLT-4	3/4	2 (.292 Dia.) - 2/0 (.419 Dia.)	998/1011	2.19	.88
RLT-5	1/2	4/0 (.528 Dia.) - 250kcmil (.575 Dia.)	998/1011	1.94	.88
RLT-6	5/8	4/0 (.528 Dia.) - 250kcmil (.575 Dia.)	998/1011	2.14	.88
RLT-7	3/4	4/0 (.528 Dia.) - 250kcmil (.575 Dia.)	998/1011	2.19	.88
RLT-8	5/8	300kcmil (.630 Dia.) - 500kcmil (.813 Dia.)	998/1011	2.14	.88
RLT-9	3/4	300kcmil (.630 Dia.) - 500kcmil (.813 Dia.)	998/1011	2.44	.88

UL File E158587



ILSCO Die Cast Ground Clamp



TYPE
DCGC

Features

- Manufactured from die cast zinc alloy
- UL Listed for 600 volts
- Assembled with zinc plated steel hardware

Benefits

- Provides maximum durability while providing economy
- Ensures reliability for copper conductor
- Provides corrosion resistance

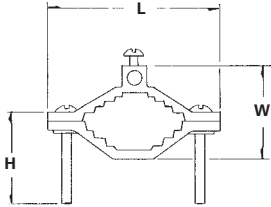

Catalog Number	Conduit Size	Ground Wire Range	L	W	H
DCGC-1	1/2, 3/4, 1	2-8	2-13/64	1-3/8	1-1/2

UL File E158587

G



ILSCO Cast Brass Ground Clamp



TYPE BGC

Features

- Manufactured from cast brass
- UL Listed and CSA Certified for 600 volts
- Type BGC-DB supplied with stainless steel or silicone bronze hardware

Benefits

- Provides maximum conductivity and strength
- Ensures reliability for copper conductor
- BGC-1DB and BGC-2DB are suitable for direct burial in earth or concrete. Can be used to ground swimming pools and spas.

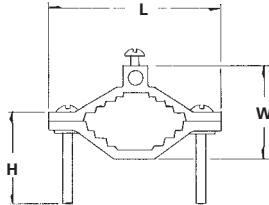

Catalog Number	Pipe Size	Ground Wire Range	Dimensions		
			L	W	H
BGC-1	1/2, 3/4, 1	2-10	2-9/32	2-17/32	1-1/2
BGC-2	1-1/4, 1-1/2, 2	2-10	3-9/16	2-1/4	2
BGC-1DB*	1/2, 3/4, 1	2-10	2-9/32	2-17/32	1-1/2
BGC-2DB*	1-1/4, 1-1/2, 2	2-10	3-8/16	2-1/4	2

* Suitable for direct burial in earth or concrete.

UL File E158587

G



ILSCO Cast Bronze Ground Clamps



TYPE BGC

Features

- Manufactured from cast bronze
- UL Listed for 600 volts
- Versatile

Benefits

- Provides maximum conductivity and strength
- Ensures reliability for copper conductor
- Type BGC supplied with conduit hub for 1/2"-1" rigid conduit; type BGC-A can be used for bare or armoured cable

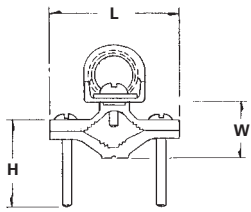

Fig. 1

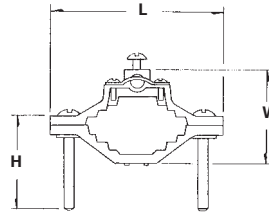

Fig. 2

Catalog Number	Figure Number	Pipe Size	Conduit Hub Size	Wire Range	Dimensions		
					H	W	L
BGC1-50	1	1/2-1	1/2	4str-8sol	1-1/2	1-1/32	2-1/4
BGC1-75	1	1/2-1	3/4	4str-8sol	1-1/2	1-1/32	2-1/4
BGC1-10	1	1/2-1	1	4str-8sol	1-1/2	1-1/32	2-1/4
BGC2-50	1	1-1/4-2	1/2	4str-8sol	2	1-3/4	3-19/32
BGC2-75	1	1-1/4-2	3/4	4str-8sol	2	1-3/4	3-19/32
BGC2-10	1	1-1/4-2	1	4str-8sol	2	1-3/4	3-19/32
BGC-1A*	2	1/2-1	-	4str-8sol	1-1/2	1-3/8	2-1/4
BGC-2A	2	1-1/4-2	-	4str-8sol	2	2-3/32	3-19/32

* CSA Certified

UL File E158587

G

ILSCO Cast Bronze Ground Clamps



TYPE BGDB

Features

- Manufactured from bronze alloy
- UL Listed for direct burial in earth or concrete
- Lay-In feature

Benefits

- Ensures maximum strength and superior conductivity
- Ensures reliability
- Reduces installation time

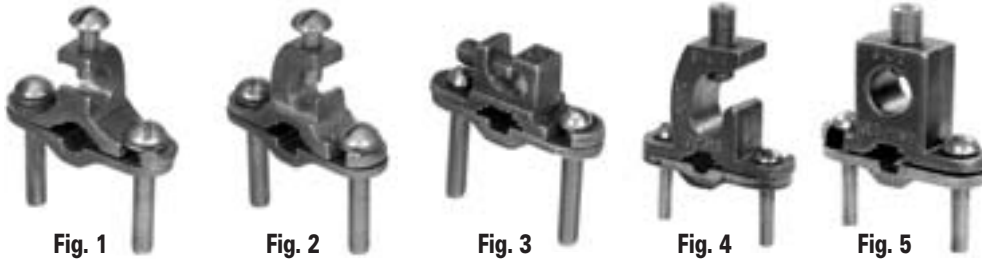

Catalog Number	Figure Number	Pipe Size	Rebar Size	Ground Rod Size	Ground Wire Range	Screw Material	Dimensions	
							L	W
BGC-2T-DB*	1	1/2-1	3/8-1	1/2-1	2str-10sol	silicon bronze	2-3/4	2-1/4
BGC-2P-DB*	2	1/2-1	3/8-1	1/2-1	2str-10sol	silicon bronze	2-3/4	2-1/4
BGC-2PS-DB+	3	1/2-1	3/8-1	1/4-1	2str-10sol 2 #8sol	stainless steel	2-1/4	2-1/4
BGC-4/0P-DB=	4	1/2-1	3/8-1	1/2-1	4/0-8str	stainless steel	3	2-1/4
BGC-4/0S-DB=	5	1/2-1	3/8-1	1/2-1	4/0-8str	stainless steel	2-3/4	2-1/4

* UL File E207816

+ UL File E198108

= UL File E178441



ILSCO Ground Clamp with Strap

TYPE BGCS

Features

- UL Listed and CSA Certified for 600 Volts
- Conduit hub for 1/2" thru 1" rigid conduit
- Zinc plated screws
- ETP copper strap
- For copper conductor only

Benefits

- Ensures reliability
- Range taking
- Corrosion resistance
- Protects conduit system from vibrations and provides maximum conductivity

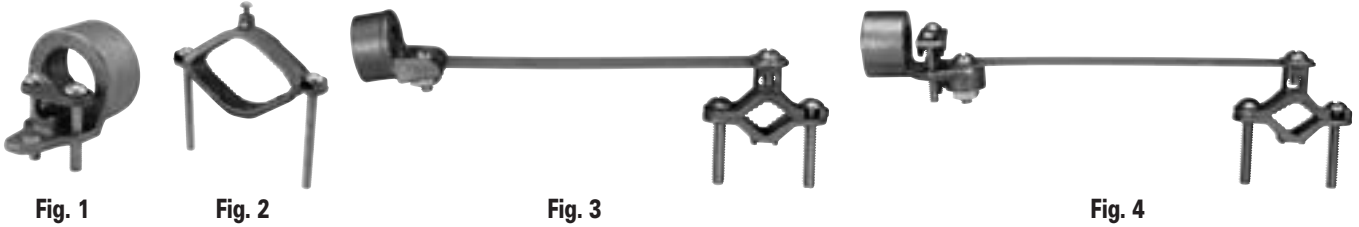

Catalog Number	Figure Number	Water Pipe Range	Conduit Hub Size	Ground Wire Range
CH-1	1	-	1	3/0 AWG - 10sol
CH-34	1	-	3/4	2/0 AWG - 10sol
J2124	2	2-1/2-4	-	4str - 10sol
J6	2	4-1/2-6	-	4str - 10sol
BGC-1-50S	3	1/2-1	1/2	8sol - 4str
BGC-1-75S	3	1/2-1	3/4	8sol - 4str
BGC-1-10S	3	1/2-1	1	8sol - 4str
BGC-1-50SH	4	1/2-1	1/2	2/0 - 10
BGC-1-75SH	4	1/2-1	3/4	2/0 - 10
BGC-1-10SH	4	1/2-1	1	2/0 - 10

UL File E207816

TYPE SPS

Features

- Range taking
- Re-usable
- UL 486A and UL 467 Listed
- For grounding of steel structures, fence posts and tapping cables from bus bar
- For copper to copper connections

Benefits

- Permits inventories to be kept to a minimum
- Provides efficient use and flexibility in the field
- Ensures reliability
- Flexibility in the field

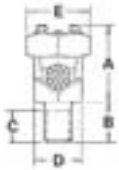

Catalog Number	Conductor Range AWG MM ²				Maximum Diameter Range	Stud Size	Dimensions				
	Stranded		Solid				A	B	C	D	E
	Max.	Min.	Max.	Min.							
SPSS-0	8	12 (4mm ²)	8 (10mm ²)	12 (4mm ²)	.146-.080	1/4-20 x 1/2	11/16	1/2	23/64	15/32	1/2
SPSS-1	7 (10mm ²)	10 (6mm ²)	6 (10mm ²)	10 (6mm ²)	.170-.102	1/4-20 x 1/2	13/16	1/2	23/64	15/32	21/32
SPSS-2	5 (16mm ²)	10 (6mm ²)	4 (16mm ²)	10 (6mm ²)	.217-.102	5/16-18 x 5/8	15/16	5/8	25/64	17/32	23/32
SPSS-3	3 (25mm ²)	10 (6mm ²)	2 (35mm ²)	10 (6mm ²)	.271-.102	3/8-16 x 5/8	1/2	5/8	29/64	5/8	25/32
SPSS-4	1 (35mm ²)	8 (6mm ²)	2 (35mm ²)	8 (10mm ²)	.332-.128	3/8-16 x 5/8	1-1/16	5/8	29/64	11/16	7/8
SPSS-5	1/0 (50mm ²)	2 (35mm ²)	2 (35mm ²)	-	.385-.258	1/2-13 x 3/4	1-1/4	3/4	37/64	3/4	15/16
SPSS-6	2/0 (70mm ²)	2 (35mm ²)	2 (35mm ²)	-	.443-.258	1/2-13 x 3/4	1-13/32	3/4	37/64	7/8	1-1/16
SPSS-8	4/0 (95mm ²)	1 (35mm ²)	-	-	.570-.289	5/8-11 x 1	1-9/16	1	51/64	1	1-5/16
SPSS-9	350 (150mm ²)	1/0 (70mm ²)	-	-	.715-.373	5/8-11 x 1	2	1-1/4	51/64	1-5/16	1-11/16
SPSS-10	500 (240mm ²)	3/0 (95mm ²)	-	-	.840-.464	3/4-10 x 1-1/4	2-1/4	1-3/4	63/64	1-1/2	1-7/8

UL File E158587



TYPE SPS

Features

- Range taking
- Re-usable
- UL 486A and UL 467 Listed
- For grounding of steel structures, fence posts and tapping cables from bus bar
- For copper to copper connections

Benefits

- Permits inventories to be kept to a minimum
- Provides efficient use and flexibility in the field
- Ensures reliability
- Flexibility in the field

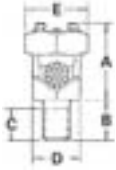

Catalog Number	Conductor Range AWG MM ²				Maximum Diameter Range	Stud Size	Dimensions				
	Stranded		Solid				A	B	C	D	E
	Max.	Min.	Max.	Min.							
SPSL-0	8	12 (4mm ²)	8 (10mm ²)	12 (4mm ²)	.146-.080	1/4-20 x 1	11/16	1	55/64	15/32	1/2
SPSL-1	7 (10mm ²)	10 (6mm ²)	6 (10mm ²)	10 (6mm ²)	.170-.102	1/4-20 x 1	13/16	1	55/64	15/32	21/32
SPSL-2	5 (16mm ²)	10 (6mm ²)	4 (16mm ²)	10 (6mm ²)	.217-.102	5/16-18 x 1	15/16	1	53/64	17/32	23/32
SPSL-3	3 (25mm ²)	10 (6mm ²)	2 (35mm ²)	10 (6mm ²)	.271-.102	3/8-16 x 1-1/8	1/2	1-1/8	61/64	5/8	25/32
SPSL-4	1 (35mm ²)	8 (6mm ²)	2 (35mm ²)	8 (10mm ²)	.332-.128	3/8-16 x 1-1/8	1-1/16	1-1/8	61/64	11/16	7/8
SPSL-5	1/0 (50mm ²)	2 (35mm ²)	2 (35mm ²)	-	.385-.258	1/2-13 x 1-1/4	1-1/4	1-1/4	1-5/64	3/4	15/16
SPSL-6	2/0 (70mm ²)	2 (35mm ²)	2 (35mm ²)	-	.443-.258	1/2-13 x 1-1/4	1-13/32	1-1/4	1-5/64	7/8	1-1/16
SPSL-8	4/0 (95mm ²)	1 (35mm ²)	-	-	.570-.289	5/8-11 x 1-1/2	1-9/16	1-1/2	1-19/64	1	1-5/16
SPSL-9	350 (150mm ²)	1/0 (70mm ²)	-	-	.715-.373	5/8-11 x 1-1/2	2	1-1/2	1-19/64	1-5/16	1-11/16
SPSL-10	500 (240mm ²)	3/0 (95mm ²)	-	-	.840-.464	3/4-10 x 1-3/4	2-1/4	1-1/2	1-31/64	1-1/2	1-7/8

UL File E158587

TYPE SPD

Features

- Range taking
- Re-usable
- UL 486A and UL 467 Listed
- For grounding of steel structures, fence posts and tapping cables from bus bar
- For copper to copper connections

Benefits

- Permits inventories to be kept to a minimum
- Provides efficient use and flexibility in the field
- Ensures reliability
- Flexibility in the field

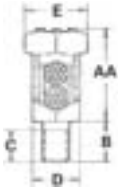

Catalog Number	Conductor Range AWG MM ²				Maximum Diameter Range	Stud Size	Dimensions				
	Stranded		Solid				AA	B	C	D	E
	Max.	Min.	Max.	Min.							
SPDS-0	8	12 (4mm ²)	8 (10mm ²)	12 (4mm ²)	.146-.080	1/4-20 x 1/2	13/16	1/2	23/64	15/32	1/2
SPDS-1	7 (10mm ²)	10 (6mm ²)	6 (10mm ²)	10 (6mm ²)	.170-.102	1/4-20 x 1/2	31/32	1/2	23/64	15/32	21/32
SPDS-2	5 (16mm ²)	10 (6mm ²)	4 (16mm ²)	10 (6mm ²)	.217-.102	5/16-18 x 5/8	1-1/8	5/8	25/64	17/32	23/32
SPDS-3	3 (25mm ²)	10 (6mm ²)	2 (35mm ²)	10 (6mm ²)	.271-.102	3/8-16 x 5/8	1-1/4	5/8	29/64	5/8	25/32
SPDS-4	1 (35mm ²)	8 (6mm ²)	2 (35mm ²)	8 (10mm ²)	.332-.128	3/8-16 x 5/8	1-3/8	5/8	29/64	11/16	7/8
SPDS-5	1/0 (50mm ²)	2 (35mm ²)	2 (35mm ²)	-	.385-.258	1/2-13 x 3/4	1-19/32	3/4	37/64	3/4	15/16
SPDS-6	2/0 (70mm ²)	2 (35mm ²)	2 (35mm ²)	-	.443-.258	1/2-13 x 3/4	1-13/16	3/4	37/64	7/8	1-1/16
SPDS-8	4/0 (95mm ²)	1 (35mm ²)	-	-	.570-.289	5/8-11 x 1	2-1/16	1	51/64	1	1-5/16
SPDS-9	350 (150mm ²)	1/0 (70mm ²)	-	-	.715-.373	5/8-11 x 1	2-3/4	1-1/4	51/64	1-5/16	1-11/16
SPDS-10	500 (240mm ²)	3/0 (95mm ²)	-	-	.840-.464	3/4-10 x 1-1/4	3-1/8	1-3/4	63/64	1-1/2	1-7/8

UL File E158587



TYPE SPD

Features

- Range taking
- Re-usable
- UL 486A and UL 467 Listed
- For grounding of steel structures, fence posts and tapping cables from bus bar
- For copper to copper connections

Benefits

- Permits inventories to be kept to a minimum
- Provides efficient use and flexibility in the field
- Ensures reliability
- Flexibility in the field

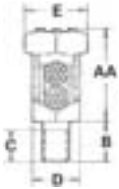

Catalog Number	Conductor Range AWG MM ²				Maximum Diameter Range	Stud Size	Dimensions				
	Stranded		Solid				AA	B	C	D	E
	Max.	Min.	Max.	Min.							
SPDL-0	8	12 (4mm ²)	8 (10mm ²)	12 (4mm ²)	.146-.080	1/4-20 x 1	13/16	1	55/64	15/32	1/2
SPDL-1	7 (10mm ²)	10 (6mm ²)	6 (10mm ²)	10 (6mm ²)	.170-.102	1/4-20 x 1	31/32	1	55/64	15/32	21/32
SPDL-2	5 (16mm ²)	10 (6mm ²)	4 (16mm ²)	10 (6mm ²)	.217-.102	5/16-18 x 1	1-1/8	1	53/64	17/32	23/32
SPDL-3	3 (25mm ²)	10 (6mm ²)	2 (35mm ²)	10 (6mm ²)	.271-.102	3/8-16 x 1-1/8	1-1/4	1-1/8	61/64	5/8	25/32
SPDL-4	1 (35mm ²)	8 (6mm ²)	2 (35mm ²)	8 (10mm ²)	.332-.128	3/8-16 x 1-1/8	1-3/8	1-1/8	61/64	11/16	7/8
SPDL-5	1/0 (50mm ²)	2 (35mm ²)	2 (35mm ²)	-	.385-.258	1/2-13 x 1-1/4	1-19/32	1-1/4	1-5/64	3/4	15/16
SPDL-6	2/0 (70mm ²)	2 (35mm ²)	2 (35mm ²)	-	.443-.258	1/2-13 x 1-1/4	1-13/16	1-1/4	1-5/64	7/8	1-1/16
SPDL-8	4/0 (95mm ²)	1 (35mm ²)	-	-	.570-.289	5/8-11 x 1-1/2	2-1/16	1-1/2	1-19/64	1	1-5/16
SPDL-9	350 (150mm ²)	1/0 (70mm ²)	-	-	.715-.373	5/8-11 x 1-1/2	2-3/4	1-1/2	1-19/64	1-5/16	1-11/16
SPDL-10	500 (240mm ²)	3/0 (95mm ²)	-	-	.840-.464	3/4-10 x 1-3/4	3-1/8	1-1/2	1-31/64	1-1/2	1-7/8

UL File E158587

ILSCO Bronze, Transformer Tank Ground Connectors

TYPE TTGC

Features

- Manufactured from bronze
- Eye bolt on TTGC2 rotates to accommodate cable in vertical or horizontal direction
- Range taking
- Stud fits all standard EEI-NEMA distribution transformers

Benefits

- Provides maximum strength and superior conductivity
- Flexibility
- Permits inventories to be kept to a minimum
- Reliability

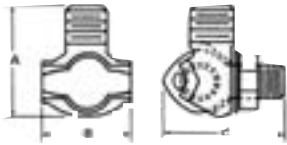

Catalog Number	Conductor Range		Stud Thread Size UNC - 2A	Dimensions		
	Max.	Min.		A	B	C
TTGC2	2/0	8 sol	1/2-13	1-51/64	1-9/64	1-21/32
TTGC3	1 str	10 sol	1/2-13	1-3/8	1-3/64	1-9/16
TTGC4+	1 str	10 sol	1/2-13	1-1/4	7/8	1-3/8
TTGC2TN+	2/0	8 sol	1/2-13	1-51/64	1-9/64	1-21/32
TTGC3TN*	1 str	10 sol	1/2-13	1-3/8	1-3/64	1-9/16
TTGC4TN*	1 str	10 sol	1/2-13	1-1/4	7/8	1-3/8

+ RUS Listed

* Tin Plated

G



ILSCO Bronze, U-Bolt Ground Clamp



TYPE GUB

Features

- Components are cast or forged from copper alloy
- Specially designed spacer
- Range taking
- Re-usable
- UL 467 Listed for direct burial and CSA Certified

Benefits

- Provides maximum conductivity
- Affords more positive contact area
- Permits inventories to be kept to a minimum
- Provides efficient use and flexibility in the field
- Ensures reliability

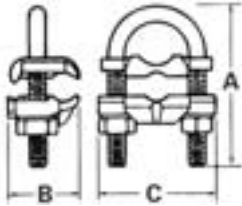

Catalog Number	Conductor		Nominal Rod		IPS Pipe Size		Dimensions		
	Max.	Min.	Max.	Min.	Max.	Min.	A	B	C
GUB-1	4	8	3/4	5/8	3/8	-	2-13/16	1-9/16	2-1/4
GUB-2	2/0	4	3/4	5/8	3/8	-	2-13/16	1-9/16	2-1/4
GUB-3	250kcmil	2/0	3/4	5/8	3/8	-	2-13/16	1-9/16	2-1/4
GUB-4	4	8	1	7/8	3/4	1/2	2-3/4	1-9/16	2-5/8
GUB-5	2/0	4	1	7/8	3/4	1/2	2-3/4	1-9/16	2-5/8
GUB-6	250kcmil	2/0	1	7/8	3/4	1/2	2-3/4	1-9/16	2-5/8
GUB-7	4	8	1-1/4	1-1/8	1	-	3-5/16	1-9/16	2-3/4
GUB-8	2/0	4	1-1/4	1-1/8	1	-	3-5/16	1-9/16	2-3/4
GUB-9	4	8	1-1/2	1-3/8	1-1/4	-	3-7/16	1-9/16	2-15/16
GUB-10	2/0	4	1-1/2	1-3/8	1-1/4	-	3-7/16	1-9/16	2-15/16
GUB-11	250kcmil	2/0	1-1/2	1-3/8	1-1/4	-	3-7/16	1-9/16	2-15/16
GUB-12	4	8	1-7/8	1-5/8	1-1/2	-	3-15/16	1-9/16	3-3/16
GUB-13	2/0	4	1-7/8	1-5/8	1-1/2	-	3-15/16	1-9/16	3-3/16
GUB-14	250kcmil	2/0	1-7/8	1-5/8	1-1/2	-	3-15/16	1-9/16	3-3/16
GUB-15	4	8	2-3/8	2	2	-	4-7/16	1-9/16	3-11/16
GUB-16	2/0	4	2-3/8	2	2	-	4-7/16	1-9/16	3-11/16
GUB-17	250kcmil	2/0	2-3/8	2	2	-	4-7/16	1-9/16	3-11/16
GUB-18	2/0	4	2-7/8	2-1/2	2-1/2	-	4-15/16	1-9/16	4-3/16
GUB-19	250kcmil	2/0	2-7/8	2-1/2	2-1/2	-	4-15/16	1-9/16	4-3/16
GUB-20	2/0	4	3-1/2	3	3	-	5-9/16	1-9/16	4-13/16
GUB-21	250kcmil	2/0	3-1/2	3	3	-	5-9/16	1-9/16	4-13/16
GUB-22	2/0	4	4	3-1/2	3-1/2	-	6-1/16	1-9/16	5-1/2
GUB-23	2/0	4	4-1/2	4	4	-	6-5/16	1-9/16	5-11/16
GUB-24	250kcmil	2/0	4-1/2	4	4	-	6-5/16	1-9/16	5-11/16

UL File E158587



ILSCO Tin Plated Copper Flexible Braid

TYPE T

Features

- Manufactured from pure copper braid
- Electro-tin plated
- Seamless pure copper ferrules
- Inside ferrule ends are rounded
- Swedged terminal to copper braid by cold forming
- Extra flexible braided connector
- Rated for 600 volts

Benefits

- Provides high conductivity
- Provides low contact resistance
- Provides superior contact
- Prevents chafing of strands
- Provides a reduced resistance form point to point; much lower than standard power cables or loose - piece type terminals
- Multi-purpose use for bonding, grounding and connecting moving parts
- Ensures reliability

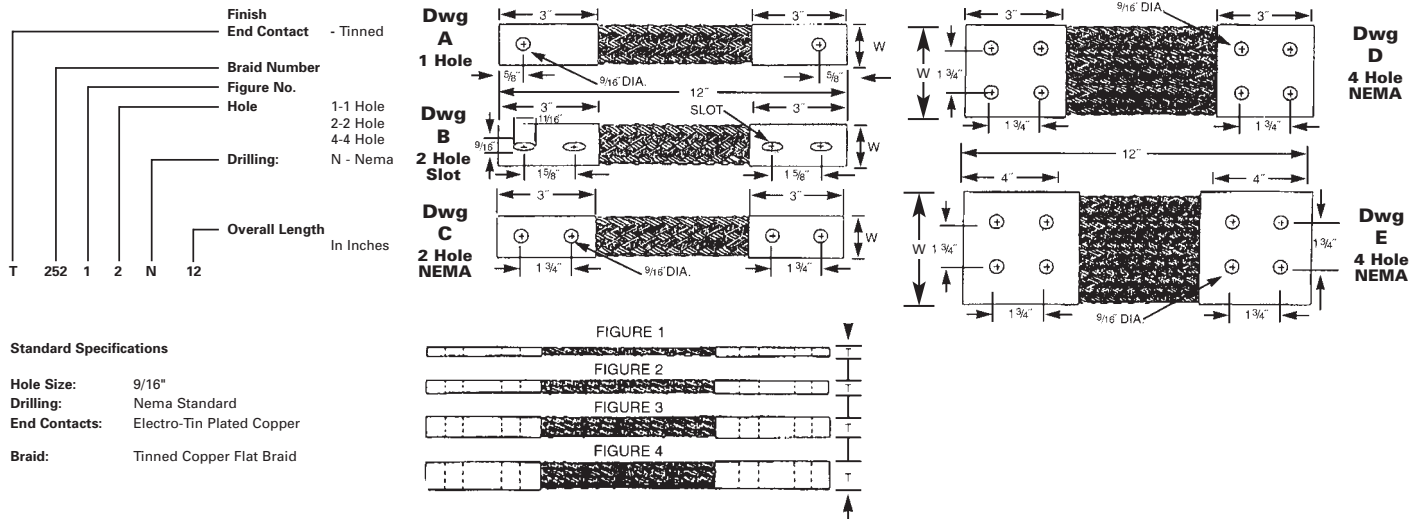

Catalog Number	Figure Number	Drawing Number	Ampere Rating (Indoors)*	Circular Mils. of Braids	Dimensions		
					L	T	W
T252/11N12	1	A	200	77,184	12	0.19	1.00
T252/11N18	1	A	200	77,184	18	0.25	1.00
T252/11N24	1	A	200	77,184	24	0.25	1.00
T252/21N12	2	A	340	154,386	12	0.25	1.00
T252/21N18	2	A	340	154,386	18	0.25	1.00
T252/21N24	2	A	340	154,386	24	0.25	1.00
T252/31N12	3	A	470	231,552	12	0.38	1.00
T252/31N18	3	A	470	231,552	18	0.38	1.00
T252/31N24	3	A	470	231,552	24	0.38	1.00
T252/41N12	4	A	600	308,734	12	0.38	1.25
T252/41N18	4	A	600	308,734	18	0.38	1.25
T252/41N24	4	A	600	308,734	24	0.38	1.25
T282/11N12	1	A	340	153,600	12	0.25	1.63
T282/11N18	1	A	340	153,600	18	0.25	1.63
T282/11N24	1	A	340	153,600	24	0.25	1.63

* Ampere ratings are suggested for use as a guide only. Actual values used for a given application will depend on such factors as permissible temperature rise, permissible voltage drop, number of cables together and other conditions of service. For outdoor use, these ratings may be increased from 22% to 40% depending upon the size and position of the braid.



ILSCO Tin Plated Copper Flexible Braid

TYPE T

Features

- Manufactured from pure copper braid
- Electro-tin plated
- Seamless pure copper ferrules
- Inside ferrule ends are rounded
- Swaged terminal to copper braid by cold forming
- Extra flexible braided connector
- Rated for 600 volts

Benefits

- Provides high conductivity
- Provides low contact resistance
- Provides superior contact
- Prevents chafing of strands
- Provides a reduced resistance form point to point; much lower than standard power cables or loose - piece type terminals
- Multi-purpose use for bonding, grounding and connecting moving parts
- Ensures reliability

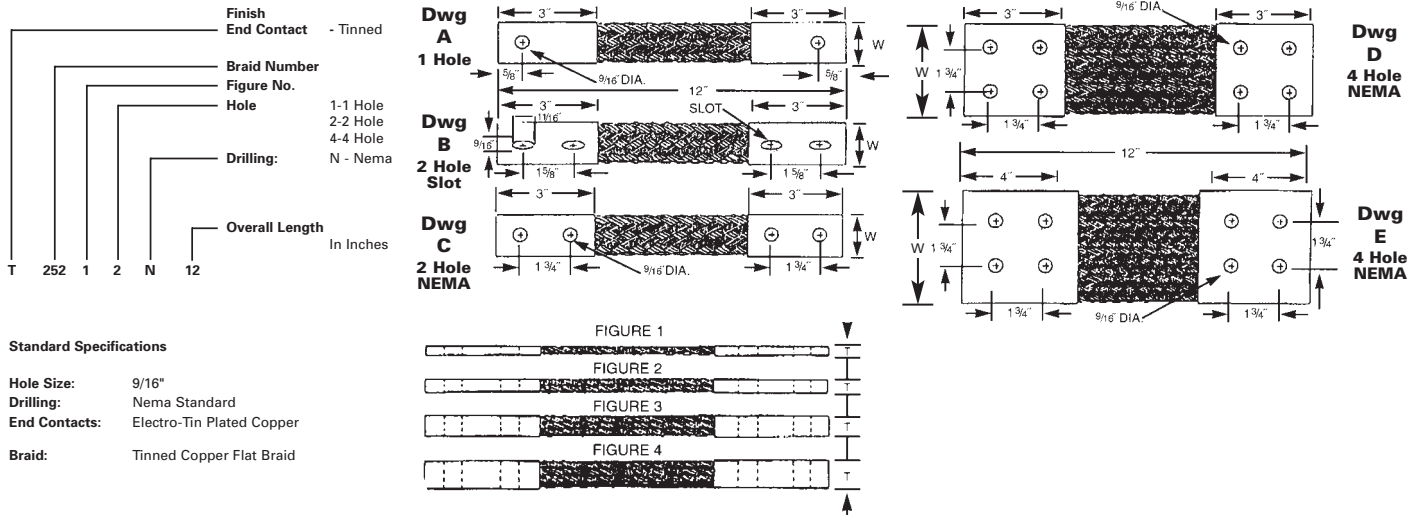

G

Catalog Number	Figure Number	Drawing Number	Ampere Rating (Indoors)*	Circular Mils. of Braids	Dimensions		
					L	T	W
T282/21N12	2	A	530	307,000	12	0.25	1.63
T282/21N18	2	A	530	307,000	18	0.25	1.63
T282/21N24	2	A	530	307,000	24	0.25	1.63
T282/31N12	3	A	700	460,800	12	0.31	1.63
T282/31N18	3	A	700	460,800	18	0.31	1.63
T282/31N24	3	A	700	460,800	24	0.31	1.63
T282/41N12	4	A	800	614,400	12	0.38	1.63
T282/41N18	4	A	800	614,400	18	0.38	1.63
T282/41N24	4	A	800	614,400	24	0.38	1.63
T252/12N12	1	C	200	77,184	12	0.19	1.00
T252/12N18	1	C	200	77,184	18	0.25	1.00
T252/12N24	1	C	200	77,184	24	0.25	1.00
T252/22N12	2	C	340	154,386	12	0.25	1.00
T252/22N18	2	C	340	154,386	18	0.25	1.00
T252/22N24	2	C	340	154,386	24	0.25	1.00

* Ampere ratings are suggested for use as a guide only. Actual values used for a given application will depend on such factors as permissible temperature rise, permissible voltage drop, number of cables together and other conditions of service. For outdoor use, these ratings may be increased from 22% to 40% depending upon the size and position of the braid.

ILSCO Tin Plated Copper Flexible Braid

TYPE T

Features

- Manufactured from pure copper braid
- Electro-tin plated
- Seamless pure copper ferrules
- Inside ferrule ends are rounded
- Swedged terminal to copper braid by cold forming
- Extra flexible braided connector
- Rated for 600 volts

Benefits

- Provides high conductivity
- Provides low contact resistance
- Provides superior contact
- Prevents chafing of strands
- Provides a reduced resistance form point to point; much lower than standard power cables or loose - piece type terminals
- Multi-purpose use for bonding, grounding and connecting moving parts
- Ensures reliability

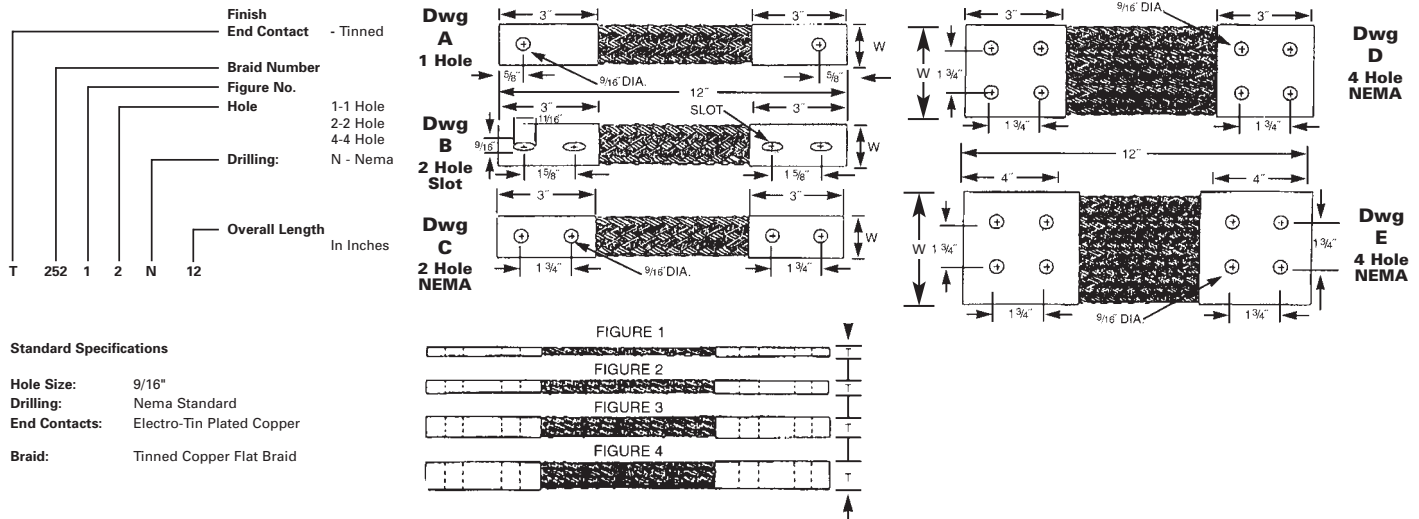

Catalog Number	Figure Number	Drawing Number	Ampere Rating (Indoors)*	Circular Mils. of Braids	Dimensions		
					L	T	W
T252/32N12	3	C	470	231,552	12	0.38	1.00
T252/32N18	3	C	470	231,552	18	0.38	1.00
T252/32N24	3	C	470	231,552	24	0.38	1.00
T252/42N12	4	C	600	308,734	12	0.38	1.25
T252/42N18	4	C	600	308,734	18	0.38	1.25
T252/42N24	4	C	600	308,734	24	0.38	1.25
T282/12N12	1	C	340	153,600	12	0.25	1.63
T282/12N18	1	C	340	153,600	18	0.25	1.63
T282/12N24	1	C	340	153,600	24	0.25	1.63
T282/22N12	2	C	530	307,000	12	0.25	1.63
T282/22N18	2	C	530	307,000	18	0.25	1.63
T282/22N24	2	C	530	307,000	24	0.25	1.63
T282/32N12	3	C	700	460,800	12	0.31	1.63
T282/32N18	3	C	700	460,800	18	0.31	1.63
T282/32N24	3	C	700	460,800	24	0.31	1.63

* Ampere ratings are suggested for use as a guide only. Actual values used for a given application will depend on such factors as permissible temperature rise, permissible voltage drop, number of cables together and other conditions of service. For outdoor use, these ratings may be increased from 22% to 40% depending upon the size and position of the braid.



ILSCO Tin Plated Copper Flexible Braid

TYPE T

Features

- Manufactured from pure copper braid
- Electro-tin plated
- Seamless pure copper ferrules
- Inside ferrule ends are rounded
- Swedged terminal to copper braid by cold forming
- Extra flexible braided connector
- Rated for 600 volts

Benefits

- Provides high conductivity
- Provides low contact resistance
- Provides superior contact
- Prevents chafing of strands
- Provides a reduced resistance form point to point; much lower than standard power cables or loose - piece type terminals
- Multi-purpose use for bonding, grounding and connecting moving parts
- Ensures reliability

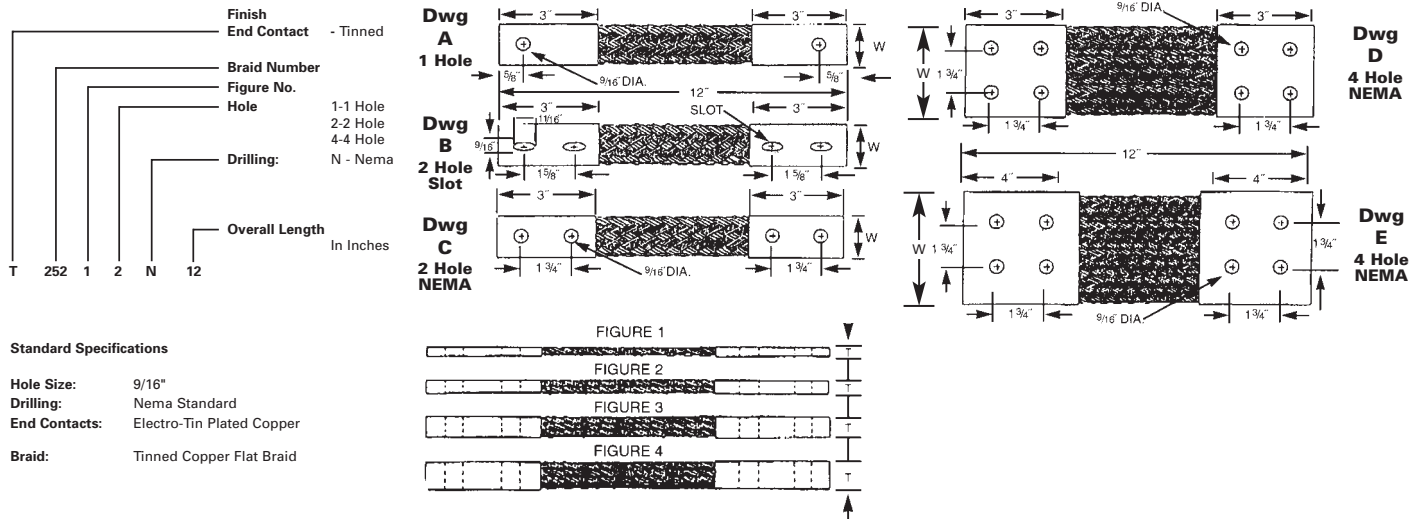

G

Catalog Number	Figure Number	Drawing Number	Ampere Rating (Indoors)*	Circular Mils. of Braids	Dimensions		
					L	T	W
T282/42N12	4	C	800	614,400	12	0.38	1.63
T282/42N18	4	C	800	614,400	18	0.38	1.63
T282/42N24	4	C	800	614,400	24	0.38	1.63
T287/12N12	1	C	360	230,000	12	0.25	1.50
T287/12N18	1	C	360	230,000	18	0.25	1.50
T287/12N24	1	C	360	230,000	24	0.25	1.50
T287/22N12	2	C	700	460,000	12	0.38	1.50
T287/22N18	2	C	700	460,000	18	0.38	1.50
T287/22N24	2	C	700	460,000	24	0.38	1.50
T287/32N12	3	C	820	690,000	12	0.50	1.50
T287/32N18	3	C	820	690,000	18	0.50	1.50
T287/32N24	3	C	820	690,000	24	0.50	1.50
T287/42N12	4	C	1000	920,000	12	0.75	1.63
T287/42N18	4	C	1000	920,000	18	0.75	1.63
T287/42N24	4	C	1000	920,000	24	0.75	1.63

* Ampere ratings are suggested for use as a guide only. Actual values used for a given application will depend on such factors as permissible temperature rise, permissible voltage drop, number of cables together and other conditions of service. For outdoor use, these ratings may be increased from 22% to 40% depending upon the size and position of the braid.

ILSCO Tin Plated Copper Flexible Braid

TYPE T

Features

- Manufactured from pure copper braid
- Electro-tin plated
- Seamless pure copper ferrules
- Inside ferrule ends are rounded
- Swedged terminal to copper braid by cold forming
- Extra flexible braided connector
- Rated for 600 volts

Benefits

- Provides high conductivity
- Provides low contact resistance
- Provides superior contact
- Prevents chafing of strands
- Provides a reduced resistance form point to point; much lower than standard power cables or loose - piece type terminals
- Multi-purpose use for bonding, grounding and connecting moving parts
- Ensures reliability

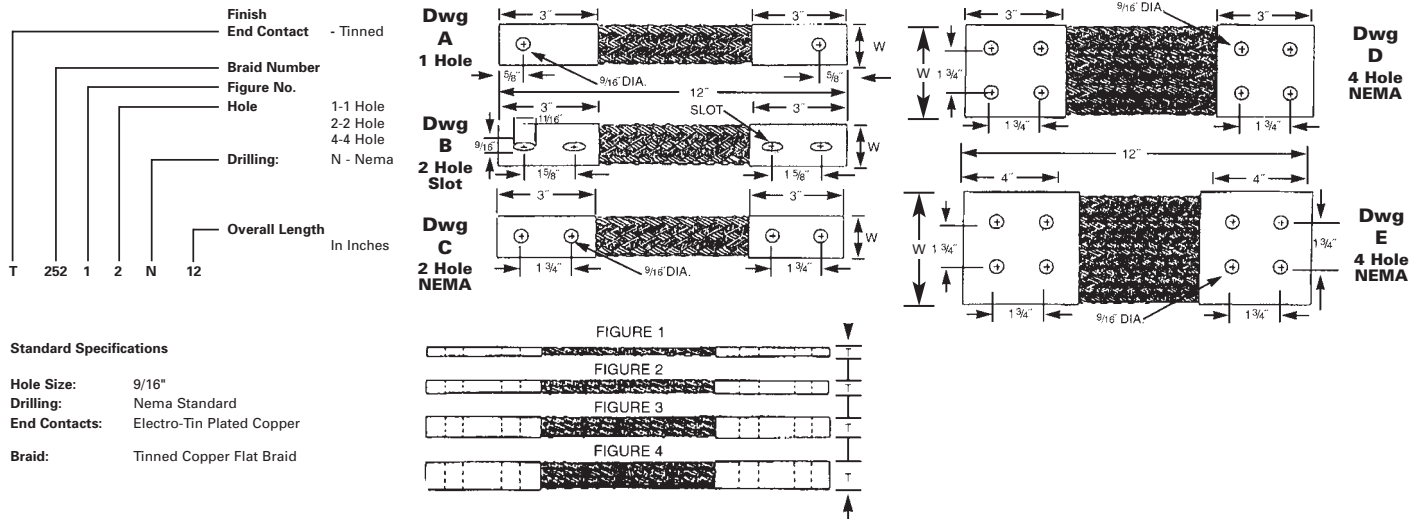

Catalog Number	Figure Number	Drawing Number	Ampere Rating (Indoors)*	Circular Mils. of Braids	Dimensions		
					L	T	W
T294/12N12	1	C	415	300,000	12	0.25	1.50
T294/12N18	1	C	415	300,000	18	0.25	1.50
T294/12N24	1	C	415	300,000	24	0.25	1.50
T294/22N12	2	C	700	600,000	12	0.50	1.50
T294/22N18	2	C	700	600,000	18	0.50	1.50
T294/22N24	2	C	700	600,000	24	0.50	1.50
T294/32N12	3	C	960	900,000	12	0.75	1.63
T294/32N18	3	C	960	900,000	18	0.75	1.63
T294/32N24	3	C	960	900,000	24	0.75	1.63
T294/42N12	4	C	1200	1,200,000	12	1.00	1.63
T294/42N18	4	C	1200	1,200,000	18	1.00	1.63
T294/42N24	4	C	1200	1,200,000	24	1.00	1.63
T278/14N12-4	1	E	625	422,000	12	0.25	4.00
T278/14N18-4	1	E	625	422,000	18	0.25	4.00
T278/14N24-4	1	E	625	422,000	24	0.25	4.00

* Ampere ratings are suggested for use as a guide only. Actual values used for a given application will depend on such factors as permissible temperature rise, permissible voltage drop, number of cables together and other conditions of service. For outdoor use, these ratings may be increased from 22% to 40% depending upon the size and position of the braid.



ILSCO Tin Plated Copper Flexible Braid

TYPE T

Features

- Manufactured from pure copper braid
- Electro-tin plated
- Seamless pure copper ferrules
- Inside ferrule ends are rounded
- Swedged terminal to copper braid by cold forming
- Extra flexible braided connector
- Rated for 600 volts

Benefits

- Provides high conductivity
- Provides low contact resistance
- Provides superior contact
- Prevents chafing of strands
- Provides a reduced resistance form point to point; much lower than standard power cables or loose - piece type terminals
- Multi-purpose use for bonding, grounding and connecting moving parts
- Ensures reliability

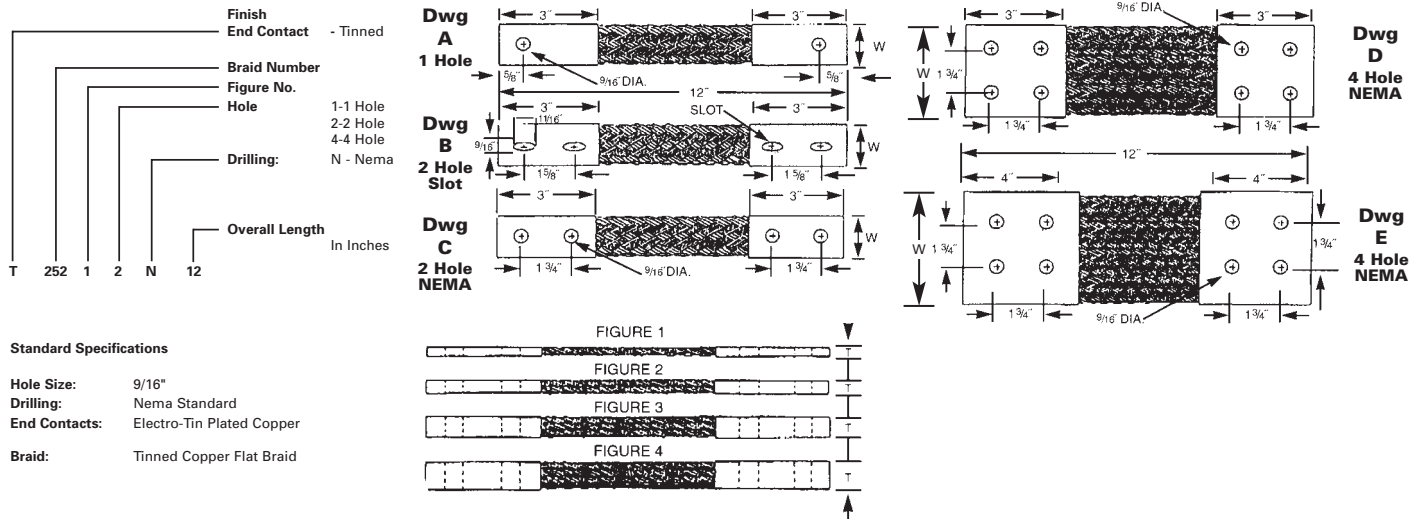

G

Catalog Number	Figure Number	Drawing Number	Ampere Rating (Indoors)*	Circular Mils. of Braids	Dimensions		
					L	T	W
T278/24N12-4	2	E	940	844,000	12	0.31	4.00
T278/24N18-4	2	E	940	844,000	18	0.31	4.00
T278/24N24-4	2	E	940	844,000	24	0.31	4.00
T278/34N12-4	3	E	1200	1,266,000	12	0.38	4.00
T278/34N18-4	3	E	1200	1,266,000	18	0.38	4.00
T278/34N24-4	3	E	1200	1,266,000	24	0.38	4.00
T278/44N12-4	4	E	1600	1,688,000	12	0.50	4.00
T278/44N18-4	4	E	1600	1,688,000	18	0.50	4.00
T278/44N24-4	4	E	1600	1,688,000	24	0.50	4.00
T278/14N12-3	1	D	370	211,200	12	0.25	3.00
T278/14N18-3	1	D	370	211,200	18	0.25	3.00
T278/14N24-3	1	D	370	211,200	24	0.25	3.00
T278/24N12-3	2	D	625	422,400	12	0.31	3.00
T278/24N18-3	2	D	625	422,400	18	0.31	3.00
T278/24N24-3	2	D	625	422,400	24	0.31	3.00

* Ampere ratings are suggested for use as a guide only. Actual values used for a given application will depend on such factors as permissible temperature rise, permissible voltage drop, number of cables together and other conditions of service. For outdoor use, these ratings may be increased from 22% to 40% depending upon the size and position of the braid.

ILSCO Tin Plated Copper Flexible Braid

TYPE T

Features

- Manufactured from pure copper braid
- Electro-tin plated
- Seamless pure copper ferrules
- Inside ferrule ends are rounded
- Swedged terminal to copper braid by cold forming
- Extra flexible braided connector
- Rated for 600 volts

Benefits

- Provides high conductivity
- Provides low contact resistance
- Provides superior contact
- Prevents chafing of strands
- Provides a reduced resistance form point to point; much lower than standard power cables or loose - piece type terminals
- Multi-purpose use for bonding, grounding and connecting moving parts
- Ensures reliability

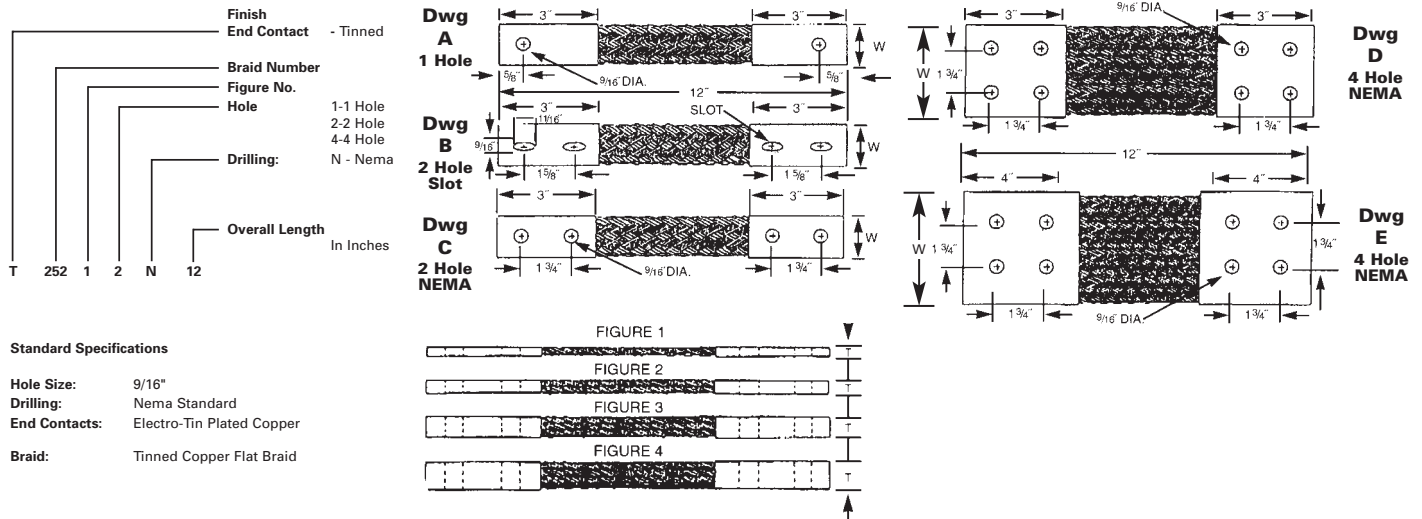

Catalog Number	Figure Number	Drawing Number	Ampere Rating (Indoors)*	Circular Mils. of Braids	Dimensions		
					L	T	W
T278/34N12-3	3	D	800	633,600	12	0.38	3.00
T278/34N18-3	3	D	800	633,600	18	0.38	3.00
T278/34N24-3	3	D	800	633,600	24	0.38	3.00
T278/44N12-3	4	D	940	844,900	12	0.50	3.00
T278/44N18-3	4	D	940	844,900	18	0.50	3.00
T278/44N24-3	4	D	940	844,900	24	0.50	3.00

* Ampere ratings are suggested for use as a guide only. Actual values used for a given application will depend on such factors as permissible temperature rise, permissible voltage drop, number of cables together and other conditions of service. For outdoor use, these ratings may be increased from 22% to 40% depending upon the size and position of the braid.



TYPE T

Features

- Manufactured from pure copper braid
- Electro-tin plated
- Seamless pure copper ferrules
- Inside ferrule ends are rounded
- Swedged terminal to copper braid by cold forming
- Extra flexible braided connector
- Rated for 600 volts

Benefits

- Provides high conductivity
- Provides low contact resistance
- Provides superior contact
- Prevents chafing of strands
- Provides a reduced resistance form point to point; much lower than standard power cables or loose - piece type terminals
- Multi-purpose use for bonding, grounding and connecting moving parts
- Ensures reliability

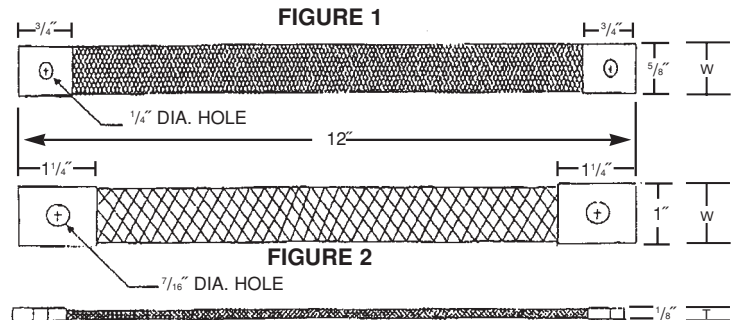
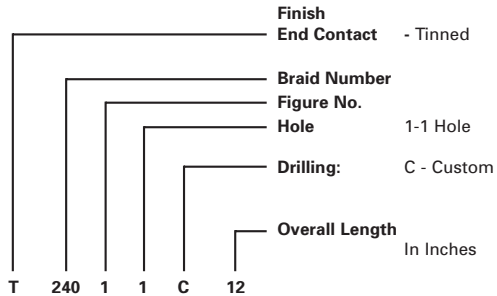

Standard Specifications

- End Contacts:** Electro-Tin Plated Copper
- Braid:** Tinned Copper Flat Braid
- Options:** - Custom drilling pattern (drawing must be supplied)

G

Catalog Number	Figure Number	Ampere Rating (Indoors)*	Circular Mils. of Braids	Dimensions		
				L	T	W
T240/11C12	1	95	24,000	12	0.13	0.63
T240/11C18	1	95	24,000	18	0.13	0.63
T240/11C24	1	95	24,000	24	0.13	0.63
T244/21C12	2	145	48,000	12	0.13	1.00
T244/21C18	2	145	48,000	18	0.13	1.00
T244/21C24	2	145	48,000	24	0.13	1.00

* Ampere ratings are suggested for use as a guide only. Actual values used for a given application will depend on such factors as permissible temperature rise, permissible voltage drop, number of cables together and other conditions of service. For outdoor use, these ratings may be increased from 22% to 40% depending upon the size and position of the braid.

ILSCO Copper Ground Straps

TYPE GS GSR

Features

- Manufactured from annealed copper sheet
- Two styles available
- Type GSR supplied in 10' coils with 1/4" holes

Benefits

- Provides maximum conductivity and greater flexibility
- Heavy-Duty or lightweight in four different lengths
- Can be cut to desired length which reduces inventory



Fig. 1



Fig. 2

Catalog Number	Figure Number	Pipe Size	Dimensions		Type
			L	W	
GS-1	1	3/8-1	5-17/32	3/4	Heavy .050 thick
GS-2	1	3/8-2	9-5/16	3/4	Heavy .050 thick
GS-3	1	3/8-3	12-3/4	3/4	Heavy .050 thick
GS-4	1	3/8-4	15-3/4	3/4	Heavy .050 thick
GS-10	1	3/8-1	5-17/32	3/4	Light .025 thick
GS-20	1	3/8-2	9-5/16	3/4	Light .025 thick
GS-30	1	3/8-3	12-3/4	3/4	Light .025 thick
GS-40	1	3/8-4	15-3/4	3/4	Light .025 thick
GSR-Plain*	2	-	10 ft.	3/4	Light .030 thick

* 1/4" Holes

G



TYPE D167

Features

- Manufactured from high strength copper tubing
- Range taking
- UL Recognized for 600 volts

Benefits

- Provides maximum conductivity
- A wide range of conductor sizes can be used in the same connector
- Ensures reliability for copper conductor

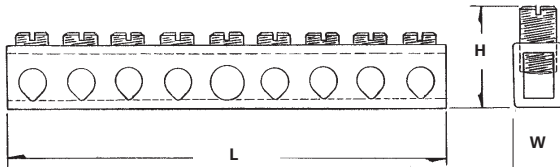

Catalog Number	Number Of Taps	Wire Range		Dimensions					Mounting Hole Positions	
		Main	Tap	L	Height With Maximum Wire	W	Bolt Size	Two Mounting Holes	From End Of Bar To First Mounting Hole	Distance Between Holes
D167-4	4	4-14	6-14	2-3/4	3/4	11/32	#10	13/64	.581 (2nd hole)	1.98
D167-6	6	4-14	6-14	3-1/2	3/4	11/32	#10	13/64	.978 (3rd hole)	1.98
D167-8	8	4-14	6-14	4-7/16	3/4	11/32	#10	13/64	1.375 (4th hole)	1.98
D167-10	10	4-14	6-14	5-1/8	3/4	11/32	#10	13/64	1.772 (5th hole)	1.98
D167-12	12	4-14	6-14	5-15/16	3/4	11/32	#10	13/64	2.169 (6th hole)	1.98
D167-14	14	4-14	6-14	6-23/32	3/4	11/32	#10	13/64	2.566 (7th hole)	1.98

Tested to UL 486A-486B, UL File E6207

G

TYPE CAN

Features

- Manufactured from high strength copper tubing
- Compact design
- Range taking
- UL Recognized and CSA Certified
- Circuit bars inserted at a 20 angle

Benefits

- Provides maximum conductivity
- Up to 42 circuit taps can be made in just 5 1/2" of space
- A wide range of conductor sizes can be used in the same connector
- Ensures reliability for copper conductor
- Provides easy wire insertion

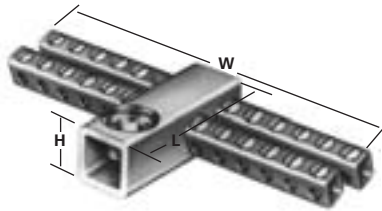

Fig. 1



Fig. 2



Fig. 3



Fig. 4

Catalog Number	Figure Number	Number Of Taps	Wire Range		Dimensions			
			Main	Tap	L	Height With Maximum Wire	W	Two Tapped Mounting Holes
CAN-300	1	24	250kcmil-6	6-14	2-5/16	1-5/16	5-1/8	10-32
CAN-301	1	30	250kcmil-6	6-14	3	1-5/16	4-13/32	10-32
CAN-302	1	36	250kcmil-6	6-14	3	1-5/16	5-1/8	10-32
CAN-303	1	42	250kcmil-6	6-14	3	1-7/16	5-1/2	10-32
R-16	2	Mounting block of general purpose (phenolic black) suitable for mounting any of CAN Neutrals. 2-1/2" wide x 2-1/2" long x 1" thick.						
E-223	3	10-32 x 1/2" round head steel machine screws for fastening neutrals to mounting blocks. (Use lock washer to provide rigid assembly.)						
E-153	3	1/4-28 wire pressure screw 7/16" long. Screw is steel, zinc plated and chromate dipped.						
N-174	4	Supplied in 5' 9" lengths. Approximately 174 outlets. Wire range 14-6.						

Tested to UL 486A-486B, UL File E6207

G

ILSCO Dual Rated Ground Clamp



TYPE
AGC
SGC

Features

- Manufactured from high strength 6061-T6 aluminum alloy
- Clear plated
- UL Listed
- Versatile
- Range taking
- SGC Lay-In feature

Benefits

- Suitable for use with either copper or aluminum conductors
- Provides low contact resistance
- Ensures reliability
- Effectively grounds aluminum or copper conductors to copper water pipe, galvanized pipe or steel conduit
- Three sizes cover a range from 1/2" to 4" pipe with a ground wire range of 250 kcmil - #14 which reduces inventory
- Provides ease of installation for long ground wire runs

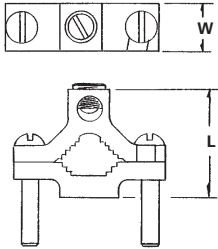

Fig. 1



Fig. 2



Fig. 3

Catalog Number	Figure Number	Pipe Size	Rebar Size	Ground Wire Range	Screw Type	Dimensions		Hex Size
						L	W	
AGC-1	1	1/2-3/4-1	4, 5, 6	1/0-14	Slot	2-1/4	11/16	Slot
AGC-2	2	1 1/4-1 1/2-2	-	250kcmil-6	Hex Socket	3-3/4	13/16	5/16
AGC-4	2	2 1/2-3-3 1/2-4	-	250kcmil-6	Hex Socket	6-5/16	1	5/16
SGC-1/0*	3	1/2-3/4-1"	-	1/0-14	Slot	2-1/4	11/16	Slot

DE-OX Inhibitor is recommended for all aluminum terminations.

* Typical application would be grounding computer floor room system.

UL File E34440

G



TYPE GBL

Features

- Manufactured from high strength 6061-T6 aluminum alloy
- Electro-tin plated
- UL Recognized for grounding and bonding
- Lay-in feature
- Rated for 600 volts

Benefits

- Suitable for use with either copper or aluminum conductors
- Provides low contact resistance
- Ensures reliability
- Provides ease of installation
- Ensures reliability

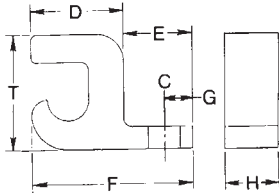

Fig. 1



Fig. 2

Catalog Number	Figure Number	Ground Wire Range	Bolt Size	Dimensions							Hex Size
				C	D	E	F	G	H	T	
*GBL-4	1	4-14	10	7/32	5/8	31/64	1-3/32	13/64	25/64	51/64	Slot
+GBL-1/0	1	1/0-14	1/4	9/32	51/64	27/32	1-5/8	7/16	5/8	1-5/32	Slot
+GBL-250	2	250kcmil-6	1/4	9/32	31/64	1	2-3/16	29/64	7/8	1-23/32	7/32

+ U.L. 467 recognized for grounding and bonding only.
DE-OX Inhibitor is recommended for all aluminum terminations.

+ UL File E34440/E6207

* UL 467 Listed

TYPE
GBL-DB

Features

- Lay-in feature
- Manufactured from high strength copper
- Stainless steel 1/4-28 torque screw
- Rated for 600 volts

Benefits

- Provides ease of installation of continuous loop grounding conductor
- Suitable for direct burial and for use with copper conductors
- Resists oxidation and corrosion in earth or concrete
- Ensures reliability

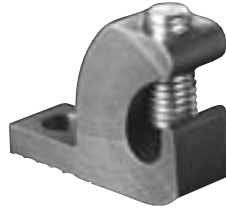
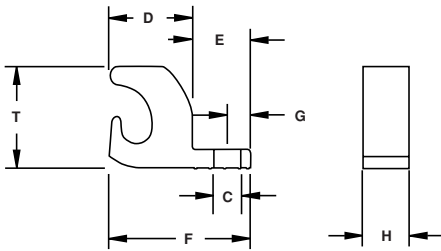

Catalog Number	Ground Wire Range	Bolt Size	Dimensions							Screw Type
			C	D	E	F	G	H	T	
GBL-4DB	4-14	10	.218	.680	.470	1.15	.19	.375	.825	Slot
GBL-4DB-14	4-14	10	.265	.680	.470	1.150	.210	.472	.825	Slot

* Add T to order tin plating

Tested to UL 467, UL File E34440

G

TYPE GBT

Features

- Approved for UL 467 (Grounding & Bonding)
- Lay in style
- No mounting required
- Dual rated
- 4 Taps (#2-14) stranded or solid
- Stainless steel screws
- Serrations in conductor wire way
- Patent Pending

Benefits

- Meets NEC 250.94 installation requirements.
- Eliminates the need to cut or splice into existing conductor
- Allows fast simple installation on ground conductor below meter
- For use with copper and aluminum conductors
- For bonding multiple communication systems (Phone, TV, Cable, etc.)
- For corrosion resistance
- Cuts oxidation



Fig. 1



Fig. 2

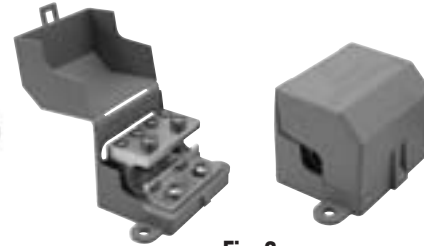
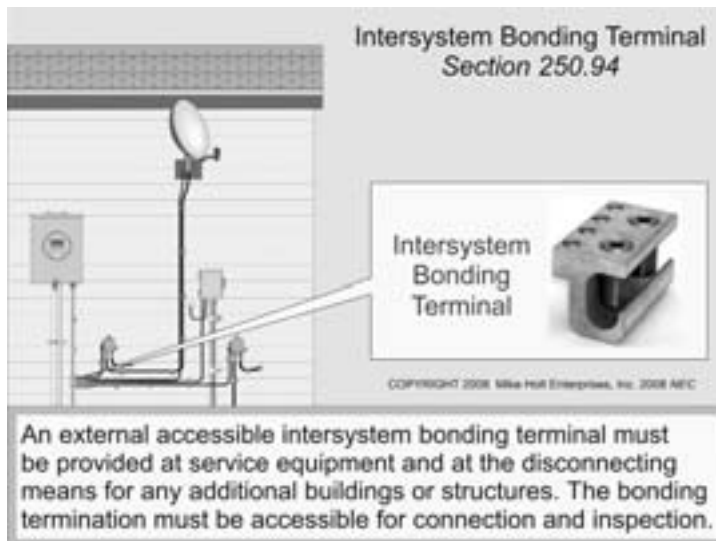

Fig. 3

Catalog Number	Figure Number	Wire Range Main	Wire Range Tap	Length	Width	Height	Hex Size	
							Main	Tap
GBT-1/0	1	1/0-8	2-14str-sol	2.250	1.125	1.160	S	S
GBT-250	1	250kcmil-8str - 1/0-8sol	2-14str-sol	2.250	1.375	1.587	7/32	S
GBT-1/0-M	2	1/0-8	2-14str-sol	2.250	1.750	1.160	S	S
GBT-1/0-M-W/C	3	1/0-8	2-14str-sol	2.730	3.930	2.110	S	S

UL File E34440



250-94 01 reproduced with approval from Mike Holt Enterprises, www.mikeholt.com



ILSCO Aluminum Grounding Connectors - Dual Rated

TYPE GRM GRF

Features

- Manufactured from high strength 6061-T6 aluminum alloy
- Electro-tin plated
- Type GRM - Elongated steel stud
- Type GRF - Threaded female design

Benefits

- Suitable for use with either copper or aluminum conductors
- Provides low contact resistance
- Provides ease of grounding a single conductor to steel structures or to tap a single conductor from bus bar
- Provides ease of installation for a variety of standard stud sizes

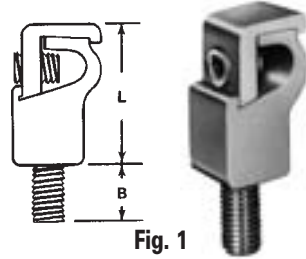

Fig. 1

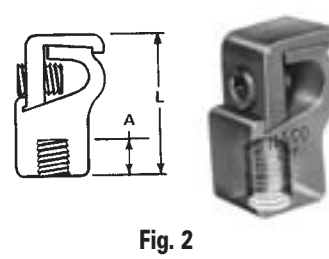

Fig. 2

Catalog Number	Figure Number	Wire Range Single Cable				Dia. Thread	Dimensions			Hex Size
		Max.	Min.	Steel Strand	A		B	L		
GRM-2A	1	2str	12sol/str	5/16	1/4"-20	-	11/16	1-1/4	Slot	
GRM-2B	1	2str	12sol/str	5/16	5/16"-18	-	3/8	1-1/4	Slot	
GRM-2C	1	2str	12sol/str	5/16	3/8"-16	-	9/16	1-1/4	Slot	
GRM-0	1	1/0str	2str	3/8	1/2"-13	-	1	1-9/16	Slot	
GRM-250A	1	250kcmil	1/0	9/16	1/2"-13	-	1	2-1/8	5/16	
GRM-250B	1	250kcmil	1/0	9/16	5/8"-11	-	1	2-1/8	5/16	
GRM-350	1	350kcmil	4/0	-	5/8"-11	-	1	2-1/2	3/8	
GRM-500	1	500kcmil	350kcmil	-	3/4"-10	-	1-3/8	2-15/16	3/8	
GRM-750	1	750kcmil	500kcmil	-	3/4"-10	-	1-3/8	3-3/8	1/2	
GRF-2A	2	2str	12sol/str	5/16	1/4"-20	5/16	-	1-1/4	Slot	
GRF-2B	2	2str	12sol/str	5/16	5/16"-18	3/8	-	1-1/4	Slot	
GRF-2C	2	2str	12sol/str	5/16	3/8"-16	7/16	-	1-1/4	Slot	
GRF-0	2	1/0str	2str	3/8	1/2"-13	1/2	-	1-9/16	Slot	
GRF-250A	2	250kcmil	1/0	9/16	1/2"-13	1/2	-	2-1/8	5/16	
GRF-250B	2	250kcmil	1/0	9/16	5/8"-11	3/4	-	2-1/8	5/16	
GRF-350	2	350kcmil	4/0	-	5/8"-11	3/4	-	2-1/2	3/8	
GRF-500	2	500kcmil	350kcmil	-	3/4"-10	7/8	-	2-15/16	3/8	
GRF-750	2	750kcmil	500kcmil	-	3/4"-10	7/8	-	3-3/8	1/2	

DE-OX Inhibitor is recommended for all aluminum terminations.

TYPE NB

Features

- Preassembled, stacked neutral bars
- Available with phenolic base
- Electro-tin plated
- Fabricated from high strength 6061-T6 aluminum alloy
- UL Recognized and CSA Certified for 600 volts, 90° C

Benefits

- Compact, space saving design offers multiple range taking flexibility and is suitable for grounding applications
- Provides insulation from mounting surface
- Provides low contact resistance
- Suitable for use with either copper or aluminum conductors
- Ensures reliability

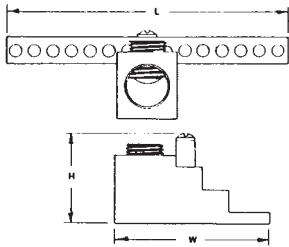

Fig. 1



Fig. 2

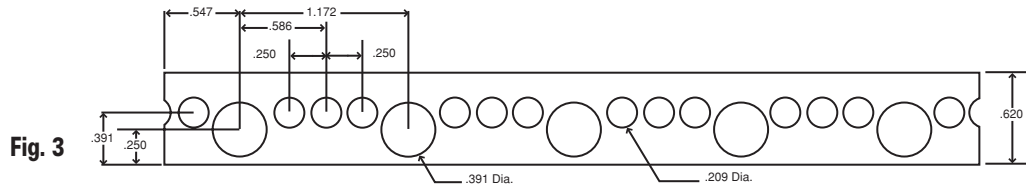

Fig. 3

Catalog Number	Figure Number	Number Of Circuit Taps	Wire Range		Dimensions			Two Tapped Mounting Holes	Hex Size	
			Circuit Taps	Line Loads	Approx. Height with Max. Wire	L	W		Main	Tap
NB-350-12	1	12	14-4	350kcmil-6	1-17/32	4-23/32	2-17/32	10-32	3/8	S
NB-350-12-W/R16*	2	12	14-4	350kcmil-6	2-17/32	4-23/32	2-17/32	10-32	3/8	S
NB-350-24	1	24	14-4	350kcmil-6	1-17/32	4-23/32	2-17/32	10-32	3/8	S
NB-350-24-W/R16*	2	24	14-4	350kcmil-6	2-17/32	4-23/32	2-17/32	10-32	3/8	S
NB-350-30	1	30	14-4	350kcmil-6	1-17/32	4-3/32	2-17/32	10-32	3/8	S
NB-350-30-W/R16*	2	30	14-4	350kcmil-6	2-17/32	4-3/32	2-17/32	10-32	3/8	S
NB-350-36	1	36	14-4	350kcmil-6	1-17/32	4-23/32	2-17/32	10-32	3/8	S
NB-350-36-W/R16*	2	36	14-4	350kcmil-6	2-17/32	4-23/32	2-17/32	10-32	3/8	S
NB-350-42	1	42	14-4	350kcmil-6	1-17/32	5-11/32	2-17/32	10-32	3/8	S
NB-350-42-W/R16*	2	42	14-4	350kcmil-6	2-17/32	5-11/32	2-17/32	10-32	3/8	S





















*S" indicates slotted screw

* Part includes phenolic mounting block R-16

Tested to UL 486A-486B, UL File E6207

Catalog Number	Figure Number	Number of Outlets	Wire Range	Length
NB-120	3	120	30 outlets 1/0-14 90 outlets 6-14	3.25'

UL File E81652

<p>DBK</p>  <p>262</p>	<p>ASK</p>  <p>262</p>	<p>USPA-SS</p>  <p>263</p>	<p>SS, SSK, SSKC</p>  <p>264</p>	<p>PED-SS</p>  <p>265</p>
<p>GGA</p>  <p>266</p>	<p>GGC</p>  <p>267</p>	<p>ELT</p>  <p>268</p>	<p>SLU-DB, XT-DB</p>  <p>269</p>	
<p>CGRC</p>  <p>270</p>	<p>BGRC</p>  <p>270</p>			
<p>SRC</p>  <p>271</p>	<p>GRC</p>  <p>272</p>			
<p>RLT</p>  <p>273</p>	<p>BGC</p>  <p>274</p>			
<p>BGDB</p>  <p>275</p>	<p>SPS</p>  <p>276 - 277</p>			
<p>SPD</p>  <p>278 - 279</p>	<p>TTGC</p>  <p>280</p>			
<p>GUB</p>  <p>281</p>				

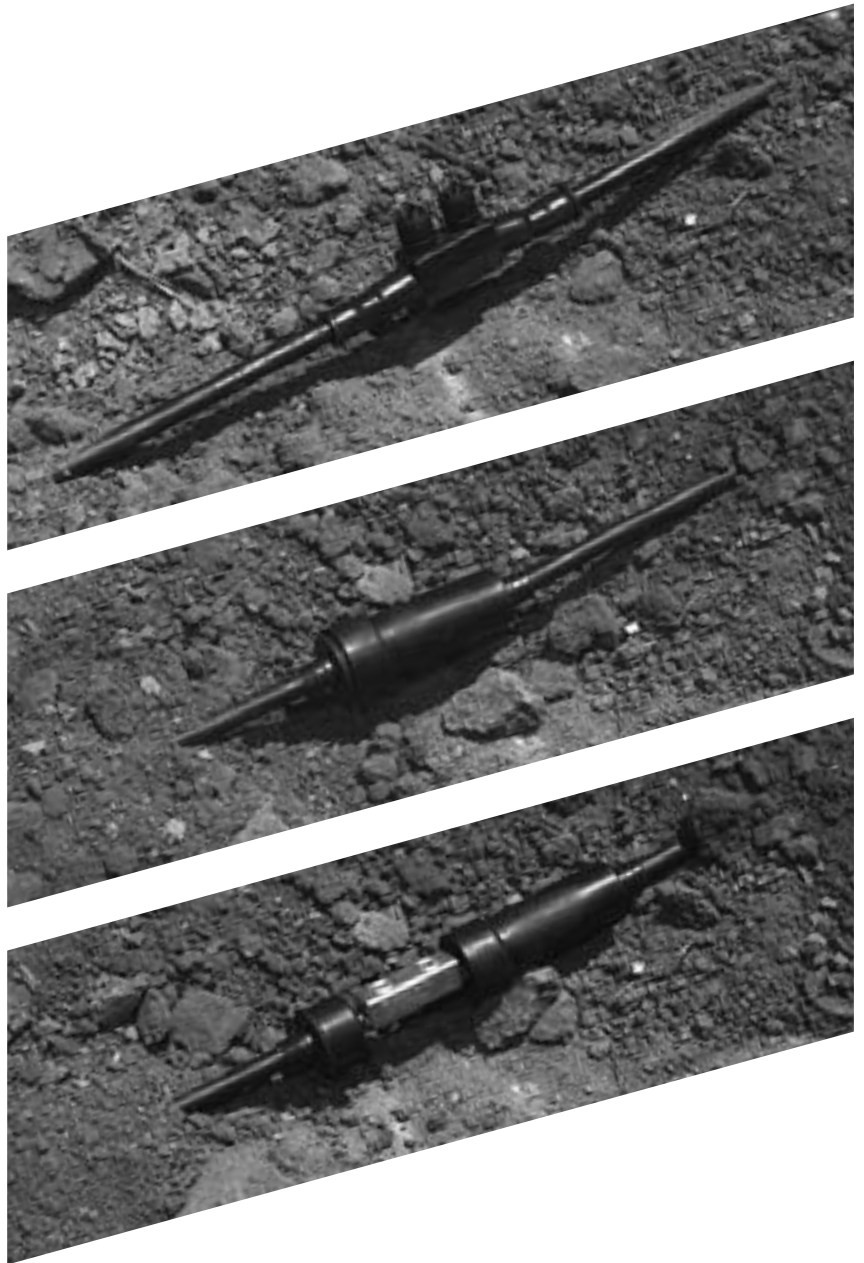

TYPE DBK ASK

Features

- DBK-1 connectors manufactured from electrolytic copper
- All other connectors manufactured from high strength aluminum alloy
- Heavy wall heat shrink tubing with sealant
- Connector and heat shrink packaged together
- UL listed, rated for 600 volts, 90° C

Benefits

- Provides maximum conductivity for UF cable
- Provides high conductivity and can be used with either aluminum or copper conductors
- Provides watertight splice. Kits with heat shrink are designed to withstand abrasions due to direct burial in rocky soil.
- Provides ease of ordering
- Ensures reliability



Fig. 1



Fig. 2



Fig. 3

Catalog Number	Figure Number	UF Cable Range		Wire Range	Testing Certification
		Minimum	Maximum		
DBK-1	1	14/2 with Ground	8/3 with Ground	-	UL LISTED 88X4
DBK-2	2	-	-	2-8	UL LISTED 88X4
DBK-250	2	-	-	250kcmil-1	UL LISTED 88X4

Tested UL 486D, UL File E125087

ABOVE GRADE SPLICE KITS

ASK-2*	3	-	-	2-8	UL LISTED 453G
ASK-250*	3	-	-	250kcmil-1	UL LISTED 453G

*Not UL Listed for direct burial.

Tested to UL 486A-486B, UL File E6207

TYPE USPA-SS

Features

- Encapsulated in EPDM rubber with a nominal thickness of 125 Mils and a dielectric strength of 240 Volts per Mil
- Pre-marked end inserts
- O-Ring design screw cap inserts
- Connector is produced from high strength 6061-T6 aluminum alloy
- Connector rated for 600 volts, 90° C
- Range taking
- UL Listed and CSA Certified for direct burial in earth or concrete

Benefits

- Completely watertight in line splice. Ready for installation. (not a mold for use with mixed compounds) No taping required. No temperature or humidity restrictions.
- Simply cut end inserts to appropriate marked wire size and insert conductor into connector
- Ensures connector integrity while allowing ease of access to set screws, ensuring excellent sealing
- Suitable for use with either copper or aluminum conductors
- Ensures reliability
- Reduces inventory



Fig. 1



Fig. 2



Fig. 3

Catalog Number	Figure Number	Wire Range		Length	Hex Size	Recommended Torque-Inch Lbs.
		Barrel A	Barrel B			
USPA-350SS-DB +	1	350kcmil-10str	350kcmil-10str	8- 5/8	5/16	350
USPA-500SS-DB*	2	500kcmil-10	500kcmil-10	9-13/16	5/16	450
USPA-750SS-DB	3	750kcmil-2	750kcmil-2	9-13/16	5/16	500

+ REA listed

* Not UL Listed

Tested to UL 486D, UL File E125087

TYPE
SS
SSK
SSKC

Features

- Watertight EPDM rubber splice cover
- Tapered ends
- Ready for installation
- Type SS is cover only supplied with lubricant
- Type SSK kit is supplied with both connector and lubricant
- Connector rated for 600 volts

Benefits

- No taping required. Suitable for direct burial
- Fits a wide range of conductor sizes
- Not a mold, can be used in any type of weather. (moisture and humidity are not a factor)
- Can be used with standard aluminum or copper compression from 500kcmil - 6. Lubricant permits easy insertion of conductors into sleeve.
- Supplied with dual-rated mechanical splice connector with a wire range of 350kcmil - 6
- Ensures reliability



Fig. 1



Fig. 2

Catalog Number	Figure Number	Wire Range		L
		Bolted Connector	Compression Sleeves	
SSK-350-Z	1	350kcmil-6	-	5-1/2
SS-350-Z	2	350kcmil-6	500kcmil-6	5-1/2



Catalog Number	Connector Catalog Number	Wire Size	Wire Range When Installed With IDT-12 Tool
SSKC-6-Z	AS-6	6	6
SSKC-4-Z	AS-4	4	4-6
SSKC-2-Z	AS-2	2	2-6
SSKC-1/0-Z	AS-1/0	1/0	1/0-1
SSKC-2/0-Z	AS-2/0	2/0	2/0-1
SSKC-3/0-Z	AS-3/0	3/0	3/0-1
SSKC-4/0-Z	AS-4/0	4/0	4/0-1
SSKC-250-Z	AS-250	250kcmil	250kcmil-1/0

Temperature rating 90° C



TYPE PED-SS

Features

- Available in a variety of conductor configurations and three wire ranges
- Manufactured from high strength aluminum alloy
- Clear plated
- Dual rated
- EPDM cover has dielectric strength of 240 volts per mil and nominal thickness of 125 mils
- UL Listed and CSA Certified for direct burial in earth or concrete
- Rated for 600 volts

Benefits

- Provides multiple conductor installation for a broad wire range
- Provides maximum conductivity
- Low contact resistance
- Use with both copper and aluminum conductors
- Completely watertight, no taping required. Suitable for direct burial in earth or concrete



Fig. 1



Fig. 2

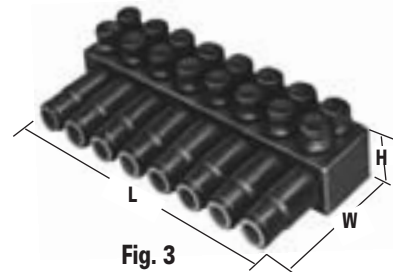

Fig. 3

Catalog Number	Figure Number	Wire Range	Number of Ports	Dimensions		
				W	H	L
PED3-350SS-DB	1	350kcmil-10str	3	4.40	2.70	3.67
PED4-350SS-DB	1	350kcmil-10str	4	4.40	2.70	4.82
PED5-350SS-DB	1	350kcmil-10str	5	4.40	2.70	6.04
PED6-350SS-DB	1	350kcmil-10str	6	4.40	2.70	7.14
PED8-350SS-DB	1	350kcmil-10str	8	4.40	2.70	9.45
* PED-3-500-SS-Z	2	500kcmil-10	3	5.06	2.82	4.57
* PED-4-500-SS-Z	2	500kcmil-10	4	5.06	2.82	6.04
* PED-5-500-SS-Z	2	500kcmil-10	5	5.06	2.82	7.50
* PED-6-500-SS-Z	2	500kcmil-10	6	5.06	2.82	8.98
* PED-8-500-SS-Z	2	500kcmil-10	8	5.06	2.82	11.92
* PED-4-750-SS-Z	3	750kcmil-2	4	6.50	3.53	6.97
* PED-6-750-SS-Z	3	750kcmil-2	6	6.50	3.53	10.35
* PED-8-750-SS-Z	3	750kcmil-2	8	6.50	3.53	13.73

Extra screw closure caps and extra conductor plugs available.

* Not UL Listed or CSA Certified.

Tested to UL 486D, UL File E125087

TYPE GGA

Features

- Manufactured from high strength copper alloy
- Clearly marked with wire size and die index
- Range taking
- Connector can be adjusted prior to installation
- Non-hazardous installation
- Prefilled with inhibiting compound
- Temp. Rating 90° C

Benefits

- Provides maximum conductivity and eliminates the possibility of corrosion. Suitable for direct burial in earth or concrete
- Provides easy identification and tooling recommendation
- Reduces inventory. Six sizes cover a wire range from 500kcmil to #6, and 1/2" to 3/4" ground rods.
- Permits adjustments to be made for misaligned cross grids
- Can be installed in all types of weather with no need for protective equipment or clothing. Does not produce heat or dangerous particles.
- Prevents oxides from forming
- Ensures reliability

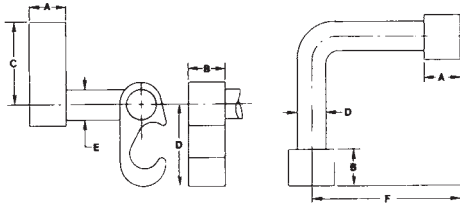

Catalog Number	Wire Range		Rod Size	Dimensions						A Die Index	B Die Index
	Main	Tap		A	B	C	D	E	F		
GGA-1	2str-6sol	2str-6sol	-	.75	.75	1.09	1.09	.313	2.50	0	0
GGA-2	250kcmil-1str	2str-6sol	1/2, 5/8	.75	.75	1.66	1.09	.313	2.50	997	0
GGA-3	250kcmil-2str	250kcmil-2str	1/2, 5/8	.75	.75	1.66	1.66	.500	2.50	997	997
GGA-4	500kcmil-250kcmil	2str-6sol	5/8, 3/4	.75	.75	2.09	1.09	.313	2.50	998	0
GGA-5	500kcmil-250kcmil	250kcmil-2str	5/8, 3/4	.75	.75	2.09	1.66	.500	2.50	998	997
GGA-6	500kcmil-250kcmil	500kcmil-250kcmil	5/8, 3/4	.75	.75	2.28	2.28	.750	2.50	999/1011	999/1011

Tested to UL 467, UL File E34440



NOTE: Hydraulic tools required on all sizes except GGA-1
 Dieless tools can not be used
 ILC-15H or similar required for GGA-4, GGA-5 and GGA-6

TYPE GGC

Features

- Manufactured from high strength copper alloy
- Clearly marked with wire size and die index
- Range taking
- Versatile
- Non-hazardous installation
- Prefilled with inhibiting compound
- Temp. Rating 90° C

Benefits

- Provides maximum conductivity and eliminates the possibility of corrosion. Suitable for direct burial in earth or concrete
- Provides easy identification and tooling recommendation
- Reduces inventory. Eight sizes cover a wire range from 500kcmil to #6, and 1/2" to 3/4" ground rods.
- Can be used as a tap connector or as a lap splice connector
- Can be installed in all types of weather with no need for protective equipment or clothing. Does not produce heat or dangerous particles.
- Prevents oxides from forming
- Ensures reliability

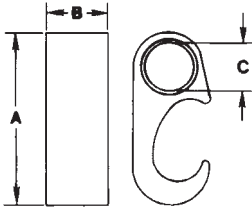

Catalog Number	Wire Range		Rod Size	Dimensions			Index
	Main	Tap		A	B	C	
GGC-1	2str-6sol	2str-6sol	-	1.4	.75	.33	0
GGC-2	250kcmil-1/0str	2str-4sol	1/2, 5/8	2.1	.75	.33	997
GGC-3	250kcmil-1/0str	2/0str-1/0str	1/2, 5/8	2.1	.75	.44	997
GGC-4	250kcmil-1/0str	250kcmil-3/0str	1/2, 5/8	2.1	.75	.61	997
GGC-5	500kcmil-250kcmil	2str-4sol	5/8, 3/4	2.6	.75	.33	998
GGC-6	500kcmil-250kcmil	2/0str-1/0str	5/8, 3/4	2.6	.75	.44	998
GGC-7	500kcmil-250kcmil	250kcmil-3/0str	5/8, 3/4	2.6	.75	.61	998
GGC-8	500kcmil-250kcmil	500kcmil-350kcmil	5/8, 3/4	2.9	.75	.84	999/1011

Tested to UL 467, UL File E34440

NOTE: Hydraulic tools required on all sizes except GGC-1

Dieless tools can not be used

ILC-15H or similar required for GGC-5, GGC-6, GGC-7 and GGC-8

TYPE ELT

Features

- Manufactured from copper alloy
- Clearly marked with wire size and die index
- Range taking
- UL Listed and CSA Certified for grounding and bonding, rated for 600 volts
- May be used in ground grid applications

Benefits

- Provides maximum conductivity and eliminates the possibility of corrosion. Suitable for direct burial in earth or concrete
- Provides easy identification and tooling recommendation
- Reduces inventory
- Ensures reliability
- Flexibility in application



Catalog Number	Copper Wire Range		W	Die Index
	Main	Tap		
ELT-1	2str-6sol	2str-6sol	.75	C (U Type)
ELT-4	2/0str-1str	2str-6str	.75	0 (U Type)
ELT-2	2/0str-1str	2/0str-1str	.75	0 (U Type)
ELT-5	250kcmil-3/0str	2/0str-6sol	.75	997 (U Type)
ELT-3	250kcmil-3/0str	250kcmil-3/0str	.900	997 (U Type)
ELT-6	500kcmil-300kcmil	250kcmil-3/0str	.875	1011 (U Type)

Tooling Information

Catalog Number	ILSCO			Burndy		
	ILC-12H-N ILC-12-N Die No. No. of Crimps	ILCB-12-N Die No. No. of Crimps	ILC-15H Die No. No. of Crimps	Y-35 Die Index No. of Crimps	Y-45 Die Index No. of Crimps	Y-46 Die Index No. of Crimps
ELT-1	ILD-C (1)	ILD-C (1)	- -	C (U Type) (1)	C (U Type) (1)	C (U Type) (1)
ELT-4	ILD-O (1)	ILD-O (1)	- -	O (U Type) (1)	O (U Type) (1)	O (U Type) (1)
ELT-2	ILD-O (1)	ILD-O (1)	- -	O (U Type) (1)	O (U Type) (1)	O (U Type) (1)
ELT-5	ILD-U997 (1)	ILD-U997 (1)	- -	997 (U Type) (1)	997 (U Type) (1)	997 (U Type) (1)
ELT-3	ILD-U997 (1)	ILD-U997 (1)	- -	997 (U Type) (1)	997 (U Type) (1)	997 (U Type) (1)
ELT-6	- -	- -	ILD-P1011 (2)	- -	1011 (U Type) (2)	1011 (U Type) (1)

See stuffer sheet for complete information on tooling.

Tested to UL 467, UL File E34440

TYPE SLU

Features

- Manufactured from electrolytic copper tubing and strip stock
- Compact design
- Range taking
- Re-usable
- UL Listed
- V-bottom collar

Benefits

- Provides maximum conductivity and strength
- Saves space and reduces installation time
- Permits inventories to be kept to a minimum
- Provides efficient use and flexibility in the field
- Ensures reliability
- Wires are wedged between arched pressure bar and collar establishing positive contact and firm permanent grip

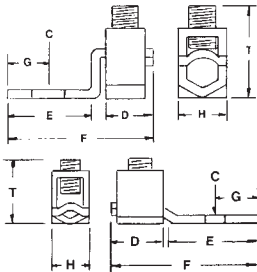

Catalog Number	Screw Type	Figure Number	Wire Range Copper	Bolt Size	Dimensions							Hex Size
					C	D	E	F	G	H	T	
SLU-35DB*		1	6-14 & List Comb. (A)	#10	13/64	7/16	15/32	1-3/16	7/32	3/8	3/4	S
SLU-70DB*		1	2-8 & List Comb. (B)	1/4	17/64	1/2	21/32	1-17/32	1/4	1/2	1	S

(A) UL Listed wire combinations: (2) 14; (2) 12; (2) 10; (2) 8 and (4) 16

(B) UL Listed wire combinations: (2) 6 and (2) 8

Tested to UL 467, UL File E34440

TYPE XT

Features

- Manufactured from electrolytic copper tubing and strip stock
- Compact design
- Range taking
- Re-usable
- UL Listed, rated for 600 volts

Benefits

- Provides maximum conductivity and strength
- Saves space and reduces installation time.
- Permits inventories to be kept to a minimum
- Provides efficient use and flexibility in the field
- Ensures reliability

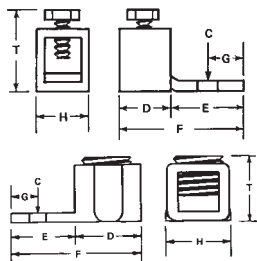

Catalog Number	Wire Range	Bolt Size	Dimensions							Hex Size
			C	D	E	F	G	H	T	
XT-6DB*	6-18	#10	13/64	3/8	17/32	1	7/32	3/8	3/4	Slot
XT-4DB*	4-14 & List Comb. (A)	1/4	17/64	1/2	5/8	1-1/8	1/4	1/2	5/8	Slot

(A) UL Listed wire combinations: (2) 14; (2) 12; (2) 10; (2) 8 and (4) 16

Tested to UL 467, UL File E34440

TYPE
BGRC
CGRC

Features

- Manufactured from cast bronze
- Supplied with stainless steel or silicone bronze hardware
- UL Listed and CSA Certified for 600 volts

Benefits

- Insures maximum strength and durability
- Suitable for direct burial in earth or concrete
- Ensures reliability

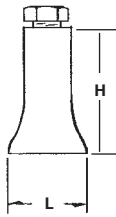
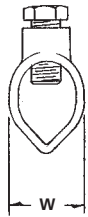

Fig. 1

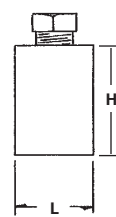

Fig. 2

Catalog Number	Figure Number	Ground Rod Size	Ground Rod Wire Range	Rebar Size	Rebar Wire Range	Dimensions		
						L	W	H
BGRC-48	1	1/2	2-10	-	-	7/8	3/4	1-1/4
BGRC-58	1	5/8	1/0-8	#5	1/0-8	1-1/32	29/32	1-13/32
BGRC-68	1	3/4	1/0-8	-	-	1	1	1-5/8
CGRC-38*	2	3/8	4-10	#3	4-10	1/2	11/16	1
CGRC-48*	2	1/2	2-10	#4	2-10	9/16	27/32	1-3/16
CGRC-58*	2	5/8	2-10	#5	4-10	9/16	15/16	1-9/32
CGRC-68*	2	3/4	2-10	#6	4-10	9/16	1-1/16	1-9/32

* Plain copper finish.

Tested to UL 467, UL File E34440



TYPE
SRC

Features

- Manufactured from bronze alloy
- Stainless steel bolt
- UL Listed for both copper clad and galvanized ground rods
- Range taking

Benefits

- Provides maximum strength and superior conductivity
- For direct burial
- Ensures reliability
- Reduces inventory requirement



Catalog Number	Ground Rod Size	Ground Rod Wire Range	Dimensions		
			L	W	H
SRC-1/0	3/8, 1/2, 5/8 3/4	10 sol - 1/0 str 8 sol - 1/0 str	13/16	1	1-1/2

UL File E198108



TYPE GRC

Features

- Manufactured from seamless bronze tubing
- Supplied with silicon bronze screw
- UL Listed and CSA Certified for 600 volts except GRC-75
- Suitable for grounding and bonding in applications such as swimming pools and spas

Benefits

- Provides maximum strength and superior conductivity
- Ground rod clamp is suitable for direct burial in earth or concrete
- Ensures reliability for copper conductor

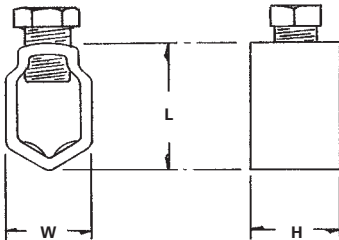

Catalog Number	Ground Rod Size	Ground Wire Range	Rebar Size	Rebar Wire Range	Dimensions	
					L	W
GRC-38	3/8	4-10	#3	4-10	5/8	5/8
GRC-58+	5/8	2-8	-	-	15/16	7/8
GRC-68	3/4, 5/8	2-8 for 3/4 rod, 1/0-8 for 5/8 rod	#5	1/0-8	1	1
GRC-75*	3/4	3/0-8	-	-	3/4	1-5/32

Plain copper finish.

+ REA Listed.

* Not UL Listed

Tested to UL 467, UL File E34440

TYPE RLT

Features

- Prefilled with oxide inhibitor and bagged
- Clearly marked with wire size and die index
- UL Listed for 600 Volts and CSA Certified for direct burial in earth or concrete
- Range taking
- Manufactured from high strength copper alloy

Benefits

- Prevents oxides from forming
- Provides easy identification and tooling recommendation
- Ensures reliability
- Reduces inventory. Eight sizes cover a wire range of #2-500kcmil
- Provides maximum conductivity and eliminates the possibility of corrosion

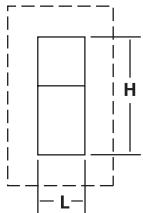

Catalog Number	Ground Rod Size	Wire Range	Die Index	Dimensions	
				H	L
RLT-2	1/2	2 (.292 Dia.) - 2/0 (.419 Dia.)	998/1011	1.94	.88
RLT-3	5/8	2 (.292 Dia.) - 2/0 (.419 Dia.)	998/1011	1.97	.88
RLT-4	3/4	2 (.292 Dia.) - 2/0 (.419 Dia.)	998/1011	2.19	.88
RLT-5	1/2	4/0 (.528 Dia.) - 250kcmil (.575 Dia.)	998/1011	1.94	.88
RLT-6	5/8	4/0 (.528 Dia.) - 250kcmil (.575 Dia.)	998/1011	2.14	.88
RLT-7	3/4	4/0 (.528 Dia.) - 250kcmil (.575 Dia.)	998/1011	2.19	.88
RLT-8	5/8	300kcmil (.630 Dia.) - 500kcmil (.813 Dia.)	998/1011	2.14	.88
RLT-9	3/4	300kcmil (.630 Dia.) - 500kcmil (.813 Dia.)	998/1011	2.44	.88

UL File E158587

TYPE BGC

Features

- Manufactured from cast brass
- UL Listed and CSA Certified for 600 volts
- Type BGC-DB supplied with stainless steel or silicone bronze hardware

Benefits

- Provides maximum conductivity and strength
- Ensures reliability for copper conductor
- BGC-1DB and BGC-2DB are suitable for direct burial in earth or concrete. Can be used to ground swimming pools and spas.

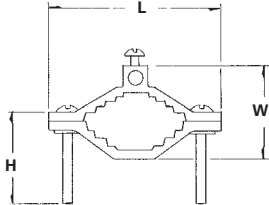

Catalog Number	Pipe Size	Ground Wire Range	Dimensions		
			L	W	H
BGC-1	1/2, 3/4, 1	2-10	2-9/32	2-17/32	1-1/2
BGC-2	1-1/4, 1-1/2, 2	2-10	3-9/16	2-1/4	2
BGC-1DB*	1/2, 3/4, 1	2-10	2-9/32	2-17/32	1-1/2
BGC-2DB*	1-1/4, 1-1/2, 2	2-10	3-8/16	2-1/4	2

* Suitable for direct burial in earth or concrete. UL467

UL File E158587



TYPE BGDB

Features

- Manufactured from bronze alloy
- UL Listed for direct burial in earth or concrete
- Lay-In feature

Benefits

- Ensures maximum strength and superior conductivity
- Ensures reliability
- Reduces installation time

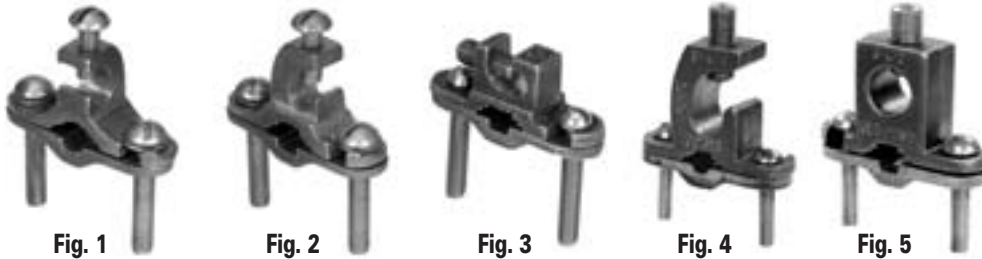

Catalog Number	Figure Number	Pipe Size	Rebar Size	Ground Rod Size	Ground Wire Range	Screw Material	Dimensions	
							L	W
BGC-2T-DB*	1	1/2-1	3/8-1	1/2-1	2str-10sol	silicon bronze	2-3/4	2-1/4
BGC-2P-DB*	2	1/2-1	3/8-1	1/2-1	2str-10sol	silicon bronze	2-3/4	2-1/4
BGC-2PS-DB+	3	1/2-1	3/8-1	1/4-1	2str-10sol 2 #8sol	stainless steel	2-1/4	2-1/4
BGC-4/0P-DB=	4	1/2-1	3/8-1	1/2-1	4/0-8str	stainless steel	3	2-1/4
BGC-4/0S-DB=	5	1/2-1	3/8-1	1/2-1	4/0-8str	stainless steel	2-3/4	2-1/4

* UL File E207816

+ UL File E198108

= UL File E178441

TYPE SPS

Features

- Range taking
- Re-usable
- UL 486A and UL 467 Listed
- For grounding of steel structures, fence posts and tapping cables from bus bar
- For copper to copper connections

Benefits

- Permits inventories to be kept to a minimum
- Provides efficient use and flexibility in the field
- Ensures reliability
- Flexibility in the field

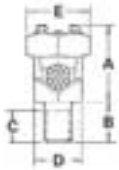

Catalog Number	Conductor Range AWG MM ²				Maximum Diameter Range	Stud Size	Dimensions				
	Stranded		Solid				A	B	C	D	E
	Max.	Min.	Max.	Min.							
SPSS-0	8	12 (4mm ²)	8 (10mm ²)	12 (4mm ²)	.146-.080	1/4-20 x 1/2	11/16	1/2	55/64	15/32	1/2
SPSS-1	7 (10mm ²)	10 (6mm ²)	6 (10mm ²)	10 (6mm ²)	.170-.102	1/4-20 x 1/2	13/16	1/2	55/64	15/32	21/32
SPSS-2	5 (16mm ²)	10 (6mm ²)	4 (16mm ²)	10 (6mm ²)	.217-.102	5/16-18 x 5/8	15/16	5/8	53/64	17/32	23/32
SPSS-3	3 (25mm ²)	10 (6mm ²)	2 (35mm ²)	10 (6mm ²)	.271-.102	3/8-16 x 5/8	1/2	5/8	61/64	5/8	25/32
SPSS-4	1 (35mm ²)	8 (6mm ²)	2 (35mm ²)	8 (10mm ²)	.332-.128	3/8-16 x 5/8	1-1/16	5/8	61/64	11/16	7/8
SPSS-5	1/0 (50mm ²)	2 (35mm ²)	2 (35mm ²)	-	.385-.258	1/2-13 x 3/4	1-1/4	3/4	1-5/64	3/4	15/16
SPSS-6	2/0 (70mm ²)	2 (35mm ²)	2 (35mm ²)	-	.443-.258	1/2-13 x 3/4	1-13/32	3/4	1-5/64	7/8	1-1/16
SPSS-8	4/0 (95mm ²)	1 (35mm ²)	-	-	.570-.289	5/8-11 x 1	1-9/16	1	1-19/64	1	1-5/16
SPSS-9	350 (150mm ²)	1/0 (70mm ²)	-	-	.715-.373	5/8-11 x 1	2	1-1/4	1-19/64	1-5/16	1-11/16
SPSS-10	500 (240mm ²)	3/0 (95mm ²)	-	-	.840-.464	3/4-10 x 1-1/4	2-1/4	1-3/4	1-31/64	1-1/2	1-7/8

UL File E158587



TYPE SPS

Features

- Range taking
- Re-usable
- UL 486A and UL 467 Listed
- For grounding of steel structures, fence posts and tapping cables from bus bar
- For copper to copper connections

Benefits

- Permits inventories to be kept to a minimum
- Provides efficient use and flexibility in the field
- Ensures reliability
- Flexibility in the field

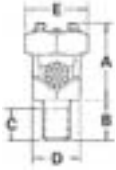

Catalog Number	Conductor Range AWG MM ²				Maximum Diameter Range	Stud Size	Dimensions				
	Stranded		Solid				A	B	C	D	E
	Max.	Min.	Max.	Min.							
SPSL-0	8	12 (4mm ²)	8 (10mm ²)	12 (4mm ²)	.146-.080	1/4-20 x 1	11/16	1	55/64	15/32	1/2
SPSL-1	7 (10mm ²)	10 (6mm ²)	6 (10mm ²)	10 (6mm ²)	.170-.102	1/4-20 x 1	13/16	1	55/64	15/32	21/32
SPSL-2	5 (16mm ²)	10 (6mm ²)	4 (16mm ²)	10 (6mm ²)	.217-.102	5/16-18 x 1	15/16	1	53/64	17/32	23/32
SPSL-3	3 (25mm ²)	10 (6mm ²)	2 (35mm ²)	10 (6mm ²)	.271-.102	3/8-16 x 1-1/8	1/2	1-1/8	61/64	5/8	25/32
SPSL-4	1 (35mm ²)	8 (6mm ²)	2 (35mm ²)	8 (10mm ²)	.332-.128	3/8-16 x 1-1/8	1-1/16	1-1/8	61/64	11/16	7/8
SPSL-5	1/0 (50mm ²)	2 (35mm ²)	2 (35mm ²)	-	.385-.258	1/2-13 x 1-1/4	1-1/4	1-1/4	1-5/64	3/4	15/16
SPSL-6	2/0 (70mm ²)	2 (35mm ²)	2 (35mm ²)	-	.443-.258	1/2-13 x 1-1/4	1-13/32	1-1/4	1-5/64	7/8	1-1/16
SPSL-8	4/0 (95mm ²)	1 (35mm ²)	-	-	.570-.289	5/8-11 x 1-1/2	1-9/16	1-1/2	1-19/64	1	1-5/16
SPSL-9	350 (150mm ²)	1/0 (70mm ²)	-	-	.715-.373	5/8-11 x 1-1/2	2	1-1/2	1-19/64	1-5/16	1-11/16
SPSL-10	500 (240mm ²)	3/0 (95mm ²)	-	-	.840-.464	3/4-10 x 1-3/4	2-1/4	1-1/2	1-31/64	1-1/2	1-7/8

UL File E158587

TYPE SPD

Features

- Range taking
- Re-usable
- UL 486A and UL 467 Listed
- For grounding of steel structures, fence posts and tapping cables from bus bar
- For copper to copper connections

Benefits

- Permits inventories to be kept to a minimum
- Provides efficient use and flexibility in the field
- Ensures reliability
- Flexibility in the field

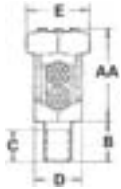

Catalog Number	Conductor Range AWG MM ²				Maximum Diameter Range	Stud Size	Dimensions				
	Stranded		Solid				AA	B	C	D	E
	Max.	Min.	Max.	Min.							
SPDS-0	8	12 (4mm ²)	8 (10mm ²)	12 (4mm ²)	.146-.080	1/4-20 x 1/2	13/16	1/2	55/64	15/32	1/2
SPDS-1	7 (10mm ²)	10 (6mm ²)	6 (10mm ²)	10 (6mm ²)	.170-.102	1/4-20 x 1/2	31/32	1/2	55/64	15/32	21/32
SPDS-2	5 (16mm ²)	10 (6mm ²)	4 (16mm ²)	10 (6mm ²)	.217-.102	5/16-18 x 5/8	1-1/8	5/8	53/64	17/32	23/32
SPDS-3	3 (25mm ²)	10 (6mm ²)	2 (35mm ²)	10 (6mm ²)	.271-.102	3/8-16 x 5/8	1-1/4	5/8	61/64	5/8	25/32
SPDS-4	1 (35mm ²)	8 (6mm ²)	2 (35mm ²)	8 (10mm ²)	.332-.128	3/8-16 x 5/8	1-3/8	5/8	61/64	11/16	7/8
SPDS-5	1/0 (50mm ²)	2 (35mm ²)	2 (35mm ²)	-	.385-.258	1/2-13 x 3/4	1-19/32	3/4	1-5/64	3/4	15/16
SPDS-6	2/0 (70mm ²)	2 (35mm ²)	2 (35mm ²)	-	.443-.258	1/2-13 x 3/4	1-13/16	3/4	1-5/64	7/8	1-1/16
SPDS-8	4/0 (95mm ²)	1 (35mm ²)	-	-	.570-.289	5/8-11 x 1	2-1/16	1	1-19/64	1	1-5/16
SPDS-9	350 (150mm ²)	1/0 (70mm ²)	-	-	.715-.373	5/8-11 x 1	2-3/4	1-1/4	1-19/64	1-5/16	1-11/16
SPDS-10	500 (240mm ²)	3/0 (95mm ²)	-	-	.840-.464	3/4-10 x 1-1/4	3-1/8	1-3/4	1-31/64	1-1/2	1-7/8

UL File E158587



TYPE SPD

Features

- Range taking
- Re-usable
- UL 486A and UL 467 Listed
- For grounding of steel structures, fence posts and tapping cables from bus bar
- For copper to copper connections

Benefits

- Permits inventories to be kept to a minimum
- Provides efficient use and flexibility in the field
- Ensures reliability
- Flexibility in the field

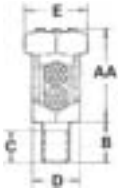

Catalog Number	Conductor Range AWG MM ²				Maximum Diameter Range	Stud Size	Dimensions				
	Stranded		Solid				AA	B	C	D	E
	Max.	Min.	Max.	Min.							
SPDL-0	8	12 (4mm ²)	8 (10mm ²)	12 (4mm ²)	.146-.080	1/4-20 x 1	13/16	1	55/64	15/32	1/2
SPDL-1	7 (10mm ²)	10 (6mm ²)	6 (10mm ²)	10 (6mm ²)	.170-.102	1/4-20 x 1	31/32	1	55/64	15/32	21/32
SPDL-2	5 (16mm ²)	10 (6mm ²)	4 (16mm ²)	10 (6mm ²)	.217-.102	5/16-18 x 1	1-1/8	1	53/64	17/32	23/32
SPDL-3	3 (25mm ²)	10 (6mm ²)	2 (35mm ²)	10 (6mm ²)	.271-.102	3/8-16 x 1-1/8	1-1/4	1-1/8	61/64	5/8	25/32
SPDL-4	1 (35mm ²)	8 (6mm ²)	2 (35mm ²)	8 (10mm ²)	.332-.128	3/8-16 x 1-1/8	1-3/8	1-1/8	61/64	11/16	7/8
SPDL-5	1/0 (50mm ²)	2 (35mm ²)	2 (35mm ²)	-	.385-.258	1/2-13 x 1-1/4	1-19/32	1-1/4	1-5/64	3/4	15/16
SPDL-6	2/0 (70mm ²)	2 (35mm ²)	2 (35mm ²)	-	.443-.258	1/2-13 x 1-1/4	1-13/16	1-1/4	1-5/64	7/8	1-1/16
SPDL-8	4/0 (95mm ²)	1 (35mm ²)	-	-	.570-.289	5/8-11 x 1-1/2	2-1/16	1-1/2	1-19/64	1	1-5/16
SPDL-9	350 (150mm ²)	1/0 (70mm ²)	-	-	.715-.373	5/8-11 x 1-1/2	2-3/4	1-1/2	1-19/64	1-5/16	1-11/16
SPDL-10	500 (240mm ²)	3/0 (95mm ²)	-	-	.840-.464	3/4-10 x 1-3/4	3-1/8	1-1/2	1-31/64	1-1/2	1-7/8

UL File E158587

TYPE TTGC

Features

- Manufactured from bronze
- Eye bolt on TTGC2 rotates to accommodate cable in vertical or horizontal direction
- Range taking
- Stud fits all standard EEI-NEMA distribution transformers

Benefits

- Provides maximum strength and superior conductivity
- Flexibility
- Permits inventories to be kept to a minimum
- Reliability

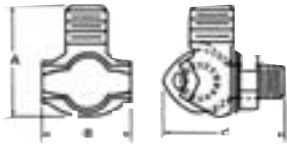

Catalog Number	Conductor Range		Stud Thread Size UNC - 2A	Dimensions		
	Max.	Min.		A	B	C
TTGC2	2/0	8 sol	1/2-13	1-51/64	1-9/64	1-21/32
TTGC3	1 str	10 sol	1/2-13	1-3/8	1-3/64	1-9/16
TTGC4+	1 str	10 sol	1/2-13	1-1/4	7/8	1-3/8
TTGC2TN+	2/0	8 sol	1/2-13	1-51/64	1-9/64	1-21/32
TTGC3TN*	1 str	10 sol	1/2-13	1-3/8	1-3/64	1-9/16
TTGC4TN*	1 str	10 sol	1/2-13	1-1/4	7/8	1-3/8

+ RUS Listed

* Tin Plated



TYPE GUB

Features

- Components are cast or forged from copper alloy
- Specially designed spacer
- Range taking
- Re-usable
- UL 467 Listed for direct burial and CSA Certified

Benefits

- Provides maximum conductivity
- Affords more positive contact area
- Permits inventories to be kept to a minimum
- Provides efficient use and flexibility in the field
- Ensures reliability

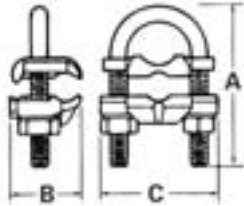

Catalog Number	Conductor		Nominal Rod		IPS Pipe Size		Dimensions		
	Max.	Min.	Max.	Min.	Max.	Min.	A	B	C
GUB-1	4	8	3/4	5/8	3/8	-	2-13/16	1-9/16	2-1/4
GUB-2	2/0	4	3/4	5/8	3/8	-	2-13/16	1-9/16	2-1/4
GUB-3	250kcmil	2/0	3/4	5/8	3/8	-	2-13/16	1-9/16	2-1/4
GUB-4	4	8	1	7/8	3/4	1/2	2-3/4	1-9/16	2-5/8
GUB-5	2/0	4	1	7/8	3/4	1/2	2-3/4	1-9/16	2-5/8
GUB-6	250kcmil	2/0	1	7/8	3/4	1/2	2-3/4	1-9/16	2-5/8
GUB-7	4	8	1-1/4	1-1/8	1	-	3-5/16	1-9/16	2-3/4
GUB-8	2/0	4	1-1/4	1-1/8	1	-	3-5/16	1-9/16	2-3/4
GUB-9	4	8	1-1/2	1-3/8	1-1/4	-	3-7/16	1-9/16	2-15/16
GUB-10	2/0	4	1-1/2	1-3/8	1-1/4	-	3-7/16	1-9/16	2-15/16
GUB-11	250kcmil	2/0	1-1/2	1-3/8	1-1/4	-	3-7/16	1-9/16	2-15/16
GUB-12	4	8	1-7/8	1-5/8	1-1/2	-	3-15/16	1-9/16	3-3/16
GUB-13	2/0	4	1-7/8	1-5/8	1-1/2	-	3-15/16	1-9/16	3-3/16
GUB-14	250kcmil	2/0	1-7/8	1-5/8	1-1/2	-	3-15/16	1-9/16	3-3/16
GUB-15	4	8	2-3/8	2	2	-	4-7/16	1-9/16	3-11/16
GUB-16	2/0	4	2-3/8	2	2	-	4-7/16	1-9/16	3-11/16
GUB-17	250kcmil	2/0	2-3/8	2	2	-	4-7/16	1-9/16	3-11/16
GUB-18	2/0	4	2-7/8	2-1/2	2-1/2	-	4-15/16	1-9/16	4-3/16
GUB-19	250kcmil	2/0	2-7/8	2-1/2	2-1/2	-	4-15/16	1-9/16	4-3/16
GUB-20	2/0	4	3-1/2	3	3	-	5-9/16	1-9/16	4-13/16
GUB-21	250kcmil	2/0	3-1/2	3	3	-	5-9/16	1-9/16	4-13/16
GUB-22	2/0	4	4	3-1/2	3-1/2	-	6-1/16	1-9/16	5-1/2
GUB-23	2/0	4	4-1/2	4	4	-	6-5/16	1-9/16	5-11/16
GUB-24	250kcmil	2/0	4-1/2	4	4	-	6-5/16	1-9/16	5-11/16

UL File E158587

HEAVY WALL



283

HEAVY WALL END CAPS



284

MEDIUM WALL



285

THIN WALL



286

THIN WALL BULK REELS



287

HEAT GUN



288

TYPE Heavy Wall

Features

- 3:1 shrink ratio
- UL Listed 486D and CSA Certified for 600 volts
- Inner adhesive liner
- Flame retardant

Benefits

- Provides a wide range of coverage when used on connectors and cable
- Ensures reliability for insulating terminations and splices
- Melts to form intimate contact with part to seal out elements and produce a watertight seal suitable for above ground, direct burial and underwater applications
- Meets Mil Spec 23053/15 rigid requirements for flame retardancy



Catalog Number	Wire Range	Exp. Id.	Rec. Id.	Recovered Wall Thickness	L
21106-B3*	6-14	0.400	0.150	0.060	6"
21112-B3*	6-14	0.400	0.150	0.060	12"
21206-B3	1-8	0.750	0.220	0.090	6"
21209-B3	1-8	0.750	0.220	0.090	9"
21212-B3	1-8	0.750	0.220	0.090	12"
21230	1-8	0.750	0.220	0.090	30"
21406-B2	4/0-2	1.100	0.375	0.120	6"
21409-B2	4/0-2	1.100	0.375	0.120	9"
21412-B2	4/0-2	1.100	0.375	0.120	12"
21448	4/0-2	1.100	0.375	0.120	48"
21609-B2	400kcmil-4/0	1.500	0.500	0.140	9"
21612-B2	400kcmil-4/0	1.500	0.500	0.140	12"
21648	400kcmil-4/0	1.500	0.500	0.140	48"
21709-B	1000kcmil-500kcmil	2.000	0.750	0.155	9"
21712-B	1000kcmil-500kcmil	2.000	0.750	0.155	12"
21748	1000kcmil-500kcmil	2.000	0.750	0.155	48"

*UL Listed wire range 12 - 6.

UL File E158587



Heat Shrinkable End Caps - Heavy Wall with Adhesive Liner

TYPE Heavy Wall

Features

- 3:1 shrink ratio
- Inner adhesive liner
- Rated for 600 volts

Benefits

- Provides a wide range of coverage when used on connectors and cable
- Melts to form intimate contact with part to seal out elements and produce a watertight seal suitable for above ground, direct burial and underwater applications
- Ensures reliability



Catalog Number	Wire Range	Exp. Id.	Rec. Id.	Recovered Wall Thickness	L
23081-B2	4/0-8	.75	0.22	.08	3.5"
23125-B2	500kcmil-4/0	1.30	0.43	.08	4.5"
23210-B2	1000kcmil-400kcmil	2.05	0.75	.08	4.5"



Heat Shrinkable Tubing - Medium Wall with Adhesive Liner

TYPE

Medium Wall

Features

- Clear tubing
- 2.5:1 shrink ratio
- Inner adhesive liner
- Rated for 600 volts

Benefits

- Provides convenient see through capability which gives assurance that termination was made properly after shrink process has been performed
- Provides a wide range of coverage when used on connectors and cable
- Melts to form intimate contact with part to seal out elements and produce a watertight seal suitable for above ground, direct burial and underwater applications
- Ensures reliability



Catalog Number	Wire Range	Exp. Id.	Rec. Id.	Recovered Wall Thickness	L
22106-B3	14-18	0.290	0.080	0.047	6"
22112-B3	14-18	0.290	0.080	0.047	12"
22206-B3	8-12	0.375	0.135	0.050	6"
22212-B3	8-12	0.375	0.135	0.050	12"
22306-B3	2-8	0.500	0.195	0.055	6"
22312-B3	2-8	0.500	0.195	0.055	12"
22406-B2	4/0-1	1.000	0.400	0.075	6"
22412-B2	4/0-1	1.000	0.400	0.075	12"

TYPE Thin Wall

Features

- 2:1 shrink ratio
- UL Recognized and CSA Certified
- Rated for 600 volts
- Convenient disk dispenser

Benefits

- Provides a wide range of coverage when used on connectors and cable
- Assures product reliability for insulating and protecting terminations and splices
- Ensures reliability
- Protects tubing from damage and keeps it clean



Catalog Number	Wire Range	Exp. Id.	Rec. Id.	Recovered Wall Thickness	L
24001-B10	26-34	0.046	0.023	0.016	6"
24002-B10	24-30	0.063	0.031	0.017	6"
24003-B10	22-28	0.093	0.046	0.020	6"
24004-B10	20-26	0.125	0.062	0.020	6"
24005-B10	18-22	0.187	0.093	0.020	6"
24006-B10	14-16	0.250	0.125	0.025	6"
24007-B5	10-12	0.312	0.156	0.025	6"
24008-B5	6-8	0.375	0.187	0.025	6"
24009-B5	4-6	0.500	0.250	0.025	6"
24010-B5	2/0-2	0.750	0.375	0.030	6"
24011-B5	4/0-1	1.000	0.500	0.035	6"
24999-B12+	-	-	-	-	-
25001	26-34	0.046	0.023	0.016	96" Disk
25002	24-30	0.063	0.031	0.017	96" Disk
25003	22-28	0.093	0.046	0.020	96" Disk
25004	20-26	0.125	0.062	0.020	96" Disk
25005	18-22	0.187	0.093	0.020	96" Disk
25006	14-16	0.250	0.125	0.025	96" Disk
25007	10-12	0.3112	0.156	0.025	96" Disk
25008	6-8	0.375	0.187	0.025	96" Disk
25009	4-6	0.500	0.250	0.025	96" Disk
25010	2/0-2	0.750	0.375	0.030	96" Disk
25011	4/0-1	1.000	0.500	0.035	96" Disk

+ 24999-B12 contains 3 ea. 24005, 24006, 24008, 24009

UL File E158587

TYPE
**Thin
Wall**

Features

- 2:1 shrink ratio
- UL Recognized and CSA Certified
- Rated for 600 volts

Benefits

- Provides a wide range of coverage when used on connectors and cable
- Assures product reliability for insulating and protecting terminations and splices
- Ensures reliability



Catalog Number	Wire Range	Exp. Id.	Rec. Id.	Recovered Wall Thickness	Cut Length
26001	26-34	0.046	0.023	0.016	1000'
26002	24-30	0.063	0.031	0.017	1000'
26003	22-28	0.093	0.046	0.020	500'
26004	20-26	0.125	0.062	0.020	500'
26005	18-22	0.187	0.093	0.020	200'
26006	14-16	0.250	0.125	0.025	200'
26007	10-12	0.312	0.156	0.025	500'
26008	6-8	0.375	0.187	0.025	200'
26009	4-6	0.500	0.250	0.025	200'
26010	2/0-2	0.750	0.375	0.030	200'
26011	4/0-1	1.000	0.500	0.035	200'

TYPE

Electric Heat Gun**Features**











- Two temperature settings 750F and 1100F
- Three way switch OFF/HI/LO
- Built-in fold down stand
- 1200 Watt 120 V AC
- Heat deflector
- Impact resistant
- Six foot cord

Benefits

- Provides versatility in applying recommended heat, deliverable in seconds
- Aids in producing proper air flow from heat gun
- Provides hands free operation
- Provides high output of air and heat
- Allows for concentration of heat for rapid heat shrink process
- Provides extra durability in harsh environments
- Provides operator convenience



Catalog Number	Description
27001	Heat Gun, 11 Disks Thin Wall Heat Shrink
94502	Electric Heat Gun 120v
94504	Replacement Adaptor for 94502

<p>IDTB-6</p>  <p>290</p>		<p>ILCB-12-N</p>  <p>291</p>		<p>ILC-10-N</p>  <p>292</p>			
<p>MT-25</p>  <p>293</p>	<p>94285</p>  <p>294</p>	<p>ND-58</p>  <p>295</p>	<p>ND-60</p>  <p>296</p>	<p>ILC-12-N</p>  <p>297</p>	<p>ILC-12H-N</p>  <p>298</p>		
<p>IDT-12-N</p>  <p>299</p>	<p>IDT-6</p>  <p>300</p>	<p>IDT-6H</p>  <p>301</p>	<p>ILC-15H</p>  <p>302</p>	<p>5ACR</p>  <p>303</p>	<p>FP-1</p>  <p>304</p>		
<p>HH-10N</p>  <p>305</p>	<p>COMPRESSION INDEX</p> <p>306 - 312</p>		<p>COMPRESSION DIES AND ADAPTORS</p>  <p>313 - 314</p>		<p>TOOL ACCESSORIES</p>  <p>315</p>	<p>94130</p>  <p>316</p>	<p>94140</p>  <p>316</p>
<p>WS-1</p>  <p>316</p>	<p>CTR</p>  <p>317</p>		<p>TS</p>  <p>318</p>				
<p>TW</p>  <p>318</p>		<p>WR</p>  <p>318</p>					
<p>94502</p>  <p>319</p>							

TYPE
IDTB-6

Features

- Dieless operation
- Battery powered
- No set-up time
- Flip top head
- Head rotates 360 degrees, angled pistol grip
- Lightweight - only 10.8 lbs.
- Battery provides up to 35 crimps per charge
- One-hour 120 volt charger and two 12 volt batteries included

Benefits

- No dies to lose or replace, one tool does it all
- Flexibility in use - can use where power access is limited
- Speeds installation
- Easy connector loading and unloading
- Convenience when working in tight areas
- Easy to hold, less tiring for numerous crimps
- Easy to charge, dependable performance
- Convenience

Specifications

Force developed: 6.2 Tons
 Weight: 10.8 lbs.
 Overall Length: 14-7/8"
 Connector Range: 750kcmil-#6



For Use with

Aluminum Connectors	Copper Connectors
ACL, ACN Series thru 750kcmil	CLN4, CLN9, CLND,
2ACL, 2ACN Series thru 750kcmil	CLNF, CLNN, CLNS,
AS Series thru 750kcmil	CLNU, CLW4, CLW9,
IACL Series thru 500kcmil	CLWD, CLWF, CLWN,
2IACL Series thru 500kcmil	CLWS, CSN4, CSN9,
	CSND, CSNF, CSNN,
	CSNS, CSW4, CSW9,
	CSWD, CSWF, CSWN,
	CSWS 750kcmil thru 6

Includes:

- 2 Batteries
- 1 Battery Charger
- Steel Carrying Case
- Instruction Manual



Battery Powered Crimping Tool

TYPE ILCB-12-N

Features

- Head tested to 50,000 crimp cycles
- Accepts industry standard "U" dies
- Light weight - 14.9 lbs.
- Two speed pump
- Ram automatically retracts when crimp cycle is complete
- Head rotates 360 degrees
- Battery provides up to 35 crimps per charge
- One-hour 120 volt charger and two 12 volt batteries included

Benefits

- Durable and dependable
- Flexibility and economy
- Easy to hold, less tiring for numerous crimps
- Reduces cycle time
- Confirms crimp was completed
- Convenience when working in tight areas
- Easy to charge, dependable performance
- Convenience

Specifications

Force developed: 12 Tons
 Weight: 14.9 lbs.
 Overall length: 15-1/4"
 Jaw Opening: 1.65"
 Connector Range: 1000kcmil-#8



For Use with*

Aluminum Connectors	Copper Connectors
CPM Series	CLN4, CLN9, CLND,
ACM Series	CLNF, CLNN, CLNS,
ACO Series	CLNU, CLW4, CLW9,
ACO-90 Series	CLWD, CLWF, CLWN,
ACL, ACN Series thru 750kcmil	CLWS, CSN4, CSN9,
2ACL, 2ACN Series thru 750kcmil	CSND, CSNF, CSNN,
AS Series thru 750kcmil	CSNS, CSW4, CSW9,
AH 1-4	CSWD, CSWF, CSWN,
HT Series	CSWS 1000kcmil thru 8
IACL Series thru 750kcmil	
2IACL Series thru 750kcmil	

*See page 312 for required compression dies

Includes:

- 2 Batteries
- 1 Battery Charger
- Steel Carrying Case
- Instruction Manual



Hand Operated Crimping Tool

TYPE ILC-10-N

Features

- Rotatable die
- Additional die affixed to frame
- Crimp cavities are color coded to industry standards
- Ratchet control mechanism
- Heat treated frame and dies
- Long, molded handles

Benefits

- Crimps #2, #4, #6 and #8 copper compression connectors
- Crimps 1/0 and #1 copper compression connectors
- Reduces the possibility of improper die selection
- Assures a complete crimp
- Dependable, long lasting tool
- Ergonomic design to reduce hand stress

Specifications

Weight: 1-3/8 lbs.
 Overall Length: 11"
 Width: 3.75"
 Jaw Opening: .5"
 Conductor Range: 1/0-8 CU



For Use with

Copper Connectors

CLN4, CLN9, CLND,

CLNF, CLNN, CLNS,

CLNU, CLW4, CLW9,

CLWD, CLWF, CLWN,

CLWS, CSN4, CSN9,

CSND, CSNF, CSNN,

CSNS, CSW4, CSW9,

CSWD, CSWF, CSWN,

CSWS 1/0 thru 8



TYPE MT-25

Features

- Dieless single indent compressor
- Steel adjusting knob
- UL Listed terminals and splices
- Broad wire range
- Mounting hole for bench mounting applications

Benefits

- Reduces installed cost by having no separate dies to purchase, change or lose
- Provides fast and easy setting. Simply align the line on the die nest with the wire size gauge for proper crimping results.
- Ensures reliability. ILSCO's standard line of connectors are UL Listed when crimped with the MT-25 tool
- Convenience

Specifications

Length: 22.65"
 Weight: 6 lbs.
 Depth: 4.86"
 Width: 1.12"
 Conductor Range: 250kcmil-8 CU
 4/0-8 AL



For Use with

Aluminum Connectors	Copper Connectors
ACL, ACN 4/0-8	CLN4, CLN9, CLND,
2ACL, 2ACN 4/0-8	CLNF, CLNN, CLNS,
AS 4/0-8	CLNU, CLW4, CLW9,
	CLWD, CLWF, CLWN,
	CLWS, CSN4, CSN9,
	CSND, CSNF, CSNN,
	CSNS, CSW4, CSW9,
	CSWD, CSWF, CSWN,
	CSWS 250kcmil thru 8
	CCL, CRAM

TYPE
94285

Features

- ① • Controlled cycle ratchet mechanism
- ② • Built in rotatable dies
- ③ • Comfort grip handles
- UL Listed terminals and splices

Benefits

- Acts as a quality control device, once a crimp is started, the tool will not open until it is completed. (Tool has emergency release mechanism.)
- No separate dies to purchase or lose
- Helps ease fatigue with continuous use
- Ensures reliability. ILSCO's standard line of connectors are UL Listed when crimped with the 94285 tool

Specifications

Length: 25-1/4"
 Weight: 6.1 lbs.
 Conductor Range: 250kcmil-8 CU
 3/0-8 AL

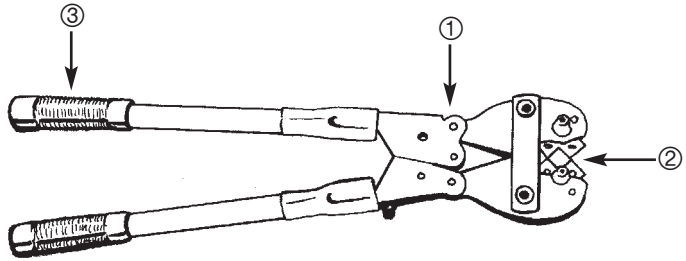

For Use with	
Aluminum Connectors	Copper Connectors
ACL, ACN 3/0-8	CLN4, CLN9, CLND,
2ACL, 2ACN 3/0-8	CLNF, CLNN, CLNS,
AS 3/0-8	CLNU, CLW4, CLW9,
	CLWD, CLWF, CLWN,
	CLWS, CSN4, CSN9,
	CSND, CSNF, CSNN,
	CSNS, CSW4, CSW9,
	CSWD, CSWF, CSWN,
	CSWS 250kcmil thru 8

TYPE ND-58

- Features**
- ① • High strength, butting, forged steel jaw
 - ② • Two permanent die grooves
 - ③ • Large diameter hardened steel bolts
 - ④ • Spring loaded positive lock die retainer buttons
 - ⑤ • Orange alignment grooves
 - ⑥ • PTFE[®] impregnated steel backed bronze bushings
 - ⑦ • Over center cam action
 - ⑧ • Adjustment screws
 - ⑨ • Handle butt stops and heat shrink tubing
 - ⑩ • High quality clear hickory handles
 - ⑪ • Bent handles and anti-slip handle grips

- Benefits**
- Assures proper crimps
 - No additional dies required for "0" and "D₃" size tap connectors. The "D₃" groove accommodates the complete line of type "W-" die inserts.
 - Provides increased strength and greater bearing area
 - Allows fast, easy, one-hand die insertion. No lost dies.
 - Allows easy visual field check for proper tool adjustment
 - Over 90,000 crimps provided with Teflon impregnated steel backed bronze bushings
 - Assures full crimp force
 - Easy tool adjustment with allen wrench screws
 - Operator protection provided with butt stops and heat shrink tubing
 - Long life expectancy provided with select clear hickory handles and light weight high strength aluminum alloy castings
 - Easier tool operation is provided with bent handles and anti-slip grips

Specifications

Crimp Force: 9,000 lbs.
 Length: 25-3/8"
 Weight: 9 lbs.

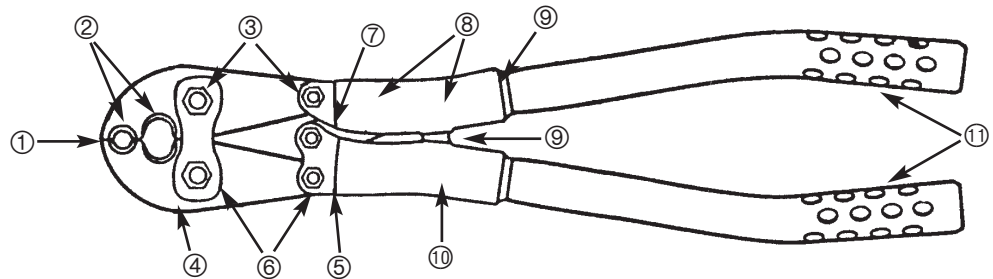

For Use with

Aluminum Connectors	Copper Connectors
PICS Series	GGA-1
P840 Series	GGC-1
UCL 1/0-4	ULT 4-7
UCS 1/0-4	
HT Series	
AH 1-4	

Accessories:

- Carrying bag included

TYPE ND-60

- Features**
- ① • High strength, butting, forged steel jaw
 - ② • Two permanent die grooves
 - ③ • Large diameter hardened steel bolts
 - ④ • Spring loaded positive lock die retainer buttons
 - ⑤ • Orange alignment grooves
 - ⑥ • PTFE[®] impregnated steel backed bronze bushings
 - ⑦ • Over center cam action
 - ⑧ • Adjustment screws
 - ⑨ • Handle butt stops and heat shrink tubing
 - ⑩ • High quality clear hickory handles
 - ⑪ • Bent handles and anti-slip handle grips

- Benefits**
- Assures proper crimps
 - No additional dies required for "BG" and "D₃" size tap connectors. The "D₃" groove accommodates the complete line of type "W." die inserts.
 - Provides increased strength and greater bearing area
 - Allows fast, easy, one-hand die insertion. No lost dies.
 - Allows easy visual field check for proper tool adjustment
 - Over 90,000 crimps provided with Teflon impregnated steel backed bronze bushings
 - Assures full crimp force
 - Easy tool adjustment with allen wrench screws
 - Operator protection provided with butt stops and heat shrink tubing
 - Long life expectancy provided with select clear hickory handles and light weight high strength aluminum alloy castings
 - Easier tool operation is provided with bent handles and anti-slip grips

Specifications

Crimp Force: 9,000 lbs.
 Length: 25-3/8"
 Weight: 9 lbs.

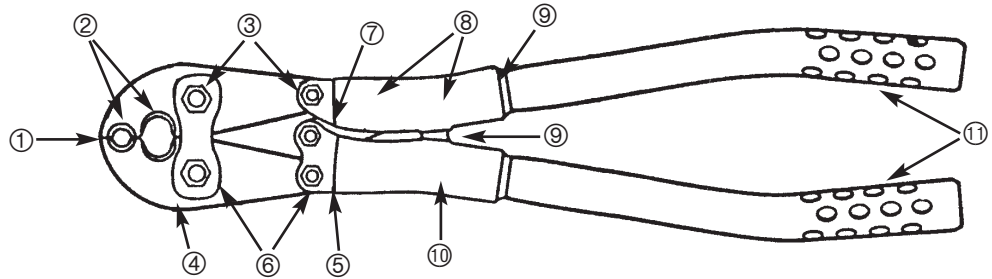

For Use with

Aluminum Connectors	Copper Connectors
PICS Series	GGA-1
P840 Series	GGC-1
UCL 1/0-4	ULT 4-7
UCS 1/0-4	
HT Series	
AH 1-4	

Accessories:

- Carrying bag included

TYPE ILC-12-N

Features

- Head tested to 50,000 crimp cycles
- Accepts industry standard "U" dies
- Light head - 13.2 lbs.
- Two speed pump
- Ram automatically retracts when crimp cycle is complete
- Head rotates 360 degrees

Benefits

- Durable and dependable
- Flexibility and economy
- Easy to hold, less tiring for numerous crimps
- Reduces cycle time
- Confirms crimp was completed
- Convenience when working in tight areas

Specifications

Force developed: 12 Tons
 Operating pressure: 10,000 PSI
 Weight: 13.2 lbs.
 Overall length: 21-1/2"
 Jaw Opening: 1.65"
 Conductor Range: 1000kcmil-#8



For Use with*

Aluminum Connectors	Copper Connectors
CPM Series	CLN4, CLN9, CLND,
ACM Series	CLNF, CLNN, CLNS,
ACO Series	CLNU, CLW4, CLW9,
ACO-90 Series	CLWD, CLWF, CLWN,
ACL, ACN 750kcmil-8	CLWS, CSN4, CSN9,
2ACL, 2ACN 750kcmil-1/0	CSND, CSNF, CSNN,
AS 750kcmil-8	CSNS, CSW4, CSW9,
AH 1-4	CSWD, CSWF, CSWN,
HT Series	CSWS 1000kcmil thru 8
IACL Series thru 750kcmil	
2IACL Series thru 750kcmil	

*See page 312 for required compression dies

Includes:

Steel Carrying Case
 Instruction Manual

J

TYPE ILC-12H-N

Features

- Head tested to 50,000 crimp cycles
- Accepts industry standard "U" dies
- Hot stick attachment point
- Light head - 9.7 lbs
- Equipped with 3/8" male screw coupler
- Ram automatically retracts when crimp cycle is complete

Benefits

- Durable and dependable
- Flexibility and economy
- Offers the option of performing line maintenance when properly protected
- Easy to hold, less tiring for numerous crimps
- For use with standard industry hoses
- Confirms crimp was completed

Specifications

Force developed: 12 Tons
 Operating pressure: 10,000 PSI
 Weight: 9.7 lbs.
 Overall Length: 11-7/8"
 Jaw Opening: 1.65"
 Conductor Range: 1000kcmil-#8



For Use with*	
Aluminum Connectors	Copper Connectors
CPM Series	CLN4, CLN9, CLND,
ACM Series	CLNF, CLNN, CLNS,
ACO Series	CLNU, CLW4, CLW9,
ACO-90 Series	CLWD, CLWF, CLWN,
ACL 750kcmil-8	CLWS, CSN4, CSN9,
2ACL 750kcmil-1/0	CSND, CSNF, CSNN,
AS 750kcmil-8	CSNS, CSW4, CSW9,
AH 1-7	CSWD, CSWF, CSWN,
HT Series	CSWS 1000kcmil thru 8
IACL Series	
2IACL Series	

*See page 312 for required compression dies

Additional Requirements:

- Hose
- Pump

Includes:

Steel Carrying Case
 Instruction Manual



TYPE IDT-12-N

Features

- Dieless operation
- Pressure system automatically changes crimping force for each connector and size
- Seven indent profiles
- Automatic two speed pump
- 15 ton maximum crimping force
- Head rotates 180 degrees
- Hinged head

Benefits

- No dies to lose or replace, one tool does it all
- Eliminates crimping errors
- Requires fewer crimps per connector
- Rapid advance, reduces cycle time
- Ability to crimp 1000 kcmil
- Convenience when working in tight areas
- Easy connector loading and unloading

Specifications

Force developed: 15 Tons
 Overall length: 26.5"
 Weight: 16.5 lbs.
 Conductor Range: 1000kcmil - #4 CU
 1000kcmil - #6 AL



For Use with

Aluminum Connectors	Copper Connectors
ACL, ACN Series	CLN4, CLN9, CLND,
2ACL, 2ACN Series	CLNF, CLNN, CLNS,
AS Series	CLNU, CLW4, CLW9,
IACL Series	CLWD, CLWF, CLWN,
2IACL Series	CLWS, CSN4, CSN9,
	CSND, CSNF, CSNN,
	CSNS, CSW4, CSW9,
	CSWD, CSWF, CSWN,
	CSWS 1000kcmil thru 4

Includes:

Steel Carrying Case
 Instruction Manual



Hand Operated Dieless Crimping Tool

TYPE IDT-6

Features

- Dieless operation
- Automatic two speed pump
- Ram automatically retracts when crimp cycle is complete
- Head rotates 360 degrees
- Flip top head
- Lightweight - 9.0 lbs.

Benefits

- No dies to lose or replace, one tool does it all
- Rapid advance, reduces cycle time
- Confirms crimp was completed
- Convenience when working in tight areas
- Easy connector loading and unloading
- Easy to hold, less tiring for numerous crimps

Specifications

Force developed: 6.2 Tons
 Weight: 9.0 lbs.
 Overall Length: 21-1/16"
 Connector Range: 750kcmil-#6



For Use with

Aluminum Connectors	Copper Connectors
ACL, ACN Series thru 750kcmil	CLN4, CLN9, CLND,
2ACL, 2ACN Series thru 750kcmil	CLNF, CLNN, CLNS,
AS Series thru 750kcmil	CLNU, CLW4, CLW9,
IACL Series thru 500kcmil	CLWD, CLWF, CLWN,
2IACL Series thru 500kcmil	CLWS, CSN4, CSN9,
	CSND, CSNF, CSNN,
	CSNS, CSW4, CSW9,
	CSWD, CSWF, CSWN,
	CSWS 1000kcmil thru 6

Includes:

Steel Carrying Case
 Instruction Manual



TYPE
IDT-6H

Features

- Dieless operation
- Flip top head
- Lightweight - 6.2 lbs
- Equipped with 3/8" male screw coupler

Benefits

- No dies to lose or replace, one tool does it all
- Easy connector loading and unloading
- Easy to hold, less tiring for numerous crimps
- For use with standard industry hoses

Specifications

Force developed: 6.2 Tons
 Operating pressure: 10,000 PSI
 Overall Length: 10-1/2"
 Weight: 6.2 lbs.
 Conductor Range: 750kcmil-#6



For Use with

Aluminum Connectors	Copper Connectors
ACL, ACN Series thru 750kcmil	CLN4, CLN9, CLND,
2ACL, 2ACN Series thru 750kcmil	CLNF, CLNN, CLNS,
AS Series thru 750kcmil	CLNU, CLW4, CLW9,
IACL Series thru 500kcmil	CLWD, CLWF, CLWN,
2IACL Series thru 500kcmil	CLWS, CSN4, CSN9,
	CSND, CSNF, CSNN,
	CSNS, CSW4, CSW9,
	CSWD, CSWF, CSWN,
	CSWS 750kcmil thru 6

Additional Requirements:

- Hose
- Pump

Includes:

Steel Carrying Case
 Instruction Manual

TYPE ILC-15H

Features

- Lightweight - only 14.1 lbs
- Accepts P or U dies with adaptor
- Hot stick attachment point
- Equipped with 3/8" male screw coupler
- Zinc plated head

Benefits

- Easy to hold, less tiring for numerous crimps
- Versatility and efficiency. Use your current dies with this tool
- Offers the option of performing line maintenance when properly protected
- For use with standard industry hoses
- Excellent corrosion resistance for long tool life

Specifications

Force developed: 15 Tons
 Operating pressure: 10,000 PSI
 Weight (with case): 14.1 lbs.
 Overall length: 15"
 Maximum width: 3"
 Conductor Range: 1000kcmil-#8



For Use with*	
Aluminum Connectors	Copper Connectors
CPM Series	CLN4, CLN9, CLND,
ACM Series	CLNF, CLNN, CLNS,
ACO Series	CLNU, CLW4, CLW9,
ACO-90 Series	CLWD, CLWF, CLWN,
ACL, ACN 1000kcmil-8	CLWS, CSN4, CSN9,
2ACL, 2ACN 1000kcmil-1/0	CSND, CSNF, CSNN,
AS 1000kcmil-8	CSNS, CSW4, CSW9,
HT Series	CSWD, CSWF, CSWN,
AH Series	CSWS 1000kcmil thru 8
IACL Series	
2IACL Series	

*See page 312 for required compression dies
 Note: If using "P" dies, an ILD-PADP must be used.
 If using "U" dies, an ILD-UADP must be used.

Additional Requirements:

- Hose
- Pump
- Adaptor required with all dies



**TYPE
5ACR****Features**

- 1/2 HP, 115VSC 50/60 Hz Motor
- Lightweight, compact design with carrying handle
- 10,000 PSI high-pressure pump with high-pressure relief valve
- Two-stage pump for rapid advance
- Pressure matched quick coupler

Benefits

- Convenient 115 V-AC electric powered motor and run on as low as 60 VAC
- Easy to lift, carry and transport tool around job site with lightweight body and handle
- High quality crimps are achieved with built in, factory set pressure release valve
- Two-stage pumping system of the unique, intermittent duty pump is designed for years of dependable service
- Saves time with quick disconnect hydraulic fitting

Technical Data:

Motor: 1/2 HP single phase, 115VAC 9 amps
 Electric Control: Remote control with 10' cord
 Oil Delivery per minute: 250 cu in @ 200 PSI,
 19 cu in @ 10,000 PSI
 Oil Reservoir: 1 gallon (3.7 liters)
 Overall Length: 10.52"
 Overall Width: 8.10"
 Overall Height: 15.95"
 Pump Weight (with oil): 29 lbs

**For Use with**

ILC-12H	ILC-12H-N
IDT-12H	IDT-6H
ILC-14H	ILC-15H
ILC-15	

TYPE FP-1

Features

- ① • Lightweight rugged design, portable
- ② • Built in handle
- ③ • Spring loaded arm
- ④ • Long arm
- ⑤ • Diamond plate steel foot pad
- ⑥ • Sturdy leg stabilizers
- ⑦ • Quick-disconnect hydraulic fitting, uses only Pioneer fittings
- ⑧ • Built-in factory set pressure relief valve

Benefits

- Easy to lift and carry
- Easy to transport and move tool around job site with built in handle
- Easy operation provided with spring assisted return arm
- Maximum mechanical advantage provided with long arm extending beyond pump body
- Quality, heavy duty foot pad provided with diamond plate steel. (slip resistant)
- Solid tool base provided with sturdy broad leg stabilizers
- Time saving quick disconnect hydraulic fitting
- High quality crimps provided with factory set pressure release valve with audible click to signal completion of crimp

Specifications

Reservoir volume:	1-1/8 qts.
Length:	24-3/4"
Width:	5"
Weight:	19 lbs.
Closed Height:	6-1/2"
Height (with arm open):	17"
Output Pressure:	10,000 PSI

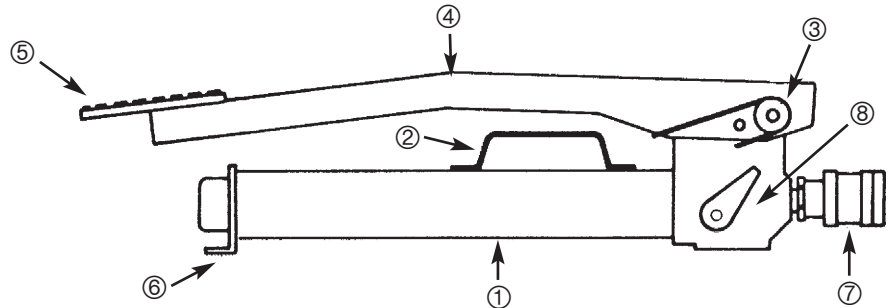

For Use on

Hydraulic Tools

ILC-12H	ILC-12H-N
IDT-12H	IDT-6H
ILC-14H	ILC-15H
ILC-15	



TYPE
HH-10N**Features**

- Pre-filled with oil
- Strain reliefs
- Insulated hose
- Rated 10,000 PSI
- Pioneer fittings
- 10 ft. Hose length

Benefits

- Convenience
- Safety
- Safety
- Powers most remote heads
- Standard for most hydraulic tools
- Convenience

**For use with IlSCO and other hydraulic tools,
IlSCO 5ACR pump and FP-1 foot pump.**

Catalog Number	Coupler Type	For Use With
HH-10N	Male - Female	IDT-6H, ILC-12H-N, ILC-15H





Series CS, CL Compression Connectors for Class B/C Copper Wire Only



ILSCO TOOLS - Tooling Information

WARNING! Do Not Use with Aluminum Wire

Hydraulic Tools

Manual Hand Tools

Lug Size	Class B/C Wire Size	Color Code	Die Index	Manual Hand Tools						Hydraulic Tools					
				94285			MT-25	ILC-10-N		IDT-6, IDT-6H 6.2 Ton Dieless, IDTB-6 6.2 Ton Dieless Battery	ILC-12-N, ILC-12H-N, ILC-12, ILC-12H, ILC-14, ILC-14H 12 Ton, ILCB-12-N, ILCB-12 12 Ton Battery	IDT-12-N 15 Ton Dieless	IDT-12, IDT-12H, IDTB-12 11 Ton Dieless	ILC-15H 15 Ton, ILC-30H 30 Ton	ILC-750
				Left Die	Right Die	Crimps	Crimps	Index	Crimps						
8	8 AWG	Red	21	M	K	2	1	Red	1		1			1	1
6	6 AWG	Blue	24	K	K	2	1	Blue	2	1	1			1	1
4	4 AWG	Gray	29	K	K	2	1	Gray	2	1	1	1	1	1	1
3	3 AWG	White	29	K	K	2	1	Gray	2	1	1	1	1	1	1
2	2 AWG	Brown	33	H	H	2	2	Brown	2	1	1	1	1	1	1
1	1 AWG	Green	37	H	H	2	2	Green	2	1	1	1	1	1	1
1/0	1/0 AWG	Pink	42	E	A	2	2	Pink	4	1	1	1	1	1	1
2/0	2/0 AWG	Black	45	E	A	3	2			1	1	1	1	1	1
3/0	3/0 AWG	Orange	50	A	C	3	2			2	1	1	1	1	1
4/0	4/0 AWG	Purple	54	A	B	3	2			2	1	1	1	1	1
250	250kcmil	Yellow	62	A	A	3	2			2	1	1	1	1	1
300	300kcmil	White	66							2	2	1	1	2	2
350	350kcmil	Red	71							2	2	1	1	2	2
400	400kcmil	Blue	76							2	2	1	1	2	2
500	500kcmil	Brown	87							2	2	1	1	2	2
600	600kcmil	Green	94							2	2	1	1	2	2
700	700kcmil	Pink	99							3	2	1	1	2	2
750	750kcmil	Black	106							3	2	1	1	2	2
1000	1000kcmil	White	125								2	1	1	2	

RANGE TAKING

Lug Size	Standard Wire Size	Expanded Wire Size	No. Crimps for ILSCO IDT-12, IDT-12-N and Burndy Y644M, PAT644	No. Crimps for ILSCO IDTB-6, IDT-6 and IDT-6H
4	4 AWG	4 - 6 AWG		1
3	3 AWG	3 - 6 AWG	1	1
2	2 AWG	2 - 6 AWG	1	1
1	1 AWG	1 - 6 AWG	1	1
1/0	1/0 AWG	1/0 - 6 AWG	1	1
2/0	2/0 AWG	2/0 - 4 AWG	1	1
3/0	3/0 AWG	3/0 - 2 AWG	1	2
4/0	4/0 AWG	4/0 - 1 AWG	1	2
250	250kcmil	250kcmil - 1/0 AWG	1	2
300	300kcmil	300kcmil - 2/0 AWG	1	2
350	350kcmil	350kcmil - 3/0 AWG	1	2
400	400kcmil	400kcmil - 4/0 AWG	1	2
500	500kcmil	500kcmil - 250kcmil	1	2
600	600kcmil	600kcmil - 250kcmil	1	2
700	700kcmil	700kcmil - 350kcmil	1	3
750	750kcmil	750kcmil - 500kcmil	1	3
1000	1000kcmil	1000kcmil - 750kcmil	1	

UL Listed and CSA Certified when installed with tools and dies shown above

- Connectors are marked with color, die numbers and required number of crimps for ILSCO hydraulic tools. When using other listed tools, consult chart for crimps required. Crimps should be evenly spaced on connector.
- The ILSCO 94285, MT-25 and all dieless tools are not color coded or do not contain the die index.
- Strip Length = Barrel Length + 1/16 Inch
- For long barrel connectors double the amount of crimps indicated on chart except for 1000kcmil add only one additional crimp.



ILSCO TOOLS - Tooling Information

WARNING! Do Not Use with Aluminum Wire

Hydraulic Tools

Manual Hand Tools

Lug Size	Class B/C Wire Size	Color Code	Die Index	Manual Hand Tools						Hydraulic Tools				
				94285			MT-25	ILC-10-N		IDT-6, IDT-6H 6.2 Ton Dieless, IDTB-6 6.2 Ton Dieless Battery	ILC-12-N, ILC-12H, ILC-12, ILC-14, ILC-14H 12 Ton, ILCB-12-N, ILCB-12 12 Ton Battery	IDT-12-N 15 Ton Dieless	IDT-12, IDT-12H, IDTB-12 11 Ton Dieless	ILC-15H 15 Ton, ILC-30H 30 Ton
				Left Die	Right Die	Crimps	Crimps	Index	Crimps					
8	8 AWG	Red	21	M	K	2	1	Red	1		1			1
6	6 AWG	Blue	24	K	K	2	1	Blue	2	1	1		1	1
4	4 AWG	Gray	29	K	K	2	1	Gray	2	1	1	1	1	1
3	3 AWG	White	29	K	K	2	1	Gray	2	1	1	1	1	1
2	2 AWG	Brown	33	H	H	2	2	Brown	2	1	1	1	1	1
1	1 AWG	Green	37	H	H	2	2	Green	2	1	1	1	1	1
1/0	1/0 AWG	Pink	42	E	A	2	2	Pink	4	1	1	1	1	1
2/0	2/0 AWG	Black	45	E	A	3	2			1	1	1	1	1
3/0	3/0 AWG	Orange	50	A	C	3	2			2	1	1	1	1
4/0	4/0 AWG	Purple	54	A	B	3	2			2	1	1	1	1
250	250kcmil	Yellow	62	A	A	3	2			2	1	1	1	1
300	300kcmil	White	66							2	2	1	1	2
350	350kcmil	Red	71							2	2	1	1	2
400	400kcmil	Blue	76							2	2	1	1	2
500	500kcmil	Brown	87							2	2	1	1	2
600	600kcmil	Green	94							2	2	1	1	2
700	700kcmil	Pink	99							3	2	1	1	2
750	750kcmil	Black	106							3	2	1	1	2
1000	1000kcmil	White	125								2	1	1	2

UL Listed and CSA Certified when installed with tools and dies shown above

- a) Number of crimps shown on chart must be on each end of the CT splicer connectors.
- b) The CT connectors are marked with color, the die numbers and required number of crimps for ILSCO hydraulic tools. When using other listed tools, consult chart for crimps required. Crimps should be evenly spaced on connector.
- c) The ILSCO 94285, MT-25 and all dieless tools are not color coded or do not contain the die index.
- d) For long barrel (CTL) connectors add one additional crimp to each side of barrel.

J

ILSCO TOOLS - Tooling Information

WARNING! Do Not Use with Aluminum Wire

Hydraulic Tools

Lug Size	Fine Strand Wire Size	Approved Wire Classes	Color Code	Die Index	Manual Hand Tools					Hydraulic Tools					
					94285			ILC-10-N		IDT-6, IDT-6H 6.2 Ton Dieless, IDTB-6 6.2 Ton Dieless Battery	ILC-12-N, ILC-12H-N, ILC-12, ILC-12H, ILC-14, ILC-14H 12 Ton, ILCB-12-N, ILCB-12 12 Ton Battery	IDT-12-N 15 Ton Dieless	IDT-12H, IDTB-12 11 Ton Dieless	ILC-15H 15 Ton, ILC-30H 30 Ton	ILC-750
					Left Die	Right Die	Crimps	Index	Crimps						
8	8	G,H,I,K,M,DLO	Red	21				Red	1		1			1	1
4	6	G,H,I,K,M,DLO	Gray	29				Blue	2		1			1	1
3	4	G,H,I,K,M,DLO	White	29	K	K	2	Gray	2	1	1	1	1	1	1
1	2	G,H,I,K,M,DLO	Green	37	H	H	2	Green	2	1	1	1	1	1	1
1/0	1	G,H,I,K,M,DLO	Pink	42	H	H	2	Pink	4	1	1	1	1	1	1
2/0	1/0	G,H,I,K,M,DLO	Black	45	E	A	3			1	1	1	1	1	1
3/0	2/0	G,H,I,K,M,DLO	Orange	50	E	A	3			1	1	1	1	1	1
4/0	3/0	G,H,I,K,M,DLO	Purple	54	A	B	3			1	1	1	1	1	1
250	4/0	G,H,I,K,M,DLO	Yellow	62	A	B	3			1	1	1	1	1	1
300	250	G,H	White	66						1	2	1	1	2	2
350	250	I,K,M	Red	71						1	2	1	1	2	2
350	262	DLO	Red	71						1	2	1	1	2	2
400	300	G,H,I,K,M	Blue	76						2	2	1	1	2	2
400	313	DLO	Blue	76						2	2	1	1	2	2
500	350	G,H,I,K,M	Brown	87						2	2	1	1	2	2
500	373	DLO	Brown	87						2	2	1	1	2	2
600	400	G,H,I,K,M	Green	94						2	2	1	1	2	2
600	444	DLO	Green	94						2	2	1	1	2	2
700	500	G,H,I,K,M	Pink	99						3	2	1	1	2	2
700	535	DLO	Pink	99						3	2	1	1	2	2
750	600	G,H,I,M	Black	106						3	2	1	1	2	2
750	646	DLO	Black	106						3	2	1	1	2	2
1000	750	G,H,I	White	125							3	1	1	3	
1000	777	DLO	White	125							3	1	1	3	

UL Listed and CSA Certified when installed with tools and dies shown above

- Connectors are marked with color, die numbers and required number of crimps for ILSCO hydraulic tools. When using other listed tools, consult chart for crimps required. Crimps should be evenly spaced on connector.
- The ILSCO 94285, MT-25 and all dieless tools are not color coded or do not contain the die index.
- Strip Length = Barrel Length + 1/16 Inch
- For long barrel connectors double the amount of crimps indicated on chart except for 1000kcmil add only one additional crimp.



ILSCO TOOLS - Tooling Information

WARNING! Do Not Use with Aluminum Wire

Hydraulic Tools

Lug Size	Fine Strand Wire Size	Approved Wire Classes	Color Code	Die Index	Manual Hand Tools					Hydraulic Tools					
					94285			ILC-10-N		Crimps	Crimps	Crimps	Crimps	Crimps	Crimps
					Left Die	Right Die	Crimps	Index	Crimps						
8	8	G,H,I,K,M,DLO	Red	21	M	K	2	Red	1		1			1	
4	6	G,H,I,K,M,DLO	Gray	29	K	K	2	Blue	2		1			1	
3	4	G,H,I,K,M,DLO	White	29	K	K	2	Gray	2	1	1	1	1	1	
1	2	G,H,I,K,M,DLO	Green	37	H	H	2	Green	2	1	1	1	1	1	
1/0	1	G,H,I,K,M,DLO	Pink	42	H	H	2	Pink	4	1	1	1	1	1	
2/0	1/0	G,H,I,K,M,DLO	Black	45	E	A	3			1	1	1	1	1	
3/0	2/0	G,H,I,K,M,DLO	Orange	50	E	A	3			2	1	1	1	1	
4/0	3/0	G,H,I,K,M,DLO	Purple	54	A	B	3			2	1	1	1	1	
250	4/0	G,H,I,K,M,DLO	Yellow	62	A	B	3			2	1	1	1	1	
300	250	G,H	White	66						2	2	1	1	2	
350	250	I,K,M	Red	71						2	2	1	1	2	
350	262	DLO	Red	71						2	2	1	1	2	
400	300	G,H,I,K,M	Blue	76						2	2	1	1	2	
400	313	DLO	Blue	76						2	2	1	1	2	
500	350	G,H,I,K,M	Brown	87						2	2	1	1	2	
500	373	DLO	Brown	87						2	2	1	1	2	
600	400	G,H,I,K,M	Green	94						2	2	1	1	2	
600	444	DLO	Green	94						2	2	1	1	2	
700	500	G,H,I,K,M	Pink	99						3	3	1	1	3	
700	535	DLO	Pink	99						3	3	1	1	3	
750	600	G,H,I,M	Black	106						3	3	1	1	3	
750	646	DLO	Black	106						3	3	1	1	3	
1000	750	G,H,I	White	125							3	1	1	3	
1000	777	DLO	White	125							3	1	1	3	

UL Listed and CSA Certified when installed with tools and dies shown above

- a) Number of crimps shown on chart must be on each end of the CT splicer connectors.
- b) The CT connectors are marked with color, the die numbers and required number of crimps for ILSCO hydraulic tools. When using other listed tools, consult chart for crimps required. Crimps should be evenly spaced on connector.
- c) The ILSCO 94285, MT-25 and all dieless tools are not color coded or do not contain the die index.
- d) For long barrel (CTL) connectors add one additional crimp to each side of barrel.

J

COMPETITOR'S TOOLS - Tooling Information

WARNING! Do Not Use with Aluminum Wire

Lug Size	Class B/C Wire Size	Anderson		Burdny							T&B				Greenlee					
		VC6-FT, VC6-FTR, VC6-FT-BP, VC7-FT, VC7-FTR Dieless		PAT81KFT, Y81KFT, Y81KFTMBH Dieless		‡ Y644M, PAT644 Dieless		Y35, Y35BH, Y39, Y750, Y750BH, PAT750		Y46, Y46C Requires Die Adaptor		TBM25S		13100A, TBM14M, TBM14BSCR		K111		HK06FT, RK06FT, EK06FT Dieless		1990 Dieless
		Crimps	Index	Crimps	Crimps	Crimps	Die Part	Crimps	Die Part	Crimps	Index	Crimps	Die Part	Crimps	Index	Crimps	Crimps	Crimps		
8	8 AWG	1	Red	1	1		U8CRT	1	U8CRT	1	Red	1	15520	1	Red	1				
6	6 AWG	1	Blue	1	1		U5CRT	1	U5CRT	1	Blue	1	15522	1	Blue	2	1			
4	4 AWG	1	Gray	2	1	1	U4CRT	1	U4CRT	1	Gray	2	15527-CK	1	Gray	2	1	1		
3	3 AWG	1	White	2	1	1	U3CRT	1	U3CRT	1					Gray	2	1	1		
2	2 AWG	1	Brown	2	1	1	U2CRT	1	U2CRT	1	Brown	2	15528	1	Brown	2	1	1		
1	1 AWG	1			1	1	U1CRT-1	1	U1CRT-1	1			15513-CK	1	Green	2	1	1		
1/0	1/0 AWG	1			1	1	U25RT	1	U25RT	1			15508	1	Pink	4	1	1		
2/0	2/0 AWG	1			1	1	U26RT	1	U26RT	1			15526	1			1	1		
3/0	3/0 AWG	1			1	1	U27RT	1	U27RT	1			15530	1			2	1		
4/0	4/0 AWG	1			1	1	U28RT	1	U28RT	1			15511	1			2	1		
250	250kcmil	2			2	1	U29RT	1	U29RT	1			15510-CK	1			2	1		
300	300kcmil	2			2	1	U30RT	2	U30RT	2			15534	2			2	1		
350	350kcmil	3*			2	1	U31RT	2	U31RT	2			15514-CK	2			2	1		
400	400kcmil	3*			2	1	U32RT	2	U32RT	2			15512	2			2	1		
500	500kcmil	3*			2	1	U34RT	2	U34RT	2			15506	2			2	1		
600	600kcmil	4*			2	1	U36RT	2	U36RT	2			15536-CK	2			2	1		
700	700kcmil	4*			3	1	U38RT	2	U38RT	2			15505	2			3	1		
750	750kcmil	4*			3	1	U39RT	2	U39RT	2			15515-CK	2			3	1		
1000	1000kcmil				3	1			P44RT	3			15504	2				1		

Dieless* - Crimps will overlap

UL Listed and CSA Certified when installed with tools and dies shown above

- a) Connectors are marked with color, die numbers and required number of crimps for ILSCO hydraulic tools. When using other listed tools, consult chart for crimps required. Crimps should be evenly spaced on connector.
- b) The ILSCO 94285, MT-25 and all dieless tools are not color coded or do not contain the die index.
- c) Consult manufacturers data for catalog numbers of dies for each tool.
- d) Strip Length = Barrel Length + 1/16 Inch
- e) For long barrel connectors double the amount of crimps indicated on chart except for 1000kcmil add only one additional crimp.

‡ Allows expanded wire range to be used.



COMPETITOR'S TOOLS - Tooling Information

WARNING! Do Not Use with Aluminum Wire

Lug Size	Fine Strand Wire Size	Approved Wire Classes	Anderson		Burdny						T&B				Greenlee					
			VC6-FT, VC6-FTR, VC6-FT-BP, VC7-FT, VC7-FTR Dieless		PAT81KFT, Y81KFT, Y81KFTMBH Dieless		‡ Y644M, PAT644 Dieless	Y35, Y35BH, Y39, Y750, Y750BH, PAT750		Y46, Y46C Requires Die Adaptor		TBM25S		13100A, TBM14M, TBM14BSCR		K111		HK06FT, RK06FT, EK06FT Dieless		1990 Dieless
			Crimps	Index	Crimps	Crimps	Crimps	Die Part	Crimps	Die Part	Crimps	Index	Crimps	Die Part	Crimps	Index	Crimps	Crimps	Crimps	
8	8	G,H,I,K,M,DLO	1	Red	1	1		U8CRT	1	U8CRT	1	Red	1	15520	1	Red	1			
4	6	G,H,I,K,M,DLO	1	Blue	2	1		U5CRT	1	U5CRT	1	Blue	2	15522	1	Blue	2			
3	4	G,H,I,K,M,DLO	1	Gray	2	1	1	U4CRT	1	U4CRT	1	Gray	2	15528	1	Gray	2	1		
1	2	G,H,I,K,M,DLO	1	Brown	2	1	1	U2CRT	1	U2CRT	1	Brown	3	15513-CK	1	Green	2	1		
1/0	1	G,H,I,K,M,DLO	1			1	1	U1CRT-1	1	U1CRT-1	1			15508	1	Pink	4	1		
2/0	1/0	G,H,I,K,M,DLO	1			1	1	U25RT	1	U25RT	1			15526	1			1		
3/0	2/0	G,H,I,K,M,DLO	2			2	1	U26RT	1	U26RT	1			15530	1			1		
4/0	3/0	G,H,I,K,M,DLO	2			2	1	U27RT	1	U27RT	1			15511	1			1		
250	4/0	G,H,I,K,M,DLO	2			2	1	U28RT	1	U28RT	1			15510-CK	2			1		
300	250	G,H	2			2	1	U29RT	2	U29RT	2			15534	2			1		
350	250	I,K,M	3*			2	1	U30RT	2	U30RT	2				2			1		
350	262	DLO	3*			2	1		2		2				2			1		
400	300	G,H,I,K,M	3*			2	1	U31RT	2	U31RT	2			15514-CK	2			1		
400	313	DLO	3*			2	1		2		2				2			1		
500	350	G,H,I,K,M	3*			2	1	U32RT	2	U32RT	2			15512	2			1		
500	373	DLO	3*			2	1		2		2			15517	2			1		
600	400	G,H,I,K,M	4*			2	1	U34RT	2	U34RT	2			15536-CK	2			1		
600	444	DLO	4*			2	1		2		2				2			1		
700	500	G,H,I,K,M	4*			3	1	U38XRT	2	U38XRT	2			15505	2			1		
700	535	DLO	4*			3	1		2		2				2			1		
750	600	G,H,I,M	4*			3	1	U39RT	2	U39RT	2			15515-CK	2			1		
750	646	DLO	4*			3	1		2		2				2			1		
1000	750	G,H,I				3	1			U44XRT	3			15504	3			1		
1000	777	DLO				3	1				3				3			1		

Dieless* - Crimps will overlap

UL Listed and CSA Certified when installed with tools and dies shown above

- a) Connectors are marked with color, die numbers and required number of crimps for ILSCO hydraulic tools. When using other listed tools, consult chart for crimps required. Crimps should be evenly spaced on connector.
- b) The ILSCO 94285, MT-25 and all dieless tools are not color coded or do not contain the die index.
- c) Strip Length = Barrel Length + 1/16 Inch
- d) For long barrel connectors double the amount of crimps indicated on chart except for 1000kcmil add only one additional crimp.

‡ Allows expanded wire range to be used.

ILSCO Compression Die Index



Compressor Dies For ILC-12-N, ILC-12H-N, ILCB-12-N, ILC-15H, ILC-12, ILC-12H, ILC-14, ILC-14H, ILCB-12, ILC-15, ILC-750

Catalog Number	Wire Size		
	Aluminum Terminals and Splices	ACM and ACO Pin Connectors	CPM Pin Connectors
ILD-1			
ILD-2	8		
ILD-3	6		
ILD-4	4		
ILD-5			
ILD-6			
ILD-7	2, 1		
ILD-8	1/0	6, 4, 2, 1	
ILD-9	6, 4, 2, 1		
ILD-10	2/0, 3/0		
ILD-11			
ILD-12	4/0	1/0, 2/0, 3/0, 4/0	1/0, 2/0, 3/0, 4/0
ILD-13	250kcmil		
ILD-14	300kcmil, 350kcmil	250kcmil, 300kcmil, 350kcmil	250kcmil, 300kcmil, 350kcmil
ILD-15			
ILD-16	400kcmil		
ILD-16A	*500kcmil	400kcmil, 500kcmil	400kcmil, 500 kcmil
ILD-17	*600kcmil, *700 kcmil		
ILD-18	*700kcmil	600kcmil, 750kcmil	600 kcmil, 750 kcmil

* Cannot be used on Sleeves with ILC-12-N, ILC-12H-N, ILC-12 and ILC-12H tools



Compressor Dies For ILC-12, ILC-12-N, ILC-12H, ILC-12H-N, ILCB-12, ILCB-12-N, ILC-14, ILC-14H, ILC-15, ILC-15H, ILC-750

Catalog Number	Class B/C Copper Wire Only	Fine Strand Copper Wire Only
	Series CS, CL, CT, CTL	Series CS, CL, CT, CTL
ILD-21	8 AWG	8 FLEX CLASS G,H,I,K,M,DLO
ILD-24	6 AWG	-
ILD-29	4-3 AWG	6-4 FLEX CLASS G,H,I,K,M,DLO
ILD-33	2 AWG	-
ILD-37	1 AWG	2 FLEX CLASS G,H,I,K,M,DLO
ILD-42	1/0 AWG	1 FLEX CLASS G,H,I,K,M,DLO
ILD-45	2/0 AWG	1/0 FLEX CLASS G,H,I,K,M,DLO
ILD-50	3/0 AWG	2/0 FLEX CLASS G,H,I,K,M,DLO
ILD-54	4/0 AWG	3/0 FLEX CLASS G,H,I,K,M,DLO
ILD-62	250kcmil	4/0 FLEX CLASS G,H,I,K,M,DLO
ILD-66	300kcmil	250 G,H
ILD-71	350kcmil	250 I,K,M, 262 DLO
ILD-76	400kcmil	300 G,H,I,K,M, 313 DLO
ILD-87	500kcmil	350 G,H,I,K,M, 373 DLO
ILD-94	600kcmil	400 G,H,I,K,M, 444 DLO
ILD-99	700kcmil	500 G,H,I,K,M, 535 DLO
ILD-106	750kcmil	600 G,H,I,M, 646 DLO
ILD-125	1000kcmil	750 G,H,I, 777 DLO



J

**TYPE W DIES FOR
ND-60
ND-58**

Catalog Number	For Use With	
	Aluminum Compression Connectors	Copper Compression Connectors
ND-0	HT-1, HT-2, AH-1	GGC-1, GGA-1, GGA-2, GGA-4
ND-BG	PICS-61 thru PICS-78	ULT-4, ULT-5
ND-C		ULT-6, ULT-7
ND-K-840	UCS-2/0, UCS-3/0, UCS-4/0, UCS-250, PICS-834 thru PICS-869	

FOR TYPE
ILC-15
ILC-15H
ILC-750



Figure 1



Figure 2

Catalog Number	Figure Number	For Use With	
		Aluminum Compression Connectors	Copper Compression Connectors
ILD-K-840*+	1	UCS-2/0, UCS-3/0, UCS-4/0, UCS-250, PICS-834 thru PICS-869	
ILD-C*+	1		ULT-6, ULT-7, ELT-1
ILD-D ₃ *+	1	HT-2, HT-3, HT-4, HT-5, HT-7, AH-2, AH-3, AH-4	ULT-12
ILD-0*	1	HT-1, HT-6, HT-8, AH-1	GGC-1, GGA-1, GGA-2, GGA-4, ELT-2, ELT-4
ILD-N*+	1	AH-5, AH-6, AH-7	
ILD-KR+	2	AH-8, AH-9, AH-10, AH-11, AH-12	AH-10, AH-11, AH-12
ILD-U997*+	1		GGA-2, GGA-3, GGA-5, GGC-2, GGC-3, GGC-4, ELT-3, ELT-5
ILD-U998+	1		GGA-4, GGA-5, GGC-5, GGC-6, GGC-7, RLT
ILD-P998	2	Can only be used with ILC-15 or ILC-15H	GGA-4, GGA-5, GGC-5, GGC-6, GGC-7, RLT
ILD-P999	2	Can only be used with ILC-15 or ILC-15H	GGA-6, GGC-8
ILD-U1011+	1		GGA-6, GGC-8, ELT-6, RLT
ILD-P1011°	2		GGA-6, GGC-8, RLT
ILD-UBG	1	PICS-61 thru PICS-78	ULT-4, ULT-5

* May also be used with ILC-12-N, ILC-12H-N, ILCB-12-N, ILC-12, ILC-12H, ILCB-12

+ Must be used with ILDPADP when using ILC-15, must be used with ILDPADP when using ILC-15H

o Must be used with ILDPADP when using ILC-15H

Die Adaptors

FOR TYPE
ILC-15
ILC-15H



Figure 1



Figure 2



Figure 3

Catalog Number	Figure Number	Description
ILD-ADP	1	Permits ILDPADP-1 to ILDPADP-18 to be inserted in ILC-15 tool
ILD-UADP	2	Permits ILDPADP-1 to ILDPADP-18 to be inserted in ILC-15H tool
ILD-PADP	3	Permits "P" style dies to be inserted in ILC-15H tool

ILSCO Tool Accessories



Fig. 1

Fig. 2

Fig. 3

Fig. 4

Fig. 5

Fig. 6

Catalog Number	Figure Number	Description
TOOL-STAND	1	Battery Tool Stand
ILD-DIE-CASE	2	Crimping die carrying case (dies not included)
IDT-6-TON-TEST-KIT	3	10 Test slugs and gauge
IDT-12-TON-TEST-KIT	3	30 Test slugs and gauge
CUTTER-DIES	4	Guy wire cutting dies
CAR-CHARGER(12v)	5	Car charger for battery tools
AC-ADAPTOR(120v)	6	AC adaptor for battery tools
AC-ADAPTOR(230v)	6	AC adaptor for battery tools

TYPE

94130**Controlled-Cycle
Crimper****Features**

- Dieless tool
- Ratchet mechanism
- Compound action
- Cushion grip handles
- Crimps insulated wire terminals
- Wire Range: 10-22 AWG, Weight .8 lb

Benefits

- No need to purchase and maintain dies
- Assures proper crimp force every time
- Delivers maximum crimp force with minimum effort
- Provides user comfort
- Provides flexibility in use



TYPE

94140**Multi Purpose
Crimp Tool****Features**

- Heavy duty carbon steel construction
- Comfort grip handles
- Spring loaded action
- Safety lock mechanism
- Color coded crimp nest
- Crimp nest
- Wire cutter
- Machine screw cutters
- Wire stripper/wire gauge

Benefits

- Provides durable rugged reliability
- Provides user comfort
- Enables multiple crimps
- Provides for compact storage
- For insulated terminals
- For uninsulated terminals
- Easily cuts solid and stranded wire
- Cuts and rethreads 4-40, 6-32, 8-32, 10-24, and 10-32 machine screws
- 26-8 AWG



TYPE

WS-1**Wire Stripper****Features**

- Cushion grip handles
- Crimp die
- Wire strip gauge
- Plier nose
- Wire loop holes
- Wire cutter
- "Open" spring
- Metric markings
- Precision stripping
- Wire crimp range: 14-20 AWG

Benefits

- Eases pressure on hands when working for long periods or with larger conductor
- Built in crimp die allows you to crimp insulated terminals from 20AWG to 14AWG
- Convenient stamped wire strip gauge makes it easy to strip conductors to specific length consistently
- Flat plier nose allows you to conveniently punch and twist knock outs
- Built in looping holes allow you to conveniently bend eye loop into end of conductor
- Built in cutter is precision ground to cut small conductor copper intended to be stripped (Strips #10 - 18 AWG)
- Conveniently holds tool in open position to facilitate wire insertion
- Metric markings provide for use of tool on products that have been sized metrically
- Precision ground wire stripping holes provide a clean cutting and stripping action of insulation



**TYPE
CTR-2/0****Features**

- 7-1/2" overall length
- Sharp precision ground blades
- Heat treated blades
- Narrow head design
- Cuts up to 2/0 copper or aluminum cable

Benefits

- Better leverage for easier cutting
- Clean, distortion-free cuts
- Long, dependable and durable operation
- Provides easy access to confined areas
- Wide cutting range for a pouch tool

**TYPE
CTR-350****Features**

- Sharp precision ground blades
- Moly steel blades
- Durable 16" metal handles
- Cuts copper and aluminum cable up to 350kcmil

Benefits

- Provides clean distortion-free cuts
- Offers extra strength to prevent blade breakage, blades stay sharper longer
- Provides easy handling
- Provides wide cutting range

**TYPE
CTR-500****Features**

- Sharp precision ground blades
- Moly steel blades
- Durable 20-3/4" fiberglass handles
- Cuts copper and aluminum cable up to 500kcmil

Benefits

- Provides clean, distortion-free cuts
- Offers extra strength to prevent blade breakage, blades stay sharper longer
- Provides easy handling
- Provides wide cutting range

**TYPE
CTR-750****Features**

- Cuts copper and aluminum cable up to 750kcmil
- Lightweight
- Ratchet mechanism
- 16" length
- Open/close lever
- Alloy steel precision ground replaceable blades

Benefits

- Provides large cutting capacity
- Weight of only 3 lbs. prevents operator fatigue
- Allows large cables to be cut with minimum effort
- Compact size provides ease of use in cramped spaces
- Lever that controls cutting blade direction makes the tool easy to use
- Provides years of service by being able to replace blades when necessary



TYPE MECHANICAL TOOLS



Catalog Number	Figure Number	Description	Hex Size	Length
DR-516	5	Driver for Torque Wrench	5/16	-
DR-38	5	Driver for Torque Wrench	3/8	-
DR-12	5	Driver for Torque Wrench	1/2	-
HW-13	2	Screwdriver Bit for TS-35, .214 x .040	-	-
HW-14	2	Screwdriver Bit for TS-35, .250 x .042	-	-
TK-1	-	Torque Kit with TS-35, HW-13, HW-14, TW-1, DR-516, DR-38, Case	-	-
TK-2	-	Torque Kit with TS-35, HW-13, HW-14, TW-750R, TW-150R, DR-516, DR-38, Case	-	-
TS-35	1	Torque Screwdriver 0-36 lbs.	-	-
TW-1	3	Torque Wrench 0-600 in. lbs.	-	-
TW-150R	4	Torque Wrench (Ratchet type) 5-150 in. lbs.	-	-
TW-750R	4	Torque Wrench (Ratchet type) 100-750 in. lbs.	-	-
WR-1	7	Double Wrench	3/16, 5/16	4
WR-1A	6	Wrench	3/16	4-1/2
WR-3	6	Wrench	1/4	5-1/4
WR-4	6	Wrench	5/16	3-3/16
WR-5	6	Wrench	3/8	4-1/2
WR-9	6	Wrench	5/16	10
WR-10	6	Wrench	3/8	10
WR-12	6	Wrench	1/2	5-1/2
WC	8	Wire Brush	-	-



TYPE**Electric Heat Gun****Features**









- Two temperature settings 750F and 1100F
- Three way switch OFF/HI/LO
- Built-in fold down stand
- 1200 Watt 120 V AC
- Heat deflector
- Impact resistant case
- Six foot cord
- Supplied in plastic carrying case

Benefits

- Provides versatility in applying recommended heat, deliverable in seconds
- Aids in producing proper air flow from heat gun
- Provides hands free operation
- Provides high output of air and heat
- Allows for concentration of heat for rapid heat shrink process
- Provides extra durability in harsh environments
- Provides operator convenience
- Provides ease of storage and accessibility

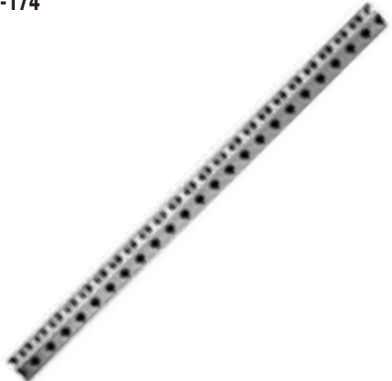

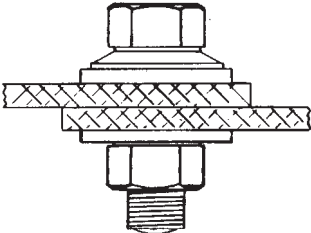
Catalog Number	Description
27001	Heat Gun, 11 Disks Thin Wall Heat Shrink
94502	Electric Heat Gun 120v
94504	Replacement Adaptor for 94502

<p>C</p>  <p>321</p>	<p>M</p>  <p>322</p> <p>M</p>  <p>323</p>	<p>T</p>  <p>324 - 331</p>
<p>D167</p>  <p>332</p>	<p>CAN</p>  <p>333</p>	<p>N-174</p>  <p>333</p>
<p>NB</p>  <p>334</p>	<p>DE-OX</p>  <p>335</p>	<p>DUCT SEAL</p>  <p>336</p>
	<p>NBW</p>  <p>337</p>	<p>Cable Ties</p>  <p>338 - 342</p>

ILSCO Fuse Clips

TYPE C

Features

- Manufactured from special bronze alloy except 100 and 200 amp styles. Arched bottoms
- All formed corners are designed with a radius

Benefits

- Spring type material ensures positive contact. Provide firm and secure mounting, and prevents expansion after fuse is inserted.
- Prevents fracturing

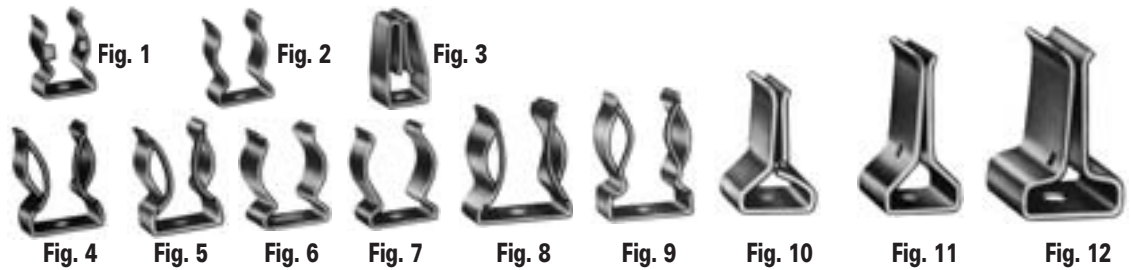
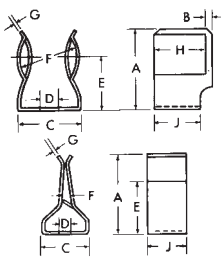

Catalog Number	Figure Number	Amp-Volts	Dimensions									
			A	B	C	Bolt Size	D	E	F	G	H	J
C-10	1	30-250	7/8	3/64	19/32	#10	13/64	17/32	9/16	1/32	19/32	1/2
C-11	4	60-250	1-1/8	1/16	51/64	#10	15/64	51/64	13/16	3/64	21/32	5/8
C-12	5	60-250	1-1/8	1/16	13/16	#8	3/16	47/64	13/16	3/64	21/32	5/8
C-13	9	60-600	1-9/32	1/16	1-1/8	1/4	17/64	13/16	1-1/16	3/64	21/32	5/8
C-14	6	60-350	1	-	51/64	*	*	5/8	13/16	3/64	-	5/8
C-15	7	60-250	1-1/32	-	51/64	#10	13/64	5/8	13/16	3/64	-	5/8
C-16	11	100-250	1-43/64	-	29/32	1/4	17/64	1-11/64	1/8	5/64	-	7/8
C-17	10	100-250	1-23/64	-	15/16	1/4	17/64	57/64	1/8	5/64	-	7/8
C-19	2	30-250	7/8	-	39/64	#8	11/64**	17/32	9/16	1/32	-	1/2
C-23	8	60-600	1-5/16	1/16	31/32	#8	3/16	29/32	1-1/16	3/64	21/32	23/32
C-24	12	200-250/600	1-15/16	-	1-1/4	5/16	11/32	1-1/8	3/16	3/32	-	1-1/4
C-28	3	50-250	61/64	-	1/2	#8	3/16	23/32	7/64	3/64	-	1/2

** Stud hole center 9/32 from one side and 7/32 from other side.

* Slotted 13/64 x 13/32.

ILSCO Wire Reinforced Fuse Clips

TYPE
M

Features

- Manufactured from copper alloy
- Supplied with permanently installed steel spring
- Spring is heat treated and plated

Benefits

- Ensures high conductivity
- Ensures tighter grip and positive contact with either knife or ferrule type fuses.
- Prevents hydrogen embrittlement

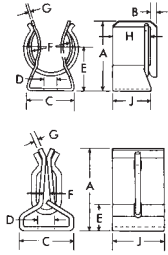

Fig. 1



Fig. 2

Catalog Number	Figure Number	Amp-Volts	Dimensions									
			A	B	C	Bolt Size	D	E	F	G	H	J
M-161	1	30-250	27/32	1/16	19/32	#10	13/64	17/32	9/16	1/32	17/32	1/2
M-162	1	30-600	1-1/32	1/16	3/4	1/4	1/4	21/32	13/16	1/32	17/32	1/2
M-163	1	60-250	1-13/64	1/16	51/64	#10	7/32	51/64	13/16	3/64	21/32	21/32
M-164	1	60-600	1-3/8	1/16	31/32	#8	3/16	29/32	1-1/16	3/64	21/32	5/8
M-165	2	100-250/600	1-23/64	-	29/32	1/4	17/64-Slot	-	1/8	5/64	-	7/8
M-233	2	200-250/600	1-15/16	-	1-1/4	5/16	11/32-Slot	-	3/16	3/32	-	1-1/4
M-628	2	400-600	2-7/16	-	1-1/2	-	5/16-18 (2)	-	1/4	1/8	-	1-3/4

K



ILSCO Class R Wire Reinforced Fuse Clips

TYPE M

Features

- Manufactured from copper alloy
- Supplied with permanently installed steel spring
- Spring is heat treated and plated
- Supplied with a slot or a hole for a steel rejection device.
- Electro-tin plated

Benefits

- Ensures high conductivity
- Ensures tighter grip and positive contact with either knife or ferrule type fuses.
- Prevents hydrogen embrittlement
- Prevents the insertion of any other type fuse except class R
- Provides low contact resistance

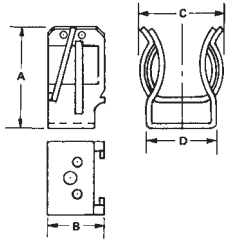

Fig. 1



Fig. 2

Catalog Number	Figure Number	Amp-Volts	Dimensions			
			A	B	C	D
M-2432	1	30-250	7/8	19/32	21/32	19/32
M-2433	1	60-250	1.200	23/32	59/64	51/64
M-2434	1	30-600	1-1/32	19/32	59/64	3/4
M-2435	1	60-600	1.390	23/32	1-5/64	31/32
M-2398	2	100-250/600	1-23/64	7/8	1/8	29/32
M-2399	2	200-250/600	1-15/16	1-1/4	3/16	1-15/64

ILSCO Tin Plated Copper Flexible Braid

TYPE T

Features

- Manufactured from pure copper braid
- Electro-tin plated
- Seamless pure copper ferrules
- Inside ferrule ends are rounded
- Swedged terminal to copper braid by cold forming
- Extra flexible braided connector
- Rated for 600 volts

Benefits

- Provides high conductivity
- Provides low contact resistance
- Provides superior contact
- Prevents chafing of strands
- Provides a reduced resistance form point to point; much lower than standard power cables or loose - piece type terminals
- Multi-purpose use for bonding, grounding and connecting moving parts
- Ensures reliability

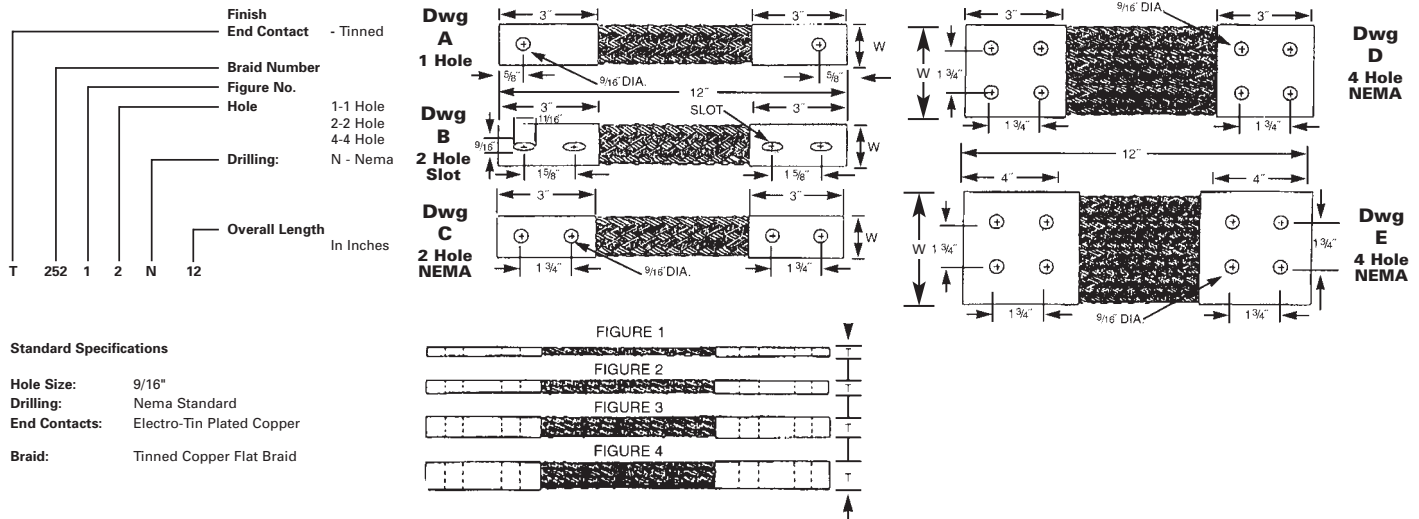

Catalog Number	Figure Number	Drawing Number	Ampere Rating (Indoors)*	Circular Mils. of Braids	Dimensions		
					L	T	W
T252/11N12	1	A	200	77,184	12	0.19	1.00
T252/11N18	1	A	200	77,184	18	0.25	1.00
T252/11N24	1	A	200	77,184	24	0.25	1.00
T252/21N12	2	A	340	154,386	12	0.25	1.00
T252/21N18	2	A	340	154,386	18	0.25	1.00
T252/21N24	2	A	340	154,386	24	0.25	1.00
T252/31N12	3	A	470	231,552	12	0.38	1.00
T252/31N18	3	A	470	231,552	18	0.38	1.00
T252/31N24	3	A	470	231,552	24	0.38	1.00
T252/41N12	4	A	600	308,734	12	0.38	1.25
T252/41N18	4	A	600	308,734	18	0.38	1.25
T252/41N24	4	A	600	308,734	24	0.38	1.25
T282/11N12	1	A	340	153,600	12	0.25	1.63
T282/11N18	1	A	340	153,600	18	0.25	1.63
T282/11N24	1	A	340	153,600	24	0.25	1.63

* Ampere ratings are suggested for use as a guide only. Actual values used for a given application will depend on such factors as permissible temperature rise, permissible voltage drop, number of cables together and other conditions of service. For outdoor use, these ratings may be increased from 22% to 40% depending upon the size and position of the braid.



ILSCO Tin Plated Copper Flexible Braid

TYPE T

Features

- Manufactured from pure copper braid
- Electro-tin plated
- Seamless pure copper ferrules
- Inside ferrule ends are rounded
- Swaged terminal to copper braid by cold forming
- Extra flexible braided connector
- Rated for 600 volts

Benefits

- Provides high conductivity
- Provides low contact resistance
- Provides superior contact
- Prevents chafing of strands
- Provides a reduced resistance form point to point; much lower than standard power cables or loose - piece type terminals
- Multi-purpose use for bonding, grounding and connecting moving parts
- Ensures reliability

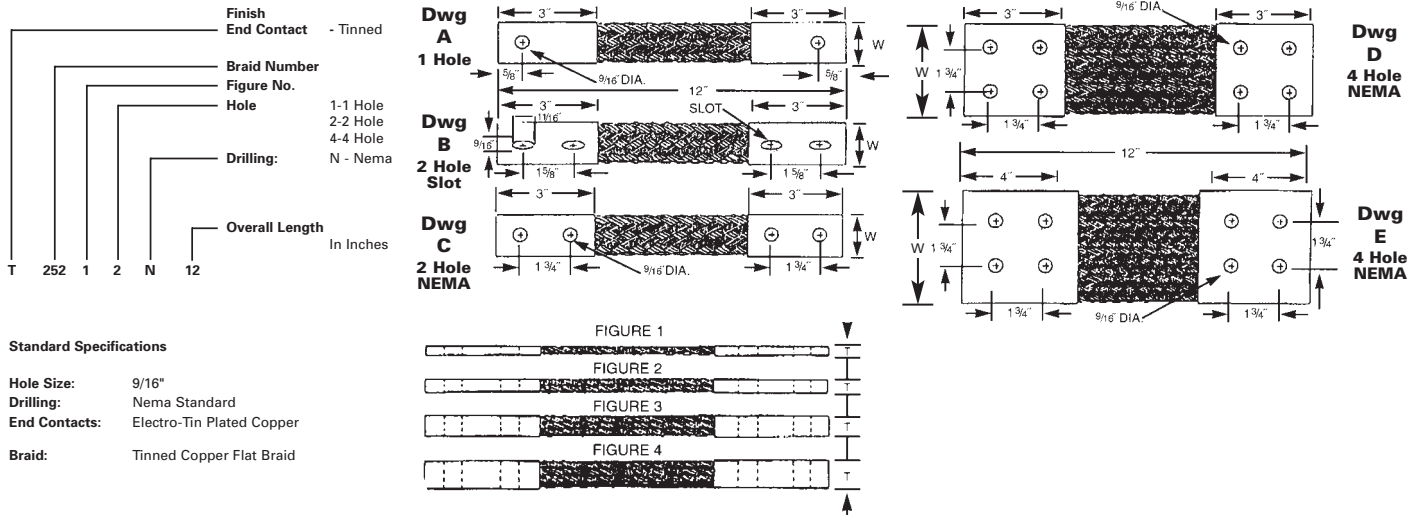

Catalog Number	Figure Number	Drawing Number	Ampere Rating (Indoors)*	Circular Mils. of Braids	Dimensions		
					L	T	W
T282/21N12	2	A	530	307,000	12	0.25	1.63
T282/21N18	2	A	530	307,000	18	0.25	1.63
T282/21N24	2	A	530	307,000	24	0.25	1.63
T282/31N12	3	A	700	460,800	12	0.31	1.63
T282/31N18	3	A	700	460,800	18	0.31	1.63
T282/31N24	3	A	700	460,800	24	0.31	1.63
T282/41N12	4	A	800	614,400	12	0.38	1.63
T282/41N18	4	A	800	614,400	18	0.38	1.63
T282/41N24	4	A	800	614,400	24	0.38	1.63
T252/12N12	1	C	200	77,184	12	0.19	1.00
T252/12N18	1	C	200	77,184	18	0.25	1.00
T252/12N24	1	C	200	77,184	24	0.25	1.00
T252/22N12	2	C	340	154,386	12	0.25	1.00
T252/22N18	2	C	340	154,386	18	0.25	1.00
T252/22N24	2	C	340	154,386	24	0.25	1.00

* Ampere ratings are suggested for use as a guide only. Actual values used for a given application will depend on such factors as permissible temperature rise, permissible voltage drop, number of cables together and other conditions of service. For outdoor use, these ratings may be increased from 22% to 40% depending upon the size and position of the braid.

ILSCO Tin Plated Copper Flexible Braid

TYPE T

Features

- Manufactured from pure copper braid
- Electro-tin plated
- Seamless pure copper ferrules
- Inside ferrule ends are rounded
- Swedged terminal to copper braid by cold forming
- Extra flexible braided connector
- Rated for 600 volts

Benefits

- Provides high conductivity
- Provides low contact resistance
- Provides superior contact
- Prevents chafing of strands
- Provides a reduced resistance form point to point; much lower than standard power cables or loose - piece type terminals
- Multi-purpose use for bonding, grounding and connecting moving parts
- Ensures reliability

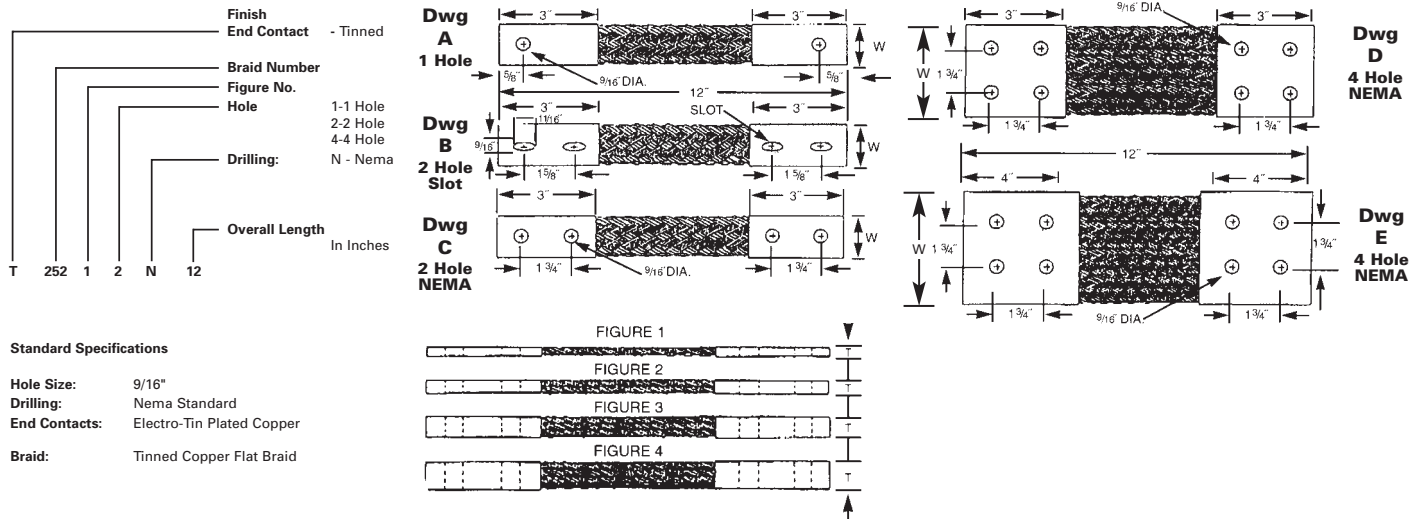

Catalog Number	Figure Number	Drawing Number	Ampere Rating (Indoors)*	Circular Mils. of Braids	Dimensions		
					L	T	W
T252/32N12	3	C	470	231,552	12	0.38	1.00
T252/32N18	3	C	470	231,552	18	0.38	1.00
T252/32N24	3	C	470	231,552	24	0.38	1.00
T252/42N12	4	C	600	308,734	12	0.38	1.25
T252/42N18	4	C	600	308,734	18	0.38	1.25
T252/42N24	4	C	600	308,734	24	0.38	1.25
T282/12N12	1	C	340	153,600	12	0.25	1.63
T282/12N18	1	C	340	153,600	18	0.25	1.63
T282/12N24	1	C	340	153,600	24	0.25	1.63
T282/22N12	2	C	530	307,000	12	0.25	1.63
T282/22N18	2	C	530	307,000	18	0.25	1.63
T282/22N24	2	C	530	307,000	24	0.25	1.63
T282/32N12	3	C	700	460,800	12	0.31	1.63
T282/32N18	3	C	700	460,800	18	0.31	1.63
T282/32N24	3	C	700	460,800	24	0.31	1.63

* Ampere ratings are suggested for use as a guide only. Actual values used for a given application will depend on such factors as permissible temperature rise, permissible voltage drop, number of cables together and other conditions of service. For outdoor use, these ratings may be increased from 22% to 40% depending upon the size and position of the braid.



ILSCO Tin Plated Copper Flexible Braid

TYPE T

Features

- Manufactured from pure copper braid
- Electro-tin plated
- Seamless pure copper ferrules
- Inside ferrule ends are rounded
- Swedged terminal to copper braid by cold forming
- Extra flexible braided connector
- Rated for 600 volts

Benefits

- Provides high conductivity
- Provides low contact resistance
- Provides superior contact
- Prevents chafing of strands
- Provides a reduced resistance form point to point; much lower than standard power cables or loose - piece type terminals
- Multi-purpose use for bonding, grounding and connecting moving parts
- Ensures reliability

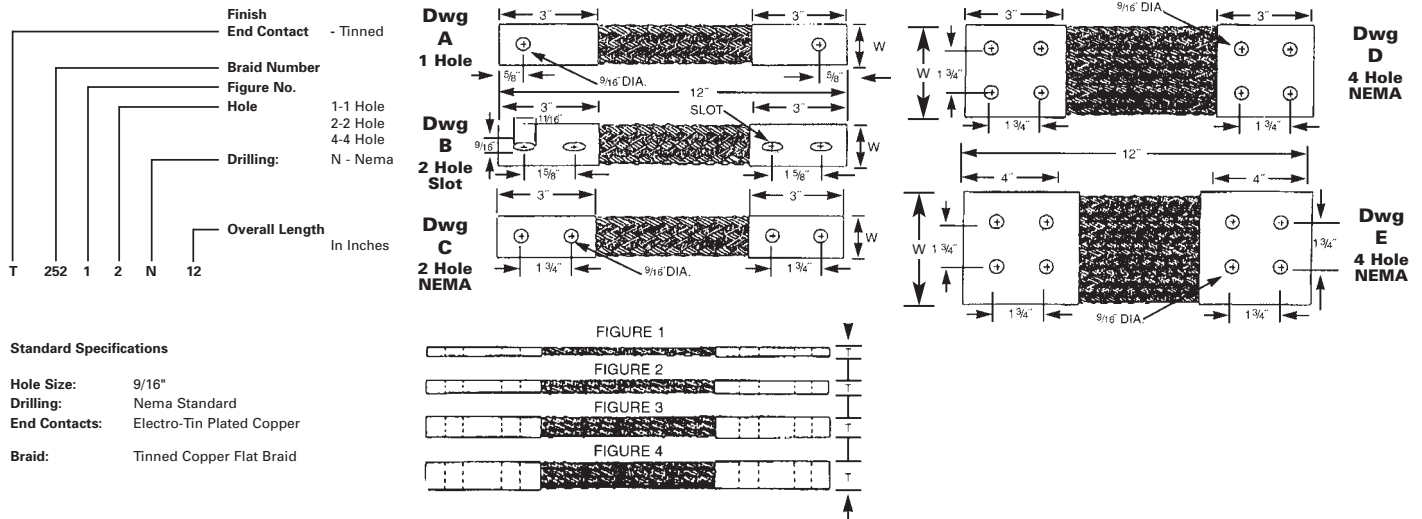

Catalog Number	Figure Number	Drawing Number	Ampere Rating (Indoors)*	Circular Mils. of Braids	Dimensions		
					L	T	W
T282/42N12	4	C	800	614,400	12	0.38	1.63
T282/42N18	4	C	800	614,400	18	0.38	1.63
T282/42N24	4	C	800	614,400	24	0.38	1.63
T287/12N12	1	C	360	230,000	12	0.25	1.50
T287/12N18	1	C	360	230,000	18	0.25	1.50
T287/12N24	1	C	360	230,000	24	0.25	1.50
T287/22N12	2	C	700	460,000	12	0.38	1.50
T287/22N18	2	C	700	460,000	18	0.38	1.50
T287/22N24	2	C	700	460,000	24	0.38	1.50
T287/32N12	3	C	820	690,000	12	0.50	1.50
T287/32N18	3	C	820	690,000	18	0.50	1.50
T287/32N24	3	C	820	690,000	24	0.50	1.50
T287/42N12	4	C	1000	920,000	12	0.75	1.63
T287/42N18	4	C	1000	920,000	18	0.75	1.63
T287/42N24	4	C	1000	920,000	24	0.75	1.63

* Ampere ratings are suggested for use as a guide only. Actual values used for a given application will depend on such factors as permissible temperature rise, permissible voltage drop, number of cables together and other conditions of service. For outdoor use, these ratings may be increased from 22% to 40% depending upon the size and position of the braid.

ILSCO Tin Plated Copper Flexible Braid

TYPE T

Features

- Manufactured from pure copper braid
- Electro-tin plated
- Seamless pure copper ferrules
- Inside ferrule ends are rounded
- Swaged terminal to copper braid by cold forming
- Extra flexible braided connector
- Rated for 600 volts

Benefits

- Provides high conductivity
- Provides low contact resistance
- Provides superior contact
- Prevents chafing of strands
- Provides a reduced resistance form point to point; much lower than standard power cables or loose - piece type terminals
- Multi-purpose use for bonding, grounding and connecting moving parts
- Ensures reliability

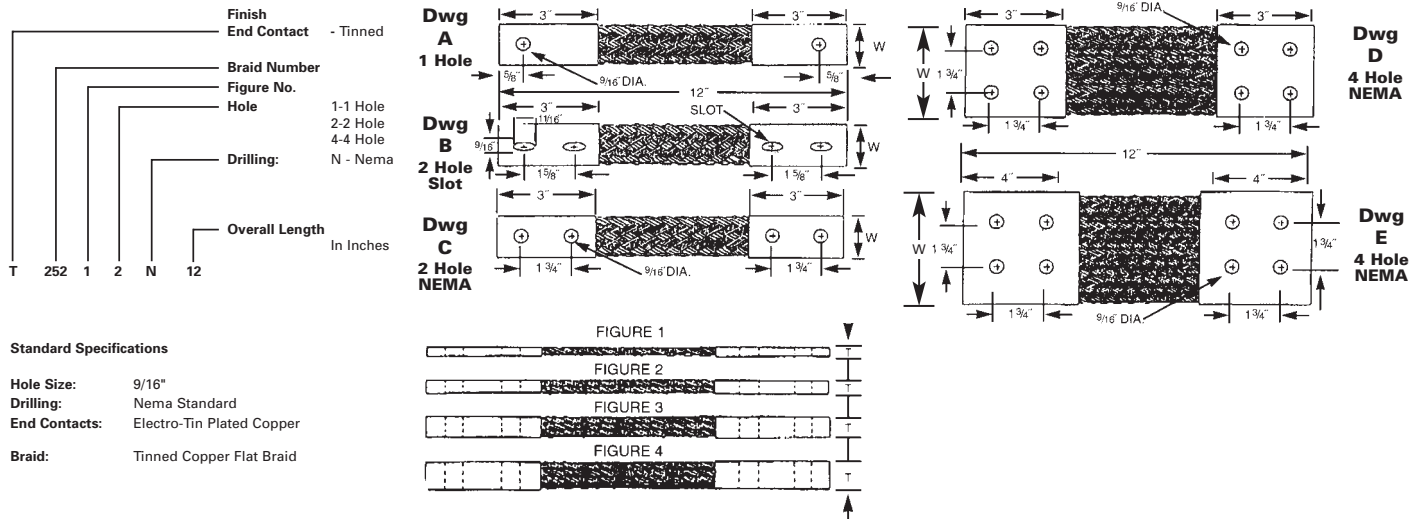

Catalog Number	Figure Number	Drawing Number	Ampere Rating (Indoors)*	Circular Mils. of Braids	Dimensions		
					L	T	W
T294/12N12	1	C	415	300,000	12	0.25	1.50
T294/12N18	1	C	415	300,000	18	0.25	1.50
T294/12N24	1	C	415	300,000	24	0.25	1.50
T294/22N12	2	C	700	600,000	12	0.50	1.50
T294/22N18	2	C	700	600,000	18	0.50	1.50
T294/22N24	2	C	700	600,000	24	0.50	1.50
T294/32N12	3	C	960	900,000	12	0.75	1.63
T294/32N18	3	C	960	900,000	18	0.75	1.63
T294/32N24	3	C	960	900,000	24	0.75	1.63
T294/42N12	4	C	1200	1,200,000	12	1.00	1.63
T294/42N18	4	C	1200	1,200,000	18	1.00	1.63
T294/42N24	4	C	1200	1,200,000	24	1.00	1.63
T278/14N12-4	1	E	625	422,000	12	0.25	4.00
T278/14N18-4	1	E	625	422,000	18	0.25	4.00
T278/14N24-4	1	E	625	422,000	24	0.25	4.00

* Ampere ratings are suggested for use as a guide only. Actual values used for a given application will depend on such factors as permissible temperature rise, permissible voltage drop, number of cables together and other conditions of service. For outdoor use, these ratings may be increased from 22% to 40% depending upon the size and position of the braid.



ILSCO Tin Plated Copper Flexible Braid

TYPE T

Features

- Manufactured from pure copper braid
- Electro-tin plated
- Seamless pure copper ferrules
- Inside ferrule ends are rounded
- Swedged terminal to copper braid by cold forming
- Extra flexible braided connector
- Rated for 600 volts

Benefits

- Provides high conductivity
- Provides low contact resistance
- Provides superior contact
- Prevents chafing of strands
- Provides a reduced resistance form point to point; much lower than standard power cables or loose - piece type terminals
- Multi-purpose use for bonding, grounding and connecting moving parts
- Ensures reliability

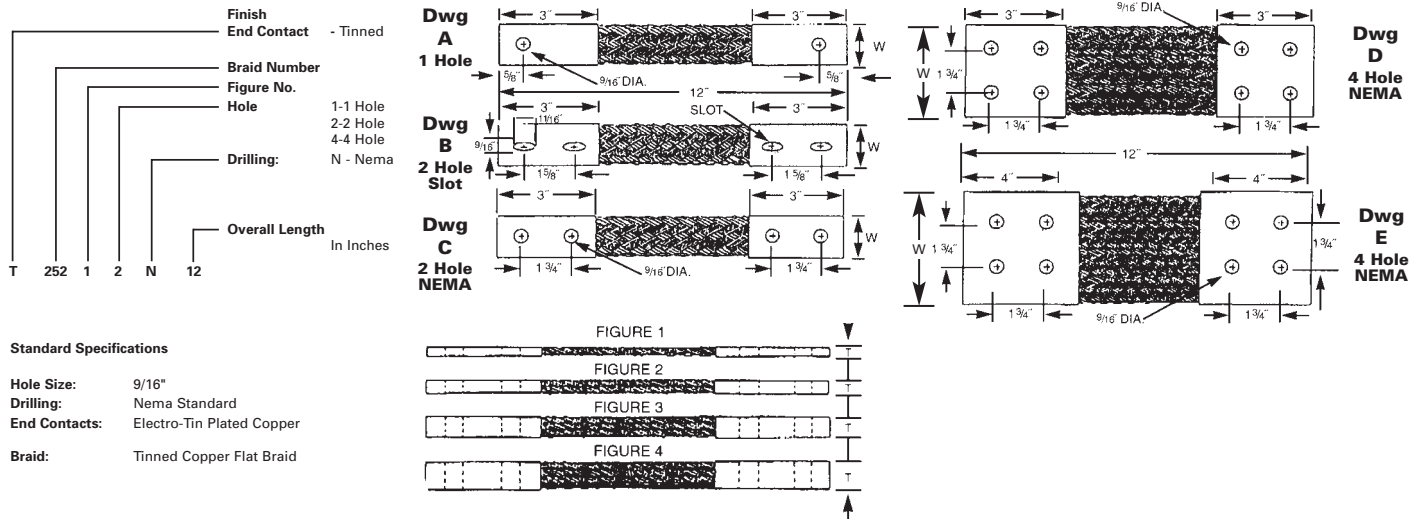

Standard Specifications

- Hole Size: 9/16"
 Drilling: Nema Standard
 End Contacts: Electro-Tin Plated Copper
 Braid: Tinned Copper Flat Braid

Catalog Number	Figure Number	Drawing Number	Ampere Rating (Indoors)*	Circular Mils. of Braids	Dimensions		
					L	T	W
T278/24N12-4	2	E	940	844,000	12	0.31	4.00
T278/24N18-4	2	E	940	844,000	18	0.31	4.00
T278/24N24-4	2	E	940	844,000	24	0.31	4.00
T278/34N12-4	3	E	1200	1,266,000	12	0.38	4.00
T278/34N18-4	3	E	1200	1,266,000	18	0.38	4.00
T278/34N24-4	3	E	1200	1,266,000	24	0.38	4.00
T278/44N12-4	4	E	1600	1,688,000	12	0.50	4.00
T278/44N18-4	4	E	1600	1,688,000	18	0.50	4.00
T278/44N24-4	4	E	1600	1,688,000	24	0.50	4.00
T278/14N12-3	1	D	370	211,200	12	0.25	3.00
T278/14N18-3	1	D	370	211,200	18	0.25	3.00
T278/14N24-3	1	D	370	211,200	24	0.25	3.00
T278/24N12-3	2	D	625	422,400	12	0.31	3.00
T278/24N18-3	2	D	625	422,400	18	0.31	3.00
T278/24N24-3	2	D	625	422,400	24	0.31	3.00

* Ampere ratings are suggested for use as a guide only. Actual values used for a given application will depend on such factors as permissible temperature rise, permissible voltage drop, number of cables together and other conditions of service. For outdoor use, these ratings may be increased from 22% to 40% depending upon the size and position of the braid.

ILSCO Tin Plated Copper Flexible Braid

TYPE T

Features

- Manufactured from pure copper braid
- Electro-tin plated
- Seamless pure copper ferrules
- Inside ferrule ends are rounded
- Swedged terminal to copper braid by cold forming
- Extra flexible braided connector
- Rated for 600 volts

Benefits

- Provides high conductivity
- Provides low contact resistance
- Provides superior contact
- Prevents chafing of strands
- Provides a reduced resistance form point to point; much lower than standard power cables or loose - piece type terminals
- Multi-purpose use for bonding, grounding and connecting moving parts
- Ensures reliability

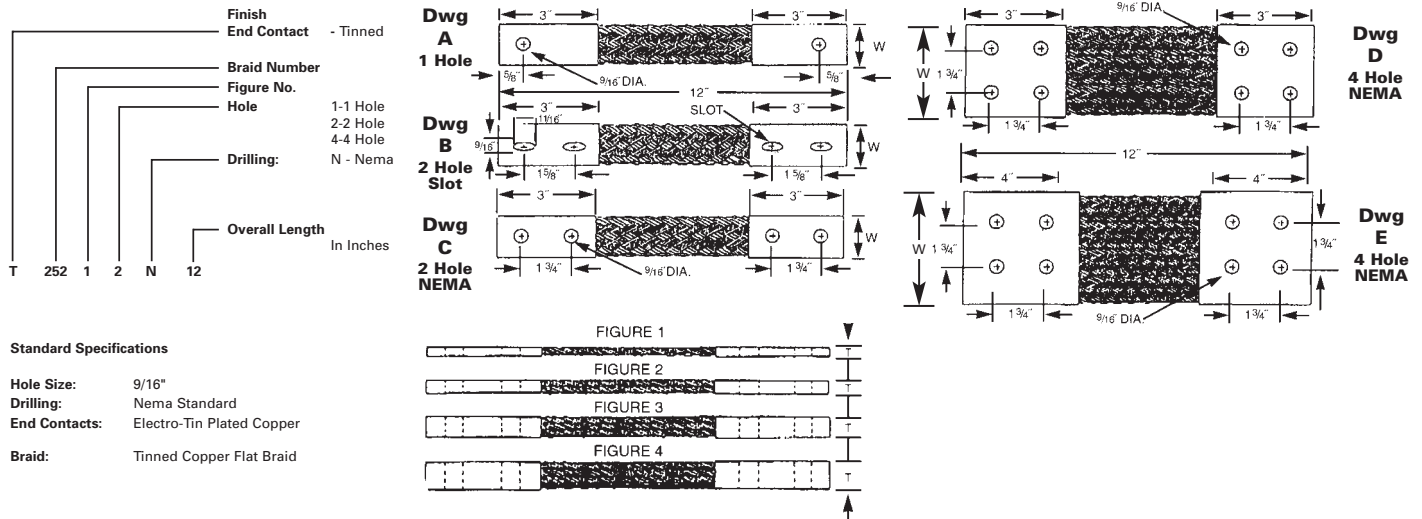

Catalog Number	Figure Number	Drawing Number	Ampere Rating (Indoors)*	Circular Mils. of Braids	Dimensions		
					L	T	W
T278/34N12-3	3	D	800	633,600	12	0.38	3.00
T278/34N18-3	3	D	800	633,600	18	0.38	3.00
T278/34N24-3	3	D	800	633,600	24	0.38	3.00
T278/44N12-3	4	D	940	844,900	12	0.50	3.00
T278/44N18-3	4	D	940	844,900	18	0.50	3.00
T278/44N24-3	4	D	940	844,900	24	0.50	3.00

* Ampere ratings are suggested for use as a guide only. Actual values used for a given application will depend on such factors as permissible temperature rise, permissible voltage drop, number of cables together and other conditions of service. For outdoor use, these ratings may be increased from 22% to 40% depending upon the size and position of the braid.



TYPE T

Features

- Manufactured from pure copper braid
- Electro-tin plated
- Seamless pure copper ferrules
- Inside ferrule ends are rounded
- Swedged terminal to copper braid by cold forming
- Extra flexible braided connector
- Rated for 600 volts

Benefits

- Provides high conductivity
- Provides low contact resistance
- Provides superior contact
- Prevents chafing of strands
- Provides a reduced resistance form point to point; much lower than standard power cables or loose - piece type terminals
- Multi-purpose use for bonding, grounding and connecting moving parts
- Ensures reliability

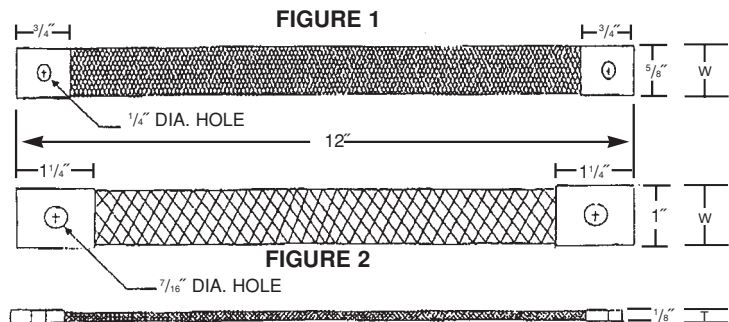
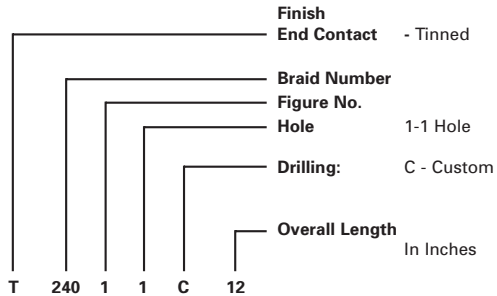

Standard Specifications

- End Contacts:** Electro-Tin Plated Copper
Braid: Tinned Copper Flat Braid
Options: - Custom drilling pattern (drawing must be supplied)

Catalog Number	Figure Number	Ampere Rating (Indoors)*	Circular Mils. of Braids	Dimensions		
				L	T	W
T240/11C12	1	95	24,000	12	0.13	0.63
T240/11C18	1	95	24,000	18	0.13	0.63
T240/11C24	1	95	24,000	24	0.13	0.63
T244/21C12	2	145	48,000	12	0.13	1.00
T244/21C18	2	145	48,000	18	0.13	1.00
T244/21C24	2	145	48,000	24	0.13	1.00

* Ampere ratings are suggested for use as a guide only. Actual values used for a given application will depend on such factors as permissible temperature rise, permissible voltage drop, number of cables together and other conditions of service. For outdoor use, these ratings may be increased from 22% to 40% depending upon the size and position of the braid.

TYPE D167

Features

- Manufactured from high strength copper tubing
- Range taking
- UL Recognized for 600 volts

Benefits

- Provides maximum conductivity
- A wide range of conductor sizes can be used in the same connector
- Ensures reliability for copper conductor

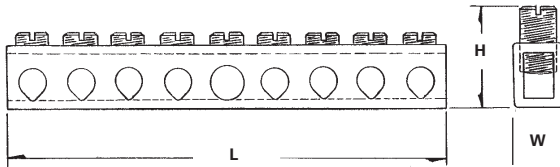

Catalog Number	Number Of Taps	Wire Range		Dimensions					Mounting Hole Positions	
		Main	Tap	L	Height With Maximum Wire	W	Bolt Size	Two Mounting Holes	From End Of Bar To First Mounting Hole	Distance Between Holes
D167-4	4	4-14	6-14	2-3/4	3/4	11/32	#10	13/64	.581 (2nd hole)	1.98
D167-6	6	4-14	6-14	3-1/2	3/4	11/32	#10	13/64	.978 (3rd hole)	1.98
D167-8	8	4-14	6-14	4-7/16	3/4	11/32	#10	13/64	1.375 (4th hole)	1.98
D167-10	10	4-14	6-14	5-1/8	3/4	11/32	#10	13/64	1.772 (5th hole)	1.98
D167-12	12	4-14	6-14	5-15/16	3/4	11/32	#10	13/64	2.169 (6th hole)	1.98
D167-14	14	4-14	6-14	6-23/32	3/4	11/32	#10	13/64	2.566 (7th hole)	1.98

Tested to UL 486A-486B, UL File E6207

TYPE CAN

Features

- Manufactured from high strength copper tubing
- Compact design
- Range taking
- UL Recognized and CSA Certified
- Circuit bars inserted at a 20 angle

Benefits

- Provides maximum conductivity
- Up to 42 circuit taps can be made in just 5 1/2" of space
- A wide range of conductor sizes can be used in the same connector
- Ensures reliability for copper conductor
- Provides easy wire insertion

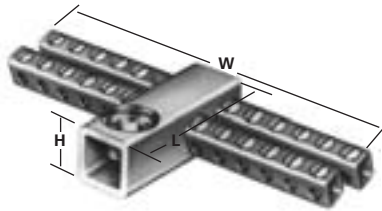

Fig. 1



Fig. 2



Fig. 3



Fig. 4

Catalog Number	Figure Number	Number Of Taps	Wire Range		Dimensions			
			Main	Tap	L	Height With Maximum Wire	W	Two Tapped Mounting Holes
CAN-300	1	24	250kcmil-6	6-14	2-5/16	1-5/16	5-1/8	10-32
CAN-301	1	30	250kcmil-6	6-14	3	1-5/16	4-13/32	10-32
CAN-302	1	36	250kcmil-6	6-14	3	1-5/16	5-1/8	10-32
CAN-303	1	42	250kcmil-6	6-14	3	1-7/16	5-1/2	10-32
R-16	2	Mounting block of general purpose (phenolic black) suitable for mounting any of CAN Neutrals. 2-1/2" wide x 2-1/2" long x 1" thick.						
E-223	3	10-32 x 1/2" round head steel machine screws for fastening neutrals to mounting blocks. (Use lock washer to provide rigid assembly.)						
E-153	3	1/4-28 wire pressure screw 7/16" long. Screw is steel, zinc plated and chromate dipped.						
N-174	4	Supplied in 5' 9" lengths. Approximately 174 outlets. Wire range 14-6.						

Tested to UL 486A-486B, UL File E6207

TYPE NB

Features

- Preassembled, stacked neutral bars
- Available with phenolic base
- Electro-tin plated
- Fabricated from high strength 6061-T6 aluminum alloy
- UL Recognized and CSA Certified for 600 volts, 90° C

Benefits

- Compact, space saving design offers multiple range taking flexibility and is suitable for grounding applications
- Provides insulation from mounting surface
- Provides low contact resistance
- Suitable for use with either copper or aluminum conductors
- Ensures reliability

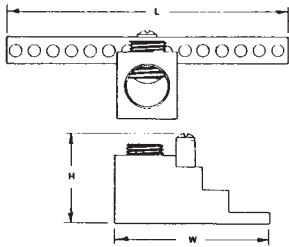

Fig. 1



Fig. 2

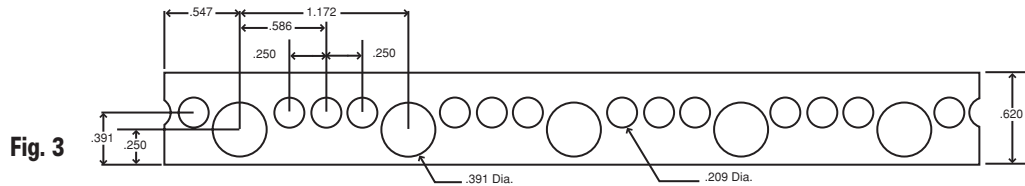

Fig. 3

Catalog Number	Figure Number	Number Of Circuit Taps	Wire Range		Dimensions			Two Tapped Mounting Holes	Hex Size	
			Circuit Taps	Line Loads	Approx. Height with Max. Wire	L	W		Main	Tap
NB-350-12	1	12	14-4	350kcmil-6	1-17/32	4-23/32	2-17/32	10-32	3/8	S
NB-350-12-W/R16*	2	12	14-4	350kcmil-6	2-17/32	4-23/32	2-17/32	10-32	3/8	S
NB-350-24	1	24	14-4	350kcmil-6	1-17/32	4-23/32	2-17/32	10-32	3/8	S
NB-350-24-W/R16*	2	24	14-4	350kcmil-6	2-17/32	4-23/32	2-17/32	10-32	3/8	S
NB-350-30	1	30	14-4	350kcmil-6	1-17/32	4-3/32	2-17/32	10-32	3/8	S
NB-350-30-W/R16*	2	30	14-4	350kcmil-6	2-17/32	4-3/32	2-17/32	10-32	3/8	S
NB-350-36	1	36	14-4	350kcmil-6	1-17/32	4-23/32	2-17/32	10-32	3/8	S
NB-350-36-W/R16*	2	36	14-4	350kcmil-6	2-17/32	4-23/32	2-17/32	10-32	3/8	S
NB-350-42	1	42	14-4	350kcmil-6	1-17/32	5-11/32	2-17/32	10-32	3/8	S
NB-350-42-W/R16*	2	42	14-4	350kcmil-6	2-17/32	5-11/32	2-17/32	10-32	3/8	S

*S" indicates slotted screw

* Part includes phenolic mounting block R-16

Tested to UL 486A-486B, UL File E6207

Catalog Number	Figure Number	Number of Outlets	Wire Range	Length
NB-120	3	120	30 outlets 1/0-14 90 outlets 6-14	3.25'

UL File E81652

ILSCO Oxide Inhibitor



TYPE DE-OX®

Features

- Provides air-tight seal around conductor
- Available in a variety of packages
- Broad working temperature range
- Conductor versatile

Benefits

- Prevents oxides from forming
- Provides convenience of selecting the right size for the job
- May be used from -30° F to 200° F
- May be used on copper or aluminum conductors



Catalog Number	Container Size & Type	Packaging
DE-OX -5CC	5cc Packet	Display Carton of 150
DE-OX-5CC-B4	5cc Packet	4 Per Bag, 25 Bags Per Carton
DE-OX-1OZ	1 oz. Tube	Display Carton of 50
DE-OX -4OZ	4 oz. Bottle	Display Carton of 12
DE-OX-8OZ	8 oz. Bottle	Display Carton of 12
DE-OX-1GAL	1 Gallon Can	1 Can
DE-OX -5GAL	5 Gallon Bucket	1 Bucket
UDE-OX-V-4OZ*+	4 oz. Bottle	Display Carton of 12
UDE-OX-V-8OZ*+	8 oz. Bottle	Display Carton of 12

* V denotes synthetic base, chalk color, doesn't stain blankets, etc.

+ Not UL Listed
UL File E312012



ILSCO Duct Seal

TYPE DS

Features

- Available in 1 LB and 5 LB packages
- Remains pliable
- Non-corrosive
- Can be painted immediately

Benefits

- Provides convenience of selecting the right size for the job
- Will not dry out, crack and fall out of installation
- Will not irritate skin, or corrode metals, or have harmful effects on plastics
- No need to wait for product to dry



Catalog Number

DS-1

DS-5

Packaging

10 1 lb. bags

5 5 lb. bags

ILSCO Mounting Hardware

TYPE NBW

Features

- Individually packaged
- Aluminum nut and bolt
- Belleville washer

Benefits

- All components for mounting one connector are kept together to avoid mismatched hardware
- Provides consistent and even thermal expansion and contraction to prevent loosening of mounting hardware due to heat cycling
- Maintains tension on connection through thermal expansion and contraction

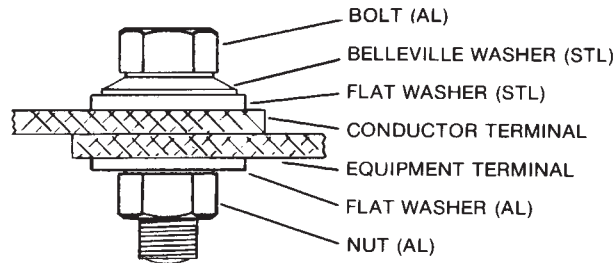

Catalog Number	Bolt Size	Bolt Length	Included In Kit
NBW-38-125	3/8-16	1-1/4	Aluminum Nut, Stainless Steel Belleville Washer, Aluminum Flat Washer, Stainless Steel Flat Washer, Aluminum Bolt
NBW-50-150	1/2-13	1-1/2	Aluminum Nut, Stainless Steel Belleville Washer, Aluminum Flat Washer, Stainless Steel Flat Washer, Aluminum Bolt
NBW-50-200	1/2-13	2	Aluminum Nut, Stainless Steel Belleville Washer, Aluminum Flat Washer, Stainless Steel Flat Washer, Aluminum Bolt
NBW-50-250	1/2-13	2-1/2	Aluminum Nut, Stainless Steel Belleville Washer, Aluminum Flat Washer, Stainless Steel Flat Washer, Aluminum Bolt
NBW-58-250	5/8-11	2-1/2	Aluminum Nut, Stainless Steel Belleville Washer, Aluminum Flat Washer, Stainless Steel Flat Washer, Aluminum Bolt
NBW-58-300	5/8-11	3	Aluminum Nut, Stainless Steel Belleville Washer, Aluminum Flat Washer, Stainless Steel Flat Washer, Aluminum Bolt



Cable Ties

Heavy Duty, Super Heavy Duty

TYPE TIES

Features

- Quick & Easy
- Strong & Flexible
- Nylon 6/6

Benefits

- Can accommodate .75" to 15" bundle diameter
- Tensile strengths from 18 lbs to 250 lbs
- Resists weather & chemicals



Heavy Duty Cable Ties

Catalog Number	Length	Width	Color	Tensile Strength	Bundle Diameter	Bag Qty
93180	25.0	0.35	NATURAL	175 LBS.	7.0	100
93280	25.0	0.35	UV BLACK	175 LBS.	7.0	100
93195	36.5	0.35	NATURAL	175 LBS.	10.7	50
93295	36.5	0.35	UV BLACK	175 LBS.	10.7	50
93199	48.0	0.35	NATURAL	175 LBS.	15.0	50
93299	48.0	0.35	UV BLACK	175 LBS.	15.0	50

Super Heavy Duty Cable Ties

Catalog Number	Length	Width	Color	Tensile Strength	Bundle Diameter	Bag Qty
93190	22.0	0.50	NATURAL	250 LBS.	6.0	100
93290	22.0	0.50	UV BLACK	250 LBS.	6.0	100
93196	34.0	0.50	NATURAL	250 LBS.	10.1	50
93296	34.0	0.50	UV BLACK	250 LBS.	10.1	50



TYPE TIES

Features

- Quick & Easy
- Strong & Flexible
- Nylon 6/6

Benefits

- Can accommodate .75" to 15" bundle diameter
- Tensile strengths from 18 lbs to 250 lbs
- Resists weather & chemicals



Standard Cable Ties

Catalog Number	Length	Width	Color	Tensile Strength	Bundle Diameter	Bag Qty
93110	4.0	0.10	NATURAL	18 LBS.	.75	100
93110M	4.0	0.10	NATURAL	18 LBS.	.75	1000
93210	4.0	0.10	UV BLACK	18 LBS.	.75	100
93210M	4.0	0.10	UV BLACK	18 LBS.	.75	1000
93120	5.7	0.14	NATURAL	40 LBS.	1.25	100
93120M	5.7	0.14	NATURAL	40 LBS.	1.25	1000
93220	5.7	0.14	UV BLACK	40 LBS.	1.25	100
93220M	5.7	0.14	UV BLACK	40 LBS.	1.25	1000
93130	8	0.19	NATURAL	50 LBS.	2.0	100
93130M	8	0.19	NATURAL	50 LBS.	2.0	1000
93230	8	0.19	UV BLACK	50 LBS.	2.0	100
93230M	8	0.19	UV BLACK	50 LBS.	2.0	1000
93150	11.8	0.19	NATURAL	50 LBS.	3.0	100
93150M	11.8	0.19	NATURAL	50 LBS.	3.0	1000
93250	11.8	0.19	UV BLACK	50 LBS.	3.0	100
93250M	11.8	0.19	UV BLACK	50 LBS.	3.0	1000
93160	14.6	0.19	NATURAL	50 LBS.	4.0	100
93160M	14.6	0.19	NATURAL	50 LBS.	4.0	1000
93260	14.6	0.19	UV BLACK	50 LBS.	4.0	100
93260M	14.6	0.19	UV BLACK	50 LBS.	4.0	1000
93170	14.5	0.30	NATURAL	120 LBS.	4.0	100
93170D	14.5	0.30	NATURAL	120 LBS.	4.0	500
93270	14.5	0.30	UV BLACK	120 LBS.	4.0	100
93270D	14.5	0.30	UV BLACK	120 LBS.	4.0	500
93185	28	0.30	NATURAL	120 LBS.	8.0	100
93185D	28	0.30	NATURAL	120 LBS.	8.0	500
93285	28	0.30	UV BLACK	120 LBS.	8.0	100
93285D	28	0.30	UV BLACK	120 LBS.	8.0	500

TYPE TIES

Features

- Quick & Easy
- Strong & Flexible
- Nylon 6/6

Benefits

- Can accommodate .75" to 15" bundle diameter
- Tensile strengths from 18 lbs to 250 lbs
- Resists weather & chemicals



Mounting Head Cable Ties

Catalog Number	Length	Width	Bolt Size	Color	Tensile Strength	Bundle Diameter	Bag Qty
93310	4.5	.10	#4	NATURAL	18 LBS.	.62	100
93410	4.5	.10	#4	UV BLACK	18 LBS.	.62	100
93320	5.9	.14	#8	NATURAL	40 LBS.	1.25	100
93420	5.9	.14	#10	UV BLACK	40 LBS.	1.25	100
93340	8	.19	#10	NATURAL	50 LBS.	2	100
93440	8	.19	#10	UV BLACK	50 LBS.	2	100
93350	12.6	.19	#10	NATURAL	50 LBS.	3	100
93450	12.6	.19	#10	UV BLACK	50 LBS.	3	100
93380	15	.19	#10	NATURAL	50 LBS.	4	100
93480	15	.19	#10	UV BLACK	50 LBS.	4	100
93390	15	.30	#10	NATURAL	120 LBS.	4	100
93490	15	.30	#10	UV BLACK	120 LBS.	4	100

Push Mount Cable Ties

Catalog Number	Length	Width	Color	Tensile Strength	Bundle Diameter	Bag Qty
93345	7.9	.19	NATURAL	50 LBS.	2	100
93445	7.9	.19	UV BLACK	50 LBS.	2	100

Releasable Cable Ties

Catalog Number	Length	Width	Color	Tensile Strength	Bundle Diameter	Bag Qty
93620	5.9	.30	NATURAL	50 LBS.	1.2	100
93720	5.9	.30	UV BLACK	50 LBS.	1.2	100
93640	7.8	.30	NATURAL	50 LBS.	2	100
93740	7.8	.30	UV BLACK	50 LBS.	2	100
93650	10.5	.30	NATURAL	50 LBS.	3	100
93750	10.5	.30	UV BLACK	50 LBS.	3	100



Cable Ties

Colored, Stainless Steel

TYPE TIES

Features

- Quick & Easy
- Strong & Flexible
- Nylon 6/6

Benefits

- Can accommodate .75" to 15" bundle diameter
- Tensile strengths from 18 lbs to 250 lbs
- Resists weather & chemicals



Colored Cable Ties



Catalog Number	Length	Width	Color	Tensile Strength	Bundle Diameter	Bag Qty
93110-R	4.0	0.10	RED	18 LBS.	.75	100
93230-R	8	0.19	RED	50 LBS.	2.0	100
93110-GR	4.0	0.10	GREEN	18 LBS.	.75	100
93230-GR	8	0.19	GREEN	50 LBS.	2.0	100
93110-Y	4.0	0.10	YELLOW	18 LBS.	.75	100
93230-Y	8	0.19	YELLOW	50 LBS.	2.0	100
93110-BL	4.0	0.10	BLUE	18 LBS.	.75	100
93230-BL	8	0.19	BLUE	50 LBS.	2.0	100
93110-OR	4.0	0.10	ORANGE	18 LBS.	.75	100
93230-OR	8	0.19	ORANGE	50 LBS.	2.0	100

Stainless Steel Cable Ties

Catalog Number	Length	Width	Color	Tensile Strength	Bundle Diameter	Bag Qty
93804	8	.18	SS Steel (302/304)	100	2	100
93808	14	.18	SS Steel (302/304)	100	4	100
93812	20	.18	SS Steel (302/304)	100	6	100
93805	8	.30	SS Steel (302/304)	250	2	100
93809	14	.30	SS Steel (302/304)	250	4	100
93813	26	.30	SS Steel (302/304)	250	8	100



Cable Ties

Mounting Bases, Installation Tool, Kit

TYPE TIES

Features

- Quick & Easy
- Strong & Flexible
- Nylon 6/6
- Adhesive backed mounting bases

Benefits

- Can accommodate .75" to 15" bundle diameter
- Tensile strengths from 18 lbs to 250 lbs
- Resists weather & chemicals
- Easy Installation



Mounting Bases

Catalog Number	Length	Width	Height	Color	Bolt Size	Slot Size	Bag Qty
93511	.75	.75	.205	NATURAL	#6	.05	100
93513	.75	.75	.205	UV BLACK	#6	.05	100
93510	1.0	1.0	.215	NATURAL	#8	.07	100
93512	1.0	1.0	.215	UV BLACK	#8	.07	100
93514	2.0	2.0	.300	NATURAL	#6 & #8	.30	100
93515	2.0	2.0	.300	UV BLACK	#6 & #8	.30	100

Cable Tie Installation Tool

Catalog Number	Color	Description
94400	RED	Installation and cutoff tool for standard cable ties 18-50 lbs

Cable Tie Kit

Catalog Number	Qty	Kit Includes
93403	1	94400 Cable Tie Installation Tool
	50	93230 8 UV Black 50 LB Cable Ties
	100	93120 5.7 Natural 40 LB Cable Ties
	10	93510 1 X 1 Natural Mounting Bases



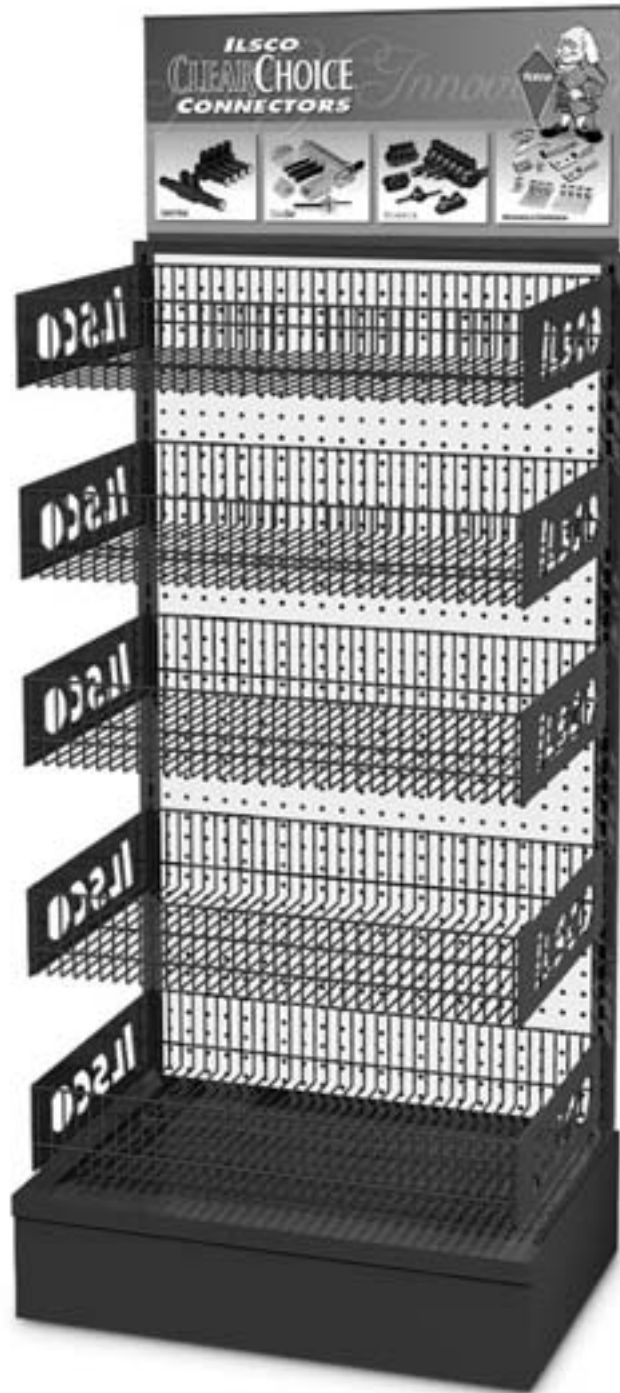

All Inclusive Merchandisers

Merchandiser-2ft:

- 1 Gondola
- 1 Header
- 5 Laser Engraved Wire Shelves
- 10 4" Blue Bins
- 5 6 1/2" Blue Bins
- 5 8" Blue Bins
- 20 Basket Clips for Labels
- 20 Basket Clip Labels *

Merchandiser-3ft:

- 1 Gondola
- 1 Header
- 5 Laser Engraved Wire Shelves
- 15 4" Blue Bins
- 5 6 1/2" Blue Bins
- 10 8" Blue Bins
- 25 Basket Clips for Labels
- 25 Basket Clip labels *

Optional (part numbers noted):

- Wheel-Kit-2ft (for 2ft merchandiser)
- Wheel-Kit-3ft (for 3ft merchandiser)

* Basket Clip Labels are printed on demand.
Part #'s required to print labels.



**Blue-Bin-4
Blue-Bin-6
Blue-Bin-8**



**Wheel-Kit-2ft
Wheel-Kit-3ft**



CONTACT ILSCO OF CANADA

1050 Lakeshore Road East, Mississauga, Ontario, Canada L5E1E4
Phone 905 274-2341 Fax 905 274-8763

Technical..... 346 - 351

Decimal Conversion Chart..... 352

Wire Size Charts 353

Wire Amperage Rating Chart..... 354 - 359
(FROM NEC 2005 CODEBOOK)

Torque Index 360

Torque Information 361

RoHS Compliance 362

Cross Reference Guide 363

A brief summary of comparative properties of metals suitable for current carrying applications and required features of the connector are listed below in Table 1.

Order	Metal	% Volume Conductivity	Relative Abundance earth's surface %
1.	Silver	108.3	
2.	Copper	100.0	0.088%
3.	Gold	73.4	
4.	Aluminum	64.9	8.0%
5.	Magnesium	38.0	1.8%

The commercial use of copper and aluminum for electrical application are obvious, in terms of economic justifications. The accelerated use of aluminum becomes even more obvious when realized that it requires twice the amount of copper by weight, to carry a specified amount of current. At the unit price per pound of prime metal it is readily seen why aluminum is increasing in electrical application.

As the next logical step, an examination of available alloys and forms of aluminum should be made to determine the optimum choice for the manufacture of electrical connectors. Please refer to Table 2

Alloy	Form	Typical Yield Strength	Minimum Yield Strength	Elongation	% Conductivity
6061-T6	Extrusion	40-45,000	35,000	12	40
6063-T6	Extrusion	31,000	25,000	12	53
Al. Mag.	Sand Cast	22,000	22,000	12	25
356-T6	Sand Cast	24,000	24,000	3½	39
AXS 679 (380A)	Die Cast	21,000	21,000	3	25

During the initial analysis of these materials, reference was made to the experience over many years of the effect of stress on tensioned overhead conductors. It is well documented that in order to assure mechanical stability of these conductors, over long periods of time, it is necessary to design the line so that the maximum stress will not exceed 50% of the conductors rated breaking strength. In the case of aluminum conductors the alloy most commonly used is EC-H19 having a yield strength of 22,000 psi and a tensile strength of 24,000 psi. From the foregoing it is obvious that a maximum stress level of 12,000 psi representing 50% of ultimate tensile strength or approximately 55% of yield strength, will result in the conductor remaining mechanically stable throughout its life.

With this initial premise being established it was necessary to confirm whether or not a determinable stress limit could be effectively applied to the design of connectors. The method of testing used to confirm this premise is noted in detail in table 8.

Additional factors of design were recognized as necessary to achieve a stable and reliable connector. Requirements of aluminum connectors for use with aluminum or copper conductors.

- a. Adequate strength of the connector to prevent creep loss in the connection from exceeding the creep loss of the conductor.
- b. Strong enough clamping force (torque) to keep the connector operating temperature at a level below the operating temperature of the maximum size conductor.
- c. High enough conductivity to provide adequate efficiency (minimum of 40%).

To illustrate the significance of these requirements, Table 3 headed *Terminal life Cycle*, presents an examination of terminal temperature in relation to clamping force. The horizontal dotted line indicates the temperature of the conductor at maximum rise. The tightening characteristic curve shows a lowering of terminal temperature rise with an increased clamping force. Terminal temperature, measured in degrees centigrade, is used in our illustration as a measure of connector resistance. As the tightening characteristic curve approaches the dotted conductor temperature line at the same current value, the connector and conductor resistance approximate each other.

The curves labeled Relaxation Characteristic, merely indicate the anticipated progression a connector would follow to failure, once clamping force has been reduced to a level where terminal resistance can no longer be maintained at a low level. Point A on each curve represents that point where resistance is sufficiently high to cause and elevated operating temperature of the connector which will then progress to ultimate connector failure.

Proceeding with the assumption that stress limitation is a most critical factor in connector design it was then necessary to select and test the alloy materials which evidence the most favorable conductivity/yield strength/economic factors. The initial selection of aluminum alloy 6061-T6 has long since been determined to be the best available material from which to fabricate connectors for use with both aluminum and copper conductors.

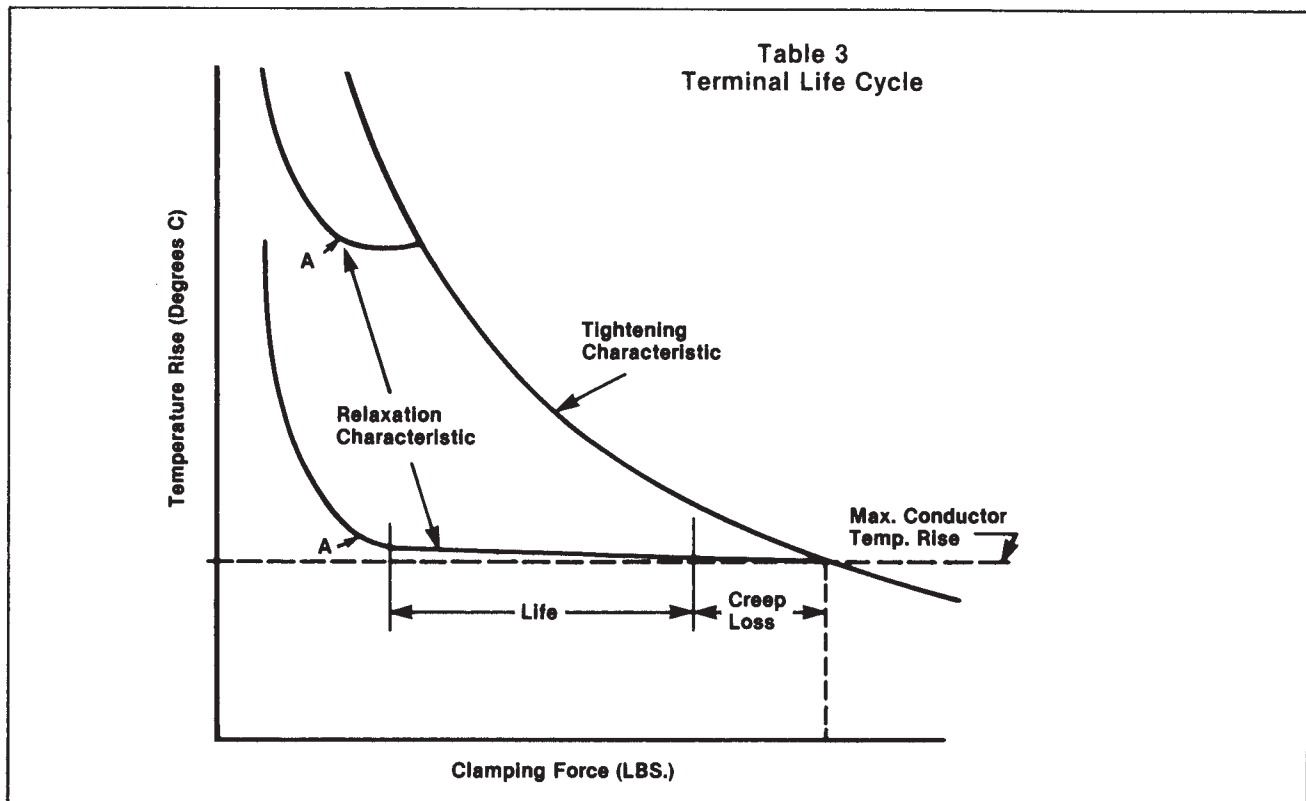

Before proceeding further a definition of terms used, to assure understanding of the basis for the conclusions reached later in the paper, are listed.

Physical Property of Aluminum

Tensile Strength

The maximum tensile load which a material is capable of withstanding under gradually and uniformly applied loading, divided by the original cross-sectional area in the minimum plane perpendicular to the direction of loading. Commonly the term is taken to mean the same as "ultimate tensile strength" or the less accurate "breaking strength."

Yield Strength

The stress at which material exhibits a specified permanent set. The value of set used for aluminum and its alloys is 0.002 inch per inch or 0.2%. For the aluminum alloys the yield strength in tension and compression are approximately the same.

Elongation

The increase in distance between two gage marks that results from stressing the specimen in tension to fracture. Please see table 5.

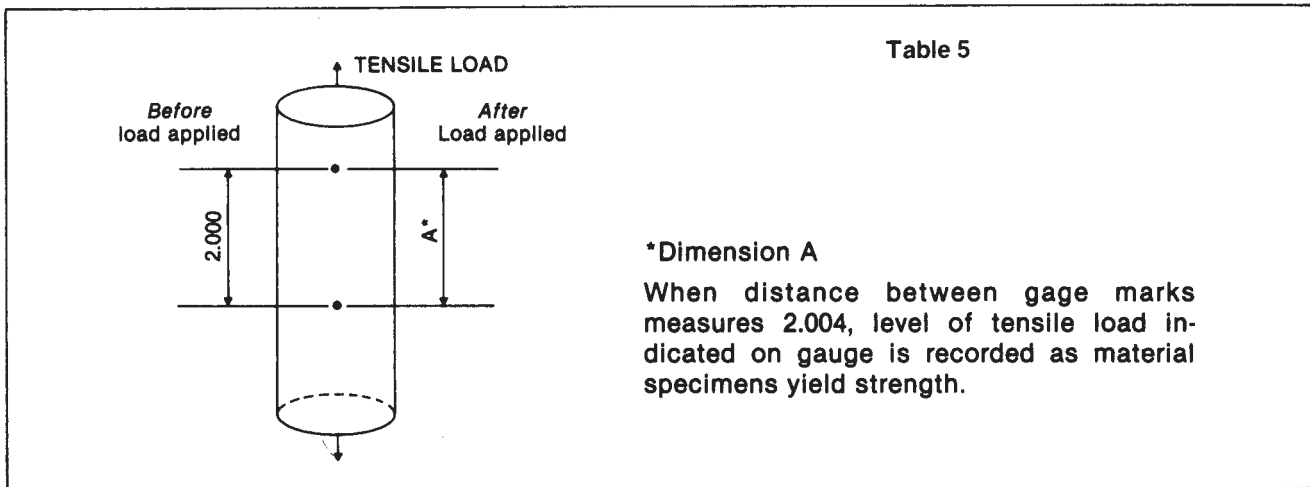

To record elongation, tensile loading is continually applied until specimen fractures, at which time two pieces are mated and distance between gage marks accurately measured. The resultant dimension divided by the original increment provides the value expressed in %, of the materials ability to stretch under load, or its elongation.

Elastic Limit

The stress value below which no permanent set or permanent deformation takes place; the highest stress which will permit return to original shape upon removal of force causing the stress.

Elasticity

The ability of a material to return to its original shape and size upon removal of a load below the elastic limit.

Creep

A precise unit of measure disclosing the increase in dimension of a unit specimen having a specified area =A, an applied force =W with resultant constant stress= $\frac{W}{A}$. The initial increment of measurement L, is

effected by three factors resulting in amount of increase or creep, stress, time and temperature.

To determine and express the creep rate for a given specimen in terms of inches of creep, per inches of original gage length, per hour, the factors of stress and temperature must be maintained constant. A change in either or both, will result in a change in the creep rate. Please refer to Tables 6 and 7.

N

Table 6
Creep Measurement

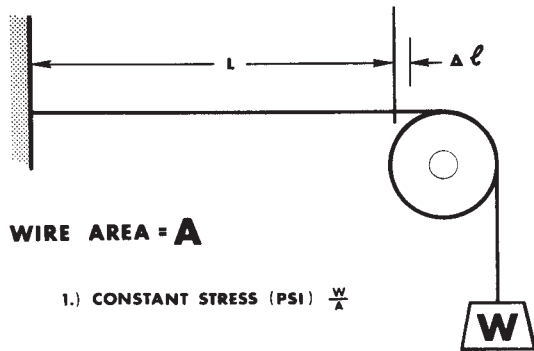

WIRE AREA = A

- 1.) CONSTANT STRESS (PSI) $\frac{W}{A}$
- 2.) TOTAL CREEP = $\Delta \ell$
 CREEP RATE = $\frac{\Delta \ell}{L \times \text{HRS}}$ Inches / Inch / Hour
 (At Temperature T)
- 3.) TEMPERATURE CONSTANT FOR EACH MEASUREMENT
 VARIED TO REDUCE CREEP VS TEMP. CURVES

Table 7
Creep Rate vs. Temp.

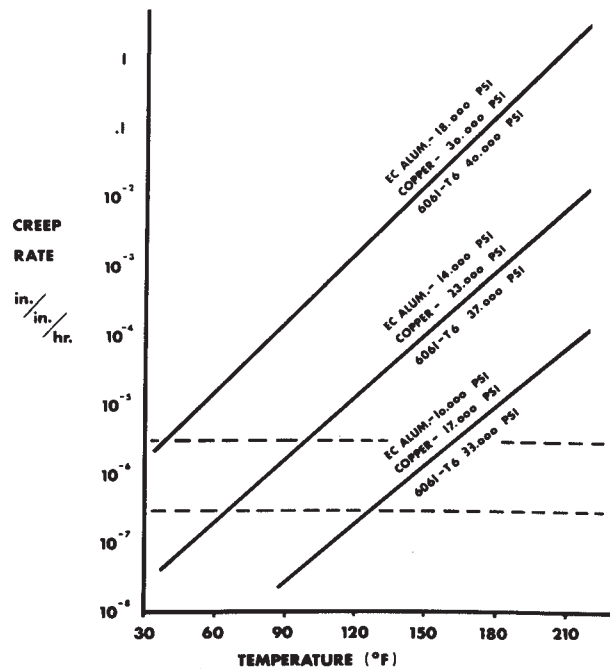

Cold Flow

As compared to Creep, cold flow has no units of measure. The best description of cold flow relating to application within the electrical industry, is an excessively high rate of creep i.e. normal creep rate static load condition would be expressed in a fraction of an inch per inch of length. Cold flow, conversely if possible to measure it in definable terms, would be expressed in terms of inches of movement per inch of length. Cold flow then can be expressed as movement of appreciable magnitude occurring at a stress level in a very short length of time at an ambient temperature. Neither time or temperature are critical in assessing the effecting force of cold flow.

It is significant to realize that it is an absolute necessity to have cold flow of the conductor within a bolted connector to develop the desired low resistance contact, required for electrical/mechanical stability of the connection. So is it necessary to have cold flow of both the conductor and connector in the making of a compression connection. In these two instances a mechanical union of the two components is made by means of an externally applied force to assure both electrical and mechanical reliability. In the case of a soldered or welded connection this component union is made metallurgically.

Creep Loss

The unit of measurement, expressed in % of the initially applied mechanical force to a connection, divided by the resultant measured force after the unit has been subjected to controlled loadings of temperature and time. This value is relatively easy to determine for bolted connectors by accurately measuring applied torque before and after applying control factors of time and temperature. The resultant loss of torque is the creep loss experienced within the connection assembly.

It is difficult and inaccurate to project anticipated creep loss within a compression assembly since there is no way of effecting a measurement of the initially applied force and the resultant force remaining on the connection after the mechanical or hydraulic compression tool is removed from the connector.

The maximum desired creep loss in a connector/conductor assembly stated, is that portion of the total creep component represented by the creep component of the conductor alone.

This brings us to the threshold of the discussion of design parameters used by IlSCO in the manufacturer of aluminum connectors.

Table 8
Tolerable Creep Limits for Aluminum Connector

Material
Aluminum 6061T6

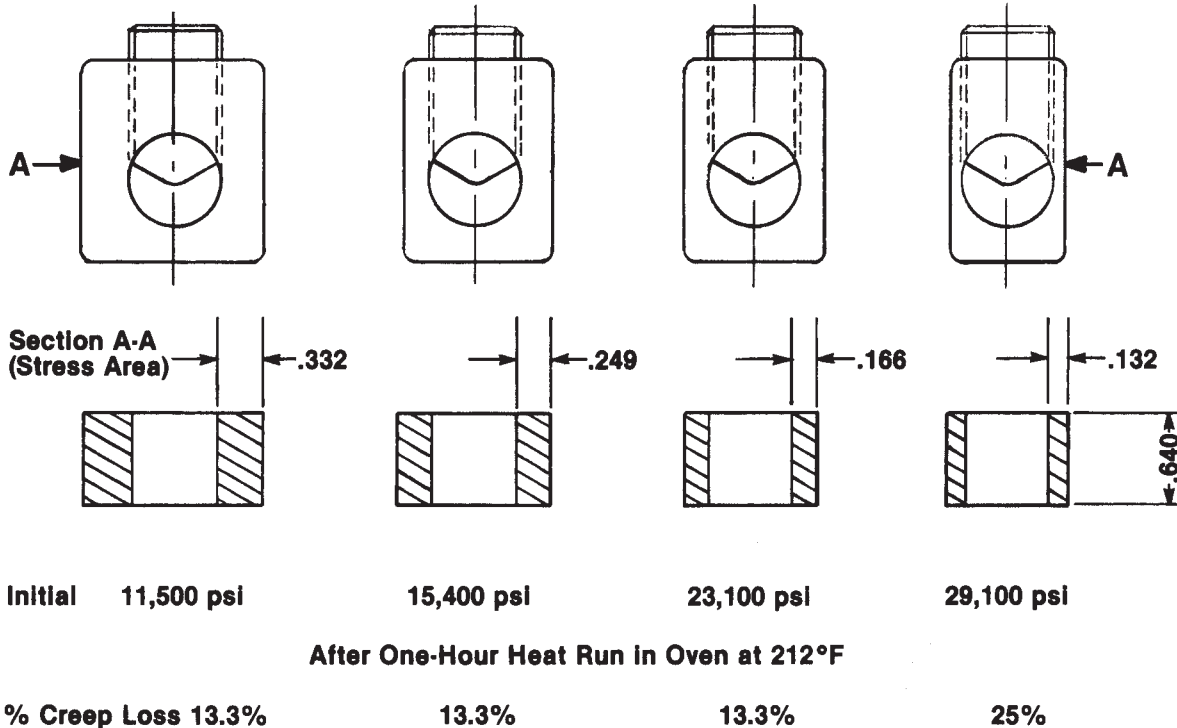

To best understand the importance of the function of creep components in a connection assembly, recall the definition of cold flow wherein it is stated that it is necessary to the formulation of an electrically/mechanically stable connection to have cold flow of the conductor. Since cold flow is by definition a high rate of creep and since creep occurs only where constant stress is applied; the connection will undergo creep movement as a result of load cycling. It is mandatory that the connector be so designed that all creep within the assembly occur in the conductor.

The determination of tolerable creep limits for aluminum connector design were established through the test described below and pictured in Table 8

This test established the maximum stress which can be imposed on an aluminum connector made from Alloy 6061-T6 as being 23,000 psi which is approximately 1/2 typical yield strength. The value of creep loss for the first three connectors were identical; 13.3% whereas the fourth exhibited a 25% creep loss. The explanation is simply that the loads applied to the section modulus of each of the first three test connectors resulted in a stress level below the elastic limit of the material and thereby causing no creep movement in the connector. The conductor on the other hand must be physically moved, and this conductor movement resulted in a redistribution of strand displacement and resultant redistribution of load. The 13.3% creep loss therefore can be stated as being that movement occurring within the conductor.

N

The Fourth sample, however, evidenced in higher creep loss, resulting from creep in the conductor and the connector since the connector was stressed beyond its elastic limit and contributed to the total creep of the assembly.

The confirmation by actual test of this limitation of stress to 1/2 the materials yield strength has been utilized in the design of all connectors manufactured by IlSCO.

Preparation of wire

When an aluminum cable is installed, certain procedures should be followed to insure a good connection.

1. The insulation should be stripped with a whittling motion to prevent the cable from being nicked.
2. The cable should then be cleaned with a wire brush. This removes the oxides from the surface of the conductor.
3. In many cases, an oxide inhibitor is applied to the conductor immediately prior to installation. However, this is not absolutely necessary.
4. For mechanical connectors, the set screw should be tightened. After a few seconds, the set screw should be retightened to insure a good connection. For compression connectors, the lug should be crimped around the conductor using the proper tool.



MILLIMETER/DECIMAL/FRACTION CONVERSION CHART

Milli-meter	Decimal	Fraction (inches)	Milli-meter	Decimal	Fraction (inches)	Milli-meter	Decimal	Fraction (inches)	Milli-meter	Decimal	Fraction (inches)	Milli-meter	Decimal	Fraction (inches)
0.1	.0039		5.159	.2031	13/64	10.2	.4016		15.3	.6024		20.3	.7992	
0.2	.0079		5.2	.2047		10.3	.4055		15.4	.6063		20.4	.8031	
0.3	.0118		5.3	.2087		10.319	.4063	13/32	15.478	.6094	39/64	20.5	.8071	
0.397	.0156	1/64	5.4	.2126		10.4	.4094		15.5	.6102		20.6	.8110	
0.4	.0157		5.5	.2165		10.5	.4134		15.6	.6142		20.638	.8125	13/16
0.5	.0197		5.556	.2188	7/32	10.6	.4173		15.7	.6181		20.7	.8150	
0.6	.0236		5.6	.2205		10.7	.4213		15.8	.6220		20.8	.8189	
0.7	.0276		5.7	.2244		10.716	.4219	27/64	15.875	.6250	5/8	20.9	.8228	
0.794	.0313	1/32	5.8	.2283		10.8	.4252		15.9	.6260		21.0	.8268	
0.8	.0315		5.9	.2323		10.9	.4291		16.0	.6299		21.034	.8281	53/64
0.9	.0354		5.953	.2344	15/64	11.0	.4331		16.1	.6339		21.1	.8307	
1.0	.0394		6.0	.2362		11.1	.4370		16.2	.6378		21.2	.8346	
1.1	.0433		6.1	.2402		11.113	.4375	7/16	16.272	.6406	41/64	21.3	.8386	
1.191	.0469	3/64	6.2	.2441		11.2	.4409		16.3	.6417		21.4	.8425	
1.2	.0472		6.3	.2480		11.3	.4449		16.4	.6457		21.431	.8438	27/32
1.3	.0512		6.350	.2500	1/4	11.4	.4488		16.5	.6496		21.5	.8465	
1.4	.0551		6.4	.2520		11.5	.4528		16.6	.6535		21.6	.8504	
1.5	.0591		6.5	.2559		11.509	.4531	29/64	16.669	.6563	21/32	21.7	.8543	
1.588	.0625	1/16	6.6	.2598		11.6	.4567		16.7	.6575		21.8	.8583	
1.6	.0630		6.7	.2638		11.7	.4606		16.8	.6614		21.828	.8594	55/64
1.7	.0669		6.747	.2656	17/64	11.8	.4646		16.9	.6654		21.9	.8622	
1.8	.0709		6.8	.2677		11.9	.4685		17.0	.6693		22.0	.8661	
1.9	.0748		6.9	.2717		11.906	.4688	15/32	17.066	.6719	43/64	22.1	.8701	
1.984	.0781	5/64	7.0	.2756		12.0	.4724		17.1	.6732		22.2	.8740	
2.0	.0787		7.1	.2795		12.1	.4764		17.2	.6772		22.225	.8750	7/8
2.1	.0827		7.144	.2813	9/32	12.2	.4803		17.3	.6811		22.3	.8780	
2.2	.0866		7.2	.2835		12.3	.4843		17.4	.6850		22.4	.8819	
2.3	.0906		7.3	.2874		12.303	.4844	31/64	17.463	.6875	11/16	22.5	.8858	
2.381	.0938	3/32	7.4	.2913		12.4	.4882		17.5	.6890		22.6	.8898	
2.4	.0945		7.5	.2953		12.5	.4921		17.6	.6929		22.622	.8906	57/64
2.5	.0984		7.541	.2969	19/64	12.6	.4961		17.7	.6968		22.7	.8937	
2.6	.1024		7.6	.2992		12.7	.5000	1/2	17.8	.7008		22.8	.8976	
2.7	.1063		7.7	.3031		12.8	.5039		17.859	.7031	45/64	22.9	.9016	
2.778	.1094	7/64	7.8	.3071		12.9	.5079		17.9	.7047		23.0	.9055	
2.8	.1102		7.9	.3110		13.0	.5118		18.0	.7087		23.019	.9063	29/32
2.9	.1142		7.938	.3125	5/16	13.097	.5156	33/64	18.1	.7126		23.1	.9094	
3.0	.1181		8.0	.3150		13.1	.5157		18.2	.7165		23.2	.9134	
3.1	.1220		8.1	.3189		13.2	.5197		18.256	.7188	23/32	23.3	.9173	
3.175	.1250	1/8	8.2	.3228		13.3	.5236		18.3	.7205		23.4	.9213	
3.2	.1260		8.3	.3268		13.4	.5276		18.4	.7244		23.416	.9219	59/64
3.3	.1299		8.334	.3281	21/64	13.494	.5313	17/32	18.5	.7283		23.5	.9252	
3.4	.1339		8.4	.3307		13.5	.5315		18.6	.7323		23.6	.9291	
3.5	.1378		8.5	.3346		13.6	.5354		18.653	.7344	47/64	23.7	.9331	
3.572	.1406	9/64	8.6	.3386		13.7	.5394		18.7	.7362		23.8	.9370	
3.6	.1417		8.7	.3425		13.8	.5433		18.8	.7402		23.813	.9375	15/16
3.7	.1457		8.731	.3438	11/32	13.891	.5469	35/64	18.9	.7441		23.9	.9409	
3.8	.1496		8.8	.3465		13.9	.5472		19.0	.7480		24.0	.9449	
3.9	.1535		8.9	.3504		14.0	.5512		19.050	.7500	3/4	24.1	.9488	
3.969	.1563	5/32	9.0	.3543		14.1	.5551		19.1	.7520		24.2	.9528	
4.0	.1575		9.1	.3583		14.2	.5591		19.2	.7559		24.209	.9531	61/64
4.1	.1614		9.128	.3594	23/64	14.288	.5625	9/16	19.3	.7598		24.3	.9567	
4.2	.1654		9.2	.3622		14.3	.5630		19.4	.7638		24.4	.9606	
4.3	.1693		9.3	.3661		14.4	.5669		19.447	.7656	49/64	24.5	.9646	
4.366	.1719	11/64	9.4	.3701		14.5	.5709		19.5	.7677		24.6	.9685	
4.4	.1732		9.5	.3740		14.6	.5748		19.6	.7717		24.606	.9688	31/32
4.5	.1772		9.525	.3750	3/8	14.684	.5781	37/64	19.7	.7756		24.7	.9724	
4.6	.1811		9.6	.3780		14.7	.5787		19.8	.7795		24.8	.9764	
4.7	.1850		9.7	.3819		14.8	.5827		19.844	.7813	25/32	24.9	.9803	
4.763	.1875	3/16	9.8	.3858		14.9	.5866		19.9	.7835		25.0	.9843	
4.8	.1890		9.9	.3898		15.0	.5906		20.0	.7874		25.003	.9844	63/64
4.9	.1929		9.922	.3906	25/64	15.081	.5938	19/32	20.1	.7913		25.1	.9882	
5.0	.1969		10.0	.3937		15.1	.5945		20.2	.7953		25.2	.9921	
5.1	.2008		10.1	.3976		15.2	.5984		20.241	.7969	51/64	25.3	.9961	
												25.400	1.0000	1



AWG VS. METRIC WIRE SIZES

Circ. Mils	Equivalent Circ. Mils	Awg. Size	Metric Wire Size mm ²	Stranding/ Wire Diameter Per Strand		Approximate Overall Diameter		Circ. Mils	Equivalent Circ. Mils	Awg. Size	Metric Wire Size mm ²	Stranding/ Wire Diameter Per Strand		Approximate Overall Diameter	
				in	mm	in	mm					in	mm	in	mm
-	937	-	0.50	1/.032	1/.813	.032	0.81	83690	-	1	-	19/.0664	19/1.69	.332	8.43
1020	-	20	-	7/.0121	7/.030	.036	0.91	-	98680	-	50	19/.073	19/1.85	.365	9.27
-	1480	-	0.75	1/.039	1/.991	.039	0.99	105600	-	1/0	-	19/.0745	19/1.89	.373	9.46
1620	-	18	-	1/.0403	1/1.02	.040	1.02	133100	-	2/0	-	19/.0837	19/2.13	.419	10.6
1620	-	18	-	7/.0152	7/.386	.046	1.16	-	138100	-	70	19/.086	19/2.18	.430	10.9
-	1974	-	1.0	1/.045	1/1.14	.045	1.14	167800	-	3/0	-	19/.094	19/2.39	.470	11.9
-	1974	-	1.0	7/.017	7/.432	.051	1.30	167800	-	3/0	-	37/.0673	37/1.71	.471	12.0
2580	-	16	-	1/.0508	1/1.29	.051	1.29	-	187500	-	95	19/.101	19/2.57	.505	12.8
2580	-	16	-	7/.0192	7/.488	.058	1.46	-	187500	-	95	37/.072	37/1.83	.504	12.8
-	2960	-	1.5	1/.055	1/1.40	.055	1.40	211600	-	4/0	-	19/.1055	19/2.68	.528	13.4
-	2960	-	1.5	7/.021	7/.533	.063	1.60	-	237.8 kcmil	-	120	37/.081	37/2.06	.567	14.4
4110	-	14	-	1/.0641	1/1.63	.064	1.63	250 kcmil	-	-	-	37/.0822	37/2.09	.575	14.6
4110	-	14	-	7/.0242	7/.615	.073	1.84	300 kcmil	-	-	150	37/.090	37/2.29	.630	16.0
-	4934	-	2.5	1/.071	1/1.80	.071	1.80	350 kcmil	-	-	-	37/.0973	37/2.47	.681	17.3
-	4934	-	2.5	7/.027	7/.686	.081	2.06	-	365.1 kcmil	-	185	37/.100	37/2.54	.700	17.8
6530	-	12	-	1/.0808	1/2.05	.081	2.05	400 kcmil	-	-	-	37/.104	37/2.64	.728	18.5
6530	-	12	-	7/.0305	7/.775	.092	2.32	-	473.6 kcmil	-	240	37/.114	37/2.90	.798	20.3
-	7894	-	4	1/.089	1/2.26	.089	2.26	-	473.6 kcmil	-	240	61/.089	61/2.26	.801	20.3
-	7894	-	4	7/.034	7/.864	.102	2.59	500 kcmil	-	-	-	37/.1162	37/2.95	.813	20.7
-	-	-	-	-	-	-	-	500 kcmil	-	-	-	61/.0905	61/2.30	.814	20.7
10380	-	10	-	1/.1019	1/2.59	.102	2.59	-	592.1 kcmil	-	300	61/.099	61/2.51	.891	22.6
10380	-	10	-	7/.0385	7/.978	.116	2.93	-	61/.0992	-	-	61/.0992	61/2.52	.893	22.7
-	11840	-	6	1/.109	1/2.77	.109	2.77	600 kcmil	-	-	-	61/.1071	61/2.72	.964	24.5
-	11840	-	6	7/.042	7/1.07	.126	3.21	700 kcmil	-	-	-	61/.1109	61/2.82	.998	25.4
13090	-	9	-	1/.1144	1/2.91	.114	2.91	750 kcmil	-	-	-	91/.0908	91/2.31	.999	25.4
13090	-	9	-	7/.0432	7/1.10	.130	3.30	750 kcmil	-	-	-	61/.114	61/2.90	1.026	26.1
16510	-	8	-	1/.1285	1/3.26	.128	3.26	-	789.4 kcmil	-	400	61/.1145	61/2.91	1.031	26.2
16510	-	8	-	7/.0486	7/1.23	.146	3.70	800 kcmil	-	-	-	91/.0938	91/2.38	1.032	26.2
-	19740	-	10	1/.141	1/3.58	.141	3.58	800 kcmil	-	-	-	61/.1280	61/3.25	1.152	29.3
-	19740	-	10	7/.054	7/1.37	.162	4.12	1000 kcmil	986.8 kcmil	-	500	91/.1048	91/2.66	1.153	29.3
20820	-	7	-	1/.1443	1/3.67	.144	3.67	1000 kcmil	-	-	-	91/.117	91/2.97	1.287	32.7
20820	-	7	-	7/.0545	7/1.38	.164	4.15	-	1233.7 kcmil	-	625	91/.117	91/2.97	1.287	32.7
26240	-	6	-	1/.162	1/4.11	.162	4.11	1250 kcmil	-	-	-	91/.1172	91/2.98	1.289	32.7
26240	-	6	-	7/.0612	7/1.55	.184	4.66	1250 kcmil	-	-	-	127/.0992	127/2.52	1.290	32.8
-	31580	-	16	7/.068	7/1.73	.204	5.18	1500 kcmil	-	-	-	91/.1284	91/3.26	1.412	35.9
33090	-	5	-	7/.0688	7/1.75	.206	5.24	1500 kcmil	-	-	-	127/.1087	127/2.76	1.413	35.9
41740	-	4	-	7/.0772	7/1.96	.232	5.88	-	1578.8 kcmil	-	800	91/.132	91/3.35	1.452	36.9
-	49340	-	25	7/.085	7/2.16	.255	6.48	-	1973.5 kcmil	-	1000	91/.147	91/3.73	1.617	41.1
-	49340	-	25	19/.052	19/1.32	.260	6.60	2000 kcmil	-	-	-	127/.1255	127/3.19	1.632	41.5
52620	-	3	-	7/.0867	7/2.20	.260	6.61	2000 kcmil	-	-	-	169/.1088	169/2.76	1.632	41.5
66360	-	2	-	7/.0974	7/2.47	.292	7.42	-	-	-	-	-	-	-	-
-	69070	-	35	7/.100	7/2.54	.300	7.62	-	-	-	-	-	-	-	-
-	69070	-	35	19/.061	19/1.55	.305	7.75	-	-	-	-	-	-	-	-

DIESEL LOCOMOTIVE AND CAR WIRING CABLE

Conductor Stranding	Approx. Size Awg	Circular Mil Area	Conductor Diameter Inches
19/0117	16	2601	.060
19/27	14	3831	.096
19/25	12	6088	.116
27/24	10	10910	.146
37/24	8	14950	.166
61/24	6	24640	.226
91/24	5	36760	.256
105/24	4	42420	.286
125/24	3	50500	.300
150/24	2	60600	.366
225/24	1	90900	.424
275/24	1/0	111100	.454
325/24	2/0	131300	.494
450/24	3/0	181800	.604
550/24	4/0	222200	.634
650/24	262.6	262600	.712
775/24	313.1	313100	.792
925/24	373.7	373700	.852
1100/24	444.4	444400	.922
1325/24	535.3	535300	1.022
1600/24	646.4	646400	1.122
1925/24	777.7	777700	1.182
2300/24	929.2	929200	1.292
2750/24	1111.0	1111000	1.43

* Reprinted with permission from NFPA 70, *National Electrical Code*®

Table 310.16 Allowable Ampacities of Insulated Conductors Rated 0 Through 2000 Volts, 60°C Through 90°C (140°F Through 194°F), Not More Than Three Current-Carrying Conductors in Raceway, Cable, or Earth (Directly Buried), Based on Ambient Temperature of 30°C (86°F)

Size AWG or kcmil	Temperature Rating of Conductor						Size AWG or kcmil
	60°C (140°F)	75°C (167°F)	90°C (194°F)	60°C (140°F)	75°C (167°F)	90°C (194°F)	
	Types TW, UF	Types RHW, THHW, THW, THWN, XHHW, USE, ZW	Types TBS, SA, SIS, FEP, FEPB, MI, RHH, RHW-2, THHN, THHW, THW-2, THWN-2, USE-2, XHH, XHHW, XHHW-2, ZW-2	Types TW, UF	Types RHW, THHW, THW, THWN, XHHW, USE	Types TBS, SA, SIS, THHN, THHW, THW-2, THWN-2, RHH, RHW-2, USE-2, XHH, XHHW, XHHW-2, ZW-2	
	COPPER			ALUMINUM OR COPPER-CLAD ALUMINUM			
18	—	—	14	—	—	—	—
16	—	—	18	—	—	—	—
14	20	20	25	—	—	—	—
12	25	25	30	20	20	25	12*
10	30	35	40	25	30	35	10*
8	40	50	55	30	40	45	8
6	55	65	75	40	50	60	6
4	70	85	95	55	65	75	4
3	85	100	110	65	75	85	3
2	95	115	130	75	90	100	2
1	110	130	150	85	100	115	1
1/0	125	150	170	100	120	135	1/0
2/0	145	175	195	115	135	150	2/0
3/0	165	200	225	130	155	175	3/0
4/0	195	230	260	150	180	205	4/0
250	215	255	290	170	205	230	250
300	240	285	320	190	230	255	300
350	260	310	350	210	250	280	350
400	280	335	380	225	270	305	400
500	320	380	430	260	310	350	500
600	355	420	475	285	340	385	600
700	385	460	520	310	375	420	700
750	400	475	535	320	385	435	750
800	410	490	555	330	395	450	800
900	435	520	585	355	425	480	900
1000	455	545	615	375	445	500	1000
1250	495	590	665	405	485	545	1250
1500	520	625	705	435	520	585	1500
1750	545	650	735	455	545	615	1750
2000	560	665	750	470	560	630	2000
CORRECTION FACTORS							
Ambient Temp. (°C)	For ambient temperatures other than 30°C (86°F), multiply the allowable ampacities shown above by the appropriate factor shown below.						Ambient Temp. (°F)
21–25	1.08	1.05	1.04	1.08	1.05	1.04	70–77
26–30	1.00	1.00	1.00	1.00	1.00	1.00	78–86
31–35	0.91	0.94	0.96	0.91	0.94	0.96	87–95
36–40	0.82	0.88	0.91	0.82	0.88	0.91	96–104
41–45	0.71	0.82	0.87	0.71	0.82	0.87	105–113
46–50	0.58	0.75	0.82	0.58	0.75	0.82	114–122
51–55	0.41	0.67	0.76	0.41	0.67	0.76	123–131
56–60	—	0.58	0.71	—	0.58	0.71	132–140
61–70	—	0.33	0.58	—	0.33	0.58	141–158
71–80	—	—	0.41	—	—	0.41	159–176

National Electrical Code® and NEC® are registered trademarks of the National Fire Protection Association, Inc., Quincy, MA 02169

* Reprinted with permission from NFPA 70, *National Electrical Code*® Copyright © 2004, National Fire Protection Association, Quincy, MA 02169. This reprinted material is not the complete and official position of the National Fire Protection Association on the referenced subject which is represented only by the standard in its entirety.

* Reprinted with permission from NFPA 70, *National Electrical Code*®

Table 310.17 Allowable Ampacities of Single-Insulated Conductors Rated 0 Through 2000 Volts in Free Air, Based on Ambient Air Temperature of 30°C (86°F)

Size AWG or kcmil	Temperature Rating of Conductor						Size AWG or kcmil
	60°C (140°F)	75°C (167°F)	90°C (194°F)	60°C (140°F)	75°C (167°F)	90°C (194°F)	
	Types TW, UF	Types RBW, THHW, THW, THWN, XHHW, ZW	Types TBS, SA, SIS, FEP, FEPB, MI, RHH, RHW-2, THHN, THHW, THW-2, THWN-2, USE-2, XHH, XHHW, XHHW-2, ZW-2	Types TW, UF	Types RHW, THHW, THW, THWN, XHHW	Types TBS, SA, SIS, THHN, THHW, THW-2, THWN-2, RHH, RHW-2, USE-2, XHH, XHHW, XHHW-2, ZW-2	
	COPPER			ALUMINUM OR COPPER-CLAD ALUMINUM			
18	—	—	18	—	—	—	—
16	—	—	24	—	—	—	—
14	25	30	35	—	—	—	—
12	30	35	40	25	30	35	12*
10	40	50	55	35	40	40	10*
8	60	70	80	45	55	60	8
6	80	95	105	60	75	80	6
4	105	125	140	80	100	110	4
3	120	145	165	95	115	130	3
2	140	170	190	110	135	150	2
1	165	195	220	130	155	175	1
1/0	195	230	260	150	180	205	1/0
2/0	225	265	300	175	210	235	2/0
3/0	260	310	350	200	240	275	3/0
4/0	300	360	405	235	280	315	4/0
250	340	405	455	265	315	355	250
300	375	445	505	290	350	395	300
350	420	505	570	330	395	445	350
400	455	545	615	355	425	480	400
500	515	620	700	405	485	545	500
600	575	690	780	455	540	615	600
700	630	755	855	500	595	675	700
750	655	785	885	515	620	700	750
800	680	815	920	535	645	725	800
900	730	870	985	580	700	785	900
1000	780	935	1055	625	750	845	1000
1250	890	1065	1200	710	855	960	1250
1500	980	1175	1325	795	950	1075	1500
1750	1070	1280	1445	875	1050	1185	1750
2000	1155	1385	1560	960	1150	1335	2000
CORRECTION FACTORS							
Ambient Temp. (°C)	For ambient temperatures other than 30°C (86°F), multiply the allowable ampacities shown above by the appropriate factor shown below.						Ambient Temp. (°F)
21–25	1.08	1.05	1.04	1.08	1.05	1.04	70–77
26–30	1.00	1.00	1.00	1.00	1.00	1.00	78–86
31–35	0.91	0.94	0.96	0.91	0.94	0.96	87–95
36–40	0.82	0.88	0.91	0.82	0.88	0.91	96–104
41–45	0.71	0.82	0.87	0.71	0.82	0.87	105–113
46–50	0.58	0.75	0.82	0.58	0.75	0.82	114–122
51–55	0.41	0.67	0.76	0.41	0.67	0.76	123–131
56–60	—	0.58	0.71	—	0.58	0.71	132–140
61–70	—	0.33	0.58	—	0.33	0.58	141–158
71–80	—	—	0.41	—	—	0.41	159–176

National Electrical Code® and NEC® are registered trademarks of the National Fire Protection Association, Inc., Quincy, MA 02169

* Reprinted with permission from NFPA 70, *National Electrical Code*® Copyright © 2004, National Fire Protection Association, Quincy, MA 02169. This reprinted material is not the complete and official position of the National Fire Protection Association on the referenced subject which is represented only by the standard in its entirety.



* Reprinted with permission from NFPA 70, *National Electrical Code*®

Table 310.18 Allowable Ampacities of Insulated Conductors Rated 0 Through 2000 Volts, 150°C Through 250°C (302°F Through 482°F), Not More Than Three Current-Carrying Conductors in Raceway or Cable, Based on Ambient Air Temperature of 40°C (104°F)

Size AWG or kcmil	Temperature Rating of Conductor				Size AWG or kcmil
	150°C (302°F)	200°C (392°F)	250°C (482°F)	150°C (302°F)	
	Type Z	Types FEP, FEPB, PFA, SA	Types PFAH, TFE	Type Z	
	COPPER		NICKEL OR NICKEL-COATED COPPER	ALUMINUM OR COPPER-CLAD ALUMINUM	
14	34	36	39	—	14
12	43	45	54	30	12
10	55	60	73	44	10
8	76	83	93	57	8
6	96	110	117	75	6
4	120	125	148	94	4
3	143	152	166	109	3
2	160	171	191	124	2
1	186	197	215	145	1
1/0	215	229	244	169	1/0
2/0	251	260	273	198	2/0
3/0	288	297	308	227	3/0
4/0	332	346	361	260	4/0

CORRECTION FACTORS

Ambient Temp. (°C)	For ambient temperatures other than 40°C (104°F), multiply the allowable ampacities shown above by the appropriate factor shown below.				Ambient Temp. (°F)
41–50	0.95	0.97	0.98	0.95	105–122
51–60	0.90	0.94	0.95	0.90	123–140
61–70	0.85	0.90	0.93	0.85	141–158
71–80	0.80	0.87	0.90	0.80	159–176
81–90	0.74	0.83	0.87	0.74	177–194
91–100	0.67	0.79	0.85	0.67	195–212
101–120	0.52	0.71	0.79	0.52	213–248
121–140	0.30	0.61	0.72	0.30	249–284
141–160	—	0.50	0.65	—	285–320
161–180	—	0.35	0.58	—	321–356
181–200	—	—	0.49	—	357–392
201–225	—	—	0.35	—	393–437

National Electrical Code® and *NEC*® are registered trademarks of the National Fire Protection Association, Inc., Quincy, MA 02169

* Reprinted with permission from NFPA 70, *National Electrical Code*® Copyright © 2004, National Fire Protection Association, Quincy, MA 02169. This reprinted material is not the complete and official position of the National Fire Protection Association on the referenced subject which is represented only by the standard in its entirety.



* Reprinted with permission from NFPA 70, *National Electrical Code*®

Table 310.19 Allowable Ampacities of Single-Insulated Conductors, Rated 0 Through 2000 Volts, 150°C Through 250°C (302°F Through 482°F), in Free Air, Based on Ambient Air Temperature of 40°C (104°F)

Size AWG or kcmil	Temperature Rating of Conductor				Size AWG or kcmil
	150°C (302°F)	200°C (392°F)	250°C (482°F)	150°C (302°F)	
	Type Z	Types FEP, FEPB, PFA, SA	Types PFAH, TFE	Type Z	
	COPPER		NICKEL, OR NICKEL-COATED COPPER	ALUMINUM OR COPPER-CLAD ALUMINUM	
14	46	54	59	—	14
12	60	68	78	47	12
10	80	90	107	63	10
8	106	124	142	83	8
6	155	165	205	112	6
4	190	220	278	148	4
3	214	252	327	170	3
2	255	293	381	198	2
1	293	344	440	228	1
1/0	339	399	532	263	1/0
2/0	390	467	591	305	2/0
3/0	451	546	708	351	3/0
4/0	529	629	830	411	4/0

CORRECTION FACTORS

Ambient Temp. (°C)	For ambient temperatures other than 40°C (104°F), multiply the allowable ampacities shown above by the appropriate factor shown below.				Ambient Temp. (°F)
41–50	0.95	0.97	0.98	0.95	105–122
51–60	0.90	0.94	0.95	0.90	123–140
61–70	0.85	0.90	0.93	0.85	141–158
71–80	0.80	0.87	0.90	0.80	159–176
81–90	0.74	0.83	0.87	0.74	177–194
91–100	0.67	0.79	0.85	0.67	195–212
101–120	0.52	0.71	0.79	0.52	213–248
121–140	0.30	0.61	0.72	0.30	249–284
141–160	—	0.50	0.65	—	285–320
161–180	—	0.35	0.58	—	321–356
181–200	—	—	0.49	—	357–392
201–225	—	—	0.35	—	393–437

National Electrical Code® and *NEC*® are registered trademarks of the National Fire Protection Association, Inc., Quincy, MA 02169

* Reprinted with permission from NFPA 70, *National Electrical Code*® Copyright © 2004, National Fire Protection Association, Quincy, MA 02169. This reprinted material is not the complete and official position of the National Fire Protection Association on the referenced subject which is represented only by the standard in its entirety.

* Reprinted with permission from NFPA 70, *National Electrical Code*®

Table 310.20 Ampacities of Not More Than Three Single Insulated Conductors, Rated 0 Through 2000 Volts, Supported on a Messenger, Based on Ambient Air Temperature of 40°C (104°F)

Size AWG or kcmil	Temperature Rating of Conductor				Size AWG or kcmil
	75°C (167°F)	90°C (194°F)	75°C (167°F)	90°C (194°F)	
	Types RHW, THHW, THW, THWN, XHHW, ZW	Types MI, THHN, THHW, THW-2, THWN-2, RHH, RHW-2, USE-2, XHHW, XHHW-2, ZW-2	Types RHW, THW, THWN, THHW, XHHW	Types THHN, THHW, RHH, XHHW, RHW-2, XHHW-2, THW-2, THWN-2, USE-2, ZW-2	
COPPER		ALUMINUM OR COPPER-CLAD			
			ALUMINUM		
8	57	66	44	51	8
6	76	89	59	69	6
4	101	117	78	91	4
3	118	138	92	107	3
2	135	158	106	123	2
1	158	185	123	144	1
1/0	183	214	143	167	1/0
2/0	212	247	165	193	2/0
3/0	245	287	192	224	3/0
4/0	287	335	224	262	4/0
250	320	374	251	292	250
300	359	419	282	328	300
350	397	464	312	364	350
400	430	503	339	395	400
500	496	580	392	458	500
600	553	647	440	514	600
700	610	714	488	570	700
750	638	747	512	598	750
800	660	773	532	622	800
900	704	826	572	669	900
1000	748	879	612	716	1000
CORRECTION FACTORS					
Ambient Temp. (°C)	For ambient temperatures other than 40°C (104°F), multiply the allowable ampacities shown above by the appropriate factor shown below.				Ambient Temp. (°F)
21–25	1.20	1.14	1.20	1.14	70–77
26–30	1.13	1.10	1.13	1.10	79–86
31–35	1.07	1.05	1.07	1.05	88–95
36–40	1.00	1.00	1.00	1.00	97–104
41–45	0.93	0.95	0.93	0.95	106–113
46–50	0.85	0.89	0.85	0.89	115–122
51–55	0.76	0.84	0.76	0.84	124–131
56–60	0.65	0.77	0.65	0.77	133–140
61–70	0.38	0.63	0.38	0.63	142–158
71–80	—	0.45	—	0.45	160–176

National Electrical Code® and NEC® are registered trademarks of the National Fire Protection Association, Inc., Quincy, MA 02169

* Reprinted with permission from NFPA 70, *National Electrical Code*® Copyright © 2004, National Fire Protection Association, Quincy, MA 02169. This reprinted material is not the complete and official position of the National Fire Protection Association on the referenced subject which is represented only by the standard in its entirety.



* Reprinted with permission from NFPA 70, *National Electrical Code*®

Table 310.21 Ampacities of Bare or Covered Conductors in Free Air, Based on 40°C (104°F) Ambient, 80°C (176°F) Total Conductor Temperature, 610 mm/sec (2 ft/sec) Wind Velocity

Copper Conductors				AAC Aluminum Conductors			
Bare		Covered		Bare		Covered	
AWG or kcmil	Amperes	AWG or kcmil	Amperes	AWG or kcmil	Amperes	AWG or kcmil	Amperes
8	98	8	103	8	76	8	80
6	124	6	130	6	96	6	101
4	155	4	163	4	121	4	127
2	209	2	219	2	163	2	171
1/0	282	1/0	297	1/0	220	1/0	231
2/0	329	2/0	344	2/0	255	2/0	268
3/0	382	3/0	401	3/0	297	3/0	312
4/0	444	4/0	466	4/0	346	4/0	364
250	494	250	519	266.8	403	266.8	423
300	556	300	584	336.4	468	336.4	492
500	773	500	812	397.5	522	397.5	548
750	1000	750	1050	477.0	588	477.0	617
1000	1193	1000	1253	556.5	650	556.5	682
—	—	—	—	636.0	709	636.0	744
—	—	—	—	795.0	819	795.0	860
—	—	—	—	954.0	920	—	—
—	—	—	—	1033.5	968	1033.5	1017
—	—	—	—	1272	1103	1272	1201
—	—	—	—	1590	1267	1590	1381
—	—	—	—	2000	1454	2000	1527

National Electrical Code® and *NEC*® are registered trademarks of the National Fire Protection Association, Inc., Quincy, MA 02169

* Reprinted with permission from NFPA 70, *National Electrical Code*® Copyright © 2004, National Fire Protection Association, Quincy, MA 02169. This reprinted material is not the complete and official position of the National Fire Protection Association on the referenced subject which is represented only by the standard in its entirety.

**TIGHTENING TORQUE VALUES FOR
ILSCO MECHANICAL SCREW CONNECTORS**

AWG. OR CIRCULAR MILL SIZE	TIGHTENING TORQUE IN INCH POUNDS	
	SCREW DRIVER	EXTERNAL DRIVE WRENCH
14	35	75
12	35	75
10	35	75
8	40	75
6	45	110
4	45	110
2	50	150
1	50	150
1/0	50	180
2/0	50	180
3/0		250
4/0		250
250		325
350		325
500		375
600		375
700		375
750		375
800		500
1000		500

**TIGHTENING TORQUE VALUES FOR
ILSCO SOCKETHEAD SCREW CONNECTORS**

INTERNAL SOCKET SIZE ACROSS FLATS INCHES	TIGHTENING TORQUE IN INCH POUNDS
1/8	45
5/32	100
3/16	120
7/32	150
1/4	200
5/16	275
3/8	375
1/2	500
9/16	600

Please reference the instruction sheet included with your connector for specific torque values.

Table I shows the recommended tightening torques for silicon bronze, stainless steel, galvanized steel and aluminum alloy hardware. The shaded portion represents torques presently recommended by NEMA-CC1-1984 specification.

**TABLE I
TIGHTENING TORQUES**

Bolt Diameter	Nominal Torque Values			
	Silicon Bronze, Galvanized or Stainless Steel		Aluminum Alloy (Lubricated)	
	Ft.-Lbs.	Inch-Lbs.	Ft.-Lbs.	Inch-Lbs.
5/16-18	15	180	—	—
3/8-16	20	240	14	168
1/2-13	40	480	25	300
5/8-11	55	660	40	480
3/4-10	80	960	70	840

For optimum efficiency, it is necessary that the correct bolt, nut and washer combination be used with the correct combination of conductor materials. Table II shows acceptable methods of joining different combinations of bus bar. Where different combinations of metals are being joined, a follow-up device such as a conical pressure washer is usually recommended if one, or both, bus materials are soft drawn aluminum. If both bars are hard drawn, large flat washers will suffice regardless of the bolt materials.

Other considerations which should be taken into account when selecting hardware are corrosion and vibration. For example, if severe corrosion is anticipated, non-corrosive materials such as stainless steel or silicon bronze, should be selected in preference to galvanized steel. If vibration is anticipated, the use of locking washers should be considered.

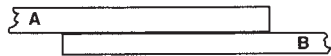

**TABLE II
METHODS OF JOINING BUS BARS**

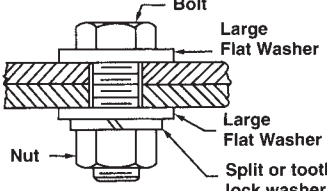
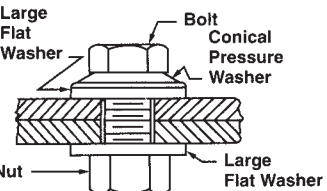
If "A" Bar is and If "B" Bar is	Copper	Aluminum	Steel	Aluminum	Steel
	Copper	Copper	Copper	Aluminum	Aluminum
Hard Drawn Bus such as aluminum alloy. 	(1) Silicon Bronze (2) Stainless Steel	(1) Silicon Bronze (2) Aluminum (3) Stainless Steel	(1) Silicon Bronze (2) Stainless Steel	(1) Aluminum (2) Stainless Steel (3) Silicon Bronze, Plated	(1) Aluminum (2) Stainless Steel
Soft Drawn Bus such as EC-H13 Aluminum. 	(1) Silicon Bronze (2) Stainless Steel	(1) Silicon Bronze (2) Aluminum (3) Stainless Steel (4) Conical Pressure Washer Plated or Stainless Steel	(1) Silicon Bronze (2) Stainless Steel	(1) Aluminum (2) Stainless Steel (3) Silicon Bronze Plated (4) Conical Pressure Washer Plated or Stainless Steel	(1) Aluminum (2) Stainless Steel (3) Conical Pressure Washer Plated or Stainless Steel

(1) Denotes preferred hardware usage
Note: Contact sealant recommended between aluminum to aluminum and aluminum to copper connections, unless other protective measures are taken.

Bar Connections

The tang of a compression or a mechanical connector is a bus bar, which connects to another bus bar. If you remember the rule about wire brushing and using joint compound with bare (unplated) aluminum, you cannot go wrong. Plated parts should be cleaned with a solvent if they are dirty, but never abrade or otherwise disturb the plating! Fig. 3 shows a typical bar connection and the type of hardware used.

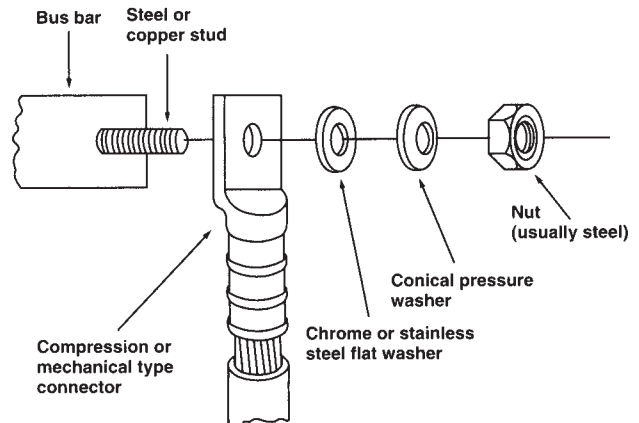

Figure 3. Contact surfaces must be clean. Use a joint compound with bare aluminum. Conical pressure washer is usually recommended if one, or both, bus materials are soft drawn aluminum.

Restriction of Hazardous Substances (RoHS) European Directive 2002/95/EC

As of July 1st 2006 ILSCO Corporation is capable of supplying all items offered for sale compliant with the standards listed in the RoHS directive.

There are still significant amounts of assembled product and components in inventory produced before all processes were made compliant. During this transition period ILSCO can only guarantee RoHS compliance on orders specifically requesting compliant parts. These orders will be acknowledged at full lead time.

ILSCO Corporation makes no independent representations or a warranty, expressed or implied, and assumes no liability in connection with the use of this information.

***Access to Cross Reference can be
found under Reference Tab
at www.ILSCO.com***

Two Ways to Search

1. Type in all or part of the competitive or IlSCO part number into the **SEARCH** box in the header, then click **GO**.
2. Click "Search Options" in the header. From there, you are given five ways to search.

By Keyword: Type in a keyword and click **GO**. For example, typing "splice" will return a list of products that can be used to splice conductor. You can click on any of the products listed and you will be taken to the catalog page.

By IlSCO Catalog #: Type in all or part of the IlSCO part number and click **GO**. You can click on any of the products listed and you will be taken to the catalog page.

By UPC/NAED Part #: Type in the IlSCO UPC number and click **GO**. The IlSCO corporate identifier, 783669, is already given. For example, typing "88774" will return information on "TA-2".

By Competitive Part #: Type in all or part of the competitive part number and click **GO**. You do not need to know the manufacturer. You are given a list of comparable IlSCO products. You can click on any of the products listed and you will be taken to the catalog page.

Choose a category: Select a product category from the list and click **GO**. You will receive a list of the product groups in that category. You can click on any of the products listed and you will be taken to the catalog page.

If your request is not in our database, you will be sent to a screen where you can send an e-mail to IlSCO's technical support department. Your request will be answered promptly.

This cross reference information has been compiled from tables, catalogs and data which are generally available. Since changes are made regularly in the industry, we cannot accept responsibility for any errors, but we will endeavor at all times to keep these tables up-to-date. Refer to our current catalog for exact specifications on ILSCO connectors. All connectors are not exact equals, but enough similarities exist that they can be used for the same application.

ILSCO Alpha Numeric Index

Catalog No.	Page No.	Catalog No.	Page No.
ACN	48-50	E	161
ACL	48-51	E (Screws)	191, 254, 333
2ACL	52-53	ELT	47, 227, 268
ACM	58-60	FP-1	304
2ACN	52	GBL	147, 256
ACO	61-62	GBL-DB	189, 257
ACO-90	63	GBT	148, 258
5ACR	303	GGA	44, 224, 266
AGC	146, 255	GGC	45, 225, 267
AH	72	GRC	184, 231, 272
AK	104, 144	GRF	159, 259
AS	66-68	GRM	159, 259
ASK	156, 262	GS	252
ASL	54	GSR	252
AU	120	GTA	107, 128
BGC	186-187, 234-235, 274	GTT	109, 129
BGCS	237	GTC	110, 130
BGDB	188, 236, 275	GT2	111, 131
BGRC	182, 229, 270	GT4T	112, 132
C	321	GTA/GTT KIT	113
CA	127	GUB	243, 281
Cable Ties	338-342	H	161
CAN	191, 254, 333	Hardware	337
CCL	32-37	Heat Shrink	282-288
CCS	42-43	HH-10N	305
CGRC	181, 228, 270	HL	177
CL	175-176, 178	H2L	179
CLND	23-28	H3L	180
CLNF	29-30	HT	73-74
CLNS	14-16	HW	318
CLNU	31	2IACL	65
CLWD	17-22	IACL	64
CLWS	11-13	IDT-12-N	299
CO	167-168	IDT-6	300
Compression Dies	313-314	IDT-6H	301
Compression Index	90-97, 306-312	IDTB-6	290
COPP	169	IK	99, 192
CP	166	IK3	100, 193
CPM	55-57	IKB	102, 195
CPML	57	IKS	103, 196
CRAM	38	ILC-10-N	292
Crimp 'N Seal	87-88	ILC-12-N	297
CSWD	5-10	ILC-12H-N	298
CSWS	2-4	ILC-15H	302
CT	40	ILCB-12-N	291
CTL	41	ILD	314
CTR	317	Ilscans	76-86
DCGC	185, 233	Ilscan Tools	89
DBA	105, 145	IPC	106, 143, 210-212
DBA-S	105, 145	LDA	135, 214
DBK	156, 262	LDB	135, 214
D167	190, 253, 332	LO	163
DE-OX	335	LO-S	164
DR	318	LU	174
Duct Seal	336	LY	165



ILSCO Alpha Numeric Index

Catalog No.	Page No.	Catalog No.	Page No.
M	322-323	T	244-251, 324-331
Merchandising	343	TA	119
MGTT	114, 133	T3A	121
MT-25	293	T4A4	122
MU	174	TC	170
N	173	Technical Information	346-363
NB	154, 260, 334	TK	318
NBW	337	TLK	124
ND	295-296	Torque Index	197, 360
N-174	191, 254, 333	TS	318
P840	71	TTGC	242, 280
PB	123	TW	318
PBT	199	Tool Accessories	315
PBTD	200-202	Tools	289-319
PBTM	206-207	UCS	69
PBTO	199	ULT	46, 226
PBTS	203-205	USGL	125
PCT	116, 208	USPA-SS	155, 263
PDA	136, 215	VT	164
PDB	137-142, 216-221	WC	318
PDC	136, 215	WR	318
PEC	150	WS	89, 316
PED-Z	149	XT	165
PED-CP	151	XT-DB	165, 269
PED-SS	265	21000	283
PED-X	150	22000	285
PET	152	23000	284
PG	158	24000	286
PICS	70	25000	286
PSA-Z	150	26000	287
PTA	115, 134	27000	288, 319
PTT	153	30000	88
R-16	190, 254, 333	31000	87-88
RLT	75, 232, 273	44000	76-85
SAU	160	45000	86
SAS	160	94130	89, 316
2SC	172	94140	89, 316
SGC	146, 255	94285	294
SK	101, 194	94502	288, 319
SLS	160	94504	288, 319
SLU	160		
SLU-DB	160, 269		
SLUH	162		
Solder Lugs	39		
SPA	126		
SPAR	108, 209		
SPD	240-241, 278-279		
SPS	238-239, 276-277		
SRC	183, 230, 271		
SS	157, 264		
SSK	157, 264		
SSKC	157, 264		
SX	171		

