

CEP7 Solid State Overload Relays

Advanced solid state motor protection

The introduction of the second generation of CEP7 solid state overload relays advances Sprecher + Schuh's leading edge technology with several improved features. This second generation of CEP7 overload relay includes features like:

- Selectable trip class and field installable modules
- A wider (5:1) set current adjustment range
- A more robust mechanical and electrical mounting
- Self-sealed latching mechanism

The basic concept of utilizing Application Specific Integrated Circuits (ASICs) resulting in an affordable solid state overload relays remains unchanged. This kind of versatility and accuracy was simply not possible with traditional bimetallic or eutectic alloy electromechanical overload relays.

Fewer units means greater application flexibility

The CEP7 Solid State Overload is available in three basic models:

- CEP7-ED1 is a Class 10, manual reset model available up to 45 amperes which covers the most common horsepower motors and your every day application. This model is economically priced to be competitive with adjustable bimetallic overload relays.
- CEP7-EE is full featured selectable trip class (10, 15, 20 & 30) 3-phase application overload relay with provision for field mountable modules to handle remote reset, jam protection, and other modules previously available only in higher



priced electronic overload relays. Manual reset or automatic reset can be selected with dip switches on the CEP7-EE models.

- CEP7S-EE is a 1-phase application overload relay packing all features of the 3-phase CEP7-EE model.

Wide current adjustment range

Thermal or bimetallic overload relays typically have a small current adjustment range of 1.5:1 meaning that the maximum setting is generally 1.5 times the lower setting. The first gen-



eration of CEP7 caused the industry to take note of the flexibility when it introduced a 3.2:1 adjustment ratio. A wider adjustment range is the primary reason the industry has been turning to more specifications calling for electronic overload relay protection over thermal overload relays. Sprecher + Schuh building on field experience now introduces a CEP7 overload capable of adjustment to a maximum of five times the minimum set current which dramatically reduces the number of units required on-hand to cover the full range of current settings up to 90 amperes.

5 : 1 Current Range



45A

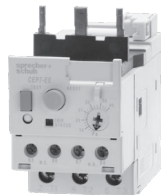

45A



90A



30A 800A

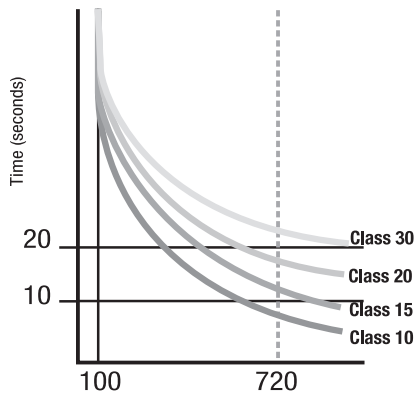

CEP7 overload relays are available with Class 10, 15, 20 or 30 tripping characteristics

Selectable tripping class

Because of today's lighter T-frame motors, Class 10 overload relays (relays that trip within 10 seconds of a locked rotor condition) have become the industry standard. If your application requires a longer motor run-up time. The CEP7-EE Selectable Trip Class has DIP-switches providing Trip Class selection of 10, 15, 20 or 30 seconds. This ability allows you to closely match the Trip Class with the run-up time of the motor.

Choice of reset options

Most industrial applications usually calls for an overload relay that must be manually reset in the event of a trip. This allows the cause of the overload

to be identified before the motor is restarted. In specialized cases, however, such as rooftop AC units or where restarting the motor will not harm people or equipment, automatic reset may be desired. CEP7-ED1 overload relays are available with Manual Reset exclusively which keeps the cost down. CEP7-EE

models have a selectable dip switch in Manual and Automatic Reset modes.

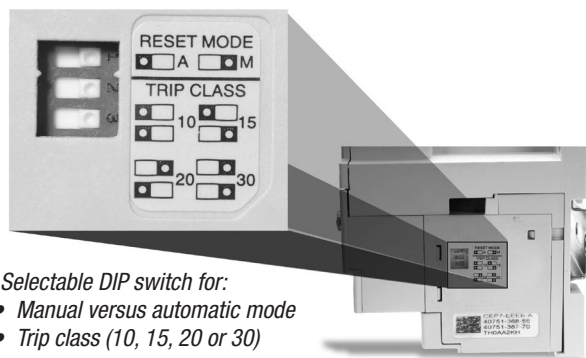

Selectable DIP switch for:
 • Manual versus automatic mode
 • Trip class (10, 15, 20 or 30)

mental debris. The CEP7 has been tested to operate in -20° C. or up to 60° C (140 °F.) and withstand 3G of vibration or 30G of shock on a mount up to an altitude of 2000m or in a jungle at 95% humidity. Reliability under every conceivable environmental condition is a quality built into the design of this second generation of CEP7 electronic overload relay.

Self-powered design means convenience

By developing the power it requires from the applied voltage, the CEP7 is "self-powered," eliminating the need for a separate control power source. This is not the case with some other competitive electronic overload relays. Since the CEP7 is self-powered and a traditional auxiliary contact is used to interface with the contactor, the user can apply the CEP7 the same way as an electromechanical overload. No special connections or control schematic diagram provisions are required in 3-phase applications.

Superior phase failure protection

The CEP7's on-board electronics are constantly monitoring all three phases. If the ASIC board senses that one phase is missing during a steady state running condition on a fully loaded motor, it will trigger in 3 seconds. If a single phase condition is present during starting, the CEP7 will trip within 8 seconds (for a motor >80% loaded). These times are much faster than any thermal bimetallic overload relay. In addition, CEP7 overload relays detect a 50% phase imbalance in the same way as a phase loss.

More robust design

The CEP7 has been re-designed to physically extend to the back-pan therefore aligning the mounting of the overload with the corresponding contactor. Further, the mechanical attachment and direct electrical connection to the contactor has been "beefed-up." This provides for a more robust mounting which means less damage from shipping or during field wire installation. The bipolar latching relay which controls the normally closed trip contacts and normally open alarm circuit contacts have been self-enclosed therefore insulating the electromagnet and shielding against airborne metal particles and other potential environ-

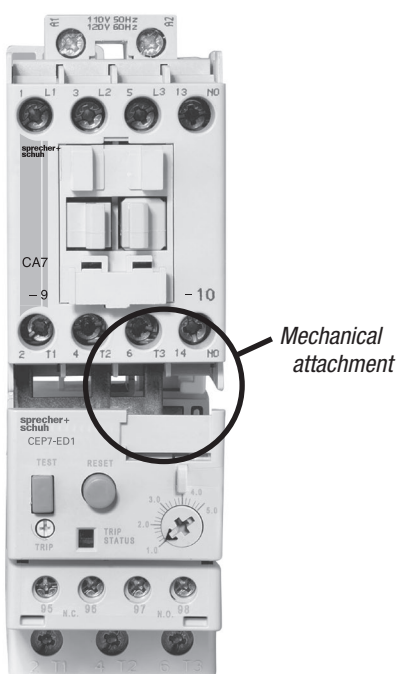

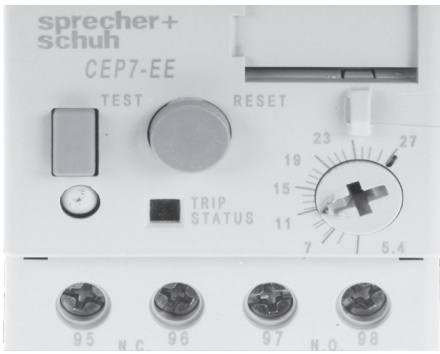

Increased accuracy and improved motor protection

Microelectronics provides flexible and accurate motor overload protection. Unlike traditional overload relays that simulate heat build-up in the motor by passing current through a heater element, CEP7 solid state overload relays measure motor current directly through integrated current transformers. The transformers, in turn, create a magnetic field that induces DC voltage onto the ASIC board. The electronics identify excessive current or loss of phase more accurately, and react to the condition with greater speed and reliability, than traditional overload relays. In addition, CEP7 solid state relays offer setting accuracies from 2.5 – 5% and repeat accuracy of 1%.

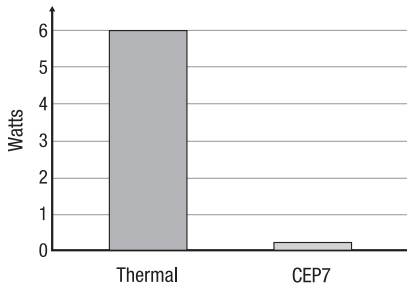

Conventional overload relays dissipate as much as six watts of energy compared with as little as 150 milliwatts for the CEP7

Dramatically lowered energy requirement saves money, reduces panel space

Because traditional overload relays work on the principle of “modeling” the heat generated in the motor (recreating the heat in the bimetal elements or heaters), a significant amount of energy is wasted. In traditional bimetallic overload relays, as many as six watts of heat are dissipated to perform the protective function. Because the CEP7 uses sampling techniques to actually measure the current flowing in the circuit, very little heat is dissipated in the device...as little as 150 milliwatts. This not only reduces the total amount of electrical energy consumed in an application, but it can also have a dramatic impact on the design and layout of control panels. The density of motor starters can be much greater because less heat is generated by each of the individual components. Higher density results in smaller control panels. In addition, special ventilation or air conditioning that might have been required to protect sensitive electronic equipment such as PLC’s can now be reduced or eliminated. CEP7 overload relays dramatically reduced energy requirement saves money and reduces panel space.



Additional Protection with Side Mount Modules



The CEP7 offers a variety of field installable accessories for side mount on the left side. Side mount modules provide additional motor protection functionality traditionally found only on more expensive models. Modules include the following additional features.

- **Remote Reset** provision for reset after trip from a remote pilot device
- **Jam Protection/Remote Reset** provides adjustable Jam set points and trip delay plus remote reset
- **Ground Fault Protection/Remote Reset** combined with ground fault current transformers provide adjustable set points for ground fault trip protection of equipment plus remote reset
- **Ground Fault/Jam Protection/Remote Reset** combines all three features as described above
- **PTC Thermistor Relay/Remote Reset** manages thermistor sensor signals from the motor
- **Network Communication Modules** provide motor diagnostic information via **Profibus** or **Ethernet** communication
 - Two discreet Inputs and one discreet Output
 - Differentiate between various motor protection algorithms
 - Overload and underload warning
 - Jam protection
 - Proactively alert maintenance personnel just before or when a fault occurs
 - Plus remote reset

Directly Mounted CEP7 Solid State Overload Relays, Manual Reset ①②④

Overload Relay	Directly Mounts to Contactor... ②	Adjustment Range (A)	Trip Class 10	
			Catalog Number	Price
Manual Reset for 30 Applications ①				
	CA7-9...CA7-23 CAN7-12, CAN7-16	0.1...0.5	CEP7-ED1AB	77
		0.2...1.0	CEP7-ED1BB	77
		1.0...5.0	CEP7-ED1CB	77
		3.2...16	CEP7-ED1DB	77
		5.4...27	CEP7-ED1EB	77
	CA7-30...CA7-55 CAN7-37, CAN7-43	1.0...5.0	CEP7-ED1CD	123
		3.2...16	CEP7-ED1DD	123
		5.4...27	CEP7-ED1ED	123
		9...45	CEP7-ED1FD	123

Directly Mounted CEP7 Solid State Overload Relays, Automatic/Manual Reset ①②③④

Overload Relay	Directly Mounts to Contactor... ②	Adjustment Range (A)	Adjustable Trip Class 10, 15, 20 & 30	
			Catalog Number	Price
Automatic or Manual Reset for 30 Applications ①				
	CA7-9...CA7-23 CAN7-12, CAN7-16	0.1...0.5	CEP7-EEAB	88
		0.2...1.0	CEP7-EEBB	88
		1.0...5.0	CEP7-EECB	88
		3.2...16	CEP7-EEDB	88
		5.4...27	CEP7-EEEB	88
	CA7-30...CA7-55 CAN7-37, CAN7-43	1.0...5.0	CEP7-EECD	138
		3.2...16	CEP7-EEDD	138
		5.4...27	CEP7-EEED	138
		9...45	CEP7-EEFD	138
	CA7-60...CA7-97 CAN7-85	5.4...27	CEP7-EEEE	158
		9...45	CEP7-EEFE	158
		18...90	CEP7-EEGE	164
		60...120	CEP7-EEVE	164
Automatic or Manual Reset for 10 Applications ①				
	CA7-9...CA7-23 CAN7-12, CAN7-16	1.0...5.0	CEP7S-EEP B	88
		3.2...16	CEP7S-EER B	88
		5.2...27	CEP7S-EES B	88
	CA7-30...CA7-43 CAN7-37, CAN7-43	9...45	CEP7S-EET D	138
	CA7-60...CA7-85 CAN7-85	18...90	CEP7S-EEU E	164

TIP!

Most industrial applications usually call for an overload relay that must be manually reset in the event of a trip. This allows the cause of the overload to be identified before the motor is restarted. An overload relay that resets automatically is generally for specialized, or remote applications, such as rooftop AC units where restarting the motor will not harm people or equipment.

- ① 3-phase CEP7 units are only designed for 30 applications. Single phase CEP7S units are only designed for single phase applications.
- ② This reference is not intended to be a guide for selecting contactors. Size overload relays using the full load current of the motor.
- ③ The reset time of a CEP7 set in the automatic mode is approximately 120 seconds.
- ④ CEP7 overload relays do not work with Variable Frequency Drives, DC Applications or Softstarters with braking options.

Pass-Thru CEP7 Solid State Overload Relays ⑤

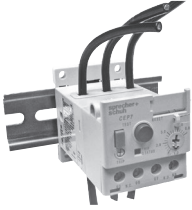
Overload Relay	Separate Mount for use with... ②	Adjustment Range (A)	Trip Class 10	
			Catalog Number	Price
Manual Reset for 3Ø Applications ①④				
 Fig. 1	CA8-09...12 CA7-9...CA7-23 CAN7-12...CAN7-37	1.0...5.0	CEP7-ED1CP	77
		3.2... 16	CEP7-ED1DP	
		5.4...27	CEP7-ED1EP	

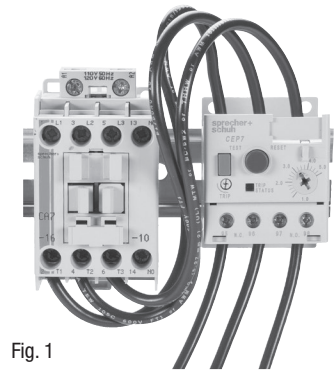

Fig. 1

Overload Relay	Separate Mount for use with... ②	Adjustment Range (A)	Adjustable Trip Class 10, 15, 20 & 30	
			Catalog Number	Price
Automatic or Manual Reset for 3Ø Applications ①③④				
 Fig. 1	CA8-09...12 CA7-9...CA7-23 CAN7-12...CAN7-37	1.0...5.0	CEP7-EECP	88
		3.2... 16	CEP7-EEDP	
		5.4...27	CEP7-EEEP	
Automatic or Manual Reset for 1Ø Applications ①③④				
 Fig. 1	CA8-09...12 CA7-9...CA7-23 CAN7-12...CAN7-37	1.0...5.0	CEP7S-EERP	88
		3.2...16	CEP7S-EERP	
		5.2...27	CEP7S-EESP	



Fig. 2

Pass-thru window

Description

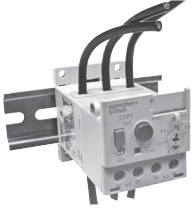
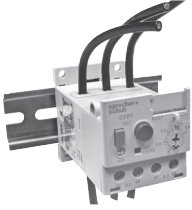
Fig. 1 - The Pass-Thru version of the CEP7 permits separate mounting of the overload relay.

Fig. 2 - Motor load side cables simply pass-thru a window in the overload relay body. The internal current transformers monitor the current flow.

Benefits



- No need for a panel mount adapter as required with direct-connect versions
- Eliminates 3 to 6 wire terminations
- Designed for use with CA8 or CA7 Contactors
- Easily replaces outdated overload relays in existing starter assemblies
- Provides state-of-the-art accuracy and motor protection

① 3-phase CEP7 units are only designed for 3Ø applications. Single phase CEP7S units are only designed for single phase applications.
 ② This reference is not intended to be a guide for selecting contactors. Size overload relays using the full load current of the motor.
 ③ The reset time of a CEP7 set in the automatic mode is approximately 180 seconds.
 ④ CEP7 overload relays do not work with Variable Frequency Drives, DC Applications or Softstarters with braking options.
 ⑤ Pass-Thru windows will accept one power wire up to #10 AWG wire (6mm²).

Large Amp CEP7 Solid State Overload Relays, Automatic and Manual Reset ①②③④⑥

Overload Relay	Directly Mounts to Contactor... ②	CT Ratio	Adjustment Range (A)	Selectable Trip Class (10,15,20 & 30)	
				Catalog Number	Price
Automatic or Manual Reset for 3Ø Applications ①③					
 <p>CEP7-EEHF</p>	CA6-115...CA6-180 CA6-115-EI...CA6-180-EI CAN6-180(EI)	150:5	30...150	CEP7-EEHF	508
		200:5	40...200	CEP7-EEJF	508
	CA6-210-EI...CA6-420-EI CAN6-300-EI	200:5	40...200	CEP7-EEJG	888
		300:5	60...300	CEP7-EEKG	888
	CA6-630-EI...CA6-860-EI	500:5	100...500	CEP7-EELG	888
		600:5	120...600	CEP7-EEMH	1397
	800:5	160...800	CEP7-EENH	1397	

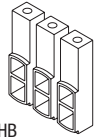
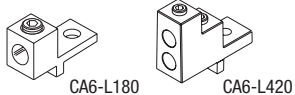
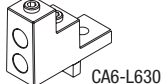
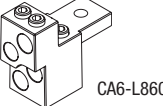



Load Side Lugs & Accessories

Lug or Accessory	Description	For Use With...	Catalog Number	Price
 <p>CA6-HB</p>	Main Terminal Set, ⑤ Dual Conductor, Touch Safe <ul style="list-style-type: none"> Accommodation for dual connections to each pole Accepts flat or round conductors Touch safe to IP20 according to IEC 60529 Eliminates need for Terminal Shields (price as complete set, containing 2 blocks, 6 lugs) 	CEP7-EEHF CEP7-EEJF	CA6-HB2	See page A99
		CEP7-EEJG CEP7-EEKG CEP7-EELG	CA6-HB3	
 <p>CA6-L180 CA6-L420</p>	Screw Type Lugs - <ul style="list-style-type: none"> Accepts round conductors only Copper construction (set of 3 lugs) 	CEP7-EEHF CEP7-EEJF	CA6-L180	
		CEP7-EEJG CEP7-EEKG CEP7-EELG	CA6-L420	
 <p>CA6-L630</p>	Screw Type Lugs - <ul style="list-style-type: none"> Accommodation for dual connections to each pole Copper construction accepts round conductors only (set of 3 lugs) 	CEP7-EEMH CEP7-EENH	CA6-L630	
 <p>CA6-L860</p>		CEP7-EEMH CEP7-EENH	CA6-L860	
	Main Terminal Cover - ⑥ <ul style="list-style-type: none"> CA6 touch protection Line or load (price each) IP20; IEC60529 & DIN 40 050 protection 	CA6-115(-EI) to 180(-EI) CA6-210-EI to 420-EI CA6-630-EI to 860-EI	CA6-TC180 CA6-TC420 CA6-TC860	See page A101

- ① 3-phase CEP7 units are only designed for 3Ø applications.
- ② This reference is not intended to be a guide for selecting contactors. Size overload relays using the full load current of the motor.
- ③ The reset time of a CEP7 set in the automatic mode is approximately 180 seconds.
- ④ CEP7 Overload relays do not work with Variable Frequency Drives or any Sprecher + Schuh Softstarter with braking options.
- ⑤ Terminal covers not necessary when using CA6-HB-__ insulated lugs.
- ⑥ CEP7-EEHF...CEP7-EENH include current transformers used to monitor high amperage.

Accessories - CEP7 Side Mount Modules ①②



B
CEP7 Overloads

Accessory	Description	For use with...	Catalog Number	Price																				
 CEP7-ERR	Remote Reset Module (Series B) <ul style="list-style-type: none"> Dip switch adjustable reset mode & type <ul style="list-style-type: none"> - Automatic or Manual reset mode - 1- or 3-Phase relay type operation Provision for reset after trip from remote pilot device 	Side-mount to any CEP7-EE_ CEP7S-EE_	CEP7-ERR	100																				
 CEP7-EJM	Jam Protection and Remote Reset Module ③ <ul style="list-style-type: none"> Dip switch adjustable Jam Protection <ul style="list-style-type: none"> - Jam set points -150%, 200%, 300%, or 400% FLA - Trip delay- 0.5, 1, 2, or 4 sec. Provision for reset after trip from remote pilot device 		CEP7-EJM	110																				
 CEP7-EPT	PTC Thermistor Relay and Remote Reset Module <ul style="list-style-type: none"> PTC Protection and LED Status indication <table border="0" style="margin-left: 20px;"> <tr> <td>Type of Control Unit</td> <td>Mark A</td> </tr> <tr> <td>Number of Sensors</td> <td>6</td> </tr> <tr> <td>Maximum Cold Resistance of Sensor Chain</td> <td>1500 Ω</td> </tr> <tr> <td>Trip Resistance</td> <td>3400 Ω ± 150 Ω</td> </tr> <tr> <td>Reset Resistance</td> <td>1600 Ω ± 50 Ω</td> </tr> <tr> <td>Short Circuit Trip Resistance</td> <td>25 Ω ± 10 Ω</td> </tr> <tr> <td>Open Circuit Trip Resistance</td> <td>> 20,000 Ω</td> </tr> <tr> <td>Maximum Voltage at 1T1 / 1T2 (R_{ptc}=4kΩ)</td> <td>< 7.5 Vdc</td> </tr> <tr> <td>Maximum Voltage at 1T1 / 1T2 (R_{ptc}=open)</td> <td>< 30 Vdc</td> </tr> <tr> <td>PTC Response Time</td> <td>500ms...800ms</td> </tr> </table> Provision for reset after trip from remote pilot device 	Type of Control Unit	Mark A	Number of Sensors	6	Maximum Cold Resistance of Sensor Chain	1500 Ω	Trip Resistance	3400 Ω ± 150 Ω	Reset Resistance	1600 Ω ± 50 Ω	Short Circuit Trip Resistance	25 Ω ± 10 Ω	Open Circuit Trip Resistance	> 20,000 Ω	Maximum Voltage at 1T1 / 1T2 (R _{ptc} =4kΩ)	< 7.5 Vdc	Maximum Voltage at 1T1 / 1T2 (R _{ptc} =open)	< 30 Vdc	PTC Response Time	500ms...800ms	Side-mount to any CEP7-EE_ CEP7S-EE_	CEP7-EPT	125
Type of Control Unit	Mark A																							
Number of Sensors	6																							
Maximum Cold Resistance of Sensor Chain	1500 Ω																							
Trip Resistance	3400 Ω ± 150 Ω																							
Reset Resistance	1600 Ω ± 50 Ω																							
Short Circuit Trip Resistance	25 Ω ± 10 Ω																							
Open Circuit Trip Resistance	> 20,000 Ω																							
Maximum Voltage at 1T1 / 1T2 (R _{ptc} =4kΩ)	< 7.5 Vdc																							
Maximum Voltage at 1T1 / 1T2 (R _{ptc} =open)	< 30 Vdc																							
PTC Response Time	500ms...800ms																							
 PROFIBUS CEP7-EPRB	Network Communication Modules <ul style="list-style-type: none"> Delivers direct access to motor performance and diagnostic data on a field bus based network in addition to seamless control Includes integrated I/O <ul style="list-style-type: none"> 2 inputs 1 output Operational and diagnostic data <ul style="list-style-type: none"> Average motor current Percentage of thermal capacity usage Device status Trip and warning identification Trip history (last five trips) Protective functions <ul style="list-style-type: none"> Overload warning <ul style="list-style-type: none"> - 1...100% TCU Jam protection; <ul style="list-style-type: none"> - Trip setting 150...600% FLA - Trip delay 0.5...25 seconds - Warning setting 100...600% FLA Underload warning <ul style="list-style-type: none"> - 20...100% FLA 	Side-mount to any CEP7-EE_ CEP7S-EE_	CEP7-EPRB	415																				
 ETHERNET/IP CEP7-ETN			CEP7-ETN	422																				

① Side mount modules must have 24 - 240V, 47 - 63HZ or DC applied to terminals A1 and A2 for control power. CEP7-EPRB and CEP7-ETN require 20.4 - 26.4 VDC only. See B18 for more information.

② See Technical Data, Wiring, and DIP Switch set up starting on page B16
 ③ Dynamic inhibit: Protective function is enabled after the motor current goes above 150% and then falls below 125%.

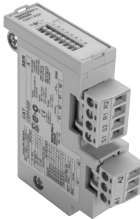
Accessories - CEP7 Side Mount Modules ①③

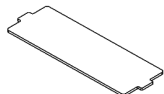
Accessory	Description	For use with...	Catalog Number	Price
 CEP7-EGF	Ground Fault Protection and Remote Reset Module ②⑥• Dip switch adjustable Ground Fault Protection > GF Current range set points - 20...100ma - 100...500mA - 0.2...1.0A - 1.0...5.0A > GF Trip level 20%-100% • LED status indication • Provision for reset after trip from remote pilot device	Side-mount to any CEP7-EE_ CEP7S-EE_	CEP7-EGF	110
 CEP7-EGJ	Ground Fault/Jam Protection and Remote Reset Module ②⑥ • Dip switch adjustable Ground Fault Protection same as CEP7-EGF shown above. • Jam trip when the motor current exceeds 400% FLA setting when enabled. • LED status indication • Provision for reset after trip from remote pilot device	Must use with CEP7-CBCT_ Current Sensor	CEP7-EGJ	145
	Adjustment Cover for External Modules	All modules with DIP Switches	CEP7-EMC	13



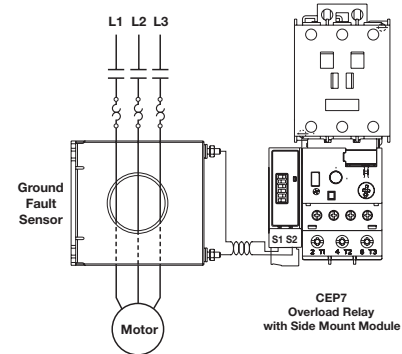

CEP7 Ground Fault Sensor Installation

Ground Fault Sensor Control Wiring



CEP7 Ground Fault Sensor Selection ③

Ground fault current is sensed by passing all lines carrying current to and from a motor through the window of a special current transformer called a ground fault sensor. If all the current to the motor returns through the lines in the sensor window, no significant current will be induced in the sensor secondary. If, however, ground fault current returns via a path external to the sensor, such as via the conduit walls, a current will be induced in the sensor secondary. This current will be sensed and amplified by solid state circuits. If the ground fault current is larger than the selected ground fault trip level of the overload relay, the overload relay will trip.

Sensor Type	Maximum Current	Frequency	Turns Ratio	Sensor Window I.D. 	Maximum Recommended Cable Size	For use with CEP7-EGF and CEP7-EGJ and contactor...	Catalog Number	Price
	45A	50/60 Hz	1000:1	19.1mm (0.75 in.)	8 AWG @ 600V ④	CA7-9...CA7-37	CEP7-CBCT1	50
	90A	50/60 Hz	1000:1	39.6mm (1.56 in.)	2 AWG @ 600V ④	CA7-9...CA7-85	CEP7-CBCT2	175
	180A	50/60 Hz	1000:1	63.5 mm (2.50 in.)	250MCM (120mm ²) @ 600V ④	CA7-9...CA6-180	CEP7-CBCT3	226
	420A	50/60 Hz	1000:1	82.3 mm (3.25 in.)	350MCM (185mm ²) @ 600V ⑤	CA7-9...CA6-420	CEP7-CBCT4	287

① Side mount modules must have 24 - 240V, 47 - 63HZ or DC applied to terminals A1 and A2 for control power. See B18 for more information.

② ATTENTION: The CEP7 Overload relay is not a ground fault circuit interrupter for personnel protection as defined in Article 100 of the NEC.

③ See Application Details on page B16-B18

④ For a three phase system with one cable per phase.

⑤ For a three phase system with two cables per phase.

⑥ Dynamic inhibit: Protective function is enabled after the motor current goes above 150% and then falls below 125%.

Accessories

B
CEP7 Overloads

Accessory	Description	For use with...	Catalog Number	Price
	Remote Indication Display "Intellibutton" ④ Connects, communicates, and receives power from CEP7 Side Mount Modules to remotely view status of CEP7-EE Overload Relays 	CEP7-EJM CEP7-EGF CEP7-EGJ CEP7-EPT CEP7-ERR	CEP7-ERID	100
	Replacement Parts Kit for CEP7-ERID Includes (1) each Mounting Ring (Plastic), Terminal Block Plug, and L.E.D. Fault Code Label	CEP7-ERID	CEP7-NCRID	27
	DIN-rail / Panel Adaptor For separate mounting of overload relay to back pan or top hat DIN-rail	CEP7-ED1...B CEP7(S)-EE...B	CEP7-EPB	29
		CEP7-ED1..D CEP7(S)-EE...D	CEP7-EPD	29
		CEP7(S)-EE...E	CEP7-EPE	35
	Current Adjustment Shield Prevents inadvertent adjustment of the current setting	all CEP7-ED1 CEP7-EE	CEP7-BC8	13
	Solenoid Remote Reset ⑤ - For remote resetting of the solid state overload relay. Replace * in Catalog Number with Coil Code.	CEP7 all	CEP7-EMR*	81
	External Reset Button Used for manually resetting overloads mounted in enclosures	all CEP7	Use D7 Reset - See Section H.	~
	External Reset Button Adaptor Provides a larger "target area" for resetting the overload relay when using an External Reset Button	CEP7-ED1(all), CEP7-EE_B, CEP7-EE_D, CEP7-EE_E, CEP7-EE_P ①	CEP7-ERA	14

Solenoid Remote Reset Coil Codes

(Replace * with coil code below)

A.C. Coil Code	Voltage Range 50 / 60 Hz ④
J	24V
D	120V
A	240V

D.C. Coil Code	Voltage ⑤
Z24	24VDC
Z48	48VDC
Z01	115VDC

① At the time of this printing CEP7-ERA does not fit CEP7-EE(HF...HH) without removing the CEP7 cover.



② Solenoid Reset Modules only mount on CEP7 Series C or later.

③ See page B21 for additional details on installation and LED functions.

④ Coil consumption of AC coils is 8VA.









⑤ Coil consumption of DC coils is 12 watts.







CEP7 Intelli-button Reset Kit with Side Mount Module (For use on CEP7(S)-EE_)

Accessory	Description	Kit includes...	Catalog Number	Price
	Remote Reset Only	CEP7-ERID CEP7-ERR	CEP7-IB1	200
	Jam and Remote Reset	CEP7-ERID CEP7-EJM (B)	CEP7-IB2	210
	Thermistor Relay and Remote Reset	CEP7-ERID CEP7-EPT	CEP7-IB3	225
	Ground Fault and Remote Reset	CEP7-ERID CEP7-EGF CEP7-CBCT1 (45A)	CEP7-IB4	260
		CEP7-ERID CEP7-EGF CEP7-CBCT2 (90A)	CEP7-IB5	385
		CEP7-ERID CEP7-EGF CEP7-CBCT3 (180A)	CEP7-IB6	436
		CEP7-ERID CEP7-EGF CEP7-CBCT4 (420A)	CEP7-IB7	497
	Ground Fault and Jam and Remote Reset Module	CEP7-ERID CEP7-EGJ CEP7-CBCT1 (45A)	CEP7-IB8	295
		CEP7-ERID CEP7-EGJ CEP7-CBCT2 (90A)	CEP7-IB9	420
		CEP7-ERID CEP7-EGJ CEP7-CBCT3 (180A)	CEP7-IB10	471
		CEP7-ERID CEP7-EGJ CEP7-CBCT4 (420A)	CEP7-IB11	532

Technical Information

B
CEP7 Overloads

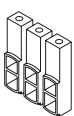
		CEP7-ED1...B CEP7(S)-EE...B	CEP7-ED1...D CEP7(S)-EE...D	CEP7(S)-EE...E
Rated Insulation Voltage - U_i		[V]	690 AC	
Rated Insulation Strength- U_{imp}		[kV]	6 AC	
Rated Operation Voltage - U_e		[V]	690 AC (IEC) / 600 AC (UL/CSA)	
Rated Operating Frequency		[Hz]	50/60	
Terminal Cross Sections				
Terminal Type				
Terminal Screw		M5	M5	M8
	One conductor	[mm ²]	1 x (2.5...16)	1 x (2.5...16)
	Torque	[Nm]	2.5	2.5
	Two conductors	[mm ²]	2 x (2.5...10) ①	2 x (2.5...10) ①
	Torque	[Nm]	3.4	3.4
	One conductor	[mm ²]	1 x (2.5...25)	1 x (2.5...25)
	Torque	[Nm]	2.5	2.5
	Two conductors	[mm ²]	2 x (6...16) ①	2 x (6...16) ①
	Torque	[Nm]	3.4	3.4
	One conductor	[AWG]	1 x (14...6)	1 x (14...6)
	Torque	[lb-in]	22	22
	Two conductors	[AWG]	2 x (14...6) ①	2 x (14...6) ①
	Torque	[lb-in]	30	30
Poizdrive Screwdriver Size			2	2
Slotted screwdriver		[mm]	1 x 6	1 x 6
Hexagon Socket Size		[mm]	---	---

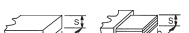
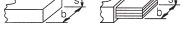
		CEP7-EE_F	CEP7-EE_G	CEP7-EE_H
Rated Insulation Voltage - U_i		[V]	1000 AC	
Rated Insulation Strength- U_{imp}		[kV]	6 AC	
Rated Operation Voltage - U_e		[V]	1000 AC (IEC) / 600 AC (UL/CSA)	
Rated Operating Frequency		[Hz]	50/60	
Terminal Power				
Type				
Direct Connection 		Hexagonal Bolt	Hexagonal Bolt	Hexagonal Bolt
Recommended Torque		[Nm]	M8 x 25	M10 x 30
		[lb-in]	11	43
			100	380
				68
				600
With Main Terminal Set (CA6...HB...)		With CA6-HB2	With CA6-HB3	
	sm. opening	[mm ²]	16...50	25...240
	lg. opening	[mm ²]	16...120	25...240
	sm. opening	[mm ²]	16...50	25...240
	lg. opening	[mm ²]	16...120	25...240
	b max.	[mm]	20	25
	s. sm. opening	[mm]	3...9	6...20
	lg. opening	[mm]	3...14	6...20
	Recommended Torque	[Nm]	10...12	20...25
Wire size per UL/CSA	sm. opening	[AWG]	#6...1 / 0	#4...600MCM
	lg. opening	[AWG]	#6...250MCM	#4...600MCM
Recommended Torque		[lb-in]	90...110	180...220
With Screw-type Lugs - Copper Clad (CA6-L...)				W/CEP7-EEMH W/CEP7-EEHH
CA6-L180		[AWG]	#6...250 MCM	~
Recommended Torque		[lb-in]	90...110	~
CA6-L420		[AWG]	~	#2...350 MCM
Recommended Torque		[lb-in]	~	375
CA6-L630		[AWG]	~	2/0...500 MCM
Recommended Torque		[lb-in]	~	400
CA6-L860		[AWG]	~	~
Recommended Torque		[lb-in]	~	2/0...500 MCM
				400

① For multiple conductor applications the same style and size of wire must be used.

Technical Information



Control Circuit			
Rated Insulation Voltage - U_i	[V]		690 AC
Rated Insulation Strength- U_{imp}	[kV]		6 AC
Rated Operation Voltage - U_e	[V]		690 AC (IEC) / 690 AC (UL/CSA)
Rated Designation			B600
Rated Operating Current			NO NC
AC-15	12...120V	[A]	3 2
	220...240V	[A]	1.5 1.5
	380...480V	[A]	0.75 0.75
	500...600V	[A]	0.6 0.6
DC-13 at L/R 15ms	24V	[A]	1.1 1.1
	110V	[A]	0.4 0.4
	220V	[A]	0.2 0.2
	440V	[A]	0.08 0.08
Thermal Current - I_{the}	[A]		5
Contact Reliability	[kV]		17V, 5mA
Screw Terminal Cross Sections			
Terminal Screw			M3
 Flexible with wire end ferrule	One conductor	[mm ²]	1 x (0.5...2.5)
	Torque	[Nm]	0.55
	Two Conductors	[mm ²]	2 x (0.25...1.5)
	Torque	[Nm]	0.55
 Course stranded / solid	One conductor	[mm ²]	1 x (0.5...4)
	Torque	[Nm]	0.55
	Two conductors	[mm ²]	2 x (0.22...2.5)
	Torque	[Nm]	0.55
 Stranded / Solid	One conductor	[AWG]	1 x (24...10)
	Torque	[lb-in]	5
	Two conductors	[AWG]	2 x (24...12)
	Torque	[lb-in]	5
Poizdrive Screwdriver Size			#1
Slotted Screwdriver Size			[mm] 0.6 x 3.5

Table for using Current Transformers with CEP7-EECB (range 1.0...5.0 amps) overload relay

Current Setting	CT Ratio 150:5 Equivalent FLA	CT Ratio 200:5 Equivalent FLA	CT Ratio 300:5 Equivalent FLA	CT Ratio 500:5 Equivalent FLA	CT Ratio 600:5 Equivalent FLA	CT Ratio 800:5 Equivalent FLA	CT Ratio 1000:5 Equivalent FLA	CT Ratio 1500:5 Equivalent FLA
1.00	30	40	60	100	120	160	200	300
1.25	38	50	75	125	150	200	250	375
1.50	45	60	90	150	180	240	300	450
1.75	53	70	105	175	210	280	350	525
2.00	60	80	120	200	240	320	400	600
2.25	68	90	135	225	270	360	450	675
2.50	75	100	150	250	300	400	500	750
2.75	83	110	165	275	330	440	550	825
3.00	90	120	180	300	360	480	600	900
3.25	98	130	195	325	390	520	650	975
3.50	105	140	210	350	420	560	700	1050
3.75	113	150	225	375	450	600	750	1125
4.00	120	160	240	400	480	640	800	1200

Technical Information

Environmental Ratings

Ambient Temperature	Storage	[°C]	-40...+85 (-40...+185 °F)
	Operating	[°C]	-20...+60 (-4...+140 °F)
Humidity	Operating	[%]	5...95, non-condensing
	Damp Heat		per IEC 68-2-3 and IEC 68-2-30
Vibration (per IEC 68-2-6)		[G]	3
Shock (per IEC 68-2-27)		[G]	30
Maximum Altitude		[m]	2000
Pollution Environment			Pollution Degree 3
Degree of Protection			IP20
Type of Relay			Ambient compensated, time delay, phase loss sensitive
Nature of Relay			Solid-state
Trip Rating			120% FLA
Trip Class	Type ED		10
	Type EE		10, 15, 20, 30
Reset Mode	Type ED		Manual
	Type EE		Manual or Automatic

Electromagnetic Compatibility

Electrostatic Discharge Immunity	Test Level	[kV]	8kV air discharge 6kV contact discharge
	Performance Level		1 1 2
RF Immunity	Test Level	[V/m]	10 V/m
	Performance Level		1 1 2
Electrical Fast Transient Burst Immunity	Test Level	[kV]	4 kV
	Performance Level		1 1 2
Surge Immunity	Test Level	[V/m]	2 kV (L-E) 1 kV (L-L)
	Performance Level		1 1 2

General

Standards	UL 508, CSA C22.2 No. 14, NEMA (ICS 2-1993 Part 4, EN 60947-4-1, EN 60947-5-1		
Approvals	CE, cULus, C-Tick, CCC		
	CEP7-ED1...B CEP7(S)-EE...B	CEP7-ED1...D CEP7(S)-EE...D	CEP7(S)-EE...E
Weights (unpackaged)	[Kg]	0.25	0.52
	[Lb]	0.55	1.06

Wiring Diagrams

Typical Wiring
for Single Phase Applications

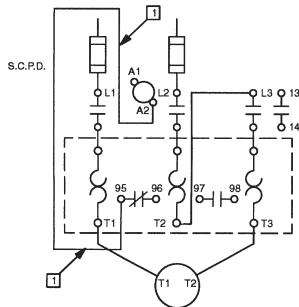

CEP7 Single Phase Overload Relay
Must be connected as shown in Fig. 1 or 2 only.

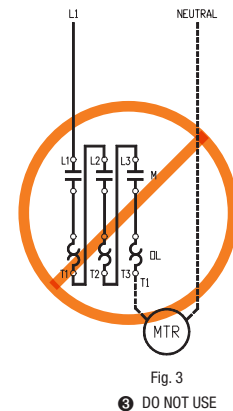
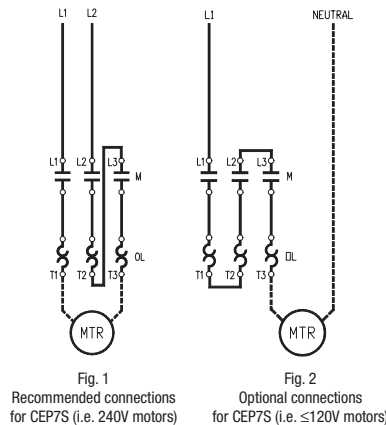

- ❶ Performance Criteria 1 requires the DUT to experience no degradation or loss of performance.
- ❷ Environment 2.
- ❸ If the CEP7S is connected as shown in Fig. 3 the overload will not trip! The CEP7S contains an electronic circuit board that is self powered. If connected as shown in Fig. 3, the CEP7S circuit board will not power up and the CEP7S would not trip.
- ❹ Connecting a CEP7S in this manner powers the electronic circuit board. Connecting a 3-phase CEP7 in this manner to handle 1-phase will NOT work.

Technical Information

Trip Curves ①

B
CEP7 Overloads

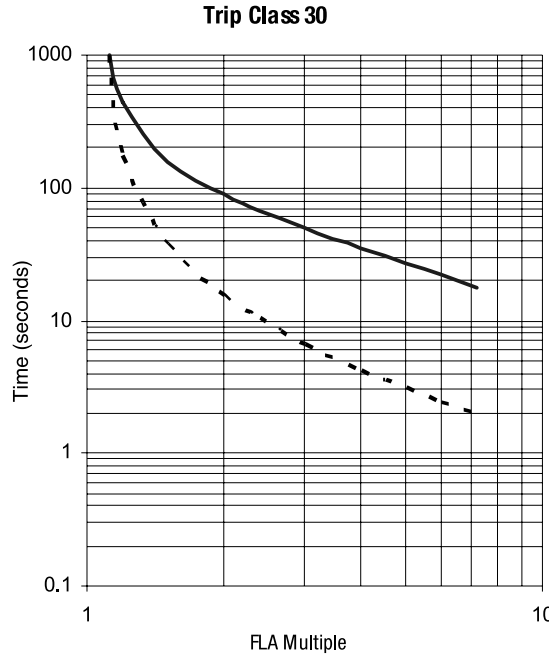
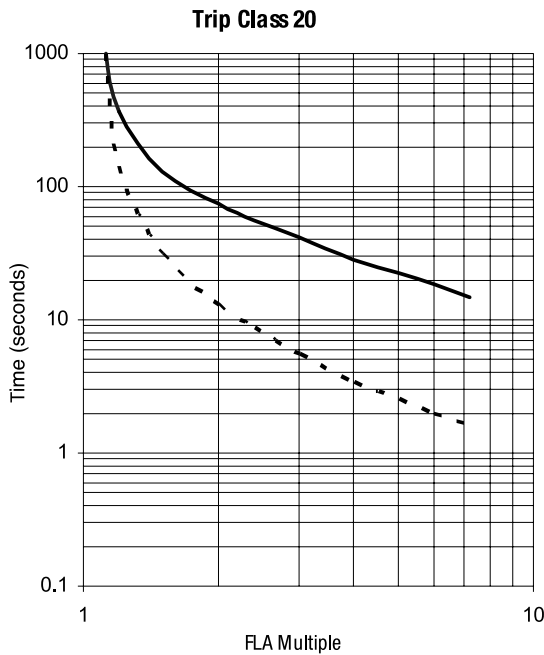
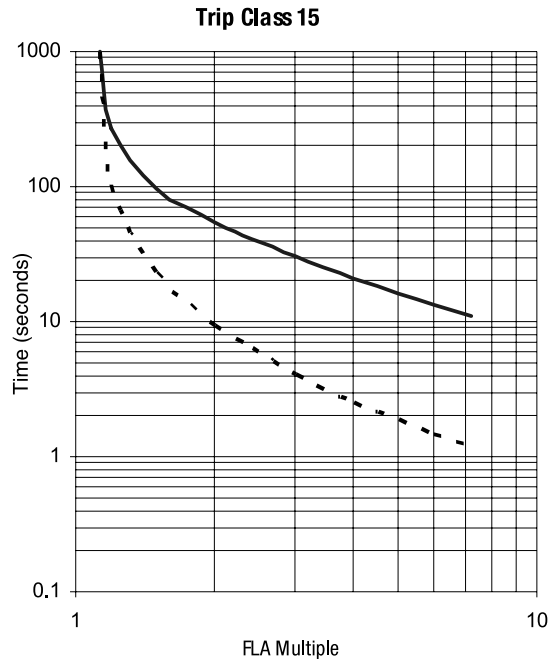
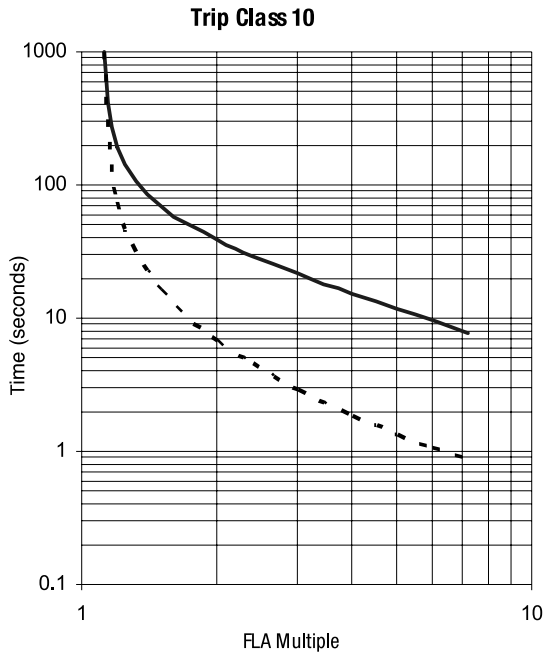

Trip Curve Legend
 Cold Trip ———
 Hot Trip - - - - -

① Typical reset time for CEP7 Second Generation devices set to "automatic reset" mode is 120 seconds.

CEP7-ERR & CEP7-EJM Wiring Diagrams

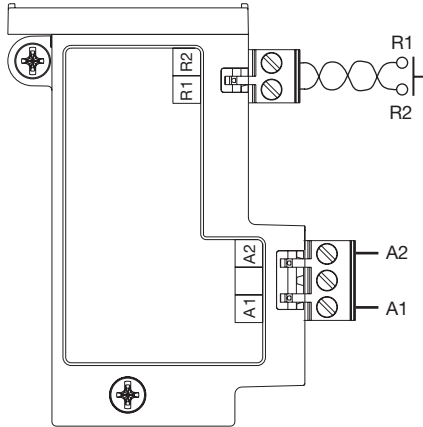

- Apply 24 - 240V, 47 - 63HZ or DC to terminals A1 and A2 for control power.
- Connect remote reset pilot device to Terminals R1 and R2.

CEP7-ERR Operational LED

Status LED:
Steady Green- Module is powered up.

CEP7-ERR Dip Switch

Series B Adjustment Settings

Overload Relay Remote Reset		
SW1	Manual: 1	Automatic: 0

Overload Relay Type		
SW2	3 Phase: 1	1 Phase: 0
SW3	Not Used	

CEP7-EJM Operational LED

Status LED:
Green flash- module powered
Green solid- module powered plus motor current present
Red flash- warning: Fault detected and CEP7 preparing to trip.
Red solid- hardware fault: Internal hardware fault detected and CEP7 trip attempted. Recover fault by cycling supply voltage.

CEP7-EJM Dip Switch

Adjustment Settings

Overload Relay Reset Mode			
SW1	Manual: 1	Automatic: 0	
Jam Trip Delay			
	SW 2	SW 3	SW 4
0.1 sec	0	0	0
0.5 sec	0	0	1
1 sec	0	1	0
2 sec	0	1	1
3 sec	1	0	0
4 sec	1	0	1
5 sec	1	1	0
10 sec	1	1	1
Jam Trip Level			
	SW 5	SW 6	SW 7
Disable / OFF	0	0	0
100% FLA	0	0	1
125% FLA	0	1	0
150% FLA	0	1	1
200% FLA	1	0	0
300% FLA	1	0	1
400% FLA	1	1	0
600% FLA	1	1	1
SW8 3 Phase: 1 1 Phase: 0			

CEP7-EPT Wiring Diagrams

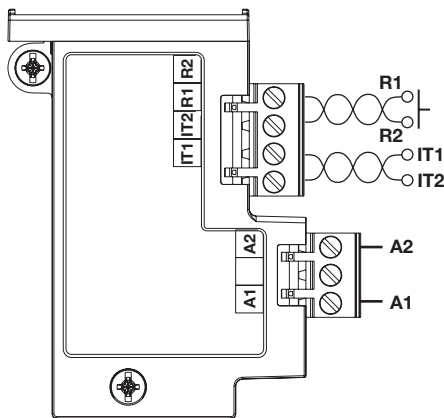

- Apply 24 - 240V, 47 - 63HZ or DC to terminals A1 and A2 for control power.
- Connect remote reset pilot device to Terminals R1 and R2
- Connect Terminal IT1 and IT2 to PTC Chain

CEP7-EPT Operational LED

Status LED:
Steady Green - Module is powered up
Flashing LED - The number of flashes followed by a pause identifies the specific trip code as follows:
(1) Flash - overload trip
(2) Flash - phase loss trip
(3) Flash - PTC trip
(4) Flash - PTC open circuit
(5) Flash - PTC short circuit
Fast Flash - Impending trip. PTC Thermistor fault detected and CEP7 not yet capable of tripping.
Steady Red - Hardware fault. Internal hardware fault detected and CEP7 trip attempted.

CEP7-EPT Dip Switch

Adjustment Settings

Overload Relay and PTC Reset Mode		
SW1	Manual: 1	Automatic: 0

PTC Protection		
SW2	Enable: 1	Disable: 0

Overload Relay Type		
SW3	3 Phase: 1	1 Phase: 0

① Dynamic inhibit: Protective function is enabled after the motor current goes above 150% and then falls below 125%.

② The delay between the occurrence of a PTC out-of-range fault and a trip of the CEP7 varies, but is generally described by one of the following: a) 500 ms ± 250 ms, typical; or b) < 6 seconds, for a PTC out-of-range fault present at power-up of the side mount module. Under no conditions should a PTC trip take longer than 6 seconds.

CEP7-EGF & CEP7-EGJ Wiring Diagrams ①

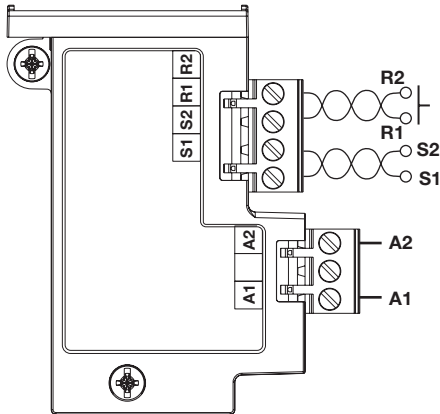

- Apply 24 - 240V, 47 - 63HZ or DC to terminals A1 and A2 for control power.
- Connect remote reset pilot device to Terminals R1 and R2
- Connect current sensor to Terminal S1 and S2

CEP7-EGF Operational LED

Status LED:
Steady Green - Module is powered up.
Flashing LED - The number of flashes followed by a pause identifies the specific trip code as follows:
(1) Flash - overload trip
(2) Flash - phase loss trip
(3) Flash - ground fault trip
Fast Flash - Impending trip Ground fault detected and CEP7 not yet capable of tripping.
Steady Red - Hardware fault. Internal hardware fault detected and CEP7 trip attempted.

CEP7-EGF Dip Switch

Adjustment Settings			
Overload Relay Reset Mode			
SW1	Manual: I	Automatic: 0	
Ground Fault Current Range			
	SW 2	SW3	
20...100mA	0	0	
100...500mA	0	I	
0.2...1.0A	I	0	
1.0...5.0A	I	I	
Ground Fault Trip Level			
	SW 4	SW 5	SW 6
Disable/Off	0	0	0
20% Max GF Current	0	0	I
35% Max GF Current	0	I	0
50% Max GF Current	0	I	I
65% Max GF Current	I	0	0
80% Max GF Current	I	0	I
90% Max GF Current	I	I	0
100% Max GF Current	I	I	I
Overload Relay Type			
SW7	3 Phase: I	1Phase: 0	
SW8	Not Used		

CEP7-EGF & CEP7-EGJ Installation ①

Ground Fault Sensor Control Wiring

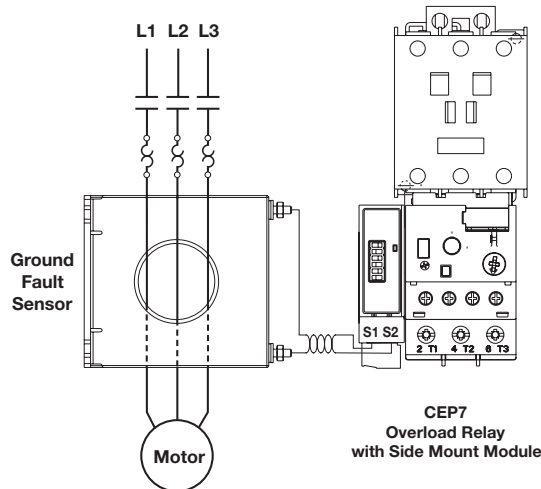

CEP7-EGJ Operational LED

Status LED:
Steady Green - Module is powered up.
Flashing LED - The number of flashes followed by a pause identifies the specific trip code as follows:
(1) Flash - overload trip
(2) Flash - phase loss trip
(3) Flash - ground fault trip
(4) Flash - jam trip
Fast Flash - Impending trip Ground fault detected and CEP7 not yet capable of tripping.
Steady Red - Hardware fault. Internal hardware fault detected and CEP7 trip attempted.

CEP7-EGJ Dip Switch

Adjustment Settings			
Overload Relay Reset Mode			
SW1	Manual: I	Automatic: 0	
Ground Fault Current Range			
	SW 2	SW3	
20...100mA	0	0	
100...500mA	0	I	
0.2...1.0A	I	0	
1.0...5.0A	I	I	
Ground Fault Trip Level			
	SW 4	SW 5	SW 6
Disable/Off	0	0	0
20% Max GF Current	0	0	I
35% Max GF Current	0	I	0
50% Max GF Current	0	I	I
65% Max GF Current	I	0	0
80% Max GF Current	I	0	I
90% Max GF Current	I	I	0
100% Max GF Current	I	I	I
Overload Relay Type			
SW7	3 Phase: I	1Phase: 0	
Jam Protection			
SW8	Enable: I	Disable: 0	

① Dynamic inhibit: Protective function is enabled after the motor current goes above 150% and then falls below 125%.

Electrical Data

Power Supply Ratings:

Rated Supply Voltage	<i>Us</i>	24V DC
Rated Operating Range	<i>Ue</i>	20.4 - 26.4
Rated Supply Current	<i>Ie</i>	0.1 A
Maximum Surge Current at Power-Up		2.5 A
Maximum Power Consumption		2.5...2.7 W

Output Relay Ratings:

Terminals		
OUT A:		13/14
Type of Contacts		Form A SPST - NO
Rated Thermal Current	<i>I_{the}</i>	5 A
Rated Insulation Voltage	<i>Ui</i>	300V AC
Rated Operating Voltage	<i>Ue</i>	240V AC
Rated Operating Current	<i>Ie</i>	3 A (at 120V AC), 1.5 A (at 240V AC) 0.25 A (at 110V DC), 0.1 A (at 220V DC)
Minimum Operating Current		10 mA at 5V DC
Rating Designation		B300
Utilization Category		AC-15
Resistive Load Rating (p.f.=1.0)		5 A, 250V DC
Inductive Load Rating (p.f.=0.4), (L/R=7 ms)		2 A, 250V AC
Short Circuit Current Rating		1,000 A
Recommended Control Circuit Fuse		KTK-R-6 (6 A, 600V)

Input Ratings:

Terminals		
IN1:		1
IN2:		2
SSV (Sensor Supply Voltage)		3
Supply Voltage (Provided my module)		20.4 - 26.4V DC
Type of Inputs		Current Sinking

Jam Protection:

Trip Level		150...600% FLA
Trip Delay		0.1...25.0 sec.
Inhibit		0...250 sec.

Standards:

		UL 508
		CSA 22.2, No. 14
		EN 60947-

Mechanical Data

Ambient Temperature	<i>T_{amb}</i>	
Storage		-40...+85°C (-40...+185°F)
Operating (Open)		-20...+60°C (-4...+140°F)
Operating (Enclosed)		-20...+40°C (-4...+104°F)
Humidity		
Operating		5...95% non-condensing
Damp Heat - Steady State		per IEC 68-2-3
Damp Heat - Cyclic		per IEC 68-2-30
Maximum Altitude		2000 m
Degree of Protection		IP20

PROFIBUS Communication

Baud Rate		9.6 k, 19.2 k, 45.45 k, 93.75 k, 187.5 k, 500 k, 1.5 M, 3 M, 6 M, 12 M
Auto-Baud Rate identification		Yes
DP-V0 (Cyclic data exchange)		Yes
DP-V1 (Acyclic services)		Yes
DP-V2 (Acyclic services)		No
Set Slave Address (SSA) support		Yes

CEP7-EPRB Wiring Diagram

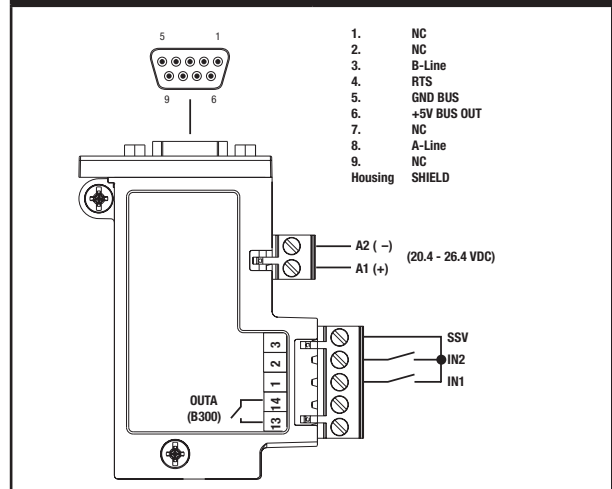

ETHERNET Communication

TCP Connection		150
CIP Connection		40
CIP Unconnected Messages		128
I/O Packet Rates		500/s
Explicit Packet Rates		500/s
Speed Duplex (Half/Full)		10/100
Duplicate IP Detection		Yes

CEP7-ETN Wiring Diagram

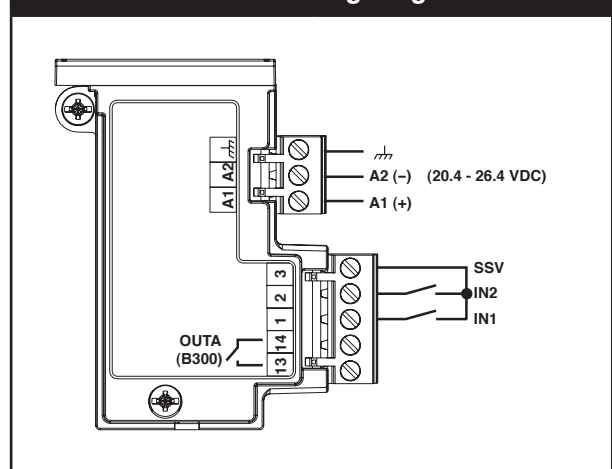

CEP7-CBCT Installation

Dimensions are in millimeters (inches). Dimensions not intended for manufacturing purposes.

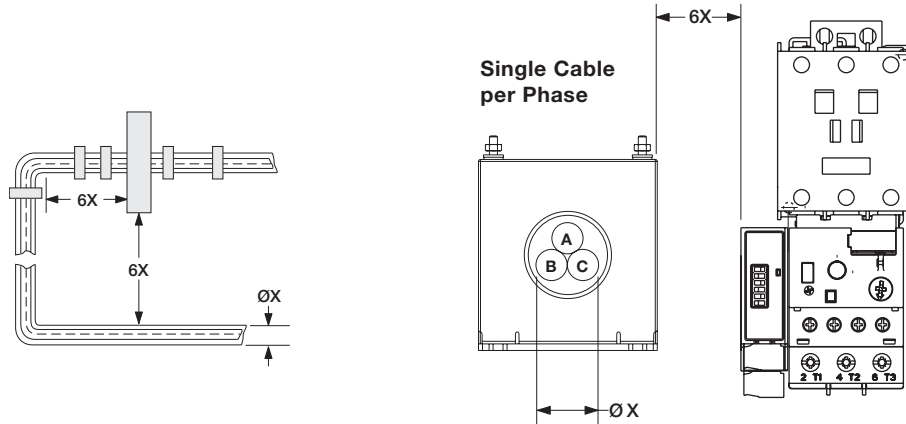

CEP7-CBCT Dimensions

CEP7-CBCT1

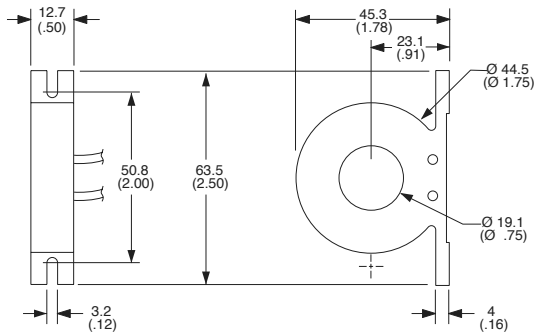

CEP7-CBCT2 & 3

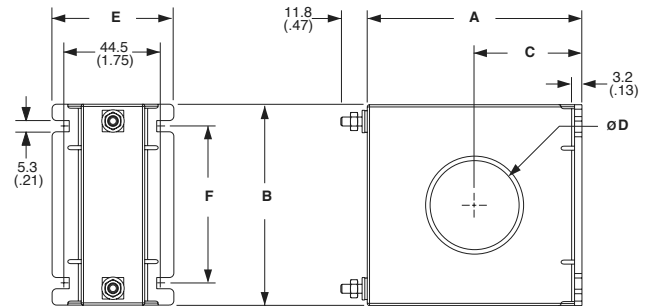

CEP7-CBCT4

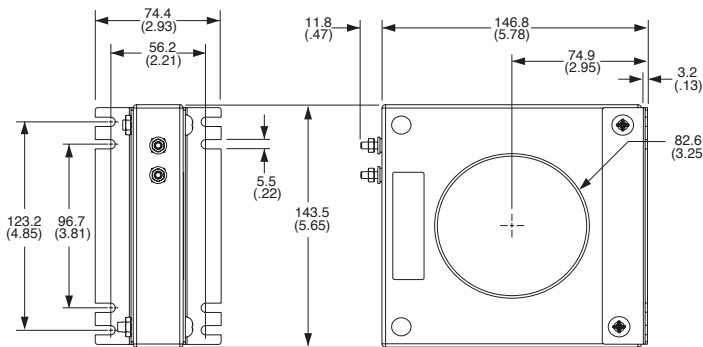

Catalog Number	A	B	C	ØD	E	F
CEP7-CBCT2	96 (3.78)	89 (3.53)	48.3 (1.90)	39.6 (1.56)	54.6 (2.15)	69.9 (2.75)
CEP7-CBCT3	122.4 (4.82)	115.9 (4.56)	59.7 (2.35)	63.5 (2.50)	54.1 (2.13)	96 (3.78)

CEP7-CBCT Ground Fault Trip Data

ATTENTION: The CEP7 Overload relay is not a ground fault circuit interrupter for personnel protection as defined in Article 100 of the NEC.

Ground fault trip delay: The delay between the occurrence of a ground fault and a trip of the CEP7 varies, but is generally described by one of the following:

- 50 ms ± 20 ms, typical
- < 6 seconds, for a ground fault present at power-up of the side mount module
- < 30 seconds, if the protection inhibit has not been cleared.

Under no conditions should a ground fault trip take longer than 31 seconds.

Dynamic inhibit: Protective function is enabled after the motor current goes above 150% and then falls below 125%.

CEP7 Mounted to CA7 Contactor

Dimensions are in millimeters (inches). Dimensions not intended for manufacturing purposes.

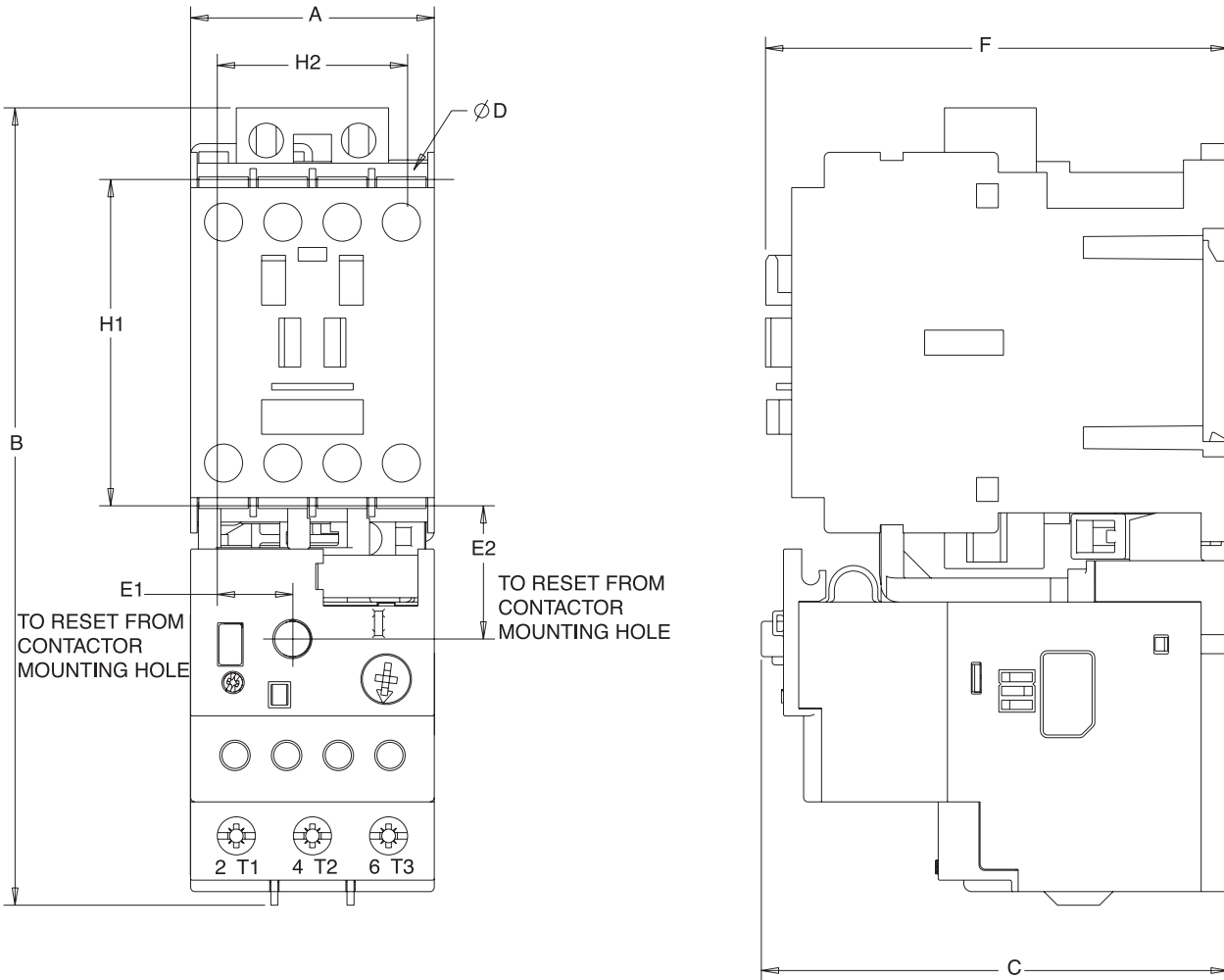

Overload	Mounted to Contactor		A Width	B Height	C Depth	D	E1	E2	F	H1	H2
CEP7-ED1...B CEP7-EE...B CEP7S-EE...B	CA7-9...23	mm (in)	45 (1-25/32)	146.6 (5-25/32)	85.2 (3-23/64)	4.5 (3/16)	13.9 (35/64)	24.5 (31/32)	86.5 (3-13/32)	60 (2-23/64)	35 (1-3/8)
CEP7-ED1...D CEP7-EE...D CEP7S-EE...D	CA7-30...37	mm (in)	45 (1-25/32)	146.6 (5-25/32)	101.2 (3-63/64)	4.5 (3/16)	13.9 (35/64)	24.5 (31/32)	104 (4-3/32)	60 (2-23/64)	35 (1-3/8)
CEP7-ED1...D CEP7-EE...D CEP7S-EE...D	CA7-43...55	mm (in)	54 (2-1/8)	146.6 (5-25/32)	101.2 (3-63/64)	4.5 (3/16)	18.9 (3/4)	24.5 (31/32)	107 (4-3/32)	60 (2-23/64)	45 (1-25/32)
CEP7-EE...E CEP7S-EE...E	CA7-60...97	mm (in)	72 (2-53/64)	192.3 (7-37/64)	120.4 (4-3/4)	5.4 (7/32)	23.8 (15/16)	29 (1-9/64)	125.5 (4-15/16)	100 (3-15/16)	55 (2-11/64)

CEP7 Pass-thru Overload

Dimensions are in millimeters (inches). Dimensions not intended for manufacturing purposes.

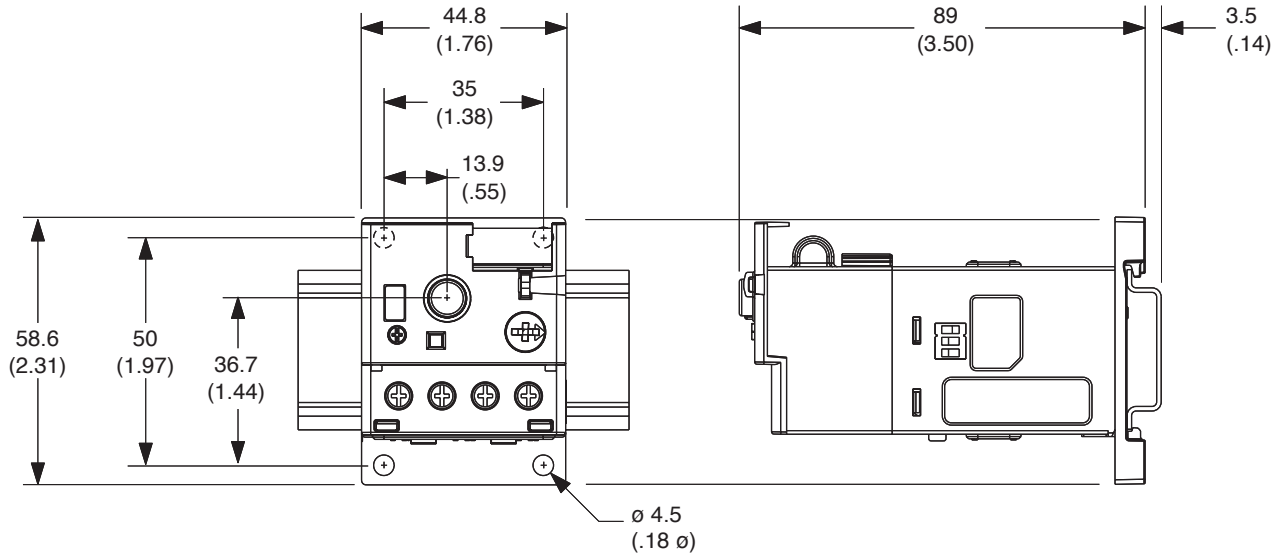

CEP7-ERID Remote Indicator

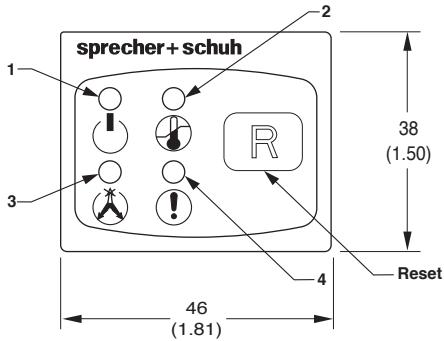

LED Indicators

L.E.D.	Function	Symbol	Fault or Status	Flash Code
1	Module Power / Status		Module Power	Green (Flash)
			Module Power + Motor Current	Green (Solid)
			Hardware Fault	Red (Solid)
2	Overload		Overload Trip	Red (Solid)
			Overload Warning (> 110%)	Yellow (Flash)
3	Phase Loss		Phase Loss Trip	Red (Solid)
4	Fault Status		Ground Fault Trip	1 Red
			Jam Trip	2 Red
			PTC Trip	3 Red
			Fault Detected	Red (Rapid)

Operating Temperatures -20°C ... 60°C (-4°F ... +140°F)
Storage Temperatures -40°C ... 85°C (-4°F ... +185°F)

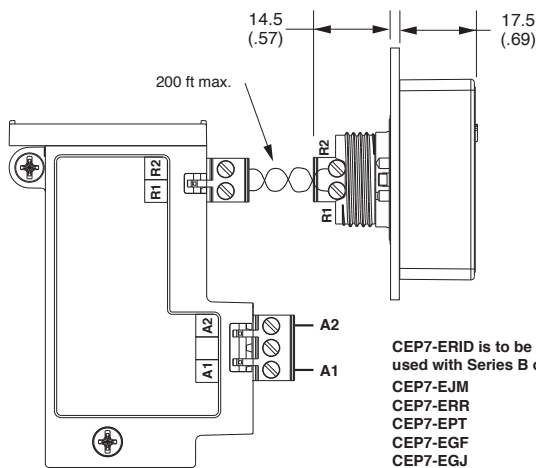

CEP7-ERID is to be used with Series B or later:
CEP7-EJM
CEP7-ERR
CEP7-EPT
CEP7-EGF
CEP7-EGJ

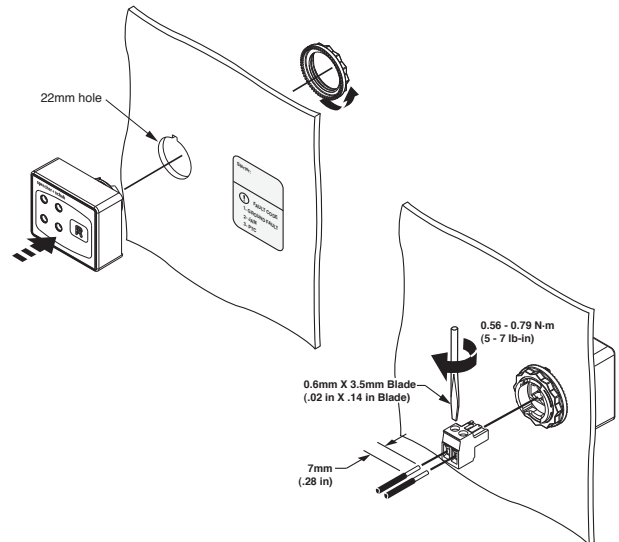

CEP7 Mounted to CA7 Contactor (with side mounted module)

Dimensions are in millimeters (inches). Dimensions not intended for manufacturing purposes.

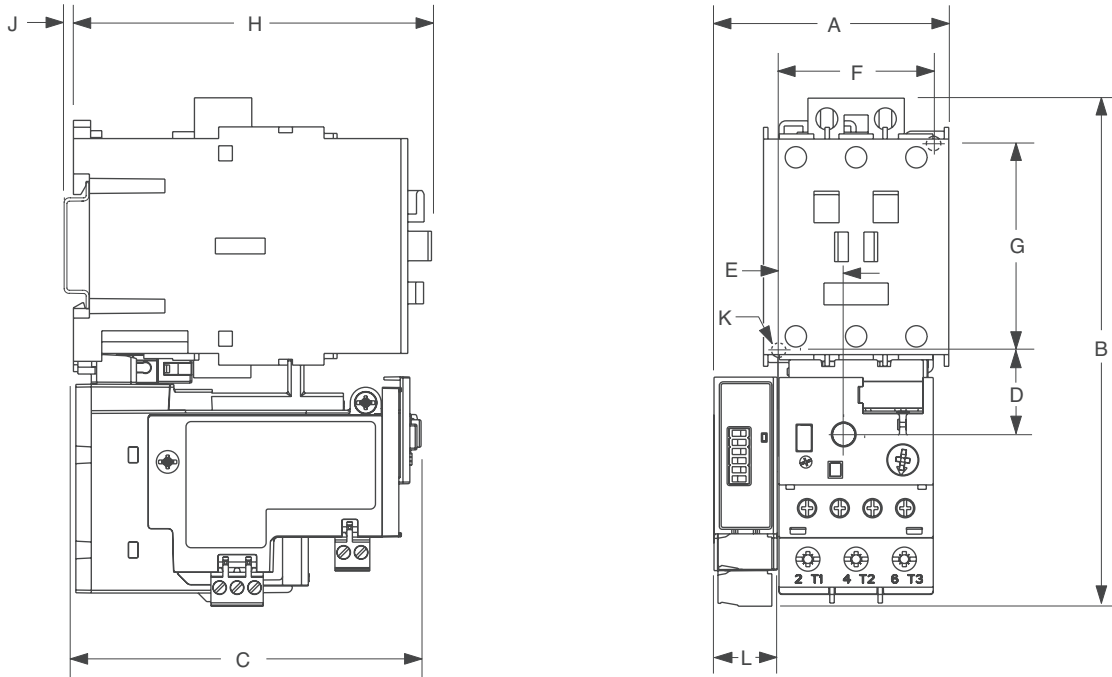

Contactor Cat. No.	Overload Cat. No.		A ①	B	C	D	E	F	G	H	J	K	L ①
CA7-9, CA7-12, CA7-16, CA7-23	CEP7*-EE_B	mm (in)	63 (2.48)	148 (5.83)	85.2 (3.35)	24.5 (.96)	13.9 (.55)	35 (1.38)	60 (2.38)	86.5 (3.40)	2 (0.8)	4.5 (.17)	18 (.71)
CA7-30, CA7-37	CEP7*-EE_D	mm (in)	63 (2.48)	148 (5.83)	101.2 (3.98)	24.5 (.96)	13.9 (.55)	35 (1.38)	60 (2.38)	104 (4.09)	2 (0.8)	4.5 (.17)	18 (.71)
CA7-43...55		mm (in)	67.5 (2.66)	148 (5.83)	101.2 (3.98)	24.5 (.96)	18.4 (.74)	45 (1.77)	60 (2.38)	107 (4.09)	2 (0.8)	4.5 (.17)	18 (.71)
CA7-60, CA7-72, CA7-85, CA7-97	CEP7*-EE_E	mm (in)	90 (3.54)	191.6 (7.54)	120.4 (4.74)	29 (1.14)	23.8 (.94)	55 (2.16)	100 (3.94)	126 (4.94)	2 (0.8)	5.4 (.21)	18 (.71)

* No letter indicates 3-phase; "S" indicates 1-phase

① Dimension shown covers all side mount modules EXCEPT CEP7-EPRB and CEP7-ETN, where "L" equals 22mm (0.86 in). Add 4mm (0.16 in) to dimension "A".

CEP7-ERR/EJM/EGE/EGJ/EPT Module Technical Information

Wire Size and Torque Specifications

	1X	24.....12 AWG
	2X	24.....16 AWG 5 lb-in
	1X	0.2.....2.5 mm ²
	2X	0.25.....1 mm ² 0.55 N·m
	1X	0.2.....2.5 mm ²
	2X	0.2.....1 mm ² 0.55 N·m

- Connect remote reset pilot device to Terminals R1 and R2.
- Do not apply external voltage to R1 and R2. Equipment damage will occur.
- Recommend use of twisted pair for remote reset, #24 AWG minimum.
- Apply 24 - 240V, 47 - 63HZ or DC to terminals A1 and A2 for control power.
- Rated Insulation Voltage (Ui) 300V
- Rated Operating Voltage (Ue) 24 - 240 VAC, 50/60 Hz
24 - 240 VDC
- Power at Rated Operating Voltage (Typical)

24 VAC	0.8 W
120 VAC	0.8 W
240 VAC	1.0 W
- Rated Impulse Withstand Voltage (U imp) 2.5 kV
- Dynamic inhibit on start. A unique circuit within the CEP7 Protection Modules monitors for motor starting inrush current. The circuit inhibits the protection feature during the motor start period and arms the protection function after the inrush current falls to motor rated current. This allows the motor to start and run, avoiding nuisance tripping during the inrush period.

CEP7 with CEP7-EP... Panel Mount Adaptor

Dimensions are in millimeters (inches). Dimensions not intended for manufacturing purposes.

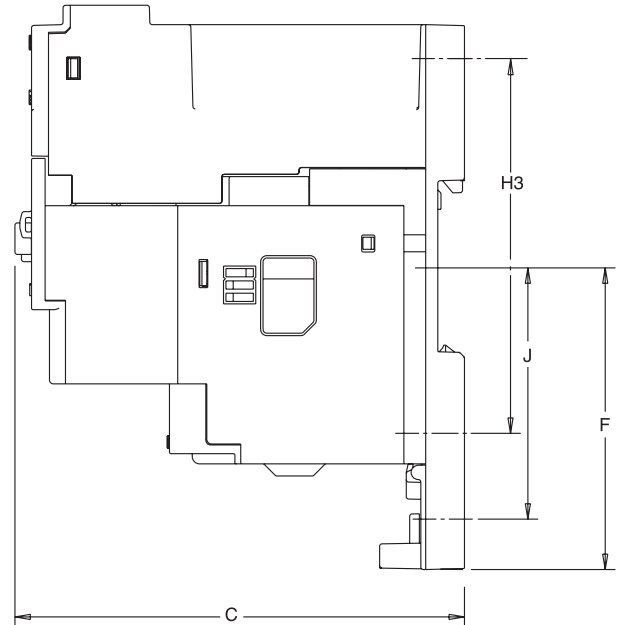
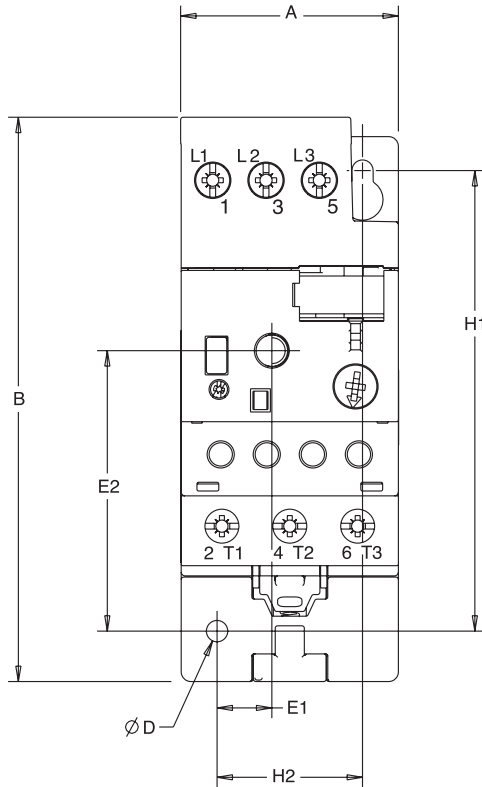

Panel Mount Adaptor	Overload Relay	A Width	B Height	C Depth	D	E1	E2	F	H1	H2	H3	J
CEP7-EPB	CEP7-ED1_B	45 (1-25/32)	116.5 (4-9/16)	92.7 (3-21/32)	4.4 (11/64)	11.4 (29/64)	57.9 (2-9/32)	62.5 (2-15/32)	95 (3-3/4)	30 (1-3/16)	75 (2-31/32)	52.1 (2-3/64)
	CEP7-ED_B											
	CEP7(S)-EE_B											
CEP7-EPD	CEP7-ED1_D	45 (1-25/32)	112.4 (4-7/16)	108.7 (4-9/32)	4.4 (11/64)	11.4 (29/64)	57.9 (2-9/32)	62.5 (2-15/32)	95 (3-3/4)	30 (1-3/16)	75 (2-31/32)	52.1 (2-3/64)
	CEP7(S)-EE_D											
	CEP7(S)-EE_E											
CEP7-EPE	CEP7(S)-EE_E	72 (2-53/64)	107.4 (4-15/64)	127 (5-1/64)	5.5 (5/32)	26.4 (3/4)	54.5 (2-9/64)	48.3 (1-29/32)	90 (3-23/64)	60 (2-23/64)	~	43.3 (1-45/64)

DIN-rail / Panel Adaptor Terminal Cross Sections		CEP7-EPB ❶	CEP7-EPD ❶	CEP7-EPE
Flexible stranded with ferrule	Single conductor	1.0...4.0mm ²	2.5...16mm ²	4.0...35mm ²
	Torque	1.8 Nm	2.3 Nm	4.0 Nm
	Two conductor	1.0...4.0mm ²	2.5...10mm ²	4.0...25mm ²
	Torque	1.8 Nm	2.3 Nm	4.0 Nm
Course stranded / solid	Single conductor	1.5...6.0mm ²	2.5...25mm ²	4.0...50mm ²
	Torque	1.8 Nm	2.3 Nm	4.0 Nm
	Two conductor	1.5...6.0mm ²	2.5...16mm ²	4.0...35mm ²
	Torque	1.8 Nm	2.3 Nm	4.0 Nm
Stranded / solid	Single conductor	14...8 AWG	16...6 AWG	12...1 AWG
	Torque	16 lb-in	20 lb-in	35 lb-in
	Two conductor	14...10 AWG	16...6 AWG	12...2 AWG
	Torque	16 lb-in	20 lb-in	35 lb-in

❶ For multiple conductor applications, the same size and style of wire must be used.

B
CEP7 Overloads

CEP7 Current Transformer Models mounted to CA6 Contactor

Dimensions are in millimeters (inches). Dimensions not intended for manufacturing purposes.

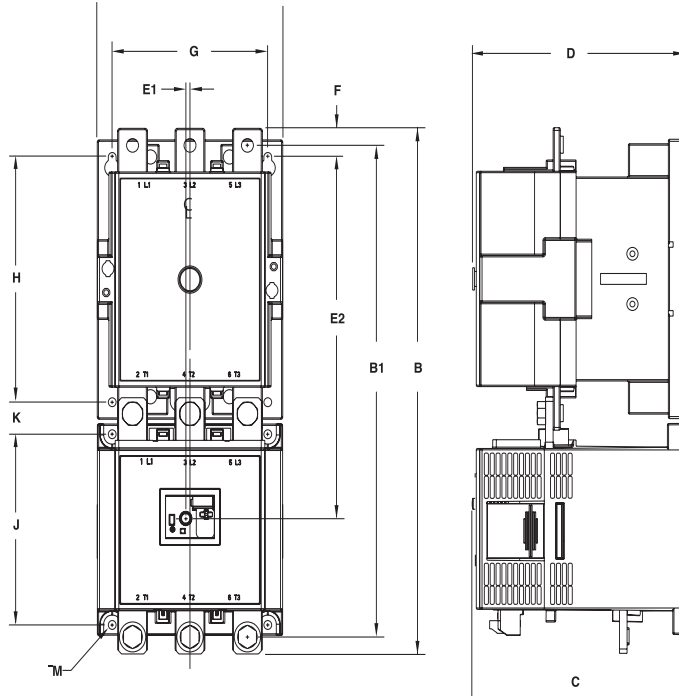

Overload Relay Cat.	Contactor Cat.	A Width	B Height		B1	C Depth	D	E1	E2	F	G	H	J	K	M
			Without Terminal Covers	With Terminal Covers											
CEP7-EEHF CEP7-EEJF	CA6-115 (EI)	120 (4.72)	339.8	418	317.8 (12.51)	152.7 (6.01)	156 (6.14)	36 (.14)	226.3 (8.91)	16 (.63)	100 (3.94)	145 (5.71)	135 (5.31)	22.3 (.88)	8 – 5.6 (8 – .22)
	CA6-140 (EI)		385.8	487.4											
	CA6-180 (EI)		487.4	508											
CEP7-EE_G	CA6-210 EI	155 (6.10)	385.8	487.4	360.8 (14.2)	176.5 (6.95)	180 (7.09)	36 (.14)	265.5 (10.44)	21 (.83)	130 (5.12)	180 (7.09)	140 (5.51)	23.5 (.93)	8 – 6.5 (8 – .26)
	CA6-300-EI		487.4	508											
	CA6-420 EI		508	508											
CEP7-EE_H	CA6-630 EI	255 (10.04)	552	915	508 (20)	269.3 (10.6)	270.7 (10.66)	36 (.14)	384.1 (15.12)	52.5 (2.07)	226 (8.90)	230 (9.06)	108 (4.25)	109 (4.29)	8 – 13 (8 – .51)
	CA6-860 EI		915	915											

Assembly Instructions

- CEP7-EE_F: (M5)
3.4 N Σ m (30 lb-in)
- CEP7-EE_G: (M6)
5.1 N Σ m (45 lb-in)
- CEP7-EE_H: (M12 Provided)
17 N Σ m (150 lb-in)

