

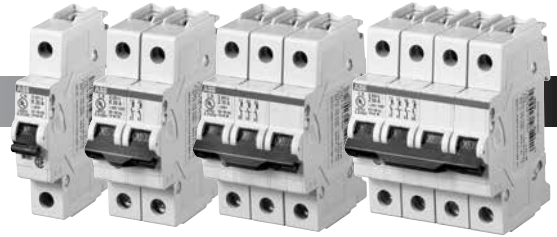

15 - Miniature circuit breakers



S200 Miniature circuit breakers15.1 - 15.42

UL 489 Series

Ordering details	
Description.....	15.1
Features.....	15.1
S200U-K, 240 VAC.....	15.2
S200U-Z, 240 VAC.....	15.3
S200UP-K, 480Y/277 VAC.....	15.4
S200UP-Z, 480Y/277 VAC.....	15.5
SU200PR-K, 480Y/277 VAC.....	15.6
S200UDC-K, 1 pole 60 VDC, 2 pole 125 VDC.....	15.7
S200UDC-Z, 1 pole 60 VDC, 2 pole 125 VDC.....	15.8

Accessories.....	15.9 - 15.12
Technical data.....	15.13 - 15.15
Dimensions.....	15.16

UL 1077 Series

Ordering details	
Description & features.....	15.17
S200-B, 480Y/277 VAC.....	15.18
S200-C, 480Y/277 VAC.....	15.19
S200-D, 480Y/277 VAC.....	15.20
S200-K, 480Y/277 VAC.....	15.21
S200-Z, 480Y/277 VAC.....	15.22
S200P-B, 480Y/277 VAC.....	15.23
S200P-C, 480Y/277 VAC.....	15.24
S200P-D, 480Y/277 VAC.....	15.25
S200P-K, 480Y/277 VAC.....	15.26
S200P-Z, 480Y/277 VAC.....	15.27
S200PR-K, 240 VAC, Ring tongue.....	15.28
S280UC-K, 500 VDC.....	15.29
S280UC-Z, 500 VDC.....	15.30
Accessories.....	15.31 - 15.39
Technical data.....	15.40 - 15.42
Dimensions.....	15.43 - 15.44

Application guide15.45 - 15.52

Introduction, overload, short circuit, breaker definition.....	15.45
Circuit breaker construction.....	15.46 - 15.47
Circuit breaker current limitation.....	15.48 - 15.49
Selective coordination and series ratings.....	15.50 - 15.51
Miniature circuit breaker cutaway.....	15.52

S800 Miniature circuit breakers15.53 - 15.80

UL 489 Series

Ordering details	
Description & features.....	15.53
S800U-K, 240 VAC.....	15.54
S800U-Z, 240 VAC.....	15.55
S803W-SCL-SR UL Short circuit current limiter.....	15.56 - 15.57
S800W-RSU Remote sensing unit.....	15.58

IEC Series

Ordering details	
Description & features.....	15.59
S800S-B, 690 VAC.....	15.60
S800S-C, 690 VAC.....	15.61
S800S-D, 690 VAC.....	15.62
S800S-K, 690 VAC.....	15.63

UL & IEC Series

Accessories.....	15.64 - 15.65
Technical data.....	15.67 - 15.78
Dimensions.....	15.79

S500 Miniature circuit breakers15.81 - 15.87

Ordering details

Description & features.....	15.81
S500-K, UL 600Y/277 VAC / IEC 690 VAC.....	15.82
S500UC-B, 250 VDC per pole (600 VDC 4P).....	15.83
S500UC-K, 250 VDC per pole (600 VDC 4P).....	15.84
Accessories.....	15.85
Technical data.....	15.86
Dimensions.....	15.87

Technical data.....15.89 - 15.97

S200 UL 489 Series Miniature circuit breakers



S200
UL 489 Series



Description

The S200 Series miniature circuit breaker offers a compact solution for protection requirements. The S200U AND S200UP devices are UL 489 tested current limiting and DIN rail mounted.

The S200U and S200UP is available with application-specific trip characteristics to provide maximum circuit protection.

The breakers offer thermal-magnetic trip protection according to K and Z characteristics.

For the worldwide market, the breakers carry UL, CSA, IEC, CE and many other agency approvals and certifications.

Features

- UL current limiting
- Fast breaking time (2.3 – 2.5 ms)
- Bus connection system
- Wide range of accessories
- Available with variable depth handle mechanism
- CE certified and marked
- DIN rail mounting
- Finger safe terminals
- Multi-function terminals
- Suitable for reverse feed but S200UDC has polarity
- UL 489 Listed - branch circuit protective device. UL File #E212323

	S200U	S200UP	SU200PR	S200UDC
Amperage	0.2 – 63	0.2 – 25	0.2 – 35A ; 40 – 63A	1 – 63
Voltage	240 VAC	480Y/277VAC	480Y/277 VAC ; 240 VAC	60-125 VDC
Poles	1, 2, 3, 4	1, 2, 3, 4	1, 2, 3, 4	1, 2
Trip characteristics	K, Z	K, Z	K	K, Z
Interrupting ratings	Up to 25 kA: IEC 60947-2 10 kA: UL 489 10 kA: CSA 22.2 No. 5	Up to 25 kA: IEC 60947-2 10 kA: UL 489 10 kA: CSA 22.2 No. 5	10kA: UL489 10kA: CSA 22.2 No.5	14 kA: UL489 14 kA: CSA 22.2 No. 5
Auxiliary contacts	Yes	Yes	Yes	Yes
Bell alarm	Yes	Yes	Yes	Yes
Shunt trip	Yes	Yes	Yes	Yes
Bus bar	Yes	Yes	No	Yes

S200U-K, 240 VAC

Branch circuit protection
UL 489, CSA 22.2 No. 5

K



S201U-K



S202U-K



S203U-K



S204U-K

No. of poles	Rated current	Catalog number	No. of poles	Rated current	Catalog number
1	0.2	S201U-K0.2	3	0.2	S203U-K0.2
	0.3	S201U-K0.3		0.3	S203U-K0.3
	0.5	S201U-K0.5		0.5	S203U-K0.5
	0.75	S201U-K0.75		0.75	S203U-K0.75
	1	S201U-K1		1	S203U-K1
	1.6	S201U-K1.6		1.6	S203U-K1.6
	2	S201U-K2		2	S203U-K2
	3	S201U-K3		3	S203U-K3
	4	S201U-K4		4	S203U-K4
	5	S201U-K5		5	S203U-K5
	6	S201U-K6		6	S203U-K6
	8	S201U-K8		8	S203U-K8
	10	S201U-K10		10	S203U-K10
	15	S201U-K15		15	S203U-K15
	16	S201U-K16		16	S203U-K16
	20	S201U-K20		20	S203U-K20
25	S201U-K25	25	S203U-K25		
2	0.2	S202U-K0.2	4	0.2	S204U-K0.2
	0.3	S202U-K0.3		0.3	S204U-K0.3
	0.5	S202U-K0.5		0.5	S204U-K0.5
	0.75	S202U-K0.75		0.75	S204U-K0.75
	1	S202U-K1		1	S204U-K1
	1.6	S202U-K1.6		1.6	S204U-K1.6
	2	S202U-K2		2	S204U-K2
	3	S202U-K3		3	S204U-K3
	4	S202U-K4		4	S204U-K4
	5	S202U-K5		5	S204U-K5
	6	S202U-K6		6	S204U-K6
	8	S202U-K8		8	S204U-K8
10	S202U-K10	10	S204U-K10		
15	S202U-K15	15	S204U-K15		
16	S202U-K16	16	S204U-K16		
20	S202U-K20	20	S204U-K20		
25	S202U-K25	25	S204U-K25		
3	30	S201U-K30	4	30	S204U-K30
	32	S201U-K32		32	S204U-K32
	40	S201U-K40		40	S204U-K40
	50	S201U-K50		50	S204U-K50
	60	S201U-K60		60	S204U-K60
	63	S201U-K63		63	S204U-K63

Tripping characteristic K

UL 489
240 VAC
10 kA

Inductive loads

- K Curve
- Designed for allowing higher in-rush currents during system start up
- Example: motors, transformers

Accessories & technical data

Accessories – See page 15.9 - 15.13

Technical data – See page 15.14 - 15.16

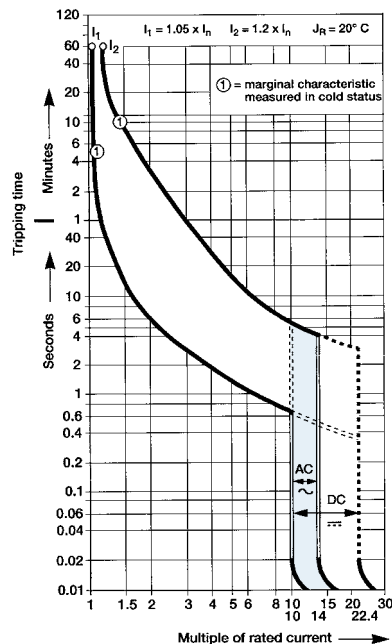

Note: This breaker for AC use only

S200U-Z, 240 VAC

Branch circuit protection
UL 489, CSA 22.2 No. 5

Z



S201U-Z



S202U-Z



S203U-Z



S204U-Z

No. of poles	Rated current	Catalog number	No. of poles	Rated current	Catalog number	
1	0.5	S201U-Z0.5	3	0.5	S203U-Z0.5	
	1	S201U-Z1		1	S203U-Z1	
	1.6	S201U-Z1.6		1.6	S203U-Z1.6	
	2	S201U-Z2		2	S203U-Z2	
	3	S201U-Z3		3	S203U-Z3	
	4	S201U-Z4		4	S203U-Z4	
	5	S201U-Z5		5	S203U-Z5	
	6	S201U-Z6		6	S203U-Z6	
	8	S201U-Z8		8	S203U-Z8	
	10	S201U-Z10		10	S203U-Z10	
	15	S201U-Z15		15	S203U-Z15	
	16	S201U-Z16		16	S203U-Z16	
	20	S201U-Z20		20	S203U-Z20	
	25	S201U-Z25		25	S203U-Z25	
	30	S201U-Z30		30	S203U-Z30	
2	0.5	S202U-Z0.5	4	0.5	S204U-Z0.5	
	1	S202U-Z1		1	S204U-Z1	
	1.6	S202U-Z1.6		1.6	S204U-Z1.6	
	2	S202U-Z2		2	S204U-Z2	
	3	S202U-Z3		3	S204U-Z3	
	4	S202U-Z4		4	S204U-Z4	
	5	S202U-Z5		5	S204U-Z5	
	6	S202U-Z6		6	S204U-Z6	
	8	S202U-Z8		8	S204U-Z8	
	10	S202U-Z10		10	S204U-Z10	
	15	S202U-Z15		15	S204U-Z15	
	16	S202U-Z16		16	S204U-Z16	
	20	S202U-Z20		20	S204U-Z20	
	25	S202U-Z25		25	S204U-Z25	
	30	S202U-Z30		30	S204U-Z30	
3	32	S201U-Z32	3	32	S203U-Z32	
	40	S201U-Z40		40	S203U-Z40	
	50	S201U-Z50		50	S203U-Z50	
	60	S201U-Z60		60	S203U-Z60	
	63	S201U-Z63		63	S203U-Z63	
	32	S202U-Z32		4	32	S204U-Z32
	40	S202U-Z40			40	S204U-Z40
	50	S202U-Z50			50	S204U-Z50
	60	S202U-Z60			60	S204U-Z60
	63	S202U-Z63			63	S204U-Z63

Tripping characteristic Z

UL 489
240 VAC
10 kA

Resistive loads

- Z Curve
- Designed to provide maximum protection with a very low short circuit trip setting
- Example: semiconductors, control circuits

Accessories & technical data

Accessories – See page 15.9 - 15.13

Technical data – See page 15.14 - 15.16

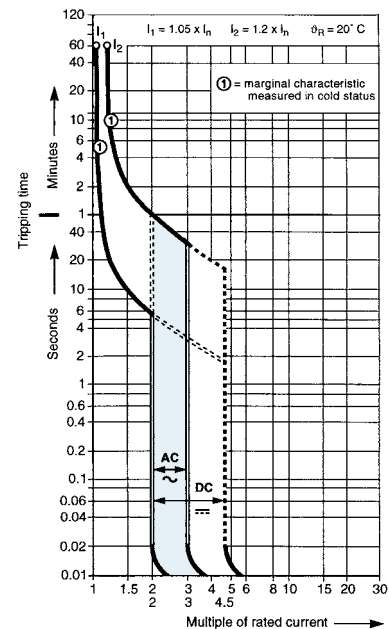

Note: This breaker for AC use only

S200UP-K, 480Y/277 VAC

Branch circuit protection

UL 489, CSA 22.2 No. 5

K



S201UP-K



S202UP-K



S203UP-K



S204UP-K

No. of poles	Rated current	Catalog number	No. of poles	Rated current	Catalog number
1	0.2	S201UP-K0.2	3	0.2	S203UP-K0.2
	0.3	S201UP-K0.3		0.3	S203UP-K0.3
	0.5	S201UP-K0.5		0.5	S203UP-K0.5
	0.75	S201UP-K0.75		0.75	S203UP-K0.75
	1	S201UP-K1		1	S203UP-K1
	1.6	S201UP-K1.6		1.6	S203UP-K1.6
	2	S201UP-K2		2	S203UP-K2
	3	S201UP-K3		3	S203UP-K3
	4	S201UP-K4		4	S203UP-K4
	5	S201UP-K5		5	S203UP-K5
	6	S201UP-K6		6	S203UP-K6
	8	S201UP-K8		8	S203UP-K8
	10	S201UP-K10		10	S203UP-K10
15	S201UP-K15	15	S203UP-K15		
16	S201UP-K16	16	S203UP-K16		
20	S201UP-K20	20	S203UP-K20		
25	S201UP-K25	25	S203UP-K25		
2	0.2	S202UP-K0.2	4	0.2	S204UP-K0.2
	0.3	S202UP-K0.3		0.3	S204UP-K0.3
	0.5	S202UP-K0.5		0.5	S204UP-K0.5
	0.75	S202UP-K0.75		0.75	S204UP-K0.75
	1	S202UP-K1		1	S204UP-K1
	1.6	S202UP-K1.6		1.6	S204UP-K1.6
	2	S202UP-K2		2	S204UP-K2
	3	S202UP-K3		3	S204UP-K3
	4	S202UP-K4		4	S204UP-K4
	5	S202UP-K5		5	S204UP-K5
	6	S202UP-K6		6	S204UP-K6
	8	S202UP-K8		8	S204UP-K8
	10	S202UP-K10		10	S204UP-K10
15	S202UP-K15	15	S204UP-K15		
16	S202UP-K16	16	S204UP-K16		
20	S202UP-K20	20	S204UP-K20		
25	S202UP-K25	25	S204UP-K25		

Tripping characteristic K

UL 489
480Y/277 VAC
10 kA

Inductive loads

- K Curve
- Designed for allowing higher in-rush currents during system start up
- Example: motors, transformers

Accessories & technical data

Accessories – See page 15.9 - 15.13

Technical data – See page 15.14 - 15.16

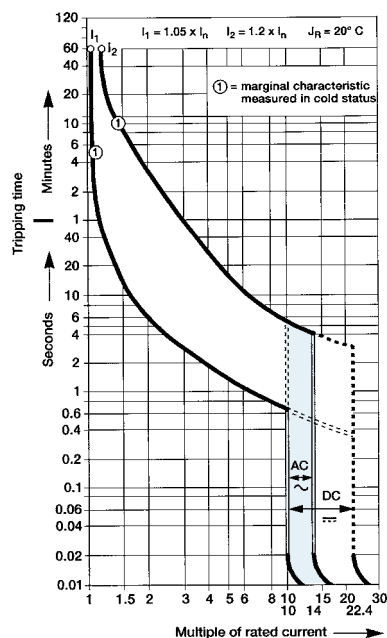

Note: This breaker for AC use only

S200UP-Z, 480Y/277 VAC

Branch circuit protection

UL 489, CSA 22.2 No. 5

Z

No. of poles	Rated current	Catalog number	No. of poles	Rated current	Catalog number
1	0.5	S201UP-Z0.5	3	0.5	S203UP-Z0.5
	1	S201UP-Z1		1	S203UP-Z1
	1.6	S201UP-Z1.6		1.6	S203UP-Z1.6
	2	S201UP-Z2		2	S203UP-Z2
	3	S201UP-Z3		3	S203UP-Z3
	4	S201UP-Z4		4	S203UP-Z4
	5	S201UP-Z5		5	S203UP-Z5
	6	S201UP-Z6		6	S203UP-Z6
	8	S201UP-Z8		8	S203UP-Z8
	10	S201UP-Z10		10	S203UP-Z10
	15	S201UP-Z15		15	S203UP-Z15
	16	S201UP-Z16		16	S203UP-Z16
20	S201UP-Z20	20	S203UP-Z20		
25	S201UP-Z25	25	S203UP-Z25		
2	0.5	S202UP-Z0.5	4	0.5	S204UP-Z0.5
	1	S202UP-Z1		1	S204UP-Z1
	1.6	S202UP-Z1.6		1.6	S204UP-Z1.6
	2	S202UP-Z2		2	S204UP-Z2
	3	S202UP-Z3		3	S204UP-Z3
	4	S202UP-Z4		4	S204UP-Z4
	5	S202UP-Z5		5	S204UP-Z5
	6	S202UP-Z6		6	S204UP-Z6
	8	S202UP-Z8		8	S204UP-Z8
	10	S202UP-Z10		10	S204UP-Z10
	15	S202UP-Z15		15	S204UP-Z15
	16	S202UP-Z16		16	S204UP-Z16
20	S202UP-Z20	20	S204UP-Z20		
25	S202UP-Z25	25	S204UP-Z25		



S201UP-Z



S202UP-Z



S203UP-Z



S204UP-Z

Tripping characteristic Z

UL 489
480Y/277 VAC
10 kA

Resistive loads

- Z Curve
- Designed to provide maximum protection with a very low short circuit trip setting
- Example: semiconductors, control circuits

Accessories & technical data

Accessories – See page 15.9 - 15.13
Technical data – See page 15.14 - 15.16

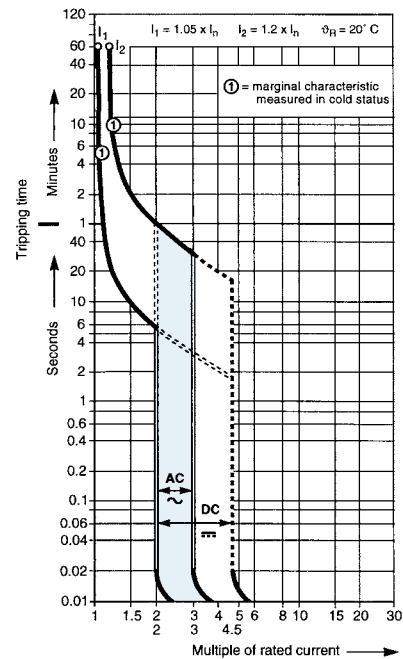

Note: This breaker for AC use only

SU200PR-K, 480Y/277 VAC, Ring tongue

Branch circuit protection

UL489, CSA 22.2 No.5

K



SU201PR-K0.2



SU202PR-K0.2



SU203PR-K0.2



SU204PR-K0.2

No. of poles	Rated current	Catalog number	No. of poles	Rated current	Catalog number
1	0.2	SU201PR-K0.2	3	0.2	SU203PR-K0.2
	0.3	SU201PR-K0.3		0.3	SU203PR-K0.3
	0.5	SU201PR-K0.5		0.5	SU203PR-K0.5
	0.75	SU201PR-K0.75		0.75	SU203PR-K0.75
	1	SU201PR-K1		1	SU203PR-K1
	1.6	SU201PR-K1.6		1.6	SU203PR-K1.6
	2	SU201PR-K2		2	SU203PR-K2
	3	SU201PR-K3		3	SU203PR-K3
	4	SU201PR-K4		4	SU203PR-K4
	5	SU201PR-K5		5	SU203PR-K5
	6	SU201PR-K6		6	SU203PR-K6
	8	SU201PR-K8		8	SU203PR-K8
	10	SU201PR-K10		10	SU203PR-K10
	13	SU201PR-K13		13	SU203PR-K13
	15	SU201PR-K15		15	SU203PR-K15
	16	SU201PR-K16		16	SU203PR-K16
	20	SU201PR-K20		20	SU203PR-K20
	25	SU201PR-K25		25	SU203PR-K25
	30	SU201PR-K30		30	SU203PR-K30
32	SU201PR-K32	32	SU203PR-K32		
35	SU201PR-K35	35	SU203PR-K35		
40	SU201PR-K40	40	SU203PR-K40		
50	SU201PR-K50	50	SU203PR-K50		
60	SU201PR-K60	60	SU203PR-K60		
63	SU201PR-K63	63	SU203PR-K63		
2	0.2	SU202PR-K0.2	4	0.2	SU204PR-K0.2
	0.3	SU202PR-K0.3		0.3	SU204PR-K0.3
	0.5	SU202PR-K0.5		0.5	SU204PR-K0.5
	0.75	SU202PR-K0.75		0.75	SU204PR-K0.75
	1	SU202PR-K1		1	SU204PR-K1
	1.6	SU202PR-K1.6		1.6	SU204PR-K1.6
	2	SU202PR-K2		2	SU204PR-K2
	3	SU202PR-K3		3	SU204PR-K3
	4	SU202PR-K4		4	SU204PR-K4
	5	SU202PR-K5		5	SU204PR-K5
	6	SU202PR-K6		6	SU204PR-K6
	8	SU202PR-K8		8	SU204PR-K8
	10	SU202PR-K10		10	SU204PR-K10
	13	SU202PR-K13		13	SU204PR-K13
	15	SU202PR-K15		15	SU204PR-K15
	16	SU202PR-K16		16	SU204PR-K16
	20	SU202PR-K20		20	SU204PR-K20
	25	SU202PR-K25		25	SU204PR-K25
	30	SU202PR-K30		30	SU204PR-K30
32	SU202PR-K32	32	SU204PR-K32		
35	SU202PR-K35	35	SU204PR-K35		
40	SU202PR-K40	40	SU204PR-K40		
50	SU202PR-K50	50	SU204PR-K50		
60	SU202PR-K60	60	SU204PR-K60		
63	SU202PR-K63	63	SU204PR-K63		

Tripping characteristic K

UL 489
480Y/277 VAC
10 kA

Inductive loads

- K Curve
- Designed for allowing higher in-rush currents during system start up
- Example: motors, transformers

Accessories & technical data

Accessories – See page 15.9 - 15.13

Technical data – See page 15.14 - 15.16

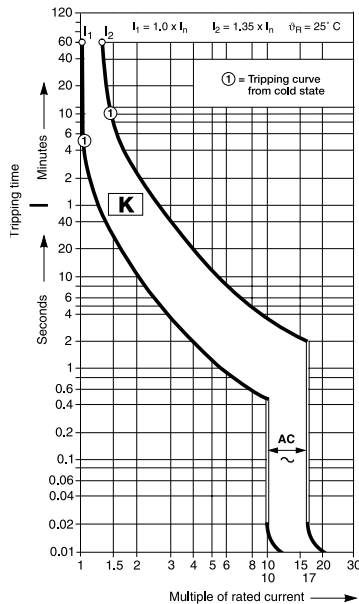

S200UDC-K, 1 pole 60 VDC, 2 pole 125 VDC

Branch circuit protection

UL 489, CSA 22.2 No. 5

K



S201UDC-K1



S202UDC-K1

No. of poles	Rated current	Catalog number	No. of poles	Rated current	Catalog number
1	1	S201UDC-K1	2	1	S202UDC-K1
	1.6	S201UDC-K1.6		1.6	S202UDC-K1.6
	2	S201UDC-K2		2	S202UDC-K2
	3	S201UDC-K3		3	S202UDC-K3
	4	S201UDC-K4		4	S202UDC-K4
	5	S201UDC-K5		5	S202UDC-K5
	6	S201UDC-K6		6	S202UDC-K6
	8	S201UDC-K8		8	S202UDC-K8
	10	S201UDC-K10		10	S202UDC-K10
	13	S201UDC-K13		13	S202UDC-K13
	15	S201UDC-K15		15	S202UDC-K15
	16	S201UDC-K16		16	S202UDC-K16
	20	S201UDC-K20		20	S202UDC-K20
	25	S201UDC-K25		25	S202UDC-K25
30	S201UDC-K30	30	S202UDC-K30		
32	S201UDC-K32	32	S202UDC-K32		
40	S201UDC-K40	40	S202UDC-K40		
50	S201UDC-K50	50	S202UDC-K50		
60	S201UDC-K60	60	S202UDC-K60		
63	S201UDC-K63	63	S202UDC-K63		

NOTE: Standard UL 489 (only DC; please note polarity of device).

Tripping characteristic K

UL 489
480Y/277 VAC
14 kA

Inductive loads

- K Curve
- Designed for allowing higher in-rush currents during system start up
- Example: motors, transformers

Accessories & technical data

Accessories – See page 15.9 - 15.13

Technical data – See page 15.14 -15.16

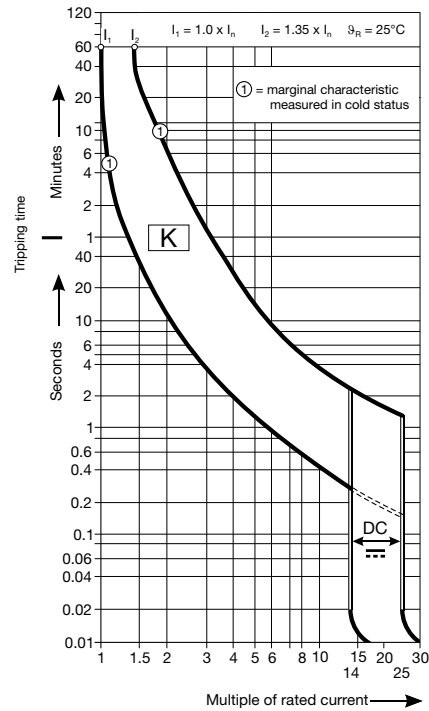

S200UDC-Z, 1 pole 60 VDC, 2 pole 125 VDC

Branch circuit protection

UL 489, CSA 22.2 No. 5

Z



S201UDC-K1



S202UDC-K1

No. of poles	Rated current	Catalog number	No. of poles	Rated current	Catalog number
1	1	S201UDC-Z1	2	1	S202UDC-Z1
	1.6	S201UDC-Z1.6		1.6	S202UDC-Z1.6
	2	S201UDC-Z2		2	S202UDC-Z2
	3	S201UDC-Z3		3	S202UDC-Z3
	4	S201UDC-Z4		4	S202UDC-Z4
	5	S201UDC-Z5		5	S202UDC-Z5
	6	S201UDC-Z6		6	S202UDC-Z6
	8	S201UDC-Z8		8	S202UDC-Z8
	10	S201UDC-Z10		10	S202UDC-Z10
	13	S201UDC-Z13		13	S202UDC-Z13
	15	S201UDC-Z15		15	S202UDC-Z15
	16	S201UDC-Z16		16	S202UDC-Z16
	20	S201UDC-Z20		20	S202UDC-Z20
	25	S201UDC-Z25		25	S202UDC-Z25
	30	S201UDC-Z30		30	S202UDC-Z30
32	S201UDC-Z32	32	S202UDC-Z32		
40	S201UDC-Z40	40	S202UDC-Z40		
50	S201UDC-Z50	50	S202UDC-Z50		
60	S201UDC-Z60	60	S202UDC-Z60		
63	S201UDC-Z63	63	S202UDC-Z63		

NOTE: Standard UL 489 (only DC; please note polarity of device).

Tripping characteristic Z

UL 489

480Y/277 VAC

14 kA

Resistive loads

- Z Curve
- Designed to provide maximum protection with a very low short circuit trip setting
- Example: semiconductors, control circuits

Accessories & technical data

Accessories – See page 15.9 - 15.13

Technical data – See page 15.14 -15.16

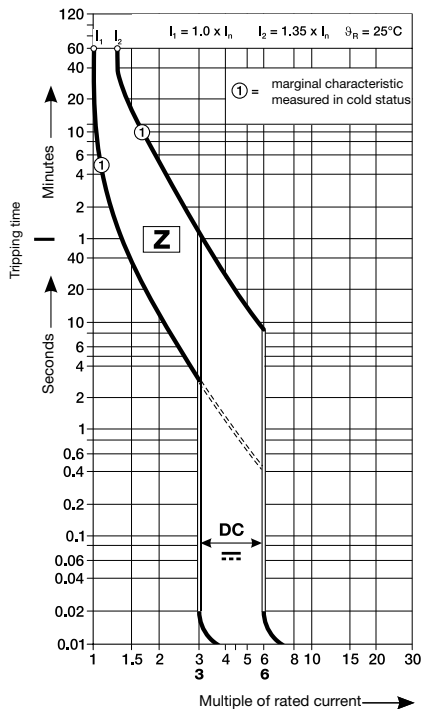

Accessories

S200U, S200UP, SU200PR & S200UDC
UL 489, CSA 22.2 No. 5

Auxiliary contacts

The auxiliary contacts will signal whether the breaker is in the ON or OFF position.

Description	Catalog number
For field mounting: right side	S2C-H6RU



S2C-H6RU

Bell alarm

The bell alarm includes a set of contacts that will only signal when the breaker has tripped. Typically the contacts would be connected to an alarm or bell to signal the operator that an overcurrent trip has occurred. The bell alarm also includes a test button for testing the alarm contacts without opening the breaker.

Description	Catalog number
For field mounting: right side	S2C-S6RU



S2C-S6RU

Rotary operating mechanism

Allows "through the door" operation.

Description	Catalog number
Handle mechanism	S2C-DH



S2C-DH

Shunt trip

For remote tripping of breaker, a shunt trip device can be added to the MCB. The solenoid device opens the breaker after control voltage is applied.

Description	Catalog number
For field mounting: right side 12...60 VAC/DC	S2C-A1U
For field mounting: right side 110...415 VAC 110...250 VDC	S2C-A2U

NOTE: For shafts and handles, refer to parts in the MCCB section.



S2C-A1U

Possible mounting arrangements of MCB accessories

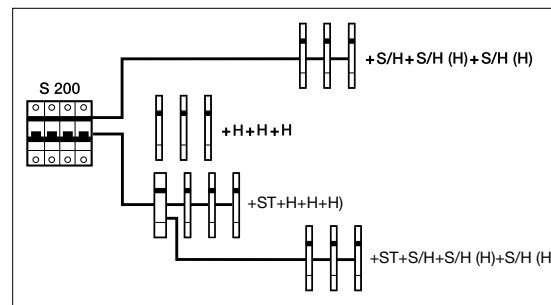

Legend

Auxiliary contact	H
Bell alarm/Auxiliary contact	S/H
Bell alarm/Auxiliary contact used as auxiliary contact	S/H (H)
Shunt trip	ST

NOTE: Right hand mount accessories cannot be used in conjunction with S2C-DH, Rotary operating mechanism.

Accessories

S200U, S200UP, S200UDC & SU200PR
UL 489, CSA 22.2 No. 5

Connection drawings

Bell alarm S2C-S6RU

In ON and OFF position after hand operation

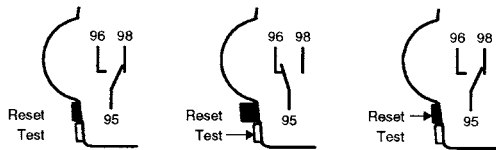

In OFF position after tripping

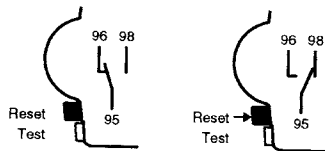

Auxiliary contact S2C-H6RU

Auxiliary contact in ON position

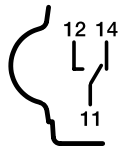

Auxiliary contact in OFF position

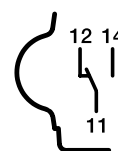

Shunt trip S2C-A...U

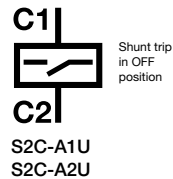

Mounting

Addition of a S2C-H6RU auxiliary contact

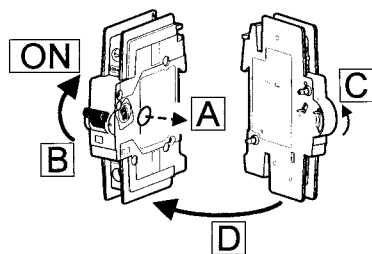

Addition of a S2C-S6RU bell alarm contact

15

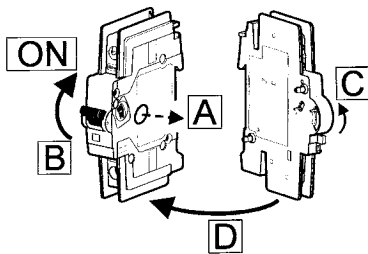

Addition of a S2C-A...U shunt trip

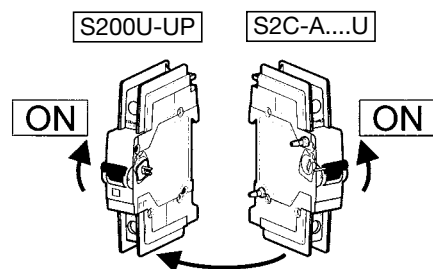

Accessories

SU200PR

UL 489, CSA 22.2 No. 5

SU200PR Accessory overview

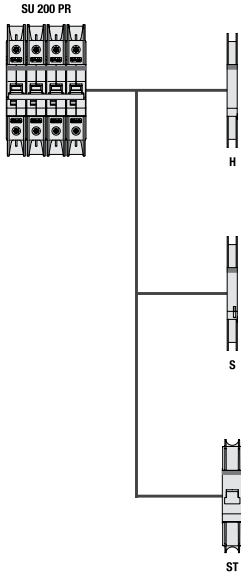

- H Auxiliary contact S2C-H6RU
- S Signal contact S2C-S6RU
- ST Shunt trip S2C-A...U

SU200PR Instructions for use

Ring Tongue Details

Only or ring cable lugs	Insulated only 	A	B	C
	Rated voltage 480Y/277 V AC	max. 11.0 mm (0.43")	max. 12.2 mm (0.48")	Suitable for M5 (0.20")
	Insulated only 	A	B	C
	Rated voltage 240/240 V AC	max. 14.0 mm (0.55")	max. 12.2 mm (0.48")	Suitable for M5 (0.20")

CU only
 60/75°C
 (140/167°F)

PZ 2 Torque: 2.8 Nm (25lb-in)

max. 2.0 mm (0.08")

Ring Tongue Terminal, Special purpose - Not for general use

Installation Instructions

Please insert or withdraw the cable lug only when the screw is completely open.

Please make sure that the terminal screw penetrates the ring lug hole properly and completely during tightening.

Please ensure that the screw is securely tightened before applying any mechanical force on the cable / cable lug.

< 2.8 Nm
 2.8 Nm

Do not apply abnormal downward pressure on the screw during tightening or loosening of the screw.

F = max, 30 N
 F = Maximum to operate

Please follow the Ring Tongue Details on the rear of this sheet.

Accessories

S200U, S200UP & S200UDC

UL 489, CSA 22.2 No. 5

UL approved busbars UL file # E250145

UL 489 busbar cannot be cut.



PS2/6/16 BP

For use on:	Amp rating	Number of poles	Phases	Busbar length (mm)	Catalog number
S200U	80	6	1	103.2	PS 1/6/16BP
S200UP		12	1	208.8	PS 1/12/16BP
S201UDC		18	1	314.4	PS 1/18/16BP
S200U	80	6	2	103.2	PS 2/6/16BP
S200UP		12	2	208.8	PS 2/12/16BP
S201UDC		18	2	314.4	PS 2/18/16BP
S200U	80	6	3	103.2	PS 3/6/16BP
S200UP		12	3	208.8	PS 3/12/16BP
S201UDC		18	3	314.4	PS 3/18/16BP

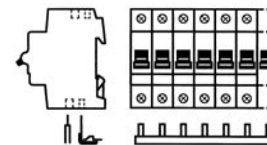

1 Phase

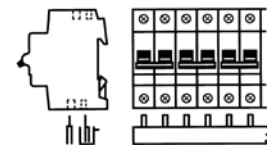

2 Phase

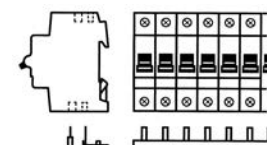

3 Phase



BSK-BP

Busbar tooth covers for BS...BP (UL 489)

Description	Catalog number
Covers three unused poles of busbar	BSK-BP



AST35/15BP



SZ-ESPBP

Feeder terminals for PS...BP (UL 489)

Description	Catalog number
Terminal, insulated with pin contact	AST35/15BP
Feeder Terminal, single-pole terminal, can be mounted side by side, feed on the pin of the busbar	SZ-ESK BP

Technical data

S200U, S200UP, SU200PR & S200UDC

UL 489, CSA 22.2 No. 5

Miniature
circuit breakers
S200

Technical data	S200U	S200UP	SU200PR	S200UDC
Specifications:	UL 489, C 22.2 No. 5, IEC 60947-2			UL 489, VDE 0660
UL File-Number:	E 212323, UL, Current limiting series ratings			E212323, UL
No. of poles:	1, 2, 3 & 4			1, 2
Tripping characteristics:	K, Z		K	K, Z
Rated current:	0.2 (K) 0.5 (Z) ... 63 A	0.2 (K) 0.5 (Z) ... 25 A	0.2 ... 63A	1 - 63 A
Rated voltage:	Single pole: 240VAC Multi pole: 240VAC	Single pole: 277VAC Multi pole: 480Y/277VAC	Single pole: 277VAC (<=35A); 240VAC (>35A) Multi pole: 480Y/277VAC (<=35A); 240VAC (>35A)	1P: 60 V DC 2P: 125 V DC ⊕
Short circuit capacity:	10 kA			14 kA
Frequency:	50/60 Hz			50/60 Hz
Degree of protection:	IP 20		IP20, IP40 in enclosure w/cover	IP 20
Mounting position:	Vertical and horizontal		Any	Vertical and horizontal
Fixing:	35 mm DIN rail			35 mm DIN rail
Clamps only for Cu:	18-4 AWG (0.75 ... 25 mm ²)			18-4 AWG (0.75 ... 25 mm ²)
Service life, mech. and at rated load:	20,000 operations		6000 operations (AC) 1 cycle (1s-ON, 9S-OFF)	20,000 operations
Tightening torque:	25 in. lbs (2.8 Nm)			25 in. lbs (2.8 Nm)
Ambient temperature:	- 25 °C ... + 55 °C/- 13 °F ... + 131 °F			- 25 °C ... + 55 °C/- 13 °F ... + 131 °F
Shock resistance:	30 g at least 2 impacts shock, duration 13 ms		25 g, 2 shocks - 13ms	30 g at least 2 impacts shock, duration 13 ms

Auxiliary contact S2C-H6RU and S2C-S6RU

Rated current:	10
Rated voltage AC / DC:	24
Contact:	1 pole double throw
Connection capacity mm ²	18 - 14 AWG (0.75...2.5 mm ²)
Tightening torque:	11 in.lbs (1.2 Nm)
Shock resistance acc. to DIN IEC 68-2-6:	5 g, 20 frequency cycles 5...150...5 Hz at 24 VAC/DC, 5 mA auto-reclosing < 10 ms
Mechanical service life:	10,000 operations

Shunt trip		Type	S2C-A1U	S2C-A2U
Rated voltage	AC	V	12 ... 60	110 ... 415
	DC	V	12 ... 60	110 ... 250
Max. release duration		ms	<10	<10
Min. release voltage	AC	V	7	55
	DC	V	10	80
Consumption on release	AC	VA	40 ... 200	55 ... 210
	DC	VA	40 ... 200	55 ... 110
Coil resistance		Ω	3.7	225
Terminals		AWG/mm ²	18...6 / 0.75 - 16	18...6 / 0.75 - 16
Tightening torque		in.lbs/Nm	18 / 2	18 / 2

⊕ Poles connected in series.

Technical data

S200U, S200UP, SU200PR & S200UDC

UL 489, CSA 22.2 No. 5

Internal resistance and power loss

Internal resistance per pole in mΩ, power loss per pole in W.

Type	Rated current A	Device series K		Device series Z	
		mΩ	W	mΩ	W
S200U S200UP	0.2	42500	1.7	–	–
	0.3	20000	1.8	–	–
	0.5	6340	1.6	10100	2.5
	0.75	2500	1.4	–	–
	1	1400	1.4	2270	2.3
	1.6	625	1.6	1100	2.8
	2	460	1.8	619	2.5
	3	211	1.9	211	1.9
	4	163	2.6	163	2.6
	6	67	2.4	104	3.7
	8	45	2.9	55	3.5
	10	19	1.9	21	2.1
	13	–	–	–	–
	16	8.2	2.1	10.9	2.8
	20	7.3	2.9	7.3	2.9
	25	5.6	3.5	5.6	3.5
	32	4.1	4.2	4.1	4.2
	40	4.0	6.4	4.0	6.4
	50	1.2	3.0	1.8	4.4
	63	1.3	5.2	1.3	5.2

Type	Rated current A	Device series K		Device series Z	
		mΩ	W	mΩ	W
S200UDC	1	1400	1.4	2270	2.3
	1.6	625	1.6	1100	2.8
	2	460	1.8	619	2.5
	3	211	1.9	211	1.9
	4	153	2.6	163	2.5
	6	67	2.4	104	3.7
	8	45	2.9	55	3.5
	10	19	1.9	21	2.1
	13	–	–	–	–
	16	8.2	2.1	10.9	2.8
	20	7.3	2.0	7.3	2.9
	25	5.6	3.5	5.6	3.5
	32	4.1	4.2	4.1	4.2
	40	4.0	6.4	4.0	6.4
	50	1.2	3.0	1.8	4.4
	63	1.3	5.2	1.3	5.2

SU200PR

Rated current A	Internal resistance per pole ¹⁾	
	mΩ	Power loss per pole ¹⁾ W
0.2	25300	1.01
0.3	13700	1.23
0.5	4740	1.19
0.75	2067	1.16
1	1270	1.27
1.5	610	1.56
2	442	1.77
3	140	1.26
4	109	1.75
5	50	1.26
6	54	1.94
8	22	1.41
10	18.2	1.82
13	14.8	2.50
15	8.1	1.83
16	11.1	2.83
20	8.5	3.40
25	5.5	3.43
30	3.8	3.39
32	4.6	4.70
35	3.9	4.76
40	2.8	4.40
50	1.7	4.25
60	1.7	6.18
63	1.9	7.56

⁴⁾ Internal resistances and power loss are subject to application-specific and environment-specific conditions and are therefore to be considered as typical values.

Technical data

S200U, S200UP, SU200PR & S200UDC

UL 489, CSA 22.2 No. 5

Tripping characteristic K (68 °F)

Breaker calibration temperature 68°F
See chart below for temperature DeRating

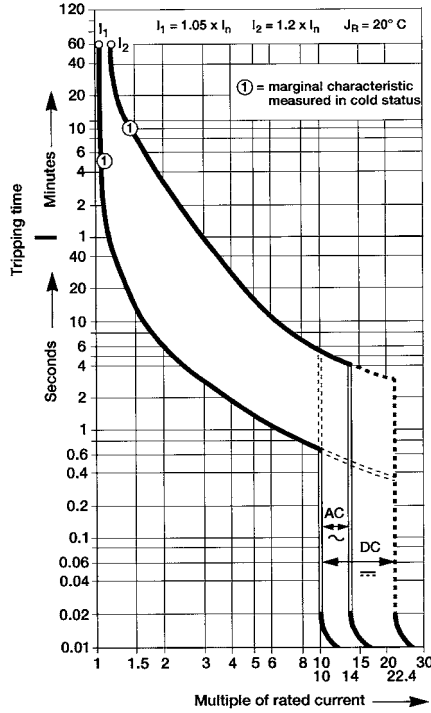

Tripping characteristic Z (68 °F)

Breaker calibration temperature 68°F
See chart below for temperature DeRating

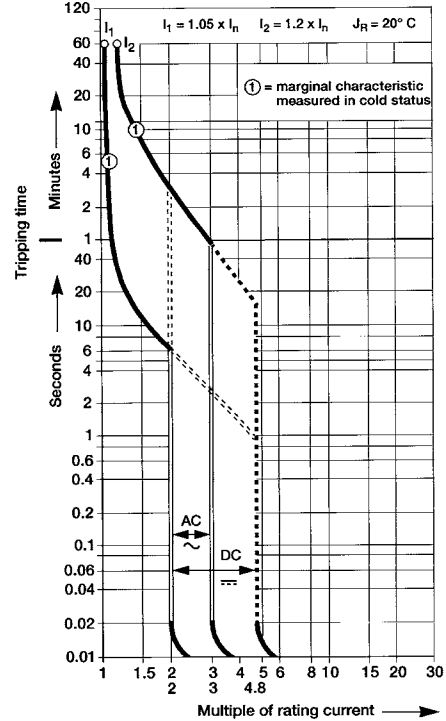

Temperature derating

Max. operating current values depending on the ambient temperature for a circuit-breaker of characteristics type K and Z

K and Z I_n (A)	Ambient temperature T (°C/°F)												
	-40/-40	-30/-22	-20/-4	-10/14	0/32	10/50	20/68	30/86	40/104	50/122	60/140	70/158	
0.5	0.66	0.64	0.61	0.59	0.56	0.53	0.50	0.47	0.43	0.40	0.35	0.31	
1.0	1.32	1.27	1.22	1.17	1.12	1.06	1.00	0.94	0.87	0.79	0.71	0.61	
1.6	2.12	2.04	1.96	1.88	1.79	1.70	1.60	1.50	1.39	1.26	1.13	0.98	
2.0	2.65	2.55	2.45	2.35	2.24	2.12	2.00	1.87	1.73	1.58	1.41	1.22	
3.0	4.0	3.8	3.7	3.5	3.4	3.2	3.0	2.8	2.6	2.4	2.1	1.8	
4.0	5.3	5.1	4.9	4.7	4.5	4.2	4.0	3.7	3.5	3.2	2.8	2.4	
6.0	7.9	7.6	7.3	7.0	6.7	6.4	6.0	5.6	5.2	4.7	4.2	3.7	
8.0	10.8	10.2	9.8	9.4	8.9	8.5	8.0	7.5	6.9	6.3	5.7	4.9	
10.0	13.2	12.7	12.2	11.7	11.2	10.6	10.0	9.4	8.7	7.9	7.1	6.1	
13.0	17.2	16.6	15.9	15.2	14.5	13.8	13.0	12.2	11.3	10.3	9.2	8.0	
16.0	21.2	20.4	19.6	18.8	17.9	17.0	16.0	15.0	13.9	12.6	11.3	9.8	
20.0	26.5	25.5	24.5	23.5	22.4	21.2	20.0	18.7	17.3	15.8	14.1	12.2	
25.0	33.1	31.9	30.6	29.3	28.0	26.5	25.0	23.4	21.7	19.8	17.7	15.3	
32.0	42.3	40.8	39.2	37.5	35.8	33.9	32.0	29.9	27.7	25.3	22.6	19.6	
40.0	52.9	51.0	49.0	46.9	44.7	42.4	40.0	37.4	34.6	31.6	28.3	24.5	
50.0	66.1	63.7	61.2	58.6	55.9	53.0	50.0	46.8	43.3	39.5	35.4	30.6	
63.0	83.3	80.3	77.2	73.9	70.4	66.8	63.0	58.9	54.6	49.8	44.5	38.6	

Approximate dimensions

S200U, S200UP, S200UDC & SU200PR
UL 489, CSA 22.2 No. 5

Approximate dimensions in mm

S200U

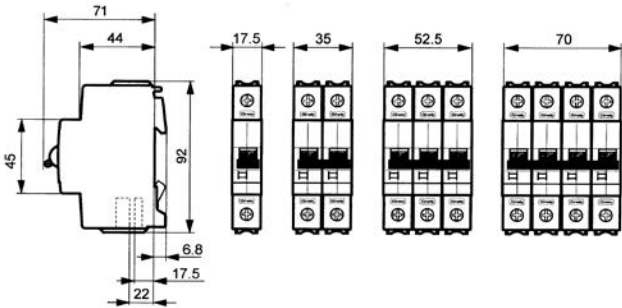

S200UDC

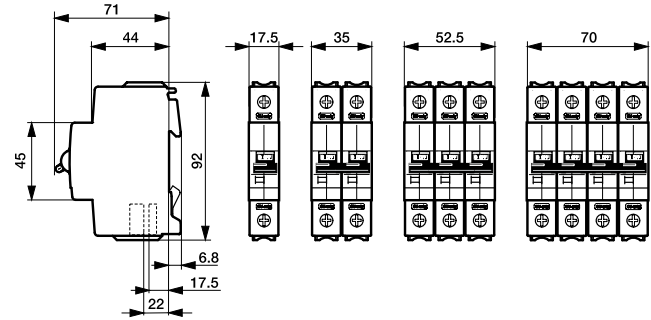

S200UP

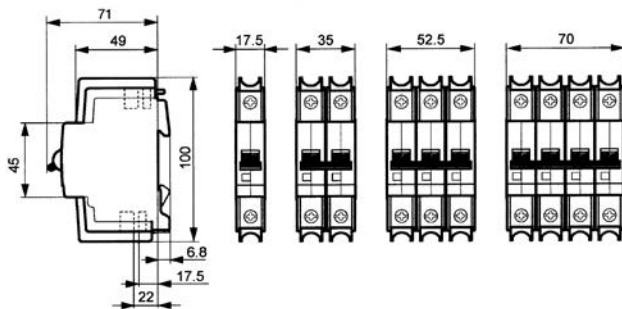

SU200PR

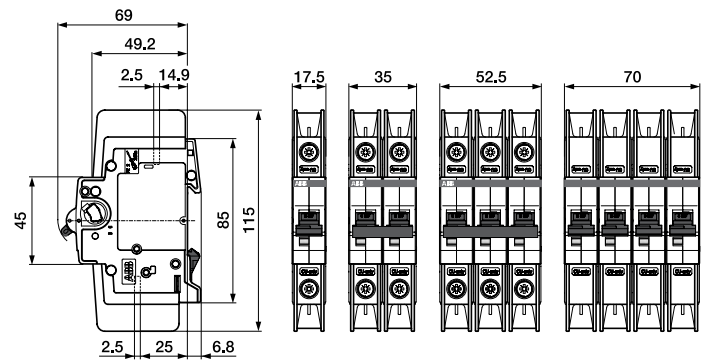

S2C-H6RU, S2C-S6RU S2C-A..U

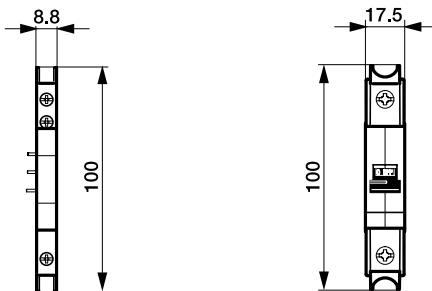

S200 UL 1077 Series Supplementary protective devices



S200

Supplementary protective devices
UL 1077 Series



Description

The S200 UL 1077 Series miniature supplementary protector offers a compact solution for protection requirements. The S200 devices are DIN rail mounted.

The S200 is available with application-specific trip characteristics to provide maximum circuit protection.

The supplementary protectors offer thermal-magnetic trip protection according to B, C, D, K and Z characteristics.

For the worldwide market, the breakers carry UL, CSA, IEC, CE and many other agency approvals and certifications.

Features

- Energy limiting
- Fast breaking time (2.3 – 2.5 ms)
- Bus connection system
- Wide range of accessories
- Available with variable depth handle mechanism
- CE certified and marked
- DIN rail mounting
- Finger safe terminals
- Multi-function terminals
- Suitable for reverse feed
- UL1077 Recognized supplemental protective device. UL file # E76126

	S200	S200P	S200PR	S280UC
Amperage	0.5 – 63 A	0.2 – 63 A	0.2 – 63A	0.2 – 63 A
Voltage	480Y/277 VAC	480Y/277 VAC	240 VAC	250/500 VDC
Poles	1, 2, 3, 4	1, 2, 3, 4	1, 2, 3, 4	1, 2, 3, 4
Trip characteristics	B, C, D, K	B, C, D, K, Z	K	K, Z
Interrupting ratings	6 kA: IEC 60898 6 kA: UL 1077 6 kA: CSA 22.2 No. 235	Up to 25kA: IEC 60947-2 10kA: UL 1077	10kA: UL1077 10kA: CSA 22.2 No.235	Up to 6kA: IEC 60947-2 10kA: UL 1077 6 kA: CSA 22.2 No. 235
Auxiliary contacts	Yes	Yes	Yes	Yes
Bell alarm	Yes	Yes	Yes	Yes
Shunt trip	Yes	Yes	Yes	Yes
Undervoltage release	Yes	Yes	Yes	Yes
Bus bar	Yes	Yes	No	Yes

S200-B, 480Y/277 VAC

Supplemental protectors
UL 1077, CSA 22.2, No. 235

B



S201-B



S203-B

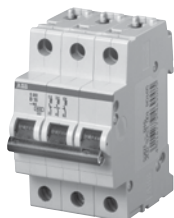

S203-B

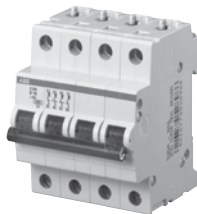

S204-B

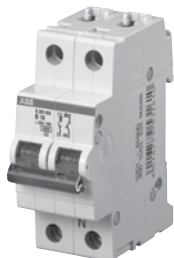

S201-BNA

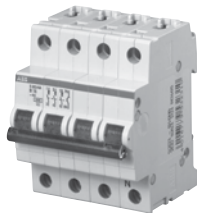

S203-BNA

No. of poles	Rated current	Catalog number	No. of poles	Rated current	Catalog number
1	6	S201-B6	3	6	S203-B6
	10	S201-B10		10	S203-B10
	13	S201-B13		13	S203-B13
	16	S201-B16		16	S203-B16
	20	S201-B20		20	S203-B20
	25	S201-B25		25	S203-B25
	32	S201-B32		32	S203-B32
	40	S201-B40		40	S203-B40
	50	S201-B50		50	S203-B50
	63	S201-B63		63	S203-B63
1 + NA	6	S201-B6NA	3 + NA	6	S203-B6NA
	10	S201-B10NA		10	S203-B10NA
	13	S201-B13NA		13	S203-B13NA
	16	S201-B16NA		16	S203-B16NA
	20	S201-B20NA		20	S203-B20NA
	25	S201-B25NA		25	S203-B25NA
	32	S201-B32NA		32	S203-B32NA
	40	S201-B40NA		40	S203-B40NA
	50	S201-B50NA		50	S203-B50NA
	63	S201-B63NA		63	S203-B63NA
2	6	S202-B6	4	6	S204-B6
	10	S202-B10		10	S204-B10
	13	S202-B13		13	S204-B13
	16	S202-B16		16	S204-B16
	20	S202-B20		20	S204-B20
	25	S202-B25		25	S204-B25
	32	S202-B32		32	S204-B32
	40	S202-B40		40	S204-B40
	50	S202-B50		50	S204-B50
	63	S202-B63		63	S204-B63

Tripping characteristic B

UL 1077
480Y/277VAC
6 kA

Resistive loads

- B Curve
- Designed for use in cable protection applications
- Example: control circuits, lighting

Accessories & technical data

Accessories – See page 15.31 - 15.34
Technical data – See page 15.35 - 15.36

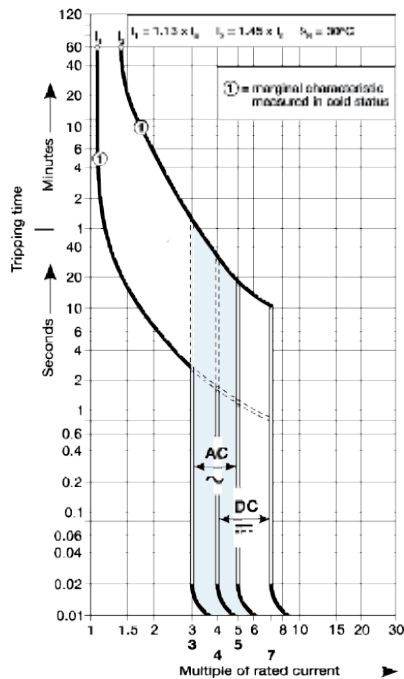

Note: Switching neutral is noted by "NA" in the catalog number.

S200-C, 480Y/277 VAC

Supplemental protectors

UL 1077, CSA 22.2, No. 235

C



S201-C



S202-C

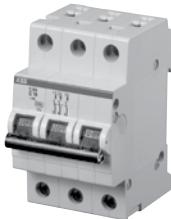

S203-C

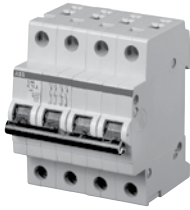

S204-C



S201-CNA

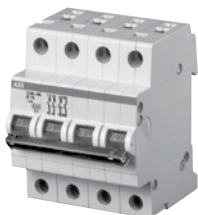

S203-CNA

No. of poles	Rated current	Catalog number	No. of poles	Rated current	Catalog number		
1	0.5	S201-C0.5	3	0.5	S203-C0.5		
	1	S201-C1		1	S203-C1		
	1.6	S201-C1.6		1.6	S203-C1.6		
	2	S201-C2		2	S203-C2		
	3	S201-C3		3	S203-C3		
	4	S201-C4		4	S203-C4		
	6	S201-C6		6	S203-C6		
	8	S201-C8		8	S203-C8		
	10	S201-C10		10	S203-C10		
	13	S201-C13		13	S203-C13		
	16	S201-C16		16	S203-C16		
	20	S201-C20		20	S203-C20		
	25	S201-C25		25	S203-C25		
	1 + NA	32		S201-C32	3 + NA	32	S203-C32
40		S201-C40	40	S203-C40			
50		S201-C50	50	S203-C50			
63		S201-C63	63	S203-C63			
0.5		S201-C0.5NA	0.5	S203-C0.5NA			
1		S201-C1NA	1	S203-C1NA			
1 + NA	1.6	S201-C1.6NA	3 + NA	1.6	S203-C1.6NA		
	2	S201-C2NA		2	S203-C2NA		
	3	S201-C3NA		3	S203-C3NA		
	4	S201-C4NA		4	S203-C4NA		
	6	S201-C6NA		6	S203-C6NA		
	8	S201-C8NA		8	S203-C8NA		
	10	S201-C10NA		10	S203-C10NA		
	13	S201-C13NA		13	S203-C13NA		
	16	S201-C16NA		16	S203-C16NA		
	20	S201-C20NA		20	S203-C20NA		
	25	S201-C25NA		25	S203-C25NA		
	32	S201-C32NA		32	S203-C32NA		
	1 + NA	40		S201-C40NA	3 + NA	40	S203-C40NA
		50		S201-C50NA		50	S203-C50NA
63		S201-C63NA	63	S203-C63NA			
0.5		S202-C0.5	4	0.5		S204-C0.5	
1		S202-C1		1		S204-C1	
1.6		S202-C1.6		1.6		S204-C1.6	
2	S202-C2	2		S204-C2			
3	S202-C3	3		S204-C3			
4	S202-C4	4		S204-C4			
6	S202-C6	6		S204-C6			
8	S202-C8	8		S204-C8			
10	S202-C10	10		S204-C10			
13	S202-C13	13		S204-C13			
16	S202-C16	16		S204-C16			
20	S202-C20	20		S204-C20			
25	S202-C25	25		S204-C25			
2	32	S202-C32		4	32	S204-C32	
	40	S202-C40	40		S204-C40		
	50	S202-C50	50		S204-C50		
	63	S202-C63	63		S204-C63		

Tripping characteristic C

UL 1077
480Y/277 VAC
6 kA

Resistive loads

- C Curve
- Designed for use with medium magnetic start up currents
- Example: lighting, control panels

Accessories & technical data

Accessories – See page 15.31 - 15.34

Technical data – See page 15.35 - 15.36

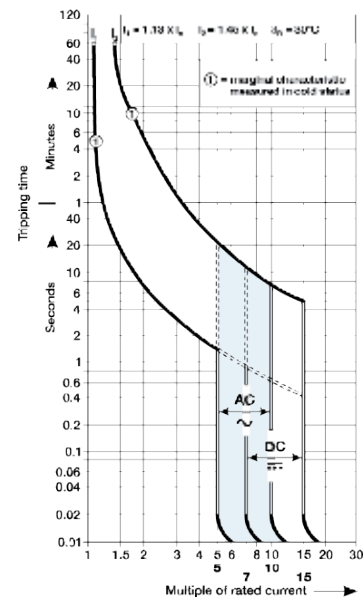

Note: Switching neutral is noted by "NA" in the catalog number.

S200-D, 480Y/277 VAC

Supplemental protectors

UL 1077, CSA 22.2, No. 235

D



S201-D



S202-D

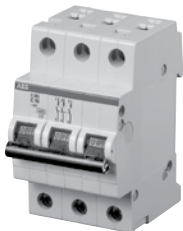

S203-D

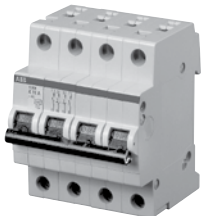

S204-D



S201-DNA

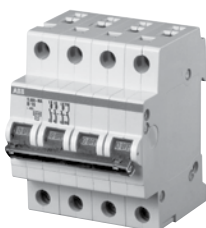

S203-DNA

No. of poles	Rated current	Catalog number	No. of poles	Rated current	Catalog number	
1	0.5	S201-D0.5	3	0.5	S203-D0.5	
	1	S201-D1		1	S203-D1	
	1.6	S201-D1.6		1.6	S203-D1.6	
	2	S201-D2		2	S203-D2	
	3	S201-D3		3	S203-D3	
	4	S201-D4		4	S203-D4	
	6	S201-D6		6	S203-D6	
	8	S201-D8		8	S203-D8	
	10	S201-D10		10	S203-D10	
	13	S201-D13		13	S203-D13	
	16	S201-D16		16	S203-D16	
	20	S201-D20		20	S203-D20	
	25	S201-D25		25	S203-D25	
		32		S201-D32	32	S203-D32
		40		S201-D40	40	S203-D40
		50		S201-D50	50	S203-D50
		63		S201-D63	63	S203-D63
	1 + NA	0.5		S201-D0.5NA	3 + NA	0.5
1		S201-D1NA	1	S203-D1NA		
1.6		S201-D1.6NA	1.6	S203-D1.6NA		
2		S201-D2NA	2	S203-D2NA		
3		S201-D3NA	3	S203-D3NA		
4		S201-D4NA	4	S203-D4NA		
6		S201-D6NA	6	S203-D6NA		
8		S201-D8NA	8	S203-D8NA		
10		S201-D10NA	10	S203-D10NA		
13		S201-D13NA	13	S203-D13NA		
16		S201-D16NA	16	S203-D16NA		
20		S201-D20NA	20	S203-D20NA		
25		S201-D25NA	25	S203-D25NA		
		32	S201-D32NA	32		S203-D32NA
		40	S201-D40NA	40		S203-D40NA
		50	S201-D50NA	50		S203-D50NA
		63	S201-D63NA	63		S203-D63NA
2		0.5	S202-D0.5	4		0.5
	1	S202-D1	1		S204-D1	
	1.6	S202-D1.6	1.6		S204-D1.6	
	2	S202-D2	2		S204-D2	
	3	S202-D3	3		S204-D3	
	4	S202-D4	4		S204-D4	
	6	S202-D6	6		S204-D6	
	8	S202-D8	8		S204-D8	
	10	S202-D10	10		S204-D10	
	13	S202-D13	13		S204-D13	
	16	S202-D16	16		S204-D16	
	20	S202-D20	20		S204-D20	
	25	S202-D25	25		S204-D25	
		32	S202-D32		32	S204-D32
		40	S202-D40		40	S204-D40
		50	S202-D50		50	S204-D50
		63	S202-D63		63	S204-D63

Tripping characteristic D

UL 1077
480Y/277 VAC
6 kA

Inductive loads

- D Curve
- Designed for allowing higher in-rush currents during system start up
- Example: motors, transformers

Accessories & technical data

Accessories – See page 15.31 - 15.34

Technical data – See page 15.35 - 15.36

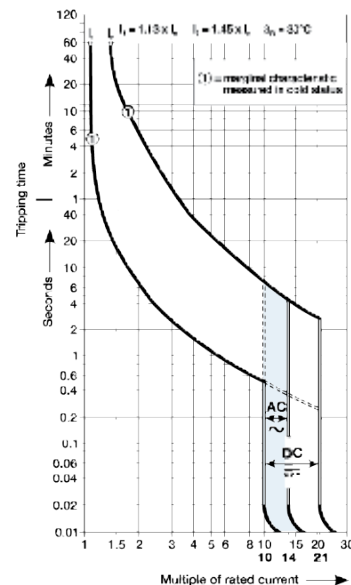

Note: Switching neutral is noted by "NA" in the catalog number.

S200-K, 480Y/277 VAC

Supplemental protectors

UL 1077, CSA 22.2, No. 235

K



S201-K



S202-K



S203-K



S204-K



S201-KNA

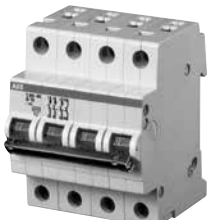

S203-KNA

No. of poles	Rated current	Catalog number	No. of poles	Rated current	Catalog number
1	0.5	S201-K0.5	3	0.5	S203-K0.5
	1	S201-K1		1	S203-K1
	1.6	S201-K1.6		1.6	S203-K1.6
	2	S201-K2		2	S203-K2
	3	S201-K3		3	S203-K3
	4	S201-K4		4	S203-K4
	5	S201-K5		5	S203-K5
	6	S201-K6		6	S203-K6
	8	S201-K8		8	S203-K8
	10	S201-K10		10	S203-K10
	13	S201-K13		13	S203-K13
	15	S201-K15		15	S203-K15
	16	S201-K16		16	S203-K16
	20	S201-K20		20	S203-K20
25	S201-K25	25	S203-K25		
1 + NA	0.5	S201-K0.5NA	3 + NA	0.5	S203-K0.5NA
	1	S201-K1NA		1	S203-K1NA
	1.6	S201-K1.6NA		1.6	S203-K1.6NA
	2	S201-K2NA		2	S203-K2NA
	3	S201-K3NA		3	S203-K3NA
	4	S201-K4NA		4	S203-K4NA
	6	S201-K6NA		6	S203-K6NA
	8	S201-K8NA		8	S203-K8NA
	10	S201-K10NA		10	S203-K10NA
	13	S201-K13NA		13	S203-K13NA
	16	S201-K16NA		16	S203-K16NA
	20	S201-K20NA		20	S203-K20NA
	25	S201-K25NA		25	S203-K25NA
	32	S201-K32NA		32	S203-K32NA
40	S201-K40NA	40	S203-K40NA		
50	S201-K50NA	50	S203-K50NA		
63	S201-K63NA	63	S203-K63NA		
2	0.5	S202-K0.5	4	0.5	S204-K0.5
	1	S202-K1		1	S204-K1
	1.6	S202-K1.6		1.6	S204-K1.6
	2	S202-K2		2	S204-K2
	3	S202-K3		3	S204-K3
	4	S202-K4		4	S204-K4
	5	S202-K5		5	S204-K5
	6	S202-K6		6	S204-K6
	8	S202-K8		8	S204-K8
	10	S202-K10		10	S204-K10
	13	S202-K13		13	S204-K13
	15	S202-K15		15	S204-K15
	16	S202-K16		16	S204-K16
	20	S202-K20		20	S204-K20
25	S202-K25	25	S204-K25		
32	S202-K32	32	S204-K32		
40	S202-K40	40	S204-K40		
50	S202-K50	50	S204-K50		
60	S202-K60	60	S204-K60		
63	S202-K63	63	S204-K63		

Tripping characteristic K

UL 1077
480Y/277 VAC
6 kA

Inductive loads

- K Curve
- Designed for allowing higher in-rush currents during system start up
- Example: motors, transformers

Accessories & technical data

Accessories – See page 15.31 - 15.34

Technical data – See page 15.35 - 15.36

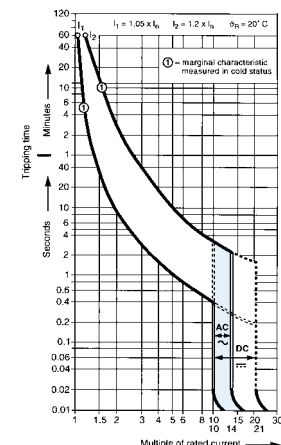

Note: Switching neutral is noted by "NA" in the catalog number.

S200-Z, 480Y/277 VAC

Supplemental protectors

UL 1077, CSA 22.2, No. 235

Z



S201-Z0.5



S202-Z0.5



S203-Z0.5



S204-Z0.5

No. of poles	Rated current	Catalog number	No. of poles	Rated current	Catalog number
1	0.5	S201-Z0.5	3	0.5	S203-Z0.5
	1	S201-Z1		1	S203-Z1
	1.6	S201-Z1.6		1.6	S203-Z1.6
	2	S201-Z2		2	S203-Z2
	3	S201-Z3		3	S203-Z3
	4	S201-Z4		4	S203-Z4
	6	S201-Z6		6	S203-Z6
	10	S201-Z10		10	S203-Z10
	13	S201-Z13		13	S203-Z13
	16	S201-Z16		16	S203-Z16
	20	S201-Z20		20	S203-Z20
	25	S201-Z25		25	S203-Z25
	32	S201-Z32		32	S203-Z32
2	0.5	S202-Z0.5	4	0.5	S204-Z0.5
	1	S202-Z1		1	S204-Z1
	1.6	S202-Z1.6		1.6	S204-Z1.6
	2	S202-Z2		2	S204-Z2
	3	S202-Z3		3	S204-Z3
	4	S202-Z4		4	S204-Z4
	6	S202-Z6		6	S204-Z6
	10	S202-Z10		10	S204-Z10
	13	S202-Z13		13	S204-Z13
	16	S202-Z16		16	S204-Z16
	20	S202-Z20		20	S204-Z20
	25	S202-Z25		25	S204-Z25
	32	S202-Z32		32	S204-Z32
40	S202-Z40	40	S204-Z40		
50	S202-Z50	50	S204-Z50		
63	S202-Z63	63	S204-Z63		

Tripping characteristic Z

UL 1077
480Y/277VAC
6 kA

Resistive loads

- Z Curve
- Designed to provide maximum protection with a very low short circuit trip setting
- Example: semiconductors

Accessories & technical data

Accessories – See page 15.31 - 15.34

Technical data – See page 15.35 - 15.36

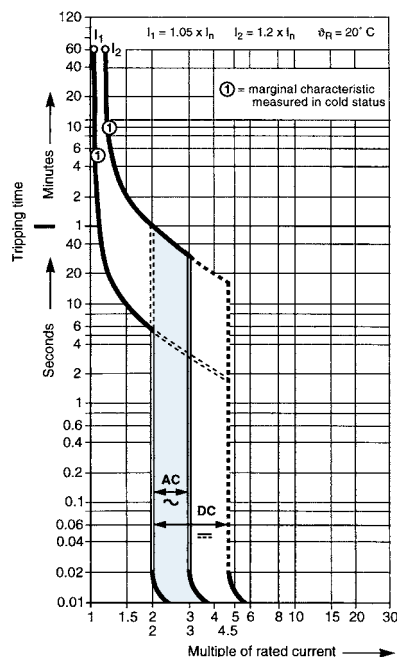

S200P-B, 480Y/277 VAC

Supplemental protectors
UL 1077, CSA 22.2, No. 235

B



S210P-B6



S210P-B6

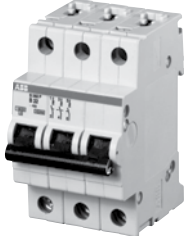

S210P-B6



S210P-B6

No. of poles	Rated current	Catalog number	No. of poles	Rated current	Catalog number
1	6	S201P-B6	3	6	S203P-B6
	10	S201P-B10		10	S203P-B10
	13	S201P-B13		13	S203P-B13
	16	S201P-B16		16	S203P-B16
	20	S201P-B20		20	S203P-B20
	25	S201P-B25		25	S203P-B25
	32	S201P-B32		32	S203P-B32
	40	S201P-B40		40	S203P-B40
	50	S201P-B50		50	S203P-B50
	63	S201P-B63	63	S203P-B63	
2	6	S202P-B6	4	6	S204P-B6
	10	S202P-B10		10	S204P-B10
	13	S202P-B13		13	S204P-B13
	16	S202P-B16		16	S204P-B16
	20	S202P-B20		20	S204P-B20
	25	S202P-B25		25	S204P-B25
	32	S202P-B32		32	S204P-B32
	40	S202P-B40		40	S204P-B40
	50	S202P-B50		50	S204P-B50
	63	S202P-B63	63	S204P-B63	

Tripping characteristic B

UL 1077
480Y/277 VAC
10 kA

Resistive loads

- B Curve
- Designed for use in cable protection applications
- Example: Control circuits, lighting

Accessories & technical data

Accessories – See page 15.31 - 15.34

Technical data – See page 15.35 - 15.36

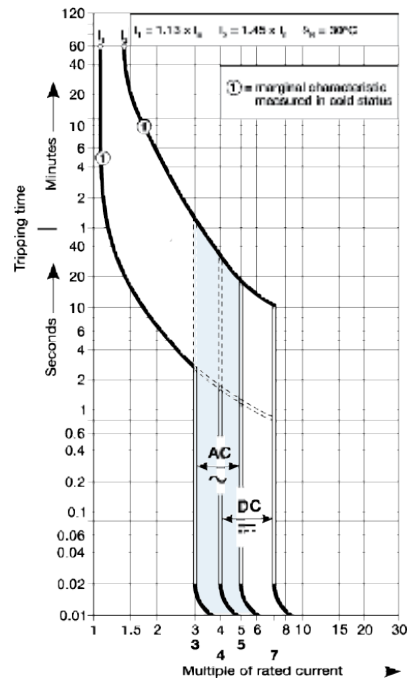

S200P-C, 480Y/277 VAC

Supplemental protectors

UL 1077, CSA 22.2, No. 235

C



S210P-B6



S210P-B6



S210P-B6

No. of poles	Rated current	Catalog number	No. of poles	Rated current	Catalog number
1	0.5	S201P-C0.5	3	0.5	S203P-C0.5
	1	S201P-C1		1	S203P-C1
	1.6	S201P-C1.6		1.6	S203P-C1.6
	2	S201P-C2		2	S203P-C2
	3	S201P-C3		3	S203P-C3
	4	S201P-C4		4	S203P-C4
	6	S201P-C6		6	S203P-C6
	8	S201P-C8		8	S203P-C8
	10	S201P-C10		10	S203P-C10
	13	S201P-C13		13	S203P-C13
	16	S201P-C16		16	S203P-C16
	20	S201P-C20		20	S203P-C20
	2	0.5		S202P-C0.5	
1		S202P-C1	1	S203P-C1	
1.6		S202P-C1.6	1.6	S203P-C1.6	
2		S202P-C2	2	S203P-C2	
3		S202P-C3	3	S203P-C3	
4		S202P-C4	4	S203P-C4	
6		S202P-C6	6	S203P-C6	
8		S202P-C8	8	S203P-C8	
10		S202P-C10	10	S203P-C10	
13		S202P-C13	13	S203P-C13	
16		S202P-C16	16	S203P-C16	
20		S202P-C20	20	S203P-C20	
25		S202P-C25	25	S203P-C25	
32	S202P-C32	32	S203P-C32		
40	S202P-C40	40	S203P-C40		
50	S202P-C50	50	S203P-C50		
63	S202P-C63	63	S203P-C63		

Tripping characteristic C

UL 1077
480Y/277 VAC
10 kA

Resistive loads

- C Curve
- Designed for use with medium magnetic start up currents
- Example: Lighting, control panels

Accessories & technical data

Accessories – See page 15.31 - 15.34

Technical data – See page 15.35 - 15.36

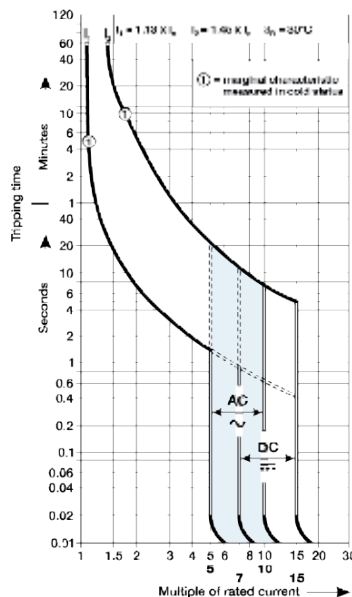

S200P-D, 480Y/277 VAC

Supplemental protectors

UL 1077, CSA 22.2, No. 235

D



S201P-D0.5



S202P-D0.5

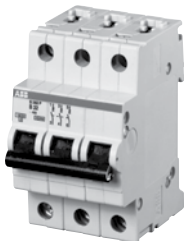

S203P-D0.5

No. of poles	Rated current	Catalog number	No. of poles	Rated current	Catalog number
1	0.5	S201P-D0.5	3	0.5	S203P-D0.5
	1	S201P-D1		1	S203P-D1
	1.6	S201P-D1.6		1.6	S203P-D1.6
	2	S201P-D2		2	S203P-D2
	3	S201P-D3		3	S203P-D3
	4	S201P-D4		4	S203P-D4
	6	S201P-D6		6	S203P-D6
	8	S201P-D8		8	S203P-D8
	10	S201P-D10		10	S203P-D10
	13	S201P-D13		13	S203P-D13
	16	S201P-D16		16	S203P-D16
	20	S201P-D20		20	S203P-D20
	25	S201P-D25		25	S203P-D25
	32	S201P-D32		32	S203P-D32
40	S201P-D40	40	S203P-D40		
50	S201P-D50	50	S203P-D50		
63	S201P-D63	63	S203P-D63		
2	0.5	S202P-D0.5			
	1	S202P-D1			
	1.6	S202P-D1.6			
	2	S202P-D2			
	3	S202P-D3			
	4	S202P-D4			
	6	S202P-D6			
	8	S202P-D8			
	10	S202P-D10			
	13	S202P-D13			
	16	S202P-D16			
	20	S202P-D20			
	25	S202P-D25			
	32	S202P-D32			
40	S202P-D40				
50	S202P-D50				
63	S202P-D63				

Tripping characteristic D

UL 1077
480Y/277 VAC
10 kA

Inductive loads

- D Curve
- Designed for allowing higher in-rush currents during system start up
- Example: motors, transformers

Accessories & technical data

Accessories – See page 15.31 - 15.34

Technical data – See page 15.35 - 15.36

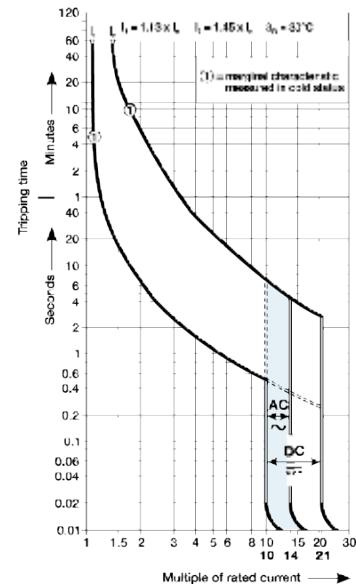

S200P-K, 480Y/277 VAC

Supplemental protectors

UL 1077, CSA 22.2, No. 235

K



S201P-K



S202P-K



S203P-K

No. of poles	Rated current	Catalog number	No. of poles	Rated current	Catalog number
1	0.2	S201P-K0.2	3	0.2	S203P-K0.2
	0.3	S201P-K0.3		0.3	S203P-K0.3
	0.5	S201P-K0.5		0.5	S203P-K0.5
	0.75	S201P-K0.75		0.75	S203P-K0.75
	1	S201P-K1		1	S203P-K1
	1.6	S201P-K1.6		1.6	S203P-K1.6
	2	S201P-K2		2	S203P-K2
	3	S201P-K3		3	S203P-K3
	4	S201P-K4		4	S203P-K4
	6	S201P-K6		6	S203P-K6
	8	S201P-K8		8	S203P-K8
	10	S201P-K10		10	S203P-K10
	13	S201P-K13		13	S203P-K13
	16	S201P-K16		16	S203P-K16
20	S201P-K20	20	S203P-K20		
25	S201P-K25	25	S203P-K25		
32	S201P-K32	32	S203P-K32		
2	40	S201P-K40	3	40	S203P-K40
	50	S201P-K50		50	S203P-K50
	63	S201P-K63		63	S203P-K63
	0.2	S202P-K0.2		0.2	S202P-K0.2
	0.3	S202P-K0.3		0.3	S202P-K0.3
	0.5	S202P-K0.5		0.5	S202P-K0.5
	0.75	S202P-K0.75		0.75	S202P-K0.75
	1	S202P-K1		1	S202P-K1
	1.6	S202P-K1.6		1.6	S202P-K1.6
	2	S202P-K2		2	S202P-K2
3	S202P-K3	3	S202P-K3		
4	S202P-K4	4	S202P-K4		
6	S202P-K6	6	S202P-K6		
8	S202P-K8	8	S202P-K8		
10	S202P-K10	10	S202P-K10		
13	S202P-K13	13	S202P-K13		
16	S202P-K16	16	S202P-K16		
20	S202P-K20	20	S202P-K20		
25	S202P-K25	25	S202P-K25		
32	S202P-K32	32	S202P-K32		
40	S202P-K40	40	S202P-K40		
50	S202P-K50	50	S202P-K50		
63	S202P-K63	63	S202P-K63		

Tripping characteristic K

UL 1077
480Y/277 VAC
10 kA

Inductive loads

- K Curve
- Designed for allowing higher in-rush currents during system start up
- Example: motors, transformers

Accessories & technical data

Accessories – See page 15.31 - 15.34

Technical data – See page 15.35 - 15.36

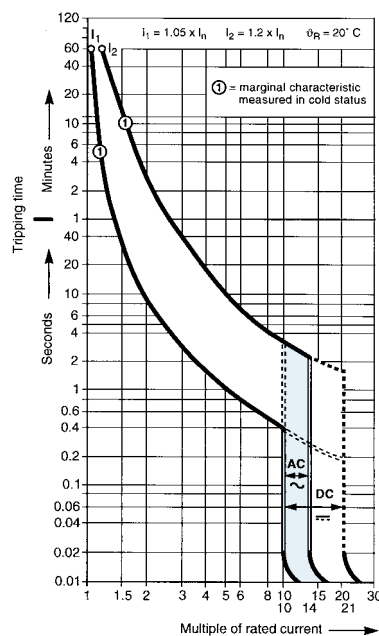

S200P-Z, 480Y/277 VAC
Supplemental protectors
UL 1077, CSA 22.2, No. 235

Z

No. of poles	Rated current	Catalog number	No. of poles	Rated current	Catalog number		
1	0.5	S201P-Z0.5	3	0.5	S203P-Z0.5		
	1	S201P-Z1		1	S203P-Z1		
	1.6	S201P-Z1.6		1.6	S203P-Z1.6		
	2	S201P-Z2		2	S203P-Z2		
	3	S201P-Z3		3	S203P-Z3		
	4	S201P-Z4		4	S203P-Z4		
	6	S201P-Z6		6	S203P-Z6		
	8	S201P-Z8		8	S203P-Z8		
	10	S201P-Z10		10	S203P-Z10		
	16	S201P-Z16		16	S203P-Z16		
	20	S201P-Z20		20	S203P-Z20		
	25	S201P-Z25		25	S203P-Z25		
	2	0.5		S202P-Z0.5	3	32	S203P-Z32
		1		S202P-Z1		40	S203P-Z40
1.6		S202P-Z1.6	50	S203P-Z50			
2		S202P-Z2	63	S203P-Z63			
3		S202P-Z3					
4		S202P-Z4					
6		S202P-Z6					
8		S202P-Z8					
10		S202P-Z10					
16		S202P-Z16					
20		S202P-Z20					
25		S202P-Z25					
32		S202P-Z32					
40		S202P-Z40					
50	S202P-Z50						
63	S202P-Z63						



S201P-Z



S202P-Z

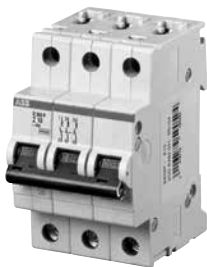

S203P-Z

Tripping characteristic Z

UL 1077
480Y/277 VAC
10 kA

Resistive loads

- Z Curve
- Designed to provide maximum protection with a very low short circuit trip setting
- Example: semiconductors

Accessories & technical data

Accessories – See page 15.31 - 15.34

Technical data – See page 15.35 - 15.36

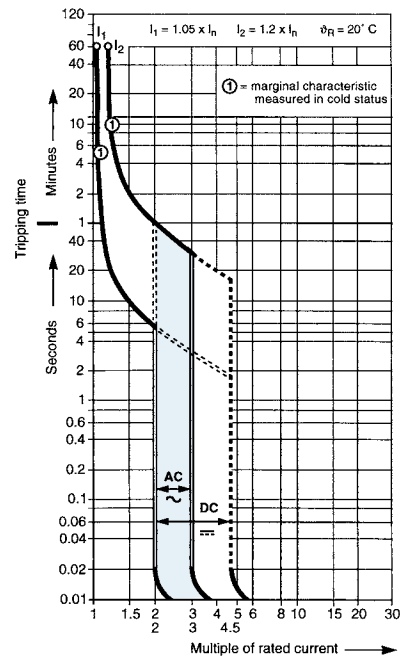

S200PR-K, 240 VAC, Ring tongue

Supplemental protectors

UL1077, CSA 22.2 No. 235

K



S201PR-K0.2



S202PR-K0.2



S203PR-K0.2



S203PR-K0.2

No. of poles	Rated current	Catalog number	No. of poles	Rated current	Catalog number
1	0.2	S201PR-K0.2	3	0.2	S203PR-K0.2
	0.3	S201PR-K0.3		0.3	S203PR-K0.3
	0.5	S201PR-K0.5		0.5	S203PR-K0.5
	0.75	S201PR-K0.75		0.75	S203PR-K0.75
	1	S201PR-K1		1	S203PR-K1
	1.6	S201PR-K1.6		1.6	S203PR-K1.6
	2	S201PR-K2		2	S203PR-K2
	3	S201PR-K3		3	S203PR-K3
	4	S201PR-K4		4	S203PR-K4
	5	S201PR-K5		5	S203PR-K5
	6	S201PR-K6		6	S203PR-K6
	8	S201PR-K8		8	S203PR-K8
	10	S201PR-K10		10	S203PR-K10
	13	S201PR-K13		13	S203PR-K13
	15	S201PR-K15		15	S203PR-K15
	16	S201PR-K16		16	S203PR-K16
	20	S201PR-K20		20	S203PR-K20
25	S201PR-K25	25	S203PR-K25		
30	S201PR-K30	30	S203PR-K30		
32	S201PR-K32	32	S203PR-K32		
35	S201PR-K35	35	S203PR-K35		
40	S201PR-K40	40	S203PR-K40		
50	S201PR-K50	50	S203PR-K50		
60	S201PR-K60	60	S203PR-K60		
63	S201PR-K63	63	S203PR-K63		
2	0.2	S202PR-K0.2	4	0.2	S204PR-K0.2
	0.3	S202PR-K0.3		0.3	S204PR-K0.3
	0.5	S202PR-K0.5		0.5	S204PR-K0.5
	0.75	S202PR-K0.75		0.75	S204PR-K0.75
	1	S202PR-K1		1	S204PR-K1
	1.6	S202PR-K1.6		1.6	S204PR-K1.6
	2	S202PR-K2		2	S204PR-K2
	3	S202PR-K3		3	S204PR-K3
	4	S202PR-K4		4	S204PR-K4
	5	S202PR-K5		5	S204PR-K5
	6	S202PR-K6		6	S204PR-K6
	8	S202PR-K8		8	S204PR-K8
	10	S202PR-K10		10	S204PR-K10
	13	S202PR-K13		13	S204PR-K13
	15	S202PR-K15		15	S204PR-K15
	16	S202PR-K16		16	S204PR-K16
	20	S202PR-K20		20	S204PR-K20
25	S202PR-K25	25	S204PR-K25		
30	S202PR-K30	30	S204PR-K30		
32	S202PR-K32	32	S204PR-K32		
35	S202PR-K35	35	S204PR-K35		
40	S202PR-K40	40	S204PR-K40		
50	S202PR-K50	50	S204PR-K50		
60	S202PR-K60	60	S204PR-K60		
63	S202PR-K63	63	S204PR-K63		

Tripping characteristic K

UL 1077

480Y/277 VAC

10 kA

Inductive loads

- K Curve
- Designed for allowing higher in-rush currents during system start up
- Example: motors, transformers

Accessories & technical data

Accessories – See page 15.31 - 15.34

Technical data – See page 15.35 - 15.36

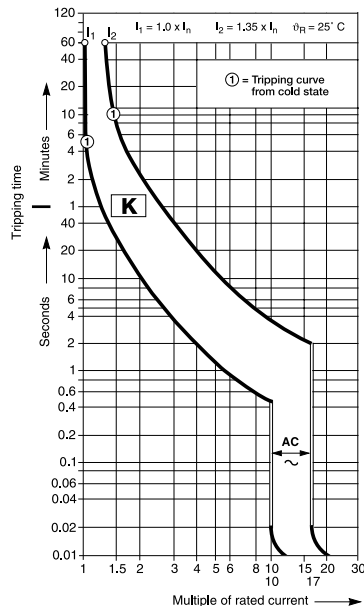

S280UC-K, 500 VDC

Supplemental protectors

UL 1077, CSA 22.2, No. 235

K



S281UC-K



S282UC-K



S283UC-K

No. of poles	Rated current	Catalog number	No. of poles	Rated current	Catalog number
1	0,2	S281UC-K0.2	3	0,2	S283UC-K0.2
	0,3	S281UC-K0.3		0,3	S283UC-K0.3
	0,5	S281UC-K0.5		0,5	S283UC-K0.5
	0,75	S281UC-K0.75		0,75	S283UC-K0.75
	1	S281UC-K1		1	S283UC-K1
	1,6	S281UC-K1.6		1,6	S283UC-K1.6
	2	S281UC-K2		2	S283UC-K2
	3	S281UC-K3		3	S283UC-K3
	4	S281UC-K4		4	S283UC-K4
	6	S281UC-K6		6	S283UC-K6
	8	S281UC-K8		8	S283UC-K8
	10	S281UC-K10		10	S283UC-K10
	16	S281UC-K16		16	S283UC-K16
	20	S281UC-K20		20	S283UC-K20
	25	S281UC-K25		25	S283UC-K25
2	32	S281UC-K32	3	32	S283UC-K32
	40	S281UC-K40		40	S283UC-K40
	50	S281UC-K50		50	S283UC-K50
	63	S281UC-K63		63	S283UC-K63
	0,2	S282UC-K0.2		0,2	S282UC-K0.2
	0,3	S282UC-K0.3		0,3	S282UC-K0.3
	0,5	S282UC-K0.5		0,5	S282UC-K0.5
	0,75	S282UC-K0.75		0,75	S282UC-K0.75
	1	S282UC-K1		1	S282UC-K1
	1,6	S282UC-K1.6		1,6	S282UC-K1.6
2	S282UC-K2	2	S282UC-K2		
3	S282UC-K3	3	S282UC-K3		
4	S282UC-K4	4	S282UC-K4		
6	S282UC-K6	6	S282UC-K6		
8	S282UC-K8	8	S282UC-K8		
10	S282UC-K10	10	S282UC-K10		
16	S282UC-K16	16	S282UC-K16		
20	S282UC-K20	20	S282UC-K20		
25	S282UC-K25	25	S282UC-K25		
32	S282UC-K32	32	S282UC-K32		
40	S282UC-K40	40	S282UC-K40		
50	S282UC-K50	50	S282UC-K50		
63	S282UC-K63	63	S282UC-K63		

Tripping characteristic K

UL 1077
250/500 VDC
10 kA

Inductive loads

- K Curve
- Designed for allowing higher in-rush currents during system start up
- Example: motors, transformer

Accessories & technical data

Accessories – See page 15.31 - 15.34

Technical data – See page 15.35 - 15.36

Direct current applications

The S280UC differs from standard miniature circuit breakers in that the UC versions include a permanent magnet which aids in the extinguishing of the arc during medium and high level faults. It is necessary to observe the correct polarity and current direction when connecting the UC breakers. Two examples of correct connection are shown.

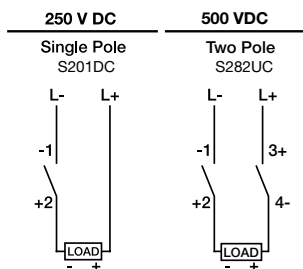

Termination points are marked on all UC type MCBs, points one (1) and four (4) are negative and points two (2) and three (3) are positive.

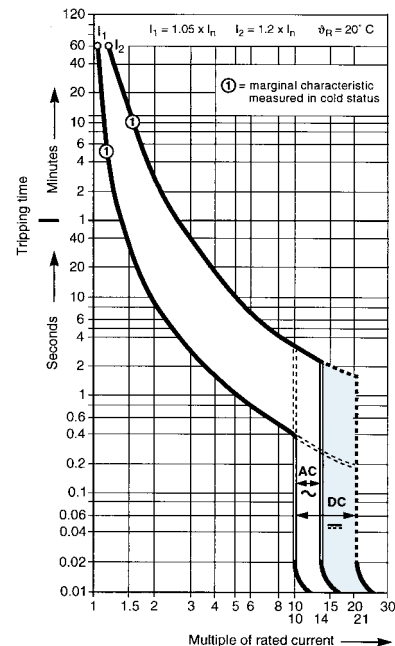

S280UC-Z, 500 VDC

Supplemental protectors

UL 1077, CSA 22.2, No. 235

Z



S281UC-Z



S282UC-Z



S283UC-Z

No. of poles	Rated current	Catalog number	No. of poles	Rated current	Catalog number
1	0.5	S281UC-Z0.5	3	0.5	S283UC-Z0.5
	1	S281UC-Z1		1	S283UC-Z1
	1.6	S281UC-Z1.6		1.6	S283UC-Z1.6
	2	S281UC-Z2		2	S283UC-Z2
	3	S281UC-Z3		3	S283UC-Z3
	4	S281UC-Z4		4	S283UC-Z4
	6	S281UC-Z6		6	S283UC-Z6
	8	S281UC-Z8		8	S283UC-Z8
	10	S281UC-Z10		10	S283UC-Z10
	16	S281UC-Z16		16	S283UC-Z16
	20	S281UC-Z20		20	S283UC-Z20
	25	S281UC-Z25		25	S283UC-Z25
	32	S281UC-Z32		32	S283UC-Z32
	40	S281UC-Z40		40	S283UC-Z40
50	S281UC-Z50	50	S283UC-Z50		
63	S281UC-Z63	63	S283UC-Z63		
2	0.5	S282UC-Z0.5			
	1	S282UC-Z1			
	1.6	S282UC-Z1.6			
	2	S282UC-Z2			
	3	S282UC-Z3			
	4	S282UC-Z4			
	6	S282UC-Z6			
	8	S282UC-Z8			
	10	S282UC-Z10			
	16	S282UC-Z16			
	20	S282UC-Z20			
	25	S282UC-Z25			
	32	S282UC-Z32			
	40	S282UC-Z40			
50	S282UC-Z50				
63	S282UC-Z63				

Tripping characteristic Z

UL 1077
250/500 VDC
10 kA

Resistive loads

- Z Curve
- Designed to provide maximum protection with a very low short circuit trip setting
- Example: semiconductors

Accessories & technical data

Accessories – See page 15.31 - 15.34

Technical data – See page 15.35 - 15.36

Direct current applications

The S280UC differs from standard miniature circuit breakers in that the UC versions include a permanent magnet which aids in the extinguishing of the arc during medium and high level faults. It is necessary to observe the correct polarity and current direction when connecting the UC breakers. Two examples of correct connection are shown.

Termination points are marked on all UC type MCBs, points one (1) and four (4) are negative and points two (2) and three (3) are positive.

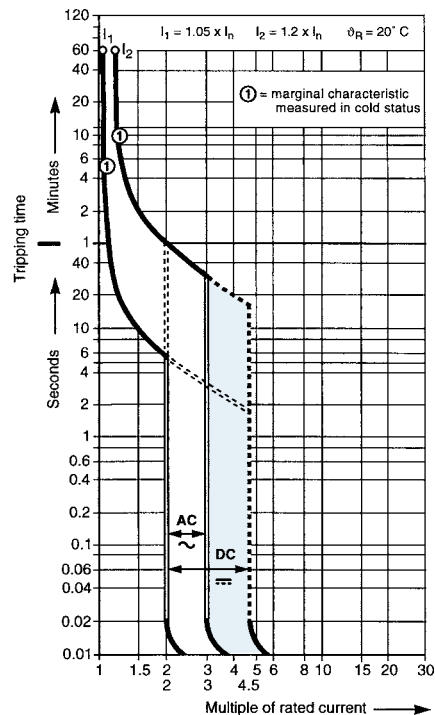
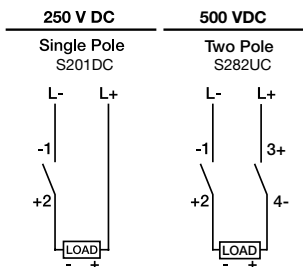

Accessories

S200, S200P & S200PR

UL 1077, CSA 22.2, No. 235

Auxiliary contacts

The auxiliary contacts will signal whether the breaker is in the ON or OFF position.

Description	Catalog number
For field mounting: right side	S2C-H6R



S2C-H6R

Bell alarm - signal contact

The bell alarm includes a set of contacts that will only signal when the breaker has tripped.

Typically the contacts would be connected to an alarm or bell to signal the operator that an overcurrent trip has occurred. The bell alarm also includes a test button for testing the alarm contacts without opening the breaker.

Description	Catalog number
For field mounting: right side	S2C-S/H6R ①

Shunt trip

For remote tripping of breaker, a shunt trip device can be added to the MCB. The solenoid device opens the breaker after control voltage is applied.

Description	Catalog number
For field mounting: right side	
A1-12-60 VAC (12 – 60 VDC)	S2C-A1
A2-110-415 VAC (110 – 250 VDC)	S2C-A2



S2C-A

Undervoltage release

When control voltage drops below approximately 50 % of rated voltage, the UVR opens the breaker. The breaker can not be operated unless proper control voltage is first applied to the UVR coil.

Description	Catalog number
For field mounting: right side	
12 VDC	S2C-UA 12
24 VAC/VDC	S2C-UA 24
48 VAC/VDC	S2C-UA 48
110 VAC/VDC	S2C-UA 110
220 VAC/VDC	S2C-UA 230
380 VAC	S2C-UA 400



S2C-UA



SA 1



SA 2

Possible mounting arrangements of MCB accessories

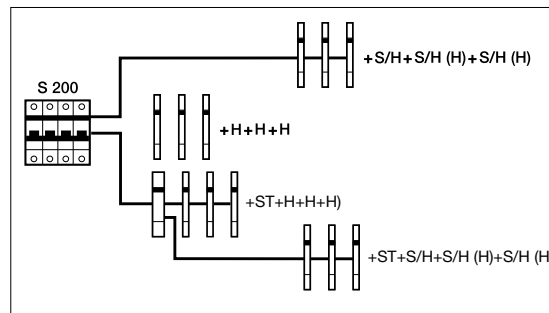

Legend	
Auxiliary contact	H
Bell alarm/Auxiliary contact	S/H
Bell alarm/Auxiliary contact used as auxiliary contact	S/H (H)
Shunt trip	ST
Undervoltage release	UR

Locking devices

Description	Catalog number
Locking devices, 3 mm	SA1
Padlock with 2 keys	SA2

① Combination bell alarm/auxiliary contact.

Accessories

S200PR

UL 1077, CSA 22.2, No. 235

S200PR Accessory overview

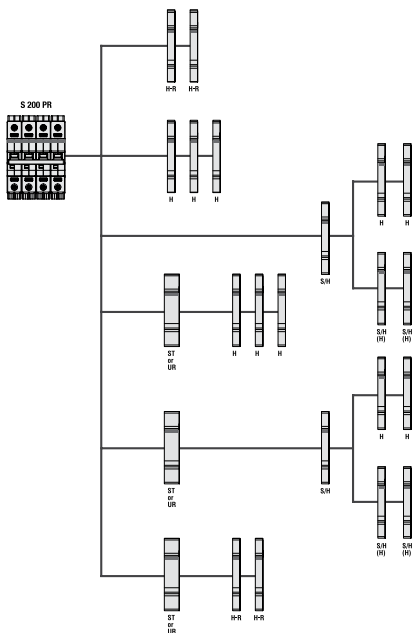

- H Auxiliary contact S2C-H6R
- H-R Auxiliary contact S2C-H6-...R
- S/H Signal/Auxiliary contact S2C-S/H6R
- S/H (H) Signal/Auxiliary contact S2C-S/H6R used as auxiliary contact
- ST Shunt trip S2C-A...
- UR Undervoltage release S2C-UA

S200PR Instructions for use

Ring Tongue Details

Only or ring cable lugs	Insulated only Rated voltage 480V/277 V AC	A	B	C
	Insulated only Rated voltage 240/240 V AC	max. 11.0 mm (0.43")	max. 12.2 mm (0.48")	Suitable for M5 (0.20")
		A	B	C
		max. 14.0 mm (0.55")	max. 12.2 mm (0.48")	Suitable for M5 (0.20")

CU only
 60/75°C
 (140/167°F)

max. 2.0 mm
 (0.08")

PZ 2 Torque: 2.8 Nm (25lb-in)

Ring Tongue Terminal, Special purpose - Not for general use

Installation Instructions

Please insert or withdraw the cable lug only when the screw is completely open.

Please make sure that the terminal screw penetrates the ring lug hole properly and completely during tightening.

Please ensure that the screw is securely tightened before applying any mechanical force on the cable / cable lug.

Do not apply abnormal downward pressure on the screw during tightening or loosening of the screw.

F = max, 30 N F = Maximum to operate

Please follow the Ring Tongue Details on the rear of this sheet.

Accessories

S280UC

UL 1077, CSA 22.2, No. 235



S2-A1

Shunt trips

Function: remote opening of the device when a voltage is applied
Suitable for MCBs S 280 and S 280 UC series.

Description	Catalog number
12-60 VAC/VDC shunt trip	S2-A1
110-415 VAC and 110-250 VDC shunt trip	S2-A2

S2-A1 I
S2-A2 I

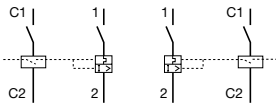

Auxiliary contacts

Function: indication of the position of the device's contacts
Suitable for MCBs S 280 and S 280 UC series

Signal contacts

Function: indication of the position of the device's contacts only after the automatic release of the MCBs and RCBOs due to an overload or a short-circuit
Suitable for MCBs S 280 and S 280 UC series

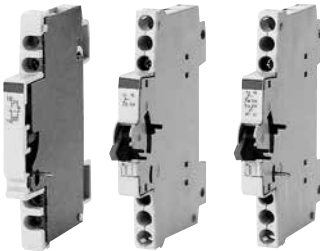

Description	Catalog number
Auxiliary contact 1 NO + 1 NC (1/2 module)	S2-H11
Auxiliary contact 2 NO (1/2 module)	S2-H20
Auxiliary contact 2 NC (1/2 module)	S2-H02
Auxiliary contact 1 NO + 1 NC (1/2 module) with Faston connections	S2-H11X
Auxiliary contact 2 NO (1/2 module) with Faston connections	S2-H20X
Auxiliary contact 2 NC (1/2 module) with Faston connections	S2-H02X
Auxiliary contact 2 NO + 1 NC (1/2 module)	S2-H21
Auxiliary contact 1 NO + 2 NC (1/2 module)	S2-H12
Auxiliary contact 3 NO (1/2 module)	S2-H30
Auxiliary contact 3 NC (1/2 module)	S2-H03
Signal contact (1/2 module)	S2-S
Signal contact + Auxiliary contact (1/2 module)	S2-S/H



S2-UA12

Undervoltage release

Function: protection of the load in the event of a voltage drop (between 70% and 35% of its rated value); positive safety (device's tripping when the voltage is disconnected) emergency stop by means of a button.
Suitable for MCBs S 280 and S 280 UC series.

Description	Catalog number
Undervoltage release 12V DC (1 module)	S2-UA12
Undervoltage release 24V AC/DC (1 module)	S2-UA24
Undervoltage release 48V AC/DC (1 module)	S2-UA48
Undervoltage release 110V AC/DC (1 module)	S2-UA110
Undervoltage release 220V AC/DC (1 module)	S2-UA220
Undervoltage release 380V AC (1 module)	S2-UA380

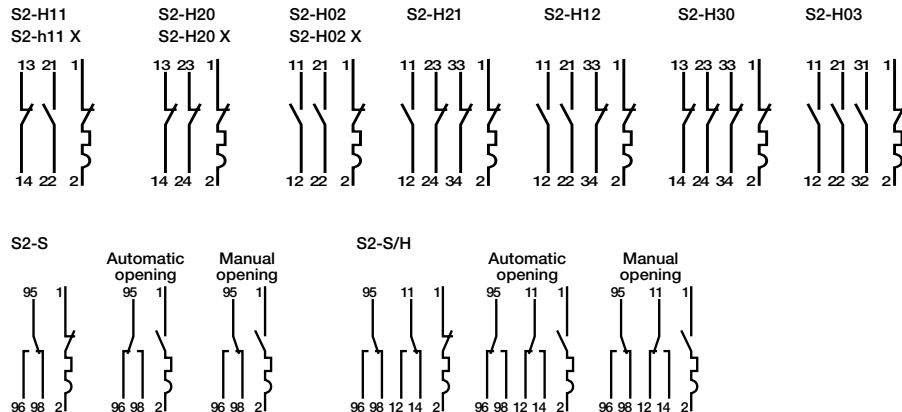
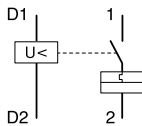

Accessories

S280UC

UL 1077, CSA 22.2, No. 235

Hand operated neutral

The hand operated neutral has to be mounted to the left side of the MCB and be snapped on the DIN rail. It is used for measuring duties where the neutral conductor must be in the open position. Due to the special design of the handle - when switching ON the MCB – the neutral will make before the MCB is closed. The S2C - Nt is not to switch with a tool (screw driver).

Description	Catalog number
Hand operated neutral	S2-NT

Schemes for combination and technical features

Auxiliary elements for MCBs S 280 series

Miniature
circuit breakers
S200

Combination between auxiliary elements and S 280

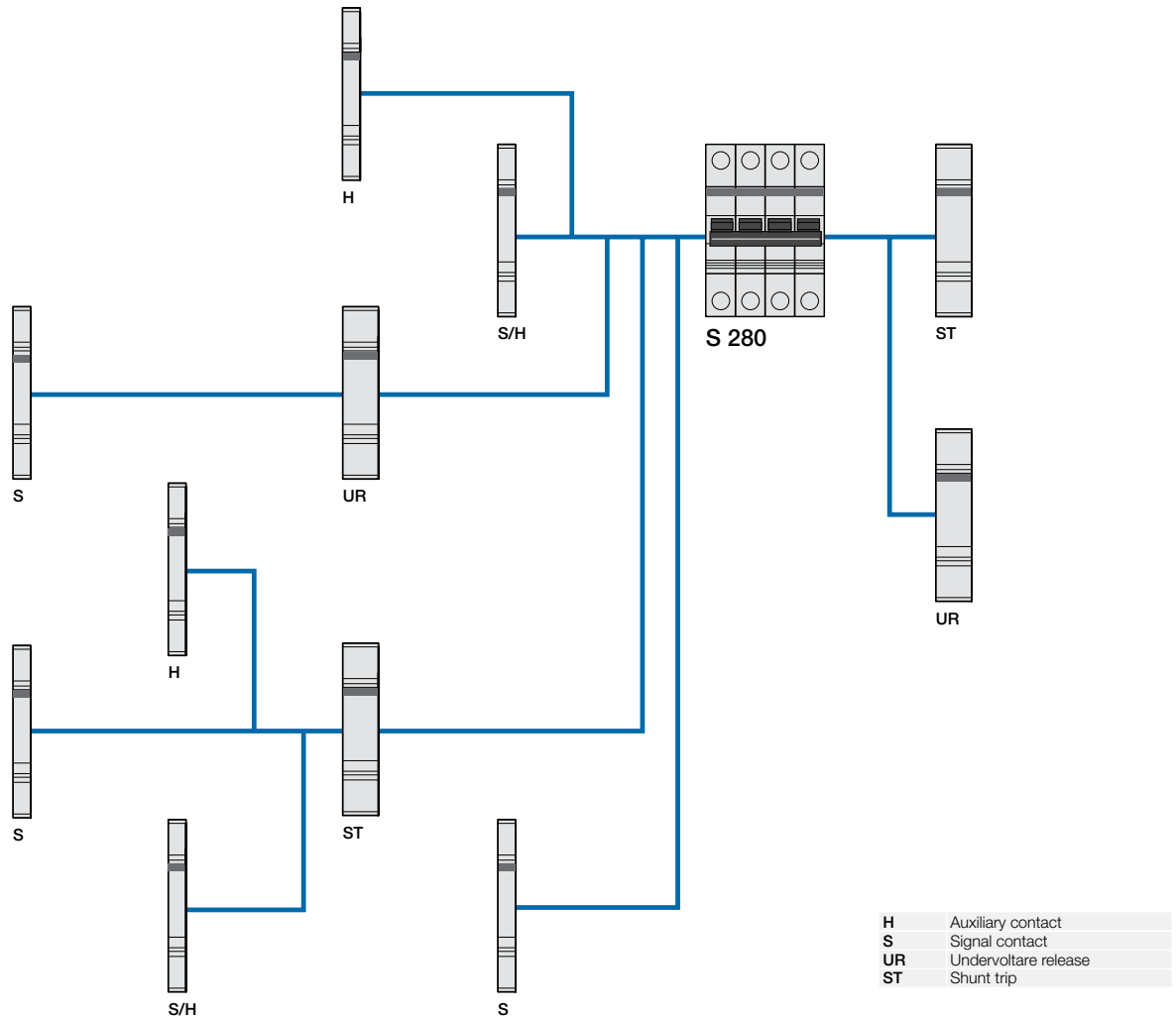

Technical characteristics of auxiliary and signal contacts

Type		S2-H11 I S2-H11 X	S2-H20 I S2-H20 X	S2-H02 I S2-H02 X	S2-H21	S2-H12	S2-H30	S2-H03
Description		1NO+1NC	2NO	2NC	2NO+1NC	1NO+2NC	3NO	3NC
Alternating current	Ue [V]				240	415		
	Ie [A]				6	2		
Direct current	Ue [V]			24	60	110	250	
	Ie [A]			4	2	1.5	1	
Min. operating voltage	[V]				12 a.c.-12 d.c.			
Min. operating current	[mA]				12			
Terminals	[mm ²]				up to 2x1.5			
Dielectric strength	[kV]				3			
Resistance to short-circuit at 240 V a.c.	[A]				1000 (protected with S 2 breaker characteristic K - 6 A)			
Impulse voltage withstand capacity	[kV]				4			
Tightening torque	[Nm]				0.7			
Dimensions (WxDxH)	[mm]				8.75x68x90			

NB: the auxiliary contacts S2-H11 X, S2-H20 X, S2-H02 X differ from the contacts S2-H11, S2-H20, S2-H02 in that they do not have a terminal to tighten the cable which is replaced by a bayonet for the Faston connection.

Technical features

Auxiliary elements for MCBs S 280 series

Technical characteristics of shunt trips

Type		S2-A1	S2-A2
Rated voltage	[V] a.c.	12 - 60	110 - 415
	d.c.	12 - 60	110 - 250
Max. release duration	[ms]	<10	<10
Min. release voltage	[V] a.c.	7	55
	d.c.	10	80
Consumption on release	[VA] 12 V a.c.	35	
	12 V d.c.	30	
	24 V a.c.	140	
	24 V d.c.	100	
	48 V a.c.	600	
	48 V d.c.	330	
	110 V a.c.		40
	110 V d.c.		40
	220 V a.c.		180
	220 V d.c.		170
Coil resistance	[Ω]	3.7	225
Terminals	[mm ²]	25	25
Tightening torque	[Nm]	2	2
Dimens.(WxDxH)	[mm]	17.5x68x90	17.5x68x90

Technical characteristics of undervoltage releases

Type		S2-UA 12	S2-UA 24	S2-UA 48	S2-UA 110	S2-UA 220	S2-UA 380
Standards		VDE0660 part I - IEC EN 60947.1					
Rated voltage	[V] a.c.	-	24	48	110	220-240	380
	[V] d.c.	12	24	-	110	220-240	380
Frequency	[Hz]	50...60					
Release trip	[V]	0.35 Un ≤ V ≤ 0.7 Un					
Terminals	[mm ²]	2 x 1.5					
Consumption	[mA]	10					
Resistance to corrosion	[°C/RH]	const. climatic cond.: 23/83-40/93-55/20; var. climatic cond.: 25/95-40/93					
Protection degree		IP20					
Tightening torque	[Nm]	0.4					
Dimensions (WxDxH)	[mm]	17.5x68x90					

S2-S

S2-SH

1 change over	2 change over			
	240	415		
	6	2		
	250	110	60	24
	0.5	1	1	4
	12 a.c.-12 d.c.			
	12			
	up to 2x1.5			
	3			
	1000 (protected with S 2 breaker characteristic K - 6 A)			
	4			
	0.7			
	8.75x68x90			

Accessories

S200 & S200P

UL 1077, CSA 22.2, No. 235 (suitable for cutting)

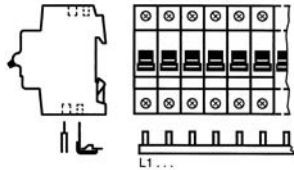

1 Phase

1 Phase

For use on:	Amp rating	Number of poles	Phases	Busbar length (mm)	End cap catalog number	Catalog number
S200	63	60	1	986	PS-END0	PS1/60SP
S200 P	80	60	1	986	PS-END0	PS1/60/16SP

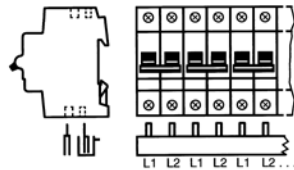

2 Phase

2 Phase

For use on:	Amp rating	Number of poles	Phases	Busbar length (mm)	End cap catalog number	Catalog number
S200	63	58	2	1035	PS-ENDSP	PS2/58SP
S200 P	80	58	2	1035	PS-ENDSP	PS2/58/16SP

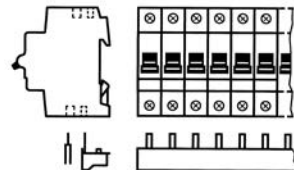

3 Phase

3 Phase

For use on:	Amp rating	Number of poles	Phases	Busbar length (mm)	End cap catalog number	Catalog number
S200	63	60	3	1065	PSB-ENDSP	PS3/60SP
S200 P	80	60	3	1065	PSB-ENDSP	PS3/60/16SP

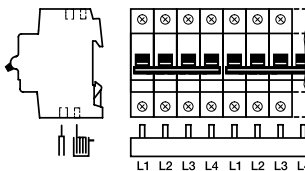

4 Phase

4 Phase

For use on:	Amp rating	Number of poles	Phases	Busbar length (mm)	End cap catalog number	Catalog number
S200	80	60	4	1056	PS-END1	PS4/60/16SP

NOTE

ALL BUSBARS MAY BE CENTER FED IN ORDER TO INCREASE AMPACITY UP TO 130 A.

NOTE

BUSBARS MAY BE USED ON LINE OR LOAD SIDE OF MCBS

Accessories

S200 & S200P

UL 1077, CSA 22.2, No. 235

1 Phase with 1 auxiliary

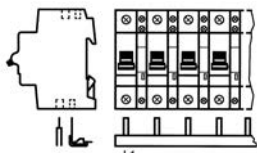

1 Phase + Aux

For use on:	Amp rating	Number of poles	Phases	Busbar length (mm)	End cap catalog number	Catalog number
S200 & S200 P	63	38	1	1044	-	PS1/38H
	80	38	1	1044	-	PS1/38/16H

2 Phase with 1 auxiliary

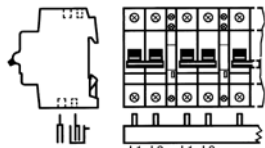

2 Phase + Aux

For use on:	Amp rating	Number of poles	Phases	Busbar length (mm)	End cap catalog number	Catalog number
S200 & S200 P	80	48	2	1065	PS-ENDSP	PS2/48/16SP

3 Phase with 1 auxiliary

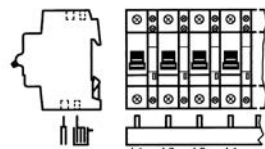

3 Phase + Aux

For use on:	Amp rating	Number of poles	Phases	Busbar length (mm)	End cap catalog number	Catalog number
S200 & S200 P	80	39	3	980	PS-ENDSP	PS3/39/16SP

3 Phase + N, for use with 2 pole-MCBs on 3 phase/4W system

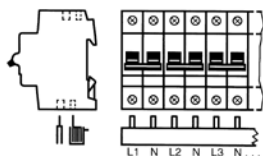

3 Phase + N

For use on:	Amp rating	Number of poles	Phases	Busbar length (mm)	End cap catalog number	Catalog number
S200 & S200 P	80	58	4	1048	PS-END1SP	PS4/58/16NSP

NOTE

ALL BUSBARS MAY BE CENTER FED IN ORDER TO INCREASE AMPACITY UP TO 130 A.

NOTE

BUSBARS MAY BE USED ON LINE OR LOAD SIDE OF MCBS

Accessories

S200 & S200P

UL 1077, CSA 22.2, No. 235



BSK-SP

Busbar tooth covers

Description	Catalog number
Covers five unused poles of busbar	BSK-SP



PS2/6/16 SP

Feeder terminals

Description	Catalog number
Insulated with pin contact, 35mm sq.	AST35/15SP
For side by side mounting; feed on pin of busbar, 50mm sq.	SZ-ESKSP



AST35/15SP



SZ-ESK SP

Technical data

S200, S200P, S200PR & S280UC

UL 1077, CSA 22.2, No. 235

Technical data	S200	S200P	S200PR	S280UC
Specifications:	UL 1077, CSA C 22.2, VDE 0660, 60898, 60947-2		UL1077, CSA 22.2 No. 235, IEC 60947-2	UL1077, CSA 22.2, No. 235
UL File-Number:	E 76126 UL CL	E 76126 UL CL	E 76126 UL CL	-
No. of poles:	1, 2, 3 & 4	1, 2, 3 & 4	1, 2, 3 & 4	1, 2, 3
Tripping characteristics:	B, C, D, K & Z	B, C, D, K & Z	K	K, Z
Rated current:	0.5-63 A	0.2-63 A	0.2-63 A	0.2-63 A
Rated voltage:	Multi pole, 480Y/277 VAC		1 pole, 277 VAC, Multi pole, 480Y/277 VAC	1 pole, 250 VDC, 230 VAC, Multipole, 500 VDC, 480 VAC
Short circuit capacity:	S200 6kA; S200P 10 kA		10 kA	4.5 kA (10 kA, 60 VD 1P, 125 VDC, 2P)
Frequency:	50/60 Hz		50/60 Hz	50/60 Hz
Degree of protection:	IP 20		IP 20, IP40 in enclosure w/cover	IP 20
Mounting position:	Vertical, horizontal		Any	Any
Fixing:	35mm DIN rail			
Clamps only for Cu:	18-4 AWG			
Service life, mech. and at rated load:	20,000 operations		6000 ops (AC), 1 cycle (1s -ON, 9s -OFF)	6000 ops (AC/DC), 1 cycle (1s -ON, 9s -OFF)
Tightening torque:	25 in. lbs (2.8 Nm)			17.5 in. lbs (2.5 Nm)
Ambient temperature:	-25°C ... -13°F / 70°C ... 158°F		-25°C ... +55°C	-25°C ... +55°C
Shock resistance:	30 g at least 3 impacts, shock duration of 11 ms		25g, 2 shocks, 13ms	30g, 3 shocks, 11ms

Auxiliary contact S2C-H6R and Signal contact S2C-S6R for S200, S200P & S200PR

Rated current:	10
Rated voltage AC / DC:	24
Contact:	1 pole, single throw
Connection capacity mm ²	18 - 14 AWG (0.75...2.5)
Tightening torque:	11 in. lbs (1.2 Nm)
Shock resistance acc. to DIN IEC 68-2-6:	5 g, 20 frequency cycles 5...150...5 Hz at 24 VAC/DC, 5 mA auto-reclosing < 10 ms
Mechanical service life:	10,000 operations

Shunt trip

		S2C-A1	S2C-A2
Rated voltage	AC	12 ... 60 V	110 ... 415 V
	DC	12 ... 60 V	110 ... 250 V
Max. release duration		< 10 ms	< 10 ms
Min. release voltage	AC	7 V	55 V
	DC	10 V	80 V
Consumption on release	AD	40 ... 200 VA	55 ... 210 VA
	DC	40 ... 200 VA	55 ... 110 VA
Coil resistance		3.7 Ω	225 Ω
Terminals		18...6/0.75 - 16 AWG/mm ²	18...6/0.75 - 16 AWG/mm ²
Tightening torque		18/2 in.lbs/Nm	18/2 in.lbs/Nm

Undervoltage release

		S2C-UA 12 DC	S2C-UA 24 AC	S2C-UA 24 DC	S2C-UA 48 AC	S2C-UA 48 DC	S2C-UA 110 AC	S2C-UA 110 DC	S2C-UA 230 AC	S2C-UA 230 DC	S2C-UA 400 AC
Standards		IEC/EN 60947-1									
Rated voltage	AC		24 V		48 V		110 V		230 V		400 V
	DC	12 V		24 V		48 V		110 V		230 V	
Frequency		50 ... 60 Hz									
Release trip		0.35 UnOVO 0.7 Un V									
Terminals		2 x 16/2 x 1.5 AWG/mm ²									
Consumption		0.2 VA	3.6 VA	2 VA	3.6 VA	2.1 VA	3.5 VA	2.2 VA	3.7 VA	2.3 VA	2.4 VA
Resistance to corrosion		constant atmosphere: 23/83 - 40/93 - 55/20; variable atmosphere: 25/95 - 40/93 °C/RH									
Protection degree		IPXXB/IP2X									
Tightening torque		3.5/0.4 in.lbs/Nm									

Technical data

S200, S200P & S200PR

UL 1077, CSA 22.2, No. 235

Miniature
circuit breakers
S200

Internal resistance and power loss

Internal resistance per pole in mΩ, power loss per pole in W

Type	Rated current A	Device series B, C, D [Ⓞ]		Device series K		Device series Z	
		mΩ	W	mΩ	W	mΩ	W
S200 & S200P	0.5	5500	1.4	6340	1.6	10100	2.5
	1	1440	1.4	1550	1.6	2270	2.3
	1.6	630	1.6	695	1.8	1100	2.8
	2	460	1.8	460	1.9	619	2.5
	3	150	1.3	165	1.5	202	1.8
	4	110	1.8	120	2.0	149	2.4
	6	55	2.0	52	1.9	104	3.7
	8	15	1.0	38	2.5	53.9	3.45
	10	13.3	1.3	12.6	1.26	17.5	1.7
	13	13.3	2.3	12.6	1.26	-	-
	16	7.0	1.8	7.7	2.0	10.9	2.8
	20	6.25	2.5	6.7	2.7	6.0	2.4
	25	5.0	3.2	4.6	2.9	4.1	2.6
	32	3.6	3.7	3.5	3.6	2.8	2.9
	40	3.0	4.8	2.8	4.5	2.5	4.1
	50	1.3	3.25	1.25	2.9	1.8	4.4
	63	1.2	4.8	0.7	5.2	1.3	5.2

Ⓞ Current intensities 0.5 - 4 apply exclusively to C-type trip characteristics

S200PR

Rated current A	Internal resistance per pole ⁴⁾ mΩ	Power loss per pole ⁴⁾ W
0.3	13700	1.23
0.5	4740	1.19
0.75	2067	1.16
1	1270	1.27
1.5	610	1.56
2	442	1.77
3	140	1.26
4	109	1.75
5	50	1.26
6	54	1.94
8	22	1.41
10	18.2	1.82
13	14.8	2.50
15	8.1	1.83
16	11.1	2.83
20	8.5	3.40
25	5.5	3.43
30	3.8	3.39
32	4.6	4.70
35	3.9	4.76
40	2.8	4.40
50	1.7	4.25
60	1.7	6.18
63	1.9	7.56

Temperature derating

Max operating current depending on the ambient temperature of a circuit breaker characteristics type B, C and D

B, C, D, K, & Z	Ambient Temperatures T (C°/F°)											
	-40/-40	-30/-22	-20/-4	-10/14	0/32	10/50	20/68	30/86	40/104	50/122	60/140	70/158
Amps	0.67	0.65	0.62	0.60	0.58	0.55	0.53	0.50	0.47	0.44	0.41	0.37
	1.33	1.29	1.25	1.20	1.15	1.11	1.05	1.00	0.94	0.88	0.82	0.75
	2.13	2.07	2.00	1.92	1.85	1.77	1.69	1.60	1.51	1.41	1.31	1.19
	2.67	2.58	2.49	2.40	2.31	2.21	2.11	2.00	1.89	1.76	1.63	1.49
	4.0	3.9	3.7	3.6	3.5	3.3	3.2	3.0	2.8	2.6	2.4	2.2
	5.3	5.2	5.0	4.8	4.6	4.4	4.2	4.0	3.8	3.5	3.3	3.0
	8.0	7.7	7.5	7.2	6.9	6.6	6.3	6.0	5.7	5.3	4.9	4.5
	10.7	10.3	10.0	9.6	9.2	8.8	8.4	8.0	7.5	7.1	6.5	6.0
	13.3	12.9	12.5	12.0	11.5	11.1	10.5	10.0	9.4	8.8	8.2	7.5
	17.3	16.8	16.2	15.6	15.0	14.4	13.7	13.0	12.3	11.5	10.6	9.7
	21.3	20.7	20.0	19.2	18.5	17.7	16.9	16.0	15.1	14.1	13.1	11.9
	26.7	25.8	24.9	24.0	23.1	22.1	21.1	20.0	18.9	17.6	16.3	14.9
	33.3	32.3	31.2	30.0	28.9	27.6	26.4	25.0	23.6	22.0	20.4	18.6
	42.7	41.3	39.9	38.5	37.0	35.4	33.7	32.0	30.2	28.2	26.1	23.9
	53.3	51.6	49.9	48.1	46.2	44.2	42.2	40.0	37.7	35.3	32.7	29.8
	66.7	64.5	62.4	60.1	57.7	55.3	52.7	50.0	47.1	44.1	40.8	37.3
	84.0	81.3	78.6	75.7	72.7	69.6	66.4	63.0	59.4	55.6	51.4	47.0
	112.6	107.2	102.1	97.2	92.6	88.2	84.0	80.0	76.0	72.2	68.6	65.2
140.7	134.0	127.6	121.6	115.8	110.3	105.0	100.0	95.0	90.3	85.7	81.5	
175.9	167.5	159.5	151.9	144.7	137.8	131.3	125.0	118.8	112.8	107.2	101.8	

Tripping characteristic B

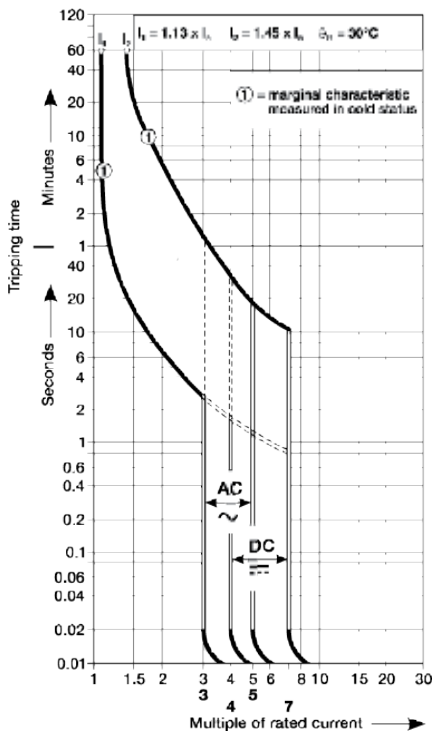

Tripping characteristic C

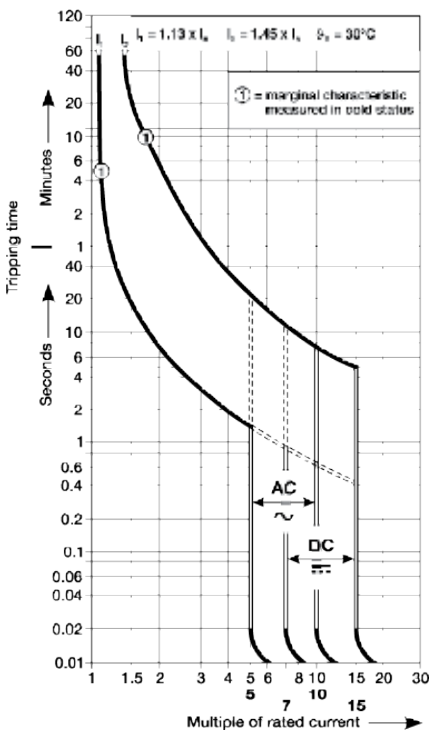

Tripping characteristic D

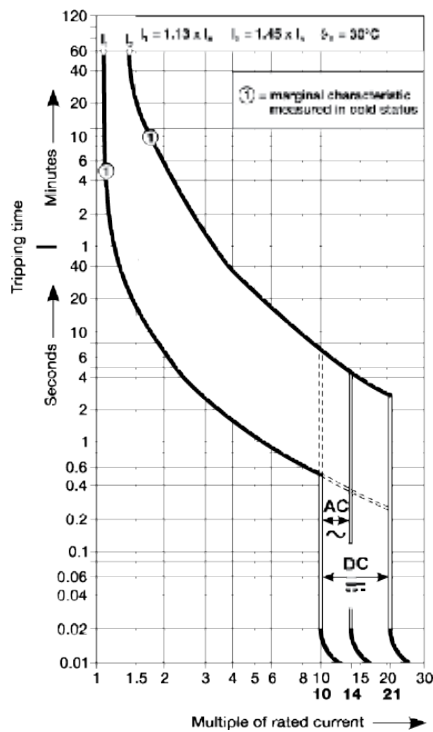

Tripping characteristic K

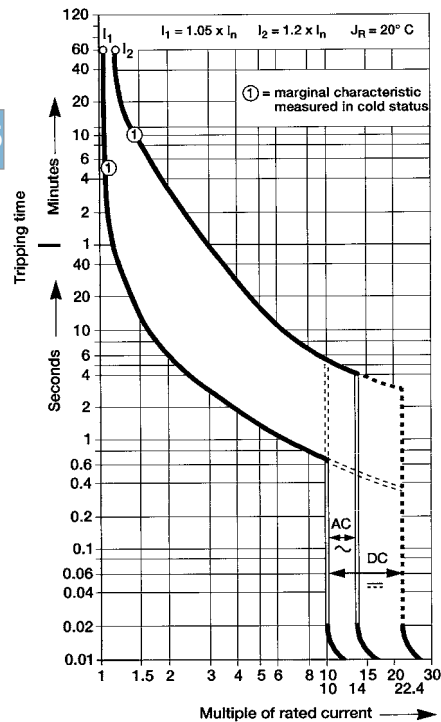

Tripping characteristic Z

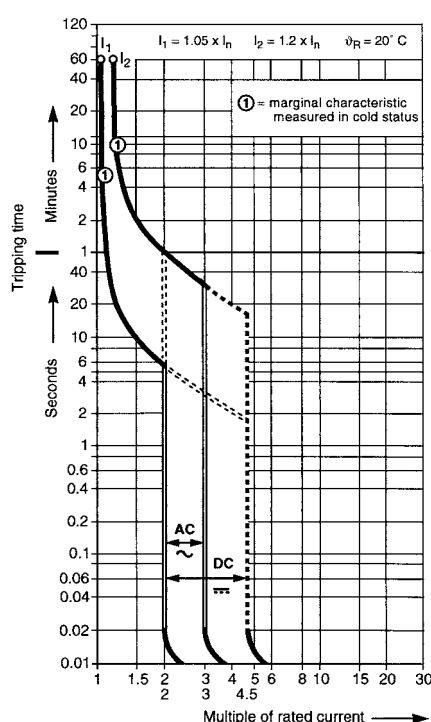

Approximate dimensions S200, S200P, S200PR UL 1077, CSA 22.2, No. 235

S200, S200P

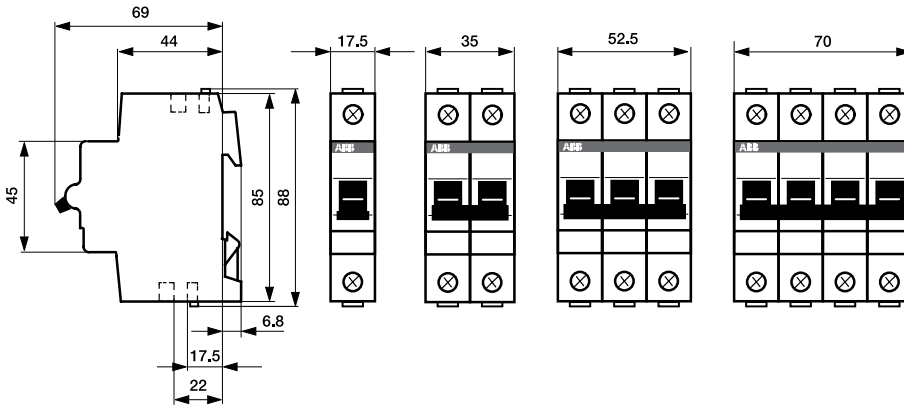

S200PR

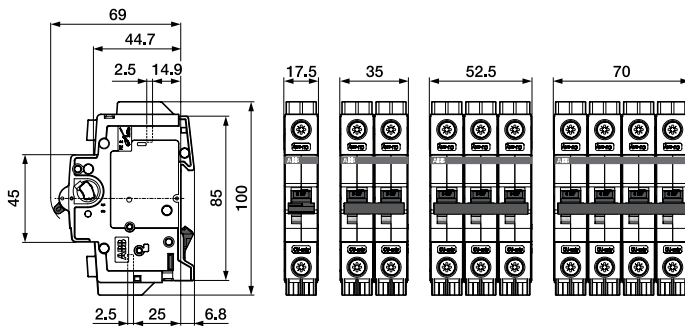

SU200PR Instructions for use

Ring Tongue Details

 Only LISTED or ring cable lugs	Insulated only 	A	B	C
	Rated voltage 480Y/277 V AC	max. 11.0 mm (0.43")	max. 12.2 mm (0.48")	Suitable for M5 (0.20")
Rated voltage 240/240 V AC	Insulated only 	A	B	C
	max. 14.0 mm (0.55")	max. 12.2 mm (0.48")	Suitable for M5 (0.20")	

CU only
 60/75°C
 (140/167°F)

max. 2.0 mm
 (0.08")

PZ 2 Torque: 2.8 Nm (25lb-in)

Ring Tongue Terminal, Special purpose - Not for general use

Installation Instructions

Please insert or withdraw the cable lug only when the screw is completely open.

Please make sure that the terminal screw penetrates the ring lug hole properly and completely during tightening.

Please ensure that the screw is securely tightened before applying any mechanical force on the cable / cable lug.

< 2.8 Nm

 2.8 Nm

Do not apply abnormal downward pressure on the screw during tightening or loosening of the screw.

F = max. 30 N

 F = Maximum to operate

Please follow the Ring Tongue Details on the rear of this sheet.

Approximate dimensions
S280UC, S2C-H6R, S2C-A...U
UL 1077, CSA 22.2, No. 235

S280UC

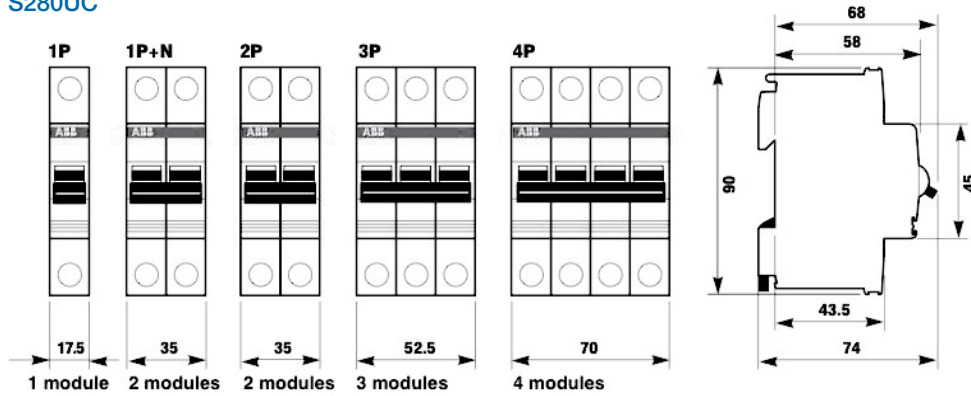

S2C-H6R, S2C-A... S2C

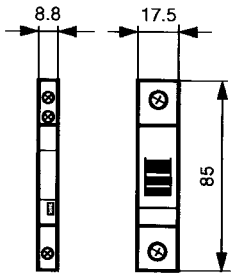

Addition of S2C-A...U

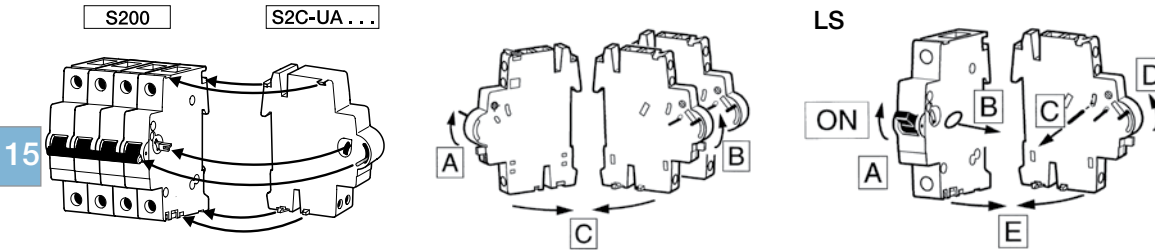

Introduction

The circuit breaker plays an important role in providing over-current protection and a disconnect means in electrical networks. Recent advancements in circuit breaker technology has increased breaker performance and protection.

Overload

A slow and small overcurrent situation that causes the ampacity and temperature of the circuit to gradually increase over time. This type of event is characterized by a slight increase in the load (ampacity) on the circuit and is interrupted by the thermal trip unit of the breaker.

Thermal Example

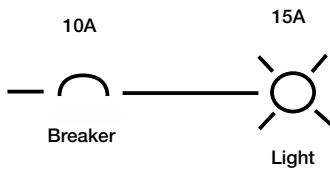

The light draws more than 10 amps for an extended period of time creating a thermal overload.

Short circuit

A rapid and intense overcurrent situation that causes the ampacity of the circuit to increase. This type of event is characterized by a dramatic increase in the load (ampacity) on the circuit and is interrupted by the magnetic trip unit of the breaker.

Magnetic Example

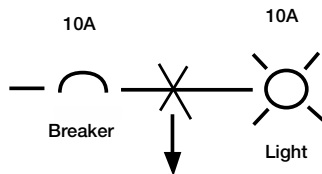

The wire connected between the light and breaker is cut and shorted to ground creating a short circuit.

Breaker definition

A breaker is a device designed to isolate a circuit during an overcurrent event without the use of a fusible element. A breaker is a resettable protective device that protects against two types of overcurrent situations; Overload and Short Circuit.

ABB current limiting breaker

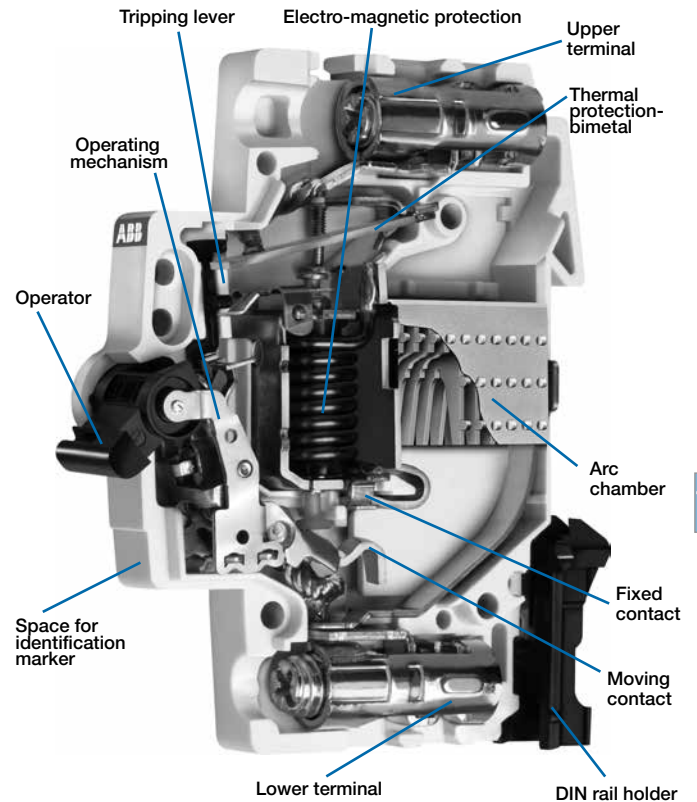

Circuit breaker construction

Thermal / Magnetic trip units definition

ABB Current Limiting Breakers use an electromechanical (Thermal / Magnetic) trip unit to open the breaker contacts during an overcurrent event. The thermal trip unit is temperature sensitive and the magnetic trip unit is current sensitive. Both units act independently and mechanically with the breaker's trip mechanism to open the breaker's contacts.

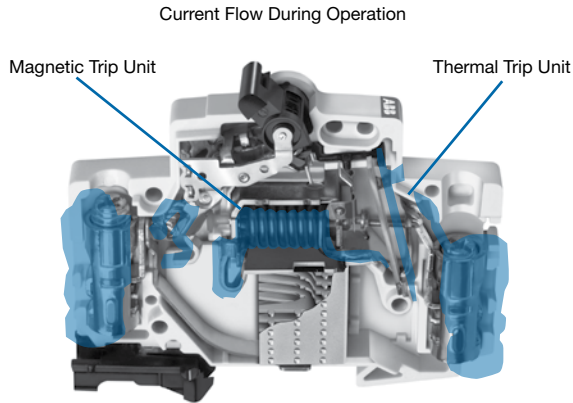

All highlighted components are energized during operation

Overload protection

The thermal trip unit protects against a continuous overload. The thermal unit is comprised of a bimetal element located behind the circuit breaker trip bar and is part of the breaker's current carrying path. When there is an overload, the increased current flow heats the bimetal causing it to bend. As the bimetal bends it pulls the trip bar which opens the breaker's contacts.

The time required for the bimetal to bend and trip the breaker varies inversely with the current. Because of this, the tripping time becomes quicker as current increases in magnitude.

Overload protection is applicable to any installation, conductor, or component which can be subjected to low-magnitude but long-time over-currents. Low-magnitude, long-time over-currents can be dangerous because they reduce the life of the electrical installation, conductor, and components and if left unchecked could result in fire.

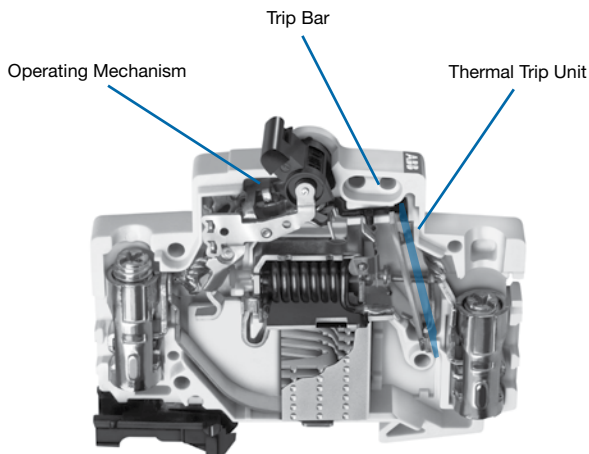

Magnetic trip units (short circuit protection)

The Magnetic trip unit protects against a short circuit. The magnetic trip unit is comprised of an electromagnet and an armature.

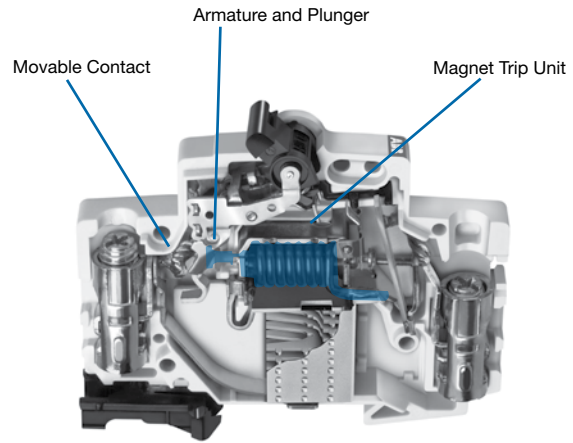

Components of a magnetic trip unit

When there is a short circuit, a high magnitude of current passes through the coils creating a magnetic field that attracts the movable armature towards the fixed armature. The hammer trip is pushed against the movable contact and the contacts are opened. The opening of the breaker's contacts during a short circuit is complete in .5 milli-seconds.

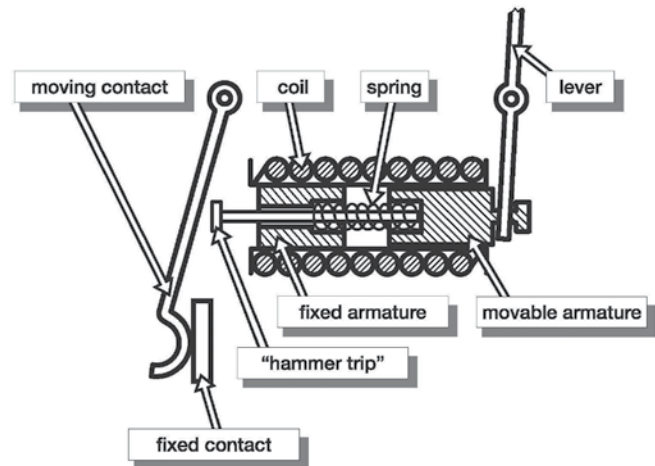

Arc runners / Arc chutes

The arc runner and arc chute limit and dissipate the arc energy during the interruption of an overload or short circuit event.

During an overload or short circuit event, the contacts of the breaker separate and an electrical arc is formed between the contacts through air. The arc is moved into the arc chute by "running" the arc down the interior of the breaker along the arc runner. When the arc reaches the arc chute it is broken into small segmented arcs. The segmented arcs split the overall energy level into segments less than 25V. Each 25V segment does not have a high enough energy level to maintain an arc and all energy is naturally dissipated.

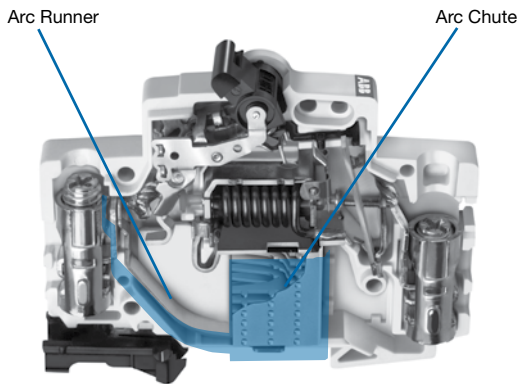

Breaker curves

Thermal Trip Unit (region one)

The first sloping region of the breaker curve is a graphical representation of the tripping characteristics of the thermal trip unit. This portion of the curve is sloped due to the nature of the thermal trip unit. The trip unit bends to trip the breaker's trip bar in conjunction with a rise in amperage (temperature) over time. As the current on the circuit increases, the temperature rises, the faster the thermal element will trip.

Example using the curve below: If you had a 10A breaker and the circuit was producing 30 amps of current, the breaker would trip between 2 seconds and 1 minute. In this example you would find the circuit current on the bottom of the graph (Multiples of rated current). The first line is 10 amps (10 amp breaker x a multiple of one), the second line is 20 amps (10 amp breaker x multiple of 2), and the third line is 30 amps (10amp breaker x multiple of 3). Next you would trace the vertical 30A line up until it intersects the red portion of the breaker thermal curve. If you follow the horizontal lines, on both sides of the red curve, to the left you will see that the breaker can trip as fast as 2 seconds and no slower than 1 minute.

Magnetic Trip Unit (region two)

This region of the breaker curve is the instantaneous trip unit. ABB's miniature circuit breaker's instantaneous trip unit interrupts a short circuit in 2.3 to 2.5 milliseconds. Because of this the curve has no slope and is graphically represented as a vertical straight line.

Example using the curve above: If you had a 10 amp breaker the magnetic trip element would interrupt a short circuit between 10 and 30 amps (10 amp breaker x multiple of 2 and 3) in 2.3 to 2.5 milliseconds.

Breaker Contacts (region three)

This region of the curve is the time required for the contacts of the breaker to begin to separate. The contacts will open in less than .5 milliseconds and is graphically represented by the bottom vertical portion of the curve.

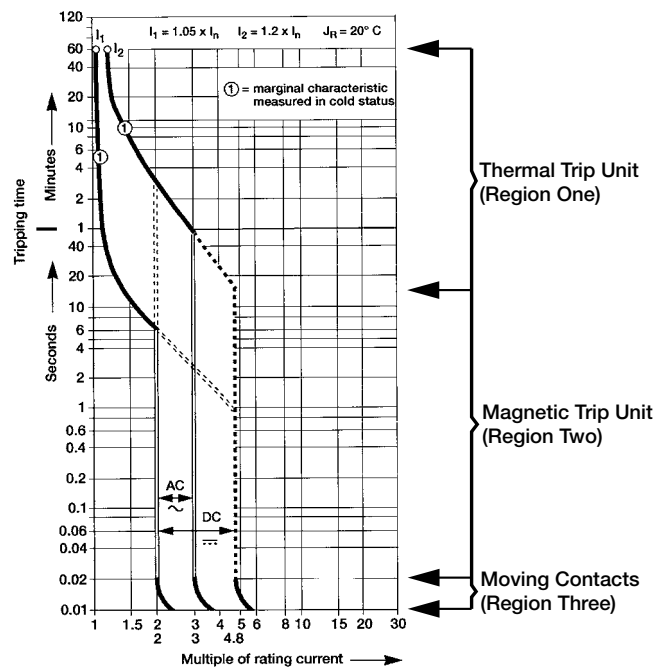

Circuit breaker current limitation

Current limiting definitions

All ABB Miniature Circuit Breakers are UL tested and certified as current limiting protective devices. Current limiting circuit breakers provide a higher level of circuit protection than a typical zero point external breakers.

UL AC 60Hz cycle

UL defines an AC cycle as the potential energy of the wave form traveling from Zero-to-Positive amplitude, Positive-to-Zero amplitude, Zero-to-Negative amplitude, Negative-to-Zero amplitude 60 times in one second. One cycle is completed every 16.6 milliseconds.

UL breaker current limiting

UL defines breaker current limitation as a breaker that interrupts and isolates a fault in less than 1/2 of an AC cycle. 1/2 a cycle is completed in 8.3 milliseconds.

NEC240.2 current limiting

A device that, when interrupting current in its current-limiting range, reduces the current flowing in the faulted circuit to a magnitude substantially less than that obtainable in the same circuit if the device were replaced with a solid conductor having comparable impedance.

IEC 60947-2 current limiting circuit breaker

A circuit breaker with sufficiently short trip time to prevent the short-circuit current from reaching the peak value which would otherwise be reached.

ABB current limiting breakers

ABB current limiting breakers can interrupt and isolate a fault in 1/8 of an AC cycle. The breaker fault interruption is completed in 2.3 to 2.5 milliseconds.

Zero point extinguishing breakers

A typical zero point extinguishing breaker interrupts a fault and does not isolate the energy. The breaker allows an arc to be present between the open contacts until the AC wave form crosses zero. When the wave form crosses zero, the potential energy is zero and the arc (fault) naturally extinguishes. The arc could be present for up to 8.3 milliseconds.

Current limiting breakers and electrical networks

Current Limitation

When a short-circuit condition occurs, the “ideal” current limiting circuit breaker opens before the current waveform can reach its full potential magnitude which occurs at 1/4 cycle (4.17ms). ABB’s current limiting breakers can interrupt a fault in about 1/2 cycle or 2.3ms to 2.5ms.

ABB’s current limiting breakers interrupt a short circuit in less than 1/8 cycle and limit the amount of current that can reach a circuit. Limiting the available current on the circuit provides additional protection against network, breaker, or bus damage and prevents the tripping of upstream breakers (selective coordination).

IsqT

The true destructive nature of a short circuit is measured by the time it is available combined with the peak value of the short circuit. The IsqT (Amps Squared over Time) value represents the amount of energy available on a network during a short circuit and is represented by the shaded area on the graph below.

During a short circuit both magnetic forces and thermal energy combine to damage devices on the electrical network. The level of thermal energy and magnetic forces are directly proportional to the square of the current. The magnetic forces vary as a square of the peak current available and the thermal energy varies as a square of the RMS (root mean square) current available. ABB’s current limiting breakers will limit the let-through energy to a fraction (1/100th) of the value which is available from the network. By comparison, a Zero Crossing breaker would let-through approximately 100 times as much destructive energy as the current limiting circuit breaker [(100,000A / 10,000A) squared – 100X].

ABB’s current limiting breakers limit the short circuit current to a relatively small magnitude in a extremely short time, which dramatically limits a short circuit’s destructive energy.

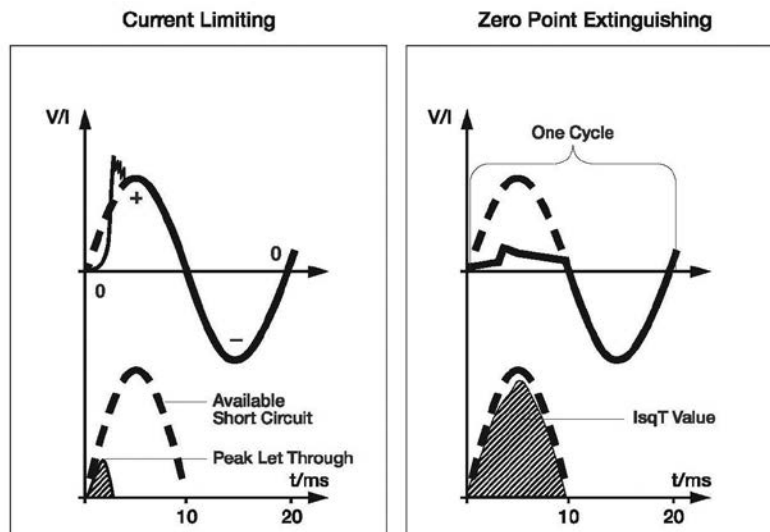

Current limiting and zero crossing breakers

During the initial stages of a short circuit a breaker's contacts open to interrupt the circuit. After the contacts open an arc forms in the air between the contacts on both the current limiting and zero crossing breaker contacts. What distinguishes a current limiting breaker from a zero crossing breaker is what each breaker does after an arc is formed between the open contacts.

A current limiting breaker "runs" the arc down the breaker arc runner into an arc chute that extinguishes the arc.

A zero crossing breaker does not attempt to extinguish the arc. The breaker is designed to withstand the energy of the arc long enough for the waveform to cross zero. When the wave form crosses zero the potential energy is zero and the arc naturally extinguishes itself.

ABB's current limiting breakers interrupt the arc energy in 2.3ms to 2.5ms (1/8 cycle) and a zero crossing breaker allows the arc to be present for up to 8.3ms (1/2 cycle). A zero crossing breaker will let through 100 times as much energy as an ABB current limiting breaker.

Current limiting example

The lab test report below details a 20A S200 series current limiting breaker interrupting a 28kA fault in 1.7 milliseconds. The total "I Square T" value is 32.0kA.

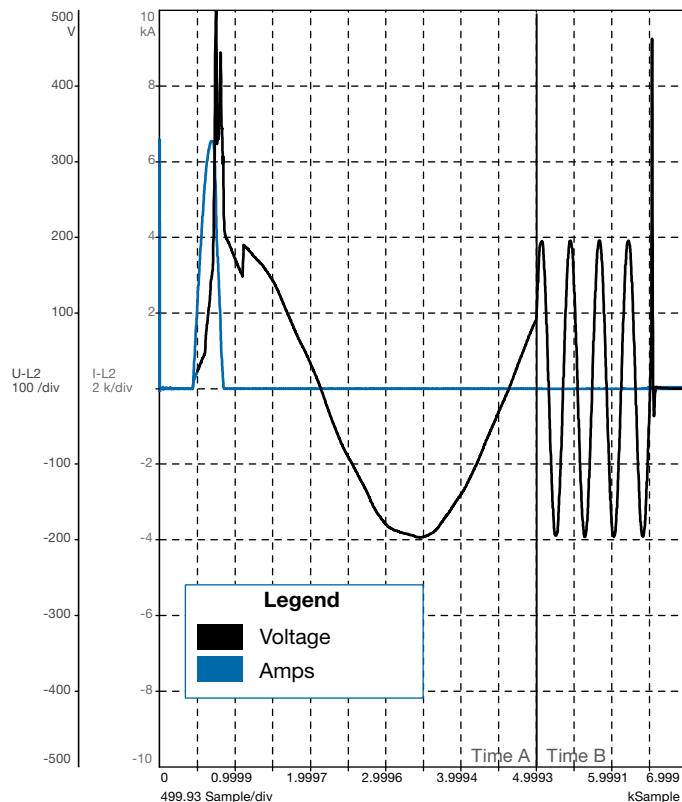
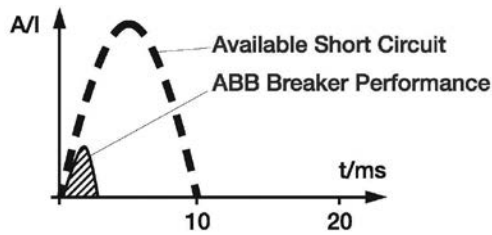

Zero crossing example

The test report below details a 20A Zero Point Extinguishing breaker interrupting a 9kA fault in 9 milliseconds. The total "I Square T" value is 104.0kA.

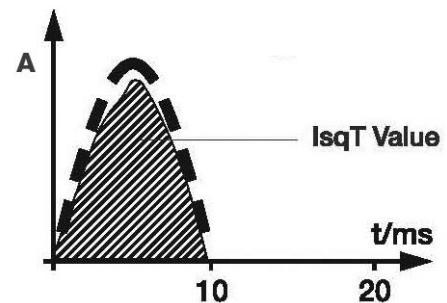
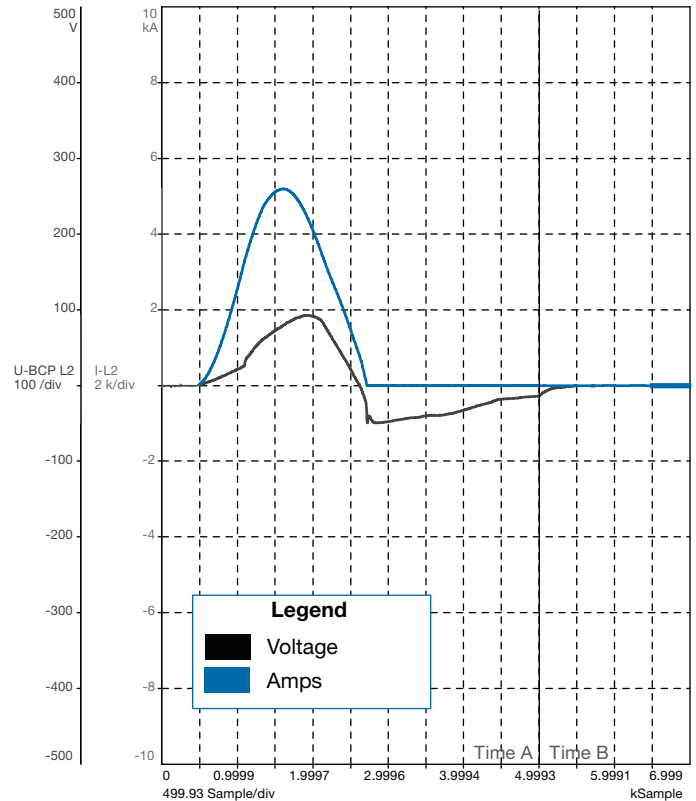

Selective coordination and series ratings

IEC 60497-1 selective coordination definition

Coordination between the operating characteristics of two or more over-current protection devices, so that when an over-current within established limits occurs, the device designated to operate within those limits trips whereas the other do not trip.

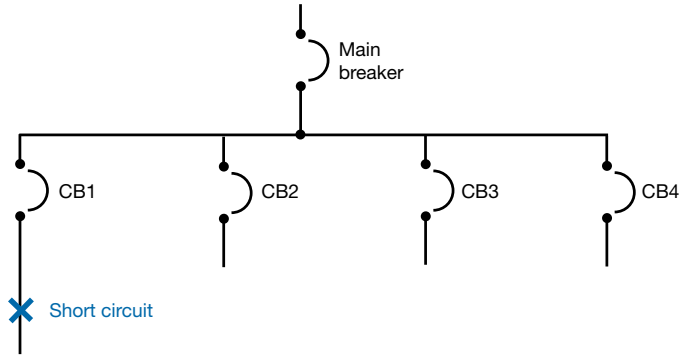

Example of breaker coordination

When an over-current event occurs at the branch breaker level (CB1), and the event is within the operating characteristics of the breaker, then the branch breaker should interrupt the circuit (open) and the main breaker should remain closed and energized. The chart below gives a graphical representation of a down stream branch breaker (B curve) and a main breaker (A curve) with coordination. The separation between the curves allows the branch breaker to react to the fault and the main breaker remain closed and energized.

Coordination

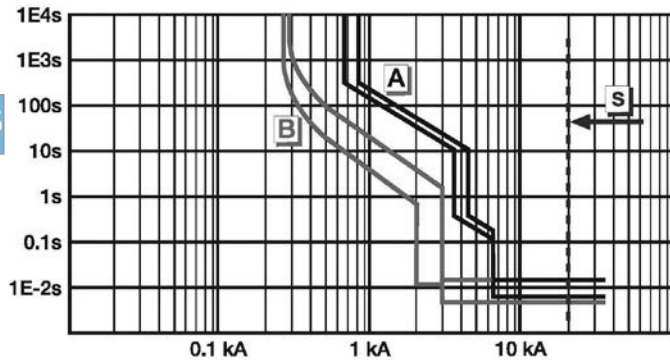

Example of no breaker coordination

Selective breaker coordination is not achieved when there is an overload event at the branch breaker level (MCB1) and both the branch breaker and main breaker interrupt the circuit (open). When there is no breaker coordination several circuits lose power that should remain operational during and after the overload event. The chart below gives a graphical representation of a down stream branch breaker (B curve) and a main breaker (A curve) without coordination. There is no separation between the curves. The branch breaker will react to a fault and the main breaker will open and de-energize all circuits down stream.

No Coordination

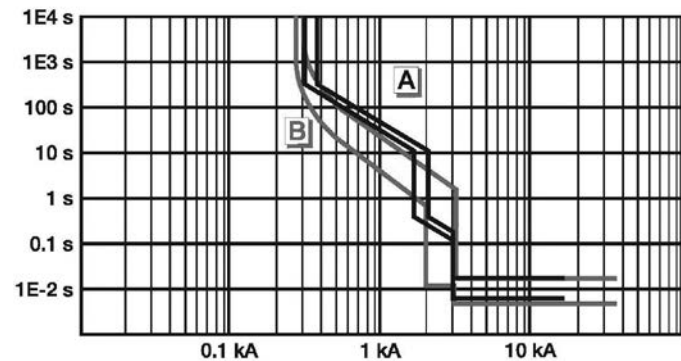

Problems in coordination occur when the branch breaker allows the "I Square T" value of the short circuit to rise to a level that is in the operating range of the up-stream main breaker. Proper breaker coordination is easier to achieve with the use of current limiting breakers at the branch level.

Selective coordination and current limiting breakers

Recent improvements in ABB circuit breaker technology has pushed the performance of breakers to the same level as fuses. The reaction time and tripping characteristics of current limiting breakers are now on par with fuses. This allows ABB to provide a high level of coordination between branch breakers and the main. A current limiting branch breaker will limit the "I Square T" value well below the level of the operating range of the up-stream main breaker.

ABB's current limiting branch breakers can coordinate between the main breaker up to 35kA.

Selective coordination and zero crossing breakers

Zero crossing breakers do not limit the "I Square T" value. They wait for the wave form to cross zero and allow a high level of let-through energy to pass through the system. The "I Square T" value of a zero crossing breaker is high enough that the main breaker will likely trip during a short circuit. With zero crossing breakers it is extremely difficult to coordinate between branch and main breakers.

A typical zero crossing breaker's coordination level is below 10kA. There are a few manufactures that have achieved coordination between a branch zero crossing breaker and the main by slowing the performance (protection) of the main breaker.

Series ratings –vs- selective coordination

Selective coordination

Selective coordination is achieved when there is a short circuit on a branch circuit breaker, the branch breaker opens and isolates the fault, and the main breaker remains closed. The rating is usually a value above the “stand alone” interrupting rating of the branch breaker and the “stand alone” rating of the main breaker.

Example:

65kA rated main breaker
10kA rated branch breaker
Coordination between the two breakers up to 35kA

There can be a short circuit on the branch breaker up to 35kA where the branch will open (CB1) and the main breaker will remain closed. Although the branch has a 10kA “stand alone” rating both the breakers work together to limit the available short circuit to allow the branch (CB1) to isolate the fault.

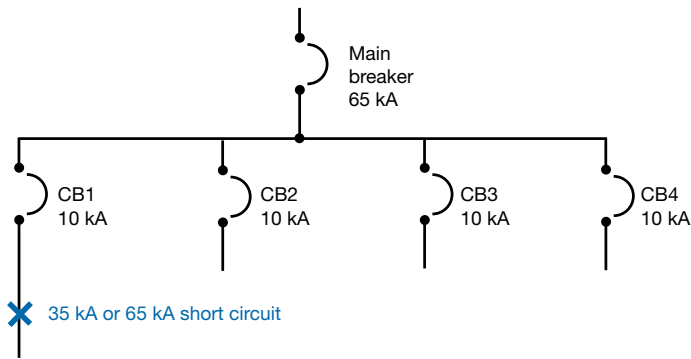

Series ratings

Series ratings are different from coordination ratings. Unlike coordination ratings where the branch opens and the main remains closed, a series rated combination is one where both the branch and main breakers open and work together to isolate the fault.

The series rating combination of two breakers is equal to the “stand alone” interrupting value of the main breaker. This is a result of the main breaker let-through value being lower than the “stand alone” interrupting value of the branch breaker. During a short circuit the main breaker will limit the energy to a level that is below the “stand alone” value of the branch breaker.

Example:

65kA rated main breaker
10kA rated branch breaker
Series combination rating between the two breakers up to 65kA

There can be a short circuit on the branch breaker up to 65kA where the branch will open and the main breaker will open. Although the branch breaker (CB1) has a 10kA “stand alone” rating the main breaker has a let-through value below 10kA. If there is a fault up to 65kA on the network the main breaker will limit the energy to a value less than the rating of the branch breaker (CB1). Both breakers will trip (no coordination) but the network can safely withstand a fault of 65kA.

Miniature circuit breaker cutaway

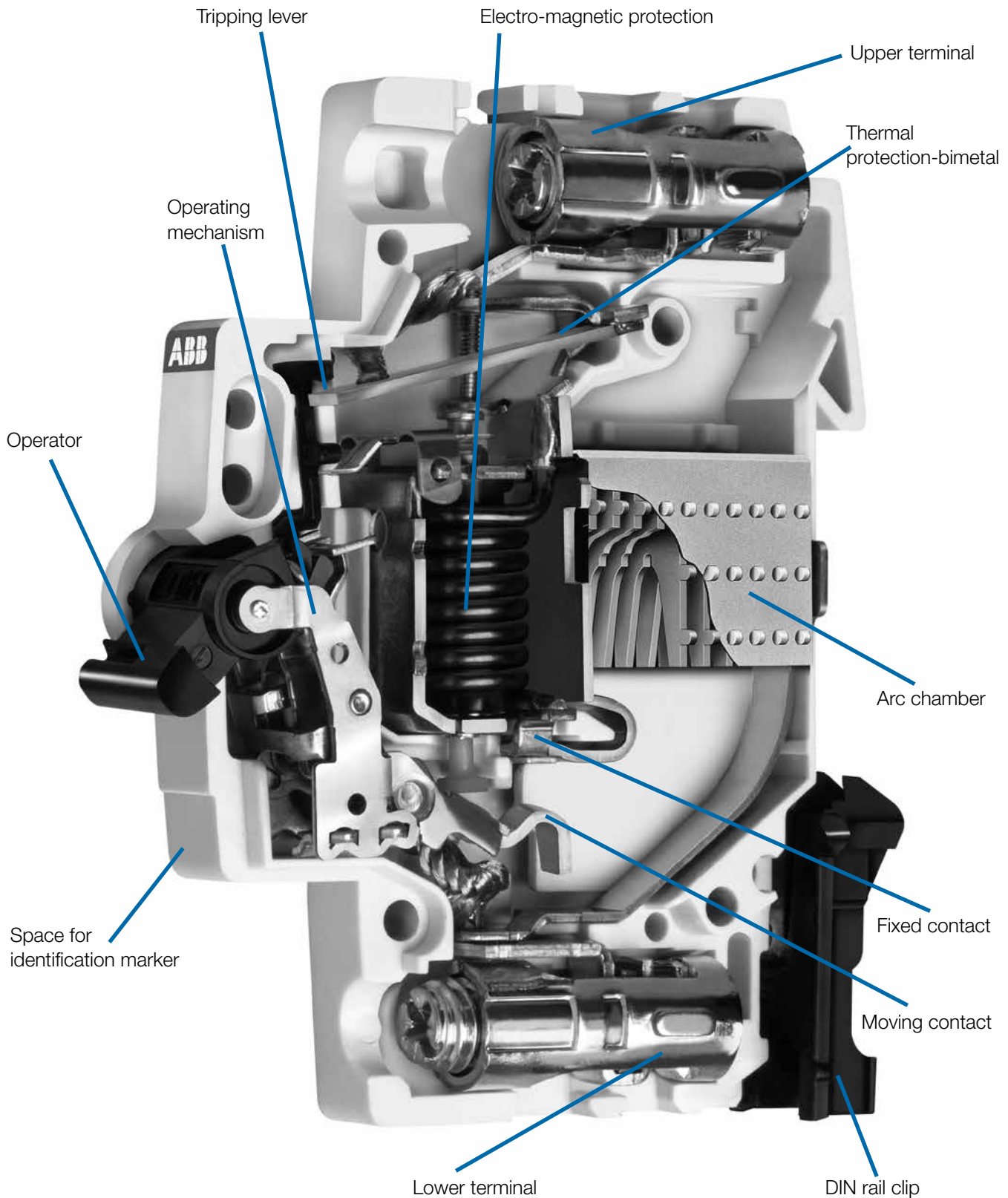



S800

High performance circuit breakers
UL 489 Series



Description

The S800 high performance MCB offers a compact solution to circuit protection. The S800 devices are DIN rail mounted. The S800 is available with application-specific trip characteristics to provide maximum circuit protection.

The breakers offer thermal-magnetic trip protection according to Z and K characteristics.

For the worldwide market, the breakers carry CSA, IEC, CE and many other agency approvals.

Features

- Energy limiting
- Fast breaking time (2.3 – 2.5 ms)
- Wide range of accessories
- DIN rail mounting
- Finger safe terminals
- Multi-function terminals
- Ring tongue compatible
- UL489 File # E312425

S800U

Amperage	10 – 100 A
Voltage	240 VAC
Poles	1, 2, 3, 4 poles
Trip characteristics	Z, K
Interrupting ratings	30kA: UL 489, single pole 50kA: UL 489, multi-pole
Auxiliary contacts	Yes
Bell alarm	Yes
Shunt trip	Yes
Undervoltage release	Yes
Ring tongue	Yes

S800U-K, 240 VAC

Branch circuit protection

UL 489

K



S801U-K



S802U-K



S803U-K



S804U-K

No. of poles	Rated current	Catalog number	No. of poles	Rated current	Catalog number
1	10	S801U-K10	3	10	S803U-K10
	15	S801U-K15		15	S803U-K15
	20	S801U-K20		20	S803U-K20
	25	S801U-K25		25	S803U-K25
	30	S801U-K30		30	S803U-K30
	40	S801U-K40		40	S803U-K40
	50	S801U-K50		50	S803U-K50
	60	S801U-K60		60	S803U-K60
	70	S801U-K70		70	S803U-K70
	80	S801U-K80		80	S803U-K80
2	90	S801U-K90	4	90	S803U-K90
	100	S801U-K100		100	S803U-K100
	10	S802U-K10		10	S804U-K10
	15	S802U-K15		15	S804U-K15
	20	S802U-K20		20	S804U-K20
	25	S802U-K25		25	S804U-K25
	30	S802U-K30		30	S804U-K30
	40	S802U-K40		40	S804U-K40
	50	S802U-K50		50	S804U-K50
	60	S802U-K60		60	S804U-K60
70	S802U-K70	70	S804U-K70		
80	S802U-K80	80	S804U-K80		
90	S802U-K90	90	S804U-K90		
100	S802U-K100	100	S804U-K100		

Tripping characteristic K

UL 489
240 VAC
30 kA, single pole
50 kA, multi-pole

Resistive loads

- K Curve
- Designed for use in cable protection applications
- Example: control circuits, lighting

Accessories & technical data

Accessories – See page 15.52

Technical data – See page 15.76 - 15.82

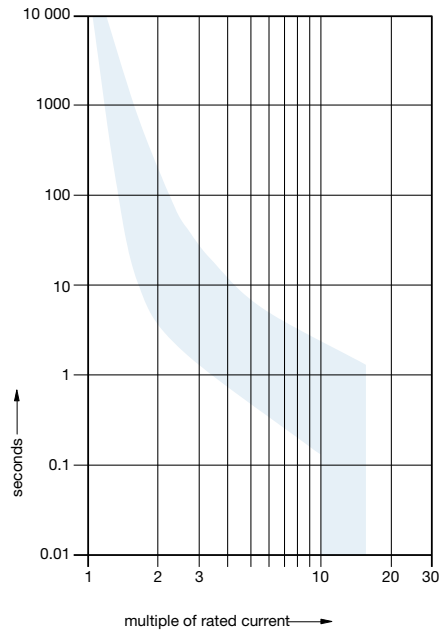

S800U-Z, 240 VAC

Branch circuit protection

UL 489

Z



S801U-Z



S802U-Z



S803U-Z



S804U-Z

No. of poles	Rated current	Catalog number	No. of poles	Rated current	Catalog number
1	10	S801U-Z10	3	10	S803U-Z10
	15	S801U-Z15		15	S803U-Z15
	20	S801U-Z20		20	S803U-Z20
	25	S801U-Z25		25	S803U-Z25
	30	S801U-Z30		30	S803U-Z30
	40	S801U-Z40		40	S803U-Z40
	50	S801U-Z50		50	S803U-Z50
	60	S801U-Z60		60	S803U-Z60
	70	S801U-Z70		70	S803U-Z70
	80	S801U-Z80		80	S803U-Z80
2	90	S801U-Z90	4	90	S803U-Z90
	100	S801U-Z100		100	S803U-Z100
	10	S802U-Z10		10	S804U-Z10
	15	S802U-Z15		15	S804U-Z15
	20	S802U-Z20		20	S804U-Z20
	25	S802U-Z25		25	S804U-Z25
	30	S802U-Z30		30	S804U-Z30
	40	S802U-Z40		40	S804U-Z40
	50	S802U-Z50		50	S804U-Z50
	60	S802U-Z60		60	S804U-Z60
70	S802U-Z70	70	S804U-Z70		
80	S802U-Z80	80	S804U-Z80		
90	S802U-Z90	90	S804U-Z90		
100	S802U-Z100	100	S804U-Z100		

Tripping characteristic Z

UL 489
240 VAC
30 kA, single pole
50 kA, multi-pole

Resistive loads

- Z Curve
- Designed for use in cable protection applications
- Example: control circuits, lighting

Accessories & technical data

Accessories – See page 15.52
Technical data – See page 15.76 - 15.82

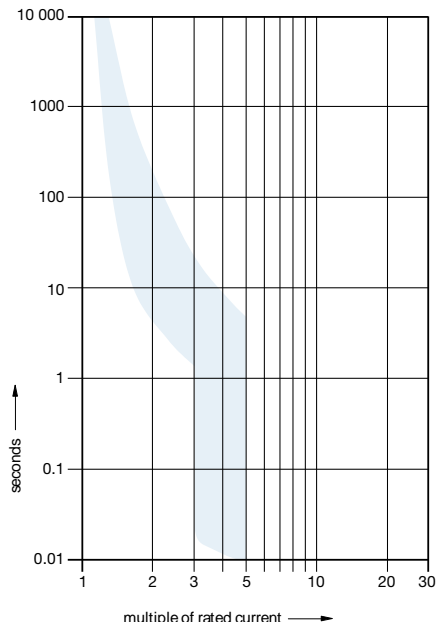

S803W-SCL-SR UL Short circuit current limiter Self-resetting

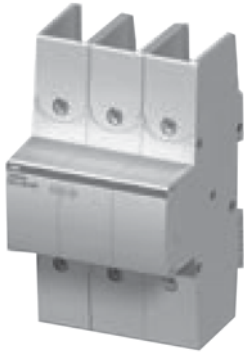

S803W-SCL-SR

UL version short circuit current limiter, self resetting, 3 pole

Item	Catalog number
32A Self resetting current limiter	S803W-SCL32-SR
63A Self resetting current limiter	S803W-SCL63-SR
100A Self resetting current limiter	S803W-SCL100-SR

Technical data

Rated voltage	600 VAC per UL508
Short circuit current rating according to UL508, CSA 22.2	480 VAC 50/60 Hz, 65 kA
	600 VAC 50/60 Hz, 65 kA

Approved combinations with motor starter

Downstream devices	Upstream devices
	S803W-SCL-SR
	Self resetting short-circuit limiter

Rated current I_e [A]	32	63	100
MS/MO325			
0.1–2.5	■	■	■
4	■	■	■
6.3	■	■	■
9	■	■	■
12.5	■	■	■
16	■	■	■
20		■	■
25		■	■
MS/MO132			
0.1–2.5	■	■	
4	■	■	
6.3	■	■	■
10	■	■	■
16	■	■	■
20		■	■
25		■	■
32		■	■

– Combinations with S500-K and S500-KM on request

■ Applies for all voltages according to the table below

S803W-SCL-SR

Rated ultimate short-circuit breaking capacity

Short-circuit rating according to UL 508, CSA 22.2

(AC) 50/60 Hz 480 V	[kA]	65
(AC) 50/60 Hz 600 V	[kA]	65

$I_{cu} = I_{cs}$ according to IEC 60947-2

(AC) 50/60 Hz 240/415 V	[kA]	100
(AC) 50/60 Hz 254/440 V	[kA]	100
(AC) 50/60 Hz 277/480 V	[kA]	65
(AC) 50/60 Hz 289/500 V	[kA]	65
(AC) 50/60 Hz 346/600 V	[kA]	65
(AC) 50/60 Hz 400/690 V	[kA]	50

S803W-SCL-SR UL508 Short circuit current limiter

Approximate dimensions

Miniature
circuit breakers
S800

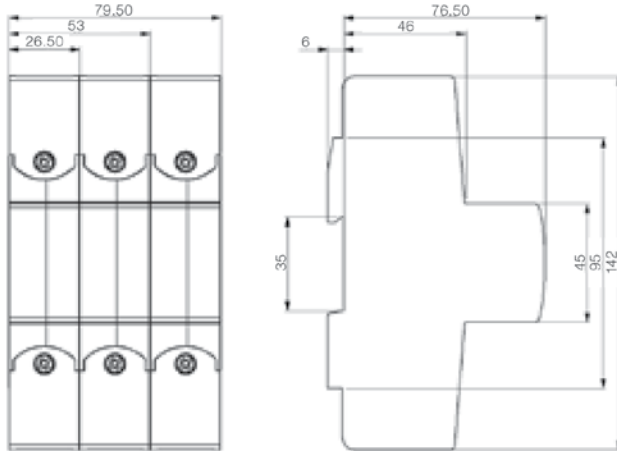

Minimum cable length between S803W-SCL-SR and downstream devices (Connection has to be short-circuit proofed acc. to IEC 61439-1)

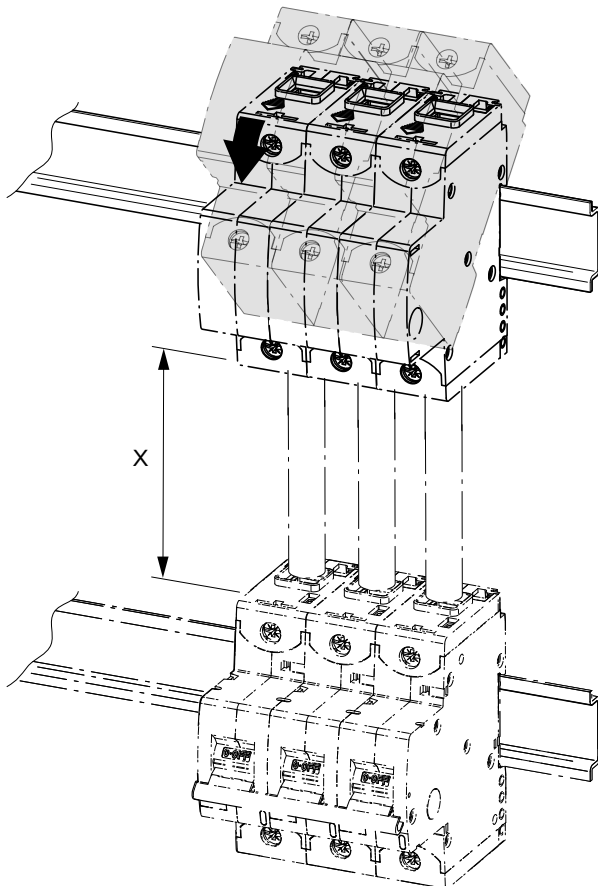

MS/M0325
MS/M0132
S800

S800-SCL-SR	min. length X	min. cross section
32 A	80 mm	6 mm ²
63 A	80 mm	16 mm ²
100/125 A	250 mm	35 mm ²

S800W-RSU Remote sensing unit

UL489



S800W-RSU

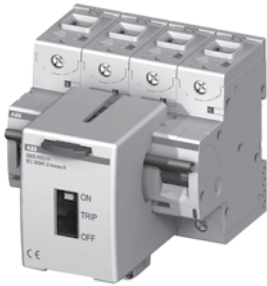

S800W-RSU mounted on MCB



S800-RSU-CP

Remote switching unit

Item	Catalog number
Remote switching unit S800W-RSU	S800W-RSU

S800-RSU cable including plug

Item	Catalog number
3 meter cable 0.5mm ² (AWG20) including 10 pole Micro Fit 3.0 plug	S800-RSU-CP

Key Features

- The remote Switching unit S800W-RSU has a brushless high precision DC motor to ensure fast remote control operation.
- Low power consumption
- Short switching times
- The S800W-RSU is mounted on any multipole S800 High Performance MCB
- Installation and wiring can be field installable
- The connection is done by a 10-pole Micro Fit 3.0 (not included in delivery)
- The S800W-RSU can be operated by a standard pushbutton or drive by a PLC

Switching times

- OFF -> ON <<500ms
from signal to contact closing
- ON -> OFF <<250ms
from signal to contact opening
- TRIP -> OFF -> ON <<1500ms
from signal to contact closing

For differing requirements, please contact your local ABB partner

Safety intelligence

- Inputs are deactivated when detecting manual use
- All outputs become active when spindle is rotated more than 360 degrees
- S800W-RSU is locked for 5 minutes after three switching attempts leading to a trip
- Manual switch off possible for 3 & 4 pole devices

Technical specifications

Operational voltage	24 VDC
Current consumption I_{ms}	2,5
Standby current $I_{standby}$	< 50mA
Switching time OFF-ON	< 500 msec
Switching time ON-OFF	<250 mse
Ambient operation temperature	-25...+70°C
Number of switching operations	10.000
Maximum cable lengths(AWG20/ 0.5mm ²)	10m
Degree of protection (mounted)	IP2
Weight	300 gr
Connection	10 pole Micro Fit 3.0

Approximate dimensions

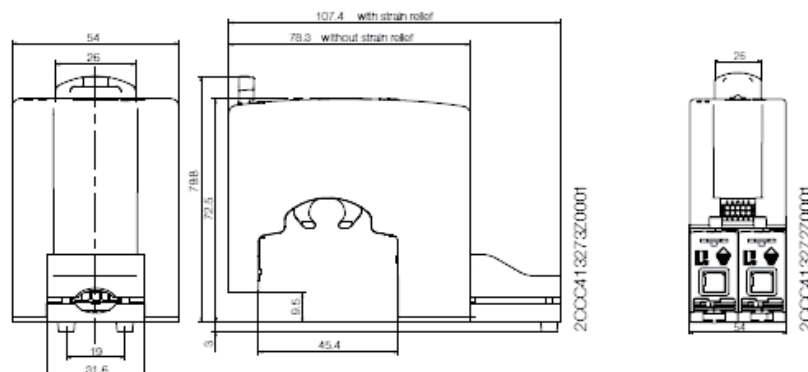

S800 IEC Series High performance circuit breakers



S800

High performance circuit breakers
IEC Series



Description

The S800 high performance MCB offers a compact solution to circuit protection. The S800 devices are IEC tested current limiting and DIN rail mounted. The S800 is available with application-specific trip characteristics to provide maximum circuit protection.

The breakers offer thermal-magnetic trip protection according to B, C, D & K characteristics.

For the worldwide market, the breakers carry CSA, IEC, CE and many other agency approvals.

Features

- Current limiting
- Fast breaking time (2.3 – 2.5 ms)
- Wide range of accessories
- DIN rail mounting
- Finger safe terminals
- Multi-function terminals
- Ring tongue compatible

S800S

Amperage	10 – 125 A
Voltage	690 VAC
Poles	1, 2, 3, 4
Trip characteristics	B, C, D, K
Interrupting ratings	50 kA : IEC
Auxiliary contacts	Yes
Bell alarm	Yes
Shunt trip	Yes
Undervoltage release	Yes
Ring tongue	Yes

S800S-B, 690 VAC IEC

B



S801U-B



S802U-B



S803U-B



S804U-B

No. of poles	Rated current	Catalog number	No. of poles	Rated current	Catalog number
1	10	S801S-B10	3	10	S803S-B10
	13	S801S-B13		13	S803S-B13
	16	S801S-B16		16	S803S-B16
	20	S801S-B20		20	S803S-B20
	25	S801S-B25		25	S803S-B25
	32	S801S-B32		32	S803S-B32
	40	S801S-B40		40	S803S-B40
	50	S801S-B50		50	S803S-B50
	63	S801S-B63		63	S803S-B63
	80	S801S-B80		80	S803S-B80
	100	S801S-B100		100	S803S-B100
	125	S801S-B125		125	S803S-B125
2	10	S802S-B10	4	10	S804S-B10
	13	S802S-B13		13	S804S-B13
	16	S802S-B16		16	S804S-B16
	20	S802S-B20		20	S804S-B20
	25	S802S-B25		25	S804S-B25
	32	S802S-B32		32	S804S-B32
	40	S802S-B40		40	S804S-B40
	50	S802S-B50		50	S804S-B50
	63	S802S-B63		63	S804S-B63
	80	S802S-B80		80	S804S-B80
	100	S802S-B100		100	S804S-B100
	125	S802S-B125		125	S804S-B125

Tripping characteristic B

IEC
690 VAC
50 kA

Resistive loads

- B Curve
- Designed for use in cable protection applications
- Example: control circuits, lighting

Accessories & technical data

Accessories – See page 15.52

Technical data – See page 15.76 - 15.82

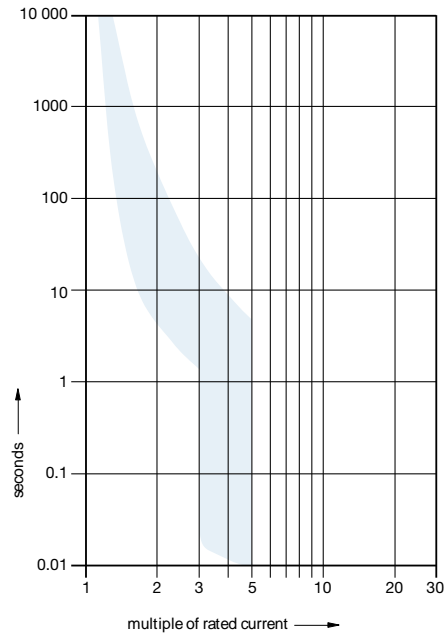

S800S-C, 690 VAC IEC

C



S801S-C



S802S-C



S803S-C



S804S-C

No. of poles	Rated current	Catalog number	No. of poles	Rated current	Catalog number
1	10	S801S-C10	3	10	S803S-C10
	13	S801S-C13		13	S803S-C13
	16	S801S-C16		16	S803S-C16
	20	S801S-C20		20	S803S-C20
	25	S801S-C25		25	S803S-C25
	32	S801S-C32		32	S803S-C32
	40	S801S-C40		40	S803S-C40
	50	S801S-C50		50	S803S-C50
	63	S801S-C63		63	S803S-C63
	80	S801S-C80		80	S803S-C80
	100	S801S-C100		100	S803S-C100
	125	S801S-C125		125	S803S-C125
2	10	S802S-C10	4	10	S804S-C10
	13	S802S-C13		13	S804S-C13
	16	S802S-C16		16	S804S-C16
	20	S802S-C20		20	S804S-C20
	25	S802S-C25		25	S804S-C25
	32	S802S-C32		32	S804S-C32
	40	S802S-C40		40	S804S-C40
	50	S802S-C50		50	S804S-C50
	63	S802S-C63		63	S804S-C63
	80	S802S-C80		80	S804S-C80
	100	S802S-C100		100	S804S-C100
	125	S802S-C125		125	S804S-C125

Tripping characteristic C

IEC
690 VAC
50 kA

Resistive loads

- C Curve
- Designed for use with medium magnetic start up currents
- Example: lighting, control panels

Accessories & technical data

Accessories – See page 15.52

Technical data – See page 15.76 - 15.82

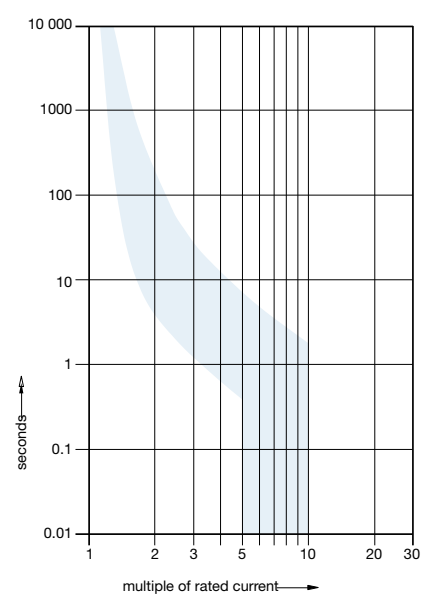

S800S-D, 690 VAC IEC

D



S801S-D



S802S-D



S803S-D



S804S-D

No. of poles	Rated current	Catalog number	No. of poles	Rated current	Catalog number
1	10	S801S-D10	3	10	S803S-D10
	13	S801S-D13		13	S803S-D13
	16	S801S-D16		16	S803S-D16
	20	S801S-D20		20	S803S-D20
	25	S801S-D25		25	S803S-D25
	32	S801S-D32		32	S803S-D32
	40	S801S-D40		40	S803S-D40
	50	S801S-D50		50	S803S-D50
	63	S801S-D63		63	S803S-D63
	80	S801S-D80		80	S803S-D80
	100	S801S-D100		100	S803S-D100
	125	S801S-D125		125	S803S-D125
2	10	S802S-D10	4	10	S804S-D10
	13	S802S-D13		13	S804S-D13
	16	S802S-D16		16	S804S-D16
	20	S802S-D20		20	S804S-D20
	25	S802S-D25		25	S804S-D25
	32	S802S-D32		32	S804S-D32
	40	S802S-D40		40	S804S-D40
	50	S802S-D50		50	S804S-D50
	63	S802S-D63		63	S804S-D63
	80	S802S-D80		80	S804S-D80
	100	S802S-D100		100	S804S-D100
	125	S802S-D125		125	S804S-D125

Tripping characteristic D

IEC
690 VAC
50 kA

Inductive loads

- D Curve
- Designed for allowing higher in-rush currents during system start up
- Example: motors, transformers

Accessories & technical data

Accessories – See page 15.52

Technical data – See page 15.76 - 15.82

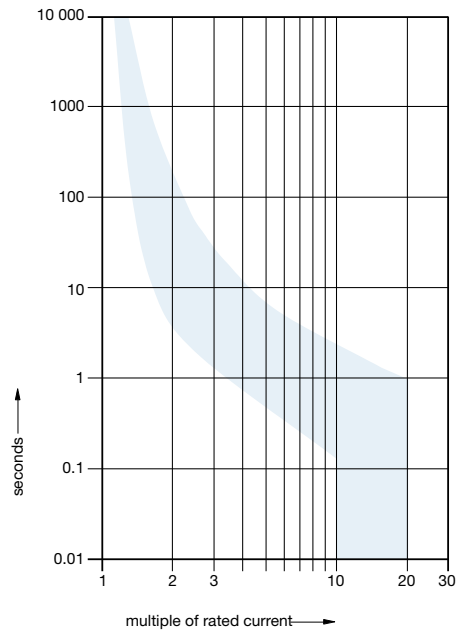

S800S-K, 690 VAC IEC

K



S801S-K



S802S-K



S803S-K



S804S-K

No. of poles	Rated current	Catalog number	No. of poles	Rated current	Catalog number
1	10	S801S-K10	3	10	S803S-K10
	13	S801S-K13		13	S803S-K13
	16	S801S-K16		16	S803S-K16
	20	S801S-K20		20	S803S-K20
	25	S801S-K25		25	S803S-K25
	32	S801S-K32		32	S803S-K32
	40	S801S-K40		40	S803S-K40
	50	S801S-K50		50	S803S-K50
	63	S801S-K63		63	S803S-K63
	80	S801S-K80		80	S803S-K80
2	100	S801S-K100	4	100	S803S-K100
	125	S801S-K125		125	S803S-K125
	10	S802S-K10		10	S804S-K10
	13	S802S-K13		13	S804S-K13
	16	S802S-K16		16	S804S-K16
	20	S802S-K20		20	S804S-K20
	25	S802S-K25		25	S804S-K25
	32	S802S-K32		32	S804S-K32
	40	S802S-K40		40	S804S-K40
	50	S802S-K50		50	S804S-K50
63	S802S-K63	63	S804S-K63		
80	S802S-K80	80	S804S-K80		
100	S802S-K100	100	S804S-K100		
125	S802S-K125	125	S804S-K125		

Tripping characteristic K

IEC
690 VAC
50 kA

Inductive loads

- K Curve
- Designed for allowing higher in-rush currents during system start up
- Example: motors, transformers

Accessories & technical data

Accessories – See page 15.52
Technical data – See page 15.76 - 15.82

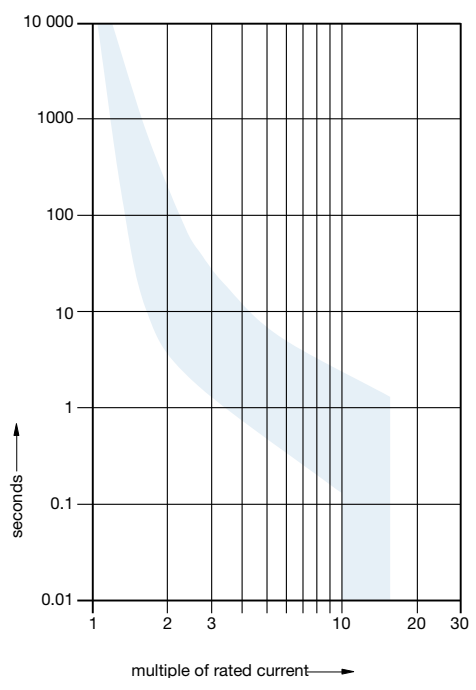

Accessories

S800U & S800S

UL & IEC



S800-SOR

Shunt trip

For remote tripping of breaker, a shunt trip device can be added to the MCB. The device opens the breaker after control voltage is applied.

Description (for field mounting, left side)	Catalog number
Shunt operation release 24 VAC/DC	S800-SOR24
Shunt operation release 48...130 VAC/DC	S800-SOR130
Shunt operation release 110...250 VAC/DC	S800-SOR250



S800-UVR

Undervoltage release

When control voltage drops below approximately 50 % of rated voltage, the UVR opens the breaker. The breaker can not be operated unless proper control voltage is first applied to the UVR coil.

Description	Catalog number
Under voltage release 24...36 VAC/DC	S800-UVR36
Under voltage release 48...60 VAC/DC	S800-UVR60
Under voltage release 110...130 VAC/DC	S800-UVR130
Under voltage release 220...250 VAC/DC	S800-UVR250



S800-AUX

Auxiliary contacts

The auxiliary contacts will signal whether the breaker is in the ON or OFF position.

Description	Catalog number
Auxiliary contact	S800-AUX



S800-AUX/ALT

Bell alarm

The bell alarm includes a set of contacts that will only signal when the breaker has tripped. Typically the contacts would be connected to an alarm or bell to signal the operator that an overcurrent trip has occurred. The bell alarm also includes a test button for testing the alarm contacts without opening the breaker.

Description	Catalog number
Bell alarm	S800-AUX/ALT

Accessories

S800U & S800S

UL & IEC



S800-RT2125

Ring tongue adaptor

Description	Catalog number
Ring terminal cable connection, 40-125A	S800-RT2125



S800-RD

Rotary operating mechanism

Allows "through the door" operation.

Description	Catalog number
Handle mechanism	S800-RD

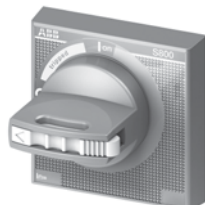

S800-RHE-H

Description	Catalog number
Grey rotary handle	S800-RHE-H

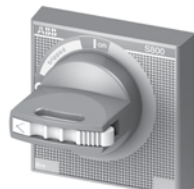

S800-RHE-EM

Description	Catalog number
Red rotary handle	S800-RHE-EM



S800-RHE-S

Description	Catalog number
Shaft extension	S800-RHE-S



S800U-PLL

UL Locking device

Description	Catalog number
Padlock not included	S800U-PLL

				S800U	
Characteristics				K, Z	
Rated operational current I_n			[A]	10...100	
Pole				1..4	
Rated operational voltage U_n compliant to UL 489					
(AC)	50/60 Hz		[V]	240	
Rated ultimate short-circuit breaking capacity compliant to UL489					
(AC)	50/60 Hz	240 V	Single-pole	[kA]	30
(AC)	50/60 Hz	240 V	Multipole	[kA]	50
Rated operational voltage U_n compliant to IEC 60947-2					
(AC)			[V]	240/415	
Rated ultimate short-circuit breaking capacity I_{cu} compliant to IEC 60947-2					
(AC)	50/60 Hz	240/415 V	Single-pole	[kA]	30
(AC)	50/60 Hz	240/415 V	Multipole	[kA]	50
Rated service short-circuit breaking capacity I_{cs} compliant to IEC 60947-2					
(AC)	50/60 Hz	240/415 V	Single-pole	[kA]	25
(AC)	50/60 Hz	240/415 V	Multipole	[kA]	40
Connections C_u		10...30 A		14-2 AWG	
		40...100 A		8-1 AWG	
Rated frequency				50/60	
Tightening torque			[Hz]	3,5 (31 in.lb.)	
Protection category			[Nm]	IP40	
				(actuating end only)	
Mounting position				any	
Contacts				cadmium-free	
Permissible ambient temperature			[°C]	-25...+60	
Standards				UL 489	
				IEC 60947-2	
				CSA22.2 NO.5-02	
Approval				cULus	
				File E312425	

Technical data

S800U

UL

Typical internal resistances
and power losses at 25°C
ambient temperature

Rated current I_n	Internal resistance R_i	Power loss P_v
[A]	[mΩ] K, Z	[W] K, Z
10	15.2	1.5
15	12.1	2.7
20	8.7	3.5
25	6.8	4.2
30	3.1	2.8
40	2.3	3.7
50	1.7	4.3
60	1.6	5.8
70	1.0	4.9
80	1.0	6.4
90	0.8	6.5
100	0.8	8.3

Influence of ambient
temperature

Devices mounted singly (specifications in A)

S800U-K, -Z

I_n [A]	10°C	15°C	20°C	25°C	30°C	35°C	40°C	45°C	50°C	55°C	60°C
10	10.9	10.7	10.4	10.0	9.6	9.3	9.0	8.7	8.4	8.0	7.6
15	16.5	16.0	15.6	15.0	14.4	14.0	13.5	13.0	12.6	12.0	11.4
20	22.0	21.4	20.8	20.0	19.2	18.6	18.0	17.4	16.8	16.0	15.2
25	27.5	26.8	26.0	25.0	24.0	23.3	22.5	21.8	21.0	20.0	19.0
30	33.1	32.1	31.2	30.0	28.8	27.9	27.0	26.1	25.2	24.0	22.9
40	44.0	42.8	41.6	40.0	38.4	37.2	36.0	34.8	33.6	32.0	30.9
50	55.1	53.5	52.0	50.0	48.0	46.5	45.0	43.5	42.0	40.0	38.3
60	66.2	64.2	62.4	60.0	57.6	55.8	54.0	52.2	50.4	48.0	46.0
70	76.9	74.9	72.8	70.0	67.2	65.1	63.0	60.9	58.8	56.0	53.4
80	88.0	85.6	83.2	80.0	76.8	74.4	72.0	69.6	67.1	64.0	61.6
90	99.1	96.3	93.6	90.0	86.4	83.7	81.0	78.3	75.6	72.0	69.5
100	110.5	107.0	104.0	100.0	96.0	93.0	90.0	87.0	83.8	80.0	77.8

Technical data

S800S

IEC

Internal resistance and power loss

Internal resistance per pole in mΩ, power loss per pole in W

Type	Rated current A	Device series	Power loss
		B C D K mΩ	B C D K W
S800S	10	15.2	1.5
	13	12.1	2.0
	16	12.1	3.1
	20	8.7	3.5
	25	6.8	4.2
	32	3.1	3.1
	40	2.3	3.7
	50	1.7	4.3
	63	1.6	6.2
	80	1.0	6.4
	100	0.8	8.3
	125	0.6	9.4

Temperature derating

Max. operating current values depending on the ambient temperature for a circuit-breaker in load circuit of type B, C, D, & K characteristics.

S800S-B, -C, -D In [A]	Ambient temperature T (°C/°F)										
	10/50	15/59	20/68	25/77	30/86	35/95	40/104	45/113	50/122	55/131	60/140
10	11.2	11.0	10.7	10.4	10.0	9.6	9.3	9.0	8.7	8.4	8.0
13	14.6	14.3	13.9	13.5	13.0	12.5	12.1	11.7	11.3	10.9	10.4
16	17.9	17.6	17.1	16.6	16.0	15.4	14.9	14.4	13.9	13.4	12.8
20	22.4	22.0	21.4	20.8	20.0	19.2	18.6	18.0	17.4	16.8	16.0
25	28.0	27.5	26.8	26.0	25.0	24.0	23.3	22.5	21.8	21.0	20.0
32	35.8	35.2	34.2	33.3	32.0	30.7	29.8	28.8	27.8	26.9	25.6
40	44.8	44.0	42.8	41.6	40.0	38.4	37.2	36.0	34.8	33.6	32.0
50	56.0	55.0	53.5	52.0	50.0	48.0	46.5	45.0	43.5	42.0	40.0
63	70.6	69.3	67.4	65.5	63.0	60.5	58.6	56.7	54.8	52.9	50.4
80	89.6	88.0	85.6	83.2	80.0	76.8	74.4	72.0	69.6	67.2	64.0
100	112.0	110.0	107.0	104.0	100.0	96.0	93.0	90.0	87.0	84.0	80.0
125	140.0	137.5	133.8	130.0	125.0	120.0	116.3	112.5	108.8	105.0	100.0

15

S800S-K In [A]	Ambient temperature T (°C/°F)										
	10/50	15/59	20/68	25/77	30/86	35/95	40/104	45/113	50/122	55/131	60/140
10	11.9	11.6	11.2	11.0	10.7	10.4	10.0	9.6	9.3	9.0	8.7
13	15.6	15.1	14.6	14.3	13.9	13.5	13.0	12.5	12.1	11.7	11.3
16	19.1	18.6	17.9	17.6	17.1	16.6	16.0	15.4	14.9	14.4	13.9
20	23.9	23.2	22.4	22.0	21.4	20.8	20.0	19.2	18.6	18.0	17.4
25	29.9	29.1	28.0	27.5	26.8	26.0	25.0	24.0	23.3	22.5	21.8
32	38.2	37.2	35.8	35.2	34.2	33.3	32.0	30.7	29.8	28.8	27.8
40	47.8	46.5	44.8	44.0	42.8	41.6	40.0	38.4	37.2	36.0	34.8
50	59.7	58.1	56.0	55.0	53.5	52.0	50.0	48.0	46.5	45.0	43.5
63	75.3	73.2	70.6	69.3	67.4	65.5	63.0	60.5	58.6	56.7	54.8
80	95.6	93.0	89.6	88.0	85.6	83.2	80.0	76.8	74.4	72.0	69.6
100	119.5	116.2	112.0	110.0	107.0	104.0	100.0	96.0	93	90.0	87.0
125	149.4	145.3	140.0	137.5	133.8	130.0	125.0	120.0	116.3	112.5	108.8

Technical data
S800S
IEC

Tripping Characteristic B

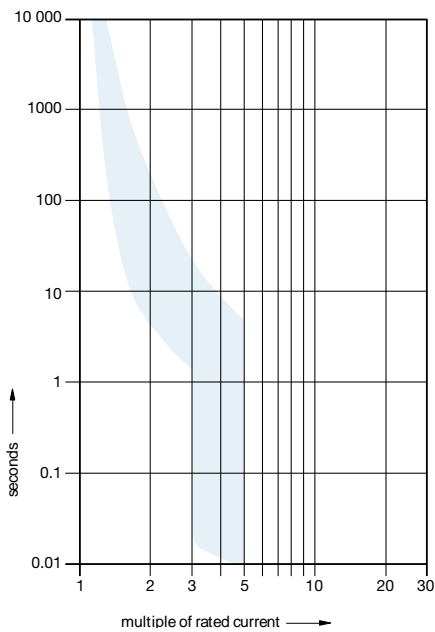

Tripping Characteristic C

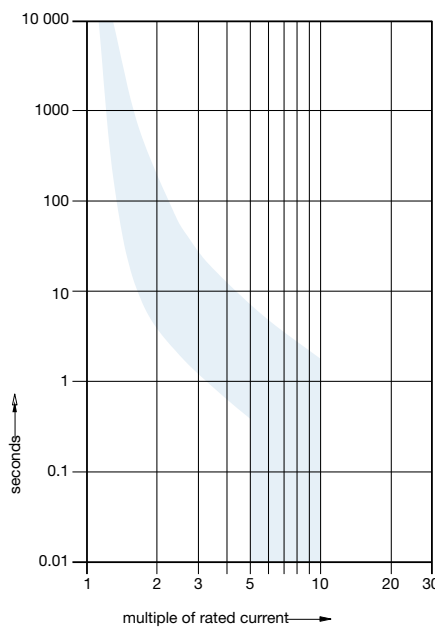

Tripping Characteristic D

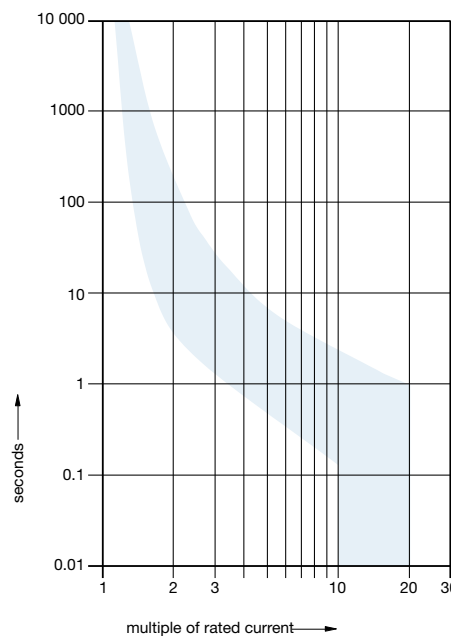

Tripping Characteristic K

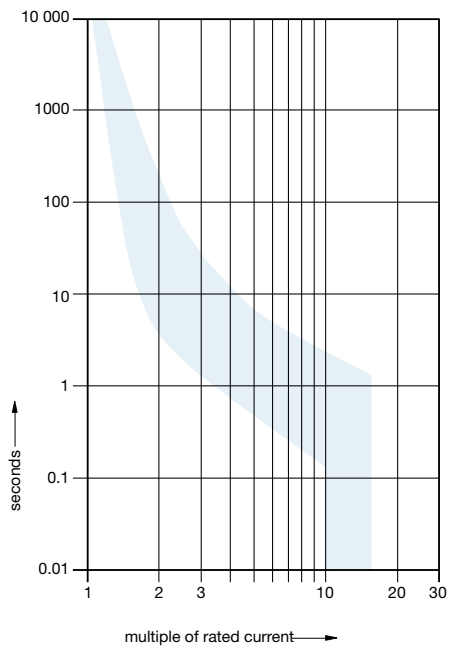

Tripping Characteristic Z

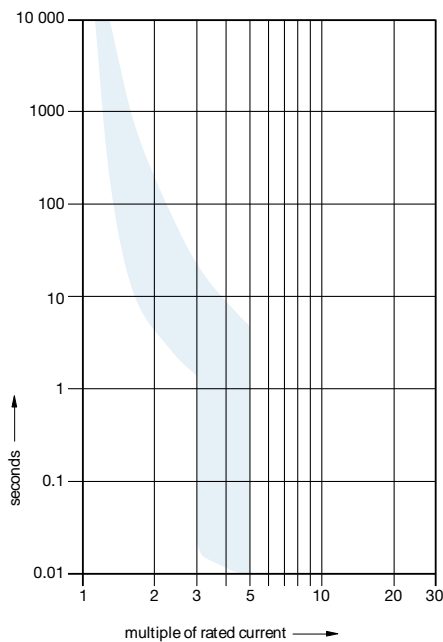

Technical data S800U & S800S Accessories

Auxiliary contact S800-AUX

	S800-AUX
Usage category	AC15 400/2 A-UL AC15 240/ -UL DC13 250/0.55 A125 V/1.1A-IEC DC13 125 V/1.1A DC13 60 V/2A DC13 24 V/4A
Continuous thermal current I_n	6 A
Rated insulation voltage U_i	690 V
Number of contacts	2
Surge U_{test} (1.2/50 μ s)	6 kV
Degree of protection	3
Function of contact	Changeover contacts
Connection Cu	1 x 2.5 mm ² 2 x 1.5 mm ²
Tightening torque	1 Nm
Ensured contacts during shake test acc. to IEC 68-2-6	5g, 20 frequency cycle at 24 VAC/DC, 5mA brief interrupt <10 ms
AC/DC supply	any EN 60715
Mounting on DIN top hat rail	EN 60715 IP20
Type of protection	IP20
Permissible ambient temperature for operations	-25...+60 °C; -13 °F... 140 °F
Storage temperature	-40...+70 °C; -40 °F... 158 °F
Mechanical device service life	6000 switching cycles
I_{cu} with S450E	1000 A
Resistance to vibration	IEC 60068-2-27; IEC 60068-2; EN 61373 Cat.1/class B

Undervoltage release S800-UVR

	S800-UVR36	S800-UVR60	S800-UVR130	S800-UVR250
Rated voltage U_e	24...36 VAC/DC	48...60 VAC/DC	110...130 VAC/DC	220...250 VAC/DC
Operating range				
Operating opening	35...70% U_e			
Operating closing	85% U_e			
Rated insulation voltage U_i	690 V			
Coil pull in consumption	1 W, 14 vA	1 W, 25 vA	1 W, 41 vA	1 W, 91 vA
Rated frequency	DC; 50/60 Hz			
Protection degree	3			
Connection Cu	1...35 cable			
Tightening torque	min.3/ max.4 Nm			
AC/DC supply	any			
DIN top hat rail	EN 60715			
Type of protection	IP20 IP40 (only actuation side)			
Permissible ambient temperature of operations	-25...+60 °C; -13 °F... 140 °F			
Storage temperature	-40...+70 °C; -40 °F... 158 °F			
Resistance to vibration	IEC 60068-2-27; IEC 60068-2; EN61373 Cat.1/class B			

Technical data

S800U & S800S

Accessories

Combined auxiliary and bell alarm

Usage category	AC15 400/2A-UL AC15 240/6A-UL DC13 250/0.55A125V/1.1A-IEC DC13 125V/1.1A-IEC DC13 60V/2A DC13 24V/4A
Continuous thermal current I_n	6 A
Rated insulation voltage U_i	690 V
Number of contacts	2 (1x AUX, 1 x AUX/ALT)
Surge U_{test} (1.2/50 μ s)	6 kV
Degree of protection	3
Function of contact	Changeover contacts
Connection Cu	1 x 2.5 mm ² 2 x 1.5 mm ²
Tightening torque	1 Nm
Ensured contacts during shake test acc. to IEC 68-2-6	5g, 20 frequency cycle 5...150...5Hz at 24VAC/DC, 5mA brief interrupt <10ms
AC/DC supply	any EN 60715
Mounting on DIN top hat rail	EN 60715
Type of protection	IP20
Permissible ambient temperature for operations	-25 °C... 60 °C; -13 °F... 140 °F
Storage temperature	-40 °C... 70 °C; -40 °F... 150 °F
mech. Device service life	6000 switching cycles
I_{cu} with S450E	1000 A
Resistance to vibration	IEC 60068-2-27; IEC 60068-2; EN 61373 Cat.1/class B

Shunt operation release – S800-SOR

	S800-SOR24	S800-SOR130	S800-SOR250	S800-SOR400
Rated voltage U_e	24 VAC/DC	48...130 VAC/DC	110...250 VAC/DC	220...250
Operating range	70... 110% U_e			
Rated insulation voltage U_i	690 V			
Coil pull in consumption	19.2 W/vA	On request		
Rated frequency	DC; 50/60 Hz			
Degree of protection	3			
Connection Cu	1...35 AWG			
Tightening torque	min.3/ max.4 Nm			
AC/DC supply	any			
DIN top hat rail	EN 60715			
Type of protection	IP20; IP40 (only actuation side)			
Permissible ambient temperature of operations	-25 °C... 60 °C; -13 °F... 140 °F			
Storage temperature	-40 °C... 70 °C; -40 °F... 158 °F			
Resistance to vibration	IEC 60068-2-27; IEC 60068-2; EN61373 Cat.1/class B			

Technical data

Backup

S800S - S200 @ 230/400 V

L.	Char.	E.											
		S800S											
		B, C, D, K											
I _{cu} [kA]	I _n [A]	50											
		S200	B	6	6	50	50	50	50	50	50	50	50
10	50				50	50	50	50	50	50	50	50	50
13	50				50	50	50	50	50	50	50	50	50
16	50				50	50	50	50	50	50	50	50	50
20					50	50	50	50	50	50	50	50	50
25						50	50	50	50	50	50	50	50
32							50	50	50	50	50	50	50
40								50	50	50	50	50	50
50									50	50	50	50	50
63										50	50	50	50

L.	Char.	E.											
		S800S											
		B, C, D, K											
I _{cu} [kA]	I _n [A]	50											
		S200P	B	25	6...16	50	50	50	50	50	50	50	50
20					50	50	50	50	50	50	50	50	50
25						50	50	50	50	50	50	50	50
32							50	50	50	50	50	50	50
15	40							50	50	50	50	50	50
	50								50	50	50	50	50
	63									50	50	50	50

L.	Char.	E.											
		S800S											
		B, C, D, K											
I _{cu} [kA]	I _n [A]	50											
		S200	C	6	0.5...6	50	50	50	50	50	50	50	50
8	50				50	50	50	50	50	50	50	50	50
10	50				50	50	50	50	50	50	50	50	50
13	50				50	50	50	50	50	50	50	50	50
16	50				50	50	50	50	50	50	50	50	50
20					50	50	50	50	50	50	50	50	50
25						50	50	50	50	50	50	50	50
32							50	50	50	50	50	50	50
40								50	50	50	50	50	50
50									50	50	50	50	50
63										50	50	50	50

L.	Char.	E.											
		S800S											
		B, C, D, K											
I _{cu} [kA]	I _n [A]	50											
		S200P	C	25	0.5...16	50	50	50	50	50	50	50	50
20					50	50	50	50	50	50	50	50	50
25						50	50	50	50	50	50	50	50
32							50	50	50	50	50	50	50
15	40							50	50	50	50	50	50
	50								50	50	50	50	50
	63									50	50	50	50

LEGEND

E. = supply side
L. = load side
Back-up limit values are specified in kA

Technical data

Selectivity

S800S - S200 @ 230/400 V

		E.		S800S													
L.		Char.		B													
		I _{cu} [kA]		50													
		I _n [A]		25	32	40	50	63	80	100	125						
S200	B	6	6			0.4	0.5	0.7	1	1.5	2.6						
			10				0.4	0.6	0.7	1	1.4						
			13					0.5	0.7	0.9	1.3						
			16						0.7	0.9	1.3						
			20							0.9	1.3						
			25								0.9	1.3					
			32									0.8	1.1				
			40										0.8	1.1			
			50											1			
			63												0.9		

		E.		S800S												
L.		Char.		B												
		I _{cu} [kA]		50												
		I _n [A]		25	32	40	50	63	80	100	125					
S200	D	6	0.5	T	T	T	T	T	T	T	T	T				
			1	0.8	4.5	T	T	T	T	T	T	T	T			
			1.6	0.5	1	2.3	T	T	T	T	T	T	T			
			2	0.3	0.5	0.7	2.3	T	T	T	T	T	T			
			3		0.4	0.5	0.7	1.2	2.5	T	T	T	T			
			4		0.4	0.4	0.7	1	1.7	3	T	T	T			
			6				0.6	0.8	1.2	2	3.6	T	T			
			8					0.7	0.9	1.3	2	T	T			
			10						0.9	1.3	2	T	T			
			13							1	1.5	T	T			
			16										1.5			
			20													
			25													
			32													
			40													
			50													
			63													

		E.		S800S												
L.		Char.		B												
		I _{cu} [kA]		50												
		I _n [A]		25	32	40	50	63	80	100	125					
S200	C	6	0.5	T	T	T	T	T	T	T	T					
			1	3.3	T	T	T	T	T	T	T	T				
			1.6	0.6	1.3	T	T	T	T	T	T	T				
			2	0.4	0.7	1.3	T	T	T	T	T	T				
			3		0.4	0.6	0.7	1.1	2.6	T	T	T				
			4		0.4	0.6	0.7	1	1.7	3.1	T	T				
			6			0.4	0.5	0.7	1	1.5	2.6	T	T			
			8				0.4	0.6	0.7	1	1.4	T	T			
			10				0.4	0.6	0.7	1	1.4	T	T			
			13					0.5	0.7	0.9	1.3	T	T			
			16						0.7	0.9	1.3	T	T			
			20							0.9	1.3	T	T			
			25								0.9	1.3	T			
			32									0.8	1.1			
			40										0.8	1.1		
50											1					
63												0.9				

		E.		S800S												
L.		Char.		B												
		I _{cu} [kA]		50												
		I _n [A]		25	32	40	50	63	80	100	125					
S200	K	6	0.5	T	T	T	T	T	T	T	T	T				
			1	0.8	5	T	T	T	T	T	T	T	T			
			1.6	0.5	1	2.1	T	T	T	T	T	T	T			
			2	0.3	0.5	0.7	2.1	T	T	T	T	T	T			
			3		0.4	0.5	0.7	1.2	2.5	T	T	T	T			
			4		0.4	0.4	0.7	1	1.7	3	T	T	T			
			6				0.6	0.8	1.2	2	3.6	T	T			
			8					0.7	0.9	1.3	2	T	T			
			10						0.9	1.3	2	T	T			
			13							1	1.5	T	T			
			16										1.5			
			20													
			25													
			32													
			40													
			50													
			63													

LEGEND

E. = supply side
L. = load side
Back-up limit values are specified in kA

Technical data

Selectivity

S800S - S200 @ 230/400 V

L.	Char.	E.		S800S											
		I _n [A]	I _{cu} [kA]	C											
				50											
S200	B	6	6	0.4	0.5	0.7	0.9	1.4	2.4	4.8					
			10	0.3	0.4	0.5	0.7	0.9	1.3	2					
			13		0.3	0.4	0.5	0.7	0.9	1.3	1.9				
			16		0.3	0.4	0.5	0.7	0.9	1.3	1.9				
			20			0.4	0.5	0.7	0.9	1.2	1.8				
			25			0.4	0.5	0.7	0.9	1.2	1.8				
			32				0.5	0.6	0.8	1	1.4				
			40					0.6	0.8	1	1.4				
			50						0.7	0.9	1.3				
			63							0.9	1.2				

L.	Char.	E.		S800S															
		I _n [A]	I _{cu} [kA]	C															
				50															
S200	D	6	0.5	T	T	T	T	T	T	T	T	T	T	T	T	T	T		
			1	2.1	T	T	T	T	T	T	T	T	T	T	T	T	T	T	
			1.6	0.8	2.3	T	T	T	T	T	T	T	T	T	T	T	T	T	T
			2	0.4	0.7	2.3	T	T	T	T	T	T	T	T	T	T	T	T	T
			3	0.3	0.5	0.7	1.2	2.2	T	T	T	T	T	T	T	T	T	T	T
			4	0.3	0.4	0.7	1	1.4	2.6	T	T	T	T	T	T	T	T	T	T
			6		0.4	0.6	0.8	1.1	1.8	3.2	T	T	T	T	T	T	T	T	T
			8			0.5	0.7	0.9	1.2	1.8	2.8	T	T	T	T	T	T	T	T
			10				0.7	0.9	1.2	1.8	2.8	T	T	T	T	T	T	T	T
			13					0.7	1	1.4	2								
			16						1	1.4	2								
			20							1	1.4	2							
			25								1	1.4	2						
			32																
			40																
			50																
			63																

L.	Char.	E.		S800S											
		I _n [A]	I _{cu} [kA]	C											
				50											
S200	C	6	0.5	T	T	T	T	T	T	T	T	T	T	T	
			1	T	T	T	T	T	T	T	T	T	T	T	
			1.6	0.6	T	T	T	T	T	T	T	T	T	T	T
			2	0.5	1	T	T	T	T	T	T	T	T	T	T
			3	0.3	0.5	0.7	1.2	2.1	T	T	T	T	T	T	T
			4	0.3	0.4	0.7	1	1.5	2.6	T	T	T	T	T	T
			6		0.4	0.5	0.7	0.9	1.4	2.4	4.8				
			8		0.3	0.4	0.5	0.7	0.9	1.3	2				
			10		0.3	0.4	0.5	0.7	0.9	1.3	2				
			13		0.3	0.4	0.5	0.7	0.9	1.3	1.9				
			16		0.3	0.4	0.5	0.7	0.9	1.3	1.9				
			20			0.4	0.5	0.7	0.9	1.2	1.8				
			25			0.4	0.5	0.7	0.9	1.2	1.8				
			32				0.5	0.6	0.8	1	1.4				
			40					0.6	0.8	1	1.4				
50						0.7	0.9	1.3							
63							0.9	1.2							

L.	Char.	E.		S800S										
		I _n [A]	I _{cu} [kA]	C										
				50										
S200	K	6	0.5	T	T	T	T	T	T	T	T	T	T	T
			1	2.1	T	T	T	T	T	T	T	T	T	T
			1.6	0.8	2.3	T	T	T	T	T	T	T	T	T
			2	0.4	0.7	2.3	T	T	T	T	T	T	T	T
			3	0.3	0.5	0.7	1.2	2.2	T	T	T	T	T	T
			4	0.3	0.4	0.7	1	1.4	2.6	T	T	T	T	T
			6		0.4	0.6	0.8	1.1	1.8	3.2	T	T	T	T
			8			0.5	0.7	0.9	1.2	1.8	2.8	T	T	T
			10				0.7	0.9	1.2	1.8	2.8	T	T	T
			13					0.7	1	1.4	2			
			16						1	1.4	2			
			20							1	1.4	2		
			25								1	1.4	2	
			32											
			40											
			50											
			63											

LEGEND

E. = supply side
L. = load side
Back-up limit values are specified in kA

Technical data

Selectivity

S800S - S200 @ 230/400 V

Miniature
circuit breakers
S800

		E.		S800S							
L.	Char.	I _{cu} [kA]	D								
			50								
			I _n [A]	25	32	40	50	63	80	100	125
S200	B	6	6	0.5	1	1.2	2	2.8	T	T	T
			10	0.4	0.6	0.8	1.1	1.4	2.8	3.9	T
			13	0.4	0.6	0.8	1.1	1.4	2.5	3.3	T
			16		0.6	0.8	1.1	1.4	2.5	3.3	5.6
			20			0.8	1.1	1.3	2.3	3	4.7
			25			0.8	1.1	1.3	2.3	3	4.7
			32				0.9	1.1	1.9	2.4	3.7
			40					1.1	1.9	2.4	3.7
			50						1.5	1.9	2.3
			63							1.7	2.3

		E.		S800S									
L.	Char.	I _{cu} [kA]	D										
			50										
			I _n [A]	25	32	40	50	63	80	100	125		
S200	D	6	0.5	T	T	T	T	T	T	T	T	T	T
			1	T	T	T	T	T	T	T	T	T	T
			1.6	T	T	T	T	T	T	T	T	T	T
			2	2.3	T	T	T	T	T	T	T	T	T
			3	0.7	1.3	4.4	T	T	T	T	T	T	
			4	0.7	1	2.2	4.4	T	T	T	T	T	
			6	0.6	0.8	1.5	2.5	3.6	T	T	T	T	
			8	0.5	0.7	1.1	1.5	2	4	5.5	T	T	
			10	0.5	0.7	1.1	1.5	2	4	5.5	T	T	
			13		0.6	0.9	1.2	1.5	2.6	3.4	5.2	T	
			16			0.9	1.2	1.5	2.6	3.4	5.2	T	
			20				0.9	1.1	1.8	2.2	3.2	T	
			25					1.1	1.8	2.2	3.2	T	
			32						1.7	2	2.9	T	
			40							1.9	2.6	T	
			50								2.2	T	
63									T				

		E.		S800S								
L.	Char.	I _{cu} [kA]	D									
			50									
			I _n [A]	25	32	40	50	63	80	100	125	
S200	C	6	0.5	T	T	T	T	T	T	T	T	T
			1	T	T	T	T	T	T	T	T	T
			1.6	T	T	T	T	T	T	T	T	T
			2	T	T	T	T	T	T	T	T	T
			3	0.7	2.2	4.4	T	T	T	T	T	T
			4	0.7	1.3	2.2	4.4	T	T	T	T	T
			6	0.5	1	1.2	2	2.8	T	T	T	T
			8	0.4	0.6	0.8	1.1	1.4	2.8	3.9	T	T
			10	0.4	0.6	0.8	1.1	1.4	2.8	3.9	T	T
			13	0.4	0.6	0.8	1.1	1.4	2.5	3.3	5.6	T
			16		0.6	0.8	1.1	1.4	2.5	3.3	5.6	T
			20			0.8	1.1	1.3	2.3	3	4.7	T
			25			0.8	1.1	1.3	2.3	3	4.7	T
			32				0.9	1.1	1.9	2.4	3.7	T
			40					1.1	1.9	2.4	3.7	T
			50						1.5	1.9	2.3	T
63							1.7	2.3	T			

		E.		S800S								
L.	Char.	I _{cu} [kA]	D									
			50									
			I _n [A]	25	32	40	50	63	80	100	125	
S200	K	6	0.5	T	T	T	T	T	T	T	T	T
			1	T	T	T	T	T	T	T	T	T
			1.6	T	T	T	T	T	T	T	T	T
			2	2.3	T	T	T	T	T	T	T	T
			3	0.7	1.3	4.4	T	T	T	T	T	T
			4	0.7	1	2.2	4.4	T	T	T	T	T
			6	0.6	0.8	1.5	2.5	3.6	T	T	T	T
			8	0.5	0.7	1.1	1.5	2	4	5.5	T	T
			10	0.5	0.7	1.1	1.5	2	4	5.5	T	T
			13		0.6	0.9	1.2	1.5	2.6	3.4	5.2	T
			16			0.9	1.2	1.5	2.6	3.4	5.2	T
			20				0.9	1.1	1.8	2.2	3.2	T
			25					1.1	1.8	2.2	3.2	T
			32						1.7	2	2.9	T
			40							1.9	2.6	T
			50								2.2	T
63									T			

LEGEND

E. = supply side
L. = load side
Back-up limit values are specified in kA

Technical data

Selectivity

S800S - S200 @ 230/400 V

L.	Char.	E.		S800S							
		I _{cu} [kA]	I _n [A]	B							
				50							
S200P	B	25	6			0.4	0.5	0.7	1	1.5	2.6
			10			0.4	0.6	0.7	1	1.4	
			13				0.5	0.7	0.9	1.3	
			16					0.7	0.9	1.3	
			20						0.9	1.3	
			25						0.9	1.3	
	15	32						0.8	1.1		
		40						0.8	1.1		
		50							1		
		63								0.9	

L.	Char.	E.		S800S							
		I _{cu} [kA]	I _n [A]	C							
				50							
S200P	B	25	6			0.4	0.5	0.7	1	1.5	2.6
			10			0.4	0.6	0.7	1	1.4	
			13				0.5	0.7	0.9	1.3	
			16					0.7	0.9	1.3	
			20						0.9	1.3	
			25						0.9	1.3	
	15	32						0.8	1.1		
		40						0.8	1.1		
		50							1		
		63								0.9	

L.	Char.	E.		S800S							
		I _{cu} [kA]	I _n [A]	B							
				50							
S200P	C	25	0.5	T	T	T	T	T	T	T	T
			1	3.3	T	T	T	T	T	T	T
			1.6	0.6	1.3	T	T	T	T	T	T
			2	0.4	0.7	1.2	T	T	T	T	T
			3			0.6	0.7	1.1	2.6	8.8	T
			4			0.6	0.7	1	1.7	3.1	7
			6			0.4	0.5	0.7	1	1.5	2.6
			8				0.4	0.6	0.7	1	1.4
			10				0.4	0.6	0.7	1	1.4
			13					0.5	0.7	0.9	1.3
			16						0.7	0.9	1.3
			20							0.9	1.3
			25							0.9	1.3
			32							0.8	1.1
			40							0.8	1.1
			50								1
			63								0.9

L.	Char.	E.		S800S								
		I _{cu} [kA]	I _n [A]	C								
				50								
S200P	C	25	0.5	T	T	T	T	T	T	T	T	
			1	3.3	T	T	T	T	T	T	T	
			1.6	0.6	1.3	T	T	T	T	T	T	
			2	0.4	0.7	1.3	T	T	T	T	T	
			3			0.4	0.6	0.7	1.1	2.6	8.8	T
			4			0.4	0.6	0.7	1	1.7	3.1	7
			6				0.4	0.5	0.7	1	1.5	2.6
			8					0.4	0.6	0.7	1	1.4
			10					0.4	0.6	0.7	1	1.4
			13						0.5	0.7	0.9	1.3
			16							0.7	0.9	1.3
			20								0.9	1.3
			25								0.9	1.3
			32								0.8	1.1
			40								0.8	1.1
			50									1
			63									0.9

L.	Char.	E.		S800S							
		I _{cu} [kA]	I _n [A]	B							
				50							
S200P	K	25	0.2	T	T	T	T	T	T	T	T
			0.3	T	T	T	T	T	T	T	T
			0.5	T	T	T	T	T	T	T	T
			0.75	T	T	T	T	T	T	T	T
			1	0.8	5	T	T	T	T	T	T
			1.6	0.5	1	2.3	T	T	T	T	T
			2	0.3	0.5	0.7	2.1	T	T	T	T
			3		0.4	0.5	0.7	1.2	2.5	8.6	T
			4		0.4	0.4	0.7	1	1.7	3	7.7
			6				0.6	0.8	1.2	2	3.6
			8					0.7	0.9	1.3	2
			10						0.9	1.3	2
			13							1	1.5
			16								1.5
			20								
			25								
			32								
			40								
			50								
			63								

L.	Char.	E.		S800S							
		I _{cu} [kA]	I _n [A]	C							
				50							
S200P	K	25	0.2	T	T	T	T	T	T	T	T
			0.3	T	T	T	T	T	T	T	T
			0.5	T	T	T	T	T	T	T	T
			0.75	T	T	T	T	T	T	T	T
			1	0.8	5	T	T	T	T	T	T
			1.6	0.5	1	2.3	T	T	T	T	T
			2	0.3	0.5	0.7	2.3	T	T	T	T
			3		0.4	0.5	0.7	1.2	2.5	8.6	T
			4		0.4	0.4	0.7	1	1.7	3	7.7
			6				0.6	0.8	1.2	2	3.6
			8					0.7	0.9	1.3	2
			10						0.9	1.3	2
			13							1	1.5
			16								1.5
			20								
			25								
			32								
			40								
			50								
			63								

LEGEND

E. = supply side
L. = load side
Back-up limit values are specified in kA

Technical data

Selectivity

S800S - S200P @ 230/400 V

Miniature
circuit breakers
S800

		E.		S800S							
L.	Char.	I _{cu} [kA]	D								
			50								
			I _n [A]	25	32	40	50	63	80	100	125
S200P	B	25	6	0.5	1	1.2	2	2.8	9.9	21.3	T
			10	0.4	0.6	0.8	1.1	1.4	2.8	3.9	7.4
			13	0.4	0.6	0.8	1.1	1.4	2.5	3.3	5.6
			16		0.6	0.8	1.1	1.4	2.5	3.3	5.6
			20			0.8	1.1	1.3	2.3	3	4.7
			25			0.8	1.1	1.3	2.3	3	4.7
			32				0.9	1.1	1.9	2.4	3.7
		15	40					1.1	1.9	2.4	3.7
			50						1.5	1.9	2.3
			63							1.7	2.3

		E.		S800S								
L.	Char.	I _{cu} [kA]	D									
			50									
			I _n [A]	25	32	40	50	63	80	100	125	
S200P	C	25	0.5	T	T	T	T	T	T	T	T	T
			1	T	T	T	T	T	T	T	T	T
			1.6	T	T	T	T	T	T	T	T	T
			2	T	T	T	T	T	T	T	T	T
			3	0.7	2.2	4.4	T	T	T	T	T	T
			4	0.7	1.3	2.2	4.4	7.7	T	T	T	T
			6	0.5	1	1.2	2	2.8	9.9	22	T	T
			8	0.4	0.6	0.8	1.1	1.4	2.8	3.9	7.4	T
			10	0.4	0.6	0.8	1.1	1.4	2.8	3.9	7.4	T
			13	0.4	0.6	0.8	1.1	1.4	2.5	3.3	5.6	T
			16		0.6	0.8	1.1	1.4	2.5	3.3	5.6	T
			20			0.8	1.1	1.3	2.3	3	4.7	T
			25			0.8	1.1	1.3	2.3	3	4.7	T
			15	32				0.9	1.1	1.9	2.4	3.7
		40						1.1	1.9	2.4	3.7	T
		50							1.5	1.9	2.3	T
		63								1.7	2.3	T

		E.		S800S								
L.	Char.	I _{cu} [kA]	D									
			50									
			I _n [A]	25	32	40	50	63	80	100	125	
S200P	K	25	0.2	T	T	T	T	T	T	T	T	T
			0.3	T	T	T	T	T	T	T	T	T
			0.5	T	T	T	T	T	T	T	T	T
			0.75	T	T	T	T	T	T	T	T	T
			1	T	T	T	T	T	T	T	T	T
			1.6	T	T	T	T	T	T	T	T	T
			2	2.3	T	T	T	T	T	T	T	T
			3	0.7	1.3	4.4	T	T	T	T	T	T
			4	0.7	1	2.2	4.4	7.7	T	T	T	T
			6	0.6	0.8	1.5	2.5	3.6	12.1	24.2	T	T
			8	0.5	0.7	1.1	1.5	2	4	5.5	9.9	T
			10	0.5	0.7	1.1	1.5	2	4	5.5	9.9	T
			13		0.6	0.9	1.2	1.5	2.6	3.4	5.2	T
			16			0.9	1.2	1.5	2.6	3.4	5.2	T
		20				0.9	1.1	1.8	2.2	3.2	T	
		25						1.8	2.2	3.2	T	
		15	32							1.7	2	2.9
			40								1.9	2.6
			50									2.2
			63									

LEGEND

E. = supply side
L. = load side
Back-up limit values are specified in kA

Technical data

Selectivity

S800S - S280 @ 230/400 V

		E.		S800S							
L.		Char.		B, C, D, K							
		I _{cu} [kA]		50							
		I _n [A]		25	32	40	50	63	80	100	125
S280	B	10	6	50	50	50	50	50	50	50	50
			10	50	50	50	25	20	16	16	16
		25	13	50	50	50	25	20	16	16	16
			16	50	50	50	25	20	16	16	16
			20		50	50	25	20	16	16	16
			25			50	25	20	16	16	16
		15	32				25	20	16	16	16
			40					20	16	16	16
		10	50						16	16	16
			63							16	16

		E.		S800S								
L.		Char.		B, C, D, K								
		I _{cu} [kA]		50								
		I _n [A]		25	32	40	50	63	80	100	125	
S400E	B	6	6	50	50	50	50	50	50	50	50	
			10	50	50	50	50	50	50	50	50	
			13	50	50	50	50	50	50	50	50	
			16	50	50	50	50	50	50	50	50	
			20		50	50	50	50	50	50	50	
			25			50	50	50	50	50	50	
			32				50	50	50	50	50	
			40						50	50	50	50
			50							50	50	50
			63								50	50

		E.		S800S							
L.		Char.		B, C, D, K							
		I _{cu} [kA]		50							
		I _n [A]		25	32	40	50	63	80	100	125
S280	C	10	3	50	50	50	50	50	50	50	50
			4	50	50	50	50	50	50	50	50
			6	50	50	50	50	50	50	50	50
			8	50	50	50	25	20	16	16	16
		25	10	50	50	50	25	20	16	16	16
			13	50	50	50	25	20	16	16	16
			16	50	50	50	25	20	16	16	16
			20		50	50	25	20	16	16	16
		15	25			50	25	20	16	16	16
			32				25	20	16	16	16
10	40					20	16	16	16		
	50						16	16	16		
63								16	16		

		E.		S800S							
L.		Char.		B, C, D, K							
		I _{cu} [kA]		50							
		I _n [A]		25	32	40	50	63	80	100	125
S400E	C	6	0.5...6	50	50	50	50	50	50	50	50
			8	50	50	50	50	50	50	50	50
			10	50	50	50	50	50	50	50	50
			13	50	50	50	50	50	50	50	50
			16	50	50	50	50	50	50	50	50
			20		50	50	50	50	50	50	50
			25			50	50	50	50	50	50
			32				50	50	50	50	50
			40					50	50	50	50
			50						50	50	50
63								50	50		

		E.		S800S							
L.		Char.		B, C, D, K							
		I _{cu} [kA]		50							
		I _n [A]		25	32	40	50	63	80	100	125
S280	K, Z	10	3	50	50	50	50	50	50	50	50
			4	50	50	50	50	50	50	50	50
			6	50	50	50	50	50	50	50	50
			8	50	50	50	25	20	16	16	16
		25	10	50	50	50	25	20	16	16	16
			13	50	50	50	25	20	16	16	16
			16	50	50	50	25	20	16	16	16
			20		50	50	25	20	16	16	16
		15	25			50	25	20	16	16	16
			32				25	20	16	16	16
10	40					20	16	16	16		
	50						16	16	16		
63								16	16		

LEGEND

E. = supply side
L. = load side
Back-up limit values are specified in kA

Approximate dimensions
S800U & S800S
UL & IEC

Dimension drawings in mm

S800S & S800U

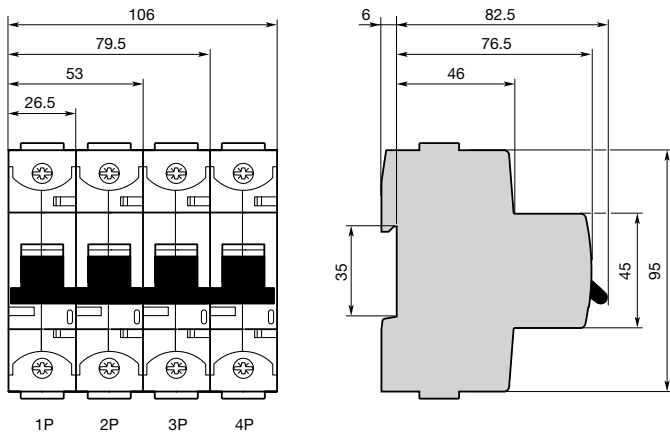

S800-SOR & S800-UVR

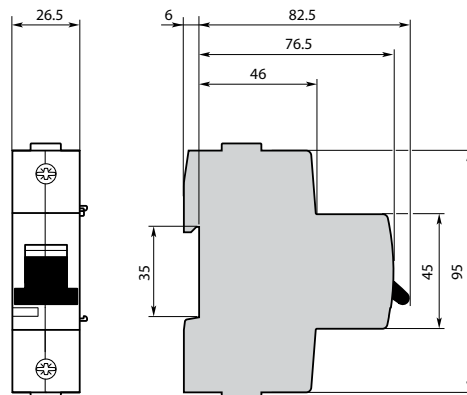

S800-AUX

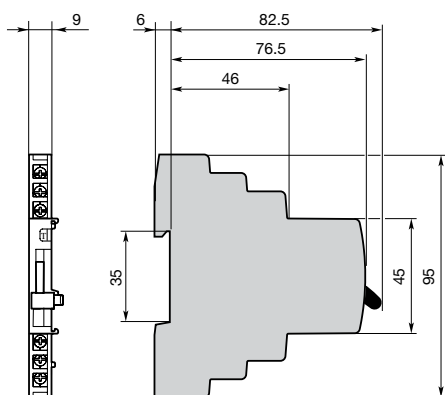

S800-AUX/ALT

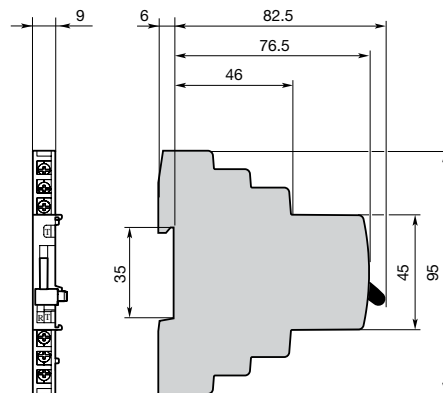

S800-RD & S800-RHE

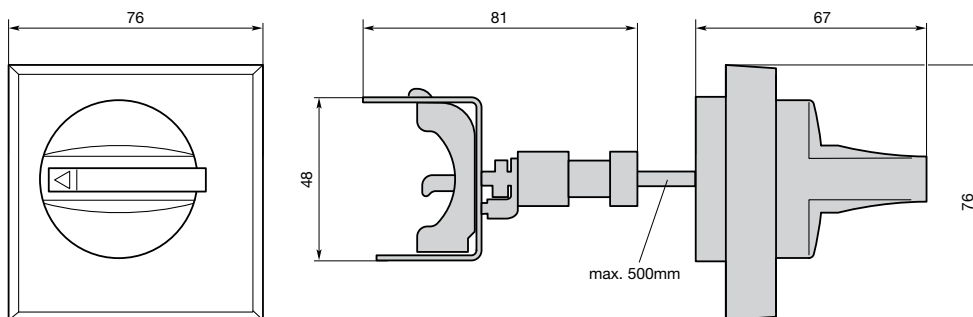

S500 UL 1077 Series Miniature circuit breakers



S500 Series
UL 1077

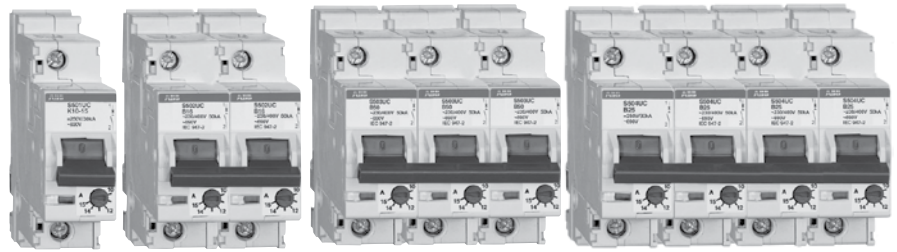

Description

The S500 high performance MCB offers a compact solution to circuit protection. The S500 devices are UL tested current limiting and DIN rail mounted. The S500 is available with application-specific trip characteristics to provide maximum circuit protection.

The breakers offer thermal-magnetic trip protection according to B and K characteristics.

For the worldwide market, the breakers carry CSA, IEC, CE and many other agency approvals.

Features

- High breaking capacity
- Fast breaking time (2.3 - 2.5 ms)
- Adjustable trip unit
- DIN rail mounting
- Finger safe terminals
- Multi-functional terminals
- Wide range of accessories
- UL 1077 recognized 600 VAC and 600 VDC versions
- UL1077 AC adjustable K
- UL1077 DC adjustable B, K
- UL File # E167556
- IEC #E60497-2

	S500	S500UC
Amperage	0.1 – 45 A	0.1 – 63 A
Voltage	UL: 600Y/277 VAC IEC: 690 VAC	UL: 250 VDC per pole (600 VDC for 4P) IEC: 250 VDC per pole (750 VDC for 4P)
Poles	1, 2, 3	1, 2, 3, 4
Trip characteristics	K	B, K
Interrupting ratings	Up to 30 kA: UL 1077 Up to 30 kA: CSA C22.2	30 kA: UL 1077 30 kA: CSA C22.2
Auxiliary contacts	Yes	Yes
Bell alarm	Yes	Yes
Shunt trip	No	No
Undervoltage release	No	No
Bus bar	Yes	Yes

S500-K, UL 600Y/277 VAC / IEC 690 VAC

Supplemental protection
UL 1077, CSA 22.2, IEC

K



S501-K



S502-K

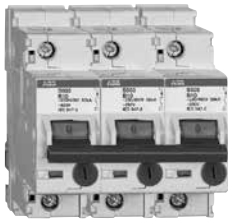

S503-K

No. of poles	Rated current	Catalog number	No. of poles	Rated current	Catalog number
1	0.1 – 0.15	S501-K0.15	3	0.1 – 0.15	S503-K0.15
	0.14 – 0.21	S501-K0.21		0.14 – 0.21	S503-K0.21
	0.2 – 0.3	S501-K0.3		0.2 – 0.3	S503-K0.3
	0.28 – 0.42	S501-K0.42		0.28 – 0.42	S503-K0.42
	0.38 – 0.58	S501-K0.58		0.38 – 0.58	S503-K0.58
	0.53 – 0.8	S501-K0.8		0.53 – 0.8	S503-K0.8
	0.73 – 1.1	S501-K1.1		0.73 – 1.1	S503-K1.1
	1 – 1.5	S501-K1.5		1 – 1.5	S503-K1.5
	1.4 – 2.1	S501-K2.1		1.4 – 2.1	S503-K2.1
	2 – 3	S501-K3		2 – 3	S503-K3
	2.8 – 4.2	S501-K4.2		2.8 – 4.2	S503-K4.2
	3.8 – 5.8	S501-K5.8		3.8 – 5.8	S503-K5.8
	5.3 – 8	S501-K8		5.3 – 8	S503-K8
	7.3 – 11	S501-K11		7.3 – 11	S503-K11
	10 – 15	S501-K15		10 – 15	S503-K15
	14 – 20	S501-K20		14 – 20	S503-K20
	18 – 26	S501-K26		18 – 26	S503-K26
	23 – 32	S501-K32		23 – 32	S503-K32
	29 – 37	S501-K37		29 – 37	S503-K37
	34 – 41	S501-K41		34 – 41	S503-K41
38 – 45	S501-K45	38 – 45	S503-K45		
2	0.1 – 0.15	S502-K0.15			
	0.14 – 0.21	S502-K0.21			
	0.2 – 0.3	S502-K0.3			
	0.28 – 0.42	S502-K0.42			
	0.38 – 0.58	S502-K0.58			
	0.53 – 0.8	S502-K0.8			
	0.73 – 1.1	S502-K1.1			
	1 – 1.5	S502-K1.5			
	1.4 – 2.1	S502-K2.1			
	2 – 3	S502-K3			
	2.8 – 4.2	S502-K4.2			
	3.8 – 5.8	S502-K5.8			
	5.3 – 8	S502-K8			
	7.3 – 11	S502-K11			
	10 – 15	S502-K15			
	14 – 20	S502-K20			
	18 – 26	S502-K26			
	23 – 32	S502-K32			
	29 – 37	S502-K37			
	34 – 41	S502-K41			
38 – 45	S502-K45				

Tripping characteristic K

UL 1077	IEC
600 VAC	690 VAC
Up to 30 kA	Up to 30 kA

Inductive loads

- K Curve
- Designed for allowing higher in-rush currents during system start up
- Example: motors, transformers

Accessories & technical data

Accessories – See page 15.71

Technical data – See page 15.76 - 82

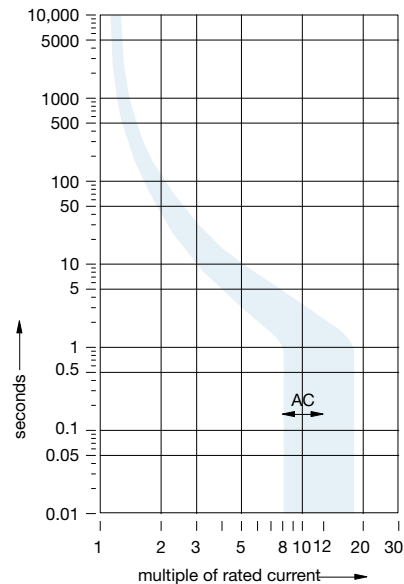

S500UC-B, 250 VDC per pole (600 VDC 4P)

UL/IEC (750 VDC 4P)

Supplemental protectors, UL1077, CSA 22.2, IEC

B



S501UC-B



S502UC-B

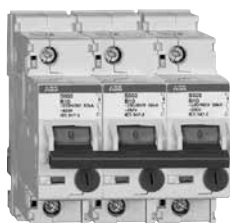

S503UC-B

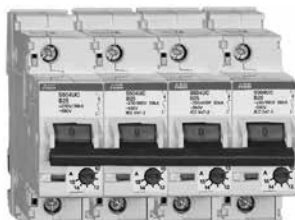

S504UC-B

No. of poles	Rated current	Catalog number	No. of poles	Rated current	Catalog number
1	6	S501UC-B6	3	6	S503UC-B6
	10	S501UC-B10		10	S503UC-B10
	13	S501UC-B13		13	S503UC-B13
	16	S501UC-B16		16	S503UC-B16
	20	S501UC-B20		20	S503UC-B20
	25	S501UC-B25		25	S503UC-B25
	32	S501UC-B32		32	S503UC-B32
	40	S501UC-B40		40	S503UC-B40
	50	S501UC-B50		50	S503UC-B50
2	6	S502UC-B6	4	6	S504UC-B6
	10	S502UC-B10		10	S504UC-B10
	13	S502UC-B13		13	S504UC-B13
	16	S502UC-B16		16	S504UC-B16
	20	S502UC-B20		20	S504UC-B20
	25	S502UC-B25		25	S504UC-B25
	32	S502UC-B32		32	S504UC-B32
	40	S502UC-B40		40	S504UC-B40
	50	S502UC-B50		50	S504UC-B50
	63	S502UC-B63	63	S504UC-B63	

Tripping characteristic B

UL 1077	IEC
250 VDC per pole (600 VDC 4P)	250 VDC per pole (750 VDC 4P)
30 kA	30 kA

Inductive loads

- B Curve
- Designed for allowing higher in-rush currents during system start up
- Example: motors, transformers

Accessories & technical data

Accessories – See page 15.71

Technical data – See page 15.76 - 82

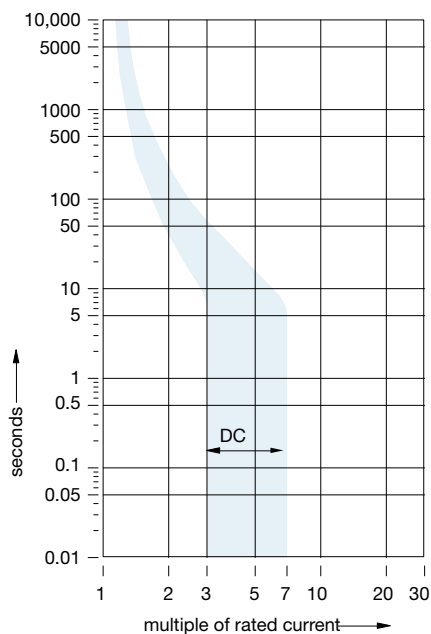

S500UC-K, 250 VDC per pole (600 VDC 4P) UL/IEC (750 VDC 4P)

Supplemental protectors, UL1077, CSA 22.2, IEC

K

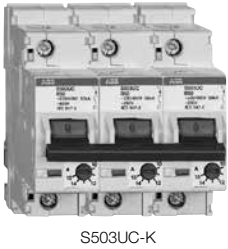

No. of poles	Rated current	Catalog number	No. of poles	Rated current	Catalog number
1	0.1 – 0.15	S501UC-K0.15	3	0.1 – 0.15	S503UC-K0.15
	0.14 – 0.21	S501UC-K0.21		0.14 – 0.21	S503UC-K0.21
	0.2 – 0.3	S501UC-K0.3		0.2 – 0.3	S503UC-K0.3
	0.28 – 0.42	S501UC-K0.42		0.28 – 0.42	S503UC-K0.42
	0.38 – 0.58	S501UC-K0.58		0.38 – 0.58	S503UC-K0.58
	0.53 – 0.8	S501UC-K0.8		0.53 – 0.8	S503UC-K0.8
	0.73 – 1.1	S501UC-K1.1		0.73 – 1.1	S503UC-K1.1
	1 – 1.5	S501UC-K1.5		1 – 1.5	S503UC-K1.5
	1.4 – 2.1	S501UC-K2.1		1.4 – 2.1	S503UC-K2.1
	2 – 3	S501UC-K3		2 – 3	S503UC-K3
	2.8 – 4.2	S501UC-K4.2		2.8 – 4.2	S503UC-K4.2
	3.8 – 5.8	S501UC-K5.8		3.8 – 5.8	S503UC-K5.8
	5.3 – 8	S501UC-K8		5.3 – 8	S503UC-K8
	7.3 – 11	S501UC-K11		7.3 – 11	S503UC-K11
	10 – 15	S501UC-K15		10 – 15	S503UC-K15
	14 – 20	S501UC-K20		14 – 20	S503UC-K20
	18 – 26	S501UC-K26		18 – 26	S503UC-K26
	23 – 32	S501UC-K32		23 – 32	S503UC-K32
29 – 37	S501UC-K37	29 – 37	S503UC-K37		
34 – 41	S501UC-K41	34 – 41	S503UC-K41		
38 – 45	S501UC-K45	38 – 45	S503UC-K45		
2	0.1 – 0.15	S502UC-K0.15	4	0.1 – 0.15	S504UC-K0.15
	0.14 – 0.21	S502UC-K0.21		0.14 – 0.21	S504UC-K0.21
	0.2 – 0.3	S502UC-K0.3		0.2 – 0.3	S504UC-K0.3
	0.28 – 0.42	S502UC-K0.42		0.28 – 0.42	S504UC-K0.42
	0.38 – 0.58	S502UC-K0.58		0.38 – 0.58	S504UC-K0.58
	0.53 – 0.8	S502UC-K0.8		0.53 – 0.8	S504UC-K0.8
	0.73 – 1.1	S502UC-K1.1		0.73 – 1.1	S504UC-K1.1
	1 – 1.5	S502UC-K1.5		1 – 1.5	S504UC-K1.5
	1.4 – 2.1	S502UC-K2.1		1.4 – 2.1	S504UC-K2.1
	2 – 3	S502UC-K3		2 – 3	S504UC-K3
	2.8 – 4.2	S502UC-K4.2		2.8 – 4.2	S504UC-K4.2
	3.8 – 5.8	S502UC-K5.8		3.8 – 5.8	S504UC-K5.8
	5.3 – 8	S502UC-K8		5.3 – 8	S504UC-K8
	7.3 – 11	S502UC-K11		7.3 – 11	S504UC-K11
	10 – 15	S502UC-K15		10 – 15	S504UC-K15
	14 – 20	S502UC-K20		14 – 20	S504UC-K20
	18 – 26	S502UC-K26		18 – 26	S504UC-K26
	23 – 32	S502UC-K32		23 – 32	S504UC-K32
29 – 37	S502UC-K37	29 – 37	S504UC-K37		
34 – 41	S502UC-K41	34 – 41	S504UC-K41		
38 – 45	S502UC-K45	38 – 45	S504UC-K45		

Tripping characteristic K

UL 1077	IEC
250 VDC per pole (600 VDC 4P)	250 VDC per pole (750 VDC 4P)
30 kA	30 kA

Inductive loads

- K Curve
- Designed for allowing higher in-rush currents during system start up
- Example: motors, transformers

Accessories & technical data

Accessories – See page 15.71

Technical data – See page 15.76 - 82

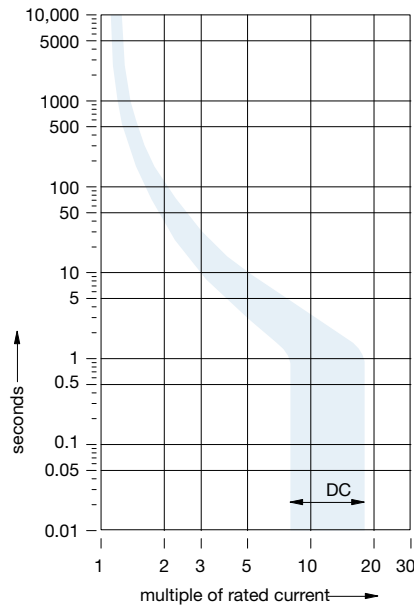

Accessories S500 UL1077



S500-H11, -H20

Auxiliary contacts

The auxiliary contacts will signal whether the breaker is in the ON or OFF position.

Description	Catalog number
For field mounting; left side	S500-H11 S500-H20
1 N.O./1 N.C. 2 N.O.	



S500-S11, -S20

Bell alarm

The bell alarm includes a set of contacts that will only signal when the breaker has tripped. Typically the contacts would be connected to an alarm or bell to signal the operator that an overcurrent trip has occurred. The bell alarm also includes a test button for testing the alarm contacts without opening the breaker.

Description	Catalog number
For field mounting; left side	S500-S11 S500-S20
1 N.O./1 N.C. 2 N.O.	



S500-RD3

Handle mechanism

Description	Catalog number
Handle mechanism	S500-RD3

For use with 1-4 pole S500 MCBs and disconnect switch selector handles with 5mm shafts.

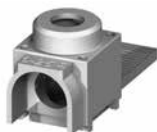

S500-K1

Power feed terminal - Accepts into 2/0 AWG

Description	Catalog number
Rear mount terminal	S500-K2

Rear mount terminal - Accepts into 2/0 AWG

Description	Catalog number
Accepts 4AWG/25mm	S500-K1

Technical data

S500-K & S500UC-B, K

Technical data	S500-K	S500UC-B, K
Approvals	1077 C22.2 - No. 235	1077 C22.2 - No. 235
Number of poles	1, 2, 3	1, 2, 3, 4
Tripping characteristic	K	B, K
Rated currents	0.1 to 45 A	B: 6 - 63 A; K: 0.15 - 45 A
Rated voltage	480Y/277 VAC, 600Y/346 VAC	250 VDC per pole (600 VDC 4 pole)
Frequency	50/60 Hz	50/60 Hz
Mounting position	vertical, horizontal	vertical, horizontal
Standard mounting	35mm DIN rail	35mm DIN rail
Clamps only for CU	16 - 4 AWG	16 - 4 AWG
Service life, mechanical at rated load	20,000	20,000
Ambient temperature	40°C... 104°F	40°C... 104°F

Tripping characteristic K

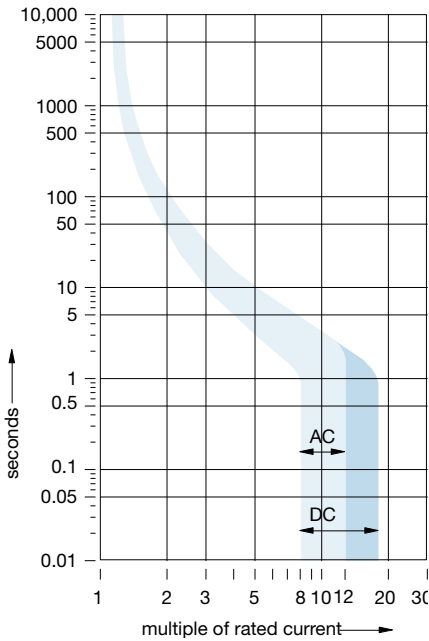

Tripping characteristic B

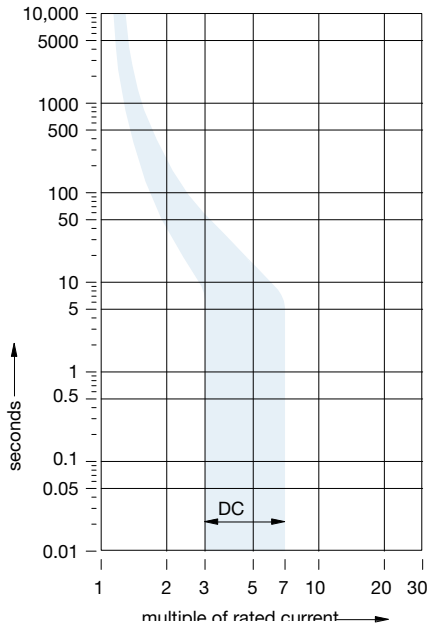

Approximate dimensions S500 & Accessories

S500

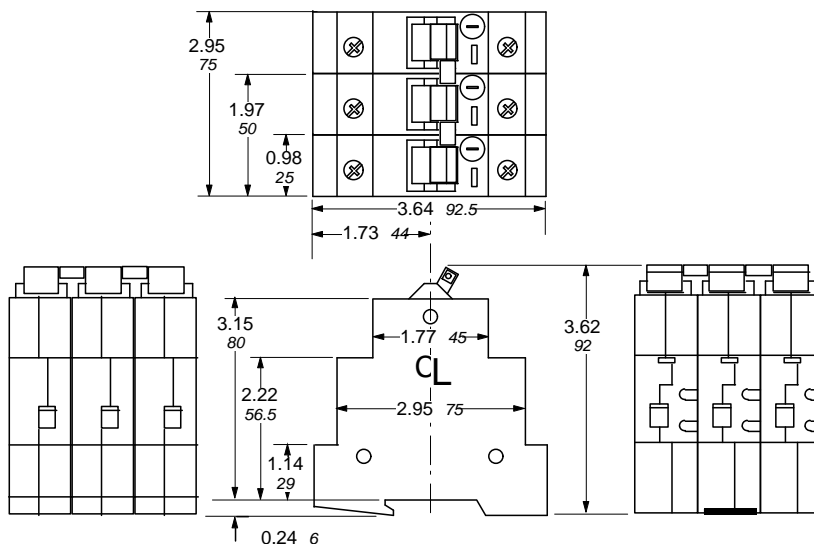

S500-H11, S500-H20 S500-S11, S500-S20

S500-RD3 Handle mechanism

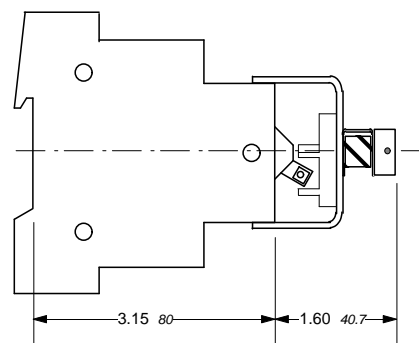
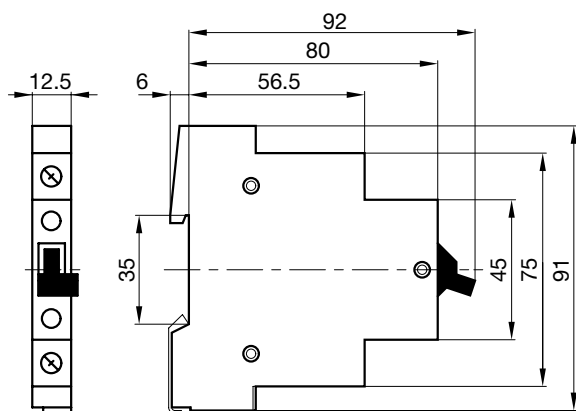

S500 Front mounting kit

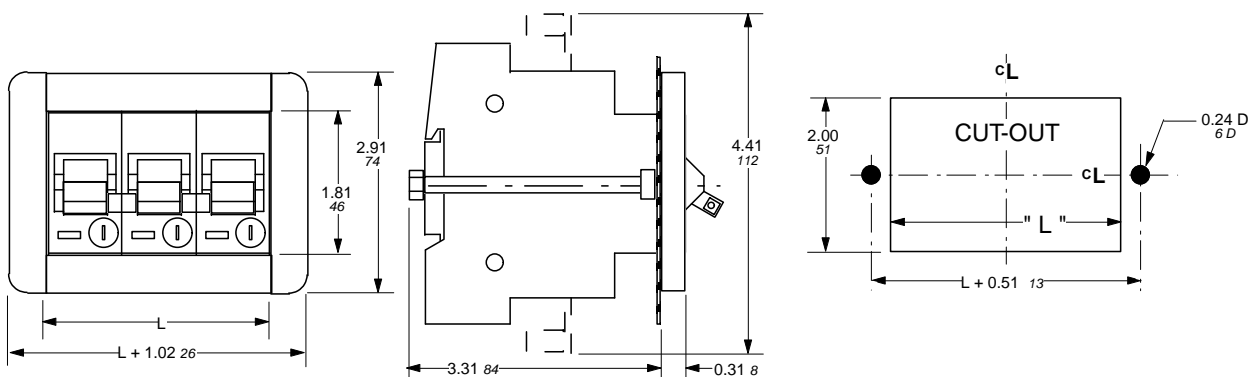



Miniature circuit breakers Technical data



S201UP-K



S201UP-K



S201-B



S201P-Z



S201PR-K0.2



S201UDC-K1



S501-K



S801U-B

S200

UL489

S200U-K.....	15.90
S200U-Z.....	15.90
S200UP-K.....	15.90
S200UP-Z.....	15.90
SU200PR-K.....	15.91
S200UDC-K.....	15.91
S200UDC-Z.....	15.91

UL1077

S200-B.....	15.92
S200-C, D.....	15.92
S200-K.....	15.92
S200-Z.....	15.92
S200P-B.....	15.93
S200P-C.....	15.93
S200P-D.....	15.93
S200P-K.....	15.93
S200P-Z.....	15.94
S200PR-K.....	15.94
S280UC-K.....	15.94
S280UC-Z.....	15.94

S800

UL489

S800U-K, Z.....	15.95
-----------------	-------

IEC

S800S-B.....	15.95
S800S-C.....	15.95
S800S-D.....	15.95
S800S-K.....	15.96

S500

UL1077

S500-K.....	15.97
S500UC-B, K.....	15.97

Technical data

S200U-K, S200U-Z, S200UP-K, S200UP-Z

Item	S200U-K	S200U-Z	S200UP-K	S200UP-Z
Approvals:				
UL	489	489	489	489
CSA	C22.2 No. 5	C22.2 No. 5	C22.2 No. 5	C22.2 No. 5
VDE	0660	0660	0660	0660
IEC	898, 60947-2	898, 60947-2	898, 60947-2	898
Number of Poles:	1,2,3,4	1,2,3,4	1,2,3,4	1,2,3,4
Tripping Characteristic:	K	Z	K	Z
Rated Currents:	0.2 to 63A	0.2 to 63A	0.2 to 25A	0.2 to 25A
Minimum Operating Voltage:	12V	12V	12V	12V
UL/CSA Rated Voltage & Interrupting Capacity:				
Frequency:	50/60 Hz	50/60 Hz	50/60 Hz	50/60 Hz
120VAC	10kA	10kA	10kA	10kA
240 VAC	10kA	10kA	10kA	10kA
277 VAC	—	—	10kA	10kA
277/480 VAC	—	—	10kA	10kA
60VDC	15kA	15kA	15kA	15kA
125VDC	15kA	15kA	15kA	15kA
250VDC	—	—	—	—
500VDC	—	—	—	—
IEC Rated Voltage				
Frequency:	50/60 Hz	50/60 Hz	50/60 Hz	50/60 Hz
Rated Voltage				
IEC Single Pole	240/415VAC, 220VDC	240/415VAC, 60VDC	240/415VAC, 220VDC	240/415VAC, 220VDC
IEC Multi-Pole	415VAC, 440VDC	415VAC, 110VDC	415VAC, 440VDC	415VAC, 440VDC
Production Category:	IP20	IP20	IP20	IP20
Depth of Unit Per DIN 43880:	68mm/ 2.68 in.	68mm/ 2.68 in.	68mm/ 2.68 in.	68mm/ 2.68 in.
Mounting Position:	Vertical / horizontal	Vertical / horizontal	Vertical / horizontal	Vertical / horizontal
Standard Mounting:	35mm DIN rail	35mm DIN rail	35mm DIN rail	35mm DIN rail
Main and Shunt Trip Terminals:				
Wire Size	18-4 AWG/.82-21.2mm ²	18-4 AWG/.82-21.2mm ²	18-4 AWG/.82-21.2mm ²	18-4 AWG/.82-21.2mm ²
Torque	17.5 in-lbs. / 1.978 Nm	17.5 in-lbs. / 1.978 Nm	17.5 in-lbs. / 1.978 Nm	17.5 in-lbs. / 1.978 Nm
Tool	# 2 Posidrive	# 2 Posidrive	# 2 Posidrive	# 2 Posidrive
Accessory Terminals				
Wire Size	18-16 AWG/.82-1.3mm ²	18-16 AWG/.82-1.3mm ²	18-16 AWG/.82-1.3mm ²	18-16 AWG/.82-1.3mm ²
Torque	4.5 in-lbs./ .51nm	4.5 in-lbs./ .51nm	4.5 in-lbs./ .51nm	4.5 in-lbs./ .51nm
Tool	# 1 Posidrive	# 1 Posidrive	# 1 Posidrive	# 1 Posidrive
Service Life at Rated Load:	No Load 20,000 operations	No Load 20,000 operations Full Load 10,000 operations	No Load 20,000 operations Full Load 10,000 operations	No Load 20,000 operations Full Load 10,000 operations
Ambient Temperatures:				
Minimum	-25°C... -13°F	-25°C... -13°F	-25°C... -13°F	-25°C... -13°F
Maximum	70°C... 158°F	70°C... 158°F	70°C... 158°F	70°C... 158°F
Storage Temperatures:				
Minimum	-40°C... -40°F	-40°C... -40°F	-40°C... -40°F	-40°C... -40°F
Maximum	70°C... 158°F	70°C... 158°F	70°C... 158°F	70°C... 158°F
Shock Resistance:	30g minimum of 2 impacts, shock duration of 13ms	30g minimum of 2 impacts, shock duration of 13ms	30g minimum of 2 impacts, shock duration of 13ms	30g minimum of 2 impacts, shock duration of 13ms
Vibration Resistance:	5g, 20 cycles, 5 Hz, 150 Hz	5g, 20 cycles, 5 Hz, 150 Hz	5g, 20 cycles, 5 Hz, 150 Hz @ 0.8 ~ 1n	5g, 20 cycles, 5 Hz, 150 Hz @ 0.8 ~ 1n
Disconnecting Neutral Rating:	—	—	—	—

Technical data

SU200PR-K, S200UDC-K, S200UDC-Z

Item	SU200PR-K	S200UDC-K	S200UDC-Z
Approvals:			
UL	489	489	489
CSA	CS22.2 No. 5	—	—
VDE	0660	0660	0660
IEC	60947-2	—	—
Number of Poles:	1,2,3,4	1, 2	1, 2
Tripping Characteristic:	K	K	Z
Rated Currents:	0.2 to 63A	1 to 63A	1 to 63A
Minimum Operating Voltage:	12 VAC	—	—
UL/CSA Rated Voltage & Interrupting Capacity:			
Frequency:	50/60 Hz	50/60 Hz	50/60 Hz
120VAC	10 kA	—	—
240 VAC	10 kA	—	—
277 VAC	10 kA	—	—
277/480 VAC	10 kA	—	—
60VDC	—	14 kA	14 kA
125VDC	—	—	—
250VDC	—	—	—
500VDC	—	—	—
IEC Rated Voltage Frequency:	50/60 Hz	50/60 Hz	50/60 Hz
Rated Voltage			
IEC Single Pole	240 VAC	—	—
IEC Multi-Pole	400 VAC	—	—
Production Category:	IP20	IP20	IP20
Depth of Unit Per DIN 43880:	68mm/ 2.68 in.	68mm/ 2.68 in.	68mm/ 2.68 in.
Mounting Position:	Any	Vertical / horizontal	Vertical / horizontal
Standard Mounting:	35mm DIN rail	35mm DIN rail	35mm DIN rail
Main and Shunt Trip Terminals:			
Wire Size	18-4 AWG/.82-21.2 mm ²	18-4 AWG/.82-21.2 mm ²	18-4 AWG/.82-21.2 mm ²
Torque	25 in.-lbs. / 2.8 Nm	17.5 in.-lbs. / 1.978 Nm	17.5 in.-lbs. / 1.978 Nm
Tool	# 2 Posidrive	# 2 Posidrive	# 2 Posidrive
Accessory Terminals			
Wire Size	18-16 AWG/.82-1.3mm ²	18-16 AWG/.82-1.3mm ²	18-16 AWG/.82-1.3mm ²
Torque	4.5 in.-lbs. / .51 Nm	4.5 in.-lbs. / .51 Nm	4.5 in.-lbs. / .51 Nm
Tool	# 1 Posidrive	# 1 Posidrive	# 1 Posidrive
Service Life at Rated Load:	6000 operations (AC), 1 cycle (1s-ON, 9s-OFF)	Full Load 10,000 operations	Full Load 10,000 operations
Ambient Temperatures:			
Minimum	-25°C... -13°F	-25°C... -13°F	-25°C... -13°F
Maximum	55°C	70°C... 158°F	70°C... 158°F
Storage Temperatures:			
Minimum	-40°C... -40°F	-40°C... -40°F	-40°C... -40°F
Maximum	70°C... 158°F	70°C... 158°F	70°C... 158°F
Shock Resistance:	25g minimum of 2 impacts, shock duration of 13 ms	30g minimum of 2 impacts, shock duration of 13 ms	30g minimum of 2 impacts, shock duration of 13 ms
Vibration Resistance:	5g, 20 cycles, 5-150, 5Hz with load 0.8in	5g, 20 cycles, 5 Hz, 150 Hz	5g, 20 cycles, 5 Hz, 150 Hz
Disconnecting Neutral Rating:	—	—	—

Technical data

S200-B; S200-C, D; S200-K; S200-Z

Item	S200-B		S200-C, D		S200-K		S200-Z	
Approvals:	1077		1077		1077		1077	
UL	C22.2 No. 235		C22.2 No. 235		C22.2 No. 235		C22.2 No. 235	
CSA	0641, 0660		0660		0660		0660	
VDE	898, 60947-2		898, 60947-2		898, 60947-2		898, 60947-2	
IEC	1,2,3,4, 1+N, 3+N		1,2,3, 1+N, 3+N		1,2,3,4, 1+N, 3+N		1,2,3,4, 1+N, 3+N	
Number of Poles:	B		C, D		K		K	
Tripping Characteristic:	6 to 63A		0.5 to 63A		0.5 to 63A		0.5 to 63A	
Rated Currents:	12VAC		12VAC		12 V		12 V	
Minimum Operating Voltage:	Single pole	Multi pole	Single pole	Multi pole	Single pole	Multi pole	Single pole	Multi pole
UL/CSA Rated Voltage & Interrupting Capacity:	50/60 Hz		50/60 Hz		50/60 Hz		50/60 Hz	
Frequency:	10 kA	—	10 kA	—	10 kA	—	10 kA	—
120VAC	6 kA	10 kA	6 kA	10 kA	6 kA	10 kA	6 kA	10 kA
240 VAC	6 kA	—	6 kA	—	6 kA	—	6 kA	—
277 VAC	—	6 kA	—	6 kA	—	6 kA	—	6 kA
277/480 VAC	10 kA	10 kA	10 kA	10 kA	10 kA	10 kA	10 kA	10 kA
60VDC	10 kA	10 kA	10 kA	10 kA	10 kA	10 kA	10 kA	10 kA
125VDC	—	—	—	—	—	—	—	—
250VDC	—	—	—	—	—	—	—	—
500VDC	50/60 Hz		50/60 Hz		50/60 Hz		50/60 Hz	
IEC Rated Voltage Frequency:	240/415 VAC, 60 VDC		240/415 VAC, 60 VDC		240/415 VAC, 60 VDC		240/415 VAC, 60 VDC	
Rated Voltage	415 VAC, 110 VDC		415 VAC, 110 VDC		415 VAC, 110 VDC		415 VAC, 110 VDC	
IEC Single Pole	IP20		IP20		IP20		IP20	
IEC Multi-Pole	68mm/ 2.68 in.		68mm/ 2.68 in.		68mm/ 2.68 in.		68mm/ 2.68 in.	
Production Category:	Vertical / horizontal		Vertical / horizontal		Vertical / horizontal		Vertical / horizontal	
Depth of Unit Per DIN 43880:	35mm DIN rail		35mm DIN rail		35mm DIN rail		35mm DIN rail	
Mounting Position:	18-4 AWG/.82-21.2 mm ²		18-4 AWG/.82-21.2 mm ²		18-4 AWG/.82-21.2 mm ²		18-4 AWG/.82-21.2 mm ²	
Standard Mounting:	17.5 in-lbs. / 1.978 Nm		17.5 in-lbs. / 1.978 Nm		17.5 in-lbs. / 1.978 Nm		17.5 in-lbs. / 1.978 Nm	
Main and Shunt Trip Terminals:	# 2 Posidrive		# 2 Posidrive		# 2 Posidrive		# 2 Posidrive	
Wire Size	18-16 AWG/.82-1.3 mm ²		18-16 AWG/.82-1.3 mm ²		18-16 AWG/.82-1.3 mm ²		18-16 AWG/.82-1.3 mm ²	
Accessory Terminals	4.5 in-lbs./ .51 Nm		4.5 in-lbs./ .51 Nm		4.5 in-lbs./ .51 Nm		4.5 in-lbs./ .51 Nm	
Wire Size	# 1 Posidrive		# 1 Posidrive		# 1 Posidrive		# 1 Posidrive	
Torque	No Load 20,000 operations		No Load 20,000 operations		No Load 20,000 operations		No Load 20,000 operations	
Tool	Full Load 10,000 operations		Full Load 10,000 operations		Full Load 10,000 operations		Full Load 10,000 operations	
Service Life at Rated Load:	-25°C... -13°F		-25°C... -13°F		-25°C... -13°F		-25°C... -13°F	
Ambient Temperatures:	70°C... 158°F		70°C... 158°F		70°C... 158°F		70°C... 158°F	
Minimum	-40°C... -40°F		-40°C... -40°F		-40°C... -40°F		-40°C... -40°F	
Maximum	70°C... 158°F		70°C... 158°F		70°C... 158°F		70°C... 158°F	
Storage Temperatures:	30g minimum of 2 impacts, shock duration of 13 ms		30g minimum of 2 impacts, shock duration of 13 ms		30g minimum of 2 impacts, shock duration of 13 ms		30g minimum of 2 impacts, shock duration of 13 ms	
Shock Resistance:	5g, 20 cycles, 5 Hz, 150 Hz		5g, 20 cycles, 5 Hz, 150 Hz		5g, 20 cycles, 5 Hz, 150 Hz		5g, 20 cycles, 5 Hz, 150 Hz	
Vibration Resistance:	6 kA switching		6 kA switching		6 kA switching		6 kA switching	
Disconnecting Neutral Rating:								

Technical data

S200-P-B; S200P-C; S200P-D; S200P-K

Miniature
circuit breakers
Technical data

Item	S200P-B		S200P-C		S200P-D		S200P-K	
Approvals:								
UL	1077		1077		1077		1077	
CSA	C22.2 No. 235		C22.2 No. 235		C22.2 No. 235		—	
VDE	0660		0660		0660		0660	
IEC	898, 60947-2		898, 60947-2		898, 60947-2		898, 60947-2	
Number of Poles:	1,2,3,4, 1+N, 3+N		1,2,3,4, 1+N, 3+N		1,2,3,4, 1+N, 3+N		1,2,3,4, 1+N, 3+N	
Tripping Characteristic:	K		K		K		K	
Rated Currents:	0.5 to 63A		0.5 to 63A		0.5 to 63A		0.2 to 63A	
Minimum Operating Voltage:	12 V		12 V		12 V		12 V	
UL/CSA Rated Voltage & Interrupting Capacity:	Single pole	Multi pole	Single pole	Multi pole	Single pole	Multi pole	Single pole	Multi pole
Frequency:	50/60 Hz		50/60 Hz		50/60 Hz		50/60 Hz	
120VAC	10 kA	—	10 kA	—	10 kA	—	10 kA	—
240 VAC	6 kA	10 kA	6 kA	10 kA	6 kA	10 kA	10 kA	10 kA
277 VAC	6 kA	—	6 kA	—	6 kA	—	10 kA	—
277/480 VAC	—	6 kA	—	6 kA	—	6 kA	—	10 kA
60VDC	10 kA	10 kA	10 kA	10 kA	10 kA	10 kA	15 kA	15 kA
125VDC	10 kA	10 kA	10 kA	10 kA	10 kA	10 kA	15 kA	15 kA
250VDC	—	—	—	—	—	—	—	—
500VDC	—	—	—	—	—	—	—	—
IEC Rated Voltage								
Frequency:	50/60 Hz		50/60 Hz		50/60 Hz		50/60 Hz	
Rated Voltage								
IEC Single Pole	240/415 VAC, 60 VDC		240/415 VAC, 60 VDC		240/415 VAC, 60 VDC		240/415 VAC, 60 VDC	
IEC Multi-Pole	415 VAC, 110 VDC		415 VAC, 110 VDC		415 VAC, 110 VDC		415 VAC, 110 VDC	
Production Category:	IP20		IP20		IP20		IP20	
Depth of Unit Per DIN 43880:	68mm/ 2.68 in.		68mm/ 2.68 in.		68mm/ 2.68 in.		68mm/ 2.68 in.	
Mounting Position:	Vertical / horizontal		Vertical / horizontal		Vertical / horizontal		Vertical / horizontal	
Standard Mounting:	35mm DIN rail		35mm DIN rail		35mm DIN rail		35mm DIN rail	
Main and Shunt Trip Terminals:								
Wire Size	18-4 AWG/.82-21.2 mm ²		18-4 AWG/.82-21.2 mm ²		18-4 AWG/.82-21.2 mm ²		18-4 AWG/.82-21.2 mm ²	
Torque	17.5 in.-lbs. / 1.978 Nm		17.5 in.-lbs. / 1.978 Nm		17.5 in.-lbs. / 1.978 Nm		17.5 in.-lbs. / 1.978 Nm	
Tool	# 2 Posidrive		# 2 Posidrive		# 2 Posidrive		# 2 Posidrive	
Accessory Terminals								
Wire Size	18-16 AWG/.82-1.3 mm ²		18-16 AWG/.82-1.3 mm ²		18-16 AWG/.82-1.3 mm ²		18-16 AWG/.82-1.3 mm ²	
Torque	4.5 in.-lbs./ .51 Nm		4.5 in.-lbs./ .51 Nm		4.5 in.-lbs./ .51 Nm		4.5 in.-lbs./ .51 Nm	
Tool	# 1 Posidrive		# 1 Posidrive		# 1 Posidrive		# 1 Posidrive	
Service Life at Rated Load:	No Load 20,000 operations Full Load 10,000 operations		No Load 20,000 operations Full Load 10,000 operations		No Load 20,000 operations Full Load 10,000 operations		No Load 20,000 operations Full Load 10,000 operations	
Ambient Temperatures:								
Minimum	-25°C... -13°F		-25°C... -13°F		-25°C... -13°F		-25°C... -13°F	
Maximum	70°C... 158°F		70°C... 158°F		70°C... 158°F		70°C... 158°F	
Storage Temperatures:								
Minimum	-40°C... -40°F		-40°C... -40°F		-40°C... -40°F		-40°C... -40°F	
Maximum	70°C... 158°F		70°C... 158°F		70°C... 158°F		70°C... 158°F	
Shock Resistance:	30g minimum of 2 impacts, shock duration of 13 ms		30g minimum of 2 impacts, shock duration of 13 ms		30g minimum of 2 impacts, shock duration of 13 ms		30g minimum of 2 impacts, shock duration of 13 ms	
Vibration Resistance:	5g, 20 cycles, 5 Hz, 150 Hz		5g, 20 cycles, 5 Hz, 150 Hz		5g, 20 cycles, 5 Hz, 150 Hz		5g, 20 cycles, 5 Hz, 150 Hz	
Disconnecting Neutral Rating:	6 kA switching		6 kA switching		6 kA switching		—	

Technical data

S200P-Z; S200PR-K; S280UC-K; S280C-Z

Item	S200P-Z		S200PR-K	S280UC-K		S280UC-Z	
Approvals:	1077		489	1077		1077	
UL	—		CS22.2 No. 5	22.2, No. 235		22.2, No. 235	
CSA	—		0660	0660		0660	
VDE	898, 60947-2		60947-2	898, 60947-2		898, 60947-2	
IEC	—		—	—		—	
Number of Poles:	1,2,3,4		1,2,3,4	1,2,3		1,2,3	
Tripping Characteristic:	Z		K	K		Z	
Rated Currents:	0.5 to 63A		0.2 to 63A	0.2 to 63A		0.5 to 63A	
Minimum Operating Voltage:	12 V		12 VAC	12 V		12 V	
UL/CSA Rated Voltage & Interrupting Capacity:	Single pole	Multi pole		Single pole	Multi pole	Single pole	Multi pole
Frequency:	50/60 Hz		50/60 Hz	50/60 Hz		50/60 Hz	
120VAC	10 kA	—	10 kA	10 kA	6 kA	10 kA	—
240 VAC	10 kA	10 kA	10 kA	10 kA	6 kA	10 kA	10 kA
277 VAC	10 kA	—	10 kA	10 kA	6 kA	10 kA	—
277/480 VAC	—	—	10 kA	—	4.5 kA for 0.2-40 A 5 kA for 50-63 A	—	4.5 kA for 0.2-40 A 5 kA for 50-63 A
60VDC	15 kA	15 kA	—	10 kA	10 kA	10 kA	10 kA
125VDC	15 kA	15 kA	—	10 kA	—	10 kA	10 kA
250VDC	—	—	—	4.5 kA	4.5 kA	4.5 kA	4.5 kA
500VDC	—	—	—	—	4.5 kA	—	4.5 kA
IEC Rated Voltage	50/60 Hz		50/60 Hz	50/60 Hz		50/60 Hz	
Frequency:	50/60 Hz		50/60 Hz	50/60 Hz		50/60 Hz	
Rated Voltage	240/415 VAC, 220 VDC		240 VAC	240/415VAC, 220VDC		240/415VAC, 220VDC	
IEC Single Pole	415 VAC, 440 VDC		400 VAC	415VAC, 440VDC		415VAC, 440VDC	
IEC Multi-Pole	—		—	—		—	
Production Category:	IP20		IP20	IP20		IP20	
Depth of Unit Per DIN 43880:	68mm/ 2.68 in.		68mm/ 2.68 in.	68mm/ 2.68 in.		68mm/ 2.68 in.	
Mounting Position:	Vertical / horizontal		Any	Vertical / horizontal		Vertical / horizontal	
Standard Mounting:	35mm DIN rail		35mm DIN rail	35mm DIN rail		35mm DIN rail	
Main and Shunt Trip Terminals:	18-4 AWG/.82-21.2 mm ²		18-4 AWG/.82-21.2 mm ²	18-4 AWG/.82-21.2 mm ² for 0.2 - 40A		18-4 AWG/.82-21.2 mm ² for 0.5 - 40A	
Wire Size	17.5 in-lbs. / 1.978 Nm # 2 Posidrive		25 in-lbs. / 2.8 Nm # 2 Posidrive	18-2 AWG for 50 A & above 17.5 in-lbs. / 1.978 Nm # 2 Posidrive		18-2 AWG for 50 A & above 17.5 in-lbs. / 1.978 Nm # 2 Posidrive	
Torque	17.5 in-lbs. / 1.978 Nm # 2 Posidrive		25 in-lbs. / 2.8 Nm # 2 Posidrive	18-2 AWG for 50 A & above 17.5 in-lbs. / 1.978 Nm # 2 Posidrive		18-2 AWG for 50 A & above 17.5 in-lbs. / 1.978 Nm # 2 Posidrive	
Tool	17.5 in-lbs. / 1.978 Nm # 2 Posidrive		25 in-lbs. / 2.8 Nm # 2 Posidrive	18-2 AWG for 50 A & above 17.5 in-lbs. / 1.978 Nm # 2 Posidrive		18-2 AWG for 50 A & above 17.5 in-lbs. / 1.978 Nm # 2 Posidrive	
Accessory Terminals	18-16 AWG/.82-1.3 mm ²		18-16 AWG/.82-1.3 mm ²	18-16 AWG/.82-1.3 mm ²		18-16 AWG/.82-1.3 mm ²	
Wire Size	4.5 in-lbs./ .51 Nm # 1 Posidrive		4.5 in-lbs./ .51 Nm # 1 Posidrive	4.5 in-lbs./ .51 Nm # 1 Posidrive		4.5 in-lbs./ .51 Nm # 1 Posidrive	
Torque	4.5 in-lbs./ .51 Nm # 1 Posidrive		4.5 in-lbs./ .51 Nm # 1 Posidrive	4.5 in-lbs./ .51 Nm # 1 Posidrive		4.5 in-lbs./ .51 Nm # 1 Posidrive	
Tool	4.5 in-lbs./ .51 Nm # 1 Posidrive		4.5 in-lbs./ .51 Nm # 1 Posidrive	4.5 in-lbs./ .51 Nm # 1 Posidrive		4.5 in-lbs./ .51 Nm # 1 Posidrive	
Service Life at Rated Load:	No Load 20,000 operations Full Load 10,000 operations		6000 operations (AC), 1 cycle (1s-ON, 9s-OFF)	No Load 20,000 operations Full Load 10,000 operations		No Load 20,000 operations Full Load 10,000 operations	
Ambient Temperatures:	-25°C... -13°F		-25°C... -13°F	-25°C... -13°F		-25°C... -13°F	
Minimum	70°C... 158°F		55°C	70°C... 158°F		70°C... 158°F	
Maximum	70°C... 158°F		55°C	70°C... 158°F		70°C... 158°F	
Storage Temperatures:	-40°C... -40°F		-40°C... -40°F	-40°C... -40°F		-40°C... -40°F	
Minimum	70°C... 158°F		70°C... 158°F	70°C... 158°F		70°C... 158°F	
Maximum	70°C... 158°F		70°C... 158°F	70°C... 158°F		70°C... 158°F	
Shock Resistance:	30g minimum of 2 impacts, shock duration of 13 ms		25g minimum of 2 impacts, shock duration of 13 ms	30g minimum of 2 impacts, shock duration of 13 ms		30g minimum of 2 impacts, shock duration of 13 ms	
Vibration Resistance:	5g, 20 cycles, 5 Hz, 150 Hz		5g, 20 cycles, 5-150, 5Hz with load 0.8in	5g, 20 cycles, 5 Hz, 150 Hz		5g, 20 cycles, 5 Hz, 150 Hz	
Disconnecting Neutral Rating:	—		—	—		—	

Technical data

S800U-K, Z; S800S-B, S800S-C, S800S-D

Item	S800U-K, Z	S800S-B	S800S-C	S800S-D
Approvals:				
UL	489, E312425	—	—	—
CSA	22.2 No. 5.1	—	—	—
VDE	—	—	—	—
IEC	60947-2	60947-2	60947-2	60947-2
Number of Poles:	1,2,3,4	1,2,3,4	1,2,3,4	1,2,3,4
Tripping Characteristic:	K	B	C	D
Rated Currents:	10 to 100A	10 to 125A	10 to 125A	10 to 125A
Minimum Operating Voltage:	—	400/690VAC	400/690VAC	400/690VAC
UL/CSA Rated Voltage & Interrupting Capacity:				
Frequency:	50/60 Hz	50/60 Hz	50/60 Hz	50/60 Hz
120VAC	—	—	—	—
240 VAC	50 kA multi, 30 kA single	50 kA multi, 30 kA single; IEC	50 kA multi, 30 kA single; IEC	50 kA multi, 30 kA single; IEC
277 VAC	—	—	—	—
277/480 VAC	—	—	—	—
60VDC	—	—	—	—
125VDC	—	—	—	—
250VDC	—	—	—	—
500VDC	—	—	—	—
IEC Rated Voltage				
Frequency:	—	50/60 Hz	50/60 Hz	50/60 Hz
Rated Voltage				
IEC Single Pole	—	690 VAC	690 VAC	690 VAC
IEC Multi-Pole	—	—	—	—
Production Category:	IP20	IP20	IP20	IP20
Depth of Unit Per DIN 43880:	—	—	—	—
Mounting Position:	Vertical / horizontal	Vertical / horizontal	Vertical / horizontal	Vertical / horizontal
Standard Mounting:	35mm DIN rail	35mm DIN rail	35mm DIN rail	35mm DIN rail
Main and Shunt Trip Terminals:				
Wire Size	1... 25	1... 25	1... 25	1... 25
Torque	35 in-lbs. / 4 Nm	35 in-lbs. / 4 Nm	35 in-lbs. / 4 Nm	35 in-lbs. / 4 Nm
Tool	—	—	—	—
Accessory Terminals				
Wire Size	1... 35	1... 35	1... 35	1... 35
Torque	35 in-lbs./4 Nm	35 in-lbs./4 Nm	35 in-lbs./4 Nm	35 in-lbs./4 Nm
Tool	—	—	—	—
Service Life at Rated Load:	6,000 operations	6,000 operations	6,000 operations	6,000 operations
Ambient Temperatures:				
Minimum	-25°C... -13°F	-25°C... -13°F	-25°C... -13°F	-25°C... -13°F
Maximum	60°C... 140°F	60°C... 140°F	60°C... 140°F	60°C... 140°F
Storage Temperatures:				
Minimum	-40°C... -40°F	-40°C... -40°F	-40°C... -40°F	-40°C... -40°F
Maximum	70°C... 158°F	70°C... 158°F	70°C... 158°F	70°C... 158°F
Shock Resistance:	—	—	—	—
Vibration Resistance:	—	—	—	—
Disconnecting Neutral Rating:	—	—	—	—

Technical data S800S-K

Item	S800S-K
Approvals:	
UL	—
CSA	—
VDE	—
IEC	60947-2
Number of Poles:	1,2,3,4
Tripping Characteristic:	K
Rated Currents:	10 to 125A
Minimum Operating Voltage:	400/690 VAC
UL/CSA Rated Voltage & Interrupting Capacity:	
Frequency:	50/60 Hz
120VAC	—
240 VAC	50 kA multi; 30 kA single; IEC
277 VAC	—
277/480 VAC	—
60VDC	—
125VDC	—
250VDC	—
500VDC	—
IEC Rated Voltage	
Frequency:	50/60 Hz
Rated Voltage	
IEC Single Pole	690 VAC
IEC Multi-Pole	—
Production Category:	IP20
Depth of Unit Per DIN 43880:	—
Mounting Position:	Vertical / horizontal
Standard Mounting:	35mm DIN rail
Main and Shunt Trip Terminals:	
Wire Size	1... 25
Torque	35 in-lbs. / 4 Nm
Tool	—
Accessory Terminals	
Wire Size	1... 35
Torque	35 in-lbs./4 Nm
Tool	—
Service Life at Rated Load:	6,000 operations
Ambient Temperatures:	
Minimum	-25°C... -13°F
Maximum	60°C... 140°F
Storage Temperatures:	
Minimum	-40°C... -40°F
Maximum	70°C... 158°F
Shock Resistance:	—
Vibration Resistance:	—
Disconnecting Neutral Rating:	—

Technical data

S500-K, Z; S500UC-B, K

Item	S500-K, Z
Approvals: UL CSA VDE IEC	1077 C22.2 - No. 235 0641/6.78 —
No. of poles:	1,2,3, +N, +NA
Tripping characteristic:	K
Rated currents:	0.1 to 45A
Rated voltage: UL/CSA single pole UL/CSA multi pole IEC single pole	277VAC 600VAC 690VAC
Rated interrupting capacity:	
Single pole	0.15-25A – 30KA/240VAC 14KA/277VAC 26-45A – 18KA/240VAC 14KA/277VAC
Multi-pole	0.15-45A – 14KA/480VAC 6KA/600VAC
Frequency:	50/60Hz
Mounting position:	Vertical / horizontal
Standard mounting:	35mm DIN rail
Terminals:	16-4AWG / 1-25mm ²
Service life at rated load:	20,000 operations
Calibration temperature:	40°C

Item	S500UC-B, K
Approvals: UL CSA VDE	1077 C22.2 0660
No. of poles:	1,2,3, 4
Tripping characteristic:	B, K
Rated currents:	B: 6 to 63A K: 0.15 to 45A
Rated voltage: UL single pole UL multi pole IEC multi pole	277VAC/250VDC 600VAC/600VDC 690VAC/750VDC
Rated interrupting capacity:	
	B single pole: 6 – 25A 18KA/240VAC 14KA/277VAC 30KA/250VDC 32 – 63A 30KA/240VAC 14KA/277VAC 30KA/250VDC B two-pole: 6 – 63A 14KA/480VAC 6KA/600VAC 30KA/500VDC B three-pole: 6 – 63A 14KA/480VAC 6KA/600VAC 30KA/600VDC K single pole: 0.15 – 25A 30KA/240VAC 14KA/277VAC 30KA/250VDC 32 – 45A 18KA/240VAC 14KA/277VAC 30KA/250VDC K two-pole: 0.15 – 45A 14KA/480VAC 6KA/600VAC 30KA/500VDC K three-pole: 0.5 – 45A 14KA/480VAC 6KA/600VAC 30KA/600VDC
Frequency:	50/60Hz
Mounting position:	Vertical / horizontal
Standard mounting:	35mm DIN-rail
Terminals:	16-4AWG / 1-25mm ²
Service life at rated load:	20,000 operations