



BALLAST NAVIGATOR

Table of Contents

Fluorescent Electromagnetic Ballasts Section 1- Page

Product Overview	1-2
Application Operation Information	1-4
Typical Specifications.....	1-8
Lead Lengths	1-9
T8 (265 mA).....	1-10
T12	1-11
T12 High Output	1-13
T12 Very High Output.....	1-17
Circline	1-18
T12 Slimline.....	1-19
Preheat and Trigger Start	1-21
Export	1-25
Dimming	1-29
Export	1-30

Fluorescent Electronic Ballasts Section 2- Page

Product Overview	2-2
Application Operation Information	2-4
Typical Specifications.....	2-7
F17T8	2-14
F25T8	2-16
F32T8 (32, 30, 25 & 28 Watt Four Foot Lamps)	2-19
F40T8	2-31
F96T8 Slimline	2-33
F96T8HO High Output.....	2-34
T5	2-35
T5HO	2-37
T12	2-39
T12 Slimline.....	2-41
T12HO High Output	2-43
T2	2-44

Energy Management Systems Section 3- Page

--DCL With DEMANDflex

Product Overview	3-2
DemandFlex T8	3-3
DemandFlex T5, T5HO & TT5	3-6
DemandFlex T8 Wiring Diagram	3-7

Controllable Lighting Section 3- Page

--Fluorescent Energy Management/Dimming Ballasts and Controls

Product Overview	3-10
Ballastar® Light Level Switching	3-10
SuperDim® Analog Dimming	3-11
DaliPro™ Digital Dimming	3-13
Application Operation Information.....	3-14
Controls for Analog Dimming Ballasts	3-15
DaliPro®.....	3-16
SuperDim®	3-17
Ballastar® 0-10 Volt.....	3-18
Ballastar® Light Level Switching	3-19

Table of Contents

Compact Fluorescent Ballasts Section 4- Page

Product Overview	4-2
Understanding Compact Fluorescent Technology	4-3
Configurations	4-4
Lamp Matrix	4-5
Typical Specifications.....	4-6
Nomenclature	4-7
5-13 Watt Twin, Quad and Triple	4-8
18 Watt Twin, Quad and Multiple	4-10
26-28 Watt Quad and Triple	4-11
32 to 70 Watt Triple and Multiple	4-12
2D and T5 Circular	4-14
Long Twin T5	4-18

High Intensity Discharge (HID) Ballasts Section 5- Page

Product Overview	5-3
Oil Filled Capacitors	5-5
Dry Capacitors	5-7
Bracket Reference Chart.....	5-9
Application and Operation Information.....	5-10
Nomenclature	5-13
Typical Specifications.....	5-14
Distributor Replacement Kits	5-15
Core and Coil	
Metal Halide	5-19
Pulse Start Metal Halide	5-23
High Pressure Sodium.....	5-30
50 Hz Core and Coil Ballasts	5-34
F-Can Ballast.....	5-36
Potted Core and Coil.....	5-39
Indoor Encased.....	5-40
Ignitors.....	5-41
Reference Drawings.....	5-43

Electronic High Intensity Discharge (eHID) Ballasts Section 6- Page

Product Overview	6-2
Product Family Chart.....	6-3
Wiring Diagrams.....	6-4
Dimensions	6-5
Application and Operation Information.....	6-7

Sign Ballasts Section 7- Page

Application and Operation Information.....	7-2
Sign Ballast Footage Chart & Lead Lengths	7-3
Standard	7-4
Max-3 Series	7-5
SIGNA Electronic Sign Ballasts	7-6

Table of Contents

Glossary	Section 8- Page
.....	7-1
Obsolete Cross Reference	Section 9- Page
.....	8-1
Index	Section 10-Page
.....	9-1
Warranty	Section 11-Page
.....	10-1

Electromagnetic Fluorescent Ballasts

A Wide Product Line To Meet All Your Needs

Our comprehensive line of magnetic ballasts offer outstanding performance and value. These energy-efficient ballasts carry the trusted UNIVERSAL® brand and are available for a wide variety of applications.

Universal Lighting Technologies' ("Universal") full spectrum of solutions includes ballasts for T12/T10/T8 applications, plus Slimline, Circline, trigger-start and preheat ballasts. We also make rugged weatherproof ballasts ... and models specifically engineered for the fast growing export market.



Our comprehensive line of energy-efficient magnetic ballasts carry the trusted UNIVERSAL® brand name.

Product Overview

Rapid Start Ballasts

These ballasts provide smooth starting to Rapid Start lamps — reaching full brightness in about two seconds without the use of starters. They have built-in filament windings that energize the low-voltage cathodes in Rapid Start lamps. Because electrodes are continuously heated, less voltage is required to strike an arc through a Rapid Start lamp than a Slimline one.



Rapid Start Ballasts

Ballasts for T12/T10 Applications

Universal offers a wide variety of T12 and T10 ballasts to operate 1 - 3 Rapid Start lamps. This lamp/ballast system provides smooth, virtually instant starting without the use of starters (30- and 40-watt T12 models and 40-watt T10 models are available). Models for U-lamp applications are also available. UNIVERSAL® PLUS models are available for use where maximum efficiency is required. These “hybrid” type ballasts incorporate an electronic switch which disconnects power to the lamp cathodes after start-up, saving additional energy.



T12/T10 Applications

Ballasts for T8 Applications

Universal's T8 product offering includes models for F17, F25, F32 and F40 type T8 lamps. This product line features our OcTek™ electromagnetic ballast models. These models are low initial cost energy efficient options for use with F32T8, 4 foot Rapid Start lamps. These models are available in several variations, including full, medium, low light output and hybrid versions (OcTek™ Plus). These models maximize energy savings and provide effective choices when retrofitting 4-foot T12 fixtures.



T8 Applications

Slimline Ballasts

Our Slimline models are designed for use with single-pin Slimline lamps. They do not require the use of starters. These ballasts deliver a high starting voltage to the lamps, enabling an arc to strike through the tube without preheating the lamp cathodes (which are specially constructed to withstand the shock).



Slimline Ballasts

Product Overview

Circline Ballasts

These products are available in 430 mA Rapid Start and preheat types, designed for use with Circline lamps. The operating characteristics are the same for both Circline and conventional lamps. All Circline socket wires are fully sleeved.

Trigger-Start Ballasts

These ballasts are designed for use with general fluorescent lamps and do not require the use of starters. They contain preheat windings which allow regular lamp filaments to be heated in one second. However, they require a higher open-circuit voltage than Rapid Start ballasts.

Preheat Ballasts

These units are designed for use with general fluorescent lamps and require the use of starters. These ballasts deliver an open-circuit voltage high enough to activate the starter to preheat lamp filaments to a temperature approximately 1750° F. After a few seconds, the starter opens the filament circuit. This provides an additional power surge to enable an electric arc to strike through the lamp and ignite it. Lamp current is then limited by the ballast to an operating level proper for the lamp.

Export (50/60 Hz) Ballasts

Our export product offering consists of a variety of one- and two-lamp models for Rapid Start, Preheat, High Output, Slimline, and 1500 mA lamps. Included in this product line are ballasts for 50 and 60 Hz applications, including 120, 127 and 220 volts. Many of these models are available with resetting thermal protection.

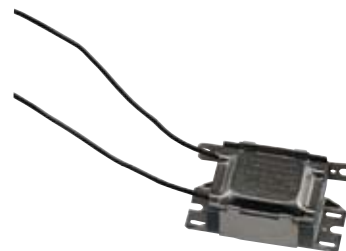

Preheat Ballast



Export (50/60 Hz) Ballast

Application And Operating Information

SAFETY

NEC & UL Requirements

Ballast installation presents the possibility of exposure to potentially hazardous voltages and should be performed only by qualified personnel. All installation, inspection and maintenance should be performed only with power to the fixture turned off. Additionally, all fixtures and ballasts must be installed and operated in compliance with the National Electrical Code, Underwriters Laboratories Inc. (UL) requirements and all applicable codes and regulations.

Polarity

Polarity refers to the proper connection of ballast lead wires to line wires. To aid you in making a correct installation, Universal ballast leads are color-coded for easy identification. The WHITE ballast lead is to be connected to the neutral (grounded) and the BLACK (or black with white tracer) lead always to the phase (“hot”) line wire. Systems where neither of the line wires are at ground potential require specially designed ballasts. A change in polarity may result in the voltage from the lead to the ground exceeding UL-specified limits. In some types of ballasts, a change in polarity may decrease voltage from the lead to the ground, thereby impeding the starting dependability of the ballast.

Grounding

Ballast cases and fixtures must always be grounded. The ballast case may be grounded to the fixture or otherwise grounded. It could be hazardous to make contact with an ungrounded fixture or ballast when in operation. Neglecting to properly ground the ballast and fixture combination may also result in failure of certain lamps to start or for unacceptable levels of electromagnetic noise to be conducted onto the power lines.

Operating Line Voltage Limits

To receive the full benefits of rated lamp output and to prolong ballast life, it is essential that voltage supplied to an installation be maintained within limits prescribed for each circuit. These limits are listed below:

Nominal Voltage	VOLTAGE RANGE	
	Minimum	Maximum
120	110	125
220	205	232
240	220	250
277	255	290
347	315	364
480	450	505
600	570	630

Subjecting a ballast to excessive voltage for an extended period of time results in the deterioration of the insulation. This insulation breakdown will cause early ballast failure. Low voltage has no damaging effect on the ballast. However, lamps may not start reliably, and early lamp failure could result.

Internal Ballast Protection

Class P Classification - Since January 1, 1984, the National Electrical Code requires that “where Fluorescent fixtures are installed indoors, the ballast shall have thermal protection integral within the ballast except for simple reactance ballasts.” This ruling applies to replacement ballasts as well as to those contained within new light fixtures.

In compliance with the National Electrical Code, UL has established a Class P ballast classification for fluorescent light fixtures indoors.

A Class P ballast must employ internal thermal protection limiting its operating temperature.

Universal UL-approved Class P ballasts comply with the National Electrical Code requirement and are equipped with an automatic resetting thermal protector, built-in and adjacent to the transformer coils. The resetting thermal protector functions as a thermostat which will open and temporarily deactivate the ballast when it exceeds the permissible temperature. It will reset when the ballast cools to a safe operating temperature. The ballast will continue to cycle until the cause of overheating is eliminated. If the ballast is defective, it must be replaced. If the cause is external, a Class P ballast will resume normal operation after abnormal conditions are eliminated.

Fusing

Class P ballasts do not require fusing. Fusing can be used when a single circuit has a large number of fixtures/ballasts. For a comprehensive list of appropriate fuses, contact our Technical Engineering Services (TES) Department at 1-800-BALLAST or check out our TES home page at www.unvlt.com

Application And Operating Information

PERFORMANCE

Lamp Connections

Electromagnetic fluorescent ballasts are designed to generate voltages in excess of 300 volts. It is imperative that proper connection to good quality sockets be assured in accordance with wiring diagrams on each page of the catalog and on product labels. Some applications may not require the use of all of the ballasts output leads. If any leads are not to be connected, each should be individually capped and insulated to at least 600 volts.

Application Versatility

Many models are designed to allow for applications with different types or quantities of lamps. Use of products other than noted is not covered by UL Listing and/or CSA certification and cannot be warranted.

Audible Noise (Sound)

Electrical equipment, including most fluorescent lamp ballasts, produces some noise. Care must be taken to select a ballast with the proper sound rating for a particular lighting installation. Ballast sound will be noticeable only when it exceeds the ambient sound level.

Although no industry standards currently exist, the generally accepted criteria for sound rating specifications are as follows:

Location	Average Ambient Noise	Ballast Recommendation
Typical Office	< 30 decibels	A
Noisy Office or Retail	31-36 decibels	B
Factory, Outdoor	> 36 decibels	C

Remote Mounting

Excessive hot or cold temperatures, audible noise requirements or a desire to operate lamps in more than one fixture with the same ballast (master/slave), may make it desirable to mount the ballast remotely. Care must be taken to allow for ballast heat dissipation and proper grounding.

In any application, the wire used to extend leads must be at least as large as the wire supplied on the ballast (18 AWG) with an insulation rating of 1000 VAC at 90°C.

Lead lengths in excess of those noted cause loading effects that can dramatically impact ballast performance and void the warranty.

Electromagnetic and hybrid ballasts may be remote mounted according to the table below:

Wire Size	30-40 Watt Rapid Start		800 mA - HO 1500 mA - VHO		Instant Start (Slimline)
	Red/Blue Leads	Yellow Leads	Red/Blue Leads	Yellow Leads	All Leads
#6	544'	384'	272'	192'	544'
#8	340'	240'	170'	120'	340'
#10	214'	150'	107'	75'	214'
#12	134'	94'	67'	47'	134'
#14	84'	60'	42'	30'	84'
#16	52'	36'	26'	18'	52'
#18	30'	20'	21'	15'	30'

Application And Operating Information

PERFORMANCE

Operating Temperature

Most fluorescent ballasts and lamps are designed to provide optimum performance at ambient temperature of 77°F. Three key performance attributes can be impacted by the ambient (room) temperature of the installation:

- **Lamp Starting Dependability**
Fluorescent lamps are inherently more difficult to start at low temperatures. All ballasts have limitations as to their ability to start lamps at low ambient temperatures. In this catalog, the low starting point for each lamp/ballast combination appears in the column marked "Minimum Starting Temperature."
- **Light Output**
Optimum light output from fluorescent lamps is achieved when the lamp wall is at 100-110°F. Any substantial excursion (either colder or warmer) will result in a reduction in light output.
- **Ballast Life**
A fluorescent lamp ballast, like any other electrical device, generates heat during its normal operation. Ballast temperatures should be kept as low as possible. Maximum dissipation of heat through fixture design and proper ballast installation will help. Although excessive temperature may not cause the ballast to fail immediately, it can dramatically shorten ballast life. To assure maximum life, the ballast case temperature should not exceed 90°C.

CAUSES OF BALLAST OVERHEATING:

- Incorrect primary voltage or frequency
- Incorrect size, type or number of lamps
- Failed lamp starter
- Incorrect wiring
- Poor heat dissipation due to surrounding insulation
- Sealed (Vapor Tight) Fixtures - Unusual heat build-up due to lack of ventilation in fixtures may cause thermal (on/off) cycling of certain ballasts. Consult Universal for specific recommendations.

RECOMMENDATIONS...

- Selection of a proper ballast to match the requirements of the lamp, fixture, voltage and installation.
- Mounting of ballast within the fixture with as much surface contact as possible between the ballast and metal portions of the fixture.
- The use of heat-conducting dissipators (radiators), if necessary, which increase surface contact between the ballast and fixture.
- If necessary, locate the ballast in a remote, cooler area outside the fixture.
- Planned lamp maintenance – the organized replacement of failed and failing lamps, particularly with Preheat or Slimline Systems.
- Use of special LOW HEAT (-LH) rise, VERY LOW HEAT (-VLH) rise and SUPER LOW HEAT (-SLH) rise ballasts where available and necessary.

Application And Operating Information

LOW-LEAKAGE CURRENT TO GROUND BALLASTS

Many one- and two-lamp, 30- and 40-watt high power Rapid Start ballasts – and two- and three-lamp 20-watt Trigger Start ballasts – meet requirements for “low-leakage-current-to-ground.” Those most frequently used in low-leakage applications are listed below.

Lamps	Line Voltage @ 60Hz	Maximum Leakage To Ground	Catalog Number
(1)F40T12/RS	120	30uA	412-L-SLH-TC-P
(2)F40T12/RS	120	30uA	446-L-SLH-TC-P
(1)F40T12/RS	277	50uA	458-L-SLH-TC-P
(2)F40T12/RS	277	50uA	443-L-SLH-TC-P
(2)F20T12	120	15uA	447-LR-VLH-TC-P

Other ballasts can also be manufactured to meet low-leakage requirements. Consult Universal’s Technical Engineering Services Department at 1-800-BALLAST for complete information regarding low-leakage ballasts.

TYPE 1 BALLASTS

All Universal outdoor non-weatherproof magnetic ballasts (except those for sign applications) are designed to meet UL requirements for Type 1 use (metal enclosure required for wet or damp locations).

BALLASTS FOR GERMICIDAL LAMPS

Universal manufactures ballasts to operate germicidal lamps. When ordering, make sure the ANSI designation of the germicidal lamp matches exactly with the ballast’s recommended application.

Several typically encountered germicidal lamps are listed below along with the proper Universal ballast for their operation.

Contact Universal’s Technical Engineering Services at

1-800-BALLAST

for additional information or applications not listed

Germicidal Lamp	Universal Ballast	See Page Number
(1)G15T8	200-H2	1-46 – 1-48

All high power factor ballasts are equipped with capacitors. Oil-filled capacitors contain non-resetting internal protection and are manufactured without PCBs.

Specifications

TYPICAL SPECIFICATIONS FOR ELECTROMAGNETIC BALLASTS

1. Ballasts shall be certified energy saving magnetic type and operate lamps at a frequency of 60 Hz.
2. Ballasts shall be specifically designed to operate (Quantity & Type) lamps.
3. Ballasts shall operate from 60 Hz input source of _____ volts, and tolerate sustained variations of +5%-10% with no damage to the ballasts.
4. Ballasts shall provide transient immunity as specified by ANSI C62.41-1991, Location Category A1.
5. Ballasts shall provide starting sequence consistent with ANSI standard C82.1.
6. Ballasts shall tolerate sustained open circuit and short circuit output conditions with no damage to the ballasts.
7. Ballasts shall be:
 - UL LISTED as Class P, and for use in indoor or Type 1 outdoor applications.
 - CSA CERTIFIED where applicable (120 and 347 volt models).
8. Ballasts shall tolerate operation, in most fixtures, at ambient temperatures up to 105°F (40°C). Ballast enclosure is limited to 90°C maximum temperature.
9. Ballasts shall have Power Factor greater than .90.
10. Lamp Current Crest Factor (ratio of peak to RMS lamp current) shall be 1.7 or less in accordance with lamp manufacturers recommendation and ANSI C82.1.
 - 1.85 or less for instant start slimline (also per ANSI C82.1).
11. Ballasts shall have a Ballast Factor greater than .925 per ANSI C82.1.
 - .95 or greater for HO and VHO applications.
12. Input current Total Harmonic Distortion shall not exceed .32 per ANSI C82.1.
13. Ballasts shall be fully encapsulated (potted) to ensure maximum thermal and structural integrity.
14. Manufacturer shall provide written warranty against defects in material or workmanship.
15. Manufacturer shall have been manufacturing electromagnetic ballasts for at least twenty years.
16. Ballasts shall be manufactured in North America.
17. Universal model _____ (or approved equal).

Lead Lengths

Lead Quantities (per color), Exits (L=Left, R=Right, B=Bottom) and Lengths (in inches, +/- 1")

Catalog #	Black			Black/White			White			Red			Blue			Yellow			Blue/White			Brown			Red/White			
	Quantity	Exit	Length	Quantity	Exit	Length	Quantity	Exit	Length	Quantity	Exit	Length	Quantity	Exit	Length	Quantity	Exit	Length	Quantity	Exit	Length	Quantity	Exit	Length	Quantity	Exit	Length	
200-C-S-P	1	R	12				2	R	12	1	R	12	1	R	12	1	R	12										
200-H2	2		8-15																									
202-B-TC-P	1	L	12				1	L	12				1	R	12													
202-SB-TC-P	1		12				2		12	1		26	1		12	1		12										
213-TC-P	1	L	12				1	L	12	1	R	12	1	R	12													
412-L-SLH-TC-P				1	L	12	1	L	12	2	L	12							2	R	12							
412-L-TC-P				1	L	12	1	L	25	2	L	37							2	R	27							
413-C-TC-P	1	L	9				1	L	29	2	R	30	1	L	29													
420-L-TC-P	1	L	20				1	L	20	2	R	24	2	R	24	2	L	36										
443-L-SLH-TC-P	1	L	12				1	L	12	2	R	12	2	R	12	2	L	12										
445-RS-WS-TC-P	1	L	12				2		12	2	R	12	1	R	12													
446-L-SLH-TC-P	1	L	12				1	L	12	2	R	12	2	R	12	2	L	12										
446-LR-TC-P	1	L	22				1	L	22	2	R	26	2	R	26	2	L	36										
447-LR-TC-P	1	L	10				1	L/R	10	2	R	13	2	R	13	2	L	18										
447-LR-VLH-TC-P	1	L	10				1	L	10	2	R	13	2	R	13	2	L	18										
458-L-SLH-TC-P				1	L	12	1	L	12	2	L	12	2	R	12				2	R	12							
480-SLH-TC-P	1	L	18				1	L	18	2	R	46	2	R	46	2	L	65										
480-XLH-TC-P	1	L	12				1	L	12	2	R	12	2	R	12	2	L	12										
481-LH-TC-P	1	L	10				1	L	10	2	R	44	2	L	60													
487-SLH-TC-P	1	L	18				1	L	18	2	R	46	2	R	46	2	L	65										
487-XLH-TC-P	1	L	12				1	L	12	2	R	12	2	R	12	2	L	12										
490-XLH-TC-P	1	L	18				1	L	18	2	R	33	2	R	33	2	L	51										
502-A-TC-P	1	L	12				1	L	12	2	R	12	1	L	12	2	R	12	1	L	12	1	R	12				
532-BR-TC-P	1	L	12				1	L	12	1	R	12	1	R	12							2	L	12				
540-L-TC-P	1	L	20				1	L	20	2	R	25	2	R	25	2	L	37										
546-B-TC-P	1	L	12				1	L	12	2	R	12	1	L	12													
547-RS-WS-TC-P	1	L	12				2	L/R	12	2	R	12	1	R	12													
554-L-TC-P	1	L	12				1	L	12	2	R	12	2	R	12	2	L	12										
564-L-TC-P	1	L	10				1	L	10	2	R	13	2	R	13	2	L	16										
567-L-TC	1	L	10				1	L	10	2	R	13	2	R	13	2	L	16										
573-L-TC-P	1	L	12				1	L	12	2	R	12	2	R	12	2	L	12										
595-L-TC-P	1	L	20				1	L	20	2	R	24	2	R	24	2	L	36										
597-L-TC-P	1	L	10				1	L	10	2	R	13	2	R	13	2	L	16										
631-LH-TC-P	1	L	18				1	L	18	2	R	20	2	R	20	2	L	32										
698-L-SLH-TC	1	L	22				1	L	22	2	R	26	2	R	26	2	L	36										
726-L-VLH-WS-TC-P	1	L	12				1	L	12	2	L	12	2	R	12	4	L/R	12										
757-XLH-TC	1	L	18				1	L	18	2	R	46	2	R	46	2	L	65										
778-XLH-TC	1	L	18				1	L	18	2	R	33	2	R	33	2	L	51										
789-SLH-TC-P	1	L	10				1	L	10	2	R	10	2	R	10	2	L	10										
806-BR-TC-P	1	L	68				1	L	68	1	R	44	1	R	44													
806-SLH-TC-P	1	L	12				1	L	12	1	R	12	1	R	12													
808-BR-TC-P	1	L	68				1	L	68	1	R	44	1	R	44													
822-BR-TC-P				1	L	8	1	L	68	1	R	44																
827-SLH-TC-P	1	L	12				1	L	12	1	R	12	1	R	12							2	L	12				
828-BR-TC-P				1		12	1	L	12	1	R	12																
831-TC				1	L	73				1	L	73	1	R	49	1	R	49										
881-BR-TC-P	1	L	12				1	L	12	1	R	12	1	R	12													
897-SLH-TC	1	L	12				1	L	12	1	R	12	1	R	12													
930-K-TC-P	1	L	12				1	L	12	2	R	12	2	R	12	2	L	12										
931-LH-TC-P	1	L	12				1	L	12	2	R	12	2	R	12	2	L	12				2	L	12				
937-K-TC-P	1	L	12				1	L	12	2	R	12	2	R	12	2	L	12										
CF1320H2P	1,1	L,R	9,18																									
M232SR120C	1	L	20				1	L	20	2	R	24	2	R	24	2	L	36										
M232SR277C	1	L	20				1	L	20	2	R	24	2	R	24	2	L	36										
W-589-D-TC-P	1	L	12				1	L	12	2	R	12	2	R	12	2	L	12										
4105F2P	2	L	10																									
4105P	2	L	12																									

Fluorescent-Electromagnetic

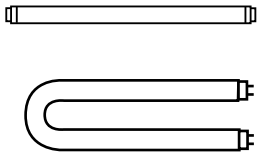

- 265 mA
- 4' Lamp Applications
- OcTek™ Series Featured

UNIVERSAL® ELECTROMAGNETIC BALLASTS

FOR F32T8 and F32T8/U LAMPS

Fluorescent-Electromagnetic

Lamp		Line Volts	Catalog Number	Certification					Line Current (Amps)	Input Power (Watts)	Ballast Factor	Ballast Efficacy Factor	Crest Factor	THD %	Min. F/C Start Temp	Sound Rating	Wiring Diag.	Dim.
Qty.	Descr.			E	UL	SF	RoHS	NOM										
F32T8 - High Power Factor OcTek®																		
2	Rapid	120	M232SR120C	•	•	•	•	.65	74	.95	1.28	< 1.7	< 20	50/10	A	1	D2	
2	Rapid	277	M232SR277C	•	•	•	•	.28	74	.95	1.28	< 1.7	< 20	50/10	A	1	D2	
F32T8/U - High Power Factor OcTek™																		
2	Rapid	120	M232SR120C	•	•	•	•	.65	74	.95	1.28	< 1.7	< 20	50/10	A	1	D2	
2	Rapid	277	M232SR277C	•	•	•	•	.28	74	.95	1.28	< 1.7	< 20	50/10	A	1	D2	

Overall Dimensions			Mounting Dimensions		
Draw #	L	W	H	M	X
D2	9 1/2	2 3/8	1 1/2	8 57/64	1

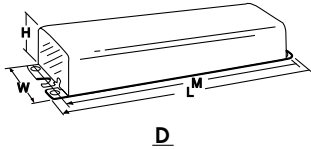

WIRING DIAGRAMS

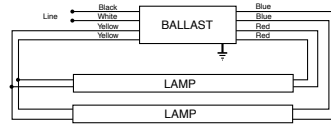
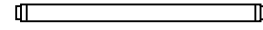

DIAGRAM 1

UNIVERSAL[®] ELECTROMAGNETIC BALLASTS

- 430 and 460 mA
- 3' and 4' Lamp Applications



T12

FOR F30T12, F30T12ES, and F40T12 LAMPS

Lamp		Line Volts	Catalog Number	Certification					Line Current Power (Amps)(Watts)	Input Ballast Factor	Efficacy Factor	Ballast Crest Factor	THD %	Start Temp	Min. F/C Sound Rating	Wiring Diag.	Dim.
Qty.	Descr.			E	UL	SF	UL	NOM									
F30T12 - High Power Factor																	
2	Rapid	120	W-589-D-TC-P■	•	•			.66	79	.90	1.14	< 1.9	< 20	0/-18	A	1	D4
2	Rapid	120	573-L-TC-P※	•	•			.66	79	.95	1.21	< 1.7	< 20	60/15	A	1	D2
F30T12 - Normal Power Factor																	
1	Rapid	120	413-C-TC-P※	•	•			.63	37	.72	1.95	< 1.7	< 10	50/10	A	8	D1
F30T12ES - High Power Factor																	
2	Rapid	120	W-589-D-TC-P■	•	•			.58	68	.86	1.26	< 1.9	< 20	60/15	A	1	D4
2	Rapid	120	573-L-TC-P※	•	•			.57	67	.89	1.33	< 1.9	< 20	50/10	A	1	D2
F40T12- High Power Factor																	
1	Rapid	120	412-L-SLH-TC-P★■•	•	•	•	•	.45	52	.95	1.83	< 1.7	< 20	50/10	A	42	D2
1	Rapid	277	458-L-SLH-TC-P★■	•	•	•	•	.19	51	.95	1.86	< 1.7	< 20	50/10	A	42	D2
2	Hybrid	120	420-L-TC-P◆	•	•	•	•	.62	72	.85	1.18	< 1.7	< 20	50/10	A	1	D2
2	Rapid	120	446-L-SLH-TC-P■•	•	•	•	•	.75	89	.94	1.06	< 1.7	< 20	50/10	A	1	D2
2	Rapid	120	W-589-D-TC-P■	•	•			.80	92	.88	0.96	< 1.7	< 20	0/-18	A	1	D4
2	Rapid	277	443-L-SLH-TC-P■•	•	•	•	•	.34	90	.95	1.06	< 1.7	< 20	50/10	A	1	D2
2	Rapid	347	698-L-SLH-TC	•	•	•	•	.27	92	.95	1.03	< 1.7	< 20	50/10	A	1	D2
F40T12- Normal Power Factor																	
1	Rapid	120	413-C-TC-P※	•	•			.53	36	.61	1.69	< 1.7	< 20	50/10	A	8	D1

- ※ For Residential Use Only
- ★ Not for use with "U" lamps
- ◆ Not for use with Energy Saver "U" lamps
- ⊕ Operates at 50 or 60 Hz
- For Replacement Only
- ※ For Distribution Only

Overall Dimensions		Mounting Dimensions				
Draw #	L	W	H	M	X	
D1	6 7/16	1 7/8	1 1/2	6	-	
D2	9 1/2	2 3/8	1 1/2	8 57/64	1 11/16	
D4	9 1/2	2 3/8	1 11/16	8 57/64	1 11/16	

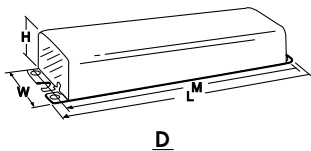

WIRING DIAGRAMS

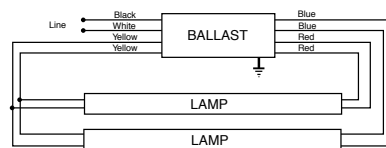

DIAGRAM 1

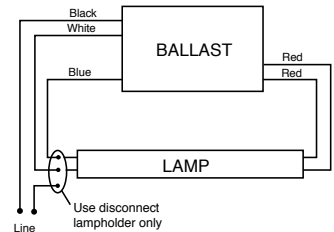

DIAGRAM 8

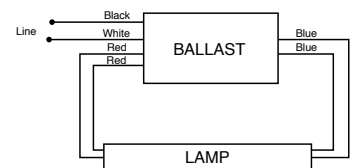
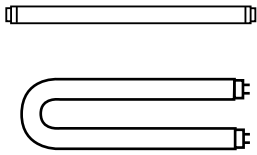

DIAGRAM 42



- 430 and 460 mA
- 4' Energy Saver Lamp Applications
- Energy Efficient

UNIVERSAL[®] ELECTROMAGNETIC BALLASTS

FOR F40T12ES, F40T12/U, F40T12ES/U, F48" 25W/UTLS
AND WORKLITE 25 LAMPS

Fluorescent-Electromagnetic

Lamp		Line Volts	Catalog Number	Certification					Line Current Power (Amps)(Watts)	Input Ballast Factor	Efficacy Factor	Ballast Crest Factor	THD %	Start Temp	Min. F/C Sound Rating	Wiring Diag.	Dim.	
Qty.	Descr.			E	UL	SF	CS	NOM										
F40T12ES - High Power Factor																		
1	Rapid	120	412-L-SLH-TC-P★	•	•	•	•	•	.38	44	.88	2.00	< 1.9	< 20	60/15	A	42	D2
1	Rapid	277	458-L-SLH-TC-P★	•	•	•	•	•	.17	44	.88	2.00	< 1.85	< 20	60/15	A	42	D2
2	Hybrid	120	420-L-TC-P◆	•	•	•	•	•	.50	59	.80	1.36	< 1.9	< 20	60/15	A	1	D2
2	Rapid	120	446-L-SLH-TC-P■	•	•	•	•	•	.65	74	.90	1.22	< 1.9	< 20	60/15	A	1	D2
2	Rapid	277	443-L-SLH-TC-P■	•	•	•	•	•	.28	74	.90	1.22	< 1.9	< 20	60/15	A	1	D2
2	Rapid	347	698-L-SLH-TC	•	•	•	•	•	.24	78	.90	1.15	< 1.9	< 20	60/15	A	1	D2
F40T12ES - Normal Power Factor																		
1	Rapid	120	413-C-TC-P※	•	•	•	•	•	.61	33	.68	2.06	< 1.9	< 20	60/15	A	8	D1
F40T12 /U - High Power Factor																		
2	Hybrid	120	420-L-TC-P◆	•	•	•	•	•	.64	74	.83	1.12	< 1.7	< 32	50/10	A	1	D2
2	Rapid	120	446-L-SLH-TC-P■	•	•	•	•	•	.76	90	.93	1.03	< 1.7	< 20	50/10	A	1	D2
2	Rapid	120	W-589-D-TC-P■	•	•	•	•	•	.84	97	.92	0.95	< 1.7	< 20	0/-18	A	1	D4
2	Rapid	277	443-L-SLH-TC-P■	•	•	•	•	•	.34	92	.95	1.03	< 1.7	< 20	50/10	A	1	D2
2	Rapid	347	698-L-SLH-TC	•	•	•	•	•	.27	92	.93	1.01	< 1.7	< 20	50/10	A	1	D2
F40T12ES/U - High Power Factor																		
2	Rapid	120	446-L-SLH-TC-P■	•	•	•	•	•	.65	74	.90	1.22	< 1.9	< 20	60/15	A	1	D2
2	Rapid	277	443-L-SLH-TC-P■	•	•	•	•	•	.28	74	.90	1.22	< 1.9	< 20	60/15	A	1	D2
2	Rapid	347	698-L-SLH-TC	•	•	•	•	•	.24	78	.90	1.15	< 1.9	< 20	60/15	A	1	D2
F48" 25W/UTLS & WORKLITE - Normal Power Factor																		
1	Rapid	120	413-C-TC-P※	•	•	•	•	•	.51	32	.90	2.79	< 1.7	< 20	50/10	A	8	D1

- ※ For Residential Use Only
- ★ Not for use with "U" lamps
- ◆ Not for use with Energy Saver "U" lamps
- For Replacement Only

Overall Dimensions	Mounting Dimensions				
Draw #	L	W	H	M	X
D1	6 7/16	1 7/8	1 1/2	6	-
D2	9 1/2	2 3/8	1 1/2	8 57/64	1
11/16					

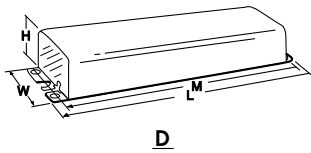

WIRING DIAGRAMS

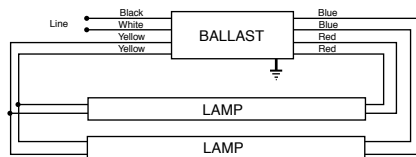

DIAGRAM 1

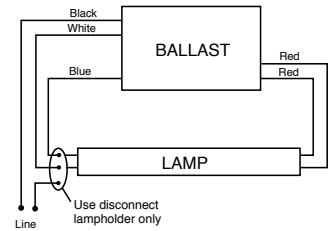

DIAGRAM 8

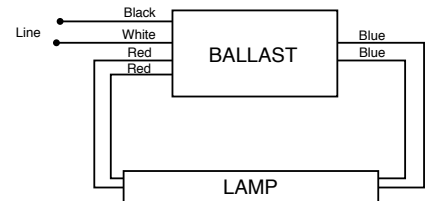
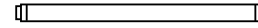

DIAGRAM 42

UNIVERSAL® ELECTROMAGNETIC BALLASTS

- 800 mA
- 2-3 1/2' Lamp Applications
- Standard & Weatherproof Models



T12 HO

FOR F24, F30, F36, F42 AND F48T12HO LAMPS

See page 1-3 for additional information on weatherproof applications.

Lamp		Line Volts	Catalog Number	Certification					Line Current (Amps)	Input Power (Watts)	Ballast Factor	Ballast Efficacy Factor	Crest Factor	THD %	Min. F/C Start Temp	Sound Rating	Wiring Diag.	Dim.
Qty.	Descr.			E	UL	SF	UL	NOM										
F24T12HO - High Power Factor																		
2	Rapid	120	490-XLH-TC-P	•	•			.95	103	.81	0.79	< 2.0	> 32	-20/-29	B	1	D7	
2	Rapid	120	631-LH-TC-P*	•	•			1.13	100	.83	0.83	< 2.0	< 32	-20/-29	B	1	D6	
2	Rapid	347	778-XLH-TC			•		.31	103	.81	0.79	< 2.0	> 32	-20/-29	B	1	D7	
F36T12HO - High Power Factor																		
2	Rapid	120	490-XLH-TC-P	•	•			1.06	121	.84	0.69	< 2.0	< 32	50/10	B	1	D7	
2	Rapid	120	631-LH-TC-P⊕	•	•			1.20	122	.85	0.69	< 1.9	< 20	-20/-29	B	1	D6	
2	Rapid	347	778-XLH-TC			•		.41	141	.80	0.57	< 2.0	< 32	-20/-29	B	1	D7	
F42T12HO - High Power Factor																		
2	Rapid	120	490-XLH-TC-P	•	•			1.12	130	.86	0.66	< 2.0	< 32	50/10	B	1	D7	
F48T12HO - High Power Factor																		
1	Rapid	120	481-LH-TC-P▼	•	•			.79	82	.84	1.02	< 1.9	> 32	-20/-29	B	12	D7	
1	Rapid	120	490-XLH-TC-P▼	•	•			.82	82	.81	0.99	< 2.0	> 32	-20/-29	B	15	D7	
1	Rapid	120	631-LH-TC-P▼	•	•			1.05	82	.83	1.02	< 1.9	< 32	-20/-29	B	15	D6	
1	Rapid	347	778-XLH-TC▼			•		.32	83	.79	0.95	< 2.0	> 32	-20/-29	B	15	D7	
2	Rapid	120	490-XLH-TC-P	•	•			1.18	139	.87	0.63	< 2.0	< 20	-20/-29	B	1	D7	
2	Rapid	120	631-LH-TC-P	•	•			1.25	137	.85	0.62	< 1.7	< 20	-20/-29	B	1	D6	
2	Rapid	347	778-XLH-TC			•		.42	139	.86	0.62	< 2.0	< 32	-20/-29	B	1	D7	

*Power Factor Corrected to 75% for (2) F24T12HO

⊕Power Factor Corrected to 85% for (2) F36T12HO

▼Power Factor Corrected to >70%

⊗For Distribution Only

See page 1-16 for Dimensions and Wiring Diagrams

Fluorescent-Electromagnetic

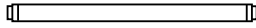

- 800-840 mA
- 4'-5'4" Lamp Applications
- Standard and Weatherproof Models

UNIVERSAL® ELECTROMAGNETIC BALLASTS

FOR F48T12HOES, F60T12HO AND
F64T12HO LAMPS

Fluorescent-Electromagnetic

Lamp		Line Volts	Catalog Number	Certification					Line Current (Amps)	Input Power (Watts)	Ballast Factor	Ballast Efficacy Factor	Crest Factor	THD %	Min. F/C Start Temp	Sound Rating	Wiring Diag.	Dim.
Qty.	Descr.			E	UL	SF	RE	NOM										
F48T12HOES - High Power Factor																		
1	Rapid	120	481-LH-TC-P▼	•	•			.77	75	.79	1.05	< 1.9	> 32	60/15	B	12	D7	
1	Rapid	120	490-XLH-TC-P▼	•	•			.80	76	.78	1.03	< 2.0	> 32	60/15	B	15	D7	
1	Rapid	120	631-LH-TC-P▼	•	•			1.03	75	.77	1.03	< 1.9	< 32	60/15	B	15	D6	
1	Rapid	347	778-XLH-TC▼	•	•			.31	78	.75	0.97	< 2.0	> 32	60/15	B	15	D7	
2	Rapid	120	490-XLH-TC-P	•	•			1.07	124	.83	0.67	< 2.0	< 32	60/15	B	1	D7	
2	Rapid	120	631-LH-TC-P	•	•			1.15	124	.80	0.64	< 1.9	< 20	60/15	B	1	D6	
2	Rapid	347	778-XLH-TC	•	•			.39	126	.81	0.64	< 2.0	< 32	60/15	B	1	D7	
F60T12HO - High Power Factor																		
1	Rapid	120	481-LH-TC-P	•	•			.86	100	.87	0.87	< 1.9	< 32	-20/-29	B	12	D7	
1	Rapid	120	490-XLH-TC-P	•	•			.92	99	.83	0.84	< 2.0	> 32	-20/-29	B	15	D7	
1	Rapid	120	631-LH-TC-P▼	•	•			1.08	94	.85	0.90	< 1.7	< 32	-20/-29	B	15	D6	
1	Rapid	347	778-XLH-TC▼	•	•			.34	96	.82	0.85	< 2.0	> 32	-20/-29	B	15	D7	
2	Rapid	120	490-XLH-TC-P	•	•			1.42	169	.89	0.53	< 2.0	< 20	-20/-29	B	1	D7	
2	Rapid	347	778-XLH-TC	•	•			.49	169	.88	0.52	< 2.0	< 20	-20/-29	B	1	D7	
F64T12HO - High Power Factor																		
1	Rapid	120	481-LH-TC-P	•	•			.90	102	.87	0.85	< 1.9	< 32	-20/-29	B	12	D7	
1	Rapid	120	490-XLH-TC-P	•	•			.93	101	.84	0.83	< 1.9	> 32	-20/-29	B	15	D7	
1	Rapid	347	778-XLH-TC▼	•	•			.35	103	.82	0.80	< 2.0	> 32	-20/-29	B	15	D7	
2	Rapid	120	490-XLH-TC-P	•	•			1.50	178	.89	0.50	< 1.9	< 20	-20/-29	B	1	D7	
2	Rapid	347	778-XLH-TC	•	•			.52	178	.93	0.52	< 2.0	< 20	-20/-29	B	1	D7	

▼ Power Factor Corrected to >70%

✱ For Distribution Only

See page 1-16 for Dimensions and Wiring Diagrams

UNIVERSAL® ELECTROMAGNETIC BALLASTS

- 800 - 840 mA
- 6' - 8' Lamp Applications
- Standard, Weatherproof & Tanning Models

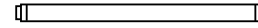

T12 HO

FOR F72T12HO, F84T12HO, F96T12HO AND F96T12HOES LAMPS

See page 1-3 for additional information on weatherproof applications.

Lamp		Line Volts	Catalog Number	Certification					Line Current (Amps)	Input Power (Watts)	Ballast Factor	Ballast Efficacy Factor	Crest Factor	THD %	Min. F/C Start Temp	Sound Rating	Wiring Diag.	Dim.
Qty.	Descr.			E	UL	SF	RE	NOM										
F72T12HO - High Power Factor																		
1	Rapid	120	481-LH-TC-P	•	•				.92	106	.89	0.84	< 1.9	< 32	-20/-29	B	12	D7
1	Rapid	120	490-XLH-TC-P	•	•				.95	107	.86	0.80	< 2.0	> 32	-20/-29	B	15	D7
1	Rapid	347	778-XLH-TC-❖			•			.35	106	.84	0.79	< 2.0	> 32	-20/-29	B	15	D7
2	Rapid	120	480-SLH-TC-P	•	•	•	•	•	1.69	196	.97	0.49	< 1.9	< 20	-20/-29	B	1	D7
2	Rapid	120	480-XLH-TC-P■	•	•				1.69	196	.97	0.49	< 1.9	< 20	-20/-29	B	1	D7
2	Rapid	120	490-XLH-TC-P	•	•				1.50	177	.92	0.52	< 1.7	< 10	-20/-29	B	1	D7
2	Rapid	277	487-SLH-TC-P	•	•	•	•	•	.74	197	.96	0.48	< 1.7	< 20	-20/-29	B	1	D7
2	Rapid	277	487-XLH-TC-P■	•	•				.78	208	.95	0.46	< 1.7	< 20	-20/-29	B	1	D7
2	Rapid	347	778-XLH-TC			•			.54	187	.95	0.51	< 1.7	< 10	-20/-29	B	1	D7
F84T12HO - High Power Factor																		
1	Rapid	120	481-LH-TC-P	•	•				1.02	119	.88	0.74	< 1.9	< 32	-20/-29	B	12	D7
2	Rapid	120	480-SLH-TC-P	•	•	•	•	•	1.87	220	.93	0.42	< 1.9	< 20	-20/-29	B	1	D7
2	Rapid	120	480-XLH-TC-P■	•	•				1.98	235	.93	0.40	< 1.9	< 20	-20/-29	B	1	D7
2	Rapid	277	487-SLH-TC-P	•	•	•	•	•	.87	235	.97	0.41	< 1.9	< 20	-20/-29	B	1	D7
2	Rapid	277	487-XLH-TC-P■	•	•				.89	244	.95	0.39	< 1.9	< 20	-20/-29	B	1	D7
F96T12HO - High Power Factor																		
1	Rapid	120	481-LH-TC-P	•	•				1.16	136	.91	0.67	< 1.9	< 20	-20/-29	B	12	D7
1	Rapid	120	490-XLH-TC-P	•	•				1.10	124	.85	0.65	< 2.0	< 20	-20/-29	B	15	D7
1	Rapid	347	778-XLH-TC			•			.41	137	.83	0.71	< 2.0	< 32	-20/-29	B	15	D7
2	Rapid	120	480-SLH-TC-P	•	•	•	•	•	1.99	237	.96	0.41	< 1.7	< 10	-20/-29	B	1	D7
2	Rapid	120	480-XLH-TC-P■	•	•				2.15	246	.96	0.39	< 1.7	< 10	-20/-29	B	1	D7
2	Rapid	277	487-SLH-TC-P	•	•	•	•	•	.87	237	.95	0.40	< 1.7	< 10	-20/-29	B	1	D7
2	Rapid	277	487-XLH-TC-P■	•	•				.95	249	.97	0.39	< 1.7	< 10	-20/-29	B	1	D7
F96T12HOES - High Power Factor																		
1	Rapid	120	481-LH-TC-P	•	•				.96	110	.84	0.77	< 1.9	< 32	60/15	B	12	D7
1	Rapid	120	490-XLH-TC-P	•	•				.94	106	.81	0.76	< 2.0	< 32	60/15	B	15	D7
1	Rapid	347	778-XLH-TC			•			.37	116	.83	0.71	< 2.0	< 32	60/15	B	15	D7
2	Rapid	120	480-SLH-TC-P	•	•	•	•	•	1.72	202	.89	0.44	< 1.9	< 20	60/15	B	1	D7
2	Rapid	120	480-XLH-TC-P■	•	•				1.80	209	.89	0.43	< 1.9	< 20	60/15	B	1	D7
2	Rapid	277	487-SLH-TC-P	•	•	•	•	•	.75	205	.91	0.44	< 1.9	< 20	60/15	B	1	D7
2	Rapid	277	487-XLH-TC-P■	•	•				.83	223	.92	0.41	< 1.9	< 20	60/15	B	1	D7

- ❖ Power Factor Corrected to >85%
- For Replacement Only
- ✳ For Distribution Only

See page 1-16 for Dimensions and Wiring Diagrams

Fluorescent-Electromagnetic

UNIVERSAL[®] ELECTROMAGNETIC BALLASTS

Overall Dimensions			Mounting Dimensions		
Draw #	L	W	H	M	X
D6	11 3/4	3 1/8	1 25/32	11 9/64	2
D7	11 3/4	3 3/16	1 5/8	11 9/64	2
D8	14 5/16	3 3/16	2 5/8	13 3/4	2
D9	19 3/16	3 3/16	2 5/8	18 5/8	2

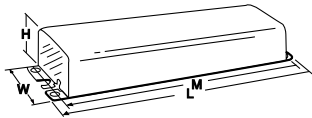

D

WIRING DIAGRAMS

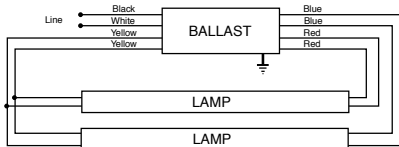

DIAGRAM 1

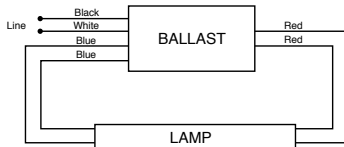

DIAGRAM 12

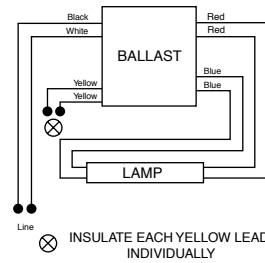
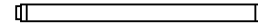

DIAGRAM 15

UNIVERSAL® ELECTROMAGNETIC BALLASTS

- 1500 - 1580 mA
- 4' and 6' VHO, SHO & PG Lamp Applications



T12 VHO

FOR F72PG17, F72T12VHO, F96PG17, F96PG17ES, F96T12VHO AND F96T12VHOES LAMPS

Lamp		Line Volts	Catalog Number	Certification					Line Current (Amps)	Input Power (Watts)	Ballast Factor	Ballast Efficacy Factor	Crest Factor	THD %	Min. F/C Start Temp	Sound Rating	Wiring Diag.	Dim.
Qty.	Descr.			E	UL	SF	IEC	NOM										
F72PG17 - High Power Factor																		
2	Rapid	120	930-K-TC-PⓉ*	•	•			3.05	360	.95	0.26	< 1.7	< 20	-20/-29	D	1	D8	
2	Rapid	120	931-LH-TC-PⓉⓈ	•	•			2.77	303	.82	0.27	< 1.7	< 20	-20/-29	D	1	D8	
2	Rapid	277	937-K-TC-PⓉ*	•	•			1.26	341	.92	0.27	< 1.7	< 20	-20/-29	D	1	D8	
F72T12VHO - High Power Factor																		
2	Rapid	120	930-K-TC-PⓉ*	•	•			3.05	360	.95	0.26	< 1.7	< 20	-20/-29	D	1	D8	
2	Rapid	120	931-LH-TC-PⓉⓈ	•	•			2.77	303	.80	0.26	< 1.7	< 20	-20/-29	D	1	D8	
2	Rapid	277	937-K-TC-PⓉ*	•	•			1.26	341	.91	0.27	< 1.7	< 20	-20/-29	D	1	D8	
F96PG17 - High Power Factor																		
2	Rapid	120	930-K-TC-PⓉ*	•	•			3.83	446	.98	0.22	< 1.7	< 20	-20/-29	D	1	D8	
2	Rapid	120	931-LH-TC-PⓉⓈ	•	•			3.25	380	.83	0.22	< 1.7	< 20	-20/-29	D	1	D8	
2	Rapid	277	937-K-TC-PⓉ*	•	•			1.61	429	.95	0.22	< 1.7	< 20	-20/-29	D	1	D8	
F96PG17ES - High Power Factor																		
2	Rapid	120	931-LH-TC-P*	•	•			2.88	333	.75	0.22	< 1.7	< 32	60/15	D	1	D8	
F96T12VHO - High Power Factor																		
2	Rapid	120	930-K-TC-PⓉ*	•	•			4.10	482	.99	0.21	< 1.7	< 20	-20/-29	D	1	D8	
2	Rapid	120	931-LH-TC-PⓉⓈ	•	•			3.83	431	.93	0.22	< 1.7	< 20	-20/-29	D	1	D8	
2	Rapid	277	937-LH-TC-PⓉ*	•	•			1.64	450	.95	0.21	< 1.7	< 20	-20/-29	D	1	D8	
F96T12VHOES - High Power Factor																		
2	Rapid	120	931-LH-TC-P*	•	•			3.09	361	.83	0.23	< 1.7	< 20	60/15	D	1	D8	

- Ⓣ Cannot be used with T10 or T10J lamps
- Ⓢ May be used with equivalent T10 or T10J Lamps
- * For Distribution Only

See page 1-18 for Dimensions and Wiring Diagrams

Fluorescent-Electromagnetic

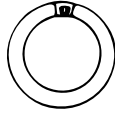

- 430 mA
- 20-40 Watt Lamp Applications

UNIVERSAL® ELECTROMAGNETIC BALLASTS

FOR 20, 22, 32 AND 40 WATT LAMPS

Fluorescent-Electromagnetic

Lamp		Line Volts	Catalog Number	Certification					Line Current (Amps)	Input Power (Watts)	Ballast Factor	Ballast Efficacy Factor	Crest Factor	THD %	Min. F/C Start Temp	Sound Rating	Wiring Diag.	Dim.
Qty.	Descr.			E	UL	SF	UL	NOM										
FC6T9 (20 Watt) - Normal Power Factor																		
1	Preheat	120	200-C-S-P♣✘	•	•			.40	29	1.01	3.47	< 1.7	<10	50/10	A	28	D11	
1	Rapid	120	547-RS-WS-TC-P✘	•	•			.64	27	.90	3.30	< 1.7	< 10	50/10	A	29	D1	
FC8T9 (22 Watt) - Normal Power Factor																		
1	Preheat	120	200-C-S-P♣✘	•	•			.24	22	.93	4.19	< 1.7	<10	50/10	A	28	D11	
1	Rapid	120	547-RS-WS-TC-P☆✘	•	•			.60	30	.85	2.83	< 1.7	< 10	50/10	A	29	D1	
FC12T9 (32 Watt) - High Power Factor																		
2	Rapid	120	W-589-D-TC-PⓈ■	•	•			.64	76	.89	1.17	< 1.9	< 20	0/-18	A	1	D4	
FC12T9 (32 Watt) - Normal Power Factor																		
1	Preheat	120	202-B-TC-PⓈ✘	•	•			.67	37	.91	2.44	< 1.7	<10	50/10	A	22	D11	
1	Preheat	120	202-SB-TC-P♣✘	•	•			.67	37	.91	2.44	< 1.7	<10	50/10	A	28	D11	
1	Rapid	120	445-RS-WS-TC-P☆✘	•	•			.60	35	.68	1.97	< 1.7	< 20	50/10	A	29	D1	
FC16T9 (40 Watt) - High Power Factor																		
2	Rapid	120	W-589-D-TC-PⓈ■	•	•			.88	98	.95	0.96	< 1.7	< 20	0/-18	A	1	D4	
FC16T9 (40 Watt) - Normal Power Factor																		
1	Rapid	120	445-RS-WS-TC-P☆✘	•	•			.55	33	.60	1.83	< 1.7	< 20	50/10	A	29	D1	

- ☆Also available in White Cans
- ♥Only available in White Cans
- ♣Starter is built in as an integral component
- ⓈRequires Starter
- ⓈMay be used with any combination of F30T12/RS, F40T12/RS, FC12T9/RS and FC16T9/RS
- For Replacement Only
- ✘For Distribution Only

Overall Dimensions		Mounting Dimensions			
Draw #	L	W	H	M	X
D1	6 7/16	1 7/8	1 1/2	6	-
D4	9 1/2	2 3/8	1 11/16	8 57/64	1
11/16					

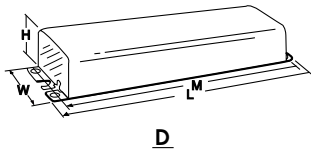

WIRING DIAGRAMS

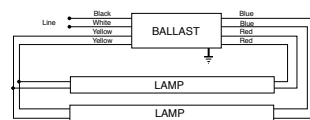

DIAGRAM 1

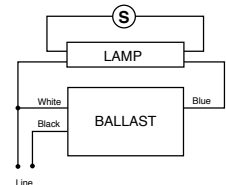

DIAGRAM 22

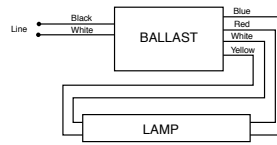

DIAGRAM 28

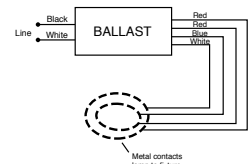
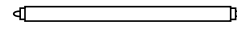

DIAGRAM 29

UNIVERSAL® ELECTROMAGNETIC BALLASTS

FOR F24 - F84T12 LAMPS

- 425-440 mA
- 2'-7' Lamp Applications
- Slimline



T12 SLIMLINE

Fluorescent-Electromagnetic

Lamp		Line Volts	Catalog Number	Certification					Line Current (Amps)	Input Power (Watts)	Ballast Factor	Ballast Efficacy Factor	Crest Factor	THD %	Min. F/C Start Temp	Sound Rating	Wiring Diag.	Dim.
Qty.	Descr.			E	UL	SF	RoHS	NOM										
F24T12 - High Power Factor																		
2	Instant	277	532-BR-TC-P	•	•			.29	60	.96	1.60	< 1.85	< 32	32 / 0	B	40	D6	
F36T12 - High Power Factor																		
2	Instant	120	213-TC-P	•	•		•	.70	77	.95	1.24	< 1.85	> 32	50/10	B	39	D10	
2	Instant	277	532-BR-TC-P	•	•			.34	75	.93	1.24	< 1.85	< 32	32 / 0	B	40	D12	
F40T12 /IS - Bi Pin - High Power Factor																		
2	Instant	120	213-TC-P	•	•		•	.80	94	.92	0.98	< 1.85	< 20	50/10	B	39	D10	
2	Instant	277	532-BR-TC-P	•	•			.37	94	.92	0.98	< 1.85	< 32	32 / 0	B	40	D12	
F42T12 - High Power Factor																		
2	Instant	120	213-TC-P	•	•		•	.74	86	.93	1.09	< 2.0	< 32	50/10	B	39	D10	
2	Instant	277	532-BR-TC-P	•	•			.34	84	.94	1.11	< 1.85	< 32	32 / 0	B	40	D12	
F48T12 - High Power Factor																		
2	Instant	120	213-TC-P	•	•		•	.79	95	.92	0.89	< 1.85	< 20	50/10	B	39	D10	
2	Instant	277	532-BR-TC-P	•	•			.35	95	.96	1.01	< 1.85	< 32	32 / 0	B	40	D12	
F48T12ES - High Power Factor																		
2	Instant	120	213-TC-P	•	•		•	.72	80	.91	1.14	< 2.0	< 32	60/15	B	39	D10	
2	Instant	277	532-BR-TC-P	•	•			.32	82	.94	1.15	< 2.0	< 32	60/15	B	40	D12	
F60T12 - High Power Factor																		
2	Instant	120	881-BR-TC-P	•	•			.96	109	.84	0.77	< 1.85	< 32	0/-18	C	39	D6	
F64T12 - High Power Factor																		
2	Instant	120	881-BR-TC-P	•	•			1.05	119	.84	0.71	< 1.85	< 32	0/-18	C	39	D6	
F72T12 - High Power Factor																		
1	Instant	120	822-BR-TC-P	•	•		•	.72	81	.95	1.17	< 1.85	< 32	0/-18	C	34	D6	
1	Instant	277	828-BR-TC-P	•	•			.30	78	.92	1.18	< 1.85	< 32	0/-18	C	34	D6	
2	Instant	120	806-SLH-TC-P	•	•	•	•	1.13	133	1.01	0.76	< 1.85	< 20	50/10	C	39	D6	
2	Instant	120	881-BR-TC-P	•	•			1.03	120	.82	0.69	< 1.85	< 32	0/-18	C	39	D6	
2	Instant	277	827-SLH-TC-P	•	•	•	•	.49	135	.93	0.69	< 1.85	< 20	50/10	C	40	D12	
2	Instant	347	897-SLH-TC	•	•	•		.37	123	.91	0.74	< 1.85	< 32	50/10	C	65	D12	
F84T12 - High Power Factor																		
1	Instant	120	822-BR-TC-P	•	•		•	.77	89	.96	1.09	< 1.85	< 32	0/-18	C	34	D6	
1	Instant	277	828-BR-TC-P	•	•			.33	86	.94	1.09	< 1.85	< 32	0/-18	C	34	D6	
2	Instant	120	806-SLH-TC-P	•	•	•	•	1.26	143	.95	0.67	< 1.85	< 20	50/10	C	39	D6v	
2	Instant	277	827-SLH-TC-P	•	•	•	•	.55	150	.95	0.63	< 1.85	< 10	50/10	C	40	D12	
2	Instant	347	897-SLH-TC	•	•	•		.42	141	.92	0.65	< 1.85	< 32	50/10	C	65	D12	

- ▶ Power Factor Corrected to >75%
- Use with any combination of F60T12 & F64T12
- For Replacement Only
- ✳ For Distribution Only

See page 1-23 for Dimensions and Wiring Diagrams

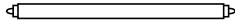

- 425-440 mA
- 8' Lamp Applications

UNIVERSAL® ELECTROMAGNETIC BALLASTS

FOR F96T12 AND F96T12ES LAMPS

Fluorescent-Electromagnetic

Lamp		Line Volts	Catalog Number	Certification					Line Current (Amps)	Input Power (Watts)	Ballast Factor	Ballast Efficacy Factor	Crest Factor	THD %	Min. F/C Start Temp	Sound Rating	Wiring Diag.	Dim.
Qty.	Descr.			E	UL	SF	UL	NOM										
F96T12 - High Power Factor																		
1	Instant	120	822-BR-TC-P	•	•			.84	96	.95	0.98	< 1.85	< 32	0/-18	C	34	D6	
1	Instant	277	828-BR-TC-P⊗	•	•			.35	93	.93	1.00	< 1.85	< 32	0/-18	C	34	D6	
2	Instant	120	806-SLH-TC-P■	•	•	•	•	1.41	165	.95	0.57	< 1.85	< 10	50/10	C	39	D6	
2	Instant	277	827-SLH-TC-P■	•	•	•	•	.58	158	.93	0.59	< 1.85	< 10	50/10	C	40	D12	
2	Instant	347	897-SLH-TC⊗		•	•		.45	151	.89	0.59	< 1.85	< 32	50/10	C	65	D12	
F96T12ES - High Power Factor																		
1	Instant	120	822-BR-TC-P	•	•			.70	79	.90	1.14	< 2.0	< 32	60/15	C	34	D6	
1	Instant	277	828-BR-TC-P⊗	•	•			.30	79	.96	1.22	< 2.0	< 32	60/15	C	34	D6	
2	Instant	120	806-SLH-TC-P■	•	•	•	•	1.13	133	.91	0.68	< 2.0	< 20	60/15	C	39	D6	
2	Instant	277	827-SLH-TC-P■	•	•	•	•	.48	132	.89	0.67	< 2.0	< 20	60/15	C	40	D12	
2	Instant	347	897-SLH-TC⊗		•	•		.38	121	.86	0.71	< 2.0	< 32	60/15	C	65	D12	

- For Replacement Only
- ⊗ For Distribution Only

Draw #	Overall Dimensions		Mounting Dimensions		
	L	W	H	M	X
D6	11 3/4	3 1/8	1 25/32	11 9/64	2
D10	9 29/64	3 3/32	1 25/32	8 57/64	1
11/16					

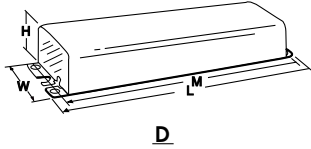

WIRING DIAGRAMS

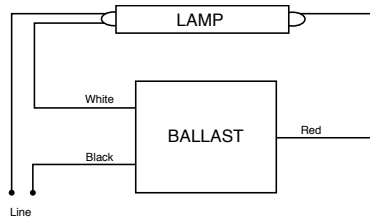

DIAGRAM 34

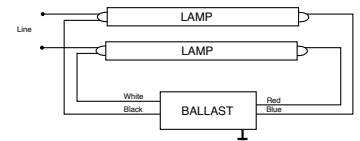

DIAGRAM 39

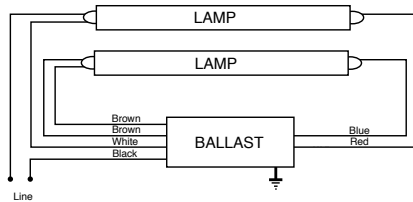

DIAGRAM 40

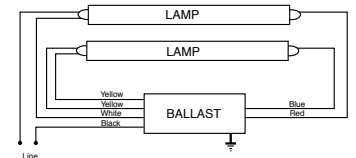
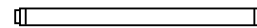

DIAGRAM 65

UNIVERSAL® ELECTROMAGNETIC BALLASTS

FOR F4, F6, F8, F13T5, F14T8
AND F14T12 LAMPS

- 4-13 Watt T5 Lamp Applications
- 14 Watt T8 & T12 Applications



**PREHEAT/
TRIGGER**

Fluorescent-Electromagnetic

Lamp		Line Volts	Catalog Number	Certification					Line Current (Amps)	Input Power (Watts)	Ballast Factor	Ballast Efficacy Factor	Crest Factor	THD %	Min. F/C Start Temp	Sound Rating	Wiring Diag.	Dim.
Qty.	Descr.			E	UL	SF	RE	NOM										
F6T5 - Normal Power Factor																		
1	Preheat	120	4105P①		•	•		.18	9	1.00	11.11	< 1.5	10	50	A	21	C1	
1	Preheat	120	4105F2P①		•	•		.18	9	1.00	11.11	< 1.5	10	50	A	21	B1	
F8T5 - Normal Power Factor																		
1	Preheat	120	4105P①		•	•		.17	9.5	1.00	10.53	< 1.5	9	50	A	21	C1	
1	Preheat	120	4105F2P①		•	•		.17	9.5	1.00	10.53	< 1.5	9	50	A	21	B1	
F14T8 - Normal Power Factor																		
1	Preheat	120	200-C-S-P♣⌘		•	•		.42	22	1.07	4.89	< 1.7	<10	50/10	A	28	D11	
1	Preheat	120	200-H2①		•	•	•	.36	19	.99	5.15	< 1.7	<10	50/10	A	21	E1	
F14T12 - High Power Factor																		
2	Preheat	120	564-L-TC-P		•	•	•	.39	45	.79	1.75	< 1.7	<20	50/10	A	1	D2	
2	Preheat	277	554-L-TC-P⌘		•	•		.17	45	.79	1.76	< 1.9	<20	50/10	A	1	D2	
F14T12 - Normal Power Factor																		
1	Preheat	120	200-C-S-P♣⌘		•	•		.43	22	1.11	4.96	< 1.7	<10	50/10	A	28	D11	
1	Preheat	120	200-H2①		•	•	•	.37	20	.98	4.85	< 1.7	<10	50/10	A	21	E1	
1	Preheat	120	546-B-TC-P♣⌘		•	•	•	.66	30	.86	2.87	< 1.7	<10	50/10	A	8	D1	
2	Preheat	120	447-LR-VLH-TC-P①		•			.62	40	.77	1.95	< 1.7	<20	50/10	A	1	D3	

- ① Requires Starter
- ♣ Starter is built in as an integral component
- ♣ Requires one circuit interrupting lamp holder
- ① Recommended for enclosed Fixtures Requiring "very low heat" ballasts
- ⌘ For Distribution Only

See page 1-24 for Dimensions and Wiring Diagrams

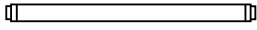

- 15, 18 & 19 Watt T8 Lamp Applications
- 15 Watt T12 Lamp Applications

UNIVERSAL® ELECTROMAGNETIC BALLASTS

FOR F15T8, F18T8, F19T8 AND F15T12 LAMPS

Fluorescent-Electromagnetic

Lamp		Line Volts	Catalog Number	Certification					Line Current (Amps)	Input Power (Watts)	Ballast Factor	Ballast Efficacy Factor	Crest Factor	THD %	Min. F/C Start Temp	Sound Rating	Wiring Diag.	Dim.
Qty.	Descr.			E	UL	SF	RECO	NOM										
F15T8 - High Power Factor																		
2	Preheat	120	564-L-TC-P	•	•			.47	51	.91	1.78	< 1.7	<32	50/10	A	1	D2	
2	Preheat	277	554-L-TC-P*	•	•			.20	51	.89	1.76	< 1.9	<20	50/10	A	1	D2	
F15T8 - Normal Power Factor																		
1	Preheat	120	200-C-S-P♣*	•	•			.36	22	1.05	4.86	< 1.7	<10	50/10	A	28	D11	
1	Preheat	120	200-H2Ⓜ	•	•		•	.32	20	1.05	5.13	< 1.7	<10	50/10	A	21	E1	
1	Preheat	120	546-B-TC-P♣*	•	•		•	.55	25	.89	3.50	< 1.7	<10	50/10	A	8	D1	
1	Preheat	120	CF1320H2PⓂ	•	•			.26	17	.75	4.55	< 1.7	<15	50/10	A	21	E2	
2	Preheat	120	447-LR-TC-P	•	•			.50	39	.75	1.92	< 1.7	<20	50/10	A	1	D3	
2	Preheat	120	447-LR-VLH-TC-PⓂ	•	•			.53	38	.76	2.02	< 1.7	<20	50/10	A	1	D3	
F18T8 - Normal Power																		
1	Preheat	120	200-C-S-P♣*	•	•			.33	21	.91	4.31	< 1.7	<10	50/10	A	28	D11	
1	Preheat	120	200-H2Ⓜ	•	•		•	.28	19	.80	4.29	< 1.7	<10	50/10	A	21	E1	
F19T8 - Normal Power																		
1	Preheat	120	200-C-S-P♣*	•	•			.31	21	.91	4.28	< 1.7	<10	50/10	A	28	D11	
1	Preheat	120	200-H2Ⓜ	•	•		•	.26	18	.80	4.33	< 1.7	<10	50/10	A	21	E1	
F15T12 - High Power																		
2	Preheat	120	564-L-TC-P	•	•		•	.43	44	.85	1.91	< 1.7	<20	50/10	A	1	D2	
2	Preheat	277	554-L-TC-P*	•	•			.20	49	.87	1.78	< 1.9	<20	50/10	A	1	D2	
F15T12 - Normal Power																		
1	Preheat	120	200-C-S-P♣*	•	•			.41	23	1.20	5.26	< 1.7	<10	50/10	A	28	D11	
1	Preheat	120	200-H2Ⓜ	•	•		•	.44	21	1.08	5.19	< 1.7	<10	50/10	A	21	E1	
1	Preheat	120	546-B-TC-P♣*	•	•		•	.61	30	.96	3.23	< 1.7	<10	50/10	A	8	D1	
2	Preheat	120	447-LR-TC-P	•	•			.56	42	.80	1.90	< 1.7	<20	50/10	A	1	D3	
2	Preheat	120	447-LR-VLH-TC-PⓂ	•	•			.58	40	.77	1.93	< 1.7	<10	50/10	A	1	D3	

- ♣ Starter is built in as an integral component
- ♠ Requires one circuit interrupting lamp holder
- Ⓜ Requires Starter
- Ⓜ Recommended for enclosed Fixtures Requiring "very low heat" ballasts
- * For Distribution Only

See page 1-24 for Dimensions and Wiring Diagrams

UNIVERSAL® ELECTROMAGNETIC BALLASTS

FOR F20, F25, F30, F40T12
AND F30T8 LAMPS

- 20-40 Watt T12 Lamp Applications
- 30 Watt T8 Lamp Applications

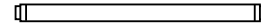

**PREHEAT/
TRIGGER**
60Hz

Fluorescent-Electromagnetic

Lamp		Line Volts	Catalog Number	Certification					Line Current (Amps)	Input Power (Watts)	Ballast Factor	Ballast Efficacy Factor	Crest Factor	THD %	Min. F/C Start Temp	Sound Rating	Wiring Diag.	Dim.
Qty.	Descr.			(E)	(UL)	(SF)	(E) (UL) (SF)	NOM										
F20T12 - High Power Factor																		
2	Preheat	120	564-L-TC-P	•	•			.51	55	.85	1.55	< 1.7	<20	50/10	A	1	D2	
2	Preheat	277	554-L-TC-P※	•	•			.22	55	.86	1.55	< 1.7	<20	50/10	A	1	D2	
F20T12 - Normal Power Factor																		
1	Preheat	120	200-C-S-P♣※	•	•			.35	23	.95	4.15	< 1.7	<10	50/10	A	28	D11	
1	Preheat	120	200-H2Ⓢ	•	•			.30	20	.83	4.15	< 1.7	<10	50/10	A	21	E1	
1	Preheat	120	546-B-TC-P♣※	•	•			.58	29	.82	2.83	< 1.7	<10	50/10	A	8	D1	
1	Preheat	120	CF1320H2PⓈ	•	•			.26	17	.75	4.55	< 1.7	<15	50/10	A	21	E2	
2	Preheat	120	447-LR-TC-P	•	•			.43	37	.56	1.51	< 1.7	<20	50/10	A	1	D3	
2	Preheat	120	447-LR-VLH-TC-PⓈ	•	•			.42	35	.55	1.57	< 1.7	<20	50/10	A	1	D3	
F30T8 - Normal Power Factor																		
1	Preheat	120	202-B-TC-PⓈ※	•	•			.62	37	.97	2.62	< 1.7	<10	50/10	A	22	D11	
1	Preheat	120	202-SB-TC-P♣※	•	•			.62	39	2.97	7.62	< 1.7	<10	50/10	A	28	D11	
F30T12 - Normal Power Factor																		
1	Preheat/RS	120	202-B-TC-PⓈ※	•	•			.68	37	.85	2.28	< 1.7	<10	50/10	A	22	D11	
1	Preheat/RS	120	202-SB-TC-P♣※	•	•			.68	37	.85	2.28	< 1.7	<10	50/10	A	28	D11	
F40T12 - Normal Power Factor																		
1	Preheat/RS	120	202-B-TC-PⓈ※	•	•			.60	39	.77	1.99	< 1.7	<10	50/10	A	22	D11	
1	Preheat/RS	120	202-SB-TC-P♣※	•	•			.60	39	.77	1.99	< 1.7	<10	50/10	A	28	D11	
F40T12ES - Normal Power Factor																		
1	Preheat/RS	120	202-B-TC-PⓈ※	•	•			.68	37	.82	2.22	< 1.9	<10	60/15	A	22	D11	
1	Preheat/RS	120	202-SB-TC-P♣※	•	•			.68	37	.82	2.22	< 1.9	<10	60/15	A	28	D11	

- ♣ Starter is built in as an integral component
- Ⓢ Requires Starter
- ♣ Requires one circuit interrupting lamp holder
- Ⓢ Recommended for enclosed Fixtures Requiring "very low heat" ballasts
- ※ For Distribution Only

See page 1-24 for Dimensions and Wiring Diagrams

Overall Dimensions		Mounting Dimensions			
Draw #	L	W	H	M	X
B1	2 3/8	27/32	1 13/32	2	-
C1	2 3/4	1 27/32	1 3/32	2 13/32	-
D1	6 7/16	1 7/8	1 1/2	6	-
D2	9 1/2	2 3/8	1 1/2	8 57/64	1
11/16					
D3	6 19/32	2 3/8	1 1/2	6	-
D11	6 7/16	1 7/8	1 5/16	6	-
E1	3 1/16	1 25/32	1 5/16	2 3/4	-

WIRING DIAGRAMS

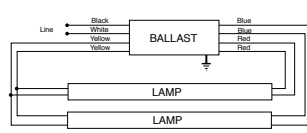

DIAGRAM 1

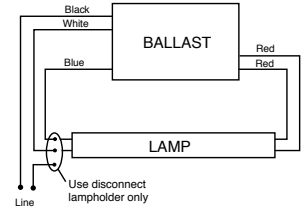

DIAGRAM 8

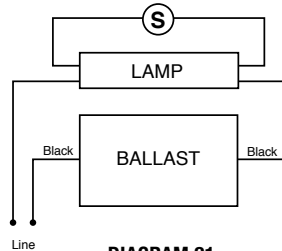
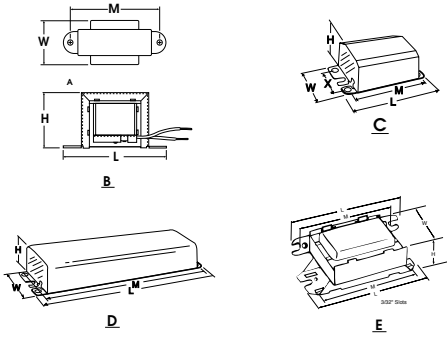

DIAGRAM 21

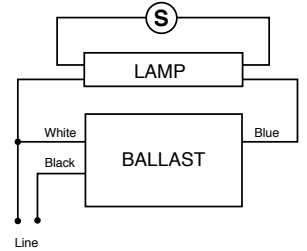

DIAGRAM 22

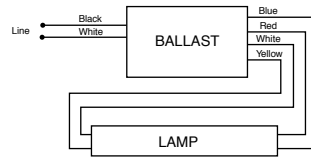
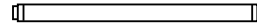

DIAGRAM 28

UNIVERSAL® ELECTROMAGNETIC BALLASTS

- 14-20 Watt
- Preheat/Trigger
- T12/T8



EXPORT

FOR 14 - 20 WATT, T8 AND T12 LAMPS

Lamp		Line Volts	Catalog Number	Certification					Line Current (Amps)	Input Power (Watts)	Ballast Factor	Ballast Efficacy Factor	Crest Factor	THD %	Min. F/C Start Temp	Sound Rating	Wiring Diag.	Dim.
Qty.	Descr.			E	UL	SF	IEC	NOM										
F14T12 - High Power Factor																		
2	Trigger	220/60Hz	567-L-TC						.22	44	.76	1.74	< 1.9	< 20	50/10	A	1	D2
F15T12 - High Power Factor																		
2	Trigger	220/60Hz	567-L-TC						.24	47	.85	1.81	< 1.9	< 20	50/10	A	1	D2
F15T8 - High Power Factor																		
2	Trigger	220/60Hz	567-L-TC						.25	49	.86	1.77	< 1.9	< 32	50/10	A	1	D2
F20T12 - High Power Factor																		
2	Trigger	127/60Hz	597-L-TC-P [Ⓞ]						.45	55	.88	1.60	< 1.7	< 15	50/10	A	1	D2
2	Trigger	220/60Hz	567-L-TC						.26	53	.83	1.55	< 1.7	< 20	50/10	A	1	D2

ⓄMay also be used with F14T12, F15T8 and F15T12 Lamps

Fluorescent-Electromagnetic

Overall Dimensions		Mounting Dimensions			
Draw #	L	W	H	M	X
D2	9 1/2	2 3/8	1 1/2	8 57/64	1

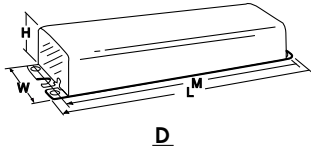

WIRING DIAGRAMS

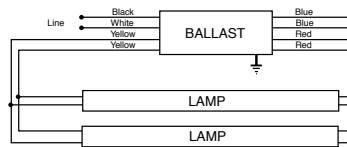
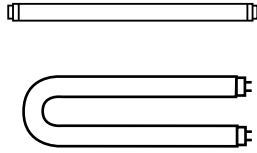

DIAGRAM 1

EXPORT



- 430-460 mA
- Rapid Start T12

UNIVERSAL® ELECTROMAGNETIC BALLASTS

**FOR F30T12, F30T12ES, F40T12, F40T12/U,
F40T12ES AND F40T12ES/U LAMPS**

Fluorescent-Electromagnetic

Lamp		Line Volts	Catalog Number	Certification					Line Current (Amps)	Input Power (Watts)	Ballast Factor	Ballast Efficacy Factor	Crest Factor	THD %	Min. F/C Start Temp	Sound Rating	Wiring Diag.	Dim.
Qty.	Descr.			E	UL	SF	CE	NOM										
F40T12 - High Power Factor																		
2	Rapid	120/60Hz	446-LR-TC-P ^⑦	•	•	•	•	.77	91	.93	1.02	<1.7	<20	50/10	A	1	D2	
2	Rapid	127/60Hz	595-L-TC-P [Ⓞ]	•	•	•	•	.70	87	.88	1.01	<1.7	<20	50/10	A	1	D2	
2	Rapid	220/60Hz	540-L-TC-P	•	•	•	•	.42	90	.91	1.01	<1.7	<20	50/10	A	1	D2	
2	Rapid	277/60Hz	808-BR-TC-P ^⑦	•	•	•	•	.36	96	.94	0.97	<1.7	<20	50/10	A	1	D2	
F40T12/U - High Power Factor																		
1	Rapid	120/60Hz	412-L-TC-P ^⑦	•	•	•	•	.48	57	.95	1.67	<1.7	<20	60/15	A	42	D2	
2	Rapid	120/60Hz	446-LR-TC-P ^⑦	•	•	•	•	.77	91	.91	1.00	<1.7	<20	50/10	A	1	D2	
F40T12ES - High Power Factor																		
1	Rapid	120/60Hz	412-L-TC-P ^⑦	•	•	•	•	.44	51	.90	1.76	<1.7	<20	50/10	A	42	D2	
2	Rapid	120/60Hz	446-LR-TC-P ^⑦	•	•	•	•	.66	75	.86	1.15	<1.9	<20	60/15	A	1	D2	
2	Rapid	220/60Hz	540-L-TC-P	•	•	•	•	.36	75	.86	1.15	<1.9	<20	60/15	A	1	D2	
2	Rapid	277/60Hz	443-L-TC-P ^⑦	•	•	•	•	.32	82	.88	1.08	<1.9	<20	60/15	A	1	D2	
F40T12ES/U - High Power Factor																		
2	Rapid	120/60Hz	446-LR-TC-P ^⑦	•	•	•	•	.66	75	.86	1.15	<1.9	<20	60/15	A	1	D2	

- Power Factor Corrected to >80%
- ⊕ Power Factor Corrected to >85%
- ⑦ For Export Only-may not be purchased for use in the USA
- ✓ For Distribution Only

- Ⓞ May also be used with F40T12ES Lamps
- For Replacement Only
- ⊗ For Distribution Only

Overall Dimensions		Mounting Dimensions			
Draw #	L	W	H	M	X
D2	9 1/2	2 3/8	1 1/2	8 57/64	1

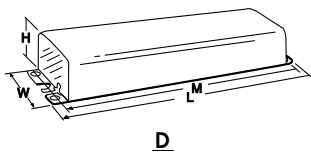

WIRING DIAGRAMS

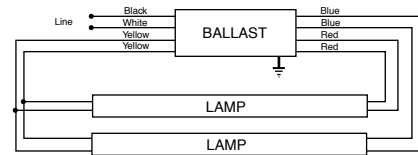

DIAGRAM 1

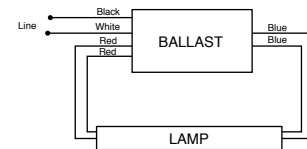
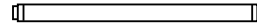

DIAGRAM 42

UNIVERSAL® ELECTROMAGNETIC BALLASTS

FOR F30T12 AND F40T12 LAMPS

- 430 mA
- Rapid Start
- Continuous Dimming



EXPORT

Fluorescent-Electromagnetic

Lamp		Line Volts	Catalog Number	Certification					Line Current (Amps)	Input Power (Watts)	Ballast Factor	Ballast Efficacy Factor	Crest Factor	THD %	Min. F/C Start Temp	Sound Rating	Wiring Diag.	Dim.
Qty.	Descr.			E	UL	SF	IEC	NOM										
F40T12 - High Power Factor																		
2	@ 100%	120	502-A-TC-P†ⓂⓈ	•	•			.85	94	.88	0.94	< 1.7	< 20	50/10	A	18	D5	
2	@ 20%	120	502-A-TC-P†ⓂⓈ	•	•			.68	35	.20	.57	< 1.7	< 32	50/10	A	18	D5	
F30T12 - Corrected Power Factor																		
2	@ 100%	120	502-A-TC-PⓂⓈ②	•	•			.87	83	.89	1.07	< 1.7	< 20	50/10	A	18	D5	
2	@ 20%	120	502-A-TC-PⓂⓈ②	•	•			.58	27	.21	.77	< 1.9	< 32	50/10	A	18	D5	

- ♣ Requires one circuit interrupting lamp holder
- † Requires two circuit interrupting lamp holder
- Ⓜ UL component recognized for use with specific Dimming Controls
- ② Power Factor Corrected to <60%
- ③ Power Factor Corrected to >60%
- Ⓢ For Distribution Only

Overall Dimensions			Mounting Dimensions		
Draw #	L	W	H	M	X
D5	16 3/8	2 3/8	1 1/2	15 25/32	1

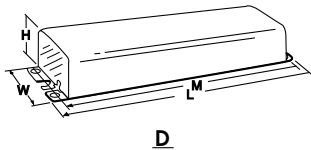

WIRING DIAGRAMS

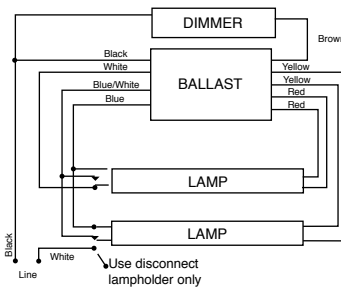

DIAGRAM 18

WARNING

External fuses should not be used with 277-volt dimming ballasts.

CAUTION

The control circuit line will carry approximately 0.375 amps per 40-watt lamps (and approximately 0.41 amps per 30-watt lamp). This means that the control circuit attached to the ballast brown wire must be sized appropriately. Please note that the ampacity of the control line is approximately double the ampacity requirement of the line when 277-volt dimming ballasts are used. When 120-volt ballasts are used, the ampacity requirement of the control lead is slightly lower than the line current.

EXPORT

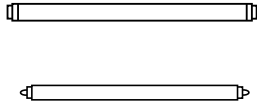

- 425-440 mA
- 4'-8' Lamp Applications
- T12 Slimline
- Instant Start

UNIVERSAL® ELECTROMAGNETIC BALLASTS

FOR F64, F72, F84, F96T12 AND F96T12ES LAMPS

Fluorescent-Electromagnetic

Lamp		Line Volts	Catalog Number	Certification					Line Current (Amps)	Input Power (Watts)	Ballast Factor	Ballast Efficacy Factor	Crest Factor	THD %	Min. F/C Start Temp	Sound Rating	Wiring Diag.	Dim.
Qty.	Descr.			E	UL	SF	RoHS	NOM										
F64T12 - High Power Factor																		
2	Instant	120/60Hz	806-BR-TC-P	•	•			1.05	124	1.05	0.84	<1.85	<20	50/10	C	39	D12	
F72T12 - High Power Factor																		
2	Instant	120/60Hz	806-BR-TC-P [Ⓢ]	•	•			1.15	131	.90	0.69	< 1.85	< 32	50/10	C	39	D12	
2	Instant	220/60Hz	808-BR-TC-PO	•				.73	134	.93	0.69	< 1.85	< 32	50/10	C	39	D12	
F84T12 - High Power Factor																		
2	Instant	120/60Hz	806-BR-TC-P [Ⓢ]	•	•			1.29	149	.92	0.62	< 1.85	< 32	50/10	C	39	D12	
2	Instant	220/60Hz	808-BR-TC-P	•				.77	152	.95	0.63	< 1.85	< 32	50/10	C	39	D12	
F96T12 - High Power Factor																		
2	Instant	120/60Hz	806-BR-TC-P [Ⓢ]	•	•			1.40	162	.89	0.55	< 1.85	< 32	50/10	C	39	D12	
2	Instant	220/60Hz	808-BR-TC-P [Ⓢ]	•	•			.85	165	.92	0.55	< 1.85	< 32	50/10	C	39	D12	
F96T12ES - High Power Factor																		
2	Instant	120/60Hz	806-BR-TC-P [Ⓢ]	•	•			1.16	129	.86	0.67	< 2.0	< 32	60/15	C	39	D12	
2	Instant	220/60Hz	808-BR-TC-P [Ⓢ]	•	•			.76	130	.86	0.66	< 2.0	< 32	60/15	C	39	D12	
2	Instant	127/60Hz	831-TC					1.07	124	.68	0.55	< 1.85	< 25	50/10	B	39	D10	

- ▶ Power Factor Corrected to >75%
- Power Factor Corrected to >80%
- Ⓢ Power Factor Corrected to >85%
- Ⓢ For Export Only-may not be purchased for use in the USA
- Ⓢ For Distribution Only

Overall Dimensions			Mounting Dimensions			
Draw #	L	W	H	M	X	
D10 11/16	9 29/64	3 3/32	1 25/32	8 57/64	1	1

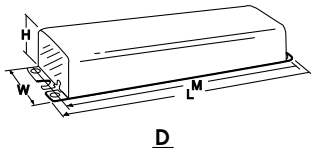

WIRING DIAGRAMS

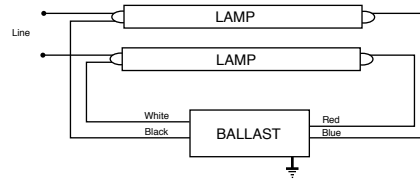
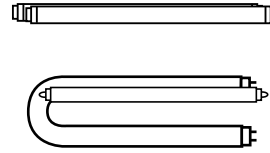

DIAGRAM 39

UNIVERSAL® ELECTROMAGNETIC BALLASTS

- 430-460 mA
- Rapid Start T12



EXPORT

**FOR F30T12, F30T12ES, F40T12, F40T12/U,
F40T12ES AND F40T12ES/U LAMPS**

Lamp		Line Volts	Catalog Number	Certification					Line Current (Amps)	Input Power (Watts)	Ballast Factor	Ballast Efficacy Factor	Crest Factor	THD %	Min. F/C Start Temp	Sound Rating	Wiring Diag.	Dim.
Qty.	Descr.			E	UL	SF	RoHS	NOM										
F40T12 - High Power Factor																		
2	Rapid	120/60Hz	446-LR-TC-P ^⑦	•	•	•	•	.77	91	.93	1.02	<1.7	<20	50/10	A	1	D2	
2	Rapid	127/60Hz	595-L-TC-P [Ⓞ]	•	•	•	•	.70	87	.88	1.01	<1.7	<20	50/10	A	1	D2	
2	Rapid	220/60Hz	540-L-TC-P	•	•	•	•	.42	90	.91	1.01	<1.7	<20	50/10	A	1	D2	
2	Rapid	277/60Hz	808-BR-TC-P ^⑦	•	•	•	•	.36	96	.94	0.97	<1.7	<20	50/10	A	1	D2	
F40T12/U - High Power Factor																		
1	Rapid	120/60Hz	412-L-TC-P ^⑦	•	•	•	•	.48	57	.95	1.67	<1.7	<20	60/15	A	42	D2	
2	Rapid	120/60Hz	446-LR-TC-P ^⑦	•	•	•	•	.77	91	.91	1.00	<1.7	<20	50/10	A	1	D2	
F40T12ES - High Power Factor																		
1	Rapid	120/60Hz	412-L-TC-P ^⑦	•	•	•	•	.44	51	.90	1.76	<1.7	<20	50/10	A	42	D2	
2	Rapid	120/60Hz	446-LR-TC-P ^⑦	•	•	•	•	.66	75	.86	1.15	<1.9	<20	60/15	A	1	D2	
2	Rapid	220/60Hz	540-L-TC-P	•	•	•	•	.36	75	.86	1.15	<1.9	<20	60/15	A	1	D2	
2	Rapid	277/60Hz	443-L-TC-P ^⑦	•	•	•	•	.32	82	.88	1.08	<1.9	<20	60/15	A	1	D2	
F40T12ES/U - High Power Factor																		
2	Rapid	120/60Hz	446-LR-TC-P ^⑦	•	•	•	•	.66	75	.86	1.15	<1.9	<20	60/15	A	1	D2	

- Power Factor Corrected to >80%
- ⊕ Power Factor Corrected to >85%
- ⑦ For Export Only-may not be purchased for use in the USA
- ✓ For Distribution Only

- Ⓞ May also be used with F40T12ES Lamps
- For Replacement Only
- ⊗ For Distribution Only

Fluorescent-Electromagnetic

Overall Dimensions		Mounting Dimensions			
Draw #	L	W	H	M	X
D1	6 7/16	1 7/8	1 1/2	6	-
D2	9 1/2	2 3/8	1 1/2	8 57/64	1

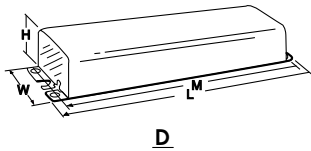

WIRING DIAGRAMS

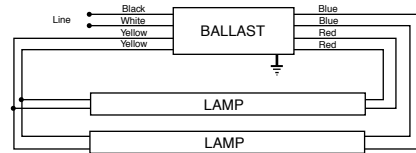

DIAGRAM 1

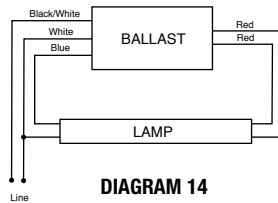

DIAGRAM 14

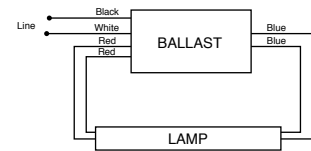
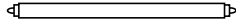
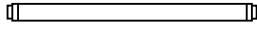

DIAGRAM 42

EXPORT



- 425-440 mA
- 4'-8' Lamp Applications
- T12 Slimline
- Instant Start

UNIVERSAL® ELECTROMAGNETIC BALLASTS

FOR F64, F72, F84, F96T12 AND F96T12ES LAMPS

Fluorescent-Electromagnetic

Lamp		Line Volts	Catalog Number	Certification					Line Current (Amps)	Input Power (Watts)	Ballast Factor	Ballast Efficacy Factor	Crest Factor	THD %	Min. F/C Start Temp	Sound Rating	Wiring Diag.	Dim.
Qty.	Descr.			E	UL	SF	CE	NOM										
F64T12 - High Power Factor																		
2	Instant	120/60Hz	806-BR-TC-P	•	•			1.05	124	1.05	0.84	<1.85	<20	50/10	C	39	D12	
F72T12 - High Power Factor																		
2	Instant	120/60Hz	806-BR-TC-P [Ⓣ]	•	•			1.15	131	.90	0.69	< 1.85	< 32	50/10	C	39	D12	
2	Instant	220/60Hz	808-BR-TC-PO	•				.73	134	.93	0.69	< 1.85	< 32	50/10	C	39	D12	
F84T12 - High Power Factor																		
2	Instant	120/60Hz	806-BR-TC-P [Ⓣ]	•	•			1.29	149	.92	0.62	< 1.85	< 32	50/10	C	39	D12	
2	Instant	220/60Hz	808-BR-TC-P	•				.77	152	.95	0.63	< 1.85	< 32	50/10	C	39	D12	
F96T12 - High Power Factor																		
2	Instant	120/60Hz	806-BR-TC-P [Ⓣ]	•	•			1.40	162	.89	0.55	< 1.85	< 32	50/10	C	39	D12	
2	Instant	220/60Hz	808-BR-TC-P [Ⓣ]	•	•			.85	165	.92	0.55	< 1.85	< 32	50/10	C	39	D12	
F96T12ES - High Power Factor																		
2	Instant	120/60Hz	806-BR-TC-P [Ⓣ]	•	•			1.16	129	.86	0.67	< 2.0	< 32	60/15	C	39	D12	
2	Instant	220/60Hz	808-BR-TC-P [Ⓣ]	•	•			.76	130	.86	0.66	< 2.0	< 32	60/15	C	39	D12	
2	Instant	127/60Hz	831-TC					1.07	124	.68	0.55	< 1.85	< 25	50/10	B	39	D10	

- ▶ Power Factor Corrected to >75%
- Power Factor Corrected to >80%
- ⊕ Power Factor Corrected to >85%
- Ⓣ For Export Only-may not be purchased for use in the USA
- Ⓣ For Distribution Only

Overall Dimensions		Mounting Dimensions			
Draw #	L	W	H	M	X
D6	11 3/4	3 1/8	1 25/32	11 9/64	2
D10	9 29/64	3 3/32	1 25/32	8 57/64	1
11/16					

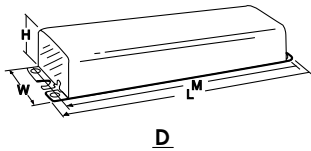

WIRING DIAGRAMS

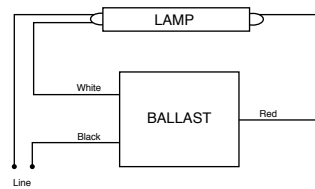

DIAGRAM 34

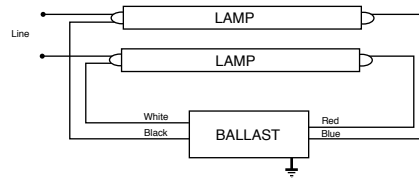
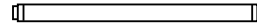

DIAGRAM 39

UNIVERSAL[®] ELECTROMAGNETIC BALLASTS

FOR F30T12 AND F40T12 LAMPS

- 430 mA
- Rapid Start
- Continuous Dimming



DIMMING

Fluorescent-Electromagnetic

Lamp		Line Volts	Catalog Number	Certification					Line Current (Amps)	Input Power (Watts)	Ballast Factor	Ballast Efficacy Factor	Crest Factor	THD %	Min. F/C Start Temp	Sound Rating	Wiring Diag.	Dim.
Qty.	Descr.			E	UL	SF	UL	NOM										
F40T12 - High Power Factor																		
2	@ 100%	120	502-A-TC-P†ⓉⓈ	•	•			.85	94	.88	0.94	< 1.7	< 20	50/10	A	18	D5	
2	@ 20%	120	502-A-TC-P†ⓉⓈ	•	•			.68	35	.20	.57	< 1.7	< 32	50/10	A	18	D5	
2	@ 100%	277	678-A-TC-P†ⓉⓈ	•	•			.39	100	.88	0.94	< 1.7	< 32	50/10	A	16	D5	
2	@ 20%	277	678-A-TC-P†ⓉⓈ	•	•			.34	30	.20	.67	< 1.7	< 32	50/10	A	16	D5	
F30T12 - Corrected Power Factor																		
2	@ 100%	120	502-A-TC-PⓉⓈ	•	•			.87	83	.89	1.07	< 1.7	< 20	50/10	A	18	D5	
2	@ 20%	120	502-A-TC-PⓉⓈ	•	•			.58	27	.21	.77	< 1.9	< 32	50/10	A	18	D5	
2	@ 100%	277	678-A-TC-PⓉⓈ	•	•			.85	96	.90	0.93	< 1.7	< 32	50/10	A	16	D5	
2	@ 20%	277	678-A-TC-P†ⓉⓈ	•	•			.68	33	.23	.70	< 1.7	< 32	50/10	A	16	D5	

- ♣ Requires one circuit interrupting lamp holder
- † Requires two circuit interrupting lamp holder
- Ⓣ UL component recognized for use with specific Dimming Controls
- ② Power Factor Corrected to <60%
- ③ Power Factor Corrected to >60%
- Ⓢ For Distribution Only

Overall Dimensions		Mounting Dimensions			
Draw #	L	W	H	M	X
D2 11/16	9 1/2	2 3/8	1 1/2	8 5/16	1

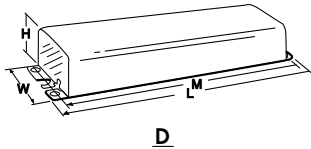

WIRING DIAGRAMS

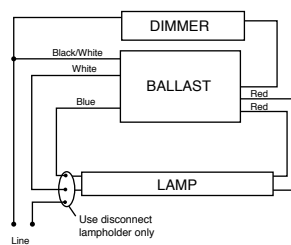

DIAGRAM 9

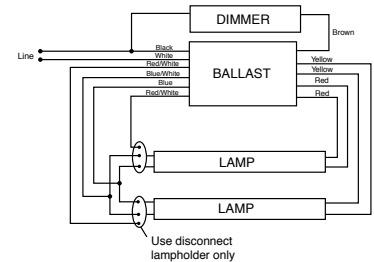

DIAGRAM 16

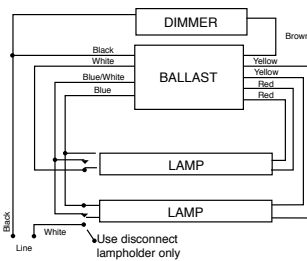

DIAGRAM 18

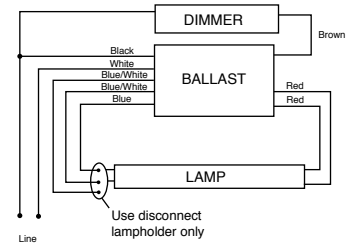

DIAGRAM 19

WARNING

External fuses should not be used with 277-volt dimming ballasts.

CAUTION

The control circuit line will carry approximately 0.375 amps per 40-watt lamps (and approximately 0.41 amps per 30-watt lamp). This means that the control circuit attached to the ballast brown wire must be sized appropriately. Please note that the ampacity of the control line is approximately double the ampacity requirement of the line when 277-volt dimming ballasts are used. When 120-volt ballasts are used, the ampacity requirement of the control lead is slightly lower than the line current.

Electronic Fluorescent Ballasts

A Complete Range of Solutions — From The Name You Trust

For more than 30 years, the lighting industry has relied on our TRIAD® brand for the most specified, most installed, most reliable electronic ballasts in the business.

The TRIAD® line offers advantages like installer-friendly universal input voltage, which ensures that you have the right voltage ballast every time. We're also the industry leader in low profile design - lightweight, space-saving ballasts that offer the same footprint and wiring as conventional ballasts. And our AccuStart™ ballasts feature programmed rapid start technology that dramatically enhances lamp life.



Universal is the leader in energy saving electronic ballasts.

Product Overview

Setting The Pace In T8 Technology

Universal Lighting keeps pushing the frontier of T8 technology with innovative products that deliver dramatic energy savings, greater fixture design flexibility, longer lamp life and installation ease. You can count on Universal for some of the industry's smallest, lightest and most hassle-free T8 ballasts.

Universal Voltage Low Profile High Performance (HP-A and HP-B)

Our low profile High Performance ballasts with THD<10% offer the convenience of universal input voltage (108 - 305 volts) as a standard feature. Universal input is "installer-friendly" - ensuring that you have the right voltage ballast every time. Our low profile models also feature a remarkably small package and cross section (1.0"H x 1.5"W) for greater flexibility in fixture design. Since the mounting and wiring footprints are the same as a standard size ballast, our low profile HP models will easily retrofit into any T12 or T8 fixture.

High Efficiency Lamp/Ballast System

The High Efficiency Lamp/Ballast System is the most significant advancement in linear fluorescent energy savings in more than a quarter century. The system delivers up to 40% energy savings compared to conventional magnetic T12 energy-saving systems and up to 11% versus standard electronic T8 systems. Our High Efficiency ballast is designed to operate any lamp manufacturer's F32T8/ES energy-saving lamp or standard F32T8 lamp. There are two options:

- EL suffix denotes .77 ballast factor
- HE suffix denotes .87 ballast factor
- HEH suffix denotes 1.18 ballast factor

AccuStart®

AccuStart® ballasts are ideal for frequently switched applications or as a rapid start alternative. They incorporate programmed rapid start technology to properly heat the lamp filaments, which yields an increase in lamp life up to 50%. The 1-4 lamp models offer universal input voltage - an industry exclusive.

T8 Super Low Profile

Our T8 super low profile models offer maximum fixture flexibility. They're ideal for pendant mount and other specialty lighting applications. They feature a small cross section (1.0"H x 1.18"W) and low profile dimensions for indirect/direct fixtures, plus installer-friendly universal input voltage (108 - 305 volts).

Low Power (L-A)



Family of Low Profile Ballasts.



AccuStart® ballasts for frequently switched applications.

Product Overview

Low Power (L-A)

The L-A Series ballasts offer the option of a .78 ballast factor for maximum energy savings. They feature space-saving low profile design. The 2- to 4-lamp models are ideal for retrofitting energy-saving T12 lamps - and offer parallel lamp operation and THD<20%.

Low Profile Reduced Harmonic (RH-A)

Our low profile RH ballasts are over 45% smaller and 30% lighter. They feature a space-saving package and cross section (1.18" H x 1.7"W) for greater flexibility in fixture design. The 1- to 4-lamp model features parallel lamp operation, with standard mounting footprint and wiring for ease of replacement. They offer high efficiency performance with THD<20%.

Reduced Harmonic High Output (RHH and RHH-A)

These ballasts deliver the maximum light output by operating lamps at their rated current of 265mA without compromising lamp life. They feature a 1.18 ballast factor versus the industry standard .88 to provide lighting design flexibility.

T5 Ballasts For Indirect And High-End Architectural Applications

T5 systems are gaining greater popularity for high-end architectural applications. Universal Lighting gives you a wide range of T5 solutions, from 14 to 54 watts. Our T5 ballasts operate multiple (1 or 2) F35T5, F28T5, F21T5 and F14T5 lamps. Additionally, our T5HO ballasts operate multiple (1 or 2) F54T5HO, F39T5HO and F24T5HO lamps. Moreover, they make your life easier with standard features that include universal input voltage (108 - 305 volts), programmed rapid start technology for longer lamp life and end of lamp life shutdown circuit with auto-reset.

T5 Standard Output

Our standard output T5 ballasts support multiple lamp operation (including 14-, 21-, 28-, and 35-watt lamps). They're ideal for indirect pendant mount, surface mount, cove, undercabinet or task lighting. With a small cross section (1.0"H x 1.18"W), our T5 models give you more options for slim fixture design. Standard features include universal input voltage, end-of-lamp-life shutdown circuit and programmed rapid start technology.

T5 High Output

Universal's high output T5 ballasts support 24-, 39- and 54-watt lamps. They offer the same standard features and compact dimensions as our T5 standard output line - and they're also well-suited to applications where space is at a premium, including slim pendant mounted fixtures, cove and task lighting.



Family of Universal HP Ballasts.



Flexible Fixture design options for T5 and T5HO lamps.

Application And Operating Information

SAFETY

NEC & UL Requirements

Ballast installation presents the possibility of exposure to potentially hazardous voltages and should be performed only by qualified personnel. All installation, inspection and maintenance should be performed only with power to the fixture turned off. Additionally, all fixtures and ballasts must be installed and operated in compliance with the National Electrical Code, Underwriters Laboratories Inc. (UL) requirements, and all local applicable codes and regulations.

Polarity

Polarity refers to the proper connection of ballast lead wires to line wires. To aid you in making a correct installation, Universal ballast leads are color-coded for easy identification. The WHITE ballast lead is to be connected to the neutral (grounded) and the BLACK (or black with white tracer) lead always to the phase (“hot”) line wire. Systems where neither of the line wires are at ground potential require specially designed ballasts. A change in polarity may result in the voltage from the lead to the ground exceeding UL-specified limits. In some types of ballasts, a change in polarity may decrease voltage from the lead to the ground, thereby impeding the starting dependability of the ballast.

Grounding

Ballast cases and fixtures must always be grounded. The ballast case may be grounded to the fixture or otherwise grounded. It could be hazardous to make contact with an ungrounded fixture or ballast when in operation. Neglecting to properly ground the ballast and fixture combination may also result in failure of certain lamps to start or for unacceptable levels of electromagnetic noise to be conducted onto the power lines.

Operating Line Voltage Limits

To receive the full benefits of rated lamp output and to prolong ballast life, it is essential that voltage supplied to an installation be maintained within limits prescribed for each circuit. These limits are listed below:

Nominal Voltage	VOLTAGE RANGE	
	Minimum	Maximum
120	108	132
220	198	242
277	249	305
347	312	382
120-277 (UNV)	108	305
347-480 (HRV)	312	528

Subjecting a ballast to excessive voltage for an extended period results in the deterioration of the insulation. This insulation breakdown will cause early ballast failure.

Low voltage has no damaging effect on the ballast. However, lamps may not start reliably, and early lamp failure could result.

Internal Ballast Protection

Class P Classification - Since January 1, 1984, the National Electrical Code requires that “where Fluorescent fixtures are installed indoors, the ballast shall have thermal protection integral within the ballast except for simple reactance ballasts.” This ruling applies to replacement ballasts as well as to those contained within new fixtures.

In compliance with the National Electrical Code, UL has established a Class P ballast classification for fluorescent light fixtures.

A Class P ballast must employ internal thermal protection limiting its operating temperature.

Universal UL-approved Class P ballasts comply with the National Electrical Code requirement and are equipped with an automatic resetting thermal protector, built-in and adjacent to the transformer coils. The resetting thermal protector functions as a thermostat which will open and temporarily deactivate the ballast when it exceeds the permissible temperature. It will reset when the ballast cools to a safe operating temperature. The ballast will continue to cycle until the cause of overheating is eliminated. If the ballast is defective, it must be replaced. If the cause is external, a Class P ballast will resume normal operation after abnormal conditions are eliminated.

Application And Operating Information

SAFETY

Dimming Ballasts - Ballastar® Dimming Ballasts are controlled by using 10-0vDC. Care should be taken to insure that the line voltage (AC) wires are not connected to the low voltage DC wires. Ballastar® Electronic Dimming Ballasts have protection (safety) circuitry, that will sense the error so as not to harm the installer or the ballast. Dimming ballasts manufactured after May 1999 have the protection circuit. Dimming ballasts manufactured before this date do not have low voltage circuit protection.

Fusing - Class P ballasts do not require fusing. Fusing can be used when a single circuit has a large number of fixtures/ballasts. For a comprehensive list of appropriate fuses, contact our Technical Engineering Services (TES) Department at 1-800-BALLAST or check out our TES home page at www.unvlt.com.

Grounding - ANSI C82.1 recommends all fixtures and ballasts be grounded. Universal requires all electronic ballasts be grounded.

Thermal Protection - All Universal electronic ballasts meet UL 935 Standard for thermal protection. These ballasts are designated Class P. A Class P ballast will disconnect the ballast from input power in the event of internal over-temperature.

PERFORMANCE

Lamp Connections

Fluorescent ballasts are designed to generate voltages in excess of 300 volts. It is imperative that proper connection to quality sockets be assured in accordance with wiring diagrams on each page of the catalog and on product labels. Some applications may not require the use of all of the ballast output leads. If any leads are not to be connected, each should be individually capped and insulated to at least 600 volts.

Application Versatility

Many Universal models are designed to allow for applications with different types or quantities of lamps. Lamp applications not listed on label cannot be warranted.

Audible Noise (Sound)

Electrical equipment, including most fluorescent lamp ballasts, produces some noise. Care must be taken to select a ballast with the proper sound rating for a particular lighting installation. Secure mounting can reduce the potential for audible noise. Typically, electronic ballasts operate up to 75% quieter than electromagnetic ballasts for fluorescent lamps.

EMI/RFI

Electronic ballasts operate at high frequency and, therefore, may produce radio frequency interference (RFI) or electromagnetic interference (EMI). Some sensitive electrical equipment such as televisions, radios, or some medical equipment can be adversely affected by this RFI or EMI interference. Currently the electronic frequencies from 450 kilohertz (kHz) to 300 megahertz (MHz) are regulated by the FCC. For electronic ballasts, the limits and regulations are listed in the Code of Federal Regulations, Title 47, Part 18, Subpart C titled RF Lighting Devices. ULT provides ballasts compliant with non-consumer limits for commercial applications, as well as several models in compliance with consumer limits for residential use.

See the Data Sheets for the electronic ballast of interest to determine which FCC requirement, consumer or non-consumer the particular product meets.

Remote Mounting

Excessive hot or cold temperatures, audible noise requirements, or a desire to operate lamps in more than one fixture with the same ballast (master/slave), may make it desirable to mount the ballast remotely. Care must be taken to allow for ballast heat dissipation and proper grounding.

In any application, the wire used to extend leads must be at least as large as the wire supplied on the ballast (18 AWG) with an insulation rating of 1000 VAC at 90°C.

Lead lengths in excess of those noted cause loading effects that can dramatically impact ballast performance and void the warranty.

Universal T8 Instant Start and Programmed Rapid Start Electronic ballasts can be mounted remotely, from the lamp sockets, up to 18 feet.

Universal T8 Rapid Start Electronic ballasts can be mounted remotely, from the lamp sockets, up to 12 feet.

Application And Operating Information

PERFORMANCE

- **Lamp Starting Dependability**

Fluorescent lamps are inherently more difficult to start at low temperatures. All ballasts have limitations as to their ability to start lamps at low ambient temperatures. In this catalog, the low starting point for each lamp/ballast combination appears in the column marked "Minimum Starting Temperature."

Universal four lamp instant start ballasts can operate at a minimum starting temperature down to -18°C (0°F) under the following conditions:

1. Lead lengths to the lamps are those supplied, by Universal, with the ballast or shorter.
2. The distance from the lamp to the ground plane is no greater than 3/4".
3. The line voltage supplied to the ballast is no less than rated nominal.
4. The ballast or lamps are not remotely mounted.
5. The lamps have been burned in per lamp manufacturer requirements (typically 100 hours).

The lamp manufacturer should be contacted for lamp operating characteristics and requirements below 15°C (50°F).

- **Light Output**

Optimum light output from fluorescent lamps is achieved when the lamp wall is at 100-110°F. Any substantial excursion (either colder or warmer) will result in a reduction in light output.

- **Ballast Life**

A fluorescent lamp ballast, like any other electrical device, generates heat during its normal operation. Ballast temperatures should be kept as low as possible. Maximum dissipation of heat through fixture design and proper ballast installation will help. Although excessive temperature may not cause the ballast to fail immediately, it can shorten ballast life. To assure maximum life, the ballast case temperature should not exceed 75°C, in a maximum ambient (fixture cavity) of 40°C.

Causes of ballast overheating:

- Incorrect line voltage or frequency
- Incorrect size, type or number of lamps
- Incorrect wiring
- Poor heat dissipation due to surrounding insulation
- Sealed (Vapor Tight) Fixtures - Unusual heat build-up due to lack of ventilation in fixtures may cause thermal (on/off) cycling of certain ballasts. Consult Universal for specific recommendations.

RECOMMENDATIONS...

- Selection of a proper ballast to match the requirements of the lamp, fixture, voltage and installation.
 - Mounting of ballast within the fixture with as much surface contact as possible between the ballast and metal portions of the fixture. Secure mounting will aid in proper heat dissipation and can minimize the potential for ballast hum.
 - The use of heat-conducting dissipators (radiators), if necessary, which increase surface contact between the ballast and fixture.
 - If necessary, locate the ballast in a remote, cooler area outside the fixture.
 - Consult Universal for remote mounting recommendations.
- **Starting Method Legend**
 - IS = Instant Start
 - PRS = Programmed Rapid Start
 - RS = Rapid Start
 - PAR-IS = Parallel Instant Start
 - PAR-PRS = Parallel Programmed Rapid Start
 - PAR-RS = Parallel Rapid Start
 - SER-RS = Series Rapid Start

Specifications

TYPICAL SPECIFICATIONS FOR INSTANT START BALLASTS FOR:

- **RH** (Reduced Harmonic)
- **L** (Low Wattage)
- **RHH and RHH-A** (Reduced Harmonic High Output)

1. Ballasts (1-4 lamp) shall operate as a Parallel Circuit, allowing remaining lamp(s) to maintain full light output if one or more lamps fail.
2. Ballasts shall operate from 60 Hz input source of 120, 277 Volts, and sustained variations of $\pm 10\%$ (Voltage & Frequency) with no damage to the ballasts.
3. Ballasts shall be a high frequency electronic type, and operate lamps at a frequency above 20 kHz.
4. Lamp Current Crest Factor (ratio of peak to RMS current) shall be 1.7 or less in accordance with lamp manufacturer recommendation and ANSI C82.11-1993.
5. Ballasts shall comply with FCC Part 18 Non-Consumer Equipment for EMI (power line conducted) and RFI (Radiated).
6. Ballasts shall provide transient immunity as recommended by ANSI C62.41-1991, Location A2.
7. Ballasts shall operate lamps with no visible flicker (<3% flicker index).
8. Ballasts shall tolerate sustained open circuit and short circuit output conditions without damage.
9. Ballasts shall be Underwriters Laboratory (UL 935) listed, Class P, Type 1 Outdoor, and CSA certified where applicable.
10. Ballast shall have a Ballast Factor greater than .85 per ANSI C82.11-1993.
- Ballast Factor for Low Power (L-A) models shall be greater than .77.
11. Input current Total Harmonic Distortion shall not exceed 20% for the primary lamp applications
12. Ballasts shall have a Power Factor greater than .95 for primary lamp applications.
13. The ballasts do not contain any PCB's.
14. The manufacturer shall provide written warranty against defects in material or workmanship, including replacement, for five years from date of manufacture.
15. Manufacturer shall have been manufacturing electronic ballasts for at least fifteen years.
16. Ballast shall be manufactured in an ISO 9001 Certified Facility
17. Ballasts shall provide instant starting sequence consistent with ANSI standard C82.11-1993.
18. Universal model _____ (or approved equal).

Specifications

TYPICAL SPECIFICATIONS FOR INSTANT START BALLASTS FOR:

Universal Voltage

•HP (High Performance)

1. Ballasts (1-4 lamp) shall operate as a Parallel Circuit, allowing remaining lamp(s) to maintain full light output if one or more lamps fail.
2. Ballasts shall operate from 50/60 Hz input source of 120 through 277 Volts, and sustained variations of $\pm 10\%$ (Voltage & Frequency) with no damage to the ballasts.
3. Ballasts shall be a high frequency electronic type, and operate lamps at a frequency above 42 kHz to minimize interference with infrared control systems.
4. Lamp Current Crest Factor (ratio of peak to RMS current) shall be 1.7 or less in accordance with lamp manufacturer recommendation and ANSI C82.11-1993.
5. Ballasts shall comply with FCC Part 18 Non-Consumer Equipment for EMI (power line conducted) and RFI (Radiated).
6. Ballasts shall provide transient immunity as recommended by ANSI C62.41-1991, Location A2.
7. Ballasts shall operate lamps with no visible flicker (<3% flicker index).
8. Ballasts shall tolerate sustained open circuit and short circuit output conditions without damage.
9. Ballasts shall be Underwriters Laboratory (UL 935) listed, Class P, Type 1 Outdoor, and CSA certified where applicable.
10. Ballast shall have a Ballast Factor greater than .85 per ANSI C82.11-1993.
11. Input current Total Harmonic Distortion shall not exceed 10% for the primary lamp.
12. Ballasts shall have a Power Factor greater than .98 for primary lamp.
13. The ballasts shall not have any PCB's.
14. The manufacturer shall provide written warranty against defects in material or workmanship, including replacement, for five years from date of manufacture.
15. Manufacturer shall have been manufacturing electronic ballasts for at least fifteen years.
16. Ballast shall be manufactured in an ISO 9001 Certified Facility.
17. Ballasts shall provide instant starting sequence consistent with ANSI standard C82.11-1993.
18. Ballast shall be Universal Lighting Technologies Bx32IUNVHP-B (x=1 or 2) or Bx32IUNVHP-A (x=3 or 4) depending upon the quantity of lamps per fixture.
19. Universal model _____ (or approved equal).

Specifications

TYPICAL SPECIFICATIONS FOR INSTANT START BALLASTS FOR:

- HP (High Performance)
 - HPL (High Performance Low Power)
 - HPH (High Performance High Light)
1. Ballasts (1-4 lamp) shall operate as a Parallel Circuit, allowing remaining lamp(s) to maintain full light output if one or more lamps fail (except T12 High Output).
 2. Ballasts shall operate from 50/60 Hz input source of 120, 277, and 347 Volts, and sustained variations of $\pm 10\%$ (Voltage & Frequency) with no damage to the ballasts.
 3. Ballasts shall be a high frequency electronic type, and operate lamps at a frequency above 20 kHz.
 4. Lamp Current Crest Factor (ratio of peak to RMS current) shall be 1.7 or less in accordance with lamp manufacturer recommendation and ANSI C82.11-1993.
 5. Ballasts shall provide transient immunity as recommended by ANSI C62.41-1991, Location A2.
 6. Ballasts shall operate lamps with no visible flicker (<3% flicker index).
 7. Ballasts shall tolerate sustained open circuit and short circuit output conditions without damage.
 8. Ballasts shall be Underwriters Laboratory (UL 935) listed, Class P, Type 1 Outdoor, and CSA certified where applicable.
 9. Ballast shall have a Ballast Factor greater than .85 per ANSI C82.11-1993.
- Ballast Factor for Low Power (L) models shall be greater than .77.
 10. Input current Total Harmonic Distortion shall not exceed 10% for the primary lamp.
 11. Ballasts shall have a Power Factor greater than .98 for primary lamp.
 12. The ballasts do not contain any PCB's.
 13. The manufacturer shall provide written warranty against defects in material or workmanship, including replacement, for five years from date of manufacture.
 14. Manufacturer shall have been manufacturing electronic ballasts for at least fifteen years.
 15. Ballast shall be manufactured in an ISO 9001 Certified Facility
 16. Ballasts shall provide instant starting sequence consistent with ANSI standard C82.11-1993.
 17. Universal model _____ (or approved equal).

Specifications

TYPICAL SPECIFICATIONS FOR RAPID START BALLASTS

1. Ballasts (1-4 lamp) shall operate as a Parallel Circuit, allowing remaining lamps(s) to maintain full light output if one or more lamps fail (except T12 High Output).
2. Ballasts shall operate from 60 Hz input source of 120, 277 Volts, and sustained variations of $\pm 10\%$ (Voltage & Frequency) with no damage to the ballasts.
3. Ballasts shall be a high frequency electronic type, and operate lamps at a frequency above 20 kHz.
4. Lamp Current Crest Factor (ratio of peak to RMS current) shall be 1.7 or less in accordance with lamp manufacturer recommendation and ANSI C82.11-1993.
5. Ballasts shall comply with FCC Part 18 Non-Consumer Equipment for EMI (power line conducted) and RFI (Radiated).
6. Ballasts shall provide transient immunity as recommended by ANSI C62.41-1991, Location A2.
7. Ballasts shall operate lamps with no visible flicker (<3% flicker index).
8. Ballasts shall tolerate sustained open circuit and short circuit output conditions without damage.
9. Ballasts shall be Underwriters Laboratory (UL 935) listed, Class P, Type 1 Outdoor, CSA Certified where applicable.
10. Ballast shall have a Ballast factor greater than .85, per ANSI C82.11-1993.
11. Input current Total Harmonic Distortion shall not exceed 10% for primary lamp applications.
12. Ballast shall be manufactured in an ISO 9001 Certified Facility
13. Ballasts shall have a Power Factor greater than 0.98 primary applications.
14. The ballasts do not contain any PCB's.
15. The manufacturer shall provide written warranty against defects in material or workmanship, including replacement, for five years from date of manufacture.
16. Manufacturer shall have been manufacturing electronic ballasts for at least fifteen years.
17. Ballasts shall provide rapid starting sequence consistent with ANSI standard C82.11-1993.
18. Universal model _____ (or approved equal).

Specifications

TYPICAL SPECIFICATIONS FOR PROGRAMMED RAPID START BALLASTS:

1. Ballasts shall have a minimum start temperature of 0°F.
2. Ballasts shall operate from a 50/60 Hz input source of 120 through 277 Volts, and sustained variations of $\pm 10\%$ (Voltage & Frequency) with no damage to the ballasts.
3. Ballasts shall be a high frequency electronic type, and operate lamps at a frequency above 42 kHz to minimize interference with infrared control systems.
4. Lamp Current Crest Factor (ratio of peak to RMS current) shall be 1.7 or less in accordance with lamp manufacturer recommendation and ANSI C82.11-1993.
5. Ballasts shall comply with FCC Part 18 Non-Consumer Equipment for EMI (power line conducted) and RFI (Radiated).
6. Ballasts shall provide transient immunity as recommended by ANSI C62.41-1991, Location A2.
7. Ballasts shall operate lamps with no visible flicker (<3% flicker index).
8. Ballasts shall tolerate sustained open circuit and short circuit output conditions without damage.
9. Ballasts shall be Underwriters Laboratory (UL 935) listed, Class P, Type 1 Outdoor, and CSA certified where applicable.
10. Ballast shall have a Ballast factor greater than .85, per ANSI C82.11-1993.
11. Input current Total Harmonic Distortion shall not exceed 10%.
12. Ballasts shall have a Power Factor greater than 0.98, for primary application.
13. The ballasts shall not have any PCB's.
14. The manufacturer shall provide written warranty against defects in material or workmanship, including replacement, for five years from date of manufacture.
15. Manufacturer shall have been manufacturing electronic ballasts for at least fifteen years.
16. Ballast shall be manufactured in an ISO 9001 Certified Facility.
17. Ballast shall be manufactured in North America.
18. Ballast shall be Universal Lighting Technologies AccuStart HP Product Bx32PUNVHP-A (x=1,2,3. or 4).
19. Universal model _____ (or approved equal).

Specifications

TYPICAL SPECIFICATIONS FOR INSTANT START T5 AND T5 HIGH OUTPUT (HO) BALLASTS :

1. Ballast shall be Instant Start.
2. Ballast shall incorporate lamp shutdown circuitry for end of lamp life protection.
3. Ballast shall allow for re-lamping without the need to cycle power.
4. Ballasts shall operate from 50/60 Hz input source from 108-305 Volts with no damage to the ballasts.
5. Ballasts shall be a high frequency electronic type, and operate lamps at a frequency above 20 kHz.
6. Lamp Current Crest Factor (ratio of peak to RMS current) shall be 1.7 or less in accordance with lamp manufacturer recommendation and ANSI C82.11-1993.
7. Ballasts shall comply with FCC Part 18 Non-Consumer Equipment for EMI (power line conducted) and RFI (Radiated).
8. Ballasts shall provide transient immunity recommended by ANSI C62.41-1991, Location A2.
9. Ballasts shall operate lamps with no visible flicker (<3% flicker index).
10. Ballasts shall tolerate sustained open and short circuit output conditions without damage.
11. Ballasts shall be Underwriters Laboratory (UL 935) listed, Class P, Type 1 Outdoor, and CSA certified where applicable.
12. Ballast shall have a Ballast Factor greater than 0.95 per ANSI C82.11-1993.
13. Input current Total Harmonic Distortion shall not exceed 10% for the primary lamp.
14. Ballasts shall have a Power Factor greater than .98.
15. The ballasts do not contain any PCB's.
16. The manufacturer shall provide written warranty against defects in material or workmanship, including replacement, for up to five years from date of manufacture.
17. Manufacturer shall have been manufacturing electronic ballasts for at least fifteen years.
18. Ballast shall be manufactured in an ISO 9001 Certified Facility.
19. Universal model _____ (or approved equal).

Specifications

TYPICAL SPECIFICATIONS FOR PROGRAMMED RAPID START T5 AND T5 HIGH OUTPUT (HO) BALLASTS :

1. Ballast shall be Programmed Rapid Start.
2. Ballast shall incorporate lamp shutdown circuitry for end of lamp life protection.
3. Ballast shall allow for re-lamping without the need to cycle power.
4. Ballasts shall operate from 50/60 Hz input source from 108-305 Volts with no damage to the ballasts.
5. Ballasts shall be a high frequency electronic type, and operate lamps at a frequency above 20 kHz.
6. Lamp Current Crest Factor (ratio of peak to RMS current) shall be 1.7 or less in accordance with lamp manufacturer recommendation and ANSI C82.11-1993.
7. Ballasts shall comply with FCC Part 18 Non-Consumer Equipment for EMI (power line conducted) and RFI (Radiated).
8. Ballasts shall provide transient immunity recommended by ANSI C62.41-1991, Location A2.
9. Ballasts shall operate lamps with no visible flicker (<3% flicker index).
10. Ballasts shall tolerate sustained open and short circuit output conditions without damage.
11. Ballasts shall be Underwriters Laboratory (UL 935) listed, Class P, Type 1 Outdoor, and CSA certified where applicable.
12. Ballast shall have a Ballast Factor greater than 0.95 per ANSI C82.11-1993.
13. Input current Total Harmonic Distortion shall not exceed 10% for the primary lamp.
14. Ballasts shall have a Power Factor greater than .98.
15. The ballasts do not contain any PCB's.
16. The manufacturer shall provide written warranty against defects in material or workmanship, including replacement, for up to five years from date of manufacture.
17. Manufacturer shall have been manufacturing electronic ballasts for at least fifteen years.
18. Ballast shall be manufactured in an ISO 9001 Certified Facility.
19. Universal model _____ (or approved equal).

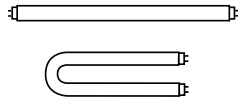

- Low Profile Designs Featured
- Instant & Programmed Rapid Starting Options
- 1-2 Lamp Applications

TRIAD® ELECTRONIC BALLASTS

**FOR (1) & (2)
F17T8 LAMP**

Lamp		Line Volts	Catalog Number	Certification			Line Current (Amps)	Input Power (Watts)	Power Factor (PF)	Ballast Factor (BF)	Ballast Efficacy Factor (BEF)	THD %	Min. F/C Start Temp	Wiring Diag.	Dim.
Qty.	Starting Method			UL	SP	NOM									
F17T8 - One Lamp Application															
1	IS	120	B132I120RH-A	•	•	•	0.17	19	> .90	0.93	4.89	< 32	0/-18	1	-A
		277	B132I277RH-A	•	•	•	0.07	20	> .90	0.93	4.65	< 32	0/-18	1	-A
		347	B132I347RH	•	•	•	0.05	18	> .95	0.92	5.11	< 20	0/-18	1	ST
		120	B132IUNVHP-B	•	•	•	0.14	17	> .95	0.89	5.24	< 10	0/-18	1	-B
		277		•	•	•	0.07								
		347	B132I347HP	•	•	•	0.05	18	> .95	0.92	5.11	< 15	0/-18	1	ST
		120	B232I120RES-A*	•	•	•	0.35	21	> .50	1.08	5.14	< 150	0/-18	3a	-A
		120	B232I120RES-G*	•	•	•	0.34	22	> .50	1.08	4.91	< 150	0/-18	3a	-G
		120	B232IUNV-C	•	•	•	0.17	20	> .98	1.04	5.20	< 10	0/-18	21a	-C
		277		•	•	•	0.08								
		120	B132IUNVEL-A	•	•	•	0.12	14	> .98	0.78	5.57	< 15	0/-18	1	-A
		277		•	•	•	0.06								
		120	B132IUNVHE-A	•	•	•	0.13	16	> .98	0.90	5.63	< 10	0/-18	1	-A
		277		•	•	•	0.07								
120	ES1608A	•	•	•	0.14	16	> .97	0.87	5.44	< 10	0/-18	39a	ESA		
277		•	•	•	0.07										
120	B132PUNVHP-A	•	•	•	0.15	17	> .99	0.91	5.35	< 10	0/-18	2	-A		
277		•	•	•	0.07										
347	ES1510A	•	•	•	0.05	18	> .97	0.87	4.83	< 10	0/-18	40	ESA		
F17T8 - Two Lamp Applications															
2	PAR-IS	120	B232I120L-A	•	•	•	0.27	30	> .90	0.85	2.83	< 32	0/-18	3	-A
		277	B232I277L-A	•	•	•	0.12	30	> .90	0.86	2.87	< 32	0/-18	3	-A
		347	B232I347L-A	•	•	•	0.09	29	> .98	0.80	2.76	< 20	0/-18	3	-A
		120	B232I120RES-G*	•	•	•	0.49	33	> .50	0.94	2.85	< 140	0/-18	3	-G
		120	B232I120RES-A*	•	•	•	0.49	32	> .50	0.94	2.94	< 140	0/-18	3	-A
		120	B232I120RH-A	•	•	•	0.31	34	> .90	0.95	2.79	< 32	0/-18	3	-A
		277	B232I277RH-A	•	•	•	0.13	34	> .90	0.95	2.79	< 32	0/-18	3	-A
		347	B232I347RH-A	•	•	•	0.09	32	> .95	0.92	2.88	< 20	0/-18	3	-A
		347	B232I347HPL	•	•	•	0.09	29	> .98	0.79	2.72	< 10	0/-18	3	ST
		120	B232IUNVHP-B	•	•	•	0.26	32	> .99	0.91	2.84	< 10	0/-18	3	-B
		277		•	•	•	0.12								
		347	B232I347HP-A	•	•	•	0.09	32	> .95	0.92	2.88	< 10	0/-18	3	-A
		120	B232IUNV-C	•	•	•	0.27	31	> .99	0.91	2.94	< 10	0/-18	21	-C
		277		•	•	•	0.12								
		120	B232IUNVEL-A	•	•	•	0.21	25	> .95	0.80	3.20	< 10	0/-18	3	-A
		277		•	•	•	0.10								
		120	B232I120EL	•	•	•	0.22	26	> .98	0.79	3.04	< 10	0/-18	3	ST
		277	B232I277EL	•	•	•	0.11	27	> .98	0.80	2.96	< 15	0/-18	3	ST
		120	B232IUNVHE-A	•	•	•	0.24	30	> .95	0.90	3.00	< 10	0/-18	3	-A
		277		•	•	•	0.12								
		120	B232IUNVHEH-A	•	•	•	0.33	41	> .95	1.18	2.88	< 10	0/-18	3	-A
		277		•	•	•	0.15								
		120	B232I120HE	•	•	•	0.25	30	> .98	0.91	3.03	< 10	0/-18	3	ST
		277	B232I277HE	•	•	•	0.12	30	> .95	0.91	3.03	< 10	0/-18	3	ST
		120	ES1608A	•	•	•	0.24	29	> .97	0.87	3.00	< 10	0/-18	39	ESA
		277		•	•	•	0.11								
		120	B232PUNVEL-A	•	•	•	0.22	26	> .90	0.72	2.77	< 10	0/-18	30	-A
		277		•	•	•	0.10								
120	B232PUNVHE-A	•	•	•	0.24	29	> .90	0.84	2.90	< 10	0/-18	30	-A		
277		•	•	•	0.11										
120	ES4800A	•	•	•	0.29	35	> .97	0.95	2.71	< 10	0/-18	37	ESA		
277		•	•	•	0.13										
120	B232PUNVHP-A	•	•	•	0.28	34	> .99	0.95	2.79	< 10	0/-18	30	-A		
277		•	•	•	0.13										
347	ES1329A	•	•	•	0.11	36	> .97	0.87	2.42	< 10	0/-18	37	ESA		

* For Residential Use Only

See page 2-18 for Dimensions and Wiring Diagrams

IS = Instant Start
PRS = Programmed Rapid Start
RS = Rapid Start

STARTING METHOD LEGEND
PAR-IS = Parallel Instant Start
PAR-PRS = Parallel Programmed Rapid Start
SER-PRS = Series Programmed Rapid Start

PAR-RS = Parallel Rapid Start
SER-RS = Series Rapid Start
SER-IS = Series Instant Start

TRIAD® ELECTRONIC BALLASTS

FOR (3) & (4) F17T8 LAMPS

- Low Profile Designs Featured
- Instant & Programmed Rapid Starting Options
- 3-4 Lamp Applications

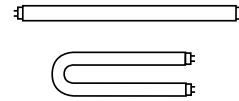

F17T8

Lamp		Line Volts	Catalog Number	Certification			Line Current (Amps)	Input Power (Watts)	Power Factor (PF)	Ballast Factor (BF)	Ballast Efficacy Factor (BEF)	THD %	Min. F/C Start Temp	Wiring Diag.	Dim.	
Qty.	Starting Method			UL	SP	NOM										
F17T8 - Three Lamp Applications																
3	PAR-IS	120	B332I120L-A	•	•		0.40	44	>.90	0.86	1.95	<30	0/-18	6	-A	
		277	B332I277L-A	•	•		0.17	44	>.95	0.88	2.00	<25	0/-18	6	-A	
		347	B332I347L		•		0.12	43	>.99	0.80	1.85	<20	0/-18	6	ST	
		120	B332I120RH-A	•	•	•	0.47	52	>.90	0.99	1.90	<32	0/-18	6	-A	
		277	B332I277RH-A	•	•	•	0.20	52	>.90	0.99	1.90	<32	0/-18	6	-A	
		347	B332I347RH		•		0.14	47	>.95	0.90	1.91	<20	0/-18	6	ST	
		347	B332I347HPL		•		0.12	43	>.99	0.80	1.85	<10	0/-18	6	ST	
		120	B332IUNVHP-A	•	•	•	0.38	45	>.99	0.92	2.04	<10	0/-18	6	-A	
		277	B332IUNVHP-A				0.18		>.90							
		347	B332I347HP		•		0.14	48	>.98	0.92	1.92	<10	0/-18	6	ST	
		120	B332IUNVEL-A	•	•		0.35	42	>.99	0.82	1.95	<10	0/-18	6	-A	
		277	B332IUNVEL-A				0.15	41	>.95		2.00	<10	0/-18	6	-A	
	120	B332I120EL	•	•		0.32	38	>.98	0.79	2.08	<10	0/-18	6	ST		
	277	B332I277EL	•	•		0.15	40	>.98	0.80	2.00	<15	0/-18	6	ST		
	120	B332IUNVHE-A	•	•		0.39	46	>.99	0.92	2.00	<10	0/-18	6	-A		
	277	B332IUNVHE-A				0.17	46	>.97			<10	0/-18	6	-A		
	120	B332I120HE	•	•		0.36	43	>.98	0.89	2.07	<10	0/-18	6	ST		
	277	B332I277HE	•	•		0.17	44	>.95	0.91	2.07	<10	0/-18	6	ST		
	120	B332IUNVHEH-A	•	•		0.49	60	>.95	1.19	1.98	<10	0/-18	6	-A		
	277	B332IUNVHEH-A				0.22	58			2.05						
	120	B432I120RES-A*	•	•	•	0.72	51	>.50	1.00	1.96	<135	0/-18	7a	-A		
	120	B432IUNV-D	•	•		0.41	49	>.98	0.99	1.98	<10	0/-18	24	-D		
	277	B432IUNV-D				0.18	48	>.95		2.02	<12					
	120	ES1720B	•	•		0.39	46			1.89	<10	0/-18	38a	ESB		
277	ES1720B				0.18	47	>.97	0.87	1.85	<10	0/-18					
120	B332PUNVHP-A	•	•	•	0.41	49	>.99	0.93	1.90	<10	0/-18	23	-A			
277	B332PUNVHP-A				0.19	48	>.90		1.94							
F17T8 - Four Lamp Applications																
4	PAR-IS	120	B432I120L-A	•	•		0.48	55	>.95	0.79	1.44	<20	0/-18	7a	-A	
		277	B432I277L-A	•	•		0.21	54	>.95	0.80	1.48	<20	0/-18	7a	-A	
		347	B432I347L		•		0.17	56	>.97	0.82	1.46	<20	0/-18	7	ST	
		120	B432I120RES-A*	•	•	•	0.84	61	>.50	0.92	1.51	<130	0/-18	7a	-A	
		120	B432I120RH-A	•	•	•	0.54	63	>.95	0.92	1.46	<20	0/-18	7a	-A	
		277	B432I277RH-A	•	•	•	0.23	61	>.95	0.92	1.51	<20	0/-18	7a	-A	
		347	B432I347RH		•		0.19	64	>.95	0.92	1.44	<20	0/-18	7a	ST	
		347	B432I347HPL		•		0.17	56	>.97	0.82	1.46	<10	0/-18	7	ST	
		120	B432IUNVHP-A	•	•	•	0.49	59	>.98	0.90	1.53	<10	0/-18	7a	-A	
		277	B432IUNVHP-A				0.22	58	>.90		1.55	<10	0/-18		-A	
		347	B432I347HP		•		0.19	62	>.98	0.92	1.48	<10	0/-18	7a	ST	
		120	B432IUNV-D	•	•		0.49	59	>.98	0.91	1.51	<10	0/-18	25	-D	
		277	B432IUNV-D				0.22	58	>.95		1.56	<12				
		120	B432IUNVEL-A	•	•		0.44	53	>.98	0.79	1.49	<10	0/-18	7a	-A	
		277	B432IUNVEL-A				0.20	52	>.95		1.52	<10	0/-18		-A	
		120	B432I120EL	•	•		0.42	51	>.98	0.81	1.59	<10	0/-18	7a	ST	
		277	B432I277EL	•	•		0.22	51	>.98	0.80	1.57	<15	0/-18	7a	ST	
		120	B432IUNVHE-A	•	•		0.49	59	>.98	0.90	1.53	<10	0/-18	7a	-A	
	277	B432IUNVHE-A				0.22	58	>.95		1.55						
	120	B432I120HE	•	•		0.47	56	>.98	0.91	1.63	<10	0/-18	7a	ST		
	277	B432I277HE	•	•		0.22	58	>.98	0.91	1.57	<10	0/-18	7a	ST		
	277	B432I277HEH	•	•		0.28	77	>.99	1.20	1.56	<10	0/-18	7a	ST		
	120	ES1720B	•	•		0.48	57	>.97	0.87	1.53	<10	0/-18	38	ESB		
	277	ES1720B				0.23	58			1.50						
	120	B432PUNVHP-A	•	•	•	0.53	63	>.99	0.91	1.44	<10	0/-18	8	-A		
	277	B432PUNVHP-A				0.24	62	>.90		1.47						

* For Residential Use Only

See page 2-18 for Dimensions and Wiring Diagrams

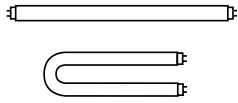

- Standard & Low Profile Designs Featured
- Instant & Programmed Rapid Starting Options
- 1-2 Lamp Applications

TRIAD® ELECTRONIC BALLASTS

FOR (1) & (2) F25T8 LAMP

Lamp		Line Volts	Catalog Number	Certification			Line Current (Amps)	Input Power (Watts)	Power Factor (PF)	Ballast Factor (BF)	Ballast Efficacy Factor (BEF)	THD %	Min. F/C Start Temp	Wiring Diag.	Dim.
Qty.	Starting Method			UL	SF	NOM									
F25T8 - One Lamp Applications															
1	IS	120	B132I120RH-A	•	•	•	0.22	26	>.97	0.92	3.54	< 25	0/-18	1	-A
		277	B132I277RH-A	•	•	•	0.10	27	>.97	0.92	3.41	< 25	0/-18	1	-A
		347	B132I347RH	•	•	•	0.07	25	>.95	0.90	3.60	< 20	0/-18	1	ST
		120	B132IUNVHP-B	•	•	•	0.21	24	>.95	0.88	3.67	< 10	0/-18	1	-B
		277	B132IUNVHP-B	•	•	•	0.09	24	>.95	0.88	3.67	< 10	0/-18	1	-B
	347	B132I347HP	•	•	•	0.07	25	>.95	0.90	3.60	< 10	0/-18	1	ST	
	120	B132IUNVEL-A	•	•	•	0.18	19	>.98	0.78	4.11	<10	0/-18	1	-A	
	277	B132IUNVEL-A	•	•	•	0.09	19	>.90	0.78	4.11	<10	0/-18	1	-A	
	120	B132IUNVHE-A	•	•	•	0.18	22	>.98	0.89	4.05	<10	0/-18	1	-A	
	277	B132IUNVHE-A	•	•	•	0.10	22	>.95	0.89	4.05	<10	0/-18	1	-A	
1	PRS	120	B132PUNVHP-A	•	•	•	0.20	24	>.99	0.91	3.79	< 10	0/-18	2	-A
		277	B132PUNVHP-A	•	•	•	0.09	24	>.98	0.91	3.79	< 10	0/-18	2	-A
		347	ES1510A	•	•	•	0.07	24	>.97	0.87	2.81	< 10	0/-18	40	ESA
		347	B232I347HPL	•	•	•	0.08	26	>.98	0.88	3.38	< 10	0/-18	3	ST
1	IS	120	B232I120RES-A*	•	•	•	0.43	28	>.50	1.08	3.86	< 150	0/-18	3a	-A
		120	B232I120RES-G*	•	•	•	0.43	28	>.50	1.08	3.86	< 150	0/-18	3a	-G
		120	B232IUNV-C	•	•	•	0.24	28	>.98	1.02	3.64	< 10	0/-18	21	-C
		277	B232IUNV-C	•	•	•	0.11	28	>.98	1.02	3.64	< 10	0/-18	21	-C
120	ES1608A	•	•	•	0.19	23	>.97	0.87	3.78	< 10	0/-18	39a	ESA		
277	ES1608A	•	•	•	0.09	24	>.97	0.87	3.63	< 10	0/-18	39a	ESA		
1	PRS	120	ES4800A	•	•	•	0.22	25	>.97	1.02	3.92	< 10	0/-18	37	ESA
		277	ES4800A	•	•	•	0.09	26	>.97	1.02	4.08	< 10	0/-18	37	ESA
F25T8 - Two Lamp Applications															
2	PAR-IS	120	B232I120L-A	•	•	•	0.37	43	>.95	0.78	1.81	< 20	0/-18	3	-A
		277	B232I277L-A	•	•	•	0.16	43	>.95	0.80	1.86	< 20	0/-18	3	-A
		347	B232I347L-A	•	•	•	0.12	39	>.98	0.79	2.03	< 20	0/-18	3	-A
		120	B232I120RES-A*	•	•	•	0.64	46	>.50	0.92	2.00	< 130	0/-18	3	-A
		120	B232I120RES-G*	•	•	•	0.64	46	>.50	0.92	2.00	< 140	0/-18	3	-G
		120	B232I120RH-A	•	•	•	0.41	48	>.95	0.93	1.94	< 20	0/-18	3	-A
		277	B232I277RH-A	•	•	•	0.18	48	>.95	0.93	1.94	< 20	0/-18	3	-A
		347	B232I347RH-A	•	•	•	0.13	46	>.95	0.89	1.93	< 20	0/-18	3	-A
		347	B232I347HPL	•	•	•	0.12	41	>.98	0.75	1.83	< 10	0/-18	3	ST
		120	B232IUNVHP-B	•	•	•	0.37	45	>.99	0.90	2.00	< 10	0/-18	3	-B
	277	B232IUNVHP-B	•	•	•	0.16	44	>.98	0.90	2.05	< 10	0/-18	3	-B	
	347	B232I347HP-A	•	•	•	0.13	46	>.95	0.89	1.93	< 10	0/-18	3	-A	
	120	B232IUNV-C	•	•	•	0.37	45	>.98	0.90	2.00	< 10	0/-18	21	-C	
	277	B232IUNV-C	•	•	•	0.16	44	>.98	0.90	2.05	< 10	0/-18	21	-C	
	120	B232IUNVEL-A	•	•	•	0.30	36	>.95	0.79	2.19	< 10	0/-18	3	-A	
	277	B232IUNVEL-A	•	•	•	0.14	37	>.95	0.80	2.18	< 10	0/-18	3	-A	
	120	B232I120EL	•	•	•	0.33	39	>.98	0.78	2.00	< 10	0/-18	3	ST	
	277	B232I277EL	•	•	•	0.15	37	>.98	0.79	2.14	< 10	0/-18	3	ST	
	120	B232IUNVHE-A	•	•	•	0.36	44	>.95	0.88	2.00	< 10	0/-18	3	-A	
	277	B232IUNVHE-A	•	•	•	0.16	44	>.95	0.88	2.00	< 10	0/-18	3	-A	
120	B232IUNVHEH-A	•	•	•	0.51	61	>.95	1.18	1.93	< 10	0/-18	3	-A		
277	B232IUNVHEH-A	•	•	•	0.22	60	>.95	1.18	1.97	< 10	0/-18	3	-A		
120	B232I120HE	•	•	•	0.35	42	>.98	0.90	2.14	< 10	0/-18	3	ST		
277	B232I277HE	•	•	•	0.16	43	>.98	0.90	2.09	< 10	0/-18	3	ST		
2	SER-IS	120	ES1608A	•	•	•	0.36	43	>.97	0.87	2.02	< 10	0/-18	39	ESA
		277	ES1608A	•	•	•	0.16	43	>.97	0.87	2.02	< 10	0/-18	39	ESA
		120	B232PUNVEL-A	•	•	•	0.31	37	>.90	0.71	1.92	<10	0/-18	30	-A
		277	B232PUNVEL-A	•	•	•	0.14	36	>.90	0.71	2.00	<10	0/-18	30	-A
120	B232PUNVHE-A	•	•	•	0.35	42	>.90	0.83	1.98	<10	0/-18	30	-A		
277	B232PUNVHE-A	•	•	•	0.15	41	>.90	0.83	2.02	<10	0/-18	30	-A		
2	SER-PRS	120	B232PUNVHP-A	•	•	•	0.40	47	>.99	0.94	2.00	<10	0/-18	30	-A
		277	B232PUNVHP-A	•	•	•	0.17	46	>.97	0.94	2.04	<10	0/-18	30	-A
		347	ES1329A	•	•	•	0.14	49	>.97	0.87	1.78	<10	0/-18	37	ESA
		120	ES4800A	•	•	•	0.40	47	>.97	0.94	2.00	< 10	0/-18	37	ESA
277	ES4800A	•	•	•	0.17	46	>.97	0.94	2.04	< 10	0/-18	37	ESA		

* For Residential Use Only

See page 2-18 for Dimensions and Wiring Diagrams

TRIAD® ELECTRONIC BALLASTS

FOR (3) & (4) F25T8 LAMPS

- Low Profile Designs Featured
- Instant & Programmed Rapid Starting Options
- 3-4 Lamp Applications

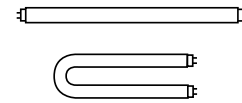

F25T8

Lamp		Line Volts	Catalog Number	Certification			Line Current (Amps)	Input Power (Watts)	Power Factor (PF)	Ballast Factor (BF)	Ballast Efficacy Factor (BEF)	THD %	Min. F/C Start Temp	Wiring Diag.	Dim.		
Qty.	Starting Method			UL	SP	NOM											
F25T8 - Three Lamp Applications																	
3	PAR-IS	120	B332I120L-A	•	•		0.52	61	> .95	0.82	1.34	< 25	0/-18	6	-A		
		277	B332I277L-A	•	•		0.22	62	< .98	0.83	1.34	< 20	0/-18	6	-A		
		347	B332I347L		•		0.17	60	> .99	0.76	1.26	< 20	0/-18	6	ST		
		120	B332I120RH-A	•	•	•	0.60	70	> .95	0.93	1.33	< 20	0/-18	6	-A		
		277	B332I277RH-A	•	•	•	0.26	70	> .95	0.93	1.33	< 25	0/-18	6	-A		
		347	B332I347RH		•		0.20	68	> .95	0.90	1.32	< 20	0/-18	6	ST		
		347	B332I347HPL		•		0.17	60	> .99	0.76	1.26	< 10	0/-18	6	ST		
		120	B332IUNVHP-A	•	•	•	0.55	66	> .99	0.92	1.36	< 10	0/-18	6	-A		
		277	B332IUNVHP-A		•		0.25	65	> .98	0.92	1.38	< 10	0/-18	6	-A		
		347	B332I347HP		•		0.20	68	> .99	0.91	1.34	< 10	0/-18	6	ST		
		120	B332IUNVEL-A	•	•		0.49	59	> .99	0.80	1.36	< 10	0/-18	6	-A		
		277	B332IUNVEL-A		•		0.22	58	> .97	0.80	1.38	< 10	0/-18	6	-A		
		120	B332I120EL	•	•		0.47	56	> .98	0.78	1.39	< 10	0/-18	6	ST		
		277	B332I277EL	•	•		0.20	56	> .98	0.79	1.41	< 10	0/-18	6	ST		
		120	B332IUNVHE-A	•	•		0.56	67	> .99	0.90	1.34	< 10	0/-18	6	-A		
		277	B332IUNVHE-A		•		0.24	66	> .98	0.90	1.36	< 10	0/-18	6	-A		
		120	B332I120HE	•	•		0.52	61	> .98	0.88	1.44	< 10	0/-18	6	ST		
		277	B332I277HE	•	•		0.24	64	> .98	0.90	1.41	< 10	0/-18	6	ST		
		120	B332IUNVHEH-A	•	•		0.69	83	> .95	1.16	1.40	< 10	0/-18	6	-A		
		277	B332IUNVHEH-A		•		0.30	81	> .95	1.16	1.43	< 10	0/-18	6	-A		
		3	SER-PRS	120	B332PUNVHP-A	•	•	•	0.58	70	> .99	0.92	1.31	< 10	0/-18	23	-A
				277	B332PUNVHP-A		•		0.26	70	> .95	0.92	1.31	< 10	0/-18	23	-A
		3	PAR-IS	120	B432I120RES-A*	•	•	•	0.96	71	> .50	0.98	1.38	< 130	0/-18	7a	-A
				277	B432IUNV-D	•	•		0.62	74	> .98	0.98	1.32	< 10	0/-18	24	-D
		277	B432IUNV-D		•		0.26	72	> .98	0.98	1.36	< 10	0/-18	24	-D		
		120	ES1720B	•	•		0.52	63	> .97	0.87	1.38	< 10	0/-18	38a	ESB		
		277	ES1720B		•		0.24	64	> .97	0.87	1.36	< 10	0/-18	38a	ESB		
F25T8 - Four Lamp Applications																	
4	PAR-IS	120	B432I120L-A	•	•		0.68	78	> .95	0.78	1.00	< 20	0/-18	7a	-A		
		277	B432I277L-A	•	•		0.30	76	> .95	0.78	1.03	< 20	0/-18	7a	-A		
		347	B432I347L		•		0.24	83	> .98	0.78	0.94	< 20	0/-18	7	ST		
		120	B432I120RES-A*	•	•	•	1.13	85	> .50	0.90	1.06	< 130	0/-18	7a	-A		
		120	B432I120RH-A	•	•	•	0.74	87	> .95	0.91	1.05	< 20	0/-18	7a	-A		
		277	B432I277RH-A	•	•	•	0.32	84	> .95	0.91	1.08	< 20	0/-18	7a	-A		
		347	B432I347RH		•		0.26	90	> .95	0.90	1.00	< 20	0/-18	7a	ST		
		347	B432I347HPL		•		0.24	83	> .98	0.78	0.94	< 10	0/-18	7	ST		
		120	B432IUNVHP-A	•	•	•	0.74	87	> .99	0.89	1.02	< 10	0/-18	7a	-A		
		277	B432IUNVHP-A		•		0.32	85	> .95	0.89	1.05	< 10	0/-18	7a	-A		
		347	B432I347HP		•		0.26	90	> .98	0.90	1.00	< 10	0/-18	7a	ST		
		120	B432IUNV-D	•	•		0.73	87	> .98	0.90	1.03	< 10	0/-18	25	-D		
		277	B432IUNV-D		•		0.31	85	> .98	0.90	1.06	< 10	0/-18	25	-D		
		120	B432IUNVEL-A	•	•		0.65	78	> .98	0.78	1.00	< 10	0/-18	7a	-A		
		277	B432IUNVEL-A		•		0.28	76	> .98	0.78	1.03	< 10	0/-18	7a	-A		
		120	B432I120EL	•	•		0.60	77	> .98	0.80	1.04	< 10	0/-18	7a	ST		
		277	B432I277EL	•	•		0.28	77	> .98	0.79	1.03	< 10	0/-18	7a	ST		
		120	B432IUNVHE-A	•	•		0.72	87	> .99	0.89	1.02	< 10	0/-18	7a	-A		
		277	B432IUNVHE-A		•		0.31	85	> .98	0.89	1.05	< 10	0/-18	7a	-A		
		120	B432I120HE	•	•		0.71	85	> .98	0.89	1.05	< 10	0/-18	7a	ST		
		277	B432I277HE	•	•		0.32	86	> .98	0.89	1.03	< 10	0/-18	7a	ST		
		277	B432I277HEH	•	•		0.41	114	> .99	1.19	1.04	< 10	0/-18	7a	ST		
		120	ES1720B	•	•		0.69	83	> .97	0.87	1.05	< 10	0/-18	38	ESB		
		277	ES1720B		•		0.31	83	> .97	0.87	1.05	< 10	0/-18	38	ESB		
		4	SER-PRS	120	B432PUNVHP-A	•	•	•	0.77	92	> .99	0.89	0.97	< 10	0/-18	8	-A
				277	B432PUNVHP-A		•		0.33	89	> .95	0.89	1.00	< 10	0/-18	8	-A

* For Residential Use Only

See page 2-18 for Dimensions and Wiring Diagrams

IS = Instant Start
 PRS = Programmed Rapid Start
 RS = Rapid Start

STARTING METHOD LEGEND
 PAR-IS = Parallel Instant Start
 PAR-PRS = Parallel Programmed Rapid Start
 SER-PRS = Series Programmed Rapid Start

PAR-RS = Parallel Rapid Start
 SER-RS = Series Rapid Start



Fluorescent-Electronic

Overall Dimensions		Mounting Dimensions			
Draw #	L	W	H	M	X
ST	9.50"	2.40"	1.55"	8.89"	1.69"
-A	9.50"	1.70"	1.18"	8.89"	1.69"
-B	9.50"	1.50"	1.00"	8.89"	0.88"
-C	14.25"	1.18"	1.00"	13.75"	---
-D	16.88"	1.18"	1.00"	16.20"	---
-G	9.50"	1.18"	1.00"	8.89"	---
ESA	9.50"	1.56"	1.00"	8.88"	0.78"
ESB	9.50"	2.38"	1.00"	8.88"	---

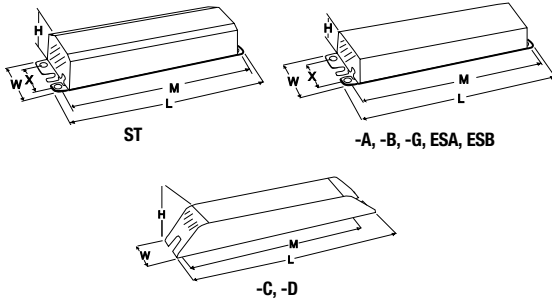

WIRING DIAGRAMS

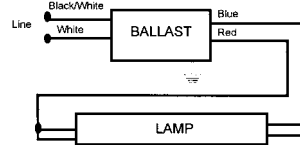

DIAGRAM 1

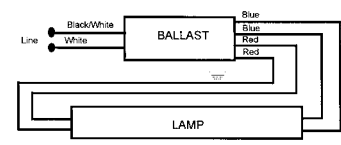

DIAGRAM 2

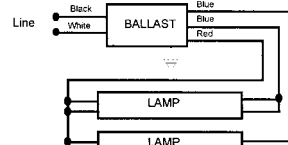
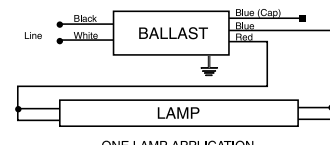

DIAGRAM 3



ONE LAMP APPLICATION
Cap unused blue lead, insulate to 600V

DIAGRAM 3a

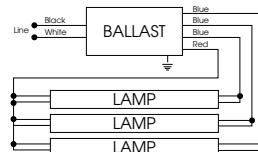
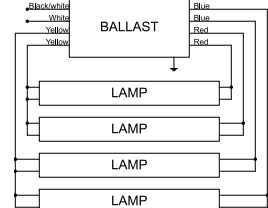
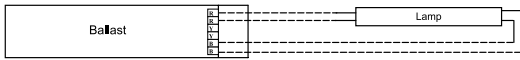

DIAGRAM 6



For three lamp operation, cap unused blue lead, insulate to 600V

DIAGRAM 7



One lamp application

DIAGRAM 37a

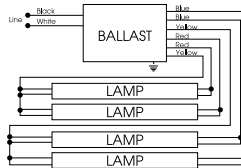

For three lamp operation, cap any blue lead, insulate to 600V

DIAGRAM 7a

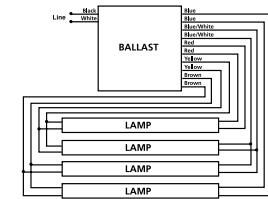

DIAGRAM 8

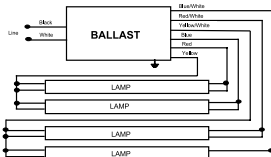
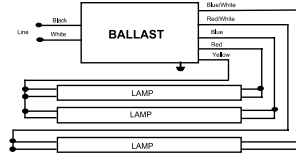
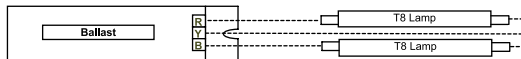

DIAGRAM 38



Note: For three lamp operation, cap Yellow/White leads, insulate to 600V

DIAGRAM 38a



Two Lamp Application

DIAGRAM 39

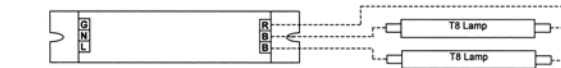

DIAGRAM 21

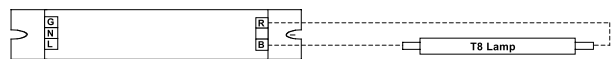
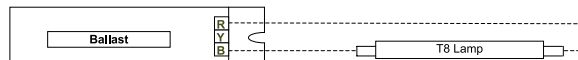

DIAGRAM 21a



One Lamp Application

DIAGRAM 39a

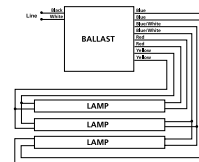
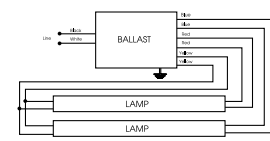

DIAGRAM 23



For One Lamp Operation, Individually cap yellow leads, insulate to 600V

DIAGRAM 30

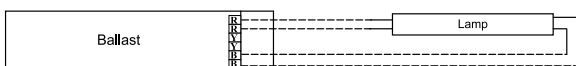

DIAGRAM 40

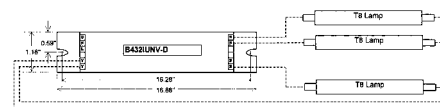
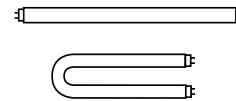

DIAGRAM 24

TRIAD® ELECTRONIC BALLASTS

FOR (1) F32T8 LAMP

- Low Profile Designs Featured
- Instant & Programmed Rapid Starting Options
- 1 Lamp Applications



F32T8

Lamp Qty.	Starting Method	Line Volts	Catalog Number	Certification			Line Current (Amps)	Input Power (Watts)	Power Factor (PF)	Ballast Factor (BF)	Ballast Efficacy Factor (BEF)	THD %	Min. F/C Start Temp	Wiring Diag.	Dim.		
				UL	SF	NOM											
F32T8 - One Lamp Applications																	
1	IS	120	B132I120RH-A	•	•	•	0.26	31	> .98	0.88	2.84	< 20	0/-18	1	-A		
		277	B132I277RH-A	•	•	•	0.11	31	> .97	0.88	2.84	< 20	0/-18	1	-A		
		347	B132I347RH	•	•	•	0.09	31	> .98	0.88	2.84	< 20	0/-18	1	ST		
		120	B132IUNVHP-B	•	•	•	0.25	30	> .95	0.88	2.93	< 10	0/-18	1	-B		
		277		0.12	29	> .95	0.88	3.03	< 10	0/-18	1	-B					
		347	B132I347HP	•	•	•	0.09	31	> .98	0.88	2.84	< 10	0/-18	1	ST		
		120	B132IUNVEL-A	•	•	•	0.22	25	> .98	0.77	3.08	< 10	0/-18	1	-A		
		277		0.11	> .95												
		120	B132IUNVHE-A	•	•	•	0.24	28	> .98	0.87	3.11	< 10	0/-18	1	-A		
		277		0.12	> .95												
		120	B232I120L-A	•	•	•	0.29	33	> .90	0.96	2.91	< 32	0/-18	3a	-A		
		277	B232I277L-A	•	•	•	0.13	33	> .90	1.00	3.03	< 32	0/-18	3a	-A		
		347	B232I347L-A	•	•	•	0.10	33	> .98	0.96	2.91	< 20	0/-18	3a	-A		
		120	B232I120RES-A*	•	•	•	0.53	35	> .50	1.06	3.03	< 135	0/-18	3a	-A		
		120	B232I120RES-G*	•	•	•	0.53	36	> .50	1.06	2.94	< 150	0/-18	3a	-G		
		120	B232I120RH-A	•	•	•	0.31	38	> .90	1.09	2.87	< 25	0/-18	3a	-A		
		277	B232I277RH-A	•	•	•	0.14	38	> .90	1.09	2.87	< 25	0/-18	3a	-A		
		347	B232I347RH-A	•	•	•	0.11	36	> .95	1.05	2.92	< 20	0/-18	3a	-A		
		347	B232I347HPL	•	•	•	0.09	32	> .98	0.91	2.84	< 10	0/-18	3a	ST		
		1	IS	120	B232IUNVHP-B	•	•	•	0.29	35	> .99	1.05	3.00	< 10	0/-18	3a	-B
				277		0.13	> .98										
				347	B232I347HP-A	•	•	•	0.11	36	> .95	1.05	2.92	< 10	0/-18	3a	-A
				120	B232IUNV-C	•	•	•	0.29	35	> .98	1.02	3.19	< 10	0/-18	22	-C
				277		0.13											
				120	B232IUNVEL-A	•	•	•	0.24	30	> .95	0.95	3.17	< 10	0/-18	3a	-A
				277		0.11											
				120	B232I120EL	•	•	•	0.24	29	> .98	0.90	3.10	< 10	0/-18	3a	ST
				277	B232I277EL	•	•	•	0.11	30	> .98	0.92	3.07	< 10	0/-18	3a	ST
				120	B232IUNVHE-A	•	•	•	0.28	33	> .95	1.05	3.18	< 10	0/-18	3a	-A
				277		0.13											
				120	B232IUNVHEH-A ¹	•	•	•	0.39	47	> .95	1.38	2.94	< 10	0/-18	3a	-A
				277		0.18	46	> .95	1.38	3.00	< 10	0/-18	3a	-A			
				120	B232I120HE	•	•	•	0.27	33	> .98	1.00	3.03	< 10	0/-18	3a	ST
				277	B232I277HE	•	•	•	0.13	34	> .98	1.03	3.03	< 10	0/-18	3a	ST
120	ES1608A			•	•	•	0.25	30	> .97	0.87	2.90	< 10	0/-18	39a	ESA		
277				0.11	31	> .97	0.87	2.81	< 10	0/-18	39a	ESA					
120	B232PUNVHE-A			•	•	•	0.24	29	> .90	0.88	3.03	< 10	0/-18	30	-A		
277				0.11													
120	B232PUNVEL-A			•	•	•	0.20	25	> .90	0.88	2.89	< 10	0/-18	30	-A		
277		0.09	23	> .90	0.88	3.09	< 10	0/-18	30	-A							
1	PRS	120	B132PUNVHP-A	•	•	•	0.26	31	> .99	0.88	2.84	< 10	0/-18	2	-A		
		277		0.11	30	> .98	0.88	2.93	< 10	0/-18	2	-A					
		347	ES1510A	•	•	•	0.09	31	> .97	0.87	2.81	< 10	0/-18	40	ESA		
		120	ES4800A	•	•	•	0.26	31	> .97	1.00	3.23	< 10	0/-18	37	ESA		
		277		0.12	32	> .97	1.00	3.13	< 10	0/-18	37	ESA					
		120	B232PUNVHP-A	•	•	•	0.27	32	> .99	1.00	3.13	< 10	0/-18	30	-A		
277	0.12	> .95					< 15										

* For Residential Use Only

¹ Consult Lamp Manufacturers for applications with Ballast Factor > 1.20

STARTING METHOD LEGEND

IS = Instant Start
 PRS = Programmed Rapid Start
 RS = Rapid Start

PAR-IS = Parallel Instant Start
 PAR-PRS = Parallel Programmed Rapid Start

PAR-RS = Parallel Rapid Start
 SER-RS = Series Rapid Start

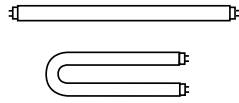

- Low Profile Designs Featured
- Instant & Programmed Rapid Starting Options
- 2 Lamp Applications

TRIAD® ELECTRONIC BALLASTS FOR (2) F32T8 LAMPS

Lamp Qty.	Starting Method	Line Volts	Catalog Number	Certification			Line Current (Amps)	Input Power (Watts)	Power Factor (PF)	Ballast Factor (BF)	Ballast Efficacy Factor (BEF)	THD %	Min. F/C Start Temp	Wiring Diag.	Dim.		
				UL	SP	NOM											
F32T8 - Two Lamp Applications																	
2	PAR-IS	120	B232I120L-A	•	•		0.44	51	> .95	0.78	1.53	< 20	0/-18	3	-A		
		277	B232I277L-A	•	•		0.19	51	> .95	0.78	1.53	< 20	0/-18	3	-A		
		347	B232I347L-A	•	•		0.15	51	> .98	0.78	1.53	< 20	0/-18	3	-A		
		120	B232I120RES-A*	•	•	•	0.80	56	> .50	0.88	1.57	< 120	0/-18	3	-A		
		120	B232I120RES-G*	•	•	•	0.80	56	> .50	0.88	1.57	< 130	0/-18	3	-G		
		120	B232I120RH-A	•	•	•	0.49	58	> .98	0.88	1.52	< 20	0/-18	3	-A		
		277	B232I277RH-A	•	•	•	0.22	58	> .98	0.88	1.52	< 20	0/-18	3	-A		
		347	B232I347RH-A	•	•	•	0.17	58	> .99	0.88	1.52	< 20	0/-18	3	-A		
		120	B232I120RHH-A	•	•	•	0.66	77	> .98	1.18	1.53	< 20	0/-18	3	-A		
		277	B232I277RHH-A	•	•	•	0.29	77	> .98	1.18	1.53	< 20	0/-18	3	-A		
		347	B232I347HPL	•	•	•	0.14	50	> .99	0.78	1.56	< 10	0/-18	3	ST		
		120	B232IUNVHP-B	•	•	•	0.47	56	> .99	0.88	1.57	< 10	0/-18	3	-B		
		277	B232I277HP-A	•	•	•	0.19	55	> .99	0.88	1.60	< 10	0/-18	3	-A		
		347	B232I347HP-A	•	•	•	0.17	58	> .99	0.88	1.52	< 10	0/-18	3	-A		
		120	B232IUNV-C	•	•	•	0.48	58	> .98	0.88	1.52	< 10	0/-18	21	-C		
		277	B232I277C	•	•	•	0.20	56	> .98	0.88	1.57	< 10	0/-18	21	-C		
		120	B232IUNVEL-A	•	•	•	0.40	48	> .95	0.77	1.60	< 10	0/-18	3	-A		
		277	B232I277EL	•	•	•	0.17	47	> .98	0.77	1.64	< 10	0/-18	3	ST		
		120	B232I120EL	•	•	•	0.40	47	> .98	0.77	1.64	< 10	0/-18	3	ST		
		277	B232I277EL	•	•	•	0.18	47	> .98	0.77	1.64	< 10	0/-18	3	ST		
		120	B232IUNVHE-A	•	•	•	0.45	55	> .95	0.87	1.58	< 10	0/-18	3	-A		
		277	B232I277HE	•	•	•	0.20	54	> .95	0.87	1.61	< 10	0/-18	3	-A		
		120	B232IUNVHEH-A	•	•	•	0.62	74	> .95	1.18	1.59	< 10	0/-18	3	-A		
		277	B232I277HE	•	•	•	0.26	73	> .95	1.18	1.62	< 10	0/-18	3	-A		
		120	B232I120HE	•	•	•	0.45	54	> .98	0.87	1.61	< 10	0/-18	3	ST		
		277	B232I277HE	•	•	•	0.20	53	> .98	0.87	1.64	< 10	0/-18	3	ST		
		347	B332IHRVHB-E	•	•	•	0.22	76	> .97	1.22	1.61	< 10	0/-18	46	-E		
		480	B332I480E	•	•	•	0.17	76	> .90	1.22	1.61	< 10	0/-18	46	-E		
2	SER-IS	120	ES1608A	•	•		0.48	57	> .97	0.87	1.53	< 10	0/-18	39	ESA		
		277	B332I277L-A	•	•		0.21	56	> .98	0.92	1.55	< 25	0/-18	6	-A		
		120	B332I120L-A	•	•		0.51	58	> .95	0.92	1.59	< 25	0/-18	6	-A		
		277	B332I277L-A	•	•		0.21	61	> .98	0.92	1.51	< 20	0/-18	6	-A		
		347	B332I347L	•	•		0.16	56	> .99	0.87	1.55	< 20	0/-18	6	ST		
		120	B332I120RH-A	•	•	•	0.59	69	> .95	1.03	1.49	< 25	0/-18	6	-A		
		277	B332I277RH-A	•	•	•	0.26	69	> .95	1.04	1.51	< 25	0/-18	6	-A		
		347	B332I347RH	•	•	•	0.19	65	> .95	0.99	1.52	< 20	0/-18	6	ST		
		347	B332I347HPL	•	•	•	0.16	56	> .99	0.87	1.55	< 10	0/-18	6	ST		
		120	B332IUNVHP-A	•	•	•	0.53	63	> .99	0.99	1.57	< 10	0/-18	6	-A		
		277	B332I277HP	•	•	•	0.24	63	> .95	0.99	1.57	< 10	0/-18	6	-A		
		347	B332I347HP	•	•	•	0.19	66	> .99	0.99	1.50	< 10	0/-18	6	ST		
		120	B332IUNVEL-A	•	•	•	0.48	57	> .99	0.89	1.56	< 10	0/-18	6	-A		
		277	B332I277EL	•	•	•	0.21	56	> .97	0.89	1.59	< 10	0/-18	6	-A		
		120	B332I120EL	•	•	•	0.45	53	> .98	0.86	1.62	< 10	0/-18	6	ST		
		277	B332I277EL	•	•	•	0.20	55	> .98	0.87	1.58	< 10	0/-18	6	ST		
		120	B332IUNVHE-A	•	•	•	0.53	64	> .99	0.99	1.55	< 10	0/-18	6	-A		
		277	B332I277HE	•	•	•	0.23	63	> .98	0.99	1.57	< 10	0/-18	6	-A		
		120	B332I120HE	•	•	•	0.50	60	> .98	0.96	1.60	< 10	0/-18	6	ST		
		277	B332I277HE	•	•	•	0.23	61	> .98	1.01	1.66	< 10	0/-18	6	ST		
		120	B332IUNVHEH-A ¹	•	•	•	0.69	83	> .95	1.27	1.53	< 10	0/-18	6	-A		
		277	B332I277HE	•	•	•	0.30	81	> .95	1.27	1.57	< 10	0/-18	6	-A		
		120	B232PUNVEL-A	•	•	•	0.40	47	> .90	0.71	1.51	< 10	0/-18	30	-A		
		277	B232PUNVHP-A	•	•	•	0.17	46	> .90	0.71	1.54	< 10	0/-18	30	-A		
		2	SER-PRS	120	B232PUNVHE-A	•	•	•	0.47	56	> .90	0.88	1.57	< 10	0/-18	30	-A
				277	B232PUNVHE-A	•	•	•	0.20	55	> .90	0.88	1.60	< 10	0/-18	30	-A
				120	B232PUNVHP-A	•	•	•	0.52	62	> .99	0.88	1.42	< 10	0/-18	30	-A
				277	B232PUNVHP-A	•	•	•	0.22	60	> .98	0.88	1.47	< 10	0/-18	30	-A

* For Residential Use Only

¹ Consult lamp manufacturers

See page 2-23 for Dimensions and Wiring Diagrams

TRIAD® ELECTRONIC BALLASTS

FOR (3) F32T8 LAMPS

- Low Profile Designs Featured
- Instant & Programmed Rapid Starting Options
- 3 Lamp Applications

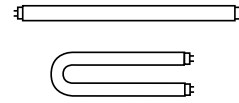

F32T8

Lamp		Line Volts	Catalog Number	Certification			Line Current (Amps)	Input Power (Watts)	Power Factor (PF)	Ballast Factor (BF)	Ballast Efficacy Factor (BEF)	THD %	Min. F/C Start Temp	Wiring Diag.	Dim.
Qty.	Starting Method			UL	SE	NOM									
		120	ES4800A	•	•		0.49	58	>.97	0.87	1.50	< 10	0/-18	37	ESA
		277					0.22	60			1.45				
		347	ES1329A	•	•		0.17	59	>.97	0.87	1.47	<10	0/-18	37	ESA
		120	B332PUNVHP-A	•	•	•	0.54	64	>.99	0.99	1.55	< 10	0/-18	23	-A
		277					0.24	63	>.90		1.57				
F32T8 - Three Lamp Applications															
		120	B332I120L-A	•	•		0.65	76	>.98	0.78	1.03	< 20	0/-18	6	-A
		277	B332I277L-A	•	•		0.28	76	>.98	0.78	1.03	< 20	0/-18	6	-A
		347	B332I347L		•		0.21	75	>.99	0.79	1.05	< 20	0/-18	6	ST
		120	B332I120RH-A	•	•	•	0.75	86	>.98	0.88	1.02	< 20	0/-18	6	-A
		277	B332I277RH-A	•	•	•	0.33	86	>.98	0.88	1.02	< 20	0/-18	6	-A
		347	B332I347RH		•		0.25	85	>.98	0.88	1.04	< 20	0/-18	6	ST
		120	B332I120RHH	•	•		0.98	113	>.98	1.18	1.04	< 20	0/-18	6	ST
		277	B332I277RHH	•	•		0.43	113	>.98	1.18	1.04	< 20	0/-18	6	ST
		347	B332I347HPL		•		0.21	75	>.99	0.79	1.05	< 10	0/-18	6	ST
3	PAR-IS	120	B332IUNVHP-A	•	•	•	0.71	85	>.99	0.88	1.02	< 10	0/-18	6	-A
		277					0.31	83	>.98		1.05				
		347	B332I347HP		•		0.25	88	>.99	0.88	1.00	< 10	0/-18	6	ST
		120	B332IUNVEL-A	•	•		0.61	74	>.99		1.05	< 10	0/-18	6	-A
		277					0.26	73	>.98	0.77	1.07				
		120	B332I120EL	•	•		0.59	70	>.98	0.77	1.10	< 10	0/-18	6	ST
		277	B332I277EL	•	•		0.26	70	>.99	0.77	1.10	< 10	0/-18	6	ST
		120	B332IUNVHE-A	•	•		0.70	83	>.99		1.04	< 10	0/-18	6	-A
		277					0.30	81	>.98		1.05				
		120	B332I120HE	•	•		0.67	80	>.98	0.87	1.09	< 10	0/-18	6	ST
		277	B332I277HE	•	•		0.30	79	>.99	0.87	1.10	< 10	0/-18	6	ST
		120	B332IUNVHEH-A	•	•		0.91	111	>.98	1.18	1.06	< 10	0/-18	6	-A
		277					0.39	108			1.09				
3	SER-IS	347	B332IHRVHB-E	•	•		0.32	110	>.98		1.07	< 10	0/-18	46	-E
		480					0.24	109	>.95	1.18	1.08				
3	SER-RS	120	B332PUNVHP-A	•	•	•	0.77	92	>.99		0.96	< 10	0/-18	23	-A
		277					0.34	90	>.95	0.88	0.98				
		120	B432I120L-A	•	•		0.71	83	>.97	0.83	1.00	< 20	0/-18	7a	-A
		277	B432I277L-A	•	•		0.31	83	>.97	0.84	1.01	< 20	0/-18	7a	-A
		347	B432I347L		•		0.24	83	>.98	0.87	1.05	< 20	0/-18	7	ST
		120	B432I120RES-A*	•	•	•	1.20	92	>.50	0.96	1.04	< 130	0/-18	7a	-A
		120	B432I120RH-A	•	•	•	0.78	92	>.95	0.94	1.02	< 20	0/-18	7a	-A
		277	B432I277RH-A	•	•	•	0.33	92	>.95	0.99	1.08	< 20	0/-18	7a	-A
		347	B432I347RH		•		0.28	95	>.95	0.99	1.04	< 20	0/-18	7a	ST
		347	B432I347HPL		•		0.24	83	>.98	0.87	1.05	< 10	0/-18	7	ST
3	PAR-IS	120	B432IUNVHP-A	•	•	•	0.77	92	>.99		1.02	< 10	0/-18	7a	-A
		277					0.34	89	>.95	0.94	1.06				
		347	B432I347HP		•		0.28	92	>.98	0.99	1.08	< 10	0/-18	7a	S
		120	B432IUNV-D	•	•		0.77	92	>.98		1.02	< 10	0/-18	24	-D
		277					0.33	91		0.96	1.05				
		120	B432IUNVEL-A	•	•		0.67	80	>.99		1.08	< 10	0/-18	7a	-A
		277					0.29	78	>.98	0.86	1.10				
		120	B432I120EL	•	•		0.67	79	>.98	0.84	1.06	< 10	0/-18	7	ST
		277	B432I277EL	•	•		0.28	76	>.98	0.87	1.14	< 10	0/-18	7	ST
		120	B432IUNVHE-A	•	•		0.74	89	>.99		1.06	< 10	0/-18	7a	-A
		277					0.32	87	>.98		1.08				
		120	B432I120HE	•	•		0.74	88	>.98	0.96	1.09	< 10	0/-18	7	ST
		277	B432I277HE	•	•		0.33	89	>.98	0.96	1.08	< 10	0/-18	7	ST
		277	B432I277HEH ¹	•	•		0.43	119	>.99	1.28	1.08	< 10	0/-18	7	ST
		120	ES1720B	•	•		0.68	80	>.97		1.09	< 10	0/-18	38a	ESB
		277					0.31	82			1.06				
3	SER-PRS	120	B432PUNVHP-A	•	•	•	0.77	92	>.99		1.01	< 10	0/-18	8	-A
		277					0.34	90	>.95	0.93	1.03				

* For Residential Use Only

¹ Consult lamp manufacturers for applications with Ballast Factor > 1.20

See page 2-23 for Dimensions and Wiring Diagrams

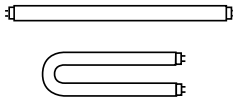

- Low Profile Designs Featured
- Instant & Programmed Rapid Starting Options
- 4 Lamp Applications

TRIAD® ELECTRONIC BALLASTS FOR (4) F32T8 LAMPS

Lamp Qty.	Starting Method	Line Volts	Catalog Number	Certification			Line Current (Amps)	Input Power (Watts)	Power Factor (PF)	Ballast Factor (BF)	Ballast Efficacy Factor (BEF)	THD %	Min. F/C Start Temp	Wiring Diag.	Dim.	
				UL	SP	NOM										
F32T8 - Four Lamp Applications																
4	PAR-IS	120	B432I120L-A	•	•		0.85	100	> .98	0.78	0.78	< 20	0/-18	7a	-A	
		277	B432I277L-A	•	•		0.36	98	> .98	0.78	0.80	< 20	0/-18	7a	-A	
		347	B432I347L				0.29	101	> .99	0.78	0.77	< 20	0/-18	7	ST	
		120	B432I120RES-A*	•	•	•	1.40	109	> .50	0.87	0.80	< 130	0/-18	7a	-A	
		120	B432I120RH-A	•	•	•	0.93	112	> .99	0.88	0.79	< 20	0/-18	7a	-A	
		277	B432I277RH-A	•	•	•	0.40	110	> .98	0.88	0.80	< 20	0/-18	7a	-A	
		347	B432I347RH			•	0.33	114	> .98	0.88	0.77	< 20	0/-18	7a	ST	
		347	B432I347HPL			•	0.29	101	> .99	0.78	0.77	< 10	0/-18	7	ST	
		120	B432IUNVHP-A		•	•	•	0.93	112	> .99	0.88	0.79	< 10	0/-18	7a	-A
		277					0.40	108	> .98	0.88	0.80	< 10	0/-18	7a	-A	
		347	B432I347HP			•	0.33	114	> .99	0.88	0.77	< 10	0/-18	7a	ST	
		120	B432IUNV-D		•	•		0.93	111	> .98	0.88	0.77	< 10	0/-18	25	-D
		277					0.40	109	> .98	0.88	0.80	< 10	0/-18	25	-D	
		120	B432IUNVEL-A		•	•		0.80	97	> .99	0.77	0.79	< 10	0/-18	7a	-A
		277					0.34	96	> .98	0.77	0.80	< 10	0/-18	7a	-A	
		120	B432I120EL	•	•		0.81	95	> .99	0.77	0.81	< 10	0/-18	7a	ST	
		277	B432I277EL	•	•		0.35	93	> .99	0.77	0.83	< 10	0/-18	7a	ST	
		120	B432IUNVHE-A		•	•		0.91	109	> .99	0.87	0.80	< 10	0/-18	7a	-A
		277					0.38	106	> .99	0.87	0.82	< 10	0/-18	7a	-A	
		120	B432I120HE	•	•		0.90	106	> .99	0.87	0.82	< 10	0/-18	7a	ST	
277	B432I277HE	•	•		0.39	105	> .99	0.87	0.83	< 10	0/-18	7a	ST			
277	B432I277HEH	•	•		0.53	145	> .99	1.18	0.81	< 10	0/-18	7a	ST			
120	ES1720B		•	•		0.88	107	> .97	0.87	0.81	< 10	0/-18	38	ESB		
277					0.40	108	> .97	0.87	0.82	< 10	0/-18	38	ESB			
120	SER-PRS		•	•	•	1.00	119	> .99	0.88	0.74	< 10	0/-18	8	-A		
277		B432PUNVHP-A				0.42	115	> .98	0.88	0.77	< 10	0/-18	8	-A		

* For Residential Use Only

See page 2-23 for Dimensions and Wiring Diagrams

STARTING METHOD LEGEND

IS = Instant Start
PRS = Programmed Rapid Start
RS = Rapid Start

PAR-IS = Parallel Instant Start
PAR-PRS = Parallel Programmed Rapid Start
SER-PRS = Series Programmed Rapid Start

PAR-RS = Parallel Rapid Start
SER-RS = Series Rapid Start

TRIAD® ELECTRONIC BALLASTS

FOR F32T8 LAMPS

F32T8

Draw #	Overall Dimensions			Mounting Dimensions	
	L	W	H	M	X
ST	9.50"	2.40"	1.55"	8.89"	1.69"
-A	9.50"	1.70"	1.18"	8.89"	1.69"
-B	9.50"	1.50"	1.00"	8.89"	0.88"
-C	14.25"	1.18"	1.00"	13.75"	---
-D	16.88"	1.18"	1.00"	16.20"	---
-E	16.88"	1.74"	1.18"	16.28"	---
-G	9.50"	1.18"	1.00"	8.89"	---
ESA	9.50"	1.56"	1.00"	8.88"	0.78"
ESB	9.50"	2.38"	1.00"	8.88"	---

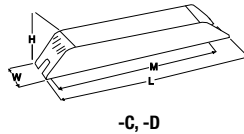
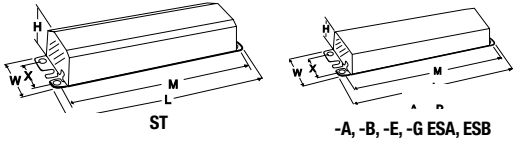

WIRING DIAGRAMS

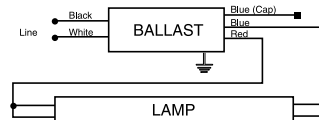
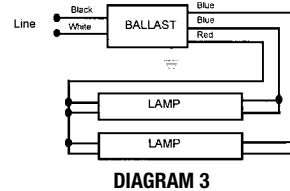
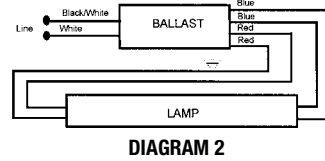
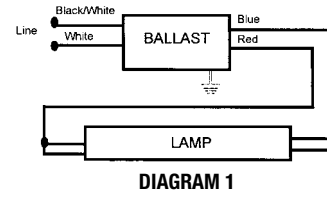

ONE LAMP APPLICATION
Cap unused blue lead, insulate to 600 volts

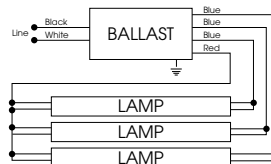

For Two Lamp operation,
Insulate one blue lead to 600V

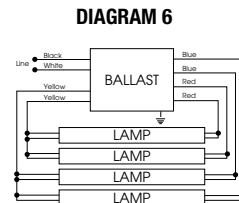

For Three Lamp Operation,
Insulate one blue lead to 600V

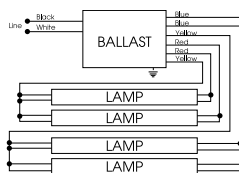

For three lamp operation, cap any
blue lead, insulate to 600V

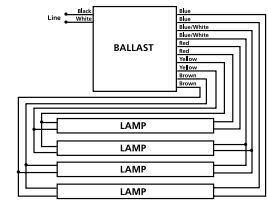

For Three Lamp Application, Individually
cap brown leads, Insulate to 600V

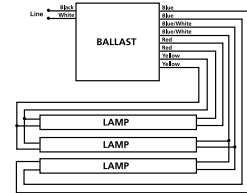

For Two Lamp operation, individually
cap yellow leads, Insulate to 600V

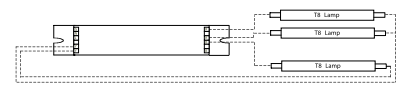

DIAGRAM 24

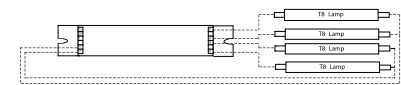
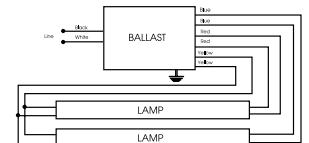

DIAGRAM 25



For One Lamp Operation, Individually cap
yellow leads, Insulate to 600V

DIAGRAM 30

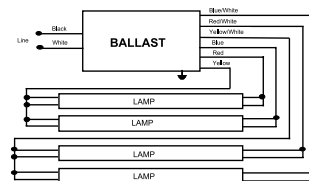

DIAGRAM 38

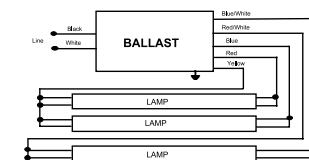

DIAGRAM 38a

Note: For three lamp operation, cap Yellow/White leads, insulate to 600 volts

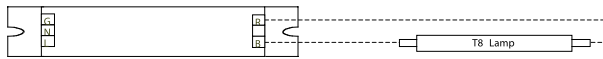
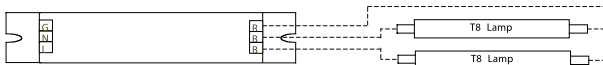
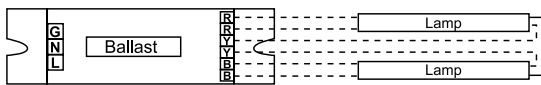
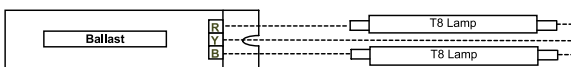

DIAGRAM 22



FOR ONE LAMP OPERATION, CAP YELLOW LEADS INDIVIDUALLY

DIAGRAM 37



Two Lamp Application

DIAGRAM 39

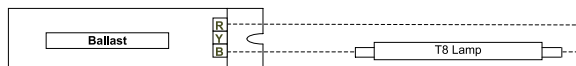

One Lamp Application

DIAGRAM 39a

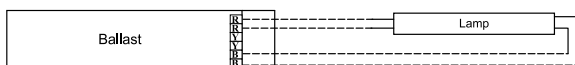
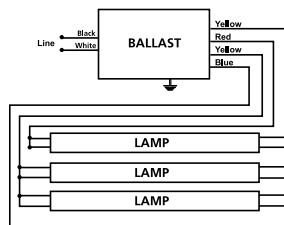

DIAGRAM 40



For two lamp application, cap one yellow lead,
insulate to 600 volts

DIAGRAM 46

F32T8ES 30 WATT

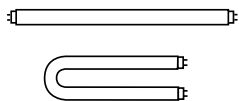

- High Performance Models and Low Profile Designs
- Instant and Programmed Rapid Starting Options
- 1-2 Lamp Applications

TRIAD® ELECTRONIC BALLASTS FOR (1) & (2) F32T8ES(30 WATT) LAMPS

Lamp		Line Volts	Catalog Number	Certification			Line Current (Amps)	Input Power (Watts)	Power Factor (PF)	Ballast Factor (BF)	Ballast Efficacy Factor (BEF)	THD %	Min. F/C Start Temp	Wiring Diag.	Dim.
Qty.	Starting Method			UL	SP	NOM									
F32T8ES(30W) - One Lamp Applications															
1	IS	277	B132I277RH-A	•	•		0.11	29	> .97	0.94	3.24	< 15	60/16	1	-A
		120	B132IUNVHP-B	•	•		0.25	29	> .95	0.88	3.03	< 10	60/16	1	-B
		277	B132IUNVEL-A	•	•		0.22	25	> .98	0.77	3.08	< 10	60/16	1	-A
		120	B132IUNVHE-A	•	•		0.11	25	> .95	0.87	3.11	< 10	60/16	1	-A
1	PRS	277	B132IUNVHE-A	•	•		0.24	28	> .98	0.87	3.11	< 10	60/16	1	-A
		120	B132PUNVHP-A	•	•	•	0.23	28	> .99	0.88	3.14	< 10	60/16	2	-A
		277	B132PUNVHP-A	•	•	•	0.10	28	> .98	0.88	3.14	< 10	60/16	2	-A
		277	B232I277L-A	•	•		0.12	33	> .90	0.98	2.97	< 32	60/16	3a	-A
1	PAR-IS	347	B232I347L-A	•	•		0.15	51	> .98	0.78	1.53	< 20	60/16	3a	-A
		120	B232I120RH-A	•	•	•	0.32	35	> .90	1.10	3.14	< 32	60/16	3a	-A
		277	B232I277RH-A	•	•	•	0.15	38	> .90	1.10	2.89	< 25	60/16	3a	-A
		347	B232I347RH-A	•	•		0.15	54	> .98	0.88	1.63	< 20	60/16	3a	-A
		120	B232IUNVHP-B	•	•	•	0.28	33	> .99	1.05	3.18	< 10	60/16	3a	-B
		277	B232IUNVHP-B	•	•	•	0.12	33	> .98	1.05	3.18	< 10	60/16	3a	-B
		347	B232I347HP-A	•	•		0.15	53	> .98	0.88	1.66	< 10	60/16	3a	-A
		120	B232IUNVEL-A	•	•		0.23	28	> .95	0.92	3.92	< 10	60/16	3a	-A
		277	B232IUNVEL-A	•	•		0.11	28	> .98	0.89	3.18	< 10	60/16	3	ST
		120	B232I120EL	•	•		0.24	28	> .98	0.89	3.18	< 10	60/16	3	ST
		277	B232I277EL	•	•		0.11	28	> .98	0.92	3.29	< 10	60/16	3	ST
		1	PRS	120	B232IUNVHE-A	•	•		0.25	32	> .95	1.05	3.28	< 10	60/16
277	B232IUNVHE-A			•	•		0.12	32	> .95	1.05	3.28	< 10	60/16	3a	-A
120	B232IUNVHEH-A ¹			•	•		0.37	43	> .95	1.38	3.21	< 10	60/16	3a	-A
277	B232IUNVHEH-A ¹			•	•		0.16	43	> .95	1.38	3.21	< 10	60/16	3a	-A
120	B232I120HE			•	•		0.26	30	> .98	1.00	3.33	< 10	60/16	3	ST
277	B232I277HE			•	•		0.12	32	> .98	1.03	3.22	< 10	60/16	3	ST
120	B232PUNVEL-A			•	•		0.19	22	> .90	0.72	3.27	< 10	60/16	30	-A
277	B232PUNVEL-A			•	•		0.09	23	> .90	0.72	3.12	< 10	60/16	30	-A
120	B232PUNVHE-A			•	•		0.22	27	> .90	0.88	3.26	< 10	60/16	30	-A
277	B232PUNVHE-A			•	•		0.10	26	> .90	0.88	3.38	< 10	60/16	30	-A
120	B232PUNVHP-A			•	•	•	0.25	30	> .99	1.00	3.33	< 10	60/16	30	-A
277	B232PUNVHP-A			•	•	•	0.11	30	> .95	1.00	3.33	< 10	60/16	30	-A
F32T8ES(30W) - Two Lamp Applications															
2	PAR-IS	120	B232IUNVEL-A	•	•		0.38	46	> .95	0.77	1.67	< 10	60/16	3	-A
		277	B232IUNVEL-A	•	•		0.17	46	> .95	0.77	1.67	< 10	60/16	3	-A
		120	B232I120EL	•	•		0.38	44	> .98	0.77	1.75	< 10	60/16	3	ST
		277	B232I277EL	•	•		0.17	44	> .98	0.77	1.75	< 10	60/16	3	ST
		120	B232IUNVHE-A	•	•		0.42	52	> .95	0.87	1.67	< 10	60/16	3	-A
		277	B232IUNVHE-A	•	•		0.19	51	> .95	0.87	1.71	< 10	60/16	3	-A
		120	B232IUNVHEH-A	•	•		0.59	70	> .95	1.18	1.69	< 10	60/16	3	-A
		277	B232IUNVHEH-A	•	•		0.25	68	> .95	1.18	1.74	< 10	60/16	3	-A
		120	B232I120HE	•	•		0.43	51	> .98	0.87	1.71	< 10	60/16	3	ST
		277	B232I277HE	•	•		0.19	50	> .98	0.87	1.74	< 10	60/16	3	ST
		277	B232I277L-A	•	•		0.18	49	> .95	0.77	1.57	< 20	60/16	3	-A
		2	PAR-IS	347	B232I347L-A	•	•		0.14	48	> .98	0.96	3.10	< 20	60/16
120	B232I120RH-A			•	•	•	0.47	55	> .98	0.89	1.62	< 20	60/16	3	-A
277	B232I277RH-A			•	•	•	0.21	58	> .98	0.89	1.53	< 20	60/16	3	-A
347	B232I347RH-A			•	•		0.10	34	> .98	1.04	3.06	< 20	60/16	3	-A
120	B232I120RHH-A			•	•		0.63	73	> .98	1.18	1.62	< 20	60/16	3	-A
277	B232I277RHH-A			•	•		0.26	73	> .98	1.18	1.62	< 20	60/16	3	-A
120	B232IUNVHP-B			•	•	•	0.44	53	> .99	0.88	1.66	< 10	60/16	3	-B
277	B232IUNVHP-B			•	•	•	0.19	52	> .98	0.88	1.69	< 10	60/16	3	-B
347	B232I347HP-A			•	•		0.10	34	> .98	1.04	3.06	< 10	60/16	3	-A
120	B232PUNVEL-A			•	•		0.37	45	> .90	0.71	1.59	< 10	60/16	30	-A
277	B232PUNVEL-A			•	•		0.16	44	> .90	0.71	1.61	< 10	60/16	30	-A
2	SER-PRS			120	B232PUNVHE-A	•	•		0.43	50	> .90	0.87	1.74	< 10	60/16
		277	B232PUNVHE-A	•	•		0.18	49	> .90	0.87	1.78	< 10	60/16	30	-A
		120	B232PUNVHP-A	•	•	•	0.50	60	> .99	0.88	1.47	< 10	60/16	30	-A
		277	B232PUNVHP-A	•	•	•	0.21	58	> .98	0.88	1.52	< 10	60/16	30	-A
2	PAR-IS	120	B332I120RH-A	•	•	•	0.54	63	> .96	1.01	1.60	< 25	60/16	6	-A
		277	B332I277RH-A	•	•	•	0.23	63	> .97	1.00	1.59	< 25	60/16	6	-A
		120	B332IUNVHP-A	•	•	•	0.50	59	> .99	0.99	1.68	< 10	60/16	6	-A
		277	B332IUNVHP-A	•	•	•	0.22	59	> .95	0.99	1.68	< 10	60/16	6	-A
		120	B332IUNVEL-A	•	•		0.46	54	> .99	0.89	1.65	< 10	60/16	6	-A
		277	B332IUNVEL-A	•	•		0.20	53	> .98	0.89	1.68	< 10	60/16	6	-A
		120	B332I120EL	•	•		0.42	51	> .98	0.86	1.69	< 10	60/16	6	ST
		277	B332I277EL	•	•		0.19	50	> .98	0.86	1.72	< 10	60/16	6	ST
2	PAR-IS	120	B332IUNVHE-A	•	•		0.49	59	> .99	0.99	1.68	< 10	60/16	6	-A
		277	B332IUNVHE-A	•	•		0.21	57	> .97	0.99	1.74	< 10	60/16	6	-A

¹ Consult lamp manufacturers

See page 2-30 for Dimensions and Wiring Diagrams

TRIAD® ELECTRONIC BALLASTS

FOR (2)(cont.), (3) & (4) F32T8ES LAMPS

- High Performance Models and Low Profile Designs
- Instant and Programmed Rapid Starting Options
- 3-4 Lamp Applications

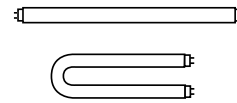

F32T8ES

30 WATT

Lamp		Line Volts	Catalog Number	Certification			Line Current (Amps)	Input Power (Watts)	Power Factor (PF)	Ballast Factor (BF)	Ballast Efficacy Factor (BEF)	THD %	Min. F/C Start Temp	Wiring Diag.	Dim.		
Qty.	Starting Method			UL	SP	NOM											
F32T8ES(30W) - Two Lamp Applications																	
2	PAR-IS	120	B332I120HE	•	•		0.47	57	> .98	0.96	1.68	< 10	60/16	6	ST		
		277	B332I277HE	•	•		0.21	58	> .98	0.99	1.71	< 10	60/16	6	ST		
2	SER-IS	120	B332IUNVHEH-A	•	•		0.65	78	> .95	1.28	1.64	< 10	60/16	6	-A		
		277	B332IUNVHEH-A	•	•		0.28	76	> .95	1.28	1.68	< 10	60/16	6	-A		
2	SER-PRS	120	B332IHRVHB-E	•	•		0.21	71	> .97	1.22	1.72	< 10	60/16	46	-E		
		277	B332IHRVHB-E	•	•		0.16	71	> .90	1.22	1.72	< 10	60/16	46	-E		
2	SER-PRS	120	B332PUNVHP-A	•	•	•	0.51	61	> .99	0.99	1.62	< 10	60/16	23	-A		
		277	B332PUNVHP-A	•	•	•	0.23	60	> .90	0.99	1.65	< 10	60/16	23	-A		
F32T8ES(30W) - Three Lamp Applications																	
3	PAR-IS	120	B332I120RH-A	•	•	•	0.69	81	> .98	0.88	1.09	< 20	60/16	6	-A		
		277	B332I277RH-A	•	•	•	0.30	81	> .98	0.88	1.09	< 20	60/16	6	-A		
		120	B332IUNVHP-A	•	•	•	0.66	79	> .99	0.89	1.13	< 10	60/16	6	-A		
		277	B332IUNVHP-A	•	•	•	0.29	77	> .95	0.89	1.16	< 10	60/16	6	-A		
		120	B332IUNVEL-A	•	•		0.58	70	> .99	0.77	1.10	< 10	60/16	6	-A		
		277	B332IUNVEL-A	•	•		0.25	69	> .98	0.77	1.12	< 10	60/16	6	-A		
	3	SER-IS	120	B332I120EL	•	•		0.56	66	> .98	0.77	1.17	< 10	60/16	6	ST	
			277	B332I277EL	•	•		0.24	65	> .99	0.77	1.18	< 10	60/16	6	ST	
			120	B332IUNVHE-A	•	•		0.65	79	> .99	0.87	1.10	< 10	60/16	6	-A	
			277	B332IUNVHE-A	•	•		0.28	77	> .98	0.87	1.13	< 10	60/16	6	-A	
			120	B332I120HE	•	•		0.63	76	> .98	0.87	1.14	< 10	60/16	6	ST	
			277	B332I277HE	•	•		0.28	75	> .99	0.87	1.16	< 10	60/16	6	ST	
3	SER-PRS	120	B332IUNVHEH-A	•	•		0.86	104	> .95	1.18	1.13	< 10	60/16	6	-A		
		277	B332IUNVHEH-A	•	•		0.37	101	> .95	1.18	1.17	< 10	60/16	6	-A		
		347	B332IHRVHB-E	•	•		0.30	102	> .98	1.18	1.16	< 10	60/16	46	-E		
		480	B332IHRVHB-E	•	•		0.22	101	> .95	1.18	1.17	< 10	60/16	46	-E		
		120	B332PUNVHP-A	•	•	•	0.73	87	> .99	0.88	1.01	< 10	60/16	23	-A		
		277	B332PUNVHP-A	•	•	•	0.32	85	> .95	0.88	1.04	< 10	60/16	23	-A		
3	PAR-IS	120	B432I120L-A	•	•		0.65	78	> .98	0.86	1.10	< 20	60/16	7a	-A		
		120	B432I120RH-A	•	•	•	0.71	85	> .99	0.88	1.04	< 10	60/16	7a	-A		
		347	B432I347HP	•	•		0.26	88	> .98	0.99	1.13	< 10	60/16	7a	ST		
		347	B432I347RH	•	•		0.26	88	> .98	0.99	1.13	< 10	60/16	7a	ST		
		120	B432IUNVHP-A	•	•	•	0.72	86	> .98	0.96	1.12	< 10	60/16	7a	-A		
		277	B432IUNVHP-A	•	•	•	0.32	84	> .95	0.96	1.14	< 10	60/16	7a	-A		
	3	SER-IS	120	B432IUNVEL-A	•	•		0.62	75	> .99	0.86	1.15	< 10	60/16	7a	-A	
			277	B432IUNVEL-A	•	•		0.27	73	> .98	0.86	1.18	< 10	60/16	7a	-A	
			120	B432I120EL	•	•		0.61	73	> .98	0.85	1.16	< 10	60/16	7a	ST	
			277	B432I277EL	•	•		0.27	73	> .98	0.84	1.15	< 10	60/16	7a	ST	
			120	B432IUNVHE-A	•	•		0.70	84	> .98	0.96	1.14	< 10	60/16	7a	-A	
			277	B432IUNVHE-A	•	•		0.30	82	> .98	0.96	1.17	< 10	60/16	7a	-A	
3	SER-PRS	120	B432I120HE	•	•		0.70	83	> .98	0.96	1.16	< 10	60/16	7	ST		
		277	B432I277HE	•	•		0.31	84	> .98	0.96	1.14	< 10	60/16	7	ST		
		120	B432PUNVHP-A	•	•	•	0.73	87	> .99	0.93	1.07	< 10	60/16	8	-A		
		277	B432PUNVHP-A	•	•	•	0.32	85	> .95	0.93	1.09	< 10	60/16	8	-A		
		F32T8ES(30W) - Four Lamp Applications															
		4	PAR-IS	120	B432I120L-A	•	•		0.80	95	> .98	0.80	0.84	< 20	60/16	7a	-A
120	B432I120RH-A			•	•	•	0.87	104	> .99	0.88	0.85	< 10	60/16	7a	-A		
347	B432I347HP			•	•		0.31	106	> .99	0.88	0.83	< 10	60/16	7a	ST		
347	B432I347RH			•	•		0.31	106	> .99	0.88	0.83	< 20	60/16	7a	ST		
120	B432IUNVHP-A			•	•	•	0.87	104	> .98	0.88	0.85	< 10	60/16	7a	-A		
277	B432IUNVHP-A			•	•	•	0.38	101	> .95	0.88	0.87	< 10	60/16	7a	-A		
4	SER-PRS		120	B432IUNVEL-A	•	•		0.80	97	> .99	0.77	0.79	< 10	60/16	7a	-A	
			277	B432IUNVEL-A	•	•		0.34	96	> .98	0.77	0.80	< 10	60/16	7a	-A	
			120	B432I120EL	•	•		0.75	89	> .99	0.77	0.87	< 10	60/16	7a	ST	
			277	B432I277EL	•	•		0.32	87	> .99	0.77	0.89	< 10	60/16	7a	ST	
			120	B432IUNVHE-A	•	•		0.91	109	> .99	0.87	0.80	< 10	60/16	7a	-A	
			277	B432IUNVHE-A	•	•		0.38	106	> .99	0.87	0.82	< 10	60/16	7a	-A	
4	SER-PRS	120	B432I120HE	•	•		0.85	100	> .99	0.87	0.87	< 10	60/16	7a	ST		
		277	B432I277HE	•	•		0.37	99	> .99	0.87	0.88	< 10	60/16	7a	ST		
		120	B432I277HEH	•	•		0.49	134	> .99	1.18	0.88	< 10	60/16	7a	ST		
		277	B432I277HEH	•	•		0.49	134	> .99	1.18	0.88	< 10	60/16	7a	ST		
		120	B432PUNVHP-A	•	•	•	0.95	114	> .99	0.88	0.77	< 10	60/16	8	-A		
		277	B432PUNVHP-A	•	•	•	0.41	110	> .95	0.88	0.80	< 10	60/16	8	-A		

See page 2-30 for Dimensions and Wiring Diagrams

STARTING METHOD LEGEND

IS = Instant Start
PRS = Programmed Rapid Start
RS = Rapid Start

PAR-IS = Parallel Instant Start
PAR-PRS = Parallel Programmed Rapid Start
SER-PRS = Series Programmed Rapid Start

PAR-RS = Parallel Rapid Start
SER-RS = Series Rapid Start
SER-IS = Series Instant Start

F32T8ES (25 WATT)

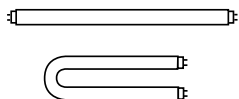

- High Performance Models and Low Profile Designs
- 1-2 Lamp Applications

TRIAD® ELECTRONIC BALLASTS

FOR (1) & (2) F32T8ES (25 WATT) LAMPS

Lamp		Line Volts	Catalog Number	Certification			Line Current (Amps)	Input Power (Watts)	Power Factor (PF)	Ballast Factor (BF)	Ballast Efficacy Factor (BEF)	THD %	Min. F/C Start Temp	Wiring Diag.	Dim.
Qty.	Starting Method			UL	SF	NOM									
F32T8ES (25W) - One Lamp Applications															
1	IS	120	B132IUNVHP-B	•	•	•	0.24	24	> .95	0.88	3.67	< 10	60/16	1	-B
		277					0.09								
		120	B132IUNVEL-A	•	•	•	0.17	20	> .98	0.77	3.85	< 10	60/16	1	-A
		277					0.07		> .95						
		120	B132IUNVHE-A	•	•	•	0.19	23	> .98	0.87	3.78	< 10	60/16	1	-A
		277					0.09		> .95						
		120	B232IUNVHP-B	•	•	•	0.23	28	> .99	1.05	3.75	< 10	60/16	3a	-B
	277					0.10		> .98							
	120	B232IUNVEL-A	•	•	•	0.20	24	> .99	0.95	3.96	< 10	60/16	3a	-A	
	277					0.09	25	> .95		3.80	< 15	60/16			
	120	B232I120EL	•	•	•	0.19	23	> .98	0.89	3.87	< 10	60/16	3a	ST	
	277	B232I277EL	•	•	•	0.08	23	> .98	0.92	4.00	< 15	60/16	3a	ST	
	120	B232IUNVHE-A	•	•	•	0.23	27	> .98	1.05	3.89	< 10	60/16	3a	-A	
	277					0.10		> .95							
120	B232IUNVHEH-A ¹	•	•	•	0.32	38	> .95	1.38	3.63	< 10	60/16	3a	-A		
277					0.14	37	> .95		3.73						
120	B232I120HE	•	•	•	0.21	25	> .98	1.00	4.00	< 10	60/16	3	ST		
277	B232I277HE	•	•	•	0.90	24	> .98	1.03	4.29	< 10	60/16	3	ST		
120	B132PUNVHP-A	•	•	•	0.21	25	> .99	0.88	3.52	< 10	60/16	2	-A		
277					0.09										
120	B232PUNVEL-A	•	•	•	0.16	19	> .90	0.71	3.74	< 10	60/16	30	-A		
277					0.08	19			3.74						
120	B232PUNVHE-A	•	•	•	0.20	25	> .90	0.88	3.52	< 10	60/16	30	-A		
277					0.09	24			3.67						
120	B232PUNVHP-A	•	•	•	0.22	27	> .99	1.00	3.70	< 10	60/16	30	-A		
277					0.10		> .94								
F32T8ES (25W) - Two Lamp Applications															
2	PAR-IS	120	B232IUNVHP-B	•	•	•	0.37	44	> .99	0.88	2.00	< 10	60/16	3	-B
		277					0.16	43	> .98		2.05				
		120	B232IUNVEL-A	•	•	•	0.33	39	> .99	0.77	1.97	< 10	60/16	3	-A
		277					0.14	38	> .98		2.03				
		120	B232I120EL	•	•	•	0.31	37	> .98	0.77	2.08	< 10	60/16	3	ST
		277	B232I277EL	•	•	•	0.14	37	> .98	0.77	2.08	< 10	60/16	3	ST
		120	B232IUNVHE-A	•	•	•	0.37	44	> .98	0.87	1.98	< 10	60/16	3	-A
		277					0.16	43			2.02				
		120	B232IUNVHEH-A	•	•	•	0.49	59	> .95	1.18	2.00	< 10	60/16	3	-A
		277					0.21	58			2.03				
		120	B232I120HE	•	•	•	0.34	41	> .98	0.87	2.12	< 10	60/16	3	ST
		277	B232I277HE	•	•	•	0.15	41	> .98	0.87	2.12	< 10	60/16	3	ST
		120	B332IUNVHP-A	•	•	•	0.43	51	> .98	1.00	1.96	< 10	60/16	6	-A
		277					0.20		> .90						
		120	B332IUNVEL-A	•	•	•	0.37	44	> .99	0.89	2.02	< 10	60/16	6	-A
		277					0.16	43	> .95		2.07				
		120	B332I120EL	•	•	•	0.35	42	> .98	0.86	2.05	< 10	60/16	6	ST
	277	B332I277EL	•	•	•	0.16	43	> .98	0.86	2.00	< 10	60/16	6	ST	
	120	B332IUNVHE-A	•	•	•	0.43	51	> .98	0.99	1.94	< 10	60/16	6	-A	
	277					0.19	50	> .95		1.98					
	120	B332I120HE	•	•	•	0.40	48	> .98	0.96	2.00	< 10	60/16	6	ST	
	277	B332I277HE	•	•	•	0.17	48	> .99	0.99	2.06	< 10	60/16	6	ST	
	120	B332IUNVHEH-A ¹	•	•	•	0.55	66	> .95	1.28	1.94	< 10	60/16	6	-A	
	277					0.25	65			1.97					
	347	B332IHRVH-E	•	•	•	0.18	61	> .95	1.14	1.87	< 10	60/16	46	-E	
	480					0.14		> .90							
	120	B232PUNVHP-A	•	•	•	0.43	52	> .99	0.88	1.69	< 10	60/16	30	-A	
	277					0.19	51	> .98		1.73					
	120	B332PUNVHP-A	•	•	•	0.42	50	> .99	0.99	1.98	< 10	60/16	23	-A	
	277					0.20		> .90							
	120	B232PUNVEL-A	•	•	•	0.32	38	> .90	0.71	1.87	< 10	60/16	30	-A	
	277					0.14	38			1.87					
	120	B232PUNVHE-A	•	•	•	0.37	44	> .90	0.87	1.98	< 10	60/16	30	-A	
	277					0.16	41			2.02					

¹ Consult lamp manufacturers for applications with Ballast Factor > 1.20

See page 2-30 for Dimensions and Wiring Diagrams

TRIAD® ELECTRONIC BALLASTS

FOR (3) & (4) F32T8ES (25 WATT) LAMPS

- High Performance Models and Low Profile Designs
- 3-4 Lamp Applications

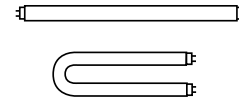

F32T8ES (25 WATT)

Lamp Qty.	Starting Method	Line Volts	Catalog Number	Certification			Line Current (Amps)	Input Power (Watts)	Power Factor (PF)	Ballast Factor (BF)	Ballast Efficacy Factor (BEF)	THD %	Min. F/C Start Temp	Wiring Diag.	Dim.			
				UL	SF	NOM												
F32T8ES (25W) - Three Lamp Applications																		
3	PAR-IS	120	B332IUNVHP-A	•	•	•	0.57	69	> .99	0.90	1.30	< 10	60/16	6	-A			
		277					0.26	68	> .95		1.32							
		120	B332IUNVEL-A	•	•		0.48	58	> .99		1.33							
		277					0.21	57	> .97	0.77	1.35	< 10	60/16	6	-A			
		120	B332I120EL	•	•		0.47	56	> .98	0.77	1.38	< 10	60/16	6	ST			
		277	B332I277EL	•	•		0.20	56	> .98	0.77	1.38	< 10	60/16	6	ST			
	3	SER-IS	120	B332IUNVHE-A	•	•		0.24	66	> .98	0.87	1.32	< 10	60/16	6	-A		
			277				0.60	65	> .95		1.34							
			120	B332I120HE	•	•		0.54	64	> .98	0.87	1.36	< 10	60/16	6	ST		
			277	B332I277HE	•	•		0.23	64	> .99	0.87	1.36	< 10	60/16	6	ST		
			120	B332IUNVHEH-A	•	•		0.72	87	> .95	1.18	1.36	< 10	60/16	6	-A		
			277					0.32	85			1.39						
3	SER-IS	347	B332IHRVHB-E	•	•		0.26	88	> .97	1.11	1.26	< 10	60/16	46	-E			
		480				0.19		> .90										
	3	PAR-IS	120	B432IUNVHP-A	•	•	•	0.61	73	> .98	0.97	1.33	< 10	60/16	7a	-A		
			277				0.27	72	> .95		1.35							
			120	B432I120EL	•	•		0.51	61	> .98	0.85	1.39	< 10	60/16	7	ST		
			277	B432I277EL	•	•		0.22	61	> .98	0.87	1.43	< 10	60/16	7	ST		
			120	B432IUNVHE-A	•	•		0.60	72	> .99	0.96	1.33	< 10	60/16	7a	-A		
			277				0.26	71	> .95		1.35							
			120	B432I120HE	•	•		0.57	68	> .99	0.96	1.41	< 10	60/16	7a	ST		
			277	B432I277HE	•	•		0.25	69	> .99	0.96	1.39	< 10	60/16	7a	ST		
			3	SER-PRS	120	B332PUNVHP-A	•	•	•	0.61	73	> .99	0.88	1.21	< 10	60/16	23	-A
					277				0.27	71	> .95		1.24					
3	SER-PRS	120	B432PUNVHP-A	•	•	•	0.62	75	> .99	0.93	1.24	< 10	60/16	8	-A			
		277				0.28	73	> .95		1.27								
F32T8ES (25W) - Four Lamp Applications																		
4	PAR-IS	120	B432IUNVHP-A	•	•	•	0.74	90	> .98	0.89	0.99	< 10	60/16	7a	-A			
		277				0.33	88	> .95		1.01								
		120	B432I120EL	•	•		0.62	74	> .98	0.77	1.04	< 10	60/16	7a	ST			
		277	B432I277EL	•	•		0.26	72	> .98	0.77	1.07	< 10	60/16	7a	ST			
		120	B432IUNVHE-A	•	•		0.73	87	> .99	0.87	1.00	< 10	60/16	7a	-A			
		277				0.31	85	> .98		1.02								
	4	SER-PRS	120	B432I120HE	•	•		0.70	84	> .99	0.87	1.04	< 10	60/16	7a	ST		
			277	B432I277HE	•	•		0.30	84	> .99	0.87	1.04	< 10	60/16	7a	ST		
			120	B432PUNVHP-A	•	•	•	0.84	100	> .99	0.88	0.88	< 10	60/16	8	-A		
			277				0.36	98	> .95		0.90							

¹ Consult lamp manufacturers for applications with Ballast Factor > 1.20

See page 2-30 for Dimensions and Wiring Diagrams

STARTING METHOD LEGEND

IS = Instant Start PAR-IS = Parallel Instant Start PAR-RS = Parallel Rapid Start
 PRS = Programmed Rapid Start PAR-PRS = Parallel Programmed Rapid Start SER-RS = Series Rapid Start
 RS = Rapid Start SER-PRS = Series Programmed Rapid Start SER-IS = Series Instant Start

TRIAD® ELECTRONIC BALLASTS FOR (1) & (2) F28T8 LAMPS

- High Performance Models and Low Profile Designs
- Instant and Programmed Rapid Starting Options
- 1-2 Lamp Applications

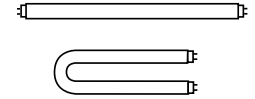

Lamp		Line Volts	Catalog Number	Certification			Line Current (Amps)	Input Power (Watts)	Power Factor (PF)	Ballast Factor (BF)	Ballast Efficacy Factor (BEF)	THD %	Min. F/C Start Temp	Wiring Diag.	Dim.	
Qty.	Starting Method			UL	SP	NOM										
F28T8 - One Lamp Applications																
1	IS	277	B132I277RH-A	•	•		0.10	27	> .98	0.97	3.59	< 20	60/16	1	-A	
		120	B132IUNVHP-B	•	•		0.21	26	> .95	0.88	3.38	< 10	60/16	1	-B	
		277	B132IUNVHP-B				0.09									
		120	B132IUNVEL-A	•	•		0.20	21	> .98	0.77	3.67	< 10	60/16	1	-A	
		277	B132IUNVEL-A				0.10		> .95							
		120	B132IUNVHE-A	•	•		0.20	24	> .98	0.87	3.63	< 10	60/16	1	-A	
		277	B132IUNVHE-A				0.10		> .95							
		277	B232I277L-A	•	•		0.12	30	> .90	0.96	3.20	< 32	60/16	3a	-A	
		347	B232I347L-A				0.08	29	> .98	0.96	3.31	< 20	60/16	3a	-A	
		120	B232I120RH-A	•	•	•	0.30	33	> .90	1.10	3.33	< 32	60/16	3a	-A	
		277	B232I277RH-A	•	•	•	0.13	33	> .90	1.10	3.33	< 32	60/16	3a	-A	
		347	B232I347RH-A				0.09	32	> .98	1.04	3.25	< 20	60/16	3a	-A	
		120	B232IUNVHP-B	•	•	•	0.26	31	> .99	1.05	3.39	< 10	60/16	3a	-B	
		277	B232IUNVHP-B				0.11	30	> .98		3.50					
		347	B232I347HP-A				0.09	32	> .98	0.88	3.25	< 10	60/16	3a	-A	
		120	B232IUNVEL-A	•	•		0.22	26	> .95	0.95	3.65	< 10	60/16	3a	-A	
		277	B232IUNVEL-A				0.10	27	> .95		3.52	< 10	60/16	3a	-A	
		120	B232I120EL	•	•		0.23	28	> .98	0.92	3.29	< 10	60/16	3a	ST	
	277	B232I277EL	•	•		0.09	26	> .98	0.92	3.54	< 10	60/16	3a	ST		
	120	B232IUNVHE-A	•	•		0.24	29	> .95	1.10	3.79	< 10	60/16	3a	-A		
	277	B232IUNVHE-A				0.11										
	120	B232IUNVHEH-A ¹	•	•		0.33	40	> .95	1.38	3.45	< 10	60/16	3a	-A		
	277	B232IUNVHEH-A ¹				0.15	39			3.54						
	120	B232I120HE	•	•		0.23	28	> .98	1.01	3.61	< 10	60/16	3a	ST		
	277	B232I277HE	•	•		0.12	29	> .98	1.02	3.52	< 10	60/16	3a	ST		
	120	B132PUNVHP-A	•	•	•	0.28	27	> .99	0.88	3.26	< 10	60/16	2	-A		
	277	B132PUNVHP-A				0.11										
	120	B232PUNVEL-A	•	•		0.18	21	> .90	0.71	3.38	< 10	60/16	30	-A		
	277	B232PUNVEL-A				0.08	21			3.38						
	120	B232PUNVHE-A	•	•		0.21	25	> .90	0.88	3.49	< 10	60/16	30	-A		
	277	B232PUNVHE-A				0.09	24			3.67						
	120	B232PUNVHP-A	•	•	•	0.25	30	> .99	1.00	3.33	< 10	60/16	30	-A		
	277	B232PUNVHP-A				0.11		> .95								
F28T8 - Two Lamp Applications																
2	PAR-IS	277	B232I277L-A	•	•		0.17	45	> .95	0.75	1.67	< 25	60/16	3	-A	
		347	B232I347L-A				0.13	44	> .98	0.78	1.77	< 20	60/16	3	-A	
		120	B232I120RH-A	•	•	•	0.43	51	> .98	0.90	1.76	< 20	60/16	3	-A	
		277	B232I277RH-A	•	•	•	0.19	51	> .98	0.90	1.76	< 20	60/16	3	-A	
		347	B232I347RH-A				0.14	50	> .98	0.88	1.76	< 20	60/16	3	-A	
		120	B232IUNVHP-B	•	•	•	0.41	48	> .99	0.88	1.83	< 10	60/16	3	-B	
		277	B232IUNVHP-B				0.17	47	> .98		1.87					
		347	B232I347HP-A				0.14	50	> .98	1.04	1.76	< 10	60/16	3	-A	
		120	B232IUNVEL-A	•	•		0.36	43	> .95	0.77	1.79	< 10	60/16	3	-A	
		277	B232IUNVEL-A				0.15									
		120	B232I120EL	•	•		0.35	41	> .98	0.77	1.88	< 10	60/16	3	ST	
		277	B232I277EL	•	•		0.14	41	> .98	0.77	1.88	< 10	60/16	3	ST	
		120	B232IUNVHE-A	•	•		0.40	49	> .95	0.87	1.78	< 10	60/16	3	-A	
		277	B232IUNVHE-A				0.18	48			1.81					
		120	B232IUNVHEH-A	•	•		0.53	64	> .95	1.18	1.84	< 10	60/16	3	-A	
		277	B232IUNVHEH-A				0.23	62			1.90					
		120	B232I120HE	•	•		0.38	48	> .98	0.87	1.81	< 10	60/16	3	ST	
		277	B232I277HE	•	•		0.17	47	> .98	0.87	1.85	< 10	60/16	3	ST	
	120	B332I120RH-A	•	•	•	0.50	57	> .95	1.02	1.79	< 32	60/16	6	-A		
	277	B332I277RH-A	•	•	•	0.22	57	> .95	1.00	1.75	< 25	60/16	6	-A		
	120	B332IUNVHP-A	•	•	•	0.46	55	> .99	0.99	1.80	< 10	60/16	6	-A		
	277	B332IUNVHP-A				0.21	54	> .90		1.83						
	120	B332IUNVEL-A	•	•		0.41	49	> .99	0.89	1.82	< 10	60/16	6	-A		
	277	B332IUNVEL-A				0.18	48	> .95		1.85						
	120	B332I120EL	•	•		0.38	45	> .98	0.86	1.91	< 10	60/16	6	ST		
	277	B332I277EL	•	•		0.18	47	> .98	0.88	1.87	< 10	60/16	6	ST		
	120	B332IUNVHE-A	•	•		0.45	54	> .99	0.99	1.83	< 10	60/16	6	-A		
	277	B332IUNVHE-A				0.19	53	> .97		1.87						
	120	B332IUNVHEH-A ¹	•	•		0.57	71	> .95	1.28	1.80	< 10	60/16	6	-A		
	277	B332IUNVHEH-A ¹				0.27	69			1.86						

¹ Consult lamp manufacturers for applications with Ballast Factors > 1.20

See page 2-30 for Dimensions and Wiring Diagrams

TRIAD® ELECTRONIC BALLASTS

FOR (2)(cont.), (3) & (4) F28T8 LAMPS

- High Performance Models and Low Profile Designs
- Instant and Programmed Rapid Starting Options
- 2-4 Lamp Applications

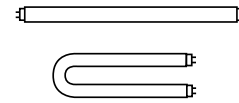

F28T8

Qty.	Lamp Starting Method	Line Volts	Catalog Number	Certification			Line Current (Amps)	Input Power (Watts)	Power Factor (PF)	Ballast Factor (BF)	Ballast Efficacy Factor (BEF)	THD %	Min. F/C Start Temp	Wiring Diag.	Dim.
				UL	SP	NOM									
2	PAR-IS	120	B332I120HE	•	•		0.42	51	> .98	0.96	1.88	< 10	60/16	6	ST
		277	B332I277HE	•	•		0.20	52	> .98	0.98	1.88	< 10	60/16	6	ST
2	SER-IS	347	B332IHRVH-E ¹	•	•		0.19	65	> .97	1.22	1.88	< 10	60/16	46	-E
		480		•	•		0.15		> .90						
2	SER-PRS	120	B232PUNVHP-A	•	•	•	0.25	30	> .99	1.00	3.33	< 10	60/16	30	-A
		277		•	•		0.11		> .95						
		120	B232PUNVEL-A	•	•		0.34	41	> .90	0.70	1.71	< 10	60/16	30	-A
		277		•	•		0.15		40						
		120	B232PUNVHE-A	•	•		0.39	47	> .90	0.87	1.85	< 10	60/16	30	-A
		277		•	•		0.17		46						
		120	B332PUNVHP-A	•	•	•	0.46	55	> .99	0.99	1.80	< 10	60/16	23	-A
		277		•	•		0.21		54						

F28T8 - Three Lamp Applications

3	PAR-IS	120	B332I120RH-A	•	•	•	0.63	74	> .98	0.88	1.19	< 20	60/16	6	-A	
		277	B332I277RH-A	•	•	•	0.27	74	> .98	0.88	1.19	< 20	60/16	6	-A	
		120	B332IUNVHP-A	•	•	•	0.61	73	> .99	0.89	1.22	< 10	60/16	6	-A	
		277		•	•		0.27	71	> .95							1.25
		120	B332IUNVEL-A	•	•		0.53	66	> .99	0.77	1.17	< 10	60/16	6	-A	
		277		•	•		0.23	65	> .97							1.18
		120	B332I120EL	•	•		0.50	62	> .98	0.77	1.24	< 10	60/16	6	ST	
		277		•	•		0.22	61	> .98							1.26
	120	B332IUNVHE-A	•	•		0.60	75	> .99	0.87	1.16	< 10	60/16	6	-A		
	277		•	•		0.26	73	> .98							1.19	
	120	B332I120HE	•	•		0.57	72	> .98	0.87	1.21	< 10	60/16	6	ST		
	277		•	•		0.24	71	> .98							1.23	
	120	B332IUNVHEH-A	•	•		0.78	95	> .95	1.18	1.24	< 10	60/16	6	-A		
	277		•	•		0.34	92	> .95							1.28	
	3	SER-IS	347	B332IHRVHB-E	•	•		0.28	94	> .97	1.18	1.26	< 10	60/16	46	-E
			480		•	•		0.21		> .90						
347			B432I347RH	•	•		0.23	78	> .98	0.99	1.27	< 10	60/16	7a	ST	
347				•	•		0.23	78	> .98							0.99
120			B432IUNVHP-A	•	•	•	0.66	79	> .98	0.97	1.23	< 10	60/16	7a	-A	
277				•	•		0.29	77	> .95							0.97
120			B432IUNVEL-A	•	•		0.57	69	> .99	0.86	1.25	< 10	60/16	7a	-A	
277				•	•		0.26	68	> .95							1.26
120		B432I277EL	•	•		0.25	66	> .98	0.88	1.33	< 10	60/16	7a	ST		
277			•	•		0.64	77	> .99							0.96	1.25
120		B432IUNVHE-A	•	•		0.28	75	> .98	0.96	1.28	< 10	60/16	7a	-A		
277			•	•		0.28	75	> .98							0.96	1.28
120		B432I277HE	•	•		0.28	74	> .98	0.98	1.32	< 10	60/16	7a	ST		
277			•	•		0.66	79	> .99							1.11	
120		B332PUNVHP-A	•	•	•	0.66	79	> .99	0.88	1.13	< 10	60/16	23	-A		
277			•	•		0.29	78	> .95							1.13	
120	B432PUNVHP-A	•	•	•	0.68	82	> .99	0.93	1.13	< 10	60/16	8	-A			
277		•	•		0.30	80	> .95							1.16		

F28T8 - Four Lamp Applications

4	PAR-IS	347	B432I347HP	•	•		0.28	95	> .99	0.88	0.93	< 10	60/16	7a	ST
		347	B432I347RH	•	•		0.28	95	> .99	0.88	0.93	< 20	60/16	7a	ST
		120	B432IUNVHP-A	•	•	•	0.80	96	> .98	0.89	0.93	< 10	60/16	7a	-A
		277		•	•		0.35	93	> .95						
		120	B432IUNVEL-A	•	•		0.70	85	> .99	0.77	0.91	< 10	60/16	7a	-A
		277		•	•		0.31	84	> .98						
		120	B432I120EL	•	•		0.75	83	> .99	0.77	0.93	< 10	60/16	7a	ST
		277		•	•		0.29	81	> .98						
	120	B432IUNVHE-A	•	•		0.77	97	> .99	0.87	0.90	< 10	60/16	7a	-A	
	277		•	•		0.33	94	> .98							0.93
	120	B432I120HE	•	•		0.85	94	> .99	0.87	0.93	< 10	60/16	7a	ST	
	277		•	•		0.32	93	> .98							0.87
	120	B432I277HEH	•	•		0.45	123	> .99	1.18	0.96	< 10	60/16	7a	ST	
	277		•	•		0.89	107	> .99							0.82
	120	B432PUNVHP-A	•	•	•	0.89	107	> .99	0.88	0.82	< 10	60/16	8	-A	
	277		•	•		0.39	104	> .95							0.85

See page 2-30 for Dimensions and Wiring Diagrams

STARTING METHOD LEGEND

IS = Instant Start
PRS = Programmed Rapid Start
RS = Rapid Start

PAR-IS = Parallel Instant Start
PAR-PRS = Parallel Programmed Rapid Start
SER-PRS = Series Programmed Rapid Start

PAR-RS = Parallel Rapid Start
SER-RS = Series Rapid Start
SER-IS = Series Instant Start

Overall Dimensions		Mounting Dimensions			
Draw #	L	W	H	M	X
ST	9.50"	2.40"	1.55"	8.89"	1.69"
-A	9.50"	1.70"	1.18"	8.89"	1.69"
-E	16.88"	1.74"	1.18"	16.28"	---

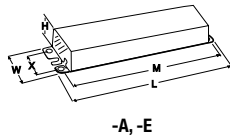
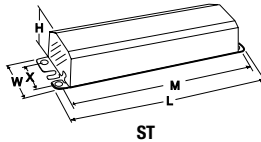

WIRING DIAGRAMS

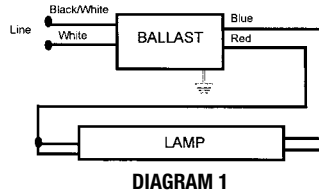

DIAGRAM 1

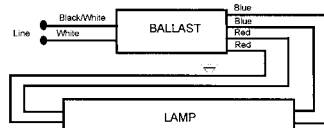

DIAGRAM 2

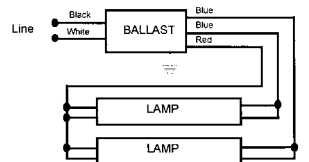
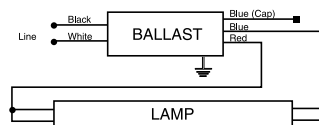
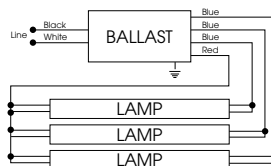

DIAGRAM 3



ONE LAMP APPLICATION
Cap unused blue lead, insulate to 600 volts

DIAGRAM 3a



For Two Lamp operation,
Insulate one blue lead to 600V

DIAGRAM 6

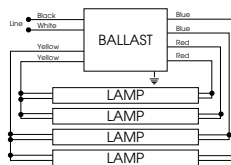

For Three Lamp Operation,
Insulate one blue lead to 600V

DIAGRAM 7

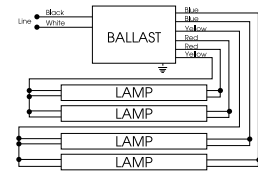

For three lamp operation, cap any
blue lead, insulate to 600V

DIAGRAM 7a

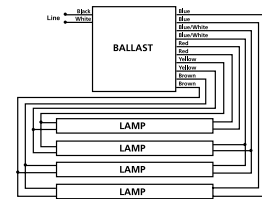

For Three Lamp Application, Individually
cap brown leads, Insulate to 600V

DIAGRAM 8

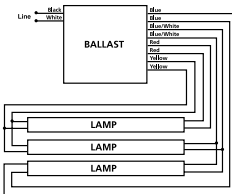

For Two Lamp operation, individually
cap yellow leads, Insulate to 600V

DIAGRAM 23

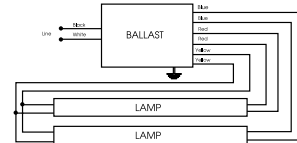

For One Lamp Operation, Individually cap
yellow leads, Insulate to 600V

DIAGRAM 30

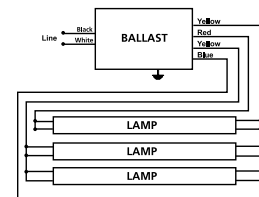

For two lamp application, cap one yellow lead,
insulate to 600 volts

DIAGRAM 46

TRIAD® ELECTRONIC BALLASTS

FOR (1), (2), AND (3) F40T8 LAMPS

- Low Profile Designs Featured
- Instant & Programmed Rapid Starting Options
- 1-3 Lamp Applications

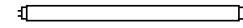

F40T8

Fluorescent-Electronic

Lamp Qty.	Starting Method	Line Volts	Catalog Number	Certification			Line Current (Amps)	Input Power (Watts)	Power Factor (PF)	Ballast Factor (BF)	Ballast Efficacy Factor (BEF)	THD %	Min. F/C Start Temp	Wiring Diag.	Dim.		
				UL	SF	NOM											
F40T8 - One Lamp Applications																	
1	IS	120	B132I120RH-A	•	•	•	0.30	35	> .96	0.83	2.37	< 15	50/10	1	-A		
		277	B132I277RH-A	•	•	•	0.13	37	> .95	0.83	2.24	< 15	50/10	1	-A		
		120	B132IUNVHP-B	•	•	•	0.31	37	> .95	0.85	2.30	< 10	32/0	1	-B		
		277	B132IUNVHP-B	•	•	•	0.13	36	> .95	0.85	2.36	< 10	32/0	1	-B		
		120	B132IUNVEL-A	•	•	•	0.25	32	> .98	0.76	2.38	< 10	0/-18	1	-A		
		277	B132IUNVEL-A	•	•	•	0.13	32	> .95	0.76	2.38	< 10	0/-18	1	-A		
		120	B132IUNVHE-A	•	•	•	0.30	35	> .98	0.86	2.46	< 10	0/-18	1	-A		
		277	B132IUNVHE-A	•	•	•	0.14	35	> .95	0.86	2.46	< 10	0/-18	1	-A		
		120	B232I120L-A	•	•	•	0.34	40	> .95	0.91	2.28	< 25	0/-18	3a	-A		
		277	B232I277L-A	•	•	•	0.15	40	> .95	0.91	2.28	< 25	0/-18	3a	-A		
		347	B232I347L-A	•	•	•	0.11	38	> .98	0.95	2.50	< 20	0/-18	3a	-A		
		120	B232I120RH-A	•	•	•	0.38	45	> .95	1.03	2.29	< 25	0/-18	3a	-A		
		277	B232I277RH-A	•	•	•	0.17	45	> .95	1.03	2.29	< 25	0/-18	3a	-A		
		347	B232I347HP-A	•	•	•	0.13	45	> .98	1.02	2.27	< 10	0/-18	3a	-A		
		347	B232I347HPL	•	•	•	0.11	38	> .98	0.86	2.26	< 10	0/-18	3a	ST		
		120	B232IUNVHP-B	•	•	•	0.36	43	> .99	1.03	2.40	< 10	32/0	3a	-B		
		277	B232IUNVHP-B	•	•	•	0.15	42	> .98	1.03	2.45	< 10	32/0	3a	-B		
		347	B232I347RH-A	•	•	•	0.13	45	> .98	1.02	2.27	< 20	0/-18	3a	-A		
120	B232IUNV-C	•	•	•	0.37	43	> .98	0.99	2.30	< 10	0/-18	22	-C				
277	B232IUNV-C	•	•	•	0.16	42	> .98	0.99	2.36	< 10	0/-18	22	-C				
120	B232PUNVEL-A	•	•	•	0.25	30	> .90	0.71	2.37	< 10	0/-18	30	-A				
277	B232PUNVEL-A	•	•	•	0.11	29	> .90	0.71	2.45	< 10	0/-18	30	-A				
120	B232PUNVHE-A	•	•	•	0.30	36	> .90	0.84	2.33	< 10	0/-18	30	-A				
277	B232PUNVHE-A	•	•	•	0.13	35	> .90	0.84	2.40	< 10	0/-18	30	-A				
120	ES4800A	•	•	•	0.31	37	> .97	1.05	2.84	< 10	0/-18	37	ESA				
277	ES4800A	•	•	•	0.14	39	> .97	1.05	2.69	< 10	0/-18	37	ESA				
347	ES1679A	•	•	•	0.13	44	> .97	0.87	1.98	< 10	0/-18	37	ESA				
F40T8 - Two Lamp Applications																	
2	PAR-IS	347	B259I347HP	•	•	•	0.22	76	> .98	0.91	1.20	< 10	0/-18	14	ST		
		120	B332I120L-A	•	•	•	0.60	71	> .98	0.87	1.23	< 20	0/-18	6	-A		
		277	B332I277L-A	•	•	•	0.26	72	> .98	0.89	1.24	< 20	0/-18	6	-A		
		347	B332I347L	•	•	•	0.20	69	> .99	0.82	1.18	< 20	0/-18	6	ST		
		120	B332I120RH-A	•	•	•	0.73	82	> .98	0.96	1.17	< 20	0/-18	6	-A		
		277	B332I277RH-A	•	•	•	0.31	82	> .98	1.00	1.22	< 20	0/-18	6	-A		
		347	B332I347HPL	•	•	•	0.20	69	> .99	0.82	1.19	< 10	0/-18	6	ST		
		120	B332IUNVHP-A	•	•	•	0.65	78	> .99	0.95	1.22	< 10	0/-18	6	-A		
		277	B332IUNVHP-A	•	•	•	0.29	77	> .95	0.95	1.23	< 10	0/-18	6	-A		
		120	B332IUNVEL-A	•	•	•	0.57	68	> .99	0.89	1.31	< 10	0/-18	6	-A		
		277	B332IUNVEL-A	•	•	•	0.25	66	> .98	0.89	1.35	< 10	0/-18	6	-A		
		120	B332IUNVHE-A	•	•	•	0.64	77	> .99	0.99	1.29	< 10	0/-18	6	-A		
		277	B332IUNVHE-A	•	•	•	0.27	75	> .98	0.99	1.32	< 10	0/-18	6	-A		
		120	B332IUNVHEH-A	•	•	•	0.84	101	> .95	1.26	1.25	< 10	0/-18	6	-A		
		277	B332IUNVHEH-A	•	•	•	0.36	101	> .95	1.26	1.25	< 10	0/-18	6	-A		
		F40T8 - Three Lamp Applications															
		3	PAR-IS	120	B432I120L-A	•	•	•	0.84	100	> .98	0.84	0.84	< 20	0/-18	7a	-A
				347	B432I347L	•	•	•	0.29	100	> .99	0.81	0.81	< 20	0/-18	7	ST
120	B432I120RH-A			•	•	•	0.93	112	> .99	0.90	0.80	< 10	0/-18	7a	-A		
277	B432I277RH-A			•	•	•	0.40	109	> .99	0.90	0.83	< 10	0/-18	7a	-A		
347	B432I347HPL			•	•	•	0.29	100	> .99	0.81	0.81	< 10	0/-18	7	ST		
120	B432IUNVHP-A			•	•	•	0.95	114	> .99	0.81	0.81	< 10	0/-18	7a	-A		
277	B432IUNVHP-A			•	•	•	0.41	109	> .98	0.92	0.84	< 10	0/-18	7a	-A		
120	B432IUNV-D			•	•	•	0.94	112	> .98	0.94	0.84	< 10	0/-18	24	-D		
277	B432IUNV-D			•	•	•	0.40	109	> .98	0.94	0.86	< 10	0/-18	24	-D		
120	B432IUNVEL-A			•	•	•	0.81	97	> .99	0.86	0.89	< 10	0/-18	7a	-A		
277	B432IUNVEL-A			•	•	•	0.35	94	> .98	0.86	0.91	< 10	0/-18	7a	-A		
120	B432IUNVHE-A			•	•	•	0.93	111	> .99	0.96	0.86	< 10	0/-18	7a	-A		
277	B432IUNVHE-A	•	•	•	0.39	107	> .98	0.96	0.90	< 10	0/-18	7a	-A				

See page 2-32 for Dimensions and Wiring Diagrams

Overall Dimensions		Mounting Dimensions			
Draw #	L	W	H	M	X
ST	9.50"	2.40"	1.55"	8.89"	1.69"
-A	9.50"	1.70"	1.18"	8.89"	1.69"
-B	9.50"	1.50"	1.00"	8.89"	0.88"
-C	14.25"	1.18"	1.00"	13.75"	---
-D	16.88"	1.18"	1.00"	16.20"	---
ESA	9.50"	1.56"	1.00"	8.88"	0.78"

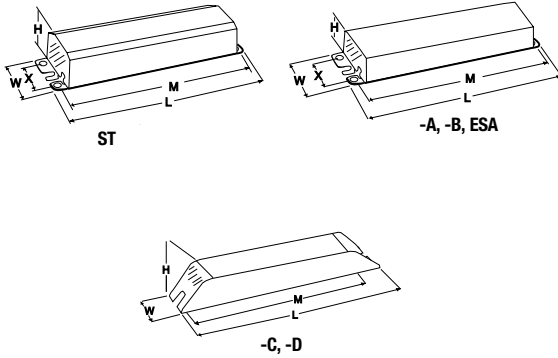

WIRING DIAGRAMS

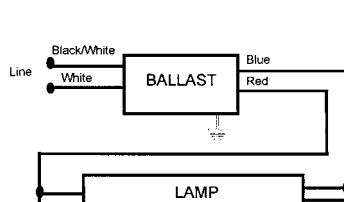
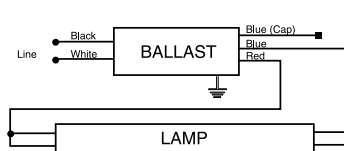
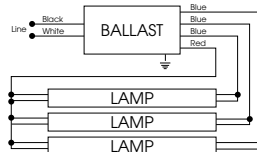

DIAGRAM 1



ONE LAMP APPLICATION
Cap unused blue lead, insulate to 600 volts

DIAGRAM 3a



For Two Lamp Operation,
Insulate one blue lead to 600V
DIAGRAM 6

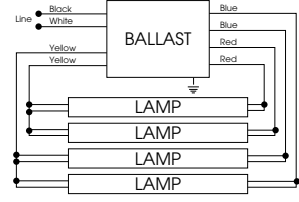

For Three Lamp Operation,
Insulate one blue lead to 600V
DIAGRAM 7

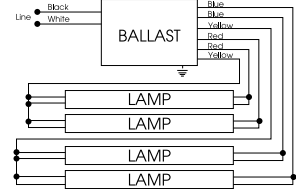

For three lamp operation, cap any
blue lead, insulate to 600V
DIAGRAM 7a

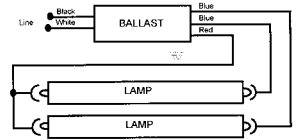

DIAGRAM 14

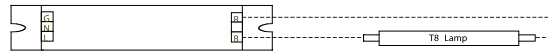

DIAGRAM 22

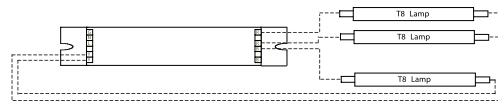
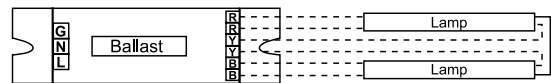

DIAGRAM 24



FOR ONE LAMP OPERATION, CAP YELLOW LEADS INDIVIDUALLY

DIAGRAM 37

TRIAD® ELECTRONIC BALLASTS

FOR (1) AND (2) F48T8, F72T8, F96T8 AND F96T8ES LAMPS

- Instant Starting Options
- 1-2 Lamp Applications
- 8' T8 SLIMLINE
- High Performance Models

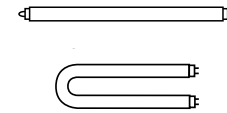

**T8
SLIMLINE**

Lamp Qty.	Starting Method	Line Volts	Catalog Number	Certification			Line Current (Amps)	Input Power (Watts)	Power Factor (PF)	Ballast Factor (BF)	Ballast Efficacy Factor (BEF)	THD %	Min. F/C Start Temp	Wiring Diag.	Dim.
				UL	SP	NOM									
F48T8 - One Lamp Applications															
1	IS	120	B259I120HE	•	•		0.29	34	>.98	1.07	3.15	<10	0/-18	14	ST
		277	B259I277HE	•	•		0.16	35	>.97	1.07	3.06	<10	0/-18	14	ST
F48T8 - Two Lamp Applications															
2	PAR-IS	120	B259I120HE	•	•		0.47	56	>.99	0.90	1.61	<10	0/-18	14	ST
		277	B259I277HE	•	•		0.20	55	>.97	0.90	1.64	<10	0/-18	14	ST
F72T8 - One Lamp Applications															
1	IS	120	B259I120HE	•	•		0.42	50	>.99	1.05	2.10	<10	0/-18	14	ST
		120	B259I277HE	•	•		0.19	51	>.97	1.05	2.06	<10	0/-18	14	ST
F72T8 - Two Lamp Applications															
2	PAR-IS	277	B259I120HE	•	•		0.71	84	>.99	0.88	1.05	<10	0/-18	14	ST
		277	B259I277HE	•	•		0.30	82	>.97	0.88	1.07	<10	0/-18	14	ST
F96T8 - One Lamp Applications															
1	IS	120	B159I120RH	•	•		0.52	58	>.96	0.88	1.52	<20	50/10	13	ST
		277	B159I277RH	•	•		0.22	58	>.96	0.88	1.52	<20	50/10	13	ST
		120	B259I120RH	•	•	•	0.62	68	>.97	1.05	1.54	<25	50/10	14	ST
		277	B259I277RH	•	•	•	0.26	68	>.97	1.05	1.54	<20	50/10	14	ST
		120	B259I120HPL	•	•		0.51	60	>.98	0.92	1.53	<10	50/10	14	ST
		277	B259I277HPL	•	•		0.22	60	>.98	0.92	1.53	<10	50/10	14	ST
		120	B259IUNVHP-A	•	•	•	0.60	72	>.99		1.50	<10	32/0	14	-A
		277	B259IUNVHP-A	•	•	•	0.26	71	>.98	1.08	1.52	<10	32/0	14	-A
		347	B259I347HP	•	•		0.20	68	>.97	1.05	1.54	<10	32/0	14	ST
		120	B259I120HE	•	•		0.58	69	>.97	1.05	1.53	<10	32/0	13	ST
277	B259I277HE	•	•		0.25	69	>.97	1.05	1.52	<10	32/0	13	ST		
F96T8 - Two Lamp Applications															
2	PAR-IS	120	B259I120RH	•	•	•	0.95	112	>.98	0.88	0.79	<20	50/10	14	ST
		277	B259I277RH	•	•	•	0.41	112	>.98	0.88	0.79	<20	50/10	14	ST
		120	B259I120RHH	•	•		1.30	150	>.98	1.18	0.79	<20	32/0	14	SL
		277	B259I277RHH	•	•		0.56	150	>.98	1.18	0.79	<20	32/0	14	SL
		120	B259I120HPL	•	•		0.84	100	>.98	0.78	0.78	<10	50/10	14	ST
		277	B259I277HPL	•	•		0.36	100	>.98	0.78	0.78	<10	50/10	14	ST
		120	B259IUNVHP-A	•	•	•	0.95	113	>.99		0.78	<10	32/0	14	-A
		277	B259IUNVHP-A	•	•	•	0.40	110	>.98		0.80	<10	32/0	14	-A
		347	B259I347HP	•	•		0.33	113	>.99	0.89	0.79	<10	32/0	14	ST
		120	B259I120HE	•	•		0.92	108	>.99	0.88	0.81	<10	32/0	14	ST
277	B259I277HE	•	•		0.38	106	>.99	0.88	0.83	<10	32/0	14	ST		
F96T8ES - One Lamp Applications															
1	PAR-IS	120	B259I120HE	•	•		0.53	63	>.97	1.05	1.66	<10	60/16	13	ST
		277	B259I277HE	•	•		0.23	63	>.97	1.05	1.66	<10	60/16	13	ST
F96T8ES - Two Lamp Applications															
2	PAR-IS	120	B259I120RHH	•	•		1.20	142	>.98	1.18	0.83	<20	60/16	14	SL
		277	B259I277RHH	•	•		0.50	138	>.98	1.18	0.86	<20	60/16	14	SL
		120	B259I120HE	•	•		0.85	102	>.99	0.88	0.86	<10	60/16	14	ST
		277	B259I277HE	•	•		0.36	100	>.99	0.88	0.88	<10	60/16	14	ST

IS = Instant Start
 PRS = Programmed Rapid Start
 RS = Rapid Start

STARTING METHOD LEGEND
 PAR-IS = Parallel Instant Start
 PAR-PRS = Parallel Programmed Rapid Start

PAR-RS = Parallel Rapid Start
 SER-RS = Series Rapid Start

Overall Dimensions		Mounting Dimensions			
Draw #	L	W	H	M	X
ST	9.50"	2.40"	1.55"	8.89"	1.69"
SL	11.75"	3.13"	1.78"	11.14"	2.00"
-A	9.50"	1.70"	1.18"	8.89"	1.69"

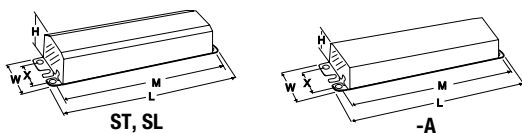

WIRING DIAGRAMS

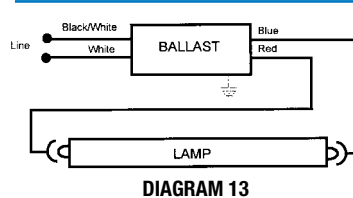
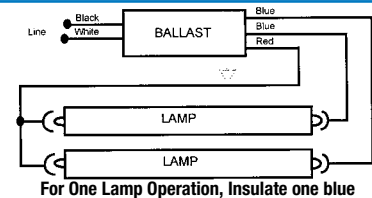
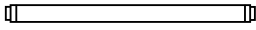

DIAGRAM 13



For One Lamp Operation, Insulate one blue lead to 600V

DIAGRAM 14



- Instant Starting Options
- 1-2 Lamp Applications
- 4-8' T8 High Output

TRIAD® ELECTRONIC BALLASTS

FOR (1) AND (2) F48T8HO, F60T8HO, F72T8HO AND F96T8HO LAMPS

Lamp Qty.	Starting Method	Line Volts	Catalog Number	Certification			Line Current (Amps)	Input Power (Watts)	Power Factor (PF)	Ballast Factor (BF)	Ballast Efficacy Factor (BEF)	THD %	Min. F/C Start Temp	Wiring Diag.	Dim.
				UL	SF	NOM									
F48T8HO - One Lamp Applications															
1	IS	120	B286I120RH	•	•	•	0.47	48	> .90	1.00	2.08	< 30	-20/-29	3	SL
		277	B286I277RH	•	•	•	0.20	47	> .90	1.00	2.13	< 30	-20/-29	3	SL
F60T8HO - One Lamp Applications															
1	IS	120	B286I120RH	•	•	•	0.56	60	> .90	0.99	1.65	< 30	-20/-29	3	SL
		277	B286I277RH	•	•	•	0.23	57	> .90	0.98	1.72	< 30	-20/-29	3	SL
F72T8HO - One Lamp Applications															
1	IS	120	B286I120RH	•	•	•	0.64	71	> .90	0.98	1.38	< 30	-20/-29	3	SL
		277	B286I277RH	•	•	•	0.26	67	> .90	0.98	1.46	< 30	-20/-29	3	SL
F96T8HO - One Lamp Applications															
1	IS	120	B286I120RH	•	•	•	0.79	92	> .90	0.96	1.04	< 25	-20/-29	3	SL
		277	B286I277RH	•	•	•	0.32	87	> .90	0.93	1.07	< 25	-20/-29	3	SL
F48T8HO - Two Lamp Applications															
2	PAR-IS	120	B286I120RH	•	•	•	0.70	80	> .95	0.85	1.06	< 25	-20/-29	3	SL
		277	B286I277RH	•	•	•	0.30	77	> .90	0.84	1.09	< 25	-20/-29	3	SL
F60T8HO - Two Lamp Applications															
2	PAR-IS	120	B286I120RH	•	•	•	0.85	99	> .95	0.85	0.86	< 20	-20/-29	3	SL
		277	B286I277RH	•	•	•	0.36	96	> .95	0.84	0.88	< 20	-20/-29	3	SL
F72T8HO - Two Lamp Applications															
2	PAR-IS	120	B286I120RH	•	•	•	1.00	117	> .95	0.85	0.73	< 20	-20/-29	3	SL
		277	B286I277RH	•	•	•	0.42	114	> .95	0.84	0.74	< 20	-20/-29	3	SL
F96T8HO - Two Lamp Applications															
2	PAR-IS	120	B286I120RH	•	•	•	1.30	151	> .95	0.81	0.54	< 20	-20/-29	3	SL
		277	B286I277RH	•	•	•	0.53	144	> .95	0.81	0.56	< 20	-20/-29	3	SL

IS = Instant Start
 PRS = Programmed Rapid Start
 RS = Rapid Start

STARTING METHOD LEGEND
 PAR-IS = Parallel Instant Start
 PAR-PRS = Parallel Programmed Rapid Start

PAR-RS = Parallel Rapid Start
 SER-RS = Series Rapid Start

Overall Dimensions Mounting Dimensions

Draw #	L	W	H	M	X
SL	11.75"	3.13"	1.78"	11.14"	2.00"

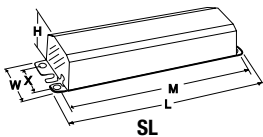

WIRING DIAGRAMS

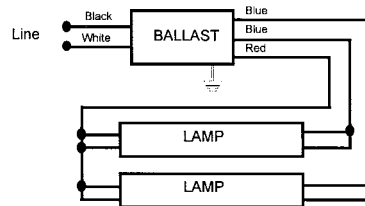

For One Lamp Operation, Insulate one blue lead to 600V

DIAGRAM 3

TRIAD® T5 ELECTRONIC BALLASTS

FOR F8, F13, F14, F21 AND F24 LAMPS

- Multiple Lamp Operation
- Rapid and Programmed Rapid Starting Options
- T5 Ballasts meet ANSI requirement for end-of-lamp life safety shutdown
- Super Low Profile Designs
- 1-2 Lamp Applications

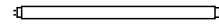

T5

Lamp Qty.	Starting Method	Line Volts	Catalog Number	Certification			Line Current (Amps)	Input Power (Watts)	Power Factor (PF)	Ballast Factor (BF)	Ballast Efficacy Factor (BEF)	THD %	Min. F/C Start Temp	Wiring Diag.	Dim.		
				UL	SF	NOM											
F8T5 - One Lamp Applications																	
1	RS	120	CBT113L-120 ■	•	•	•	0.18	10	> .50	1.30	13.00	< 150	0/-18	47	CBT		
F8T5 - Two Lamp Applications																	
2	RS	120	CBT213L-120 ■	•	•	•	0.34	22	> .50	1.30	5.91	< 150	0/-18	47	CBT		
F13T5 - One Lamp Applications																	
1	RS	120	CBT113L-120 ■	•	•	•	0.25	15	> .50	1.10	9.33	< 150	0/-18	47	CBT		
F13T5 - Two Lamp Applications																	
2	SER-RS	120	CBT213L-120 ■	•	•	•	0.48	28	> .50	1.10	3.93	< 150	0/-18	48	CBT		
F14T5 - One Lamp Applications																	
1	PRS	120	B228PUNV-C	•	•	•	0.15	18	> .98	1.05	5.83	< 10	0/-18	37	-C		
		0.07					> .90	< 15									
		120	B228PUNV90-C				0.14	16	> .98	0.89	5.56	< 15					
		0.07					17	> .85	< 20								
120	ES4528X	0.15	19	> .97	1.00	5.26	< 10	0/-18	40	ESX							
0.07		20	> .97	5.00			< 10										
1	RS	120	CBT113L-120 ■	•	•	•	0.25	16	> .50	0.97	6.06	< 150	0/-18	47	CBT		
F14T5 - Two Lamp Applications																	
2	SER-PRS	120	B228PUNV-C	•	•	•	0.28	34	> .98	1.00	2.94	< 10	0/-18	37	-C		
		0.13					> .95	< 15									
		120	B228PUNV90-C				0.24	29	> .99	0.89	3.07	< 10					
		0.11					> .90	< 15									
		120	B228PUNV95-D				0.25	31	> .99	0.95	3.06	< 10		0/-18		37	-D
		0.11					> .98	< 10									
120	B228PUNV115-D	0.31	37	> .99	1.15	3.12	< 10	0/-18	37	-D							
0.13		> .98	< 10														
2	SER-RS	120	CBT213L-120 ■	•	•	•	0.46	30	> .50	0.97	3.23	< 150	0/-18	48	CBT		
F21T5 - One Lamp Applications																	
1	PRS	120	B228PUNV-C	•	•	•	0.21	25	> .98	1.03	4.12	< 10	0/-18	37	-C		
		0.10					> .95	< 15									
		120	B228PUNV90-C				0.19	22	> .99	0.89	4.05	< 10					
		0.09					23	> .90	< 15								
		120	ES4528X				0.20	26	> .97	1.00	3.85	< 10		0/-18		40	ESX
0.09	> .97	< 10															
1	RS	120	CBT213L-120 ■	•	•	•	0.36	25	> .50	1.15	4.60	< 150	0/-18	47	CBT		
F21T5 - Two Lamp Applications																	
2	SER-PRS	120	B228PUNV-C	•	•	•	0.41	49	> .98	1.00	2.04	< 10	0/-18	37	-C		
		0.18					48	> .98	2.08			< 10					
		120	B228PUNV90-C				0.35	42	> .99	0.89	2.12	< 10					
		0.16					> .95	< 10									
		120	B228PUNV95-D				0.37	44	> .99	0.95	2.16	< 10		0/-18		37	-D
		0.16					> .98	< 10									
120	B228PUNV115-D	0.44	52	> .99	1.15	2.21	< 10	0/-18	37	-D							
0.19		> .98	< 10														
F24T5 - One Lamp Applications																	
1	RS	120	CBT126L-120 ■	•	•	•	0.40	26	> .50	1.00	3.85	< 150	0/-18	47	CBT		

■ Add "B" for Bottom Exit or "S" for Side Exit or "BS" for Bottom Exit with 2" O.C. screw studs.

See page 2-38 for Dimensions and Wiring Diagrams

STARTING METHOD LEGEND

IS = Instant Start
 PRS = Programmed Rapid Start
 RS = Rapid Start

PAR-IS = Parallel Instant Start
 PAR-PRS = Parallel Programmed Rapid Start

PAR-RS = Parallel Rapid Start
 SER-RS = Series Rapid Start

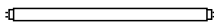

- Multiple Lamp Operation
- Rapid and Programmed Rapid Starting Options
- T5 Ballasts meet ANSI requirement for end-of-lamp life safety shutdown
- Super Low Profile Designs
- 1-2 Lamp Applications

TRIAD® T5 ELECTRONIC BALLASTS

FOR F28 AND F35T5 LAMPS

Lamp		Line Volts	Catalog Number	Certification			Line Current (Amps)	Input Power (Watts)	Power Factor (PF)	Ballast Factor (BF)	Ballast Efficacy Factor (BEF)	THD %	Min. F/C Start Temp	Wiring Diag.	Dim.
Qty.	Starting Method			UL	SF	NOM									
F28T5 - One Lamp Applications															
1	PRS	120	B228PUNV-C	•	•	•	0.28	33	> .98	1.00	3.03	< 10	0/-18	37	-C
		277					0.12	33	> .95		3.00	< 15			
		120	B228PUNV90-C	•	•	•	0.11	29	> .99	0.90	3.10	< 10	0/-18	37	-C
		277					0.25	30	> .90		3.00	< 15			
1	RS	120	ES4528X	•	•	•	0.27	34	> .97	1.00	2.94	< 10	0/-18	40	ESX
		277	CBT213L-120 ■	•	•	•	0.12	30	> .50	0.96	3.20	< 150	0/-18	47	CBT
F28T5 - Two Lamp Applications															
2	SER-PRS	120	B228PUNV-C	•	•	•	0.55	66	> .98	1.00	1.52	< 10	0/-18	37	-C
		277					0.23	64	> .95		1.56	< 10			
		120	B228PUNV90-C	•	•	•	0.48	58	> .98	0.90	1.55	< 10	0/-18	37	-C
		277					0.21	56	> .98		1.61	< 10			
		120	B228PUNV95-D	•	•	•	0.50	58	> .99	0.95	1.64	< 10	0/-18	37	-D
		277					0.21	57	> .98		1.67	< 10			
120	B228PUNV115-D	•	•	•	0.59	69	> .99	1.15	1.67	< 10	0/-18	37	-D		
277					0.25	68	> .98		1.69	< 10					
F35T5 - One Lamp Applications															
1	PRS	120	ES4528X	•	•	•	0.34	42	> .97	1.00	2.38	< 10	0/-18	40	ESX
		277					0.15								

■ Add "B" for Bottom Exit or "S" for Side Exit or "BS" for Bottom Exit with 2" O.C. screw studs.

See page 2-38 for Dimensions and Wiring Diagrams

STARTING METHOD LEGEND

IS = Instant Start

PRS = Programmed Rapid Start

RS = Rapid Start

PAR-IS = Parallel Instant Start

PAR-PRS = Parallel Programmed Rapid Start

PAR-RS = Parallel Rapid Start

SER-RS = Series Rapid Start

TRIAD® T5HO ELECTRONIC BALLASTS

FOR F24, F39 AND F54 T5HO LAMPS

- Multiple Lamp Operation
- Programmed Rapid and Instant Starting Models
- T5HO Ballasts meet ANSI requirements for end-of-lamp life safety shutdown
- Super Low Profile Designs
- 1-4 Lamp Applications



T5HO

Fluorescent-Electronic

Lamp		Line Volts	Catalog Number	Certification			Line Current (Amps)	Input Power (Watts)	Power Factor (PF)	Ballast Factor (BF)	Ballast Efficacy Factor (BEF)	THD %	Min. F/C Start Temp	Wiring Diag.	Dim.
Qty.	Starting Method			UL	SF	NOM									
F24T5HO - One Lamp Applications															
1	PRS	120 277	B224PUNV-C	•	•	•	0.23 0.10	28	> .98 > .95	1.06	3.79	< 10	0/-18	37	-C
F24T5HO - Two Lamp Applications															
2	SER-PRS	120 277	B224PUNV-C	•	•	•	0.45 0.19	53 52	> .98	1.00	1.89 1.92	< 10	0/-18	37	-C
		120 277	B239PUNV-D	•	•	•	0.51 0.22	59	> .98 > .95	1.15	1.95	< 10	0/-18	37	-D
F39T5HO - One Lamp Applications															
1	PRS	120 277	B224PUNV-C	•	•	•	0.34 0.15	41 40	> .98	0.95	2.32 2.38	< 10	0/-18	37	-C
		120 277	B239PUNV-D	•	•	•	0.39 0.18	47	> .98 > .95	1.10	2.34	< 10	0/-18	37	-D
F39T5HO - Two Lamp Applications															
2	SER-PRS	120 277	B239PUNV-D	•	•	•	0.75 0.32	89 88	> .98	1.00	1.12 1.14	< 10	0/-18	37	-D
F54T5HO - One Lamp Applications															
1	PRS	347 480	B254PHRVHB-E	•	•	•	0.19 0.15	66	> .98 > .90	1.02	1.55	< 10 < 15	0/-18	42	-E
		120 277	B254PUNV-D	•	•	•	0.52 0.23	63 62	> .99 > .95	1.02	1.62 1.65	< 10	0/-18	37	-D
		120 277	B254PUNVHB-D	•	•	•	0.52 0.23	63 62	> .99 > .95	1.02	1.62 1.65	< 10	0/-18	37	-D
		347	B254P347-D	•	•	•	0.19	64	> .95	1.02	1.59	< 10	0/-18	4b	-D
		120 277	B454PUNV-E	•	•	•	1.01 0.44	121 116	> .95	1.00	0.83 0.86	< 10 < 15	0/-18	44	-E
F54T5HO - Two Lamp Applications															
2	SER-PRS	347 480	B254PHRVHB-E	•	•	•	0.35 0.26	120 119	> .98 > .95	1.00	0.83 0.84	< 10	0/-18	41	-E
		120 277	B254PUNV-D	•	•	•	1.03 0.43	120 117	> .99 > .98	1.00	0.83 0.85	< 10	0/-18	37	-D
		120 277	B254PUNVHB-E	•	•	•	1.03 0.43	120 117	> .99 > .98	1.00	0.83 0.85	< 10	0/-18	37	-D
		347	B254P347-D	•	•	•	0.35	120	> .98	1.00	0.83	< 10	0/-18	4b	-D
		120 277	B454PUNV-E	•	•	•	1.01 0.44	121 116	> .95	1.00	0.83 0.86	< 10 < 15	0/-18	44	-E
F54T5HO - Three Lamp Applications															
3	SER-PRS	120 277	B454PUNV-E	•	•	•	1.52 0.66	181 178	> .98 > .95	1.05	0.58 0.59	< 10	0/-18	44	-E
		120 277	B454PUNVHB-E	•	•	•	1.52 0.66	184 182	> .98 > .95	1.05	0.57 0.58	< 10	0/-18	44	-E
F54T5HO - Four Lamp Applications															
4	SER-PRS	120 277	B454PUNV-E	•	•	•	2.01 0.86	240 234	> .98 > .99	1.00	0.42 0.43	< 10	0/-18	44	-E
		120 277	B454PUNVHB-E	•	•	•	1.96 0.84	235 229	> .98 > .99	1.00	0.43 0.44	< 10	0/-18	44	-E
F80T5HO - One Lamp Applications															
1	PRS	120 277	ES4515K	•	•	•	0.73 0.32	87 86	> .97	1.00	1.15 1.16	< 10	0/-18	43	ESK

See page 2-38 for Dimensions and Wiring Diagrams

IS = Instant Start
 PRS = Programmed Rapid Start
 RS = Rapid Start

STARTING METHOD LEGEND
 PAR-IS = Parallel Instant Start
 PAR-PRS = Parallel Programmed Rapid Start

PAR-RS = Parallel Rapid Start
 SER-RS = Series Rapid Start

Overall Dimensions		Mounting Dimensions			
Draw #	L	W	H	M	X
-C	14.25"	1.18"	1.00"	13.75"	—
CBT	3.86"	2.00"	1.00"	3.50"	—
-D	16.88"	1.18"	1.00"	16.20"	—
-E	16.88"	1.74"	1.18"	16.28"	—
ESK	16.65"	1.24"	1.00"	16.30"	—
ESX	14.13"	1.24"	0.73"	13.78"	—

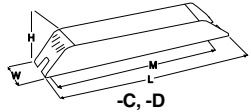

-C, -D

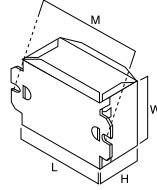

CBT

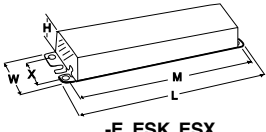

-E, ESK, ESX

T5 ballasts incorporate poke in connectors, for easy installation

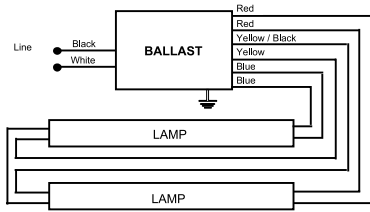

DIAGRAM 41

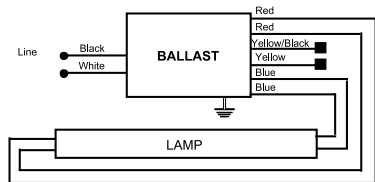

DIAGRAM 42

For one lamp operation, individually cap yellow and yellow/black leads, insulate to 600V.

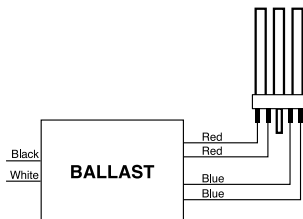

DIAGRAM 47

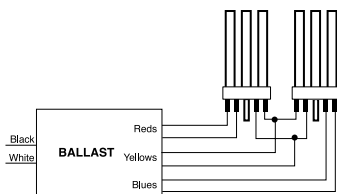

DIAGRAM 48

WIRING DIAGRAMS

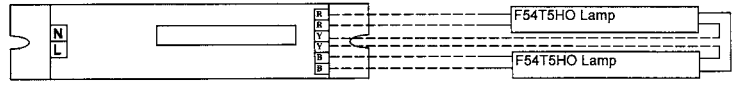

DIAGRAM 4b

FOR ONE LAMP OPERATION
CAP YELLOW LEADS INDIVIDUALLY

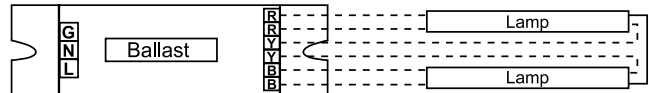

DIAGRAM 37

FOR ONE LAMP OPERATION, CAP YELLOW LEADS INDIVIDUALLY

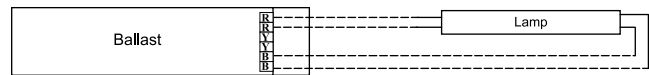

DIAGRAM 40

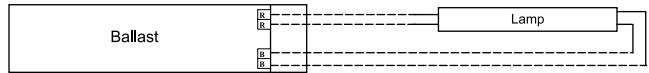

DIAGRAM 43

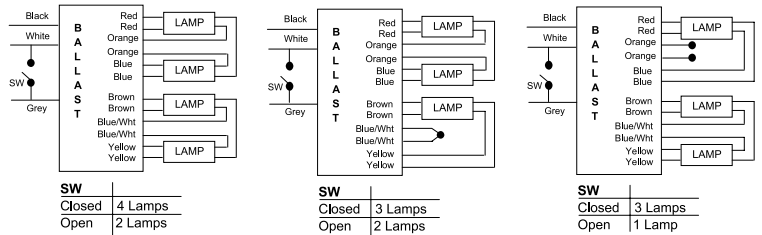

DIAGRAM 44

Application Notes:

- "SW" controls the lamps connected between the Brown and Yellow leads
- For lamp switching applications, connect "SW" between the white and the grey leads as shown in the wiring diagram above OR between the Black and Grey leads. The switch "SW" may be an on-off switch, an occupancy sensor, a relay, etc.
- If lamp switching is not required, short the white and grey leads OR the black and the grey leads
- A single control device, "SW", may be connected to control multiple ballasts
- For three lamp use: Short Blue/White leads or Orange leads and cap

TRIAD® ELECTRONIC BALLASTS

FOR (1), (2) AND (3) F30T12, F30T12ES, & (2)F32T12 LAMPS

- Rapid Starting Options
- Standard & High Performance Models
- 1-3 Lamp Applications

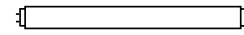

**F30T12,
F30T12ES,
F32T12**

Lamp Qty.	Starting Method	Line Volts	Catalog Number	Certification			Line Current (Amps)	Input Power (Watts)	Power Factor (PF)	Ballast Factor (BF)	Ballast Efficacy Factor (BEF)	THD %	Min. F/C Start Temp	Wiring Diag.	Dim.
				UL	SP	NOM									
F30T12 - One Lamp Applications															
1	RS	120	B140R120HP	•	•		0.26	30	> .95	0.91	3.03	< 10	50/10	2	ST
		277	B140R277HP	•	•		0.11	30	> .95	0.91	3.03	< 10	50/10	2	ST
		120	B240R120HP	•	•	•	0.33	37	> .95	1.05	2.84	< 10	50/10	4	ST
		277	B240R277HP	•	•		0.14	37	> .95	1.05	2.84	< 10	50/10	4	ST
F30T12 - Two Lamp Applications															
2	PAR-RS	120	B240R120RH	•	•		0.51	59	> .95	0.92	1.56	< 20	50/10	4	ST
		120	B240R120HP	•	•	•	0.50	60	> .95	0.92	1.53	< 10	50/10	4	ST
		277	B240R277HP	•	•		0.22	60	> .95	0.92	1.53	< 10	50/10	4	ST
F30T12 - Three Lamp Applications															
3	PAR-RS	120	B340R120HP	•	•		0.75	90	> .98	0.91	1.01	< 10	50/10	5	ST
		277	B340R277HP	•	•		0.33	90	> .98	0.91	1.01	< 10	50/10	5	ST
F30T12ES - One Lamp Applications															
1	RS	120	B140R120HP	•	•		0.24	27	> .97	0.86	3.19	< 10	60/16	2	ST
		277	B140R277HP	•	•		0.10	27	> .97	0.86	3.19	< 10	60/16	2	ST
		120	B240R120HP	•	•	•	0.30	33	> .95	1.00	3.03	< 10	60/16	4	ST
		277	B240R277HP	•	•		0.13	33	> .95	1.00	3.03	< 10	60/16	4	ST
F30T12ES - Two Lamp Applications															
2	PAR-RS	120	B240R120HP	•	•	•	0.46	53	> .98	0.88	1.66	< 10	60/16	4	ST
		277	B240R277HP	•	•		0.20	53	> .98	0.88	1.66	< 10	60/16	4	ST
F30T12ES - Three Lamp Applications															
3	PAR-RS	120	B340R120HP	•	•		0.64	76	> .98	0.88	1.16	< 10	60/16	5	ST
		277	B340R277HP	•	•		0.28	76	> .98	0.88	1.16	< 10	60/16	5	ST
F32T12 - Two Lamp Applications															
2	SER-RS	120	B234SR120M-A	•	•		0.48	56	> .98	0.90	1.61	< 25	50/10	2	-A

STARTING METHOD LEGEND

IS = Instant Start
 PRS = Programmed Rapid Start
 RS = Rapid Start

PAR-IS = Parallel Instant Start
 PAR-PRS = Parallel Programmed Rapid Start

PAR-RS = Parallel Rapid Start
 SER-RS = Series Rapid Start

Overall Dimensions			Mounting Dimensions		
Draw #	L	W	H	M	X
ST	9.50"	2.40"	1.55"	8.89"	1.69"
-A	9.50"	1.70"	1.18"	8.89"	1.69"

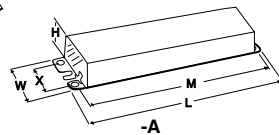
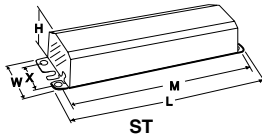

WIRING DIAGRAMS

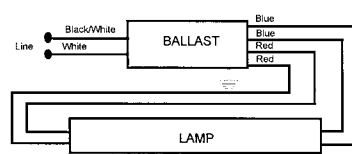
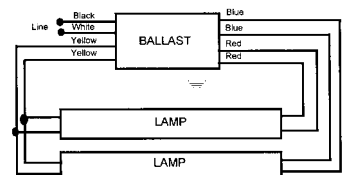

DIAGRAM 2



For One lamp Operation, Individually Cap blue leads, Insulate to 600V

DIAGRAM 4

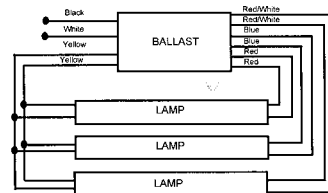
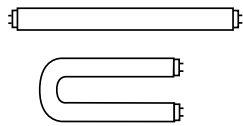

DIAGRAM 5

F40T12 & F34T12ES



- Standard & High Performance Models
- Rapid Starting Options
- 1-3 Lamp Applications

TRIAD® ELECTRONIC BALLASTS

FOR (1), (2) AND (3)
F40T12 AND F34T12ES LAMPS

Lamp Qty.	Starting Method	Line Volts	Catalog Number	Certification			Line Current (Amps)	Input Power (Watts)	Power Factor (PF)	Ballast Factor (BF)	Ballast Efficacy Factor (BEF)	THD %	Min. F/C Start Temp	Wiring Diag.	Dim.
				UL	SP	NOM									
F40T12 - One Lamp Applications															
1	RS	120	B140R120HP	•	•		0.33	38	>.99	0.88	2.32	< 10	50/10	2	ST
		277	B140R277HP	•	•		0.14	38	>.99	0.88	2.32	< 10	50/10	2	ST
		120	B134R120M-A	•	•		0.36	36	>.90	0.86	2.39	< 30	50/10	2	-A
		277	B234SR277M-A	•	•		0.17	42	>.88	0.94	2.24	< 30	50/10	4	-A
		120	B240R120RH	•	•		0.41	46	>.90	1.09	2.37	< 20	50/10	4	ST
		120	B240R120HP	•	•	•	0.42	46	>.98	1.02	2.22	< 10	50/10	4	ST
		277	B240R277HP	•	•		0.18	46	>.98	1.02	2.22	< 10	50/10	4	ST
F40T12 - Two Lamp Applications															
2	PAR-RS	120	B240R120RH	•	•		0.62	73	>.98	0.89	1.22	< 20	50/10	4	ST
		120	B240R120HP	•	•	•	0.65	75	>.99	0.90	1.20	< 10	50/10	4	ST
		277	B240R277HP	•	•		0.28	74	>.99	0.90	1.22	< 10	50/10	4	ST
		120	B340R120HP	•	•		0.70	84	>.98	1.04	1.24	< 10	50/10	5	ST
		277	B340R277HP	•	•		0.31	84	>.98	1.04	1.24	< 10	50/10	5	ST
2	SER-RS	120	B234SR120M-A	•	•		0.63	71	>.90	0.90	1.27	< 30	50/10	30	-A
		277	B234SR277M-A	•	•		0.26	70	>.90	0.87	1.24	< 30	50/10	4	-A
F40T12 - Three Lamp Applications															
3	PAR-RS	120	B340R120HP	•	•		0.94	113	>.99	0.88	0.78	< 10	50/10	5	ST
		277	B340R277HP	•	•		0.41	113	>.99	0.88	0.78	< 10	50/10	5	ST
F34T12ES - One Lamp Applications															
1	RS	120	B140R120HP	•	•		0.28	32	>.98	0.86	2.69	< 10	60/16	2	ST
		277	B140R277HP	•	•		0.12	32	>.98	0.86	2.69	< 10	60/16	2	ST
		120	B134R120M-A	•	•		0.30	31	>.90	0.86	2.77	< 30	60/16	2	-A
		277	B234SR277M-A	•	•		0.15	25	>.80	0.94	2.69	< 30	50/10	4	-A
		120	B240R120RH	•	•		0.36	39	>.89	1.10	2.82	< 20	60/16	4	ST
		120	B240R120HP	•	•	•	0.35	39	>.98	0.97	2.49	< 10	60/16	4	ST
277	B240R277HP	•	•		0.15	39	>.98	0.97	2.49	< 10	60/16	4	ST		
F34T12ES - Two Lamp Applications															
2	PAR-RS	120	B240R120RH	•	•		0.53	62	>.95	0.89	1.44	< 20	60/16	4	ST
		120	B240R120HP	•	•	•	0.54	63	>.99	0.86	1.37	< 10	60/16	4	ST
		277	B240R277HP	•	•		0.23	63	>.99	0.86	1.37	< 10	60/16	4	ST
2	SER-RS	120	B234SR120M-A	•	•		0.49	59	>.90	0.86	1.46	< 30	60/16	30	-A
		277	B234SR277M-A	•	•		0.23	60	>.90	0.87	1.45	< 30	50/10	4	-A
F34T12ES - Three Lamp Applications															
3	PAR-RS	120	B340R120HP	•	•		0.78	93	>.99	0.86	0.92	< 10	60/16	5	ST
		277	B340R277HP	•	•		0.34	93	>.99	0.86	0.92	< 10	60/16	5	ST

Fluorescent-Electronic

Overall Dimensions		Mounting Dimensions			
Draw #	L	W	H	M	X
ST	9.50"	2.40"	1.55"	8.89"	1.69"
-A	9.50"	1.70"	1.18"	8.89"	1.69"

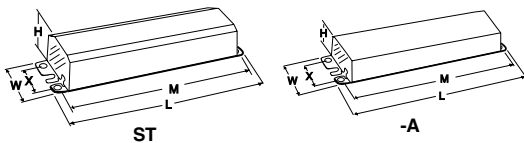

WIRING DIAGRAMS

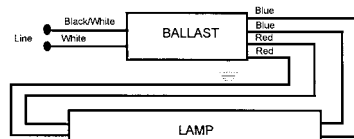
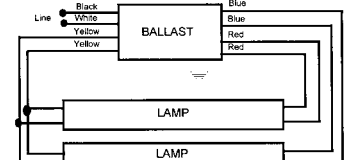

DIAGRAM 2



For One Lamp Applications, individually cap blue leads, Insulate to 600V

DIAGRAM 4

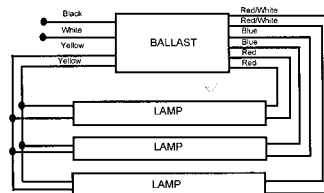
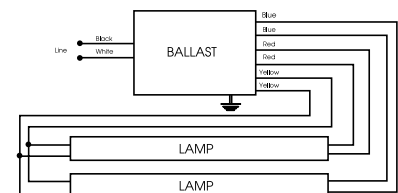

DIAGRAM 5



For One Lamp Operation, Individually cap yellow leads, Insulate to 600V

DIAGRAM 30

TRIAD® ELECTRONIC BALLASTS

FOR F48T12, F48T12ES, F60T12, F64T12 & F72T12 LAMPS

- Standard & High Performance Models
- Instant Starting Options
- 1-2 Lamp Applications

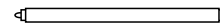

T12 SLIMLINE

Fluorescent-Electronic

Lamp Qty.	Starting Method	Line Volts	Catalog Number	Certification			Line Current (Amps)	Input Power (Watts)	Power Factor (PF)	Ballast Factor (BF)	Ballast Efficacy Factor (BEF)	THD %	Min. F/C Start Temp	Wiring Diag.	Dim.
				UL	SP	NOM									
F48T12 - One Lamp Applications															
1	IS	120	B260IUNVHP	•	•	•	0.39	47	> .95	1.10	2.34	< 10	0/-18	14	SL
		277					0.18								
F48T12 - Two Lamp Applications															
2	PAR-IS	120	B260I120RH	•	•	•	0.68	76	> .95	0.92	1.21	< 20	0/-18	14	ST
		120	B260I120M-A	•	•	•	0.62	68	> .90	0.90	1.32	< 30	50/10	14	-A
		277	B260IUNVHP	•	•	•	0.61	75	> .98	0.95	1.27	< 10	0/-18	14	SL
		277					0.27	74	> .95		1.28				
F48T12ES - One Lamp Applications															
1	IS	120	B260IUNVHP	•	•	•	0.32	38	> .98	1.10	2.89	< 10	60/16	14	SL
		277					0.15	39	> .95		2.82				
F48T12ES - Two Lamp Applications															
2	PAR-IS	120	B260I120RH	•	•	•	0.60	64	> .95	0.92	1.44	< 20	60/16	14	ST
		120	B260IUNVHP	•	•	•	0.57	67	> .95	0.93	1.39	< 10	60/16	14	SL
		277					0.25	66	> .95		1.41				
		277													
F60T12 - One Lamp Applications															
1	PAR-IS	120	B260I120RH	•	•	•	0.46	55	> .95	1.02	1.85	< 20	0/-18	14	ST
		120	B260IUNVHP	•	•	•	0.49	58	> .98	1.10	1.90	< 10	0/-18	14	SL
		277					0.22				1.01				
		277													
F60T12 - Two Lamp Applications															
2	PAR-IS	120	B260I120RH	•	•	•	0.74	89	> .95	0.90	1.01	< 20	0/-18	14	ST
		120	B260IUNVHP	•	•	•	0.77	92	> .98	0.92	1.00	< 10	0/-18	14	SL
		277					0.33	91			1.01				
		277													
F64T12 - One Lamp Applications															
1	PAR-IS	120	B260I120RH	•	•	•	0.49	59	> .95	1.03	1.75	< 20	0/-18	14	ST
		120	B260IUNVHP	•	•	•	0.51	61	> .98	1.10	1.80	< 10	0/-18	14	SL
		277					0.35	96	> .95		1.15				
		277													
F64T12 - Two Lamp Applications															
2	PAR-IS	120	B260I120RH	•	•	•	0.80	95	> .95	0.90	0.95	< 20	0/-18	14	ST
		120	B260IUNVHP	•	•	•	0.81	97	> .98	0.92	0.95	< 10	0/-18	14	SL
		277					0.35	96			0.96				
		277													
F72T12 - One Lamp Applications															
1	IS	120	B260I120RH	•	•	•	0.60	66	> .95	1.04	1.58	< 20	0/-18	14	ST
		120	B260IUNVHP	•	•	•	0.55	68	> .95	1.06	1.56	< 10	0/-18	14	SL
		277					0.25	67			1.58				
		277													

STARTING METHOD LEGEND

IS = Instant Start
 PRS = Programmed Rapid Start
 RS = Rapid Start

PAR-IS = Parallel Instant Start
 PAR-PRS = Parallel Programmed Rapid Start

PAR-RS = Parallel Rapid Start
 SER-RS = Series Rapid Start

Draw #	Overall Dimensions		Mounting Dimensions		
	L	W	H	M	X
SL	11.75"	3.13"	1.78"	11.14"	2.00"
-A	9.50"	1.70"	1.18"	8.89"	1.69"
ST	9.50"	2.40"	1.55"	8.89"	1.69"

WIRING DIAGRAMS

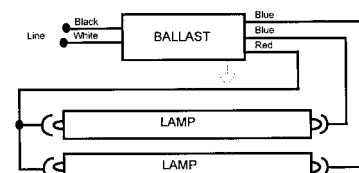

For One Lamp Operation, Insulate one blue lead to 600V

DIAGRAM 14

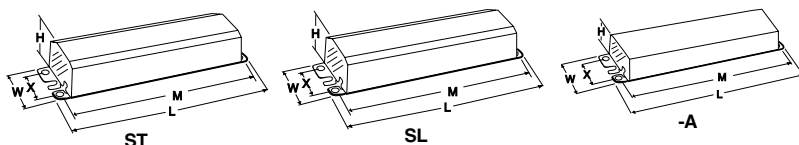

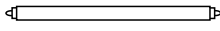

- Standard & High Performance Models
- Instant Starting Options
- 1-2 Lamp Applications

TRIAD® ELECTRONIC BALLASTS

F72T12(cont.), F84T12, F96T12 & F96T12ES LAMPS

Lamp Qty.	Starting Method	Line Volts	Catalog Number	Certification			Line Current (Amps)	Input Power (Watts)	Power Factor (PF)	Ballast Factor (BF)	Ballast Efficacy Factor (BEF)	THD %	Min. F/C Start Temp	Wiring Diag.	Dim.
				UL	SP	NOM									
F72T12 - Two Lamp Applications															
2	PAR-IS	120	B260I120RH	•	•	0.92	107	> .95	0.90	0.84	< 20	0/-18	14	ST	
		120	B260I120M-A	•	•	0.90	105	> .95	0.90	0.86	< 30	50/10	14	-A	
		120	B260IUNVHP	•	•	0.90	109	> .99	0.91	0.83	< 10	0/-18	14	SL	
		277	B260IUNVHP	•	•	0.39	107	> .99	0.91	0.85	< 10	0/-18	14	SL	
F84T12 - One Lamp Applications															
1	IS	120	B260I120RH	•	•	0.63	74	> .95	1.05	1.42	< 20	0/-18	14	ST	
		120	B260IUNVHP	•	•	0.63	76	> .98	1.10	1.45	< 10	0/-18	14	-A	
		277	B260IUNVHP	•	•	0.28	75	> .98	1.10	1.47	< 10	0/-18	14	-A	
F84T12 - Two Lamp Applications															
2	PAR-IS	120	B260I120RH	•	•	1.02	120	> .95	0.88	0.73	< 20	0/-18	14	ST	
		120	B260IUNVHP	•	•	1.03	123	> .98	0.88	0.72	< 10	0/-18	14	-A	
		277	B260IUNVHP	•	•	0.44	120	> .98	0.88	0.73	< 10	0/-18	14	-A	
F96T12 - One Lamp Applications															
1	IS	120	B260I120RH	•	•	0.73	83	> .95	1.02	1.23	< 20	0/-18	14	ST	
		120	B260IUNVHP	•	•	0.70	85	> .98	1.05	1.24	< 10	0/-18	14	SL	
		120	B260IUNVHP	•	•	0.31	84	> .98	1.05	1.25	< 10	0/-18	14	SL	
		277	B260IUNVHP	•	•	0.31	84	> .98	1.05	1.25	< 10	0/-18	14	SL	
F96T12 - Two Lamp Applications															
2	PAR-IS	120	B260I120RH	•	•	1.16	133	> .95	0.86	0.65	< 20	0/-18	14	ST	
		120	B260IUNVHP	•	•	1.16	139	> .99	0.88	0.63	< 10	0/-18	14	SL	
		277	B260IUNVHP	•	•	0.50	137	> .99	0.88	0.64	< 10	0/-18	14	SL	
F96T12ES - One Lamp Applications															
1	IS	120	B260I120RH	•	•	0.60	66	> .95	1.05	1.59	< 20	60/16	14	ST	
		120	B260I120M-A	•	•	0.61	66	> .90	1.09	1.65	< 30	60/16	14	-A	
		120	B260IUNVHP	•	•	0.59	72	> .98	1.03	1.43	< 10	60/16	14	SL	
		277	B260IUNVHP	•	•	0.26	70	> .98	1.03	1.47	< 10	60/16	14	SL	
F96T12ES - Two Lamp Applications															
2	PAR-IS	120	B260I120RH	•	•	0.93	107	> .95	0.88	0.82	< 20	60/16	14	ST	
		120	B260I120M-A	•	•	0.90	105	> .95	0.88	0.84	< 30	60/16	14	-A	
		120	B260IUNVHP	•	•	0.96	112	> .99	0.88	0.79	< 10	60/16	14	SL	
		277	B260IUNVHP	•	•	0.40	110	> .99	0.88	0.80	< 10	60/16	14	SL	

STARTING METHOD LEGEND

IS = Instant Start

PRS = Programmed Rapid Start

RS = Rapid Start

PAR-IS = Parallel Instant Start

PAR-PRS = Parallel Programmed Rapid Start

PAR-RS = Parallel Rapid Start

SER-RS = Series Rapid Start

Draw #	Overall Dimensions			Mounting Dimensions		
	L	W	H	M	X	
SL	11.75"	3.13"	1.78"	11.14"	2.00"	
-A	9.50"	1.70"	1.18"	8.89"	1.69"	
ST	9.50"	2.40"	1.55"	8.89"	1.69"	

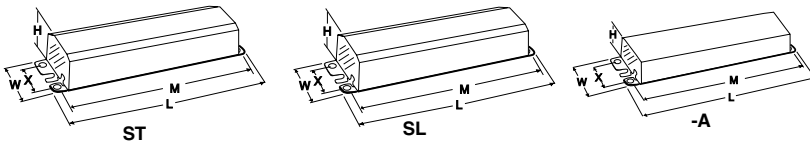

WIRING DIAGRAMS

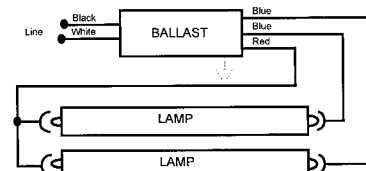

For One Lamp Operation, Insulate one blue lead to 600V

DIAGRAM 14

TRIAD® ELECTRONIC BALLASTS

FOR T12 HIGH OUTPUT LAMPS

- High Performance Models
- Rapid Starting Options
- 2 Lamp Applications

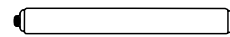

T12HO

Fluorescent-Electronic

Lamp Qty.	Starting Method	Line Volts	Catalog Number	Certification			Line Current (Amps)	Input Power (Watts)	Power Factor (PF)	Ballast Factor (BF)	Ballast Efficacy Factor (BEF)	THD %	Min. F/C Start Temp	Wiring Diag.	Dim.
				UL	SP	NOM									
F48T12HO - Two Lamp Applications															
2	SER-RS	120 277	B295SRUNVHP	•	•		0.92 0.40	110 109	> .98	0.89	0.81 0.82	< 10	-20/-29	4	SL
F60T12HO - Two Lamp Applications															
2	SER-RS	120 277	B295SRUNVHP	•	•		1.11 0.48	134 132	> .98	0.89	0.66 0.67	< 10	-20/-29	4	SL
F72T12HO - Two Lamp Applications															
2	SER-RS	120	B295SR120HP	•	•		1.40	169	> .99	0.95	0.56	< 10	-20/-29	4	SL
		120 277	B295SRUNVHP ^o	•	•		1.40 0.61	162 160	> .99	0.89	0.55 0.56	< 10	-20/-29	4	SL
F73T12/BL/HO - Two Lamp Applications															
2	SER-RS	120	493B2	•	•		1.60	180	> .90	1.00	0.56	< 25	50/10	4	ST
F84T12HO - Two Lamp Applications															
2	SER-RS	120	B295SR120HP	•	•		1.60	185	> .99	0.89	0.48	< 10	-20/-29	4	SL
		120 277	B295SRUNVHP ^o	•	•		1.60 0.69	176 173	> .99	0.89	0.48 0.49	< 10	-20/-29	4	SL
F96T12HO - Two Lamp Applications															
2	SER-RS	120	B295SR120HP	•	•		1.77	208	> .99	0.88	0.43	< 10	-20/-29	4	SL
		120 277	B295SRUNVHP ^o	•	•		1.77 0.76	205 209	> .99	0.88	0.43 0.44	< 10	-20/-29	4	SL
F96T12HOES - Two Lamp Applications															
2	SER-RS	120	B295SR120HP	•	•		1.47	174	> .99	0.88	0.51	< 10	60/16	4	SL
		120 277	B295SRUNVHP ^o	•	•		1.47 0.63	174 171	> .99	0.88	0.51	< 10	60/16	4	SL

^o Preliminary Data

STARTING METHOD LEGEND

IS = Instant Start
PRS = Programmed Rapid Start
RS = Rapid Start

PAR-IS = Parallel Instant Start
PAR-PRS = Parallel Programmed Rapid Start

PAR-RS = Parallel Rapid Start
SER-RS = Series Rapid Start

Overall Dimensions		Mounting Dimensions			
Draw #	L	W	H	M	X
ST	9.50"	2.40"	1.55"	8.89"	1.69"
SL	11.75"	3.13"	1.78"	11.14"	2.00"

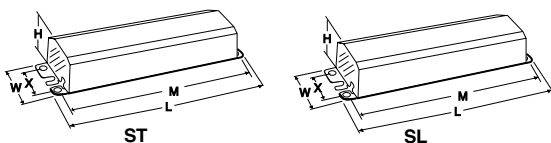

WIRING DIAGRAMS

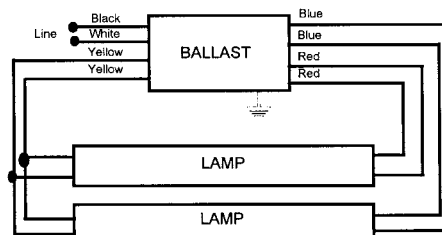
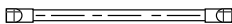

DIAGRAM 4



- Programmed Rapid Starting Options
- 1-2 Lamp Applications

TRIAD® ELECTRONIC BALLASTS

FOR F6T2, F8T2, F11T2 AND F13T2 LAMPS

Lamp		Line Volts	Catalog Number	Certification			Line Current (Amps)	Input Power (Watts)	Power Factor (PF)	Ballast Factor (BF)	Ballast Efficacy Factor (BEF)	THD %	Min. F/C Start Temp	Wiring Diag.	Dim.
Qty.	Starting Method			UL	SE	NOM									
F6T2 - One And Two Lamp Applications															
2	SER-PRS	120	ES1786X	•	•	0.12	14	> .97	1.00	7.14	< 10	0/-18	37	ESX	
		277				0.07	15			6.67					
1	PRS	120	ES1786X	•	•	0.07	8	> .97	1.00	12.50	< 10	0/-18	37	ESX	
		277				0.05	9			11.11					
F8T2 - One And Two Lamp Applications															
2	SER-PRS	120	ES1786X	•	•	0.17	20	> .97	1.00	5.00	< 10	0/-18	37	ESX	
		277				0.08	21			4.76					
1	PRS	120	ES1786X	•	•	0.10	11	> .97	1.00	9.09	< 10	0/-18	37	ESX	
		277				0.06									
F11T2 - One And Two Lamp Applications															
2	SER-PRS	120	ES1786X	•	•	0.20	26	> .97	1.00	3.85	< 10	0/-18	37	ESX	
		277				0.09	32			3.13					
1	PRS	120	ES1786X	•	•	0.12	15	> .97	1.00	6.67	< 10	0/-18	37	ESX	
		277				0.07									
F13T2 - One And Two Lamp Applications															
2	SER-PRS	120	ES1786X	•	•	0.27	31	> .97	1.00	3.23	< 10	0/-18	37	ESX	
		277				0.13	32			3.13					
1	PRS	120	ES1786X	•	•	0.15	16	> .97	1.00	6.25	< 10	0/-18	37	ESX	
		277				0.08	17			5.88					

STARTING METHOD LEGEND

IS = Instant Start
 PRS = Programmed Rapid Start
 RS = Rapid Start

PAR-IS = Parallel Instant Start
 PAR-PRS = Parallel Programmed Rapid Start

PAR-RS = Parallel Rapid Start
 SER-RS = Series Rapid Start

Overall Dimensions		Mounting Dimensions			
Draw #	L	W	H	M	X
ESX	14.13"	1.24"	0.73"	13.78"	—

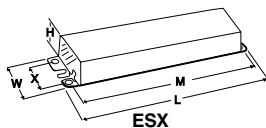

WIRING DIAGRAMS

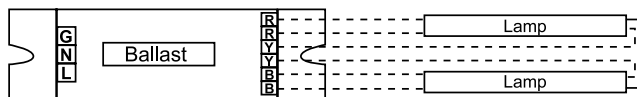

FOR ONE LAMP OPERATION, CAP YELLOW LEADS INDIVIDUALLY

DIAGRAM 37

Energy Management System

DCL[®] with DEMANDflex[®]

DEMANDflex[®] ballasts are high efficiency program start ballasts with the flexibility to be tuned at the circuit level to fixed power levels during installation. They are fully compatible with occupancy sensors and exceed the CEE requirements for high efficiency program start T8 ballasts. DEMANDflex[®] ballasts having tuning capabilities with ranges from 100% to 50% power levels, making them applicable for a wide range of lighting installations.

Installations can start with DEMANDflex[®] ballasts and after installation, the ballasts can be tuned to maximize energy savings with fixed light levels. No dimming control wires are associated with DEMANDflex[®] ballasts which makes them easy to install in all existing fluorescent lighting applications. DEMANDflex[®] ballasts can also be integrated with DCL[®] controls to be part of the most cost-effective lighting system available.

DCL[®] controls allow for local control with energy management systems and external control via the internet for networked managed systems. DCL[®] controls allow for integration with utility demand response programs that provide for improved pricing contracts to end-users in exchange for the utility to have the ability to lower lighting power levels during periods of high demand.



Product Overview

DEMANDflex® Ballasts

- Power level tuning potential to 50%
 - Set the circuit power level at installation
 - Typical 10% to 15% power reduction
- Install the same as standard PRS ballasts
 - No control wires necessary
 - Standard mounting footprint
 - Same wiring as program rapid start ballasts
- High efficiency program start operation
 - Exceeds CEE T8 requirements
 - Compatible with occupancy sensors
- NEMA premium
 - Exceeds CEE T8 requirements
 - Compatible with occupancy sensors

DCL® Controlled Systems

- Reduces lighting power by up to 50%
 - Avoid high peak charges
 - Reduce demand costs
- Programmable fade rates
 - Gradual transitions
 - No disruptions
- Use existing power connections to communicate to the ballasts
 - No control wires
- Implement with various controls and systems
 - BAS Systems
 - Photo Cells
 - Occupancy Sensors
 - Contact Closure

For more information contact Universal or visit www.unvlt.com.

- Universal DCL® Dimming
- Programmed Rapid Start
- 1, 2, 3, & 4 Lamp Applications
- Visit www.unvlt.com for a comprehensive description of the DCL® system and DEMANDflex® ballasts

Lamp		Line Volts	Catalog Number	CertificationLine		Input Current (Amps)	Power Power (Watts)	Ballast Factor (PF)	Ballast Factor (BF)	Efficacy Factor (BEF)	Min. F/C THD %	Start Temp	Wiring Diag.	Dim.		
Qty.	Starting Method			c	UL											
F32T8 - One Lamp Applications																
1	PRS	120	B232PUNVDR-A @ 100%	•	•	0.24	29	> .95	0.88	3.01	< 10	32/0	12a	-A		
			B232PUNVDR-A @ 50%	•	•	0.11	14	> .95	0.28	2.05	< 15	32/0	12a	-A		
		277	B232PUNVDR-A @ 100%	•	•	0.11	29	> .95	0.88	3.03	< 10	32/0	12a	-A		
			B232PUNVDR-A @ 50%	•	•	0.05	14	> .90	0.28	1.96	< 15	32/0	12a	-A		
		120	B232PUNVDRH-A @ 100%	•	•	0.32	38	> .95	1.15	3.03	< 10	32/0	12a	-A		
			B232PUNVDRH-A @ 50%	•	•	0.15	18	> .95	0.50	2.78	< 10	32/0	12a	-A		
		277	B232PUNVDRH-A @ 100%	•	•	0.14	39	> .95	1.15	2.95	< 10	32/0	12a	-A		
			B232PUNVDRH-A @ 50%	•	•	0.07	19	> .95	0.50	2.63	< 10	32/0	12a	-A		
		120	B232PUNVDRL-A @ 100%	•	•	0.20	24	> .95	0.68	2.85	< 10	32/0	12a	-A		
			B232PUNVDRL-A @ 50%	•	•	0.09	11	> .95	0.18	1.64	< 10	32/0	12a	-A		
		277	B232PUNVDRL-A @ 100%	•	•	0.09	24	> .95	0.68	2.85	< 10	32/0	12a	-A		
			B232PUNVDRL-A @ 50%	•	•	0.05	12	> .95	0.18	1.57	< 10	32/0	12a	-A		
		F32T8 - Two Lamp Applications														
		2	PRS	120	B232PUNVDR-A @ 100%	•	•	0.47	57	> .95	0.87	1.53	< 10	32/0	12b	-A
B232PUNVDR-A @ 50%	•				•	0.22	28	> .95	0.34	1.20	< 10	32/0	12b	-A		
277	B232PUNVDR-A @ 100%			•	•	0.20	56	> .95	0.87	1.56	< 10	32/0	12b	-A		
	B232PUNVDR-A @ 50%			•	•	0.10	28	> .95	0.35	1.22	< 10	32/0	12b	-A		
120	B232PUNVDRH-A @ 100%			•	•	0.62	75	> .95	1.15	1.53	< 10	32/0	12b	-A		
	B232PUNVDRH-A @ 50%			•	•	0.30	37	> .90	0.50	1.35	< 10	32/0	12b	-A		
277	B232PUNVDRH-A @ 100%			•	•	0.26	73	> .95	1.15	1.58	< 10	32/0	12b	-A		
	B232PUNVDRH-A @ 50%			•	•	0.13	36	> .90	0.50	1.39	< 10	32/0	12b	-A		
120	B232PUNVDRL-A @ 100%			•	•	0.40	47	> .95	0.71	1.51	< 10	32/0	12b	-A		
	B232PUNVDRL-A @ 50%			•	•	0.19	24	> .95	0.19	0.81	< 10	32/0	12b	-A		
277	B232PUNVDRL-A @ 100%			•	•	0.17	47	> .95	0.71	1.51	< 10	32/0	12b	-A		
	B232PUNVDRL-A @ 50%			•	•	0.09	24	> .95	0.19	0.81	< 10	32/0	12b	-A		
F32T8 - Three Lamp Applications																
3	PRS			120	B332PUNVDR-A @ 100%	•	•	0.70	85	> .95	0.87	1.02	< 10	32/0	12c	-A
		B332PUNVDR-A @ 50%	•		•	0.34	42	> .95	0.35	0.83	< 10	32/0	12c	-A		
		277	B332PUNVDR-A @ 100%	•	•	0.30	83	> .95	0.87	1.05	< 10	32/0	12c	-A		
			B332PUNVDR-A @ 50%	•	•	0.16	41	> .95	0.35	0.85	< 10	32/0	12c	-A		
		120	B332PUNVDRL-A @ 100%	•	•	0.59	72	> .95	0.71	0.99	< 10	32/0	12c	-A		
			B332PUNVDRL-A @ 50%	•	•	0.29	36	> .95	0.22	0.61	< 10	32/0	12c	-A		
		277	B332PUNVDRL-A @ 100%	•	•	0.25	72	> .95	0.71	0.99	< 10	32/0	12c	-A		
			B332PUNVDRL-A @ 50%	•	•	0.13	36	> .95	0.22	0.61	< 10	32/0	12c	-A		
		120	B332PUNVDRH-E @ 100%	•	•	0.95	115	> .95	1.15	1.00	< 10	32/0	12d	-A		
			B332PUNVDRH-E @ 50%	•	•	0.48	57	> .95	0.50	0.88	< 10	32/0	12d	-A		
		277	B332PUNVDRH-E @ 100%	•	•	0.41	111	> .95	1.15	1.04	< 10	32/0	12d	-A		
			B332PUNVDRH-E @ 50%	•	•	0.21	55	> .95	0.50	0.91	< 10	32/0	12d	-A		
		F32T8 - Four Lamp Applications														
		4	PRS	120	B432PUNVDR-E @ 100%	•	•	0.96	116	> .95	0.88	0.75	< 10	32/0	12e	-A
B432PUNVDR-E @ 50%	•				•	0.48	58	> .95	0.35	0.60	< 10	32/0	12e	-A		
277	B432PUNVDR-E @ 100%			•	•	0.41	112	> .95	0.88	0.79	< 10	32/0	12e	-A		
	B432PUNVDR-E @ 50%			•	•	0.20	56	> .95	0.35	0.63	< 15	32/0	12e	-A		
120	B432PUNVDRL-E @ 100%			•	•	0.78	93	> .95	0.71	0.76	< 10	32/0	12e	-A		
	B432PUNVDRL-E @ 50%			•	•	0.37	47	> .95	0.21	0.45	< 15	32/0	12e	-A		
277	B432PUNVDRL-E @ 100%			•	•	0.34	93	> .95	0.71	0.76	< 10	32/0	12e	-A		
	B432PUNVDRL-E @ 50%			•	•	0.17	47	> .95	0.21	0.45	< 15	32/0	12e	-A		

See page 3-7 for Dimensions and Wiring Diagrams

- Universal DCL[®] Dimming
- Programmed Rapid Start
- 1, 2, 3, & 4 Lamp Applications
- Visit www.unvlt.com for a comprehensive description of the DCL system and DEMANDflex ballasts

DEMANDflex[®]

FOR (1), (2), (3) & (4) LAMPS

Lamp Qty.	Starting Method	Line Volts	Catalog Number	Certification		Input Current (Amps)	Power Power (Watts)	Ballast Factor (PF)	Ballast Factor (BF)	Efficacy Factor (BEF)	Min. F/C THD %	Start Temp	Wiring Diag.	Dim.
				c	UL									
F25T8 - One Lamp Applications														
1	PRS	120	B232PUNVDR-A @ 100%	•	•	0.19	22	> .95	0.87	4.00	< 10	32/0	12a	-A
			B232PUNVDR-A @ 50%	•	•	0.10	12	> .95	0.35	2.93	< 15	32/0	12a	-A
		277	B232PUNVDR-A @ 100%	•	•	0.08	22	> .95	0.88	3.95	< 10	32/0	12a	-A
			B232PUNVDR-A @ 50%	•	•	0.05	13	> .90	0.35	2.82	< 10	32/0	12a	-A
		120	B232PUNVDRH-A @ 100%	•	•	0.25	30	> .95	1.16	3.87	< 10	32/0	12a	-A
			B232PUNVDRH-A @ 50%	•	•	0.12	14	> .95	0.50	3.57	< 10	32/0	12a	-A
		277	B232PUNVDRH-A @ 100%	•	•	0.11	30	> .95	1.16	3.81	< 10	32/0	12a	-A
			B232PUNVDRH-A @ 50%	•	•	0.06	15	> .90	0.50	3.33	< 10	32/0	12a	-A
		120	B232PUNVDRL-A @ 100%	•	•	0.15	18	> .95	0.69	3.85	< 10	32/0	12a	-A
			B232PUNVDRL-A @ 50%	•	•	0.08	10	> .95	0.18	1.84	< 15	32/0	12a	-A
		277	B232PUNVDRL-A @ 100%	•	•	0.07	18	> .95	0.69	3.77	< 10	32/0	12a	-A
			B232PUNVDRL-A @ 50%	•	•	0.04	10	> .95	0.18	1.75	< 15	32/0	12a	-A
F25T8 - Two Lamp Applications														
2	PRS	120	B232PUNVDR-A @ 100%	•	•	0.36	44	> .95	0.87	2.01	< 10	32/0	12b	-A
			B232PUNVDR-A @ 50%	•	•	0.19	23	> .95	0.35	1.56	< 10	32/0	12b	-A
		277	B232PUNVDR-A @ 100%	•	•	0.16	43	> .95	0.87	2.05	< 10	32/0	12b	-A
			B232PUNVDR-A @ 50%	•	•	0.09	23	> .95	0.35	1.53	< 10	32/0	12b	-A
		120	B232PUNVDRH-A @ 100%	•	•	0.46	55	> .95	1.15	2.09	< 10	32/0	12b	-A
			B232PUNVDRH-A @ 50%	•	•	0.21	26	> .90	0.50	1.92	< 10	32/0	12b	-A
		277	B232PUNVDRH-A @ 100%	•	•	0.20	55	> .95	1.15	2.08	< 10	32/0	12b	-A
			B232PUNVDRH-A @ 50%	•	•	0.10	26	> .90	0.50	1.92	< 10	32/0	12b	-A
		120	B232PUNVDRL-A @ 100%	•	•	0.30	36	> .95	0.69	1.93	< 10	32/0	12b	-A
			B232PUNVDRL-A @ 50%	•	•	0.15	18	> .95	0.19	1.06	< 10	32/0	12b	-A
		277	B232PUNVDRL-A @ 100%	•	•	0.13	35	> .95	0.69	1.95	< 10	32/0	12b	-A
			B232PUNVDRL-A @ 50%	•	•	0.07	18	> .95	0.19	1.03	< 10	32/0	12b	-A
F25T8 - Three Lamp Applications														
3	PRS	120	B332PUNVDR-A @ 100%	•	•	0.55	66	> .95	0.87	1.32	< 10	32/0	12c	-A
			B332PUNVDR-A @ 50%	•	•	0.27	33	> .95	0.35	1.06	< 10	32/0	12c	-A
		277	B332PUNVDR-A @ 100%	•	•	0.24	65	> .95	0.87	1.34	< 10	32/0	12c	-A
			B332PUNVDR-A @ 50%	•	•	0.13	32	> .95	0.35	1.09	< 15	32/0	12c	-A
		120	B332PUNVDRL-A @ 100%	•	•	0.47	56	> .95	0.71	1.27	< 10	32/0	12c	-A
			B332PUNVDRL-A @ 50%	•	•	0.24	28	> .95	0.23	0.81	< 10	32/0	12c	-A
		277	B332PUNVDRL-A @ 100%	•	•	0.21	55	> .95	0.71	1.29	< 10	32/0	12c	-A
			B332PUNVDRL-A @ 50%	•	•	0.11	29	> .90	0.23	0.80	< 10	32/0	12c	-A
		120	B332PUNVDRH-E @ 100%	•	•	0.74	89	> .95	1.17	1.31	< 10	32/0	12d	-A
			B332PUNVDRH-E @ 50%	•	•	0.35	42	> .95	0.50	1.19	< 15	32/0	12d	-A
		277	B332PUNVDRH-E @ 100%	•	•	0.33	89	> .95	1.17	1.31	< 10	32/0	12d	-A
			B332PUNVDRH-E @ 50%	•	•	0.16	43	> .95	0.50	1.16	< 15	32/0	12d	-A
F25T8 - Four Lamp Applications														
4	PRS	120	B432PUNVDR-E @ 100%	•	•	0.75	90	> .95	0.89	0.99	< 10	32/0	12e	-A
			B432PUNVDR-E @ 50%	•	•	0.37	44	> .95	0.35	0.80	< 15	32/0	12e	-A
		277	B432PUNVDR-E @ 100%	•	•	0.33	89	> .95	0.89	1.00	< 10	32/0	12e	-A
			B432PUNVDR-E @ 50%	•	•	0.17	44	> .90	0.35	0.80	< 15	32/0	12e	-A
		120	B432PUNVDRL-E @ 100%	•	•	0.61	73	> .95	0.71	0.97	< 10	32/0	12e	-A
			B432PUNVDRL-E @ 50%	•	•	0.31	37	> .95	0.21	0.56	< 15	32/0	12e	-A
		277	B432PUNVDRL-E @ 100%	•	•	0.27	72	> .95	0.71	0.98	< 10	32/0	12e	-A
			B432PUNVDRL-E @ 50%	•	•	0.15	38	> .90	0.21	0.56	< 15	32/0	12e	-A

See page 3-7 for Dimensions and Wiring Diagrams

DEMANDflex®

FOR (1), (2), (3) & (4) LAMPS

- Universal DCL® Dimming
- Programmed Rapid Start
- 1, 2, 3, & 4 Lamp Applications
- Visit www.unvlt.com for a comprehensive description of the DCL system and DEMANDflex ballasts

DEMANDflex
T8

Lamp		Line Volts	Catalog Number	CertificationLine		Input Current (Amps)	Power Power (Watts)	Ballast Factor (PF)	Ballast Factor (BF)	Efficacy Factor (BEF)	Min. F/C THD %	Start Temp	Wiring Diag.	Dim.		
Qty.	Starting Method			c	UL											
F17T8 - One Lamp Applications																
1	PRS	120	B232PUNVDR-A @ 100%	•	•	0.14	16	> .95	0.92	5.65	< 10	32/0	12a	-A		
			B232PUNVDR-A @ 50%	•	•	0.08	10	> .95	0.27	2.81	< 15	32/0	12a	-A		
		277	B232PUNVDR-A @ 100%	•	•	0.06	17	> .95	0.92	5.48	< 10	32/0	12a	-A		
			B232PUNVDR-A @ 50%	•	•	0.04	10	> .85	0.27	2.66	< 15	32/0	12a	-A		
		120	B232PUNVDRH-A @ 100%	•	•	0.18	22	> .95	1.15	5.23	< 10	32/0	12a	-A		
			B232PUNVDRH-A @ 50%	•	•	0.09	11	> .95	0.50	4.63	< 15	32/0	12a	-A		
		277	B232PUNVDRH-A @ 100%	•	•	0.09	22	> .95	1.15	5.23	< 10	32/0	12a	-A		
			B232PUNVDRH-A @ 50%	•	•	0.05	11	> .90	0.50	4.55	< 15	32/0	12a	-A		
		120	B232PUNVDRL-A @ 100%	•	•	0.11	13	> .95	0.70	5.47	< 10	32/0	12a	-A		
			B232PUNVDRL-A @ 50%	•	•	0.09	10	> .95	0.20	1.98	< 15	32/0	12a	-A		
		277	B232PUNVDRL-A @ 100%	•	•	0.05	13	> .95	0.70	5.22	< 10	32/0	12a	-A		
			B232PUNVDRL-A @ 50%	•	•	0.04	11	> .85	0.20	1.87	< 15	32/0	12a	-A		
		F17T8 - Two Lamp Applications														
		2	PRS	120	B232PUNVDR-A @ 100%	•	•	0.25	30	> .95	0.90	3.00	< 10	32/0	12b	-A
B232PUNVDR-A @ 50%	•				•	0.13	16	> .95	0.27	1.72	< 10	32/0	12b	-A		
277	B232PUNVDR-A @ 100%			•	•	0.13	30	> .95	0.90	3.00	< 10	32/0	12b	-A		
	B232PUNVDR-A @ 50%			•	•	0.06	16	> .95	0.27	1.67	< 10	32/0	12b	-A		
120	B232PUNVDRH-A @ 100%			•	•	0.32	38	> .95	1.16	3.05	< 10	32/0	12b	-A		
	B232PUNVDRH-A @ 50%			•	•	0.16	19	> .95	0.50	2.63	< 10	32/0	12b	-A		
277	B232PUNVDRH-A @ 100%			•	•	0.14	39	> .95	1.16	2.97	< 10	32/0	12b	-A		
	B232PUNVDRH-A @ 50%			•	•	0.07	19	> .90	0.50	2.63	< 10	32/0	12b	-A		
120	B232PUNVDRL-A @ 100%			•	•	0.21	25	> .95	0.69	2.78	< 10	32/0	12b	-A		
	B232PUNVDRL-A @ 50%			•	•	0.12	15	> .95	0.19	1.29	< 15	32/0	12b	-A		
277	B232PUNVDRL-A @ 100%			•	•	0.09	25	> .95	0.69	2.76	< 10	32/0	12b	-A		
	B232PUNVDRL-A @ 50%			•	•	0.06	15	> .95	0.19	1.24	< 10	32/0	12b	-A		
F17T8 - Three Lamp Applications																
3	PRS			120	B332PUNVDR-A @ 100%	•	•	0.40	48	> .95	0.89	1.86	< 10	32/0	12c	-A
		B332PUNVDR-A @ 50%	•		•	0.20	24	> .95	0.36	1.51	< 10	32/0	12c	-A		
		277	B332PUNVDR-A @ 100%	•	•	0.18	48	> .95	0.89	1.86	< 10	32/0	12c	-A		
			B332PUNVDR-A @ 50%	•	•	0.10	24	> .90	0.36	1.51	< 15	32/0	12c	-A		
		120	B332PUNVDRL-A @ 100%	•	•	0.33	40	> .95	0.73	1.83	< 10	32/0	12c	-A		
			B332PUNVDRL-A @ 50%	•	•	0.18	22	> .95	0.23	1.05	< 10	32/0	12c	-A		
		277	B332PUNVDRL-A @ 100%	•	•	0.15	40	> .95	0.73	1.83	< 10	32/0	12c	-A		
			B332PUNVDRL-A @ 50%	•	•	0.09	23	> .85	0.23	1.02	< 15	32/0	12c	-A		
		120	B332PUNVDRH-E @ 100%	•	•	0.54	65	> .95	1.19	1.83	< 10	32/0	12d	-A		
			B332PUNVDRH-E @ 50%	•	•	0.25	32	> .95	0.51	1.59	< 15	32/0	12d	-A		
		277	B332PUNVDRH-E @ 100%	•	•	0.24	65	> .95	1.19	1.84	< 10	32/0	12d	-A		
			B332PUNVDRH-E @ 50%	•	•	0.12	32	> .90	0.51	1.59	< 15	32/0	12d	-A		
		F17T8 - Four Lamp Applications														
		4	PRS	120	B432PUNVDR-E @ 100%	•	•	0.53	64	> .95	0.91	1.42	< 10	32/0	12e	-A
B432PUNVDR-E @ 50%	•				•	0.27	32	> .95	0.35	1.09	< 15	32/0	12e	-A		
277	B432PUNVDR-E @ 100%			•	•	0.24	63	> .95	0.91	1.44	< 10	32/0	12e	-A		
	B432PUNVDR-E @ 50%			•	•	0.13	32	> .90	0.35	1.09	< 15	32/0	12e	-A		
120	B432PUNVDRL-E @ 100%			•	•	0.43	52	> .95	0.73	1.41	< 10	32/0	12e	-A		
	B432PUNVDRL-E @ 50%			•	•	0.26	31	> .95	0.21	0.69	< 15	32/0	12e	-A		
277	B432PUNVDRL-E @ 100%			•	•	0.20	52	> .95	0.73	1.41	< 10	32/0	12e	-A		
	B432PUNVDRL-E @ 50%			•	•	0.12	31	> .90	0.21	0.67	< 15	32/0	12e	-A		

See page 3-7 for Dimensions and Wiring Diagrams

- Universal DCL® Dimming
- Programmed Rapid Start
- 2 Lamp Applications for T5 & T5HO
- 1 & 2 Lamp Applications for TT5
- Visit www.unvlt.com for a comprehensive description of the DCL system and DEMANDflex ballasts

Lamp Qty.	Starting Method	Line Volts	Catalog Number	Certification		Input Current (Amps)	Power Power (Watts)	Ballast Factor (PF)	Ballast Factor (BF)	Efficacy Factor (BEF)	Min. F/C THD %	Start Temp	Wiring Diag.	Dim.
				c	UL									
F28T5 - Two Lamp Applications														
2	PRS	120	B228PUNVDRH-D @ 100%	•	•	0.60	72	> .95	1.15	1.60	< 10	50/10	12f	-A
			B228PUNVDRH-D @ 50%	•	•	0.30	36	> .95	0.51	1.42	< 10	50/10	12f	-A
		277	B228PUNVDRH-D @ 100%	•	•	0.25	70	> .95	1.15	1.64	< 10	50/10	12f	-A
			B228PUNVDRH-D @ 50%	•	•	0.13	35	> .95	0.50	1.43	< 10	50/10	12f	-A
F35T5 - Two Lamp Applications														
2	PRS	120	B228PUNVDRH-D @ 100%	•	•	0.75	90	> .95	1.13	1.26	< 10	50/10	12f	-A
			B228PUNVDRH-D @ 50%	•	•	0.38	45	> .95	0.51	1.13	< 10	50/10	12f	-A
		277	B228PUNVDRH-D @ 100%	•	•	0.31	87	> .95	1.13	1.30	< 10	50/10	12f	-A
			B228PUNVDRH-D @ 50%	•	•	0.17	44	> .95	0.51	1.16	< 10	50/10	12f	-A
F21T5 - Two Lamp Applications														
2	PRS	120	B228PUNVDRH-D @ 100%	•	•	0.47	56	> .95	1.16	2.07	< 10	50/10	12f	-A
			B228PUNVDRH-D @ 50%	•	•	0.23	28	> .95	0.51	1.82	< 10	50/10	12f	-A
		277	B228PUNVDRH-D @ 100%	•	•	0.20	55	> .95	1.16	2.11	< 10	50/10	12f	-A
			B228PUNVDRH-D @ 50%	•	•	0.11	28	> .90	0.51	1.82	< 10	50/10	12f	-A
F14T5 - Two Lamp Applications														
2	PRS	120	B228PUNVDRH-D @ 100%	•	•	0.34	40	> .95	1.17	2.93	< 10	50/10	12f	-A
			B228PUNVDRH-D @ 50%	•	•	0.16	19	> .95	0.52	2.74	< 10	50/10	12f	-A
		277	B228PUNVDRH-D @ 100%	•	•	0.15	40	> .95	1.17	2.93	< 10	50/10	12f	-A
			B228PUNVDRH-D @ 50%	•	•	0.08	20	> .85	0.52	2.60	< 10	50/10	12f	-A
F54T5HO - Two Lamp Applications														
2	PRS	120	B254PUNVDR-D @ 100%	•	•	1.00	120	> .95	1.00	0.83	< 10	0/-18	12f	-A
			B254PUNVDR-D @ 50%	•	•	0.50	60	> .95	0.45	0.75	< 10	0/-18	12f	-A
		277	B254PUNVDR-D @ 100%	•	•	0.43	120	> .95	1.00	0.83	< 10	0/-18	12f	-A
			B254PUNVDR-D @ 50%	•	•	0.22	60	> .90	0.45	0.75	< 10	0/-18	12f	-A
FT55W/2G11 - Two Lamp Applications														
2	PRS	120	B254PUNVDR-D @ 100%	•	•	0.90	108	> .95	1.06	0.98	< 10	0/-18	12f	-A
			B254PUNVDR-D @ 50%	•	•	0.41	50	> .95	0.57	1.14	< 10	0/-18	12f	-A
		277	B254PUNVDR-D @ 100%	•	•	0.39	106	> .95	1.06	1.00	< 10	0/-18	12f	-A
			B254PUNVDR-D @ 50%	•	•	0.19	50	> .95	0.57	1.14	< 10	0/-18	12f	-A
FT50W/2G11 - Two Lamp Applications														
2	PRS	120	B254PUNVDR-D @ 100%	•	•	0.97	115	> .95	1.10	0.96	< 10	0/-18	12f	-A
			B254PUNVDR-D @ 50%	•	•	0.47	57	> .95	0.63	1.11	< 10	0/-18	12f	-A
		277	B254PUNVDR-D @ 100%	•	•	0.42	113	> .95	1.11	0.98	< 10	0/-18	12f	-A
			B254PUNVDR-D @ 50%	•	•	0.21	57	> .95	0.63	1.11	< 10	0/-18	12f	-A
FC12T5-55W - Two Lamp Applications														
2	PRS	120	B254PUNVDR-D @ 100%	•	•	0.88	106	> .95	1.04	0.98	< 10	0/-18	12f	-A
			B254PUNVDR-D @ 50%	•	•	0.41	49	> .95	0.56	1.14	< 10	0/-18	12f	-A
		277	B254PUNVDR-D @ 100%	•	•	0.38	104	> .95	1.04	1.00	< 10	0/-18	12f	-A
			B254PUNVDR-D @ 50%	•	•	0.19	48	> .95	0.56	1.17	< 10	0/-18	12f	-A
FT40W/2G11 - Two Lamp Applications														
2	PRS	120	C240PUNVDR-A @ 100%	•	•	0.59	69	> .95	0.88	1.28	< 10	32/0	12g	-A
			C240PUNVDR-A @ 50%	•	•	0.30	35	> .90	0.40	1.14	< 10	32/0	12g	-A
		277	C240PUNVDR-A @ 100%	•	•	0.25	68	> .95	0.88	1.29	< 10	32/0	12g	-A
			C240PUNVDR-A @ 50%	•	•	0.13	34	> .90	0.40	1.18	< 10	32/0	12g	-A
FT40W/2G11 - One Lamp Applications														
1	PRS	120	C240PUNVDR-A @ 100%	•	•	0.29	34	> .95	0.88	2.59	< 10	32/0	12h	-A
			C240PUNVDR-A @ 50%	•	•	0.16	18	> .90	0.40	2.22	< 10	32/0	12h	-A
		277	C240PUNVDR-A @ 100%	•	•	0.13	36	> .95	0.88	2.44	< 10	32/0	12h	-A
			C240PUNVDR-A @ 50%	•	•	0.08	20	> .90	0.40	2.00	< 10	32/0	12h	-A
FT40W/2G11/ES - Two Lamp Applications														
2	PRS	120	C240PUNVDR-A @ 100%	•	•	0.52	62	> .95	0.86	1.39	< 10	32/0	12g	-A
		277	C240PUNVDR-A @ 100%	•	•	0.22	62	> .95	0.87	1.40	< 10	32/0	12g	-A
FT40W/2G11/ES - One Lamp Applications														
1	PRS	120	C240PUNVDR-A @ 100%	•	•	0.25	28	> .95	0.87	3.11	< 10	32/0	12h	-A
		277	C240PUNVDR-A @ 100%	•	•	0.12	33	> .95	0.87	2.64	< 10	32/0	12h	-A

See page 3-7 for Dimensions and Wiring Diagrams

WIRING DIAGRAMS

Wiring Diagram 12a

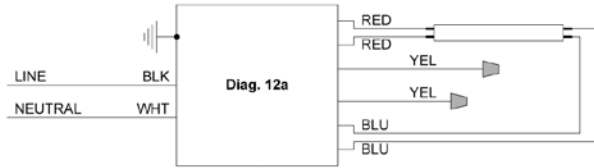

Wiring Diagram 12e

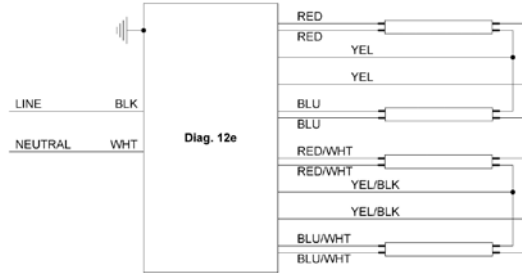

Wiring Diagram 12b

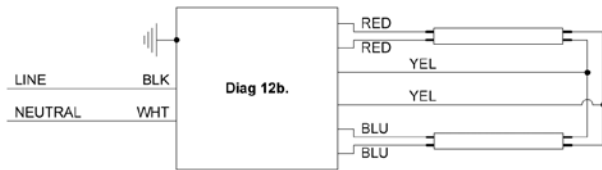

Wiring Diagram 12f

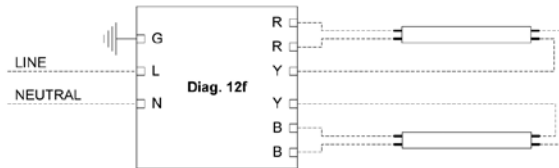

Wiring Diagram 12c

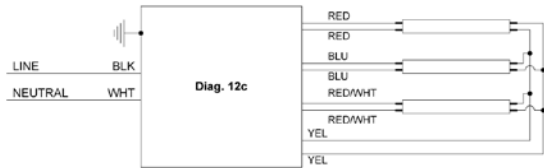

Wiring Diagram 12g

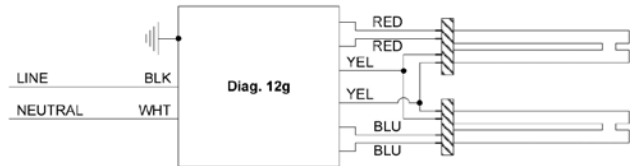

Wiring Diagram 12d



Wiring Diagram 12h

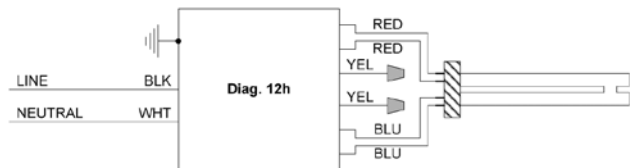

DCL CONTROLS

MODEL	DESCRIPTION
LP12DCLUNV-xx	Circuit Control Panel
SC20DCLUNV	Single Circuit Controller
RSMDC51	Contact Interface Controller
WTPDCL51	Time/Photo Controller
WPS5527K	Photo Sensor for WTPDCL

xx = number of circuits (03-12)

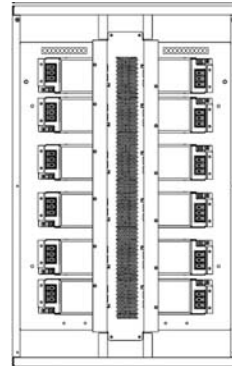

LP12DCLUNV-xx		
Dimensions		Mounting
Length	32"	24"
Width	20"	16"
Depth	4.3"	

The same cabinet size is used for the four different panels. the quantity of individual controllers installed is determined by the model number.

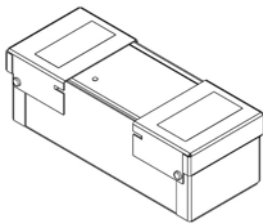

SC20DCLUNV		MOUNTING PATTERN	
Dimensions		8.46	
Length	9.66"	X	X
Width	3.98"	1.50	2.50
Depth	3.21"	X	X

Circuit control panels are used to send commands down the lighting circuit to the DemandFlex ballasts. The LP12DCLUNV-xx panels are available with 3 to 12 integral circuit control modules. If more than 12 circuits are being controlled, additional panels can be used.

The SC20DCLUNV is used when there are a small number of circuits or space limitations prevent the use of an LP12DCLUNV panel.

One RSMDC51 or WTPDCL51 can control up to 63 circuits. If more than 63 circuits are to be controlled, an RSMDC51 can be connected in parallel with either controller for another 63 circuits.

Stand Alone Time Clock/Photo Cell

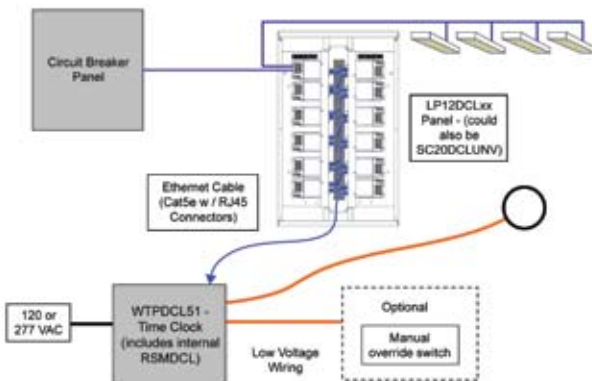

The WTPDCL51 controller provides time of day scheduling and can also be connected to the WPS5527K Photo Cell for daylight harvesting. Manual override switches are also available.

Contact Closure Interface Control

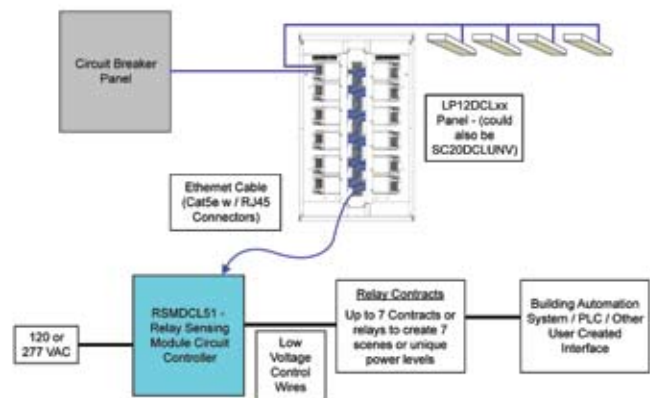

The RSMDC51 controller integrates with external relays or switches to translate commands to the DCL system. This controller can be used to interface with building automation systems, PLC's, or switches. These systems may also incorporate photo cells for daylight harvesting.

Controllable Lighting

Fluorescent Energy Management / Dimming Ballasts and Controls

The effective dimming of fluorescent lights delivers a wide range of benefits: greater control of workspace lighting, ability to create a mood, energy savings, and more.

Universal Lighting Technologies (“Universal”) line of electronic dimming ballasts and controls lets you accomplish these goals with a variety of products to suit your dimming needs. From light level switching and analog dimming to digital dimming and controls, Universal has the products and technologies to meet today’s dimming requirements for energy savings and controllable lighting.

Product Overview

Universal offers three different families of dimming products that can be used for today's dimming requirements for architectural lighting control and energy management applications:

Ballastar: Light Level Switching

SuperDim: Analog (0 to 10 volt) dimming

DaliPro: Digital Dimming with the DALI protocol

Ballastar® Light Level Switching (S30 & S50)

Our Ballastar® line offers two options of light level switching (either 100/50% or 100/60/30%). That makes Ballastar® a cost-effective solution for both new construction and retrofits.

Universal Ballastar® ballasts are designed to ensure optimum lamp performance. Their Lamp Current Crest Factors are well below the maximum 1.7 ANSI standard — and they start the lamps according to ANSI recommendations at all dimming levels. Both of these important design parameters ensure optimum lamp performance. In addition, Ballastar® ballasts actually increase cathode heating when dimming to maintain the cathode's proper temperature, which enhances lamp life and performance stability.

- 1, 2, & 3 lamp models for 120 & 277 volt
- Switches to preset light levels, keeping all lamps illuminated
- Eliminates the dark spots associated with inboard/outboard configurations
- Connects with two line voltage power leads
 - Wires the same as an inboard/outboard fixture
 - No special controls required; uses two wall switches
- Meets all ASHRAE 90.1 and California Title 24 requirements for lighting control
- THD <10%
- Lower installed costs; less wiring and equipment required



Ballastar® Light Level Switching for ultimate control.

Product Overview

SuperDim® Analog Dimming Ballasts

Universal Lighting's new SuperDim® analog dimming ballasts are the most cost-effective choice for large scale dimming applications. SuperDim® ballasts are designed for T8 and T5 linear fluorescent lamps and T4 4-pin quad and triple compact fluorescent lamps.

SuperDim® ballasts are compatible with a wide range of 0 – 10 volt controls and can be connected to photocells for daylight harvesting. The resulting energy savings makes it easy to adhere to even the strictest energy requirements, including California Title 24 and ASHRAE 90.1.

These versatile ballasts offer programmed rapid start technology for longer lamp life. They also incorporate end-of-lamp-life shutdown circuits, low profile designs and < 10% THD at full bright.

Features and Benefits

- Ideal for T8 and T5 linear fluorescent lamps and T4 4-pin quad and triple compact fluorescent lamps
- Compatible with most 0 – 10 volt manufactured controls
- Daylight harvesting options with photocells for maximum energy savings
- Programmed rapid start technology maximizes lamp life
- Low profile design for fixture design flexibility
- End-of-lamp-life shutdown circuitry ensures safe operation
- < 10% THD at full bright
- Universal input voltage (120–277 volts) for installation flexibility

Notes

Product Overview

DaliPro Digital Dimming Ballasts for DALI

New DaliPro™ ballasts from Universal Lighting let you take full advantage of the Digital Addressable Lighting Interface (DALI) standard...and that means greater flexibility, greater savings.

The DALI Advantage

The DALI protocol uses a 2-wire control loop to communicate with up to 64 ballasts. Broadcast, group and individual addressing is used to control light levels, recall scenes and poll ballast status.

Many DALI-compatible controls are now available from established manufacturers; and new varieties are being developed daily.

DaliPro Features and Benefits

- Available for T8, T5, T5HO and compact fluorescent lamps
- Provides dimming down to 1% for linear lamps and 3% for compact fluorescent lamps
- Lets you adapt instantly to additions or changes in lighting design without ballast or fixture rewiring
- Offers status/performance data, including lamp status and system faults
- Low profile designs for easy installation in a wide variety of fixtures
- Universal input voltage (120– 277 volts)
 - Installer-friendly; ensures you have the right ballast every time
 - Reduces inventory costs and requirements
- End-of-Lamp Life Shutdown with auto reset circuitry for safe operation
- Programmed Rapid Start for long lamp life



Application And Operating Information

Dimming ballasts follow the same guidelines as electronic ballasts in regard to the application and operating information. In addition to the section for electronic ballasts, the following applies specifically to dimming electronic ballasts.

SAFETY

Analog dimming ballasts are controlled by using a low voltage 10-0vDC control circuit. Care should be taken to insure that the line voltage (AC) wires are not connected to the low voltage DC wires. SuperDim® Electronic dimming ballasts have a protection circuit that will sense if the ballast has been connected in this manner and not harm the ballast or the installer. If connected in this mode, the lamps will dim to the 30% level.

New Lamp Installation

When new lamps are installed, they must operate at a full bright level for a minimum of 100 hours prior to dimming. Failure to do this will effect lamp life and cause the lamps to not dim properly. Consult your lamp manufacturer for further lamp information.

Light Level Switching Installation Note

The two power leads for the light level switching ballasts must be connected to the same power circuit. The leads should connect to separate switches or relays for control of the light level switching operation. Connection of the input leads to separate power circuits can damage the ballasts.

Note:

Do not connect any other ballast to the load side of the switches controlling the switched dimming ballast.

Compatible Dimming Controls

For a listing of compatible controls for universal analog ballasts, please consult catalog page 3-7, or call 1-800-BALLAST or check out the Dimming and Controls section of our home page at www.unvlt.com.

Fusing

Class P ballasts do not require fusing. Fusing can be used when a single circuit has a large number of fixtures/ballasts. For a comprehensive list of appropriate fuses, contact our Technical Engineering Services (TES) Department at 1-800-BALLAST.

Detailed Operating Instructions

For additional information on all of Universal's dimming products, consult our website at www.unvlt.com. Application notes, dimming brochures and online training is available

Controls For Analog Dimming Ballasts

Manual Controls: Wall Stations & Hand-Held Remotes

Manufacturer	Website	Telephone
Architectural Lighting Management	www.almsys.com	(888) 446-9137
Douglas Lighting Controls, Inc.	www.douglaslightingcontrols.com	(604) 873-2797
Electronics Diversified, Inc.	www.edionline.com	(800) 547-2690
Genlyte Controls	www.lolcontrols.com	(800) 526-2731
HUNT Dimming	www.huntdimming.com	(970) 484-9048
Lehigh Electric Products Co.	www.lehighdim.com	(610) 395-3386
Leviton	www.leviton.com	(800) 323-8902
Lutron	www.lutron.com/universal	(888) LUTRON1 - Sales (800) 523-9466 - Technical Support
NexLight	www.nexlight.com	(218) 828-3700
PLC-Multipoint	www.plcmultipoint.com	(425) 353-7552
Sensor Switch, Inc.	www.sensorswitch.com	(800) 727-7483
The Watt Stopper, Inc.	www.wattstopper.com	(800) 879-8585

Occupancy Sensors & Controls

Manufacturer	Website	Telephone
Electronics Diversified, Inc.	www.edionline.com	(800) 547-2690
Lehigh Electric Products Co.	www.lehighdim.com	(610) 395-3386
Leviton	www.leviton.com	(800) 323-8902
Lutron	www.lutron.com/universal	(888) LUTRON1 - Sales (800) 523-9466 - Technical Support
Marlin Controls, Inc.	www.marlincontrols.com	(800) 788-5750
NexLight	www.nexlight.com	(218) 828-3700
Novitas	www.novitas.com	(310) 218-5360
The Watt Stopper, Inc.	www.wattstopper.com	(800) 879-8585

Photodetectors & Daylight Controls

Manufacturer	Website	Telephone
Douglas Lighting Controls, Inc.	www.douglaslightingcontrols.com	(604) 873-2797
Electronics Diversified, Inc.	www.edionline.com	(800) 547-2690
Hubbell Building Automation, Inc.	www.hubbell-automation.com	(888) 698-3242
Lehigh Electric Products Co.	www.lehighdim.com	(610) 395-3386
Leviton	www.leviton.com	(800) 323-8902
Lutron	www.lutron.com/universal	(888) LUTRON1 - Sales (800) 523-9466 - Technical Support
Marlin Controls, Inc.	www.marlincontrols.com	(800) 788-5750
NexLight	www.nexlight.com	(218) 828-3700
Novitas	www.novitas.com	(310) 218-5360
PLC-Multipoint	www.plcmultipoint.com	(425) 353-7552
Sensor Switch, Inc.	www.sensorswitch.com	(800) 727-7483
The Watt Stopper, Inc.	www.wattstopper.com	(800) 879-8585

Systems: Control Panels, Building Management Systems, etc.

Manufacturer	Website	Telephone
Architectural Lighting Management	www.almsys.com	(888) 446-9137
Douglas Lighting Controls, Inc.	www.douglaslightingcontrols.com	(604) 873-2797
Electronics Diversified, Inc.	www.edionline.com	(800) 547-2690
Genlyte Controls	www.lolcontrols.com	(800) 526-2731
HUNT Dimming	www.huntdimming.com	(970) 484-9048
Lehigh Electric Products Co.	www.lehighdim.com	(610) 395-3386
Leviton	www.leviton.com	(800) 323-8902
Lutron	www.lutron.com/universal	(888) LUTRON1 - Sales (800) 523-9466 - Technical Support
Marlin Controls, Inc.	www.marlincontrols.com	(800) 788-5750
NexLight	www.nexlight.com	(218) 828-3700
PLC-Multipoint	www.plcmultipoint.com	(425) 353-7552
Touch-Plate Lighting Controls	www.touchplate.com	(800) 227-5154
The Watt Stopper, Inc.	www.wattstopper.com	(800) 879-8585

Universal Lighting Technologies Analog Dimming Ballasts

SuperDim[®]
A Triad[®] Brand

BallaSTAR[®]

The information listed above is provided by Universal Lighting Technologies to facilitate development of dimming systems. All information has been provided by the controls manufacturers, and Universal Lighting Technologies makes no guarantee regarding its accuracy. The reader is advised to contact these, and other manufacturers of analog dimming systems, to obtain application advice, to determine availability of the controls listed above, and to learn about other controls that may be offered.

Data is subject to change without notice.

Lamp Qty.	Starting Method	Line Volts	Catalog Number	Line Current (Amps)	Input Power (Watts)	Power Factor (PF)	Ballast Factor (BF)	Ballast Efficacy Factor (BEF)	THD %	Min. F/C Start Temp	Wiring Diag.	Dim.
F32T8												
1	PRS	120 277	B132PUNVDV1●	0.31 0.13	37 36	> .98	1.00	2.70 2.78	<10	0/-18	7	DP1
2	PRS	120 277	B232PUNVDV1●	0.61 0.26	73 70	> .98	1.00	1.37 1.43	<10	0/-18	8	DP1
F14T5												
1	PRS	120 277	B114PUNVDV1	0.15 0.07	18	> .98	1.00	5.56	<10	50/10	7	DP1
2	PRS	120 277	B214PUNVDV1	0.28 0.13	18	> .98	1.00	2.86	<10	50/10	8	DP1
F28T5												
1	PRS	120 277	B128PUNVDV1	0.27 0.11	32 31	> .98	1.00	3.13 3.23	<10	50/10	7	DP1
2	PRS	120 277	B228PUNVDV1	0.55 0.23	66 63	> .98	1.00	1.52 1.59	<10	50/10	8	DP1
F54T5HO												
1	PRS	120 277	B154PUNVDV1	0.52 0.22	62 60	> .98	1.00	1.61 1.67	<10	50/10	7	DP1
2	PRS	120 277	B254PUNVDV1	1.05 0.44	126 121	> .98	1.00	0.79 0.83	<10	50/10	8	DP1
CFQ18W/Gx24q												
1	PRS	120 277	C118PUNVDV3◆●	0.19 0.10	21 20	> .95	1.00	4.76 5.00	<10	0/-18	9	DP2
2	PRS	120 277	C218PUNVDV3◆■	0.34 0.16	39 38	> .95	1.00	2.56 2.63	<10	0/-18	10	DP2
CFQ26W/Gx24q												
1	PRS	120 277	C126PUNVDV3◆◇	0.28 0.12	28 27	> .95	1.00	3.57 3.70	<10	0/-18	9	DP2
2	PRS	120 277	C226PUNVDV3◆□	0.50 0.23	54 53	> .95	1.00	1.85 1.89	<10	0/-18	10	DP2
CFTR32W/Gx24q												
1	PRS	120 277	C132PUNVDV3◆	0.34 0.15	38 37	> .95	1.00	2.63 2.70	<10	0/-18	9	DP2
2	PRS	120 277	C232PUNVDV3◆	0.58 0.26	71 70	> .95	1.00	1.41 1.43	<10	0/-18	10	DP2
CFM42W/Gx24q												
1	PRS	120 277	C142PUNVDV3◆	0.43 0.19	47 45	> .95	1.00	2.13 2.22	<10	0/-18	9	DP2
2	PRS	120 277	C242PUNVDV3◆	0.82 0.36	92 91	> .95	1.00	1.09 1.10	<10	0/-18	10	DP2
FT40W/2G11												
1	PRS	120 277	C140PUNVDV3◆	0.37 0.16	45 44	> .95	1.00	2.22 2.27	<10	0/-18	9	DP1
2	PRS	120 277	C240PUNVDV3◆	0.83 0.37	97 94	> .95	1.00	1.03 1.06	<10	0/-18	10	DP1

All models are cULus Listed

See page 3-20 for Dimensions and Wiring Diagrams

- Minimum Dimming Temperature is 50°F / 10°C
- ◆ Minimum Dimming Temperature is 32°F / 0°C
- Also operates (1) CFTR18W/Gx24q
- Also operates (2) CFTR18W/Gx24q
- ◇ Also operates (1) CFTR26W/Gx24q
- Also operates (2) CFTR26W/Gx24q

STARTING METHOD LEGEND

- IS = Instant Start
- PRS = Programmed Rapid Start
- RS = Rapid Start
- PAR-IS = Parallel Instant Start
- PAR-PRS = Parallel Programmed Rapid Start
- PAR-RS = Parallel Rapid Start
- SER-RS = Series Rapid Start

SuperDim® DIMMING BALLASTS

SuperDim®

Please visit www.unvlt.com for the most up to date status and recent changes to the SuperDim product family.

Lamp Qty.	Starting Method	Line Volts	Catalog Number	Description	Certification		Line Current (Amps)	Input Power (Watts)	Power Factor (PF)	Ballast Factor (BF)	Ballast Efficacy Factor (BEF)	THD %	Min. F/C Start Temp	Wiring Diag.	Dim.
					UL	SF									
F17T8															
1	PRS	120 277	ES5833B	ES-1-T8-17-UNV-B-DIM-10	•	•	0.17 0.08	20 21	> .99 > .95	0.87	4.35 4.20	<10	32/0	1	ESB
1	PRS	120 277	ES5818K	ES-1-T8-17-UNV-K-DIM-10	•	•	0.17 0.08	20 21	> .99 > .95	0.87	4.35 4.20	<10	32/0	1	ESK
2	PRS	120 277	ES5834B	ES-2-T8-17-UNV-B-DIM-10	•	•	0.29 0.13	35	> .99 > .98	0.87	2.51 2.47	<10	32/0	2	ESB
2	PRS	120 277	ES5817K	ES-2-T8-17-UNV-K-DIM-10	•	•	0.29 0.13	35	> .99 > .98	0.87	2.51 2.47	<10	32/0	2	ESK
F25T8															
1	PRS	120 277	ES5821B	ES-1-T8-32/25-UNV-B-DIM-10	•	•	0.21 0.10	26	> .99 > .90	0.87	3.41 3.36	<10	32/0	1	ESB
1	PRS	120 277	ES5835K	ES-1-T8-32/25-UNV-K-DIM-10	•	•	0.21 0.10	26	> .99 > .90	0.87	3.40 3.31	<10	32/0	1	ESK
2	PRS	120 277	ES5822B	ES-2-T8-32/25-UNV-B-DIM-10	•	•	0.41 0.18	48	> .99 > .95	0.87	1.80 1.82	<10	32/0	1	ESB
2	PRS	120 277	ES5836K	ES-2-T8-32/25-UNV-K-DIM-10	•	•	0.41 0.18	48	> .99 > .95	0.87	1.80 1.82	<10	32/0	1	ESK
F32T8															
1	PRS	120 277	ES5821B	ES-1-T8-32/25-UNV-B-DIM-10	•	•	0.29 0.13	34	> .99 > .95	0.87	2.60 2.57	<10	32/0	1	ESB
1	PRS	120 277	ES5835K	ES-1-T8-32/25-UNV-K-DIM-10	•	•	0.27 0.13	33 34	> .99 > .95	0.87	2.63 2.60	<10	32/0	1	ESK
2	PRS	120 277	ES5822B	ES-2-T8-32/25-UNV-B-DIM-10	•	•	0.56 0.23	65 64	> .99 > .98	0.87	1.33 1.37	<10	32/0	2	ESB
2	PRS	120 277	ES5836K	ES-2-T8-32/25-UNV-K-DIM-10	•	•	0.56 0.23	65 64	> .99 > .95	0.87	1.33 1.37	<10	32/0	2	ESK
F14T5															
1	PRS	120 277	ES5849K	ES-1-T5-14-UNV-K-DIM-10	•	•	0.16 0.07	20	> .99 > .98	1.00	5.13 4.95	<10	32/0	1	ESK
2	PRS	120 277	ES5851K	ES-2-T5-14-UNV-K-DIM-10	•	•	0.28 0.13	34	> .99 > .95	1.00	2.94	<10	32/0	2	ESK
F21T5															
1	PRS	120 277	ES5839K	ES-1-T5-21-UNV-K-DIM-10	•	•	0.23 0.16	28	> .99 > .98	1.00	3.64	<10	32/0	1	ESK
2	PRS	120 277	ES5861K	ES-2-T5-21-UNV-K-DIM-10	•	•	0.40 0.17	48	> .99 > .98	1.00	2.08	<10	32/0	2	ESK
F28T5															
1	PRS	120 277	ES5846K	ES-1-T5-28-UNV-K-DIM-10	•	•	0.30 0.14	37	> .99 > .95	1.00	2.67 2.71	<10	32/0	1	ESK
2	PRS	120 277	ES5847K	ES-2-T5-28-UNV-K-DIM-10	•	•	0.56 0.25	67	> .99 > .98	1.00	1.49 1.50	<10	32/0	2	ESK
F35T5															
1	PRS	120 277	ES5853K	ES-1-T5-35-UNV-K-DIM-10	•	•	0.34 0.15	40 41	> .99 > .98	1.00	2.50 2.44	<10	32/0	1	ESK
CFQ/H13W															
2	PRS	120 277	ES5011GT/HT	ES-2/1-CFQ-13-UNV-GT/HT-DIM-10	•	•	0.25 0.11	30 29	> .99 > .95	1.00	3.38 3.41	<10	32/0	3	GT/HT
CFQ/H18W															
2	PRS	120 277	ES5012GT/HT	ES-2/1-CFQ-18-UNV-GT/HT-DIM-10	•	•	0.31 0.14	38	> .99 > .95	1.00	2.66	<10	32/0	3	GT/HT
CFQ/H26W															
2	PRS	120 277	ES5013GT/HT	ES-2/1-CFQ-26-UNV-GT/HT-DIM-10	•	•	0.46 0.19	54 52	> .99 > .95	1.00	1.85 1.94	<10	32/0	3	GT/HT
CFH42W															
1	PRS	120 277	ES5010GT/HT	ES-1-CFH-42/36/26-UNV-GT/HT-DIM-10	•	•	0.34 0.15	46	> .99 > .95	1.00	2.41 2.20	<10	32/0	4	GT/HT
FT40W/2G11															
1	PRS	120 277	ES5006BM	ES-1-CFT-40-UNV-BM-DIM-10	•	•	0.35 0.16	44 43	> .99 > .98	1.09	2.48 2.53	<10	32/0	5	ESBM
2	PRS	120 277	ES5007BMT	ES-2-CFT-40-UNV-BMT-DIM-10	•	•	0.73 0.31	88 87	> .99	1.09	1.24 1.25	<10	32/0	6	ESBMT

Fluorescent Dimming

- Also operates (1) CFQ/H13W
- Also operates (1) CFQ/H18W
- ◆ Also operates (1) CFQ/H26W
- Also operates (1) CFH32W and (1) FQ/H26W

- ◆ HT suffix—Lead entry is bottom feed
- ◆ GT suffix—Lead entry is end feed
- ◆ Incorporates lead wires

STARTING METHOD LEGEND
PRS = Programmed Rapid Start

See page 3-20 for Dimensions and Wiring Diagrams

BALLASTAR® 0-10V DIMMING

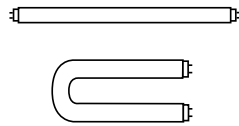

- Analog Dimming
- Rapid Start
- 1, 2, 3 & 4 Lamp Applications

BALLASTAR® 0-10 VOLT DIMMING BALLASTS

FOR (1), (2), (3) & (4) T8 LAMPS

Please visit www.unvlt.com for the most up to date status and recent changes to the Ballastar 0-10V product family.

Lamp		Line Volts	Catalog Number	Line Current (Amps)	Input Power (Watts)	Power Factor (PF)	Ballast Factor (BF)	Ballast Efficacy Factor (BEF)	THD %	Min. F/C Start Temp	Wiring Diag.	Dim.
Qty.	Starting Method											
F25T8 - One Lamp Applications												
1	RS	120	B132R120V5 @ 100%	0.22	26	> .99	0.90	3.46	< 10	50/10	13	ST
			B132R120V5 @ 5%	0.06	7	> .90	0.05	0.71	< 15	50/10	13	ST
		277	B132R277V5 @ 100%	0.10	26	> .99	0.90	3.46	< 10	50/10	13	ST
			B132R277V5 @ 5%	0.03	7	> .90	0.05	0.71	< 20	50/10	13	ST
		347	B132R347V5 @ 100%	0.08	26	> .99	0.90	3.46	< 10	50/10	13	ST
			B132R347V5 @ 5%	0.02	7	> .90	0.05	0.71	< 30	50/10	13	ST
F25T8 - Two Lamp Applications												
2	RS	347	B232SR347V5 @ 100%	0.14	47	> .99	0.93	1.98	< 10	50/10	15	-E
			B232SR347V5 @ 5%	0.04	12	> .90	0.05	0.42	< 15	50/10	15	-E
F25T8 - Four Lamp Applications												
4	PAR-PRS	277	B432P277V5-E @ 100%	0.33	90	> .98	0.88	0.98	< 10	50/10	14	-E
			B432P277V5-E @ 5%	0.09	22	> .90	0.05	0.23	< 15	0/10	14	-E
F32T8 - One Lamp Applications												
1	RS	120	B132R120V5 @ 100%	0.27	32	> .99	0.88	2.75	< 10	50/10	13	ST
			B132R120V5 @ 5%	0.07	8	> .90	0.05	0.63	< 10	50/10	13	ST
		277	B132R277V5 @ 100%	0.12	32	> .99	0.88	2.75	< 10	50/10	13	ST
			B132R277V5 @ 5%	0.03	8	> .90	0.05	0.63	< 15	50/10	13	ST
		347	B132R347V5 @ 100%	0.09	32	> .99	0.88	2.75	< 10	50/10	13	ST
			B132R347V5 @ 5%	0.02	8	> .90	0.05	0.63	< 20	50/10	13	ST
F32T8 - Two Lamp Applications												
2	SER-RS	120	B232SR120V5 @ 100%	0.52	62	> .99	0.88	1.42	< 10	50/10	15	ST
			B232SR120V5 @ 5%	0.12	13	> .90	0.05	0.38	< 10	50/10	15	ST
		277	B232SR277V5 @ 100%	0.23	62	> .99	0.88	1.42	< 10	50/10	15	ST
			B232SR277V5 @ 5%	0.05	13	> .90	0.05	0.38	< 15	50/10	15	ST
		347	B232SR347V5 @ 100%	0.18	62	> .99	0.88	1.42	< 10	50/10	15	ST
			B232SR347V5 @ 5%	0.04	13	> .90	0.05	0.38	< 15	50/10	15	ST
2	RS	347	B232SR347V5 @ 100%	0.18	62	> .99	0.88	1.42	< 10	50/10	15	-E
			B232SR347V5 @ 5%	0.04	13	> .90	0.05	0.38	< 15	50/10	15	-E
F32T8 - Three Lamp Applications												
3	SER-RS	120	B332SR120V5 @ 100%	0.77	92	> .99	0.88	0.96	< 10	50/10	17	ST
			B332SR120V5 @ 5%	0.17	20	> .90	0.05	0.25	< 10	50/10	17	ST
		277	B332SR277V5 @ 100%	0.33	92	> .99	0.88	0.96	< 10	50/10	17	ST
			B332SR277V5 @ 5%	0.07	20	> .90	0.05	0.25	< 15	50/10	17	ST
F32T8 - Four Lamp Applications												
4	SER/PAR-RS	277	B432SR277V5 @ 100%	0.42	117	> .99	0.88	0.79	< 10	50/10	18	-ZZ
			B432SR277V5 @ 5%	0.11	27	> .90	0.05	0.19	< 15	50/10	18	-ZZ
4	SER-PRS	277	B432P277V5-E @ 100%	0.42	115	> .99	0.88	0.77	< 10	50/10	14	-E
			B432P277V5-E @ 5%	0.10	24	> .90	0.05	0.21	< 15	50/10	14	-E
4	SER-PRS	277	B432P277V5H-E @ 100%	0.55	150	> .99	1.18	0.79	< 10	50/10	14	-E
			B432P277V5H-E @ 5%	0.12	28	> .90	0.06	0.22	< 15	50/10	14	-E

All models except B232SR347V5 are cULus Listed
B232SR347V5 is CSA Certified

See page 3-20 for Dimensions
and Wiring Diagrams

IS = Instant Start
PRS = Programmed Rapid Start
RS = Rapid Start

STARTING METHOD LEGEND
PAR-IS = Parallel Instant Start
PAR-PRS = Parallel Programmed Rapid Start

PAR-RS = Parallel Rapid Start
SER-RS = Series Rapid Start

BALLASTAR® STEP DIMMING BALLASTS

FOR (1), (2) & (3) T8 LAMPS

- Step Dimming
- Rapid Start
- 1-3 Lamp Applications

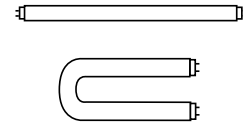

**BALLASTAR
LIGHT LEVEL
SWITCHING**

Lamp Qty.	Starting Method	Line Volts	Catalog Number	Line Current (Amps)	Input Power (Watts)	Power Factor (PF)	Ballast Factor (BF)	Ballast Efficacy Factor (BEF)	THD %	Min. F/C Start Temp	Wiring Diag.	Dim.
F17T8 - One Lamp Applications												
1	PRS	120	B232PUS50-A @ 100%	0.14	16	> .95	0.88	5.50	< 15	32/0	12a	-A
			B232PUS50-A @ 50%	0.08	9	> .95	0.29	3.22	< 15	32/0	12a	-A
		277	B232PUS50-A @ 100%	0.08	16	> .70	0.88	5.50	< 15	32/0	12a	-A
			B232PUS50-A @ 50%	0.05	9	> .70	0.29	3.22	< 15	32/0	12a	-A
F17T8 - Two Lamp Applications												
2	PRS	120	B232PUS50-A @ 100%	0.25	30	> .99	0.87	2.90	< 10	32/0	12	-A
			B232PUS50-A @ 50%	0.14	16	> .98	0.30	1.88	< 15	32/0	12	-A
		277	B232PUS50-A @ 100%	0.12	30	> .88	0.87	2.90	< 10	32/0	12	-A
			B232PUS50-A @ 50%	0.07	16	> .85	0.30	1.88	< 15	32/0	12	-A
F25T8 - One Lamp Applications												
1	RS	120	B232PUS50-A @ 100%	0.21	24	> .95	0.85	3.54	< 10	32/0	12a	-A
			B232PUS50-A @ 50%	0.10	12	> .90	0.28	2.33	< 10	32/0	12a	-A
		277	B232PUS50-A @ 100%	0.11	24	> .80	0.85	3.54	< 10	32/0	12a	-A
			B232PUS50-A @ 50%	0.06	12	> .80	0.28	2.33	< 10	32/0	12a	-A
F25T8 - Two Lamp Applications												
2	SER-RS	120	B232PUS50-A @ 100%	0.39	46	> .98	0.84	1.83	< 10	32/0	12	-A
			B232PUS50-A @ 50%	0.20	24	> .95	0.28	1.17	< 10	32/0	12	-A
		277	B232PUS50-A @ 100%	0.18	46	> .98	0.84	1.83	< 10	32/0	12	-A
			B232PUS50-A @ 50%	0.09	24	> .90	0.28	1.17	< 10	32/0	12	-A
F32T8 - One Lamp Applications												
1	RS	120	B132R120S30 @ 100%	0.27	32	> .99	0.89	2.78	< 10	50/10	11	ST
			B132R120S30 @ 60%	0.19	23	> .99	0.60	2.61	< 10	50/10	11	ST
			B132R120S30 @ 30%	0.12	14	> .98	0.28	2.00	< 10	50/10	11	ST
			B132R277S30 @ 100%	0.13	33	> .99	0.89	2.70	< 10	50/10	11	ST
		277	B132R277S30 @ 60%	0.09	25	> .98	0.63	2.52	< 15	50/10	11	ST
			B132R277S30 @ 30%	0.06	15	> .95	0.28	1.87	< 20	50/10	11	ST
			B232PUS50-A @ 100%	0.25	29	> .99	0.88	3.03	< 10	32/0	12a	ST
		120	B232PUS50-A @ 50%	0.12	14	> .98	0.29	2.07	< 10	32/0	12a	ST
			B232PUS50-A @ 100%	0.12	29	> .85	0.88	3.03	< 10	32/0	12a	ST
		277	B232PUS50-A @ 50%	0.06	14	> .80	0.29	2.07	< 20	32/0	12a	ST
F32T8 - Two Lamp Applications												
2	SER-RS	120	B232SR120S30 @ 100%	0.52	62	> .99	0.88	1.42	< 10	50/10	12	ST
			B232SR120S30 @ 60%	0.38	45	> .95	0.58	1.29	< 10	50/10	12	ST
			B232SR120S30 @ 30%	0.24	28	> .95	0.27	0.96	< 10	50/10	12	ST
			B232SR277S30 @ 100%	0.23	62	> .99	0.88	1.42	< 10	50/10	12	ST
		277	B232SR277S30 @ 60%	0.17	45	> .95	0.58	1.29	< 10	50/10	12	ST
			B232SR277S30 @ 30%	0.11	28	> .95	0.27	0.96	< 10	50/10	12	ST
			B232PUS50-A @ 100%	0.48	57	> .99	0.88	1.54	< 10	32/0	12	-A
		120	B232PUS50-A @ 50%	0.24	28	> .99	0.30	1.07	< 10	32/0	12	-A
			B232PUS50-A @ 100%	0.21	56	> .95	0.88	1.57	< 10	32/0	12	-A
		277	B232PUS50-A @ 50%	0.11	28	> .90	0.30	1.07	< 10	32/0	12	-A
F32T8 - Three Lamp Applications												
3	SER-RS	120	B332SR120S30 @ 100%	0.78	93	> .99	0.88	0.95	< 10	50/10	16	ST
			B332SR120S30 @ 60%	0.61	69	> .95	0.60	0.87	< 10	50/10	16	ST
			B332SR120S30 @ 30%	0.40	43	> .95	0.30	0.70	< 10	50/10	16	ST
		277	B332SR277S30 @ 100%	0.34	94	> .99	0.88	0.94	< 10	50/10	16	ST
			B332SR277S30 @ 60%	0.26	69	> .95	0.60	0.87	< 10	50/10	16	ST
			B332SR277S30 @ 30%	0.16	43	> .95	0.30	0.70	< 10	50/10	16	ST

All models are cULus Listed

See page 3-20 for Dimensions and Wiring Diagrams

Fluorescent Dimming

Overall Dimensions		Mounting Dimensions			
Draw #	L	W	H	M	X
ST	9.50"	2.40"	1.55"	8.89"	1.69"
-E	16.88"	1.74"	1.18"	16.28"	—
-ZZ	16.40"	2.40"	1.50"	15.88"	1.69"
ESB	9.50"	2.38"	1.00"	8.88"	—
ESK	16.65"	1.24"	1.00"	16.30"	—
GT/HT	4.95"	3.00"	1.18"	4.63"	—
ESBM	9.50"	2.38"	1.00"	8.88"	—
ESBMT	9.50"	2.38"	1.20"	8.88"	—
DP1	18.00"	1.18"	1.18"	17.70"	—
DP2	4.95"	2.93"	1.38"	4.57"	—

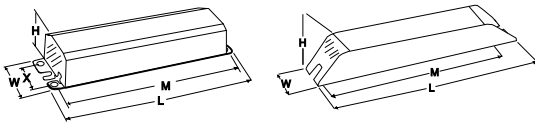

ST, -ZZ

-E, ESB, ESK, ESBM, ESBMT, DP1

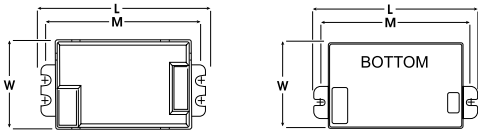

GT

HT, DP2

WIRING DIAGRAMS

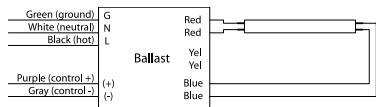

DIAGRAM 1

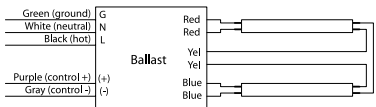

DIAGRAM 2

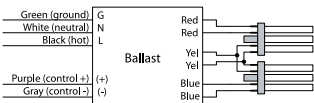

DIAGRAM 3

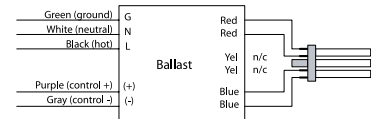

DIAGRAM 4

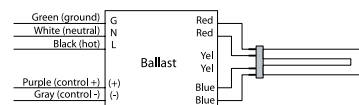

DIAGRAM 5

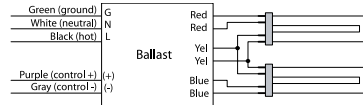

DIAGRAM 6

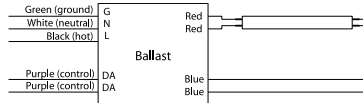

DIAGRAM 7

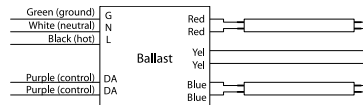

DIAGRAM 8

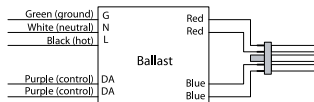

DIAGRAM 9

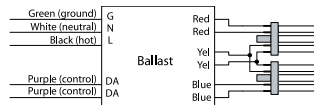

DIAGRAM 10

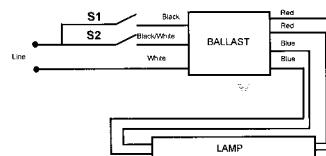

DIAGRAM 11

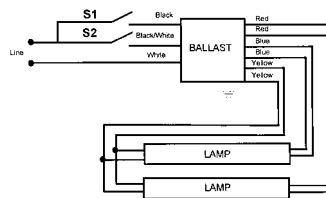

DIAGRAM 12

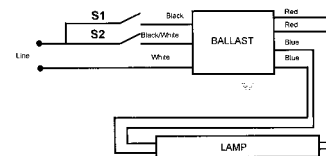

DIAGRAM 12a

INDIVIDUALLY CAP YELLOW LEADS

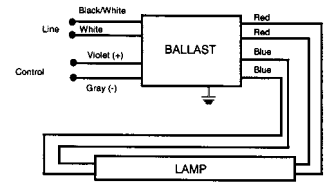

DIAGRAM 13

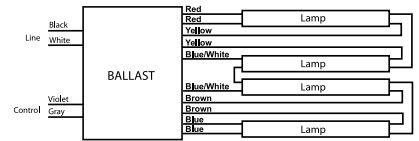

DIAGRAM 14

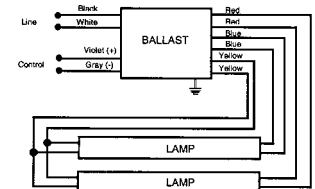

DIAGRAM 15

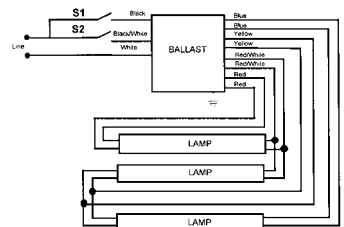

DIAGRAM 16

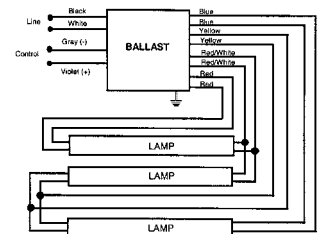

DIAGRAM 17

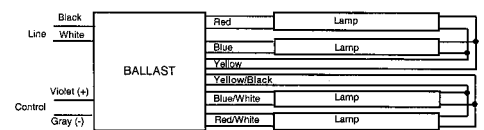
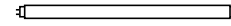

DIAGRAM 18

BALLASTAR® STEP DIMMING BALLASTS FOR T5 LAMPS

- Step Dimming
- Programmed Rapid Start
- 2 Lamp Applications



**BALLASTAR
LIGHT LEVEL
SWITCHING**

Lamp Qty.	Starting Method	Line Volts	Catalog Number	Line Current (Amps)	Input Power (Watts)	Power Factor (PF)	Ballast Factor (BF)	Ballast Efficacy Factor (BEF)	THD %	Min. F/C Start Temp	Wiring Diag.	Dim.	
F14T5 - One Lamp Applications													
1	PRS	120	B214PU115S50A @ 100%	0.17	21	> .95	1.19	5.90	< 15	50/10	12a	-A	
			B214PU115S50A @ 50%	0.09	10	> .95	0.40	3.74	< 15	50/10	12a	-A	
		277	B214PU115S50A @ 100%	0.09	21	> .75	1.19	5.80	< 15	50/10	12a	-A	
			B214PU115S50A @ 50%	0.05	10	> .75	0.40	3.50	< 15	50/10	12a	-A	
F14T5 - Two Lamp Applications													
2	PRS	120	B214PU115S50A @ 100%	0.33	37.5	> .95	1.15	3.10	< 10	50/10	12	-A	
			B214PU115S50A @ 50%	0.15	18	> .95	0.40	2.19	< 15	50/10	12	-A	
			277	B214PU115S50A @ 100%	0.15	37	> .90	1.15	3.11	< 10	50/10	12	-A
				B214PU115S50A @ 50%	0.08	19	> .85	0.40	2.14	< 15	50/10	12	-A
		120	B228PU95S50D @ 100%	0.29	35	> .95	1.00	2.86	< 10	50/10	19	-D	
			B228PU95S50D @ 50%	0.13	16	> .95	0.37	2.30	< 10	50/10	19	-D	
			277	B228PU95S50D @ 100%	0.13	35	> .95	1.00	2.86	< 10	50/10	19	-D
				B228PU95S50D @ 50%	0.06	16	> .90	0.37	2.29	< 10	50/10	19	-D
F21T5 - One Lamp Applications													
1	PRS	120	B214PU115S50A @ 100%	0.24	29	> .95	1.18	4.09	< 10	50/10	12a	-A	
			B214PU115S50A @ 50%	0.12	14	> .95	0.39	2.84	< 15	50/10	12a	-A	
		277	B214PU115S50A @ 100%	0.12	29	> .85	1.18	4.06	< 15	50/10	12a	-A	
			B214PU115S50A @ 50%	0.62	14	> .85	0.40	2.75	< 15	50/10	12a	-A	
2	PRS	120	B228PU95S50D @ 100%	0.40	48	> .95	0.99	2.06	< 10	50/10	19	-D	
			B228PU95S50D @ 50%	0.18	21	> .95	0.36	1.73	< 10	50/10	19	-D	
		277	B228PU95S50D @ 100%	0.17	47	> .95	0.99	2.10	< 10	50/10	19	-D	
			B228PU95S50D @ 50%	0.08	22	> .95	0.36	1.65	< 10	50/10	19	-D	
F28T5 - Two Lamp Applications													
2	PRS	120	B228PU95S50D @100%	0.50	58	> .99	0.95	1.64	< 10	50/10	19	-D	
			B228PU95S50D @50%	0.23	28	> .99	0.35	1.25	< 20	50/10	19	-D	
		277	B228PU95S50D @100%	0.21	57	> .98	0.95	1.67	< 10	50/10	19	-D	
			B228PU95S50D @50%	0.10	28	> .95	0.35	1.25	< 20	50/10	19	-D	
2	PRS	120	B228PU115S50D @100%	0.59	71	> .99	1.15	1.62	< 10	50/10	19	-D	
			B228PU115S50D @50%	0.29	34	> .99	0.45	1.32	< 10	50/10	19	-D	
		277	B228PU115S50D @100%	0.25	69	> .98	1.15	1.67	< 10	50/10	19	-D	
			B228PU115S50D @50%	0.12	34	> .95	0.45	1.32	< 15	50/10	19	-D	

° Preliminary Data
All models are cULus Listed

Fluorescent Dimming

STARTING METHOD LEGEND

IS = Instant Start
 PRS = Programmed Rapid Start
 RS = Rapid Start

PAR-IS = Parallel Instant Start
 PAR-PRS = Parallel Programmed Rapid Start

PAR-RS = Parallel Rapid Start
 SER-RS = Series Rapid Start

Overall Dimensions			Mounting Dimensions		
Draw #	L	W	H	M	X
-D	16.88"	1.18"	1.00"	16.20"	—
-A	9.50"	1.70"	1.18"	8.89"	—

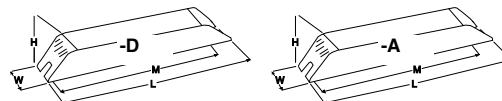

WIRING DIAGRAMS

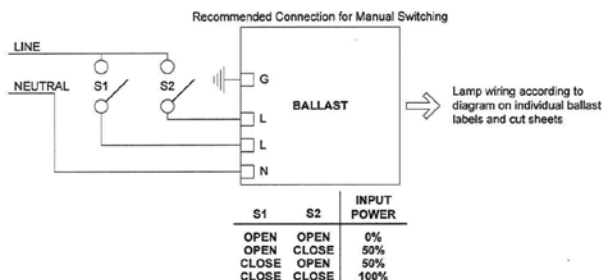

Notes

Compact Fluorescent Ballasts

The Courage To Dream Small

Universal Lighting Technologies ("Universal") offers a full range of magnetic and electronic compact fluorescent ballasts. Our magnetic models come in a variety of shapes and sizes, from core and coils to High Power Factor potted ballasts with bottom exit leads and mounting studs for all downlighting applications.

Our newest electronic models offer installer-friendly universal input voltage, which reduces your inventory and ensures that you have the right voltage ballast every time. These models feature a low profile case that fits in any fixture. And their metal housing construction meets all plenum codes and delivers maximum heat transfer to extend ballast life.



Our newest compact fluorescent models offer installer-friendly universal input voltage.

Product Overview

Electronic Compact Fluorescent Ballasts

Universal's newest TRIAD® electronic compact fluorescent ballasts feature installer-friendly universal input voltage (108 to 305 volts) and metal case designs for compliance with all plenum and construction code requirements. They also offer an end-of-lamp-life shutdown circuit with auto-reset that meets ANSI/NEMA requirements—a feature that eliminates lamp/socket damage while allowing you to replace failed lamps after shutdown without turning off the power.

Our universal voltage compact fluorescent ballasts offer both 1- and 2-lamp operation—and they're ideal for a wide variety of downlight and surface mount applications for atriums, hotel corridors, offices, and outdoors. All models operate multiple lamp types for added versatility in many different applications.

All universal voltage compact fluorescent ballasts incorporate Universal's Programmed Rapid Start (PRS) technology that increases lamp life for those frequently switched applications where occupancy sensors are used. PRS is recommended by all lamp manufacturers.

For the Canadian market, we have 347 volt compact fluorescent models. These also offer outstanding reliability and lamp performance. These 347 volt models are available for 1 and 2 lamp operation for lamps ranging from 13 to 70 Watts.

These ballasts are designed and manufactured for long life. Lamps can be mounted in close proximity to these ballasts because they have no temperature-critical components near the can sides. And their circuit board potting enhances reliability by lowering case temperatures.

CFL Mult-E Kit

The multi-exit ballast lead wire connectors accommodate side and bottom lead exit requirements. The snap mount adapter plate adds bottom-exit studs and additional flexibility for replacement of older magnetic ballasts. They also fit virtually every j-box cover and fixture application. This product is for distribution sale only.

Mult-E Kit products:

C213UNVME000K
C218UNVME000K
C2642UNVME000K

Mult-E Kit contains:

Multi-exit ballast
Snap-mount adapter plate
Lead wire set
Wire extraction tool
Instructions

Magnetic Compact Fluorescent Ballasts

Universal offers a complete line of magnetic compact fluorescent ballasts, ranging from 5 - 40 watts (10 - 38 watts for 2D lamps). Both core & coil and F-can models are available...in a variety of configurations that include Side Exit, Bottom Exit and Bottom Exit Studs.

Understanding Compact Fluorescent Technology

Compact fluorescent (CFL) lamps are single-ended and plug into sockets. They're sometimes referred to as "single-based" or "single-ended" fluorescent lamps.

Lamp Shapes

Today's CFL lamps come in these basic shapes: twin tube, quad, triple, multi and circular. Each of these shapes has its own subset of sizes. For example, the twin tube may range from 4' long (5 watt) to 22' long (40 watt).

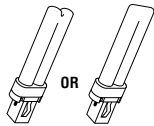

Twin, 2-Pin
5w - 13w

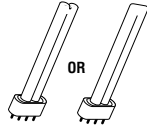

Long Twin T5, 4-Pin
5w - 80w

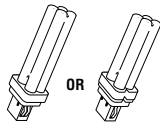

2-Pin
Quad 9w - 27w

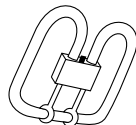

Square (2D)
10w - 55w

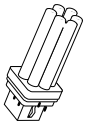

Multiple, 4-Pin
(GE & OS)
18w - 70w

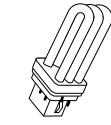

Multiple, 4-Pin
(Philips)
18w - 42w



T5 Circular
22w - 55w

Pins and Starters

CFL lamps feature either two pins or four pins. Those with two pins have starters built into their bases, and they require a magnetic preheat ballast. The two-pin CFL lamps are available in wattages from 5 to 28.

Four-pin lamps are traditionally powered by electronic ballasts. These lamps do not have an internal starter, so the other filament terminals (pins) are made accessible for external connection to the ballasts. Note: Universal offers both magnetic and electronic ballasts for the four-pin 32 and 26 watt lamps and all four-pin Long Twin T5 lamps.

Industry	Watts	GE	OSI	Philips
Single or Twin	5, 7, 9, 13	Low Watt Biax	Dulux S, S/E	PL-S
Double or Quad	9, 13, 18, 20, 26, 27	Double Biax	Dulux D, D/E	PL-C
Multiple	13, 18, 26, 32, 42	Biax T/E	Dulux T, T/E, T/E/IN	PL-T
Multiple	42, 57, 70	Biax Q/E	Dulux T/E/IN	PL-T
Long Twin T5	18, 24/27, 36/39, 40, 50, 80	High Lumen Biax	Dulux L, F	PL-L
Square	10, 16, 21, 28, 38, 55	2D	—	—
Circline	22, 40, 55	—	Pentron	Silhouette

Lamp Bases

There are a variety of lamp bases used with today's CFL lamps. This provides a safeguard to make sure that the proper lamp/ballast combination is installed. The lamp base style is part of the ANSI/NEMA designation.

In this catalog, Universal CFL ballasts are classified according to lamp type. Icons representing each lamp type provide a quick visual reference. Within each classification, the lamps and their appropriate ballasts can be found by referring to the generic NEMA lamp descriptions.

Lamp Designation

There are two different industry-recognized nomenclatures for identifying CFL lamps: ANSI Lamp Designations and NEMA Lamp Designations. Here are examples of each:

ANSI Designation

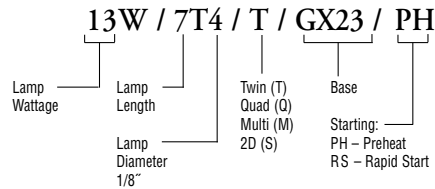

NEMA Designation

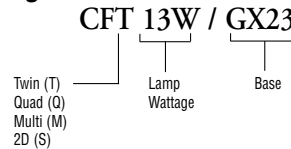

Both lamp designations refer to lamp wattage, shape, and base type. Since the NEMA designation is shorter, it will probably be the nomenclature of choice in the future. All of the major lamp companies have trade names for various CFL lamp types, such as GE's "Biax" and "2D" lamps, OSI's "Dulux," and Philips' "PL." These names have become more widely used than either of the industry designations.

Configurations

Standard Side Exit

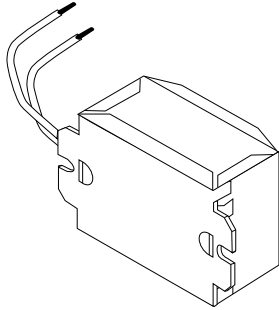

Bottom Exit*

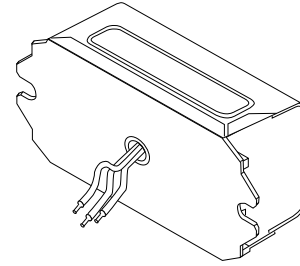

Bottom Exit with Studs**

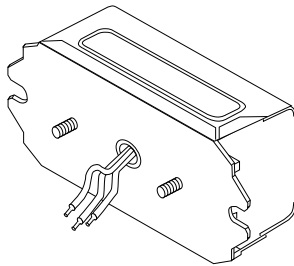

Standard Side Exit—Both Ends

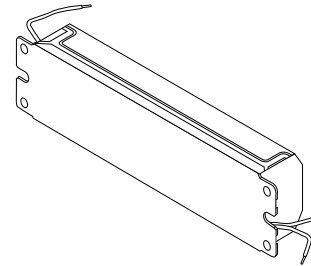

Electronic Side Exit

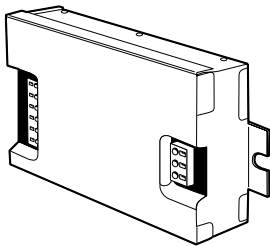

Electronic Bottom Exit

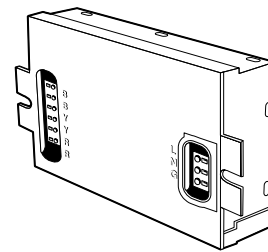

Electronic Bottom Exit with Studs

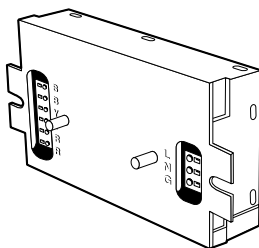



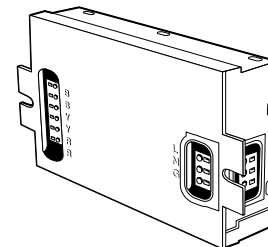







Electronic Multi-Exit



For full versatility in application according to various fixture requirements, Universal manufactures encased ballasts in three lead and mounting options. This catalog lists ordering codes for standard side exit units. *Bottom exit units should be ordered with suffix “-BE” attached to the catalog number. **Bottom exit with studs should be ordered with suffix “-BES” attached to the catalog number. (Example: Standard Unit: “4000P”; Bottom Exit unit “4000-BE”; Bottom Exit with Studs: “4000-BES”).

Product Overview

	ANSI Lamp Designation	NEMA Lamp Designation	Built-In Starter	LAMP MANUFACTURER		
				GE	OSI	Philips
	5W/4T4/T/G23/PH	CFT5W/G23	YES	F5 BX	CF 5DS	PL-S 5W
	7W/5T4/T/G23/PH	CFT7W/G23	YES	F7 BX	CF 7DS	PL-S 7W
	9W/6T4/T/G23/PH	CFT9W/G23	YES	F9 BX	CF 9DS	PL-S 9W
	13W/7T4/T/GX23/PH	CFT13W/GX23	YES	F13 BX	CF 13DS	PL-S 13W
Twin, 2-Pin						
	9W/4T4/Q/G23-2/PH	CFQ9W/G23	YES	F9 DBX23	CF 9DD	—
	13W/5T4/Q/GX23-2/PH	CFQ13W/GX23	YES	F13 DBX23	CF 13DD	PL-C 13W/USA
Quad, 2-Pin						
	13W/6T4/Q/G24d-1/PH	CFQ13W/G24d	YES	F13 DBX T4	—	PL-C 13W
	18W/7T4/Q/G24d-2/PH	CFQ18W/G24d	YES	F18 DBX T4	CF 18DD	PL-C 18W
	26W/8T4/Q/G24d-3/PH	CFQ26W/G24d	YES	F26 DBX T4	CF 26DD	PL-C 26W
Quad, 2-Pin						
	13W/6T4/Q/G24q-1	CFQ13W/G24q	NO	F13 DBX/4P	CF 13DD/E	PL-C 13W/4P
	18W/7T4/Q/G24q-2	CFQ18W/G24q	NO	F18 DBX/4P	CF 18DD/E	PL-C 18W/4P
	26W/8T4/Q/G24q-3	CFQ26W/G24q	NO	F26 DBX/4P	CF 26DD/E	PL-C 26W/4P
Quad, 4-Pin						
	10W/3.5T4/S/GR10q-4	CFS10W/GR10q	NO	F10 2D/4P	—	—
	16W/5.5T4/S/GR10q-4	CFS16W/GR10q	NO	F16 2D/4P	—	—
	21W/5.5T4/S/GR10q-4	CFS21W/GR10q	NO	F21 2D/4P	—	—
	28W/8T6/S/GR8-2/PH	CFS28W/GR8	YES	F28 2D	—	—
	28W/8T6/S/GR10q-4	CFS28W/GR10q	NO	F28 2D/4P	—	—
	38W/8T6/S/GR10q-4	CFS38W/GR10q	NO	F38 2D/4P	—	—
	55W/8T6/S/GRY10q-3	CFS55W/GRY10q	NO	F55 2D/4P	—	—
Square, (2D)						
	20W/6T5/Q/GX32d-2/PH	CFQ20W/GX32d	YES	—	—	PL-C 15MM/22W
	27W/7T5/Q/GX32d-3/PH	CFQ27W/GX32d	YES	—	—	PL-C 15MM/28W
T5 Quad, 2-Pin						
	13W/6T4/T/2GX7	CFT13W/2GX7	NO	—	CF 13DS/E	—
	18-20W/9T5/T/2G11/PH-RS	FT18W/2G11	NO	F18 BX	FT 18DL	—
	18W/10T5/T/2G11/RS	FT18W/2G11/RS	NO	F18 BX/RS	FT 18DL/RS	PL-L 18W
	18W/5T5/T/2G10	CFM18W/2G10	NO	—	CF 18DF	—
	24-27W/13T5/T/2G11/PH-RS	FT24W/2G11/RS	NO	F27 BX/RS	FT 24DL	PL-L 24W
	24W/7T5/T/2G10	CFM24W/2G10	NO	—	CF 24DF	—
	36-39W/16T5/T/2G11/PH-RS	FT36W/2G11/RS	NO	F39 BX/RS	FT 36DL	PL-L 36W
36W/9T5/T/2G10	CFM36W/2G10	NO	—	CF 36DF	—	
40W/22T5/T/2G11/RS	FT40W/2G11/RS	NO	F40 BX/RS	FT 40DL/RS	PL-L 40W/RS	
50W/22T5/T/2G11/RS	FT50W/2G11/RS	NO	F50 BX/RS	—	PL-L 50W/RS	
55W/21T5/T/2G11	FT55W/2G11	NO	F55 BX	FT 55DL	—	
80W/22T5/T/2G11	FT80W/2G11	NO	—	—	PL-L 80W	
Long Twin T5, 4-Pin						
	18W/5T4/M/GX24d-2	CFM18W/GX24d	YES	—	CF 18DT	—
	26W/6T4/M/GX24d-3	CFM26W/GX24d	YES	—	CF 26DT	—
Multiple, 2-Pin						
	13W/5T4/M/GX24q-1	CFM13W/GX24q	NO	F13 TBX/4P	CF 13DT/E	—
	18W/5T4/M/GX24q-2	CFM18W/GX24q	NO	F18 TBX/4P	CF 18DT/E/IN	PL-T 18W/4P
	26W/6T4/M/GX24q-3	CFM26W/GX24q	NO	F26 TBX/4P	CF 26DT/E/IN	PL-T 26W/4P
	32W/6T4/M/GX24q-3	CFM32W/GX24q	NO	F32 TBX/4P/EOL	CF 32DT/E/IN	PL-T 32W/4P
	42W/7T4/M/GX24q-4	CFM42W/GX24q	NO	F42 TBX/4P/EOL	CF 42DT/E/IN	PL-T 42W/4P
	57W/7T4/M/GX24q-5	CFM57W/GX24q	NO	F57 QBX/4P/EOL	CF 57DT/E/IN	—
	70W/8T4/M/GX24q-6	CFM70W/GX24q	NO	F70 QBX/4P/EOL	—	—
Multiple, 4-Pin						
	—	FC9T5-22W/2GX13	NO	—	FPC22	FC9T5 22W
	—	FC12T5-40W/2GX13	NO	—	FPC40	FC12T5 40W
	—	FC12T5-55W/2GX13	NO	—	FPC55/HO	FC12T5 55W

Specifications

TYPICAL SPECIFICATIONS FOR ELECTRONIC COMPACT FLUORESCENT BALLASTS

1. Ballast shall be Programmed Rapid Start.
2. Ballast shall incorporate lamp shutdown circuitry for end of lamp life protection.
3. Ballast shall allow for re-lamping without the need to cycle power.
4. Ballasts shall operate from 50/60 Hz input source of 120, 277, or 347 Volts with no damage to the ballasts.
- 4a. Ballasts shall operate from 50/60 Hz input source of 108-305 Volts with no damage to the ballasts for High Performance (HP) models.
5. Ballast shall be of metal can construction to meet all plenum requirements and to eliminate the need for extra grounding wires.
6. Ballasts shall be a high frequency electronic type, and operate lamps at a frequency above 50 kHz to minimize interference with infrared control systems.
7. Lamp Current Crest Factor (ratio of peak to RMS current) shall be 1.7 or less in accordance with lamp manufacturer recommendation and ANSI C82.11-1993.
8. Ballasts shall tolerate operation in ambient temperatures up to 140°F (55°C) without damage.
9. Ballasts shall have a maximum case temperature test point of 75°C printed on the label for easy fixture testing and trouble shooting.
10. Ballast shall have a maximum case temperature rise of 15°C.
11. Ballasts shall comply with FCC Part 18 Non-Consumer Equipment for EMI (power line conducted) and RFI (Radiated).
12. Ballasts shall provide transient immunity as recommended by ANSI C62.41-1991.
13. Ballasts shall operate lamps with no visible flicker (<3% flicker index).
14. Ballasts shall tolerate sustained open and short circuit output conditions without damage.
15. Ballasts shall be Underwriters Laboratory (UL 935) listed, Class P, Type 1 Outdoor, and CSA certified, and unless noted otherwise, approved for use in hazardous locations (Type HL).
16. Input current Total Harmonic Distortion shall not exceed 10% for the primary lamp.
17. Ballasts shall have a Power Factor greater than .98 for the primary lamp.
18. The ballasts shall not have any PCB's.
19. The manufacturer shall provide written warranty against defects in material or workmanship, including replacement, for five years from date of manufacture.
20. Manufacturer shall have been manufacturing electronic ballasts for at least fifteen years.
21. Ballast shall be manufactured in an ISO 9001 Certified Facility.
22. Universal model _____ (or approved equal).

Understanding Universal Part Numbers

MAGNETIC

Our part number nomenclature for magnetic ballasts is shown below:

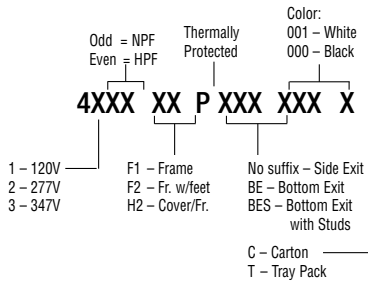

Example: 4123PBES000T

Ballast for CFL Lamps: Indicated by "4" prefix

Voltage: 120V

Lamp Type: 26W Quad Lamp (refer to catalog for wattage)

Power Factor: Normal

Encased and Potted: Indicated by absence of F1, F2, or H2)

P: Thermally protected

BES: Bottom exit leads with studs

000: Color—Black

T: Packaging container style—Tray Pack

These ballasts are available for a wide variety of applications with lamps, voltages, mounting configurations, and performance characteristics. For more detailed information, just identify the lamps to be ballasted and work forward to determine the ballast part number.

ELECTRONIC

Our nomenclature for electronic CFL ballasts follows the system already in place for other Universal electronic ballasts. The exceptions are that the model number prefix for compact fluorescent is a C rather than a B—and the suffixes for the mounting configuration will be the same as those used for magnetic products (BE and BES). If you don't see these suffixes, the ballast has traditional side exit leads.

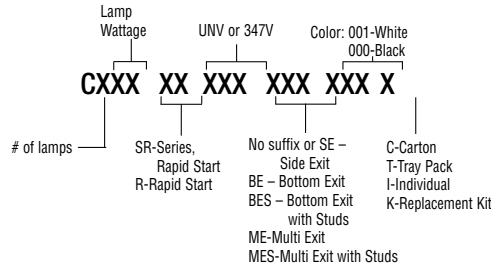

Example: Electronic C240PUNVHP-B

Ballast Type: C — CFL Electronic Ballast

Lamp Qty: 2

Lamp Type: 40W TT5, 4 Pin (FT40W/2611)

P: Programmed Rapid Start

Voltage: UNV 120 to 277 volts

HP-B: High Performance <10%; low profile can

000: Color—Black

C: Packaging container style—Carton Pack

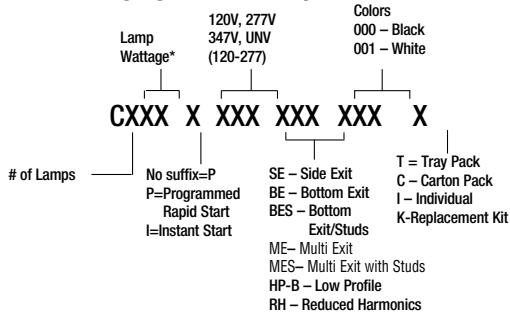

Example: C213UNVBES000C*

Ballast Type: C

Lamp Quantity: 2

Lamp Type: 13W Quad, 4 Pin (CFQ13W/G24q)

Voltage: UNV 120 to 277 volts

BES: Bottom exit connection, studs

000C: Color—Black

C: Packaging container style—Carton Pack

*Exception is C2642, which does not distinguish number of lamps. See catalog.

TWIN LAMPS

5, 7, 9 & 11 WATTS

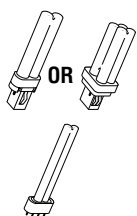

- Open core & coil or enclosed & potted designs
- 1 & 2 lamp models available
- Ideal for surface mount fixtures, exit & retail display signs

MAGNETIC AND ELECTRONIC COMPACT FLUORESCENT BALLASTS

FOR TWIN LAMPS 5, 7, 9 AND 11 WATTS

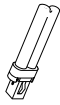
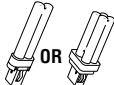
QUICK REFERENCE Nominal lamp watts and configuration	Mag or Elec	Qty of Lamps	Line Volt	Catalog Number	Input Watts	Line Current Amps	Starting Current Amps	Ballast Factor	Min Start Temp	Power Factor	THD	Lead Configuration			Starting Method	Dim	Wir Diag	
												Side Exit	Bottom Exit	Bottom Exit Studs				
Electrical Characteristics - 60 Hz																		
7 Watts	○	M	1	120	4105F2P [■] *	10	0.18	0.20	0.95	0° F	Normal	<10%	X	—	—	PH	B2	1
CFT7W/G23		M	1	120	4105P	10	0.18	0.20	0.95	0° F	Normal	<10%	X	—	—	PH	C1	1
 <p>Twin, 2-Pin</p>																		
9 Watts	○	M	1	120	4105F2P [■] *	10	0.18	0.20	0.90	25° F	Normal	<10%	X	—	—	PH	B2	1
CFT9W/G23		M	1	120	4105P	10	0.18	0.20	0.90	25° F	Normal	<10%	X	—	—	PH	C1	1
OR																		
CFQ9W/G23																		
 <p>Twin or Quad, 2-Pin</p>																		

★ Non-thermally protected models available.

☆ PH = Preheat

■ F2 indicates an open core & coil unit with mounting feet.

■ H2 indicates clamped & covered core & coil with mounting feet.

⊕ Add "B" for Bottom Exit or "S" for Side Exit or "BS" for Bottom Exit with 2" O.C. screw studs.

○ Not approved for use in hazardous locations.

The enclosed ballasts listed on this page are available in white (001) or black (000) cans, except CBT's, which are all in white cans.

All ballasts are UL listed, CSA approved

See page 4-13 for Dimensions and Wiring Diagrams.

MAGNETIC AND ELECTRONIC COMPACT FLUORESCENT BALLASTS FOR TWIN, QUAD AND MULTIPLE LAMPS 13 WATTS

- Ideal for downlights & wall sconces
- Electronic models feature universal input voltage from 120V to 277V. 347V models are also available.
- Electronic models feature programmed rapid start for excellent lamp performance & auto reset shut-down circuit

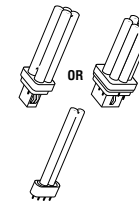

**TWIN, QUAD
& MULTIPLE
LAMPS
13 WATTS**

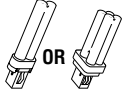
QUICK REFERENCE Nominal lamp watts and configuration	Mag or Elec	Qty of Lamps	Line Volt	Catalog Number	Input Watts	Line Current Amps	Starting Current Amps	Ballast Factor	Min Start Temp	Power Factor	THD	Lead Configuration			Starting Method	Dim	Wir Diag
												Side Exit	Bottom Exit	Bottom Exit Studs			
Electrical Characteristics - 60 Hz																	
13 Watts CFT13W/GX23 OR CFQ13W/GX23  Twin or Quad, 2-Pin U.S. type	○ M	1	120	CF1320H2P	16	0.24	0.30	0.85	32° F	Normal	<15%	X	—	—	PH	B10	1
	○ M	1	120	4113P	14	0.24	0.36	0.80	32° F	Normal	<10%	X	—	—	PH	C2	1
	○ M	1	277	4211F2P	22	0.16	0.35	1.00	32° F	Normal	<10%	X	—	—	PH	B3	1
	○ M	1	277	4211PBES	22	0.16	0.35	1.00	32° F	Normal	<10%	X	—	—	PH	C3	1
	M	1	120	4112P	14	0.13	0.14	0.80	32° F	High	<20%	X	X	X	PH	C2	2
	M	1	120	4113P	14	0.24	0.36	0.90	32° F	Normal	<10%	X	X	X	PH	C2	1
	M	1	277	4210PBES	21	0.10	0.11	1.00	32° F	High	<20%	X	X	X	PH	C3	2
	M	2	120	4114P	31	0.26	0.33	0.95	32° F	High	<20%	X	—	X	PH	C5	8
	M	2	277	4214PBES	26	0.09	0.09	0.85	32° F	High	<20%	X	—	X	PH	C4	9

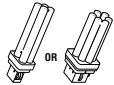
Lamp Type 13 Watts CFQ13W/G24q OR CFM13W/GX24q  Quad or Multiple, 4-Pin	E	1	120 277	C213UNV	18	0.15 0.07	—	1.00	0° F	High	<10% <15%	X	X	X	PRS	C10	18
	E	2	120 277	C213UNV	30	0.26 0.11	—	1.00	0° F	High	<10%	X	X	X	PRS	C10	19
	E	1	347	C213/347	18	0.06	—	1.00	0° F	High	<10%	X	X	X	PRS	C10	18
	E	2	347	C213/347	33	0.10	—	0.98	0° F	High	<10%	X	X	X	PRS	C10	19

Lamp Type 13 Watts CFT13W/2GX7  Twin T4, 4-Pin	E	1	120 277	CT213UNV	15	0.12 0.06	—	0.98	0° F	High	<10% <12%	X	X	X	PRS	C10	20+
	E	2	120 277	CT213UNV	26	0.22 0.10	—	0.98	0° F	High	<10%	X	X	X	PRS	C10	20

*Non-thermally protected models available.

☆ PH = Preheat; PRS = Programmed Rapid Start; RS=Rapid Start

F2 indicates an open core & coil unit with mounting feet.

H2 indicates clamped & covered core & coil with mounting feet.

◆ Add following suffix for complete catalog #: "SE" for Side Exit connectors, "BE" for Bottom Exit connectors, "BES" for Bottom Exit connectors with 2" O.C. screw studs, "ME" for Multi Exit connectors, or "MES" for Multi Exit with 2" OC screw studs.

○ Not approved for use in hazardous locations.

✕ Add "ME000K" suffix for Mult-E Kit. For Distribution only.

The enclosed ballasts listed on this page are available in white (001) or black (000) cans, except CBT's, which are all in white cans.

All ballasts are UL listed, CSA approved

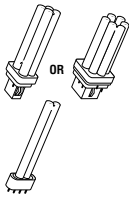

See page 4-13 for Dimensions and Wiring Diagrams.

**TWIN, QUAD
& MULTIPLE
LAMPS
18 WATTS**

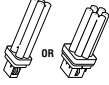

- Ideal for downlights, surface mount & outdoor fixtures
- Electronic models feature universal input voltage from 120V to 277V. 347V models are also available.
- Electronic models feature programmed rapid start for excellent lamp performance & auto reset shutdown circuit

**MAGNETIC AND ELECTRONIC
COMPACT FLUORESCENT
BALLASTS FOR TWIN, QUAD
AND MULTIPLE LAMPS
18 WATTS**

QUICK REFERENCE Nominal lamp watts and configuration	Mag or Elec	Qty of Lamps	Line Volt	Catalog Number	Input Watts	Line Current Amps	Starting Current Amps	Ballast Factor	Min Start Temp	Power Factor	THD	Lead Configuration			Starting Method*	Dim	Wir Diag
												Side Exit	Bottom Exit	Bottom Exit Studs			
Electrical Characteristics - 60 Hz																	
Lamp Type 18 Watts CFQ18W/G24d	M	2	120	4122PBES	50	0.45	0.27	0.88	15° F	High	<20%	—	—	X	PH	C6	10
 Quad, 2-Pin																	
Lamp Type 18 Watts CFQ18W/G24q OR CFM18W/GX24q	E	1	120 277	C218UNV♦×	19	0.16 0.07	—	1.00	0° F	High	<10% <15%	X	X	X	PRS	C10	18
	E	2	120 277	C218UNV♦×	35	0.30 0.13	—	0.95	0° F	High	<10%	X	X	X	PRS	C10	19
 Quad or Multiple, 4-Pin	E	1	347	C218/347♦	21	0.11	—	1.00	0° F	High	<10%	X	X	X	PRS	C10	18
	E	2	347	C218/347♦	38	0.06	—	0.98	0° F	High	<10%	X	X	X	PRS	C10	19
Lamp Type 18 Watts FT18W/2G11RS	E	1	120 277	CT218UNVSE♦	23	0.19 0.07	—	1.00	0° F	High	<10%	X	—	—	PRS	C10	18
	E	2	120 277	CT218UNVSE♦	43 42	0.37 0.16	—	0.98	0° F	High	<10%	X	—	—	PRS	C10	19
 Twin T5, 4-Pin,																	

♦ PH = Preheat; PRS = Programmed Rapid Start; RS=Rapid Start
♦ Add following suffix for complete catalog #: "SE" for Side Exit connectors, "BE" for Bottom Exit connectors, "BES" for Bottom Exit connectors with 2" O.C. screw studs, "ME" for Multi Exit connectors, or "MES" for Multi Exit with 2" OC screw studs.

✕ Add "ME000K" suffix for Mult-E Kit. For Distribution only.

The enclosed ballasts listed on this page are available in white (001) or black (000) cans, except CBT's, which are all in white cans. All ballasts are UL listed, CSA approved and designated Class P (thermally protected), Type HL.

See page 4-13 for Dimensions and Wiring Diagrams.



MAGNETIC AND ELECTRONIC COMPACT FLUORESCENT BALLASTS

FOR QUAD AND MULTIPLE LAMPS 26 AND 28 WATTS

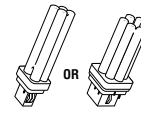
- Ideal for downlights, surface mount & outdoor fixtures
- Electronic models feature universal input voltage from 120V to 277V. 347V models are also available.
- Electronic models feature programmed rapid start for excellent lamp performance & auto reset shutdown circuit

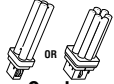

**QUAD AND
MULTIPLE
LAMPS**
26 & 28 WATTS

QUICK REFERENCE Nominal lamp watts and configuration	Mag or Elec	Qty of Lamps	Line Volt	Catalog Number	Input Watts	Line Current Amps	Starting Current Amps	Ballast Factor	Min Start Temp	Power Factor	THD	Lead Configuration			Starting Method	Dim	Wir Diag
												Side Exit	Bottom Exit	Bottom Exit Studs			
Lamp Type																	
26 Watts																	
CFQ26W/G24d 	M	1	120	4124PBES	30	0.27	0.46	0.88	25° F	High	<30%	—	X	—	PH	C4	3
	M	1	120	4124PBES	30	0.27	0.46	0.88	25° F	High	<30%	—	—	X	PH	C4	3
	M	2	120	4128PBES	61	0.55	0.38	0.90	32° F	High	<20%	X	—	X	PH	C6	16
	M	2	277	4226PBES	62	0.22	0.34	0.90	32° F	High	<20%	X	—	X	PH	C4	8
Electrical Characteristics - 60 Hz																	
Quad, 2-Pin																	
Lamp Type																	
26 Watts																	
CFQ26W/G24q OR CFM26W/GX24q 	E	1	120	C2642UNV♦×	28	0.25	—	1.02	0° F	High	<10%	X	X	X	PRS	C10	18
	E	2	120	C2642UNV♦×	56	0.47	—	0.98	0° F	High	<10%	X	X	X	PRS	C10	19
	E	1	347	C2642/347♦	31	0.09	—	1.02	0° F	High	<10%	X	X	X	PRS	C10	18
	E	2	347	C2642/347♦	57	0.17	—	0.98	0° F	High	<10%	X	X	X	PRS	C10	19
	E	2	120	C242UNV♦	56	0.46	—	1.02	0° F	High	<10%	X	X	X	PRS	C11	19
	E	2	277	C242UNV♦	55	0.20	—	1.02	0° F	High	<10%	X	X	X	PRS	C11	19
Quad or Multiple, 4-Pin																	
Lamp Type																	
28 Watts																	
CFQ28W/GX32d 	○ M	1	120	4139F2P■	32	0.65	0.84	0.95	15° F	Normal	<10%	X	—	—	PH	B3	1

- ♦ PH = Preheat; PRS = Programmed Rapid Start; RS = Rapid Start
- F2 indicates an open core & coil unit with mounting feet.
- ◆ Add following suffix for complete catalog #: "SE" for Side Exit connectors or "BE" suffix for Bottom Exit connectors or "BES" for Bottom Exit connectors with 2" O.C. screw studs.
- Not approved for use in hazardous locations.
- ✕ Add "ME" suffix for Mult-E Kit. For Distribution only.
- ⊕ Add "B" for Bottom Exit or "S" for Side Exit or "BS" for Bottom Exit with 2" O.C. screw studs.

The enclosed ballasts listed on this page are available in white (001) or black (000) cans, except CBT's, which are all in white cans.
All ballasts are UL listed, CSA approved

See page 4-13 for Dimensions
and Wiring Diagrams.

MULTIPLE LAMPS





32, 42, 57 & 70 WATTS



- Ideal for downlights, surface mount & outdoor fixtures
- Electronic models feature universal input voltage from 120V to 277V. 347V models are also available.
- Electronic models feature programmed rapid start for excellent lamp performance & auto reset shutdown circuit

ELECTRONIC COMPACT FLUORESCENT BALLASTS FOR MULTIPLE LAMPS

32, 42, 57 & 70 WATTS

QUICK REFERENCE Nominal lamp watts and configuration	Mag or Elec	Qty of Lamps	Line Volt	Catalog [⊛] Number	Input Watts	Line Current Amps	Starting Current Amps	Ballast Factor	Min Start Temp	Power Factor	THD	Lead Configuration			Starting Method [⊛]	Dim	Wir Diag
												Side Exit	Bottom Exit	Bottom Exit Studs			
Lamp Type																	
32 Watts																	
CFM32W/GX24q 	E	1	120	C2642UNV [⊛] ×	36	0.30	---	1.00	0° F	High	<10%	X	X	X	PRS	C10	18
			277		36	0.13	---	0.98	0° F	High	<10%	X	X	X	PRS	C10	18
	E	1	347	C2642/347 [⊛]	36	0.11	---	0.98	0° F	High	<10%	X	X	X	PRS	C10	18
	E	2	120	C242UNV [⊛]	69	0.58	---	1.00	0° F	High	<10%	X	X	X	PRS	C11	19
		277	67		0.26	---	1.00	0° F	High	<10%	X	X	X	PRS	C11	19	
E	2	347	C242/347 [⊛]	62	0.19	---	1.00	0° F	High	<10%	X	X	X	PRS	C11	19	
Multiple, 4-Pin																	
Lamp Type																	
42 Watts																	
CFM42W/GX24q 	E	1	120	C2642UNV [⊛] ×	48	0.41	---	0.98	0° F	High	<10%	X	X	X	PRS	C10	18
			277		48	0.18	---	0.98	0° F	High	<10%	X	X	X	PRS	C10	18
	E	1	347	C2642/347 [⊛]	50	0.15	---	1.00	0° F	High	<10%	X	X	X	PRS	C10	18
	E	1	120	C242UNV [⊛]	45	0.40	---	1.00	0° F	High	<10%	X	X	X	PRS	C11	19
			277		91	0.76	---	0.98	0° F	High	<10%	X	X	X	PRS	C11	19
	E	2	120	C242UNV [⊛]	90	0.32	---	0.98	0° F	High	<10%	X	X	X	PRS	C11	19
E	1	347	C242/347 [⊛]	42	0.13	---	1.00	0° F	High	<10%	X	X	X	PRS	C11	18	
E	2	347	C242/347 [⊛]	80	0.25	---	0.98	0° F	High	<10%	X	X	X	PRS	C11	19	
Multiple, 4-Pin																	
Lamp Type																	
57 Watts																	
CFM57W/GX24q 	E	1	120	C242UNV [⊛]	58	0.52	---	1.00	0° F	High	<10%	X	X	X	PRS	C11	19
			277		57	0.21	---	1.00	0° F	High	<10%	X	X	X	PRS	C11	19
E	1	347	C242/347 [⊛]	61	0.18	---	1.00	0° F	High	<10%	X	X	X	PRS	C11	19	
Multiple, 4-Pin																	
Lamp Type																	
70 Watts																	
CFM70W/GX24q 	E	1	120	C242UNV [⊛]	73	0.61	---	1.00	0° F	High	<10%	X	X	X	PRS	C11	19
			277		72	0.27	---	1.00	0° F	High	<10%	X	X	X	PRS	C11	19
E	1	347	C242/347 [⊛]	74	0.21	---	1.00	0° F	High	<10%	X	X	X	PRS	C11	19	
Multiple, 4-Pin																	

⊛ RS = Rapid Start; PRS = Programmed Rapid Start

◆ Add following suffix for complete catalog #: "SE" for Side Exit connectors or "BE" suffix for Bottom Exit connectors or "BES" for Bottom Exit connectors with 2" O.C. screw studs.

✕ Add "ME" suffix for Mult-E Kit. For Distribution only.

⊙ Add "B" for Bottom Exit or "S" for Side Exit or "BS" for Bottom Exit with 2" O.C. screw studs.

The encased ballasts listed on this page are available in white (001) or black (000) cans. All ballasts are UL listed, CSA approved and designated Class P (thermally protected), Type HL.

See page 4-13 for Dimensions and Wiring Diagrams.

MAGNETIC AND ELECTRONIC COMPACT FLUORESCENT BALLASTS

WIRING DIAGRAMS AND DIMENSIONS

REFERENCE DRAWING FOR B1-B3

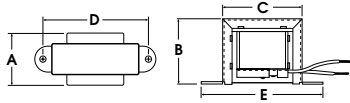

Dwg.	A	B	C	D	E
B1	0.84"	1.41"	1.72"	2.00"	2.38"
B2	1.23"	1.64"	1.97"	2.38"	2.81"
B3	1.50"	1.95"	2.34"	2.81"	3.25"

Lead Lengths: 10"-12"

REFERENCE DRAWING FOR C1, C2

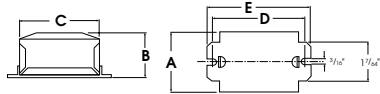

Dwg.	A	B	C	D	E
C1	1.84"	1.09"	2.06"	2.41"	2.75"
C2	1.84"	1.42"	2.40"	2.75"	3.13"

Lead Lengths: Side-12"
BE/BES-8"

REFERENCE DRAWING FOR C6

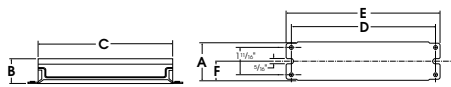

Dwg.	A	B	C	D	E	F
C6	2.38"	1.53"	8.31"	8.89"	9.48"	1.19"

Lead Lengths: Side
11"

- Black/White-
- Red/Blue-12"
BE/BES-8"

REFERENCE DRAWING FOR C11

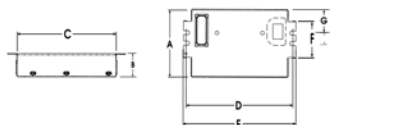

Dwg.	A	B	C	D	E	F	G
C11	2.98"	1.00"	4.25"	4.61"	4.94"	1.55"	1.00"

Leadless-Poke-in wire connection

REFERENCE DRAWING FOR CBT

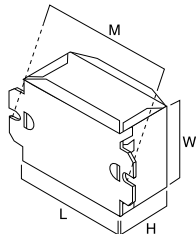

Dwg.	A	B	C	D	E
CBT	3.86"	2.00"	1.00"	3.50"	--

REFERENCE DRAWING FOR C3, C4, C5

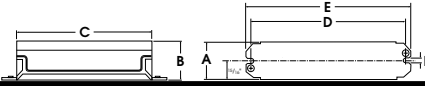

Dwg.	A	B	C	D	E	F
C3	2.14"	1.56"	3.50"	4.31"	4.75"	0.22"
C4	2.34"	1.53"	5.45"	6.00"	6.59"	0.31"
C5	1.88"	1.47"	5.13"	6.00"	6.44"	0.25"

Lead Lengths: Side-12"
BE/BES-8"

REFERENCE DRAWING FOR C10

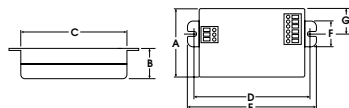

Dwg.	A	B	C	D	E	F	G
C10	2.31"	1.00"	4.25"	4.61"	4.94"	0.98"	1.00"

Leadless-Poke-in wire connection

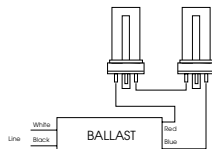

DIAGRAM 16
Series lamp operation

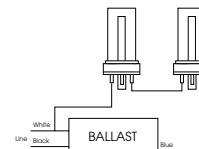

DIAGRAM 17
Series lamp operation

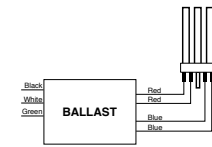

DIAGRAM 18
Ballast should be ground-

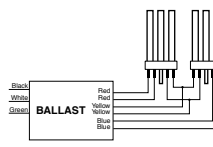

DIAGRAM 19
Series lamp operation
Ballast should be grounded

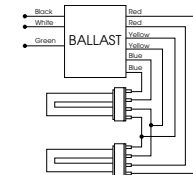

DIAGRAM 20
Series lamp opera-

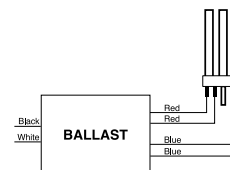

DIAGRAM 47

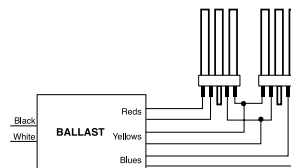

DIAGRAM 48

WIRING DIAGRAMS

Install in accordance with
National Electrical Code.

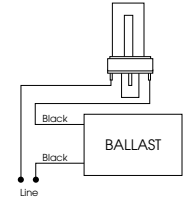

DIAGRAM 1

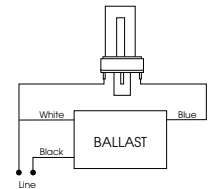

DIAGRAM 2

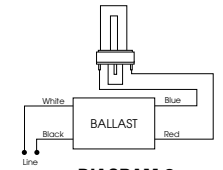

DIAGRAM 3

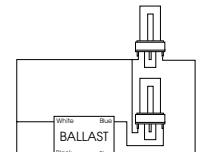

DIAGRAM 8
Parallel lamp operation

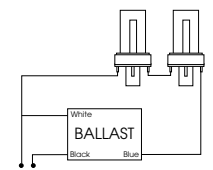

DIAGRAM 9
Series lamp opera-

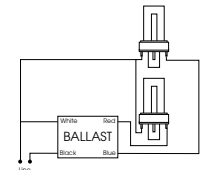





DIAGRAM 10
Parallel lamp operation

2D LAMPS 10, 16 & 21 WATTS



- Ideal for surface mount fixtures
- All magnetic models are encased & potted.
- Magnetic and electronic models available.
- Electronic models feature universal input voltage from 120V to 277V. 347V models are also available.
- Electronic models feature programmed rapid start for excellent lamp performance & auto reset shutdown circuit

MAGNETIC & ELECTRONIC COMPACT FLUORESCENT BALLASTS FOR 2D LAMPS 10, 16 AND 21 WATTS

QUICK REFERENCE Nominal lamp watts and configuration	Mag or Elec	Qty of Lamps	Line Volt	Catalog Number	Input Watts	Line Current Amps	Starting Current Amps	Ballast Factor	Min Start Temp	Power Factor	THD	Lead Configuration			Starting Method	Dim	Wir Diag
												Side Exit	Bottom Exit	Bottom Exit Studs			
Lamp Type																	
Electrical Characteristics - 60 Hz																	
10 Watts CFS10W/GR10q	E	1	120 277	C213UNV◆×	15	0.12 0.06	---	1.02	0° F	High	<10% <15%	X	X	X	PRS	C10	18a
	E	2	120 277	C213UNV◆×	26	0.22 0.10	---	1.02	0° F	High	<10%	X	X	X	PRS	C10	19a
	E	1	347	C213/347◆	16	0.05	---	1.02	0° F	High	<10%	X	X	X	PRS	C10	18a
	E	2	347	C213/347◆	28	0.08	---	1.02	0° F	High	<10%	X	X	X	PRS	C10	19a
2D, 4-Pin																	
Lamp Type																	
16 Watts CFS16W/GR10q	E	1	120 277	C213UNV◆×	19	0.15 0.07	---	0.95	0° F	High	<10% <15%	X	X	X	PRS	C10	18a
	E	1	347	C213/347◆	20	0.06	---	0.95	0° F	High	<10%	X	X	X	PRS	C10	18a
	E	2	120 277	C213UNV◆×	33	0.28 0.12	---	0.95	0° F	High	<10%	X	X	X	PRS	C10	19a
	E	2	347	C213/347◆	34	0.10	---	0.95	0° F	High	<10%	X	X	X	PRS	C10	19a
2D, 4-Pin																	
Lamp Type																	
21 Watts CFS21W/GR10q	E	1	120 277	C218UNV◆×	24	0.18 0.08	---	0.98	0° F	High	<10% <15%	X	X	X	PRS	C10	18a
	E	1	347	C218/347◆	21	0.06	---	0.98	0° F	High	<10%	X	X	X	PRS	C10	18a
	E	2	120 277	C218UNV◆×	43	0.37 0.16	---	0.95	0° F	High	<10% <15%	X	X	X	PRS	C10	19a
	E	2	347	C218/347◆	39	0.12	---	0.95	0° F	High	<10%	X	X	X	PRS	C10	19a
2D, 4-Pin																	

- Starter required: use COP-40 or FS-4 type fluorescent starter.
- ✦ PH = Preheat; PRS = Programmed Rapid Start
- ◆ Add following suffix for complete catalog #: "SE" for Side Exit connectors, "BE" for Bottom Exit connectors, "BES" for Bottom Exit connectors with 2" O.C. screw studs, "ME" for Multi Exit connectors, or "MES" for Multi Exit with 2" OC screw studs.
- ✕ Add "ME000K" suffix for Mult-E Kit. For Distribution only.

The enclosed ballasts listed on this page are available in white (001) or black (000) cans. All ballasts are UL listed, CSA approved and designated Class P (thermally protected), Type HL.

See page 4-16 for Dimensions and Wiring Diagrams.



MAGNETIC & ELECTRONIC COMPACT FLUORESCENT BALLASTS FOR 2D LAMPS

28, 38 & 55 WATTS

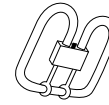
- Ideal for surface mount fixtures
- All magnetic models are encased & potted
- Magnetic & electronic models available
- Electronic models feature universal input voltage from 120V to 277V.
- Electronic models feature programmed rapid start for excellent lamp performance & auto reset shutdown circuit



**2D
LAMPS**
28, 38 & 55
WATTS

QUICK REFERENCE Nominal lamp watts and configuration	Mag or Elec	Qty of Lamps	Line Volt	Catalog [Ⓞ] Number	Input Watts	Line Current Amps	Starting Current Amps	Ballast Factor	Min Start Temp	Power Factor	THD	Lead Configuration			Starting Method [⚡]	Dim	Wir Diag
												Side Exit	Bottom Exit	Bottom Exit Studs			
Electrical Characteristics - 60 Hz																	
Lamp Type																	
28 Watts																	
CFS28W/GR8	M	1	120	4124PBES	37	0.34	0.46	0.88	32° F	High	<20%	—	X	—	PH	C4	1a
	M	1	120	4124PBES	37	0.34	0.46	0.88	32° F	High	<20%	—	—	X	PH	C4	1a
	M	2	120	4128PBES	61	0.55	0.38	0.90	32° F	High	<20%	X	—	X	PH	C6	13a
	M	2	277	4226PBES	66	0.23	0.34	0.93	25° F	High	<20%	X	—	X	PH	C4	7a
																	
2D, 2-Pin																	
Lamp Type																	
28 Watts																	
CFS28W/GR10q	E	1	120	C2642UNV [⚡] ×	31	0.27	—	0.95	0° F	High	<10%	X	X	X	PRS	C10	18a
	E	1	347	C2642/347 [⚡]	33	0.10	—	0.95	0° F	High	<10%	X	X	X	PRS	C10	18a
	E	2	120	C242UNV [⚡]	64	0.54	—	1.00	0° F	High	<10%	X	X	X	PRS	C11	19a
	E	2	277	C242/347 [⚡]	63	0.24	—	1.00	0° F	High	<10%	X	X	X	PRS	C11	19a
E	2	347	C242/347 [⚡]	60	0.18	—	1.00	0° F	High	<10%	X	X	X	PRS	C11	19a	
																	
2D, 4-Pin																	
Lamp Type																	
38 Watts																	
CFS38W/GR10q	E	1	120	C2642UNV [⚡] ×	33	0.27	—	0.80	0° F	High	<10%	X	—	X	PRS	C10	18a
																	
2D, 4-Pin																	

⚡ PH = Preheat; PRS = Programmed Rapid Start
 ⚡ Add following suffix for complete catalog #: "SE" for Side Exit connectors or "BE" suffix for Bottom Exit connectors or "BES" for Bottom Exit connectors with 2" O.C. screw studs.
 × Add "ME" suffix for Multi-E Kit. For Distribution only.

The enclosed ballasts listed on this page are available in white (001) or black (000) cans. All ballasts are UL listed, CSA approved and designated Class P (thermally protected), Type HL.

See page 4-16 for Dimensions and Wiring Diagrams.

MAGNETIC & ELECTRONIC COMPACT FLUORESCENT BALLASTS FOR 2D LAMPS

WIRING DIAGRAMS AND DIMENSIONS

REFERENCE DRAWING FOR C4, C5

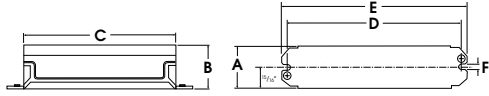

Dwg.	A	B	C	D	E	F
C4	2.34"	1.53"	5.45"	6.00"	6.59"	0.31"
C5	1.88"	1.47"	5.13"	6.00"	6.44"	0.25"

Lead Lengths: Side-12"
BE/BES-8"

REFERENCE DRAWING FOR C6

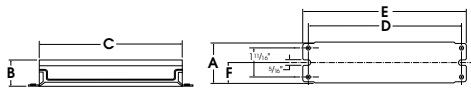

Dwg.	A	B	C	D	E	F
C6	2.40"	1.55"	8.31"	8.89"	9.50"	1.19"

Lead Lengths: Side-12"
BE/BES-8"

REFERENCE DRAWING FOR C10

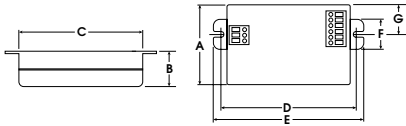

Dwg.	A	B	C	D	E	F	G
C10	2.31"	1.00"	4.25"	4.61"	4.94"	0.98"	1.00"

Leadless-Poke-in wire connection

REFERENCE DRAWING FOR C11

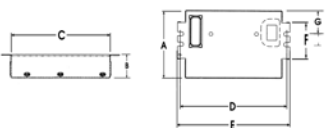

Dwg.	A	B	C	D	E	F	G
C11	2.98"	1.00"	4.25"	4.61"	4.94"	1.55"	1.00"

Leadless-Poke-in wire connection

WIRING DIAGRAMS

Install in accordance with
National Electrical Code.

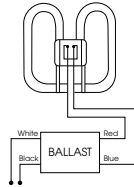

DIAGRAM 1a

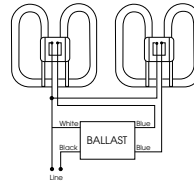

DIAGRAM 7a
Parallel lamp opera-

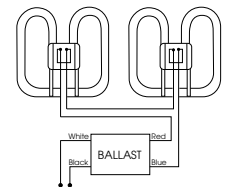

DIAGRAM 13a
Series lamp operation

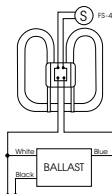

DIAGRAM 5a

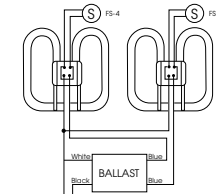

DIAGRAM 9a
Parallel lamp operation

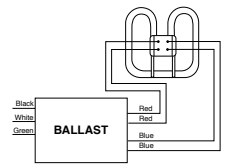

DIAGRAM 18a

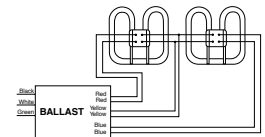
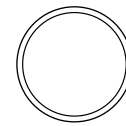

DIAGRAM 19a
Series lamp operation

ELECTRONIC COMPACT FLUORESCENT BALLASTS

22, 40 & 55 WATTS

- Ideal for surface mount fixtures
- Electronic models feature universal input voltage from 120V to 277V. 347V models are also available.
- Electronic models feature rapid and programmed rapid start for excellent lamp performance & auto reset shutdown circuit



**T5
CIRCULAR
LAMPS**
22,40 & 55 WATTS

QUICK REFERENCE
Nominal lamp watts and configuration

Lamp Type	Mag or Elec	Qty of Lamps	Line Volt	Catalog [Ⓞ] Number	Input Watts	Line Current Amps	Starting Current Amps	Ballast Factor	Min Start Temp	Power Factor	THD	Lead Configuration			Starting Method [⚡]	Dim	Wir Diag
												Side Exit	Bottom Exit	Bottom Exit Studs			
Electrical Characteristics - 60 Hz																	
22 Watts FC9T5-22W	E	1	120	C2642UNV [⚡] ×	25	0.21	---	1.00	0° F	High	<10%	X	X	X	PRS	C10	28
	E	1	347	C2642/347 [⚡]	26	0.08	---	0.98	0° F	High	<10%	X	X	X	PRS	C10	28
	E	2	120	C242UNV [⚡]	50	0.42	---	1.05	0° F	High	<10%	X	X	X	PRS	C11	23
T5 CIRCULAR	E	2	347	C242/347 [⚡]	47	0.14	---	1.05	0° F	High	<10%	X	X	X	PRS	C11	23
40 Watts FC12T5-40W	E	1	120	C2642UNV [⚡] ×	42	0.35	---	0.98	0° F	High	<10%	X	X	X	PRS	C10	28
	E	1	347	C2642/347 [⚡]	40	0.12	---	0.98	0° F	High	<10%	X	X	X	PRS	C10	28
	E	2	120	C242UNV [⚡]	80	0.65	---	0.98	0° F	High	<10%	X	X	X	PRS	C11	23
	E	2	347	C242/347 [⚡]	71	0.22	---	0.98	0° F	High	<10%	X	X	X	PRS	C11	23
T5 CIRCULAR	E	2	347	C242/347 [⚡]	71	0.22	---	0.98	0° F	High	<10%	X	X	X	PRS	C11	23
22 & 40 Watts FC9T5-22W & FC12T5-40W	E	2	120	C242UNV [⚡]	66	0.54	---	0.98	0° F	High	<10%	X	X	X	PRS	C11	23
	E	2	277	C242/347 [⚡]	64	0.24	---	0.98	0° F	High	<10%	X	X	X	PRS	C11	23
T5 CIRCULAR	E	2	277	C242/347 [⚡]	59	0.18	---	0.98	0° F	High	<10%	X	X	X	PRS	C11	23
55 Watts FC12T5-55W	○	E	1	120	B254PUNV-D	56	0.46	---	0.87	0° F	High	<10%	X	-	PRS	-D	28
	○	E	2	120	B254PUNV-D	106	0.88	---	0.85	0° F	High	<10%	X	-	PRS	-D	23
	○	E	2	277	B254PUNV-D	103	0.38	---	0.85	0° F	High	<10%	X	-	PRS	-D	23
T5 CIRCULAR	○	E	2	277	B254PUNV-D	103	0.38	---	0.85	0° F	High	<10%	X	-	PRS	-D	23

WIRING DIAGRAMS

Install in accordance with National Electrical Code.

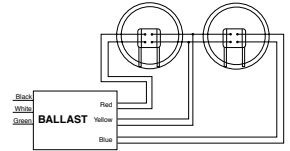

DIAGRAM 23
Series lamp operation

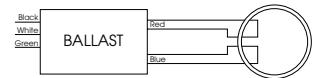

DIAGRAM 28

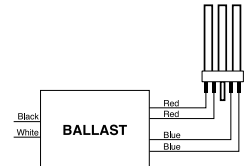
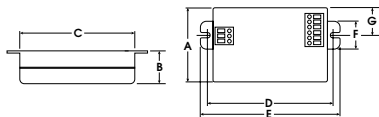

DIAGRAM 47

- ⚡ PRS = Programmed Rapid Start; RS=Rapid Start
- ◆ Add following suffix for complete catalog #: "SE" for Side Exit connectors or "BE" suffix for Bottom Exit connectors or "BES" for Bottom Exit connectors with 2" O.C. screw studs.
- Ⓞ Add "B" for Bottom Exit or "S" for Side Exit or "BS" for Bottom Exit with 2" O.C. screw studs.
- Not approved for use in hazardous locations.

The enclosed ballasts listed on this page are available in white (001) or black (000) cans, except CBT's, which are all in white cans. All ballasts are UL listed, CSA approved and designated Class P (thermally protected).

REFERENCE DRAWING FOR C10



Dwg.	A	B	C	D	E	F	G
C10	2.31"	1.00"	4.25"	4.61"	4.94"	0.98"	1.00"

Leadless-Poke-in wire connection

REFERENCE DRAWING FOR -D

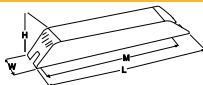

Dwg.	L	W	H	M	X
-D	16.88"	1.16"	1.00"	16.28"	---

REFERENCE DRAWING FOR C11

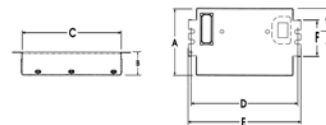

Dwg.	A	B	C	D	E	F	G
C11	2.98"	1.00"	4.25"	4.61"	4.94"	1.56"	1.00"

Leadless-Poke-in wire connection

REFERENCE DRAWING FOR CBT

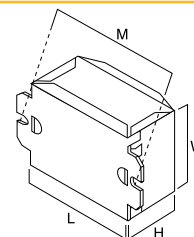

Dwg.	A	B	C	D	E
CBT	3.86"	2.00"	1.00"	3.50"	---

LONG TWIN T5 LAMPS

18, 24/27 WATTS



- Ideal for track light & surface mount fixtures
- Electronic models feature universal input voltage from 120V to 277V. 347V models are also available
- Electronic models feature rapid and programmed rapid start for excellent lamp performance & auto reset shutdown circuit

ELECTRONIC COMPACT FLUORESCENT BALLASTS FOR LONG TWIN T5 LAMPS

18 AND 24/27 WATTS (BIAx, DULUX L AND PLL)

QUICK REFERENCE Nominal lamp watts and configuration	Mag or Elec	Qty of Lamps	Line Volt	Catalog Number	Input Watts	Line Current Amps	Starting Current Amps	Ballast Factor	Min Start Temp	Power Factor	THD	Lead Configuration			Starting Method*	Dim	Wir Diag
												Side Exit	Bottom Exit	Bottom Exit Studs			
Lamp Type Electrical Characteristics - 60 Hz																	
18 Watts FT18W/2G11/RS	E	1	120	CBT126L-120	20	0.36	---	1.10	0° F	Normal	<150%	X	X	X	RS	CBT	47
	E	1	120	CT218UNVSE	23	0.19	---	1.00	0° F	High	<10%	X	---	---	PRS	C10	21
			277														X
E	2	120	CT218UNVSE	43	0.37	---	0.98	0° F	High	<10%	X	---	---	PRS	C10	20	
		277			42	0.16					---					X	---
Long Twin T5, 4-Pin																	
24/27 Watts FT24W/2G11/RS	○ E	1	120	B224PUNV-C	27	0.23	---	1.05	0° F	High	<10% <15%	X	---	---	PRS	-C	29
			277			52	0.43					---					X
	○ E	2	120	B224PUNV-C	51	0.18	---	1.00	0° F	High	<10%	X	---	---	PRS	-C	29
			277			51	0.18					---					X
	E	1	347	C2642/347	29	0.09	---	0.90	0° F	High	<10%	X	X	X	PRS	C10	21
	E	2	120	C242UNV	51	0.43	---	1.02	0° F	High	<10%	X	X	X	PRS	C11	20
			277			50	0.19					---					X
E	2	347	C242/347	49	0.14	---	1.02	0° F	High	<10%	X	X	X	PRS	C11	20	
E	1	120	C2642UNV	26	0.22	---	1.01	0° F	High	<10%	X	X	X	PRS	C10	21	
		277			26	0.10					---					X	X
E	2	120	C2642UNV	47	0.40	---	0.98	0° F	High	<10%	X	X	X	PRS	C10	21	
		277			49	0.18					---					X	X
Long Twin T5, 4-Pin																	
24/27 Watts CFM24W/2G10	○ E	1	120	B224PUNV-C	24	0.20	---	1.05	0° F	High	<10% <15%	X	---	---	PRS	-C	29
			277			48	0.40					---					X
	○ E	2	120	B224PUNV-C	47	0.17	---	1.00	0° F	High	<10%	X	---	---	PRS	-C	29
		277			47	0.17	---									X	---
T5 F-Lamp, 4-Pin																	

- ✱ RS = Rapid Start; PRS = Programmed Rapid Start
- Not approved for use in hazardous locations.
- ◆ Add following suffix for complete catalog #: "SE" for Side Exit connectors or "BE" suffix for Bottom Exit connectors or "BES" for Bottom Exit connectors with 2" O.C. screw studs.
- ✕ Add "ME" suffix for Mult-E Kit. For Distribution only.
- ⊕ Add "B" for Bottom Exit or "S" for Side Exit or "BS" for Bottom Exit with 2" O.C. screw studs.

The enclosed ballasts listed on this page are available in white (001) or black (000) cans, except CBT's, which are all in white cans.
All ballasts are UL listed, CSA approved

See pages 4-21 and 4-22 for Dimensions and Wiring Diagrams.



ELECTRONIC LONG TWIN T5 BALLASTS

36/39 AND 40 WATTS (BIAx, DULUX L AND PLL)

- Ideal for track light & surface mount fixtures
- New electronic 1 & 2 lamp models for 24 watt lamps
- Electronic models feature universal input voltage from 120V to 277V. 347V models are also available.
- Electronic models feature programmed rapid start for excellent lamp performance & auto reset shutdown circuit



**LONG TWIN
T5 LAMPS**
36/39 & 40
WATTS

QUICK REFERENCE Nominal lamp watts and configuration	Mag or Elec	Qty of Lamps	Line Volt	Catalog Number	Input Watts	Line Current Amps	Starting Current Amps	Ballast Factor	Min Start Temp	Power Factor	THD	Lead Configuration			Starting Method*	Dim	Wir Diag
												Side	Bottom Exit	Bottom Exit Studs			
Lamp Type																	
Electrical Characteristics - 60 Hz																	
36/39 Watts FT36W/2G11/RS  Long Twin T5, 4-Pin	○ E	1	120	B224PUNV-C•	36	0.30	---	0.95	0° F	High	<10%	X	—	—	PRS	-C	29
	○ E	2	120	B239PUNV-D•	71	0.59	---	0.97	0° F	High	<10%	X	—	—	PRS	-D	29
	○ E	1	120	B254PUNV-D•	44	0.37	---	1.22	0° F	High	<10%	X	—	—	PRS	-D	28
	○ E	2	120	B254PUNV-D	90	0.75	---	1.20	0° F	High	<10%	X	—	—	PRS	-D	23
	○ E	1	120	C242UNV♦	34	0.29	---	0.88	0° F	High	<10% <20%	X	X	X	PRS	C11	20
	○ E	2	120	C242UNV♦♦	64	0.43	---	0.83	0° F	High	<10%	X	X	X	PRS	C11	20
	○ E	2	347	C242/347♦♦	64	0.19	---	0.90	0° F	High	<10%	X	X	X	PRS	C11	20
	○ E	2	277	C242UNV♦♦	67	0.25	---	0.90	0° F	High	<10%	X	X	X	PRS	C11	20
Lamp Type																	
Electrical Characteristics - 60 Hz																	
36/39 Watts CFM36W/2G10  T5 F-Lamp, 4-Pin	E	1	120	B224PUNV-C•	34	0.28	---	0.95	0° F	High	<10%	X	—	—	PRS	-C	29
	E	1	120	C2642UNV♦×	32	0.27	---	0.98	0° F	High	<10%	X	X	X	PRS	C10	21
	E	1	120	C242UNV♦	33	0.28	---	0.98	0° F	High	<15%	X	X	X	PRS	C11	20
	E	2	120	C242UNV♦♦×	68	0.57	---	0.90	0° F	High	<10%	X	X	X	PRS	C11	20
Lamp Type																	
Electrical Characteristics - 60 Hz																	
40 Watts FT40W/2G11  Long Twin T5, 4-Pin	○ E	1	120	C240SI120RH	40	0.40	---	1.02	50° F	High	<20%	X	—	—	IS	C6	12+
	○ E	1	277	C240SI277RH	40	0.17	---	1.02	50° F	High	<20%	X	—	—	IS	C6	12+
	E	1	120	C240PUNVHP-B•	41	0.34	---	1.00	0° F	High	<10%	X	—	—	PRS	-B	20
	E	2	120	C242UNV♦	93	0.78	---	1.00	0° F	High	<10%	X	X	X	PRS	C11	20
	○ E	2	120	C340SI120RH	75	0.68	---	0.99	50° F	High	<20%	X	—	—	IS	C6	14+
	○ E	2	277	C340SI277RH	75	0.30	---	0.99	50° F	High	<20%	X	—	—	IS	C6	14+
	○ E	2	120	C240SI120RH	67	0.61	---	0.88	50° F	High	<20%	X	—	—	IS	C6	12
	○ E	2	277	C240SI277RH	67	0.27	---	0.88	50° F	High	<20%	X	—	—	IS	C6	12
	E	2	120	C240PUNVHP-B•	76	0.63	---	0.90	0° F	High	<10%	X	—	—	PRS	-B	20
	E	2	277	C240PUNVHP-B•	73	0.27	---	0.90	0° F	High	<10%	X	—	—	PRS	-B	20
	E	1	120	C242UNV♦	47	0.40	---	1.08	0° F	High	<10%	X	X	X	PRS	C11	20
	○ E	3	120	C340SI120RH	98	0.88	---	0.88	50° F	High	<20%	X	—	—	IS	C6	14
	○ E	3	277	C340SI277RH	98	0.39	---	0.88	50° F	High	<20%	X	—	—	IS	C6	14

- ♦ PRS = Programmed Rapid Start; IS = Instant Start
- ◆ Add following suffix for complete catalog #: "SE" for Side Exit connectors or "BE" suffix for Bottom Exit connectors or "BES" for Bottom Exit connectors with 2" O.C. screw studs.
- Not approved for use in hazardous locations.
- Consult lamp manufacturers for applications with Ballast Factor >1.20.
- × Add "ME" suffix for Mult-E Kit. For Distribution only.

The enclosed ballasts listed on this page are available in white (001) or black (000) cans.

All ballasts are UL listed, CSA approved

See pages 4-21 and 4-22 for
Dimensions and Wiring Diagrams.

ELECTRONIC LONG TWIN T5 LAMPS

50, 55 & 80 WATTS



- Ideal for track light & recessed fixtures
- Electronic models for 1, 2, 3 & 4 lamp applications
- Programmed Rapid & Instant Starting Options
- Models feature auto reset shutdown circuit

ELECTRONIC LONG TWIN T5 BALLASTS

50, 55 AND 80 WATTS (BIAx, DULUX L AND PLL)

QUICK REFERENCE Nominal lamp watts and configuration	Mag or Elec	Qty of Lamps	Line Volt	Catalog Number	Input Watts	Line Current Amps	Starting Current Amps	Ballast Factor	Min Start Temp	Power Factor	THD	Lead Configuration			Starting Method*	Dim	Wir Diag
												Side Exit	Bottom Exit	Bottom Exit Studs			
Lamp Type 50 Watts FT50W/2G11	○ E	1	120 277	B254PUNV-D	60 59	0.50 0.22	---	1.12	0° F	High	<10%	X	--	--	PRS	-D	29
 Long Twin T5, 4-Pin	○ E	2	120 277	B254PUNV-D	112 109	1.00 0.43	---	1.10	0° F	High	<10%	X	--	--	PRS	-D	29
	○ E	1	347	B254P347-D	58	0.17	---	1.12	0° F	High	<10%	X	--	--	PRS	-D	27
	○ E	2	347	B254P347-D	106	0.31	---	1.10	0° F	High	<10%	X	--	--	PRS	-D	27
	E	1	347 480	B254PHRVHB-E	65	0.19 0.15	---	1.12	0° F	High	<10% <15%	X	--	--	PRS	-E	42
	E	2	347 480	B254PHRVHB-E	115 114	0.33 0.25	---	1.10	0° F	High	<10%	X	--	--	PRS	-E	41
	E	3	120 277	B454PUNV-E	180 178	1.51 0.65	---	1.13	0° F	High	<10%	X	--	--	PRS	-E	44
	E	4	120 277	B454PUNV-E	233 225	1.87 0.80	---	1.10	0° F	High	<10%	X	--	--	PRS	-E	44
E	4	120 277	B454PUNVHB-E	240 235	1.98 0.84	---	1.10	0° F	High	<10%	X	--	--	PRS	-E	44	
Lamp Type 55 Watts FT55W/2G11	E	1	120 277	B254PUNV-D	58	0.48 0.22	---	0.92	0° F	High	<10%	X	--	--	PRS	-D	29
 Long Twin T5, 4-Pin	E	2	120 277	B254PUNV-D	112 109	0.93 0.40	---	0.90	0° F	High	<10%	X	--	--	PRS	-D	29
	E	1	347	B254P347-D	57	0.17	---	0.92	0° F	High	<10%	X	--	--	PRS	-D	27
	E	2	347	B254P347-D	102	0.30	---	0.90	0° F	High	<10%	X	--	--	PRS	-D	27
	E	1	120 277	C242UNV◆	46	0.38 0.17	---	0.83	0° F	High	<10%	X	X	X	PRS	C11	21
	E	1	347	C242/347◆	43	0.13	---	0.83	0° F	High	<10%	X	X	X	PRS	C11	21
	E	1	347 480	B254PHRVHB-E	61	0.19 0.14	---	0.92	0° F	High	<10% <15%	X	--	--	PRS	-E	42
	E	2	347 480	B254PHRVHB-E	109 108	0.33 0.24	---	0.90	0° F	High	<10%	X	--	--	PRS	-E	41
	E	3	120 277	B454PUNV-E	170 167	1.42 0.62	---	0.93	0° F	High	<10%	X	--	--	PRS	-E	44
	E	4	120 277	B454PUNV-E	223 217	1.87 0.80	---	0.90	0° F	High	<10%	X	--	--	PRS	-E	44
E	4	120 277	B454PUNVHB-E	229 223	1.91 0.80	---	0.90	0° F	High	<10%	X	--	--	PRS	-E	44	
Lamp Type 80 Watts FT80W/2G11	E	1	120 277	ES4515K	88 87	0.74 0.32	---	1.00	0° F	High	<10%	X	--	--	PRS	ESK	43

* IS = Instant Start; PRS = Programmed Rapid Start
 ◆ Add following suffix for complete catalog #: "SE" for Side Exit connectors or "BE" suffix for Bottom Exit connectors or "BES" for Bottom Exit connectors with 2" O.C. screw studs.
 ○ Not approved for use in hazardous locations.

The enclosed ballasts listed on this page are available in white (001) or black (000) cans. All ballasts are UL listed, CSA approved and designated Class P (thermally protected).

Compact Fluorescent

See pages 4-21 and 4-22 for Dimensions and Wiring Diagrams.

MAGNETIC AND ELECTRONIC COMPACT FLUORESCENT BALLASTS DIMENSIONS

LONG TWIN
T5 LAMPS

REFERENCE DRAWING FOR -B

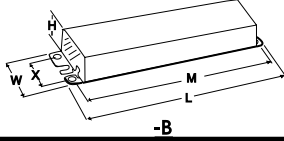

Dwg.	L	W	H	M	X
-B	9.50"	1.50"	1.00"	8.89"	0.88"

REFERENCE DRAWING FOR C10

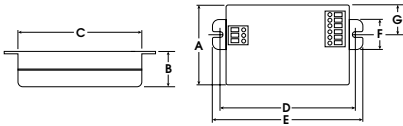

Dwg.	A	B	C	D	E	F	G
C10	2.31"	1.00"	4.25"	4.61"	4.94"	0.98"	1.00"

Leadless-Poke-in wire connection

REFERENCE DRAWING FOR CBT

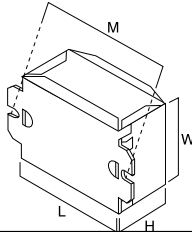

Dwg.	A	B	C	D	E
CBT	3.86"	2.00"	1.00"	3.50"	--

REFERENCE DRAWING FOR C6

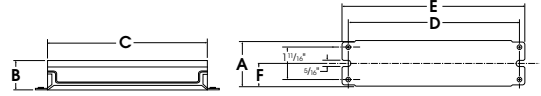

Dwg.	A	B	C	D	E	F
C6	2.40"	1.55"	8.31"	8.89"	9.50"	1.19"

Lead Lengths: Side

- Black/White-11"
- Red/Blue-16"
- Yellow-16"

REFERENCE DRAWING FOR C11

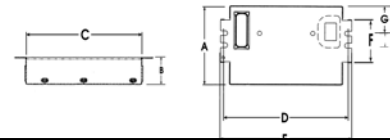

Dwg.	A	B	C	D	E	F	G
C11	2.98"	1.00"	4.25"	4.61"	4.94"	1.56"	1.00"

Leadless-Poke-in wire connection

REFERENCE DRAWING FOR -D, -E, ESK

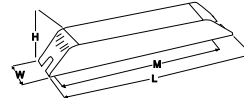

Dwg.	L	W	H	M	X
-D	16.88"	1.18"	1.00"	16.20"	---
-E	16.88"	1.74"	1.18"	16.28"	---
ESK	16.65"	1.24"	1.00"	16.30"	---

Compact Fluorescent

MAGNETIC AND ELECTRONIC COMPACT FLUORESCENT BALLASTS WIRING DIAGRAMS

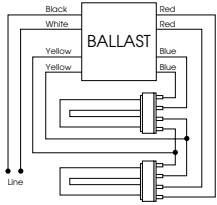

DIAGRAM 5
Parallel lamp operation

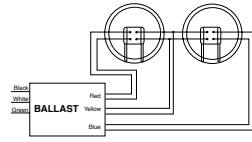

DIAGRAM 23
Series lamp operation

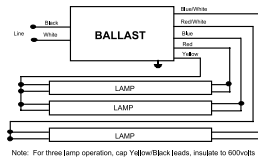
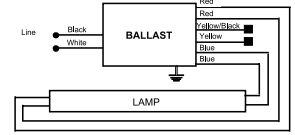

DIAGRAM 34



ONE LAMP APPLICATION

DIAGRAM 42

For one lamp application, individually cap yellow and yellow/black leads, insulate to 600V

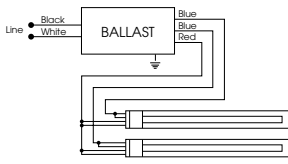

DIAGRAM 12
Parallel lamp operation

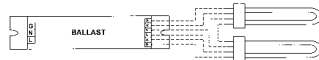
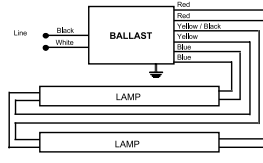

DIAGRAM 27
Series lamp operation



TWO LAMP APPLICATION
DIAGRAM 41

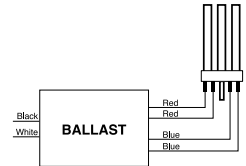

DIAGRAM 47

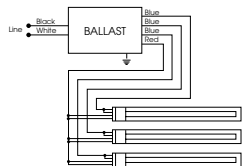

DIAGRAM 14
Parallel lamp operation
+ Cap unused blue lead; insulate to 600

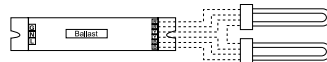
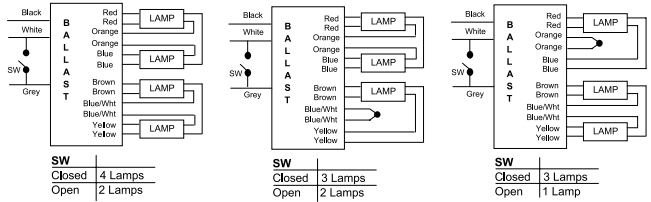

DIAGRAM 29

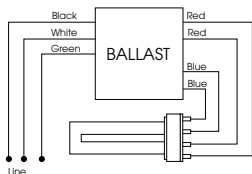

DIAGRAM 43



Application Notes:
 - "SW" controls the lamps connected between the Brown and Yellow leads
 - For lamp switching applications, connect "SW" between the white and the grey leads as shown in the wiring diagram above OR between the Black and Grey leads. The switch "SW" may be an on-off switch, an occupancy sensor, a relay, etc.
 - If lamp switching is not required, short the white and grey leads OR the black and the grey leads
 - A single control device, "SW", may be connected to control multiple ballasts
 - For three lamp use: Short Blue/White leads or Orange leads and cap

DIAGRAM 44



Mount lamp within 1" of grounded metal reflector.
DIAGRAM 21

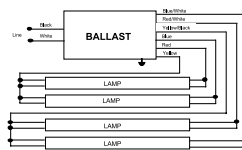

DIAGRAM 33

Ballasts For High Intensity Discharge Lamps

Universal Means Higher Expectations In High Intensity Discharge

Universal Lighting Technologies ("Universal") offers a wide array of ballasts for High Intensity Discharge (HID) lamps. Applications include Metal Halide (MH), Pulse Start Metal Halide (PSMH), and High Pressure Sodium (HPS) lamps ranging from 35 to 1500 watts.

We're the technology leader in every category of HID ballasts. Our Universal Precise™ line is the latest innovation in magnetic core & coil technology in years.



Universal offers a complete line of HID ballasts for applications ranging from 35 - 1500 watts.

Notes

HID

Product Overview

Core & Coil

Core & coil ballasts are used in over 90% of all HID fixtures. Universal's core & coil models are available for all HID lamp types, including single-, dual-, tri-, quad- and multi-volt designs. For added versatility and reduced inventory costs, Universal has also introduced the industry's first Multi-5™ ballast (120, 208, 240, 277, or 480 volt), featuring a 480-volt tap on a conventional quad-tap ballast.

Our core & coil models are ideal for a wide variety of lighting applications, including factories, warehouses, gymnasiums and retail stores. All these ballasts feature precision-wound coils, ensuring even heat dissipation and the highest electrical integrity.

Universal's Universal Precise™ is the next generation in core & coil technology, featuring a smaller, light-weight design and improved temperature performance. Universal Precise™ fits virtually all applications, and has no exposed live metal parts. There are no plastic extrusions, which prevents breakage during shipping. Color-coded leads make installation easy.

50 Hertz

Universal offers 50 Hz core & coil ballasts to meet the rapid growth in demand in international markets. Our ballasts are available for 220, 230, and 240 volt electrical systems.

F-Can

These ballasts are used primarily for indoor downlighting applications where quiet operation is essential. All the components of these ballasts are enclosed in a fluorescent-style ballast can and are thermally protected.



F-Can Ballasts



Core and Coil Ballasts



HID Ballast Kits

Product Overview

For maximum safety and reliability, all Universal capacitors come with built-in bleed resistors (patented by Universal) and approved by CSA (CSA file #LR51331, metal cases only). Environmental safety is assured by use of biodegradable, nontoxic (no PCBs) dielectric fluid (soybean oil), patented by Universal for use in capacitors. Dry-film capacitors do not include protective devices. Since they can fail in a hazardous manner, it is the responsibility of the purchaser to take appropriate precautions.

Capacitors

Universal has a comprehensive line of capacitors in metal cases (up to 525V ratings) and plastic cases (up to 400V ratings). All Universal capacitors are designed for 60,000 hours of continuous life. They're exceptionally reliable because we put them through accelerated life testing at 125% rated voltage and rated temperature +10°C.

Universal capacitors are normally packaged with ballasts. They may also be ordered separately, bulk packaged, or individually boxed with the suffix "BH" (metal cases only). Capacitor weights vary from 1/4 lb. to 1 lb. each.

Dry Capacitors

Type "P" plastic case capacitors described in this section are dry and do NOT contain safety interrupters (or oil). Plastic cases are UL rated "94V-0" (for use up to 100°C maximum). Type "P" capacitors are supplied with stranded copper wire leads 8 inches long (18 awg, with 150°C rated insulation). Capacitor rolls are sealed inside plastic cases using epoxy. Design and testing of Universal capacitors follow specifications in Electronic Industries Association (EIA) Standard 456-A, titled "Metalized Film Dielectric Capacitors for Alternating Current Application."

"P" capacitors are designed and rated for continuous duty AC voltages below 400VAC @ 50 or 60 Hz. Capacitors used with HID ballasts at voltages above 400VAC should contain interrupters (available from Universal in oval "MF" and round "RMF" oil-filled metal cases).

Plastic Dry Type Capacitors

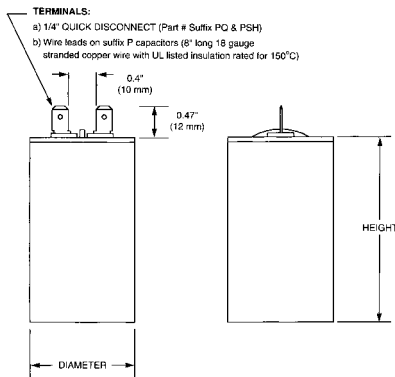

Metal and Oil Filled Capacitors

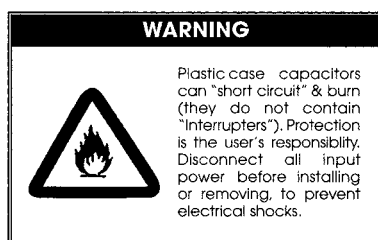
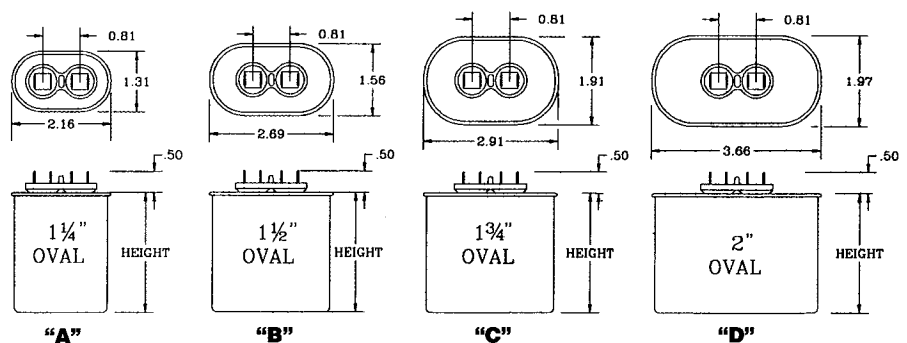

Protective Device (Only in metal cases)

Protective device to prevent case rupture

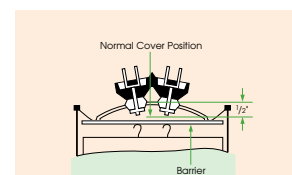
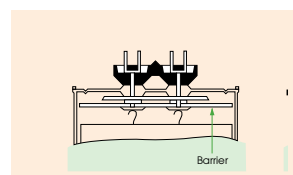

Oil-Filled Capacitors

µF	VACr	Part #	Case	Ht (")	µF	VACr	Part #	Case	Ht (")
5.0	300	005-1466-BH	1.25 oval	2.2	24.0	480	005-2779-BH	1.75 oval	3.9
6.0	300	005-1561-BH	1.25 oval	2.2	24.5	300	005-3278-BH	1.75 oval	2.7
7.0	300	005-1410-BH	1.25 oval	2.2	26.0	330	005-2669-BH	1.75 oval	3.1
8.0	330	005-1411-BH	1.25 oval	2.2	26.0	525	0052776-BH	1.75 oval	4.3
10.0	330	005-1413-BH	1.25 oval	2.7	28.0	240	005-1886-BH	1.75 dia	2.3
10.0	400	005-2666-BH	1.25 oval	3.9	28.0	300	005-1468-BH	1.75 oval	3.1
10.0	400	005-1184-BH	1.50 oval	2.7	28.0	425	005-1799-BH	1.75 oval	3.9
10.0	400	005-2167-BH	1.75 dia	2.9	30.0	440	005-1475-BH	1.75 oval	3.9
12.0	300	005-1467-BH	1.25 oval	3.1	32.0	300	005-2351-BH	1.75 oval	3.1
12.0	400	005-2799-BH	1.50 oval	2.7	32.0	525	005-1474-BH	2.00 oval	3.9
12.0	440	005-1464-BH	1.50 oval	3.1	33.0	300	005-1470-BH	1.75 oval	3.1
13.0	300	005-1414-BH	1.25 oval	3.1	35.0	330	005-1421-BH	1.75 oval	3.1
14.0	240	005-1884-BH	1.75 dia	2.3	36.0	525	005-2793-BH	2.00 oval	4.3
14.0	300	005-1415-BH	1.50 oval	2.7	40.0	240	005-1887-BH	1.75 dia	2.7
15.0	400	005-1185-BH	1.75 oval	2.7	40.0	300	005-1768-BH	1.75 oval	3.9
16.0	300	005-1498-BH	1.50 oval	2.7	48.0	330	005-1422-BH	1.75 oval	3.9
17.5	300	005-1417-BH	1.50 oval	3.1	52.0	240	005-1888-BH	2.00 dia	2.9
18.0	440	005-1401-BH	1.75 oval	3.1	55.0	240	005-1594-BH	1.75 oval	3.5
18.5	330	005-1796-BH	1.50 oval	3.1	55.0	300	005-2117-BH	1.75 oval	3.9
20.0	240	005-1885-BH	1.75 dia	2.3					
20.0	330	005-1418-BH	1.50 oval	3.1					
20.5	400	005-3262-BH	1.75 oval	3.1					
21.0	525	005-1495-BH	1.75 oval	3.9					
22.5	300	005-1419-BH	1.50 oval	3.5					
24.0	360	005-3160-BH	1.75 oval	3.1					
24.0	400	005-2664-BH	1.75 oval	3.1					

Notes

HID

Dry Capacitors

--		90°C Rated			100°C Rated			105°C Rated		
µF	V	Part #	DIA (")	L (")	Part #	DIA (")	L (")	Part #	DIA (")	L (")
5.0	280	005-4400-BH	1.18	2.20	R17058511-BH	1.26	2.36			
5.0	280	005-4051-BH	1.18	2.76	R17058512-BH	1.26	2.83			
5.0	330				R17058539-BH	1.26	2.24			
6.0	280				R17058513-BH	1.26	2.36			
6.0	280	005-4052-BH	1.18	2.76	R17058514-BH	1.26	2.83			
7.0	280	005-4053-BH	1.58	2.76	R17058515-BH	1.65	2.83			
8.0	300	005-4054-BH	1.58	2.76	R17058535-BH	1.65	2.83			
8.0	330				R17058541-BH	1.65	2.83			
10.0	280	005-4407-BH	1.18	2.76	R17058517-BH	1.26	2.83			
10.0	280	005-4056-BH	1.58	2.76	R17058519-BH	1.65	2.83	R17058226-BH	1.65	2.83
10.0	330	005-4408-BH	1.58	2.76	R17058578-BH	1.65	2.83	R17058227-BH	1.65	2.83
10.0	400	005-4409-BH	1.58	2.76	R17058555-BH	1.65	2.83			
10.0	400	005-4025-BH	1.58	3.74	R17058557-BH	1.65	3.82	R17058310-BH	1.65	3.82
11.0	400	005-4485-BH	1.58	2.76	R17058558-BH	1.65	2.83			
12.0	300	005-4099-BH	1.58	2.76	R17058536-BH	1.65	2.83			
12.0	330	005-4411-BH	1.58	2.76	R17058543-BH	1.65	2.83			
12.0	400	005-4412-BH	1.58	3.74	R17058580-BH	1.65	3.82			
13.0	330	005-4044-BH	1.58	3.74						
14.0	170				R17058500-BH	1.26	2.83			
14.0	280	005-4060-BH	1.58	2.76	R17058520-BH	1.65	2.83			
14.0	280	005-4416-BH	1.58	2.76	R17058520-BH	1.65	2.83	R17058232-BH	1.65	2.83
14.0	400	005-4164-BH	1.58	3.74	R17058560-BH	1.65	3.82			
15.0	400				R17058562-BH	1.65	3.82			
15.0	400	005-4026-BH	1.77	3.74	R17058563-BH	1.85	3.82	R17058320-BH	1.85	3.82
16.0	280	005-4062-BH	1.58	2.76	R17058522-BH	1.65	2.83			
16.0	280	005-4420-BH	1.58	2.76	R17058522-BH	1.65	2.83			
16.0	330				R17058547-BH	1.65	2.83			
17.0	400				R17058588-BH	1.65	3.82			
17.5	280				R17058523-BH	1.65	3.82			
20.0	170	005-4065-BH	1.58	2.76	R17058501-BH	1.65	2.83			
20.0	280	005-4066-BH	1.58	3.74	R17058526-BH	1.65	3.82			
20.0	330									
20.0	400				R17058564-BH	1.85	3.82			
20.5	400	005-4432-BH	1.77	3.74	R17058565-BH	1.85	3.82			
21.0	400	005-4128-BH	1.77	3.74	R17058567-BH	1.85	3.82			
22.0	400	005-4483-BH	1.77	3.74	R17058569-BH	1.85	3.82			
22.5	280				R17058527-BH	1.65	3.15			
22.5	280				R17058528-BH	1.65	3.82			
24.0	280				R17058529-BH	1.65	3.82			
24.0	400	005-4438-BH	1.85	3.74	R17058571-BH	1.85	3.82	R17058342-BH	1.85	5.31
24.0	400	005-4027-BH	1.77	4.61						
24.5	330	005-4047-BH	1.58	4.61	R17058552-BH	1.65	4.76			
26.0	300	005-4048-BH	1.58	4.61	R17058537-BH	1.65	4.76			
26.5	400	005-4484-BH	1.77	4.61	R17058574-BH	1.85	4.76			
28.0	170	005-4071-BH	1.58	2.76	R17058502-BH	1.65	2.83			
28.0	280	005-4072-BH	1.58	4.61	R17058530-BH	1.65	4.76			
28.0	330	005-4447-BH	1.77	3.74	8R17058553-BH	1.85	3.82			

CHD

Dry Capacitors (Cont.)

μF	V	90°C Rated			100°C Rated			105°C Rated		
		Part #	DIA (")L (")		Part #	DIA (")L (")		Part #	DIA (")L (")	
35.0	280				R17058531-BH	1.65	3.82			
35.0	280	005-4075-P	1.77	4.61	R17058532-BH	1.85	4.76			
40.0	240	005-4456-P	1.58	3.74	R17058505-BH	1.65	3.82			
40.0	240	005-4077-P	1.58	4.61	R17058506-BH	1.65	4.76			
48.0	280				R17058533-BH	1.85	4.76			
48.0	330				R17058554-BH	2.05	4.76			
52.0	170	005-4087-P	1.77	3.74	R17058503-BH	1.85	3.82			
52.0	280	005-4127-P	1.77	4.61	R17058534-BH	1.85	4.76			
55.0	240	005-4465-P	1.77	3.74	R17058507-BH	1.85	3.82	R17058212-BH	1.85	5.31
55.0	240	005-4084-P	1.77	4.61	R17058509-BH	1.85	4.76			
55.0	300				R17058538-BH	1.85	4.76			

HT HID Ballasts

Designed for high temperature applications
Includes 105° Capacitors and Igniters

Lamp Wattage	Voltage	Catalog Number	Carton Pack	Kit
Metal Halide				
175W	Quad-Tap	M175MLTAC3M	818C	
175W	Multi-5	M175ML5AC3M	818C	818K
175W	480V	M17548TAC3M	818C	
175W	Tri-Tap	M175TRIAC30	818C	
250W	Quad-Tap	M250MLTAC3M	818C	
250W	Quad-Tap	M250MLTAC4M	818C	
250W	Multi-5	M250ML5AC3M	818C	818K
250W	Multi-5	M250ML5AC4M		818K
250W	480V	M25048TAC3M	818C	
250W	480V	M25048TAC4M	818C	
400W	Quad-Tap	M400MLTAC4M	818C	
400W	Multi-5	M400ML5AC4M	818C	818K
400W	480V	M40048TAC4M	818C	
400W	Tri-Tap	M400TRIAC4M	818C	

Lamp Wattage	Voltage	Catalog Number	Carton Pack	Kit
Pulse Start Metal Halide				
175W	Quad-Tap	P175MLTAC3M	818C	
175W	Multi-5	P175ML5AC3M		818K
400W	Quad-Tap	P400MLTAC4M	818C	
400W	Multi-5	P400ML5AC4M		818K
High Pressure Sodium				
100W	Quad-Tap	S100MLTLC3M	818C	818K
100W	480V	S10048TLC3M	818C	
150W	Quad-Tap	S150MLTLC3M	818C	818K
150W	480V	S15048TLC3M	818C	
150W	Tri-Tap	S150TRILC3M	818C	
250W	Multi-5	S250ML5AC4M		818K
400W	Quad-Tap	S400MLTAC4M	818C	
400W	Multi-5	S400ML5AC4M	818C	818K
400W	Multi-5	S400ML5AC5M		818K
400W	480V	S40048TAC4M	818C	

Refer to catalog pages for ballast dimensions and electrical data

Quad-Tap: 120/208/240/277 Volt

Multi-5: 120/208/240/277/480 Volt

Tri-Tap: 120/277/347

480V include 120V tap for stand-by lighting

Bracket Reference Chart

CORE & COIL WELDED BRACKETS

All welded brackets are .093" thick.

Ref. Drawing B1

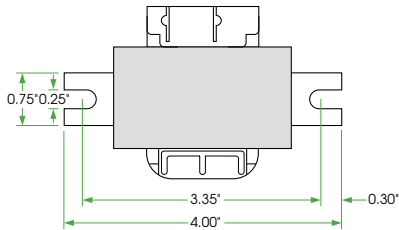

Ref. Drawing B2

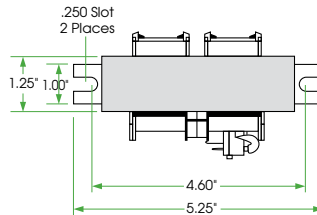

Ref. Drawing B1-A

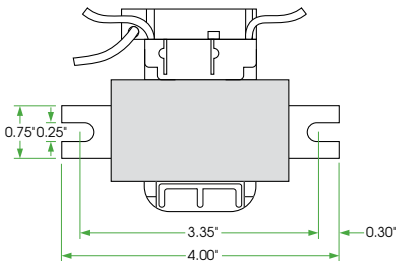

Ref. Drawing B3

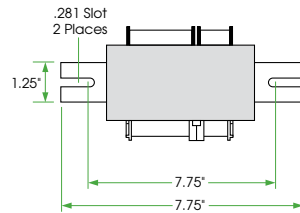

Ref. Drawing B1-B

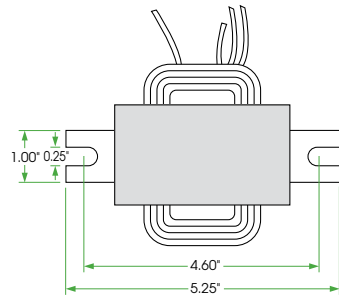

Ref. Drawing B4

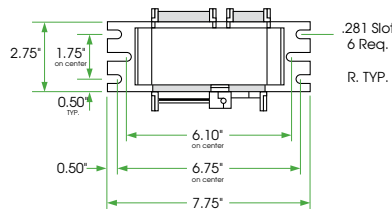

CORE & COIL ADJUSTABLE MOUNTING BRACKETS

Routinely supplied with replacement kits.

Ref. Drawing ADJ1

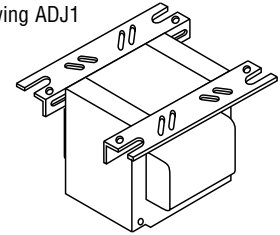

Ref. Drawing ADJ2

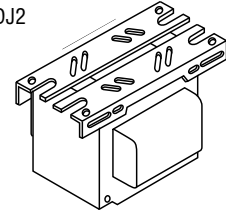

Ref. Drawing MB1

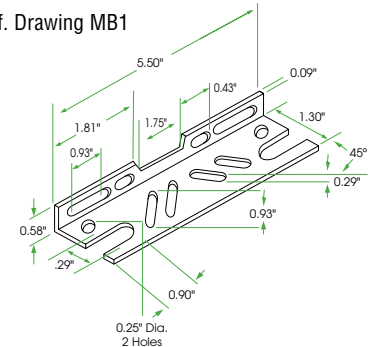

For use with:

- 50 to 175 watt Mercury, High Pressure Sodium and Metal Halide and some 250 watt Metal Halide

Ref. Drawing MB2

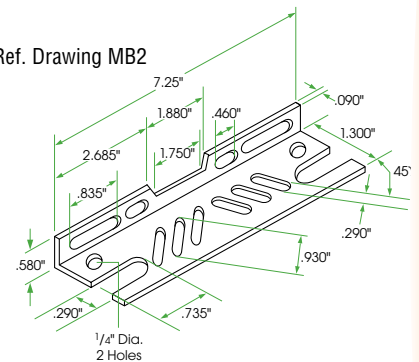

For use with:

- 250 to 1500 watt Metal Halide
- 250 to 1000 watt High Pressure Sodium and Mercury Vapor

Application And Operating Information

Underwriters' Laboratories, Inc. Acceptance
All F-Can and Weatherproof ballasts listed in this catalog are Underwriters' Laboratories, Inc. white card listed, except those for 347 volt operation. All Core & Coil and Potted Core & Coil ballasts listed in this catalog are Underwriters' Laboratories, Inc. yellow card listed (component recognized).

Ballast Replacement

Ballast replacement presents the possibility of exposure to potentially hazardous voltages and should be performed only by qualified personnel. All installation, inspection and maintenance should be performed only with the entire circuit power to fixture or equipment turned off. Installation shall be in accordance with National Electric Code.

Heat

A ballast, like any other electrical device, generates heat during normal operation. Planning for maximum heat dissipation with proper fixture design, installation planning and ballast selection will minimize the possibility of a heat-related problem arising. Excessive temperature will have an adverse effect on ballast life.

Normal temperature limits:

F-Can Ballasts

Maximum case temperature: 90°C

Potted Core & Coil Ballasts and
Core & Coil Ballasts

Insulation: Class 180°C

Maximum coil temperature: 165°C

(measured by change of resistance method)

All F-Can ballasts listed in this catalog are equipped with built-in automatic resetting internal thermal protection as a standard feature.

Whenever a ballast with thermal protection is used, it is imperative that the fixture/ballast/lamp combination be heat tested under actual or simulated installation conditions to assure that the ballast will not cycle. The resetting thermal protector functions as a thermostat which will open and temporarily deactivate the ballast when it exceeds the permissible

temperature. The ballast will continue to cycle until the cause of overheating is eliminated. If the ballast is defective, it must be replaced. If the cause is external, the ballast will resume normal operation after abnormal conditions are eliminated.

To attain normal ballast life, the maximum coil temperature of the ballast should not exceed the rating of the insulation system. A temperature increase of 10° C results in a 50% reduction of ballast life.

Low Ambient Temperature (cold)

As temperatures drop, less and less vaporized gas is available within the arc tube of a high intensity discharge lamp, thereby causing an increase in the open circuit voltage required to initiate an arc in the lamp, until a point is reached where the lamp cannot be started. The minimum temperature at which any ballast listed in this catalog will provide reliable starting is listed with the electrical characteristics.

Ballasts should be protected from weather, moisture, or other abnormal atmospheric conditions, unless specifically designed for use under adverse conditions.

Fusing

The purpose of fusing an HID ballast is to remove the ballast from the power line in the event of a ballast system failure. A fuse does not protect the ballast from failing.

Because the temperature in the ballast compartment is high, typically 90°C, fuse ratings are specified at 25°C, and that this rating declines as the temperature increases, HID fuse recommendations are made between 2 and 3 times the maximum current the ballast will draw during all normal conditions.

Fast-blow fuses should not be used due to the possibility of high inrush currents. These currents are due to the fact that the power can be applied at any point in the AC voltage waveform. Standard and slow-blow are acceptable.

When using the 120V tap for auxiliary lighting, a slow-blow fuse should be used to protect the ballast from damage from a fault in the auxiliary lighting circuit.

REMOTE MOUNTING DISTANCE

Maximum Length in Feet for Remote Mounting of HID Ballasts to Lamp

ANSI	Lamp Type	Watts	12 GA	14 GA	16 GA	18 GA
M57	Metal Halide	175	272	171	107	67
M58	Metal Halide	250	194	122	77	48
M59	Metal Halide	400	132	83	52	33
M47	Metal Halide	1000	196	123	77	48
M48	Metal Halide	1500	146	92	58	36

For proper installation, insure that remote ballasts are properly vented and mounted to a heat-dissipating surface.

Application And Operating Information

Sound

High intensity discharge lamp ballasts, like all electromagnetic devices, produce noise, or “hum.” It is the degree of noise which determines the existence of a problem. Ballast noise will only be noticeable when it exceeds the ambient sound level of the installation. It is obvious that a ballast designed primarily for outdoor or factory use would not be suitable in an office environment.

The vast improvements in all high intensity discharge lamps and ballasts, and their excellent energy efficiency, have made them viable options for many indoor applications. The ballasts being considered should be carefully analyzed to insure that there will not be an objectionable level of ballast noise.

All F-Can ballasts listed in this catalog are “Sound Rated” to aid in the selection of a ballast which is proper for the environment in which it will operate.

Potted Core & Coil ballasts are also designed to operate at reduced sound levels, generally several decibels lower than a standard Core & Coil ballast. Core & Coil ballasts are not sound rated.

In situations where light output necessitates using a ballast with a sound rating or noise level not normally acceptable, the ballast should be remotely mounted. Note, however, that not all ballasts listed in this catalog are designed or recommended for remote mounting.

Polarity

Polarity refers to the proper connection of ballast lead wires to line wires. To aid you in making a correct installation, Universal ballast leads are color-coded for easy identification. The white or yellow ballast lead is to be connected to the neutral or common. Choose the appropriate ballast voltage lead to connect to the line.

Grounding

Ballasts and capacitors or starters in metallic casings must always be grounded. Ballasts and components may be grounded to the fixture or otherwise connected to ground. It would be hazardous to make contact with an ungrounded fixture, ballast or other

electrical component while in operation.

Operating Line Voltage Limits

To receive the full benefits of rated lamp output and to prolong ballast life, it is essential that the voltage supplied to an installation be maintained within the prescribed limits.

In general, the line voltage supplied to a lag type ballast (reactor or high reactance autotransformer) should be maintained within 5% of the voltage for which the ballast is rated. The line voltage to lead type ballasts (constant wattage autotransformer or constant wattage isolated) should be maintained within 10%.

Subjecting a ballast to excessive voltage for an extended period of time results in the deterioration of the coil insulation. This insulation breakdown will cause early ballast failure.

Low voltage has no damaging effect on the ballast. It could, however, have an adverse effect on lamp performance and starting dependability.

Maintenance

Selecting and installing an adequate and efficient lighting system means nothing if it is not properly maintained. Maintenance must always be considered as part of the life cycle cost of any high intensity discharge lighting installation in order to assure the continued performance of the system as originally specified.

First and foremost in importance is proper lamp maintenance. High intensity discharge lamps do not “burn out” like an incandescent bulb, but rather, undergo changes within the arc tube which prevent the lamp from starting properly, warming up and producing full light output. The beginning of difficulties such as these generally indicates the end of a lamp’s useful life. Also, a dead lamp left in a fixture can be very damaging to the ignitor in systems which utilize them. To overcome this problem, Universal offers automatic shutoff ignitors, which are described in the ignitor section of this catalog.

Application And Operating Information

In difficult locations, group replacement of all the lamps, working or not, is often more economical and convenient than spot replacement. The same, of course, applies to ballasts which might be approaching the end of their life. Only you can decide what is right for your lighting system, but what is important is that you have a maintenance program.

Periodic cleaning of the fixtures' lenses and reflectors is also important in maintaining proper light output. For indoor systems, maintenance of reflective surfaces, such as walls and ceilings, will also help assure proper levels of illumination.

STANDBY LIGHTING AND PACKAGING

Standby Lighting

To provide light during a high intensity discharge lamp's warmup period, or the cool-down period following a power interruption which has extinguished it, incandescent standby lighting can be incorporated. This is accomplished by use of a standby lighting device, or remote, that switches off an incandescent lamp incorporated into the fixture once an arc has been established, or reestablished, in the HID lamp. Generally, standby lighting devices operate on 120 volts, so a tap must be provided on ballasts designed to operate at higher line voltages.

The 120 volt terminal or lead on all Universal dual-, tri-, quad- and multi-volt ballasts can be used as a tap for standby lighting when the ballast is utilized for any of the higher voltages. Many single voltage ballasts are available with a 120 volt tap and are listed throughout the Core & Coil data section. Other single voltage ballasts may be available in this version. Consult our Customer Service Department for availability and price information.

Any connection to the 120 volt tap must be accomplished by means of a slow-blow fuse. This fuse will protect the ballast from abnormal conditions in the standby lamp circuit or its control device. The fuse should be located in the coolest place in the fixture (below 80°C). The recommended fuse amperage and maximum auxiliary lamp wattage are listed in this catalog for each ballast suitable for standby lighting applications.

Be sure to follow the wiring instructions of the standby lighting device manufacturer. All applicable requirements of the National Electrical Code must be met.

Packaging

Standard Pack

Universal's high intensity discharge lamp ballasts are routinely packed in easy-to-handle cartons containing from 1 to 20 units per carton, depending on the size and weight of the ballasts. Consult Customer Service for the number of "units per carton" for shipment with attached mounting brackets, capacitors (for high power factor units), and ignitors (if required). Other ordering criteria may cause packaging to vary.

Tray Pack

For the convenience of large quantity users who request it, Universal ballasts may be packed in trays. The number of units depends upon the size and weight of each ballast. These trays are large corrugated cartons with lids and sides that come off easily. This type of packaging affords Universal customers a savings of time and money on their own production costs. There are fewer cartons to open, break up and dispose of on the assembly line; warehouse handling is reduced and inventory control is easier. There is no additional charge for tray packing.

Individual Cartons

All Distributor Replacement Kits, Weatherproof, Potted Core & Coil and other larger ballasts are packaged in individual cartons.

Individual cartons serve a threefold purpose: as a display carton, a stock package, and a shipping container for the retail market. Individual cartons may be packed in master cartons, depending on weight and size.

Individual carton packaging may be available for other ballasts. Contact our Customer Service Department for availability and cost.

Nomenclature

UNIVERSAL PRECISE™

ABBREVIATIONS

CWA	Constant Wattage Autotransformer
CWI	Constant Wattage Isolated
ISO	Regulated Lag
R-HPF	Reactor—High Power Factor
R-NPF	Reactor—Normal Power Factor
HX-HPF	Lag Type — High Reactance Autotransformer—High Power Factor
HX-NPF	Lag Type — High Reactance Autotransformer—Normal Power Factor

UL Bench Top Rise Temperature Code

To facilitate UL inspection, the UL Bench Top Rise Temperature Code is shown on the Universal Core & Coil Ballast label as 1029X. 1029 is the UL Standard for HID Ballasts, and the X is the temperature code. If a fixture is UL listed for 1029D, then automatically all ballasts with an A, B, C or D temperature classification are acceptable for use within that same fixture.

UL Bench Top Rise Letter Code Temperature Range for Class H (180° C) Ballasts

A <75°C	B 75°C < 80°C	C 80°C < 85°C
D 85°C < 90°C	E 90°C < 95°C	F 95°C < 100°C

←	Field	→						
1	2	3	4	5	6	7	8	9
← Number of Digits →								
1	2 to 4	3	1	1	1	1	3	1
M	2 0 0 0	M L T	A	C	5	M	0 0 0	C
Lamp Type (M/P/S/H)	← Wattage →	Primary Voltage (MLT/ML5/TRI/ 48T/120/277/ 230)	Circuit Type (R/A/I/O/L/M)	Style (C/F/W/E/I/P)	Frame Size (E/3/4/5/X)	Socket Type & Other Oddities (M/D/X/L)	Pack Code (000 TO 999)	Container Type (C/T/I/K)
Field	Description							
1	(M) Metal Halide, (P) Pulse Start Metal Halide, (S) High Pressure Sodium							
2	35 to 2000 Watts (Varies from two to four digits)							
3	(MLT) Quad, (ML5) Multi-5, (TRI) TriVolt, (48T) 480/120, (120) 120, (277) 277, (230) 230V/50Hz							
4	(R) Reactor, (A) CWA, (I) CWI, (O) IsoReg, (L) High Reactance/Lag, (M) MagLag							
5	(C), C&C, (F) F-Can, (W) Weatherproof, (E) Encased/Potted C&C (I) Indoor Encased							
6	(E) E&I, (3) 3x4, (4) 4-3/4, (5) 5-3/4, (X) Non Core and Coil							
7	(M) Mogul or Medium, (D) Double Ended, (X) Multiple Lamps, (L) Low Loss							
8	Pack Code (000 to 999, per pack code listing)							
9	(C) Carton, (T) Tray, (I) Individual, (K) Kit							

Specifications

TYPICAL SPECIFICATIONS FOR HID BALLASTS

1. Ballasts shall be designed in accordance with all applicable ANSI specifications including ANSI C82.4.
2. The Core & Coil ballast shall be designed with class “H” (180°C) or higher insulation system and vacuum impregnated with a 100% solid based resin.
3. All coils shall be precision wound.
4. Core & Coil ballasts shall be designed to operate at least 180 cycles of 12 hours on and 12 hours off, with the lamp circuit in an open or short-circuited condition and without undue reduction in ballast life.
5. Core & Coil ballast and starter combinations shall be designed to provide a reliable lamp starting down to -40°C for High Pressure Sodium and Pulse Start Metal Halide and -30°C for Metal Halide and Mercury at minimum rated line voltage.
6. Manufacturer shall provide written warranty against defects in workmanship, including replacement, for two years from date of manufacture.

CAPACITORS

1. All capacitors will be provided with a self-contained internal bleeder resistor.
2. All oil-filled capacitors will be housed in corrosion-resistant steel cans and contain .25” quick disconnect terminals.
3. All capacitors will be supplied by ballast manufacturer.

IGNITORS

1. All ignitors will be epoxy-filled with either a plastic or aluminum external housing.
2. The ignitor shall be so designed to provide six months of lamp open circuit operation without failure.

KITS

1. All HID kits shall be precision wound to insure proper insulation.
2. All HID kits shall be pre-wired.
3. All HID kits shall be built with color-coded leads.
4. All HID kits are to be UL and CSA recognized following the guidelines found in UL 1029 and CAN/CSA-22.2 No. 74-92 (part 2 and 3).
5. Universal Model _____ (or approved equal).

Distributor Replacement Kits

Universal's HID distributor replacement kits contain the appropriate core & coil, a properly rated capacitor, and all other components required for ballast replacement. Our kits are the quickest and easiest to install of any on the market, thanks to unique design features like:

- Prewired capacitor and ignitor (if required) to save installation time and reduce wiring errors.
- Color-coded leads to reduce risk of incorrect wiring inside the fixture.
- Features that exceed UL standards, including capacitors that offer trip fault protection.
- Simple installation instructions and troubleshooting tips.
- UPS shippable box.

Our kit offerings include many quad voltage (120, 208, 240, or 277 volt) and 480 volt core & coil ballasts, as well as the new Multi-5 five-voltage ballast. 480 volt ballasts are equipped with a 120 volt tap to accommodate stand by lighting.

Also available for Metal Halide and High Pressure Sodium applications, Universal Lighting's Multi-5™ Ballast-Lamp Replacement Kit. This easy to carry convenient all-in-one kit ensures ballast lamp compatibility.

Distributor replacement kit cartons are packaged in master cartons in quantities from 1 to 6 units. Master carton quantities can be found on Universal's list and distributor price sheets.

Quad, 480 Volt, Multi-5™ and Multi-5™ Uni-Pak™ Distributor Replacement Kits

LampType	Wattage	Voltage	Frame Size	Old Part Number	New Part Number
Metal Halide	175	120/208/240/277	3 x 4	1130-91R-500K	M175MLTAC3M500K
	175	Multi-5	3 x 4	New	M175ML5AC3M500K
	175	Multi-5™ Uni-Pak™	3 x 4	New	M175ML5AC3M555K
	175	480-120	3 x 4	1130-31-500K	M17548TAC3M500K
	250	120/208/240/277	3 x 4	1130-92-500K	M250MLTAC3M500K
	250	Multi-5	3 x 4	New	M250ML5AC3M500K
	250	Multi-5™ Uni-Pak™	3 x 4	New	M250ML5AC3M555K
	250	480-120	3 x 4	1130-32-500K	M25048TAC3M500K
	250	120/208/240/277	4.25 x 4.75	1130-92R-500K	M250MLTAC4M500K
	250	Multi-5	4.25 x 4.75	New	M250ML5AC4M500K
	250	Multi-5™ Uni-Pak™	4.25 x 4.75	New	M250ML5AC4M555K
	250	480-120	4.25 x 4.75	1130-32R-500K	M25048TAC4M500K
	400	120/208/240/277	4.25 x 4.75	1130-93U-500K	M400MLTAC4M500K
	400	120/208/240/277	4.25 x 4.75	1130-93R-500K	M400MLTAC4M500K
	400	Multi-5	4.25 x 4.75	1130-826S-500K	M400ML5AC4M500K
	400	Multi-5™ Uni-Pak™	4.25 x 4.75	New	M400ML5AC4M555K
	400	480-120	4.25 x 4.75	1130-33R-500K	M40048TAC4M500K
	1000	120/208/240/277	4.25 x 5.75	1130-97-500K	M1000MLTAC5M500K
	1000	120/208/240/277	4.25 x 5.75	1130-97R-500K	M1000MLTAC5M500K
	1000	Multi-5	4.25 x 5.75	New	M1000ML5AC5M500K
1000	Multi-5™ Uni-Pak™	4.25 x 5.75	New	M1000ML5AC5M555K	
1000	480-120	4.25 x 5.75	1130-57-500K	M100048TAC5M500K	
1250	120/208/240/277	4.25 x 5.75	New	M1250MLTAC5M500K	
1500	120/208/240/277	4.25 x 5.75	1130-99R-500K	M1500MLTAC5M500K	
1500	480-120	4.25 x 5.75	1130-69R-500K	M150048TAC5M500K	

Distributor Replacement Kits

Quad, 480 Volt, Multi-5™ and Multi-5™ Uni-Pak™ Distributor Replacement Kits

Lamp Type	Wattage	Voltage	Frame Size	Old Part Number	New Part Number
Pulse Start Metal Halide	35	120/208/240/277	3 x 4	New	M35MLTLC3M500K
	50	120/208/240/277	3 x 4	11310-95-500K	M50MLTLC3M500K
	70	120/208/240/277	3 x 4	11310-510-500K	M70MLTLC3M500K
	70	480-120	3 x 4	New	M7048TLC3M500K
	70	120/208/240/277	3 x 4	New	M70MLTLC3D500K
	100	120/208/240/277	3 x 4	11310-90-500K	M100MLTLC3M500K
	100	120/208/240/277	3 x 4	New	M100MLTLC3D500K
	100	480-120	3 x 4	New	M10048TLC3M500K
	150	120/208/240/277	3 x 4	11310-543-500K	M150MLTLC3M500K
	150	120/208/240/277	3 x 4	New	M150MLTLC3D500K
	150	480-120	3 x 4	New	M15048TLC3M500K
	175	120/208/240/277	3 x 4	New	P175MLTAC3M500K
	175	120/208/240/277	3 x 4	New	P175MLTAC3L500K
	175	Multi-5	3 x 4	New	P175ML5AC3M500K
	175	120/208/240/277	4.25 x 5.75	New	P175MLTAC4L500K
	175	480-120	4.25 x 5.75	New	P17548TAC4L500K
	200	Multi-5	3 x 4	New	P200ML5AC3M500K
	250	120/208/240/277	4.25 x 4.75	New	P250MLTAC4L500K
	250	Multi-5	4.25 x 4.75	New	P250ML5AC4M500K
	250	Multi-5	4.25 x 4.75	New	P250ML5AC4L500K
	250	480-120	4.25 x 4.75	New	P25048TAC4L500K
	320	120/208/240/277	4.25 x 4.75	1130-827-500K	P320MLTAC4O500K
	320	Multi-5	4.25 x 4.75	New	P320ML5AC4M500K
	320	480-120	4.25 x 4.75	New	P32048TAC4M500K
	320	480-120	4.25 x 4.75	New	P32048TAC4L500K
	350	120/208/240/277	4.25 x 4.75	1130-622-500K	P350MLTAC4M500K
	350	Multi-5	4.25 x 4.75	New	P350ML5AC4M500K
	350	Multi-5	4.25 x 4.75	New	P350ML5AC4L500K
	350	480-120	4.25 x 4.75	New	P35048TAC4L500K
	400	120/208/240/277	4.25 x 4.75	1130-829-500K	P400MLTAC4L500K
	400	Multi-5	4.25 x 4.75	New	P400ML5AC4M500K
	400	480-120	4.25 x 4.75	New	P40048TAC4M500K
	450	120/208/240/277	4.25 x 4.75	New	P450MLTAC4M500K
	450	Multi-5	4.25 x 4.75	New	P450ML5AC4M500K
	450	480-120	4.25 x 4.75	New	P45048TAC4M500K
	750	120/208/240/277	4.25 x 5.75	New	P750MLTAC5M500K
	750	Multi-5	4.25 x 5.75	New	P750ML5AC5M500K
	750	480-120	4.25 x 5.75	New	P75048TAC5M500K
	875	120/208/240/277	4.25 x 5.75	New	P875MLTAC5M500K
	1000	120/208/240/277	4.25 x 5.75	New	P1000MLTAC5M500K
1000	Multi-5	4.25 x 5.75	New	P1000ML5AC5M500K	

Distributor Replacement Kits

Quad, 480 Volt, Multi-5™ and Multi-5™ Uni-Pak™ Distributor Replacement Kits

Lamp Type	Wattage	Voltage	Frame Size	Old Part Number	New Part Number
H.P.S.	50	120/208/240/277	3 x 4	12310-95-500K	S50MLTLC3M500K
	70	120/208/240/277	3 x 4	12310-153-500K	S70MLTLC3M500K
	70	480-120	3 x 4	12310-148R-500K	S7048TLC3M500K
	100	120/208/240/277	3 x 4	12310-90-500K	S100MLTLC3M500K
	100	480-120	3 x 4	12310-30R-500K	S10048TLC3M500K
	150	120/208/240/277	3 x 4	12310-165-500K	S150MLTLC3M500K
	150	480-120	3 x 4	12310-160S-500K	S15048TLC3M500K
	200	120/208/240/277	4.25 x 4.75	New	S200MLTAC4M500K
	200	480-120	4.25 x 4.75	New	S20048TAC4M500K
	250	Multi-5	4.25 x 4.75	New	S250ML5AC4M500K
	250	120/208/240/277	4.25 x 4.75	1230-92S-500K	S250MLTAC4M500K
	250	480-120	4.25 x 4.75	1230-32S-500K	S25048TAC4M500K
	250	Multi-5™ Uni-Pak™	4.25 x 4.75	New	S250ML5AC4M555K
	400	Multi-5	4.25 x 4.75	New	S400ML5AC4M500K
	400	120/208/240/277	4.25 x 4.75	1230-93U-500K	S400MLTAC4M500K
	400	480-120	4.25 x 4.75	1230-33U-500K	S40048TAC4M500K
	400	Multi-5	4.25 x 5.75	New	S400ML5AC5M500K
	400	120/208/240/277	4.25 x 5.75	1230-93S-500K	S400MLTAC5M500K
	400	480-120	4.25 x 5.75	1230-33S-500K	S40048TAC5M500K
	400	Multi-5™ Uni-Pak™	4.25 x 4.75	New	S400ML5AC4M555K
600	120/208/240/277	4.25 x 5.75	New	S600MLTAC5M500K	
1000	120/208/240/277	4.25 x 5.75	1230-97S-500K	S1000MLTAC5M500K	
1000	Multi-5	4.25 x 5.75	New	S1000ML5AC5M500K	
1000	Multi-5™ Uni-Pak™	4.25 x 5.75	New	S1000ML5AC5M555K	
1000	480-120	4.25 x 5.75	1230-57S-500K	S100048TAC5M500K	

Distributor Replacement Kits



Canadian Tri-Tap Distributor Replacement Kits

LampType	Wattage	Voltage	Frame Size	Old Part Number	New Part Number
Metal Halide	175	120/277/347	3 x 4	1130-605-502K	M175TRIAC30502K
	250	120/277/347	3 x 4	New	M250TRIAC3M502K
	250	120/277/347	4.25 x 4.75	1130-593R-502K	M250TRIAC4M502K
	400	120/277/347	4.25 x 4.75	1130-595R-502K	M400TRIAC4M502K
	1000	120/277/347	4.25 x 5.75	1130-598-502K	M1000TRIAC5M502K
	1500	120/277/347	4.25 x 5.75	1130-599-502K	M1500TRIAC5M502K
Pulse Start Metal Halide	35	120/277/347	3 x 4	New	M35TRILC3M502K
	50	120/277/347	3 x 4	New	M50TRILC3M502K
	70	120/277/347	3 x 4	11310-604-502K	M70TRILC3M502K
	100	120/277/347	3 x 4	11310-584-502K	M100TRILC3M502K
	150	120/277/347	3 x 4	11310-590-502K	M150TRILC3M502K
	175	120/277/347	3 x 4	New	P175TRIAC3M502K
	200	120/277/347	3 x 4	New	P200TRIAC3M502K
	250	120/277/347	4.25 x 4.75	New	P250TRIAC4M502K
	320	120/277/347	4.25 x 4.75	New	P320TRIAC4M502K
	350	120/277/347	4.25 x 4.75	New	P350TRIAC4M502K
	400	120/277/347	4.25 x 4.75	New	P400TRIAC4M502K
	450	120/277/347	4.25 x 4.75	New	P450TRIAC4M502K
	750	120/277/347	4.25 x 5.75	New	P750TRIAC5M502K
H.P.S.	70	120/277/347	3 x 4	12310-579-502K	S70TRILC3M502K
	100	120/277/347	3 x 4	12310-584-502K	S100TRILC3M502K
	150	120/277/347	3 x 4	12310-588-502K	S150TRILC3M502K
	250	120/277/347	4.25 x 4.75	1230-593S-502K	S250TRIAC4M502K
	400	120/277/347	4.25 x 4.75	1230-595U-502K	S400TRIAC4M502K
	400	120/277/347	4.25 x 5.75	1230-595S-502K	S400TRIAC5M502K
	1000	120/277/347	4.25 x 5.75	1230-598S-502K	S1000TRIAC5M502K

HID CORE & COIL BALLASTS

METAL HALIDE

- 60 Hz
- Minimum starting temperature: -30° C
- Normal and High Power Factor models available

MH
175-250
WATT

Input Volts	Catalog* Number	Circuit Type	Watts Input	Max Input Current	Nom Open Circuit Voltage	Fuse Rating	Wir Dia	Ref Dwg	Dimensions		Capacitor				Total Weight (lbs.)	Ignitor		UL Bench Top Rise		
									A	B	µF	Min Volt	Dry Film			Oil Filled			Catalog Number	Max Distance to lamp (ft)
(1) 175 WATT M57, M107 METAL HALIDE LAMP																				
120	M175120AC3M	CWA	213	1.90	305	5	17	PC1	2.2	3.6	10	400	1.65	2.83	1.56x2.69	2.69	6.1	n/a	n/a	A
230	M175230AC3M	CWA	205	1.00	310	3	46	PC1	2.25	3.55	12	400	1.65	3.82	1.56x2.69	2.7	6.7	n/a	n/a	C
120 or 277 or 347	M175TRIAC30	CWA	211	2.15	305	5	17	PC1	2.45	3.8	10	400	1.65	2.83	1.56x2.69	2.69	6.8	n/a	n/a	C
347				0.95		2														
120 or 208 or 240 or 277	M175MLTAC3M	CWA	213	1.90	305	5	16	PC1	2.2	3.6	10	400	1.65	2.83	1.56x2.69	2.69	6.1	n/a	n/a	A
208 or 240 or 277				1.10		3														0.95
120 or 208 or 240 or 277 or 480	M175ML5AC3M	CWA	208	1.94	300	5	25	PC1	2.3	3.6	10	400	1.65	2.83	1.56x2.69	2.69	6.8	n/a	n/a	B
277 or 480				1.11		3														1.00
480	M17548TAC3M	CWA	210	0.51	315	2	15	PC1	2.0	3.3	10	400	1.65	2.83	1.56x2.69	2.69	5.6	n/a	n/a	D
(1) 250 WATT M58 METAL HALIDE LAMP - 4" Frame																				
230	M250230AC3M	CWA	282	1.40	285	4	46	PC1	3.0	4.3	18	400	n/a	n/a	1.75	3.1	9.0	n/a	n/a	D
120 or 277 or 347	M250TRIAC3M	CWA	295	2.78	320	8	17	PC1	3.0	4.5	15	400	1.85	3.82	2.01x3.01	2.69	9.0	n/a	n/a	B
347				1.30		3														1.05
120 or 208 or 240 or 277	M250MLTAC3M	CWA	297	2.65	315	8	16	PC1	3.0	4.3	15	400	1.85	3.82	2.01x3.01	2.69	9.0	n/a	n/a	D
208 or 240 or 277				1.58		5														1.30
120 or 208 or 240 or 277 or 480	M250ML5AC3M	CWA	280	2.50	290	8	25	PC1	3.0	4.3	15	400	1.6	3.82	2.01x3.01	2.69	9.0	n/a	n/a	C
277 or 480				1.50		5														1.25
347	M250347AC3M	CWA	293	1.05	320	3	42	PC1	3.0	4.5	15	400	1.85	3.82	2.01x3.01	2.69	9.0	n/a	n/a	D
480	M25048TAC3M	CWA	292	0.71	320	2	15	PC1	3.0	4.3	15	400	1.85	3.82	2.01x3.01	2.69	9.0	n/a	n/a	D

³ Capacitors are available as an option for high power factor operation.

See page 5-23 for Reference Drawings and Wiring Diagrams.

- 60 Hz
- Minimum starting temperature: -30° C
- High Power Factor models available
- Feature CWA design

HID CORE & COIL BALLASTS
METAL HALIDE

Input Volts	Catalog* Number	Circuit Type	Watts Input	Max Input Current	Nom Open Circuit Voltage	Fuse Rating	Wir Dia	Dimensions			Capacitor				Total Weight (lbs.)	Ignitor				
								Ref Dwg	A	B	µF	Min Volt	Dry Film			Oil Filled		Catalog Number	Max Distance to lamp (ft)	UL Bench Top Rise
(1) 250 WATT M58 METAL HALIDE LAMP - 4.75" Frame																				
120 or 277 or 347	M250TRIAC4M	CWA	280	3.05	305	8	17	PC2	1.63	3.63	15	400	1.85	3.82	2.01x3.01	2.69	9.5	n/a	n/a	B
				1.25		3														
				1.05		3														
120 or 208 or 240 or 277	M250MLTAC4M	CWA	290	3.05	310	8	16	PC2	1.53	3.53	15	400	1.85	3.82	2.01x3.01	2.69	9.5	n/a	n/a	B
				1.65		5														
				1.55		4														
120 or 208 or 240 or 277 or 480	M250ML5AC4M	CWA	282	2.42	300	8	25	PC2	1.82	3.62	15	360	1.85	3.82	2.01x3.01	2.69	10.8	n/a	n/a	A
				1.40		5														
				1.20		4														
480	M25048TAC4M	CWA	284	0.60	300	2	15	PC2	1.82	3.62	15	360	1.85	3.82	2.01x3.01	2.69	10.8	n/a	n/a	B
(1) 400 WATT M59 METAL HALIDE LAMP																				
120	M400120AC4M	CWA	458	3.94	299	10	28	PC2	2.0	3.86	24	360	1.85	3.82	2.01x3.01	3.12	11.2	n/a	n/a	E
230	M400230AC4M	CWA	448	2.20	300	6	46	PC2	2.13	3.75	28	425	n/a	n/a	2.91	3.88	13.0	n/a	n/a	D
277	M400277AC4M	CWA	458	1.69	299	5	14	PC2	2.0	3.86	24	360	1.85	3.82	2.01x3.01	3.12	11.2	n/a	n/a	E
120 or 277 or 347	M400TRIAC4M	CWA	455	4.22	297	10	17	PC2	2.0	3.9	24	360	1.85	3.82	2.01x3.01	3.12	11.0	n/a	n/a	C
				1.67		5														
				1.44		5														
120 or 277 or 347	M400TRIAC40	CWA	455	3.90	295	10	29	PC2	2.15	3.90	24	360	n/a	n/a	1.91x2.91	3.10	10.5	n/a	n/a	D
				1.70		5														
				1.35		4														
120 or 208 or 240 or 277	M400MLTAC4M	CWA	458	3.94	299	10	16	PC2	2.0	3.9	24	360	1.85	3.82	2.01x3.01	3.12	11.2	n/a	n/a	E
				2.20		8														
				1.93		5														
120 or 208 or 240 or 277 or 480	M400ML5AC4M	CWA	458	4.00	300	10	25	PC2	2.0	3.9	24	360	1.85	3.82	2.01x3.01	3.12	11.2	n/a	n/a	E
				2.30		8														
				2.00		5														
480	M40048TAC4M	CWA	458	1.70	300	5	15	PC2	2.0	3.9	24	360	1.85	3.82	2.01x3.01	3.12	11.0	n/a	n/a	E
480	M40048TAC4M	CWA	458	1.00	300	3	15	PC2	2.0	3.9	24	360	1.85	3.82	2.01x3.01	3.12	11.0	n/a	n/a	E

See page 5-23 for Reference Drawings and Wiring Diagrams.

HID CORE & COIL BALLASTS

METAL HALIDE- FEATURING MULTI-5™

- 60 HZ.
- Minimum Starting Temperature: -30° C
- Feature CWA Design

MH
1000-1500
WATT

Input Volts	Catalog* Number	Circuit Type	Watts Input	Max Input Current	Nom Open Circuit Voltage	Fuse Rating	Wir Dia	Dimensions			Capacitor				Total Weight (lbs.)	Ignitor		UL Bench Top Rise		
								Ref Dwg	A	B	µF	Min Volt	Dry Film			Oil Filled			Catalog Number	Max Distance to lamp (ft)
(1) 1000 WATT M47 METAL HALIDE LAMP																				
120	M1000120AC5M	CWA	1080	9.00	425	23	28	PC3	2.9	4.75	24	480	n/a	n/a	2.01x3.01	4.0	18.0	n/a	n/a	D
230	M1000230AC5M	CWA	1080	4.70	420	13	46	PC3	3.4	5.30	30	440	n/a	n/a	2.91	3.87	21.0	n/a	n/a	C
120 or 277 or 347	M1000TRIAC5M	CWA	1080	9.00 3.90 3.20	420	20 10 8	17	PC3	3.0	4.95	24	480	n/a	n/a	2.01x3.01	4.0	19.0	n/a	n/a	D D E
120 or 208 or 240 or 277	M1000MLTAC5M	CWA	1080	8.95 5.15 4.50 3.90	425	20 15 10 10	16	PC3	2.9	5.05	24	480	n/a	n/a	2.01x3.01	4.0	22.0	n/a	n/a	D
120 or 208 or 240 or 277 or 480	M1000ML5AC5M	CWA	1080	9.15 5.25 4.55 3.95 2.30	420	20 15 10 10 6	25	PC3	2.9	5.05	24	480	n/a	n/a	2.01x3.01	4.0	22.0	n/a	n/a	F E E E E
480	M100048TAC5M	CWA	1080	2.30	410	6	15	PC3	2.85	4.80	24	480	n/a	n/a	2.01x3.01	4.0	22.0	n/a	n/a	D
480	M100048TAN5M	CWA	1080	2.30	410	6	15	PC3	2.85	4.75	24	480	n/a	n/a	2.01x3.01	3.9	22.0	n/a	n/a	A
(1) 1250 WATT M180 METAL HALIDE LAMP																				
120 or 208 or 240 or 277	M1250MLTAC5M	CWA	1360	12.00 6.90 6.00 5.20	420	30 20 15 15	17	PC3	4.4	6.4	32	440	n/a	n/a	1.97x3.66	3.88	25.0	n/a	n/a	F D D E
(1) 1500 WATT M48 METAL HALIDE LAMP																				
230	M1500230AC5M	CWA	1605	7.00	430	20	46	PC3	4.38	6.18	42(2x21)	480	n/a	n/a	1.96x3.65	3.9	30.0	n/a	n/a	C
120 or 277 or 347	M1500TRIAC5M	CWA	1610	13.70 6.00 4.70	460	40 20 15	17	PC3	4.38	6.38	32	525	n/a	n/a	1.96x3.65	3.9	29.5	n/a	n/a	G
120 or 208 or 240 or 277	M1500MLTAC5M	CWA	1615	14.30 8.30 7.20 6.20	455	40 25 20 20	48	PC3	4.4	6.4	32	525	n/a	n/a	1.96x3.65	3.9	30.0	n/a	n/a	F G F E
480	M150048TAC5M	CWA	1620	3.50	445	10	15	PC3	4.4	6.4	32	525	n/a	n/a	1.96x3.65	3.9	30.0	n/a	n/a	E

See page 5-23 for Reference Drawings and Wiring Diagrams.

HID
CORE & COIL

DESCRIPTION	SUFFIX *
For Ballast Only	000
For Bracket Only (see pg. 5-7)	200
For Capacitor Only (see pg. 5-5, 5-6)	500
For Distributor Replacement Kit (see pg. 5-13 thru 5-15)	500K
For Canadian Distributor Replacement Kit (see pg. 5-16)	502K
For Dry-Capacitor & Ballast (see pg. 5-6)	518
For Bracket & Capacitor (see pg. 5-5, 5-7)	700
For Bracket & Dry-Capacitor (see pg. 5-6, 5-7)	718

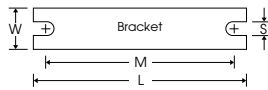

Ref. Dwg.	L	W	M	S
1	4.00"	0.75"	3.35"	0.25"
PC1	5.25"	1.25"	4.60"	0.25"
PC2	7.75"	2.75"	6.10"	0.25"
PC3	7.75"	2.75"	6.10"	0.25"

See p. 5-7 for adjustable mounting brackets and detailed bracket drawings.

REFERENCE DRAWING 1

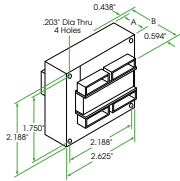

REFERENCE DRAWING PC1

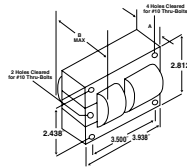

REFERENCE DRAWING PC2

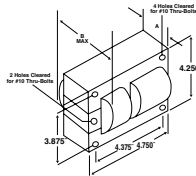

REFERENCE DRAWING PC3

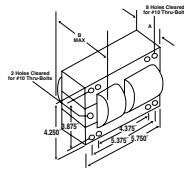

WIRING DIAGRAMS

Wiring Diagram 14

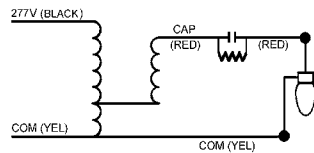

Wiring Diagram 15

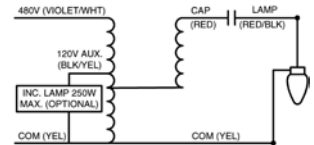

Wiring Diagram 16

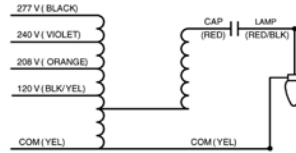

Wiring Diagram 17

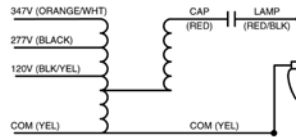

Wiring Diagram 25

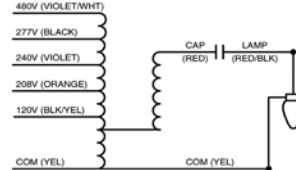

Wiring Diagram 28

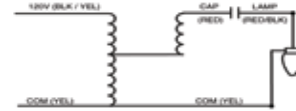

Wiring Diagram 29

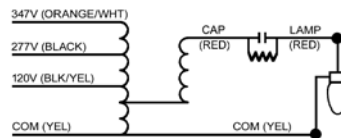

Wiring Diagram 30

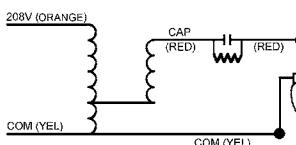

Wiring Diagram 31

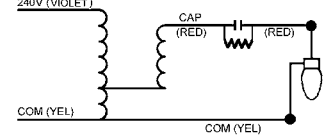

Wiring Diagram 32

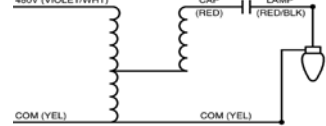

Wiring Diagram 33

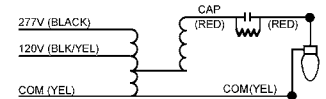

Wiring Diagram 42

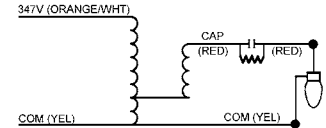

Wiring Diagram 46

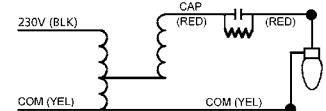

Wiring Diagram 48

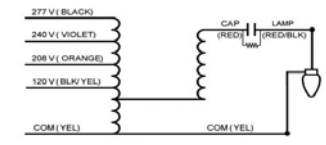

HID CORE & COIL BALLASTS

PULSE START METAL HALIDE

- 60 Hz
- Minimum starting temperature: -30° C
- Normal and High Power Factor models available

**PULSE START
MH
35/39-100 WATT**

Input Volts	Catalog* Number	Circuit Type	Watts Input	Max Input Current	Nom Open Circuit Voltage	Fuse Rating	Wir Dia	Ref Dwg	Dimensions			Capacitor				Total Weight (lbs.)	Ignitor			
									A	B	µF	Min Volt	Dry Film		Oil Filled		Catalog Number	Max Distance to lamp (ft)	UL Bench Top Rise	
(1) 35/39 WATT M130 METAL HALIDE LAMP																				
120 or 277 or 347	M35TRILC3M	HX-HPF	54	.84 .40 .30	235	2 1 1	4	PC1	0.85	2.15	5	300	1.26	2.36	1.31x2.16	2.2	1.7	MH100-3A	5	A
120 or 208 or 240 or 277	M35MLTLC3M	HX-HPF	50	.82 .48 .42 .36	230	2 1 1 1	3	PC1	0.85	2.0	5	277	1.26	2.83	1.31x2.16	2.2	1.7	MH100-3A	5	A
(1) 50 WATT M110 METAL HALIDE LAMP — Medium Base																				
120 or 277 or 347	M50TRILC3M	HX-HPF	67	1.30 .61 .48	250	3 2 2	5	PC1	1.05	2.55	6	300	1.26	2.83	1.31x2.16	2.2	4.25	MH100-3A	10	A
120 or 208 or 240 or 277	M50MLTLC3M	HX-HPF	67	1.16 0.67 0.57 0.50	252	3 3 2 2	3	PC1	1.05	2.55	6	300	1.26	2.36	1.31x2.16	2.2	4.25	MH100-3A	10	A
(1) 70 WATT M98 METAL HALIDE LAMP - Medium Base																				
120 or 277 or 347	M70TRILC3M	HX-HPF	91	1.85 0.80 0.65	260	4 2 2	4	PC1	1.5	2.65	8	280	1.65	2.83	1.31x2.16	2.2	5.0	MH100-3A	10	A
120 or 208 or 240 or 277	M70MLTLC3M	HX-HPF	95	1.70 1.04 0.87 0.78	250	4 3 3 2	3	PC1	1.33	2.88	8	300	1.65	2.83	1.31x2.16	2.2	4.25	MH100-3A	10	B
480	M7048TLC3M	HX-HPF	100	0.50	250	1	6	PC1	1.38	2.88	8	300	1.65	2.83	1.31x2.16	2.2	4.25	MH100-3A	10	E
(1) 70 WATT M85 METAL HALIDE LAMP - Double Ended																				
120 or 208 or 240 or 277	M70MLTLC3D	HX-HPF	95	1.70 1.04 0.87 0.78	250	4 3 3 2	3	PC1	1.38	2.88	8	300	1.65	2.83	1.31x2.16	2.2	4.25	MH70-3B	10	B
(1) 100 WATT M90 OR M92 METAL HALIDE LAMP - Medium Base																				
120 or 277 or 347	M100TRILC3M	HX-HPF	125	2.50 1.10 0.90	265	7 3 3	4	PC1	1.6	2.95	12	280	1.65	2.83	1.31x2.16	3.13	5.5	MH100-3A	10	A
120 or 208 or 240 or 277	M100MLTLC3M	HX-HPF	130	2.40 1.45 1.20 1.00	260	5 4 3 3	13	PC1	1.5	2.8	12	300	1.65	2.83	1.31x2.16	3.12	5.0	MH100-3A	10	A
480	M10048TLC3M	HX-HPF	132	0.62	285	2	6	PC1	1.7	3.0	10	300	1.65	2.83	1.31x2.16	2.7	5.5	MH100-3A	10	C
(1) 100 WATT M91 METAL HALIDE LAMP - Double Ended																				
120 or 208 or 240 or 277	M100MLTLC3D	HX-HPF	130	2.40 1.45 1.20 1.00	260	5 4 3 3	13	PC1	1.5	2.6	12	300	1.65	2.83	1.31x2.16	3.12	5.0	MH70-3B	10	A

³ Capacitors are available as an option for high power factor operation.

See page 5-23 for Reference Drawings and Wiring Diagrams.

HID
CORE & COIL

- 60 Hz
- Minimum Starting Temperature: -40° C
- Feature CWA Design

**HID CORE & COIL BALLASTS
PULSE START METAL HALIDE**

Input Volts	Catalog* Number	Circuit Type	Watts Input	Max Input Current	Nom Open Circuit Voltage	Fuse Rating	Wir Dia	Dimensions			Capacitor				Total Weight (lbs.)	Ignitor		UL Bench Top Rise		
								Ref Dwg	A	B	µF	Min Volt	Dry Film Dia	Ht		Oil Filled Oval	Ht		Catalog Number	Max Distance to lamp (ft)
(1) 150 WATT M102/M142 METAL HALIDE LAMP - Medium Base																				
120 or 277 or 347	M150TRILC3M	HX-HPF	185	3.32 1.48 0.65	245	10 4 2	5	PC1	2.38	3.65	16	280	1.65	2.83	1.56x2.69	2.69	7.3	MH100-3A	10	D
120 or 208 or 240 or 277	M150MLTLC3M	HX-HPF	185	3.32 1.93 1.66 1.48	245	10 5 5 4	3	PC1	2.38	3.88	16	300	1.65	2.83	1.56x2.69	2.69	7.3	MH100-3A	10	A
120 or 208 or 240 or 277	M150MLTAC3M	CWA	188	1.50 0.90 0.75 0.65	210	4 3 3 2	9	PC1	2.5	3.75	16	330	1.65	3.82	n/a	n/a	7.1	MH150-1A	10	C D C C
480	M15048TLC3M	HX-HPF	185	1.00	260	3	6	PC1	2.3	3.6	16	280	1.65	2.83	1.56x2.69	2.69	7.0	MH100-3A	10	F
(1) 150 WATT M81 METAL HALIDE LAMP - Double Ended																				
120 or 208 or 240 or 277	M150MLTLC3D	HX-HPF	185	3.32 1.93 1.66 1.48	245	10 5 5 4	3	PC1	2.38	3.88	16	277	1.65	2.83	1.56x2.69	2.69	7.3	MH70-3B	10	D
(1) 175 WATT M152 METAL HALIDE PULSE START LAMP																				
277	P175277RCEM	RX-NPF RX-HPF	199	1.50 1.25	277	3	1	RX1	2.3	3.4	12	300	n/a 1.6	n/a 2.8	n/a 1.31x2.16	n/a 3.9	3.9	MH350-1A	10	C
120 or 277 or 347	P175TRIAC3M	CWA	208	1.84 0.79 0.63	308	5 2 2	12	PC1	2.5	3.6	10	400	1.6	2.8	1.31x2.16	3.9	6.8	MH350-1	10	B
120 or 208 or 240 or 277	P175MLTAC3M	CWA	208	2.09 1.26 1.02 0.96	306	5 3 3 2	9	PC1	2.5	3.6	10	400	1.6	2.8	1.31x2.16	3.9	6.8	MH350-1A	10	A
120 or 208 or 240 or 277	P175MLTAC3L	CWA	198	1.95 1.10 1.00 0.80	285	5 3 3 2	9	PC1	3.10	4.20	11	370	1.65	2.83	n/a	n/a	8.5	MH350-1A	2	A
120 or 208 or 240 or 277	P175MLTAC4L	CWA	198	1.70 0.95 0.85 0.75	270	5 3 3 2	9	PC2	1.77	3.3	12.5	330	1.55	2.83	n/a	n/a	8.45	MH350-1A	10	A
120 or 208 or 240 or 277 or 480	P175ML5AC3M	CWA	210	1.80 1.05 0.90 0.80 0.45	295	5 3 3 2 2	26	PC1	2.6	4.0	10	400	1.6	2.8	2.7	2.7	8.0	MH350-1A	10	B
480	P17548TAC3L	CWA	198	0.50	285	2	11	PC1	3.10	4.20	11	360	1.65	2.83	n/a	n/a	8.5	MH350-1A	2	A
480	P17548TAC4L	CWA	198	0.40	275	2	11	PC2	1.80	3.5	12.5	330	1.6	2.8	n/a	n/a	9.6	MH350-1A	10	A
(1) 200 WATT M136 METAL HALIDE PULSE START LAMP																				
277	P200277RCEM	RX-HPF	218	0.92	277	4	1	RX1	1.0	2.8	13	280	1.6	3.6	n/a	n/a	4.7	MH350-1A	10	A
120 or 277 or 347	P200TRIAC3M	CWA	240	2.70 1.04 0.87	310	6 3 3	12	PC1	2.8	4.0	11	400	1.6	2.8	2.7	3.6	8.0	MH350-1A	10	C
120 or 208 or 240 or 277 or 480	P200ML5AC3M	CWA	233	2.66 1.52 1.31 1.12 0.68	303	6 4 3 3 2	26	PC1	2.7	4.0	11	400	1.6	2.7	n/a	n/a	8.0	MH350-1A	10	C
480	P20048TAC3M	CWA	232	0.50	305	2	11	PC1	2.8	4.1	11	400	1.6	2.8	1.56x2.69	2.7	8.5	MH350-1	10	C

HID CORE & COIL BALLASTS

PULSE START METAL HALIDE

- 60 Hz
- Minimum Starting Temperature: -40° C
- CWA and High Power Factor Models Available

**PULSE START
MH
250-320 WATT**

Input Volts	Catalog* Number	Circuit Type	Watts Input	Max Input Current	Nom Open Circuit Voltage	Fuse Rating	Wir Dia	Dimensions			Capacitor				Total Weight (lbs.)	Ignitor		UL Bench Top Rise			
								Ref Dwg	A	B	µF	Min Volt	Dry Film			Oil Filled			Catalog Number	Max Distance to lamp (ft)	
												Dia	Ht	Oval	Ht						
(1) 250 WATT M153 METAL HALIDE PULSE START LAMP																					
277	P250277RCEM	RX-NPF RX-HPF	278	2.00 1.25	277	5	1	RX1	1.0	2.8	17.5	300	n/a 1.6	n/a 3.7	n/a n/a	n/a n/a	4.8	MH350-1A	10	A	
120 or 277 or 347	P250TRIAC4M	CWA	300	2.61 1.28 1.09		8 3												MH350-1A	10	A	
120 or 208 or 240 or 277	P250MLTAC40	CWA	291	2.40 1.40 1.20 1.05	277	8 5		9	PC2	1.45	3.10	17	360	1.6	3.7	2.3	3.1	9.0	MH350-1A	10	A
120 or 208 or 240 or 277	P250MLTAC4L	CWA	283	2.50 1.50 1.30 1.10	270	8 5		9	PC2	2.05	3.65	17	360	1.65	3.82	2.3	3.1	10.9	MH350-1A	15	A
120 or 208 or 240 or 277 or 480	P250ML5AC4M	CWA	285	2.45 1.42 1.22 1.05 0.62	290	8 5		26	PC2	2.0	3.9	14	400	1.6	3.7	1.56x2.69	3.1	11.3	MH350-1A	10	A
120 or 208 or 240 or 277 or 480	P250ML5AC4M	CWA	285	2.45 1.42 1.22 1.05	290	8 5		26	PC2	2.0	3.9	14	400	1.6	3.7	1.56x2.69	3.1	11.3	MH350-1A	10	A
480	P25048TAC4L	CWA	283	0.60	275	2	11	PC2	1.9	3.6	17	360	1.65	3.82	n/a	n/a	10.0	MH350-1A	10	A	
(1) 320 WATT M154 METAL HALIDE PULSE START LAMP																					
277	P320277RCEM	RX-NPF RX-HPF	348	3.05 1.51	277	10 6	1	RX1	1.5	3.3	22.5	280	n/a 1.8	n/a 3.6	n/a n/a	n/a n/a	6.8	MH350-1A	10	A	
120 or 277 or 347	P320TRIAC4M	CWA	370	4.50 2.00 1.50		8 3												MH350-1A	10	C	
120 or 208 or 240 or 277	P320MLTAC40	CWA	364	3.10 1.80 1.55 1.35	275	9 5		9	PC2	2.0	3.9	21.0	360	1.85	3.82	2.9	3.6	11.0	MH350-1A	10	A
120 or 208 or 240 or 277 or 480	P320ML5AC4M	CWA	370	4.00 2.40 2.10 1.85 1.06	280	10 7		26	PC2	2.0	3.9	20.5	360	1.8	3.7	1.91x2.91	3.6	11.3	MH350-1A	10	D
120 or 208 or 240 or 277 or 480	P320ML5AN4M	CWA	405	4.00 2.40 2.10 1.85 1.06	282	10 7		26	PC2	2.0	3.86	20.5	360	1.85	3.82	1.75	3.1	11.3	MH350-1A	10	A
120 or 208 or 240 or 277 or 480	P320ML5AC4L	CWA	363	3.10 1.80 1.55 1.35 0.80	275	10 7		26	PC2	1.88	3.8	21	360	n/a	n/a	2.91	3.13	12.0	MH350-1A	10	A

HID
CORE & COIL

See page 5-29 for Reference Drawings and Wiring Diagrams.

- 60 Hz
- Minimum Starting Temperature: -40° C
- Feature CWA Design

**HID CORE & COIL BALLASTS
PULSE START METAL HALIDE**

Input Volts	Catalog* Number	Circuit Type	Watts Input	Max Input Current	Nom Open Circuit Voltage	Fuse Rating	Wir Dia	Dimensions			Capacitor				Total Weight (lbs.)	Ignitor		UL Bench Top Rise			
								Ref Dwg	A	B	µF	Min Volt	Dry Film			Oil Filled			Catalog Number	Max Distance to lamp (ft)	
(1) 350 WATT M131 METAL HALIDE PULSE START LAMP																					
120 or 208 or 240 or 277 or 480	P320ML5AN4L	CWA	363	3.10	275	8	26	PC2	1.88	3.8	21	360	1.85	3.82	n/a	n/a	12.0	MH350-1A	10	A	
				1.80		5															
				1.55		5															
				1.35		4															
				0.80		3															
480	P32048TAC4L	CWA	364	0.80	280	3	11	PC2	2.0	3.9	21	360	1.85	3.82	n/a	n/a	11.0	MH350-1A	10	A	
277	P350277RCEM	RX-NPF	377	3.80	277	8	1	RX1	1.5	3.3	22.5	300	—	—	—	—	6.8	MH350-1	10	A	
		RX-HPF		2.34									n/a	n/a	1.56x2.69	3.9					
120 or 277 or 347	P350TRIAC4M	CWA	405	4.00	280	10	12	PC2	2.0	4.0	21	400	n/a	n/a	2.9	3.1	11.5	MH350-1A	10	C	
				1.50		3															
120 or 208 or 240 or 277	P350MLTAC4M	CWA	400	3.40	275	9	9	PC2	2.0	3.9	22	360	n/a	n/a	2.7	3.9	11.0	MH350-1A	10	C	
				2.00		6															
				1.70		5															
				1.45		4															
				2.40		9															
120 or 208 or 240 or 277	P350MLTAN4M	CWA	400	2.00	275	6	47	PC2	2.0	3.9	22	360	n/a	n/a	2.7	3.9	11.0	MH350-1A	10	A	
				1.70		5															
				1.45		4															
				4.22		10															
				2.49		7															
120 or 208 or 240 or 277 or 480	P350ML5AC4M	CWA	405	2.16	282	5	26	PC2	2.0	3.9	21	400	n/a	n/a	1.91x2.91	3.1	11.3	MH350-1A	10	D	
				1.87		5															
				1.09		3															
				4.22		10															
				2.49		7															
120 or 208 or 240 or 277 or 480	P350ML5AN4M	CWA	405	2.16	282	5	26	PC2	2.0	3.9	21	400	n/a	n/a	1.91x2.91	3.1	11.3	MH350-1A	10	D	
				1.87		5															
				1.09		3															
				4.22		10															
				2.49		7															
120 or 208 or 240 or 277 or 480	P350ML5AC4L	CWA	397	3.35	275	10	26	PC2	1.88	3.8	22	360	1.85	3.82	2.69	3.9	12.0	MH350-1A	10	B	
				1.90		7															
				1.65		9															
				1.45		5															
				0.85		3															
120 or 208 or 240 or 277 or 480	P350ML5AN4L	CWA	397	3.35	275	9	26	PC2	1.88	3.8	22	360	1.85	3.82	2.69	3.9	12.0	MH350-1A	10	A	
				1.90		6															
				1.65		5															
				1.45		4															
				0.85		3															
480	P35048TAC4L	CWA	397	0.85	280	3	11	PC2	2.00	3.9	22	360	1.85	3.82	2.69	3.9	11.0	MH350-1A	10	C	

See page 5-29 for Reference Drawings and Wiring Diagrams.

HID CORE & COIL BALLASTS

PULSE START METAL HALIDE

- 60 Hz
- Minimum Starting Temperature: -40° C
- CWA and High Power Factor Models Available

**PULSE START
MH
400 WATT**

Input Volts	Catalog* Number	Circuit Type	Watts Input	Max Input Current	Nom Open Circuit Voltage	Fuse Rating	Wir Dia	Dimensions			Capacitor				Total Weight (lbs.)	Ignitor		UL Bench Top Rise				
								Ref Dwg	A	B	µF	Min Volt	Dry Film			Oil Filled			Catalog Number	Max Distance to lamp (ft)		
(1) 400 WATT M135 METAL HALIDE PULSE START LAMP																						
120 or 277 or 347	P400TRIAC4M	CWA	457	4.40		10																
				2.01	287	5	12	PC2	2.0	3.8	24	400	1.8	3.6	2.9	3.1	11.0	MH350-1A	10	D		
				1.52		4																
120 or 208 or 240 or 277	P400MLTAC4L	CWA	454	3.90		10														B		
				2.25	280	7	9	PC2	2.30	4.20	26	330	1.85	3.82	n/a	n/a	11	MH350-1A	10	B		
				1.95		5																B
				1.70		5																C
120 or 208 or 240 or 277 or 480	P400ML5AC4M	CWA	457	4.00		10																
				2.40		7																
				2.10	286	5	26	PC2	2.0	3.9	24	400	1.8	3.7	1.91x2.91	3.1	11.3	MH350-1A	10	D		
				1.85		5																
				1.06		3																
120 or 208 or 240 or 277 or 480	P400ML5AC4L	CWA	454	3.90		10														C		
				2.25		7																D
				1.90	280	5	26	PC2	2.35	4.25	26	330	1.85	3.82	1.91x2.91	3.1	11.3	MH350-1A	10	C		
				1.65		5																C
				0.95		3																D
480	P40048TAC4L	CWA	454	1.00	285	3	11	PC2	2.35	4.25	26	330	1.85	3.82	n/a	n/a	12.5	MH350-1A	10	D		
480	P40048TAC4M	CWA	457	1.00	285	3	11	PC2	2.0	3.9	24	400	1.8	3.6	3.7	3.1	11.3	MH350-1A	10	D		

See page 5-29 for Reference Drawings and Wiring Diagrams.

HID
CORE & COIL

**PULSE START
MH
450-1000 WATT**

- 60 Hz
- Minimum Starting Temperature: -40° C
- CWA and High Power Factor Models Available

**HID CORE & COIL BALLASTS
PULSE START METAL HALIDE**

Input Volts	Catalog* Number	Circuit Type	Watts Input	Max Input Current	Nom Open Circuit Voltage	Fuse Rating	Wir Dia	Dimensions			Capacitor				Total Weight (lbs.)	Ignitor		UL Bench Top Rise		
								Ref Dwg	A	B	µF	Min Volt	Dry Film Dia	Ht		Oil Filled Oval	Ht		Catalog Number	Max Distance to lamp (ft)
(1) 450 WATT M144 METAL HALIDE PULSE START LAMP																				
120 or	P450MLTAC4L	CWA	508	4.35	280	10	9	PC2	2.25	4.0	26.5	400	1.85	4.76	2.9	3.5	13.0	MH350-1A	10	B
208 or				2.55		8														C
240 or				2.15		7														C
277				1.90		5														C
120 or	P450ML5AC4L	CWA	508	4.10	280	10	26	PC2	2.65	4.55	26.5	360	1.85	4.76	1.91x2.91	3.9	15.5	MH350-1	10	C
208 or				2.35		8														B
240 or				2.05		7														C
277 or				1.85		5														C
480	P45048TAC4L	CWA	511	1.05	277	4	11	PC2	2.40	4.25	26.5	360	1.85	4.76	2.9	3.5	14.5	MH350-1A	10	B
480				1.40		3														D
(1) 750 WATT M149 METAL HALIDE PULSE START LAMP																				
120 or	P750TRIAC5M	CWA	820	7.05	340	15	12	PC3	2.8	4.6	28	425	n/a	n/a	2.91	3.9	18.0	P750-1B	10	B
277 or				3.05		8														C
347				2.45		8														C
120 or	P750MLTAC5M	CWA	825	7.10	340	18	9	PC3	2.8	4.8	28	400	n/a	n/a	2.91	3.9	18.0	P750-1B	10	D
208 or				4.10		10														A
240 or				3.55		10														B
277				3.10		8														B
120 or	P750ML5AC5M	CWA	820	6.95	340	18	26	PC3	2.8	4.9	28	400	n/a	n/a	2.9	3.9	19.0	P750-1B	16	C
208 or				4.00		10														C
240 or				3.50		10														D
277 or				3.00		8														D
480	P75048TAC5M	CWA	822	1.75	335	5	11	PC3	2.8	4.8	28	400	n/a	n/a	2.91	3.9	18.0	P750-1B	10	C
480				1.80		5														D
(1) 875 WATT M166 METAL HALIDE PULSE START LAMP																				
120 or	P875MLTAC5M	CWA	945	8.50	395	20	9	PC3	2.8	4.5	24	440	n/a	n/a	2.9	3.9	17.5	HPS1000-48	10	D
208 or				5.30		15														C
240 or				4.30		10														A
277				3.80		10														C
120 or	P875ML5AC5M	CWA	950	8.05	395	20	26	PC3	2.8	4.8	24	440	n/a	n/a	2.9	3.9	19.4	HPS1000-4B	10	E
208 or				4.65		12														C
240 or				4.05		10														B
277 or				3.50		10														C
480	P100048TAC5M	CWA	1080	2.00	410	5	11	PC3	2.8	4.8	24	480	n/a	n/a	2.9	3.9	22.0	HPS1000-4B	15	C
480				2.55		10														D
(1) 1000 WATT M141 METAL HALIDE PULSE START LAMP																				
120 or	P1000MLTAC5M	CWA	1080	9.00	420	20	9	PC3	2.9	5.1	24	480	n/a	n/a	2.9	3.9	22.0	HPS1000-4B	20	D
208 or				5.20		15														
240 or				4.50		10														
277				3.90		10														
120 or	P1000ML5AC5M	CWA	1080	8.95	420	20	26	PC3	2.9	5.1	24	480	n/a	n/a	2.9	3.9	22.0	HPS1000-4B	20	G
208 or				5.15		15														B
240 or				4.45		10														C
277 or				3.85		10														C
480	P100048TAC5M	CWA	1080	2.25	410	10	11	PC3	2.8	4.8	24	480	n/a	n/a	2.9	3.9	22.0	HPS1000-4B	15	C
480				2.55		10														D

See page 5-29 for Reference Drawings and Wiring Diagrams.

HID
CORE & COIL

HID CORE & COIL BALLASTS

PULSE START METAL HALIDE

PULSE START
MH

DESCRIPTION	SUFFIX *
For Ballast Only	000
For Bracket Only (see pg. 5-7)	200
For Capacitor Only (see pg. 5-5, 5-6)	500
For Distributor Replacement Kit (see pg. 5-13 thru 5-15)	500K
For Canadian Distributor Replacement Kit (see pg. 5-16)	502K
For Dry-Capacitor & Ballast (see pg. 5-6)	518
For Bracket & Capacitor (see pg. 5-5, 5-7)	700
For Bracket & Dry-Capacitor (see pg. 5-6, 5-7)	718

REFERENCE DRAWING PC1

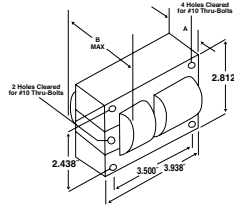

REFERENCE DRAWING PC2

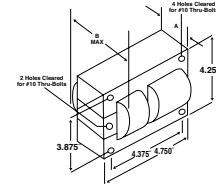

REFERENCE DRAWING PC3

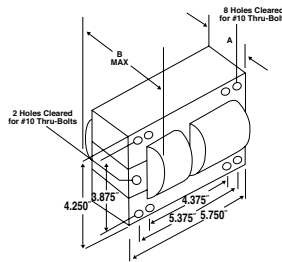

REFERENCE DRAWING RX1

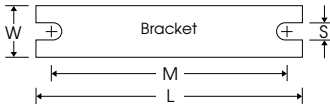
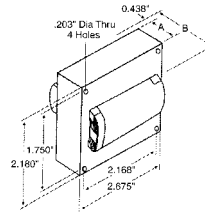

Ref. Dwg.	L	W	M	S
PC1	5.25"	1.25"	4.60"	0.25"
PC2	7.75"	1.25"	5.75"	0.25"
PC3	7.75"	2.75"	6.10"	0.25"
RX1	4.00"	0.75"	3.35"	0.25"

See p. 5-7 for adjustable mounting brackets and detailed bracket drawings.

WIRING DIAGRAMS

Wiring Diagram 1

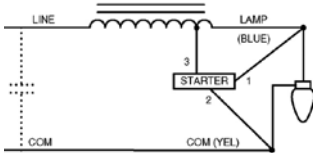

Wiring Diagram 3

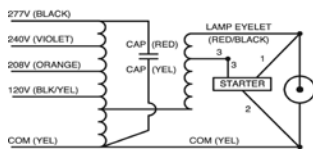

Wiring Diagram 4

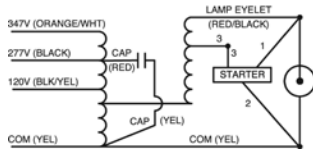

Wiring Diagram 5

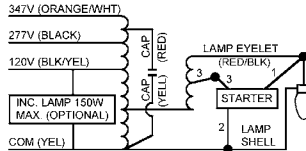

Wiring Diagram 6

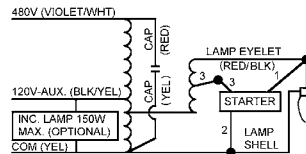

Wiring Diagram 9

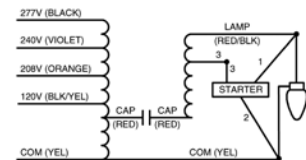

Wiring Diagram 13

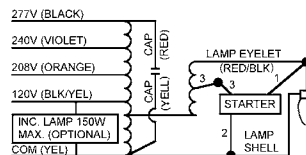

Wiring Diagram 11

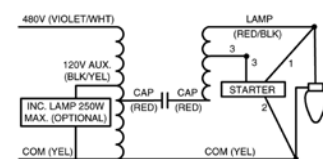

Wiring Diagram 12

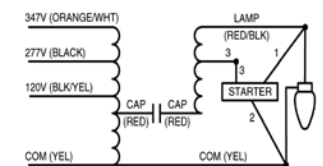

Wiring Diagram 26

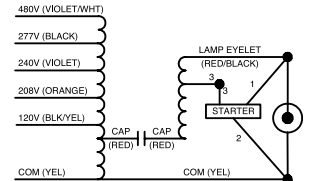

Wiring Diagram 47

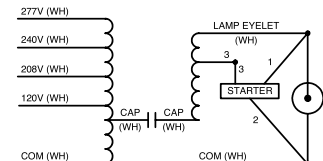

- 60 Hz
- Minimum Starting Temperature: -40° C
- Normal and High Power Factor Models

HID CORE & COIL BALLASTS
HIGH PRESSURE SODIUM

Input Volts	Catalog* Number	Circuit Type	Watts Input	Max Input Current	Nom Open Circuit Voltage	Fuse Rating	Wir Dia	Dimensions			Capacitor				Total Weight (lbs.)	Ignitor		UL Bench Top Rise		
								Ref Dwg	A	B	Min Volt	Dry Film		Oil Filled		Catalog Number	Max Distance to lamp (ft)			
(1) 35 WATT S76 HIGH PRESSURE SODIUM LAMP																				
120 ¹	1233-251W*	R-HPF ³	43	0.65	120	2	2	1a	0.6	1.7	14	120	n/a	n/a	1.56x2.69	2.7	1.5	HPS150-3A	3	A
Permanently Attached																				
120	S35120RCEM	RX-NPF RX-HPF	44	0.85 0.63	120	2 3	1	5	0.6	1.7	14	240	—	—	1.9	2.3	1.0	HPS150-3A	10	A
(1) 50 WATT S68 HIGH PRESSURE SODIUM LAMP																				
120 ¹	1233-35W*	R-HPF ³	60	0.90	120	5	2	1a	0.9	2.4	20	240	n/a	n/a	1.56x2.69	3.1	2.0	HPS150-3A	3	A
Permanently Attached																				
120	S50120RCEM	RX-NPF RX-HPF	60	1.12 0.90	120	8 5	1	5	0.8	2.0	20	240	—	—	1.9	2.3	2.0	HPS150-3A	3	A
120 or 208 or 240 or 277	S50MLTLC3M	HX-HPF	66	1.24 0.60 0.52 0.45	130	5 3 3 2	3	PC1	1.3	2.7	5	300	1.2	2.2	2.2	2.2	4.1	HPS150-3A	5	A
(1) 70 WATT S62 HIGH PRESSURE SODIUM LAMP																				
120	1233-142W*	R-HPF	83	1.30	120	5	2	1a	1.3	2.8	2.8	120	1.6	2.7	n/a	n/a	2.5	HPS150-3A	3	A
Permanently Attached																				
120	S70120RCEM	RX-NPF RX-HPF	80	1.60 1.30	120	8 4	1	RX1	1.1	2.8	28	240	n/a	n/a	1.3	2.7	2.0	HPS150-3A	3	A
230	S70230LC3M	HX-HPF	88	1.00	120	2	35	PC1	1.9	3.2	10	280	1.6	2.7	1.3	2.7	5.7	HPS150-3A	3	A
120 or 277	S7027TLC3M	HX-HPF	98	1.50 0.65	120	5 2	36	PC1	1.3	2.8	7	300	n/a	n/a	1.3	2.2	4.1	HPS150-3A	10	B
120 or 277 or 347	S70TRILC3M	HX-HPF	94	1.50 0.65 0.50	120	5 2 2	4	PC1	2.0	3.5	7	300	1.2	2.7	1.31x2.16	2.2	4.2	HPS150-3A	10	B
120 or 208 or 240 or 277	S70MLTLC3M	HX-HPF	98	1.50 0.88 0.75 0.65	120	5 3 3 2	3	PC1	1.3	2.8	7	300	1.2	2.8	1.31x2.16	2.2	4.2	HPS150-3A	10	B
480	S7048TLC3M	HX-HPF	94	0.34	120	2	6	PC1	1.8	2.9	7	300	1.2	2.8	1.3	2.2	5.6	HPS150-3A	10	A
(1) 100 WATT S54 HIGH PRESSURE SODIUM LAMP																				
120 ¹	1233-10W*	R-HPF ³	117	1.80	120	8	2	1a	1.5	2.9	40	240	1.6	3.6	1.87	2.9	2.8	HPS150-3A	3	A
Permanently Attached																				
120	S100120RCEM	RX-NPF RX-HPF	115 112	2.24 1.81	120	10 8	1	5	1.50	2.8	40	240	—	—	1.8	2.7	2.0	HPS150-3A	10	A
120 or 277	S10027TLC3M	HX-HPF	122	2.20 0.95	120	3 2	36	PC1	2.0	3.4	10	330	1.6	2.7	1.3	2.7	5.9	HPS150-3A	10	B
120 or 277 or 347	S100TRILC3M	HX-HPF	130	2.20 0.95 0.69	120	8 3 2	5	PC1	2.0	3.5	10	330	1.2	2.7	1.31x2.16	2.7	5.9	HPS150-3A	10	B
120 or 208 or 240 or 277	S100MLTLC3M	HX-HPF	122	2.20 1.30 1.10 0.95	120	8 5 5 3	3	PC1	2.0	3.4	10	330	1.2	2.7	2.2	2.7	6.0	HPS150-3A	10	B
480	S10048TLC3M	HX-HPF	135	0.57	120	2	6	PC1	2.0	3.3	10	277	1.6	2.8	1.3	2.2	6.2	HPS150-3A	5	E

¹ Also can be used on a 277 volt line in conjunction with the step down transformers

³ Capacitors are available as an option for High Power Factor operation

* Ballast has built-in starter.

See pages 5-34 and 5-35 for Reference Drawings and Wiring Diagrams.

HID CORE & COIL BALLASTS

HIGH PRESSURE SODIUM

- 60 Hz
- Minimum Starting Temperature: -40° C
- CWA, Normal and High Power Factor Models

HPS
150-250
WATT

Input Volts	Catalog* Number	Circuit Type	Watts Input	Max Input Current	Nom Open Circuit Voltage	Fuse Rating	Wir Dia	Dimensions			Capacitor				Total Weight (lbs.)	Ignitor		UL Bench Top Rise		
								Ref Dwg	A	B	µF	Min Volt	Dry Film			Oil Filled			Catalog Number	Max Distance to lamp (ft)
(1) 150 WATT S55 HIGH PRESSURE SODIUM LAMP																				
120 ¹	1233-154W*	R-HPF ³	171	2.40	120	8	2	1a	2.0	3.4	52	240	1.8	3.0	2.12	2.9	3.5	HPS150-3A	3	A
																		Permanently Attached		
120	S150120RCEM	RX-NPF RX-HPF	168	4.40 2.35	120	5	1	5	2.0	3.1	15	240	n/a	n/a	2.0	2.9	3.3	HPS150-3A	3	A
208	S150208LC3M	HX-HPF	190	0.95	120	5	37	PC1	2.3	3.8	14	300	n/a	n/a	1.5	2.7	7.0	HPS150-3A	10	C
120 or 277	S150277TLC3M	HX-HPF	295	1.90 0.80	185	10 5	36	PC1	2.5	3.9	14	280	n/a	n/a	2.7	2.7	7.0	HPS150-3A	10	B A
120 or 277 or 347	S150TRILC3M	HX-HPF	188	3.00 1.35 1.00	120	10 5 4	5	PC1	2.3	3.7	14	300	1.6	2.8	1.56x2.69	2.7	7.0	HPS150-3A	10	B C B
120 or 208 or 240 or 277	S150MLTLC3M	HX-HPF	188	1.90 1.00 0.95 0.80	120	10 5 5 5	3	PC1	2.5	3.9	14	280	1.6	2.8	2.7	2.7	7.0	HPS150-3A	10	B A B A
480	S15048TLC3M	HX-HPF	189	0.72	120	3	6	PC1	3.0	4.5	14	277	1.6	2.7	1.56x2.69	2.7	8.7	HPS150-3A	10	D
(1) 150 WATT S56 HIGH PRESSURE SODIUM LAMP																				
120	S150MLTAC3M	CWA	188	1.65	210	5	9	PC1	2.5	3.9	20	240	1.6	3.6	n/a	n/a	8.0	HPS150-3A	10	D
208				1.50		3														
240				0.85		3														
277				0.75		3														
(1) 200 WATT S66 HIGH PRESSURE SODIUM LAMP																				
240	1233-183S	R-NPF R-HPF ³	225	2.80 2.00	240	8 3	1	4	1.5	3.0	—	—	—	—	—	—	5.3	HPS450-1B	5	A
120	S200TRIAC4M	CWA	233	2.00	184	7	12	PC2	1.4	3.3	28	280	n/a	n/a	1.91x2.91	3.1	8.7	HPS400-3A	10	C
277				0.86		3														
347				0.68		3														
120 or 208 or 240 or 277	S200MLTAC4M	CWA	230	2.10 1.20 1.00 0.88	175	7 4 4 3	9	PC2	1.2	3.0	28	300	1.8	3.7	1.91X2.91	3.1	8.5	HPS400-3A	10	B
480	S20048TAC4M	CWA	240	0.56	172	2	34	PC2	2.0	3.8	28	280	1.6	4.6	1.7	3.1	11.0	HPS400-3A	10	C
(1) 250 WATT S50 HIGH PRESSURE SODIUM LAMP																				
240	1233-24S	R-NPF R-HPF	278	3.50 2.50	240	10 5	1	4	2.0	3.5	—	—	—	—	—	—	6.8	HPS450-1B	5	A
120	S250120AC4M	CWA	295	2.50	185	8	38	PC2	1.8	3.7	35	330	n/a	n/a	1.8	3.1	10.3	HPS400-3A	10	A
230	S250230AC4M	CWA	280	1.24	188	5	39	PC2	1.7	3.6	40	300	n/a	n/a	1.8	3.9	10.3	HPS400-3A	3	B
240	S250240AC4M	CWA	295	1.20	185	4	40	PC2	1.8	3.7	35	330	n/a	n/a	1.8	3.1	10.3	HPS400-3A	10	A
120	S250TRIAC4M	CWA	300	2.50	190	8	12	PC2	1.7	3.8	35	330	1.6	3.7	1.91x2.91	3.1	10.3	HPS400-3A	10	C
277				1.20		4														
347				1.00		3														
120	S250MLTAC4M	CWA	295	2.50	190	8	9	PC2	1.8	3.7	35	330	1.6	3.7	1.91x2.91	3.1	10.3	HPS400-3A	10	A
208				1.40		5														
240				1.20		4														
277				1.10		4														
120	S250ML5AC4M	CWA	300	2.50	200	8	26	PC2	2.0	3.8	35	330	1.6	3.7	1.91x2.91	3.1	14.0	HPS400-3A	10	A
208				1.40		5														
277				1.10		4														
480	S250480AC4M	CWA	285	0.62	200	2	39	PC2	1.8	3.7	35	280	1.8	4.6	n/a	n/a	10.4	HPS400-3A	5	A
480	S25048TAC4M	CWA	285	0.62	200	2	11	PC2	1.8	3.7	35	280	1.6	3.7	1.91x2.91	3.1	10.4	HPS400-3A	5	A

* Ballast has built-in starter.

* Also can be used on a 277 volt line in conjunction with the step-down transformers described on page 5-53.

³ Capacitors are available as an option for high power factor operation.

- 60 Hz
- Minimum Starting Temperature: -40° C
- CWA, Normal and High Power Factors Models Available

HID CORE & COIL BALLASTS
HIGH PRESSURE SODIUM-
FEATURING MULTI-5™

Input Volts	Catalog* Number	Circuit Type	Watts Input	Max Input Current	Nom Open Circuit Voltage	Fuse Rating	Wir Dia	Dimensions			Capacitor				Total Weight (lbs.)	Ignitor		UL Bench Top Rise			
								Ref Dwg	A	B	µF	Min Volt	Dry Film			Oil Filled			Catalog Number	Max Distance to lamp (ft)	
(1) 400 WATT S51 HIGH PRESSURE SODIUM LAMP - 4 3/8" Frame																					
230	S400230AC4M	CWA	465	2.05	190	8	39	PC2	2.5	4.3	64	300	n/a	n/a	1.8	3.2	15.5	HPS400-3A	10	D	
277	S400277AC4M	CWA	460	1.70	192	5	41	PC2	2.32	4.1	55	240	1.8	4.6	1.8	3.9	14.0	HPS400-3A	10	D	
120 or 277 or 347	S400TRIAC4M	CWA	465	3.95	192	5	12	PC2	2.32	4.1	55	240	1.8	3.7	1.91x2.91	3.5	14.0	HPS400-3A	10	D	
347				1.35																	4
120 or 208 or 240 or 277	S400MLTAC4M	CWA	463	3.80	190	6	9	PC2	2.32	4.1	55	240	1.8	3.7	1.91x2.91	3.5	14.0	HPS400-3A	10	D	
277				2.20																	5
120 or 208 or 240 or 277 or 480	S400ML5AC4M	CWA	465	1.80	190	5	26	PC2	2.44	4.3	55	240	1.8	3.7	1.91x2.91	3.5	14.0	HPS400-3A	10	D	
480				1.70																	5
480	S400480AC4M	CWA	464	1.00	190	3	11	PC2	2.32	4.1	55	240	1.8	4.6	1.8	3.9	14.0	HPS400-3A	10	D	
480	S40048TAC4M	CWA	464	1.00	190	3	11	PC2	2.32	4.1	55	240	1.8	3.7	1.91x2.91	3.5	14.0	HPS400-3A	10	D	
(1) 400 WATT S51 HIGH PRESSURE SODIUM LAMP - 5 3/8" Frame																					
120 or 277 or 347	S400TRIAC5M	CWA	467	3.90	200	5	12	PC2	2.2	4.1	48	280	2.0	4.7	1.91x2.91	3.9	16.0	HPS400-3A	10	E	
347				1.35																	4
120 or 208 or 240 or 277	S400MLTAC5M	CWA	470	3.95	200	6	9	PC3	2.25	4.1	48	280	2.0	4.7	1.91x2.91	3.9	16.0	HPS400-3A	10	D	
277				2.30																	5
120 or 208 or 240 or 277 or 480	S400ML5AC5M	CWA	468	4.00	200	5	26	PC3	2.5	4.5	48	300	2.0	4.7	1.91x2.91	3.9	17.5	HPS400-3A	10	D	
480				2.30																	6
480	S40048TAC5M	CWA	467	1.00	200	3	11	PC3	2.25	4.1	48	280	2.0	4.7	1.91x2.91	3.9	16.0	HPS400-3A	10	D	
(1) 430 WATT SON AGRO HIGH PRESSURE SODIUM LAMP																					
120 or 208 or 240 or 277	S430MLTAC4M	CWA	490	4.50	205	8	9	PC2	2.2	4.3	48	330	2.0	4.7	1.91x2.91	3.9	11.0	HPS400-3A	10	D	
208 or 240 or 277				2.50																	7
240 or 277				2.10																	7
277				1.80																	5

³ Capacitors are available as an option for high power factor operation.

See pages 5-34 and 5-35 for Reference Drawings and Wiring Diagrams.

HID CORE & COIL BALLASTS

HIGH PRESSURE SODIUM

- 60 Hz
- Minimum starting temperature: -40° C
- CWA models available

HPS
600-1000
WATT

Input Volts	Catalog* Number	Circuit Type	Watts Input	Max Input Current	Nom Open Circuit Voltage	Fuse Rating	Wir Dia	Dimensions			Capacitor				Total Weight (lbs.)	Ignitor		UL Bench Top Rise			
								Ref Dwg	A	B	µF	Min Volt	Dry Film			Oil Filled			Catalog Number	Max Distance to lamp (ft)	
(1) 600 WATT S106 HIGH PRESSURE SODIUM LAMP																					
120 or	S600MLTAC5M	CWA	640	5.10	240	20	9	PC3	3.0	5.0	55	300	1.8	4.7	1.91x2.91	3.9	21.0	HPS600-1B	10	A	
208 or				3.10																	15
240 or				2.70																	10
277				2.35																	10
(1) 1000 WATT S52 HIGH PRESSURE SODIUM LAMP																					
220 or	S1000230AC5M	CWA	1100	5.15	405	15	39	PC3	4.0	5.8	36	540	n/a	n/a	3.66	4.25	25.5	HPS1000-4B	10	D	
230 or				5.00																	15
240				4.80																	15
120 or	S100024TAC5M	CWA	1100	9.50	440	20	40	PC3	3.7	5.7	26	525	n/a	n/a	1.8	4.3	26.0	HPS1000-4B	10	C	
240				4.80																	10
120 or	S1000TRIAC5M	CWA	1100	9.60	440	20	12	PC3	3.8	5.8	26	525	n/a	n/a	1.9	2.9	27.0	HPS1000-4B	15	D	
277 or				4.30																	10
347				3.40																	10
120 or	S1000MLTAC5M	CWA	1100	9.50	440	20	9	PC3	3.7	5.7	26	525	n/a	n/a	1.91x2.91	4.3	26.0	HPS1000-4B	15	C	
208 or				5.50																	15
240 or				4.80																	10
277				4.20																	10
120 or	S1000ML5AC5M	CWA	1048	9.10	440	20	26	PC3	3.7	5.6	26	480	n/a	n/a	1.91x2.91	4.3	26.0	HPS1000-4B	15	D	
208 or				5.40																	15
240 or				4.60																	10
277 or				4.10																	10
480				2.45																	8
480	S1000480AC5M	CWA	1100	2.45	440	8	11	PC3	3.7	6.0	26	500	n/a	n/a	1.8	4.3	25.0	HPS1000-4B	15	D	
480	S100048TAC5M	CWA	1100	2.45	440	8	11	PC3	3.7	6.0	26	525	n/a	n/a	1.91x2.91	4.3	25.0	HPS1000-4B	15	D	

See pages 5-34 and 5-35 for Reference Drawings and Wiring Diagrams.

HID
CORE & COIL

DESCRIPTION	SUFFIX *
For Ballast Only	000
For Bracket Only (see pg. 5-7)	200
For Capacitor Only (see pg. 5-5, 5-6)	500
For Distributor Replacement Kit (see pg. 5-13 thru 5-15)	500K
For Canadian Distributor Replacement Kit (see pg. 5-16)	502K
For Dry-Capacitor & Ballast (see pg. 5-6)	518
For Bracket & Capacitor (see pg. 5-5, 5-7)	700
For Bracket & Dry-Capacitor (see pg. 5-6, 5-7)	718

REFERENCE DRAWING 1

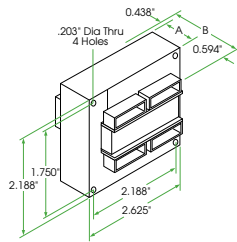

REFERENCE DRAWING 1a

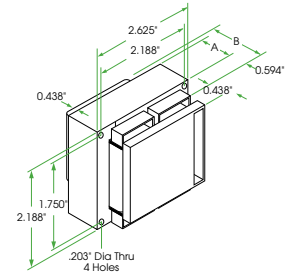

REFERENCE DRAWING 4

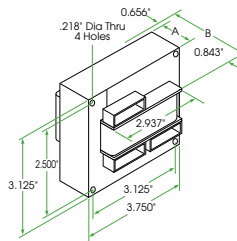

REFERENCE DRAWING 5

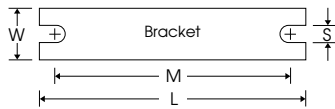
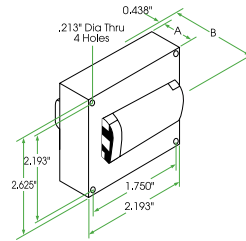

Ref. Dwg.	L	W	M	S
1, 1a, 5	4.00"	0.75"	3.35"	0.25"
PC1, 4	5.25"	1.25"	4.60"	0.25"
PC2, PC3	7.75"	1.25"	5.75"	0.25"

See p. 5-7 for adjustable mounting brackets and detailed bracket drawings.

REFERENCE DRAWING PC1

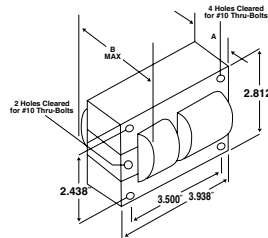

REFERENCE DRAWING PC2

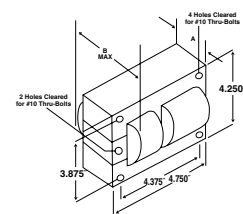

REFERENCE DRAWING PC3

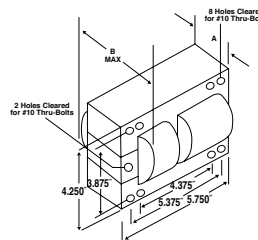

HID CORE & COIL BALLASTS

HIGH PRESSURE SODIUM

HPS

WIRING DIAGRAMS

Wiring Diagram 1

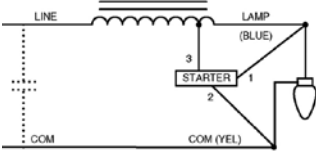

Wiring Diagram 2

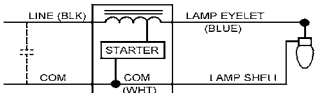

Wiring Diagram 3

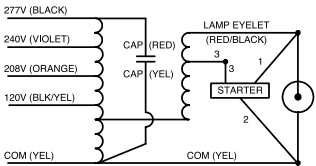

Wiring Diagram 4

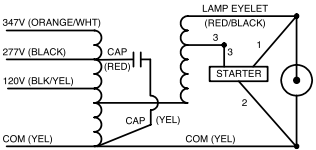

Wiring Diagram 5

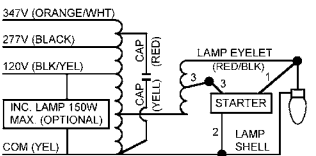

Wiring Diagram 6

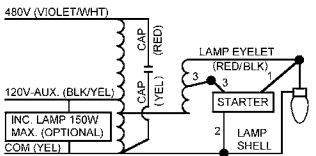

Wiring Diagram 9

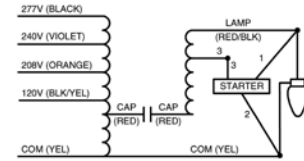

Wiring Diagram 11

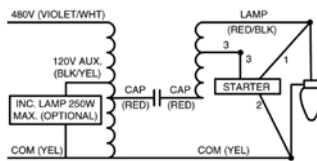

Wiring Diagram 12

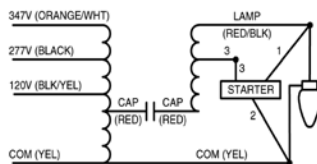

Wiring Diagram 26

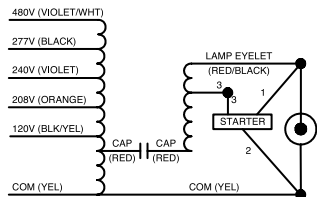

Wiring Diagram 34

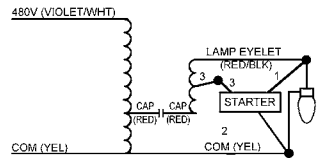

Wiring Diagram 35

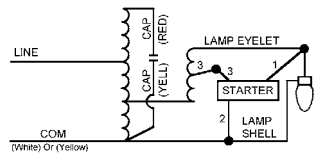

Wiring Diagram 36

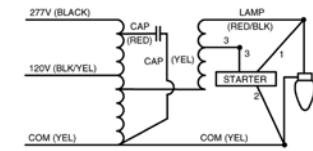

Wiring Diagram 37

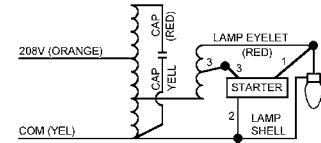

Wiring Diagram 38

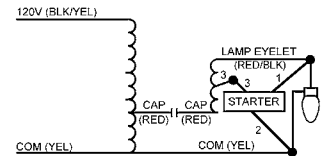

Wiring Diagram 39

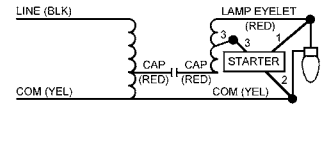

Wiring Diagram 40

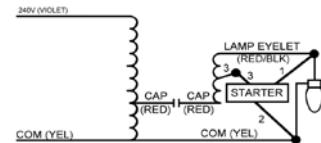

Wiring Diagram 41

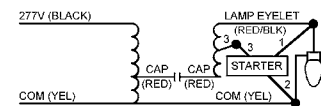

HID
CORE & COIL

- 50 Hz
- Minimum Starting Temperature: -40° C
- CWA, Normal and High Power factor models available

HID CORE & COIL BALLASTS 50 HERTZ

Input Volts	Catalog* Number	Circuit Type	Input Watts	Max Input Curr.	Nom Open Circuit Volt.	Fuse Rating	Wir Dia	Dimensions			Capacitor				Total Wt. (lbs.)	Ignitor		UL Bench Top Rise		
								Ref Dwg	A	B	µF	Min Volt	Dry Film			Oil Filled			Catalog Number	Max Dist. lamp
													Dia	Ht	Oval	Ht				
(1) 175 WATT M57 METAL HALIDE LAMP																				
230	M175230AC3M	CWA	205	1.17	312	2	14	PC1	2.25	3.55	12	400	1.56	3.74	1.5	3.13	6.7	n/a	n/a	C
(1) 250 WATT M58 METAL HALIDE LAMP																				
230	M250230AC3M	CWA	282	1.55	285	3	14	PC1	3.0	4.3	18	400	n/a	n/a	2.01x3.01	3.1	9.0	n/a	n/a	D
(1) 400 WATT M59 METAL HALIDE LAMP																				
230	M400230AC4M	CWA	435	2.44	300	5	14	PC2	2.13	3.73	28	425	n/a	n/a	1.91x2.91	3.9	13.0	n/a	n/a	D
(1) 1000 WATT M47 METAL HALIDE LAMP																				
230	M1000230AC5M	CWA	1080	5.33	405	15	14	PC3	3.44	5.24	30	440	n/a	n/a	2.01x3.01	3.9	24.0	n/a	n/a	C
(1) 1500 WATT M48 METAL HALIDE LAMP																				
230	M1500230AC5M	CWA	1605	7.29	430	20	14	PC3	4.38	6.18	42(2x21)	480	n/a	n/a	1.97x3.66	3.9	30	n/a	n/a	C
(1) 200 WATT S66 HIGH PRESSURE SODIUM LAMP																				
240	1238-183S	R-NPF R-HPF	225	2.90 2.06	240	8 3	1	4	1.5	3.0	—	—	—	—	—	—	5.4	HPS460-1B	10	D
(1) 250 WATT S50 HIGH PRESSURE SODIUM LAMP																				
230	1238-133S	R-NPF R-HPF	278	3.60 2.50	230	10 5	1	4	2.0	3.5	—	—	—	—	—	—	7.1	HPS460-1B	10	A
230	S250230AC4M	CWA	280	1.38	188	5	8	PC2	1.78	3.58	40	300	n/a	n/a	2.01x3.01	3.9	10.3	HPS400-3A	3	B
(1) 400 WATT S51 HIGH PRESSURE SODIUM LAMP (continued)																				
230	S400230AC4M	CWA	465	2.26	190	8	10	PC2	2.5	4.3	64	300	n/a	n/a	1.91x2.91	3.1	15.5	HPS400-3A	3	D
(1) 1000 WATT S52 HIGH PRESSURE SODIUM LAMP																				
230	S1000230AC5M	CWA	1100	5.44	405	15	39	PC3	4.0	5.8	36	540	n/a	n/a	1.96x3.65	4.25	25.5	HPS1000-4B	10	D

See page 5-37 for Reference Drawings and Wiring Diagrams.

HID CORE & COIL BALLASTS

50 HERTZ

50 HZ

DESCRIPTION	SUFFIX *
For Ballast Only	000
For Capacitor Only (see pg. 5-5, 5-6)	500

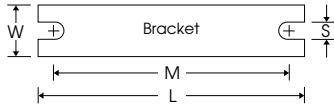

Ref. Dwg.	L	W	M	S
1	4.00"	0.75"	3.60"	0.25"
2, 3, 4	5.25"	1.75"	4.60"	0.25"
PC1	5.25"	1.25"	4.60"	0.25"
PC2	7.75"	1.25"	5.75"	0.25"
PC3	7.75"	2.75"	6.10"	0.25"

See p. 5-8 for adjustable mounting brackets and detailed bracket drawings.

REFERENCE DRAWING PC1

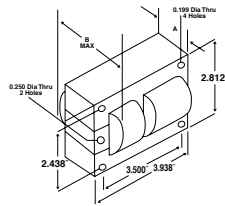

REFERENCE DRAWING 4

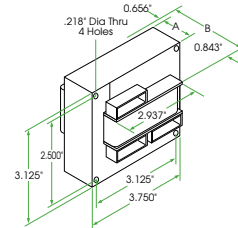

REFERENCE DRAWING PC2

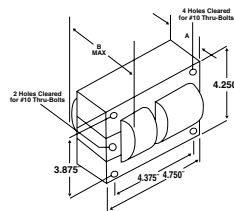

REFERENCE DRAWING PC3

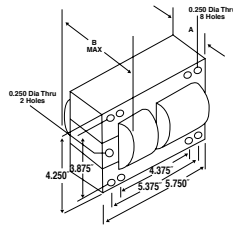

WIRING DIAGRAMS

Wiring Diagram 1

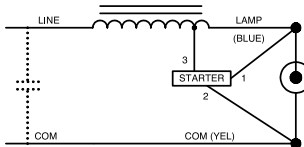

Wiring Diagram 10

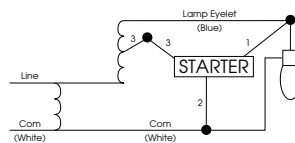

Wiring Diagram 8

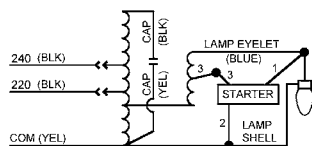

Wiring Diagram 14

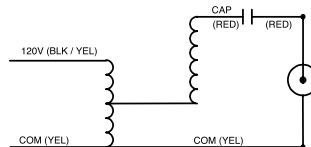

Wiring Diagram 39

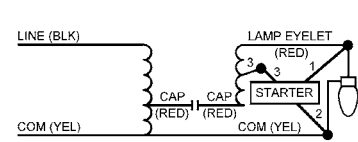

HID
CORE & COIL 50 HERTZ

- 60 Hz
- Minimum Starting Temperature: -30° C
- CWA and High Power Factor Designs

**F-CAN BALLASTS
METAL HALIDE**

Input Volts	Catalog Number	Circuit Type	Input Watts	Max Input Current	Nom Open Circuit Voltage	Fuse Rating	Wir Dia	Dimensions			Total Weight	Max Dist To Lamp (ft)	Sound Rating	Certifications	
								Overall Length	Case Length	Mtg Dim				UL	CSA
(1) 35/39 WATT M130 METAL HALIDE (with built-in ignitor)															
120	1120-251A-TC	CWA	55	0.50	225	2	21	9.50	8.35	8.85	3.0	20	B	Yes	Yes
(1) 50 WATT M110 METAL HALIDE (with built-in ignitor)															
120 or 277	11210-236C-TC	HX-HPF	70	0.64 0.65	240	3 2	20	11.75	10.56	11.14	11.0	20	B	Yes	Yes
(1) 70 WATT M85 METAL HALIDE (with built-in ignitor)															
120 or 277	11210-277C-TC ⁷	HX-HPF	98	2.00 0.90	250	6 3	20	11.75	10.56	11.14	11.0	20	B	Yes	Yes
(1) 70 WATT M98 METAL HALIDE (with built-in ignitor)															
120 or 277	11210-506C-TC ²²	HX-HPF	90	2.00 0.90	250	6 3	20	11.75	10.56	11.14	11.0	20	B	Yes	Yes
120 or 347	11210-554C-TC	HX-HPF	90	2.00 0.80	250	6 3	20	11.75	10.56	11.14	11.0	20	B	No	Yes
(1) 100 WATT M90 METAL HALIDE (with built-in ignitor)															
120 or 277	11210-239C-TC	HX-HPF	125	2.20 1.00	250	8 4	20	11.75	10.56	11.14	11.0	20	B	Yes	Yes
120 or 347	11210-606C-TC	HX-HPF	125	2.20 0.70	250	8 2	20	11.75	10.56	11.14	11.0	20	B	No	Yes
(1) 150 WATT M81 METAL HALIDE (with built-in ignitor)															
120 or 277	11210-242C-TC	HX-HPF	185	3.70 1.60	260	10 5	20	14.31	13.19	13.75	14.0	20	B	Yes	Yes
(1) 150 WATT M102 METAL HALIDE (with built-in ignitor)															
120 or 277	11210-539C-TC	HX-HPF	185	3.70 1.60	260	10 4	20	14.31	13.19	13.75	14.0	20	B	Yes	Yes
(1) 175 WATT M57 METAL HALIDE LAMP															
120 or 277	1110-245SC-TC	CWA	205	1.75 0.75	300	5 3	20	14.32	13.19	13.75	14.0	*	B	Yes	Yes
120 or 347	1110-564C-TC	CWA	205	1.75 0.62	300	5 2	20	11.75	10.55	11.10	14.0	*	B	Yes	Yes
(1) 250 WATT M58 METAL HALIDE LAMP															
120 or 277	1110-246C-TC ^{8*}	CWA	295	2.50 1.10	280	8 4	20	16.75	15.57	16.13	17.5	*	C	Yes	Yes
120 or 277	1111-246C-TC ²³	CWA	300	2.50 1.10	300	8 4	22	11.75	10.55	11.10	11.0	*	B	Yes	Yes
120 or 347	1110-566C-TC	CWA	295	2.50 0.95	285	8 3	20	16.65	15.55	16.10	17.5	*	C	Yes	Yes
(1) 400 WATT M59 METAL HALIDE LAMP															
120 or 277	1110-247SC-TC	CWA	455	3.90 1.70	300	10 5	20	19.25	18.06	18.63	23.0	*	C	Yes	Yes
120 or 277	1111-247SC-TC ²³	CWA	460	3.90 1.70	300	10 5	22	14.31	13.19	13.75	14.0	*	B	Yes	Yes
120 or 347	1110-568C-TC	CWA	460	3.90 1.30	300	10 5	20	19.25	18.05	18.60	23.0	*	C	Yes	Yes

⁷ This ballast may also be used with (1) 70 watt S88 High Pressure Sodium lamp.

²² M98 Designates Venture Lighting catalog numbers MH70/4/MED, C/4/MED or MS70/C/84/MED/W

^{8*} This ballast can be used with a MH200 ignitor to operate (1) 250 watt M103 lamp. Consult Universal for instructions.

²³ Two of these ballasts are required to operate the lamp. Electrical data is for two ballasts, except for "Sound Rating," which is for each ballast

* Refer to Page 5-5.

See page 5-40 for Reference Drawings and Wiring Diagrams.

F-CAN BALLASTS

HIGH PRESSURE SODIUM

- 60 Hz
- Minimum Starting Temperature: -40° C
- CWA and High Power Factor Designs

HPS
35-250
WATT

Input Volts	Catalog Number	Circuit Type	Input Watts	Max Input Current	Nom Open Circuit Voltage	Fuse Rating	Wir Dia	Dimensions			Total Weight	Max Dist To Lamp (ft)	Sound Rating	Certifications	
								Overall Length	Case Length	Mtg Dim				UL	CSA
(1) 35 WATT S76 HIGH PRESSURE SODIUM (with built-in starter)															
120 or 277	12210-261C-TC	HX-HPF	55	0.80 0.35	120	5 2	20	11.75	10.55	11.10	9.0	10	B	Yes	Yes
(1) 50 WATT S68 HIGH PRESSURE SODIUM (with built-in starter)															
120 or 277	12210-236C-TC	HX-HPF	75	1.40 0.60	120	5 2	20	11.75	10.55	11.10	9.0	10	B	Yes	Yes
(1) 70 WATT S62 HIGH PRESSURE SODIUM (with built-in starter)															
120 or 277	12210-237C-TC	HX-HPF	97	1.60 0.70	140	5 2	20	11.75	10.56	11.14	9.15	10	B	Yes	Yes
120 or 347	12210-552C-TC	HX-HPF	109	1.69 0.63	145	5 2	20	11.75	10.55	11.10	9.2	10	B	Yes	Yes
(1) 100 WATT S54 HIGH PRESSURE SODIUM (with built-in starter)															
120 or 277	12210-239C-TC	HX-HPF	125	2.10 1.00	130	6 3	20	11.75	10.55	11.10	10.4	10	B	Yes	Yes
120 or 347	12210-606C-TC	HX-HPF	126	2.10 0.90	165	6 3	20	11.75	10.55	11.10	10.4	10	B	Yes	Yes
(1) 150 WATT S55 HIGH PRESSURE SODIUM (with built-in starter)															
120 or 277	12210-241C-TC	HX-HPF	185	2.80 1.20	120	8 4	20	14.30	13.15	13.75	14.1	10	B	Yes	Yes
120 or 347	12210-602C-TC	HX-HPF	185	2.80 1.03	120	8 3	20	14.30	13.15	13.75	14.1	10	B	Yes	Yes

See page 5-40 for Reference Drawings and Wiring Diagrams.

HID
F-CAN

F-CAN BALLASTS OPTIONAL ACCESSORIES

Mounting Bracket Assemblies

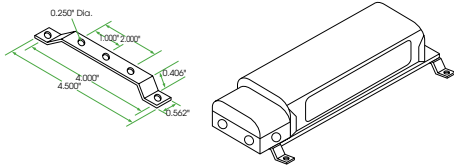

Catalog Number 2-BMB-1.

Available for the remote installation of ballasts. Each assembly consists of two (2) mounting brackets, four (4) screws, four (4) washers and four (4) nuts.

Tee-Pee Lead Wire Covers

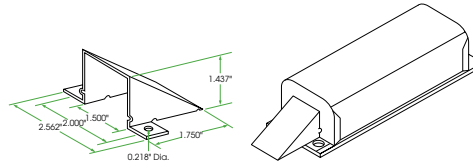

Catalog Number TP5. Ref. part #001-2013.

For use where ballast is attached to the surface of an enclosure or raceway.

Splice Box

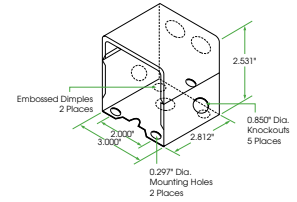

Catalog Number SB-4. Ref. part #001-2009

For use with all F-Can Ballasts. It is easily installed on the anchor bracket provided on each F-Can ballast. It contains five (5) 7/8\"/>

REFERENCE DRAWING FOR F-CAN

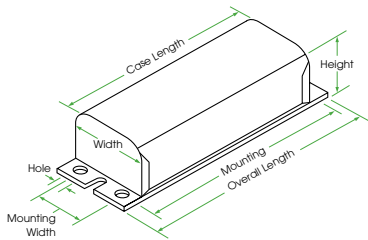

WIRING DIAGRAMS

Wiring Diagram 20

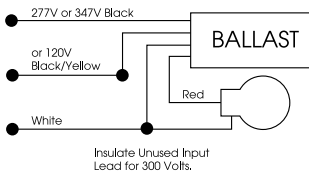

Wiring Diagram 21

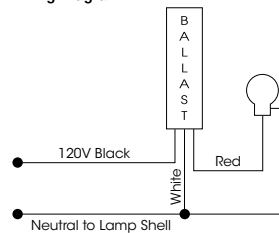

Wiring Diagram 22

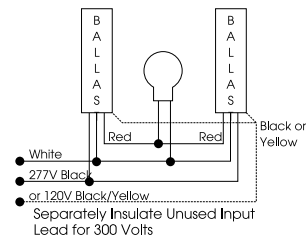

STANDARD IGNITORS • INSTANT RESTRIKE IGNITORS • LONG DISTANCE IGNITORS • AUTOMATIC SHUTOFF IGNITORS • SHUTOFF DEVICES

IGNITORS

Catalog Number	Description	Reference Drawing Number
--STANDARD IGNITORS		(See pg. 5-43)
PULSE START METAL HALIDE		
MH 70-3B ¹³	For double-ended MH lamps with HX-HPF ballasts: 70 watt (M85), 100 watt (M91), and 150 watt (M81)	27
MH 100-3A	For MH lamps with HX-HPF ballasts: 35/39w(M130), 50w(M110), 70w(M98), 100w(M90/M140), and 150w(M102/M142)	25
MH 150-1A	For 150 watt (M102/M142) lamp with CWA ballast	28
MH 200-1B ¹³	For double-ended MH 250 watt (M80) lamp	28
MH 350-1A	For MH lamps with CWA ballasts: 175 watt (M152/M137), 200 watt (M136), 250 watt (M153/M138), 320 watt (M154/M132), 350 watt (M131), 400 watt (M155/M135), and 450 watt (M144)	24
P 750-1B ¹³	For 750 watt (M149) MH lamp	28
HPS 1000-4B ¹³	For MH lamps: 875 watt (M166) and 1000 watt (M141). It is also used for 1000W HPS lamps	28
HIGH PRESSURE SODIUM		
HPS 150-3A	For HPS lamps of 150 watt or less with HX-HPF ballast, except 150 watt S56 lamp	24
HPS 400-3A	For HPS lamps from 200 to 400 watts and 150 watt S56 lamp with CWA ballasts	25
HPS 450-1B ¹³	For 150 watt S56, 200, 250 or 400 watt lamps with 240 volt/60 Hz reactor ballasts. With attached mounting bracket.	28
HPS 460-1B ¹³	For 200, 250 and 400 watt lamps with HX-HPF ballasts and 50 Hz reactor ballasts. With attached mounting bracket.	28
HPS 600-1B	For 600 watt lamps.	28
HPS 610-1B	For 600 watt lamps.	27
HPS 1000-4B ¹³	For 1000 watt HPS and Pulse Start Metal Halide lamps. With attached mounting bracket.	27
HPS 1000-6B ¹³	Obsolete	27
PLUG REPLACEABLE IGNITORS		
PULSE START METAL HALIDE		
MH 150-G15	For MH lamps with HX-HPF ballasts: 35/39 watt (M130), 50 watt (M110), 70 watt (M98), 100 watt (M90/M140), and 150 watt (M102/M142)	32
MH 350-G05	For MH lamps with CWA ballasts: 175 watt (M152/M137), 200 watt (M136), 250 watt (M153/M138), 320 watt (M154/M132), 350 watt (M131), 400 watt (M155/M135), and 450 watt (M144)	32
HIGH PRESSURE SODIUM		
HPS 150-G01	For HPS lamps of 150 watt or less with HX-HPF ballast, except 150 watt S56 lamp	32
HPS 400-G05	For HPS lamps from 200 to 400 watts and 150 watt S56 lamp with CWA ballasts	32
INSTANT RESTRIKE IGNITORS		
HIGH PRESSURE SODIUM		
HPS 150-5B ¹³	Instant Restrike Ignitor — for lamps of 150 watts or less except 150 watt S56. Ignitor has attached mounting bracket.	30
LONG DISTANCE IGNITORS		
PULSE START METAL HALIDE		
MH 100-5A	For MH lamps from 35 to 50 watts. Max Ballast to Lamp Distance ($\approx 20'$)	25
MH 100-5A	For MH lamps from 70 to 150 watts. Max Ballast to Lamp Distance ($\approx 30'$)	25
MH UNV-5B	For MH lamps from 35 to 450 watts. Ignitor incorporates automatic resetting thermal protection. Max Ballast to Lamp Distance ($\approx 50'$)	25
HIGH PRESSURE SODIUM		
HPS 150-4A	For HPS lamps of 150 watt or less, except 150 watt S56 lamp. Max Ballast to Lamp Distance ($\approx 20'$)	24
HPS 400-4A	For HPS lamps from 200 to 400 watts and 150 watt S56 lamp. Max Ballast to Lamp Distance ($\approx 25'$)	25
HPS 1000-5B	For 1000 watt HPS lamps. Ignitor incorporates automatic resetting thermal protection. Max Ballast to Lamp Distance ($\approx 50'$)	25
AUTOMATIC SHUTOFF IGNITORS		
PULSE START METAL HALIDE		
MH 100-35B ¹³	For MH lamps: 35/39 watt (M130), 50 watt (M110), 70 watt (M98), 100 watt (M90/M140), and 150 watt (M102/M142). With attached mounting bracket	28
MH 150-35B ¹³	For 150 watt M81 lamp with CWA ballasts. With attached mounting bracket.	31
MH 350-15B ¹³	For MH lamps: 175 watt (M152/M137), 200 watt (M136), 250 watt (M153/M138), 320 watt (M154/M132), 350 watt (M131), 400 watt (M155/M135), and 450 watt (M144)	31
P 750-15B ¹³	For 750 watt (M149) MH lamp	31
HPS 1000-55B ¹³	For MH lamps: 875 watt (M166) and 1000 watt (M141). It is also used for 1000W HPS lamps	31
HIGH PRESSURE SODIUM		
HPS 150-45B ¹³	For lamps of 150 watts or less except 150 watt S56. With attached mounting bracket.	28
HPS 400-45B ¹³	For lamps from 200 to 400 watts and 150 watt S56 with constant wattage autotransformer ballasts. With attached mounting bracket.	28
HPS 1000-55B ¹³	For 1000 watt HPS and Pulse Start Metal Halide lamps. With attached mounting bracket.	31
AUTOMATIC SHUTOFF DEVICES		
In addition to one-piece shutoff ignitors, automatic shutoff devices are available as separate components for use with the ignitors below.		
SA-55	HPS 150-3A, HPS 150-5B	25
SA-100	MH70-3B, MH100-3A, MH150-1A, MH350-1A, HPS150-4A, HPS400-3A, HPS600-1B	25
SA-250	HPS1000-4B ignitor, only with 1000 watt HPS ballasts	33

¹³ May also be available without attached mounting bracket. Substitute "A" suffix for "B" suffix when ordering. Minimum quantities may apply.

Lamp Watts	ANSI Code	Circuit Type	Standard Igniters	Auto Shutoff	Instant Restrike	Long Distance Igniters
HIGH PRESSURE SODIUM IGNITORS						
35	S76	Reactor	HPS 150-3A	HPS 150-45B	HPS 150-5B	HPS 150-4A
50	S68	Reactor, HX	HPS 150-3A	HPS 150-45B	HPS 150-5B	HPS 150-4A
70	S62	Reactor, HX	HPS 150-3A	HPS 150-45B	HPS 150-5B	HPS 150-4A
100	S54	Reactor, HX	HPS 150-3A	HPS 150-45B	HPS 150-5B	HPS 150-4A
150	S55	Reactor, HX	HPS 150-3A	HPS 150-45B	HPS 150-5B	HPS 150-4A
150	S56	CWA	HPS 400-3A	HPS 400-45B	—	HPS 400-4A
250	S50	Reactor	HPS 450-1B	HPS 400-45B	—	HPS 400-4A
250	S50	CWA	HPS 400-3A	HPS 400-45B	—	HPS 400-4A
250	S50	HX	HPS 460-1B	HPS 400-45B	—	HPS 400-4A
400	S51	Reactor	HPS 450-1B	HPS 400-45B	—	HPS 400-4A
400	S51	CWA	HPS 400-3A	HPS 400-45B	—	HPS 400-4A
400	S51	HX	HPS 460-1B	HPS 400-45B	—	HPS 400-4A
600	S106	CWA	HPS 600-1B	—	—	—
600	S106	Reactor	HPS 610-1B	—	—	—
1000	S52	CWA	HPS 1000-4B	HPS 1000-55B	—	—

Lamp Watts	ANSI Code	Circuit Type	Standard Igniters	Auto Shutoff	Long Distance Igniters
METAL HALIDE IGNITORS					
35	M130	Reactor	MH 100-3A	—	MH 100-5A
50	M110	HX	MH 100-3A	—	MH 100-5A
70	M85	HX	MH 70-3B	MH 70-35B	MH 100-5A
70	M98	HX	MH 100-3A	MH 100-35B	MH 100-5A
100	M90	Reactor	MH 100-3A	MH 100-35B	MH 100-5A
100	M90	CWA	MH 100-3A	MH 100-35B	MH 100-5A
100	M91	HX	MH 70-3B	—	—
150	M81	HX	MH 70-3B	—	—
150	M81	CWA	MH 150-35B	MH 150-35B	—
150	M102	HX	MH 100-3A	MH 100-35B	MH 100-5A
350	M131	Reactor	MH 70-3B	—	—
350	M131	HX	MH 70-3B	—	—

STANDARD IGNITORS

Standard Igniters are supplied with all Universal High Pressure Sodium and Metal Halide ballasts requiring igniters. These ballasts are supplied with an appropriate external ignitor unless the ignitor is permanently attached to or built into the ballast.

INSTANT RESTRIKE IGNITORS

An Instant Restrike Ignitor generates multiple pulses to restrike a lamp arc after a brief power interruption has extinguished it, without the typical 3-minute cool-down time. A Standard Ignitor cannot restrike an arc until the lamp has had time to sufficiently cool. Even though an Instant Restrike Ignitor can reinitiate the lamp arc immediately upon restoration of power, the lamp is still subject to warmup. The following chart is based on an S55 lamp.

Time Lamp Is Extinguished	Restrike Time	Light Output On Reignition	Lamp Warmup Time
1 second	2 seconds	87%	35 seconds
5 seconds	Instant	83%	70 seconds
15 seconds	Instant	76%	130 seconds
30 seconds	Instant	62%	190 seconds
1 minute	Instant	46%	255 seconds
Cold Start	Instant	36%	360 seconds

PLUG REPLACEABLE IGNITORS

Incorporates terminals and a separate mounting base to simplify construction and replacement.

LONG DISTANCE IGNITORS

Long Distance Igniters are used in situations where a ignitor must be mounted further from the lamp than is recommended for a standard ignitor. The maximum lamp to ignitor distance for these igniters is 50 feet, which may vary depending on the type of lamp, ballast, fixture, and wiring.

AUTOMATIC SHUTOFF IGNITORS

In the event of a lamp failure, a Standard Ignitor will continue to pulse, trying to start the lamp. This may reduce the life of the ignitor. An Automatic Shutoff Ignitor will apply pulses for 10 to 12 minutes and then deactivate if a lamp arc cannot be initiated. Resetting the ignitor is accomplished by momentarily interrupting the power to the ballast. For this reason, these igniters are not recommended for use on unswitched circuits.

SHUTOFF DEVICES

Ignitor Accessory (IA) devices can be used to convert a Standard Ignitor into an Automatic Shutoff Ignitor. Simply match the Shutoff Device catalog number on page 5-62 with the Standard Ignitor that is supplied with the ballast. Using the IA device with the Standard Ignitor eliminates the need to buy a separate Automatic Shutoff Ignitor.

TEMPERATURE RATING

Most igniters are rated for a 105°C maximum case temperature. Consult ballast specification sheets at www.unvlt.com for specific details.

REFERENCE DRAWINGS

All dimensions in decimals.
All lead lengths: 13 inches ±1

IGNITORS

Ref. Drawing 24

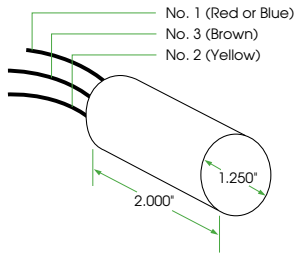

Ref. Drawing 25

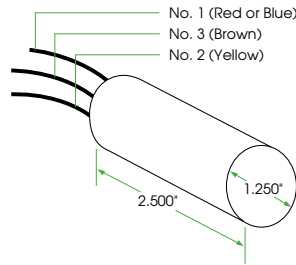

Ref. Drawing 27

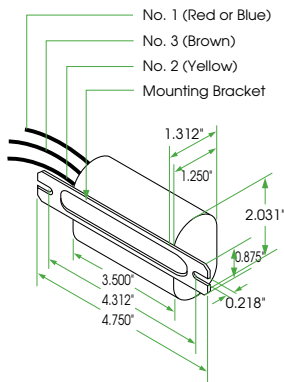

Ref. Drawing 28

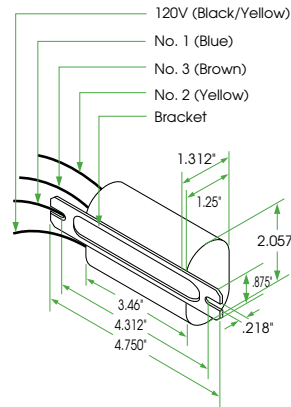

Ref. Drawing 30

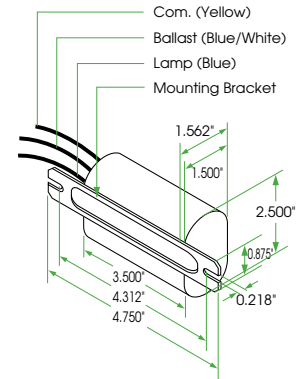

Ref. Drawing 31

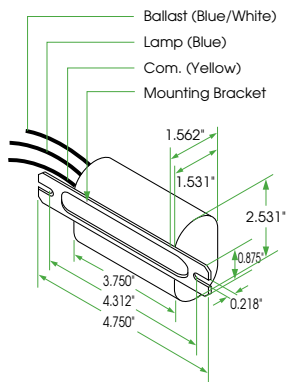

Ref. Drawing 32

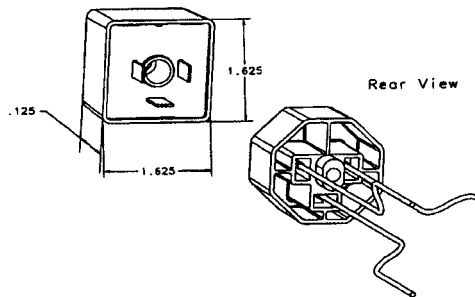

Ref. Drawing 33

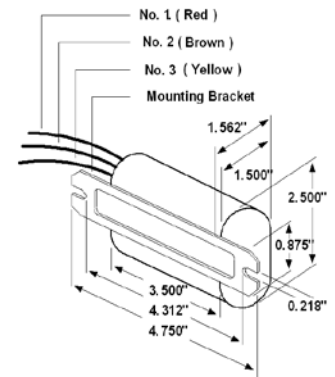

HID
IGNITORS

Notes

HID

eHID

Less energy. Enhanced performances.

Experience significant energy savings and increased lumen output vs. halogen lamps with Electronic High Intensity Discharge (HID) ballasts from Universal Lighting Technologies. Vossloh-Schwabe (VS), also a Panasonic Lighting Company, recently merged its US operation into Universal. This merger combines Vossloh's market leading high quality electronic HID product line with Universal's extensive offering.

There are numerous advantages of using VS electronic HID ballasts. Operating HID lamps used in HID lighting systems with electronic ballasts greatly increases system efficiency in comparison with magnetic ballasts. These ballasts are designed to provide optimal lamp performance and maximum energy savings. With enhanced capabilities to downsize the form factor of luminaire housings and reduce wiring costs, VS electronic HID ballasts lead the way to electronic solutions for HID lighting. Micro-processor controlled intelligence offers superior lamp performance and the flexibility for proprietary value-added functions. VS electronic HID ballasts cover your HID needs with products for Metal Halide Lamps ranging from 20 Watts to 250 Watts.



VS electronic HID ballasts continuously monitors lamp characteristics during operation and adjusts the lamp current to optimize performance. This guarantees controlled operation in all modes of operation. The lamp color temperature is also stabilized by using VS electronic HID ballasts due to its relatively constant output power characteristics in addition to producing flicker free lighting that usually occurs at the end of the discharge lamp's service life. The technology enhancements of VS electronic HID ballasts, allowing very small form factors and light weight designs, has enabled new, innovative luminaire designs.

Product Overview

Micro Series: The introduction of the smallest eHID ballasts in the market was coordinated with the launch of the new miniaturized capsule MH lamps enabling the ultimate luminaire design flexibility. Extremely compact and aesthetically pleasing, luminaire designs are approaching the form factor and size of low voltage halogen systems.



Mini Ballast Series: Two ideal form factors that are used in millions of HID track light luminaires characterize the mini series of eHID ballasts. The mini-slim and mini-square units revolutionized track lighting by allowing significantly smaller and greater variety of luminaire designs while providing energy savings of 60-70% versus halogen systems.



Standard Case "Valued-added Series": Millions of recessed, track-head and specialty luminaires have used the de facto industry standard enclosure since introduction. The significant energy savings and enhanced reliability of our ballasts promoted the rapid escalation of electronically ballasted MH luminaires for almost 15 years. Technological advancements have now allowed the integration of multiple, value-added functions such as: a powersource for the self-heating thermal protectors, an electronic 277V step-down transformer, and an intelligent auxiliary lighting control for back-up lighting during lamp hot restrike modes. Ideal for new, retrofit and replacement applications in recessed luminaires.

Features and Benefits:

- Optimum lamp performance
- Rugged, compact and lightweight design
- High power factor
- Enhanced color and CRI uniformity
- Shut-down protection
- Reduced wiring costs
- Eliminates nuisance lamp cycling at end-of-lamp life (intelligent lamp sensing capabilities)
- Constant lamp power
- Reduced lamp dropouts due to improved line voltage dip withstand
- Quiet operation
- Durable performance for various applications
- Fewer SKUs required in inventory
- Broadens design flexibility for new applications and luminaries

eHID Product Family

Order code	Part #	Lamp Wattage	Lamp Type	Input Voltage	Input Power	Mounting	Lead Exit	Dimensions	Wiring
Micro Series									
188514	M2012CK-7EUN	20	M/C156	120	24.5	No Feet	Side	1	1
188882	M2012CK-7EUN-F	20	M/C156	120	24.5	Feet	Side	2	1
188883	M2012CK-7EUN-J	20	M/C156	120	24.5	Studs	Top	3	1
188574	M2212CK-7EUN	22	M/C175	120	26.5	No Feet	Side	1	1
188884	M2212CK-7EUN-F	22	M/C175	120	26.5	Feet	Side	2	1
188885	M2212CK-7EUN-J	22	M/C175	120	26.5	Studs	Top	3	1
188635	M3912CK-7EUN	39	M/C130	120	45	No Feet	Side	4	1
188776	M3912CK-7EUN-F	39	M/C130	120	45	Feet	Side	2	1
188756	M3912CK-7EUN-J	39	M/C130	120	45	Studs	Top	3	1
188757	MTm3912CK-7EUN	39Tm	M/C179	120	45	No Feet	Side	4	1
188777	MTm3912CK-7EUN-F	39Tm	M/C179	120	45	Feet	Side	2	1
188758	MTm3912CK-7EUN-J	39Tm	M/C179	120	45	Studs	Top	3	1
Mini-Slim Series									
188152	M2012CK-6EUN-F	20	M/C156	120	23	Feet	Side	5	1
188246	M3912CK-6EUN-F	39	M/C130	120	45	Feet	Side	5	1
188702	M3927CK-6EUN-F	39	M/C130	277	44	Feet	Side	6	1
188774	M3927CK-6EUN-J	39	M/C130	277	44	Studs	Top	7	1
188164	M7012CK-6EUN-F	70	M/C98, M/C139, M/C143	120	77	Feet	Side	5	1
188703	M7027CK-6EUN-F	70	M/C98, M/C139, M/C143	277	77	Feet	Side	6	1
188775	M7027CK-6EUN-J	70	M/C98, M/C139, M/C143	277	77	Studs	Top	7	1
Mini-Square Series									
188151	M2012CK-6EU-F	20	M/C156	120	23	Feet	Side	8	1
188627	M2012CK-6EU-J	20	M/C156	120	23	Studs	Top	9	1
188701	M2212CK-6EU-J	22	M/C175	120	26.5	Studs	Top	9	1
188293	M3912CK-6EU-F	39	M/C130	120	45	Feet	Side	8	1
188512	M3912CK-6EU-J	39	M/C130	120	45	Studs	Top	9	1
188402	M3927CK-6EU-F	39	M/C130	277	44	Feet	Side	10	1
188551	M3927CK-6EU-J	39	M/C130	277	44	Studs	Top	9	1
188377	JM7012CK-6EU-F	70	M/C98, M/C139, M/C143	120	77	Feet	Side	11	1
188628	M7012CK-6EU-J	70	M/C98, M/C139, M/C143	120	77	Studs	Top	9	1
188895	M3912-27CK-6EU-F	39	M/C130	120-277	44	Feet	Side	10	1
188896	M3912-27CK-6EU-J	39	M/C130	120-277	44	Studs	Top	9	1
188897	M3912-27CK-6EU-JT3	39	M/C130	120/277	44/46	Studs	Top	9	2a,2b,2c
188901	M2012-27CK-6EU-F	20	M/C156	120-277	24	Feet	Side	10	1
188902	M2012-27CK-6EU-J	20	M/C156	120-277	24	Studs	Top	9	1
188903	M2012-27CK-6EU-JT3	20	M/C156	120/277	24/26	Studs	Top	9	2a,2b,2c
188939	M7012-27CK-6EU-F	70	M/C198, M/C139, M/C143	120-277	77	Feet	Side	10	1
188940	M7012-27CK-6EU-J	70	M/C198, M/C139, M/C143	120-277	77	Studs	Top	9	1
188941	M7012-27CK-6EU-JT3	70	M/C198, M/C139, M/C143	120/277	77/79	Studs	Top	9	2a,2b,2c
Standard Series									
188610	M2012-27CK-5EU-F	20	M/C156	120-277	24	Feet	Side	12	1
188611	M2012-27CK-5EU-JT3	20	M/C156	120/277	24/26	Studs	Top	13	2a, 2b, 2c
188156	M3912-27CK-5EU	39	M/C130	120-277	44	No Feet	Side	14	1
188157	M3912-27CK-5EU-F	39	M/C130	120-277	44	Feet	Side	12	1
188301	M3912-27CK-5EU-J	39	M/C130	120-277	44	Studs	Top	13	1
188629	M3912-27CK-5EU-JT3	39	M/C130	120/277	44/46	Studs	Top	13	2a, 2b, 2c
188630	M3912-27CK-5EU-JA3	39	M/C130	120/277	46/187	Studs	Top	13	3a, 3b, 3c
188612	M5012-27CK-5EU-F	50	M148 or M110	120-277	56	Feet	Side	12	1
188613	M5012-27CK-5EU-JT3	50	M148 or M110	120/277	56/58	Studs	Top	13	2a, 2b, 2c
188165	M7012-27CK-5EU	70	M/C98, M/C139, M/C143	120-277	78	No Feet	Side	14	1
188166	M7012-27CK-5EU-F	70	M/C98, M/C139, M/C143	120-277	78	Feet	Side	12	1
188167	M7012-27CK-5EU-J	70	M/C98, M/C139, M/C143	120-277	78	Studs	Top	13	1
188631	M7012-27CK-5EU-JT3	70	M/C98, M/C139, M/C143	120/277	79/81	Studs	Top	13	2a, 2b, 2c
188632	M7012-27CK-5EU-JA3	70	M/C98, M/C139, M/C143	120/277	81/212	Studs	Top	13	3a, 3b, 3c
188633	M10012-27CK-5EU-JT3	100	M/C90, M/C140 and M/C164	120/277	110/212	Studs	Top	13	2a, 2b, 2c
188168	M10012-27CK-5EU	100	M/C90, M/C140 and M/C164	120-277	110	No Feet	Side	14	1
188169	M10012-27CK-5EU-F	100	M/C90, M/C140 and M/C164	120-277	110	Feet	Side	12	1
188302	M10012-27CK-5EU-J	100	M/C90, M/C140 and M/C164	120-277	110	Studs	Top	13	1
188634	M10012-27CK-5EU-JA3	100	M/C90, M/C140 and M/C164	120/277	112/235	Studs	Top	13	3a, 3b, 3c
188638	M15012-27CK-5EU-F	150	M/C102/E and M/C142/E	120-277	163	Feet	Side	12	1
188639	M15012-27CK-5EU-J	150	M/C102/E and M/C142/E	120-277	163	Studs	Top	13	1
Mid Wattage									
188909	M21020-27CK-2EUN-F	210	C183	208-277	227	Feet	Side	17	4a, 4b
188911	M25020-27CK-2EUN-F	250 (100V)	M80/M168	208-277	277	Feet	Side	17	4a, 4b

Wiring Diagrams

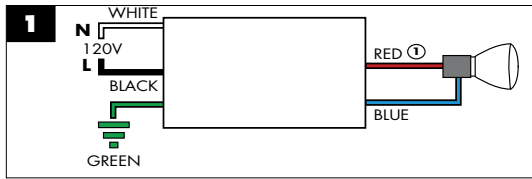

120/277V with IDTP Tap

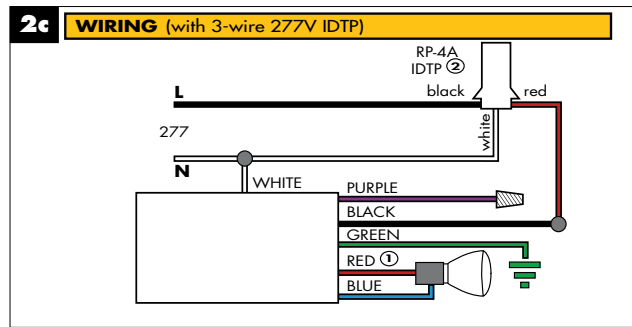
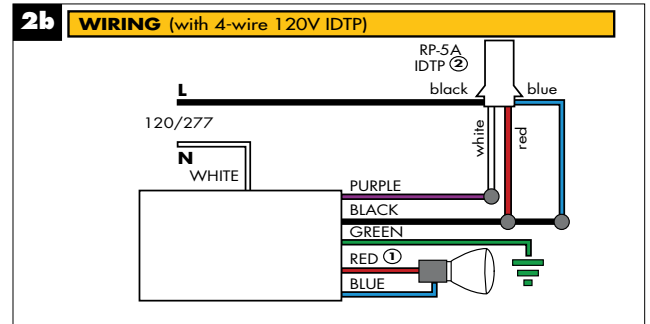
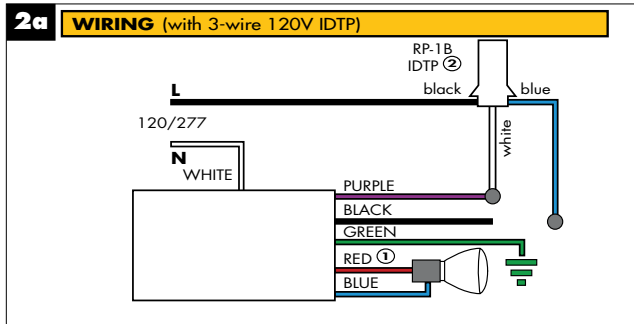

120/277V with Auxiliary Control + IDTP Tap

Wiring & Dimensions Diagrams (shown in millimeters and inches)

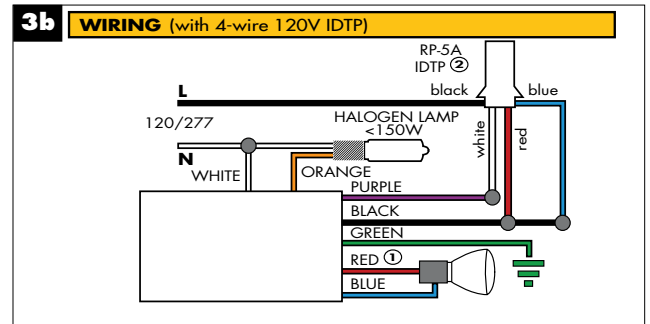
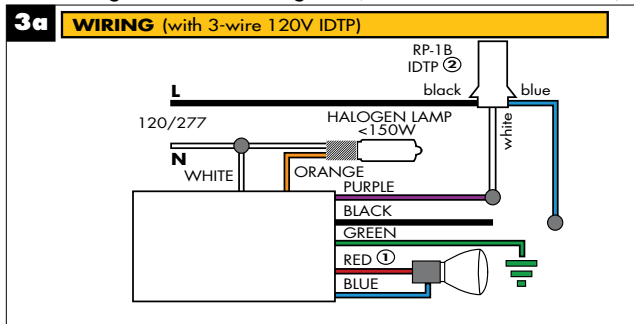

Notes for Wiring Diagram

- ① Connect red lead to center contact on Edison base lampholders
- ② IDTP - Insulation Detector Thermal Protector

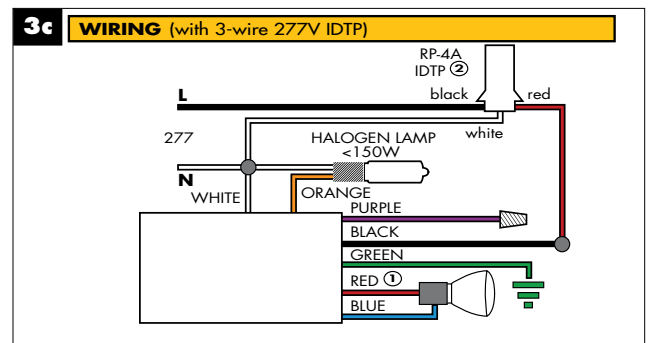

Dimming Ballasts

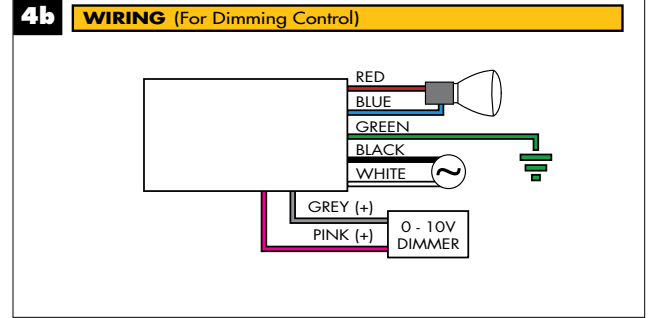
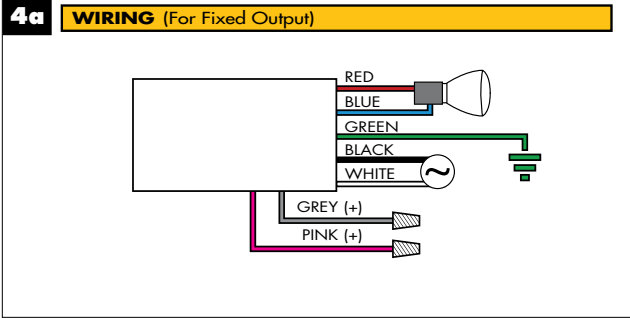

Dimensions

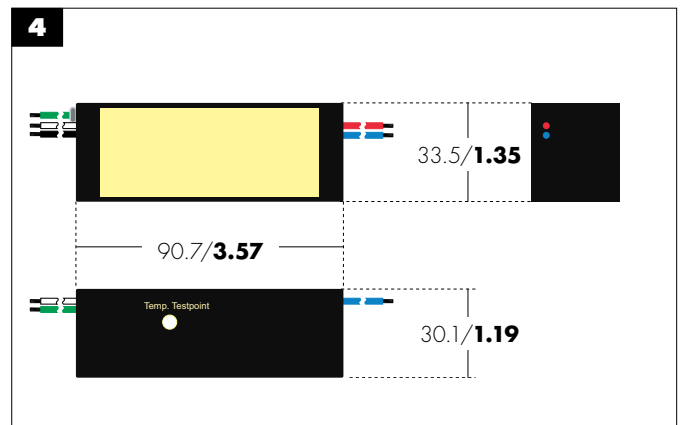
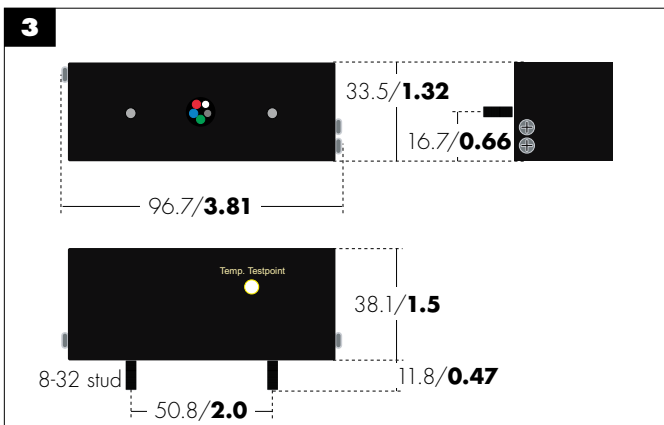
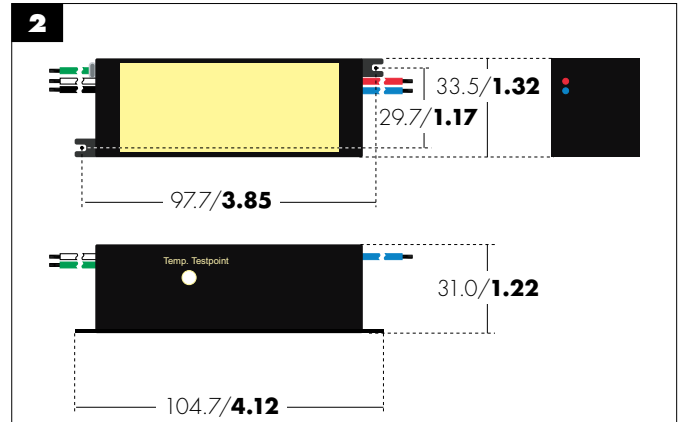
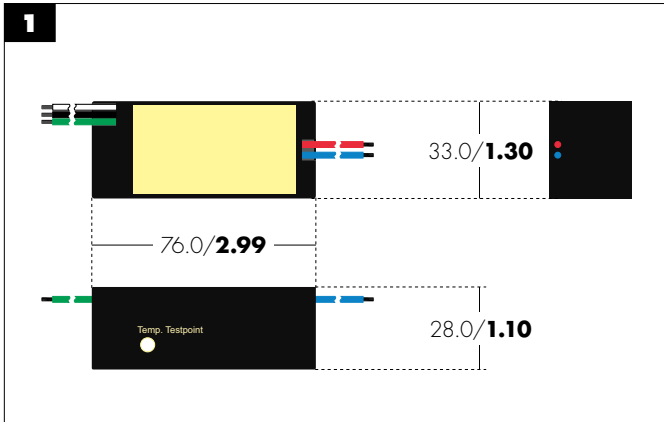

Dimensions

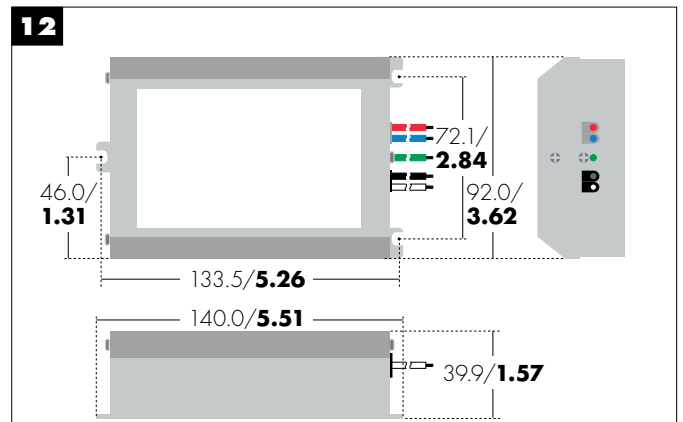
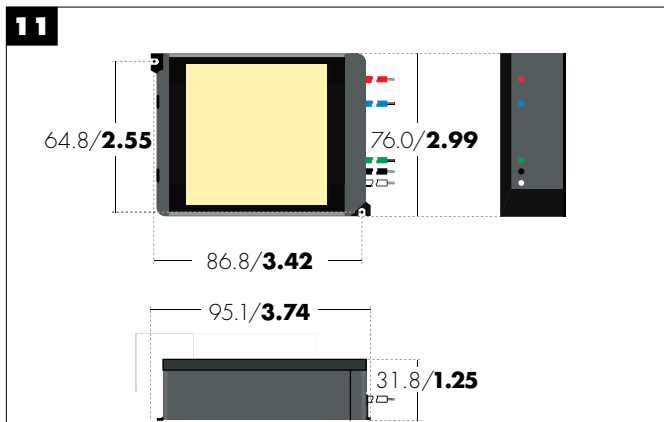
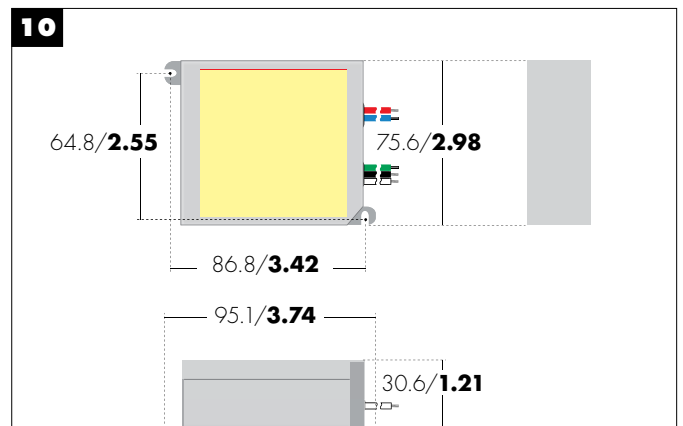
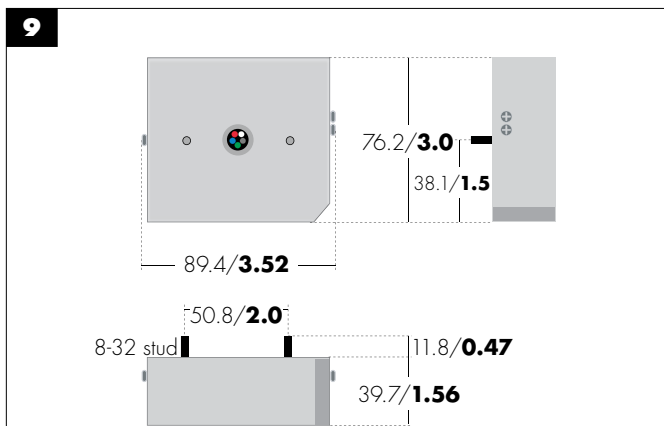
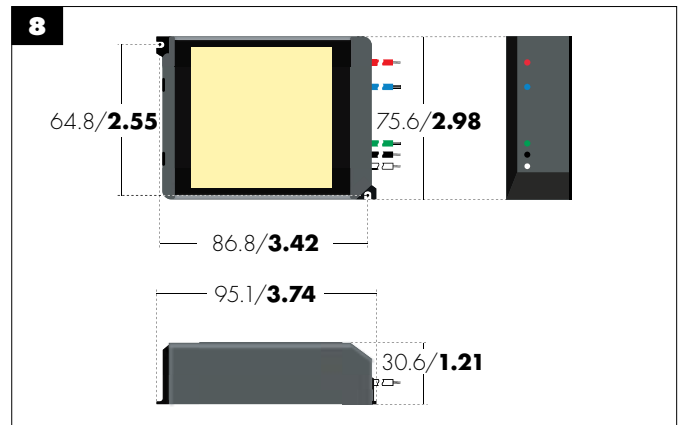
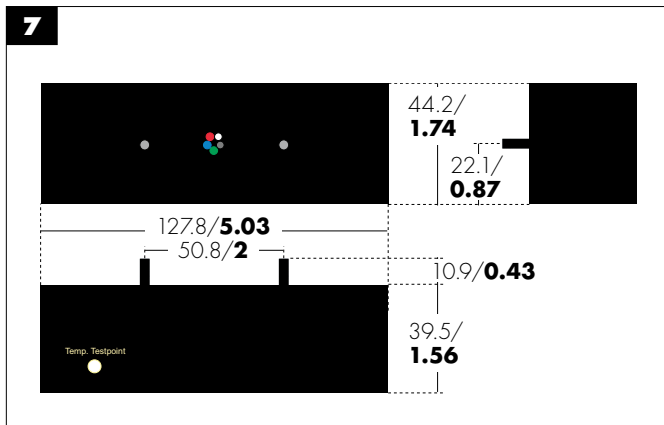
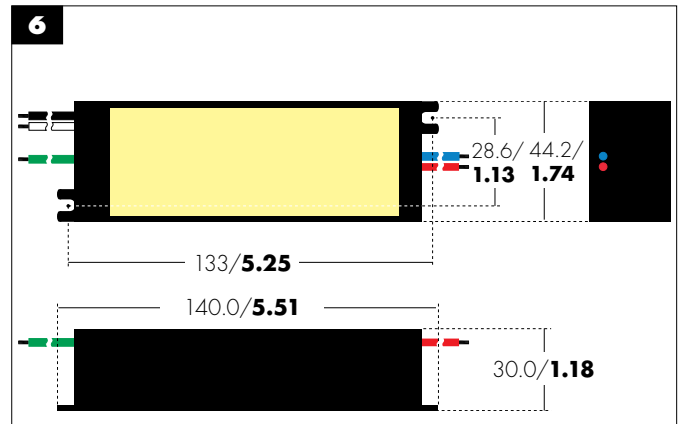
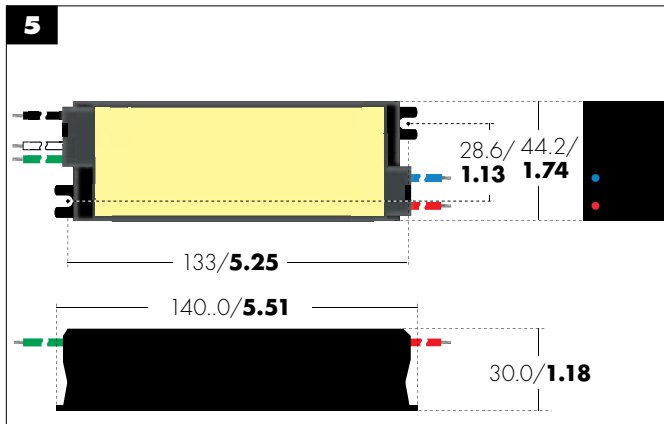

Dimensions

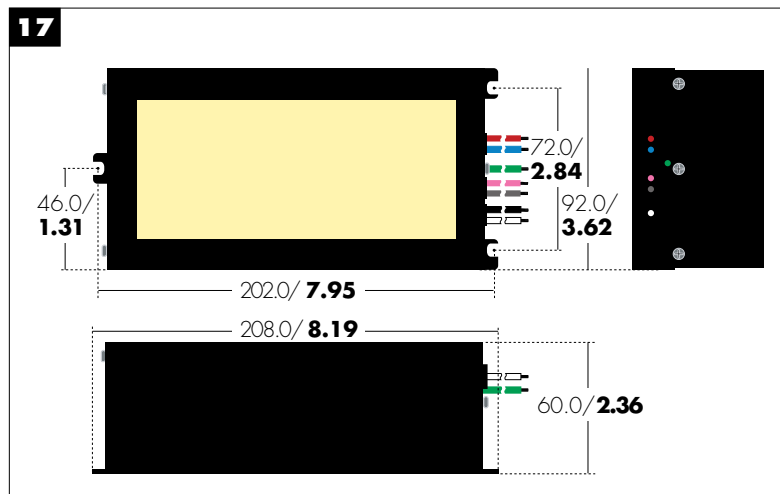
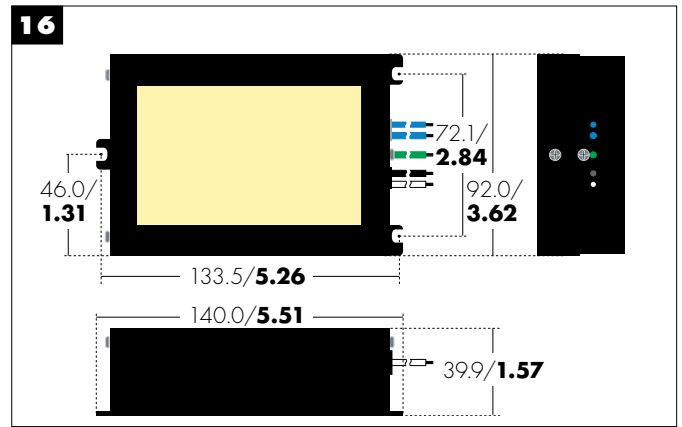
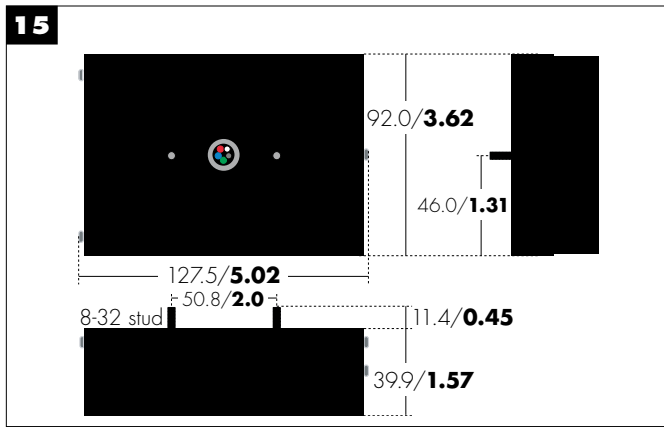
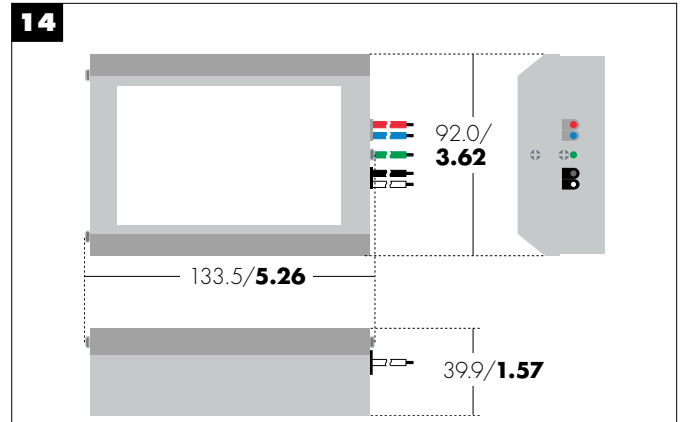
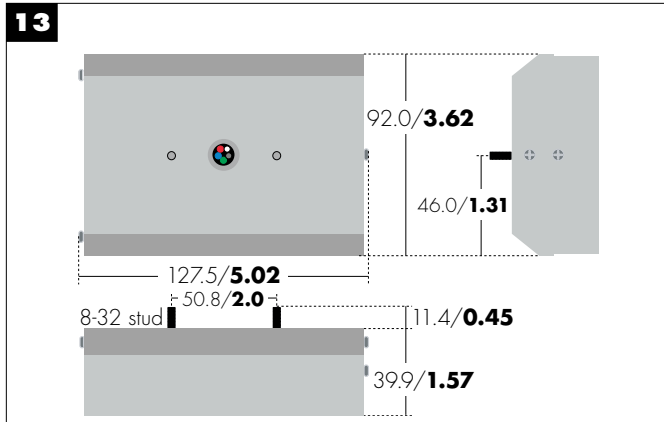

Application And Operating Information

General:

If the electrical current through an HID lamp is properly stabilized, an HID plasma arc with very high luminous efficiency is created in the arc tube chamber resulting in a very efficient light source. The internal pressure of the arc tube chamber rises as the arc tube temperature increases and will attain between 1 and 10 bar; thereby, defining these lamps as high-pressure HID lamps, high intensity discharge lamps or simply HID lamps. The light output and color rendition of HID lamps vary considerably depending on the lamp family (mercury, metal halide or sodium lamps).

HID lamps can only be started and operated with ballasts. Ignitors or ignition voltage characteristics are additionally required for sodium and metal halide lamps. As well as stabilizing the lamp's operating point, ballasts also influence the lamp's output and luminous flux, the system light output, the service life of the lamps as well as the color temperature of the light source.

Electromagnetic or electronic ballasts can be used for HID lamps, but unlike fluorescent lamps, lamp efficiency is not significantly improved by the use of electronic ballasts. However, electronic ballasts can lead to a reduction of the inherent losses and thus to an increase in system efficiency. In addition, electronic ballasts can ensure gentle lamp operation, which may increase lamp's service life.

Electronic Ballasts for Metal Halide Lamps

Electronic ballasts are designed with all the components required to operate metal halide lamps, including ignition, power factor correction, and stable normal operation. Furthermore, they safely shutdown lamps at the end of their service life to prevent high temperatures from being generated in the luminaires that could influence the service life of the luminaire or its components. Vossloh-Schwabe also provides special electronic ballasts for additional luminaire functions such as heater power for insulation detection thermal protectors and for switching on of an auxiliary incandescent lamp for the dark phase of an HID lamp during initial warm-up or during hot-restrike cool-down mode.

Standards/Regulations

ANSI C82.14 Low-Frequency Square Wave Electronic Ballasts for Metal Halide Lamps

UL 1598 Standard for Safety-Luminaires

ANSI C82.77 Harmonic Emission Limits-Related Power Quality Requirements or Lighting Equipment

ANSI/UL 1029 Standard for Safety-High Intensity HID Lamp Ballasts

ANSI/IEEE C62.41 Surge Voltages in Low Voltage AC Power Circuits

US Code of Federal Regulations Title 47 –Telecommunications Part 18– Industrial, Scientific and Medical Devices

Application And Operating Information

Technical Specifications:

Operating voltage range

120VAC rated: 120V 277V $\pm 10\%$

277VAC rated: 277V $\pm 10\%$

120–277V rated: 108V–305V

120/277V rated: 108V–132V and 249V–305V

Leakage current $\leq 0.5\text{mA}$

Hot restrike auxiliary lamp operation

In order to ensure continuous illumination even during the ignition period or in the event of a lamp drop-out due to short term power outage, an additional incandescent lamp (maximum 150W) can be used on models designated with a JA suffix.

Short circuit issues

The ballast output metal halide lamp leads are basically short-circuit-proof. However, any shorts or connections between those lamp leads to the ballast case or to safetyneutral (earth ground) will destroy the ballasts. Likewise the metal halide lamp leads shall not be connected to input power connections nor shall the auxiliary lamp leads be shorted together otherwise the ballast's circuitry could be damaged or fail.

Provisions in the luminaire design should be implemented to prevent all lead wires but especially lamp leads from being pinched, damaged, or cut during luminaire assembly, field installation or normal service.

Mechanical Mounting:

Surface

Firm, flat, preferably metal surface required to ensure good heat transfer for long ballast service life and reliability. Avoid mounting on uneven or protruding surfaces.

Mounting Location

Electronic ballasts must be protected against moisture and heat. Outdoor applications must utilize luminaires with the appropriate weatherproof ratings depending on location. Most Vossloh-Schwabe electronic ballasts are rated "Outdoor Type 1".

Fastening

Use mechanical means to ensure ballasts are fixed tightly to flat surfaces. Use appropriately sized screws depending on the ballast mounting slot size or spring clips to provide interference fit.

Heat transfer

If ballast is destined for installation in a luminaire, sufficient heat transfer must be ensured between the electronic ballast and the luminaire housing. Electronic ballasts should be mounted with the greatest possible clearance from heat sources or lamps. During operation, the temperature measured at the ballast's tc point must not exceed the specified maximum value.

Application And Operating Information

Technical Specifications:

- **Dimensional tolerances:**

- Case: $\pm 1\text{mm}$ ($\pm 0.039''$)
- Standard lead length tolerances: $+50\text{mm}$ ($+2''$) or -30mm ($-1''$) Micro lead length tolerances: $\pm 15\text{mm}$ ($\pm 0.6''$)
- Slot width on "F" mounting tabs: 5mm ($0.20''$); for Mini-Square Size: 4mm ($0.157''$)

- **Remote wiring guidelines:**

- Each lamp's lead wires must be run in a separate conduit from the input power leads to achieve good EMI performance and maximum remote capabilities. Lamp leads shall not be bundled together, but each set of lamp leads shall be run in its own conduit.
- Individual lamp lead wires must be used for external fixture wire extensions using wire types SF-2 (equivalent to SEW-2 or 3071) or SFF-2 (equivalent to SEWF-2 or 3070) or alternately, if approved by VS, high voltage luminaire wire with a 18AWG conductor and a 1000VAC minimum voltage rating. Temperature rating is especially critical if the lamp lead extension wires are directly connected to lampholder terminals.
- Maximum remote distances:
See individual model specification sheets.
The specified maximum remote distances are based on lamp leads run in a minimum $\frac{1}{2}''$ internal diameter conduit, pipe or flexible conduit. For longer remote distances contact the TES group at Universal Lighting.
- Using service power cords (types SJ, SO, ST, SV etc.) or metal clad cable assemblies for lamp lead extension wire are **not** recommended as they are not compatible with the above characteristics, can cause starting problems and shall not be used unless VS gives written approval.

Insulation clearance

Remote mounted ballasts shall be installed per National Electrical Code and local codes while also complying with wiring methods per Vossloh-Schwabe recommendations. Per UL requirements, thermal insulation shall be a minimum of 3" from any ballast surface.

Application And Operating Information

Safety Functions:

Regulatory approvals

Vossloh-Schwabe electronic HID ballasts are UL listed or UL recognized component and cUL listed for use in Canada.

Shutdown of defective lamps

In the event of a lamp failing to ignite or of a lamp with low or high operating voltages (end of lamp's service life), the electronic ballast will switch off after a defined period of time (typically 30 minutes). The ballast will also shut-down if the lamp fails to achieve symmetrical current operation (rectification) or if lamp leads are shorted to each other. After lamp replacement, the ballast output can be reset by disconnecting (count to 10) and then reconnecting input power.

Transient input voltage

Electronic ballasts incorporate transient protection that complies with ANSI C62.41 and ANSI C82.14 test procedure and values.

Temperature Protection

To prevent excess temperatures, ballasts contain thermal protection devices or thermal sensing circuitry. A ballast will restart after it has cooled down, however, it might be necessary to briefly reset the input power after the over-temperature condition is resolved.

General guidelines

Always disconnect power to the luminaire before installation or service of the ballasts. Install to all provisions of local or National Electric Codes. The ballast case/green lead must be grounded. Dispose of any replaced ballasts or lamps properly per local environmental regulations.

Reliability and Service Life:

The electronic ballast service life is inversely proportional to the temperature of its critical internal components. Normal ballast operation shall have the temperature of the tc point less than the warranted values in the individual specification sheets

Electrical Installation:

3-Phase connection of luminaires with electronic ballasts

Prior to operating newly installed lighting systems, please check the ballast's rated voltage range to ensure it is appropriate for the job site input power supply voltage. The neutral power supply wire must be connected securely to all luminaires and to all ballasts. Power supply conductors must only be connected or disconnected when the circuit is not energized. The neutral conductor must never be disconnected as the first disconnected wire nor individually at the circuit panel, at a distribution wiring junction box or at the luminaire during energized power supply operation as out-of balance voltage operation can lead to serious over-voltages and subsequent ballast failures.

Power factor compensation

Luminaires with electronic ballasts do not need power factor compensation, as the typical power factor range of electronic ballasts is 95 to 99%.

Application And Operating Information

Wiring

Wiring between the power supply, electronic ballasts and lamp must comply with the respective circuit diagram.

Note: the ballast (metal) case (using toothed washer) or provided green lead must be connected to safety-neutral (earth ground). In addition, all metal luminaire parts and metal lamp reflector/housings shall also be connected to earth ground for safety and for proper lamp starting. Metal halide luminaires must only be fitted with electrical components that are rated to withstand ignition voltages of 4kV. To ensure compliance with RFI suppression limits, input and output conductors should not be run in the same conduit as lamp conductors. Conduit size recommendations are stated in the individual ballast specification sheets or construction notes.

Lamp maintenance notice

To replace end-of-service lamps, turn-off luminaire power, remove and replace lamps then turn-on luminaire power. If power was not turned off during lamp replacement, the luminaire/ballast-input power must be reset to restart the new lamp. If the lamp or wiring is defective, the ballast will “shut-down” in 1.5 to 30 minutes depending upon the fault condition.

Supplemental IDTP wiring

The IDTP (insulation detector thermal protector) is required by UL for most recessed luminaires. This fast acting thermal protector is typically mounted on the same junction box as the electronic ballast. Special “JT” electronic ballasts provide a separate 120V power supply for the IDTP heater to allow the luminaire to be rated for both 120V and 277V operation. See the individual ballast specifications for the proper wiring procedures for JT & JA ballasts with this IDTP heater function.

Note: When using JT or JA ballasts on multiple lamp luminaires, only one ballast yellow or purple lead should be connected to the IDTP heater. All other ballasts’ yellow or purple leads should be capped-off. Operation of JT and JA ballasts on 208V and 240V is not recommended, as the IDTP may not function properly.

Lamp compatibility

Not all HID lamps are compatible with all electronic ballasts. Therefore, consult with Vossloh-Schwabe Technical Support or a specific lamp company regarding a certain lamp’s compatibility.

Sign Illuminating Ballasts

A Complete Range Of Solutions... From The Name You Trust

Universal Lighting Technologies ("Universal") is known throughout the sign business as a company that can set and meet today's toughest industry standards. Our high-output ballasts are great for rugged outdoor sign cabinet applications because they provide ultra-reliable, low-temperature starting as low as -20° F. All Universal sign ballasts offer Class P thermal protection. We have three product lines spanning the sign business:

- The UNIVERSAL® USB is a line that offers complete coverage with 6 units.
- The UNIVERSAL® MAX-3 ensures that the installer has the right sign ballast on the truck for every application, from 1-6 lamps, 2-48 feet — replacing up to 100 conventional ballasts with a maximum of three models.
- Signa® Electronic Sign ballasts are ideal for new sign installations with minimum wire connections, universal input voltage, parallel lamp operation, and maximum energy savings.

Universal offers the convenience of one-stop shopping for not just sign ballasts, but compact fluorescent, linear fluorescent, HID, and all your other ballast needs.

For the unmistakable sign of quality and reliability, turn to Universal.



Universal® sign ballasts provide ultra-reliable low-temperature starting — plus Class P thermal protection.

Application And Operating Information

Heat

Ballasts generate heat during normal operation. By design, fluorescent ballasts should operate so that their maximum hot-spot case temperature does not exceed 90°C (194°F). Operating at higher temperatures will shorten ballast life or may cause the thermal protection circuit to trip.

The temperature the ballast reaches depends on the temperature of the area surrounding it — plus the heat-conducting surface touching the ballast. Ballasts should be installed in a manner that avoids future overheating. To maintain normal ballast temperature, you should:

1. Mount the ballast against a flat surface of heavy gauge metal such as the structural part of the sign.
2. Keep the ballast as far away as possible from other ballasts, lamps or reflective surfaces. (Lamps generate approximately three-fourths of the heat in a plastic sign.) The ends of the lamps are the hottest part, so you should mount the ballast as far away from the ends as possible.
3. Paint the inside of the sign with flat white paint.

Moisture Protection

1. Vent the sign as well as possible without allowing water to enter.
2. Ballasts should be mounted horizontally (except for weatherproof types). If the ballast must be mounted vertically, allow room for sufficient air circulation. Wherever possible, mount the ballast in an enclosure outside the sign by using Universal pup tents. You can get pup tents at no charge when you order the plastic sign ballast. Your wholesaler will also have a supply for your convenience.

Grounding

The white lead of a 120-volt ballast must be connected to the neutral or ground side of the power supply. All metal parts of the sign, as well as the ballast case, must be grounded either through the conduit which holds the power supply or by direct connection with a grounding wire. An ungrounded sign is a potential hazard—and it can give misleading symptoms when looking for sign faults.

Proper Lamp Life and Starting

In rapid-start installations, proper filament heating is necessary for reliable starting and normal lamp life. To ensure that proper heating is taking place, the following steps are recommended:

1. Lamp leads should be kept as short as possible and with a minimum of splices.
2. All connections should be soldered.
3. Maintain proper alignment and spacing of lamp holders to ensure good contact in the sockets.
4. Mount lamps within one inch of grounded metal. This is one lamp manufacturer's published requirement for reliable starting.

Light Output vs. Temperature

The light output of a fluorescent lamp varies according to the mercury vapor pressure inside the lamp. This pressure is controlled by the coldest spot on the bulb wall. The ballast may start the lamp, but the light output can be very low if the bulb wall temperature is low. Several factors influence this, including ambient temperatures, wind, type of enclosure, etc. If maximum light output is critical, consult a lamp manufacturer for advice.

Lamp Starting Problems

Occasionally a field problem will arise involving improper lamp starting. The usual complaint is that the lamps start slowly (or not at all). Here are some of the causes:

1. Low line voltage
2. Improper sign grounding
3. Insufficient or no filament voltage
4. Insufficient or no open circuit voltage
5. Dirty lamps during high-humidity operating conditions
6. Lamps improperly inserted in the sockets

If lamp starting is a problem in your installation, check the sign grounding, filament voltage (3.4 - 3.9 volts), and open circuit voltage. If all are normal, the probable cause is dirty lamps. The lamps should be washed in clean water, drip-dried, and reinstalled. If this doesn't solve the problem, contact your nearest Universal representative for further assistance.

Short Lamp Life

If the lamp has not given proper length of service as specified by the lamp manufacturer, the following reasons for early failure should be considered:

1. Improper starting due to insufficient filament voltage
2. Frequent starting and short operating periods
3. Improper ballast
4. Improper voltage supply
5. Faulty wiring
6. Defective lamps
7. Lamps improperly inserted in sockets

Early lamp failure will be preceded by a dense blackening on either or both ends of the lamps. This blackening will extend three or four inches from the lamp base and should not be confused with a small dense spot, which is a mercury deposit that can occur any time during lamp life. Dense blackening due to early lamp failure should not be confused with the gray bands that sometimes appear toward the end of normal lamp life (about two inches from either end of the lamp).

Sign Ballast Footage Chart

UNIVERSAL® USB Fluorescent Sign Ballast Matrix																																
No. of Lamps Per Ballast	TOTAL LAMP FOOTAGE REQUIRED																															
	2	4	6	8	10	12	14	16	18	20	22	24	26	28	30	32	34	36	38	40	42	44	46	48								
1-2	USB-0412-12																															
1-4	USB-0816-14																															
	USB-1024-14																															
2-4	USB-1632-24																															
4-6	USB-2036-46																															
	USB-2048-46																															

UNIVERSAL® USB Fluorescent Sign Ballast Matrix																																	
No. of Lamps Per Ballast	TOTAL LAMP FOOTAGE REQUIRED																																
	2	4	6	8	10	12	14	16	18	20	22	24	26	28	30	32	34	36	38	40	42	44	46	48									
1-6	USB-0218-16																																
	USB-1232-16																																
	USB-1048-16																																

SIGNA® Electronic Sign Ballast Matrix																																	
No. of Lamps Per Ballast	TOTAL LAMP FOOTAGE REQUIRED																																
	2	4	6	8	10	12	14	16	18	20	22	24	26	28	30	32	34	36	38	40	42	44	46	48									
1-2	ESB216-12																																
2-4	ESB432-14																																
4-6	ESB848-46																																
1-4	ESB1040-14																																

Plastic Sign Ballasts LEAD LENGTHS (Inches)

Catalog Number	White	Black	Blues	Reds	Yellows	Browns	Oranges	Orange Blacks	Blue Whites	Red Whites
PLASTIC SIGN BALLASTS - HIGH OUTPUT 800mA RS LAMPS - 120 Volts - 60 Hz										
TWO LAMP BALLASTS										
USB-0412-12	24	24	38	38	48					
FOUR LAMP BALLASTS										
USB-0816-14	36	24	65	40	39	56			48	
USB-1024-14	24	24	79	48	75	83			57	
USB-1632-24	24	24	80	54	60	80			72	
SIX LAMP BALLASTS										
USB-2036-46	24	24	50	80	70	38	50	50	38	
USB-2048-46	24	24	80	80	70	50	50	50	50	
MAX-3 HIGH OUTPUT SIGN BALLASTS 800mA RS LAMPS - 120 Volts - 60 Hz										
ONE TO SIX LAMP BALLASTS										
USB-0218-16	24	24	60	60	60	60	60	60	60	
USB-1232-16	24	24	80	60	60	80	60	60	72	
USB-1048-16	24	24	80	80	70	50	60	60	50	
SIGNA ELECTRONIC SIGN BALLASTS- T12 RAPID START HIGH OUTPUT LAMPS - 108 to 305 VOLTS - 50/60 Hz										
ONE TO SIX LAMP BALLASTS										
ESB216-12			68	68						
ESB432-14			80	80					80	80
ESB848-46			80	80			80	80	80	80

Note: Maximum volts above ground, any lead 590 volts.

HIGH OUTPUT BALLASTS



- Provide ultra-reliable low-temperature starting (as low as -20°F)
- Support 1 to 6 lamps
- Ideal for rugged outdoor sign cabinet applications
- Class P thermally protected

STANDARD HIGH OUTPUT SIGN BALLASTS

Catalog Number	Total Lamp Footage	Start Temp (°F)	Max. Line Cur.	Max. Input Watts	Open Circuit Volt.	Wiring Diagram	Dimen. Chart Ref.	Weight (lbs.)
----------------	--------------------	-----------------	----------------	------------------	--------------------	----------------	-------------------	---------------

PLASTIC SIGN BALLASTS - HIGH OUTPUT 800mA RS LAMPS - 120 Volts - 60 Hz

TWO LAMP BALLASTS

USB-0412-12	4' min. - 12' max.	-20	1.35	160	500	1a, 2a	1	8
-------------	--------------------	-----	------	-----	-----	--------	---	---

FOUR LAMP BALLASTS

USB-0816-14	8' min. - 16' max.	-20	1.90	220	590	4a, 6a, 9, 1b	2	12
USB-1024-14	10' min. - 24' max.	-20	2.70	325	720	4a, 6a, 9, 1b	3	14
USB-1632-24	16' min. - 32' max.	-20	3.50	420	950	4a, 6a, 9	4	16

SIX LAMP BALLASTS

USB-2036-46	20' min. - 36' max.	-20	4.00	480	600	5a, 7, 7a	4	18
USB-2048-46	20' min. - 48' max.	-20	5.00	600	720	5a, 7, 7a	4	18

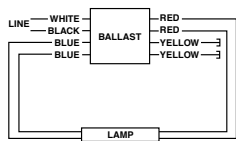

Diagram 1a

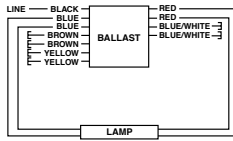

Diagram 1b

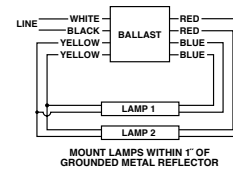

Diagram 2a

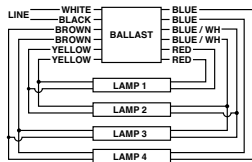

Diagram 4a

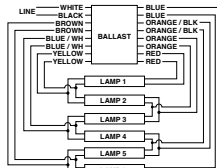

Diagram 5a

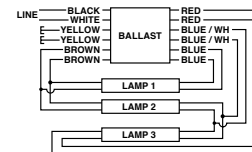

Diagram 6a

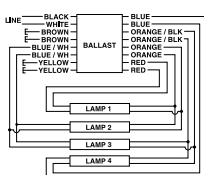

Diagram 7

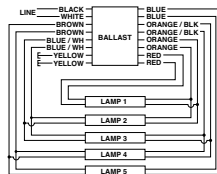

Diagram 7a

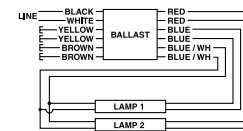
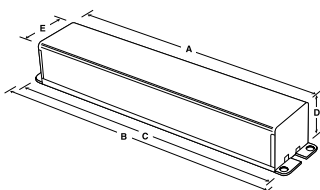

Diagram 9



PLASTIC SIGN FLUORESCENT BALLASTS DIMENSION CHART - STANDARD CASE (INCHES)

Ref. #	A	B	C	D	E
1	10 37/64"	11 45/64"	11 9/64"	1 3/4"	3 3/16"
2	10 37/64"	11 45/64"	11 9/64"	2 43/64"	3 3/16"
3	13 3/16"	14 5/16"	13 3/4"	2 43/64"	3 3/16"
4	15 3/16"	16 11/16"	16 1/8"	2 43/64"	3 3/16"

Diagrams Notes:

Note 1: When operating a two-lamp ballast on one lamp insulate each yellow lead.

Note 3: When operating a four-lamp ballast on three lamps insulate each yellow blue/white, and brown lead.

UNIVERSAL® MAX-3 HIGH OUTPUT SIGN BALLASTS

- Superior fill material coats all components and fills all voids to dissipate heat for cooler operation, longer life.
- Supports 1 to 6 lamps, 2 to 48 feet total length
- Low watt-loss steel lamination and all-copper coils assure cooler, more efficient operation and performance.
- Class P thermally protected



MAX-3 BALLASTS

Catalog Number	Total Lamp Footage	Start Temp (°F)	Max. Line Cur.	Max. Input Watts	Open Circuit Volt.	Wiring Diagram	Dimen. Chart Ref.	Weight (lbs.)
MAX-3 HIGH OUTPUT SIGN BALLASTS 800mA RS LAMPS - 120 Volts - 60 Hz								
ONE TO SIX LAMP BALLASTS								
USB-0218-16	2' min. - 18' max.	-20°	2.00	240	625	3, 4, 5, 6, 7, 8	1	15
USB-1232-16	12' min. - 32' max.	-20°	3.50	410	970	3, 4, 5, 6, 7, 8	1	16
USB-1048-16	10' min. - 48' max.	-20°	4.80	570	800	1, 2, 3, 4, 7, 8	2	18

See page 6-3 for Lead Lengths

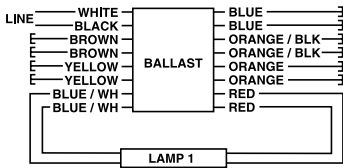

Diagram 1

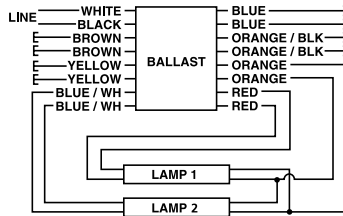

Diagram 2

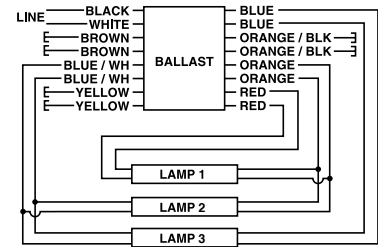
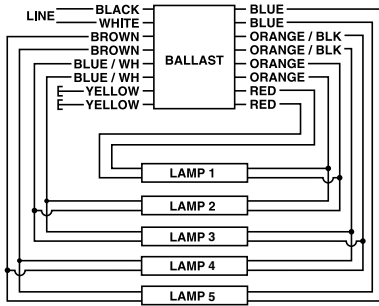

Diagram 3



INDIVIDUALLY CAP THE YELLOW LEADS

Diagram 4

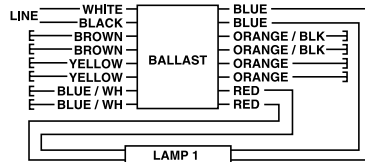

Diagram 5

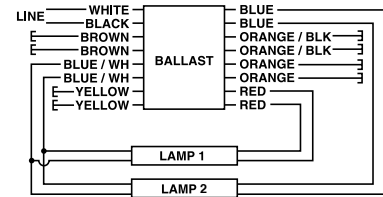

Diagram 6

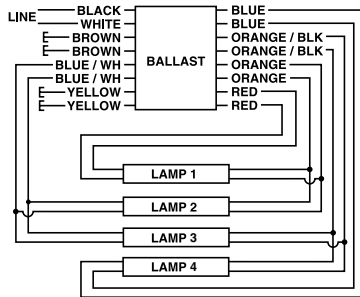

Diagram 7

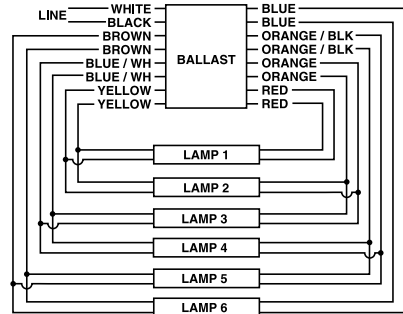
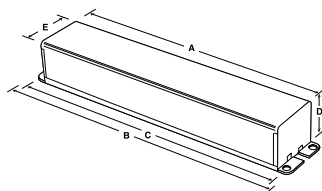

Diagram 8



MAX-3 SERIES HIGH OUTPUT SIGN BALLASTS DIMENSION CHART

Ref. #	A	B	C	D	E
1	13 ^{3/16} "	14 ^{5/16} "	13 ^{3/4} "	2 ^{43/64} "	3 ^{3/16} "
2	15 ^{9/16} "	16 ^{11/16} "	16 ^{1/8} "	2 ^{43/64} "	3 ^{3/16} "

Diagrams Notes:

Note 1: When operating a two-lamp ballast on one lamp insulate each yellow lead.

Note 2: When operating a three-lamp ballast on two lamps insulate each yellow and blue/white lead.

Note 3: When operating a four-lamp ballast on three lamps insulate each yellow blue/white, and brown lead.

- Instant start for maximum energy savings
- Simplified wiring for fewer connections
- Universal input voltage
- Parallel Lamp Operation

Catalog Number	Total Lamp Footage	Start Temp (°F)	Input Voltage	Max. Input Watts	Max. Line Current (A)	Wiring Diagram	Dimen. Chart Ref.	Weight (lbs.)
----------------	--------------------	-----------------	---------------	------------------	-----------------------	----------------	-------------------	---------------

T12HO UP TO 8' IN LENGTH OR T8HO UP TO 6' IN LENGTH - 120 to 277 Volts - 50/60 Hz

ONE TO TWO LAMP BALLASTS

ESB216-12	2' min. - 16' max.	-20	120	134	1.12	10	1	4.2
			277	130	0.47			

ONE, TWO, THREE OR FOUR LAMP BALLASTS

ESB432-14	4' min. - 32' max.	-20	120	280	2.34	11	2	7.4
			277	274	0.99			

FOUR, FIVE OR SIX LAMP BALLASTS

ESB848-46	8' min. - 48' max.	-20	120	408	3.41	12	3	9.7
			277	395	1.47			

T12HO UP TO 8' IN LENGTH OR T8HO UP TO 8' IN LENGTH - 120 to 277 Volts - 50/60 Hz

ONE, TWO, THREE OR FOUR LAMP BALLASTS

ESB1040-14	10' min. - 40' max.	-20	120	341	2.85	11	3	10
			277	331	1.25			

Consult www.signasign.com for complete specification information

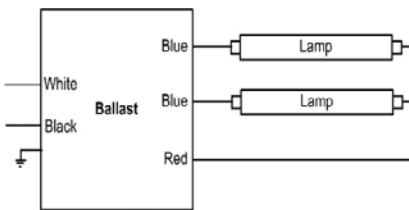

Diagram 10

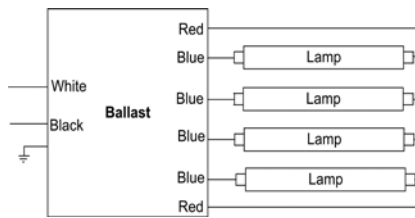

Diagram 11

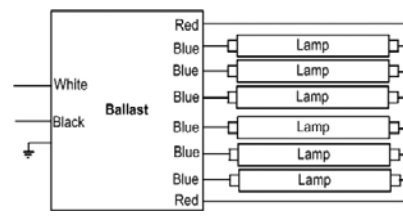
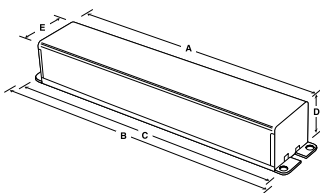

Diagram 12



**ELECTRONIC SIGN BALLASTS
DIMENSION CHART - STANDARD CASE (INCHES)**

Ref. #	A	B	C	D	E
1	10 ^{37/64} "	11 ^{45/64} "	11 ^{9/64} "	1 ^{3/4} "	3 ^{3/16} "
2	13 ^{3/16} "	14 ^{5/16} "	13 ^{3/4} "	2 ^{43/64} "	3 ^{3/16} "
3	15 ^{9/16} "	16 ^{11/16} "	16 ^{1/8} "	2 ^{43/64} "	3 ^{3/16} "

Diagrams Notes:

When Operating less than the maximum number of lamps, insulate unused blue leads.

Glossary

AC (Alternating Current)—Current which passes from the generator in one direction and then the other, alternately

ANSI (American National Standards Institute)—Non-profit organization that generates voluntary product performance standards for many U.S. industries. ANSI Standard C82.1 applies to electromagnetic ballasts.

Arc—Intense luminous discharge formed by the passage of electric current across a space between electrodes.

Auto Reset Shutdown Circuit—Circuit senses lamp end of life and will automatically shut off power to the lamp(s). When a new lamp is inserted in the socket, the ballast resets, and turns on the lamp automatically. Some shutdown circuits require the power to be interrupted before a new lamp will re-light.

Ballast—Device for starting and regulating fluorescent and high intensity discharge lamps.

Ballast Efficacy Factor (BEF)—Value used to evaluate various lighting systems based on light output and power input. The BEF can only be used to compare systems operating the same type and quantity of lamps.

Ballast Factor (BF)—Measure of light output from lamp operated by commercial ballast as compared to a laboratory standard reference ballast. Ballast factor .94 means ballast produces 94% of light produced by ANSI C82.2 reference ballast operating same lamps.

Ballast Hum—Sound generated by the vibration of laminations in the electromagnetic field that transforms the current for discharge lamp use.

Ballast Losses—Power which is supplied to a ballast that is not converted into lamp energy. Ballast loss is dissipated as heat.

Bottom Exit (BE)—A configuration with leads or a wire-trap on the bottom or base of the ballast. This type of configuration is usually used when the ballast is mounted onto a junction box plate.

Bottom Exit Studs (BES)—A configuration with screw studs mounted on the base plate or bottom of the ballast. The screws are 3/8" inches long with a #8-32 thread size (#8-32 nut). They are mounted on a two-inch center. The studs are usually used to mount the ballast directly onto a junction box plate.

 **Canadian Energy Standards**—Indicates ballast complies with Canadian Energy Standards and meets the requirements of CAN/CSA-C654-M91.

 **Canadian Standards Association (CSA)**—Association that generates product performance and safety standards for many Canadian industries.

Capacitor—Device in ballast that stores electrical energy. Often used for power factor correction and lamp regulation (see "Power Factor").

Cathode—See "Electrode"

Centigrade (C)—Celsius temperature scale where 0°C = 32°F.

Circle E—Designates a ballast meets or exceeds the requirements of Public Law 100-357 establishing standards of efficiency.

Class P Thermal Protector—A switching device sensitive to current and heat that automatically disconnects ballast if the ballast temperature exceeds UL temperature limitations.

Coil—Windings of copper or aluminum wire surrounding the steel core in ballast.

Core—Component of electromagnetic ballast that is surrounded by the coil. Core is comprised of steel laminations or solid ferrite material.

Core & Coil Ballast—Another term for an electromagnetic ballast.

Crest Factor (Lamp Current Crest Factor)—Ratio of peak lamp current to RMS or average lamp operating current.

Efficacy—Lumen output per unit of power supplied to ballast (lumens per watt).

Electrical Testing Laboratory (ETL)—Independent testing laboratory that performs ballast tests and certifies accuracy of performance data.

Electrode—Metal filaments that emit electrons in a fluorescent lamp. Negatively charged free electrons emitted by one electrode are attracted to the positive electrode (anode), creating an electric current and arc between electrodes.

Electromagnetic Ballast (Magnetic Ballast)—A ballast that uses a "Core & Coil" assembly to transform electrical current to start and operate fluorescent lamps.

EMI (Electromagnetic Interference)—Electrical interference (noise) generated by electrical and electronic devices. Levels generated by high frequency electronic devices are subject to regulation by Federal Communications Commission (FCC).

Filament—Metal Tungsten wire coated with Barium Oxide that emits electrons when voltage is applied.

Filament Voltage—Voltage applied to the lamp cathode.

Fluorescent Lamp—Gas filled lamp in which light is produced by the interaction of electrons with phosphors lining the lamp's glass tube.

Foot Candles—Measure of light level on a surface being illuminated. Defined as one lumen of light per one square foot of surface area.

Four-Pin Compact Fluorescent Lamps—Type of lamps that do not have any starter built into the base of the lamp. Therefore, the ballast has the starting circuit. Traditionally 4-pin lamps are designed to work with electronic ballasts; however, Universal does offer magnetic ballasts to operate some 4-pin lamps.

Frequency—Rate of alteration in an AC current. Expressed in cycles per second or Hertz (Hz).

Harmonic—An integral multiple of the fundamental frequency (60 Hz) that becomes a component of the current (see "Harmonic Distortion").

Harmonic Distortion—Distortion of an AC waveform caused by multiples of the fundamental frequency (harmonics). Odd triplet harmonics (thirds, ninths, etc.) may result in large currents on the neutral line in a four-wire Wye three-phase system.

Hertz (Hz)—Unit used to measure frequency of alteration of current or voltage; cycles per second.

Glossary

High Efficiency (Energy Saving) Electromagnetic Ballast—Ballast with Core & Coils, designed to minimize ballast losses compared to the “standard” ballast.

High Intensity Discharge (HID) Lamp—A lamp containing a filled arc tube in which the active element becomes vaporized (a gaseous state) and is discharged into the arc stream to produce light.

High Power Factor—A ballast whose power factor is corrected to 90% or greater by use of a capacitor.

Incandescent Lamp—Lamp in which light is produced by a filament heated by an electric current.

Input Voltage—Power supply voltage required for proper operation of an arc discharge lighting ballast.

Inputs Watts—The total power input to the ballast which includes lamp watts and ballast losses. The total power input to the fixture is the input watts to the ballast or ballasts and is the value to be used when calculating cost of energy and air conditioning loads.

Instant Start Lamp—a fluorescent lamp with a single pin at each end. The lamp is ignited by a high voltage without any filament heating.

Instant Start—Lamp starting method in which lamps are started by high voltage input with no preheating of lamp filaments. Some rapid start lamps are designed so that they may be instant started.

Laminations—Layers of steel, making up the “core” that is surrounded by the coils in a core & coil ballasts.

Lamp Current Crest Factor—See “Crest Factor.”

Lamp Filament—See “Electrode.”

Lamp Watts—Input power used to operate lamps.

Lumens/Watt—A measurement of white light produced by each output watt.

Metal Cases—Case design used in both magnetic and electronic ballasts. These ballasts are grounded once they are mounted to the fixture. They meet all safety codes, some of which do not allow plastic in open plenum areas.

National Electric Code (NEC)—A nationally accepted electrical installation code to reduce the risk of fire, developed by the National Fire Protection Association.

National Energy Standards for Fluorescent Ballasts—A federal law enacted in 1988 that sets energy standards for ballasts consistent throughout the United States.

NOM—Laboratory that sets safety standards for building materials, electrical appliances and other products for Mexico.

Non-PCB Capacitor—Capacitor used in ballasts to help provide power factor correction. Contains no polychlorinated biphenyls and meets EPA requirements.

Normal Power Factor—Ballasts with power factor less than .90 and do not incorporate any means of Power Factor Correction.

Parallel Lamp Operation—Refers to ballasts that employ multiple-output current paths from a single ballast to allow lamps to operate independent of one another, allowing other lamps operated by the ballast to remain lit should companion lamp(s) fail.

PCB (Polychlorinated Biphenyls)—Chemical pollutant formerly used in ballast capacitors.

Potting—Material used to completely surround and cover components of some magnetic and electronic ballasts. Potting compound fulfills functions of protecting components, dampening sound, and dissipating heat.

Power Factor—Measurement of the relationship between the AC source voltage and current. High power factor ballasts require less AC operating current operating at the same wattage than an equivalent low power factor ballast. Formula: Power Factor equals Input Watts divided by the product of Line Volts times Line Amps (Volt Amps or VA).

Power Factor Corrected—Ballasts that incorporate a means of Power Factor Correction but whose power factor is <90% and >50%.

Preheat Lamp—A fluorescent lamp in which the filament must be heated by use of a starter before the arc is created. These lamps are typically operated with electromagnetic ballasts.

Programmed Rapid Start—lamp starting method which preheats the lamp filaments while not allowing the lamp to ignite and then applies the open circuit voltage (OCV) to start the lamp. The user may experience a half to one-second delay after turning on the lamps while the pre-heating takes place. This type of starting circuit keeps lamp end blackening to a minimum and improves lamp life performance, especially in applications where the lamps are frequently switched on and off.

Rapid Start Lamp—A fluorescent lamp with two pins at each end connected to the filament. The filaments are heated by the ballast to aid in starting. Some rapid start lamps may be instant started without filament heat, for example, the F32T8 lamp.

Rapid Start—Lamp starting method in which lamp filaments are heated while open circuit voltage (OCV) is applied to facilitate lamp ignition.

Series Lamp Operation—Refers to ballasts that employ a single current path passing through all lamps operated by the ballast. If one lamp should fail, companion lamps operated by the same ballasts will also extinguish or dim.

Standard Alternating Current Frequency in the United States—60 Hertz (Hz) or 60 cycles per second.

Total Harmonic Distortion (THD)—The combined effect of Harmonic Distortion on the AC waveform produced by a ballast or other device. Expressed as a percentage. Excessive levels of THD can create large currents on the neutral line of a four-wire Wye three phase system. (See “Harmonic Distortion”)

Transients—High voltage surges through an electrical system caused by lightning strikes to nearby transformers, overhead lines or the ground. May also be caused by switching of motors and compressors, as well as by short circuits or utility system switching. Can lead to premature ballast failure.

Two-Pin Compact Fluorescent Lamps—Type of lamps that have the glow bottle starter built into the base of the lamp. Traditionally 2-pin lamps are designed to work with electromagnetic ballasts.

 UL (Underwriters' Laboratories, Inc.)—Laboratory that sets safety standards for building materials, electrical appliances and other products.

Watts—Measurement of electrical ability to do work.

Index

Catalog #	Page #	Catalog #	Page #
200-C-S-P	1-24, 1-25, 1-26, 1-27	1010-246C-TC	5-39
200-H2	1-25, 1-26, 1-27	1010-247SC-TC	5-39
202-B-TC-P	1-24, 1-27	1033-15S	5-43
202-SB-TC-P	1-24, 1-27	1033-16S	5-34
213-TC-P	1-22	1033-17S	5-34
300-H2	1-27	1033-23S	5-43
412-L-SLH-TC-P	1-13, 1-14	1033-24S	5-34
412-L-TC-P	1-30	1038-113S	5-33
413-C-TC-P	1-13, 1-14	1038-122S	5-36
420-L-TC-P	1-13, 1-14	1038-130S	5-36
443-L-SLH-TC-P	1-13, 1-14	1110-245SC-TC	5-38
445-RS-WS-TC-P	1-24	1110-246C-TC	5-38
446-L-SLH-TC-P	1-13, 1-14	1110-247SC-TC	5-52
446-LR-TC-P	1-30	1110-564C-TC	5-38
447-LR-TC-P	1-26, 1-27	1110-566C-TC	5-38
447-LR-VLH-TC-P	1-25, 1-26, 1-27	1110-568C-TC	5-38
458-L-SLH-TC-P	1-13, 1-14	1111-246C-TC	5-38
480-SLH-TC-P	1-17	1111-247SC-TC	5-38
480-XLH-TC-P	1-17	1120-251A-TC	5-38
481-LH-TC-P	1-16, 1-17	11210-236C-TC	5-38
487-SLH-TC-P	1-17	11210-239C-TC	5-38
487-XLH-TC-P	1-17	11210-242C-TC	5-38
490-XLH-TC-P	1-15, 1-16, 1-17	11210-277C-TC	5-38
493B2	2-41	11210-506C-TC	5-38
532-BR-TC-P	1-22	11210-539C-TC	5-38
540-L-TC-P	1-30	11210-554C-TC	5-38
546-B-TC-P	1-25, 1-26, 1-27	11210-606C-TC	5-38
547-RS-WS-TC-P	1-24	1220-246C-TC	5-39
554-L-TC-P	1-25, 1-26, 1-27	1233-10W	5-26
564-L-TC-P	1-25, 1-26, 1-27	1233-24S	5-27
567-L-TC	1-34	1233-35UN	5-26
573-L-TC-P	1-13	1233-35W	5-26
595-L-TC-P	1-30	1233-142W	5-26
597-L-TC-P	1-34	1233-154W	5-27
631-LH-TC-P	1-15, 1-16	1233-183S	5-27
698-L-SLH-TC	1-13, 1-14	1233-251UN	5-26
726-L-VLH-WS-TC-P	1-24	1233-251W	5-26
778-XLH-TC	1-15, 1-16, 1-17	1238-133S	5-36
806-BR-TC-P	1-33	1238-183S	5-36
806-SLH-TC-P	1-22, 1-23	12210-236C-TC	5-39
808-BR-TC-P	1-33	12210-237C-TC	5-39
822-BR-TC-P	1-22, 1-23	12210-239C-TC	5-39
827-SLH-TC-P	1-22, 1-23	12210-241C-TC	5-39
828-BR-TC-P	1-22, 1-23	12210-261C-TC	5-39
831-TC	1-33	12210-552C-TC	5-39
897-SLH-TC	1-22, 1-23	12210-602C-TC	5-39
930-K-TC-P	1-19, 1-20	12210-606C-TC	5-39
931-LH-TC-P	1-19, 1-20	4105F2P	1-25, 4-8
937-K-TC-P	1-19, 1-20	4105P	1-25
1010-236RC-TC	5-39	4112PBES	4-9
1010-238C-TC	5-39	4113P	4-9
1010-239RC-TC	5-39	4114P	4-9
1010-245C-TC	5-39	4114PBES	4-9

Index

Catalog #	Page #	Catalog #	Page #
4122PBES	4-10	B232I277RHH-A	2-20, 2-24
4124PBES	4-11, 4-15	B232I347HP-A	2-14, 2-16, 2-19, 2-20, 2-24, 2-27, 2-30
4128PBES	4-11, 4-15	B232I347HPL	2-14, 2-16, 2-19, 2-20, 2-30
4139F2P	4-19	B232I347L-A	2-14, 2-16, 2-19, 2-20, 2-24, 2-27, 2-30
4205F2P	4-8	B232I347RH-A	2-14, 2-16, 2-19, 2-20, 2-24, 2-27, 2-30
4214PBES	4-9	B232IUNV-C	2-14, 2-16, 2-19, 2-20, 2-30
4226PBES	4-11, 4-15	B232IUNVEL-A	2-14, 2-16, 2-19, 2-20, 2-24, 2-26, 2-27
B114PUNVDV1	3-10	B232IUNVHE-A	2-14, 2-16, 2-19, 2-20, 2-24, 2-26, 2-27
B128PUNVDV1	3-10	B232IUNVHEH-A	2-14, 2-16, 2-19, 2-20, 2-24, 2-26, 2-27
B132I120RH-A	2-14, 2-16, 2-19, 2-30	B232IUNVHP-B	2-14, 2-16, 2-19, 2-20, 2-24, 2-26, 2-27, 2-30
B132I277RH-A	2-14, 2-16, 2-19, 2-24, 2-26, 2-27, 2-30	B232PUNVDV1	3-10
B132I347HP	2-14, 2-16, 2-19	B232PUNVEL-A	2-20
B132I347RH	2-14, 2-16, 2-19	B232PUNVHE-A	2-20
B132IUNVEL-A	2-14, 2-16, 2-19, 2-24, 2-27, 2-30	B232PUNVHP-A	2-14, 2-16, 2-19, 2-20, 2-24, 2-26, 2-27
B132IUNVHE-A	2-14, 2-16, 2-19, 2-24, 2-26, 2-27, 2-30	B232SR120S30	3-13
B132IUNVHP-B	2-14, 2-16, 2-19, 2-24, 2-26, 2-27, 2-30	B232SR120V5	3-12
B132PUNVDV1	3-10	B232SR277S30	3-13
B132PUNVHP-A	2-14, 2-16, 2-19, 2-24, 2-26, 2-29	B232SR277V5	3-12
B132R120S30	3-13	B232SR347V5	3-12
B132R120S50	3-13	B234SR120M-A	2-37, 2-38
B132R120V5	3-12	B234SR277M-A	2-37, 2-38
B132R277S30	3-13	B239PUNV-D	2-35, 4-19
B132R277S50	3-13	B240R120HP	2-37, 2-38
B132R277V5	3-12	B240R120RH	2-37, 2-38
B132R347V5	3-12	B240R277HP	2-37, 2-38
B134R120M-A	2-38	B254P347-D	2-35, 4-20
B140R120HP	2-37, 2-38	B254HRVHB-E	2-35, 4-20
B140R277HP	2-37, 2-38	B254PUNVDV1	3-10
B154PUNVDV1	3-10	B254PUNV-D	2-35, 4-17, 4-19, 4-20
B159I120RH	2-32	B254PUNVHB-D	2-35, 4-17, 4-19, 4-20
B159I277RH	2-32	B259I120HE	2-32
B214PUNVDV1	3-10	B259I120HPL	2-32
B224PUNV-C	2-35, 4-18, 4-19	B259I120RH	2-32
B228PU90S50D	3-15	B259I120RHH	2-32
B228PU95S50D	3-15	B259I277HE	2-32
B228PU115S50D	3-15	B259I277HPL	2-32
B228PUNV90-C	2-34	B259I277RH	2-32
B228PUNV95-D	2-34, 2-36	B259I277RHH	2-32
B228PUNV115-D	2-34, 2-36	B259I347HP	2-30, 2-32
B228PUNVDV1	3-10	B259IUNVHP-A	2-32
B228PUNV-C	2-34	B260I120M-A	2-39, 2-40
B232I120EL	2-14, 2-16, 2-19, 2-20, 2-24, 2-26, 2-27	B260I120RH	2-39, 2-40
B232I120HE	2-14, 2-16, 2-19, 2-20, 2-24, 2-26, 2-27	B260IUNVHP	2-39, 2-40
B232I120L-A	2-14, 2-16, 2-19, 2-20, 2-30	B286I120RH	2-33
B232I120RES-A	2-14, 2-16, 2-19, 2-20	B286I277RH	2-33
B232I120RES-G	2-14, 2-16, 2-19, 2-20	B295SR120HP	2-41, 4-32
B232I120RH-A	2-14, 2-16, 2-19, 2-20, 2-24, 2-27, 2-30	B295SRUNVHP	2-41
B232I120RHH-A	2-20, 2-24	B332I120EL	2-15, 2-17, 2-20, 2-21, 2-24, 2-25, 2-26, 2-27, 2-28
B232I277EL	2-14, 2-16, 2-19, 2-20, 2-24, 2-26, 2-27	B332I120HE	2-15, 2-17, 2-20, 2-21, 2-24, 2-25, 2-26, 2-27, 2-28
B232I277HE	2-14, 2-16, 2-19, 2-20, 2-24, 2-26, 2-27		
B232I277L-A	2-14, 2-16, 2-19, 2-20, 2-24, 2-27, 2-30		
B232I277RH-A	2-14, 2-16, 2-19, 2-20, 2-24, 2-27, 2-30		

Index

Catalog #	Page #	Catalog #	Page #
B332I120L-A	2-15, 2-17, 2-20, 2-21, 2-30		2-26, 2-28, 2-30
B332I120RH-A	2-15, 2-17, 2-20, 2-21, 2-24, 2-25, 2-27, 2-28, 2-30	B432PUNVHP-A	2-15, 2-17, 2-21, 2-22, 2-25, 2-26, 2-28
B332I120RHH	2-21	B432P277V5-E	3-12
B332I277EL	2-15, 2-17, 2-20, 2-21, 2-24, 2-25, 2-26, 2-27, 2-28	B432P277V5H-E	3-12
B332I277HE	2-15, 2-17, 2-20, 2-21, 2-24, 2-25, 2-26, 2-27, 2-28	B432SR277V5	3-12
B332I277L-A	2-15, 2-17, 2-20, 2-21, 2-30	B454PUNV-E	2-35, 4-20
B332I277RH-A	2-15, 2-17, 2-20, 2-21, 2-24, 2-25, 2-27, 2-28, 2-30	B454PUNVHB-E	2-35, 4-20
B332I277RHH	2-21	C118PUNVDV3	3-10
B332I347HP	2-15, 2-17, 2-20, 2-21	C126PUNVDV3	3-10
B332I347HPL	2-15, 2-17, 2-20, 2-21, 2-30	C132PUNVDV3	3-10
B332I347RH	2-15, 2-17, 2-20, 2-21	C140PUNVDV3	3-10
B332I347L	2-15, 2-17, 2-20, 2-21, 2-30	C142PUNVDV3	3-10
B332IHRVH-E	2-20, 2-21, 2-24, 2-25, 2-26, 2-28	C213/347	4-9, 4-14
B332IUNVEL-A	2-15, 2-17, 2-20, 2-21, 2-24, 2-25, 2-26, 2-27, 2-28, 2-30	C213UNV	4-9, 4-14
B332IUNVHE-A	2-15, 2-17, 2-20, 2-21, 2-24, 2-25, 2-26, 2-27, 2-28, 2-30	C218/347	4-10, 4-14
B332IUNVHEH-A	2-15, 2-17, 2-20, 2-21, 2-24, 2-25, 2-26, 2-27, 2-28, 2-30	C218PUNVDV3	3-10
B332IUNVHP-A	2-15, 2-17, 2-20, 2-21, 2-24, 2-25, 2-26, 2-27, 2-28	C218UNV	4-10, 4-14
B332PUNVHP-A	2-15, 2-17, 2-20, 2-21, 2-24, 2-25, 2-26, 2-27, 2-28	C226PUNVDV3	3-10
B332SR120S30	3-13	C232PUNVDV3	3-10
B332SR120V5	3-12	C240PUNVDV3	3-10
B332SR277S30	3-13	C240PUNVHP-B	4-19
B332SR277V5	3-12	C240SI120RH	4-19
B340R120HP	2-37, 2-38	C240SI277RH	4-19
B340R277HP	2-37, 2-38	C242/347	4-11, 4-12, 4-15, 4-17, 4-18, 4-19, 4-20
B432I120EL	2-15, 2-17, 2-21, 2-22, 2-25, 2-26, 2-27	C242PUNVDV3	3-10
B432I120HE	2-15, 2-17, 2-21, 2-22, 2-25, 2-26, 2-27	C242UNV	4-11, 4-12, 4-15, 4-17, 4-18, 4-19, 4-20
B432I120L-A	2-15, 2-17, 2-21, 2-22, 2-25, 2-30	C340SI120RH	4-19
B432I120RES-A	2-15, 2-17, 2-21, 2-22	C340SI277RH	4-19
B432I120RH-A	2-15, 2-17, 2-21, 2-22, 2-25, 2-30	C2642/347	4-11, 4-12, 4-15, 4-17, 4-18
B432I277EL	2-15, 2-17, 2-21, 2-22, 2-25, 2-26, 2-28	C2642UNV	4-11, 4-12, 4-15, 4-17, 4-20
B432I277HE	2-15, 2-17, 2-21, 2-22, 2-25, 2-26, 2-28	CBT113L-120	2-34, 4-8, 4-9
B432I277HEH	2-15, 2-17, 2-21, 2-22, 2-25, 2-28	CBT213L-120	2-34, 4-8, 4-9
B432I277L-A	2-15, 2-17, 2-21, 2-22	CBT218L-120xC	4-10
B432I277RH-A	2-15, 2-17, 2-21, 2-22, 2-30	CBT126L-120	2-34, 4-11, 4-17, 4-18
B432I347HP	2-15, 2-17, 2-21, 2-22	CF1320H2P	1-26, 1-27, 4-9
B432I347HPL	2-15, 2-17, 2-21, 2-22, 2-30	CT213UNV	4-9
B432I347L	2-15, 2-17, 2-21, 2-22, 2-30	CT218UNVSE	4-10, 4-18
B432I347RH	2-15, 2-17, 2-21, 2-22	ESB213-12	7-6
B432IUNV-D	2-15, 2-17, 2-21, 2-22, 2-30	ESB432-14	7-6
B432IUNVEL-A	2-15, 2-17, 2-21, 2-22, 2-25, 2-28, 2-30	ES1329A	2-14, 2-16, 2-20
B432IUNVHE-A	2-15, 2-17, 2-21, 2-22, 2-25, 2-26, 2-28, 2-30	ES1510A	2-14, 2-16, 2-19
B432IUNVHP-A	2-15, 2-17, 2-21, 2-22, 2-25,	ES1608A	2-14, 2-16, 2-19, 2-20
		ES1679A	2-30
		ES1720B	2-15, 2-17, 2-21, 2-22
		ES1786X	2-42
		ES4515K	2-35, 4-20
		ES4528X	2-34
		ES4800A	2-14, 2-16, 2-19, 2-20, 2-30
		ES5000GT/HT	3-8
		ES5001GT/HT	3-8
		ES5002GT/HT	3-8
		ES5003GT/HT	3-8

Index

Catalog #	Page #	Catalog #	Page #
ES5006BM	3-11	ES5901CTL	3-9
ES5007BMT	3-11	ES5902CTL	3-9
ES5008BM	3-8	ES5903CTL	3-9
ES5009BMT	3-8	ES5961CTL	3-9
ES5010GT/HT	3-11	HPS 150-3A	5-41
ES5011GT/HT	3-11	HPS 150-4A	5-41
ES5012GT/HT	3-11	HPS 150-5B	5-41
ES5013GT/HT	3-11	HPS 150-45B	5-41
ES5702CTL	3-9	HPS 150-G01	5-43
ES5703CTL	3-9	HPS 400-3A	5-43
ES5704CTL	3-9	HPS 400-4A	5-43
ES5705CTL	3-9	HPS 400-45B	5-43
ES5720CTL	3-9	HPS 400-G05	5-43
ES5721CTL	3-9	HPS 450-1B	5-43
ES5722CTL	3-9	HPS 460-1B	5-43
ES5723CTL	3-9	HPS 600-1B	5-43
ES5723HT	3-9	HPS 1000-4B	5-43
ES5733HT	3-9	HPS 1000-55B	5-43
ES5734HT	3-9	M35MLTLC3M	5-17
ES5817K	3-11	M35TRILC3M	5-17
ES5818K	3-11	M50MLTLC3M	5-17
ES5821B	3-11	M50TRILC3M	5-17
ES5822B	3-11	M70MLTLC3D	5-17
ES5825K	3-8	M70MLTLC3M	5-17
ES5826K	3-8	M70TRILC3M	5-17
ES5827B	3-8	M100MLTLC3D	5-19
ES5828K	3-8	M100MLTLC3M	5-17
ES5829K	3-8	M100TRILC3M	5-17
ES5830K	3-8	M150MLTLC3D	5-18
ES5831B	3-8	M150MLTLC3M	5-18
ES5832B	3-8	M150TRILC3M	5-18
ES5833B	3-11	M175ML5AC3M	5-18
ES5834B	3-11	M175MLTAC3M	5-18
ES5835K	3-11	M175MLTAE3M	5-41
ES5836K	3-11	M175TRIAC30	5-18
ES5838K	3-8	M232SR120C	1-12
ES5839K	3-11	M232SR277C	1-12
ES5840K	3-8	M250ML5AC3M	5-18
ES5842K	3-8	M250ML5AC4M	5-19
ES5843K	3-8	M250MLTAC3M	5-18
ES5844K	3-11	M250MLTAC4M	5-19
ES5846K	3-11	M250MLTAE3M	5-41
ES5847K	3-11	M250TRIAC3M	5-18
ES5848K	3-8	M250TRIAC4M	5-19
ES5849K	3-11	M260I120L	1-39, 1-40
ES5850K	3-8	M400ML5AC4M	5-19
ES5851K	3-11	M400MLTAC4L	5-19
ES5852K	3-8	M400MLTAC4M	5-19
ES5853K	3-11	M400MLTAE4M	5-41
ES5860K	3-8	M400MLTAI4X	5-42
ES5861K	3-11	M400TRIAC4M	5-19

Index

Catalog #	Page #	Catalog #	Page #
M1000ML5AC5M	5-20	P250MLTAC4M	5-22
M1000MLTAC5M	5-20	P250TRIAC4M	5-22
M1000TRIAC5M	5-20	P320ML5AC4M	5-23
M1500MLTAC5M	5-20	P320MLTAC4M	5-23
M1500TRIAC5M	5-20	P320TRIAC4M	5-23
M7048TLC3M	5-17	P350ML5AC4M	5-23
M10048TLC3M	5-17	P350MLTAC4M	5-23
M15048TLC3M	5-18	P350TRIAC4M	5-23
M17548TAC3M	5-18	P400ML5AC4M	5-24
M25048TAC3M	5-18	P400MLTAC4M	5-24
M25048TAC4M	5-19	P400TRIAC4M	5-24
M400120AC4M	5-19	P450ML5AC4M	5-24
M400208AC4M	5-19	P450MLTAC4M	5-24
M400277AC4M	5-19	P750ML5AC5M	5-24
M40027TAC4M	5-19	P750MLTAC5M	5-24
M40048TAC4M	5-19	P750TRIAC5M	5-24
M100048TAC5M	5-20	P1000ML5AC5M	5-24
M150048TAC5M	5-20	P1000MLTAC5M	5-24
M100120LC3N	5-17	P17548TAC3M	5-22
M175120AC3M	5-18	P20048TAC3M	5-22
M175277AC3M	5-18	P25048TAC4M	5-22
M250120AC3M	5-18	P32048TAC4M	5-23
M250208AC3M	5-18	P35048TAC4M	5-23
M250230AC3M	5-36	P40048TAC4M	5-24
M250240AC3M	5-18	P45048TAC4M	5-24
M250277AC3M	5-18	P75048TAC5M	5-24
M250347AC3M	5-18	P100048TAC5M	5-24
M400230AC4M	5-36	P175277RCEM	5-22
M1000120AC5M	5-20	P200277RCEM	5-22
M1000208AC5M	5-20	P250277RCEM	5-22
M1000230AC5M	5-36	P32027TAFXM	5-38
M1000240AC5M	5-20	P320277RCEM	5-23
M1000277AC5M	5-20	P350277RCEM	5-23
M1000480AC5M	5-20	P350480AC4M	5-23
M1500230AC5M	5-20, 5-36	P400277RCEM	5-24
M1500480AC5M	5-20	S35120RCEM	5-26
MH 70-3B	5-43	S70120RCEM	5-26
MH 100-3A	5-43	S50120RCEM	5-26
MH 100-5A	5-43	S50MLTLC3M	5-26
MH 100-35B	5-43	S70MLTLC3M	5-26
MH 150-35B	5-43	S70TRILC3M	5-26
MH 200-1B	5-43	S100120RCEM	5-26
MH 350-1A	5-43	S100MLTLC3M	5-26
MH150-G15	5-43	S100TRILC3M	5-26
P 350-15B	5-43	S150120RCEM	5-27
P175ML5AC3M	5-22	S150MLTLC3M	5-27
P175MLTAC3M	5-22	S150TRILC3M	5-27
P175TRIAC3M	5-22	S20048TAC4M	5-27
P200ML5AC3M	5-22	S200MLTAC4M	5-27
P200MLTAC3M	5-22	S200TRIAC4M	5-27
P200TRIAC3M	5-22	S250240AC4M	5-27
P250ML5AC4M	5-22	S250480AC4M	5-27

Limited Warranty

Universal Lighting Technologies, 26 Century Blvd., Suite 500, Nashville, TN 37214-3683, 1-800-BALLAST, (hereinafter called "Universal") warrants to the purchaser that its lamp ballasts (hereinafter called "Lighting Products") will be free from defects in material and workmanship for the specified warranty periods beginning from the date of manufacture.

TRIAD Electronic Fluorescent Ballasts	up to 60 Months*
Universal, Energy Saving Electromagnetic Fluorescent Ballasts	36 Months
AddressPro, SuperDim, and DaliPro Ballasts	36 Months
Standard Universal Electromagnetic, Fluorescent & HID Ballasts	24 Months
Universal Sign Ballasts	24 Months
MAX-3 Series Sign Ballasts	36 Months
Basic-12 and Homestar Electronic Ballasts	36 Months
VS Lampholders	36 Months
VS Brand Magnetic IEC, Electronic IEC, Ignitors, Switches and Capacitors	36 Months
Electronic HID	up to 60 Months*

**Consult individual product information sheets at www.unvlt.com for specific warranty information.*

If it appears within the specified warranty period that any Universal Lighting Product does not meet the warranty specified above, Universal will provide a replacement lighting product. Universal extends this limited warranty to the first end-user purchaser only. This warranty is conditional based upon proper storage, installation, use and maintenance.

This warranty is not applicable to, and Universal makes no warranty whatsoever with respect to, any Lighting Product not installed and operated in accordance with the National Electric Code (NEC), the Standards for Safety of Underwriters Laboratories, Inc. (UL), Standards for the American National Standards Institute (ANSI), in Canada, the Canadian Standards Association (CSA), or the International Electrotechnical Commission (IEC). Nor is this warranty applicable to any Lighting Product which has not been installed and operated in accordance with Universal's specifications and connection diagrams or Lighting Products which have been submitted to abnormal operating conditions. This includes, but is not limited to, excessive temperatures as specified in Universal's published literature. The conditions for any tests (to be) performed on Lighting Products which are claimed to have not performed in accordance with the terms of the warranty shall be mutually agreed upon in writing and Universal may be represented at any such tests.

NO IMPLIED WARRANTY OF MERCHANTABILITY OR FITNESS FOR A PARTICULAR PURPOSE SHALL APPLY BEYOND THE AFOREMENTIONED WARRANTY PERIOD. The foregoing warranty is exclusive of all other statutory, written or oral warranties and no other warranties of any kind, statutory or otherwise, are given or herein expressed. Warranty claims are to be made in accordance with Universal's published Warranty Service Program, which is available upon request. This warranty sets forth Universal's obligations and responsibilities regarding its Lighting Products and is the exclusive remedy available to the claimant.

LIMITATIONS OF LIABILITY. Under no circumstances, whether as a result of breach of contract, breach of warranty, tort, strict liability or otherwise, will Universal be liable for consequential, incidental, special or exemplary damages, including, but not limited to, loss of profits, loss of use or damage to any property or equipment, cost of capital, cost of substitute product, facilities or services, down time costs or claims of claimant's customers. Universal's liability for all claims of any kind or for any loss or damages arising out of, resulting from or concerning any aspect of this warranty or from the Lighting Products or services furnished hereunder, shall not exceed the price of the specific Lighting Product which gives right to the claim, except in accordance with Universal's Technical Engineering Service Program.

STATE LAW RIGHT. Some states do not allow the exclusion or limitation of consequential or incidental damages or the duration of time for an implied warranty. Therefore, the limitations or exclusions of consequential or incidental damage and implied warranties may not apply to certain claimants. This warranty provides the claimant with specific legal rights and claimants may have other rights that vary from state to state.



UniversalTM Lighting Technologies

IT'S EASY TO REACH US...



Universal Lighting Technologies, Inc.
26 Century Blvd., Suite 500
Nashville, TN 37214-3683



General Info: (615) 316-5100

For Technical Engineering Services (TES), application support and warranty information, call 1-800-BALLAST



Website: www.unvlt.com

Email: webmaster@unvlt.com
