

Instruction 512-0250

08-07-14

Copyright © 2006, 2014
by S&S® Cycle, Inc.

All rights reserved.
Printed in the U.S.A.

S&S® Cycle, Inc.

14025 Cty Hwy G PO Box 215

Viola, Wisconsin 54664

Phone: 608-627-1497 • Fax: 608-627-1488

Technical Service Phone: 608-627-TECH (8324)

Technical Service Email: sstech@sscycycle.com

Website: www.sscycycle.com

Installation and Jetting Instructions for S&S Super E and G Series "Shorty" Performance Carburetors for 1936-'84 Harley-Davidson® Big Twins and 1957-'85 Ironhead Sportster® Models

DISCLAIMER:

S&S parts are designed for high performance, closed course, racing applications and are intended for the very experienced rider only. The installation of S&S parts may void or adversely affect your factory warranty. In addition such installation and use may violate certain federal, state, and local laws, rules and ordinances as well as other laws when used on motor vehicles used on public highways, especially in states where pollution laws may apply. Always check federal, state, and local laws before modifying your motorcycle. It is the sole and exclusive responsibility of the user to determine the suitability of the product for his or her use, and the user shall assume all legal, personal injury risk and liability and all other obligations, duties, and risks associated therewith.

The words Harley®, Harley-Davidson®, H-D®, Sportster®, Evolution®, and all H-D part numbers and model designations are used in reference only. S&S Cycle is not associated with Harley-Davidson, Inc.

SAFE INSTALLATION AND OPERATION RULES:

Before installing your new S&S part it is your responsibility to read and follow the installation and maintenance procedures in these instructions and follow the basic rules below for your personal safety.

- Gasoline is extremely flammable and explosive under certain conditions and toxic when breathed. Do not smoke. Perform installation in a well ventilated area away from open flames or sparks.
- If motorcycle has been running, wait until engine and exhaust pipes have cooled down to avoid getting burned before performing any installation steps.
- Before performing any installation steps disconnect battery to eliminate potential sparks and inadvertent engagement of starter while working on electrical components.
- Read instructions thoroughly and carefully so all procedures are completely understood before performing any installation steps. Contact S&S with any questions you may have if any steps are unclear or any abnormalities occur during installation or operation of motorcycle with a S&S part on it.
- Consult an appropriate service manual for your motorcycle for correct disassembly and reassembly procedures for any parts that need to be removed to facilitate installation.
- Use good judgment when performing installation and operating motorcycle. Good judgment begins with a clear head. Don't let alcohol, drugs or fatigue impair your judgment. Start installation when you are fresh.
- Be sure all federal, state and local laws are obeyed with the installation.
- For optimum performance and safety and to minimize potential damage to carb or other components, use all mounting hardware that is provided and follow all installation instructions.
- Motorcycle exhaust fumes are toxic and poisonous and must not be breathed. Run motorcycle in a well ventilated area where fumes can dissipate.

IMPORTANT NOTICE:

Statements in this instruction sheet preceded by the following words are of special significance.



WARNING

Means there is the possibility of injury to yourself or others.



CAUTION

Means there is the possibility of damage to the part or motorcycle.

NOTE

Other information of particular importance has been placed in italic type.

S&S recommends you take special notice of these items.

WARRANTY:

All S&S parts are guaranteed to the original purchaser to be free of manufacturing defects in materials and workmanship for a period of twelve (12) months from the date of purchase. Merchandise that fails to conform to these conditions will be repaired or replaced at S&S's option if the parts are returned to us by the purchaser within the 12 month warranty period or within 10 days thereafter.

In the event warranty service is required, the original purchaser must call or write S&S immediately with the problem. Some problems can be rectified by a telephone call and need no further course of action.

A part that is suspect of being defective must not be replaced by a Dealer without prior authorization from S&S. If it is deemed necessary for S&S to make an evaluation to determine whether the part was defective, a return authorization number must be obtained from S&S. The parts must be packaged properly so as to not cause further damage and be returned prepaid to S&S with a copy of the original invoice of purchase and a detailed letter outlining the nature of the problem, how the part was used and the circumstances at the time of failure. If after an evaluation has been made by S&S and the part was found to be defective, repair, replacement or refund will be granted.

ADDITIONAL WARRANTY PROVISIONS:

- (1) S&S shall have no obligation in the event an S&S part is modified by any other person or organization.
- (2) S&S shall have no obligation if an S&S part becomes defective in whole or in part as a result of improper installation, improper maintenance, improper use, abnormal operation, or any other misuse or mistreatment of the S&S part.
- (3) S&S shall not be liable for any consequential or incidental damages resulting from the failure of an S&S part, the breach of any warranties, the failure to deliver, delay in delivery, delivery in non-conforming condition, or for any other breach of contract or duty between S&S and a customer.
- (4) S&S parts are designed exclusively for use in Harley-Davidson® and other American v-twin motorcycles. S&S shall have no warranty or liability obligation if an S&S part is used in any other application.

INTRODUCTION

S&S® Super E and G Shorty carburetors are butterfly type carburetors with fully adjustable idle mixture and circuit and changeable mid range and high speed jets. The high speed circuit features a changeable air bleed. Both carburetors also feature an adjustable accelerator pump and variable enrichment/fast idle device for improved throttle response, engine starting and warm ups.

The Super E has a 17/8" (47.6mm) bore and 19/16" (39.6mm) venturi. It is identified by an "E" cast into the throttle linkage side of the body below the letters "S&S SUPER". The Super E is recommended for use on any displacement big twin or Sportster® model.

The Super G has a 21/16" (52.3mm) bore and 3/4" (44.5mm) venturi. It is identified by a "G" cast into the carb body. See **Picture 1**.

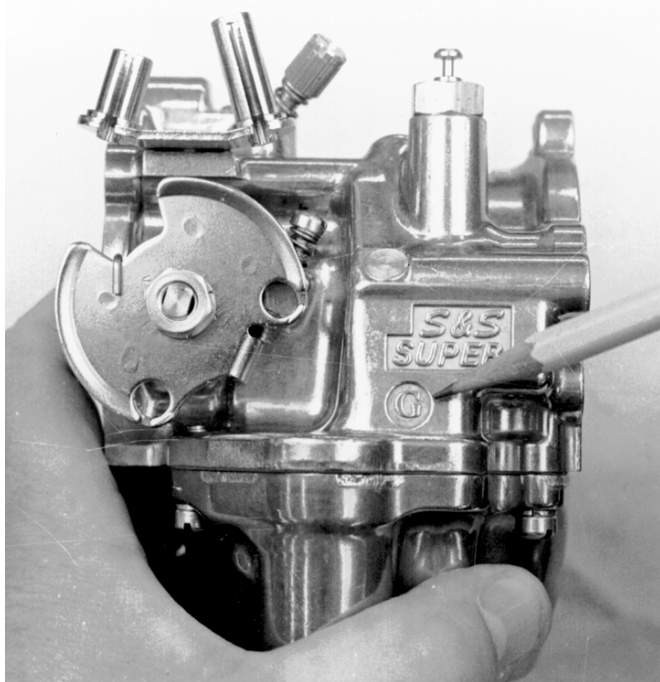

Picture 1

The Super G is recommended for use on modified engines of 100 cubic inches or more. While both carburetors can be made to work on most engines, the Super G is not recommended for small, low compression engines. If there is doubt as to which carburetor to use, S&S suggests the Super E.

IMPORTANT NOTES

- **Recommended for Racing Only** - S&S Super E & G carburetors covered by these instructions are not legal for use in California on motor vehicles operated on public highways or in other states where similar pollution laws apply. The user shall determine the

suitability of the product for his or her use and shall assume all risk and liability in connection therewith.

- *Because S&S carburetors are significantly larger than OEM units, unmodified, small displacement engines such as 883 Sportster® models may experience sluggish low speed response when equipped with S&S carburetors. This can often be minimized with performance exhaust and careful tuning.*
- *All manufacturer warranties become void if any part of the carburetor is polished, chrome plated or otherwise altered.*

THROTTLE REQUIREMENTS

NOTE: S&S Super E and G carburetors require the use of a two cable, pull open - pull closed throttle assembly. All 1980 and earlier stock H-D® models equipped with a single cable throttle mechanism must be converted to the two cable, pull open-pull closed type. S&S offers these throttle assemblies, but does not include them with any carburetor kit because of the multitude of chassis designs and fitment requirements.



Single, braided wire cable throttle mechanisms cannot mechanically close the throttle. If throttle inadvertently sticks in open position, loss of control of motorcycle and personal injury to operator or others may result.

1980 and Earlier Motorcycles

All stock chassis 1980 and earlier, or any motorcycle equipped with single cable throttle system must be converted to a two cable system. Throttle assembly kits may be ordered separately.

1981 to '84 Big Twin Models and 1981 to 1985 Harley-Davidson® Sportster® Models

The stock two cable throttle system designed for stock, butterfly type carburetors on these models can be installed on the S&S Super E or G throttle linkage with no cable modification. S&S Super E and G carb kits for 1936 to 1984 big twins contain a throttle cable guide designed for stock butterfly type throttle cables

CARB INSTALLATION

Read instructions thoroughly to familiarize yourself with all procedures before beginning installation.

NOTE: Installation of S&S® Super E and G carb kits on certain models is easier with gas tanks removed. Some owners may elect to perform installation without removing gas tanks. This is left to individual discretion. If installer elects to remove tanks or other stock parts, S&S recommends referring to appropriate Harley-Davidson® service manual for correct removal procedure as necessary.

1- Remove Old Carburetor And Manifold

- A- Shut off fuel petcock and disconnect battery.**
- B- Remove air cleaner assembly. Drain fuel from existing carburetor. Remove carburetor, manifold, choke cable and any carburetor mounting hardware.**



WARNING



- Gasoline is extremely flammable and explosive under certain conditions. Do not smoke around gasoline. Gasoline fumes are toxic when inhaled. Perform installation in a well ventilated area away from open flames or sparks. Any gasoline leak or spill constitutes a health and fire hazard.
- If motorcycle has been running, wait until engine and exhaust have cooled to avoid getting burned during installation.
- Electrical sparks can ignite explosive gasoline fumes. Failure to disconnect battery while working on motorcycle can also result in inadvertent engagement of starter and personal injury.

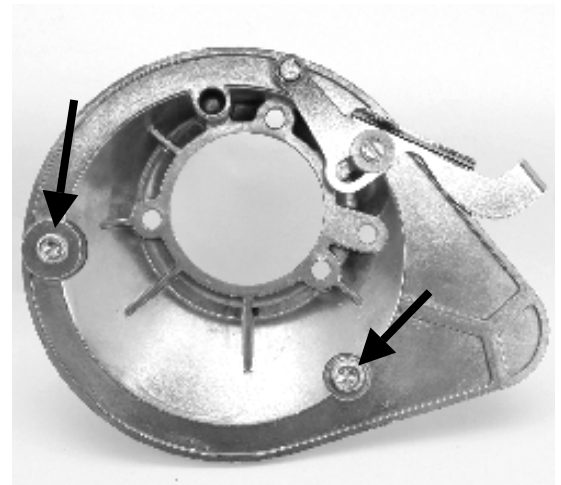

Picture 3

NOTE - Removing and tightening hard to reach Allen bolts like carb-manifold mounting bolts can be greatly simplified by using some special tools. Allen ball-end drivers are very helpful, and are available at most automotive and tool supply houses. See Picture 2.

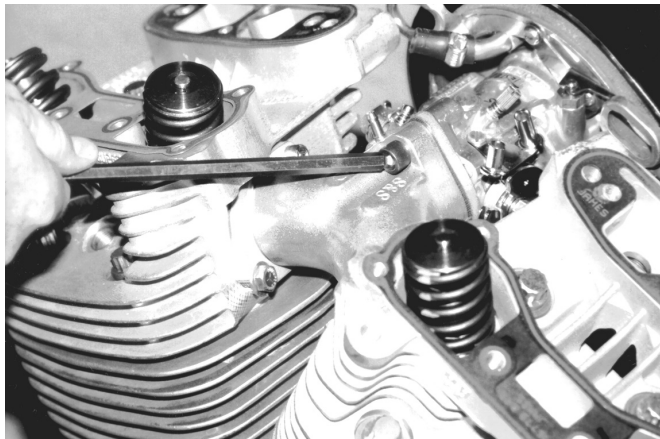

Picture 2

2- Prepare Air Cleaner Backplate

NOTE: Fast idle lever screws must not be over tightened. Loctite® or other thread locking compound may be used sparingly on threads to prevent screws from vibrating loose.



CAUTION



Over tightening fast idle lever screws may damage backplate.

A- 1936-'84 models

- 1- Knucklehead & panhead, 1936 to 1965 - Install plugs into holes in air cleaner backplate.

See Picture 3

- 2- Shovelhead, 1966 to 1979 and ironhead (IH) Harley-Davidson® Sportster® models, 1957 to 1979 - Install plug into hole in air cleaner backplate. See Picture 4.

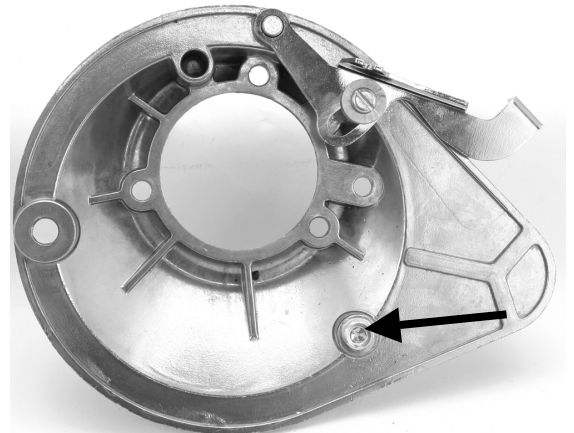

Picture 4

- 3- Shovel, 1980 to 1984 and Sportster® models 1980 to 1985 - Screw crankcase breather vent elbow fitting into hole in air cleaner backplate and angle downward as shown in Picture 5.

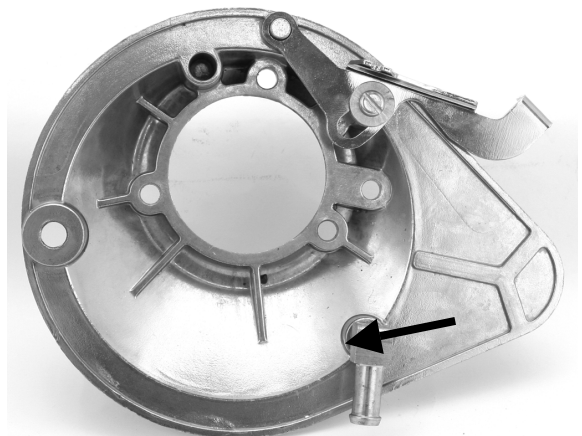

Picture 5

- 4- On 1983 and 1984 shovel engines press plug into

remaining hole on left in Picture 5.

5- Assemble fast idle mechanism as shown in Figure A.

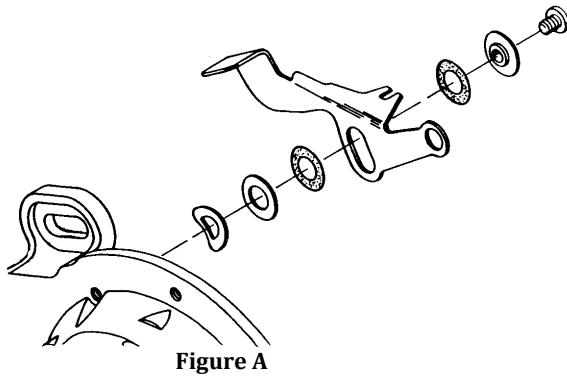

Figure A

On current backplates, the pivot point for the enricher does not have a screw holding it; a boss has been cast onto the backplate to replace this.

3- Throttle Preparation

NOTE: Throttle grip assembly must be assembled correctly and work freely to prevent possible sticking during operation. Throttle must snap closed when released. Cable routing must be free of tight bends to minimize friction between cable and housing.



If throttle does not work freely, it may inadvertently stick open possibly causing loss of control of motorcycle and personal injury to operator or others.

A- Install new throttle assembly - Motorcycles not equipped with two cable pull open-pull closed type throttle assembly.

- 1- Remove existing throttle cables and throttle grip assembly. Note routing of stock cables.
- 2- Install new throttle assembly and throttle cables. Position grip and cables so cables can be angled back toward carb for easy adjustment and free operation.
- 3- Apply light coat of cable lubricant to cables/fittings.
- 4- Loosen cable free play adjustment locknuts and thread adjusting screw so half of threads are exposed. See Picture 6.



Picture 6

B- Prepare existing throttle assembly - 1981-1985 Harley-

Davidson® Sportster® and 1981-1984 big twin chassis equipped with two cable pull open-pull closed type throttle assembly.

- 1- Loosen cable free play adjustment locknuts and thread adjusting screw so half of threads are exposed. See Picture 6.
- 2- Clean grease and dirt off cables, cable housings and cable fittings.
- 3- Apply light coat of cable lubricant to cables and fittings.

4- Install New Manifold and Mounting Hardware

NOTE: When applicable, all carburetor mounting brackets and hardware supplied in kit must be installed to secure carburetor and air cleaner backplate assembly or air horn rigidly to engine.



Improperly mounted carburetor could loosen unexpectedly, resulting in air leak, poor performance and possible damage to engine or carburetor.

Incorrect combinations of mounting hardware may cause mounting bolts to bottom out in holes or inadvertently contact other parts possibly causing damage to engine or carburetor components.



Improperly mounted carburetor may break free in event of collision or other vehicle accident creating a fire hazard with potential personal injury to operator/others.

A- All models: Clean intake ports on cylinder heads to insure proper manifold to head seal.

NOTE: Cylinder heads for knucklehead engines 1936-'47 and panhead engines 1948-'54 must be converted to o-ring style manifold and seals. Conversion kits are available from S&S®. See the Vintage section of the S&S Catalog.

B- All models: Install S&S® intake manifold. If applicable, vacuum advance fitting must point upward. Do not completely tighten manifold clamps.

C- Knucklehead and panhead engines - Remove center crankcase stud nut between tappet blocks. Install bracket, to connect crankcase stud to bottom carb-manifold mounting bolt and reinstall nut. Do not tighten at this time.

D- Shovelhead engines 1966 to 1982 - Bolt end of bracket with sharp bend to front rocker cover using 5/16"-18 x 5/8" bolt, 5/16" flatwasher and 5/16" lockwasher provided in kit. Do not tighten at this time.

E- Shovelhead engines 1983 to 1984 - Remove center crankcase stud nut between tappet blocks. Install adjustable bracket to connect crankcase stud to lower carb-manifold mounting bolt and reinstall nut.

F- Sportster® models 1957 to 1985 - Bolt end of bracket with sharp bend to front tappet guide using 5/16"-18 x 1 1/4" bolt, 5/16" flatwasher and 5/16" lockwasher provided in kit. Do not tighten at this time.

NOTE: E & G carb will not fit Sportster® models equipped with OEM style magneto due to interference between magneto and carb fuel inlet fitting. S&S does not offer adapters or other components for this application.

G- Sportster models 1983-'85 Connect vacuum operated advance ignition switch (VOES) to manifold using 8" piece of black tubing supplied in kit. Cut tubing to shorter length if necessary.

5- Install Carb

A- Check idle mixture and idle speed screw settings. Check setting of idle mixture screw on top of carb body. Turn screw clockwise to close screw, counting number of turns to fully closed position - setting should be 1 1/2 turns. Reset by turning screw counterclockwise to 1 1/2 turns open. After engine is started, screw must be reset as explained in "Adjusting Idle Mixture" section of instructions. See Picture 7.

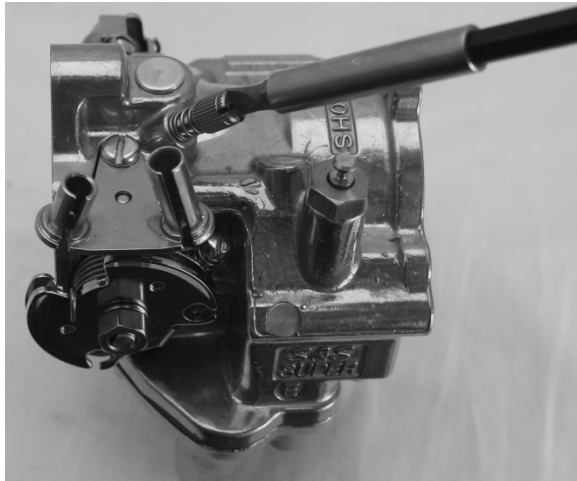

Picture 7

NOTE: Turn idle mixture screw in only far enough to contact seat. Do not over tighten.



Over tightening idle mixture screw may cause irreversible damage to carburetor body.

B- Check setting of idle speed adjusting screw. See Picture 8.

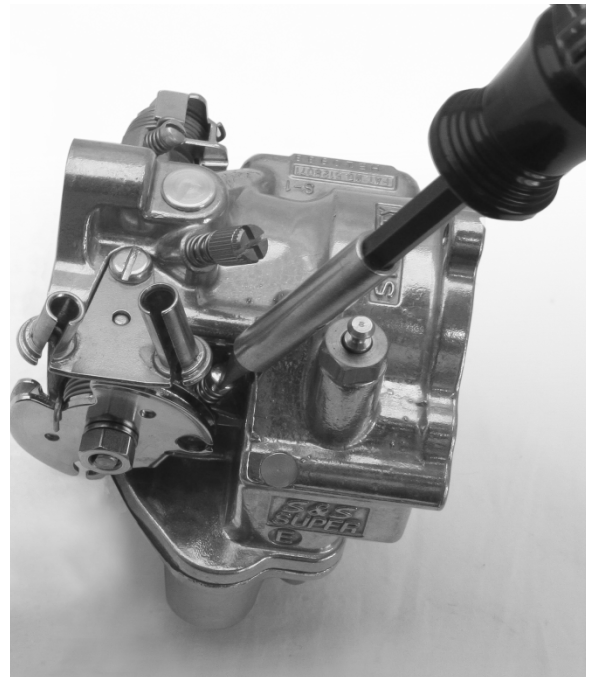

Picture 8

Turn screw counterclockwise until it no longer contacts throttle linkage spool. Next, turn screw clockwise until it just contacts spool. Then turn additional 1/2 turn clockwise to slightly open throttle plate. After engine is started, screw must be reset as explained in "Adjusting Idle Mixture" section of instructions.

C- Install throttle cables on carburetor.

- 1- Apply drop of Loctite® 242 or equivalent to threads of cable bracket screw and install the throttle cable guide on the carburetor.
- 2- Install opening side throttle cable barrel fitting and throttle cable in throttle linkage and appropriate side of throttle cable housing bracket. Opening side cable housing outside diameter is smaller and measures .190".
- 3- Repeat step 2 for closing side throttle cable. Closing side cable is easy to identify as it has a spring around inner cable wire. See Picture 9.

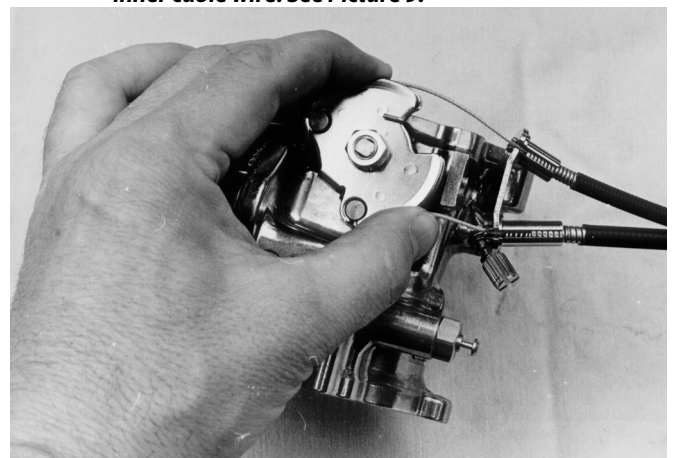

Picture 9

D- Install carb on manifold

- 1- Install manifold o-ring in o-ring groove in

insulator block.

- 2- 1936-'65 knucklehead and panhead big twins - Bolt carb and insulator block to intake manifold, (O-ring side of block faces manifold) These kits include one 3/8"-16 x 1 1/4" socket cap screw and one 3/8"-16 x 1 3/8" socket cap screw. Use the longer screw in the bottom manifold bolt hole to secure the crankcase-to-manifold support bracket to the manifold. (See important note below and concerning insulator block.)
- 3- 1957-'85 Sportster® models and 1966-'82 shovelhead big twins - Bolt carb and insulator block to intake manifold using two 3/8"-16 x 1 1/4 socket head cap screws provided in kit. (O-ring side of block faces manifold) (See important note below and caution concerning insulator block.)
- 4- 1983-84 shovelhead big twins - Bolt carb and insulator block to intake manifold, (O-ring side of block faces manifold) These kits include one 3/8"-16 x 1 1/4" socket cap screw and one 3/8"-16 x 1 3/8" socket cap screw. Use the longer screw in the bottom manifold bolt hole to secure the adjustable crankcase-to-manifold support bracket to the manifold. (See important note below and caution concerning insulator block.)

NOTE: If insulator block is not installed, manifold bolts supplied in kit will be too long and may bottom in holes. Shorter manifold bolts must be used if insulator block is not installed.

If insulator block is not installed, lower manifold bolt may damage carburetor bowl causing possible gasoline leak.



WARNING



Gasoline is extremely flammable and explosive under certain conditions. Do not smoke around gasoline. Gasoline fumes are toxic when inhaled. Any gasoline leak or spill constitutes a health and fire hazard.

D- Adjust throttle cables

- 1- Turn threaded throttle cable adjusters to remove excessive freeplay.
- 2- Test throttle to insure that it opens and closes freely. Turn handlebars to extreme left and open and close throttle, then turn bars to extreme right and open and close throttle. If throttle binds, loosen cable adjusters to put more freeplay in cables. Tighten adjusting screw locknuts after making final adjustments.

NOTE: Throttle must not bind and must snap shut to fully closed position when released.



WARNING



If throttle does not return to fully closed position when released, it may inadvertently stick open, causing possible loss of control of motorcycle and personal injury to operator or others.

- E- Slip fuel overflow hose onto fitting on carb bowl and neatly route behind pushrod tubes. On a big twin model, hose should go toward back of engine. On Harley-Davidson® Sportster® models, hose should go toward front of engine. Exit end of overflow hose must extend down below engine and away from exhaust pipes. See Pictures 10 and 11



Picture 10



Picture 11

Overflow hose must not contact hot surface such as exhaust pipe where it could melt and catch fire.

- F- Slip hose clamp over end of fuel line. Apply thin coat of oil to carb fuel inlet fitting and slip end of fuel line on fitting. Position fuel line in such a way as to avoid contact with cylinders and other hot engine parts. Tighten hose clamp. Slip protective fuel line covering over fuel line and position where contact with engine parts could occur. On models equipped with fuel line support guide, use guide if possible. Connect other end of fuel line to gas tank petcock using hose clamp provided.



CAUTION



Fuel line must be clamped securely and not contact hot surfaces such as exhaust pipes where it could melt and catch fire.

6- Install Air Cleaner Backplate

NOTE: Backplate screws supplied with kit have pre-applied thread locking compound on threads. If screw without thread locking compound is used, a thread locking compound such as Loctite® 242 must be applied to threads, and screws properly tightened. If screws are removed in future, Loctite® 242 or equivalent must be applied before reinstallation.



CAUTION



Failure to apply thread locking compound or properly tighten screws may cause screws to loosen and fall into engine, resulting in engine damage not covered under warranty.

- A- Mount air cleaner backplate on carb using three 1/4"-20 x 9/16" screw/washer assemblies. Confirm that enrichment device lever, engages enrichment device plunger, and that enrichment device plunger does not bind at any point in the travel of the lever. See Picture 12. Tighten backplate mounting screws to 5-7 ft-lbs (60-84 in-lbs).

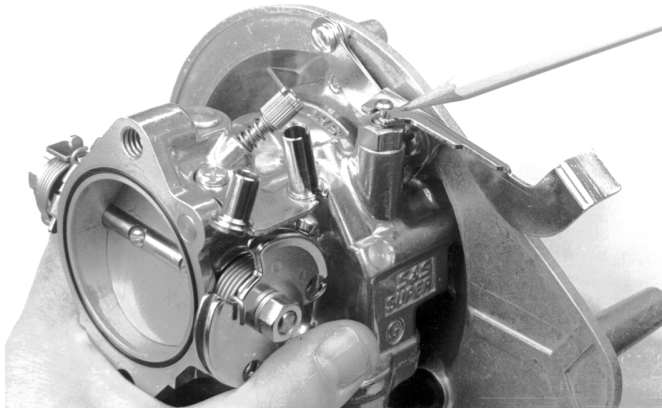

Picture 12

- B- 1957-'85 Sportster® models and 1966-'82 shovelhead big twins - Bolt carb mounting bracket to air cleaner backplate. Head of 5/16"-18 x 1" bolt should rest in hex recess on inside of backplate with threaded portion extending through backplate, two 1/8" shims and bracket. Secure with 5/16" flatwasher and locknut provided.
- C- All models - Final tighten of all mounting bracket bolts and manifold clamps.
- D- 1980-'84 Harley-Davidson® big twin & 1980 to 1985 Sportster® models - Connect crankcase breather hose to air cleaner backplate hose fitting. See Pictures 13 and 14.

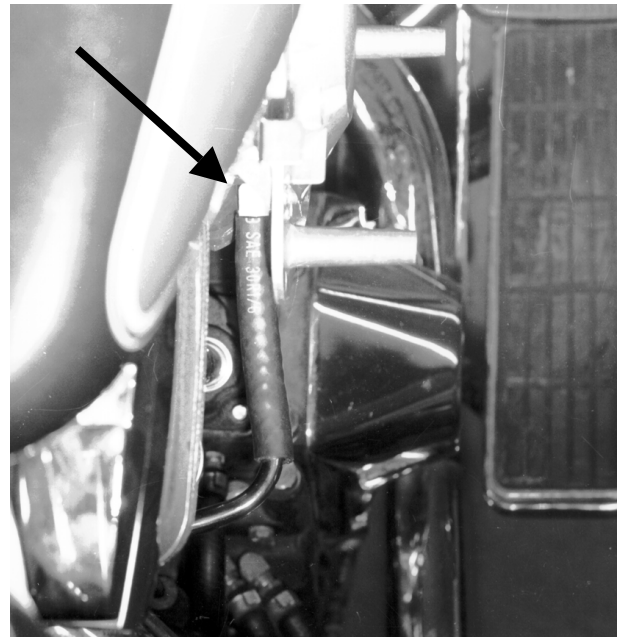

Picture 13

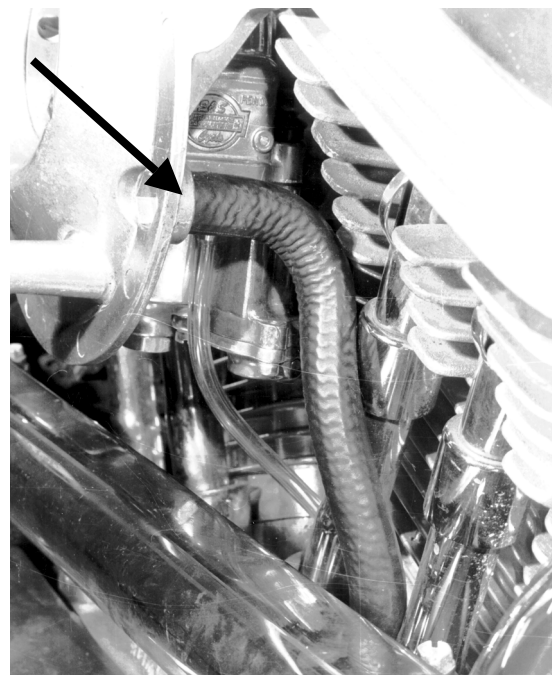

Picture 14

7- Final assembly and checks.

- A- Check carb to manifold mounting bolts.
- B- Check carb to air cleaner backplate mounting screws.
- C- Check each of following that is applicable:
- Air cleaner mounting bracket to rocker box bolts
 - Mounting bracket to air cleaner backplate bolts.
 - Mounting bracket to center case stud.
 - Mounting bracket to tappet guide bolt.
- D- Check fuel line connections and routing. Avoid hot surfaces.
- E- Check vacuum operated ignition advance connections if applicable.
- F- Check crankcase to backplate vent hose connections if

applicable.

G- Check fuel overflow hose routing. Avoid hot surfaces.

H- Test throttle to be sure it opens and closes freely. Turn handlebars to extreme left and open and close throttle, then turn bars to extreme right and check throttle. When released, throttle should snap closed in all positions.

I- Reassemble components that were removed or disassembled for carb installation. Consult authorized Harley-Davidson® service manual for installation procedure for stock parts not covered in S&S® carb instructions.

J- Check fuel needle and seat assembly. Fill gas tank with just enough fuel to test system. Lean motorcycle over towards carburetor side, turn on fuel petcock, and wait 20 seconds. If gas runs out end of carb or out overflow hose, turn off petcock and check needle and seat. See "General Information."

K- Check fuel inlet fitting and fuel line connections for leaks. Hose clamps must be tight.

NOTE: Fuel needle and seat assembly must completely shut off fuel supply to carburetor bowl. Fuel inlet fittings and fuel line connections must not leak.



Gasoline leaking past inlet needle may flood engine causing contamination of oil supply and damage to engine.



Any gasoline leak represents a health and fire hazard.

L- Install air cleaner element. Insure that element goes around outside edge of locating tang at 9 o'clock position on backplate. Correctly installed element will remain in place on backplate without support.

M- Apply blue tread locker to the three 3/4"-20 x 1" mounting screws provided, and install air cleaner cover.

N- Fill gas tank.

INSTALLATION NOTES:

- Due to the short installed length of the carb assembly, the air cleaner cover may contact the gas tank of four-speed shovelhead chassis with 5-gallon tanks. In such instances an optional chromed, notched cover that will provide additional clearance can be ordered. See Picture 15.



Picture 15

- An optional 1" spacer block can be installed between carb and manifold as an alternative.
- Bowl vent screw should be removed for any all-out racing application, which includes use of air horn or air cleaner without filter element. Exposed passage in carb body maintains equal pressure between float bowl and atmosphere. See Picture 16.

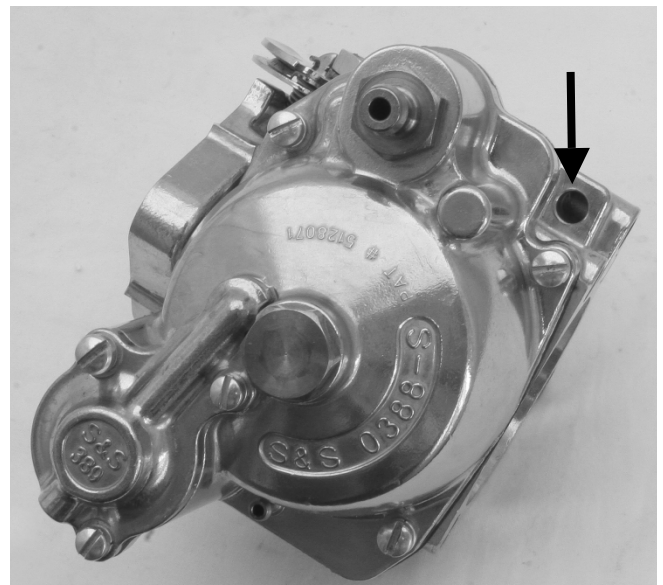

Picture 16

- On any application where air horn is used instead of air cleaner, S&S carb mounting bracket must be used to securely fasten carb to engine. See line drawing on page 21



Improperly mounted carburetor may loosen from engine resulting in gas or air leaks, poor performance and possible damage to carburetor or other components.



Any gasoline leak represents a potential health and fire hazard.

CARB OPERATION

1. Starting Procedure of Carb Operation

S&S Super E & G carburetors do not have a conventional choke. Instead, a mixture enrichment/fast idle device is used for starting and engine warm-ups. The enrichment device utilizes separate air and fuel pickup passageways and is engaged by pulling fast idle lever upward. See Picture 12 on Page 7. Super E & G carburetors also feature a fully adjustable accelerator pump which is actuated by quick throttle movements at partial throttle openings and can be used as an additional starting aid.

ENRICHMENT DEVICE NOTES:

- *Enrichment/fast idle pickup tube located directly below fast idle plunger, is pressed into carburetor body and must not be removed. See Picture 17*

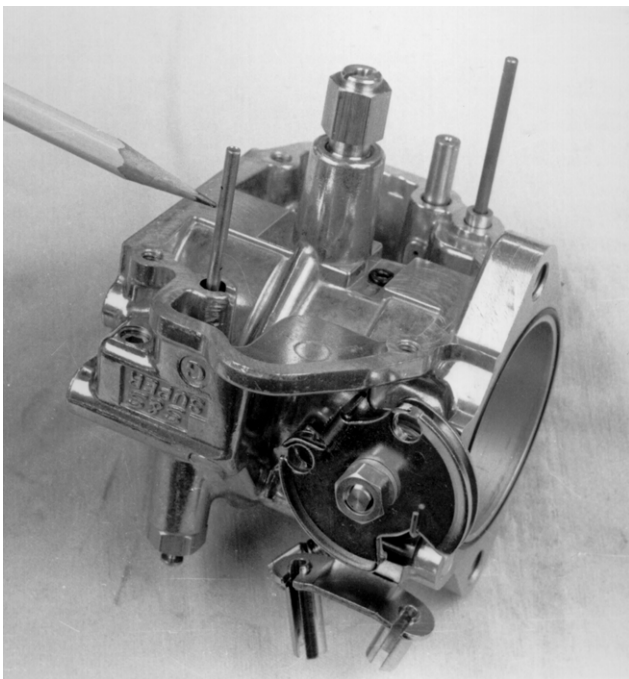

Picture 17

- *Plunger nut, plunger spring, and plunger, may be removed for cleaning purposes.*
- *If air cleaner backplate is removed, be sure fast idle lever and enrichment plunger are engaged properly and do not bind when backplate is reinstalled. See Picture 12 on page 7.*
- *S&S® enrichment system operates on manifold vacuum. If throttle is opened while starting engine, vacuum will be reduced and enrichment system will not function normally.*



CAUTION



Removal of enrichment/fast idle pickup tube from carburetor body may cause irreversible damage to carburetor.

A- Cold Starts

- 1- **Open fuel petcock.**

NOTE: When motorcycle is not running, fuel petcock/shutoff valve

should be turned off to prevent possible leakage should needle and seat not seal properly.



CAUTION



Gasoline leaking past inlet needle may flood engine causing oil contamination and engine damage.



WARNING



Gasoline leaking past inlet needle may flood engine and surrounding area creating a potential health and fire hazard.

- 2- **Prime engine with one or more squirts from accelerator pump. Ambient temperatures below 60° may require increased priming, up to 6-7 squirts depending upon exact temperature and carb jet size.**
- 3- **Pull fast idle level, to fully raised position.**
- 4- **Turn on ignition.**

NOTE: Some engines, especially those equipped with magnetos, will start easier if given two prime kicks BEFORE ignition is turned on. For reliable starting, magneto should be equipped with kill button to disable ignition for prime kicks.

- 5- **With throttle closed, kick engine through or engage electric starter.**
- 6- **If engine fails to start immediately, crack throttle enough to barely open butterfly and continue to kick or engage starter until engine fires.**
- 7- **After engine starts, position lever to maintain rpm at approximately 1000-1200 rpm with throttle closed. Lever may gradually be pushed down to closed position as engine warms. Engine should be warmed sufficiently to idle with fast idle lever off in 1 to 4 minutes or after a few miles of riding.**

NOTE: Operating engine with fast idle lever up for excessive time will result in fouled spark plugs. Push lever completely down as soon as engine will run smoothly without enrichener.

B- Hot Starts

- 1- **Open fuel petcock.**
- 2- **Turn on ignition.**
- 3- **With throttle closed, kick engine through or engage electric starter.**
- 4- **If engine fails to start immediately, open throttle slightly and continue to kick or engage starter until engine fires.**

C- Troubleshooting Tips - engine will not start:

- 1- **Fuel supply exhausted.**
- 2- **Weak or no spark - discharged battery, faulty ignition module, coil, spark plug wires, or magneto worn points or defective condenser, ,.**
- 3- **Plug gap too wide - S&S recommends .025" to .030" plug gap on engines with points type ignition and stock coil. Electronic ignitions and high output coils can run wider plug gaps. Follow ignition manufacturer's recommendations.**
- 4- **Improper ignition timing - Worn or poorly maintained mechanical advance units sometime stick in**

advanced position causing hard starting, kick-back and erratic idle.

- 5- *Tight tappet adjustment - If solid tappets are adjusted too tightly, valves may not seat properly, and the loss of compression may prevent the engine from starting.*
- 6- *Improper idle mixture and/or engine idle rpm setting. If idle mixture is set incorrectly, throttle plate must be opened farther with the idle speed screw in order to maintain idle speed. This reduces manifold vacuum and makes the enrichment circuit less effective. See "Adjusting Carburetor - Idle Circuit."*
- 7- *Enrichment device feed hole (See Picture 18) in bowl plugged. Clear with compressed air.*

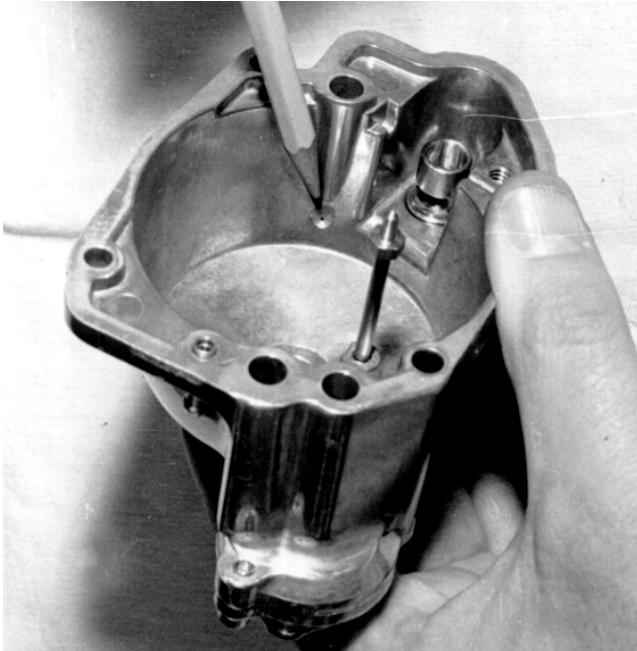

Picture 18

CAUTION

Do not use wire or drill to clear hole. If size of hole is changed, starting system will be altered and carburetor bowl irreversibly damaged.

WARNING

Compressed air and particles dislodged by compressed air are potentially harmful to eyes and body. Wear protective goggles when using compressed air and always direct air stream away from yourself and others nearby.

- 8- *Improper diagnosis of rich or lean mixture condition. If engine backfires in carb, mixture is usually lean and engine must be reprimed. If there is no response after three kicks or if engine pops in exhaust pipes, mixture is probably too rich. Leave switch on and slowly open throttle 1/4 turn with each successive kick until engine fires.*
- 9- *If engine was running properly before installation of carburetor, no other changes were made and carb settings were confirmed as instructed previously,*

hard starting is likely caused by incorrect intermediate jet or starting routine. Remain calm and patient while attempting to start motorcycle, and experiment with different starting procedures (throttle and enricher position, number of squirts from accelerator pump, etc.), especially with kickstart motorcycle. Carb tuning and ignition tuning and maintenance are critical for kick start motorcycles.

- 10- *If severe flooding is suspected, turn ignition off, slowly roll throttle to wide open position, and kick 6-8 times to clear engine. Then close throttle to approximately 1/8 turn, turn ignition on and kick until engine starts.*
- 11- *If insufficient fuel is suspected, remove air cleaner cover and confirm accelerator pump operation, with motor off, by snapping throttle open from closed position. Fuel should exit accelerator pump nozzle directly behind main discharge tube in carburetor bore.*
- 12- *If not, increase accelerator pump setting by turning adjustment screw out, in counterclockwise direction. Replace air cleaner cover and attempt to start motorcycle according to procedure previously described.*
- 13- *If more than 2-3 squirts from accelerator pump are required to start motorcycle with temperature 60° or above, larger intermediate jet may be required. This may also be caused by incorrect idle mixture adjustment or a manifold leak. Refer to following sections for additional information on tuning.*

2- Adjusting Carburetor

NOTE:

- *Adjusting Idle Circuit - Idle mixture screw regulates air/fuel mixture at idle speeds and has been angled forward for greater accessibility. See Picture 19.*
- *Throttle stop/engine rpm adjustment screw is located on boss on rear side of carburetor body. See Picture 20.*



Picture 19

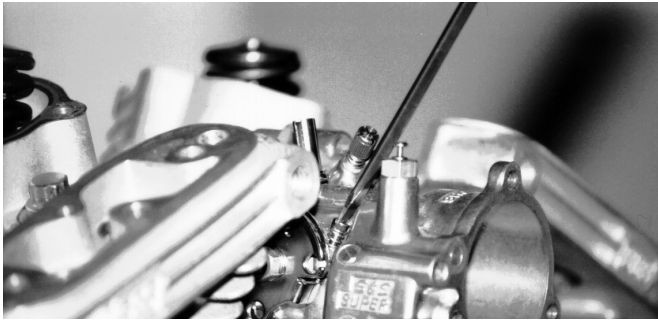

Picture 20

- 1- Start engine and run until slightly warm (approximately 1 to 2 minutes).
- 2- Turn RPM adjustment screw to obtain idle of approximately 1000 RPM.
- 3- Turn idle mixture screw clockwise, slowly leaning mixture until engine starts to stumble. Next, turn screw counterclockwise, slowly richening mixture, until engine RPM rises and then falls off. Mixture adjustment is correct when screw is positioned about halfway between these points, or generally 1/4 to 1/2 turn out from lean side of adjustment range.

NOTE: Turning screw out (counterclockwise) makes idle mixture richer. Turning screw in (clockwise) makes mixture leaner. Normally, correctly adjusted screw will be between 1 1/4 and 3/4 turns out from bottom if intermediate jet size is correct. Note that mixture screw must be adjusted according to Step 3 above. Do not leave screw at initial 1 1/2 turn setting without fine tuning.

- 4- After initial idle mixture adjustment, reset engine idle to approximately 1000 RPM. Lower idle speed can cause hard starting, poor throttle response, erratic idle and unnecessary engine wear.
- 5- After engine has reached normal operating temperature, repeat Steps 3 and 4.

IDLE CIRCUIT NOTES:

- If idle adjustments are made before engine is fully warmed, idle mixture will be rich when engine reaches operating temperature. If ambient temperature is below 60 degrees, engine may require 10-15 minutes of normal riding to reach operating temperature.
- Whenever intermediate jet change is made, idle mixture screw must be readjusted.
- If the idle mixture screw is more than 1 3/4 turns out after idle mixture is correctly adjusted, it is a fairly good indication that the intermediate jet may be too small and should be changed to the next larger size. If the idle mixture screw ends up less than 1 1/4 turn out, the intermediate jet may need to be changed to the next smaller size. Be aware that idle mixture screw adjustment can be effected by other factors, but can quite often indicate rich or lean intermediate jetting.
- If idle mixture screw is turned completely in, engine should not run at idle. If engine continues to run at idle with idle mixture screw seated, recheck initial setting of idle speed screw, and make sure enrichment plunger is seated. This may also indicate damage to the idle mixture screw needle and/or its seat.

B- Troubleshooting Tips - engine will not idle:

- 1- Improper idle mixture or rpm setting.
- 2- Intake manifold air leak.
- 3- Incorrect ignition timing, malfunctioning automatic advance mechanism, or other ignition problem.
- 4- Foreign material in air or gas passageway in carb causing gas flow restriction to idle or intermediate circuit. Picture 21 shows intermediate air bleed metering hole. Clear holes with compressed air.

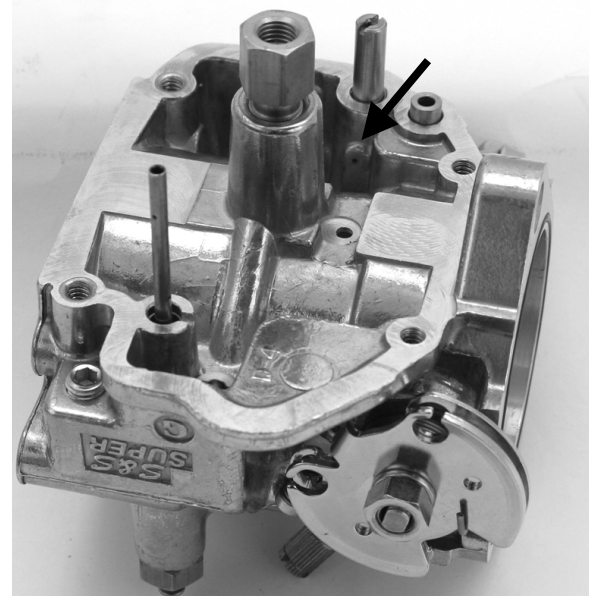

Picture 21

CAUTION

Do not use wire or drill to clear hole. If size of hole is altered, starting system will be altered and carburetor bowl irreversibly damaged.

WARNING

Compressed air and particles dislodged by compressed air are potentially harmful to eyes and body. Wear protective goggles when using compressed air and always direct air stream away from yourself and others nearby.

- 5- Enrichment/fast idle plunger not seated causing excessively rich mixture. Be sure enrichment lever is fully disengaged (in down position) allowing plunger to bottom and seal passageway. Remove air cleaner backplate. Lift and release plunger several times, letting it "snap" closed to fully seat against carb body. When backplate is reinstalled on carb, be sure lever is engaged in plunger properly and that plunger is not lifted as mounting screws are tightened. See Picture 12 on Page 7.
 - 6- 1/4" insulator block between carb and manifold omitted. Heat transfer from manifold to carb may cause temporary rich condition at idle and low rpm when engine restarted after being shut off for a short time. Install insulator block to minimize heat transfer.
- C- Adjusting Intermediate System - (See Jetting Chart Page 16) Intermediate rpm range is used most often under**

normal riding conditions. The intermediate system controls fuel delivery from just off idle to approximately 2500-3000 rpm or 55 to 60 mph depending on gearing. Close attention must be paid when selecting intermediate jet to achieve optimum performance and best gas mileage. Intermediate jet (See Picture 22) is reached by removing float bowl assembly. Size of metering hole in intermediate jet is stamped in thousandths of an inch on end or side of jet. Size of intermediate jet installed in new carburetor from S&S® is indicated on tag attached to carb or on printed label on carburetor packing box. Keep this information handy for future reference, especially when contacting S&S Technical Services Dept. for assistance. It is a good idea to record any jetting changes for future reference.

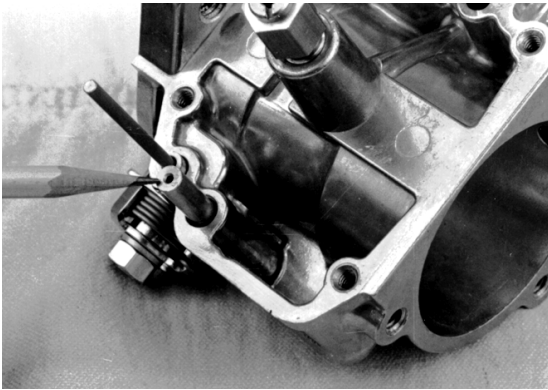

Picture 22

Intermediate Jetting Procedure:

- 1- Ride motorcycle several miles to bring engine up to normal operating temperature.
- 2- Check idle mixture adjustment to be sure setting is correct with fully hot engine. Shut off accelerator pump by turning adjusting screw clockwise until it stops. Do not force the screw.
- 3- Check throttling characteristics by slowly rolling throttle on from a steady speed. This should be done at rpm levels of approximately 2000, 2500, and 3000 rpm. (Depending upon gearing, vehicle speeds will usually be between 30 and 60 MPH). "Popping" or "spitting" (backfiring) in air cleaner indicates lean condition requiring that intermediate jet be changed to next larger size (size is stamped on end or side of jet).
- 4- Change jet accordingly, adjust mixture screw and repeat road test. Smallest intermediate jet that eliminates this condition should provide best gas mileage.

INTERMEDIATE SYSTEM NOTES:

- We recommend that you shut off accelerator pump while fine-tuning intermediate circuit as fuel supplied by pump can mask jetting symptoms. Consult "Accelerator Pump" section of instructions.
- Whenever intermediate jet is changed, idle mixture screw must be readjusted.
- Elevation changes: A simple readjustment of idle mixture

screw will often compensate for changes in elevation of several thousand feet. S&S test riders have ridden through changes upwards of 7000 feet without changing jets. In other cases, and depending upon accuracy of initial jetting, a change in intermediate and/or main jet may be required.

- Lower air density at higher elevation makes engine run richer, meaning that smaller jets may be required to correct overly rich condition. Lower elevation, nearer sea level, makes engine leaner so larger jets may be required. While rich condition can cause fouled spark plugs and poor performance, lean condition can result in engine damage. If smaller jets are installed for higher elevation, remember to install larger jets for operation at lower elevation.
- Intermediate jet provides majority of fuel under average operating conditions. While it is tempting to change main jet because it is more accessible, in most cases intermediate jet should be changed to properly address elevation/altitude-related problem.

D- Adjusting High Speed Circuit or Main Jet - High speed circuit begins around 2500-3000 rpm or 55-60 mph under steady speed conditions, and operates to maximum attainable speed. High speed circuit will be pulled in at much lower rpm if throttle is cracked open. Main jet size is best determined by testing at drag strip or dynor because maximum miles per hour, rpm and horsepower are most reliable indicators of correct jetting. Main jet (See Picture 23) is reached by removing bowl plug. (See Jetting Chart Page 16).

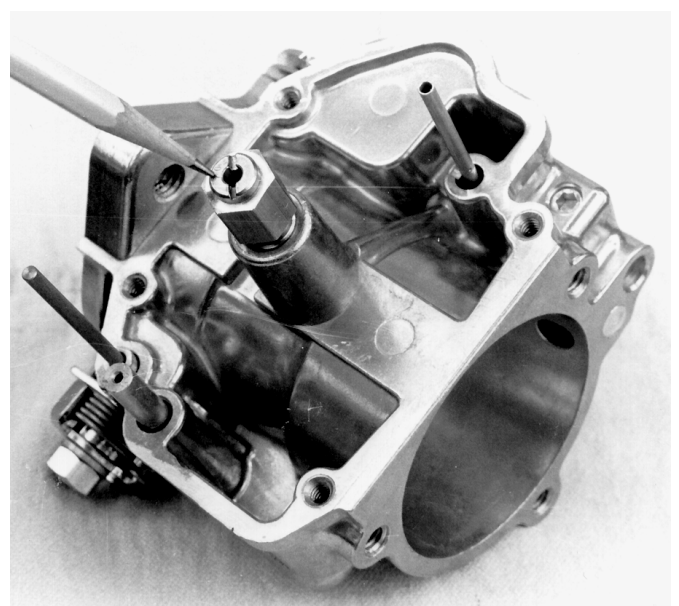

Picture 23

High Speed (Main) Jetting Procedure:

- 1- Drag strip/dynamometer procedure
 - a- Sufficiently warm engine to begin testing.
 - b- Make run noting engine rpm and final speed or horsepower.
 - c- Richen main jet by increasing jet size .004" and make second run. Again, note rpm and final speed or horsepower.
 - d- Continue procedure until mph/horsepower falls

off.

- e- Decrease or lean main jet size by .002" to gain best rpm and mph. When making runs on drag strip, strive for consistent miles per hour, not lowest ET.
- 2- Street Procedure - S&S uses "rpm" method to determine main jet size. Under racing conditions this level is where horsepower peaks and begins to taper off and is where gear shifts occur. Main jet that makes engine accelerate strongest or rpm through gears quickest is correct.

NOTE: Placing engine under load by accelerating uphill may make result of jet change more pronounced and easier to interpret.

- a- Warm engine to operating temperature.
- b- Accelerate rapidly through gears noting how quickly and smoothly engine reaches rpm level where pull of engine begins to fade and gear shift occurs.
- c- If engine backfires in carburetor and sputters or "breaks up" and/or dies during acceleration, increase or richen main jet size .004" larger and road test again. Note engine smoothness and how easily engine reaches rpm where gear shift occurs.
- d- If engine runs flat and sluggish or "blubbers" or will not take throttle, decrease or lean main jet size .004" smaller and road test again. Note engine smoothness and how easily engine reaches rpm where gear shift occurs.
- e- Continue changing main jets until jet which makes engine accelerate or rpm through gears quickest and smoothest is identified. S&S's® experience is that jetting about .006" smaller (leaner) than correct will make engine break up and quit. Jetting about .006" larger (richer) will make engine blubber and miss.

NOTES:

- Correct carb jetting is essential for optimum performance on street, strip and dynamometer. Other common causes of poor performance in modified engine are inappropriate exhaust and incorrect ignition timing.
- S&S special main jet tool is extremely handy for changing main jets. Try it, you'll like it!

E- Troubleshooting Tips for Intermediate and High Speeds Engine will not run at steady speed or rpm or quits for no apparent reason:

- 1- Restriction in fuel supply system - Gas tank vent plugged, needle and seat not working properly (See "General Information"), gas petcock too small, or defective vacuum petcock. Stock petcock is generally adequate, but may require running on reserve to provide sufficient fuel for big inch engines. If fuel delivery to carb is questionable, S&S recommends an aftermarket high flow petcock.
- 2- Faulty ignition/electrical system - Fouled plugs, worn points or condenser, defective coil or solid state module, improper ignition timing, loose wire, faulty circuit breaker or ignition switch. Many

ignition/electrical problems occur repeatedly at same rpm because of vibration specific to that rpm.

- 3- Incorrect intermediate and/or high speed jetting. See "Adjusting Carb - Intermediate System" and "High Speed Circuit or Main Jet."
- 4- Foreign material in air or gas passageway in carb causing flow restriction. Picture 24 shows intermediate air bleed metering hole. Picture 25 shows main discharge air bleed metering jet. Use compressed air to clear holes

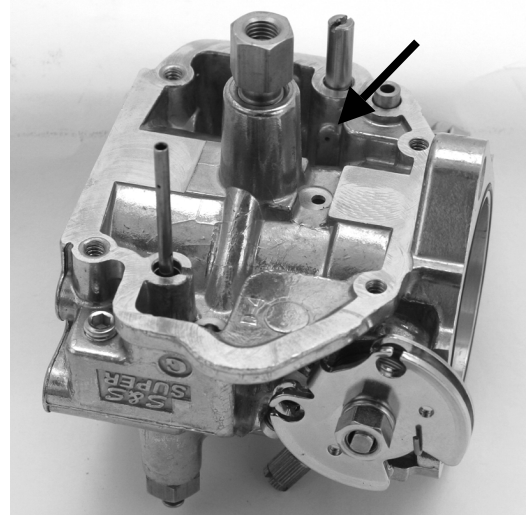

Picture 24

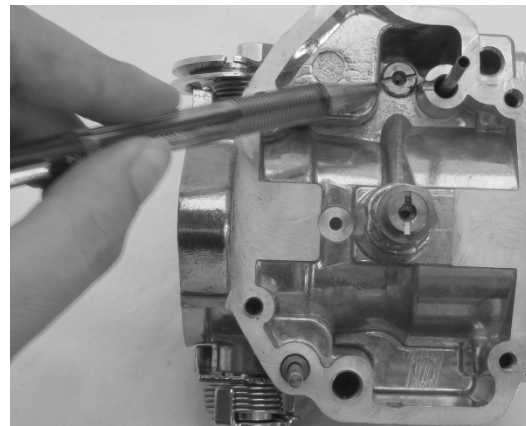

Picture 25



Do not use wire or drill to clear hole in carb bowl. If size of hole is altered, starting system will be altered and carburetor bowl irreversibly damaged.



Compressed air and particles dislodged by compressed air are potentially harmful to eyes and body. Wear protective goggles when using compressed air and always direct air stream away from yourself and others nearby.

- 6- No air cleaner used or air cleaner used is brand other

than S&S. Some air cleaners restrict air flow so that carb cannot draw air as freely as needed. Also, some air cleaners may obstruct bowl vent hole on inlet end of carb and change bowl air pressure. See Picture 26.

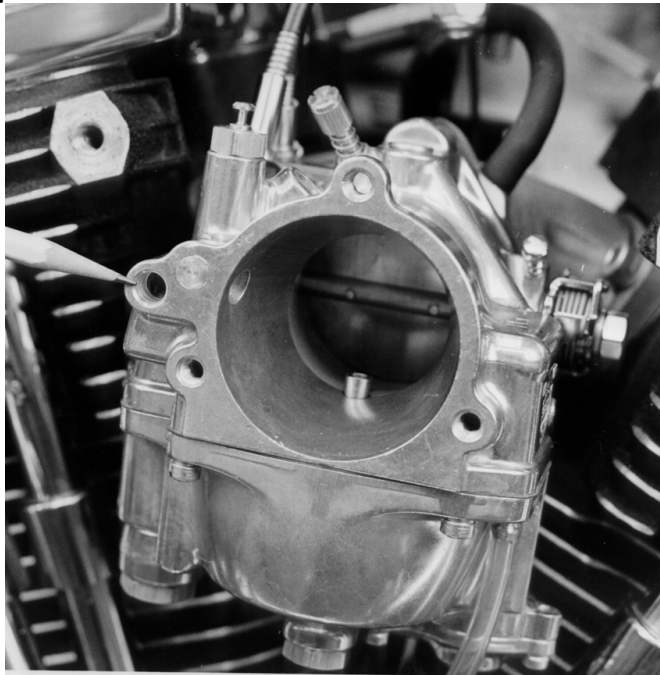

Picture 26

NOTE: Bowl vent hole passage leads to cavity above fuel in bowl. Passage equalizes bowl pressure and atmospheric pressure. If high or low bowl pressure relative to atmospheric pressure develops, engine may run erratically.

- 7- Insulator block between carb and manifold not used. Heat transfer from manifold to carb may cause temporary rich condition at idle and low rpm when hot engine is restarted after being shut off for a short time. Install insulator block to reduce heat transfer.
- 8- Air cleaner without element or air horn used without removing bowl vent screw located in downward facing boss on throttle cable side of carburetor body. See Picture 16 on Page 8.
- 9- Poor engine condition - Leaking or sticky valves, weak or broken springs, pushrod flex, improper clearances for high lift cam, or defective camshaft with improper valve timing.
- 10- Inappropriate exhaust system.

NOTE: S&S® has found that long, large diameter exhaust pipes, either baffled or unbaffled, may present insurmountable tuning problems when combined with S&S carburetor. If engine equipped with such pipes does not respond to normal tuning procedure, contact exhaust manufacturer for his tuning suggestions or call S&S for exhaust recommendation.

- 11- Too much gear- Horsepower insufficient to pull gearing.
- 12- Incorrect float setting - Setting float too high will cause engine to run rich at idle and at low speeds, and may prevent jet change from correcting over rich mixture. Float setting too low will cause poor off idle

response and may cause mixture to "lean out" at high speed or when motorcycle leaned over in curve due to insufficient fuel reserve in bowl. See General Information on Page 16 for float jetting instructions and specifications.

- 13- Fuel standoff - Occasionally, fuel may be seen misting out carburetor at full throttle when air cleaner is removed. Because carburetor is simply a conduit through which air and fuel enter engine, it does not cause fuel standoff. Usual cause is cam timing and exhaust reversion.
- 14- Overflow hose missing from the carb bowl can cause engine to miss and break up at high speeds. This problem will more than likely not occur on the dyno because the motorcycle is not moving through the air.

Adjustable Air Bleed for Super E and G Carburetors

The main air bleed passage in S&S Super "E" and "G" carburetors is fitted with a replaceable .040" jet. See Picture 25 on Page 14. The replaceable jet allows changing the size of the main air bleed. Carburetors with this feature can be identified by a serial number that begins with the letter E or higher.

NOTES:

- The standard .040" diameter air bleed is the optimum size for most engine combinations, and should not be changed under most circumstances, regardless of intermediate and main jet selections.
- Changing the main air bleed size should be done only after determining a mid range driveability problem cannot be corrected by changing the intermediate and main jets.
- For tuning the main air bleed, S&S® recommends an initial increase from the standard .040" jet to a .048" jet as a starting point. Available jets and part numbers are listed in the S&S catalog.
- It is never necessary to reduce the size of the main air bleed below .040".
- Shifting the start of main jet operation to a point higher up the rpm scale can lessen the effects of mid rpm driveability problems caused by mismatched cam and exhaust systems, but will not allow the engine to perform as well as it would with a well designed exhaust system.

INTERMEDIATE AND HIGH SPEED NOTES:

- Carburetor jetting and spark plug color - While spark plug color may be used to help determine carburetor jetting, S&S recommends that our instructions be used as primary jetting guide and that plug color indications be used as secondary aid. Different brands of gasoline, gasoline additives, engine heat, type of plugs, and spark plug heat range can effect plug color making plug reading difficult for average tuner. Also, new plugs usually require road test of 10 miles or more to properly develop color. This means that quarter mile tests may not be long enough to be a good indication of carb jetting. It is best to use recommended spark plug type and to consult spark plug manufacturer with questions.
- If bike is used exclusively on drag strip where engine temperatures vary, slightly richer jets may be necessary to

obtain best performance. Larger jets and richer mixtures will enable one to run colder engine, which is sometimes desirable. This is best determined by experimentation.

- Cams and exhaust systems can make some engines difficult to carburet. S&S has found that certain cams and exhaust systems cause poor performance at a specific rpm, and attempts to correct problem with carb tuning usually degrade carburetion at other rpm ranges. A combination of cam overlap, reversion, and back pressure, or even lack of back pressure, can cause mixture dilution at certain rpm. This will result in loss of power, engine roughness, or misfiring.
- Drag pipes –S&S does not recommend the use of straight drag pipes for street applications. They typically display a characteristic dip in midrange performance, and make tuning more difficult.
- Muffled exhaust systems - A good, economical street exhaust system consists of stock header pipes with cross-over tube and low restriction mufflers such as S&S® slip-on mufflers. This system typically produces 10 horsepower more than drag pipes in midrange, where vast majority of normal riding occurs.
- For any all-out racing application, which includes use of air cleaner without element or use of air horn, bowl vent screw (See Picture 16, page 8), should be removed to insure atmospheric air pressure exists in bowl. If high or low bowl pressure relative to atmospheric pressure develops, engine may run erratically.

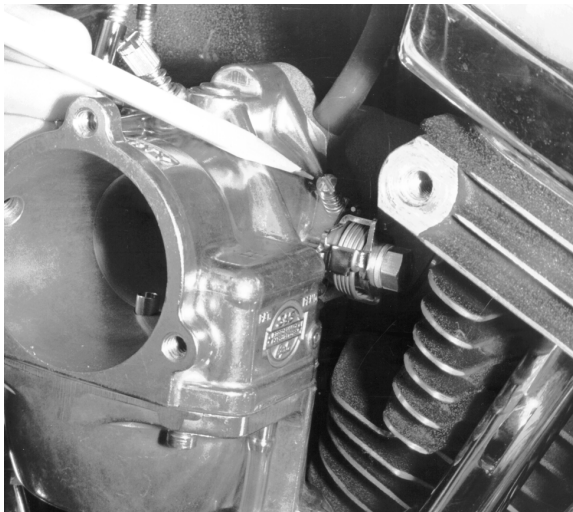

Picture 28

F- Adjusting Accelerator Pump - Function of accelerator pump is to improve throttle response when rapidly opening throttle at low rpm and to aid cold starts. Pump travel screw regulates volume of fuel delivered by accelerator pump. See Picture 28 During assembly, S&S sets screw for maximum volume to aid during initial start-up after installation. Turning screw clockwise decreases delivered pump volume. Turning screw counterclockwise increases delivered volume.

- 1- Warm engine to operating temperature.
- 2- Turn pump travel adjusting screw clockwise until screw contacts pump actuator arm. This limits actuator arm travel and shuts off pump.

CAUTION

Closing adjusting screw with excessive force may cause irreversible damage to screw threads in carburetor body.

- 3- Perform intermediate and high speed jetting tests to determine proper jetting.
- 4- With engine warm and at idle, blip throttle and note throttle response.
- 5- Turn pump travel screw counter clockwise about 1/4 turn at a time and recheck throttle response until engine no longer hesitates. This is usually about two turns out.
- 6- Road test motorcycle noting throttle response at idle and at levels in 500 rpm increments from idle to 3000-3500 rpm.
- 7- Set pump travel screw at point where best throttle response is noted with minimum pump travel. Minimum pump travel is recommended to conserve fuel, prevent spark plug fouling, and curtail black smoke from pipes when “blipping” throttle. Black smoke from pipes is usually an indication of a rich condition or excessive accelerator pump travel.

NOTE: Final accelerator pump adjustment should be confirmed by riding motorcycle and noting throttle response with motorcycle underway. Because of displacement, compression ratio, cam timing, exhaust design and other, related factors, many engines will stumble or bog if throttle is abruptly cranked fully open with engine at idle. If correct carburetor (E or G) is installed and engine properly tuned and equipped with appropriate exhaust and cam, stumble should disappear under normal riding conditions.

Approximate Jetting For S&S Super E & G Carburetors

Displacement	883cc	74 to 88ci	96 to 107 ci	111 to 124 ci
Intermediate Jet	.265 - .028	.0295	.031	.031
Main Jet	.066	.072	.076	.078

These jetting recommendations are a starting point only. Rejet carb for best performance.

GENERAL INFORMATION NOTES:

- Carburetor body has six drilled passages that are permanently sealed with drive plugs.

CAUTION

Removal of these plugs may cause irreversible damage to carburetor.

- To insure proper seal so needle completely shuts off fuel supply entering bowl, float hinge, needle lift and needle

must work freely and not bind. Float must not contact bowl gasket. If problem is suspected, remove bowl and check float movement. If obvious misalignment, binding or sticking occurs, remove, straighten and reinstall to obtain free movement. Reset float level and double check for free movement. To check, remove bowl (not accelerator pump cap) and raise float until needle is in closed position and spring in top of needle is compressed. Top of float opposite the needle and seat assembly should be $\frac{1}{8}$ " to $\frac{3}{16}$ " below bowl gasket surface. Float must not contact bowl gasket. See cut away bowl in **Picture 29**.

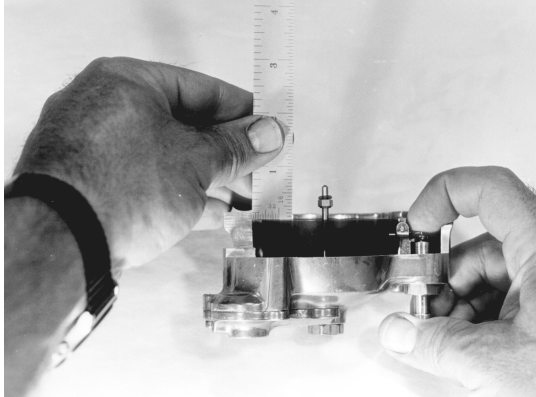

Picture 29

- When motorcycle is not running, fuel shutoff valve should always be turned off to prevent possible leakage should needle and seat not seal completely.

CAUTION

Gasoline leaking past inlet needle may flood engine causing contamination of oil supply and damage to engine.

WARNING

Any gasoline leak constitutes a fire and health hazard.

- Throttle plate and throttle shaft should be checked annually for signs of wear. Replace if necessary. If carb body throttle shaft bushings are worn, carb must be returned to S&S® for repair. If throttle plate removed, be sure to reinstall correctly. Beveled edges of plate must fit flat against carb throat. See **Figure B**.

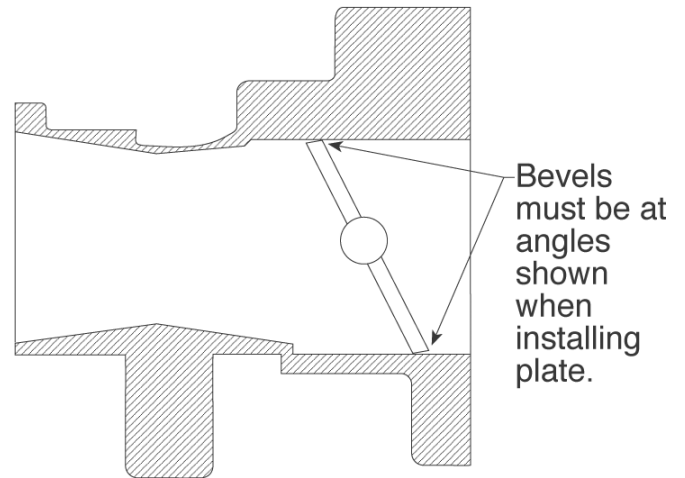
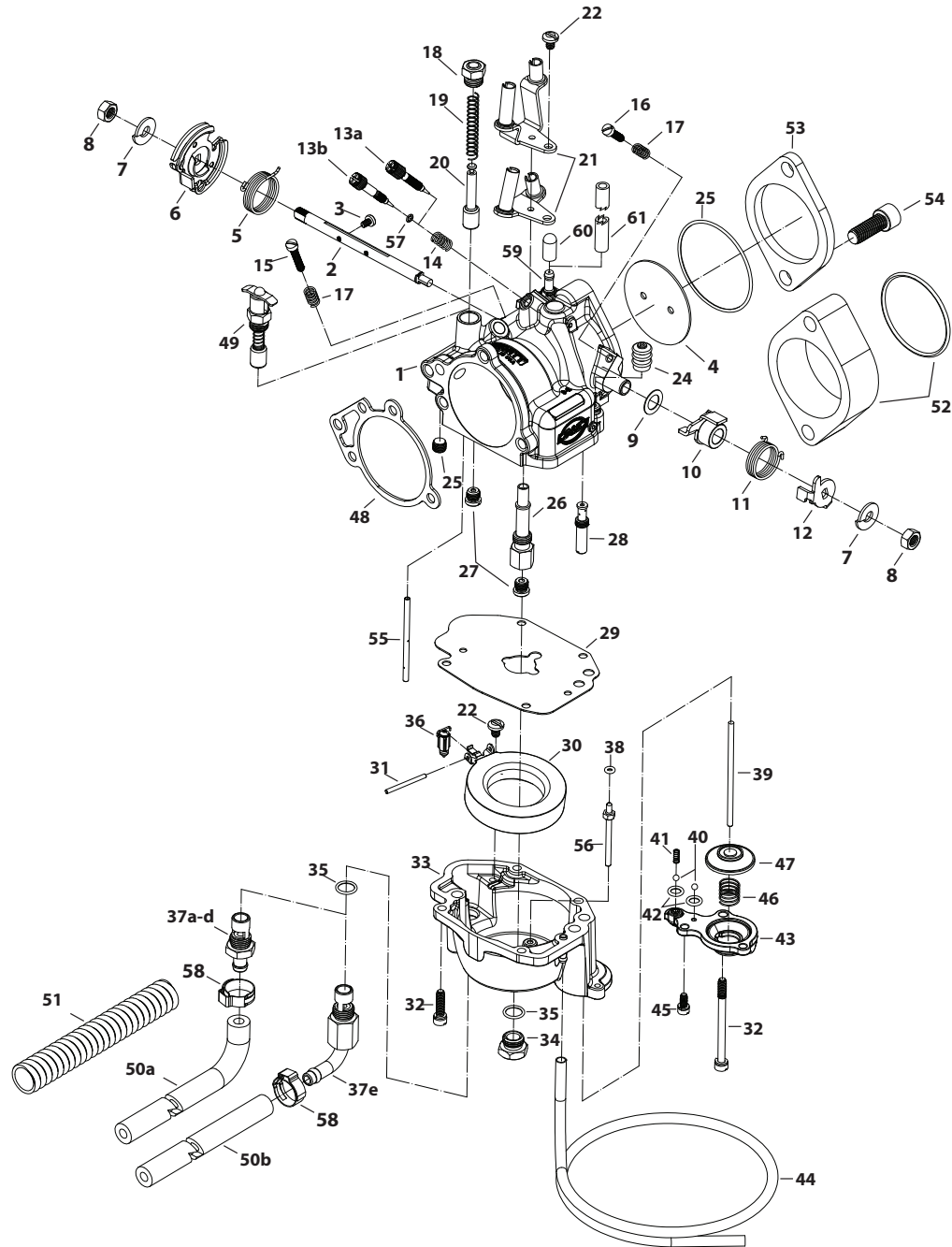

Figure B

- If accelerator pump cap is removed, lift cap slowly so small spring check balls and o-rings are not lost.
- For racing, S&S offers two air horn conversion kits which include appropriate mounting hardware and a substitute enrichment device. One includes a 2 1/2" air horn and the other includes a 4" air horn.
- If fuel delivery from stock petcock appears insufficient, S&S recommends that a high flow performance petcock be installed.
- S&S offers a complete carburetor repair and rebuild service that provides quality work at a fair price. If you are not properly equipped to service an S&S carburetor and do not have a qualified repair shop nearby, we recommend that you contact us for a Return Authorization (RA) number and send the carburetor to us. Be sure to include a note with your name and address, RA number, and a detailed description of any problems or repairs needed. Thanks for using S&S products!

SUPER E & G CARBURETOR REPLACEMENT PARTS

1. Carb body assembly		
1 $\frac{1}{8}$ " Super E	11-2381	
2 $\frac{1}{16}$ " Super G	11-2391	
2. Throttle shaft		
1 $\frac{1}{8}$ " Super E — Includes two plate screws	11-2383	
2 $\frac{1}{16}$ " Super G — Includes two plate screws	11-2483	
3. Throttle plate screw (H-D#11-2045) — (two required) (each)	50-0055-S	
10 pack	50-0064	
4. Throttle plate		
1 $\frac{1}{8}$ " Super E	11-2055	
2 $\frac{1}{16}$ " Super G	11-2355	
5. Throttle return spring (each)	11-2382	
5 Pack	11-3502	
6. Throttle spool	11-2385	
7. Throttle shaft lock washer (two required)	50-7031	
10 pack	50-7073	
8. Throttle shaft nut (two required) (each)	11-2350	
5 pack	11-2363	
9. Throttle shaft nylon washer (each)	50-7050	
10 pack	50-7072	
10. Pump actuator lever	11-2376	
11. Actuator spring (each)	11-2375-S	
5 pack	11-3501	
12. Pump actuator arm	11-2377	
13. Idle mixture screw		
a. Idle mixture screw, brass (each)	11-2354	
5 pack	11-2378	
b. Idle mixture screw only		
each	110-0003	
5 pack	110-0069	
Idle mixture screw w/ 500-0036 o-ring		
each	110-0068	
5 pack	110-0069	
14. Idle mixture screw spring (each)	11-2052	
10 Pack	11-2060	
15. Idle speed screw (each)	50-0038	
10 Pack	50-0150	
16. Pump adjustment screw (each)	50-0039	
10 Pack	50-0146	
17. Idle speed/pump adjuster spring (each)	11-2048	
10 pack	11-2053	
18. Plunger nut (each)	11-2344	
5 Pack	11-2372	
19. Plunger spring (each)	11-2340	
10 Pack	11-2359	
20. Fast idle plunger	11-2343	
21. Cable guide assembly		
Use with butterfly style cables	11-2339	
Use with constant velocity style cables	11-2338	
22. Cable clamp/float pin screw (each)	50-0041	
10 Pack	50-0062	
23. O-ring		
1 $\frac{1}{8}$ " Super E (each)	50-8016	
10 Pack	50-8094	
2 $\frac{1}{16}$ " Super G (each)	50-8015	
10 pack	50-8093	
24. Bellows seal (each)	11-2266	
5 Pack	11-2279	
25. Bowl vent plug (each)	50-0105	
10 pack	50-0151	
26. Main discharge tube	11-2085	
27. Main jet — See Chart on pg 5-58		
28. Intermediate Jets — See Chart on pg 5-58		
Series #94 fits all Super 1 $\frac{1}{8}$ ", 2 $\frac{1}{16}$ ", 2 $\frac{1}{4}$ " gas carburetors.		
29. Bowl gasket (each)	11-2386	
10 pack	11-2387	
30. Float	11-2187	
31. Float pin (each)	11-2369	
5 Pack	11-2370	
32. Bowl screw		
10-24 x $\frac{3}{4}$ " — Three required (each)	50-0034	
10 Pack	50-0063	
10-24 x $\frac{23}{8}$ " — One required (each)	50-0040	
10 Pack	50-0061	
33. Carb bowl (only)	11-2388	
Carb bowl complete assembly	11-2388P	
34. Bowl plug (each)	11-2090	
5 pack	11-2092	
35. Seat o-ring* (required with part #11-2465 & #11-2466 only when replaces 360° style fuel inlet.)		
each	50-8009	
10 pack	50-8095	
36. Needle		
1 $\frac{1}{8}$ " Super E & 2 $\frac{1}{16}$ " Super G	11-2195	
Racing only	11-2197	
37. Seat — Includes O-ring #35		
(Replaces obsolete seats 11-2347 and 11-2348)		
a. 1 $\frac{1}{8}$ " E & 2 $\frac{1}{16}$ " G (Uses part #11-2195 needle)	11-2465	
b. Racing only (Uses part #11-2197 needle)	11-2466	
c. Racing only — threaded fuel inlet (6AN .157" ID)		
(Uses part #11-2195 needle)	11-2395	
d. Racing only — threaded fuel inlet — (6AN .235" ID)		
(Uses part #11-2197 needle)	11-2396	
e. Permeation Compliant fuel inlet seat Super E or G		
(Uses part #11-2195 needle)	106-2011	
38. Ejector nozzle o-ring (each)	50-8011	
10 Pack	50-8096	
39. Pump pushrod (each)	11-2373	
5 Pack	11-2393	
40. Ball check — (two required) (each)	50-8090	
10 pack	50-8125	
41. Ball check spring (each)	11-2374	
5 Pack	11-2392	
42. Pump cap o-ring — (two required) (each)	50-8012	
10 Pack	50-8100	
43. Pump cap assembly	11-2389	
44. Overflow hose per 24" (H-D#27369-76) (each)	19-0262-S	
5 Pack	19-0263	
45. Pump cap screw 8-32 — (two required) (each)	50-0042	
10 Pack	50-0098	
46. Diaphragm spring (each)	11-2275	
10 pack	11-2278	
47. Diaphragm	11-2282	
48. Gasket, backplate (each)	106-1724	
10 pack	106-2328	
49. Enrichment device (Use with air horn only)	11-2084	
50. Fuel line		
a. Fuel line With 90° bend* 19" (Use with part #11-2465 or #11-2466)		
USA 1,2,3 TÜV 1,2,3,4,5,6,7	19-0475A	
b. Permeation Compliant straight, 311" x .563" x 17.5"		
(Use with part #106-2011, 90° seat)	190-0001	
51. Fuel line insulator — 12" USA 1,2,3 TÜV 1,2,3,6,7	19-0172	
52. Spacer, Kit, w/ O-ring		
1 $\frac{1}{8}$ " x 1"	16-0057*	
2 $\frac{1}{16}$ " x 1"	16-0357*	
2 $\frac{1}{4}$ " x 1"	16-0157*	
* Use with 1" Spacer Block	16-0058	
53. Insulator Block, Manifold, Super E, w/ O-ring		
1 $\frac{1}{8}$ " x $\frac{1}{4}$ "	16-0491	
1 $\frac{1}{8}$ " x $\frac{3}{8}$ "	16-0497	
2 $\frac{1}{16}$ " x $\frac{1}{4}$ "	16-0492	
2 $\frac{1}{16}$ " x $\frac{3}{8}$ "	16-0498	
2 $\frac{1}{4}$ " x $\frac{1}{4}$ "	16-0499	



54. Screw	
1" x 3/8" -16 (each)	50-0161
10 pack	50-0186
1 1/4" x 3/8" -16 (each)	50-0162
10 pack	50-0177
1 3/8" x 3/8" -16 (each)	50-0163
5 pack	50-0178
2" x 3/8" -16 (each)	50-0164
5 pack	50-0185
2 1/4" x 3/8" -16 (each)	50-0165
5 pack	50-0180
2 1/2" x 3/8" -16 (each)	50-0166
1 1/4" x 1/4" -20 (each)	50-0008
10 pack	50-0153
1 1/2" x 1/4" -20 (H-D#4718A)	50-0079
2 1/4" x 1/4" -20 (H-D#4717A)	50-0078

55. Tube, Fast Idle Pick-Up, Super E/G, 125" x 2.350", Brass	0381F
56. Tube, Ejector Nozzle, Super E/G, Flared, Brass	106-6124
57. O-ring, 3mm x 5mm x 1mm (each)	500-0036
10 pack	500-0148
58. Clamp, 3/8" - 7/8"	50-8002
59. Hose, Fitting straight, .040"	16-0134
60. VOES Fitting Cap	50-8372
61. VOES/Oil Return Hose	19-0395

SUPER E & G AIR CLEANERS REPLACEMENT PARTS FOR 1936-'84 BIG TWINS & 1957-'85 SPORTSTER® MODELS

- | | |
|--|---|
| 1. Air cleaner cover – All
(Except shovelhead w/5 gallon tanks & cylinders + .075") | |
| Chrome | TÜV _{2,7} 17-0378 |
| Black | 17-0384 |
| Slasher | 17-0004 |
| Shovelhead w/5 gallon tanks & cylinders +.075" | 17-0372 |
| 2. Element, pleated | 106-4722 |
| Element, pleated carbon | TÜV _{1,2,3,7} 17-0375 |
| 3. Backplate | |
| BT 1936-'84 | TÜV ₅ 17-0330 |
| 4. Cover screw | |
| Nickel (H-D#1305) (each) | 50-0072 |
| 3 pack | 50-1052 |
| 10 pack | 50-0094 |
| Black (H-D#902) (each) | 50-0310-S |
| 3 pack | 50-0310 |
| Chrome (each) | TÜV ₅ 50-0347-S |
| 10 pack | TÜV ₅ 50-0347 |
| 5. Backplate screw | |
| Zinc Plated (each) | 106-2084 |
| 10 pack | 106-2105 |
| 6. Fast idle friction washer (each) | 50-7035 |
| 10 pack | 50-7058 |
| 7. Fast idle steel washer (each) | 50-7037 |
| 10 pack | 50-7061 |
| 8. Fast idle nylon washer (each) | 50-7036 |
| 10 pack | 50-7060 |
| 9. Fast idle lever | USA _{1,2,3} TÜV _{1,3,4,5,6,7} 17-0329 |
| 10. Fast idle brass washer (each) | 50-7007 |
| 10 pack | 50-7010 |
| 11. Fast idle lever screw (one required for current
backplate) (each) | 50-0041 |
| 10 Pack | 50-0062 |
| 12. Shims | |
| $\frac{5}{16}$ " x .125" | |
| (Use on BT 1936-'84 when insulator block is installed.) | |
| each | 50-7042 |
| 2 pack | 50-7042P |
| 5 pack | 50-7066 |
| 13. Backplate mounting bolt – BT 1936-'84 | |
| $\frac{5}{16}$ "-18 x 1" (each) | 50-0108 |
| 10 pack | 50-0155 |
| $\frac{5}{16}$ "-24 x $\frac{3}{4}$ " (Obsolete) | N/A |
| 14. Elbow fitting (each) | 50-8110 |
| 5 pack | 50-1005 |
| 15. Crankcase breather hose | |
| a. BT 1978-'92 | TÜV ₅ 17-0113 |
| 16. Vent hose connector | 50-8111 |
| 17. Backplate plug $\frac{1}{8}$ "-27 (H-D#45830-48) (each) | 50-8331 |
| 10 pack | 50-1015 |
| 18. Locknut – $\frac{5}{16}$ "-1
(Use with support bracket – see #19) | 50-5021 |
| 19. Support bracket | |
| a. BT 1966-'78 | 17-0392 |
| b. BT 1979-'84 (includes #13, 18, 28) | TÜV ₅ 16-0471 |
| c. BT 1948-'65 | 16-0096 |
| d. XL 1957-'85 | 17-0393 |
| 20. Mounting bracket bolt – big twin | |
| a. IH XL 1957-'85 – $\frac{5}{16}$ "-18 x $1\frac{1}{4}$ " (each) | 50-0110 |
| b. 1966-'82 – $\frac{5}{16}$ "-18 x $\frac{5}{8}$ " (each) | 50-0106 |
| 10 pack | 50-0220 |
| 21. Lockwasher – $\frac{5}{16}$ " | 50-7032 |
| 22. Flatwasher – $\frac{5}{16}$ " x $\frac{1}{8}$ " | 50-7033 |
| 23. Wire tie (N/S) | 50-8003 |
| 24. Hose clamp (N/S) | 50-8002 |
| 25. Air cleaner assembly | |
| Includes: | |
| Chrome cover, backplate, filter element, and hardware kit.) | |
| BT 1936-'84/1957-'85 XL | 17-0400 |
| BT 1966-'84 with five gallon tanks
and cylinders .075" longer than stock | 17-0440 |
| 26. Mounting hardware package (N/S) | |
| Includes all parts needed to install following style air cleaners: | |
| BT 1936-'84 | 17-0441 |
| 27. Spring clamps (N/S) | 50-8001 |
| 28. Washer, Flat, .344" x .688" x .065", Zinc, Steel (H-D#6016, 6320, 70907-07) | 50-7034 |

(N/S) = Not Shown

N/A= No longer available

NOTE

The line drawing is used for illustration purposes only. Not all of the parts shown are included and used in every carb installation. Parts followed by an N/A are no longer available. Those followed by an (NS) means parts are not shown.

1936-'84 Big Twin & 1957-'85 XL

