



Installation Instructions: S&S® Special Application and 3½" & 3⅝" Bore Crankcases for 1991-'03 Harley-Davidson® Sportster® Models and 1994-'03 Buell® Models

DISCLAIMER:

S&S parts are designed for high performance, closed course, racing applications and are intended for the very experienced rider only. The installation of S&S parts may void or adversely affect your factory warranty. In addition such installation and use may violate certain federal, state, and local laws, rules and ordinances as well as other laws when used on motor vehicles used on public highways, especially in states where pollution laws may apply. Always check federal, state, and local laws before modifying your motorcycle. It is the sole and exclusive responsibility of the user to determine the suitability of the product for his or her use, and the user shall assume all legal, personal injury risk and liability and all other obligations, duties, and risks associated therewith.

The words Harley®, Harley-Davidson®, H-D®, Sportster®, Evolution®, and all H-D® part numbers and model designations are used in reference only. S&S Cycle is not associated with Harley-Davidson, Inc.

SAFE INSTALLATION AND OPERATION RULES:

Before installing your new S&S part it is your responsibility to read and follow the installation and maintenance procedures in these instructions and follow the basic rules below for your personal safety.

- Gasoline is extremely flammable and explosive under certain conditions and toxic when breathed. Do not smoke. Perform installation in a well ventilated area away from open flames or sparks.
- If motorcycle has been running, wait until engine and exhaust pipes have cooled down to avoid getting burned before performing any installation steps.
- Before performing any installation steps disconnect battery to eliminate potential sparks and inadvertent engagement of starter while working on electrical components.
- Read instructions thoroughly and carefully so all procedures are completely understood before performing any installation steps. Contact S&S with any questions you may have if any steps are unclear or any abnormalities occur during installation or operation of motorcycle with a S&S part on it.
- Consult an appropriate service manual for your motorcycle for correct disassembly and reassembly procedures for any parts that need to be removed to facilitate installation.
- Use good judgment when performing installation and operating motorcycle. Good judgment begins with a clear head. Don't let alcohol, drugs or fatigue impair your judgment. Start installation when you are fresh.
- Be sure all federal, state and local laws are obeyed with the installation.
- For optimum performance and safety and to minimize potential damage to carb or other components, use all mounting hardware that is provided and follow all installation instructions.
- Motorcycle exhaust fumes are toxic and poisonous and must not be breathed. Run motorcycle in a well ventilated area where fumes can dissipate.

IMPORTANT NOTICE:

Statements in this instruction sheet preceded by the following words are of special significance.

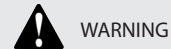

WARNING

Means there is the possibility of injury to yourself or others.



CAUTION

Means there is the possibility of damage to the part or motorcycle.

NOTE

Other information of particular importance has been placed in italic type.

S&S recommends you take special notice of these items.

WARRANTY:

All S&S parts are guaranteed to the original purchaser to be free of manufacturing defects in materials and workmanship for a period of twelve (12) months from the date of purchase. Merchandise that fails to conform to these conditions will be repaired or replaced at S&S's option if the parts are returned to us by the purchaser within the 12 month warranty period or within 10 days thereafter.

In the event warranty service is required, the original purchaser must call or write S&S immediately with the problem. Some problems can be rectified by a telephone call and need no further course of action.

A part that is suspect of being defective must not be replaced by a Dealer without prior authorization from S&S. If it is deemed necessary for S&S to make an evaluation to determine whether the part was defective, a return authorization number must be obtained from S&S. The parts must be packaged properly so as to not cause further damage and be returned prepaid to S&S with a copy of the original invoice of purchase and a detailed letter outlining the nature of the problem, how the part was used and the circumstances at the time of failure. If after an evaluation has been made by S&S and the part was found to be defective, repair, replacement or refund will be granted.

ADDITIONAL WARRANTY PROVISIONS:

- (1) S&S shall have no obligation in the event an S&S part is modified by any other person or organization.
- (2) S&S shall have no obligation if an S&S part becomes defective in whole or in part as a result of improper installation, improper maintenance, improper use, abnormal operation, or any other misuse or mistreatment of the S&S part.
- (3) S&S shall not be liable for any consequential or incidental damages resulting from the failure of an S&S part, the breach of any warranties, the failure to deliver, delay in delivery, delivery in non-conforming condition, or for any other breach of contract or duty between S&S and a customer.
- (4) S&S parts are designed exclusively for use in Harley-Davidson® and other American v-twin motorcycles. S&S shall have no warranty or liability obligation if an S&S part is used in any other application.

KIT CONTENTS:

- Crankcase assembly, S&S® Special Application for Harley-Davidson® Sportster® models, Part 31-1001 (special order) with following parts installed:
 - 31-1000LD Insert, left main bearing, w/bearing race installed
 - 31-4050 Race, right main bearing (H-D® #8881) Race is final honed with size marked on tag wired to case
 - 31-4061 Bearing, cam (H-D® #9057) (Qty 4)
 - 31-2048 Nut, press-in, 3/8" x 16", xl rear motor mount (H-D® #16240-82) (Qty 2)
 - 31-2049 Pin, shifter spring (H-D® #24530-90)
 - 50-8018 Dowel, primary cover locating (H-D® #24754-75) (Qty 3)
 - 50-8019 Dowel, gear cover alignment (H-D® #215) (Qty 2)
 - 50-8080 Stud, transmission shifter shaft (H-D® #5226A) (Qty 2)
 - 31-2005 Plug, timing hole (Qty 2)
 - 31-2006 Plug, magnetic drain (Qty 3)
 - 50-7044 Shim 5/16" x 3/4" x .350"
 - 50-0013 SHC Screw 1/4"-20 x 2"
 - 50-0319 BHC Screw 3/8"-16 x 1/2"
 - 56-3028 Bearing, trans. output shaft (H-D® #8996)
 - 56-3031 Bearing, trans. countershaft (RH) (H-D® #8977)
 - 56-3032 Bearing, trans. shifter drum (RH) (H-D® #9151)
- 31-2051 Valve assembly, reed
- 56-3020 Door kit, transmission access, includes:
 - 56-3025 Door assembly, trans. access - S&S xl cases
 - 56-3025A Door, trans. access
 - 50-8020 Pin, dowel. 1/8" x 3/4" (trans. access door)
 - 56-3030 Bushing, shifter drum (H-D® #9187)
 - 56-3026 Bearing, trans. countershaft (LH) (H-D® #8998)
 - 56-3027 Bearing, trans. mainshaft (LH) (H-D® #35030-89)
 - 50-8052 Snap ring, int. ret. Tru-arc (trans. mainshaft bearing) (H-D® #35038-89)
 - 50-8053 Snap ring, int. ret. Tru-arc (trans. idler shaft bearing) (H-D® #35021-89)
 - 50-0110 Screw, 15/16" -18" x 1 1/4" HHC (hex head cap) (H-D® #2871W)
 - 50-0102 Screw, 5/16" -18" x 4", HHC - positions E, F, G, H, S&S xl crankcases (H-D® #4100HW) (Qty 4)
 - 50-7033 Washer, flat - 5/16" x 1 1/16" x 1/8" steel (H-D® #6107B) (Qty 5)
- 31-1000HC hardware package, includes:
 - 31-2005 Plug, timing hole (H-D® #720) (Qty 2)
 - 50-0004 Screw, stator mounting, 10-24 x 1" (H-D® #2720) (Qty 4)
 - 50-0023 Screw, stator wire cover, 10-24 x 3/8" (Qty 2)
 - 31-2050 Cover, stator wire
 - 50-0044 Stator screw 10-24 x 1"
 - 50-8112 45 deg 1/8" NPT fitting
 - 50-5119 90 deg 1/8" NPT fitting
- 31-1000HB Hardware package, xl case w/trans, includes:
 - 50-7021 Washer, 1/4" flat (Qty 2)
 - 50-5010 Nut, HH lock, 1/4-28 (Qty 2)
 - 50-8115 Fitting, hose, 1/8-27 pipe (Qty 2)
 - 50-0014 Screw, 1/4-20 x 1/2" HHC
 - 50-7018 Washer, flat copper
- 106-3134 Oil Filter Mount Kit
 - 106-2682 90° Pipe Fittings 1/8-27 NPT (Qty 2)
 - 106-4423 Oil Filter Mount Gasket
 - 106-4427 Oil Filter Mount
 - 50-8110 90° Brass Fitting
 - 50-8112 45° 1/8-27 NPT Fitting (Qty 2)
 - 50-8115 Straight 1/8-27 Fitting (Qty 2)
- Following parts are also provided:
 - 8- Studs, cylinder mounting. Part # depends on cylinder type and length
 - 31-1000BA Bolts, S&S xl crankcase, one set
 - 56-3029 Seal, oil, trans. output shaft, belt drive (H-D® #12050)
 - 33-2329 Pinion shaft, S&S special xl
 - 31-4057 Bearing assembly, right main (H-D® #24659-87)
 - 31-4060 Seal, left main bearing (H-D® #35151-74) OR:
 - 31-4010 Seal, left main bearing, for 1970-up big twin sprocket shaft mainshaft (spec. order crankcase only)
 - 31-4059 Bearing assembly, Timken® sprocket shaft main (less races installed by S&S), OR:
 - 31-4013 Bearing assembly, Timken® sprocket shaft main (H-D® #9028) for 1955-'65 big twin mainshaft (spec. order crankcase only)
 - 56-3028 Bearing, trans. output shaft (H-D® #8996)

- Installation instructions
- Certificate of origin
- Optional:
 - 31-2055X Cover assembly, transmission inspection, includes:
 - 31-2055 Cover, trans. inspection hole - S&S xl cases
 - 50-8081 Stud $\frac{5}{16}$ -24 x 1.370", xl trans. inspection hole door (Qty 8)
 - 50-7034 Washer, flat - $\frac{5}{16}$ " x $\frac{1}{16}$ " x $\frac{1}{16}$ " steel (H-D® #6702) (Qty 8)
 - 50-5023 Nut, hex - $\frac{5}{16}$ -24 (H-D® #7833) (Qty 8)
- Other, additional hardware may be included depending upon individual order

INTRODUCTION

S&S Crankcases for Harley-Davidson® Sportster® motorcycles require minimum preparation. Because of their many special features and requirements, it is recommended that a skilled engine builder having considerable experience with Sportster® models and high performance engines assemble them. It is also recommended that the engine be mocked up and installed in the chassis to check exterior clearances before final assembly of the engine and motorcycle.

S&S produces crankcases to fit 1986-'03 Sportster® Models. There are a wide range of variations offered plus custom special order configurations.

These variations can be split in to some common groups. Early (1986-'90 4 speed chassis) and Late (1991-'03 5 speed chassis) are designations used to describe which valvetrain configuration the cases are machined for. So you may see parts marked as "early", "4" or "4 speed". Any of these descriptions would describe cases, lifters, lifter blocks or heads for early 1986-'90 4 speed pushrod geometry.

Another variation in pushrod geometry is the difference between stock and Special application (SA) cases. S&S Special application cases use a .5" longer than stock pinion shaft. This requires different cylinder head pushrod tube machining and unique lifter blocks. Stock geometry heads and lifter blocks will be identified by ST. SA cases will require parts marked with "SS" or "SA".

Heads, cams, cam covers, tappets, cases and tappet blocks from different groups should not be mixed and matched. Also, S&S does not produce lifter blocks that allow the use of 2000-up lifters. If S&S cases are being used in 2000 to 2003 applications, use 1991-1999 lifters and lifter blocks.

Read all instructions thoroughly. When they are completely understood, proceed with assembly and installation.

NOTE: Because of the additional width of S&S SA crankcases and possible changes in engine height due to increased stroke and/or deck height, pay particular attention to clearances between the engine and drive belt or chain, foot controls, rear brake master cylinder, and kickstand mount. Areas above the rocker covers also require close inspection. In some instances, the frame or other components will require modification.

All reference to Harley-Davidson® part numbers is for identification purposes only. We in no way are implying that any of S&S® Cycle's products are original equipment parts or that they are equivalent to the corresponding Harley-Davidson® part number shown.

FEATURES AND REQUIREMENTS

In addition to special design elements for large displacement, high performance applications, S&S® crankcases for Sportster® models incorporate what S&S believes to be the best features of four and five speed Sportster® engines. Crankcases require the following parts for completion:

- Charging system, transmission, and clutch: five speed Sportster® models 1991-'03.
- S&S cylinder heads & billet lifter guides. (See important notes below).

NOTE: While it is possible to use stock 4 speed lifter guides and cylinder heads, they require extensive modification. It is usually more time and cost-effective to use S&S products designed specifically for Special Application crankcases.

- Cases can be ordered for 1986-'90 4-speed or 1991-'03 5-speed style cams. Correct cams and gearcase cover must be used. 1986-'90 cams require 1986-'90 style gearcase cover, Harley-Davidson® #25219-86.
- 1991-'03 cams require 1991-'03 style cover, #25219-91A. S&S gasket 31-2052 must be used with 1991-'03 style cover. See following Caution concerning late 5-speed cover H-D® part #25219-91B. S&S offers various styles of gear covers for the different year groups.
- Lifter blocks are not available for 2000-'03 style lifter. 1991-'03 applications require H-D® part #18526-89 lifter.

NOTE: S&S crankcases are compatible with some early Sportster® model gearcase covers. Late model covers have different oil passage locations.

CAUTION

Use of 25219-91B cover or incorrect cover gasket on S&S crankcase will cause oil starvation and extensive engine damage not covered under warranty. See Picture 1 next page. This style cover is not available from H-D®. S&S offers billet covers for both 1986-'90 and 1991-'03 style cams.

- Any Harley-Davidson® Evolution® Sportster® model oil pump can be used.

All reference to Harley-Davidson® part numbers is for identification purposes only. We are in no way implying that any of S&S Cycle's products are original equipment parts or that they are equivalent to the corresponding Harley-Davidson® part number shown.

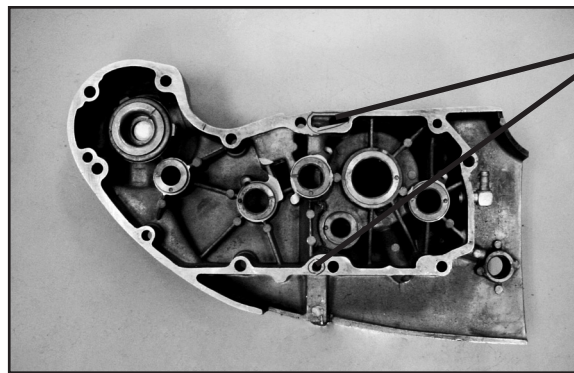

Gearcase used on S&S crankcases must have oil passages located in the indicated positions or oil starvation and engine damage will result.

Picture 1

IMPORTANT NOTES:

- To permit large cylinder bores, the cam compartment in S&S® Special Application for Sportster® model crankcases has been moved out ½". This requires a special pinion shaft and flywheels machined to accept the special S&S shaft.
- S&S flywheels for Evolution® Sportster® models utilize the 1987 style splined pinion shaft because it is stronger than the later style shaft. S&S pinion shafts require the 1986-87 style pinion gear (Available from S&S. Part # depends upon size required) and oil pump drive gear (S&S Part #33-4228). **See Picture 13 on page 12.**
- The modified cam compartment in Special Application cases required the lifter guide openings to be relocated as well, resulting in misalignment between lifter guides and cylinder heads if stock guides and heads are used. For this reason, S&S cylinder heads and billet tappet guides will likely be required for completion. While it is possible for a skilled welder/machinist to relocate the cylinder head pushrod openings, it is extremely difficult to modify stock lifter guides satisfactorily.

Crankcase standard features include:

- Clearance for all S&S connecting rods and strokes to 5".
- Modified crankcase breather system to improve oil scavenging and reduce oil loss out breather.
- Oil scraper machined to provide proper clearance for flywheel diameter specified at time of order.
- Transmission trap door easily sealed to separate lubrication supplies for engine, transmission and primary housing if desired.
- Universal fit into 1994-'03 Buell® frame.

The following options can be specified at time of order:

- Deck height up to 1" taller than stock.
- Machining for 4-speed (1986-'90) or 5-speed (1991-'03) cams.
- Oil filter boss machined for standard Harley-Davidson® Sportster® models bolt-on oil filter mechanism or homemade high capacity breather valve for all-out competition.
- Transmission inspection window to monitor transmission for damage. (Available with Special Order part number only. Not available when electric starter is used because window cover interferes with starter location.)
- Machining for 1991-'03 sprocket shaft or 1955-'65 big twin style sprocket shaft. (Big twin shaft available with Special Order and no transmission crankcase part numbers only). Big twin shaft option requires special flywheels machined to accept big twin shaft.
- Machining for 1995-'03 magnetic speedometer sensor.

POLISHING, POWDERCOATING, ETC.

S&S® does not recommend having engine parts polished, powder coated, glass bead blasted, or otherwise modified. Such procedures often leave abrasive residues which are difficult to remove from recesses and small passages.

⚠ CAUTION

Glass bead and polishing residues can cause extensive engine damage. Engine damage caused by powder coating, polishing, glass bead blasting or other modification will not be covered under warranty.

INSTALLATION INSTRUCTIONS

1. Inspect Crankcases

- A. Prior to assembling engine or altering crankcases in any way (paint, etc.) inspect them to insure correct bore size, flywheel diameter, cam style, and other options have been provided.

Under no circumstance will S&S be held responsible for expenses related to the modification of any S&S part in the event warranty service is required. Painted or otherwise modified parts cannot be accepted for credit or exchange. Inspect all parts closely immediately upon unpacking them!

- B. Confirm that crankcase serial numbers match numbers on packing carton and certificate of origin. Contact S&S immediately if numbers do not match.

NOTE: Valid certificate of origin is required for any transfer or sale of aftermarket crankcase or complete engine built with aftermarket crankcase. Certificate of origin is required to title and license any motorcycle operated on public streets and highways.

2. Clearance Frame

NOTE: Clearances between crankcase and frame, rocker cover and frame tubes, and rocker cover and gas tank must be checked and corrected as needed. It is recommended that clearances in these areas be measured before stock engine is removed from frame, and measurements then compared to those obtained with mock-up of new engine.

- A. Before removing stock engine from frame, measure clearances between rocker covers and frame and other areas where fit appears tight. Areas of least clearance are usually above and behind rear rocker cover.
- B. Mock up new engine with S&S cases and cylinders, heads, and rocker covers to be used on completed engine.
- C. Place mock-up in frame to determine if additional clearance is required.
- D. Note locations of drain plugs for future maintenance needs. In some instances, frame modification may be required.

3. Prepare Crankcases for Assembly

NOTE: Crankcases have been cleaned extensively by S&S prior to shipping. Nonetheless, it remains engine builder's responsibility to inspect all parts before final assembly and to deburr parts or perform further cleaning as needed.

CAUTION

Metal filings, dirt, or other contamination in engine can cause extensive damage not covered under warranty.

- A. Clean crankcases in solvent and hot, soapy water to remove contaminants which may have been introduced during shipping, handling, or set-up.
- B. Clear oil passages with compressed air and verify that passages are free of obstruction.

CAUTION

Oil passages must be clean and free of obstruction for proper engine lubrication. Blocked or contaminated oil passage will cause extensive engine damage not covered under warranty.

WARNING

Compressed air and particles dislodged by compressed air are potentially harmful. Wear protective goggles when using compressed air and direct air stream away from others nearby.

- C. Clean all pre-installed bearings with compressed air to remove possible debris and moisture.

4. Hardware Identification and Installation

Refer to Kit Content on pages 2-4 for identification of hardware.

NOTES:

- Hardware may include items not needed in all applications.
- Unless otherwise noted, threads of all fittings should be coated with pipe sealant or anti-seize compound prior to installation in crankcase. If PTFE plumber's tape is used, loose tape must not enter crankcase or oil passage. Do not apply tape to first few threads that enter hole. If taped fittings are removed, insure that no particles which could reach oil passage or other critical area remain behind.

CAUTION

Crankcase and other engine damage caused by improper hardware installation is not covered under warranty.

- A. Hose Fitting 31-6009. **See Picture 2** next page.
Location: Primary drive compartment vent opening.
Function: Vents primary drive compartment.
Installation: All applications with transmission and sealed primary case.
 1. Install fitting 31-6009 in opening.
 2. Install hose on fitting and connect to hose from transmission vent via "T" fitting (not supplied).

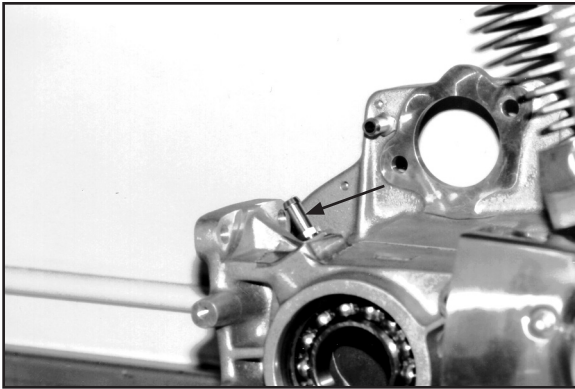

Picture 2

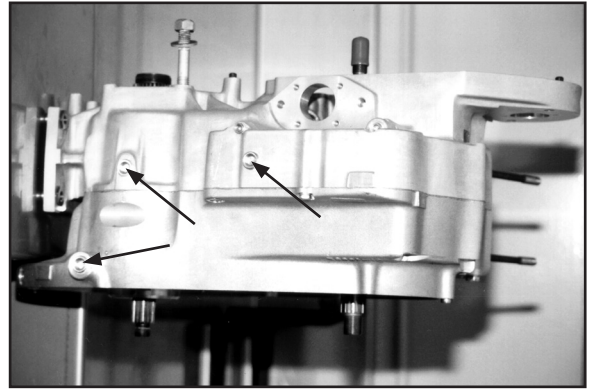

Picture 3

- B. Timing Hole Plugs 31-2005, 2 each.

Location: Timing mark access openings.

Function: Exposes flywheel timing marks for ignition timing.

Installation: Tighten after static ignition timing has been set, before starting engine.

NOTE: S&S® Crankcases for Harley-Davidson® Sportster® models have timing inspection holes in both left and right side cases. This allows access to four-speed style flywheels with timing marks on left as well as five-speed style flywheels with marks on right.

- C. 10-24 x 1" socket head cap screws 31-2013, 10-24 x 3/8" socket head cap screws 50-0023 and stator wire cover 31-2050.

Location: Left (drive side) crankcase.

Function: Mount alternator stator and clamp wires on case half.

Installation: Install in all applications equipped with alternator.

Apply Loctite® 242 (blue) or equivalent to threads, tighten to 30-40 in-lbs.

- D. Magnetic Drain Plugs 31-2006, 3 each. **See Picture 3** above.

Location: Underside of flywheel, transmission, and primary compartments.

Function: Drain lubricant, collect debris.

Installation: Tighten securely.

NOTE: Drain plugs should be safety wired for racing and other extremely high performance applications.

5. Cylinder Studs

Unless otherwise requested, S&S crankcases for Sportster® models with Evolution® Sportster® cylinder studs installed at stock height. If different stud is installed by customer, thread engagement in crankcase must be at least .750".

NOTE: Certain engines with longer than stock cylinders require big twin style cylinder studs.

CAUTION

- Removal of interference fit studs may result in damage to crankcase or stud and is not recommended.
- Cylinder studs are easily damaged. Protect studs with sections of 1/2" I.D. rubber or plastic tubing until cylinders are installed. Do not use studs as handle to lift or position crankcases.
- Seemingly minor damage to studs may cause stress risers which can lead to stud failure and possible damage to other engine components.
- Insufficient thread engagement between stud and base nut or stud and crankcase could result in thread failure and major engine damage.
- When using flanged or shovelhead cylinders, cylinder base studs must be long enough to provide adequate thread engagement for nuts. It is engine builder's responsibility to verify thread engagement. Longer studs must be installed if thread engagement is insufficient.

WARNING

Failure of cylinder studs could cause violent engine disintegration under power, resulting in possible loss of control of motorcycle with subsequent injury to operator and others.

6. Crankcase/Flywheel Assembly

NOTE: Review Section 2, Clearance Frame, before proceeding.

A. Fit Pinion Bearing

Stock Harley-Davidson® procedures and specifications for 1987 and later engines should be used to fit pinion main bearing. However, type of intended service must be taken into consideration. Engine that will receive recommended break-in and is intended for regular service may have bearing fit on tight side of range for longer engine life. Race engines that will receive little or no break-in require looser fit to avoid bearing seizure.

NOTE: Bearings included with S&S crankcases for Sportster® models have been fit to tight side of clearance range. It is engine builder's responsibility to substitute bearing of different size to provide clearance appropriate for intended use if necessary. For correct clearance, parts must be measured at room temperature, approximately 70° F.

CAUTION

Failure to establish correct bearing clearance can result in extensive engine damage not covered under warranty.

1. Refer to information tag on crankcase to determine inside diameter of pinion shaft main bearing race.
2. Measure bearing surface diameter of pinion shaft.
3. Cross reference pinion race inside diameter with pinion shaft bearing surface o.d. to find correct color code. **See Chart 1** below.

Pinion Race I.D.	Pinion Shaft Main Bearing Color Color Code for Sportster® Models			
1.5656 to 1.5658				Red
1.5654 to 1.5656			Red	Blue
1.5652 to 1.5654		Red	Blue	White
1.5650 to 1.5652	Red	Blue	White	Green
1.5648 to 1.5650	Blue	White	Green	
1.5646 to 1.5648	White	Green		
Pinion Shaft O.D.	1.2496 to 1.2498	1.2498 to 1.2500	1.2500 to 1.2502	1.2502 to 1.2504

Chart 1

EXAMPLE: Pinion shaft bearing surface O.D. measures 1.2499". Number is between 1.2498 and 1.2500 in Pinion Shaft O.D. row. Pinion race I.D. is 1.5651" and falls between 1.5650 and 1.5652 in Pinion Race I.D. column. Correct bearing color code where two columns intersect is BLUE. Selecting color where columns intersect provides proper fit for regular service. If looser fit is desired, select bearing color directly to right of color indicated by normal selection process. If color indicated from selection process is located in column on extreme right, go to row directly below and select color in column on extreme left.

B. Establish Crankshaft Endplay

S&S® recommends using dummy sprocket shaft a few thousandths smaller in diameter than standard shaft when possible to establish crankshaft endplay. This eliminates need to press flywheel assembly out of case if end play must be adjusted. Proper flywheel endplay is .001" to .005". Sprocketshaft bearings must be preloaded to obtain an accurate endplay reading.

NOTE: Crankshaft endplay must be confirmed prior to permanent installation of flywheels. Bearings and race must be clean and oil-free when endplay is checked.

CAUTION

Bearing spacer other than one provided may be required for correct endplay. It is engine builder's responsibility to establish correct endplay.



Picture 4

C. Install Flywheel Assembly

1. Thoroughly clean all parts. Apply coat of assembly lube to bearing surface of sprocket shaft and inner race of Timken® bearing. Install bearing on shaft with appropriate tool. **See Picture 4** above.

NOTE: S&S does not recommend using press-to-install sprocket shaft bearings, as this can push flywheels out of true. Preferred bearing installation tools are available from Harley-Davidson® and other sources.

2. Apply coat of petroleum jelly to Timken® bearing installed in Step 1.
3. Place left side crankcase half on engine stand and place flywheel assembly in case.
4. Install Timken® bearing spacer.
5. Lubricate rollers of remaining Timken® bearing with petroleum jelly. Apply assembly lube to bearing inner race and sprocket shaft bearing surface. Install bearing on shaft with appropriate tool.
6. Lubricate pinion bearing and pinion shaft bearing boss with petroleum jelly. Install bearing on shaft and secure with pinion shaft main bearing snap ring.

NOTES:

- Pinion and sprocket shaft bearings supplied should be correct sizes, but it is engine builder's responsibility to confirm flywheel endplay, connecting rod sideplay, bearing fit, and all clearances at time of assembly. It is of particular importance to check flywheel endplay and install different Timken® bearing spacer if necessary. Refer to Harley-Davidson® Service Manual for detailed explanation of required procedure.
- Harley-Davidson® has used different style pinion bearings in various models, some requiring different snap rings. Snap ring supplied by S&S or identical replacement must be used with pinion bearing supplied by S&S.
- Ends of snap ring are rounded on one side, sharp on other. Install snap ring with sharp edge out, away from flywheels.

D. Check Clearances

With left crankcase mounted securely on engine stand and pinion shaft well supported, temporarily install cylinders and pistons without rings. Rotate flywheel assembly several revolutions and check following clearances:

1. Piston to piston
2. Piston to flywheel
3. Connecting rod to cylinder spigot
4. Connecting rod to crankcase

NOTE: S&S® recommends at least .060" clearance between parts mentioned. Remove minimum amount of material needed to obtain correct clearance. Remove cylinders and pistons after clearances verified.

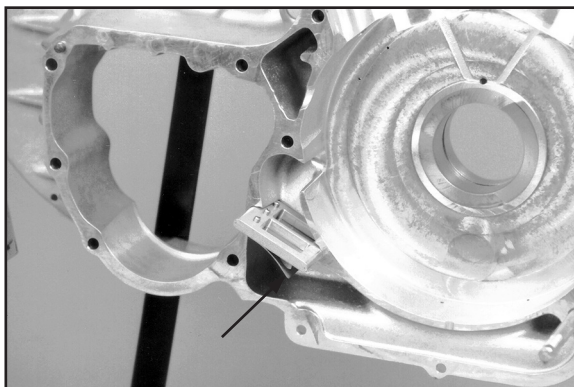

Picture 5

- E. Install Reed Valve
Install reed valve, part 31-2051, in recess in left case. With screws toward rear of engine, flapper should point down. **See Picture 5** previous page.
- F. Assemble Crankcases
1. Clean case half gasket surfaces with lacquer thinner, remove residue with clean, dry cloth, and apply thin film of preferred sealant to mating surface of one case half. Avoid areas where excess sealant could reach inside of engine. Do not apply sealant to area of crankcase that separates flywheel compartment from sump.
 2. Lubricate pinion bearing and I.D. of case race with petroleum jelly.
 3. Assemble crankcase halves. Tighten fasteners in pattern specified in **Figure 1** below. Crankcase bolt torque specs are:
 - Position A ($\frac{1}{4}$ "): 12 ft-lbs.
 - Positions B to H ($\frac{15}{16}$ "): 15-18 ft-lbs.
 4. Remove excess sealant.

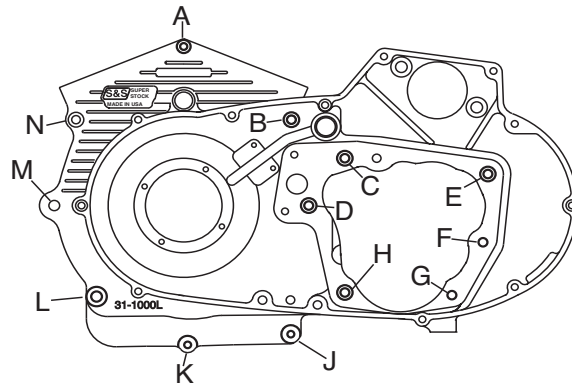
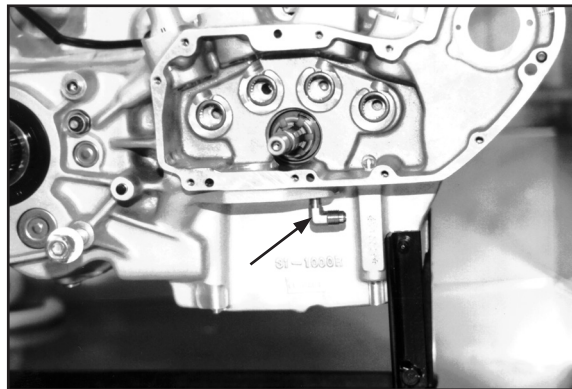

Figure 1

**Tighten gradually in order:
N - J - B - L - K - A - M**

7. Install Oil Pump

- A. If five-speed (1991-'03) oil pump is to be used, install provided 90° brass elbow in opening just forward of oil pump mounting surface in right case. **See Picture 6** below. Elbow is not needed for four-speed (1986-'90) pump. Opening in case will be covered by pump body.



Picture 6

- B. Install oil pump and correct gasket according to manufacturer's instructions. Tighten bolts evenly to 120-150 in-lbs.
- C. Install oil lines. Oil line routing must be determined by builder.

8. Install S&S Oil Filter Mount (S&S Part #106-4426)

This Oil Filter Mount kit provides parts and hardware for several different year models of big twin and Harley-Davidson® Sportster® models. Pay attention to existing engine configurations, oiling system set-ups and routing. It is the responsibility of the installer to correctly identify engine make and to ensure proper installation of prescribed parts in this kit. Hardware included in this kit are the correct sizes for use with Stock and S&S® manufactured parts or combination there of, but may not be correct for other aftermarket parts and accessories. Additional fittings are provided for special oil line routing applications. **See Picture 7** on next page for parts in kit.



Picture 7

Item	Part Number	Description	Quantity
1	106-4427	Bracket, Oil Filter	1
2	50-8112	Fitting, 45°, 1/8-27 NPTF	2
3	50-1007	Fitting, 90°, 1/8-27 NPTF, <i>Sold in 5 pack</i>	2
4	50-8115	Hose Fitting, Straight, 1/8-27 NPTF	2
5	50-1015	Taper Pipe Plug, 1/8-27 NPTF, <i>Sold in 10 pack</i>	2
6	50-0190	Screw, SHC, 5/16-24 x 2 3/4", Zinc, <i>Sold in 5 pack</i>	2
7	106-4793	Screw, SHC, 5/16-24 x 3.5", Zinc	2
8	106-4794	Gasket, Oil Filler Mount, 1936-'69 bt, 1986-'90 xl/sb, <i>Sold in 5 Pack</i>	1
9	50-8000	Hose Clamp, <i>Sold in 10 pack</i>	3
10	106-4782	Hose, Oil Return, .375" x 12", SAE 30R7	1
11	50-1005	Pipe fitting, 90°, 1/8-27 NPT x .375", Brass, UNS, <i>Sold in 5 pack</i>	1
12	106-2121	Screw, HH, Countersunk, 5/16-24 x 3-1/4", Cadmium Plated, <i>Sold in 5 Pack</i>	2

CAUTION

- Always apply pipe sealant to the threads of fittings before assembling fittings or installing fittings. Failure to install fittings correctly may damage mount and void warranty.
- Apply tape and pipe sealant to threads only. Avoid using excessive amounts that may protrude into and obstruct oil passages or contaminate engine oil. Incorrect use of PTFE tape or pipe sealant may cause engine damage not covered under warranty.

NOTE: In **Picture 8** port 1,3 and 4 are oil feed and port 2 is oil return. For Harley-Davidson® Sportster® applications use hole 4 or 1 for the pressure switch placement, hole 2 for return line fitting and hole 3 for oil feed line fitting. Place a 1/8" NPT pipe plug into the hole that is not used by 1 or 4. See **Picture 8** below.



Picture 8

- A. To properly install the Sportster® pressure switch, use a 90 degree fitting from the hardware packet and thread it into hole 4.
- B. Next thread the pressure switch into the fitting and tighten to 8-12 ft-lbs. **See Picture 9** below.

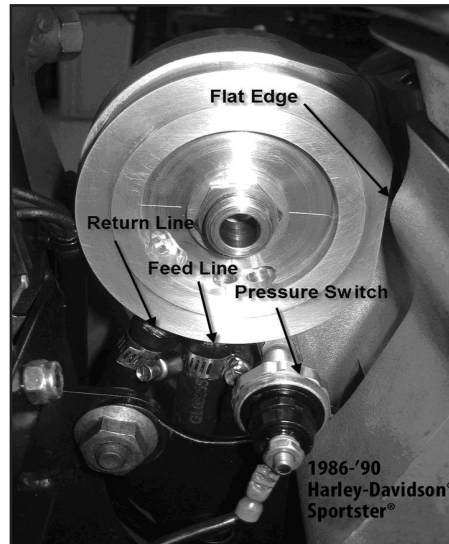

Picture 9

CAUTION

Improper filter mount installation due to incorrect identification of crankcase year group may result in engine damage not covered under warranty.

NOTE: There is no pressure regulator bypass designed into the S&S® filter bracket since modern oil filters contain a bypass valve relieving oil pressure that could potentially collapse the filter media. S&S Sportster® cases should use oil filters for 1986-'03 Sportster® applications.

- C. Install the straight, 45°, or 90° fittings that will optimize the oil line routing of the engine into the side holes as indicated in **Picture 10** below. Ensure that oil line placement does not impede oil flow by kinked lines.
- D. On 1986-'90 Sportster® models the factory return line will not be used. This line is replaced with the supplied hose in the kit and the 90° fitting. The factory supply line is used and can be installed in port 1, 3, or 4. The hose routing and an example oil mount setup is shown in **Pictures 10 and 11** below.



Picture 10

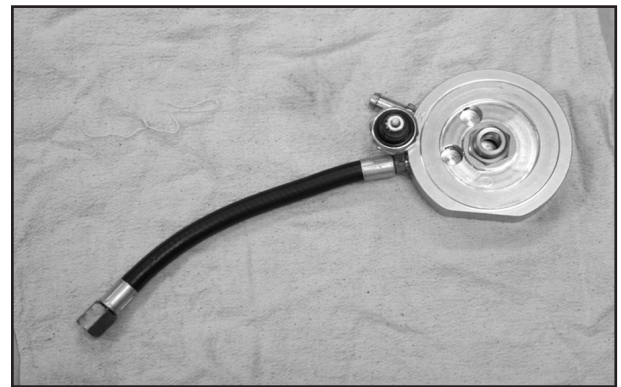

Picture 11

CAUTION

Restricted oil supply may cause extensive damage not covered under warranty.

- E. If the 45° or 90° fittings are used, thread the straight barbed fitting into the female side of the angled fitting and tighten.
- F. Place the new gasket provided in the kit between the filter mount and the crankcase, aligning its features with the filter mount facing the S&S logo outward. **See Picture 12** on next page.
- G. Place the filter mount into the proper location on the gear case, aligning the flat side towards the crankcase.

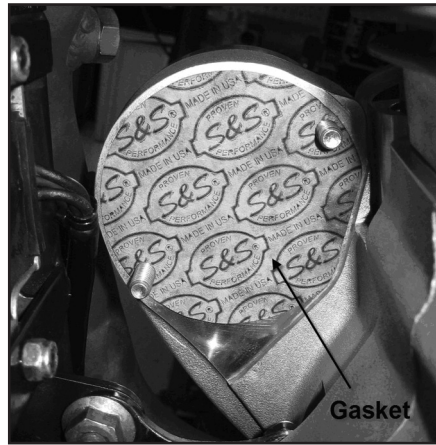

Picture 12

CAUTION

Using components other than those provided by S&S® may result in oil leaks, insufficient oil pressure and possible engine damage.

- H. Use the 3.5" cap screws for stock Harley-Davidson® Sportster® models or S&S SB engines. Place a small amount of LOCTITE® 242 blue onto the threads to secure the filter mount to the gear case.
- I. Torque screws to 13-16 ft-lbs.
- J. Place hose clamps over hoses that will be slipped over barbed fittings. Slip the return line onto the return fitting noted by the R on the mount.

WARNING

Incorrect placement of oil lines or oil line fittings can cause extensive engine damage not covered under warranty.

- K. If present, connect pressure switch wire and tighten nut.
- L. Replace any engine oil that was drained during installation.
- M. Install new oil filter by placing a small coating of oil over the rubber seal and thread the filter onto the filter adapter nut until snug. Rotate the filter an additional ¼ to ½ turns.

9. Install Pinion Gear and Camshafts

- A. Install oil pump drive gear onto the pinion shaft.

CAUTION

Failure to use thread lock compound may cause inaccurate torque readings and allow parts to loosen in use, resulting in extensive engine damage.

- B. Install pinion gear, insuring that mark on rear of gear aligns with corresponding mark on pinion shaft. **See circled areas of Picture 14** below.

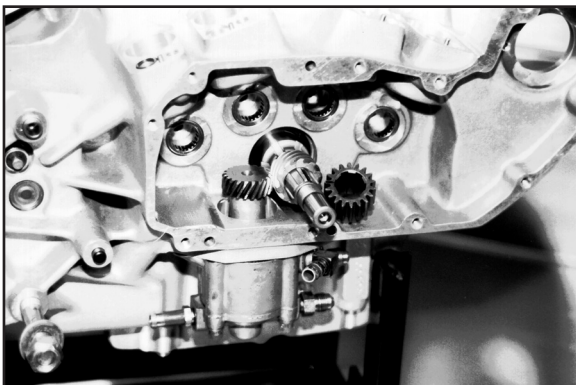

Picture 13



Picture 14

- C. Apply Loctite® 271 (red) or equivalent to threads, then install lockwasher pinion nut and tighten to 35 ft-lbs. Secure lockwasher by bending tabs over flats of pinion nut. **See Picture 15** below.

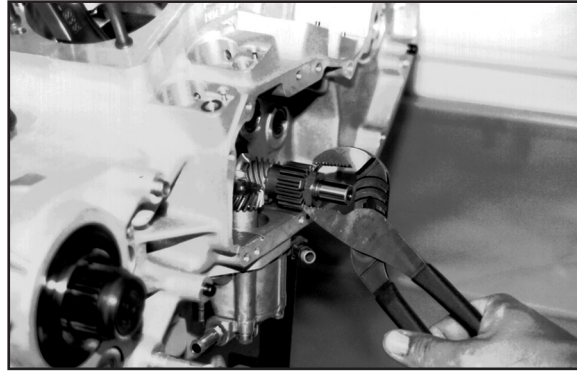

Picture 15

NOTE: 1986-'90 four-speed cams require 1986-'90 gearcase cover, Harley-Davidson® part #25219-86. 1991-'03 cams require 1991-'03 gearcase cover, H-D® part #25219-91A, which must also be used with S&S® gearcase cover gasket #31-2052. Cover #25219-91B is not compatible with S&S Crankcase for Sportster® models. S&S offers billet cam cover kits for 1986-'90 and 1991-'03 style cam chests. H-D® does not currently make a cover that fits S&S cases.

CAUTION

Using gear cover #25219-91B or non-S&S gasket with cover #25219-91A will cause oil starvation and extensive engine damage. See Picture 1 (Page 4) for reference.

- D. Apply petroleum jelly to cam bearings and bearing surfaces of camshafts. **See Picture 16** below left. Place cams in respective positions, assuring that timing marks on cams and pinion gear align. Be sure to install the cam thrust washers between the cam shafts and crankcase. **See Picture 17** below right. The chamfer on the thrust washer should face the cam. Apply assembly lube to gear cover bushings and remove excess to avoid contaminating gasket surface. Roll the crankshaft a few degrees back and forth to check timing marks.

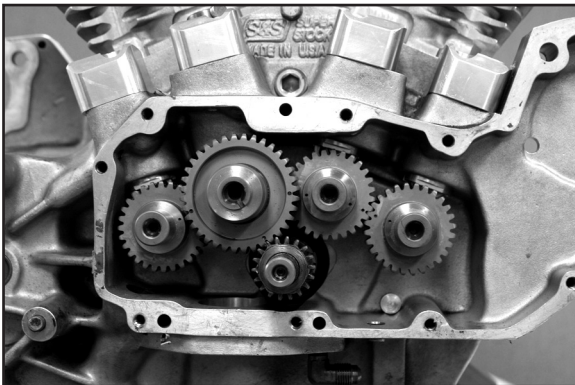

Picture 16

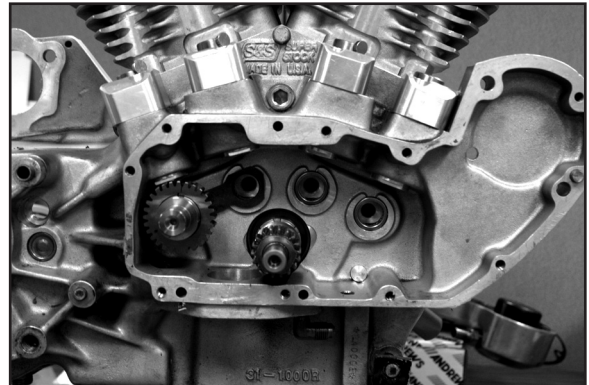

Picture 17

- E. Install gear cover and gasket after cleaning gasket surfaces of cover and crankcase. Torque to 80-110 in-lbs. evenly and in pattern specified in Harley-Davidson® Service Manual.
- F. Establish camshaft endplay according to procedure in the Harley-Davidson® Service Manual. S&S recommends .005-.030".
- G. Confirm lash between pinion gear and #2 cam gear. Proper lash exists if cam can be moved back and forth between crankcase and gear cover but there is no perceptible play between pinion and cam gears. Reinstall cover and torque to spec.

NOTES:

- S&S has had best results installing gasket without sealant. Gasket and gasket surfaces must be clean and dry for gasket to seal properly.
- Correct Sportster® cams must be used. Case is machined for four-speed OR five-speed cams according to information provided with case. S&S crankcases for Sportster® models accept cam lift up to .710" without modification. S&S strongly recommends that builder degree camshafts before final installation. Improperly degreed cams can cause sluggish performance or excessive cylinder pressure resulting in hard starting and/or detonation.

10. Install HL2T Kit (OPTIONAL), Lifters and Guides

- A. If desired, disassemble lifters and install S&S Hydraulic Lifter Limited Travel Kit according to S&S HL2T Instructions No. 5038.
- B. Lubricate lifter guide O-rings and install on guide. Thick O-ring goes nearest top of guide. Install small O-rings around oil passages in lifter guide areas of crankcase. **See Pictures 18 & 19** below.

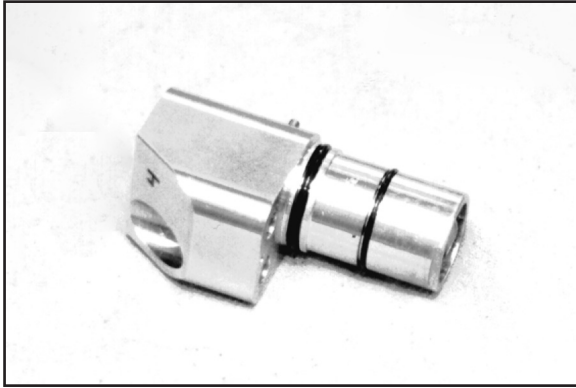

Picture 18

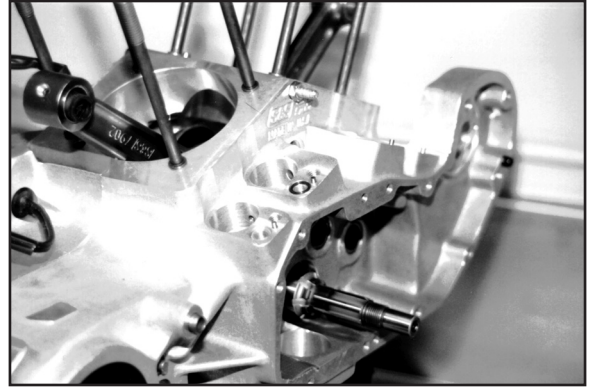

Picture 19

Lifter blocks are marked with R, F, 4, 5 or SA depending on application. **See Pictures 20 & 21** below.



Picture 20

LEFT: 1991-'99 Lifter and lifter block.
RIGHT: 1986-'90 Lifter and lifter block.

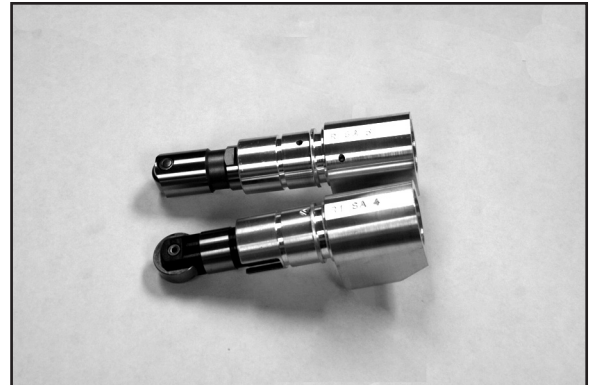

Picture 21 - Example of Marks

TOP: Rear special application 5-speed 1991-'99.
BOTTOM: Right intake special application 1986-'90.

- C. Install lifter/guide assemblies in crankcase. Use H-D® lifter #18526-89 for 1991-'03 applications. 2000-'03 lifters will not fit S&S blocks.

11. Install Top End, Transmission, and Primary

- A. Pass clean, white lint-free cloth back and forth through wristpin bores until clean. Clean pistons, rings, wristpins, cylinders, cylinder heads, and lower rocker covers in solvent, then hot soapy water. Take special care to flush oil passages thoroughly and dry with compressed air. Install components according to manufacturer's instructions and Harley-Davidson® Service Manual.

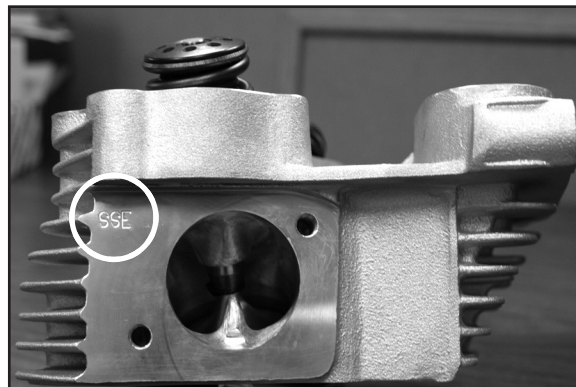

Picture 22

NOTE: Heads should have push rod geometry to match the year group style of the cam chest and lifter blocks. S&S identified their heads with the following codes:

- STE - Stock (Non SA) for 1986-'90 cams and lifters
- STL - Stock (Non SA) for 1991-'03 cams and lifters
- SSE - S&S SA for 1986-'90 cams and lifters - **as shown in circled area of Picture 22** previous page.
- SSL - S&S SA for 1991-'03 cams and lifters

⚠ WARNING

Wristpins and other engine parts may retain honing compound or other abrasive contaminants that will damage engine. S&S will not be responsible for this or other damage caused by inadequate cleaning or preparation of parts prior to assembly.

NOTE: Clearance between pushrods and pushrod bores in cylinder head must be sufficient to prevent contact. S&S® cylinder heads should require little or no modification. To check clearance, install top end including pushrods but not pushrod covers and rotate engine several revolutions while observing for contact between pushrods and cylinder head.

- B. Install push rods with cover assemblies and adjust pushrods according to manufacturer's instructions and install pushrod cover assembly clips.

NOTE: If S&S Limited Travel Kit is used, pushrods must be adjusted according to S&S HL2T Kit instruction Sheet No. 51-1039.

- C. Install transmission according to procedure outlined in Harley-Davidson® Service Manual. Transmission fluid capacity in S&S crankcase for Sportster® models is twelve ounces. Primary housing fluid capacity is 10-12 oz.

NOTE: S&S cases for Sportster® models are designed to use 1991-'03 transmission primary, clutch, shifting components, charging system, and starter. Stock transmission trap door does not fit S&S cases. Reference H-D® service manual for 1991-'03 Sportster® for proper assembly of the transmission and primary components.

- D. Install transmission inspection door if applicable. **See Picture 23** below.



Picture 23

NOTE: Electric starter cannot be installed on crankcase with trans. inspection door option.

- E. Install electric starter and magnetic speedometer sensor if applicable.
- F. Install engine in frame and connect oil lines. Check clearance between drive belt or chain and crankcase. S&S recommends at least 1/8". If necessary, remove metal from crankcase to obtain proper clearance.
- G. Sportster® Configuration - Install part 50-0319 3/8"-16 x 1/2" button head cap screw w/loctite. Torque to 13-15 ft-lbs. to plug the hole on the front of the cam chest. (**See "Item 55" in Exploded Diagram page 17**).

⚠ WARNING

Failure to establish proper clearance between case and belt or chain may result in accelerated wear and damage to components involved.

⚠ WARNING

"Air lock" or cavitation can occur if trapped air is not released from the oil pump. It can occur when oil has been removed from feed and return lines, and interferes with oil circulation. It is installer's responsibility to remove trapped air by priming the pump prior to running the engine and to confirm correct pump operation with engine running. Models with oil tank below transmission require precautions to prevent air from entering oil pump during oil changes.

- H. If necessary re-prime oil pump by loosening the oil feed connection at the pump and starting the engine at idle. Allow a few ounces of oil to leak out of the line and then tighten.
- I. Turn off engine and check oil for correct level in tank.
- J. Restart engine and check for leaks, tighten fittings or clamps if necessary.

NOTE: Oil circulation must be confirmed after initial start-up. This can be accomplished by removing oil tank cap to observe oil returning to tank. It is also suggested that oil pressure be confirmed with a professional quality gauge known to be accurate.

 **CAUTION**

- **Insufficient oil circulation will cause extensive engine damage not covered under warranty.**
- **Improperly connected oil lines may loosen and deposit oil on tire or brakes, causing possible loss of control resulting in injury or death.**

ENGINE LUBRICATION AND BREAK-IN

Race engine break-in is at discretion of engine builder and rider.

S&S recommends the use of Mobil 1® V-Twin 20W-50 synthetic oil in our engines.

First 50 miles are critical for new rings and pistons. Most engine damage occurs during this period. Keep heat down by avoiding heavy traffic and not exceeding 2500 RPM or approximately 50-60 MPH, depending on gearing, during this time. Vary speed and do not lug engine. Change oil and filter at 50 miles and inspect magnetic drain plugs at same time. Small metallic build-up is normal with new engine; excessive build-up must be investigated to determine cause.

For next 500 miles, engine may be taken to 3500 RPM or approximately 60-70 MPH (depending upon gearing) for brief periods. Speed should be varied, and lugging and heavy traffic avoided. Change oil and filter at end of first 500 miles.

Modest increases in speed are permissible during next 1500 miles, but full throttle and heavy loads must be avoided. Some operation at in-town speeds (40-45 MPH) is recommended, although lugging and heavy traffic should still be avoided. Change oil and filter at 500 mile intervals until 2000 miles.

Oil and filter should be changed every 2000 miles after break-in. Change more often if oil appears dirty, engine is subjected to extreme temperatures or dusty conditions, ridden for only short periods of time or frequently operated in heavy traffic.

REPLACEMENT PARTS FOR S&S® CRANKCASES FOR HARLEY-DAVIDSON® SPORTSTER® MODELS AND BUELL®

- 1. Crankcase assembly, half N/A
- 2. Race, right main bearing - Standard (H-D® #8881).....31-4050
- 3. Pinion shaft assembly - SA33-2329
S&S Superstock cases33-2325
- 4. Right main bearing assembly
Blue (H-D® #24647-87)31-4055
Red (H-D® #24650-87)31-4056
White (H-D® #24659-87)31-4057
Green (H-D® #24660-87)31-4058
- 5. Ring, main bearing retainer (H-D® #11177, 11177A)50-8057
- 6. Cam needle bearing assembly (H-D® #9057).....31-4061
- 7. Left Timken® main bearing assembly
S&S Super Stock® (H-D® #24729-74).....31-4059
S&S SA, (H-D® #9028)31-4013
- 8. Seal, sprocket shaft oil
S&S Super Stock® (H-D® #35151-74).....31-4060
- 9. Tappet guide assembly-All S&S

- 10. Screw, SHC - 5/16"-18 x 1" (H-D® #2708A)50-0101
- 11. O-ring
1" I.D. x 1 1/16" O.D. x 3/32" CS (upper) (H-D® #11167A)50-8004
1" I.D. x 1 1/8" O.D. x 1/16" CS (lower) (H-D® #11168A)50-8005
3/8" I.D. x 1/2" O.D. x 1/16" CS (oil hole) (H-D® #11110)50-8006
- 12. Cylinder stud 1991-up xl (H-D® #16832-86A)31-2331
S&S Super Stock® (H-D® #16837-85C).....31-2321
Standard- S&S SA (H-D® #16837-78).....31-2322
+ 1/16" longer - S&S SA31-2324
- 13. Bolt, case HH See "Bolt Position Diagram"
(Position A) -1991-'03
S&S Super Stock® 1/4"-28 x 5 1/2"50-0090
S&S SA 1/4"-28 x 6"50-0020
(Position B, C, D)
1991-'03 S&S Super Stock® 5/16"-18 x 3"50-0021
(Position E, F, G, H)
1991-'03 S&S Super Stock® 5/16"-18 x 4"50-0102
(Position J, K)
1991-'03 S&S Super Stock® 1/4"-20 x 3/4"50-0022
(Position L, M)
1991-'03 S&S Super Stock® 3/8"-24 x 5 1/2"50-0170
(Position N)
1991-'03 S&S xl S&S Super Stock® 5/16"-18 x 3 1/2"50-0117

	1986-'90		1991-'99	
	STOCK	SA	STOCK	SA
Set	33-5375	33-5365	33-5389	33-5369
F Exhaust	33-5371	33-5361	33-5385	33-5391
F Intake	33-5372	33-5362	33-5385	33-5381
R Exhaust	33-5373	33-5363	33-5387	33-5383
R Intake	33-5374	33-5364	33-5387	33-5383

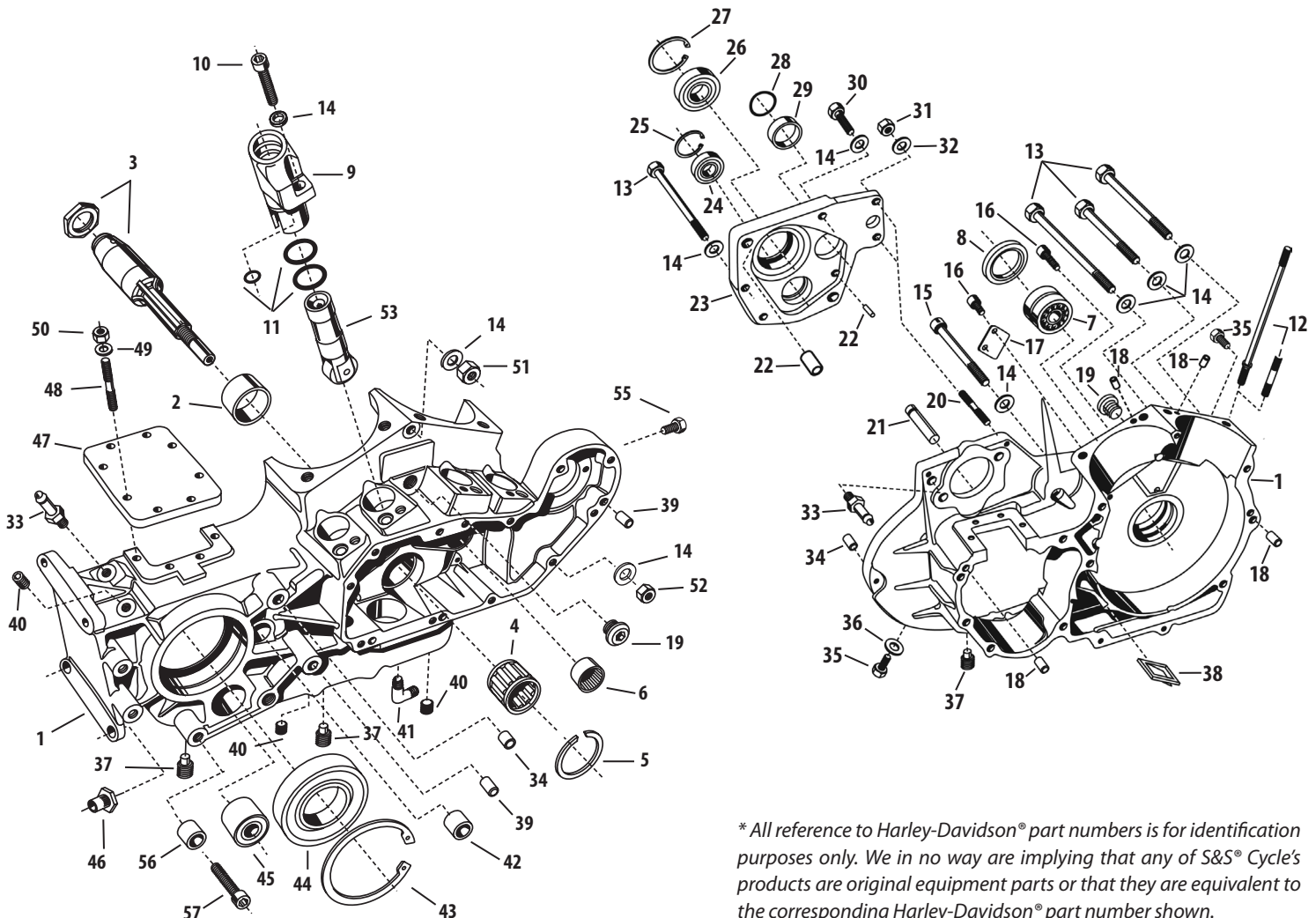

* All reference to Harley-Davidson® part numbers is for identification purposes only. We in no way are implying that any of S&S® Cycle's products are original equipment parts or that they are equivalent to the corresponding Harley-Davidson® part number shown.

14. Washer, flat See Bolt Position Diagram (below)	
(Position A, J, K)	
1/4" x .474" x .050"	50-7020
(Position B, C, D, N & Tappet guide)	
5/16" x .548" x 1/16"	50-7025
(Position E, F, G, H)	
5/16" x 1 1/16" x 1/8" (H-D® #6107B)	50-7033
(Position L, M)	
3/8" x 7/8" x .146" (H-D® #6400)	50-7053
15. Screw, SHC - 5/16"-18 x 3", See Bolt Position Diagram	
(Positions B, C, D, H)	50-0021
16. Screw, SHC	
10-24 x 3/8" (Stator wires cover)	50-0023
10-24 x 1" (Stator) (H-D® #2720)	50-0044
17. Cover, stator wires - S&S Super Stock®	
(H-D® #29950-91)	31-2050
18. Dowel pin - .250" diameter x 1/2" (H-D® #358)	50-8022
19. Plug, timing hole - S&S Super Stock® (H-D® #720)	31-2005
20. Stud -1/4"-20, 1/4"-28 x 1 1/4" (Shifter shaft) (H-D® #5226A)	50-8080
21. Spring pin - (Shifter spring) (H-D® #24530-90)	31-2049
22. Dowel pin -1/8" diameter x 1/2"	50-8020
.390" I.D. x .558" O.D. x 1/2" (H-D® #16573-83)	50-8023
23. Transmission access door assembly	
(Includes 1 each transmission access door, 50-8007, 56-3030.)	56-3025

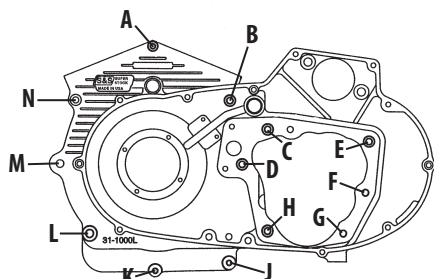

Bolt Position Diagram

* All reference to Harley-Davidson® part numbers is for identification purposes only. We in no way are implying that any of S&S® Cycle's products are original equipment parts or that they are equivalent to the corresponding Harley-Davidson® part number shown.

24. Bearing, transmission countershaft (LH) (H-D® #8998)	56-3026
25. Ring, transmission countershaft bearing retainer (H-D® #35021-89)	50-8053
26. Bearing, transmission mainshaft (LH) (H-D® #35030-89)	56-3027
27. Ring, transmission mainshaft bearing retainer (H-D® #35038-89)	50-8052
28. O-ring - 32mm x 1.5mm CS - Shifter drum bushing	50-8007
29. Bushing, shifter drum - unfinished (H-D® #9187)	56-3030
30. Screw, HHC 5/16"-18 x 1 1/4" (H-D® #2871W)	50-0110
31. Lock nut, hex 1/4"-28 (H-D® #7683)	50-5010
32. Washer, flat 1/4" x 5/8" x 1/16" (H-D® #6245)	50-7021
33. Fitting, hose 1/8" -27 pipe male - transmission vent (H-D® #6353341)	50-8115
34. Dowel pin - .309" I.D. x .430" O.D. x 1/2" (H-D® #24754-75)	50-8018
35. Screw, HHC - 1/4"-20 x 1/2", primary oil lever (H-D® #3728)	50-0014
36. Washer, flat - 1/4" x 5/8" x 1/32" copper, primary oil level (H-D #63858-49)	50-7018
37. Mfg after 5-1-2000 - 1/2"-20 thread (Includes O-ring).....	50-8335
38. Reed valve assembly (Optional)	31-2051
39. Dowel pin -5/16" diameter x 1/2" (H-D® #215)	50-8019
40. Speedometer hole plug kit	56-1063
a. SHCS, 1/4"-20 x 3/4", Chrome	50-0067
b. Flat washer 1/4", Chrome	50-7017
c. O-ring, 1/2" I.D. x 5/8" O.D.	50-8032
41. Fitting, 90° -1/8"-27 pipe male x 5/16" flared tube	50-8119
42. Bearing, transmission shifter drum (RH) (H-D® #9151)	56-3032
43. Ring, transmission output shaft bearing retainer,	
109" x 3.734" tru-arc (H-D® #11161)	50-8051
44. Bearing, transmission output shaft (H-D® #8996)	56-3028
45. Bearing, transmission countershaft (RH) (H-D® #8977)	56-3031
46. Nut, press-in, 3/8"-24 (H-D® #16240-82)	31-2048
47. Cover, transmission inspection window S&S SA.....	31-2055
48. Stud -5/16"-18, 5/16"-24 x 1.370" S&S SA	50-8081
49. Washer, flat - 5/16" x 1 1/16" x 1/16" (H-D® #6016, 6702)	50-7034
50. Nut, hex - 5/16" -24 (H-D® #7833)	50-5023
51. Nut, hex -1/4"-28 (H-D® #7675, 7676).....	50-5011
52. Nut, hex -3/8"-24 (H-D® #7861)	50-5037
53. Hydraulic tappet assembly	
1986-'90.....	33-5352
1991-'99	N/A
54. 45° hose fitting - 1/8" pipe male/female (Oil pump) (N/S)	50-8112
55. 3/8"-16 x 1 1/2" BHCS	50-0319
56. 5/16" x 3/4" .35 Shim	50-7044
57. 1/4"-20 x 2" SHCS	50-0013
58. Gasket, gearcover, (N/S)	31-2052

