

High-Power Wireless AC600 Outdoor Access Point User Manual

Model 525824



INT-525824-UM-1215-01

TABLE OF CONTENTS

Introduction	3
Package Contents	3
Product Features	3
Product Specifications	4
Hardware.....	5
Device Status LEDs	5
Connectors	6
Passive-PoE Injector	6
Hardware Installation.....	7
Connecting the device to the network.....	8
Configuring the device	9
Accessing the web configuration interface.....	9
Operation Modes – When to use which	10
Access Point	10
Router	11
WISP-Wireless ISP	12
Repeater.....	13
Status	14
Wireless Settings.....	15
Basic Settings.....	15
2.4G Advanced Settings	15
AC Advanced Settings.....	17
WPS Settings	18
Other Settings	19
Password Settings	19
Time Zone Settings.....	19
Save/Reload Settings.....	19
Upgrade Firmware	20
Appendix A: Changing the IP Address of a Network Adapter	21
Appendix B: Troubleshooting.....	26
Appendix C: Warranty Information.....	27

INTRODUCTION

The Intellinet High-Power Wireless AC600 Outdoor Access Point, Model 525824, is a cost-effective WISP CPE (customer-premises equipment) and long-distance wireless AP solution. It combines the functionality of a classic wireless access point, a wireless ISP (WISP) client, two 7 dBi high-gain antennas and an IP65 weatherproof enclosure. High output power (up to 4 watts in FCC-regulated countries) and high receiver sensitivity significantly extend the transmission range, making the Intellinet 525824 Wireless AC600 Access Point an excellent choice for increasing wireless coverage in an outdoor environment.

PACKAGE CONTENTS

Ensure that the following items are included:

- High-Power Wireless AC600 Outdoor Access Point
- Quick installation guide
- Installation CD with user manual (this document)
- Passive PoE injector
- Power adapter
- Cable ties
- Rubber seal
- Wall mount kit

PRODUCT FEATURES

- The latest in wireless technology transfer delivers up to 433 Mbps (5 GHz) and 150 Mbps (2.4 GHz) speeds
- Weatherproof and corrosion resistant, IP65
- Simultaneous dual-band operation (2.4 GHz and 5 GHz) provides twice the bandwidth
- Supports WEP and WPA/WPA2 (TKIP and AES) data encryption
- Supports WMM (IEEE 802.11e QoS standard) prioritizing bandwidth for multimedia applications
- Powerful 7 dBi gain antennas, detachable, with RP-SMA female connectors
- Supported modes: Access Point, Router, Repeater and WISP (Wireless ISP)
- Supports Wi-Fi Protected Setup (WPS)
- Included passive POE injector for up to 60 meters (200 feet) connection distance
- Easy installation through Web-based user interface
- Firmware upgradeable

PRODUCT SPECIFICATIONS

Standards

- IEEE 802.11ac (433 Mbps Wireless LAN)
- IEEE 802.11b (11 Mbps Wireless LAN)
- IEEE 802.11g (54 Mbps Wireless LAN)
- IEEE 802.11n (150 Mbps Wireless LAN)
- IEEE 802.3 (10Base-T Ethernet)
- IEEE 802.3u (100Base-TX Fast Ethernet)

Wireless

- Wireless frequency range: 2.400 – 2.484 GHz
- EIRP output power EU (ETSI): 20 dBm
- EIRP output power U.S. (FCC): 35 dBm
- Wireless channels EU (ETSI): 1-13, U.S. (FCC): 1-11





Power

- External power adapter: 24 V DC, 0.5 A
- Power consumption: 7 watts max.

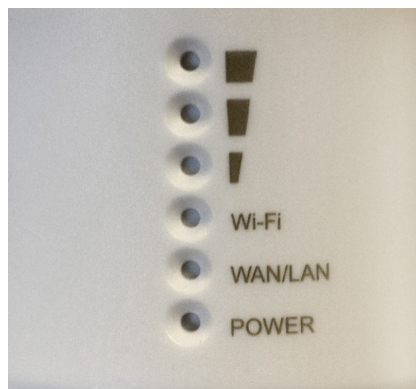
HARDWARE

DEVICE STATUS LEDS



LED Indicator	State	Description
POWER	On	The Intellinet Access Point is turned on.
	Off	The Intellinet Access Point is turned off.
Wi-Fi	On	The wireless radio is active.
	Off	The wireless radio is inactive.
	Flashing	The wireless radio is active, and data is being transmitted and received.
WAN/LAN	On	Link on Ethernet port is active.
	Off	Link on Ethernet port is inactive.
	Flashing	Link on Ethernet port is active, and data is being transmitted and received.
Signal Strength		
	Flashing	No wireless connection
	On	AP Mode: Power output set to 1/3 (33%). Repeater Mode: Weak reception, signal strength below 25%.
	On	AP Mode: Power output set to 2/3 (66%). Repeater Mode: Medium reception, signal strength between 25 and 50%.
	On	AP Mode: Power output set to 3/3 (100%). Repeater Mode: Good reception, signal strength greater 50%.

CONNECTORS

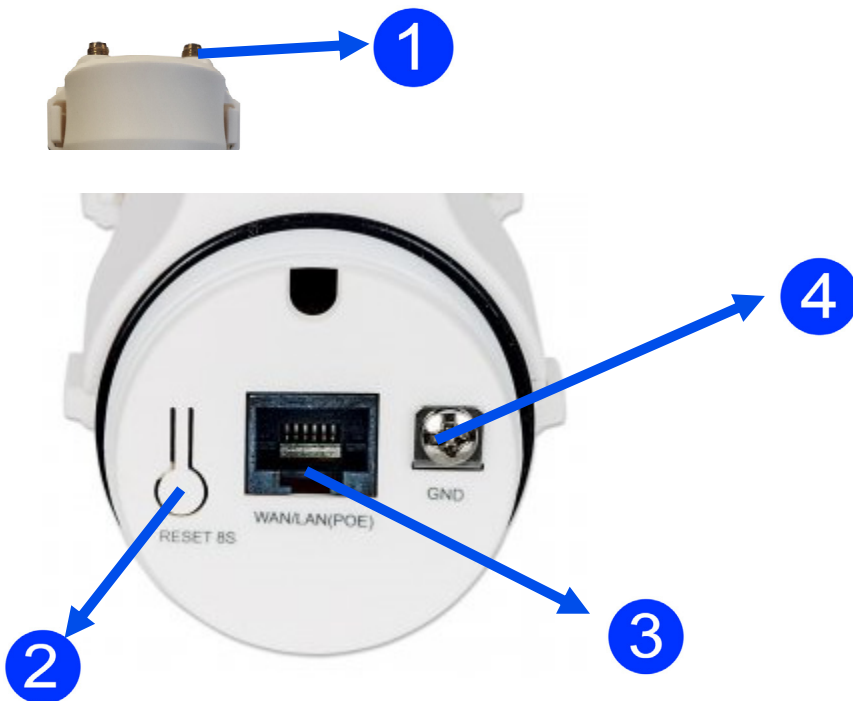

Item	Description
1	Female RP-SMA connectors for the connection of the external high-gain antennas (included). Be sure to match up 2.4 and 5 GHz
2	Reset button. Depress for 10 seconds to initiate a reset to factory default values.
3	WAN/LAN connector and passive-PoE input port.
4	Ground connector.

PASSIVE-POE INJECTOR

The Intellinet Access Point comes with a Passive-PoE Injector that allows you to merge power and data to one Ethernet cable and supply them to the access point. It has three connection points: a power input port for the external 24 V DC power adapter (2), a LAN port for the connection to your local network (1), and a PoE port for the connection to the access point's LAN port (4). The power button (3) does what you think it does.

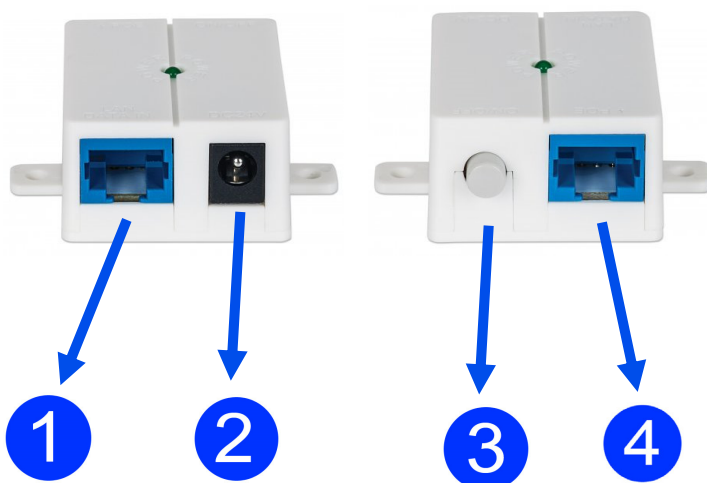

HARDWARE INSTALLATION

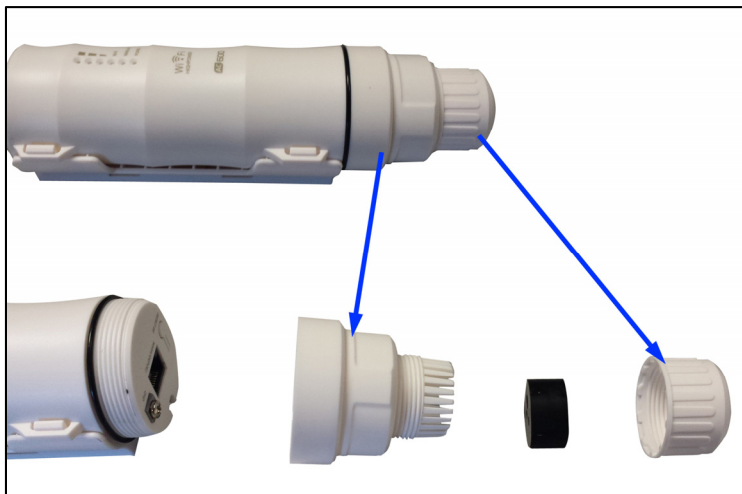

Unscrew the housing covers and remove the black rubber seal as shown above.

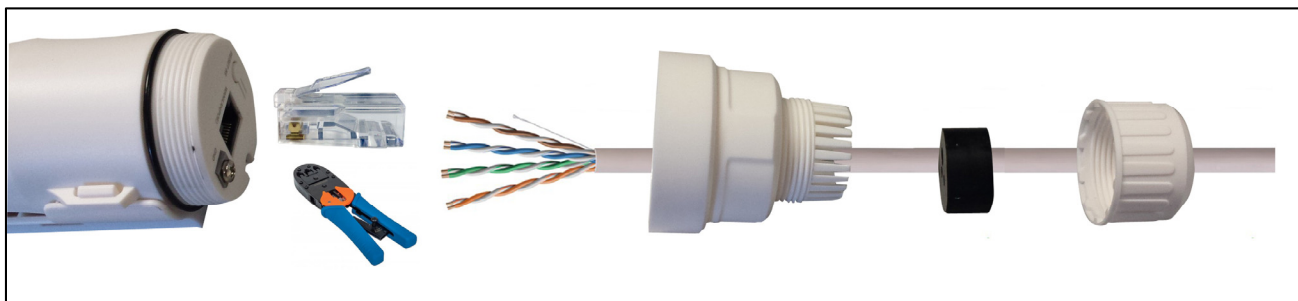

Use a Cat5e or Cat6 installation cable and thread it through the two plastic covers and the black rubber seal. Then use a crimp tool to affix an RJ45 plug to the cable.

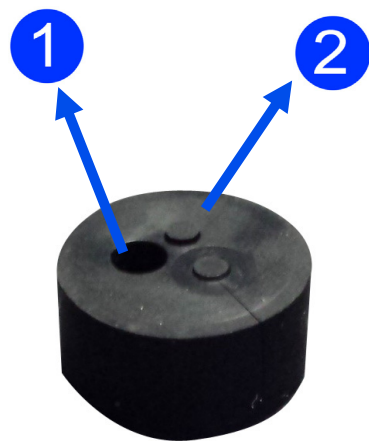

(1): Hole for network cable

(2): Holes for grounding wire.

CONNECTING THE DEVICE TO THE NETWORK

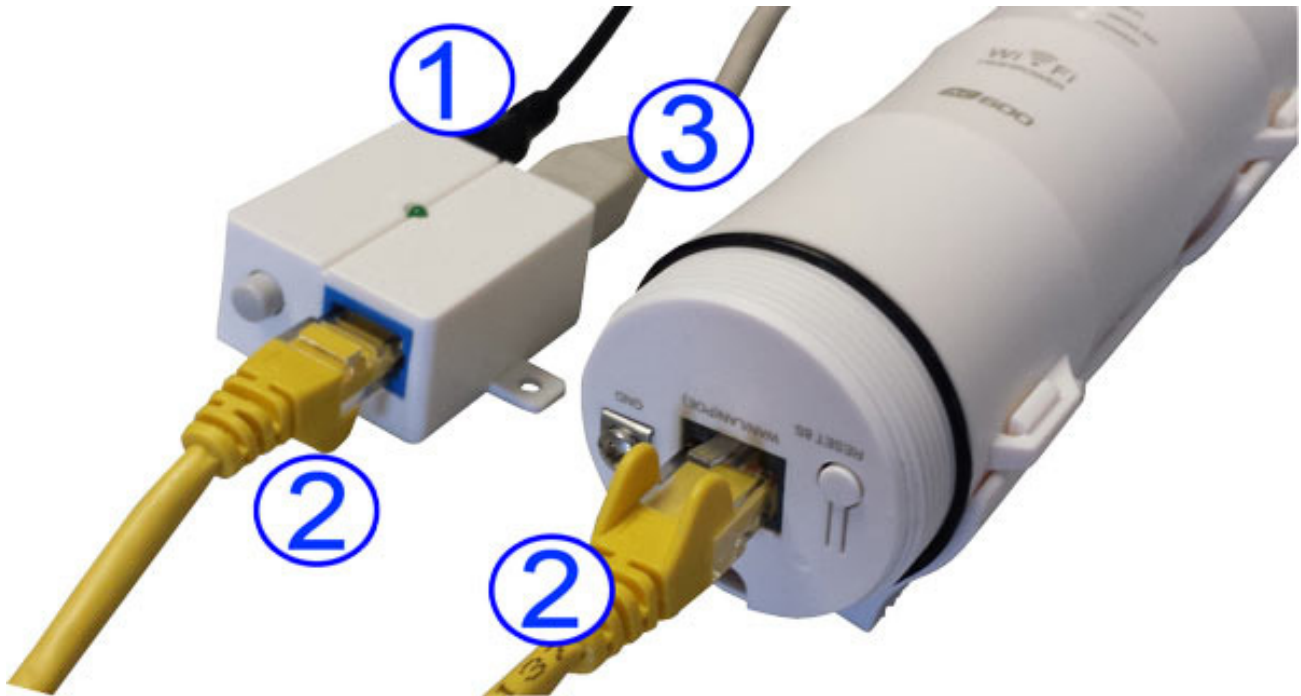

Item	Description
1	Connect the external power adapter (24 V DC) to a power outlet and to the Passive-PoE Injector. Once the connection is made, the power LED on the PoE Injector will light up.
2	Connect a standard RJ45 Ethernet cable (8P8C) from the PoE port of the Passive-PoE Injector to the LAN port of the Intellinet Access Point. This connection provides power and data connectivity to the access point.
3	Connect a standard RJ45 Ethernet cable to the LAN port on the Passive-PoE Injector. That cable connects the PoE injector (and thus the access point) to the rest of your network.

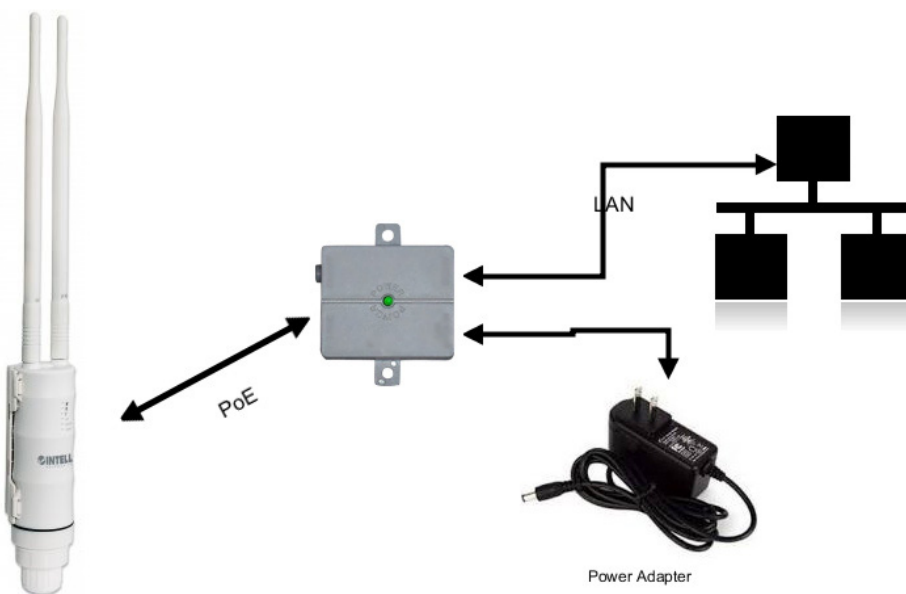

CONFIGURING THE DEVICE

ACCESSING THE WEB CONFIGURATION INTERFACE

The Intellinet Access Point is equipped with an array of features, which can be configured to your needs. Configuration is done by means of a standard Web browser. Connect to the device either using a network cable, or by connecting to one of the SSIDs 'intellinet-ac50' or 'intellinet-n24'.

Open `http://ap:setup` or `http://192.168.2.1` in your Web browser, and then type in admin as the user name and 1234 as the password. Click **Log In** to connect.

Default IP address: 192.138.2.1 ***

Default IP subnet mask: 255.255.255.0

User name: admin

Password: 1234

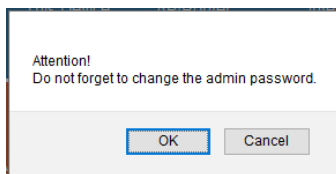
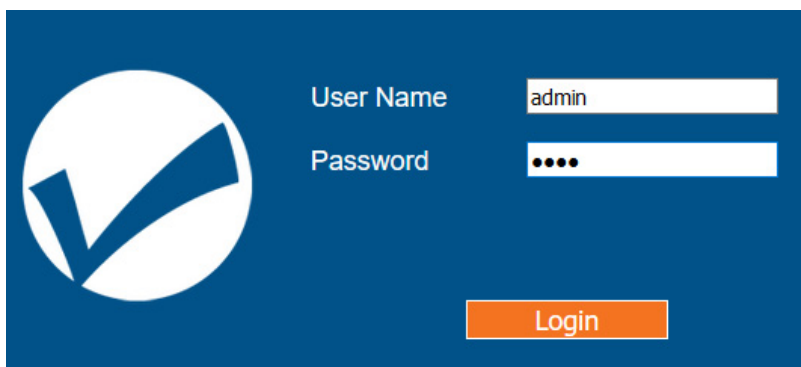

Note: When you log in for the first time, you will see the message above. Click 'OK' to change the administrator password.

Should you encounter problems connecting to the Web interface of the access point, one of the following issues may be occurring.

- Your computer's IP address is not compatible with the IP address of the Intellinet Access Point. It must be in the range of 192.168.2.2 to 192.168.2.254. Refer to Appendix A for information on how to set up the IP address of the network adapter.
- The Intellinet Access Point isn't properly connected to either the LAN port of your computer or the network. Verify that the LAN status LED is lit.
- The IP address of your Intellinet Access Point may have been changed. To be certain, a hardware reset should be performed. To do that, simply press the reset button for 10 seconds while the device is powered up.

*** Note: The device default IP address is 192.168.2.1, unless you connect the LAN port to your network where a router or DHCP server is present. If connected to your network, the access point will receive an IP address from your router. In that case you can access it via `http://ap.setup`.

OPERATION MODES – WHEN TO USE WHICH

Your Intellinet Access Point supports four operation modes: Router, WISP, Access Point (AP) and Repeater. Before you start making changes to the configuration, you should familiarize yourself with these modes.

ACCESS POINT

This is the default operation mode of the Intellinet Access Point. A wireless access point (AP) is a device that allows wireless devices to connect to a wired network using Wi-Fi. In this mode, the device acts as a simple network switch connecting wireless and wired network clients.

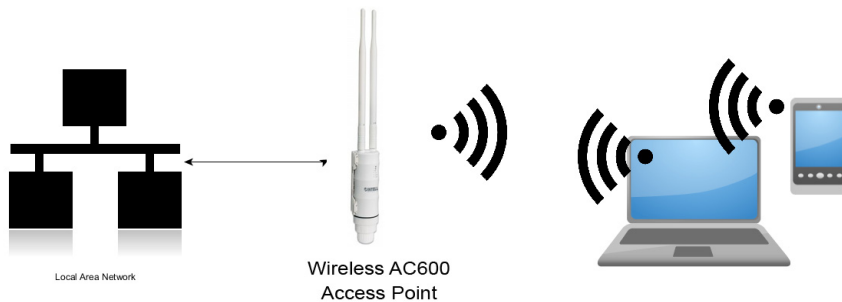
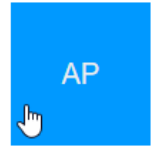

Click on AP to open up the wireless network screen.

Provide the **SSID** (name of the wireless network) for both the 2.4 and 5 GHz ('AC') radio. Set up the **Security Type** for the wireless networks. **WPA2 PSK** is recommended as it provides the most robust security for your wireless networks.

Click 'Apply' to activate the settings. The Access Point will then perform a reboot. After this, you can re-connect to the admin web interface, and from there you have access to advanced wireless settings.

The screenshot shows the 'AP Wizard' configuration interface. It has a green background and a white back arrow icon. The fields are:

- 2.4G SSID:
- AC SSID:
- Security Type:
- Wi-Fi Key: 18
- Hide Characters

 At the bottom, there are two buttons: 'Apply' and 'Cancel'.

Default values for Access Point (AP) mode, if device is not connected to a router or DHCP server with the LAN port.

Parameter	Value
Access Point IP Address	192.168.2.1
Access Point DHCP Server	Activated, Access Point provides IP addresses to clients.
Access Point DHCP Client	Disabled, LAN IP address is 192.168.2.1
Access to Web UI via	http://192.168.2.1 or http://ap.setup

Default values for Access Point (AP) mode, if device is connected to a router or DHCP server with the LAN port.

Parameter	Value
Access Point IP Address	Variable, depends on the Router or DHCP server in your network.
Access Point DHCP Server	Disabled. The Access Point will not provide IP addresses to clients.
Access Point DHCP Client	Enabled. LAN IP of Access Point is provided by Router or DHCP server in your network.
Access to Web UI via	http://ap.setup or IP addresses provided by Router or DHCP server in your network.

ROUTER

A router connects multiple local network clients to one Internet connection, and provides basic NAT firewall protection at the same time. Use this mode if you want the Intellinet Access Point to function as the (wireless) router in your network. If you choose this mode, you must connect the LAN port of the access point to a network port that provides an Internet connection, such as a DSL or cable modem. Note that this device only provides very basic NAT router functionality.

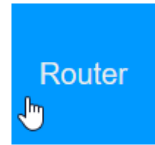

Select the correct WAN type for your ISP; e.g., **PPPoE** for xDSL connections or DHCP for cable Internet service. If you select PPPoE, you must provide the username and password of your DSL service. If your Internet service uses **Static IP**, you'll need to enter the IP address and related information into the configuration interface. In many cases, however, your Internet access is established by means of DHCP. In this case, select **Dynamic IP**.

Provide the **SSID** (name of the wireless network) for both the 2.4 and 5 GHz ('AC') radio. Set up the **Security Type** for the wireless networks.

Note that **WPA2 Personal** is recommended as it provides the most robust security for your wireless networks.

Click 'Apply' to activate the settings. The Access Point will then perform a reboot. After this, you can re-connect to the admin web interface, and from there you have access to advanced wireless settings.

Default values for Router mode:

Parameter	Value
Access Point IP Address	192.168.2.1
Access Point DHCP Server	Activated, Access Point provides IP addresses to clients
Access Point DHCP Client	Disabled, LAN IP address is 192.168.2.1
Access to Web UI via	http://192.168.2.1 or http://ap.setup

WISP-WIRELESS ISP

A wireless Internet service provider (WISP) is an Internet service provider with a network based on wireless networking. If you live in an area where Internet service is provided by a 2.4 GHz Wireless IEEE 802.11n signal or a 5 GHz Wireless IEEE 802.11ac signal, you can utilize the Intellinet Access Point as a CPE (customer-premises equipment). When you activate WISP mode, you will need to specify the SSID of the WISP signal, along with the security settings if so required. You also need to define how the connection to the WISP is established; i.e., DHCP, PPPoE, etc. After the obligatory reboot, the Intellinet Access Point wirelessly connects to the WISP and provides local wireless access in your network.

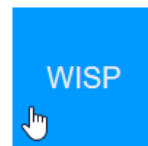

As soon as you enter WISP mode, the Access Point begins searching for available wireless signals in the area. Select the wireless network **SSID** of your ISP. Keep in mind that this Intellinet Access Point is equipped with a dual band radio, capable of communicating with both 2.4 GHz and 5 GHz wireless devices. But while you may be picking up a mix of both 2.4 GHz and 5 GHz networks, you can only use one wireless signal as your WISP source. Next, provide the **WiFi Key** that allows you to access your ISP wireless network. Finally, type in the name of the wireless networks, which the Intellinet Access Point should broadcast for your local wireless clients. You need to provide the **SSID** for both the 2.4 and 5 GHz network.

Click 'Apply' to activate the settings. The Access Point will then perform a reboot. After this, you can re-connect to the admin web interface, and from there you have access to advanced wireless settings.

Note: The wireless encryption key for your clients is the same as the encryption key of the WISP network.

SSID	Channel	Security	Select
Wisp50Signal	36	WPA2PSK	<input checked="" type="radio"/>
Wisp24Signal	1	WPA2PSK	<input type="radio"/>

Connect to: Wisp50Signal

Wi-Fi Key: 12
 Hide Characters

2.4G SSID:

AC SSID:

The repeater wireless key is the same as that of your wireless AP/Router.

Default values for WISP mode:

Parameter	Value
Access Point IP Address	192.168.2.1
Access Point DHCP Server	Activated, Access Point provides IP addresses to clients
Access Point DHCP Client	Disabled, LAN IP address is 192.168.2.1
Access to Web UI via	http://192.168.2.1 or http://ap.setup

REPEATER

A wireless repeater (also called a wireless range extender) takes an existing signal from a wireless router or wireless access point and rebroadcasts it to amplify the wireless signal, extending its range in the process. When you activate this mode, you need to specify the wireless network which you wish to amplify, or “repeat.” After you provide the required security information, the Intellinet Access Point performs a restart.

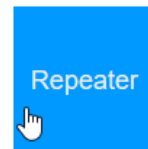

The setup is virtually identical to that of the WISP mode. The Access Point shows all wireless networks in range, and you then have to select the wireless network that you wish to repeat (extend its range), and provide the required security for the network. Keep in mind that this Intellinet Access Point is equipped with a dual band radio, capable of communicating with both 2.4 GHz and 5 GHz wireless devices. But while you may be picking up a mix of both 2.4 GHz and 5 GHz networks, you can only use one wireless signal as your repeater source.

Type in the name of the wireless networks, which the Intellinet Access Point should broadcast for your local wireless clients. You need to provide the **SSID** for both the 2.4 and 5 GHz network.

Click ‘Apply’ to activate the settings. The Access Point will then perform a reboot. After this, you can re-connect to the admin web interface, and from there you have access to advanced wireless settings.

Note: The wireless encryption key for your clients is the same as the encryption key of the source (repeated) network.

SSID	Channel	Security	Select
ICU-WLS4_5g	36	WPA2PSK	<input type="radio"/>
ICU-WLS2_5G	40	WPA2	<input checked="" type="radio"/>
ICU-WLS4	1	WPA2	<input type="radio"/>
IC_GUESTGATE	1	NONE	<input type="radio"/>
ManhattanAC24	7	WPA2PSK	<input type="radio"/>

Connect to: ICU-WLS2_5G

Wi-Fi Key: Hide Characters

2.4G SSID: ICU-WLS2_5G(2G)

AC SSID: ICU-WLS2_5G

The repeater wireless key is the same as that of your wireless AP/Router.

Default values for Repeater mode:

Parameter	Value
Access Point IP Address	Variable, depends on the Router or DHCP server in your network.
Access Point DHCP Server	Disabled. The Access Point will not provide IP addresses to clients.
Access Point DHCP Client	Enabled. LAN IP of Access Point is provided by Router or DHCP server in your network.
Access to Web UI via	http://ap.setup or IP addresses provided by Router or DHCP server in your network.

STATUS

This section provides various bits and pieces of information about the current status of the Intellinet Wireless Access Point. Depending on the operational mode the device is set to, you will see one of four possible menus displays. The example below shows the factory default AP mode.

The screenshot shows the 'AP Status' menu. On the left, a diagram illustrates the network topology: a User (laptop) connects to 'This Device' (antenna), which connects to an AP/Router, which in turn connects to the Internet (globe). The status panel on the right lists the following information:

AP Status	
2.4G SSID	intellinet-N24
AC SSID	intellinet-AC50
Clients	0
Channel	11 / 40
Security	OPEN
Internet	Disconnected

If you create a repeater or WISP setup, this display can be very helpful in determining whether or not the connection succeeded. The example below shows an unsuccessful repeater connection. The status continues to show 'Scanning ...' and Internet displays as 'Disconnected'.

The screenshot shows the 'Repeater Status' menu. On the left, a diagram illustrates the network topology: a User (laptop) connects to 'This Device' (antenna with a warning triangle), which connects to an AP/Router, which in turn connects to the Internet (globe). The status panel on the right lists the following information:

Repeater Status	
2.4G SSID	ManhattanAC24
AC SSID	ManhattanAC24(AC)
Clients	1
Connect to	ManhattanAC24
Status	Scanning...
Internet	Disconnected

The image below shows a successful repeater connection.

The screenshot shows the 'Repeater Status' menu. On the left, a diagram illustrates the network topology: a User (laptop) connects to 'This Device' (antenna), which connects to an AP/Router, which in turn connects to the Internet (globe). The status panel on the right lists the following information:

Repeater Status	
2.4G SSID	ManhattanAC5(2G)
AC SSID	ManhattanAC5
Clients	1
Connect to	ManhattanAC5
Status	Connected
Internet	Connected

Note: If you experience problems getting a repeater or WISP connection to work, consider that the most common reason for that is that the wireless password was entered incorrectly.

WIRELESS SETTINGS

This menu provides access to all parameters related to the wireless function of the Intellinet Access Point. As this is a dual band device, capable of providing both 2.4 GHz and 5 GHz wireless service, there are advanced settings that are unique to each of the frequency bands.

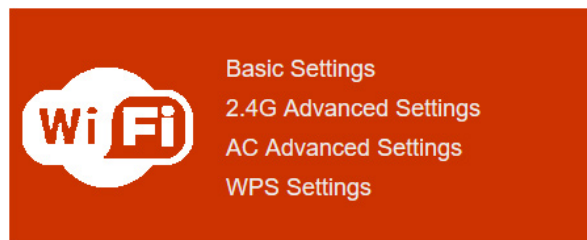

BASIC SETTINGS

Wireless ON/OFF: You can activate or deactivate the wireless function for each band independently.

SSID: The name of the wireless network.

Security Type: In order to secure access to the wireless network, you can enable encryption. WPA2-PSK is recommended as it provides the best security, while WEP really should not be used anymore, unless you have some legacy equipment that does not support WPA or WPA2.

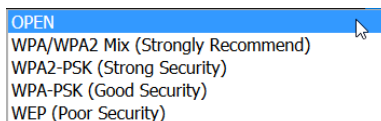

Wi-Fi Key: Type in the password for your wireless network here. The password is valid for both the 2.4 and 5 GHz network.

Wi-Fi Channel: Set the channel to a value that puts this wireless network at least four channels apart from an existing wireless network that might be in close proximity. For example, if another 2.4 GHz wireless network in range is set to channel 2, then it'd be best to set your Intellinet Access Point to channel 6 or higher.

Output Power: You can adjust the output power to low, medium or high.

A screenshot of the 'Basic Settings' configuration page. It features two columns for 'Wi-Fi 2.4G' and 'Wi-Fi 5G / AC'. The 'Wireless ON/OFF' section has radio buttons for 'ON' and 'OFF' for both bands. The 'SSID' section has text input fields for 'intellinet-N24' and 'intellinet-AC50'. The 'Security Type' is a dropdown menu set to 'WPA2-PSK (Strong Security)'. The 'Wi-Fi Key' section has two password input fields. The 'Wi-Fi Channel' section has dropdown menus for '11' and '40'. The 'Output Power' section has radio buttons for 'High', 'Medium', and 'Low'. An 'Apply' button is at the bottom.

2.4G ADVANCED SETTINGS

Protection Mode: Protection should be set to Auto or On. The B/G Protection mode ensures that older wireless 802.11b and 802.11g devices will not degrade the performance of the much faster wireless 802.11n network. If you have a mix of older and newer wireless stations in the network, it's recommended that you enable the protection mechanism. Only if you know for certain that your network consists only of wireless N clients should you consider disabling this option, as it can increase the performance of your connections ever so slightly.

Standard: The Intellinet Access Point supports all types of wireless devices ranging from 802.11b to 802.11n in the 2.4 GHz range. This parameter enables or disables support for b, g and n devices. Your likely choice is going to be 11b/g/n.

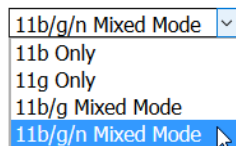
A screenshot of the '2.4G Advanced Settings' configuration page. It includes the following settings: Protection Mode (Auto), Standard (11b/g/n Mixed Mode), Beacon Interval (ms) (100), Data Beacon Rate (ms) (1), RTS Threshold (2347), Broadcast SSID (Enable), WMM (Enable), AP Isolation (Disable), Short GI (Enable), and 20/40 MHz Coexist (40MHz). An 'Apply' button is at the bottom.

Beacon Interval (ms): A wireless access point sends out specific data packets containing the SSID, the channel number and security settings. These packets are called beacons. Any client that wants to join a wireless network listens for these beacon frames, and any wireless client already connected also receives them whenever they are sent out. The beacon interval controls how often the access point broadcasts the beacon frames. Possible values range from 20 to 1000 (ms). The shorter the beacon interval, the more often the beacon frames are sent out. The more often the beacon frames are sent out, the quicker the association and roaming process will be, but it also leads to more network overhead, which then leads to a drop in throughput performance. You can increase the beacon interval to reduce the network overhead, but that comes at the expense of a slightly slower association time, which means it takes just a little bit longer for wireless clients to join the network. The default value is 100.

Data Beacon Rate (ms): The data beacon rate, also called DTIM (delivery traffic indication map) rate notifies a wireless client with power-save mode how many beacons until buffered multicast traffic will be broadcast by the access point. The higher the DTIM rate, the longer a client device may sleep and therefore the more power that particular client device may potentially save. You can specify a value between 1 and 255. The default value is 1, which makes the DTIM Interval the same as the Beacon Interval.

RTS Threshold: RTS (request to send) packets are sent by wireless clients to access points. The clients essentially ask for permission to send the next data packet. The lower the threshold, the more stable your wireless network, since it essentially asks more often when sending packages. The default value is 2347, and you are well advised to leave this value unchanged.

Broadcast SSID: If disabled, the Intellinet AC600 Access Point will no longer broadcast its network name to the public. Note that hiding the SSID is not a security feature. If you want to keep unauthorized users from accessing your wireless network, you need to enable wireless WPA2 encryption.

WMM: WMM stands for WiFi Multimedia. WMM prioritizes network traffic in four categories:

1. Voice
2. Video
3. Best effort (this is the majority of traffic from applications other than video and voice)
4. Background jobs such as printing, file downloads and other non-latency sensitive applications. Simply by activating WMM for the SSIDs of the Intellinet Access Point you can already achieve a noticeable improvement of the quality of service.

AP Isolation: When activated, wireless clients are isolated from one another. Wireless clients can only communicate with other clients that are connected via the LAN port of the Intellinet Access Point. AP isolation prevents wireless client to client traffic, including broadcasts. Use this option to provide additional protection for your wireless users in a public network.

Short GI: This option activates the short guard interval (SGI), which can increase your wireless performance by up to 11%. If your wireless access point is installed in a very crowded network environment, with different access points occupying different channels all around you, the slower guard interval of 800 ns will provide better results.

20/40 MHz Coexist: When set to 20/40MHz, the Intellinet Access Point will 'play nice' with other wireless networks in range, meaning, it will create less overlap to and interference with other wireless networks in range. In order to achieve the maximum performance in terms of pure link speed, this value should be set to 40MHz. However, in busy network environments with many wireless networks, using 40 MHz can actually be detrimental to the performance. That is because your wireless network occupies a much larger frequency spectrum and is therefore subject to a potentially larger amount of interference.

AC ADVANCED SETTINGS

Protection Mode: Protection should be set to Auto or On.

Only if you know for certain that your network consists only of wireless AC clients should you consider disabling this option, as it can increase the performance of your connections ever so slightly.

Standard: The Intellinet Access Point supports all types of wireless devices in the 5 GHz range. This parameter enables or disables support for a, n and ac devices. Your likely choice is going to be 11ac/an/a VHT, as it includes all forms of 5 GHz wireless communications. If you know for certain that no IEEE 802.3a clients will ever need to connect to your network, you may enable the option 11ac/an VHT.

Beacon Interval (ms): See 2.4G Advanced Settings.

Data Beacon Rate (ms): See 2.4G Advanced Settings.

RTS Threshold: See 2.4G Advanced Settings.

Broadcast SSID: See 2.4G Advanced Settings.

WMM: See 2.4G Advanced Settings.

AP Isolation: See 2.4G Advanced Settings.

Short GI: See 2.4G Advanced Settings.

20/40 MHz Coexist: See 2.4G Advanced Settings.

DFS Support: Dynamic Frequency Selection (DFS) is a requirement for radio systems operating in the 5GHz band to be equipped with the ability to identify and take action to avoid other radio transmissions that are considered primary-use or mission-critical. These mission-critical devices are various flavors of radar systems used by specific industrial, federal civilian and military organizations. Set this value to 'enable' and select your region, i.e., FCC or CE/ETSI, and then set the channel in the 5G AC settings to 'Auto (DFS)'.

VHT BandWidth: Select 80 MHz to benefit from the full advantage of the increased Wireless AC throughput, but select 20/40MHz in a crowded network environment with many wireless networks, to reduce the possibility of interference.

VHT Short GI: See 2.4G Advanced Settings.

AC Advanced Settings

Protection Mode	<input type="text" value="Auto"/>
Standard	<input type="text" value="11ac/an/a VHT"/>
Beacon Interval (ms)	<input type="text" value="100"/>
Data Beacon Rate (ms)	<input type="text" value="1"/>
RTS Threshold	<input type="text" value="2347"/>
Broadcast SSID	<input checked="" type="radio"/> Enable <input type="radio"/> Disable
WMM	<input checked="" type="radio"/> Enable <input type="radio"/> Disable
AP Isolation	<input type="radio"/> Enable <input checked="" type="radio"/> Disable
Short GI	<input checked="" type="radio"/> Enable <input type="radio"/> Disable
20/40 MHz Coexist	<input type="radio"/> 20/40MHz <input checked="" type="radio"/> 40MHz
DFS Support	<input type="radio"/> Enable <input checked="" type="radio"/> Disable
Output Power	<input checked="" type="radio"/> High <input type="radio"/> Medium <input type="radio"/> Low
VHT BandWidth	<input type="radio"/> 20/40MHz <input checked="" type="radio"/> 80MHz
VHT Short GI	<input checked="" type="radio"/> Enable <input type="radio"/> Disable

WPS SETTINGS

WPS stands for Wi-Fi Protected Setup (also referred to as Wi-Fi Simple Config) and is a computing standard that attempts to allow easy establishment of a secure wireless home network. This means, that you can join a secured wireless network without entering a complicated password, but simply by pushing a button or by entering a so-called pin-code. Not all wireless clients support WPS, however.

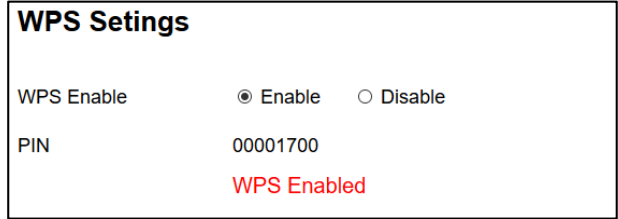

WPS Enable: This activates or deactivates the WPS function.

Pin: Pin code that the client must enter in order to join, if the pin code method is used.

The lower part of the screen is dedicated to the push button method. Here is how it works:

1. Click on 'Start'.
2. Wait for the message 'setting' to be displayed.
3. Push the WPS button on your wireless client. If the client does not have a physical button, then usually a 'software button' is provided. An example of the Android WPS push button function is shown below.
4. When the connection is established, the message will change to 'Successful'.

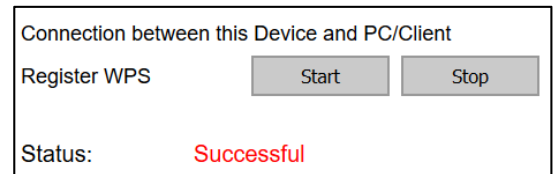
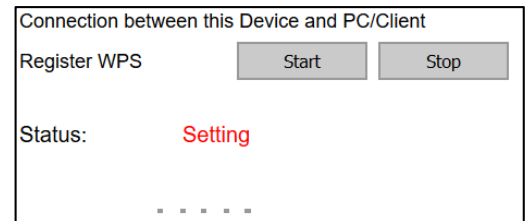

Client Setup Example – Android 5.x::

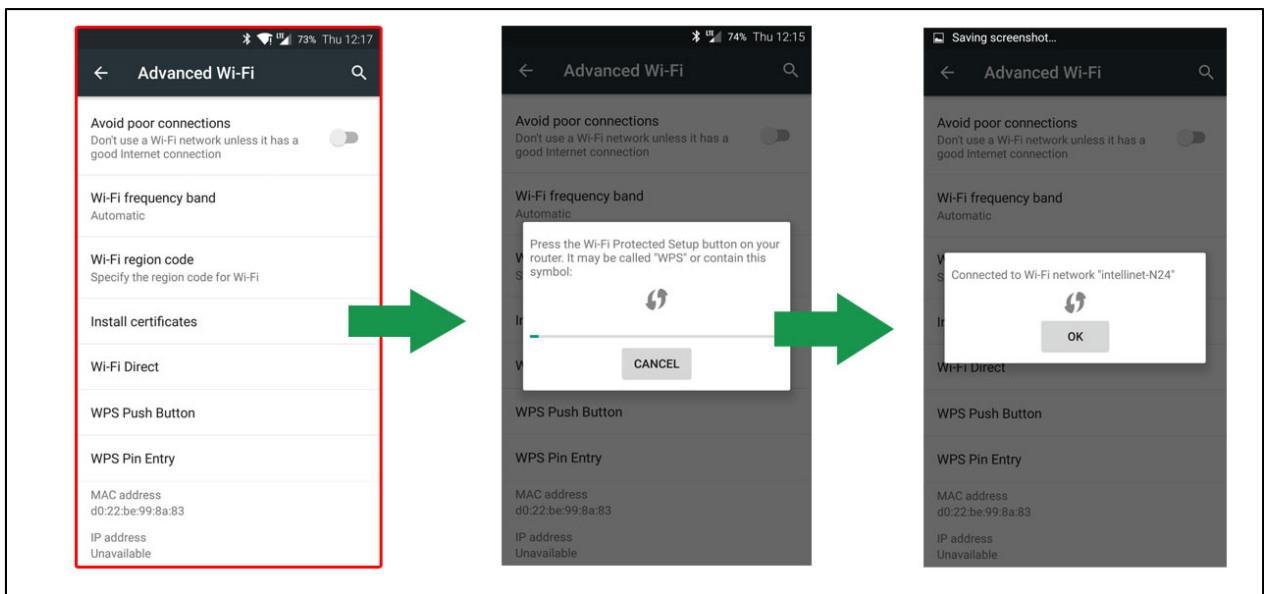

OTHER SETTINGS

The web administrator UI provides access to additional settings, which are explained in this section.

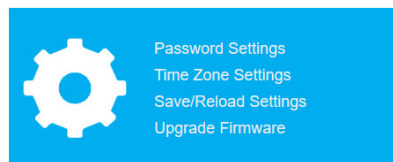

PASSWORD SETTINGS

On this screen you define the password that allows access to the administrator web UI.

User Name: Type in the user name for the administrator account. The default value is 'admin', but you can enter a different value.

New Password: Type in the password you wish to use for the administrator account.

Retype Password: Repeat the new password in this field. Make sure it matches the password you have entered above.

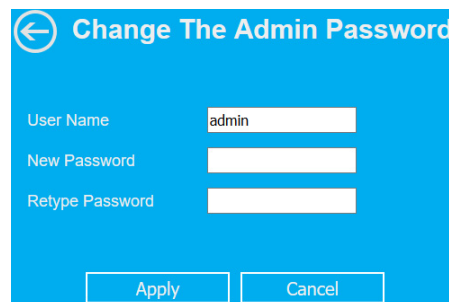

TIME ZONE SETTINGS

The Intellinet AC600 Access Point has an internal clock, which can be synchronized with external NTP servers. To do that, activate the option (x) Enable NTP client update, then specific the time zone you are in, i.e., (GMT-05:00 Eastern Time), and finally select an NTP server from the drop down list.

Note: The time function can only work, if the Intellinet Access Point has access to the Internet.

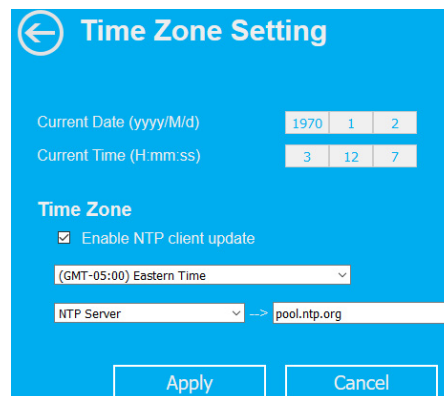

SAVE/RELOAD SETTINGS

With this screen you can create a backup of the current system configuration, which you can reload at a later time.

Save Settings: Click on 'Save...', then select the location where you want to save the file, i.E., a folder on your HDD or USB thumb drive.

Load Settings: Click 'Browse...', then select the previously saved file and click 'Upload' to restore the previously saved settings. The device will perform a restart when you use this function.

Reset Settings: In order to reinstate all factory default values, click on the 'Load Default' button. The device will perform a restart when you use this function.

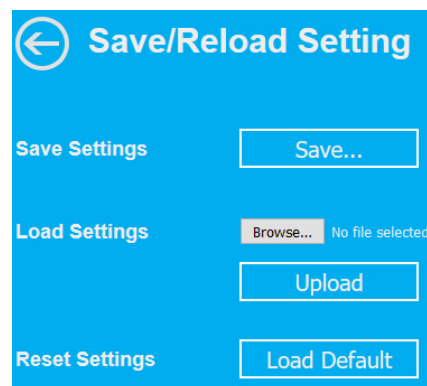

UPGRADE FIRMWARE

A new firmware version may be released from time to time to improve the performance of the device or to add new features. You can find the latest firmware for the Intellinet Access Point at intellinetnetwork.com.

Search for the keyword '525824', and then check the downloads tab for any new firmware versions.

In order to install a new firmware, you first need to download the firmware from the web site. When that is done, you need to un-compress the ZIP file. Then click on 'Browse...'. Select the firmware file, and then click on 'Apply.' Allow the process to finish. The device will perform a restart when you use this function.

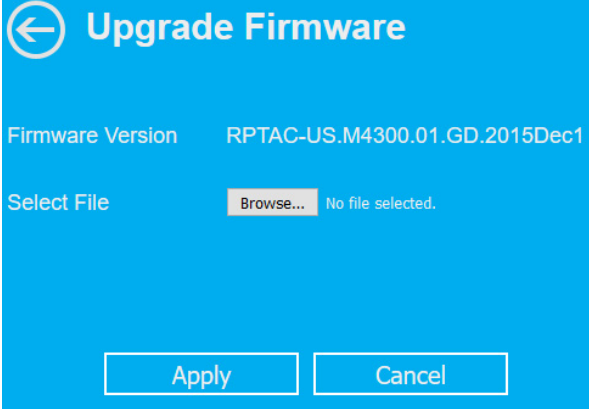

← Upgrade Firmware

Firmware Version RPTAC-US.M4300.01.GD.2015Dec1

Select File No file selected.

APPENDIX A: CHANGING THE IP ADDRESS OF A NETWORK ADAPTER

The Intellinet Access Point operates on the IP address 192.168.2.1. For your computer to access the administrator configuration interface, the IP address of the network adapter in your computer has to be in the same range; e.g., 192.168.2.50. Refer to the instructions that came with your computer for information on how to change the IP address on the network adapter in your computer for any operating system that is not explained in this user manual.

WINDOWS 8

1. If you are using a PC, move the mouse cursor to the bottom or top right corner of the screen and select the cog icon for Settings. If you are using a tablet, swipe left from the right side of the screen and select Settings.

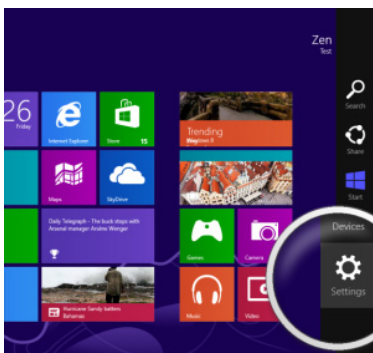

2. Click "Control Panel."

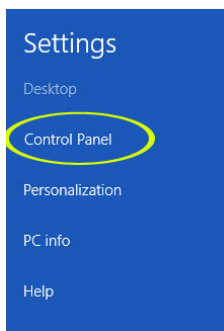

3. Select "Small icons."

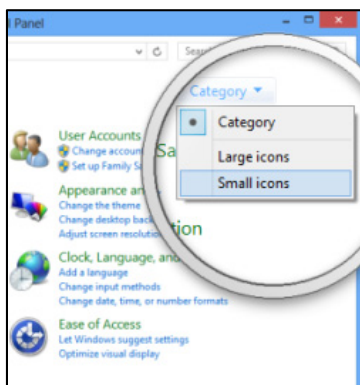

4. Open "Network and Sharing Center."

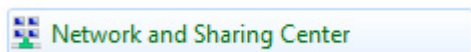

5. Click "Change adapter settings."

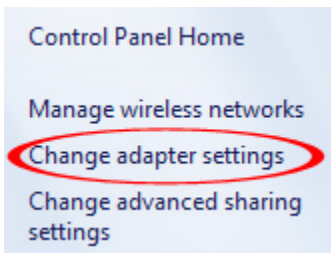

6. Right-click your network adapter and select "Properties."

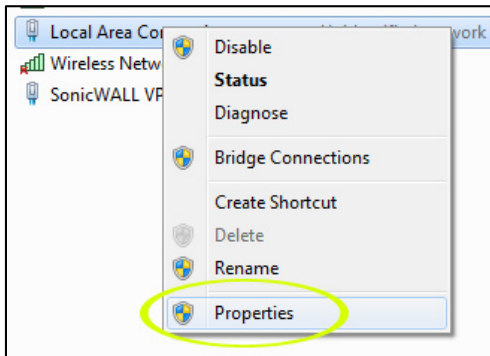

7. Select "Internet Protocol Version 4" from the list and click "Properties."

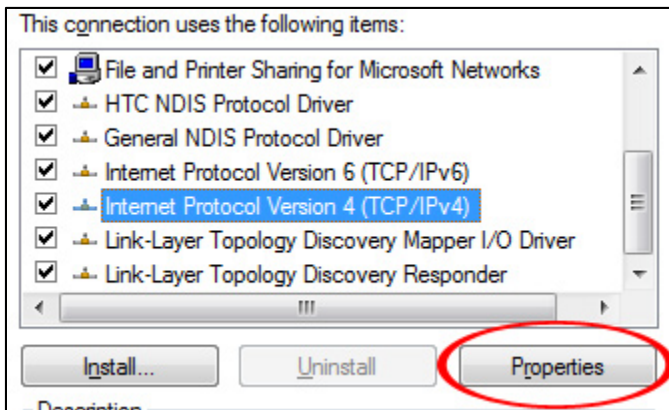

8. Enter the information as shown below, then click "OK" to save the settings.

A screenshot of the Windows IP address configuration dialog box. The "Use the following IP address:" radio button is selected. Below it are three input fields: "IP address:" with the value "192 . 168 . 2 . 50", "Subnet mask:" with the value "255 . 255 . 255 . 0", and "Default gateway:" with the value ". . .".

1. Open the Network and Sharing Center.

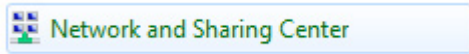

2. Click on "Change adapter settings."

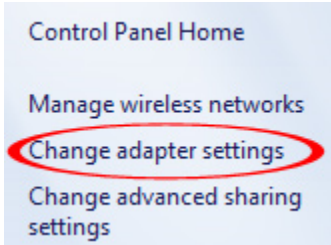

3. Right-click your network adapter and select "Properties."
4. Select "Internet Protocol Version 4" from the list and click "Properties."

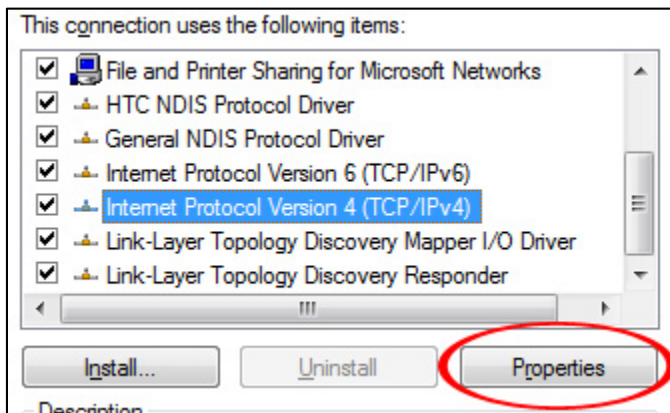

5. Enter the information as shown below, then click "OK" to save the settings.

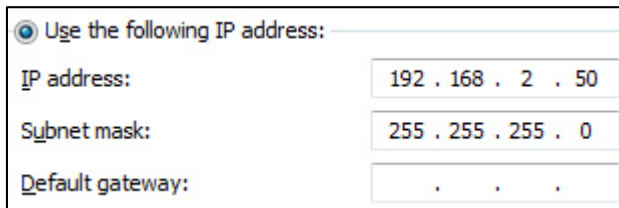

WINDOWS XP:

1. Double-click the “Network Connections” icon in the control panel.

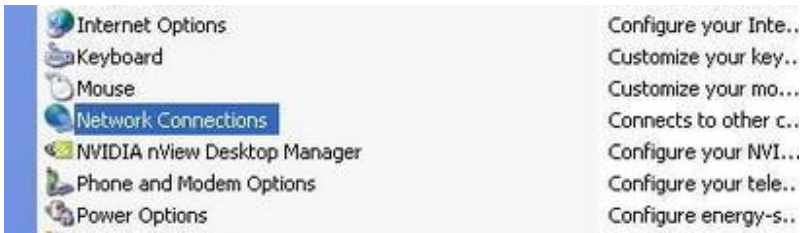

2. Right-click the connection (e.g., Local Area Connection) and select “Properties.”

3. Select “Internet Protocol (TCP/IP)” from the list and click “Properties.”

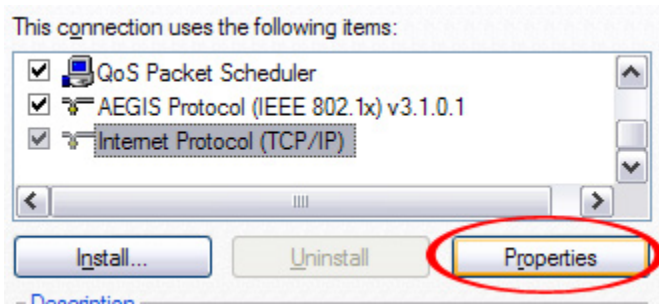

4. Enter the information as shown below, then click “OK” to save the settings.

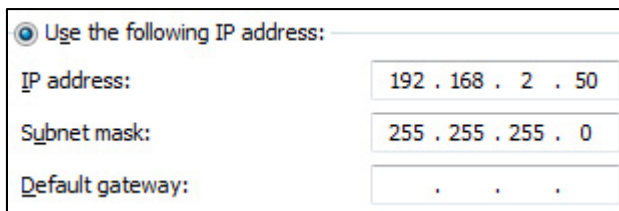

1. Open the System Preferences page.
2. In the Internet & Network section, click the Network icon.



3. Select either Built-in Ethernet or AirPort, depending on how you connect to the wireless access point, then click "Configure... ."

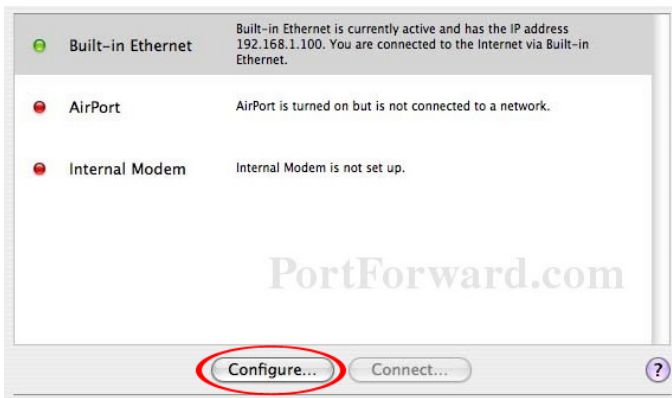

4. Set the value for Configure IPv4 to "Manually" and enter 192.168.2.50 in the IP Address field. Click "Apply Now" (not shown in screen shot) to save the settings.

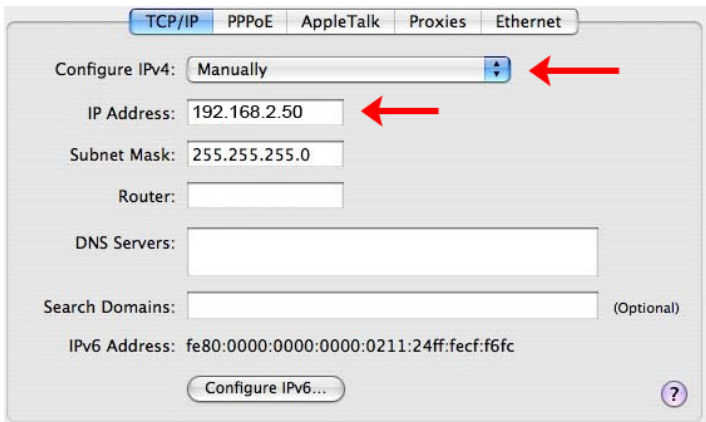

Symptom	How to address
The Power LED is not lit.	<p>Make sure that the power adapter is either properly inserted into the power connector on the PoE injector or the access point itself. If you use the PoE injector, be sure that you use an 8-pin network cable between the PoE injector and the access point's LAN port. A 4-pin cable won't work.</p> <p>Also, if you use the PoE injector, be sure that the Power LED on the injector is lit, and that you have connected the port labeled as "POE" with a network cable to the WAN/LAN(POE) port on the access point.</p> <p>In addition, check and make sure that the power outlet provides power.</p>
The LAN LED does not light up.	<p>Check the network connection between the access point's LAN port and the Ethernet port of the device you're connecting. The network cable must be inserted properly and the Ethernet device must be turned on. Try using a different network cable, if available.</p>
The WAN LED does not light up.	<p>Check the network connection between the access point's WAN port and the Ethernet port of the modem you're connecting to. The network cable must be inserted properly and the Ethernet device must be turned on. Try using a different network cable, if available.</p>
The WLAN LED is not lit.	<p>The WLAN LED should always be lit, whether a wireless connection has been established or not. It essentially indicates that the wireless module has started successfully. If the LED is off, it means that the wireless function has been disabled in the basic wireless settings.</p> <p>If the wireless function is enabled in the wireless setting, but the LED is off and you cannot connect to any wireless network, the access point needs to be replaced through your dealer (place of purchase).</p> <p>If the LED is off yet you have a working wireless connection, the LED may simply have failed.</p>
The hardware reset is not working.	<p>The reset button needs to be pressed firmly for 10 seconds while the wireless range extender is powered on. If it still does not work, the reset button could be malfunctioning.</p>

Deutsch Garantieinformationen finden Sie hier unter intellinetnetwork.com/warranty.

English For warranty information, go to intellinetnetwork.com/warranty.

Español Si desea obtener información sobre la garantía, visite intellinetnetwork.com/warranty.

Français Pour consulter les informations sur la garantie, rendezvous à l'adresse intellinetnetwork.com/warranty.

Italiano Per informazioni sulla garanzia, accedere a intellinetnetwork.com/warranty.

Polski Informacje dotyczące gwarancji znajdują się na stronie intellinetnetwork.com/warranty.

México Póliza de Garantía Intellinet — Datos del importador y responsable ante el consumidor IC Intracom México, S.A.P.I. de C.V. • Av. Interceptor Poniente # 73, Col. Parque Industrial La Joya, Cuautitlan Izcalli, Estado de México, C.P. 54730, México. • Tel. (55)1500-4500

La presente garantía cubre los siguientes productos contra cualquier defecto de fabricación en sus materiales y mano de obra.

A. Garantizamos cámaras IP y productos con partes móviles por 3 años.

B. Garantizamos los demás productos por 5 años (productos sin partes móviles), bajo las siguientes condiciones:

1. Todos los productos a que se refiere esta garantía, ampara su cambio físico, sin ningún cargo para el consumidor.
2. El comercializador no tiene talleres de servicio, debido a que los productos que se garantizan no cuentan con reparaciones, ni refacciones, ya que su garantía es de cambio físico.
3. La garantía cubre exclusivamente aquellas partes, equipos o sub-ensambles que hayan sido instaladas de fábrica y no incluye en ningún caso el equipo adicional o cualesquiera que hayan sido adicionados al mismo por el usuario o distribuidor.

Para hacer efectiva esta garantía bastará con presentar el producto al distribuidor en el domicilio donde fue adquirido o en el domicilio de IC Intracom México, S.A.P.I. de C.V., junto con los accesorios contenidos en su empaque, acompañado de su póliza debidamente llenada y sellada por la casa vendedora (indispensable el sello y fecha de compra) donde lo adquirió, o bien, la factura o ticket de compra original donde se mencione claramente el modelo, número de serie (cuando aplique) y fecha de adquisición. Esta garantía no es válida en los siguientes casos: Si el producto se hubiese utilizado en condiciones distintas a las normales; si el producto no ha sido operado conforme a los instructivos de uso; o si el producto ha sido alterado o tratado de ser reparado por el consumidor o terceras personas.



intellinetnetwork.com

© IC Intracom. All rights reserved.

Intellinet is a trademark of IC Intracom, registered in the U.S. and other countries.