

CANTEX®

NONMETALLIC ELECTRICAL BOXES

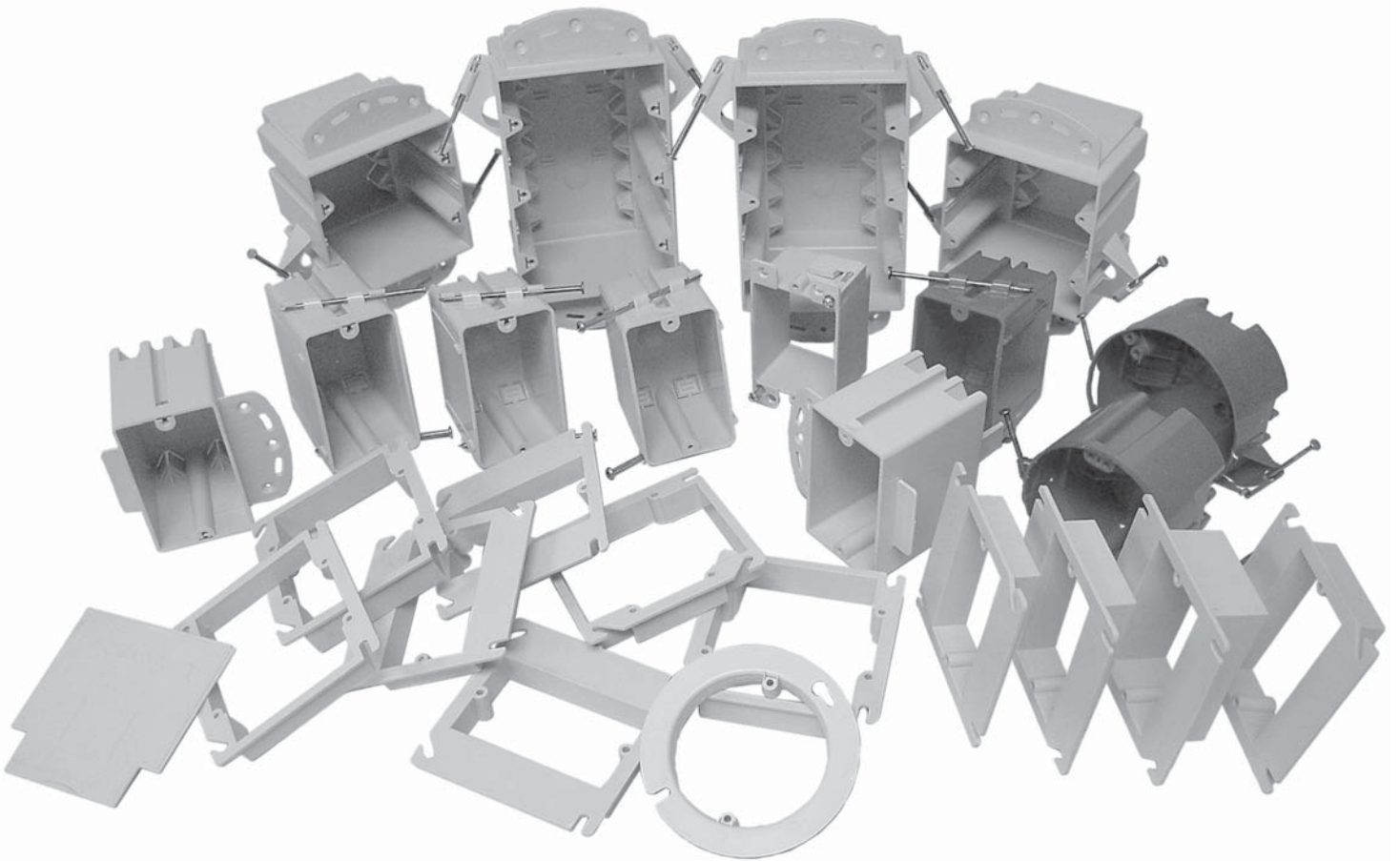

EZ BOX®

August 2008

NEW EXPRESS-CLIP FROM CANTEX

EZ INSTALLATION

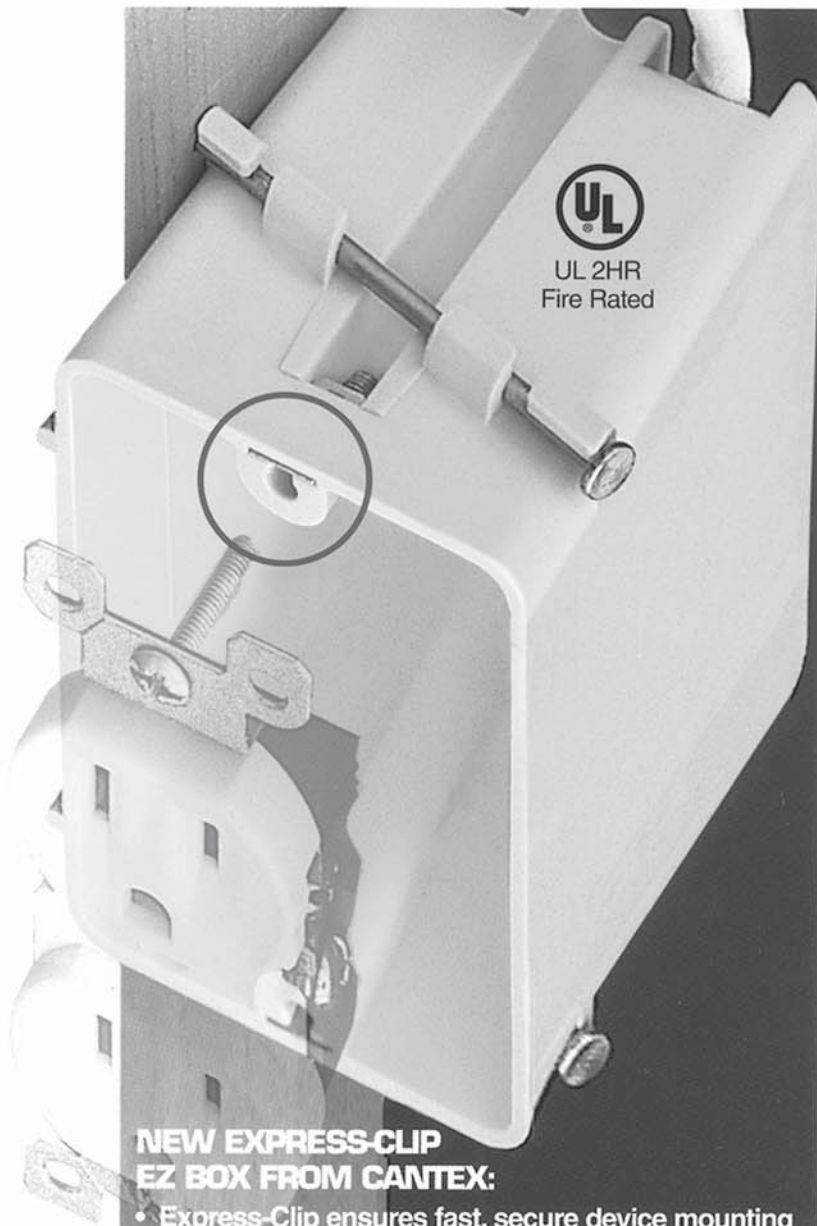
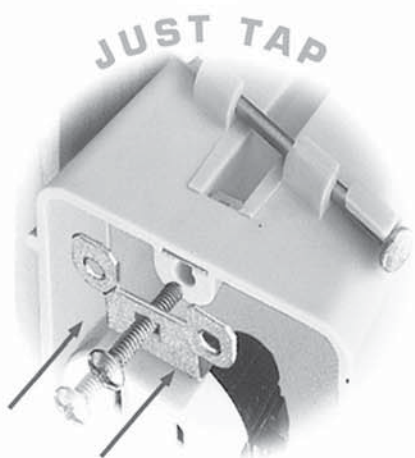

NEW EXPRESS-CLIP EZ BOX FROM CANTEX:

- Express-Clip ensures fast, secure device mounting
- No damage to device screw
- Express-Clip is constructed of quality steel for dependability and strength
- Available in nail-on 18, 20 and 23 cu.in. single gang, 48 cu.in. two gang and 74 cu.in. three gang for wood studs.
- For steel stud applications, the Express Clip is available in the 20 cu.in single gang, 48 cu.in. two gang and the 74 cu.in. three gang box.

EZ BOX FROM CANTEX®

A FITTING SOLUTION TO YOUR ELECTRICAL NEEDS.
P.O. Box 340, Mineral Wells, Texas 76068, 940-325-3344, Fax: 940-325-4644

CONTACT YOUR CANTEX REPRESENTATIVE
www.cantexinc.com

ELECTRICAL OUTLET AND SWITCH BOXES	PAGE
Single Gang Nonmetallic Outlet and Switch Boxes	6-8
Two, Three and Four Gang Nonmetallic Outlet and Switch Boxes	9-10
Maximum Capacity Outlet and Switch Boxes	12-13
Four Square and Shallow Nonmetallic Boxes and Communications EZ Box®	14
Nonmetallic Ceiling Boxes	15-16
Red Ceiling and Single Gang Boxes for Fire Alarm or Smoke Detector	17
Old Work Nonmetallic Outlet and Switch Boxes	18
Nonmetallic Electrical Covers & Covers with Riser	19
ENT Nonmetallic Electrical Boxes & ENT Adapter	20-21
EZ Box Part Number Cross Reference	22
4' Gondola Planogram	23
Limited Warranty	24
Terms and Conditions of Sale	25
Distributor Policy	26



Part Number Legend

EZ 20 CNG

Identifies the
CANTEX
EZ BOX®

08 = 8 Cubic Inch
14 = 14 Cubic Inch
16 = 16 Cubic Inch
18 = 18 Cubic Inch
20 = 20 Cubic Inch
25 = 25 Cubic Inch
32 = 32 Cubic Inch
44 = 44 Cubic Inch
55 = 55 Cubic Inch

CK = Ceiling Box
Blank Cover
DK = Double Gang
Blank Cover
ES = Extended Cover
Single Gang
ED = Extended Cover
Double Gang

A = Alarm
B = Bracketed
C = Ceiling Box
D = Double Gang (2)
E = Extended Cover
F = Flanged
G = Ground Lug
H = Hanger
K = Blank
L = Lid (Cover)
M = Metal
N = Nail On
O = Old Work
P = Project Pack
Q = Quad Gang (4)
R = Retail Pack
S = Single Gang (1)
T = Triple Gang (3)
U = Express Clip
X = 4" Square
Y = 4" Round
Z = Screw Nail

Uniform Product Code – Bar Codes

UPC-ITF

Shipping container Bar Code to identify each standard carton of products using interleaved 2 of 5 Symbology.

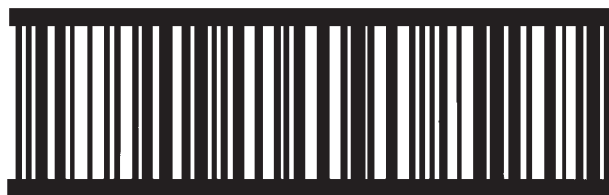

3 00 88700 56765 9

Packaging
Level

Number
System
Characters

Manufacturer
I.D. Number

Item
Number

Check Digit



SINGLE GANG EZ BOX®
 16 Cubic Inch, Nail On
 Suitable for Masonry Walls

2 1/4" x 3 5/8" x 2 1/2"
 Four knockouts
 Enhanced angled nails for
 quick mounting between studs

Part Number	Carton			UPC-A 0 88700	UPC-ITF 3 0088700
	Quantity	Weight	Cube		
EZ16SN	100	17.00	2.67	01982 9	01982 0
EZ16SNR	25	4.25	.79	01982 9	01983 7

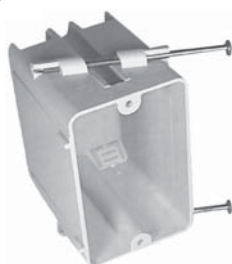

SINGLE GANG EZ BOX®
 18 Cubic Inch, Nail On
 Suitable for Masonry Walls

2 1/4 " x 3 5/8" x 2 13/16"
 Four knockouts
 Enhanced angled nails for
 quick mounting between studs

Part Number	Carton			UPC-A 0 88700	UPC-ITF 3 0088700
	Quantity	Weight	Cube		
EZ18SN	100	18.00	2.67	01979 9	01979 0
EZ18SNR	25	4.50	.79	01979 9	01980 6



SINGLE GANG EZ BOX®
 20.3 Cubic Inch, Nail On
 Suitable for Masonry Walls

2 1/4" x 3 5/8" x 3 1/4"
 Four knockouts
 Enhanced angled nails for
 quick mounting between studs

Part Number	Carton			UPC-A 0 88700	UPC-ITF 3 0088700
	Quantity	Weight	Cube		
EZ20SN	100	21.00	2.89	02022 1	02022 2
EZ20SNR	25	5.25	.88	02022 1	02023 9

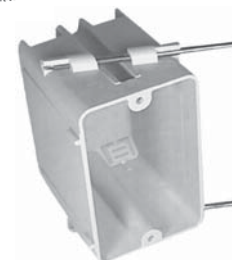

SINGLE GANG EZ BOX®
 23 Cubic Inch, Nail On
 Suitable for Masonry Walls

2 1/4" x 3 5/8" x 3 1/2"
 Four knockouts
 Enhanced angled nails for
 quick mounting between studs

Part Number	Carton			UPC-A 0 88700	UPC-ITF 3 0088700
	Quantity	Weight	Cube		
EZ23SN	100	22.00	3.33	02267 6	02267 7
EZ23SNR	25	5.50	.88	02267 6	02733 7

Designed for use on aluminum, light to medium grade steel or wood studs. The sharp point, slotted head and threaded body allow for installation

EZ Box® WITH THE SCREW-NAIL

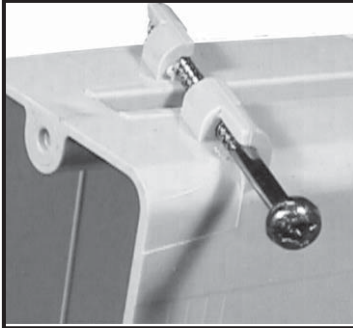

using a power screwdriver without having to pre-drill. It can just as easily be installed on wood studs using a hammer.



SINGLE GANG EZ BOX®
18 Cubic Inch, w / Screw-Nail
Suitable for Masonry Walls

2 1/4" x 3 5/8" x 2 13/16"
Four knockouts
Enhanced angled screw-nails for quick mounting between studs

Part Number	Carton			UPC-A 0 88700	UPC-ITF 3 0088700
	Quantity	Weight	Cube		
EZ18SNZ	100	18.00	2.67	02403 8	02403 9



SINGLE GANG EZ BOX®
20.3 Cubic Inch, w / Screw-Nail
Suitable for Masonry Walls

2 1/4" x 3 5/8" x 3 1/4"
Four knockouts
Enhanced angled nails for quick mounting between studs

Part Number	Carton			UPC-A 0 88700	UPC-ITF 3 0088700
	Quantity	Weight	Cube		
EZ20SNZ	100	21.00	2.89	02429 8	02429 9



SINGLE GANG EZ BOX®
23 Cubic Inch, w / Screw-Nail
Suitable for Masonry Walls

2 1/4" x 3 5/8" x 3 1/2"
Four knockouts
Enhanced angled screw-nails for quick mounting between studs

Part Number	Carton			UPC-A 0 88700	UPC-ITF 3 0088700
	Quantity	Weight	Cube		
EZ23SNZ	100	22.00	3.33	02405 2	02405 3

EXPRESS CLIP®
 Designed to provide EZ
 installation of electrical
 devices

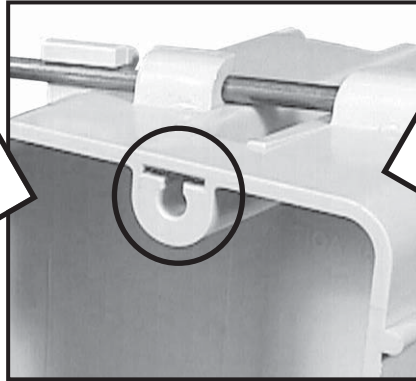

Just tap and turn the
 device screw for quick
 and secure mounting



SINGLE GANG EZ BOX®
 18 Cubic Inch, Nail On Express Clip
 Suitable for Masonry Walls

2 1/4" x 3 5/8" x 2 13/16"
 Four knockouts
 Enhanced angled screw-nails for
 quick mounting between studs

Part Number	Carton			UPC-A 0 88700	UPC-IT 3 0088700
	Quantity	Weight	Cube		
EZ18SNU	100	18.00	2.67	02402 1	02402 2



SINGLE GANG EZ BOX®
 20.3 Cubic Inch, Nail On Express Clip
 Suitable for Masonry Walls

2 1/4" x 3 5/8" x 3 1/4"
 Four knockouts
 Enhanced angled nails for
 quick mounting between studs

Part Number	Carton			UPC-A 0 88700	UPC-ITF 3 0088700
	Quantity	Weight	Cube		
EZ20SNU	100	21.00	2.89	02430 5	02430 4



SINGLE GANG EZ BOX®
 23 Cubic Inch, Nail On Express Clip
 Suitable for Masonry Walls

2 1/4" x 3 5/8" x 3 1/2"
 Four knockouts
 Enhanced angled screw-nails for
 quick mounting between studs

Part Number	Carton			UPC-A 0 88700	UPC-ITF 3 0088700
	Quantity	Weight	Cube		
EZ23SNU	100	22.00	3.33	02404 6	02404 5

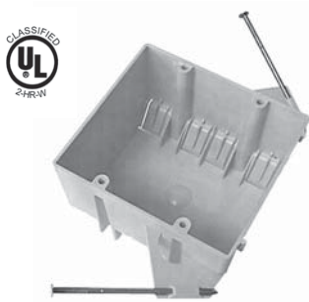

TWO GANG EZ BOX®
 32 Cubic Inch, Nail On
 Suitable for Masonry Walls

3 5/8" x 4" x 3"
 Enhanced angled nails for
 quick mounting between studs
 Eight clamps

Part Number	Carton			UPC-A 0 88700	UPC-ITF 3 0088700
	Quantity	Weight	Cube		
EZ32DN	50	13.00	3.33	01988 1	01988 2
EZ32DNR	15	3.90	1.07	01988 1	01989 9



THREE GANG EZ BOX®
 44 Cubic Inch, Nail On
 Suitable for Masonry Walls

3 5/8" x 5 7/8" x 2 3/4"
 Enhanced angled nails for
 quick mounting between studs
 Twelve clamps

Part Number	Carton			UPC-A 0 88700	UPC-ITF 3 0088700
	Quantity	Weight	Cube		
EZ44TN	50	23.50	3.81	01995 9	01995 0
EZ44TNR	8	3.76	.79	01995 9	01996 7



FOUR GANG EZ BOX®
 55 Cubic Inch, Nail On
 Suitable for Masonry Walls

3 5/8" x 7 5/8" x 2 5/8"
 Enhanced angled nails and
 adjustable bracket for quick
 mounting between studs
 Twelve clamps

Part Number	Carton			UPC-A 0 88700	UPC-ITF 3 0088700
	Quantity	Weight	Cube		
EZ55QNB	25	17.5	2.22	02005 4	02005 5

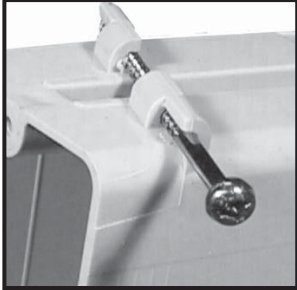

Designed for use on aluminum, light to medium grade steel or wood studs. The sharp point, slotted head and threaded body allow for installation using a power screwdriver without having to pre-drill. It can just as easily be installed on wood studs using a hammer.

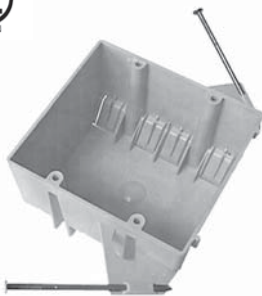

TWO GANG EZ BOX®
 32 Cubic Inch, w / Screw-Nail
 Suitable for Masonry Walls

3 5/8" x 4" x 3"

Enhanced angled screw-nails for quick mounting between studs
 Eight clamps

Part Number	Carton			UPC-A 0 88700	UPC-ITF 3 0088700
	Quantity	Weight	Cube		
EZ32DNZ	50	13.00	3.33	02427 4	02427 5



THREE GANG EZ BOX®
 44 Cubic Inch, w / Screw-Nail
 Suitable for Masonry Walls

3 5/8" x 5 7/8" x 2 3/4"

Enhanced angled screw-nails for quick mounting between studs
 Twelve clamps

Part Number	Carton			UPC-A 0 88700	UPC-ITF 3 0088700
	Quantity	Weight	Cube		
EZ44TNZ	50	23.50	2.75	02426 7	02426 8

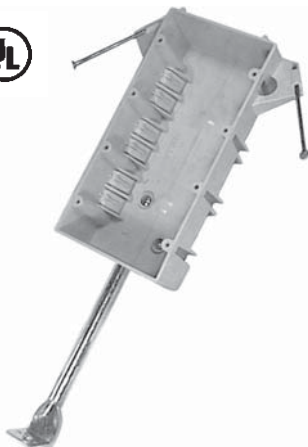

FOUR GANG EZ BOX®
 55 Cubic Inch, w / Screw-Nail
 Suitable for Masonry Wall

3 5/8" x 7 5/8" x 2 5/8"

Enhanced angled screw-nails and adjustable bracket for quick mounting between studs
 Twelve clamps

Part Number	Carton			UPC-A0 88700	UPC-ITF 3 0088700
	Quantity	Weight	Cube		
EZ55QNBZ	25	17.50	2.22	02432 8	02432 9

EZ DOES IT!

For Steel or Wood Stud Applications



**Maximum Depth Multi-gang
Electrical Boxes are now available**

Contractor
preferred clamps
lock wiring in place

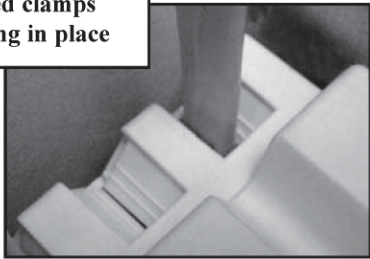

- 3 7/8" Deep
- Accepts larger wiring devices:
i.e. dimming switches, fan switches, GFCI, motion sensors
- Bracketed for steel stud installations
- Nails turned at a sharper angle for wood studs
- Divider available for Low Voltage/Communication installation
- 20 cubic inch single gang steel stud also available

Call your CANTEX Sales
Representative Today

**EZ BOX FROM
CANTEX®**

A Fitting Solution to Your Electrical Needs.
CANTEX INC. 301 Commerce Ste 2700 Fort Worth, Texas 76102
817/215-7000 Fax: 817/215-7001 www.cantexinc.com

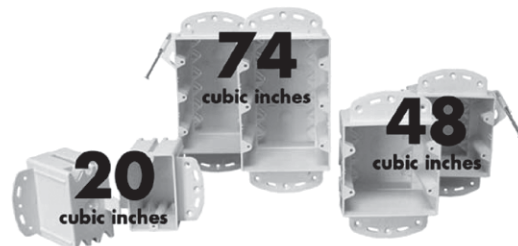



SINGLE GANG EZ BOX®
 20 Cubic Inch, Nail On
 Suitable for Masonry Walls

2 1/4" x 3 5/8" x 3 1/4"
 Bracket molded with box
 Eight clamps

Part Number	Carton			UPC-A 0 88700	UPC-ITF 3 0088700
	Quantity	Weight	Cube		
EZ20SB	100	18.8	--	04212 4	04212 5

MULTI-GANG NONMETALLIC MAXIMUM CAPACITY BOXES

MAXIMUM CAPACITY MULTI-GANG BOXES FOR USE ON STEEL OR WOOD STUDS NOW AVAILABLE!



TWO GANG EZ BOX®
 48 Cubic Inch, Nail On
 Suitable for Masonry Walls

3 7/8" x 3 7/8" x 3 7/8"
 Enhanced angled nails for
 quick mounting between studs
 Eight clamps

Part Number	Carton			UPC-A 0 88700	UPC-ITF 3 0088700
	Quantity	Weight	Cube		
EZ48DN	50	18.05	--	04190 5	04190 6



THREE GANG EZ BOX®
 74 Cubic Inch, Nail On
 Suitable for Masonry Walls

5 7/8" x 3 7/8" x 3 7/8"
 Enhanced angled nails for
 quick mounting between studs
 Twelve clamps

Part Number	Carton			UPC-A 0 88700	UPC-ITF 3 0088700
	Quantity	Weight	Cube		
EZ74TN	50	29.25	--	04191 2	04191 3

MULTI-GANG NONMETALLIC MAXIMUM CAPACITY BOXES WITH THE EXPRESS CLIP



TWO GANG EZ BOX®
 48 Cubic Inch, Nail On Express Clip
 Suitable for Masonry Walls

3 7/8" x 3 7/8" x 3 7/8"
 Enhanced angled nails for
 quick mounting between studs
 Eight clamps

Part Number	Carton			UPC-A 0 88700	UPC-ITF 3 0088700
	Quantity	Weight	Cube		
EZ48DNU	50	18.05	--	94284 4	94285 2



THREE GANG EZ BOX®
74 Cubic Inch, Nail On Express Clip
Suitable for Masonry Walls

5 7/8" x 3 7/8" x 3 7/8"
Enhanced angled nails for quick mounting between studs
Twelve clamps

Part Number	Carton			UPC-A 0 88700	UPC-ITF 3 0088700
	Quantity	Weight	Cube		
EZ74TNU	50	29.25	--	04191 2	04191 3

MULTI-GANG NONMETALLIC MAXIMUM CAPACITY BOXES WITH THE SCREW NAIL

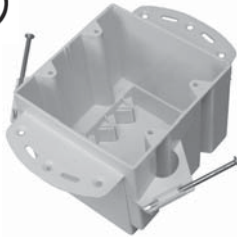

TWO GANG EZ BOX®
48 Cubic Inch Express Clip w/Screw-Nail
Suitable for Masonry Walls

3 7/8" x 3 7/8" x 3 7/8"
Enhanced angled nails for quick mounting between studs
Eight clamps

Part Number	Carton			UPC-A 0 88700	UPC-ITF 3 0088700
	Quantity	Weight	Cube		
EZ48DNZ	50	18.05	--	04388 6	04388 7



THREE GANG EZ BOX®
74 Cubic Inch Express Clip w/Screw-Nail
Suitable for Masonry Walls

5 7/8" x 3 7/8" x 3 7/8"
Enhanced angled nails for quick mounting between studs
Twelve clamps

Part Number	Carton			UPC-A 0 88700	UPC-ITF 3 0088700
	Quantity	Weight	Cube		
EZ74TNZ	50	29.25	--	04387 9	04387 0

NON-CONDUCTIVE DIVIDER FOR USE WITH LOW VOLTAGE DEVICES



LOW VOLTAGE DIVIDER
Fits two or three gang box

Used to divided multi-gang , maximum capacity boxes to allow installation of communication device with standard switch or outlet

Part Number	Carton			UPC-A 0 88700	UPC-ITF 3 0088700
	Quantity	Weight	Cube		
EZLVD	50	3.50	--	94234 9	94235 7



**FOUR SQUARE EZ BOX®
18 Cubic Inch, Nail On**

4" x 4" x 1 5/8"
Enhanced angled nails for quick mounting between studs
Flange mounting
Eight clamps



Part Number	Carton			UPC-A 0 88700	UPC-ITF 3 0088700
	Quantity	Weight	Cube		
EZ18XN	75	20.25	3.33	02008 5	02008 6
EZ18XNR	8	2.16	.79	02008 5	02009 3



**FOUR SQUARE EZ BOX®
32 Cubic Inch, Nail On
Suitable for Masonry Walls**

4" x 4" x 2 5/8"
Enhanced angled nails for quick mounting between studs
Ten clamps



Part Number	Carton			UPC-A 0 88700	UPC-ITF 3 0088700
	Quantity	Weight	Cube		
EZ32XN	50	17.00	3.33	01999 7	01999 8
EZ32XNR	8	2.72	.79	01999 7	02000 0



**SHALLOW EZ BOX®
FLANGED**

8 Cubic Inch
2 3/8" x 3 1/2" x 1 1/4"



Part Number	Carton			UPC-A 0 88700	UPC-ITF 3 0088700
	Quantity	Weight	Cube		
EZ08SF	25	2.50	.79	01997 3	01997 4



**SHALLOW EZ BOX®
BRACKETED**

8 Cubic Inch
2 3/8" x 3 1/2" x 1 1/4"



Part Number	Carton			UPC-A 0 88700	UPC-ITF 3 0088700
	Quantity	Weight	Cube		
EZ08SB	25	2.50	.44	01998 0	01998 1

NONMETALLIC COMMUNICATIONS BOXES



**SINGLE GANG COMMUNICATIONS EZ BOX®
14 Cubic Inch
Suitable for Masonry Walls**

2 1/4" x 3" x 2 7/8"
2 EZ Mount retainers

Part Number	Carton			UPC-A 0 88700	UPC-ITF 3 0088700
	Quantity	Weight	Cube		
EZ10SOLV	25	4.18	.79	04232 2	04232 3



CEILING EZ BOX®
 18 Cubic Inch, Nail On
 Suitable for Masonry Walls

3 1/2" Diameter 2 5/8" Depth
 Nails for quick mounting
 between rafters
 Four clamps

Part Number	Carton			UPC-A 0 88700	UPC-ITF 3 0088700
	Quantity	Weight	Cube		
*EZ18CN	75	14.25	2.89	02012 2	02012 3
*EZ18CNR	15	2.85	.79	02012 2	02013 0

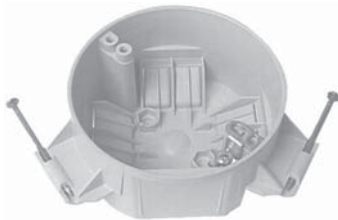

CEILING EZ BOX®
 18 Cubic Inch, Nail On
 with ground lug
 Suitable for Masonry Walls

3 1/2" Diameter 2 5/8" Depth
 Ground lug and screw attached
 Nails for quick mounting
 between rafters
 Six clamps

Part Number	Carton			UPC-A 0 88700	UPC-ITF 3 0088700
	Quantity	Weight	Cube		
*EZ18CNG	75	14.25	2.89	02010 8	02010 9
*EZ18CNGR	15	2.85	.79	02010 8	02011 6

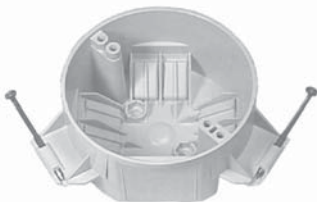

CEILING EZ BOX®
 20 Cubic Inch, Nail On
 Suitable for Masonry Walls

4" Diameter 2 3/8" Depth
 Nails for quick mounting
 between rafters
 Six clamps

Part Number	Carton			UPC-A 0 88700	UPC-ITF 3 0088700
	Quantity	Weight	Cube		
EZ20CN	75	14.25	2.89	01986 7	01986 8
*EZ20CNR	15	2.85	.79	01986 7	01987 5



CEILING EZ BOX®
 20 Cubic Inch, Nail On
 with ground lug

4" Diameter 2 3/8" Depth
 Ground lug and screw attached
 Nails for quick mounting
 between rafters
 Six clamps

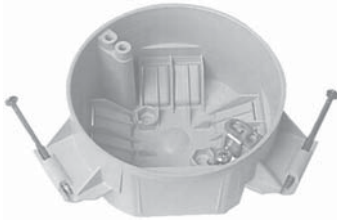

Part Number	Carton			UPC-A 0 88700	UPC-ITF 3 0088700
	Quantity	Weight	Cube		
*EZ20CNG	75	15.75	2.89	02003 0	02003 1
*EZ20CNGR	15	3.15	.79	02003 0	02004 8

NOTE: * Not suitable for ceiling fan installation.



CEILING EZ BOX®
 20 Cubic Inch,
 with Bar Hanger

4" Diameter 2 3/8" Depth
 Adjustable bar hanger for
 quick mounting between rafters
 Six clamps



Part Number	Carton			UPC-A 0 88700	UPC-ITF 3 0088700
	Quantity	Weight	Cube		
*EZ20CH	75	41.25	3.33	02001 6	02001 7
*EZ20CHR	8	5.10	.79	02001 6	02002 4



CEILING EZ BOX®
 20 Cubic Inch
 with Bar Hanger and ground lug

4" Diameter 2 3/8" Depth
 Ground lug and screw attached
 Adjustable bar hanger for quick
 mounting between rafters
 Six clamps



Part Number	Carton			UPC-A 0 88700	UPC-ITF 3 0088700
	Quantity	Weight	Cube		
*EZ20CHG	75	42.00	3.33	02006 1	02006 2
*EZ20CHGR	8	5.10	.79	02006 1	02007 9

NOTE: *Not suitable for ceiling fan installation.



CEILING FAN BOX
12.5 Cubic Inch

Accommodates 3 1/2" and
2 9/16" mounting
Supports up to 70 lbs. fan
weight or 200 lbs. fixture
weight

Part Number	Carton			UPC-A 0 88700 95371 0	UPC-ITF 3 0088700 95372 8
	Quantity	Weight	Cube		
EZ12CF	24	7.00	16.38		

NONMETALLIC CEILING BOXES FOR FIRE ALARM INSTALLATION



CEILING EZ BOX®
18 & 20 Cubic Inch, Nail On
Fire Alarm or Smoke Detector
Installations
Suitable for Masonry Walls

Red in color for easy identification
Nails for quick mounting
between rafters
Four clamps

Part Number	Carton			UPC-A 0 88700 03543 0	UPC-ITF 3 0088700 03543 1
	Quantity	Weight	Cube		
*EZ18CNA	75	14.25	2.89		
*EZ20CNA	75	14.25	2.89	03544 7	03544 8

Note: *Not suitable for ceiling fan installation.



SINGLE GANG EZ BOX®
Fire Alarm or Smoke Detector
Installations
Suitable for Masonry Walls

2 1/4" x 3 5/8" x 2 1/2"
Red in color for easy identification
Four knockouts
Enhanced angled nails for
quick mounting between studs

Part Number	Carton			UPC-A 0 88700 94460 2	UPC-ITF 3 0088700 94461 0
	Quantity	Weight	Cube		
EZ18SNA	100	18.00	2.67		
EZ20SNA	100	21.00	2.89	04410 4	04410 5
EZ23SNA	100	22.00	3.33	94458 9	94459 7



**SINGLE GANG
OLD WORK EZ BOX®**
14 Cubic Inch
Suitable for Masonry Walls

2 1/4" x 3" x 2 7/8"
Four clamps
2 EZ Mount retainers

Part Number	Carton			UPC-A 0 88700	UPC-ITF 3 0088700
	Quantity	Weight	Cube		
EZ14SO	50	8.50	1.78	01984 3	01984 4
EZ14SOR	25	4.25	.79	01984 3	01985 1
EZ21SO	50	8.93	2.02	95412 0	95413 8



**TWO GANG
OLD WORK EZ BOX®**
25 Cubic Inch

3" x 4" x 2 3/4"
Six clamps
2 EZ Mount retainers

Part Number	Carton			UPC-A 0 88700	UPC-ITF 3 0088700
	Quantity	Weight	Cube		
EZ25DO	30	4.50	1.78	01991 1	01991 2
EZ25DOR	10	1.50	.79	01991 1	01992 9



ROUND OLD WORK EZ BOX®
18 Cubic Inch

3 3/8" diameter 2 5/8" depth
Four clamps
3 EZ Mount retainers

Part Number	Carton			UPC-A 0 88700	UPC-ITF 3 0088700
	Quantity	Weight	Cube		
*EZ18CO	100	20.00	3.33	01993 5	01993 6
*EZ18COR	8	1.60	.79	01993 5	01994 3



ROUND OLD WORK EZ BOX®
18 Cubic Inch
with ground lug

3 3/8" diameter 2 5/8" depth
Ground lug and screw attached
Four clamps
3 EZ Mount retainers

Part Number	Carton			UPC-A 0 88700	UPC-ITF 3 008870
	Quantity	Weight	Cube		
*EZ18COG	100	20.00	3.33	02258 4	02258 5
*EZ18COGR	8	1.60	.79	02258 4	02259 2

NOTE: *Not suitable for fixture support nor for ceiling fan installation. See Ceiling Fan on page 17 of this catalog.



4" ROUND BLANK COVER

Part Number	Carton			UPC-A 0 88700	UPC-ITF 3 0088700
	Quantity	Weight	Cube		
EZYKL	100	6.00	.14	02014 6	02014 7
EZYKLR	50	3.00	.14	02014 6	02015 4



* UL LISTING PENDING

4" ROUND BLANK COVER WITH 1/2" KNOCKOUT

Part Number	Carton			UPC-A 0 88700	UPC-ITF 3 0088700
	Quantity	Weight	Cube		
EZYL1	100	6.20	.28	02548 6	02548 7
EZYL1R	50	3.10	.14	02548 6	02549 4



4" TWO GANG BLANK COVER

Part Number	Carton			UPC-A 0 88700	UPC-ITF 3 0088700
	Quantity	Weight	Cube		
EZXKL	100	7.00	.14	02016 0	02016 1
EZXKLR	25	1.75	.14	02016 0	02017 8

NONMETALLIC ELECTRICAL COVERS WITH RISER



* UL LISTING PENDING

4" ROUND PLASTER RING

Part Number	Rise	Carton			UPC-A 0 88700	UPC-ITF 3 0088700
		Quantity	Weight	Cube		
* EZ03YC	1/2"	100	3.70	.28	02550 9	02550 0
* EZ03YCR	1/2"	20	.74	.14	02550 9	02551 7
* EZ04YC	5/8"	100	3.30	.28	02552 3	02552 4
* EZ04YCR	5/8"	15	.49	.14	02552 3	02553 1



SINGLE GANG COVERS WITH RISER

Part Number	Rise	Carton			UPC-A 0 88700	UPC-ITF 3 0088700
		Quantity	Weight	Cube		
EZ03SXA	1/2"	100	7.00	.55	02018 4	02018 5
EZ03SXAR	1/2"	20	1.40	.14	02018 4	02019 2
EZ04ES	5/8"	50	4.25	.55	02349 9	02349 0
EZ04ESR	5/8"	15	1.28	.14	02349 9	02554 8
EZ05ES	3/4"	50	4.65	.55	02555 4	02555 5
EZ05ESR	3/4"	15	1.40	.14	02555 4	02556 2
EZ06ES	1"	40	4.32	.55	02557 8	02557 9
EZ08ES	1-1/4"	30	3.84	.55	02559 2	02559 3

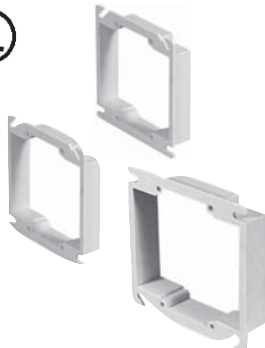

TWO GANG COVERS WITH RISER

Part Number	Rise	Carton			UPC-A 0 88700	UPC-ITF 3 0088700
		Quantity	Weight	Cube		
EZ06DXA	1/2"	75	3.75	.55	00038 4	02020 8
EZ06DXAR	1/2"	15	.75	.14	00038 4	00038 5
EZ08ED	5/8"	50	3.50	.55	02561 5	02561 6
EZ09ED	3/4"	50	4.00	.55	02563 9	02563 0



ENT Single Gang
18 Cubic Inch

Gray box with 3 Knockouts
for 1/2" and 3/4" ENT
4" x 2 1/4" x 3 1/16"

Part Number	Carton			UPC-A 0 88700	UPC-ITF 3 0088700
	Quantity	Weight	Cube		
EN18SB	50	6.28	1.87	02541 7	02541 8



ENT Two Gang
22.5 Cubic Inch

Gray box with 10 Knockouts
for 1/2" ENT
4" square - 1 1/2" deep

Part Number	Carton			UPC-A 0 88700	UPC-ITF 3 0088700
	Quantity	Weight	Cube		
EN22DB	50	6.28	1.87	02543 1	02543 2



ENT Two Gang Box
31.0 Cubic Inch

Gray box with 10 Knockouts
for 1/2" and 3/4" ENT
4" square - 2 1/8" deep

Part Number	Carton			UPC-A 0 88700	UPC-ITF 3 0088700
	Quantity	Weight	Cube		
EN31DB	50	14.15	1.87	02542 4	02542 5



ENT Ceiling Box
20.3 Cubic Inch

Black box with 6 Knockouts
for 1/2" and 3/4" ENT
4" Diameter 2 1/16" Depth

Part Number	Carton			UPC-A 0 88700	UPC-ITF 3 0088700
	Quantity	Weight	Cube		
EN20CB	50	8.35	.93	02546 2	02546 3

NOTE: * Not suitable for ceiling fan installation.



ENT Ceiling Box with Bar Hanger
20.03 Cubic Inch

Black box with 6 Knockouts
for 1/2" and 3/4" ENT
4" Diameter 2 1/16" Depth
Bar adjust 14 1/4" to 22 1/2"
in length

Part Number	Carton			UPC-A 0 88700	UPC-ITF 3 0088700
	Quantity	Weight	Cube		
EN20CH	25	9.93	1.06	02545 5	02545 6

ENT Slab Box with Knockouts



Part Number	Carton		Knockouts	UPC-A 0 88700	UPC-ITF 3 0088700
	Quantity	Weight			
ENS0507K	25	14	4 x 1/2" / 4 x 3/4"	04173 8	04173 9
ENS0500K	25	14	8 x 1/2"	04129 5	04129 6

ENT Slab Box with Connectors



Part Number	Carton		Knockouts	UPC-A 0 88700	UPC-ITF 3 0088700
	Quantity	Weight			
ENS0507C	25	15	4 x 1/2" / 4 x 3/4"	04130 1	04130 2
ENS0500C	25	15	8 x 1/2"	04131 8	04131 9

CSA NRTL/C Listed

ENT Stubby



Part Number	Size	Carton			UPC-A 0 88700	UPC-ITF 3 0088700
		Quantity	Weight	Cube		
EN075SBY	3/4"	150	04408 2	6.00	04408 1	04408 2
EN100SBY	1"	200	04409 9	12.00	04409 8	04409 9

ENT NONMETALLIC ELECTRICAL ADAPTERS



**Terminal Adapters
Threaded**



Part Number	Size	Carton			UPC-A 0 88700	UPC-ITF 3 0088700
		Quantity	Weight	Cube		
5163415	1/2	200	.40	--	00031 5	01209 8
5163416	3/4	200	.40	--	00032 2	01210 4



**Terminal Adapters
Snap In**



Part Number	Size	Carton			UPC-A 0 88700	UPC-ITF 3 0088700
		Quantity	Weight	Cube		
5163405	1/2	200	.40	--	00015 5	56718 5
5163406	3/4	200	.40	--	00016 2	56719 2

CANTEX EZ BOX® CROSS REFERENCE

CANTEX PART NO.	DESCRIPTION	T&B/CARLON		T&B/BOWERS		T&B/CHALLENGER		ALLIED		RACO		SLATER (P&S)		THEPITT	
		PART NO.	PART NO.	PART NO.	PART NO.	PART NO.	PART NO.	PART NO.	PART NO.	PART NO.	PART NO.	PART NO.	PART NO.	PART NO.	PART NO.
EZ08SF	8 CUBIC INCH FLANGED SHALLOW BOX	B108R													
EZ08SB	8 CUBIC INCH BRACKETED SHALLOW BOX	B108B													
EZ14SO	14 CUBIC INCH SINGLE GANG OLD WORK BOX	B114R	114-0W	6070-4				9363-EW		7887		S1-18-W		1680	
EZ16SN	16 CUBIC INCH SINGLE GANG NAIL-ON BOX	B116A	116N	SN-16				1085-N		7355		P1-16-R			
EZ18SN	18 CUBIC INCH SINGLE GANG NAIL-ON BOX	B118A	118N	SN-18				1086-N		7302		P1-18-R		1800	
EZ20SN	20 CUBIC INCH SINGLE GANG NAIL-ON BOX	B120A	120N	1050				1088-N		7820					
EZ23SN	23 CUBIC INCH SINGLE GANG NAIL-ON BOX	B122A													
EZ32DN	32 CUBIC INCH TWO GANG NAIL-ON BOX	B232A	234N	SN-232				2300-NC4		7835		P2-35-RAC		3600	
EZ18CO	18 CUBIC INCH OLD WORK CEILING BOX	B618R													
EZ18COG	18 CUBIC INCH OLD WORK CEILING BOX W/GRD LUG														
EZ25DO	25 CUBIC INCH TWO GANG OLD WORK BOX	B225R		6062-4				9312-BWK				S2-32-W		3490	
EZ44TN	44 CUBIC INCH THREE GANG NAIL-ON BOX	B344A	345N	1043-C				3300-NC6		7846		S3-54-RAC		4600	
EZ32XN	32 CUBIC INCH 4 SQUARE DEEP NAIL-ON BOX	B432A	45-32N	4000-N				9343-NC2		7234		S44-35-RAC			
EZ55QNB	55 CUBIC INCH FOUR GANG NAIL ON & BRACKET	B455A	4605B	7074-BH				3300-NBC4		7644		S468-RAC		6100	
EZ18XN	18 CUBIC INCH 4 SQUARE SHALLOW NAIL-ON BOX	B418A		SN-418				9340-C2		7218		S4421RAC		1900	
EZ18CN	18 CUBIC INCH CEILING BOX 3/0 NAIL-ON	B518A	3R-16N	3090-N				9355-NC2		7118		C1-18-RAC		16310	
EZ18CNG	18 CUBIC INCH CEILING BOX 3/0 NAIL-ON W/GRD LUG	B518P	3R-16NGP	3090-N-40				9335-NGC2		7918		C1-19-RGAC		16311	
EZ20CN	20 CUBIC INCH CEILING BOX 4/0 NAIL-ON	B520A	4R-20N	4170-C				9351-NC2		7163		A1-20-RAC			
EZ20CNG	20 CUBIC INCH CEILING BOX 4/0 NAIL ON W/GRD LUG	B520P	4R-20NGP	4170-C-40				9351-NGC2		7823		S1-20-RGAC		16110	
EZ20CH	20 CUBIC INCH CEILING BOX W/1/4" -23 1/2" HANGER	B620H	4R-20BH	4070-94				9350-24C2		7335		S1-20-HAC		16117/ 16122	
EZ20CHG	20 CUBIC INCH CEILING BOX W/4 1/4"-23 1/2" HANGER WITH GROUND LUG	B620HG	4R-20BHGP	4070-94-40				9350-24GC2		7985		S1-20-HGAC		16118/ 16123	
EZXKL	4" SQUARE 2 GANG BLANK COVER	A400	4S-B	*4041/45PB				9344							
EZ03SXA	4" SQUARE SINGLE GANG SQUARE COVER W/1/2" RISER	A410	4S-1G	*4042-12						7772		RC1		1010	
EZ04ES	4" SQUARE SINGLE GANG COVER WITH 5/8" RISER	A411								7071					
EZ05ES	4" SQUARE SINGLE GANG COVER WITH 3/4" RISER	A412													
EZ06ES	4" SQUARE SINGLE GANG COVER WITH 1" RISER	A413													
EZ08ES	4" SQUARE SINGLE GANG COVER WITH 1 1/4" RISER	A414													
EZ06DXA	4" SQUARE 2 GANG COVER WITH 1/4" RISER														
EZ08ED	4" SQUARE 2 GANG COVER WITH 5/8" RISER	A421								7076					
EZ09ED	4" SQUARE 2 GANG COVER WITH 3/4" RISER	A422								4SP1-214					
EZ06DXA	4" SQUARE 2 GANG SQUARE COVER W/1/2" RISER	A420	4S-2G	*4022-12						7778					
EZ03YC	4" ROUND PLASTER RING WITH 1/2" RISER	A471													
EZ04YC	4" ROUND PLASTER RING WITH 5/8" RISER	A472								4SP2-31R					
EZYKL	4" ROUND BLANK COVER	E460													
EZYL1	4" ROUND BLANK COVER WITH KNOCKOUT	A470D								7081					
EN18SB	18 CUBIC INCH SINGLE GANG ENT BOX	A58381D/								7050					
EN22DB	22.5 CUBIC INCH 2 GANG ENT BOX	AA521DE								7053					
EN31DB	31 CUBIC INCH 2 GANG ENT BOX	AA5217DE								7054					
EN20CB	20.3 CUBIC INCH ENT CEILING BOX	A615DE								7052					
EN20CH	20.3 CUBIC INCH ENT CEILING BOX WITH HANGER	A615DH								7051					

* REINFORCED PHENOLIC

4' GONDOLA PLANOGRAM

EZ BOX[®] FROM CANTEX[®]

1. 8 cu. in. Shallow Box w/Brkts 20 pcs.	2. 8 cu. in. Shallow Box w/Flange 20 pcs.	3. 4" Square Blank Cover 20 pcs.	4. 4" Round Blank Cover 20 pcs.	5. 4" Single Gang 1/2" Riser 12 pcs.	6. 4" Two Gang 1/2" Riser 12 pcs.	7. Single Gang Low Voltage 10 pcs
EZ08SB	EZ08SF	EZXKLR	EXYKLR	EZ03SXAR	EZ06DXAR	EZ10SOLV

8. 14 cu. in. Single Gang Old Work Box 20 pcs.	9. 25 cu. in. Two Gang Old Work Box 6 pcs.	10. 18 cu. in. Old Work Ceiling Box 6 pcs.	11. 20 cu. in. Ceiling Box 8 pcs.
EZ14SOR	EZ25DO	EZ18CO	EZ20CN

12. 32 cu. in. Two Gang Nail On 6 pcs.	13. 44 cu. in. Three Gang Nail On 4 pcs.	14. 32 cu. in. Square Shallow Box 4 pcs	15. 20 cu. in. Ceiling Box w/Hanger Bar 7 pcs
EZ32DN	EZ44TN	EZ32XN	EZ20CH

16. 18 cu. in. Single Gang Nail On 36 pcs.	17. 20 cu. in. Single Gang Nail On 36 pcs.
EZ18SN	EZ20SN

Limited Warranty

The Seller, **CANTEX Inc.**, warrants its PVC plastic pipe, conduit, fittings, accessories, residential electrical boxes and solvents against defective workmanship and material for a period of one year from date of applicable invoice. Seller's liability hereunder, either for breach of warranty or for negligence, is expressly limited, at Seller's option, to:

A) Replacement at the agreed point of delivery, at no cost to the Purchaser, of any product found by the Seller to be defective or found not to conform to the applicable industry manufacturing standards, or

B) to refund or credit to the Purchaser of the purchase price of such products, provided that Seller is notified immediately upon the discovery of any claimed defect and that representative samples of the allegedly defective product are returned, transportation prepaid, to Seller, F.O.B. shipping point, at Seller's request. No claim under this Limited Warranty will be considered until the product and representative samplings thereof have been examined by Seller.

The above warranty constitutes the entire liability of the Seller. Seller shall not be liable for any incidental or consequential damages directly or indirectly arising or resulting from the sale, transportation, handling, installation or use of the products sold, nor for product losses, re-installation or labor costs.

THIS WARRANTY IS EXPRESSLY IN LIEU OF ANY OTHER WARRANTIES, EXPRESSED OR IMPLIED, INCLUDING ANY IMPLIED WARRANTY OF MERCHANTABILITY OR FITNESS FOR ANY PARTICULAR PURPOSE, AND OF ANY OTHER OBLIGATION OR LIABILITY ON THE PART OF THE SELLER.

Situations that void this Limited Warranty:

1. Excessive temperature combination during test of operation.
2. Use of the product under conditions for which the product was not designed.
3. Failure to adhere to Seller's General Instruction Sheets concerning the proper handling, installation and testing of the product. General Instruction Sheets are available on request; Call 817-215-7000.
4. Use of non-suitable solvent cement. Suitable solvent cement shall be cement made in accordance with ASTM D 2564 and of the proper grade (viscosity) for the size of pipe being joined. CANTEX solvent cements meet these requirements.

CANTEX[®]

817-215-7000 • 301 Commerce Ste. 2700
Fort Worth, Texas 76102

941-967-4161 • 101 Gandy Road
Auburndale, Florida 33823

702-747-5010 • 130 Woodland Ave.
Reno, Nevada 89533

940-325-3344 • 2101 NE 1st St
Mineral Wells, Texas 76067

330-995-3665 • 11444 Chamberlin Rd. #1
Aurora, Ohio 44202

573-341-3000 • 2021 Industrial Park Blvd.
Rolla, Missouri 65401

928-681-3301 • 4045 Bonanza Drive
Kingman, Arizona 86401

Terms and Conditions of Sale

1. BUYER'S ACCEPTANCE

No waiver, alteration, or modification of these conditions will be binding unless in writing signed by an authorized employee of CANTEX INC.

2. PAYMENT TERMS

All prices are F.O.B. shipping point with freight costs being collect, prepaid or allowed and do not include local, state or Federal taxes. Taxes are for the account of Buyer. Payment terms appear on the face of Buyer's invoice. All orders are subject to credit approval.

3. LIQUIDATED DAMAGES

If any invoice or part thereof is not paid within 30 days of date of invoice, CANTEX will impose as Liquidated Damages a charge of one (1%) percent per month or the maximum applicable legal amount upon any overdue amount to offset CANTEX's anticipated damages including collection and accounting costs. Buyer agrees that the law of the State of Buyer's location will govern the construction and validity of this Contract and all other legal aspects of this sale.

4. CANCELLATION

Buyer may cancel prior to shipment subject to Liquidated Damages of the cost of labor, overhead and materials used plus ten (10%) percent of the sales price. Special orders may not be cancelled.

5. WARRANTY

CANTEX's products are warranted to be free from defective workmanship for one (1) year from date of shipment.

BUYER'S SOLE AND EXCLUSIVE REMEDY FOR BREACH OF THIS WARRANTY IS EXPRESSLY LIMITED. CANTEX may, at CANTEX's sole option: replace product at delivery location; repair product or refund or credit to Buyer the costs of the product.

CANTEX will not be liable for the costs of labor expended on any rejected material nor for any special, direct, indirect or consequential damage by reason of the fact that any material is defective or not in conformity with applicable specifications.

THIS WARRANTY IS EXPRESSLY IN LIEU OF ANY OTHER WARRANTIES, EXPRESS OR IMPLIED, INCLUDING ANY IMPLIED WARRANTY OR MERCHANTABILITY OF FITNESS FOR ANY PARTICULAR PURPOSE.

6. RETURNS

No material may be returned for credit without the Seller's written consent.

7. SHIPMENT/DELIVERY

CANTEX will ship common carrier or CANTEX truck. Buyer must file Claims for errors or breakage of product delivered by CANTEX trucks in writing to CANTEX within five (5) days of delivery. Errors or breakage of product delivered by common carrier are Buyer's responsibility.

Buyer is responsible for prompt unloading of trucks and/or freight cars. If delivery of Products is delayed by Buyer more than 60 days, Buyer will pay CANTEX eighty (80%) percent of total cost of Products.

8. INSTALLATION

Supervision of installation not included unless specifically requested.

9. DELAY

CANTEX will not be responsible for any delay in performance due to acts of God, war, riots, embargoes, acts of civil or military authorities, fires, floods, accidents, quarantine restrictions, supplier conditions, strikes, differences with workmen, cessation of plant operations, delays in transportation, nuclear incident, shortage of cars, fuel, labor or materials, or any cause beyond the reasonable control of CANTEX.

10. COMPLIANCE

CANTEX states its intentions to comply with all Federal laws applicable to CANTEX's performance.

Terms and Conditions of Sale

1. Pricing: Distributor pricing is in accordance with current company pricing policy. All pricing/delivery is contingent upon strikes, accidents, acts of God or other causes beyond our control.
2. Price Change: CANTEX will endeavor to give distributors advance notice of price change but reserves the right to make changes with or without written notice.
3. Additions, Changes and Cancellations: Addition of items or a change in quantities already accepted will be at the discretion of CANTEX. Cancellation of any order after acceptance by CANTEX may result in a penalty charge, the amount of which will be determined by the status of that order at the time of cancellation.
4. Minimum Charges: Minimum invoice value is \$100 net. Orders received below the minimum net value will be processed and billed the minimum charge of \$100 net.
5. Termination: CANTEX may terminate an authorized distributor for good cause effective immediately upon written notice addressed to the authorized distributor's last known address. In the event of termination with or without cause, CANTEX shall honor all purchase orders given in good faith by the distributor prior to termination, provided CANTEX receives reasonable assurances of payment for such orders. After termination, a person or firm shall cease to advertise or represent that it is an authorized distributor of CANTEX.
6. CANTEX Terms: Terms are 2% 10th prox, net 30. Freight allowed on single destination shipments of \$10,000 conduit only or combined conduit and accessories or \$1,000 net value for accessories and switch/outlet boxes or covers only. Shipments of less than the prepaid value are to be prepaid and the freight cost is added to the invoice.
7. Stock orders will be in standard package quantities.
8. CANTEX reserves the right to apply to the selling price any tax imposed by Law on the sale of the product.

Returned Goods Policy

Stock Inventory:

- A. Permission for such return of goods must first be obtained from CANTEX in writing. Such request must show CANTEX invoice number, date, quantity of items and CANTEX part number.
- B. Material to be returned must be new, unused, properly packaged and in resalable condition. No credit will be issued for open or partially used packages.
- C. Request for return must be processed within 6 months from the date of purchase.
- D. The RGA will expire six (6) months from date of issue. If the material is received after that date, terms of the return must be renegotiated.
- E. Material must be received at the location indicated on the RGA or it will become null and void.
- F. Restocking charge is 25%.
- G. The distributor will prepay freight cost to return the product and the outbound freight will be deducted from the credit issued.

CANTEX[®]

Commerce Ste. 2700
Fort Worth, Texas 76102
817-215-7000 Fax: 817-215-7001
www.cantexinc.com