

NEBO[®]



NEBO[®]
Sports
Bicycle Accessories

*i***PROTEC**[™]
Firearm Lighting

NEBO[®]
Innovative Lighting

WEATHERRITE[®]
SINCE 1941
Outdoor Accessories

Quarrow[®]
Fishing Accessories

GREETINGS FROM YOUR FRIENDS AT NEBO®!

We are excited to introduce you to our latest line-up of new and innovative products! Each one is designed to wow your customers and grow your sales. We are sure, that together, this is going to be the most successful year that we have ever experienced. Thanks for your support of NEBO® products!

A FEW OF THE NEW PRODUCTS FOR 2014

- O² BEAM™ 1-2
- REDLINE® RC™ - 300 Lumen Rechargeable Flashlight 3-4
- REDLINE® OC™ - 200 Lumen Flashlight..... 5-6
- EDGE™ 200 Lumen Flashlight 7-8
- WEATHERRITE® Outfitter XXL Cot 66
- 17 New Quarrow® Products 69-72,75

ADDITIONAL TABLE OF CONTENTS

- NEBO® Lights and Tools 1-42
- iPROTEC™ Firearm Accessories 43-56
- NEBO® Sports Bicycle Accessories 57-60
- WEATHERRITE® Outdoor Products 61-66,42
- Quarrow® Fishing Products 67-75
- HOT BUYS & LAST CALLS 76
- Custom Printing Program 77
- MAP Policy 78
- Lighting Information 79-80
- FAQ's 81-82
- Price Sheet 83-84



We love creating great, quality products for our customers! Don't forget, no one ships faster than NEBO®! And we always guarantee your total satisfaction as expressed by our NEBO® "Guaranteed Buyback Program" that you will find on the back of this catalog. We appreciate your business and the support and feedback you give our products.

Thanks and best wishes for your success!

THE NEBO® FAMILY
800-255-6061

NEW IN 2014

In 2014, we are redefining the standard of what a flashlight is supposed to be. The changes that we're making you literally have to see to believe.

We're taking everything that we expect a flashlight to be and we're making it better.

• O²™ Technology

We don't just want the light 15 feet in front of us; we want to shine it **fifteen hundred feet** ahead of us. Until we developed **O²™ Technology**, that was just a wild idea. Now it's a reality with the new **#6000 O² BEAM™** (pg.1-2).

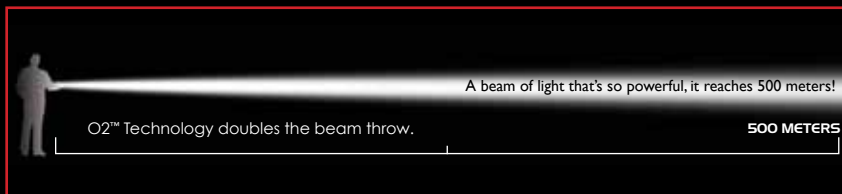

• OC™ Technology

Eliminating inconsistencies in light, the OC™ (Optimized Clarity) Technology provides intense, clear, pristine light that is easier on the eyes. This technology allows the edge of the light beam to be just as bright as the center in flood mode. You will discover this exciting breakthrough in clarity with the new **#6092 REDLINE® OC™** (pg.5-6).



• RC™ RECHARGEABLE

Our customers asked us for a fully rechargeable flashlight. We created one with proven performance by combining all the features of our top-selling REDLINE® series. Introducing the new **#6007 REDLINE® RC™** (pg.3-4), NEBO's first fully rechargeable flashlight.



• EDGE™ TACTICAL

The EDGE™ series has a new, long-awaited addition...the **#6085 EDGE™200** (pg.7-8). Jumping 110 lumens ahead of its predecessor, the EDGE™200 now has the lumen capabilities of our REDLINE® & BLUELINE® series. Still small and compact, the new EDGE™ has a stealth, aggressive look, which proves the claim..."Small never looked so mean!"



There are two different schools of thought in the consumer product business:

1. Create a product and tell the public how much they need it.
2. Find out what the public wants and deliver it.

We've chosen to take the latter approach. No one knows what our customers want more than our customers. Most of our products are what they are today because of the feedback that we get from our customers. We pride ourselves in not only giving our customers exactly what they want, but also exceeding their expectations.

THAT'S OUR STORY; FIND US ONLINE AND TELL US YOURS



NEBOTOOLS.COM



/NEBOTOOLS



@NEBOTOOLS



/NEBOTOOLS

Item#6000

O² BEAM™

BY NEBO®



5 Lighting Modes

High - 420 Lumens Run Time: 20 Hours Viewing Distance: 500 Meters	
Med - 200 Lumens Run Time: 55 Hours Viewing Distance: 240 Meters	
Low - 85 Lumens Run Time: 100 Hours Viewing Distance: 60 Meters	
Beacon* - 420 Lumens Run Time: 200 Hours Viewing Distance: 500 Meters	
Strobe - 420 Lumens Run Time: 70 Hours Viewing Distance: 500 Meters	

*Beacon mode emits two flashes of light (420 lumens) every 5 seconds. Perfect for emergency situations and distress signaling, this setting provides 200 hours of continuous use.



SPOT LIGHT

FLOOD LIGHT

4. 4x ADJUSTABLE ZOOM

Turn the bezel clockwise for flood light, perfect for short range lighting. Turn the bezel counter-clockwise for spot light to focus light 500 meters away.



1. HIGH-POWER 420 LUMEN LED

2. AGGRESSIVE SELF-DEFENSE FACE

3. HEAT-SINK BEZEL DESIGN

Integrated heat-sinking rings are used to disperse heat from the bezel during extended periods of use.

5. CONVEX LENS

Evenly distributes the light for a highly-concentrated beam, without dull or dark spots.

6. LO-LIGHT™

An internal glow-in-the-dark component located behind the lens provides a secondary light source, without using any battery life. The LO-LIGHT™ recharges when the O² Beam™ is on and with natural light. A 10 second charge will provide 5 minutes of illumination from the LO-LIGHT™. This low signature light source ensures stealth and preserves night vision.



OPTIMIZED OPTICS (O²)

This new, international patent pending technology enhances the performance of the flashlight, causing the beam to project at a distance that is **COMPARABLE TO THE BEAM THROW OF A FLASHLIGHT THAT IS 800-1200 LUMENS!**

FL 1 STANDARD



Each flashlight includes a gift box, owner's guide and instruction manual.



4pc Display

The display is designed to showcase one open case with light positioned as in the image. Underneath the display, there is room for 3 products in their gift box for customers to purchase.

Display Dimensions

(H) 9.29" x (W) 10.82" x (D) 10.27"

7. ANODIZED AIRCRAFT-GRADE ALUMINUM WATER-RESISTANT BODY

Actual Size: 8.625" x 1.5"
(1.5" - Barrel Diameter)



11. LANYARD INCLUDED

12. SERIALIZED

Each O² Beam™ is specially coded for quality assurance purposes.



8. USER INSTRUCTIONS

Each O² Beam™ flashlight has helpful information printed on the side: lighting modes, lumen ratings, run time and beam distance.

9. SMART SELECT DIAL

This smart select dial allows you to easily choose the mode you want without having to cycle through each setting. The dial can be used while the flash light is on or off.



10. GLOW-IN-THE-DARK BUTTON WITH BATTERY INDICATOR

Button will also glow red when battery life is less than 20%.

4 AA BATTERIES INCLUDED

With the O² technology™, the O² Beam™ outperforms flashlights with twice the lumen output, making it the most cost and energy efficient flashlight in its class with performance that you have to see to believe! The O² Beam™ – Industry standard redefined.



A beam of light that's so powerful, it reaches 500 meters!

Standard 420 lumen beam throw - 250 meters (273 yards)

O²™ Technology doubles the beam throw.

500 METERS

UPC CODE	ITEM	DESCRIPTION	MSRP	CASE PACK
645397929185	6000	NEBO® O ² BEAM	99.99	4 PIECES

Item#6007
NEBO®

REDLINE® RC™



1. HIGH-POWER 300 LUMEN LED

2. AGGRESSIVE SELF-DEFENSE FACE

3. HEAT-SINK BEZEL DESIGN
Integrated heat-sinking rings are used to disperse heat from the bezel during extended periods of use.

4. DIMMABLE BEAM
Press button 1x to turn light ON 100%. To set desired brightness, hold down the button to dim the light from 100% - 10%. To return to 100%, hold down the button to brighten the light or turn light OFF and back ON. From the OFF position, hold down the button to brighten the light from 10% - 100%. Double click the button to activate strobe mode.

5. ANODIZED AIRCRAFT-GRADE ALUMINUM WATER-RESISTANT BODY

6. CHARGING PORT
Slide the end cap down to reveal the charging port for AC/DC adapters (included.) Light takes 2.5 hours to fully charge using AC/DC adapters. Batteries do not have to be removed to charge.

7. AC/DC ADAPTERS INCLUDED

8. REAR ON/OFF BUTTON
This button allows you to easily activate the light while maintaining constant control of the flashlight.

POWERED BY RECHARGEABLE BATTERY (INCLUDED)
2000 mAh 18650 battery lasts up to 600 life cycles (1,500 hours).

3 Lighting Modes	
High - 300 Lumens Run Time: 2.5 Hours Viewing Distance: 200 Meters	
Low - 10 Lumens Run Time: 36 Hours Viewing Distance: 10 Meters	
Strobe - 300 Lumens Run Time: 8 Hours Viewing Distance: 200 Meters	

Actual Size: 7.4375" x 1"
(1" - Barrel Diameter)



FL 1 STANDARD				
Brightness	Distance	Run Time	Water-Resistant	Impact-Resistant

Clamshell Dimensions
 (H) 14" x (W) 6" x (D) 2.75"

Freestanding package can be displayed on either a counter top or peg hook.



What could be better than a 300 lumen REDLINE® flashlight? The answer is a 300 lumen REDLINE® flashlight that you don't have to put batteries in! The REDLINE® RC™ is NEBO's® first fully-rechargeable flashlight. Integrated with a heat-sink design, anodized aluminum body and aggressive face, the RC™ has everything that you'd expect a REDLINE® to have. The RC™ comes with 2 adapters (AC & DC) to charge the light anytime, anywhere. The batteries do not need to be removed to charge, the RC™ is 100% internally rechargeable. Not only is the RC™ bright, 300 lumens to be exact, it also has an adjustable light output. Just press the button to turn the light on. To set desired brightness, hold down the button to dim the light from 100% to 10%.

UPC CODE	ITEM	DESCRIPTION	MSRP	CASE PACK
645397929239	6007	NEBO® REDLINE® RC™ Rechargeable Light	59.99	6 PIECES

Item#6092
NEBO®

PATENTED ITEM
US. PAT. NO. 659,869 S

REDLINE[®] α

1. HIGH-POWER 200 LUMEN LED

2. AGGRESSIVE SELF-DEFENSE FACE

3. RED RING

This signature red ring enhances each of the different lighting modes.

4. 6X ADJUSTABLE BEAM

Turn the bezel clockwise for flood light, perfect for short range lighting. Turn the bezel counter clockwise for spot light, perfect for focusing light over 45 yards.

5. ANODIZED AIRCRAFT-GRADE ALUMINUM WATER-RESISTANT BODY

6. CONVEX LENS

The convex lens evenly distributes the light in flood mode for a highly concentrated beam without dull or dark spots.

7. DUAL-DIRECTION BELT/POCKET CLIP

8. GLOW-IN-THE-DARK BUTTON

Button uses hard/soft touch technology allowing settings to be changed in two different ways.

Hard touch: Simply click through the functions (light will turn off in between settings.) NOTE: Light will reset to first setting (100% ON) after being off for 20 seconds.

Soft touch: Press button halfway with no click. This allows the user to cycle through the settings quickly without the light turning off between settings.

2 Lighting Modes

100% - 200 Lumens
Run Time: 2 Hours
Viewing Distance: 92 Meters



Strobe - 200 Lumens
Run Time: 4.5 Hours
Viewing Distance: 92 Meters



OPTIMIZED CLARITY (α)

Eliminating inconsistencies in light, the OC™ (Optimized Clarity) Technology provides intense, clear, pristine light that is easier on the eyes. This technology allows the edge of the light beam to be just as bright as the center in flood mode.

Actual Size



• LANYARD INCLUDED

9. POWERFUL MAGNETIC BASE

Allows you to attach product to virtually all metal surfaces, giving you hands-free lighting. Magnetic base also helps in retrieving metal objects in a tight space.

• POWERED BY 1 AA BATTERY (INCLUDED)

		FL 1 STANDARD		
100% ON				 Water-Resistant
	200 LUMENS	110m	2h	
Defensive Strobe				 Impact-Resistant
	200 LUMENS	110m	4.5h	
		Brightness	Distance	Run Time

Display Dimensions
(H) 8" x (W) 7.5" x (D) 8.25"

12pc Metal Display
Display holds 12 pieces in the display. 4 additional pieces are included as replenishments.



The newest member of the REDLINE® series is the REDLINE® OC™. This flashlight outputs 200 lumens of pristine white light. 200 lumens is bright, but what makes the OC™ so special is the OC™ (Optimized Clarity) Technology. Coupled with the convex lens, the OC™ Technology creates optimized clarity with a perfectly dispersed beam of light while in flood mode. This sophisticated technology provides the intensity of a 200 lumen light that is easier on the eyes. Even with the use of convex lenses, a flashlight will still have a hot center as well as some inconsistencies in the beam and/or halos outside of the light beam. The OC™ eliminates all of that. In flood mode, the exterior of the light beam is just as intense as the center. When a light beam has a hot center, your attention is drawn to it. The beam produced by the OC™ makes it easier for your eyes to focus on the entire illuminated area. The REDLINE® OC™...optimized clarity.

UPC CODE	ITEM	DESCRIPTION	MSRP	CASE PACK
645397929499	6092	NEBO® REDLINE® OC™ Flashlight	19.99	16 PIECES

Item#6085

EDGE 200™

BY NEBO®



2 Lighting Modes

100% - 200 Lumens
Run Time: 2 Hours
Viewing Distance: 92 Meters



Strobe - 200 Lumens
Run Time: 4.5 Hours
Viewing Distance: 92 Meters



- 1. HIGH-POWER 200 LUMEN LED
- 2. AGGRESSIVE SELF-DEFENSE FACE
Tactical bezel can be removed to have a smooth face.
(Please use caution when using flashlight.)
- 3. HEAT-SINK DESIGN
Integrated heat-sinks are used to disperse heat from the body during extended periods of use.
- 4. ANODIZED AIRCRAFT-GRADE ALUMINUM WATER-RESISTANT BODY
- 5. DUAL-DIRECTION BELT/POCKET CLIP
- 6. GLOW-IN-THE-DARK BUTTON



• POWERED BY 1 AA BATTERY (INCLUDED)

FL 1 STANDARD				
100% ON	200 LUMENS	92m	2h	Water-Resistant
Defensive Strobe	200 LUMENS	92m	4.5h	Impact-Resistant
	Brightness	Distance	Run Time	

Display Dimensions
 (H) 8" x (W) 7.5" x (D) 8.25"

16 pc Metal Display
 Display holds 16 pieces in the display. 4 additional pieces are included as replenishments.



Taking the EDGE™ series to the next level is the EDGE™ 200. The EDGE™ 200 features 200 lumens of powerful white light. Crowning the top of the EDGE™ is the aggressive self-defense face. Much like the EDGE™90 the aggressive bezel can be removed to have a less aggressive, smooth face. The aggressive lines and angles of the aircraft grade aluminum body allow for proper heat dispersion as well as ensuring a steady grip. The dual-direction belt clip works well in the pocket or on a hat to serve as a cap light. Controlling the 2 light modes is the glow-in-the-dark button located at the base of the flashlight.

UPC CODE	ITEM	DESCRIPTION	MSRP	CASE PACK
645397929475	6085	NEBO® EDGE™ 200 Flashlight	15.99	20 PIECES

Item#6095

LUMO™

BY NEBO®



1. HIGH-POWER 25 LUMEN LED
 2. DIFFUSER DOME
Top dome diffuses the light to create an omnidirectional light source
 3. ANODIZED AIRCRAFT-
GRADE ALUMINUM
WATER-RESISTANT BODY
 4. CARABINER CLIP
Conveniently clips anywhere
 5. GLOW-IN-THE-DARK BUTTON
- POWERED BY 3 LR44
BATTERIES (INCLUDED)

FL 1 STANDARD

 25 LUMENS	 3m	 5h	 Water-Resistant	 1m Impact-Resistant
Brightness	Distance	Run Time	Water-Resistant	Impact-Resistant

1 Lighting Mode

100% - 25 Lumens
Run Time: 5 Hours
Viewing Distance: 3 Meters



16pc Display

Display holds 16 pieces on hooks. 32 additional pieces are stored inside the display.

Display Dimensions
(H) 9" x (W) 6.5" x (D) 6.5"



Compact, handy and bright...the LUMO™ Clip Light by NEBO® is the perfect “whatever you need” light. Keychain light, purse light, backpack light, book light...the possibilities are endless. This compact 25 lumen light comes with a carabiner attachment to clip anywhere you need. The white top of the LUMO™ is a diffuser dome. This dome helps evenly spread the light to create a more omnidirectional light source. LUMO™ Clip Light...the brilliant clip light!

UPC CODE	ITEM	DESCRIPTION	MSRP	CASE PACK
645397929529	6095	NEBO® LUMO™ 25 Lumen Clip Light	5.99	48 PIECES

Item#6006

the **Larry**²
BY NEBO[®]

Item#6055

the **Lucy**²
BY NEBO[®]

BRIGHTER...WITH LASER!

2 Lighting Modes

Red Laser: <5mW
Viewing Distance: 412 Meters



12 LEDs - 160 Lumens
Run Time: 6 Hours
Viewing Distance: 30 Meters



1. 12 HIGH-POWER LEDs

2. RED LASER POINTER

3. POWER BUTTON
This button allows you to easily turn on the light while maintaining constant control of this work light.

4. ROTATING MAGNETIC CLIP
The clip also rotates 180° to direct the light wherever you need it.

5. LED HOUSING
The LEDs are covered by a strong plastic lens that helps protect against drops.

6. WATER-RESISTANT REINFORCED PLASTIC BODY DESIGN
The body of the Larry² is textured to ensure a strong grip to protect against any accidental drops.

• 3 AAA BATTERIES INCLUDED



Actual Size

FL 1 STANDARD				
Brightness	Distance	Run Time	Water-Resistant	Impact-Resistant

Display Dimensions
(H) 6.25" x (W) 10.23" x (D) 5"

24pc Magnetic Acrylic Display

Display holds 12 pieces on the magnetic strip. 12 additional pieces are stored inside display.

the Larry™
12 LED + Laser Work Light
By: **NEBO**

- 160 Lumen Power White Light
- Red Laser Travels over 450 Yards
- 6 Hours of Hands Free Lighting
- Light Travels 33 Yards
- Rotating Magnetic Clip

Powered by 3 AAA Batteries (Included)

TRY ME! Working on anything? Larry2 can help.

Icons: Home, Car, Boat, Motorcycle, Van, Bicycle, Truck, Tractor, SUV

The newest addition to the Larry™ family is the Larry™2. Larry™2 has a few more LEDs under his belt, which boosts his lumen output to 160! The Larry™2 also features a red laser pointer that emits from the top of the light. Being the essential handyman light, the Larry™2 still has some of the features that made the Larry™ so great: the 180° rotating magnetic clip, reinforced plastic body design and ergonomic grip. The Larry™2 is perfect for endless applications and is still convenient enough to slip into your pocket. More features...more lumens...same Larry™ style!

UPC CODE	ITEM	DESCRIPTION	MSRP	CASE PACK
645397929222	6006	NEBO® Larry™2 12 LED Work Light	15.99	24 PIECES
645397929345	6051	NEBO® Larry™2 Work Light - Bulk Orange	15.99	12 PIECES
645397929352	6052	NEBO® Larry™2 Work Light - Bulk Gray	15.99	12 PIECES
645397929369	6053	NEBO® Larry™2 Work Light - Bulk Black	15.99	12 PIECES
645397929376	6054	NEBO® Larry™2 Work Light - Bulk Lime Green	15.99	12 PIECES
645397929383	6055	NEBO® Lucy™2 Work Light - Bulk Pink	15.99	12 PIECES

Item#6001

WORKBRITE™

BY NEBO®

- 1. 20 LEDs (FACE)
 - 2. 6 LEDs (HEAD)
 - 3. HANGING HOOK
 - 4. POWERFUL MAGNETIC BASE
 - 5. PIVOTING STAND
Allows the light to stand freely and pivot 200° to point light in virtually any direction.
 - 6. IMPACT-RESISTANT, WATER-RESISTANT BODY
 - 7. ERGONOMIC NON-SLIP GRIP
- 4 AAA BATTERIES INCLUDED

FL 1 STANDARD				
20 LEDs (Face) 200 LUMENS	60m	15h	Water-Resistant	1m Impact-Resistant
6 LEDs (Head) 60 LUMENS	30m	40h	Water-Resistant	Impact-Resistant
Brightness	Distance	Run Time		

2 Lighting Modes

<p>20 LEDs - 200 Lumens Run Time: 15 Hours Viewing Distance: 60 Meters</p>	
<p>6 LEDs - 60 Lumens Run Time: 40 Hours Viewing Distance: 30 Meters</p>	



Actual Size: 9.125" x 1" x 1.75"

16pc Assorted Color Display

Each light is secured to the display using the magnetic base. Display also allows product to be easily tested by consumers.

Display Dimensions
(H) 14" x (W) 12" x (D) 9"



The NEBO® WORKBRITE™ adapts to your work environment, making it the handiest of work lights. The WORKBRITE™ features three different ways to provide you with hands-free lighting for the task at hand: a hanging hook, a 200° pivoting stand and a magnetic base. Aside from being handy, the WORKBRITE™ is...well, BRIGHT! 200 lumens of pure white light are outputted by the 20 LED face. And for standard flashlight use, another 6 LEDs are located in the head, providing 60 lumens of brightness. For handheld use, the WORKBRITE™ features an ergonomic, non-slip grip. For added durability, the body is also completely impact and water-resistant. Whether you are under the hood, under the sink, or just out in the dark, the WORKBRITE works great for any application. WORKBRITE™...It stands! It hooks! It sticks! It lights! It WORKS!

UPC CODE	ITEM	DESCRIPTION	MSRP	CASE PACK
645397929192	6001	NEBO® WORKBRITE™ Work Light	21.99	16 PIECES

NEBO®

REDLINE® SELECT

1. HIGH-POWER 310 LUMEN LED

2. AGGRESSIVE SELF-DEFENSE FACE

3. STEALTH RING

The signature red ring enhances each of the different lighting modes. For tactical purposes there is a stealth ring that can disable light from shining through the red ring. Simply turn the stealth ring clockwise to cover the red ring.

4. HEAT-SINK BEZEL DESIGN

Integrated heat-sinking rings are used to disperse heat from the bezel during extended periods of use.

5. 4X ADJUSTABLE BEAM

Turn the bezel clockwise for flood light, perfect for short range lighting. Turn the bezel counter clockwise for spot light, perfect for focusing light over 45 yards.

6. ANODIZED AIRCRAFT-GRADE ALUMINUM WATER-RESISTANT BODY

7. CONVEX LENS

The convex lens evenly distributes the light for a highly concentrated beam without dull or dark spots.

8. USER INSTRUCTIONS

Each REDLINE® Select flashlight has helpful information printed on the side: lighting modes, lumen ratings, run time and beam distance.

9. STEEL CLIP

10. SMART SELECT DIAL

This smart select dial allows you to easily choose the mode you want without having to cycle through each setting. The dial can be used while the flashlight is on or off.



Scan the QR Code to Watch
The REDLINE® Select Video by **NEBO**^{TV}
www.youtube.com/nebotools

5 Lighting Modes

100% - 310 Lumens
Run Time: 2 Hours
Viewing Distance: 198 Meters



50% - 155 Lumens
Run Time: 5 Hours
Viewing Distance: 96 Meters



10% - 31 Lumens
Run Time: 12 Hours
Viewing Distance: 37 Meters



S.O.S. - 310 Lumens
Run Time: 60 Hours
Viewing Distance: 198 Meters



Strobe - 310 Lumens
Run Time: 60 Hours
Viewing Distance: 198 Meters



11. GLOW-IN-THE-DARK BUTTON WITH BATTERY INDICATOR

Button will also glow red when battery life is less than 20%.

12. POWERFUL MAGNETIC BASE

Allows you to attach product to virtually all metal surfaces, giving you hands-free lighting. Magnetic base also helps in retrieving metal objects in a tight space.

• **POWERED BY 3 AAA BATTERIES**



Actual Size

FL 1 STANDARD				
Brightness	Distance	Run Time	Water-Resistant	Impact-Resistant

PATENTED ITEM
US. PAT. NO. 659,869 S



Item #5955 Display Side View

9pc Acrylic Display

Each flashlight comes in an individual acrylic display box. These boxes fit securely into the base of the counter-top display.

Display Dimensions

(H) 7.75" x (W) 7.94" x (D) 7.94"



Item #5620 Display Top View



Item #5620 Display

The REDLINE® Select combines maximum performance with extreme convenience. Our brightest flashlight to date, the Select features 310 lumens of intense white light which can be seen over 200 yards away (in spot light mode.) 310 Lumens is maximum performance, but what is extreme convenience? The convenience features of this flashlight prove one thing...that we listen to our customers. In addition to the steel belt clip, the Select also has a lanyard to make sure it is always within reach. The ergonomic body is suited with heat-sinks which are used to disperse heat from the flashlight during extended periods of time. The signature red ring is now coupled with a stealth ring. To go into stealth mode, simply turn the stealth ring clockwise to block light from shining through the red ring. The REDLINE® Select is named 'Select' for a reason. To improve functionality of the 5 lighting modes, a smart select dial has been added to quickly and conveniently choose your lighting mode while the light is on or off. This feature keeps you from having to cycle through each setting to get to the mode that you need. And that...is extreme convenience.

UPC CODE	ITEM	DESCRIPTION	MSRP	CASE PACK
645397111276	5620	NEBO® REDLINE® Select Flashlight Black	49.99	9 PIECES
645397066125	5955	NEBO® REDLINE® Select Flashlight Titanium	49.99	9 PIECES

NEBO® SE REDLINE®

1. HIGH-POWER 250 LUMEN LED
2. AGGRESSIVE SELF-DEFENSE FACE
3. RED RING
4. HEAT-SINK BEZEL DESIGN
Integrated heat-sinking rings are used to disperse heat from bezel during extended periods of use.
5. 4X ADJUSTABLE BEAM
Turn the bezel clockwise for flood light, perfect for short range lighting. Turn the bezel counter clockwise for spot light, perfect for focusing light over 20 yards.
6. CONVEX LENS
The convex lens evenly distributes the light for a highly concentrated beam without dull or dark spots.
7. ANODIZED AIRCRAFT-GRADE ALUMINUM WATER-RESISTANT BODY
8. USER INSTRUCTIONS
Each SE REDLINE® flashlight has helpful information printed on the side. Lighting modes, lumen ratings, run time and beam distance are listed.
9. STEEL CLIP
10. GLOW-IN-THE-DARK BUTTON WITH BATTERY INDICATOR
Button will also glow red when battery life is less than 20%.



5 Lighting Modes

Primary Lighting Mode	Secondary Lighting Modes
100% - 250 Lumens Run Time: 4 Hours Viewing Distance: 160 Meters	
Press and hold button for 3 seconds to activate secondary lighting modes.	
50% - 125 Lumens Run Time: 8 Hours Viewing Distance: 69 Meters	
10% - 25 Lumens Run Time: 15 Hours Viewing Distance: 31 Meters	
S.O.S. - 250 Lumens Run Time: 72 Hours Viewing Distance: 160 Meters	
Strobe - 250 Lumens Run Time: 72 Hours Viewing Distance: 160 Meters	

11. POWERFUL MAGNETIC BASE

Allows you to attach product to virtually all metal surfaces, giving you hands-free lighting. Magnetic base also helps in retrieving metal objects in a tight space.

• POWERED BY 3 AAA BATTERIES



Scan the QR Code to Watch
The SE REDLINE® Video by NEBO™
www.youtube.com/nebotools

FL 1 STANDARD				
250 LUMENS	160m	4h		
Brightness	Distance	Run Time	Water-Resistant	Impact-Resistant

PATENTED ITEM
US. PAT. NO. 659,869 S

#5615 14pc Magnetic Acrylic Security Display
 Display Dimensions: (H) 7.25" x (W) 13.1875" x (D) 5"

Each flashlight is secured to the display using the magnetic base. The clear acrylic cover also secures 13 of the flashlights in place, while allowing one to be easily tested by consumers. The clear acrylic cover easily lifts off from the base.



#5616
12pc
 Case Pack

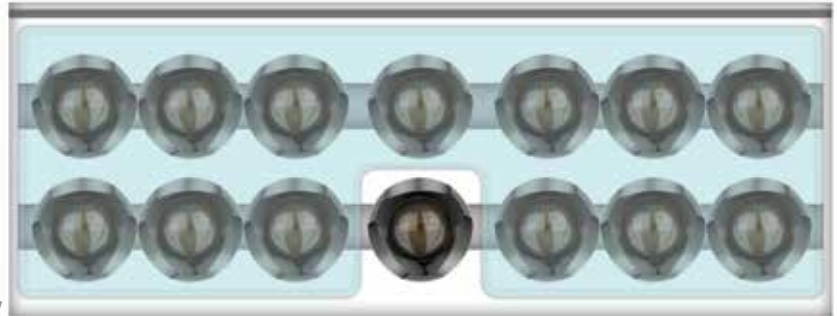

Top View

Front View

PATENT PENDING POWERED BY 3 AAA BATTERIES (INCLUDED)

SE REDLINE®

TRY ME!

250 Lumens of Supreme Brightness - 175 Yards of Visibility ASG **NEBO®**

- 4x ZOOM Feature (Flood-Spot)
- 5 Lighting Modes (100%-50%-10%-S.O.S.-Defensive Strobe)
- Low-Battery Indicator
- Water-Resistant
- Aircraft Grade Aluminum Body
- Steel Belt Clip
- Magnetic Base
- Rear Tactical Glow-In-The-Dark Power Button

ILLUMINATION	MODE 1	MODE 2	MODE 3	MODE 4	MODE 5
	250 LUMENS	125 LUMENS	25 LUMENS	S.O.S	STROBE
	4h	8h	15h	72h	72h
	160m	70m	31m	160m	160m
	2m	IP65			

To activate 100% Light Just Press Button
 Hold Button Down for 3sec to Activate Other Modes
 - Recharge in 15min. Hold button down for 3sec to turn off for 15min.

More features...more lumens...same great quality. The SE REDLINE® has some user friendly improvements. Equipped with a steel belt clip, the SE REDLINE® can always be kept within reach. The ergonomic body is suited with heat-sinks which are used to disperse heat from the flashlight during extended periods of time. The lighting modes are now separated into two categories, primary and secondary. Turning the flashlight on and off gives you the primary lighting mode, which is 250 lumens of intense white light. The secondary lighting modes, 50%, 10%, S.O.S. and Defensive Strobe can be activated by holding down the power button for 3 seconds. Speaking of the power button, it's not just for operating the light. Built into the glow-in-the-dark button is a battery indicator. The button will glow red when the battery life is less than 20%. Adding to the style of the SE REDLINE® is the signature thin, translucent red ring which enhances each of the different lighting modes.

UPC CODE	ITEM	DESCRIPTION	MSRP	CASE PACK
645397312116	5615	NEBO® SE REDLINE® 250 Lumen Flashlight	39.99	14 PIECES
645397914112	5616	NEBO® SE REDLINE® in Clamshell	39.99	12 PIECES
645397015123	5638	NEBO® SE REDLINE® Black Bulk (No PKG or Display)	39.99	18 PIECES
645397067122	5956	NEBO® SE REDLINE® Grey Bulk (No PKG or Display)	39.99	18 PIECES

NEBO®

REDLINE®

CLASSIC

1. HIGH-POWER 220 LUMEN LED

2. AGGRESSIVE SELF-DEFENSE FACE

3. RED RING

This signature red ring enhances each of the different lighting modes.

4. 4X ADJUSTABLE BEAM

Turn the bezel clockwise for flood light, perfect for short range lighting. Turn the bezel counter clockwise for spot light, perfect for focusing light over 20 yards.

5. ANODIZED AIRCRAFT-GRADE ALUMINUM WATER-RESISTANT BODY

6. CONVEX LENS

The convex lens evenly distributes the light for a highly concentrated beam without dull or dark spots.

7. USER INSTRUCTIONS

Each REDLINE® flashlight has helpful information printed on the side. Lighting modes, lumen ratings, run time and beam distance are listed.

8. GLOW-IN-THE-DARK BUTTON

Button uses hard/soft touch technology allowing settings to be changed in two different ways.

Hard touch: Simply click through the functions (light will turn off in between settings.) NOTE: Light will reset to first setting (100% ON) after being off for 20 seconds.

Soft touch: Press button halfway with no click. This allows the user to cycle through the settings quickly without the light turning off between settings.

5 Lighting Modes

100% - 220 Lumens
Run Time: 4 Hours
Viewing Distance: 138 Meters



50% - 110 Lumens
Run Time: 8 Hours
Viewing Distance: 60 Meters



10% - 22 Lumens
Run Time: 15 Hours
Viewing Distance: 27 Meters



S.O.S. - 220 Lumens
Run Time: 72 Hours
Viewing Distance: 138 Meters



Strobe - 220 Lumens
Run Time: 72 Hours
Viewing Distance: 138 Meters



9. POWERFUL MAGNETIC BASE

Allows you to attach product to virtually all metal surfaces, giving you hands-free lighting. Magnetic base also helps in retrieving metal objects in a tight space.



• POWERED BY 3 AAA BATTERIES

FL 1 STANDARD				
220 LUMENS	138m	4h	Water-Resistant	2m Impact-Resistant
Brightness	Distance	Run Time	Water-Resistant	Impact-Resistant

PATENTED ITEM
US. PAT. NO. 659,869 S

#5557 14pc Magnetic Acrylic Security Display
 Display Dimensions: (H) 7.25" x (W) 13.1875" x (D) 5"

Each flashlight is secured to the display using the magnetic base. The clear acrylic cover also secures 13 of the flashlights in place, while allowing one to be easily tested by consumers. The clear acrylic cover is removed by a slide and lift method.



#5581
12pc
 Case Pack



Top View

Front View

PATENT PENDING

REDLINE

TRY ME!

220 Lumens of Supreme Brightness - 150 Yards of Visibility **BY NEBO®**

- 4x Adjustable Beam (Flood-Spot) • High-Power LED • 5 Lighting Modes (100%-50%-10%-S.O.S.-Defensive Strobe)
- Water-Resistant / Shock-Proof Aircraft Grade Aluminum Body • Magnetic Base with Rear Tactical Hard/Soft Touch Glow Power Button

The ability to bring high-end technology to a compact, fully redesigned, extremely powerful light source is finally here. In automobiles, red-lining means reaching the peak of it's performance; with NEBO® REDLINE® we are harnessing the maximum power of this flashlight with 220 lumens of blinding bright light. (NOTE: Anything above 50 lumens within a 10 yard distance may cause temporary blindness when viewed directly.) The adjustable bezel allows you to turn the REDLINE® from a flood light to illuminate everything within a 20 yard distance, or to a spot light to focus up to 150 yards. The red ring of the NEBO® REDLINE® allows light to shine through to enhance all of the features of this flashlight.

UPC CODE	ITEM	DESCRIPTION	MSRP	CASE PACK
645397401100	5557	NEBO® REDLINE® Flashlight	34.99	14 PIECES
645397531111	5581	NEBO® REDLINE® Flashlight in Clamshell	34.99	12 PIECES
645397122111	5599	NEBO® REDLINE® Bulk (No PKG or Display)	34.99	18 PIECES
645397111115	5610	NEBO® REDLINE® Black Bulk (No PKG or Display)	34.99	18 PIECES



1. 8 POWERFUL LEDs

2. POWER BUTTON

This button allows you to easily turn on the light while maintaining constant control of this work light.

3. GRIP

The sides of the Larry™ are ribbed to ensure a strong grip and protect against those accidental drops.

4. LED HOUSING

The recessed LEDs are covered by a strong plastic lens which helps protect against drops. The recessed housing also directs the light into a strong concentrated beam of light.

5. ROTATING MAGNETIC CLIP

The clip also rotates 180° to direct the light wherever you need it.

6. WATER-RESISTANT REINFORCED PLASTIC BODY DESIGN



1 Lighting Mode

8 LEDs - 60 Lumens
 Run Time: 11 Hours
 Viewing Distance: 46 Meters



Scan QR Code to Watch The Larry™ Video by NEBO™
www.youtube.com/nebotools

FL 1 STANDARD

 60 LUMENS	 46m	 11h	 Water-Resistant	 1m
Brightness	Distance	Run Time	Water-Resistant	Impact-Resistant

#5618
24pc
Magnetic
Acrylic Display
 Display Dimensions
 (H) 6.25" x (W) 9" x (D) 5"

Angle View



Display holds 12 pieces on the magnetic strip. 12 additional pieces are stored inside display.

#5902

12pc Case Pack
 Assorted Colors

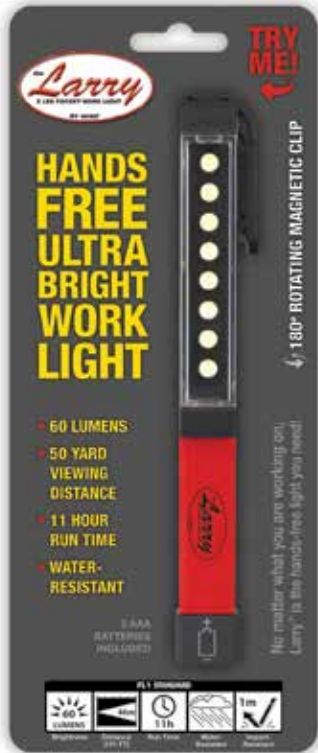

(Red, Blue & Grey)

Front View



The Larry™ 8 LED Pocket Work Light is the essential handyman light. Or if you need the essential handywoman's light then we have The Lucy™. 8 powerful LEDs provide 60 lumens of bright white light. You can't be a handyman/woman if your hands aren't...well, handy. The rotating magnetic clip gives you convenient hands-free lighting by attaching to virtually anything. The reinforced plastic body design is shock-proof and water resistant, making this light basically indestructible. The Larry™ & Lucy™ 8 LED Pocket Work Light...perfect for any job!

UPC CODE	ITEM	DESCRIPTION	MSRP	CASE PACK
645397203735	5618	The Larry™ 8 LED Pocket Work Light in Display	9.99	24 PIECES
645397018124	5894	The Larry™ 8 LED Work Light - Bulk Red	9.99	12 PIECES
645397019121	5895	The Larry™ 8 LED Work Light - Bulk Blue	9.99	12 PIECES
645397020127	5896	The Larry™ 8 LED Work Light - Bulk Grey	9.99	12 PIECES
645397021124	5897	The Larry™ 8 LED Work Light - Bulk Yellow	9.99	12 PIECES
645397036128	5902	The Larry™ 8 LED Work Light in Clamshell	9.99	12 PIECES
645397068129	5957	The Lucy™ 8 LED Work Light - Bulk Pink	9.99	12 PIECES

Item#5950



- 1. 8 POWERFUL UV LEDs**
- 2. POWER BUTTON**
Allows you to easily turn on the light while maintaining constant control of the light.
- 3. GRIP**
The sides of the Larry™ are ribbed to ensure a strong grip and protect against those accidental drops.
- 4. ROTATING MAGNETIC CLIP**
The clip also rotates 180° to direct the light wherever you need it.
- 5. LED HOUSING**
The recessed LEDs are covered by a strong plastic lens which helps protect against drops. The recessed housing also directs the light into a strong concentrated beam of light.
- 6. WATER-RESISTANT REINFORCED PLASTIC BODY DESIGN**
- 7. YELLOW LENS SAFETY GLASSES**
These glasses provide wrap around protection that covers your peripheral vision. Substances that fluoresce under UV light will fluoresce more intensely when viewed through these glasses.



1 Lighting Mode

8 UV LEDs
Wavelength: 410-415nm
Run Time: 11 Hours

UV LEDs can reveal materials that are not seen through normal lighting and can be very useful in:

- Crime scene investigation to reveal certain bodily fluids
- Document analysis and currency verification
- Leak detection (i.e. Freon)
- Rodent and pet stain detection
- Gemstone verification



The UV Larry™ Kit by NEBO® helps shed some new light on your situation. The Larry™ features 8 UV LEDs that can reveal materials that are not seen through normal lighting. While the naked eye has a hard time seeing these substances, they fluoresce when illuminated with UV light. The yellow wrap-around glasses enhance the UVs fluorescence drastically, making the substances stand out even more.

UPC CODE	ITEM	DESCRIPTION	MSRP	CASE PACK
645397061120	5950	The UV Larry™ UV Light Kit	19.95	6 PIECES

NEBO®

PATENT PENDING

BLUELINE®

1. HIGH-POWER 180 LUMEN LED

2. AGGRESSIVE SELF-DEFENSE FACE

3. BLUE RING

This signature translucent blue ring enhances each of the different lighting modes.

4. 4X ADJUSTABLE BEAM

Turn the bezel clockwise for flood light, perfect for short range lighting. Turn the bezel counter clockwise for spot light, perfect for focusing light up to 125 yards.

5. ANODIZED AIRCRAFT-GRADE ALUMINUM WATER-RESISTANT BODY

6. CONVEX LENS

The convex lens evenly distributes the light for a highly concentrated beam without dull or dark spots.

7. DUAL-DIRECTION STEEL CLIP

Allows you to keep this flashlight handy and provide hands-free lighting.

8. REAR GLOW-IN-THE-DARK BUTTON

Button uses hard/soft touch technology allowing settings to be changed in two different ways.
Hard touch: Simply click through the functions (light will turn off in between settings.) NOTE: Light will reset to first setting (100% ON) after being off for 20 seconds.
Soft touch: Press button halfway with no click. This allows the user to cycle through the settings quickly without the light turning off between settings.



#5948 20pc Magnetic Acrylic Display
 Display Dimensions: (H) 7.25" x (W) 13.1875" x (D) 5"

2 Lighting Modes

100% - 180 Lumens
 Run Time: 2 Hours
 Viewing Distance: 115 Meters



Strobe - 180 Lumens
 Run Time: 6 Hours
 Viewing Distance: 115 Meters



9. POWERFUL MAGNETIC BASE

Allows you to attach product to virtually all metal surfaces, giving you hands-free lighting. Magnetic base also helps in retrieving metal objects in a tight space.



#5602 12pc Case Pack (Black)



FL 1 STANDARD				
Brightness	Distance	Run Time	Water-Resistant	Impact-Resistant

UPC CODE	ITEM	DESCRIPTION	MSRP	CASE PACK
645397059127	5948	NEBO® BLUELINE® Flashlight	21.99	20 PIECES
645397123101	5602	NEBO® BLUELINE® Flashlight in Clamshell	21.99	12 PIECES

Item#5946

NEBO®



210 LUMEN FLASHLIGHT



**PROTEC SHIELD™
RETRACTS UPON
IMPACT**

- HIGH-POWER 210 LUMEN LED**
- AGGRESSIVE SELF-DEFENSE FACE**
- PROTEC SHIELD™**
Retracts upon hard impact to reveal the stealth aggressive jagged edge.
(Please use caution when using flashlight.)
- STEEL CLIP**
- ANODIZED AIRCRAFT-GRADE WATER-RESISTANT ALUMINUM BODY**
- GLOW-IN-THE-DARK BUTTON**
(Button uses hard/soft touch technology allowing settings to be changed in two different ways.)
Hard touch: Simply click through the functions (light will turn off in between settings.) NOTE: Light will reset to first setting (100% ON) after being off for 20 seconds.
Soft touch: Press button halfway with no click. This allows the user to cycle through the settings quickly without the light turning off between settings.



Actual Size



18pc Display Each flashlight comes with a clear protective cap that covers the aggressive self-defense face.
Display Dimensions: (H) 9" x (W) 9.75" x (D) 6"

3 Lighting Modes

100% - 210 Lumens
Run Time: 7 Hours
Viewing Distance: 110 Meters



50% - 105 Lumens
Run Time: 12 Hours
Viewing Distance: 50 Meters



Strobe - 210 Lumens
Run Time: 72 Hours
Viewing Distance: 110 Meters



Scan QR Code to
Watch The JAG™ Video by NEBO®
www.youtube.com/nebotools

FL 1 STANDARD				
Brightness	Distance	Run Time	Water-Resistant	Impact-Resistant

UPC CODE	ITEM	DESCRIPTION	MSRP	CASE PACK
645397057123	5946	NEBO® JAG™ 210 Lumen Flashlight	24.99	18 PIECES

Item#5947

ZOOM 130™

BY NEBO®

Ultra bright, compact and virtually indestructible.

1. HIGH-POWER 130 LUMEN LED

2. 4x ADJUSTABLE ZOOM
Turn the colored bezel clockwise for flood light, perfect for short range lighting. Turn the colored bezel counter-clockwise for spot light, perfect for focusing light up to 100 yards.

3. LANYARD INCLUDED
Zoom 130™ light comes with a lanyard to keep this flashlight handy and secure at all times.

4. CONVEX LENS
The convex lens evenly distributes the light for a highly concentrated beam without dull or dark spots.

5. POWDER COATED PLASTIC BODY DESIGN
Designed to fit almost anywhere, the body is virtually indestructible to ensure reliability.

6. REAR ON/OFF BUTTON
This button allows you to easily activate the light while maintaining constant control of the flashlight.



16pc
Acrylic Display
Display Dimensions
(H) 7" x (W) 7" x (D) 5.375"

1 Lighting Mode

100% - 130 Lumens
Run Time: 8 Hours
Viewing Distance: 80 Meters



FL 1 STANDARD				
Brightness	Distance	Run Time	Water-Resistant	Impact-Resistant

UPC CODE	ITEM	DESCRIPTION	MSRP	CASE PACK
645397058120	5947	NEBO® Zoom 130™ 130 Lumen Flashlight	11.99	16 PIECES

NEBO®

PATENTED ITEM
 US 6,880,951 B2
 US 8,376,568 B2

HIGHBEAM™

RECHARGEABLE-LIGHT

1. HIGH-POWER 35 LUMEN LED

2. NI-MH RECHARGEABLE BATTERY

This battery will produce more than 6 hours of run time with a full charge. Charging takes 2 hours to fully charge.

3. 12V SPRING BASE

Specially designed to fit every automobile's 12V socket



Item#5550
 35 pc Assorted Colors Acrylic Display
 Display Dimensions
 (H) 8.75" x (W) 9" x (D) 5"

RECHARGES IN
EVERY
 CAR LIGHTER
 12 VOLT SOCKET

4. ANODIZED AIRCRAFT-GRADE ALUMINUM WATER-RESISTANT COMPACT BODY DESIGN

5. RECHARGING INDICATOR

Light glows red when product is plugged in so you know it is charging. NOTE: Light will continue to glow red after charging is complete.

FL 1 STANDARD				
35 LUMENS	35m	6h	Water-Resistant	1m Impact-Resistant
Brightness	Distance	Run Time	Water-Resistant	Impact-Resistant

1 Lighting Mode

100% - 35 Lumens
 Run Time: 6 Hours
 Viewing Distance: 35 Meters



UPC CODE	ITEM	DESCRIPTION	MSRP	CASE PACK
645397900900	5550	HIGHBEAM™ Rechargeable Light in Display	9.99	35 PIECES
645397120025	5625	HIGHBEAM™ Light Black in Bulk	9.99	10 PIECES
645397003120	5626	HIGHBEAM™ Light Grey in Bulk	9.99	10 PIECES
645397004127	5627	HIGHBEAM™ Light Blue in Bulk	9.99	10 PIECES
645397005124	5628	HIGHBEAM™ Light Pink in Bulk	9.99	10 PIECES
645397006121	5629	HIGHBEAM™ Light Green in Bulk	9.99	10 PIECES
645397929123	5962	HIGHBEAM™ Light Red in Bulk	9.99	10 PIECES

Item#5872 & #5519

NEBO®

CSI EDGE

SMALL NEVER LOOKED SO MEAN

1. HIGH-POWER LED

50 Lumens - #5519 / 90 Lumens - #5872

2. AGGRESSIVE SELF DEFENSE FACE

*#5872 tactical bezel can be removed to have a smooth face.
(Please use caution when using flashlight.)

3. ANODIZED AIRCRAFT GRADE ALUMINUM WATER-RESISTANT COMPACT DESIGN

4. STEEL CLIP

5. RUBBER GRIP

6. REAR GLOW-IN-THE-DARK BUTTON

*#5872 button uses hard/soft touch technology allowing settings to be changed in two different ways.

Hard touch: Simply click through the functions (light will turn off in between settings.) NOTE: Light will reset to first setting (100% ON) after being off for 20 seconds.

Soft touch: Press button halfway with no click. This allows the user to cycle through the settings quickly without the light turning off between settings.



#5872

24pc Permanent Acrylic Display
Display Dimensions
(H) 7" x (W) 7" x (D) 5.375"



#5519



#5519 EDGE™50
Black & Grey

Lighting Modes

#5519 EDGE™50	100% - 50 Lumens Run Time: 5 Hours Viewing Distance: 45 Meters	
	100% - 90 Lumens Run Time: 3 Hours Viewing Distance: 70 Meters	
#5872 EDGE™90	Strobe - 90 Lumens Run Time: 5 Hours Viewing Distance: 70 Meters	

FL 1 STANDARD				
 90 LUMENS	 70m	 3h		
 50 LUMENS	 45m	 5h	Water-Resistant	Impact-Resistant
Brightness	Distance	Run Time		

UPC CODE	ITEM	DESCRIPTION	MSRP	CASE PACK
645397107125	5872	CSI EDGE 90™ Flashlight	12.99	24 PIECES
645397900702	5519	CSI EDGE 50™ Flashlight	9.99	24 PIECES

Item#5112

NEBO®

CSI LUMA50™

SUPER BRIGHT FROM A POCKET LIGHT

- 1. HIGH-POWER 50 LUMEN LED
- 2. AGGRESSIVE SELF-DEFENSE FACE
- 3. ANODIZED AIRCRAFT-GRADE ALUMINUM WATER-RESISTANT COMPACT BODY DESIGN
- 4. RUBBER GRIP
- 5. REAR GLOW-IN-THE-DARK BUTTON

This button allows you to easily activate the light while maintaining constant control of the flashlight. The button also glows in the dark so you can easily find this flashlight.



24pc Assorted Color Acrylic Display
Display Dimensions
(H) 7" x (W) 7" x (D) 5.375"

1 Lighting Mode

100% - 50 Lumens
Run Time: 5 Hours
Viewing Distance: 45 Meters



FL 1 STANDARD				
Brightness	Distance	Run Time	Water-Resistant	Impact-Resistant

UPC CODE	ITEM	DESCRIPTION	MSRP	CASE PACK
645397900108	5112	CSI LUMA50™ Flashlight	9.99	24 PIECES

LUMIÈRE™

NEBO®

THE DAZZLING BRIGHT LIGHT



Item#5614
24pc Case Pack
 (Assorted Colors)



Item#5604 24pc Assorted Colors
 Permanent Acrylic Display with
 reversible back piece (Black or White)
Display Dimensions
 (H) 7" x (W) 7" x (D) 5.375"

1. HIGH-POWER 50 LUMEN LED
2. AGGRESSIVE SELF-DEFENSE FACE
3. ANODIZED AIRCRAFT-GRADE ALUMINUM WATER-RESISTANT COMPACT BODY DESIGN
4. JEWELLED GRIP
5. REAR GLOW-IN-THE-DARK BUTTON
 This button allows you to easily activate the light while maintaining constant control of the flashlight. The button also glows in the dark so you can easily find this flashlight.



1 Lighting Mode

100% - 50 Lumens
 Run Time: 5 Hours
 Viewing Distance: 45 Meters



PATENTED ITEM
 US D 684,717 S

FL 1 STANDARD

50 LUMENS	45m	5h	Water-Resistant	1m Impact-Resistant
Brightness	Distance	Run Time	Water-Resistant	Impact-Resistant

UPC CODE	ITEM	DESCRIPTION	MSRP	CASE PACK
645397421115	5604	NEBO® LUMIÈRE™ 50 Lumen Flashlight	10.99	24 PIECES
645397929116	5614	NEBO® LUMIÈRE™ in Clamshell	10.99	24 PIECES

Item#5561

NEBO®

PATENT PENDING

CONTINUOUS SUPREME ILLUMINATION® CSI QUATRO™

6 Modes + 4 Features + 4 Colors = 1 Powerful Flashlight



12pc Case Pack

- 1. HIGH-POWER 75 LUMEN LED
- 2. 5 GREEN LEDs
- 3. 5 UV LEDs
- 4. RED LASER POINTER
- 5. AGGRESSIVE SELF-DEFENSE FACE
- 6. ANODIZED AIRCRAFT-GRADE ALUMINUM WATER-RESISTANT BODY
- 7. REAR GLOW-IN-THE-DARK BUTTON
- 8. POWERFUL MAGNETIC BASE

Actual Size



6 Lighting Modes	
100% - 75 Lumens Run Time: 9 Hours Viewing Distance: 65 Meters	
5 Green LEDs - 5 Lumens Run Time: 24 Hours Viewing Distance: 5 Meters	
5 UV LEDs Wavelength: 410-415nm Run Time: 52 Hours	
Red Laser: <5mW Viewing Distance: 412 Meters	
Green Flashing - 5 Lumens Viewing Distance: 5 Meters	
S.O.S. - All LEDs & Laser	

FL 1 STANDARD				
Brightness	Distance	Run Time	Water-Resistant	Impact-Resistant

UPC CODE	ITEM	DESCRIPTION	MSRP	CASE PACK
645397430100	5561	CSI QUATRO™ Flashlight in Clamshell	29.99	12 PIECES

Item#5077 & #5633

PATENT PENDING

NEBO®

CSI FLASHLIGHT/LASER 8 LEDS + LASER + FLASHER



#5077 18pc Case Pack



#5633 18pc Assorted Display
Display Dimensions

(H) 7.5" x (W) 9" x (D) 4.75"

1. 8 POWERFUL LEDS
2. RED LASER POINTER
3. AGGRESSIVE SELF-DEFENSE FACE
4. ANTI-ROLL ANODIZED AIRCRAFT-GRADE ALUMINUM WATER-RESISTANT BODY
The hexagonal shaped body controls most accidental rolls, while also ensuring toughness and reliability.
5. REAR TACTICAL BUTTON



4 Lighting Modes

8 LEDs - 24 Lumens
Run Time: 42 Hours
Viewing Distance: 9 Meters



Red Laser: <5mW
Viewing Distance: 412 Meters



8 LEDs Flashing - 24 Lumens
Viewing Distance: 9 Meters



S.O.S. - 8 LEDs & Laser



FL 1 STANDARD				
Brightness	Distance	Run Time	Water-Resistant	Impact-Resistant

UPC CODE	ITEM	DESCRIPTION	MSRP	CASE PACK
645397010128	5633	CSI Tactical Flashlight Assorted Colors	14.99	18 PIECES
645397128007	5077	CSI Tactical Flashlight in Clamshell	14.99	18 PIECES

NEBO®

FLASHLIGHT HOLSTERS

Item#6032
FLASHLIGHT HOLSTER

Item#5958
FLASHLIGHT HOLSTER



Item#5089
CSI FLASHLIGHT HOLSTER

Item#5922
LEATHER FLASHLIGHT HOLSTER

Each NEBO® Flashlight Holster has a pouch made to securely fit all of the 1"+ diameter NEBO® flashlights and most other brands as well. The holster's are designed for protection, durability and structural strength.

- Item #5089 features a metal carabiner, a stretchable pouch and a strong belt/pocket clip.
- Item #6032 features a belt loop, a hook and loop closure and is designed to be 100% compatible with the #5620 & #5955 REDLINE® Select Flashlights.
- Item #5958 features a snap/hook & loop closure and a strong belt/pocket clip.
- Item #5922 features a durable leather design, a snap cover and a belt/pocket clip.

UPC CODE	ITEM	DESCRIPTION	MSRP	CASE PACK
645397069126	5958	NEBO® Flashlight Holster	6.99	10 PIECES
645397929284	6032	NEBO® Flashlight Holster	6.99	10 PIECES
645397850892	5089	CSI Flashlight Holster	3.99	10 PIECES
645397035121	5922	NEBO® Leather Flashlight Holster	16.99	6 PIECES

NEBO® 90 LUMEN HEAD LAMP

- 1. HIGH-POWER 90 LUMEN LED**
- 2. 2 POWERFUL RED LEDs**
- 3. POWER SWITCH**
Allows you to choose between white light, red light or red light in flash mode.
- 4. ADJUSTABLE STRAP**
- 5. 90° TILT**
The head lamp tilts 90° to direct light in virtually any direction.
- 6. WATER-RESISTANT, SHOCK-PROOF REINFORCED PLASTIC BODY DESIGN**



Actual Size



Head Tilts 90° To Direct Light Wherever You Need It!

3 Lighting Modes	
White - 90 Lumens Run Time: 4 Hours Viewing Distance: 100 Meters	
2 Red LEDs - 8 Lumens Run Time: 150 Hours Viewing Distance: 3 Meters	
Red Flash - 8 Lumens Run Time: 120 Hours Viewing Distance: 3 Meters	

Red light is primarily used to preserve night vision. Best used for low-light or nighttime situations, this low-signature light provides great contrast, making it easy to read charts and maps. Red light cuts through smoke better than white light, does not interfere with night vision technology, ensures stealth in the dark and cannot be easily seen by the human eye over long distances.



6pc Case Pack

Each head lamp comes in its own clamshell style packaging that still allows the product to be tested by consumers.

FL 1 STANDARD				
90 LUMENS	100m	4h	Water-Resistant	0.6m Impact-Resistant
Brightness	Distance	Run Time	Water-Resistant	Impact-Resistant

UPC CODE	ITEM	DESCRIPTION	MSRP	CASE PACK
645397929215	6003	NEBO® 90 Lumen Head Lamp	19.99	6 PIECES

Item#5998

NEBO®

LITE - WRITER

Pen + Stylus™

“Lights where you write & navigates your device”

- 1. SMOOTH BALLPOINT PEN**
Twist to retract. Lite-Writer comes with a blue ink cartridge.
 - 2. 2 POWERFUL MICRO LEDs**
(10 Lumens) (Run Time - 30 Hours)
 - 3. ALUMINUM BODY**
 - 4. STYLUS**
The On/Off Button doubles as a stylus, which works on any touch screen.
 - 5. STEEL BELT/POCKET CLIP**
 - 6. ERGONOMIC RUBBER GRIP**
- 1 AAA BATTERY INCLUDED



On/Off Button Doubles as a Stylus



LEDs light up your writing space



1 Lighting Mode

2 Micro LEDs - 10 Lumens
Run Time: 30 Hours
Viewing Distance: 10 Meters

18pc Assorted Color Display
Display Dimensions
(H) 8" x (W) 7.375" x (D) 4.875"

UPC CODE	ITEM	DESCRIPTION	MSRP	CASE PACK
645397929161	5998	NEBO® LITE-WRITER™ Pen + Stylus	11.99	36 PIECES

Item#5571

NEBO[®]

LIGHT-WRITER

3-IN-1 PEN / LIGHT / LASER

THE POWER OF 3-IN-1



GIFT BOX
Each pen comes in its own full color gift box

1. POCKET CLIP

2. BALL POINT PEN

Each pen includes a black ink cartridge and a blue refill cartridge. Additional refills can be found at Office Depot.

BATTERIES INCLUDED

6 LR44 Button Cell Batteries included (3 inside pen and 3 extra)

2 Lighting Modes

1 LED - 12,000 MCD
Viewing Distance: 3 Meters



Red Laser: <5mW
Viewing Distance: 412 Meters



Actual Size

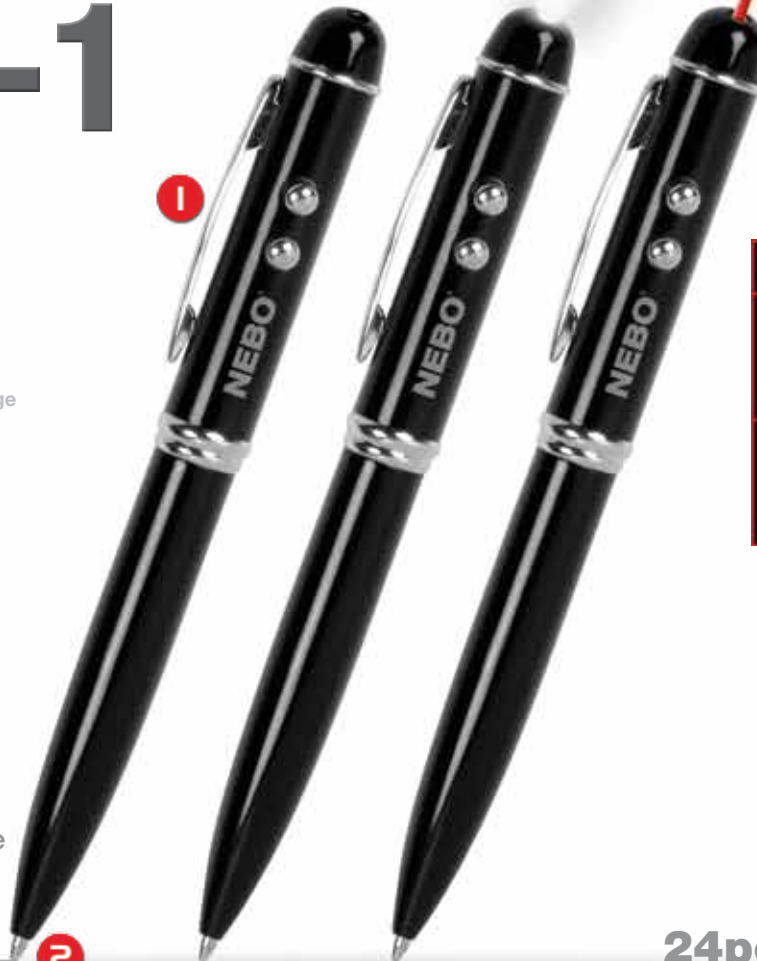

24pc Display

Display Dimensions

(H) 14.5" x (W) 6.875" x (D) 7.375"

UPC CODE	ITEM	DESCRIPTION	MSRP	CASE PACK
645397626107	5571	LIGHT-WRITER Pen/Light/Laser	9.99	24 PIECES

Item#5423

NEBO® BENDBRITE™

HANDS-FREE LIGHT WITH BEND-RITE™ FLEXIBLE NECK

This light is essential to have when you need your hands to be free!

- Flexible BEND-RITE™ neck allows you to direct light anywhere
- 2 Lighting modes (3 White LEDs On or 1 Red LED in flash mode)
- Base clip can clip onto virtually anything or use the 3 strong magnets to stick to any metal surface
- Water-Proof body design
- CR2032 Batteries Included



• BEND-RITE™ neck gives this light the flexibility to direct light in virtually any direction

• 3 White LEDs provide 9 Lumens (36,000 MCD) brightness of Hands-Free Lighting (LEDs NEVER NEED TO BE REPLACED)

• 1 Red LED in Emergency Flash Mode (0.4 Lumens)

9.5" tall

16pc Full Color Acrylic Display



Display Dimensions (H) 8" x (W) 13" x (D) 7.75"

- Clip on anywhere or use the 3 strong magnets to attach this light anywhere and direct light where you need it

This is perfect for working around the house or on your car! Use it to light up an area that has poor lighting, such as under a sink or under the hood. Clip the **BENDBRITE™** onto any book spine and now you have a book light. You can even clip the **BENDBRITE™** to a cap and use it as a cap-light. Take this light anywhere you think you may need a light. Going camping? Take the **BENDBRITE™**. Road trip? Take the **BENDBRITE™**. Working anywhere? Take the **BENDBRITE™**.

UPC CODE	ITEM	DESCRIPTION	MSRP	CASE PACK
645397900306	5423	NEBO® BENDBRITE™ Hands-Free Flex Light	9.99	16 PIECES

Item#5606

NEBO®

ULTRA™ SOCKET 14-IN-1
WRENCH & SCREWDRIVER

**Head tilts & locks
in 5 positions**

2 Way Ratchet



**7
Bits**



**5
Sockets
& Socket Adapter**



12pc Display
Display Dimensions
(H) 14.75" x (W) 9.125" x (D) 6"



Multiple Applications

All stored in Handle!

UPC CODE	ITEM	DESCRIPTION	MSRP	CASE PACK
645397610113	5606	Ultra™ 14-in-1 Socket and Screwdriver	16.99	12 PIECES

Item#4327

NEBO®

ULTRA™ SOCKET COMBINATION KIT

PATENTED ITEM	
US 6,634,262	
US 6,450,067	



12pc Case Pack

- **SOCKET WRENCH / SCREWDRIVER / NUT DRIVER ALL IN ONE**
19 SAE and Metric sockets, 12 screwdriver bits and a magnetic adapter
- **HEAD TILTS AND LOCKS AT 0°, 45° AND 90°**
Works perfectly as a nut driver for those hard to reach places
- **INDUSTRIAL STRENGTH ERGONOMIC HANDLE DESIGN**
Rubber handle for added comfort and grip to improve performance



- **600D POLYESTER CARRYING POUCH**
Convenient storage pouch with belt slide that stores everything in one place

SAE SOCKET SIZES: 3/16", 1/4", 9/32", 5/16", 11/32", 3/8", 7/16", 15/32", 1/2", 9/16"
METRIC SOCKET SIZES: 5mm, 6mm, 7mm, 8mm, 9mm, 10mm, 11mm, 12mm, 13mm
SCREWDRIVER BITS: Phillips: P1-P3, Slotted: 1/8", 3/16", 1/4", Hex: 1/8", 5/32", 7/32", TORX: T15, T20, T25, and a Magnetic 1/4" Bit Holder

UPC CODE	ITEM	DESCRIPTION	MSRP	CASE PACK
645397130406	4327	Ultra™ Socket Combination Kit	19.99	12 PIECES

Item#5517

NEBO®

FOLDING LOCK BLADE UTILITY KNIFE



18pc Display

Assorted Colors: 6 Black, 6 Yellow & 6 Silver

Display Dimensions

(H) 8.75" x (W) 14" x (D) 10.5"



- **FOLDING UTILITY LOCK-BLADE WITH QUICK CHANGE FEATURE**

Quick Change feature makes it easy to change the blade without any tools. The blade holder accepts all standard utility blades.

- **THUMB STUDS**

Studs allow for fast one-hand opening of either blade.

- **CARABINER**

For convenience and easy portability

- **ERGONOMIC ANODIZED ALUMINUM HANDLE WITH RUBBER GRIP**

Handle designed for comfort and strength while in your hand.

- **LOCK RELEASE BUTTON**

This button releases the locking mechanism that keeps the utility knife closed. Press this button to unfold utility knife.

UPC CODE	ITEM	DESCRIPTION	MSRP	CASE PACK
645397900504	5517	Folding Lock-Blade Utility Knife Assorted	6.99	18 PIECES

NEBO® SAFETY GLASSES

Z-LENS™
Sport an attitude



6pc Case Pack



#4818 Yellow



#4820 Clear

* Meets ANSI Z87.1 National Safety Standards * Complies with OSHA Requirements for Industrial Eyewear

- LIGHTWEIGHT NYLON FRAMES
- COMFORTABLE NOSEPIECE
- ADJUSTABLE TEMPLES
- HIGH-GRADE POLYCARBONATE LENS
- STYLISH PROFESSIONAL SAFETY GLASSES
- 99.9% UVA & UVB PROTECTION
- ANTI-STATIC, SCRATCH RESISTANT
- COMPLETE WRAP-AROUND PROTECTION

UPC CODE	ITEM	DESCRIPTION	MSRP	CASE PACK
645397137009	4818	Z-Lens Safety Glasses - Black w/ Yellow	6.99	6 PIECES
645397139003	4820	Z-Lens Safety Glasses - Blue w/ Clear	6.99	6 PIECES

Item#5623



Size: 36" x 16" x 14"
 Material: Weather-Proof
 Treated PVC

- 132 Liters / 8,064 in³
- 100% Weather-Proof
- Hand straps
- Top carry strap
- Precision bearing rubber wheels
- Main zipper compartment with additional water-proof interior pocket
- Top exterior zipper pocket
- Weather-proof flaps protect zippered compartments
- Reinforced backing for extra support



Put it on top



Put it in the back



The outer shell of the TORTOISE™ protects your items from the elements and its wheels allow you to roll this big beast wherever you need to go. Just tie it to the top of your vehicle or throw it in the back of your pickup.

Item#5918

NEBO
TOOL BAG

The Right Bag for the Working Man!



- Wide-open center compartment
- Padded internal adjustable compartment divider
- Internal frame keeps bag open
- 24 durable organizer pockets
 - 6 covered exterior pockets
 - 18 interior pockets
- Made of 600D Polyester/PVC fabric
- Detachable messenger style strap
- Two top carry straps
- Product dimensions: 16" x 10" x 11"

WHILE SUPPLIES LAST!

UPC CODE	ITEM	DESCRIPTION	MSRP	CASE PACK
645397112211	5623	WeatherRite® Tortoise™ Cargo Bag	99.99	4 PIECES
645397033127	5918	NEBO® Tool Bag	29.95	6 PIECES

iPROTEC™

ITEM # 5904

BAT™ LIGHT

- HIGH-POWER 200 LUMEN LED
- ANODIZED AIRCRAFT GRADE ALUMINUM WATER-RESISTANT BODY
- ERGONOMIC TEXTURED HANDLE
- RUBBERIZED PROTECTIVE SLEEVE
- REAR-POSITIONED ON/OFF BUTTON
- 4 AA BATTERIES INCLUDED

3 Lighting Modes

100% - 200 Lumens
Run Time: 8 Hours
Viewing Distance: 125 Meters



50% - 100 Lumens
Run Time: 20 Hours
Viewing Distance: 65 Meters



Strobe - 200 Lumens
Viewing Distance: 125 Meters



LANYARD INCLUDED

NOTE: This product may be restricted for sale in some local and state jurisdictions to law enforcement and security guard personnel and/or adults only. Consult local rules of law for legal advice.

NEBO® company policy does not allow this item to be sold into the following states: California, Illinois, Kansas, Massachusetts, Michigan, New Jersey and New York.

FL 1 STANDARD

Brightness	Distance	Run Time	Water-Resistant	Impact-Resistant

Product Dimension: 16.25" x 1.25"

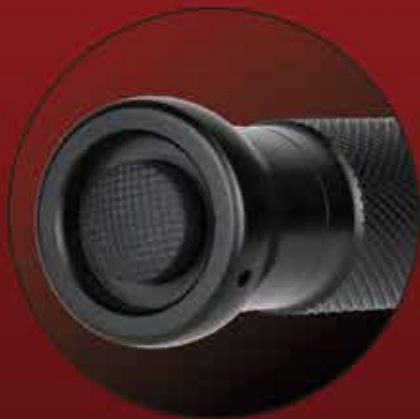

The On-Off button located at the base of the handle for convenient operation.

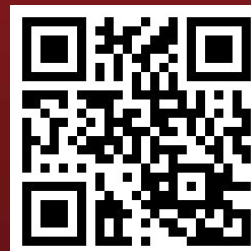

Scan the QR Code to Watch The BAT™ Light Video by NEBO® www.youtube.com/nebotools



UPC CODE	ITEM	DESCRIPTION	MSRP	CASE PACK
645397027126	5904	iPROTEC™ BAT™ Light	39.99	6 PIECES

RM400

400 Lumen Rail-Mounted Light

- **HIGH-POWER 400 LUMEN LED**
- **ANODIZED AIRCRAFT-GRADE ALUMINUM WATER-RESISTANT, SHOCK-PROOF BODY**
- **SELF-LOCKING RAIL MOUNT**
No tools required
- **FIXED TAIL CAP**
Allows for use as a standard flashlight.
- **MOMENTARY DEFENSIVE STROBE SIDE SWITCH**
Allows the user to activate the defensive strobe mode instantaneously.

4 Lighting Modes

100% - 400 Lumens Run Time: 3 Hours Viewing Distance: 300 Meters	
30% - 120 Lumens Run Time: 4.7 Hours Viewing Distance: 90 Meters	
5% - 20 Lumens Run Time: 5.3 Hours Viewing Distance: 15 Meters	
Strobe - 400 Lumens Run Time: 3.5 Hours Viewing Distance: 300 Meters	



- **TWO CR123A BATTERIES INCLUDED**

- **PRESSURE SWITCH**
Allows you to activate this light and navigate the lighting modes with total control.



FL 1 STANDARD

Brightness	Distance	Run Time	Water-Resistant	Impact-Resistant

UPC CODE	ITEM	DESCRIPTION	MSRP	CASE PACK
645397062127	5951	iPROTEC™ RM400 Rail Mount Light	79.99	6 PIECES

REDLINE®

- **HIGH-POWER 220 LUMEN LED**
- **AGGRESSIVE SELF-DEFENSE FACE**
- **4x ADJUSTABLE ZOOM**
Turn the bezel clockwise for flood light, perfect for short range lighting. Turn the bezel counter-clockwise for spot light, perfect for focusing light up to 138 meters.
- **ANODIZED AIRCRAFT-GRADE ALUMINUM WATER-RESISTANT BODY**
- **CONVEX LENS**
The convex lens evenly distributes the light for a highly concentrated beam without dull or dark spots.
- **FITS BOTH VENTED AND PLAIN BARRELS**
- **FIXED TAIL CAP**
Allows for use as a standard flashlight.

5 Lighting Modes

100% - 220 Lumens Run Time: 4 Hours Viewing Distance: 138 Meters	
50% - 110 Lumens Run Time: 8 Hours Viewing Distance: 60 Meters	
10% - 22 Lumens Run Time: 15 Hours Viewing Distance: 27 Meters	
S.O.S. - 220 Lumens Run Time: 72 Hours Viewing Distance: 138 Meters	
Strobe - 220 Lumens Run Time: 72 Hours Viewing Distance: 138 Meters	

- **UNIVERSAL ALUMINUM MOUNT**
Adjusts, tightens and locks with no tools needed. (Mount included with #5566; also sold separately as #5598)



PATENTED ITEM
D 657,840



FL 1 STANDARD				
Brightness	Distance	Run Time	Water-Resistant	Impact-Resistant

- **PRESSURE SWITCH**
Allows you to activate this light and navigate the lighting modes with total control.



UPC CODE	ITEM	DESCRIPTION	MSRP	CASE PACK
645397007128	5630	iPROTEC™ REDLINE® with Clamp/Pressure Switch	59.99	6 PIECES

GREENLIGHT™

- **HIGH-POWER 170 LUMEN LED**
- **AGGRESSIVE SELF-DEFENSE FACE**
- **4x ADJUSTABLE ZOOM**
Turn the bezel clockwise for flood light, perfect for short range lighting. Turn the bezel counter-clockwise for spot light, perfect for focusing light up to 73 meters.
- **ANODIZED AIRCRAFT-GRADE ALUMINUM WATER-RESISTANT BODY**
- **CONVEX LENS**
The convex lens evenly distributes the light for a highly concentrated beam without dull or dark spots.
- **FITS BOTH VENTED AND PLAIN BARRELS**
- **FIXED TAIL CAP**
Allows for use as a standard flashlight.

- **UNIVERSAL ALUMINUM MOUNT**
Adjusts, tightens and locks with no tools needed. (Mount included with #5566; also sold separately as #5598)



PATENTED ITEM
D 657,840

- **PRESSURE SWITCH**
Allows you to activate this light and navigate the lighting modes with total control.

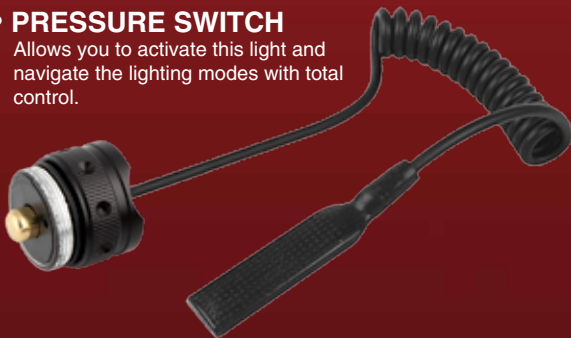

5 Lighting Modes

100% - 170 Lumens Run Time: 8 Hours Viewing Distance: 73 Meters	
50% - 85 Lumens Run Time: 14 Hours Viewing Distance: 35 Meters	
10% - 17 Lumens Run Time: 21 Hours Viewing Distance: 15 Meters	
S.O.S. - 170 Lumens Run Time: 72 Hours Viewing Distance: 73 Meters	
Strobe - 170 Lumens Run Time: 72 Hours Viewing Distance: 73 Meters	

FL1 STANDARD

170 LUMENS	73m	8h		2m
Brightness	Distance	Run Time	Water-Resistant	Impact-Resistant



UPC CODE	ITEM	DESCRIPTION	MSRP	CASE PACK
645397008125	5631	iPROTEC™ GREENLIGHT™ with Clamp/Pressure Switch	59.99	6 PIECES

LASER + FLASHLIGHT COMBO

MOUNTS ON 12-20 GAUGE SHOTGUN BARRELS

- HIGH-POWER 110 LUMEN LED
- AGGRESSIVE SELF-DEFENSE FACE
- ANODIZED AIRCRAFT-GRADE ALUMINUM WATER-RESISTANT BODY
- FITS BOTH VENTED AND PLAIN BARRELS
- FIXED TAIL CAP
Allows for use as a standard flashlight.

FL 1 STANDARD

110 LUMENS	50m	8h	Water-Resistant	2m Impact-Resistant
Brightness	Distance	Run Time	Water-Resistant	Impact-Resistant

4 Lighting Modes

Light - 110 Lumens Run Time: 8 Hours Viewing Distance: 50 Meters	
Red Laser: <5mW Viewing Distance: 412 Meters	
Light & Laser 110 Lumens / <5mW Viewing Distance: 50 Meters / 412 Meters	
Strobe - 110 Lumens Viewing Distance: 50 Meters	

• UNIVERSAL ALUMINUM MOUNT

Adjusts, tightens and locks with no tools needed. (Mount included with #5566; also sold separately as #5598)



PATENTED ITEM

D 657,840

• PRESSURE SWITCH

Allows you to activate this light and navigate the lighting modes with total control.



UPC CODE	ITEM	DESCRIPTION	MSRP	CASE PACK
645397502104	5566	iPROTEC™ ELITE with Clamp/Pressure Switch	59.99	6 PIECES

LASER + FLASHLIGHT COMBO

MOUNTS ON 12-20 GAUGE SHOTGUN BARRELS

- **8 POWERFUL LEDs (24 LUMENS)**
- **AGGRESSIVE SELF-DEFENSE FACE**
- **ANODIZED AIRCRAFT-GRADE ALUMINUM WATER-RESISTANT BODY**
- **FITS BOTH VENTED AND PLAIN BARRELS**
- **FIXED TAIL CAP**
Allows for use as a standard flashlight.

4 Lighting Modes

8 LEDs - 24 Lumens Run Time: 42 Hours Viewing Distance: 9 Meters	
Red Laser: <5mW Viewing Distance: 412 Meters	
8 LEDs & Laser Viewing Distance: 9 Meters / 412 Meters	
Strobe - 24 Lumens Viewing Distance: 9 Meters	

- **UNIVERSAL ALUMINUM MOUNT**
Adjusts, tightens and locks with no tools needed.
(Mount included with #5566; also sold separately as #5598)



PATENTED ITEM
D 657,840

FL 1 STANDARD

24 LUMENS	9m	42h	Water-Resistant	2m Impact-Resistant
Brightness	Distance	Run Time	Water-Resistant	Impact-Resistant



- **PRESSURE SWITCH**
Allows you to activate this light and navigate the lighting modes with total control.

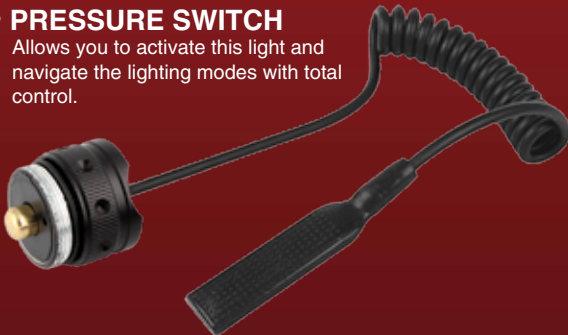

UPC CODE	ITEM	DESCRIPTION	MSRP	CASE PACK
645397501107	5565	iPROTEC™ Laser/Light with Clamp/Pressure Switch	29.99	6 PIECES

CHAMELEON™

PATENTED ITEM

US 6,880,951 B2

- HIGH-POWER 100 LUMEN LED
- STEEL BELT/POCKET CLIP
- UNBREAKABLE SHATTER-PROOF POLYCARBONATE LENS
- AGGRESSIVE SELF-DEFENSE FACE
- ANODIZED AIRCRAFT-GRADE ALUMINUM WATER-RESISTANT COMPACT BODY DESIGN
- GLOW-IN-THE-DARK BUTTON

This button allows you to easily switch settings* while maintaining constant control of the flashlight. The button also glows in the dark so that you can easily find this flashlight. (*Button uses hard/soft touch technology allowing settings to be changed in two different ways.)

Hard touch: Simply click through the functions (light will turn off in between settings.) NOTE: Light will reset to first setting (100% ON) after being off for 10 seconds.

Soft touch: Press button halfway with no click. This allows the user to cycle through the settings quickly without the light turning off between settings.



Actual Size

4 Lighting Modes

White - 100 Lumens

Run Time: 4 Hours
Viewing Distance: 80 Meters



Green - 90 Lumens

Run Time: 5 Hours
Viewing Distance: 70 Meters



Because the human eye recognizes the color green faster than other colors, green light is best used for map reading or signaling, especially in low light conditions. Also perfect for hunting as some game cannot see green light.

Red - 85 Lumens

Run Time: 7 Hours
Viewing Distance: 50 Meters



Red light is primarily used to preserve night vision. Best used for low-light or nighttime situations, this low-signature light provides great contrast, making it easy to read charts and maps. Red light cuts through smoke better than white light, does not interfere with night vision technology, ensures stealth in the dark and cannot be easily seen by the human eye over long distances.

Strobe - 100 Lumens

Viewing Distance: 80 Meters



Color changes with just a single click of the button. No Lenses, No Attachments, and No Accessories needed.

FL 1 STANDARD

100 LUMENS	80m	4h	Water-Resistant	1m Impact-Resistant
Brightness	Distance	Run Time	Water-Resistant	Impact-Resistant

UPC CODE	ITEM	DESCRIPTION	MSRP	CASE PACK
645397028123	5905	iPROTEC™ Pocket CHAMELEON™	29.99	6 PIECES

BLOOD TRACKER™

PATENTED ITEM
US 6,880,951 B2

- HIGH-POWER 100 LUMEN LED
- STEEL BELT/POCKET CLIP
- UNBREAKABLE SHATTER-PROOF POLYCARBONATE LENS
- AGGRESSIVE SELF-DEFENSE FACE
- ANODIZED AIRCRAFT-GRADE ALUMINUM WATER-RESISTANT COMPACT BODY DESIGN
- GLOW-IN-THE-DARK BUTTON

This button allows you to easily switch settings* while maintaining constant control of the flashlight. The button also glows in the dark so that you can easily find this flashlight. (*Button uses hard/soft touch technology allowing settings to be changed in two different ways.)
Hard touch: Simply click through the functions (light will turn off in between settings.) NOTE: Light will reset to first setting (100% ON) after being off for 10 seconds.
Soft touch: Press button halfway with no click. This allows the user to cycle through the settings quickly without the light turning off between settings.



Actual Size



2 Lighting Modes

White - 100 Lumens Run Time: 4 Hours Viewing Distance: 80 Meters	
Red/Green - 90 Lumens Run Time: 5 Hours Viewing Distance: 70 Meters	

The mixture of green and red light creates an amber-like color. Amber light causes materials that are truly red, like blood, to stand out from materials that have red in them, like leaves, brush, certain woods, etc.

Color changes with just a single click of the button.
No Lenses, No Attachments, and No Accessories needed.

FL 1 STANDARD

100 LUMENS	80m	4h	Water-Resistant	Impact-Resistant
Brightness	Distance	Run Time	Water-Resistant	Impact-Resistant

UPC CODE	ITEM	DESCRIPTION	MSRP	CASE PACK
645397029120	5906	iPROTEC™ BLOOD TRACKER™	29.99	6 PIECES

iPROTEC™ ELITE HP230

ITEM # 5567

HIGH-POWERED FIREARM LIGHT
MOUNTS ON RAIL-EQUIPPED PISTOLS & LONG GUNS



3 Lighting Modes

High - 230 Lumens Run Time: 3 Hours Viewing Distance: 140 Meters	
Low - 40 Lumens Viewing Distance: 25 Meters	
Strobe - 230 Lumens Viewing Distance: 140 Meters	

- **HIGH-POWER 230 LUMEN LED**
- **ANODIZED AIRCRAFT-GRADE ALUMINUM WATER-RESISTANT DESIGN**
- **ADJUSTABLE HINGE MOUNT**
Easily adjusts, tightens and locks...no tools needed!
Designed to fit most rail-equipped firearms. Not compatible with snub nose or subcompacts models.
- **ACCESSORY RAIL MOUNT**
For additional firearm accessories (12.5mm)
- **TWO CR123A BATTERIES INCLUDED**

The ELITE HP230 outputs 230 lumens of intense white light. Light of this magnitude is enough to dominate an aggressor's night-adapted vision, ideal for military, law enforcement, and self-defense. The reflector lens focuses the beam for long distance lighting while also producing enough light to support the user's peripheral vision. The HP230 features a front-positioned momentary/steady On-Off switch to provide one-finger operation. This switch allows you to select high mode, low mode or defensive strobe.

FL 1 STANDARD				
Brightness	Distance	Run Time	Water-Resistant	Impact-Resistant

UPC CODE	ITEM	DESCRIPTION	MSRP	CASE PACK
645397503101	5567	iPROTEC™ ELITE HP230	49.99	6 PIECES

iPROTEC™ ELITE HP190

ITEM # 5569

HIGH-POWERED FIREARM LIGHT MOUNTS ON RAIL-EQUIPPED PISTOLS & LONG GUNS

2 Lighting Modes

100% - 190 Lumens
Run Time: 2 Hours
Viewing Distance: 92 Meters



Strobe - 190 Lumens
Viewing Distance: 92 Meters

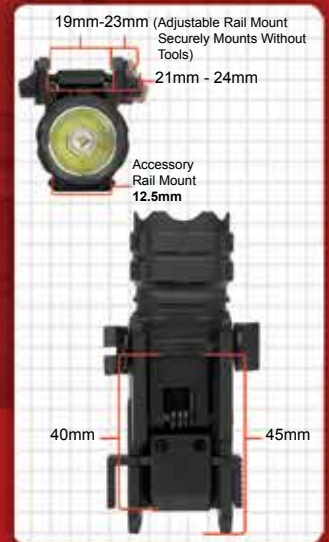

- **HIGH-POWER 190 LUMEN LED**
- **ANODIZED AIRCRAFT-GRADE ALUMINUM WATER-RESISTANT DESIGN**
- **ADJUSTABLE HINGE MOUNT**
Easily adjusts, tightens and locks...no tools needed!
Designed to fit most rail-equipped firearms. Not compatible with snub nose or subcompacts models.
- **ACCESSORY RAIL MOUNT**
For additional firearm accessories (12.5mm)
- **ONE CR123A BATTERY INCLUDED**

The **ELITE HP190** outputs 190 lumens of intense white light. Light of this magnitude is enough to dominate an aggressor's night-adapted vision, ideal for military, law enforcement, and self-defense. The reflector lens focuses the beam for long distance lighting while also producing enough light to support the user's peripheral vision. The HP190 features a back positioned On-Off switch to provide simple, one-handed operation. This switch allows you to select between 100% white light or defensive strobe. After 10 seconds in the off position, the light will reset to the first setting, which is 100% light.

FL 1 STANDARD				
190 LUMENS	92m	2h		1m
Brightness	Distance	Run Time	Water-Resistant	Impact-Resistant

UPC CODE	ITEM	DESCRIPTION	MSRP	CASE PACK
645397514107	5569	iPROTEC™ ELITE HP190	44.50	6 PIECES

iPROTEC™ ELITE HP190LS

ITEM # 5578

HIGH-POWERED FIREARM LIGHT & LASER
MOUNTS ON RAIL-EQUIPPED PISTOLS & LONG GUNS



3 Lighting Modes

100% - 190 Lumens Run Time: 2 Hours Viewing Distance: 92 Meters	
Strobe - 190 Lumens Viewing Distance: 92 Meters	
Red Laser: <5mW Viewing Distance: 412 Meters	

Laser can be used independently or with either of the lighting modes.



- **HIGH-POWER 190 LUMEN LED**
- **RED LASER SIGHT**
- **ANODIZED AIRCRAFT-GRADE ALUMINUM WATER-RESISTANT DESIGN**
- **ADJUSTABLE HINGE MOUNT**
Easily adjusts, tightens and locks...no tools needed!
Designed to fit most rail-equipped firearms. Not compatible with snub nose or subcompacts models.
- **BATTERIES INCLUDED**
One CR123A battery included for the light and three AG5 button cell batteries included for the red laser sight

The ELITE HP190LS combines a brilliant 190 lumen white light with a bright red sighting laser. Light of this magnitude is enough to dominate an aggressor's night-adapted vision, ideal for military, law enforcement, and self-defense. The reflector lens focuses the beam for long distance lighting while also producing enough light to support the user's peripheral vision. The HP190LS features a back-positioned toggle On-Off switch to provide simple, one-handed operation. This switch allows you to select between 100% white light or defensive strobe. A separate switch on the bottom is used to control the laser. A small screw driver is included to adjust the windage and elevation of the laser.

FL 1 STANDARD

Brightness	Distance	Run Time	Water-Resistant	Impact-Resistant

UPC CODE	ITEM	DESCRIPTION	MSRP	CASE PACK
645397903109	5578	iPROTEC™ ELITE HP190LS w/Laser	89.99	6 PIECES

iPROTEC™

RED LASER FIREARM SIGHT MOUNTS TO RAIL-EQUIPPED PISTOLS & LONG GUNS

ITEM # 5600



1 Lighting Mode

Red Laser: <5mW
Run Time: 4 Hours
Viewing Distance: 412 Meters



- **RED LASER SIGHT**

5 - milliwatt, 650 nanometer red laser sights up to 450 yards

- **ANODIZED AIRCRAFT-GRADE ALUMINUM WATER-RESISTANT DESIGN**

- **ADJUSTABLE HINGE MOUNT**





Easily adjusts, tightens and locks...no tools needed!
Designed to fit most rail-equipped firearms. Not compatible with snub nose or subcompacts models.

- **ACCESSORY RAIL MOUNT**

For additional firearm accessories (12.5mm)

- **THREE AG13 BATTERIES INCLUDED**

The Red Laser Firearm Sight uses a 5-milliwatt, 650 nanometer laser to sight up to 450 yards away. The On-Off switch located on the side to provide convenient one-finger operation. A small screwdriver is included to adjust the windage and elevation of the laser. There is also an accessory rail mount located on the bottom of the unit to attach additional accessories.

FL 1 STANDARD			
			
Distance	Run Time	Water-Resistant	Impact-Resistant

UPC CODE	ITEM	DESCRIPTION	MSRP	CASE PACK
645397118114	5600	iPROTEC™ Red Laser Firearm Sight	39.95	6 PIECES

iPROTEC™

ITEM # 5580

GREEN LASER FIREARM SIGHT MOUNTS TO RAIL-EQUIPPED PISTOLS & LONG GUNS



1 Lighting Mode

Red Laser: <5mW
Run Time: 4 Hours
Viewing Distance: 457 Meters



Maximum Daytime Visibility: Over 100 Yards

- **GREEN LASER SIGHT**
5 - milliwatt, 532 nanometer red laser sights over 500 yards
- **ANODIZED AIRCRAFT-GRADE ALUMINUM WATER-RESISTANT DESIGN**
- **ADJUSTABLE HINGE MOUNT**
Easily adjusts, tightens and locks...no tools needed!
Designed to fit most rail-equipped firearms. Not compatible with snub nose or subcompacts models.
- **ACCESSORY RAIL MOUNT**
For additional firearm accessories (12.5mm)
- **ONE CR123A BATTERY INCLUDED**

The **Green Laser Firearm Sight** uses a 5 - milliwatt, 532 nanometer laser to sight over 500 yards away. The green laser can be seen up to 100 yards in broad daylight. The On-Off toggle switch located on the side to provide convenient one-finger operation. A small screwdriver is included to adjust the windage and elevation of the laser. There is also an accessory rail mount located on the bottom of the unit to attach additional accessories.

FL 1 STANDARD

457m	4h	Water-Resistant	1m Impact-Resistant
Distance	Run Time	Water-Resistant	Impact-Resistant

UPC CODE	ITEM	DESCRIPTION	MSRP	CASE PACK
645397905103	5580	iPROTEC™ Green Laser Firearm Sight	79.99	6 PIECES

iPROTEC™ ACCESSORIES

ITEM #5598 MOUNTING CLAMP with Accessory Rail Mount



- **SELF-LOCKING MOUNT**
Easily adjusts, tightens and locks...no tools needed!
- **ANODIZED AIRCRAFT-GRADE ALUMINUM WATER-RESISTANT DESIGN**
- **UNIVERSAL FIT**
Fits both vented and plain barrels, 12/20 gauge shotguns, rifles and most scopes.
- **ACCESSORY RAIL MOUNT**
For additional firearm accessories (18mm x 24mm)



PATENTED ITEM
D 657,840

UPC CODE	ITEM	DESCRIPTION	COST	MSRP	CASE PACK
645397112112	5598	iPROTEC™ Mounting Clamp	9.90	19.95	12 PIECES

ITEM #5954 DUAL MODE PRESSURE SWITCH

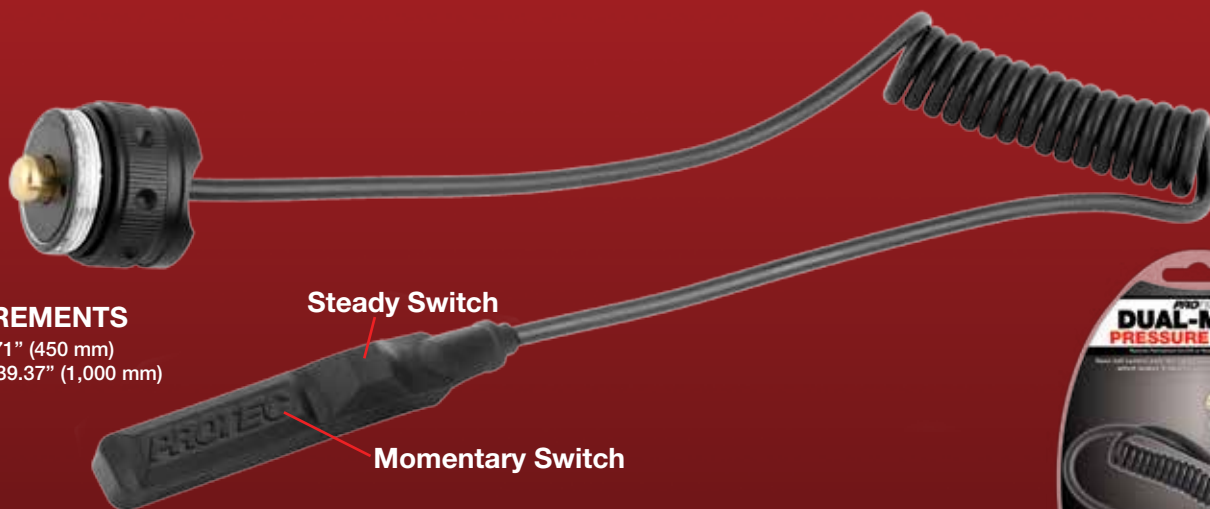

- **MEASUREMENTS**
Coiled - 17.71" (450 mm)
Extended - 39.37" (1,000 mm)
- **DUAL MODE**
This switch incorporates two buttons inside the switch, one for momentary operation and the other for steady on.



Specifically designed to be used with the following products:

#5557, #5581, #5599 & #5610 NEBO® REDLINE® • #5463 & 5564 NEBO® CHAMELEON™ • #5565 iPROTEC™ Laser / Flashlight Combo • #5566 iPROTEC™ Elite Laser / Flashlight Combo
• #5624 NEBO® REDLINE® 220 Lumen Bright Light • #5630 iPROTEC™ REDLINE® • #5631 iPROTEC™ GREENLIGHT™ • #5632 iPROTEC™ REDLIGHT™ • #5929 iPROTEC™ PRO-220 Light

UPC CODE	ITEM	DESCRIPTION	MSRP	CASE PACK
645397065128	5954	iPROTEC™ Dual Mode Pressure Switch	18.99	6 PIECES

Item#5624
NEBO®



REDLINE®

220 LUMEN BRIGHT LIGHT

With a 180° Swivel Bar Mount



- **HIGH-POWER 220 LUMEN LED**
- **ANODIZED AIRCRAFT-GRADE ALUMINUM, WATER-RESISTANT COMPACT BODY DESIGN**
- **SWIVEL HEAD**
 The head of the mount rotates 180° to direct light wherever you need it.
- **QUICK-RELEASE TAB**
 The REDLINE® easily detaches from the mount to be used as a hand-held flashlight.
- **BAR MOUNT**
 Easily attaches to any bar, no tools needed.
- **REAR GLOW-IN-THE-DARK BUTTON**
 (Button uses hard/soft touch technology allowing settings to be changed in two different ways.)
Hard touch: Simply click through the functions (light will turn off in between settings.) NOTE: Light will reset to first setting (100% ON) after being off for 20 seconds.
Soft touch: Press button halfway with no click. This allows the user to cycle through the settings quickly without the light turning off between settings.

3 Lighting Modes

100% - 220 Lumens Run Time: 4 Hours Viewing Distance: 138 Meters	
50% - 110 Lumens Run Time: 8 Hours Viewing Distance: 59 Meters	
Strobe - 210 Lumens Run Time: 72 Hours Viewing Distance: 138 Meters	

FL 1 STANDARD

Brightness	Distance	Run Time	Water-Resistant	Impact-Resistant

UPC CODE	ITEM	DESCRIPTION	MSRP	CASE PACK
645397120018	5624	NEBO® REDLINE® with Bar Mount	39.99	6 PIECES

Item#5576

NEBO®

6 WHITE LED BIKE LIGHT



- **6 POWERFUL LEDs (18 LUMENS)**
- **SHOCK-PROOF PLASTIC HOUSING**
- **SWIVEL HEAD**
The head of the mount rotates 180° to direct light wherever you need it.
- **QUICK-RELEASE TAB**
Easily detaches from the mount to be used as a hand-held flashlight.
- **BAR MOUNT**
Easily attaches to any bar, no tools needed.
- **LANYARD INCLUDED**

2 Lighting Modes

6 LEDs - 18 Lumens
Run Time: 50 Hours
Viewing Distance: 20 Meters



Strobe - 18 Lumens
Viewing Distance: 20 Meters



FL 1 STANDARD

 18 LUMENS	 20m	 50h	 Water-Resistant	 1m Impact-Resistant
Brightness	Distance	Run Time	Water-Resistant	Impact-Resistant

UPC CODE	ITEM	DESCRIPTION	MSRP	CASE PACK
645397819103	5576	NEBO® 6 White LED Bike Light	13.99	6 PIECES

Item#5953
NEBO®

75 Lumen 5 LED Red Bike Light / Tail Light



COMBO



Bike Light

- 10,000 Hour LED Bulb Life
- 1 Meter Impact-Resistant
- Water-Resistant Body
- 3 AAA Batteries Included

Both Lights Feature a Quick-Release System

4 Lighting Modes

100% - 75 Lumens Run Time: 3 Hours Viewing Distance: 300 Meters	
50% - 37.5 Lumens Run Time: 4.7 Hours Viewing Distance: 90 Meters	
Strobe - 75 Lumens Run Time: 5.3 Hours Viewing Distance: 15 Meters	
S.O.S. - 75 Lumens Run Time: 3.5 Hours Viewing Distance: 300 Meters	

Tail Light

- 100,000 Hour LED Bulb Life
- 1 Meter Impact-Resistant
- Water-Resistant Body
- 2 AAA Batteries Included

7 Lighting Modes

ON - 3.5 Lumens Run Time: 55 Hours Viewing Distance: 1.6 KM	
Flashing Run Time: 120 Hours Viewing Distance: 1.6 KM	
Slow Flashing Run Time: 120 Hours Viewing Distance: 1.6 KM	
Cascading Flash Run Time: 120 Hours Viewing Distance: 1.6 KM	
Rising Flash Run Time: 120 Hours Viewing Distance: 1.6 KM	
Rapid Cascading Flash Run Time: 120 Hours Viewing Distance: 1.6 KM	
Random Flashing Run Time: 120 Hours Viewing Distance: 1.6 KM	



No Tools Needed to Mount Lights

UPC CODE	ITEM	DESCRIPTION	MSRP	CASE PACK
645397064121	5953	NEBO® Bike Light Combo	24.99	6 PIECES
645397063124	5952	NEBO® Rear Bike Light	9.99	6 PIECES

Item#5611
NEBO®

250^{PSI}

AIR COMPRESSOR



• 18" AIR HOSE



• EASY-TO-READ PSI GAUGE

- 10FT. POWER CORD WITH 12V DC PLUG
- INFLATES STANDARD SIZE TIRE IN LESS THAN A MINUTE



UPC CODE	ITEM	DESCRIPTION	MSRP	CASE PACK
645397812111	5611	NEBO® 250 PSI Air Compressor	19.99	12 PIECES

Essential Emergency Power Supply



Be Prepared!

Portable Emergency Power – Anytime You Need It!

- 1 Bright 100 Lumen White LED
(Run Time - 80 hours)

- 3 Emergency Red LEDs
(Run Time - 200 hours)



- Backlit LCD Display



- DC In (Comes with 2 Adaptors)

- Solar In (16V / 500mA)

- 5V USB Outlet Power for Charging Cell Phones, MP3 Players, etc.

- 120 V AC Power Outlet for Laptops, Lights and Small Appliances



- Conveniently Concealed Power Cables to Jump-Start Vehicles and Boats



FL 1 STANDARD

Brightness	Distance	Run Time	Water-Resistant	Impact-Resistant

- Carrying Handle

- Powerful Wind Up Crank Handle
(20 Minutes = 1 Hour of Light)

- Internal Rechargeable Battery Storage

- 30A Fuse

- 12V DC Power Outlet



Fully Charged Power Information

Product:	Run Time: (Approximate)
2 Watt Night Light.....	40 Hours
15 Watt CD Player.....	6 Hours
18 Watt Desk Lamp.....	5 Hours
40 Watt 14" TV.....	4 Hours
55 Watt Fan.....	2 Hours
70 Watt Notebook.....	.85 Minutes
100 Watt Lamp.....	.55 Minutes
Mobile Phone DC 4.2V 1000mAh.....	20 Cycles
Digital Camera DC 3.7V 1100mAh.....	20 Cycles

UPC CODE	ITEM	DESCRIPTION	MSRP	CASE PACK
645397929208	6002	Essential Emergency Power Supply (EEPS)	249.99	2 PIECES

LED LANTERNS



**Item#6004
65 Lumen Lantern**

- 3 Lighting Modes
 - Low (22 Lumens) (35 Hours)
 - High (65 Lumens) (Run Time - 10 Hours)
 - Flashing (65 Lumens) (Run Time - 10 Hours)
- Powered by 3 AA Batteries (Included)

**Item#5949
610 Lumen Lantern**

- 3 Lighting Modes
 - Low (270 Lumens) (Run Time - 28 Hours)
 - High (610 Lumens) (15 Hours)
 - Flashing (610 Lumens) (70 Hours)
- Powered by 6 D Batteries (Not Included)

**Item#6005
300 Lumen Lantern**

- 3 Lighting Modes
 - Low (150 Lumens) (36 Hours)
 - High (300 Lumens) (Run Time - 18 Hours)
 - Flashing (300 Lumens) (70 Hours)
- Powered by 3 D Batteries (Not Included)

- 1. WATER-RESISTANT RUBBER & ABS BASE CONSTRUCTION**
- 2. COMFORT GRIP HANDLE**
- 3. GREEN BEACON LED FLASHES WHEN LANTERN IS OFF (#6004 & #6005)**
- 4. GLOW-IN-THE-DARK BUTTON**

UPC CODE	ITEM	DESCRIPTION	MSRP	CASE PACK
645397060123	5949	WEATHERRITE® 610 Lumen Lantern	39.99	4 PIECES
044435915119	6004	WEATHERRITE® 65 Lumen Lantern	21.99	6 PIECES
044435915126	6005	WEATHERRITE® 300 Lumen Lantern	29.99	4 PIECES

Item#5959

WEATHERRITE
SINCE 1941

No Batteries to Replace...EVER!

ECOLANTERN™

RECHARGEABLE 24 LED LANTERN POWERED BY
(SOLAR • WIND UP • AC/DC ENERGY)

1. 24 POWERFUL ULTRA BRIGHT LEDs

Click the button 1 time for 157 Lumens of bright white light. (LED Bulbs 50,000 - plus hour life)

2. CARRY HANDLE

For convenience and mobility. Carry Handle also has a hook for hanging.

3. CHARGING INDICATOR

When lantern is fully charged, indicator light will change from **RED** to **GREEN**.

4. REFLECTORS

Reflectors are located at the top and bottom to reflect and emit a steady and consistent light output.

5. WIRE GUARD

Protects LED housing from damage.

6. SOLAR PANEL

ECO-LANTERN™ uses the solar panel to store then recycle the absorbed energy to power the super bright LEDs.

7. CRANK HANDLE

Located underneath lantern, the crank handle is used to wind up

8. AC/DC ADAPTERS INCLUDED



• NO BATTERIES

ECOLANTERN™ uses a 6V 2.5AH valve regulated rechargeable battery to give you supreme illumination every time without having to replace batteries.

• WIND UP



Wind up for 1 minute to produce 6 minutes of light. (Run time: 2.5 hours on a full charge)

• PRECAUTIONS

To prolong battery life, always turn lantern off when not in use. A constant drain on an uncharged battery will shorten the battery's life. It's best to use/charge the lantern at least once a month to avoid permanently draining the battery.



FL 1 STANDARD

 157 LUMENS	 6h	 Water-Resistant
Brightness	Run Time	

UPC CODE	ITEM	DESCRIPTION	MSRP	CASE PACK
645397070122	5959	WEATHERRITE® ECO LANTERN™	49.99	4 PIECES

OUTDOOR LIGHTING

Item#5572 15 LED LANTERN

The traditional lantern look with efficient LED lighting!

- 9 inch high metal lantern with wire-guarded glass globe
- 25 lumens of brightness
- More than 96 hours of continuous bright light
- Uses 2 D batteries (not included)
- Adjustable light output

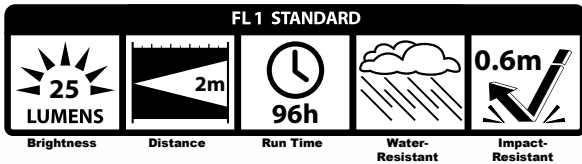

Item#6048 KEROSENE LANTERN

- 12 inch high metal lantern with wire-guarded glass globe
- 12oz. fuel capacity
- 35 hours of burn time
- Adjustable light output
- Uses kerosene, lamp oil or citronella oil ONLY
- Child-proof fuel tank cap
- Available in Black and Red

UPC CODE	ITEM	DESCRIPTION	MSRP	CASE PACK
044435627104	5572	WEATHERRITE® 15 LED Lantern	12.99	4 PIECES
044435915393	6048	WEATHERRITE® Kerosene Lanterns Red/Black	8.99	4 PIECES

Item#6037

WEATHERRITE
SINCE 1941

OUTFITTER XXL COT™



- Durable 600D polyester fabric with double stitching
- Easy set-up
- Oversized sleeping area (85" x 40")
- X-Frame design with steel brackets and steel legs
- Heavy-duty rubber bushings absorb weight and add stability

Holds up to 700 lbs
Strongest in the market



- Storage Carry Bag is custom designed to attach to the end of this cot. Carry Bag has a Drink Holder, 2 Mesh Organizer Bags, Key Ring Holder, Eyeglass Pouch, Flashlight Holder and a Large Zipper Pocket.

- Assembled size - 85" x 40" x 20"
- Folded Size - 42" x 12" x 7"



UPC CODE	ITEM	DESCRIPTION	MSRP	CASE PACK
044435915386	6037	WEATHERRITE® XXL Cot	119.99	1 PIECE

Quarrow® Fishing Kits

Item #5487 TROUT COMBO OUTFIT



ROD

- 8'6" 5 piece 5 weight IM7 graphite fly rod
- Premium cork handle

REEL

- Easily converts from right to left hand retrieve
- Large arbor disc drag fly reel

LINE

- 50 yards backing
- Weight-forward fly line
- Tapered leader

CASE

- Cordura rod tube with zipper reel pocket



UPC CODE	ITEM	DESCRIPTION	MSRP	CASE PACK
061317003566	5487	Quarrow® Trout Combo Outfit	119.99	5 PIECES

Item #5498 ELITE TROUT COMBO OUTFIT



ROD

- 9'0" 5 wt 4pc High Modulus Graphite Fly Rod
- Maple Wood Reel Seat with Aluminum Ring
- Premium Natural Cork Handle
- Hard Chrome Snake Guide

REEL

- Die cast/machined Aluminum Frame and Spool
- V-cut Large Arbor Spool Design
- Smooth Rulon Drag
- Easily Converts from Right to Left Hand Retrieve

LINES

- Weight Forward Floating Line
- 20 Lbs Backing Line
- Tapered Leader

CASE

- Cordura Tube Case with Zipper Reel Pocket & Shoulder Strap



UPC CODE	ITEM	DESCRIPTION	MSRP	CASE PACK
061317003672	5498	Quarrow® Elite Trout Combo w/Case	149.99	2 PIECES

Quarrow® Fishing Kits

Item #5497 FLY/SPIN

COMPLETE COMBO FISHING OUTFIT



ROD

- 7'6" 5 piece high modulus graphite travel spin/fly rod
- Natural cork handle

DIECAST FLY REEL

- Rim-controlled graphite spool and frame
- Fully loaded size 5/6 reel
(50 Yards of 20# Deacron Backing, WF5F, Tapered Leader)

SPINNING REEL

- 1 ball bearing spinning reel loaded 6 lb line

FLY ASSORTMENT

- 7 pc custom fly assortment

CASE

- Cordura rod tube with zipper reel pocket



UPC CODE	ITEM	DESCRIPTION	MSRP	CASE PACK
061317003665	5497	Quarrow® Fly/Spin Fishing Outfit	109.99	4 PIECES

Item #5504 FINE RIVER

FULLY LOADED FLY FISHING KIT

ROD

- 9' 3 pc 5/6 weight Fly rod
- Natural Cork Handle

REEL

- Diecast, rim-controlled graphite spool and frame
- Fully loaded size 5/6 reel
(50 yards of 20# Deacron backing, WF5F, tapered leader)

FLY ASSORTMENT

- 7 piece custom fly assortment with plastic case included



UPC CODE	ITEM	DESCRIPTION	MSRP	CASE PACK
061317003733	5504	Quarrow® Fine River Fly Fishing Kit	79.99	4 PIECES

Quarrow® Fishing Kits

Item# 6064 ELITE BASS COMBO OUTFIT



ROD

- 9'0" 8wt 4pc high modulus graphite fly rod
- Black aluminum reel seat
- Premium natural cork handle
- Hard chrome snake guide

FLY REEL

- Diecast aluminum 7/8 size frame and spool
- V-cut large arbor spool design
- Smooth Rulon drag
- Easily converts from right to left hand retrieve

LINES

- Weight forward floating line
- 25lbs backing line
- Tapered leader

CASE

- Cordura tube case with zipper reel, pocket/shoulder strap



UPC CODE	ITEM	DESCRIPTION	MSRP	CASE PACK
061317004136	6064	Quarrow® Elite Bass Combo Outfit	149.99	2 PIECES

Item# 6065 BEAR CREEK FLY REEL 5/6 SIZE



- Aluminum Diecast Frame & Spool
- Off-set Gear Drag
- Mid Arbor Design
- Convert to Right or Left Hand Retrieve

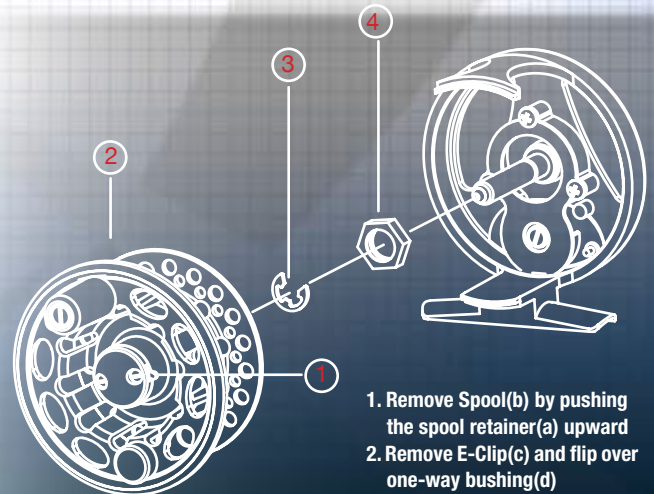

Right or Left Hand Interchange

1. Remove Spool(b) by pushing the spool retainer(a) upward
2. Remove E-Clip(c) and flip over one-way bushing(d)
3. Reattach E-Clip(c) & Spool(b)
4. Retrieve and drag will now function in opposite direction

UPC CODE	ITEM	DESCRIPTION	MSRP	CASE PACK
061317004143	6065	Quarrow® Bear Creek Fly Reel	44.99	6 PIECES

Quarrow® Fishing Tools



Item #5508 **BRAIDED LINE CUTTING PLIERS** FISHING MULTI-TOOL

- 1 - BENT NOSE SPLIT RING PLIERS
- 2 - BRAIDED LINE CUTTERS
- 3 - WIRE CUTTERS
- 4 - WIRE CRIMPER
- 5 - KNIFE BLADE
- 6 - FILE
- 7 - FLAT-HEAD SCREWDRIVER



UPC CODE	ITEM	DESCRIPTION	MSRP	CASE PACK
061317003771	5508	Quarrow® Braided Line Cutting Pliers	10.99	12 PIECES

Item #6044 **Pocket Digital Fishing Scale**



- Weighs up to 44 Lbs or 20 Kg
- Accurate to within 0.1 Lbs / 0.05 Kg
- Measures in Kg, Lbs, and Ounces
- Fast Auto-Locking Weight Feature
- Auto-Off Feature
- Tare/Reset Function
- ABS Plastic Material
- Ergonomically Designed
- Convenient Wrist Strap
- Low Battery Indicator
- Uses 2 AAA Batteries (Included)



UPC CODE	ITEM	DESCRIPTION	MSRP	CASE PACK
061317004044	6044	Quarrow® Pocket Digital Fishing Scale	10.99	6 PIECES

Item #6067, #6068 & #6069 **Floating 2-Sided Fly Boxes**

- Small, Medium & Large Sizes
- Strong ABS Plastic Body Material
- Tight Locking Latch
- Pre-cut Foam Fly Slots
- Water-Resistant Gasket



UPC CODE	ITEM	DESCRIPTION	MSRP	CASE PACK
061317004167	6067	Quarrow® 2-Sided Fly Box (Small)	12.99	6 PIECES
061317004174	6068	Quarrow® 2-Sided Fly Box (Medium)	15.99	6 PIECES
061317004181	6069	Quarrow® 2-Sided Fly Box (Large)	19.99	6 PIECES

Quarrow® Lighting

Item #6059 - #6063

Submersible Fishing Light



- Underwater Fishing Green LED Light (12 LEDs, 36 LEDs, 90 LEDs & 180 LEDs available)
- Two 12V 0.02" x 15' Cable
- Submersible up to 16 Feet Under Water
- Impact Resistant
- Watertight Rubber Caps
- 15A Protection Fuse
- Red and Black Battery Clip
- 0.2" x 0.79" 15A Fuse



WHY GREEN LIGHT?

The Quarrow® Submersible Fishing Light shines a bright green light directly into the water. The green light starts a natural food-chain reaction by attracting a concentration of small microscopic animals called plankton. Bait fish such as shad and minnows are drawn to the light to feed on the plankton and larger game fish move in to feed on the bait fish.

UPC CODE	ITEM	DESCRIPTION	MSRP	CASE PACK
061317004082	6059	Quarrow® 12 LED Submersible Fishing Light	24.99	6 PIECES
061317004099	6060	Quarrow® 36 LED Submersible Fishing Light	39.99	6 PIECES

UPC CODE	ITEM	DESCRIPTION	MSRP	CASE PACK
061317004105	6061	Quarrow® 90 LED Submersible Fishing Light	59.99	3 PIECES
061317004112	6062	Quarrow® 180 LED Submersible Fishing Light	84.99	3 PIECES

UPC CODE	ITEM	DESCRIPTION	MSRP	CASE PACK
061317004129	6063	36 LED Submersible Fishing Light w/Battery	39.99	6 PIECES

Item #6036

Handy Light

70 Lumen Pop Up Light & Flashlight

- 70 Lumen Multi-Function Light
- Pop-Up Head for Tent Light Function
- Durable Hanging Hook
- Convenient Use as Tent Light or Flashlight
- Powered by 3 AAA Batteries (Included)



FL 1 STANDARD

70 LUMENS	50m	15h	1m	Impact-Resistant
Brightness	Distance	Run Time	Water-Resistant	Impact-Resistant

UPC CODE	ITEM	DESCRIPTION	MSRP	CASE PACK
061317004006	6036	Quarrow® Handy Light	14.99	12 PIECES

Item #6042 Night Fishing Light Combo

White & UV LEDs

- 8 Powerful LEDs (White & UV)
- Rotating Magnetic Clip
- Water-Resistant Reinforced Plastic Body

LED Housing

The recessed LEDs are covered by a strong plastic lens which helps protect against drops. The recessed housing also directs the light into a strong concentrated beam of light.

- Powered by 3 AAA Batteries (Included)



FL 1 STANDARD

60 LUMENS	46m	11h	Water-Resistant	1m
Brightness	Distance	Run Time	Water-Resistant	Impact-Resistant



UPC CODE	ITEM	DESCRIPTION	MSRP	CASE PACK
061317004020	6042	Quarrow® Night Fishing Light Combo	19.99	6 PIECES

Quarrow® Fishing Lighting

Item# 5512

Dual Color Sportsman's Light

- High-Power Color-Changing LED
- 4x Adjustable Beam
- Aggressive Self-Defense Face
- Steel Belt/Pocket Clip
- Water-Resistant
- Shock-Proof
- Anodized Aircraft Grade Aluminum Body
- Powered by 1 AA Battery (Included)



Color-Changing LED



- WHITE LED
100 LUMENS
- GREEN LED
90 LUMENS

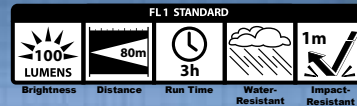

UPC CODE	ITEM	DESCRIPTION	MSRP	CASE PACK
061317003818	5512	Quarrow® Dual Color Sportsman's Light	19.99	12 PIECES

Item# 6071

Fly Tying Light

Hands-Free Precision Lighting

- 70 Lumen White Light
- Hands-Free Directional Lighting
- 360° Flexibility
- Glow-in-the-Dark On/Off Button
- Magnetic Base
- Water Resistant
- Impact Resistant
- Powered by 3 AAA Batteries (Included)

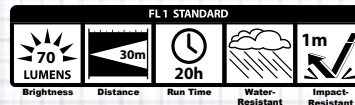

UPC CODE	ITEM	DESCRIPTION	MSRP	CASE PACK
061317004204	6071	Quarrow® Fly Tying Light	14.99	6 PIECES

Item# 6070

9 UV LED Curing Light

- 9 UV LED Light Cures / Hardens UV Adhesives (Wavelength: 400-405nm) (150 Micro Watt/cm²)
- Anodized Aircraft Grade Aluminum Body
- Water-Resistant / Shock Proof
- Lanyard Included
- Glow-in-the-Dark On/Off Button
- Powered by 3 AAA Batteries (Included)



Hold the UV Curing Light one inch away for ten seconds to cure UV sensitive adhesives. Compatible with adhesives that cure in the 400-405nm spectrum.

UPC CODE	ITEM	DESCRIPTION	MSRP	CASE PACK
061317004198	6070	Quarrow® 9 LED UV Curing Light	14.99	6 PIECES

Quarrow® Hands-Free Lighting

PATENTED ITEM
 US 6,880,951 B2
 US 7,703,952

Item# 5481

Rechargeable 40 Lumen Cap Light



Quarrow® has developed just what people want - a high powered LED light with a magnetic clip that NEVER needs batteries. The Quarrow® Rechargeable 40 Lumen Cap-Light charges in ANY 12V power outlet (cigarette lighter.)

- 40 Lumens (Viewing Distance: 40 Meters) (Run Time: 6 Hours)
- Charges fully in 2 hours
- Magnetic clip base for hands-free lighting
- Recharges in every car lighter 12 V socket
- 90° Vertical Flexibility / 360° Rotation

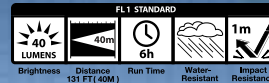

UPC CODE	ITEM	DESCRIPTION	MSRP	CASE PACK
061317003504	5481	Quarrow® Rechargeable 40 Lumen Cap-Light	14.99	12 PIECES

Item# 5492 70 Lumen Head Lamp



- 4 Lighting Modes:
70 Lumens (White), 10 UV LEDs, 4 Green LEDs, White Flashing
- Green LEDs - 4 Lumens (48,000 MCD)
- UV LEDs (2-3 milliwatts / wavelength: 410-415nm)
- Head tilts 90° to direct light wherever you need it
- Water-resistant
- Run time: 7 Hours / Viewing Distance: 70 Meters
- Two-way adjustable head strap
- Soft foam padding for non-slip comfort
- 3 AAA batteries included

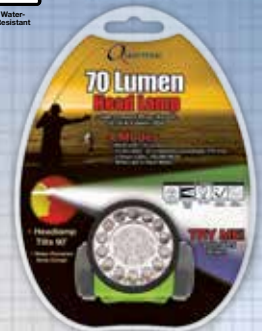

UPC CODE	ITEM	DESCRIPTION	MSRP	CASE PACK
061317003610	5492	Quarrow® 70 Lumen Head Lamp	16.99	12 PIECES

Item# 5482 & #5483 TRI-EYE™ Head Lamp

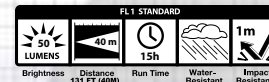

- 2 Lighting Modes:
1 High Power 50 Lumen LED & 2 UV (#5482) or Green (#5483) LEDs
- Green LEDs - 2 Lumens (22,000 MCD)
- UV LEDs - (2-3 milliwatts / wavelength: 410-415nm)
- Light weight plastic housing
- LEDs last up to 100,000 hours
- Shock-proof / water-resistant design
- Viewing Distance: 40 Meters / Run Time: 15 Hours
- Two CR2032 Batteries included
- Head lamp lip designed to protect your eyes from reflected light



UPC CODE	ITEM	DESCRIPTION	MSRP	CASE PACK
061317003511	5482	Quarrow TRI-EYE™ UV Head Lamp	12.99	12 PIECES
061317003528	5483	Quarrow TRI-EYE™ Green Head Lamp	12.99	12 PIECES

Quarrow® Fishing Accessories

Item# 5091

Turtle™ 8 Pocket Tool

- 1 - Pliers
- 2 - Wire Cutters
- 3 - Wire Stripper
- 4 - File
- 5 - Knife
- 6 - Phillips Screwdriver
- 7 - Flat-Head Screwdriver
- 8 - Carabiner

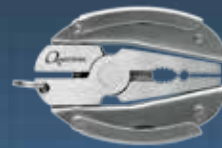

COMPACT SIZE
0.27" x 1.37" x 1.96"



UPC CODE	ITEM	DESCRIPTION	MSRP	CASE PACK
061317003023	5091	Quarrow® Turtle8™ 8-in-1 Pocket Tool	6.99	24 PIECES

Item# 5501

Knife Sharpener

The Quarrow® Knife Sharpener features two sets of sharpening rods with pre-set angles that restore dull blades with just a few strokes of the knife. These angled sharpening rods are 800 grain (Fine) and 320 grain (Coarse) to achieve a smooth finished razor edge on your knife. Coarse (320) grain is used to restore dull blades, and fine (800) grain is used to perfect already sharp blades.

Features

- Compact Design
- 3 Finger Grip Handle
- Pre-set Ceramic Sharpening System
- Uses Both Fine and Coarse Sides



UPC CODE	ITEM	DESCRIPTION	MSRP	CASE PACK
061317003702	5501	Quarrow® 2 Step Knife Sharpener	4.99	12 PIECES

Item# 5475

ALLURE-LIGHT

The Quarrow® Allure-Light shines a bright green light directly into the water. The reason why this light helps catch more fish is very simple; the green light starts a natural food chain reaction by attracting a concentration of small microscopic animals called plankton. Bait fish, such as shad and minnows, are drawn to the light to feed on the plankton and larger game fish move in to feed on the bait fish.



- Fresh or salt water use
- Polycarbonate Water-Proof Body (up to 200 ft.)
- 1 Green LED (520-525nm) (110,000 plus hours of life)
- Three LR41 Button Cell Batteries Included
- Run Time: 48+ Hours
- Swivels on both ends
- Easy to install



UPC CODE	ITEM	DESCRIPTION	MSRP	CASE PACK
061317003443	5475	Quarrow® ALLURE-Light	4.99	24 PIECES

Quarrow® Fishing Accessories

Item #5502

Hook Remover

Helps remove those deep hooks

- Lightweight aluminum body designed for easy use
- Rust-Resistant
- The long-reach hook remover is ideal for releasing larger species
- Ergonomic handle ensures a good grip
- Easily removes hook and secures it for quick, clean removal
- Extends to reach deep hooks
- 9" length



UPC CODE	ITEM	DESCRIPTION	MSRP	CASE PACK
061317003719	5502	Quarrow® Hook Remover	5.99	12 PIECES

Item #5503

Telescopic Fishing Gaff

- 2 - Piece High Quality Aluminum Alloy Collapsible Frame/Handle
- Non-Slip Comfortable PVC Grip Handle With Wrist Strap
- Gaff Extends To 23.6 Inches & Contracts to 10.75 Inches
- High Quality Stainless Steel Hook With Protective Rubber Hook Cover
- Sharpened Tip To Perfection
- Great For Boating, Jetty Fishing To Land Fish



UPC CODE	ITEM	DESCRIPTION	MSRP	CASE PACK
061317003726	5503	Quarrow® Telescopic Fishing Gaff	19.99	6 PIECES

Item #5470

Digital Fishing Scale

- Weighs up to 110 Lbs or 50 Kg
- Accurate to within 0.5 Lbs / 0.05 Kg
- Ergonomically Designed
- 2 LED Flashlight
- 3 ft. tape measure

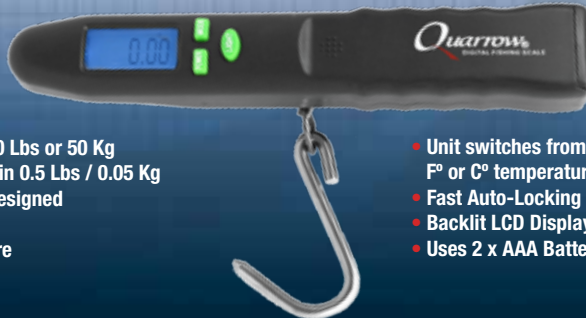

- Unit switches from Lb, Kg or Oz weights, F° or C° temperature
- Fast Auto-Locking weight feature
- Backlit LCD Display
- Uses 2 x AAA Batteries (Included)



UPC CODE	ITEM	DESCRIPTION	MSRP	CASE PACK
061317003399	5470	Quarrow® Portable Digital Scale	19.99	12 PIECES

FAQ

Frequently Asked Questions



Who is Alliance Sports Group?

Alliance Sports Group is the parent company of NEBO® Tools, NEBO® Sports, iPROTEC™ Firearm Accessories, Bollinger® Fitness, WeatherRite® Outdoor and Quarrow® Fishing.

What does NEBO® mean?

NEBO is mentioned in the Bible as the burial site of Moses. There is an excellent view of "The Promised Land" from Mt. NEBO. NEBO is also a mountain in Utah near where NEBO® Tools originated.

Can I order online?

Yes. Go to nebotools.com to purchase products at retail or sign up to become a dealer. Credit card orders only.

Are batteries included in your products?

All flashlights, cap-lights, head lamps and multi-tools that require batteries have batteries included.

Are lasers safe and legal?

Lasers of all types are regulated by the FDA. All lasers used in NEBO® flashlights meet the required standards and have the appropriate warnings to avoid direct eye contact with any laser.

Are NEBO® products waterproof?

Some NEBO® products are waterproof, however most are water-resistant. Please see product details for further information.

Do your holsters fit all your flashlights?

These holsters fit all of our flashlights except the HIGHBEAM™ Series, EDGE™ series, LUMA™ / LUMIERE™ series, BLUELINE® series, Larry™ & Larry™2 series, #5905 iPROTEC™ Pocket CHAMELEON™ and #5906 iPROTEC™ Blood Tracker.

Which iPROTEC™ product will fit my gun?

The dimension specs for each of our iPROTEC™ items is listed in our catalog and also on nebotools.com. Our rail mounted lights are now equipped with a hinge-mount design that provides a more universal fit.

Customized products with your logo?

The minimum order quantity is 100 pieces for most items. Lead time is 21 days. Contact your NEBO® sales representative for pricing and for more details.

Does NEBO® offer a warranty for its products?

Yes, NEBO® stands behind its products with a 1 year limited manufacturer's warranty. Any item that does not perform properly due to a manufacturer's defect can be returned for a warranty replacement. Warranty does not cover normal wear and tear or batteries. Contact warranty@nebotools.net or 800.255.6061.

Can't find the answer to your question?

Email: info@nebotools.net

or

Call us at: 1.800.255.6061

LIGHTING 101

Understanding LED Flashlights

LEDs Run
2X
LONGER

LED Lights Explained

An LED is a Light Emitting Diode that uses a semiconductor, rather than a filament, to create light. Because of this, LED lights are much brighter, use a fraction of the energy and last thousands of times longer than other bulb types.

Runtime of Incandescent vs LED (using equal brightness settings)

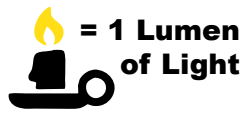
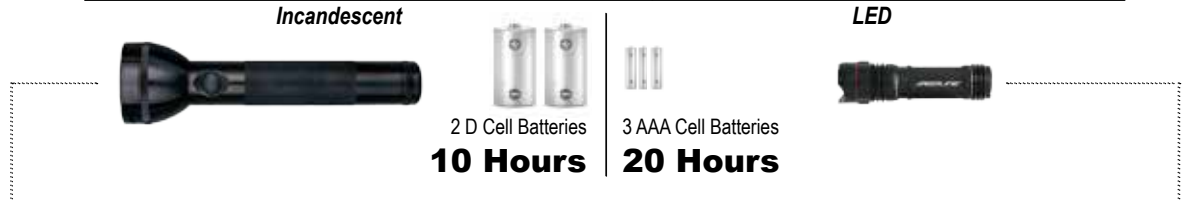

Brightness

A good rule of thumb would be to consider a single lumen of light to be as bright as one burning candle. In the past, the brightness of any given light bulb was measured by the amount of watts it consumed. Most people understood about how bright a 60 watt bulb would be without needing a scientific explanation. Recently, the unit of measurement for brightness has graduated from Watts to Lumens. This is mostly because it no longer makes sense to try and determine the brightness of a bulb based on its power consumption.

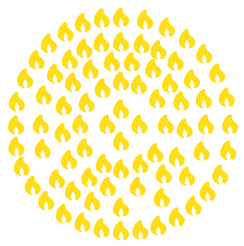

LIGHT BEAM INTENSITY
IS AFFECTED BY THE OPTICS & LUMEN RATING

Measuring the Distance Light Travels

The distance that a beam of light can travel is often referred to as the “throw.” A flashlight’s throw is important because people typically buy flashlights to help them see at a distance. The throw is determined primarily by two things: the lumen rating (brightness of the light) and the flashlight’s optics (the lens and housing of the light source.) While a high lumen rating may produce a bright light, it doesn’t necessarily mean that it will project the light at a far distance. Think of a light bulb in a lamp for example – while the light may be bright (lumen), it doesn’t reach (“throw”) very far because it lacks the optics required to focus all of the light’s intensity in one direction.



ANSI (American National Standards Institute)

In 2009, the American National Standards Institute created standards for benchmarking a flashlight’s performance (ANSI/NEMA FL 1-2009, the Flashlight Basic Performance Standard, also known as “FL 1 Standard.”) This standard makes it easier for consumers to compare different flashlights. These benchmarks rate Beam Distance (throw), Impact-Resistance, Run Time, Light Output (Lumen), Water-Resistance, Water-Proof Depth Rating and Peak Beam Intensity. Our flashlights clearly state the ANSI ratings right on the package.

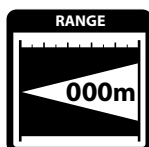

DEFINITIONS

High-Powered LEDs

These LEDs produce a more intense light that travels a further distance than cluster LEDs. Conversely, these also use more power than clusters do.

Cluster LEDs

These LEDs consume less power while still providing a bright light. They tend to produce a wide angle of light and are better used for short range lighting to illuminate your immediate area.

Adjustable Focus

The adjustable focus feature allows the user to change the focus of the light beam from a spot light (a sharply focused beam of light that illuminates more distant areas) to a flood light (a broad circular beam of light that illuminates larger, close-up areas.)

Convex Lens

The convex lens evenly distributes the light for a highly concentrated beam without dull or dark spots, as most traditional flashlights have.

Green LEDs

Because the human eye recognizes the color green faster than other colors, green light is used for map reading or signaling, especially in low light conditions. Also perfect for hunting as some game cannot see green light.

UV LEDs

These can reveal materials that are not seen through normal lighting and can be very useful in the following applications:

- Crime scene investigation to reveal certain bodily fluids
- Rodent and pet stain detection
- Document analysis and currency verification
- Gemstone verification
- Leak detection (i.e. Freon)

Red LEDs

Red light is primarily used to preserve night vision. Best used for low-light or nighttime situations, the low-signature red light provides great contrast making it easier to read charts and maps. Police and military units utilize the red LED for night operations because it will not interfere with night vision technology and cannot be seen by the human eye over long distances. Fire rescue units also use the red LED because it provides better visibility in smoky situations than white light.

Red Laser Pointer

Class IIIa lasers are used in all of our laser products. All red lasers have a maximum output of <5mW with a wavelength of 650nm +/- 10. Laser pointers work well in a variety of situations. Laser pointers can be used as a sighting tool for weapons, or more commonly used to point to an object that is out of reach.

Note: Directing laser at eyes can cause serious damage. (All laser pointers comply with 21 CFR 1040.10, 1040.11 & Ch. 1, Subchapter J)

Green Laser Pointer

Class IIIa lasers are used in all of our laser products. All green lasers have a maximum output of <5mW with a wavelength of 523nm. Green lasers are more sensitive to temperature, but they work better for day time applications.

Note: Directing laser at eyes can cause serious damage. (All laser pointers comply with 21 CFR 1040.10, 1040.11 & Ch. 1, Subchapter J.)

Hands-Free Lighting

Hands-Free lighting allows the user to illuminate a desired area while maintaining the use of both hands. We use clips, straps and magnets to give hands-free options with some of our products.

Head Lamps

Head Lamps are useful for any job that demands hands free light. Adjustable straps ensure that these lights can be worn comfortably and securely indoors, outdoors or anywhere.

Cap-Lights

Cap-lights attach to virtually all brimmed style caps for a practical, hands-free light source and offer a sleek, multi-directional lightweight design with an easy-to-activate ON/OFF button.

Lighting Modes

Our advanced circuitry allows for variable brightness control and lighting flash sequence with a simple touch of a switch that regulates the lighting mode. By decreasing brightness you can extend the run time of the battery.

Defensive Strobe Lighting Mode

Perfect for signaling, the defensive strobe mode can also be used to disorient an attacker or animal by shining it at them. Please use with caution when doing this.

S.O.S. Lighting Mode

S.O.S. is the commonly used description for the international Morse Code distress signal. The code for S.O.S. is 3 short, 3 long and 3 short signals. The S.O.S. sequence will repeat until the setting is changed or the light is turned off.

UPC Code	Item #	NEBO® Tools	MSRP	Case Pack	Page #
Flashlights and Lighting					
645397128007	5077	CSI TACTICAL LED Flashlight w/Laser in Clamshell	\$14.99	18 pieces	32
645397900108	5112	CSI LUMA50™ Mini Flashlight	\$9.99	24 pieces	29
645397900306	5423	BENDBRITE™ Hands-Free Flex Light with Magnetic Clip	\$9.99	16 pieces	37
645397900702	5519	CSI EDGE 50™ Mini Flashlight	\$9.99	24 pieces	28
645397900900	5550	HIGHBEAM™ Rechargeable Flashlight	\$9.99	35 pieces	27
645397401100	5557	NEBO® REDLINE® 220 Lumen Flashlight	\$34.99	14 pieces	19,20
645397430100	5561	CSI QUATRO™ 75 Lumen LED Flashlight w/Laser in Clamshell	\$29.99	12 pieces	31
645397626107	5571	LIGHT-WRITER 3-in-1 Pen/Light/Laser	\$9.99	24 pieces	36
645397531111	5581	NEBO® REDLINE® 220 Lumen Flashlight in Clamshell	\$34.99	12 pieces	19,20
645397122111	5599	NEBO® REDLINE® 220 Lumen Flashlight Bulk	\$34.99	18 pieces	19,20
645397123101	5602	NEBO® BLUELINE® Flashlight in Clamshell	\$21.99	12 pieces	24
645397421115	5604	NEBO® LUMIERE™ 50 Lumen Flashlight	\$10.99	24 pieces	30
645397111115	5610	NEBO® REDLINE® 220 Lumen Flashlight Black	\$34.99	18 pieces	19,20
645397929116	5614	NEBO® LUMIERE™ 50 Lumen Flashlight in Clamshell	\$10.99	24 pieces	30
645397312116	5615	NEBO® SE REDLINE® 250 Lumen Flashlight	\$39.99	14 pieces	17,18
645397914112	5616	NEBO® SE REDLINE® 250 Lumen Flashlight in Clamshell	\$39.99	12 pieces	17,18
645397203735	5618	The LARRY™ 8 LED Pocket Work Light	\$9.99	24 pieces	21,22
645397111276	5620	NEBO® REDLINE® SELECT 310 Lumen Flashlight	\$49.99	9 pieces	15,16
645397120025	5625	HIGHBEAM™ Rechargeable Flashlight Black Bulk	\$9.99	10 pieces	27
645397003120	5626	HIGHBEAM™ Rechargeable Flashlight Grey Bulk	\$9.99	10 pieces	27
645397004127	5627	HIGHBEAM™ Rechargeable Flashlight Blue Bulk	\$9.99	10 pieces	27
645397005124	5628	HIGHBEAM™ Rechargeable Flashlight Pink Bulk	\$9.99	10 pieces	27
645397006121	5629	HIGHBEAM™ Rechargeable Flashlight Green Bulk	\$9.99	10 pieces	27
645397010128	5633	CSI Tactical Flashlight Assorted Colors	\$14.99	18 pieces	32
645397015123	5638	NEBO® SE REDLINE® 250 Lumen Flashlight Black Bulk	\$39.99	18 pieces	17,18
645397107125	5872	CSI EDGE 90™ Mini Flashlight	\$12.99	24 pieces	28
645397018124	5894	The LARRY™ 8 LED Pocket Work Light Bulk Red	\$9.99	12 pieces	21,22
645397019121	5895	The LARRY™ 8 LED Pocket Work Light Bulk Blue	\$9.99	12 pieces	21,22
645397020127	5896	The LARRY™ 8 LED Pocket Work Light Bulk Dark Grey	\$9.99	12 pieces	21,22
645397021124	5897	The LARRY™ 8 LED Pocket Work Light Bulk Yellow	\$9.99	12 pieces	21,22
645397036128	5902	The LARRY™ 8 LED Pocket Work Light Clamshell	\$9.99	12 pieces	21,22
645397057123	5946	NEBO® JAG 210 Flashlight	\$24.99	18 pieces	25
645397058120	5947	NEBO® ZOOM 130 Flashlight	\$11.99	16 pieces	26
645397059127	5948	NEBO® BLUELINE® 180 Flashlight	\$21.99	20 pieces	24
645397061120	5950	The UV LARRY™ 8 LED Pocket Work Light	\$19.95	6 pieces	23
645397066125	5955	NEBO® REDLINE® SELECT 310 Lumen Flashlight Titanium	\$49.99	9 pieces	15,16
645397067122	5956	NEBO® SE REDLINE® Grey Bulk	\$39.99	18 pieces	17,18
645397068129	5957	The LUCY™ 8 LED Pocket Work Light	\$9.99	12 pieces	21,22
645397929123	5962	HIGHBEAM™ Rechargeable Flashlight Red Bulk	\$9.99	10 pieces	27
645397929161	5998	NEBO® Lite-Writer™ Pen + Stylus	\$11.99	36 pieces	35
645397929185	6000	NEBO® O ² BEAM™ <i>NEW ITEM</i>	\$99.99	4 pieces	1,2
645397929192	6001	NEBO® WORKBRITE™ Work Light	\$21.99	16 pieces	13,14
645397929215	6003	NEBO® 90 Lumen Head Lamp	\$19.99	6 pieces	34
645397929222	6006	NEBO® Larry™ 2	\$15.99	24 pieces	11,12
645397929239	6007	NEBO® REDLINE® RC™ Rechargeable Flashlight <i>NEW ITEM</i>	\$59.99	6 pieces	3,4
645397929345	6051	NEBO® Larry™ 2 Bulk Orange	\$15.99	12 pieces	12
645397929352	6052	NEBO® Larry™ 2 Bulk Grey	\$15.99	12 pieces	12
645397929369	6053	NEBO® Larry™ 2 Bulk Black	\$15.99	12 pieces	12
645397929376	6054	NEBO® Larry™ 2 Bulk Lime Green	\$15.99	12 pieces	12
645397929383	6055	NEBO® Lucy™ 2 Bulk Pink	\$15.99	12 pieces	12
645397929475	6085	NEBO® EDGE™ 200 Flashlight <i>NEW ITEM</i>	\$15.99	20 pieces	7,8
645397929499	6092	NEBO® REDLINE® OC™ 200 Lumen Flashlight <i>NEW ITEM</i>	\$19.99	16 pieces	5,6
645397929529	6095	NEBO® LUMO™ 25 Lumen Clip Light <i>NEW ITEM</i>	\$5.99	48 pieces	9,10
Tools					
645397130406	4327	Ultra™ Socket Combination Kit	\$19.99	12 pieces	39
645397137009	4818	Z-LENS Safety Glasses - Black Frame w/Yellow Lens	\$6.99	6 pieces	41
645397139003	4820	Z-LENS Safety Glasses - Blue Frame w/Clear Lens	\$6.99	6 pieces	41
645397850892	5089	CSI Flashlight Holster with Belt/Pocket Clip & Carabiner	\$3.99	10 pieces	33
645397900504	5517	Folding Lock-Blade Utility Knife Assorted Colors <i>NEW ITEM</i>	\$6.99	18 pieces	40
645397610113	5606	NEBO® 14-in-1 Ultra™ Socket	\$16.99	12 pieces	38
645397033127	5918	NEBO® Tool Bag	\$29.95	6 pieces	42
645397035121	5922	NEBO® Leather Flashlight Holster	\$16.99	6 pieces	33
645397069126	5958	NEBO® Flashlight Holster	\$6.99	10 pieces	33
645397929284	6032	NEBO® Flashlight Holster with Belt Loop <i>NEW ITEM</i>	\$6.99	10 pieces	33

UPC Code	Item #	iPROTEC™ Firearm Lighting	MSRP	Case Pack	Page #
645397501107	5565	iPROTEC™ Laser Flashlight Combo	\$29.99	6 pieces	48
645397502104	5566	iPROTEC™ ELITE Laser Flashlight Combo	\$59.99	6 pieces	47
645397503101	5567	iPROTEC™ ELITE HP230	\$49.99	6 pieces	51
645397514107	5569	iPROTEC™ ELITE HP190	\$44.50	6 pieces	52
645397903109	5578	iPROTEC™ ELITE HP190LS	\$89.99	6 pieces	53
645397905103	5580	iPROTEC™ Green Laser Firearm Sight	\$79.99	6 pieces	55
645397112112	5598	iPROTEC™ Mounting Clamp	\$19.95	12 pieces	56,45-48
645397118114	5600	iPROTEC™ Red Laser Firearm Sight	\$39.95	6 pieces	54
645397007128	5630	iPROTEC™ REDLINE® White LED	\$59.99	6 pieces	45
645397008125	5631	iPROTEC™ GREENLIGHT™ Green LED	\$59.99	6 pieces	46
645397905103	5580	iPROTEC™ Green Laser Firearm Sight	\$79.99	6 pieces	56
645397027126	5904	iPROTEC™ Bat with High Powered LED	\$39.99	6 pieces	43
645397028123	5905	iPROTEC™ Pocket CHAMELEON™	\$29.99	6 pieces	49
645397029120	5906	iPROTEC™ Blood Tracker	\$29.99	6 pieces	50
645397062127	5951	iPROTEC™ RM-400 Light	\$79.99	6 pieces	44
645397065128	5954	iPROTEC™ Dual Mode Pressure Switch	\$18.99	6 pieces	56

UPC Code	Item #	NEBO® Sports	MSRP	Case Pack	Page #
645397819103	5576	NEBO® 6 White LED BIKE LIGHT	\$13.99	6 pieces	58
645397812111	5611	NEBO® 250 PSI AIR COMPRESSOR	\$19.99	12 pieces	60
645397120018	5624	NEBO® REDLINE® with Universal Bar Mount	\$39.99	6 pieces	57
645397063124	5952	NEBO® Rear Bike Light	\$9.99	6 pieces	59
645397064121	5953	NEBO® Bike Light Combo	\$24.99	6 pieces	59

UPC Code	Item #	WEATHERRITE® Outdoor	MSRP	Case Pack	Page #
044435627104	5572	WEATHERRITE® 15 LED Lantern	\$12.99	4 pieces	65
645397112211	5623	WEATHERRITE® Tortoise™ Cargo Bag	\$99.99	4 pieces	42
645397060123	5949	WEATHERRITE® 610 Lumen Lantern	\$39.99	4 pieces	63
645397070122	5959	WEATHERRITE® ECO-LANTERN™	\$49.99	4 pieces	64
645397929208	6002	WEATHERRITE® Essential Emergency Power Supply (EEPS)	\$249.99	2 pieces	61,62
044435915119	6004	WEATHERRITE® 65 Lumen Lantern™	\$21.99	6 pieces	63
044435915126	6005	WEATHERRITE® 300 Lumen Lantern™	\$29.99	4 pieces	63
044435915386	6037	WEATHERRITE® Outfitter XXL Cot	\$119.99	1 piece	66
044435915393	6048	WEATHERRITE® Kerosene Lantern Assorted Colors Red and Black	\$8.99	4 pieces	65

UPC Code	Item #	Quarrow® Fishing	MSRP	Case Pack	Page #
061317003023	5091	Quarrow® Turtle8™ 8-in-1 Pocket Tool in Clamshell	\$6.99	24 pieces	74
061317003399	5470	Quarrow® Portable Digital Scale	\$19.99	12 pieces	75
061317003443	5475	Quarrow® ALLURE-LIGHT	\$4.99	24 pieces	74
061317003504	5481	Quarrow® 40 Lumen Rechargeable Cap-Light	\$14.99	12 pieces	73
061317003511	5482	Quarrow® TRI-EYE UV Head Lamp	\$12.99	12 pieces	73
061317003528	5483	Quarrow® TRI-EYE Green Head Lamp	\$12.99	12 pieces	73
061317003566	5487	Quarrow® Trout Combo Outfit	\$119.99	5 pieces	67
061317003610	5492	Quarrow® 70 Lumen Head Lamp with 10 UV & 4 Green LEDs	\$16.99	12 pieces	73
061317003665	5497	Quarrow® Fly/Spin Combo Kit	\$109.99	4 pieces	68
061317003672	5498	Quarrow® Elite Trout Combo Kit	\$149.99	2 pieces	67
061317003702	5501	Quarrow® 2 Stage Knife Sharpener	\$4.99	12 pieces	74
061317003719	5502	Quarrow® Hook Remover	\$5.99	12 pieces	75
061317003726	5503	Quarrow® Telescopic Gaff	\$19.99	6 pieces	75
061317003733	5504	Quarrow® Fine River Fully Loaded Fly Fishing Kit	\$79.99	4 pieces	68
061317003771	5508	Quarrow® Braided Line Cutting Pliers	\$10.99	12 pieces	70
061317003818	5512	Quarrow® Dual Color Sportsman's Light <i>NEW ITEM</i>	\$19.99	12 pieces	72
061317004006	6036	Quarrow® Handy Light <i>NEW ITEM</i>	\$14.99	12 pieces	71
061317004020	6042	Quarrow® Night Fishing Light Combo (UV/White) <i>NEW ITEM</i>	\$19.99	6 pieces	71
061317004044	6044	Quarrow® Pocket Fishing Digital Scale <i>NEW ITEM</i>	\$10.99	6 pieces	70
061317004082	6059	Quarrow® 12 LED Submersible Fishing Light <i>NEW ITEM</i>	\$24.99	6 pieces	71
061317004099	6060	Quarrow® 36 LED Submersible Fishing Light <i>NEW ITEM</i>	\$39.99	6 pieces	71
061317004105	6061	Quarrow® 90 LED Submersible Fishing Light <i>NEW ITEM</i>	\$59.99	3 pieces	71
061317004112	6062	Quarrow® 180 LED Submersible Fishing Light <i>NEW ITEM</i>	\$84.99	3 pieces	71
061317004129	6063	Quarrow® 36 LED Battery Powered Submersible Fishing Light <i>NEW ITEM</i>	\$39.99	6 pieces	71
061317004136	6064	Quarrow® Elite Bass Combo Kit <i>NEW ITEM</i>	\$149.99	2 pieces	69
061317004143	6065	Quarrow® Bear Creek Fly Reel 5/6 Size <i>NEW ITEM</i>	\$44.99	6 pieces	69
061317004167	6067	Quarrow® Double Sided Fly Box - Small <i>NEW ITEM</i>	\$12.99	6 pieces	70
061317004174	6068	Quarrow® Double Sided Fly Box - Medium <i>NEW ITEM</i>	\$15.99	6 pieces	70
061317004181	6069	Quarrow® Double Sided Fly Box - Large <i>NEW ITEM</i>	\$19.99	6 pieces	70
061317004198	6070	Quarrow® 9 LED UV Curing Light <i>NEW ITEM</i>	\$14.99	6 pieces	72
061317004204	6071	Quarrow® 70 Lumen Fly Tying Light <i>NEW ITEM</i>	\$14.99	6 pieces	72
061317004266	6084	Quarrow® Digital Fishing Scale <i>NEW ITEM</i>	\$16.99	6 pieces	75