

*For Over 47 Years Providing Quality Innovative,  
Made in U.S.A., Products Invented by Highly Experienced  
Electricians to Help Contractors do Jobs*

**Safer, Better, Faster With Less Material  
to be More Profitable and Competitive.**



*Proud to be the electricians' friend and a long time  
supporter of contractor training programs.*

*Please contact us anytime of the day – every day of the year!*

Mikel – cell: 815-353-5500 • Paul – cell: 815-451-6335 • Peter – cell: 630-399-9972

*We honestly care and promise excellent service.*



Where shown



730 Pratt Boulevard • Elk Grove Village, IL 60007 • P: (847) 593-8595 • F: (847) 593-8629 • Toll-free (800) 233-8595 • E: info@spproducts.com • www.spproducts.com



## Wire Assemblies

- EZ1** EZ Pull/EZ Read Wire Harness
- EZ2** Wiring Harness for Power & Controls
- EZ3** You Need It? We'll Make It
- EZ4** Home Runs, Networks, etc.
- EZ5** "Tree Type" Harness Diagram
- EZ6** Wire Assemblies in Flexible Conduit
- EZ7** Harnesses Outer Diameter Chart

## Innovative Installed Products

- IP1** QwikDuct HDPE Custom Template
- IP1A** QwikDuct HDPE Template Order Form
- NEW!** **IP2** Conduit/Box Support Plates
- NEW!** **IP2A** Conduit/Box Support Plate (2 & 4 Way) - No Clamps
- IP2B** Conduit/Box Support Plate (Full & Half) - No Clamps
- IP2C** Conduit/Box Support Plate Round
- IP3** No Conduit Clamp Trapeze Brackets
- NEW!** **IP4** Threaded Block to Support 3 Conduits
- NEW!** **IP5** Transition Couplings 1/2 thru 4 inch
- IP6** Down Lite Hangers for T Bar Ceilings
- NEW!** **IP7** Box Brackets for Masonry Block Walls
- NEW!** **IP8** Truss Hangers for Upper & Lower Chord
- IP9** Deck & Wall Sleeves
- NEW!** **IP10** Tie Wraps
- IP11** Roof Conduit Support Block
- IP12** Custom Mounting Plates
- IP13** EZ Cable Ties
- NEW!** **IP14** Custom Nameplates and Labels
- IP15** Barrier & Warning Tapes
- IP16** \*Box Support Brackets for Common Walls
- IP16A** \*Any Position "Big O" Support Brackets
- IP16B** \*Fixed Position Box Support Brackets
- IP16C** \*Support Brackets for Deep Boxes
- IP17** No Center Stop "Slip" Couplings

\* Also Available with UL Listed  
Prefabricated Assemblies

## Prefabricated Products

- Prefabricated Assemblies **PFA1**
- Various Prefabricated Assemblies **PFA2**
- Receptacles/Switches in Walls **PFA3**
- Grounding Pigtaills **PFA4**
- Custom Wire Leads **PFA5**
- Snap On/Off Box & Device Covers **PFA6**
- Adjustable Mud Rings **PFA7**
- Box Support Brackets for Common Walls \* **PFA8**
- Any Position "Big O" Box Support Brackets \* **PFA8A**
- Fixed Position Box Support Brackets \* **PFA8B**
- Support Brackets for Deep Boxes \* **PFA8C**
- Custom Cables for PDUs **PFA9**
- "Econo Whips" and History **PFA10**

## Innovative Tools and Equipment

- Light Pole Anchor Bolt Template **TE1**
- Live Panel Temporary Cover **TE2**
- Panel Lockout Brackets **TE3**
- Conduit Plug with ID Tag **TE4**
- 1-1/4 thru 6 inch Rigid Pipe Joiner **TE5**
- Dry Wall Cut Out Templates **TE6**
- Cable Guide for Low Voltage Cable **TE7**
- Top Slide MC/LV Cable on T Bar Ceiling **TE8**
- Wire Pulling Pal **TE9**
- Wire Pulling Rollers for Cable Tray **TE10** **NEW!**
- Portable PVC Conduit Bender **TE11**
- Laser Line Gun - Locate Pull Lines **TE12**
- Step Ladder Shoulder Pad **TE13** **NEW!**
- Bit with Plug Ejector Spring **TE14**
- Extension Cord Lock **TE15**
- Safety Vests **TE16**
- Emergency Back Packs **TE17**
- Wire Cart -Fast Load and Unload Reels **TE18** **NEW!**
- Hand Truck with Battery Operated Lift **TE19** **NEW!**
- Wire Chart EZ Peel and Stick **TE20** **NEW!**
- EZ Cable Ties **TE21**
- Clip On/Off Phone Hanger **TE22** **NEW!**
- Quick Cable/Cord/Rope Winder **TE23** **NEW!**
- "No-Dog" Offset Level **TE24** **NEW!**
- Portable Cable Puller **TE25** **NEW!**



# EZ Pull - EZ Read



## Wire Harnesses for Power, Controls, Voice, Data, etc.



### Save Over 40% On Wire Pulls!

Our unique cross tape only method, with easy to remove tabs at specified intervals allows quick, easy pulls.

UV laser cured printed numbers, letters, symbols, etc. every half inch along its entire length.

### Safer to Handle Faster to Install Excellent Quality Since 1977

**SP** PRODUCTS, INC.  
*Productivity and value thru ideas*



PATENTED



Where shown

730 Pratt Boulevard • Elk Grove Village, IL 60007 • P: (847) 593-8595 • F: (847) 593-8629 • Toll-free (800) 233-8595 • E: info@spproducts.com • www.spproducts.com



*Proud to be the electricians' friend for over 47 years and a long time supporter of contractor training programs.*



7-23-13

Home Runs  
For 50% of pulls  
on hard pipe jobs



# EZ Pull-EZ Read Wiring Harnesses

For Power, Controls, Voice, Data, etc.



- ▶ Any type, size, length, number of conductors, wire or cable including Fibre Optics Enhanced Cat 5 or 6, etc.
- ▶ Every wire is carefully tested for continuity and quality
- ▶ Extra footage is provided to guarantee harness length

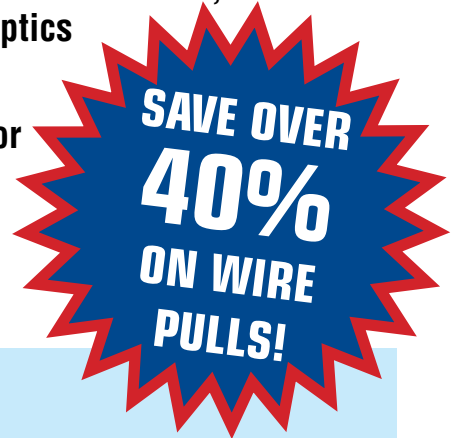

## ELIMINATES:

- Labor intensive and often injury causing loading several heavy reels on racks then tearing them down
- Time consuming ringing out, making and applying costly wire markers that can be incorrect plus fall off during handling and the pull
- Left over partial reels to handle and haul back to the shop and never use.

## NO WASTE!

Set up only one reel and pull only what you actually need.

**Trees 1983**  
Set up one reel and pull to hit several locations

**Controls**

**Low Voltage**  
Including Fibre Optic

**Large Cable**  
For Power

**Twisted/Striped**

**In Flexible Conduit**  
Steel, Aluminum, PVC, or Liquidite

NECA SHOW STOPPER 1991



**SP PRODUCTS, INC.**  
Productivity and value thru ideas



UL c UL US PATENTED  
Where shown



730 Pratt Boulevard • Elk Grove Village, IL 60007 • P: (847) 593-8595 • F: (847) 593-8629 • Toll-free (800) 233-8595 • E: info@spproducts.com • www.spproducts.com



*Proud to be the electricians' friend for over 47 years and a long time supporter of contractor training programs.*





Ideal for  
All Job Sites!



# Tell Us What You Need . . . We'll Make It!

- Apartments
  - Auto Plants
  - Baggage
  - Freight Handling
  - Bottling Companies
  - Chemical Plants
  - Condominiums
  - Convention Centers
  - Detention Centers
  - Distribution Centers
  - Food Processing
  - Hospitals
  - Hotels
  - Jails
  - Mail Facilities
  - Museums
  - Offices
  - Oil Refineries
  - Pipe Lines
  - Power Plants
  - Printing
  - Prisons
  - Schools
  - Steel Plants
  - Theaters
  - Water Treatment & Sewer
- ...and many more!

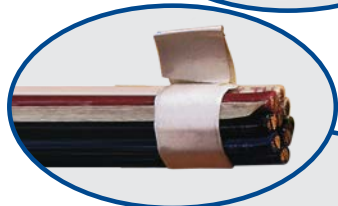
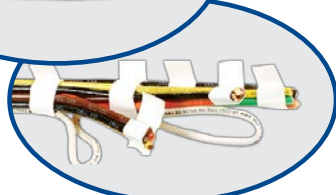
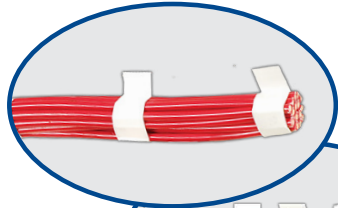

Any size wire, type of insulation, length, number of conductors, or combination of sizes and cable types in the same harness up to four thousand pounds per reel maximum. For greater weight requirements, consult factory.

- ▶ All conductors are same length or "Trees" with wires broken out and perhaps looped to hit several locations in one pull. Specify if "Trees" are pulled to or from panel.
- ▶ Each conductor UV laser cured for excellent adhesion and printed with any combination of numbers, letters, symbols repeated every 1/2 inch along its entire length.
- ▶ Wires bound by Cross Tape with easy to remove tabs or spiral laced. Cross Tape allows faster-easier pulls, adding or removing wires later and eliminates time lost and damage to wire if lacing breaks and balls up.
- ▶ Both inside flanges lined 360° with smooth fiberglass tape prevents wires being scraped or cut if pulled over edge of flanges.
- ▶ Reels shipped standing up or flat on skids for easier unloading and handling on jobsites.

**Save time, waste, reduce chance of injury, plus eliminate mistakes by using SP Wiring Harnesses on all your jobsites...  
one pull and your done!**

**SP PRODUCTS, INC.**  
Productivity and value thru ideas

Made in the USA

Where shown

730 Pratt Boulevard • Elk Grove Village, IL 60007 • P: (847) 593-8595 • F: (847) 593-8629 • Toll-free (800) 233-8595 • E: info@spproducts.com • www.spproducts.com



*Proud to be the electricians' friend for over 47 years and a long time supporter of contractor training programs.*



# Home Runs, Networks, Round Robins, Full Boats



In Flexible  
Conduit



Catalog #	Description	Reel Size	Lbs./Reel
<b>#12 THHN Solid and Stranded</b>			
HR 5C 12SOL 2500	5 Conductor #12 THNN Solid x 2500 foot Reel no wires printed or striped	22 w x 30 h	375
HR 5C 12STR 2500	5 Conductor #12 THNN Stranded x 2500 foot Reel and same as above -or- x 2500 foot reel no wires printed or striped	22 w x 30 h	375
HR 7C 12SOL 2500	7 Conductor #12 THNN Solid x 2500 foot Reel 3 Neutrals printed or striped and 4 wires not printed or striped	22 w x 30 h	525
HR 7C 12STR 2500	7 Conductor #12 THNN Stranded and same as above -or- x 2500 foot reel - 3 Neutrals printed or striped and 4 wires not printed or striped	22 w x 30 h	525
<b>#10 THHN Solid and Stranded</b>			
HR 5C 10SOL 2500	5 Conductor #10 THNN Solid x 2500 foot Reel no wires printed or striped	28 w x 36 h	600
HR 5C 10STR 2500	5 Conductor #10 THNN Stranded same as above	28 w x 36 h	600
HR 7C 10SOL 2500	7 Conductor #10 THNN Solid x 2500 foot Reel 3 Neutrals printed or striped and 4 wires not printed or striped	28 w x 36 h	840
HR 7C 10STR 2500	7 Conductor #10 THNN Stranded x 2500 foot Reel 3 Neutrals printed or striped and 4 wires not printed or striped	28 w x 36 h	840

- Every conductor is carefully inspected to provide excellent quality plus reels are properly marked and shipped laying flat or standing upright on skids for easier unloading and handling on jobsite.
- Customer must be aware very often reels furnished by manufacturers run short therefore home runs and other harnesses may only be as long as the shortest reel of the conductors involved. Also a small amount of footage loss occurs when printing or striping each conductor.
- Extremely competitive pricing with firm price blanket orders offered.
- Labor only orders (customer supplies wire) or labor with material supplied by SP negotiated.
- **An unlimited variety of manufacturers' brands and other types of wire including low voltage (Cat 5 and 6, fibre optic, etc.) size, length, wire colors, number of conductors each either striped or printed with numbers, letters, common symbols flush harness in all types of flexible conduit – steel or aluminum, liquidite, ENT, etc.available.**

**SP PRODUCTS, INC.**  
Productivity and value thru ideas

Made in the USA

Where shown

730 Pratt Boulevard • Elk Grove Village, IL 60007 • P: (847) 593-8595 • F: (847) 593-8629 • Toll-free (800) 233-8595 • E: info@spproducts.com • www.spproducts.com



*Proud to be the electricians' friend for over 47 years and a long time supporter of contractor training programs.*





# “Typical Tree Type” Harness Diagram Cook County Jail Division 11

 **Door Locking System**

**Wiring Harness Layout for the Cell Doors in a “Pod Design”**

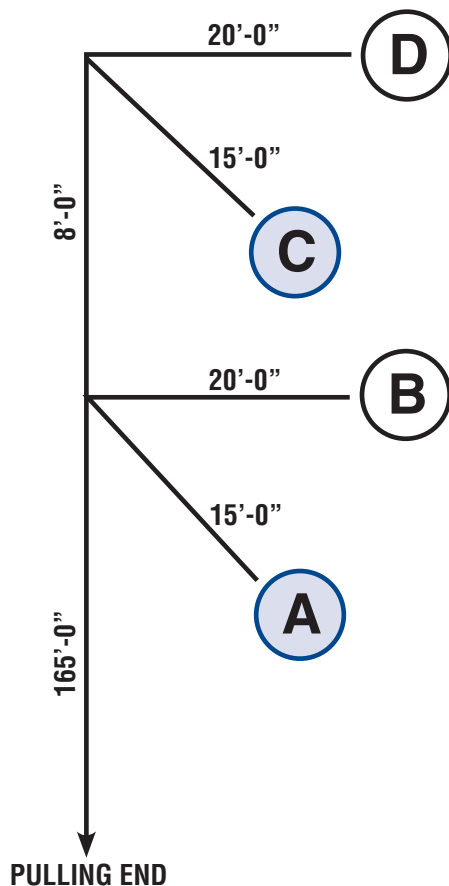

WIRE HARNESS		
Breakout	Wire Color	Printing
A	Yellow	Pod #3-Door 101
	White	Pod #3-Door 101
	Blue	Pod #3-Door 101
	Purple	Pod #3-Door 101
	Green	Pod #3-Door 101
B	Yellow	Pod #3-Door 102
	White	Pod #3-Door 102
	Blue	Pod #3-Door 102
	Purple	Pod #3-Door 102
	Green	Pod #3-Door 102
C	Yellow	Pod #3-Door 103
	White	Pod #3-Door 103
	Blue	Pod #3-Door 103
	Purple	Pod #3-Door 103
	Green	Pod #3-Door 103
D	Yellow	Pod #3-Door 104
	White	Pod #3-Door 104
	Blue	Pod #3-Door 104
	Purple	Pod #3-Door 104
	Green	Pod #3-Door 104



This was an actual layout diagram from the Door Locking System at the Cook County Jail, Div. 11 project. Approximately 1.4 million feet of #14 THHN was harnessed for this job by S-P Products. The harnesses were designed to feed 4 doors from each homerun. The printing of each wire saved the contractor enormously because the specifications for the job stated that all the wires had to be identified (tagged) at each and every junction and pull box used on the job.

NOTE: ALL WIRE TO BE #14 THHN STRANDED

## Hit Several Locations in One Set-Up and Pull for Greater Savings

**SP PRODUCTS, INC.**  
Productivity and value thru ideas

 Made in the USA

  **PATENTED**

Where shown

730 Pratt Boulevard • Elk Grove Village, IL 60007 • P: (847) 593-8595 • F: (847) 593-8629 • Toll-free (800) 233-8595 • E: info@spproducts.com • www.spproducts.com



*Proud to be the electricians' friend for over 47 years and a long time supporter of contractor training programs.*



# Pre-Wired Flexible Conduit Custom Assemblies



## Eliminate Expensive Conduit Installation and Wire Pulls

Ideal for Power, Controls, Low Voltage, Data, Surveillance, Security, Fire Alarm, Instrumentation etc., plus 480 Volt Temporary Power and other applications where extra protection for the wire is required.

Customer is responsible for compliance with the local and National Electrical Code, plus the owner's and specifying engineers' requirements. Customer must obey the National Electrical Code conduit fill and derating charts and all grounding requirements.

**PRE-WIRED FLEXIBLE CONDUIT ASSEMBLIES DO NOT MEET MC CABLE SPECIFICATIONS PER THE NATIONAL ELECTRIC CODE.**

- Available in long lengths with any number of conductors and types of wire or cable installed, including: fibre optic, in any type of flexible steel or aluminum, liquidtight, ENT, NMLT, etc. conduit up thru their maximum size. Various sizes and types of wire and cable can be combined, however low voltage and 300 volt or more cables cannot be in the same pre-wired flexible conduit assembly.
- Conductors can be printed with any combination of numbers, letters or common symbols up to 256 characters repeated every half inch along their length.
- Assemblies do not have fillers within or wrapping of mylar or any type material around conductors within the flexible conduit.
- A PVC jacket over aluminum or steel flexible conduit is available in a wide range of mil thicknesses and specified colors. Ideal for greater protection in wet locations, corrosive areas or embedding in concrete slabs.

**Ideal for Installation in difficult spaces where bends are needed - around columns, other obstructions, etc.**



Where shown



730 Pratt Boulevard • Elk Grove Village, IL 60007 • P: (847) 593-8595 • F: (847) 593-8629 • Toll-free (800) 233-8595 • E: info@spproducts.com • www.spproducts.com

**EZ6**

7-23-13

*Proud to be the electricians' friend for over 47 years and a long time supporter of contractor training programs.*







# Approximate THHN Copper Harnesses Outer Diameter

*Shown in Inches*

Size	Single OD	3	4	5	6	7	19	37	61	91	127	169	217	271	331	397	464
18	0.096	0.192	0.221	0.288	0.288	0.288	0.480	0.672	0.86	1.060	1.248	1.440	1.632	1.824	2.016	2.208	2.400
16	0.106	0.212	0.244	0.318	0.318	0.318	0.530	0.742	0.954	1.166	1.378	1.590	1.802	2.014	2.226	2.438	2.600
14	0.112	0.244	0.258	0.336	0.336	0.336	0.560	0.784	1.008	1.232	1.456	1.680	1.904	2.218	2.352	2.596	2.860
12	0.131	0.262	0.302	0.393	0.393	0.393	0.655	0.917	1.179	1.441	1.703	1.965	2.227	2.489	2.751	3.013	3.270
10	0.165	0.330	0.380	0.495	0.495	0.495	0.825	1.155	1.485	1.815	2.145	2.475	2.805	3.135	3.465	3.745	4.125
8	0.218	0.436	0.502	0.654	0.654	0.654	1.090	1.526	1.962	1.962	2.834	3.270	3.706	4.142	4.578	5.014	5.450
6	0.257	0.514	0.591	0.771	0.771	0.771	1.285	1.800	2.313	2.830	3.341	3.855	4.369	4.883	5.397	5.910	6.430
4	0.328	0.656	0.755	0.984	0.984	0.984	1.640	2.300									
3	0.356	0.710	0.820	1.070	1.070	1.070	1.780	2.490									
2	0.388	0.780	0.890	1.160	1.160	1.160	1.940	2.270									
1	0.450	0.900	1.040	1.350	1.350	1.350	2.250	3.150									
1/0	0.491	0.980	1.130	1.470	1.470	1.470	2.460										
2/0	0.537	1.070	1.240	1.610	1.610	1.610	2.690										
3/0	0.588	1.180	1.350	1.760	1.760	1.760	2.940										
4/0	0.646	1.290	1.490	1.940	1.940	1.940	3.230										
250 MCM	0.716	1.430	1.650	2.150	2.150	2.150											
300 MCM	0.771	1.540	1.770	2.310	2.310	2.310											
350 MCM	0.822	1.640	1.890	2.470	2.470	2.470											
400 MCM	0.869	1.740	2.000	2.610	2.610	2.610											
500 MCM	0.955	1.910	2.200	2.870	2.870	2.870											
600 MCM	1.058	2.120	2.430	3.170	3.170	3.170											
750 MCM	1.163	2.330	2.670	3.490	3.490	3.490											
Number of layers		2	3	3	3	3	5	7	9	11	13	15	17	19	21	23	25



Where shown

730 Pratt Boulevard • Elk Grove Village, IL 60007 • P: (847) 593-8595 • F: (847) 593-8629 • Toll-free (800) 233-8595 • E: info@spproducts.com • www.spproducts.com



*Proud to be the electricians' friend for over 47 years and a long time supporter of contractor training programs.*



# QwikDuct HDPE CUSTOM TEMPLATES

For PVC Schedule 40 and 80, EB, DB, Fiber Glass,  
PVC Coated or Plain Galvanized Rigid Conduit  
**Safer and Over 15 Times Faster**

Order by description with  
signed approved drawing.

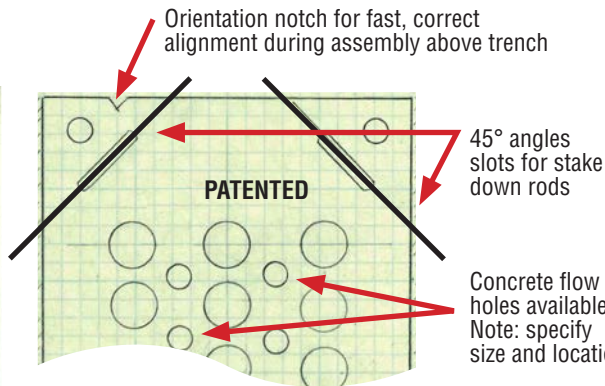
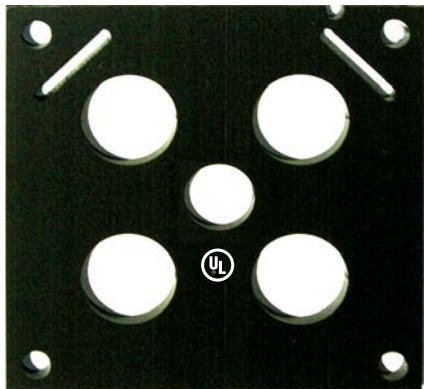

Stake assembled conduit down **FROM ABOVE**  
with plastic rod or rebar to prevent floating  
during concrete pour

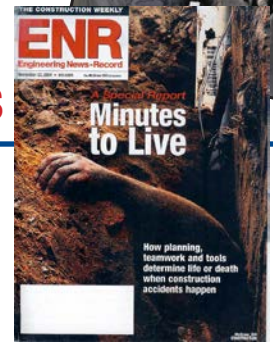

**When lifting wrap slings around conduit only – NOT TEMPLATES**

**CONTRACTOR EARNED \$950,000 ON \$1,800,000 BID...**

He assembled and lowered conduit from above and worked only in the manholes. He was able to dig a narrower trench which required less excavation, shoring, concrete, backfill...

**AND HELPED PREVENT**

**Also available with wheels to easily roll assembled conduit into caissons**

- Extremely Strong 3/8 Through 1" Thick Black Recycled High Density Polyethylene Approximately 4,000 lbs. PSI "May Qualify for LEED Credits"
- White virgin material also available for greater resistance to heat. Material does not qualify for LEED credits.
- Any Size, Shape, or Combination Different Conduit Size holes, Spacing, and Rebar Holes, Etc. available. Customer Must Furnish an Approved Drawing Before Production Begins.
- Non corrosive in sand, gravel, concrete, or dirt.
- Notch Provided on Top Left to Enable Proper Alignment of Conduit Openings When Assembling Above Trench.
- **WHEN LIFTING INSTALLER MUST WRAP WIDE NYLON STRAPS AROUND CONDUITS. NOT ATTACHED TO TEMPLATES.**
- When Many Configurations are Involved, Indicate Priorities.



Where shown

730 Pratt Boulevard • Elk Grove Village, IL 60007 • P: (847) 593-8595 • F: (847) 593-8629 • Toll-free (800) 233-8595 • E: info@spproducts.com • www.spproducts.com



7-23-13

*Proud to be the electricians' friend for over 47 years and a long time supporter of contractor training programs.*





# No Center Stop Slide On Couplings

## All Sizes EMT, IMC and Rigid Heavywall Conduit

Patent Pending



1. Slide coupling over end of pipe
2. Line up 2nd conduit and mark it to allow coupling to be centered over both conduits.
3. Slide coupling back to mark.
4. Tighten 3/8 hex head bolts and conduits are securely joined together at center of coupling.
5. Size 1/2 thru 2 inch = one bolt  
sizes 2 1/2 and larger = 2 bolts on each end

Size 1/2" thru 4" EMT, IMC plus 6"  
For Rigid Heavywall Conduit  
Order by size and type of conduit

Completely smooth inside diameter along entire length allows flexibility of movement for fast easy installation of conduit in tight difficult situations.

## Prevent injury and save hours

**SP** PRODUCTS, INC.  
Productivity and value thru ideas



Where shown



730 Pratt Boulevard • Elk Grove Village, IL 60007 • P: (847) 593-8595 • F: (847) 593-8629 • Toll-free (800) 233-8595 • E: info@spproducts.com • www.spproducts.com



*Proud to be the electricians' friend for over 47 years and  
a long time supporter of contractor training programs.*

**IP17**

7-23-13



# QwikDuct HDPE

## Ordering Details



When requesting a quote or placing an order please furnish all information and show priority needed for each QwikDuct Template configuration. We must receive signed approval drawings before production begins.

**All dimensions (hole sizes, spacing between, etc.) must be specified!**

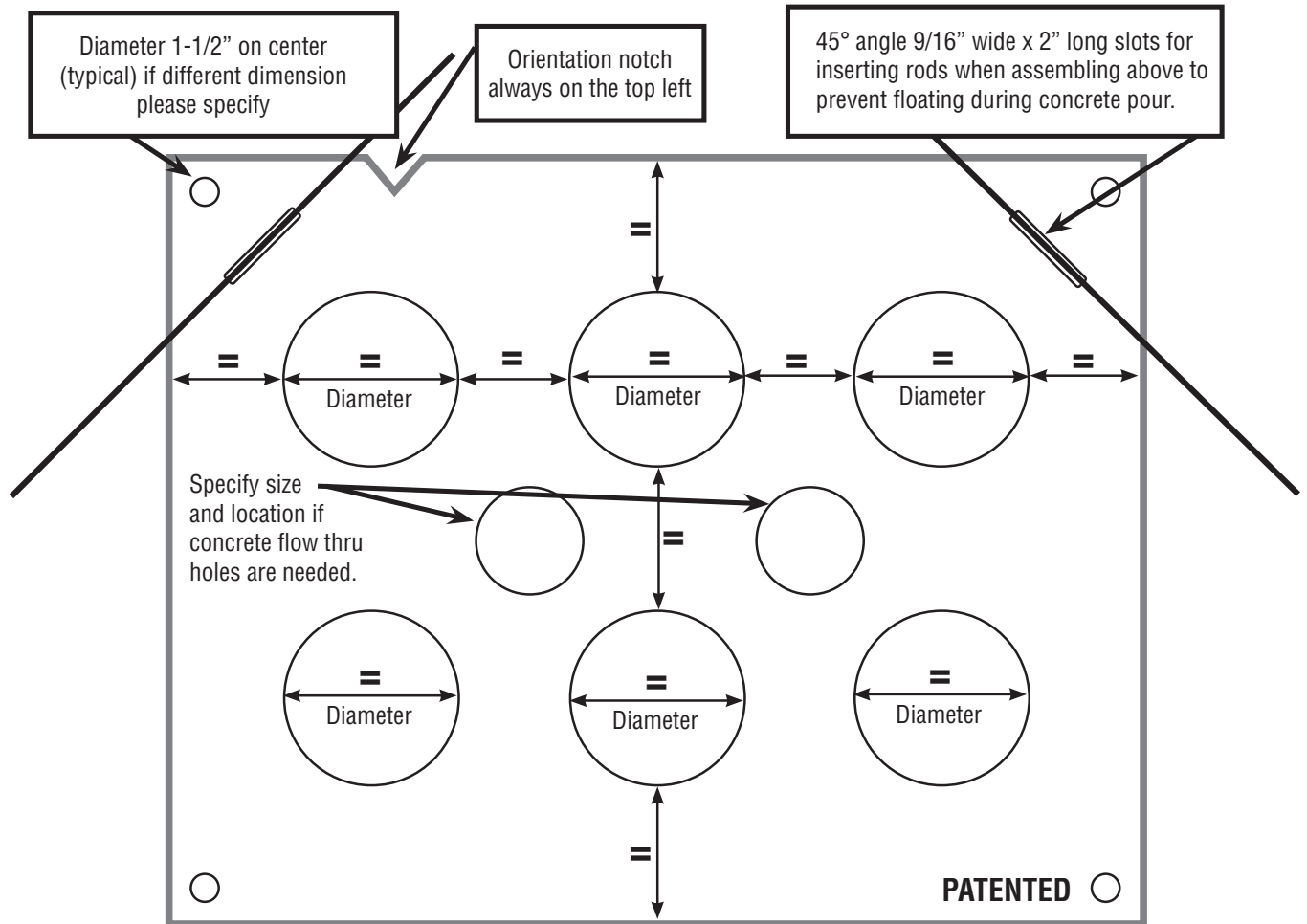

**Material thickness from 3/8 thru 3/4 inch recycled black (qualifies for LEED credits), or white virgin material that does not.**



**SP PRODUCTS, INC.**  
Productivity and value thru ideas

Made in the USA

UL c UL US PATENTED

Where shown

730 Pratt Boulevard • Elk Grove Village, IL 60007 • P: (847) 593-8595 • F: (847) 593-8629 • Toll-free (800) 233-8595 • E: info@spproducts.com • www.spproducts.com



*Proud to be the electricians' friend for over 47 years and a long time supporter of contractor training programs.*



# Conduit & Box Support Plates



## Save More Than 20 Minutes

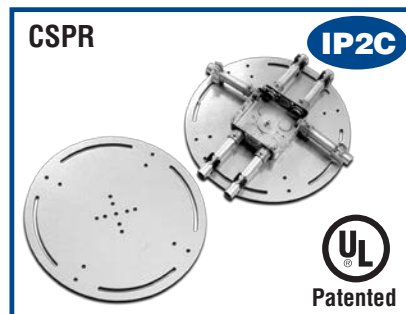

**NEW!**

## ... and Over 1 Hour per Installation

### 2 or 4 way eliminates conduit clamps

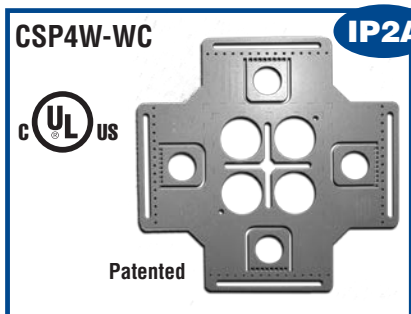

Enter any side or back and support conduit above the box – all from one support in less time and with less material.

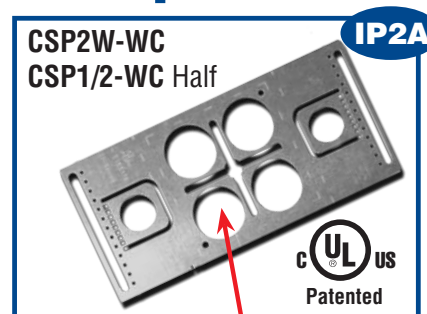

Support conduit for temperature, fire, data, security, etc. Systems ABOVE THE PLATE with clamps attached by TEK screws into closely spaced 3/32" holes provided in every wing.

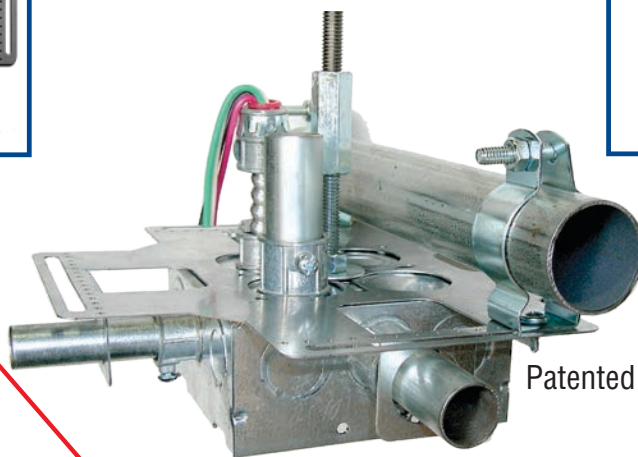

Enter back with 1/2 or 3/4 inch EMT, MC Cable or Flexible Conduit whips thru 4 large open KO's in center of plate.

1/4" wide open slot located on every wing if specifications require clamps to be attached with 1/4" nuts & bolts.

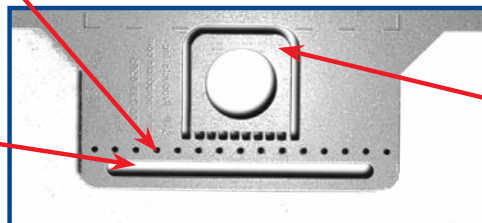

Bend built in tabs down 90° (away from box) and slide conduit thru openings into connectors installed in center KO's oneach side of box.

**SP PRODUCTS, INC.**  
Productivity and value thru ideas



**UL** **UL** **US** **PATENTED**  
Where shown



730 Pratt Boulevard • Elk Grove Village, IL 60007 • P: (847) 593-8595 • F: (847) 593-8629 • Toll-free (800) 233-8595 • E: info@spproducts.com • www.spproducts.com

**IP2**

7-23-13

*Proud to be the electricians' friend for over 47 years and a long time supporter of contractor training programs.*





# Conduit & Box Support Plates

**BUILT IN BEND DOWN TABS ELIMINATE CONDUIT CLAMPS SAVE OVER 1 HOUR PER INSTALLATION**

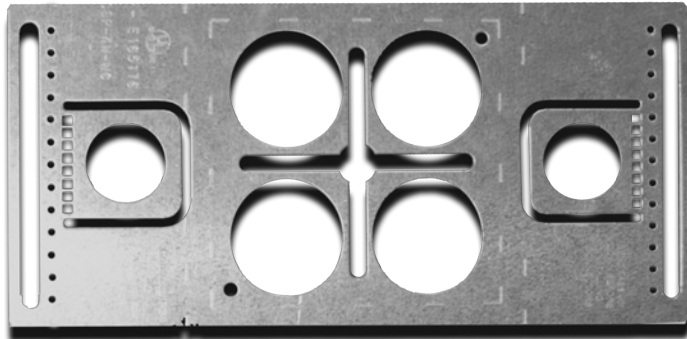

Cat# CSP2W-WC  
Cat# CSP1/2-WC Half  
Patented

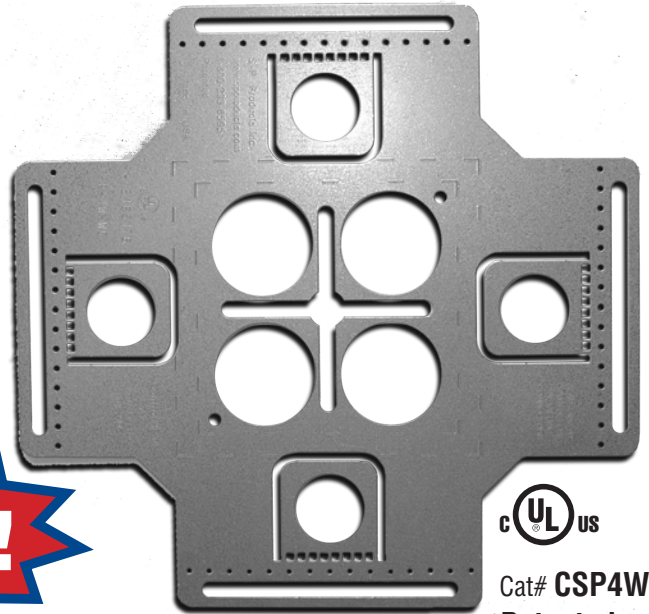

Cat# CSP4W-WC  
Patented

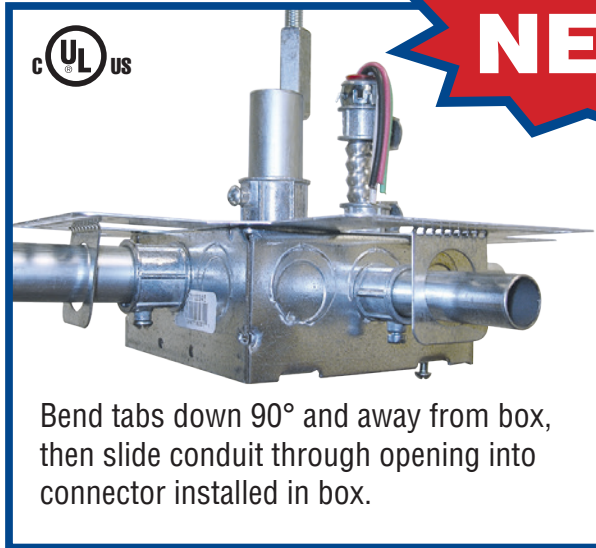

Bend tabs down 90° and away from box, then slide conduit through opening into connector installed in box.

- 3/32" Holes for Self Tappers and 1/4" Wide Open Slot at Each End Allow Fastening Conduit Clamps at any KO center.
- Plates Accommodate 4, 4-11/16 and 5 inch Square Shallow or Deep Boxes.
- All Plates Except Round CSPR Also Available in Stainless Steel.
- **UL ASSEMBLIES COMPLETE WITH BOX, CONNECTORS, ROD, "ECONO-WHIPS" ATTACHED AVAILABLE.**

***One 2- or 4-Way Patented cULus listed Plate with bend down conduit support tabs that eliminate conduit clamps and allows entering any side, back or Support Conduit above the Box. ALL FROM ONE SUPPORT!***

**SP PRODUCTS, INC.**  
Productivity and value thru ideas



Where shown



730 Pratt Boulevard • Elk Grove Village, IL 60007 • P: (847) 593-8595 • F: (847) 593-8629 • Toll-free (800) 233-8595 • E: info@spproducts.com • www.spproducts.com



*Proud to be the electricians' friend for over 45 years and a long time supporter of contractor training programs.*



6-10-13

# Conduit & Box Support Plates

**BUILT IN BEND DOWN TABS ELIMINATE CONDUIT CLAMPS SAVE OVER 1 HOUR PER INSTALLATION**

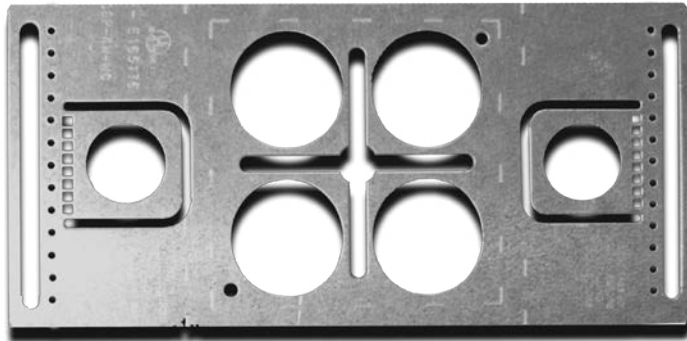

Cat# CSP2W-WC  
Cat# CSP1/2-WC Half  
Patented

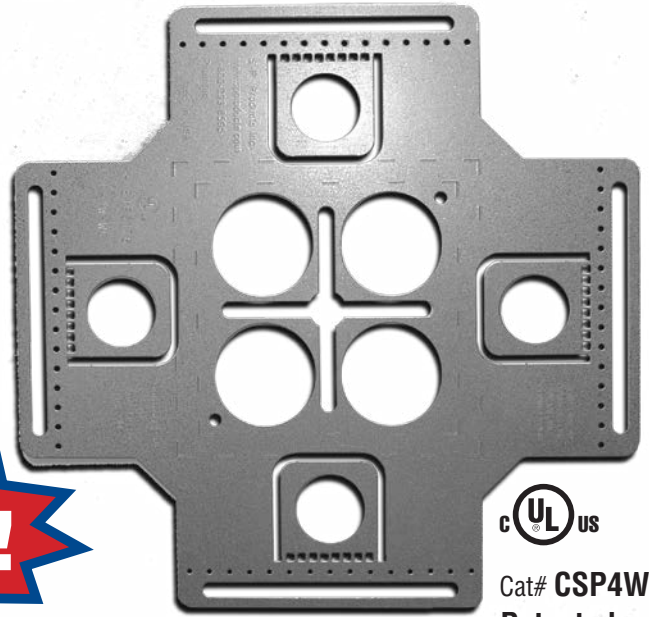

Cat# CSP4W-WC  
Patented

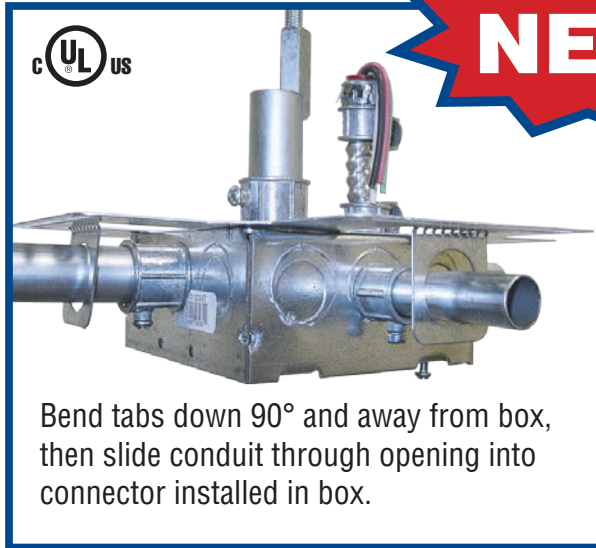

Bend tabs down 90° and away from box, then slide conduit through opening into connector installed in box.

**NEW!**

- 3/32" Holes for Self Tappers and 1/4" Wide Open Slot at Each End Allow Fastening Conduit Clamps at any KO center.
- Plates Accommodate 4, 4-11/16 and 5 inch Square Shallow or Deep Boxes.
- All Plates Except Round CSPR Also Available in Stainless Steel.
- **UL ASSEMBLIES COMPLETE WITH BOX, CONNECTORS, ROD, "ECONO-WHIPS" ATTACHED AVAILABLE.**

***One 2- or 4-Way Patented cULus listed Plate with bend down conduit support tabs that eliminate conduit clamps and allows entering any side, back or Support Conduit above the Box. ALL FROM ONE SUPPORT!***



**PRODUCTS, INC.**  
Productivity and value thru ideas



PATENTED

Where shown



730 Pratt Boulevard • Elk Grove Village, IL 60007 • P: (847) 593-8595 • F: (847) 593-8629 • Toll-free (800) 233-8595 • E: info@spproducts.com • www.spproducts.com



*Proud to be the electricians' friend for over 47 years and a long time supporter of contractor training programs.*



7-23-13

# Conduit & Box Support Plates

SAVE MORE THAN 20 MINUTES PER INSTALLATION

**THE ORIGINAL**



Cat# CSP 1/2  
PATENTED



Cat# CSP1  
PATENTED

Plates Accommodate 4, 4-11/16 and 5 inch Square Shallow or Deep Boxes.

3/32" Holes for Self Tappers and 1/4" Wide Open Slot at Each End Allow Fastening Conduit Clamps at any KO center.

CSP 1/2 and CSP1 Also Available in Stainless Steel.

UL Assemblies Complete with Box, Connectors, Rod, "Econo-Whips" Attached Available.

## Enter Box 2 Ways, Cross 2 to Enter From Any Direction or Cut in Half for Greater Material Savings.



Productivity and value thru ideas



Where shown



730 Pratt Boulevard • Elk Grove Village, IL 60007 • P: (847) 593-8595 • F: (847) 593-8629 • Toll-free (800) 233-8595 • E: info@spproducts.com • www.spproducts.com



7-23-13

*Proud to be the electricians' friend for over 47 years and a long time supporter of contractor training programs.*





# Conduit & Box Support Plates

SAVE MORE THAN 20 MINUTES PER INSTALLATION

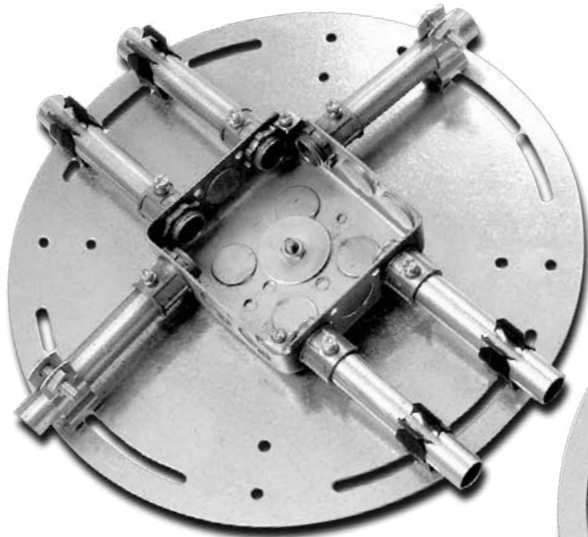

Cat# CSPR  
Patented

Plates Accommodate 4, 4-11/16 and 5 inch Square Shallow or Deep Boxes.

3/32" Holes for Self Tappers and 1/4" Wide Open Slot at Each End Allow

Fastening Conduit Clamps at any KO center.

Round CSPR Available only in Galvanized Steel – Not Stainless.

UL Assemblies Complete with Box, Connectors, Rod, "Econo-Whips" Attached Available.

Enter Box from any Direction with  
the Round Support Plate.

**SP** PRODUCTS, INC.  
Productivity and value thru ideas



Where shown



730 Pratt Boulevard • Elk Grove Village, IL 60007 • P: (847) 593-8595 • F: (847) 593-8629 • Toll-free (800) 233-8595 • E: info@spproducts.com • www.spproducts.com



*Proud to be the electricians' friend for over 47 years and  
a long time supporter of contractor training programs.*



7-23-13

# Conduit Trapeze Brackets

**SAVE OVER 20 MINUTES PER FOOT**  
**Conduits automatically run parallel to each other for a fast, professional looking job.**



- EZ UTB 12-72 SERIES (order by length)
- Max length 6 feet - 5 openings per foot spaced 1/2 inch apart
- Slide conduit through openings and press tabs down (optional) to secure conduit
- Attach conduit support plate and box above and below

PATENTED US

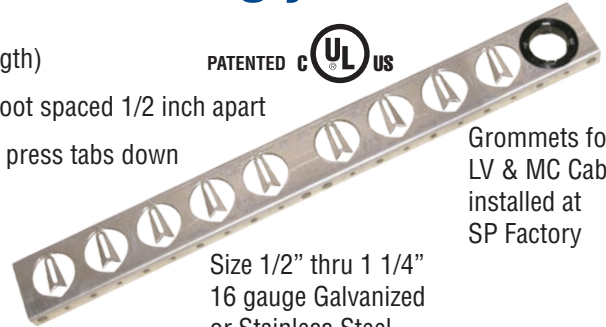

Grommets for LV & MC Cable installed at SP Factory

Size 1/2" thru 1 1/4"  
 16 gauge Galvanized or Stainless Steel

PATENTED US

**Stack Overhead**



**Or NEW Wide Flange "WF Series"**

Allows clearance for drill to attach on:  
**Decks or Vertical on Walls**

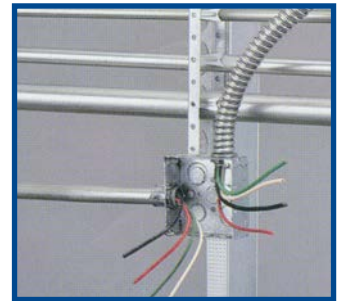
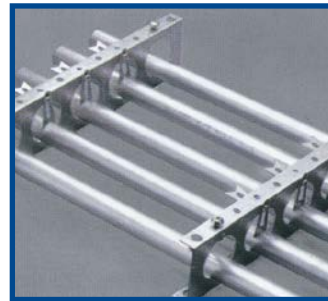

**Eliminate conduit clamps, handling and cutting heavy awkward strut, etc.**

**NEW!** For 1-1/2 inch thru any larger size conduit or pipe.

**FEED THRU...**  
 (4 inch conduit)

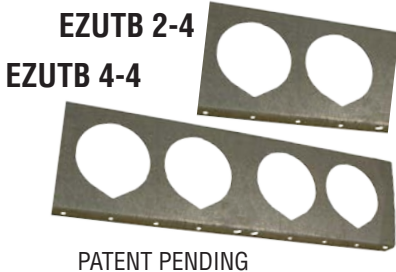

EZUTB 2-4 Li



EZUTB 4-4 Li

PATENT PENDING

**...OR LAY IN LARGER SIZE CONDUIT SAFER AND FASTER**

**NEW!**

1. Secure bracket to structure
2. Swivel angle iron with captive bolts parallel to run and lay conduit in
3. Return angle iron & bolt it down
4. Captive threaded bolts at center point of each opening lock conduit in place

**An unlimited variety of conduit sizes and configurations, spacing, and any guage galvanized or stainless steel etc. available**



730 Pratt Boulevard • Elk Grove Village, IL 60007 • P: (847) 593-8595 • F: (847) 593-8629 • Toll-free (800) 233-8595 • E: info@spproducts.com • www.spproducts.com



*Proud to be the electricians' friend for over 47 years and a long time supporter of contractor training programs.*





# Threaded Block for up to 3 conduits

Use half the material and labor to  
install conduit, plumbing pipe or condensate lines.

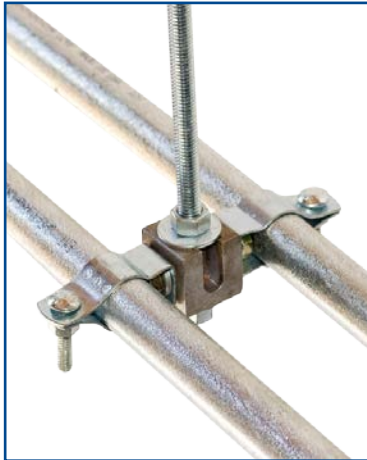

1/4 inch = Cat# **TBT25**  
3/8 inch = Cat# **TBT38**  
**PATENTED**



Vertical strut supports from  
a single threaded rod for  
use with standard 1/4 x 20,  
3/8 x 16 hardware.

Extremely strong. Rated at  
approximately 3,750 lbs.  
pull across threads and  
approximately 1,600 lbs  
pull across T Slots.



**Eliminate building a costly trapeze.  
Support all conduit from a single threaded rod.**



*Productivity and value thru ideas*



Made in the USA



US PATENTED

Where shown



730 Pratt Boulevard • Elk Grove Village, IL 60007 • P: (847) 593-8595 • F: (847) 593-8629 • Toll-free (800) 233-8595 • E: info@spproducts.com • www.spproducts.com



*Proud to be the electricians' friend for over 47 years and  
a long time supporter of contractor training programs.*



7-23-13



# Transition Couplings

## Transitions for PVC Conduit Stubs...

USE PVC ELBOWS THROUGHOUT JOB WITH NO RISK OF DAMAGE. ELIMINATE TIME LOST CHIPPING CONCRETE, REPAIRING CONDUIT, ETC AND AGGRAVATION CAUSED BY OTHERS. SAFER PLUS **SAVE MORE THAN ONE HOUR** EACH INSTALLATION!

Transition is completed in less than 5 minutes with a flush fit throughout the inside diameter for fast, trouble free wire pulls.

**NEW**

**SIZES 1/2" – 6" PVC STUBS TO:  
PVC or Rigid and up through  
4" EMT Conduit**

**LARGER SIZES AVAILABLE ON SPECIAL ORDER.**

**U.S. ARMY CORPS ENGINEERS APPROVED**  
Order by size and description



PATENT PENDING

1. Cut elbow flush to deck and cap it for protection.
2. Later remove cap, ream out elbow with drill and bit, apply glue and insert coupling.

**NEW  
1-PIECE**



**Reaming Bit  
IPRB50 -IPRB400 Series**  
Order by size 1/2 thru 6 inch  
PATENT PENDING

**5-Part Reaming Bit  
5PRB50 -5PRB200 Series**  
1/2 thru 2 inch  
**Order by size.**



## ...and For 1/2 thru 5 inch Rigid Heavy Wall and PVC Conduit Stubs



PATENTED

***1/2 thru 5 inch Rigid Conduit Couplings to set  
Transformers and Gear, Nipple up to Panels etc.  
Allows flexibility of movement in difficult situations***

Slide down over conduit, bolt in place and job is done in a few minutes.

**Order by Size  
HWTC 50 – 500 SERIES**

- 5 female threads receive conduit or connectors and 10 male threads for two lock nuts and a ground bushing
- One 3/8 inch Hex Head Bolt at bottom position for size 1/2 inch thru 2 inch
- Two bolts for sizes 2 1/2 inch thru 5 inch

## Safer Installation and Save Hours

**SP PRODUCTS, INC.**  
*Productivity and value thru ideas*



**UL** **UL** **US** **PATENTED**  
Where shown



730 Pratt Boulevard • Elk Grove Village, IL 60007 • P: (847) 593-8595 • F: (847) 593-8629 • Toll-free (800) 233-8595 • E: info@spproducts.com • www.spproducts.com

**IP5**

7-23-13

***Proud to be the electricians' friend for over 47 years and  
a long time supporter of contractor training programs.***



# EZ Bar Hangers

For Down Lites, Speakers, Exit Signs, Fire Alarm Boxes, etc. in 2 and 4 foot T Bar Ceilings



PATENTED

Save up to  
**20 MINUTES**  
with a perfectly aligned  
installation every time.

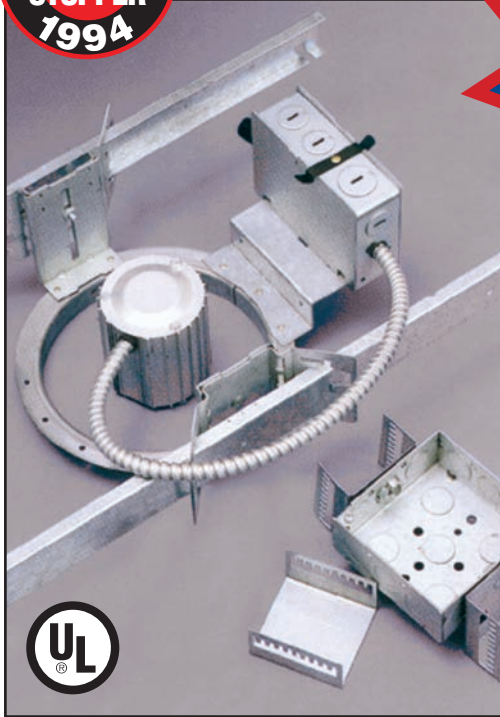

2 Foot T Bar = **2B1**    4 Foot T Bar = **4B1**

- ▶ Allows movement of fixtures and boxes in both directions to quickly ensure their proper alignment.
- ▶ Extremely strong with a 50 lb load rating and no extra parts to drop or lose during installation.
- ▶ Hangers have a center mark and 2 mounting holes each 1-1/2 inch from center to quickly mount speakers or other devices in center of tile plus one at each end for support independently of T Bar per NEC requirements.

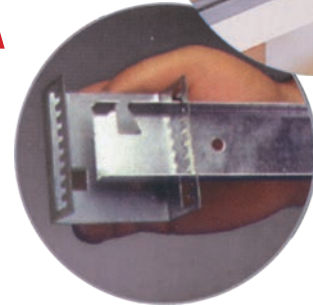

**1** Snap hangers onto T Bar and bend tabs to lock in place.

**2** Brackets for mounting boxes at various heights.

Box Brackets = **PB1**

**Perfect Alignment Every Time**

Slide 2 bar hangers and housing along T Bar Box ...

**Faster Installation**

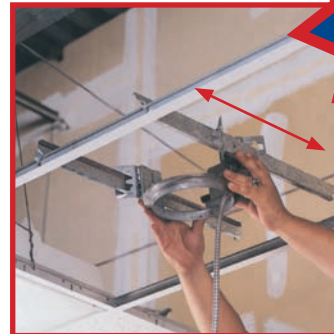
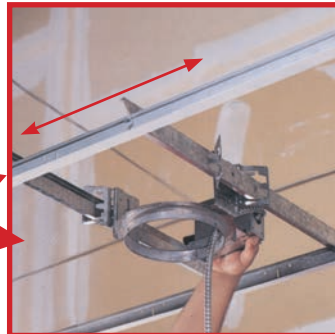

... and fixture housing only along bar hangers to exact location desired and bend tabs down to lock housing in place.

**Eliminate labor intensive cutting and tying down lathers channel, black iron, conduit, etc.**



Where shown



730 Pratt Boulevard • Elk Grove Village, IL 60007 • P: (847) 593-8595 • F: (847) 593-8629 • Toll-free (800) 233-8595 • E: info@spproducts.com • www.spproducts.com



*Proud to be the electricians' friend for over 47 years and a long time supporter of contractor training programs.*



7-23-13

# **NEW!** Box Brackets for Masonry Block Walls

**Strong Heat Treated Steel**

(Galvanized Steel also available)

Save more than **20 minutes** per box

- Snap Bracket on box in one second to firmly secure it in place.
- Eliminate code violations caused when attempting to keep boxes properly aligned with glues, sticks, crushed paper, etc and still not solve the problem.

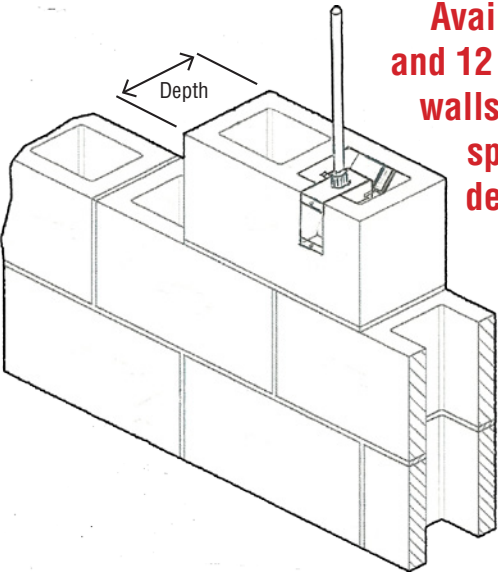

Available for 6, 8, 10 and 12 inch depth block walls. Customer must specify. Show wall depth as a suffix to catalog numbers shown.

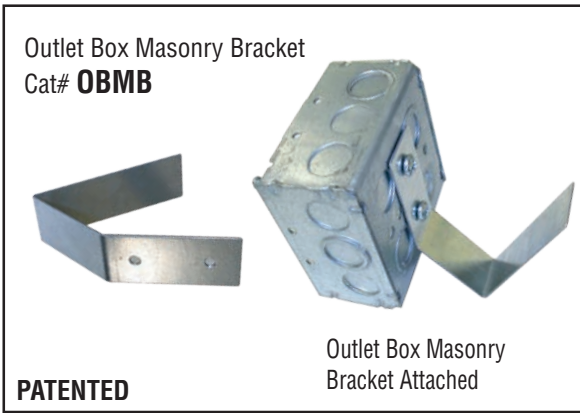
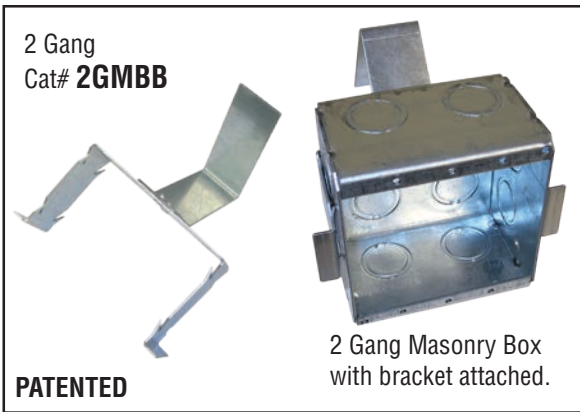
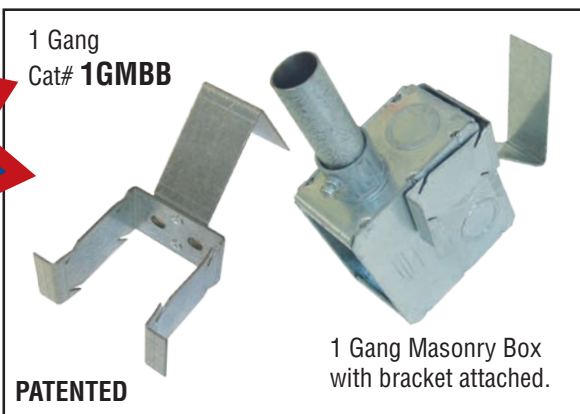

**Avoid time lost and aggravation when boxes do not properly line up**

**SP PRODUCTS, INC.**  
Productivity and value thru ideas



730 Pratt Boulevard • Elk Grove Village, IL 60007 • P: (847) 593-8595 • F: (847) 593-8629 • Toll-free (800) 233-8595 • E: info@spproducts.com • www.spproducts.com

**IP7**  
7-23-13

*Proud to be the electricians' friend for over 47 years and a long time supporter of contractor training programs.*







# Truss Hanger

## for Supporting Cable Tray, Conduit and other Heavy Equipment

### Safer and faster. Eliminates climbing and working above trusses. Install in seconds while standing on deck below.



Upper Chord  
**THUC 38** = 3/8"  
**THUC 50** = 1/2"

Lower Chord  
**THLC 38** = 3/8"  
**THLC 50** = 1/2"

Distributes load evenly over the center of the bar joint.  
Eliminates angle iron distribution.



**CAT 38** = 3/8"  
**CAT 50** = 1/2"

Use 3/8 or 1/2 inch threaded coupling to lengthen rod and install from deck with no ladder or lift.



Attach a KLEVIS or other types of readily available hardware



**THW 38** = 3/8"  
**THW 50** = 1/2"

**One piece KEPS® integrated nut/washer firmly locks into chord.**

**Provides rigid seismic restraint.**

**Seismic bracing not required when used in top chord applications (9.3.5.3.8 NFPA 13)**

## Also suitable for overhead structural attachment for electrical, fire suppression, plumbing, and HVAC applications in open web bar joists



730 Pratt Boulevard • Elk Grove Village, IL 60007 • P: (847) 593-8595 • F: (847) 593-8629 • Toll-free (800) 233-8595 • E: info@spproducts.com • www.spproducts.com



*Proud to be the electricians' friend for over 47 years and  
a long time supporter of contractor training programs.*



7-23-13

# Deck & Wall Sleeves

## Decks

### Specify location of base plate

Flush or Pan Decks

Any size EMT 1/2 thru 2 inch in any length specified or 3 thru 14 inch diameter from 6 thru 15 inch long in 26 guage galvanized steel. Custom order.

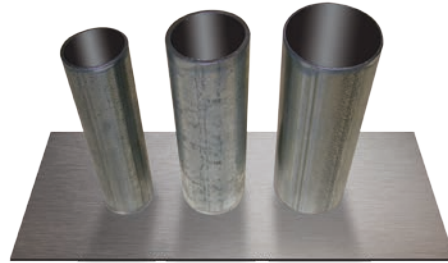
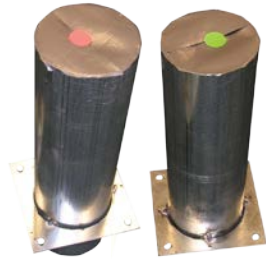

Larger than 14 inch diameter from 15 inch and longer in 26 guage galvanized steel. An unlimited variety of other configurations –length, diameter, guage steel, available on special order.

## Walls

### Fast, Accurate Installation

1. Tilt assembly between studs.
2. Level at correct height.
3. Screw into studs.

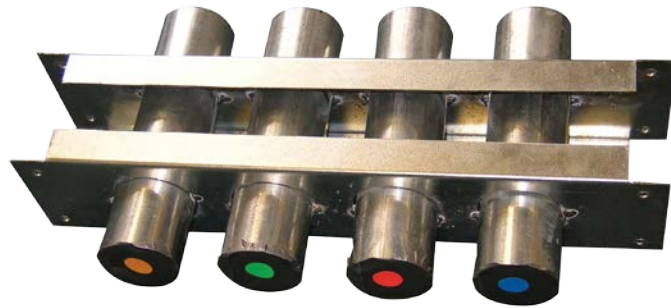

All above sleeves available with easy to install UL fire stop plugs

- Available in any frame width
- Frames are adjustable for any stud depth
- Corners rounded for safer handling
- O.D. and I.Ds conform to EMT or specify if other dimensions are required
- Sleeves can be color coded as a custom order per customers' specifications
- Extremely strong steel construction

## Excellent quality, competitive prices

**SP** PRODUCTS, INC.  
Productivity and value thru ideas



Where shown



730 Pratt Boulevard • Elk Grove Village, IL 60007 • P: (847) 593-8595 • F: (847) 593-8629 • Toll-free (800) 233-8595 • E: info@spproducts.com • www.spproducts.com

**IP9**

7-23-13

*Proud to be the electricians' friend for over 47 years and a long time supporter of contractor training programs.*



# Tie Wraps

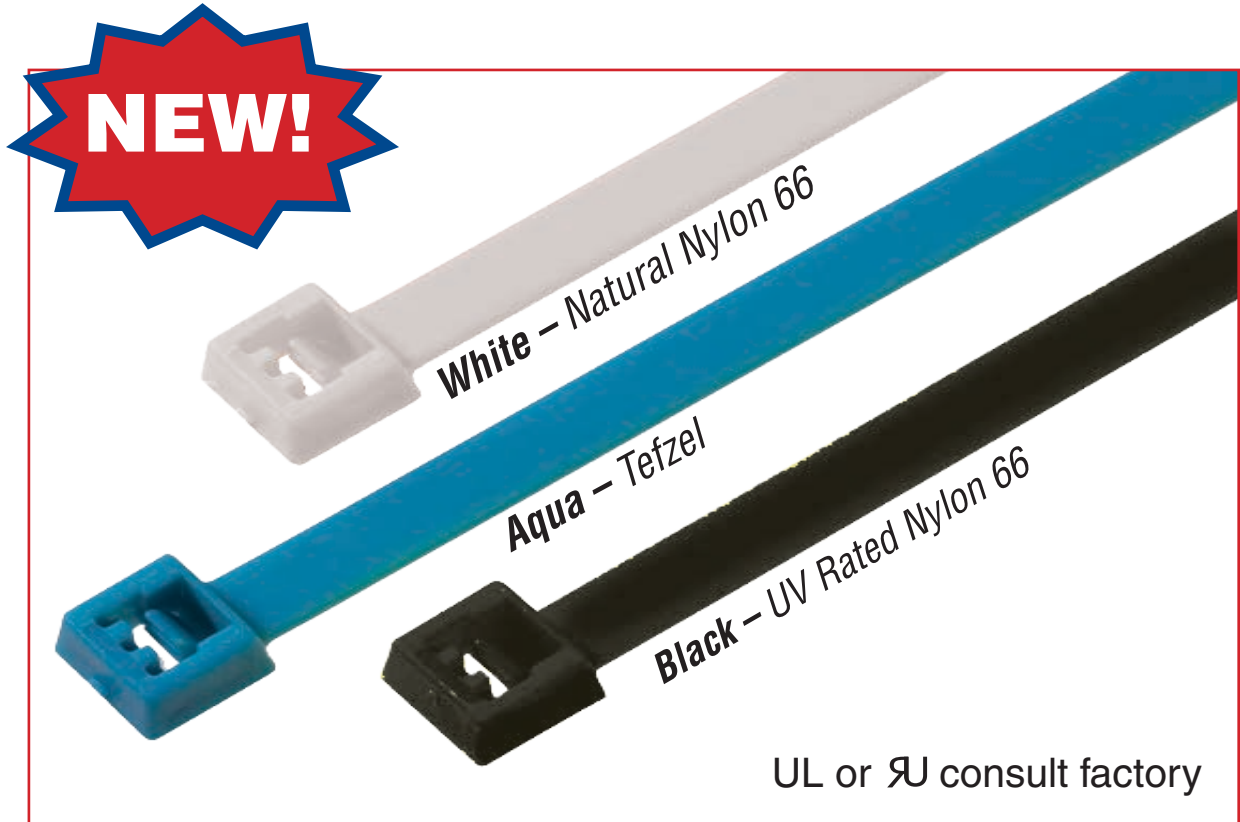

- Any Size, Length and Other Colors Available
- Strong for Secure Installations
- High Quality - Made in U.S.A.
- Available in Bags of 100 or Bulk

**Fast Delivery. Competitive Prices.**

**SP PRODUCTS, INC.**  
Productivity and value thru ideas

 Made in the USA

  **US PATENTED**

Where shown

730 Pratt Boulevard • Elk Grove Village, IL 60007 • P: (847) 593-8595 • F: (847) 593-8629 • Toll-free (800) 233-8595 • E: info@spproducts.com • www.spproducts.com



*Proud to be the electricians' friend for over 47 years and a long time supporter of contractor training programs.*





# “Quick Pipe” Conduit Support Roof Block

## Safer, Lighter and Faster!

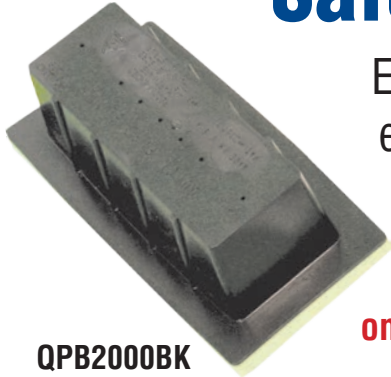

QP2000BK

Eliminates cutting and hauling heavy, expensive treated lumber up to roof.

**Just set black block with yellow certiform foam base on tar and gravel and white one piece free floating block on membrane roofs then quickly secure conduit with an inexpensive one hole strap.**

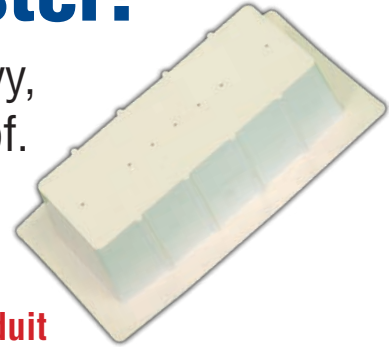

QP2000WH

Patented

- Design allows stacking them together for easier handling
- Prevents costly damage to roof membrane. Moves slightly when conduit or pipe expands or contracts during temperature changes.
- Strong HDPE resin with a long life

## Suitable for electrical, plumbing, HVAC, etc. installations

**SP PRODUCTS, INC.**  
Productivity and value thru ideas



Where shown



730 Pratt Boulevard • Elk Grove Village, IL 60007 • P: (847) 593-8595 • F: (847) 593-8629 • Toll-free (800) 233-8595 • E: info@spproducts.com • www.spproducts.com



7-23-13

*Proud to be the electricians' friend for over 47 years and a long time supporter of contractor training programs.*



# Custom Mounting Plates

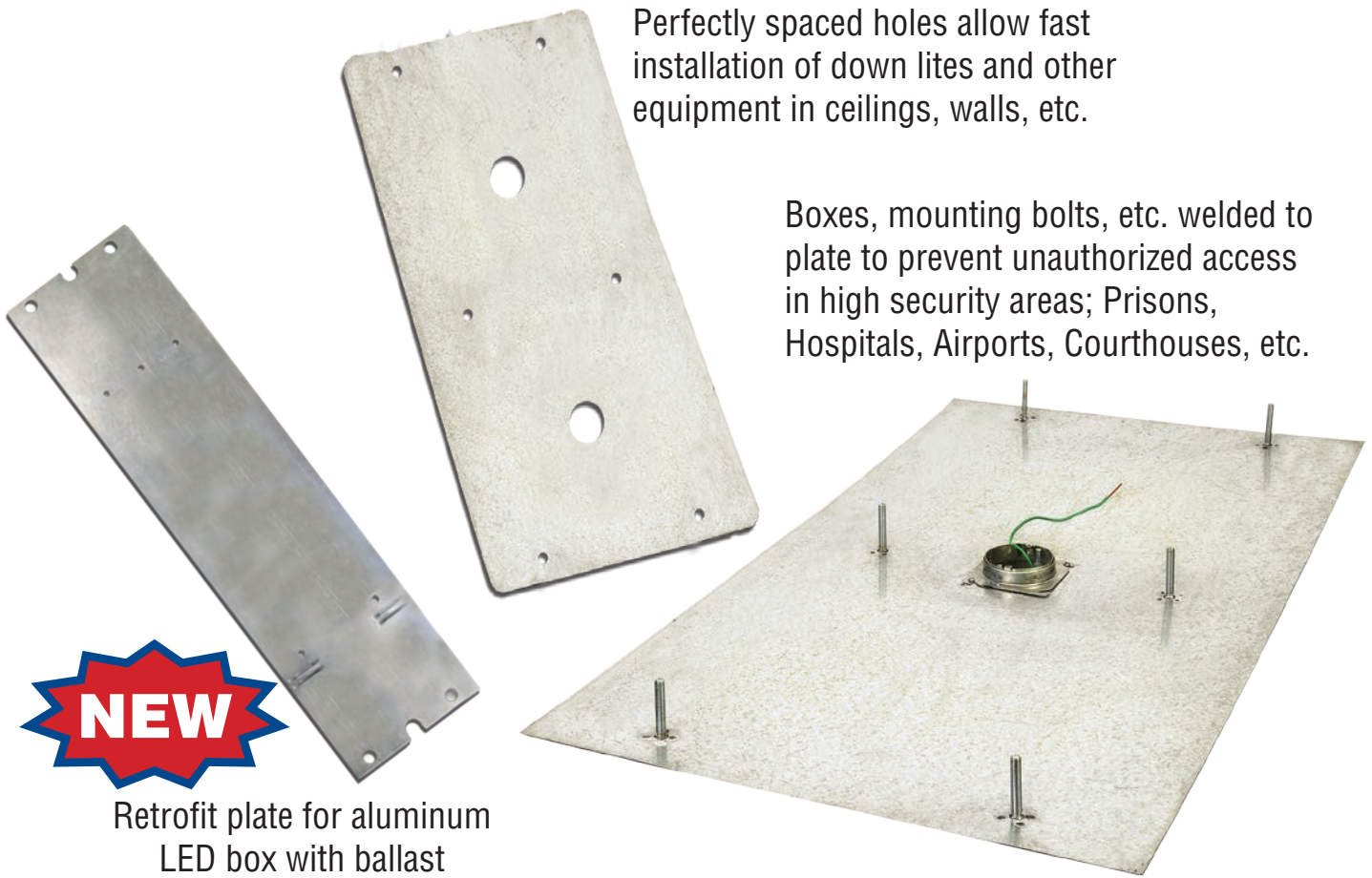

Perfectly spaced holes allow fast installation of down lites and other equipment in ceilings, walls, etc.

Boxes, mounting bolts, etc. welded to plate to prevent unauthorized access in high security areas; Prisons, Hospitals, Airports, Courthouses, etc.

**NEW**

Retrofit plate for aluminum LED box with ballast

- Any configuration and gauge galvanized or stainless steel per customers' requirements
- Mounting holes and slots provided at locations specified
- Rounded corners for safer handling and installation

**Excellent Quality at  
Extremely Competitive Prices.**

**SP** PRODUCTS, INC.  
*Productivity and value thru ideas*



Where shown



730 Pratt Boulevard • Elk Grove Village, IL 60007 • P: (847) 593-8595 • F: (847) 593-8629 • Toll-free (800) 233-8595 • E: info@sproducts.com • www.sproducts.com



*Proud to be the electricians' friend for over 47 years and  
a long time supporter of contractor training programs.*



7-23-13

# EZ Cable Ties

## For Low Voltage and Other Cable

Wide, flat band prevents loss or signal distortion caused by kinking or damage to cables when securing together.

- 1 On/off in seconds for a secure installation. Just wrap around cables and feed plastic head thru loop.
- 2 Especially suitable for sensitive low voltage cables.
- 3 Also reuseable for bundling ropes hoses, etc. together for easy handling and storage. Extremely strong, long lasting ozone resistant EDPM rubber.

Catalog #	Dimensions	Qty
CT3.5-38	3.5" L x 3/8"	10/bag
CT5.0-58	5.0" L X 5/8" W	10/bag
CT7.0-58	7.0" L x 5/8" W	10/bag
CT11.0-58-5	11.0" L x 5/8" W	5/bag
CT11.0-58-10	11.0" L x 5/8" W	10/bag
Bulk Pack	Assorted Sizes	Specified

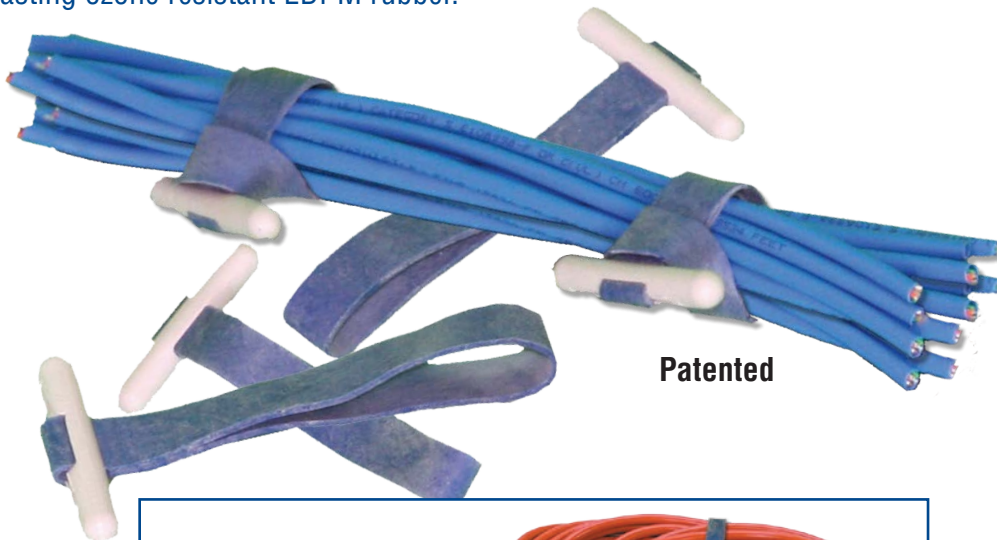

Patented

Also Excellent for Bundling, Tying and Storing all Types of Cord, Rope, Hoses, etc.



**Extremely strong, fast and secure installations.  
On and off in seconds.**

**SP PRODUCTS, INC.**  
Productivity and value thru ideas



Where shown



730 Pratt Boulevard • Elk Grove Village, IL 60007 • P: (847) 593-8595 • F: (847) 593-8629 • Toll-free (800) 233-8595 • E: info@spproducts.com • www.spproducts.com

**IP13**

7-23-13

*Proud to be the electricians' friend for over 47 years and a long time supporter of contractor training programs.*





# Custom Engraved Nameplates and Labels for Electrical and Mechanical Identification



- Available in steel or plastic materials.
- Laser engraved stainless steel and aluminum signs with vinyl lettering also available.
- Extensive experience labeling complex redundant base building systems in data centers (tenant labels for PDUs, FDCs, RPPs, cabinet rows, server racks, power strips) and hospitals.
- We provide professional submittals of materials and layouts according to project specifications for engineer approval.

**Submittals to satisfy specifying engineers, government requirements, etc. available**

**SP PRODUCTS, INC.**  
*Productivity and value thru ideas*

 Made in the USA

  US PATENTED

Where shown

730 Pratt Boulevard • Elk Grove Village, IL 60007 • P: (847) 593-8595 • F: (847) 593-8629 • Toll-free (800) 233-8595 • E: info@spproducts.com • www.spproducts.com



*Proud to be the electricians' friend for over 47 years and a long time supporter of contractor training programs.*



# Barrier and Warning Tapes

Any configuration, wording in any language, color, etc.

APWA color coded diagonal stripes for representation and visibility of buried utility lines



Meets all government, military and other strict specifications.

Excellent Quality  
Competitive Pricing

Catalog #	Size Length	Thickness	Approx. Net Wgt.	Standard Packaging	Pallet Packaging
BT 300L-3W-2M	3" x 300 ft.	2.0 mil	1.0 lbs/Roll	24 Rolls	1,200 Rolls
BT 300L-3W-3M	3" x 300 ft.	3.0 mil	1.2 lbs/Roll	18 Rolls	900 Rolls
BT 300L-3W-4M	3" x 300 ft.	4.0 mil	1.5 lbs/Roll	12 Rolls	600 Rolls
BT 1000L-3W-2M	3" x 1,000 ft.	2.0 mil	2.8 lbs/Roll	12 Rolls	384 Rolls
BT 1000L-3W-3M	3" x 1,000 ft.	3.0 mil	3.8 lbs/Roll	12 Rolls	384 Rolls
BT 1000L-3W-4M	3" X 1,000 ft.	4.0 mil	4.8 lbs/Roll	10 Rolls	320 Rolls

Consult factory for other widths, lengths, etc.



730 Pratt Boulevard • Elk Grove Village, IL 60007 • P: (847) 593-8595 • F: (847) 593-8629 • Toll-free (800) 233-8595 • E: info@spproducts.com • www.spproducts.com



7-23-13

*Proud to be the electricians' friend for over 47 years and a long time supporter of contractor training programs.*



**Save More  
Than 30 MINUTES  
with a Perfect  
Installation  
Every Time!**

# Common Wall Conduit & Box Supports

## For Hotels, Commercial Buildings, Etc.

**Install only  
one instead  
of two**

- Wide Wings allow movement left or right when studs are not 16 or 24 inch on center
- Predrilled pilot holes allow attaching boxes at various locations between studs
- 4 or 4 -11/16 square shallow or deep box

**UL  
PATENTED**

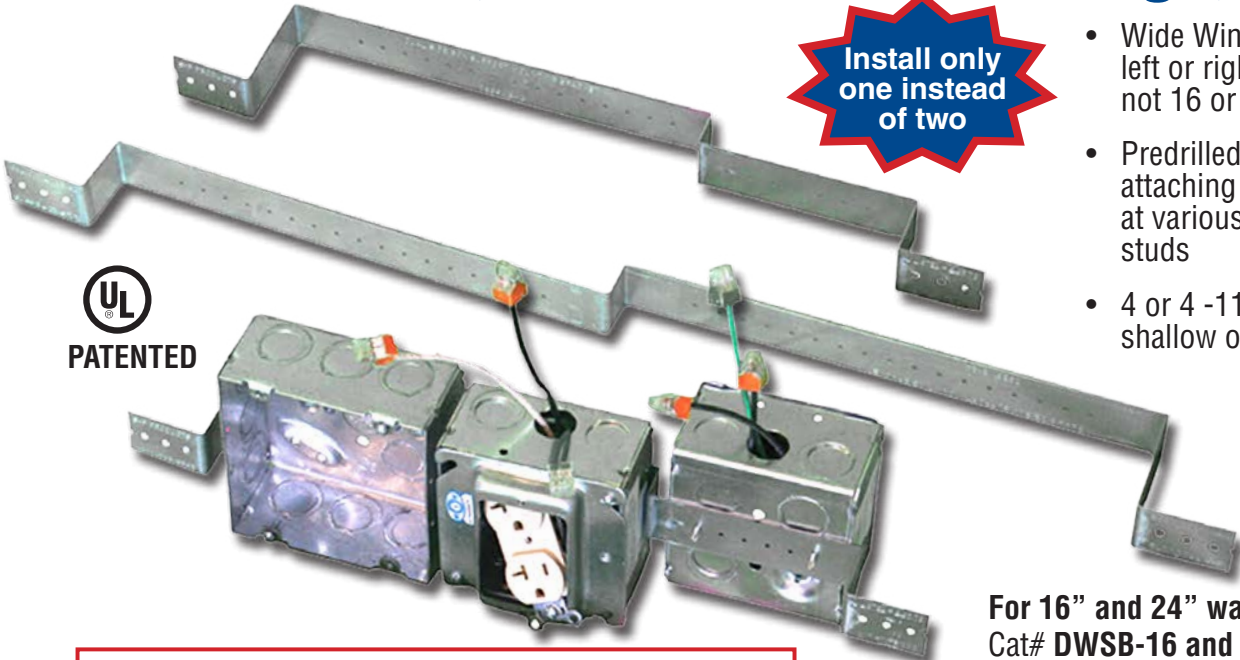

**For 16" and 24" wall stud spacing  
Cat# DWSB-16 and DWSB-24**

Mount boxes back to back for bedrooms, bathrooms, etc.

Also suitable for supporting conduits vertically per NEC 348-13

### Snap On/Off Protective Covers



Bend tabs out to plug in for temporary power and back in to protect device

**Available as a UL Listed Assembly with any combination of Boxes, Mud Rings, Wiring Devices, Protective Covers etc. plus with any type of other hardware or "Econo-Whips" attached to boxes. Carefully inspected, plus marked and packed.**

*Customer is responsible to determine assemblies comply with all applicable codes plus owner's and specifying engineers requirements*

**SP PRODUCTS, INC.**  
Productivity and value thru ideas

Made in the USA

**UL c UL US PATENTED**  
Where shown

730 Pratt Boulevard • Elk Grove Village, IL 60007 • P: (847) 593-8595 • F: (847) 593-8629 • Toll-free (800) 233-8595 • E: info@spproducts.com • www.spproducts.com



*Proud to be the electricians' friend for over 47 years and a long time supporter of contractor training programs.*

**IP16**  
7-23-13



# “Big O” Supports

## For Boxes at Any Location Between Studs



- Mount 4 or 4-11/16 inch square shallow or deep boxes then loosen two box screws to quickly relocate boxes
- Mud Ring Sandwiches Box to Bracket
- Built in ruler every 1/4 inch allows fast, accurate bench loading

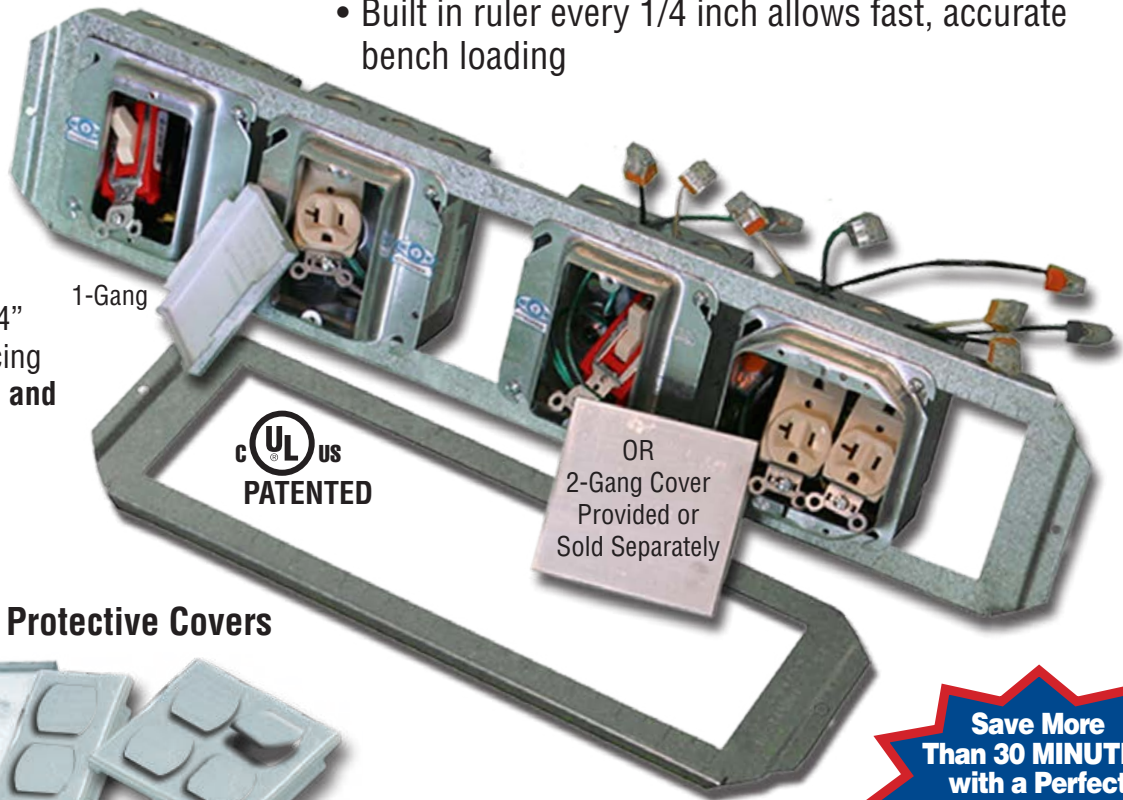

For 16” and 24”  
wall stud spacing  
Cat# **Big O-16** and  
**Big O-24**

1-Gang

**UL** **US**  
PATENTED

OR  
2-Gang Cover  
Provided or  
Sold Separately

### Snap On/Off Protective Covers



PATENTED

PATENT  
PENDING

Bend tabs out to plug in for temporary  
power and back in to protect device

**Save More  
Than 30 MINUTES  
with a Perfect  
Installation  
Every Time!**

**Available as a UL Listed Assembly with any combination  
of Boxes, Mud Rings, Wiring Devices, Protective Covers etc. plus with  
any type of other hardware or “Econo-Whips” attached to boxes.  
Carefully inspected, plus marked and packed.**

**Customer is responsible to determine assemblies comply with all applicable  
codes plus owner’s and specifying engineers requirements**

**Flat versions with no offsets available. Not UL listed.**

**SP PRODUCTS, INC.**  
*Productivity and value thru ideas*



**UL** **US** PATENTED  
Where shown



730 Pratt Boulevard • Elk Grove Village, IL 60007 • P: (847) 593-8595 • F: (847) 593-8629 • Toll-free (800) 233-8595 • E: info@spproducts.com • www.spproducts.com

**IP16A**

7-23-13

*Proud to be the electricians’ friend for over 47 years and  
a long time supporter of contractor training programs.*



# Fixed Position Box Supports

For 16" and 24" wall stud spacing  
 Cat# BSB3-16 = 16" and  
 Cat# BSB4-24 = 24"

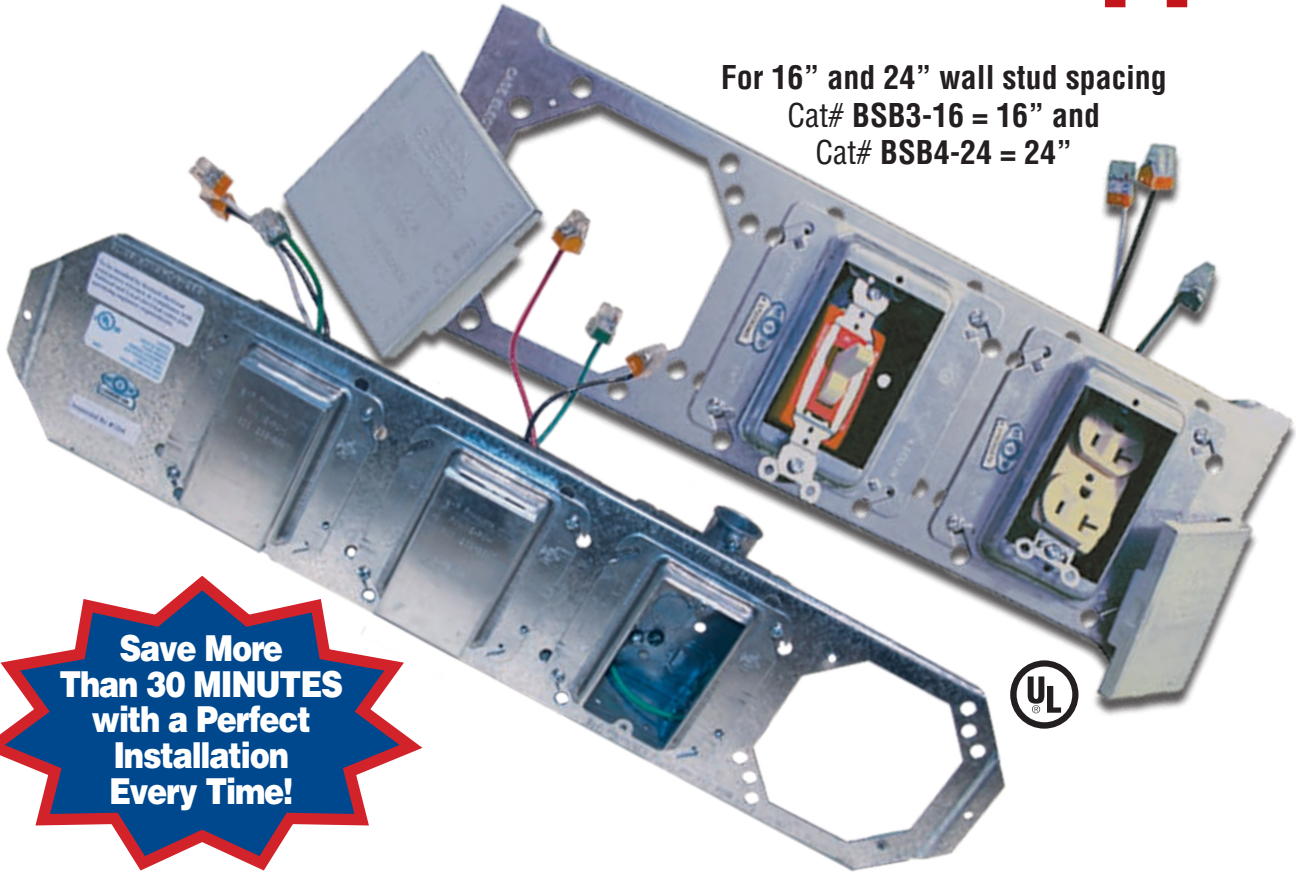

**Save More  
 Than 30 MINUTES  
 with a Perfect  
 Installation  
 Every Time!**

- Mount 4 or 4-11/16 square shallow or deep boxes in fixed positions evenly spaced evenly and at same height
- Fast – Perfectly level and spaced – Installation – Just pass screws attached to box thru holes on bracket and secure box with mud ring
- Extremely strong. Bracket will not bend or bow during installation

## Snap On/Off Protective Covers



Bend tabs out to plug in for temporary power and back in to protect device

**Available as a UL Listed Assembly with any combination of Boxes, Mud Rings, Wiring Devices, Protective Covers etc. plus with any type of other hardware or "Econo-Whips" attached to boxes. Carefully inspected, plus marked and packed.**

**Customer is responsible to determine assemblies comply with all applicable codes plus owner's and specifying engineers requirements**



Where shown



730 Pratt Boulevard • Elk Grove Village, IL 60007 • P: (847) 593-8595 • F: (847) 593-8629 • Toll-free (800) 233-8595 • E: info@spproducts.com • www.spproducts.com



*Proud to be the electricians' friend for over 47 years and a long time supporter of contractor training programs.*



# Supports for 3 1/2 Deep Boxes

Save More  
Than 30 MINUTES  
with a Perfect  
Installation  
Every Time!



Cat# **FAB-350**  
**PATENTED**

- Wide Flanges allow – supporting boxes in from 15 thru 25 inches stud span
- Automatically sets box with or without mud ring flush in one or two layers of drywall
- Ideal for fire alarm, speakers, strobes, etc.

**Also available with any depth box, devices, other hardware and “Econo-Whips” attached. Carefully inspected, plus marked and packed.**

**Customer is responsible to determine assemblies comply with all applicable codes plus owner’s and specifying engineers requirements**

**SP PRODUCTS, INC.**  
*Productivity and value thru ideas*



730 Pratt Boulevard • Elk Grove Village, IL 60007 • P: (847) 593-8595 • F: (847) 593-8629 • Toll-free (800) 233-8595 • E: info@spproducts.com • www.spproducts.com

**IP16C**

7-23-13

*Proud to be the electricians’ friend for over 47 years and a long time supporter of contractor training programs.*





# Prefabricated Assemblies

Any Type, Manufacturers' Brand and Configuration of Components for Repetitive Applications.

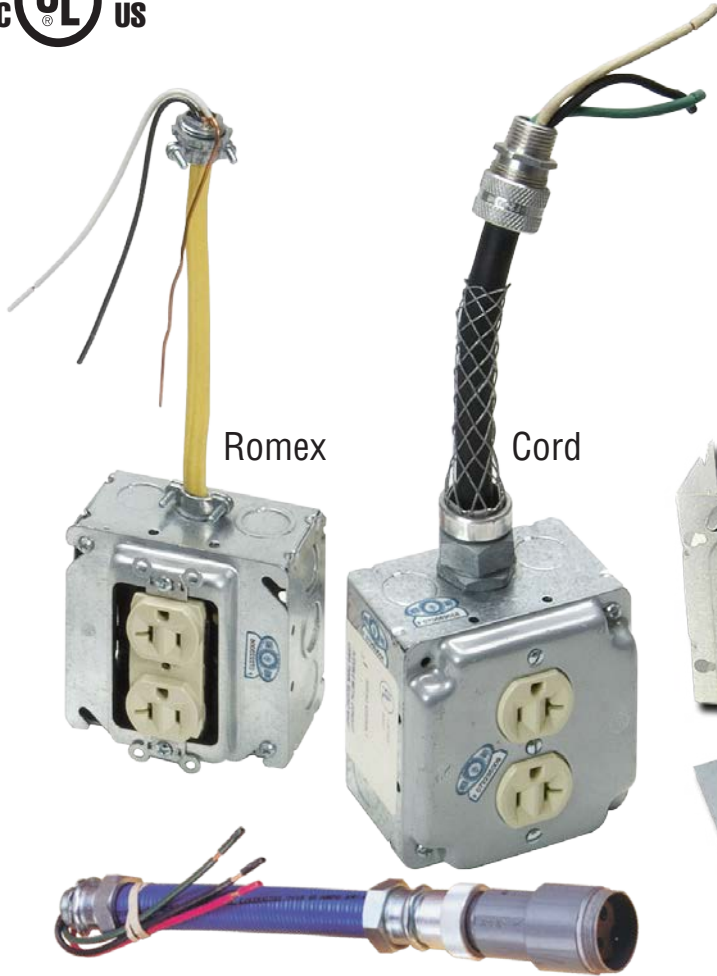

Romex

Cord

Liquidtight for **P**ower **D**istribution **U**nits

Save more than \$15<sup>00</sup> per outlet!



Patented

Patent Pending

Bend tabs out to plug in for temporary power and back in to protect device

Carefully inspected plus marked and packed before shipment!

Customer is responsible to determine assemblies comply with all applicable codes plus owner's and specifying engineers requirements



730 Pratt Boulevard • Elk Grove Village, IL 60007 • P: (847) 593-8595 • F: (847) 593-8629 • Toll-free (800) 233-8595 • E: info@spproducts.com • www.spproducts.com



Proud to be the electricians' friend for over 47 years and a long time supporter of contractor training programs.



# Prefabricated Assemblies

## Any Configuration For Repetitive Applications



**Machinery, Refrigeration, Drops, etc.**

*Any type, size, length and color of cord.  
Also available with Kellems™ Grips.*



**Data Center PDUs**

*MC Cable or any Liquidtite jacket color, size, length, UL Listed with any type of device and ID Labels under clear heat tubing.*



- Available for Plastic or Steel Boxes, Hard Pipe EMT, MC Cable, Romex and All Types of Flexible Conduit installations.
- Every unit has a UL label plus is tested for excellent quality
- Multi gang assemblies available
- Marked and packed per customer's specifications



**...and Other Applications**



*All types and configurations of flexible Conduit, Cord or Cable, "Econo-Whips" attached.*

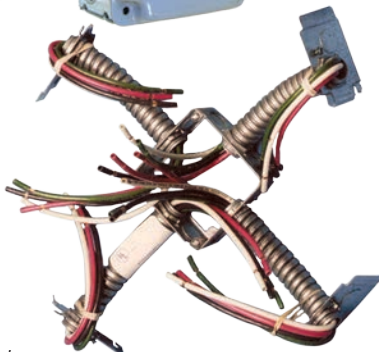

*"Octopus" for Ceiling Lighting Layouts*

### Snap On/Off Covers for Protection and Access to Temporary Power



1 Gang = **SOC-1G**  
2 Gang = **SOC-2G**

Bend tabs out to plug in for temporary power and back in to protect device

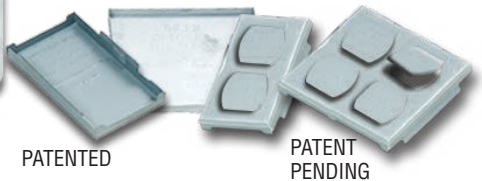

PATENTED

PATENT PENDING

*Strong steel, reusable and adjustable. Fit all manufacturers' mud rings. Snap on/off inside edges to allow router to cut a smaller opening. Eliminate labor intensive screws. Also suited when tucking wired in devices toward back of deep box.*

**Protective covers sold separately.**

## Quantity discounts and "Labor Only" orders (customer supplies material) available for greater Savings!

**Customer is responsible to determine assemblies comply with all applicable codes plus owner's and specifying engineers requirements**



Where shown



730 Pratt Boulevard • Elk Grove Village, IL 60007 • P: (847) 593-8595 • F: (847) 593-8629 • Toll-free (800) 233-8595 • E: info@spproducts.com • www.spproducts.com



*Proud to be the electricians' friend for over 47 years and a long time supporter of contractor training programs.*



# Prefabricated Assemblies



## For Typical Wall Outlets

*Keep a small quantity of commonly needed assemblies on hand for everyday jobs and order large quantities for projects.*

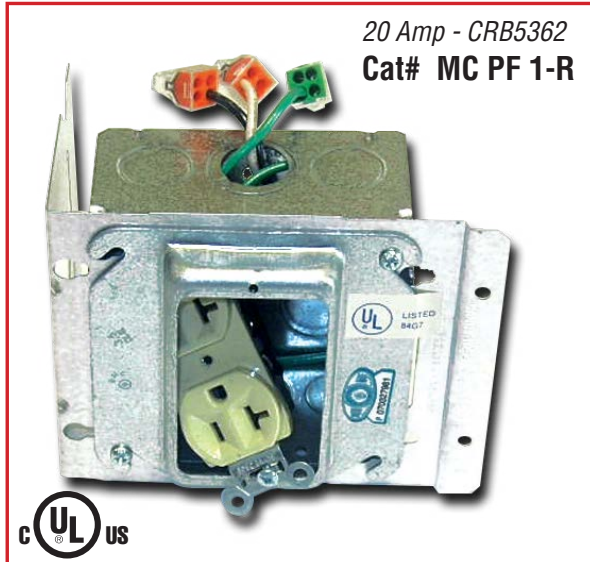

20 Amp - CRB5362  
Cat# MC PF 1-R

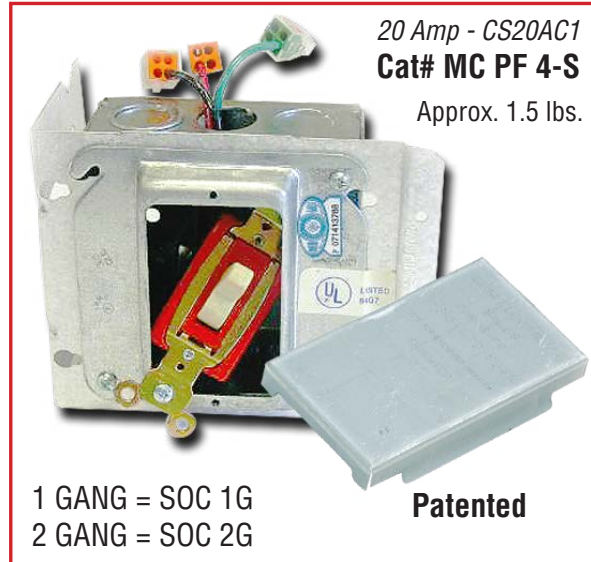

20 Amp - CS20AC1  
Cat# MC PF 4-S  
Approx. 1.5 lbs.

1 GANG = SOC 1G  
2 GANG = SOC 2G

Patented

## Complete with the following components

*If not specified manufacturers' equals in brands of our choice will be supplied.*

- 1- 4 square 1/2" - 3/4" KO x 2 1/8 deep box
- 1- 1 gang x 5/8" raised mud ring
- 1- 20 AMP specification grade back wired device tucked in back of box or attached to mud ring
- 1- #12 stranded 8 inch long pigtail grounded to box
- 1- Single side back box support for any stud depths.
- 3- #12 stranded 8" long any color wire leads each with a Wago push on quick connector or live spring wirenut attached. Looped devices have 6 leads – 3 in and 3 out of box, all on same circuit.
- 1- One or two gang snap on/off strong steel patented adjustable and reuseable protective cover attached to mud ring.

***Covers also available as a separate item.***

## An unlimited variety of other types, manufacturers brands and configuration of components available

**Customer is responsible to determine assemblies comply with all applicable codes plus owner's and specifying engineers requirements**



730 Pratt Boulevard • Elk Grove Village, IL 60007 • P: (847) 593-8595 • F: (847) 593-8629 • Toll-free (800) 233-8595 • E: info@spproducts.com • www.spproducts.com



7-23-13

***Proud to be the electricians' friend for over 47 years and a long time supporter of contractor training programs.***









# Grounding Pigtails

## For Prefabricated Assemblies and Other Applications

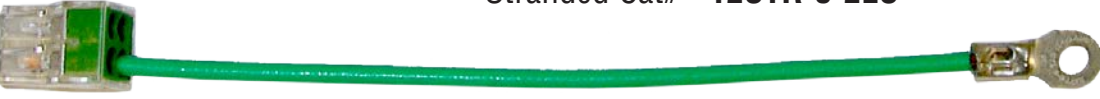

	<b>Set Screw</b>
#12 THNN x 8" Long      Solid Cat# <b>12SOL-8-SC</b> Stranded Cat# <b>12STR-8-SC</b>	
	<b>Ring</b>
#12 THNN x 8" Long      Solid Cat# <b>12SOL-8-RT</b> Stranded Cat# <b>12STR-8-RT</b>	
	<b>Fork/Spade</b>
#12 THNN x 8" Long      Solid Cat# <b>12SOL-8-FT</b> Stranded Cat# <b>12STR-8-FT</b>	
	<b>One End Stripped</b>
#12 THNN x 8" Long      Solid Cat# <b>12SOL-8-1ES</b> Stranded Cat# <b>12STR-8-1ES</b>	
	<b>Both Ends Stripped</b>
#12 THNN x 8" Long      Solid Cat# <b>12SOL-8-2ES</b> Stranded Cat# <b>12STR-8-2ES</b>	
	<b>Ring End with Push-On Type</b>
#12 THNN x 8" Long      Solid Cat# <b>12SOL-8-WA-RT</b> Stranded Cat# <b>12STR-8-WA-RT</b>	

An unlimited variety of configurations with or without any type of above connections attached at one or both ends, and in any type insulation, size, length, color, plain, or striped etc., solid or stranded wire available.

**Excellent quality with fast delivery at competitive prices**

Customer is responsible to determine assemblies comply with all applicable codes plus owner's and specifying engineers requirements

	<b>PRODUCTS, INC.</b> <i>Productivity and value thru ideas</i>	 Made in the USA	  <b>PATENTED</b>		
<i>Where shown</i>					
730 Pratt Boulevard • Elk Grove Village, IL 60007 • P: (847) 593-8595 • F: (847) 593-8629 • Toll-free (800) 233-8595 • E: info@spproducts.com • www.spproducts.com					



*Proud to be the electricians' friend for over 47 years and a long time supporter of contractor training programs.*



# Custom Wire Leads

## For Power and Other Applications



Set Screw



Push On Type  
UL Listed for 600 v - 20 amp  
Solid or Stranded



Ring



Fork/Spade

(insulated or unisulated)

**Customer is responsible to determine assemblies comply with all applicable codes plus owner's and specifying engineers requirements**



An unlimited variety of configurations with or without any type of above connections attached at one or both ends, and in any type insulation, size, length, color, plain, or striped etc., solid or stranded wire available.

## Excellent quality with fast delivery at competitive prices



730 Pratt Boulevard • Elk Grove Village, IL 60007 • P: (847) 593-8595 • F: (847) 593-8629 • Toll-free (800) 233-8595 • E: info@spproducts.com • www.spproducts.com



7-23-13

*Proud to be the electricians' friend for over 47 years and a long time supporter of contractor training programs.*



# Snap On/Off Reusable Protective Box & Device Covers

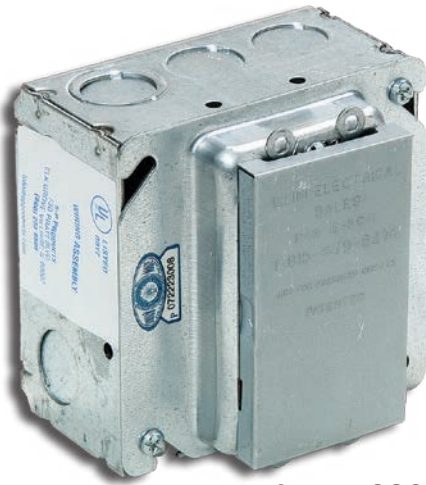
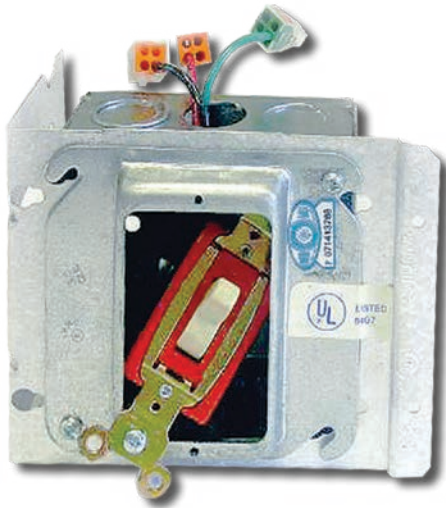

**SAVE**  
a great amount  
of time and money  
on all outlets for  
jobs throughout  
the year!

**PATENTED**

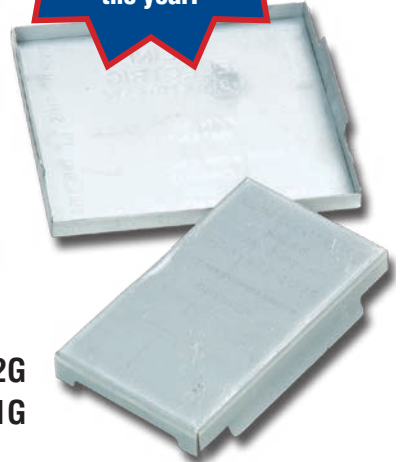

2-Gang = **SOC2G**

1-Gang = **SOC1G**

- ▶ Protect against costly damage to devices and wires, plus prevent paint, mud, and debris from entering box
- ▶ Adjustable to fit all manufacturers brand mud rings
- ▶ Snap On/Off inside edges of mud rings to allow router to cut a smaller opening and eliminate screws that require labor and often are dropped or lost
- ▶ Strong galvanized or stainless steel



**PATENT  
PENDING**

Bend tabs out to plug in for temporary power and back in to protect device

**Also suited for tucking wired-in devices  
toward the back of deep boxes**

**SP PRODUCTS, INC.**  
Productivity and value thru ideas



Where shown



730 Pratt Boulevard • Elk Grove Village, IL 60007 • P: (847) 593-8595 • F: (847) 593-8629 • Toll-free (800) 233-8595 • E: info@spproducts.com • www.spproducts.com



*Proud to be the electricians' friend for over 47 years and  
a long time supporter of contractor training programs.*



7-23-13



# Adjustable Mud Rings

5/8 thru 1-1/2" Depth  
for 4 Square Outlet Boxes

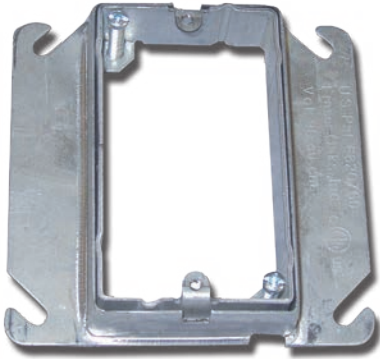

Cat# 1GADJMR  
**1 Gang**

Offer complete flexibility to quickly provide perfect alignment of devices in drywall

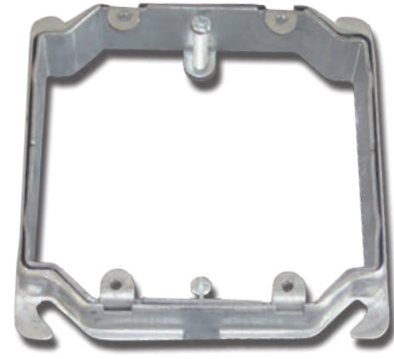

Cat# 2GADJMR  
**2 Gang**

Save time and eliminate costly problems

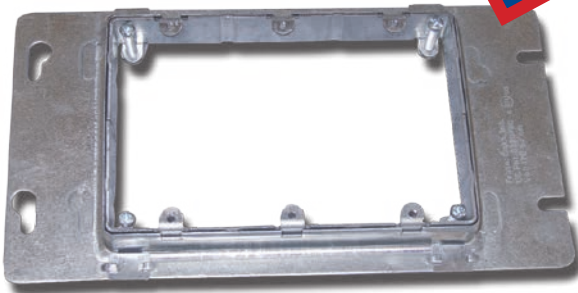

Cat# 3GADJMR  
**3 Gang**

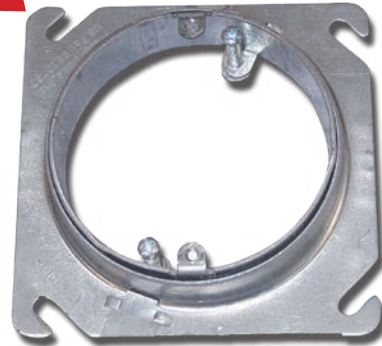

Cat# 1GADJMR  
**Round**

Eliminates time lost and damage since adjusting screws are locate inside box opening and are not covered when drywall is installed

**SP** PRODUCTS, INC.  
Productivity and value thru ideas



Where shown



730 Pratt Boulevard • Elk Grove Village, IL 60007 • P: (847) 593-8595 • F: (847) 593-8629 • Toll-free (800) 233-8595 • E: info@spproducts.com • www.spproducts.com



*Proud to be the electricians' friend for over 47 years and a long time supporter of contractor training programs.*



**Save More  
Than 30 MINUTES  
with a Perfect  
Installation  
Every Time!**

# Common Wall Conduit & Box Supports

## For Hotels, Commercial Buildings, Etc.

**Install only  
one instead  
of two**

- Wide Wings allow movement left or right when studs are not 16 or 24 inch on center
- Predrilled pilot holes allow attaching boxes at various locations between studs
- 4 or 4 -11/16 square shallow or deep box

**UL  
PATENTED**

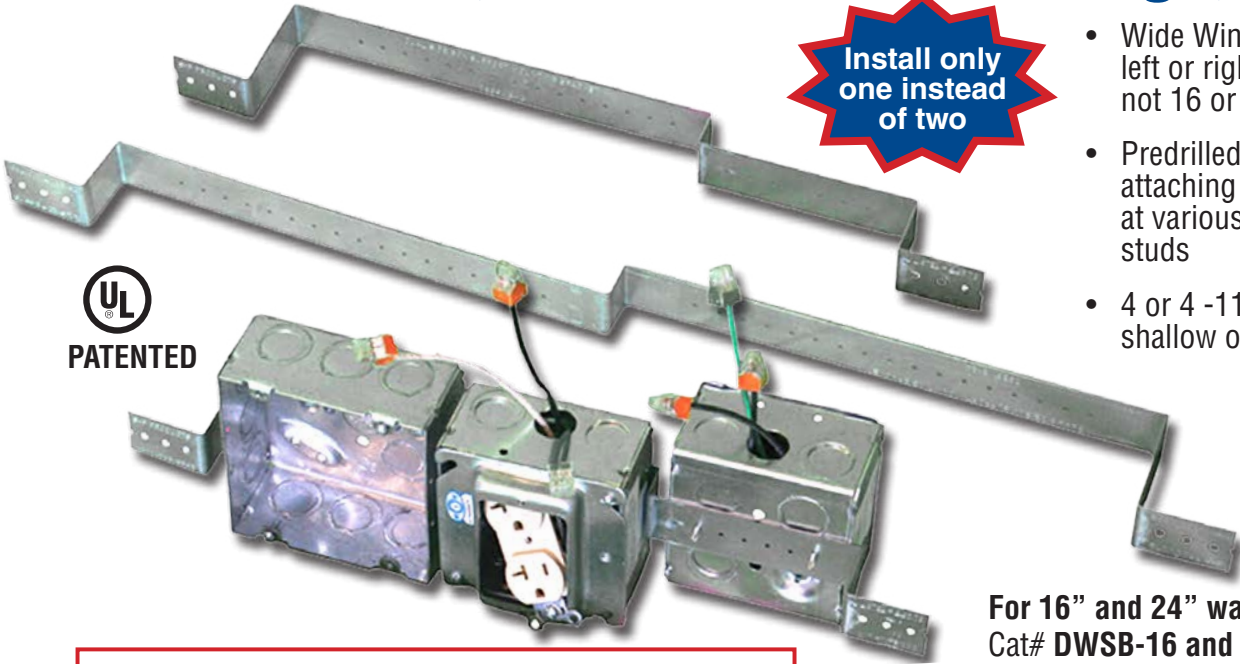

**For 16" and 24" wall stud spacing  
Cat# DWSB-16 and DWSB-24**



Mount boxes back to back for bedrooms, bathrooms, etc.

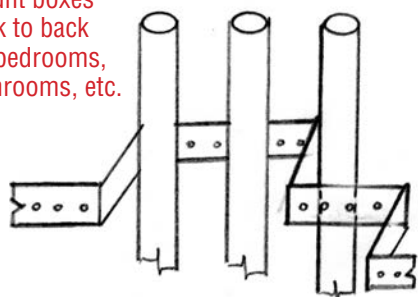

Also suitable for supporting conduits vertically per NEC 348-13

### Snap On/Off Protective Covers



**PATENTED** **PATENT PENDING**  
Bend tabs out to plug in for temporary power and back in to protect device

**Available as a UL Listed Assembly with any combination of Boxes, Mud Rings, Wiring Devices, Protective Covers etc. plus with any type of other hardware or "Econo-Whips" attached to boxes. Carefully inspected, plus marked and packed.**

*Customer is responsible to determine assemblies comply with all applicable codes plus owner's and specifying engineers requirements*



**SP PRODUCTS, INC.**  
*Productivity and value thru ideas*



Made in the USA



Where shown



730 Pratt Boulevard • Elk Grove Village, IL 60007 • P: (847) 593-8595 • F: (847) 593-8629 • Toll-free (800) 233-8595 • E: info@spproducts.com • www.spproducts.com



*Proud to be the electricians' friend for over 47 years and a long time supporter of contractor training programs.*



# “Big O” Supports

## For Boxes at Any Location Between Studs



- Mount 4 or 4-11/16 inch square shallow or deep boxes then loosen two box screws to quickly relocate boxes
- Mud Ring Sandwiches Box to Bracket
- Built in ruler every 1/4 inch allows fast, accurate bench loading

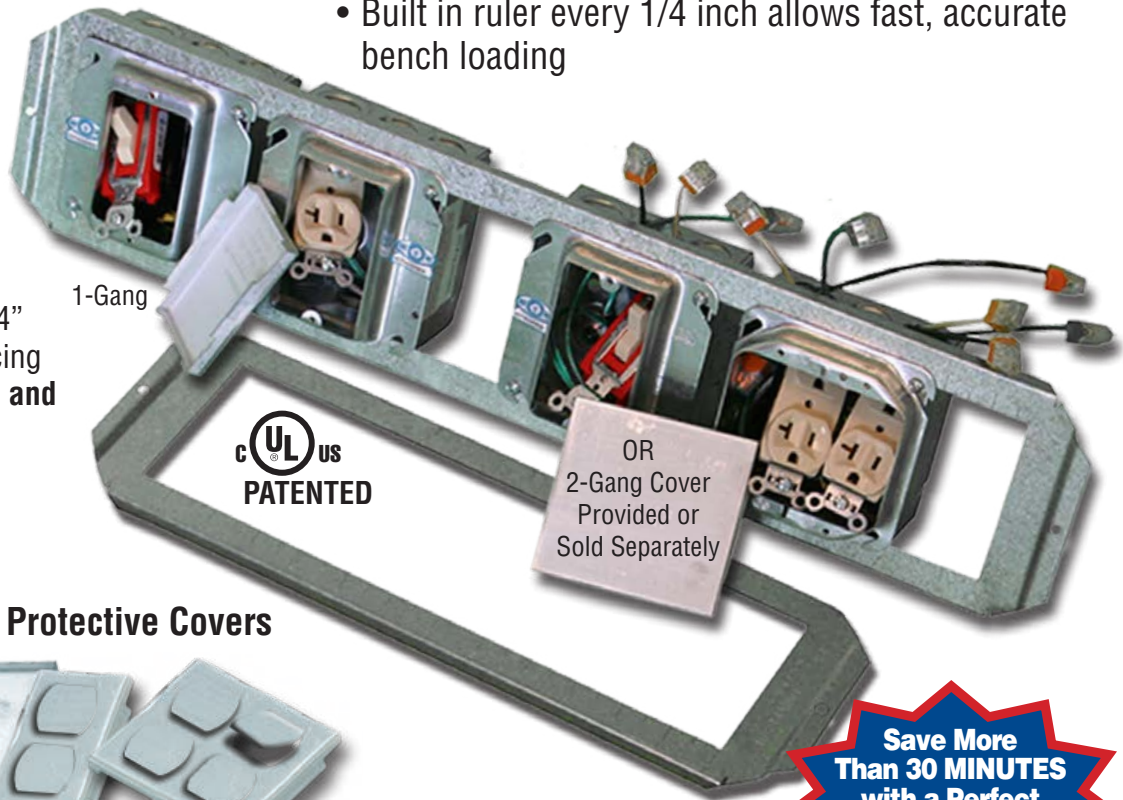

For 16” and 24”  
wall stud spacing  
Cat# **Big O-16** and  
**Big O-24**



OR  
2-Gang Cover  
Provided or  
Sold Separately

### Snap On/Off Protective Covers



Bend tabs out to plug in for temporary power and back in to protect device

Save More  
Than 30 MINUTES  
with a Perfect  
Installation  
Every Time!

**Available as a UL Listed Assembly with any combination of Boxes, Mud Rings, Wiring Devices, Protective Covers etc. plus with any type of other hardware or “Econo-Whips” attached to boxes. Carefully inspected, plus marked and packed.**

**Customer is responsible to determine assemblies comply with all applicable codes plus owner’s and specifying engineers requirements**

**Flat versions with no offsets available. Not UL listed.**



730 Pratt Boulevard • Elk Grove Village, IL 60007 • P: (847) 593-8595 • F: (847) 593-8629 • Toll-free (800) 233-8595 • E: info@spproducts.com • www.spproducts.com

**PFA8A**

*Proud to be the electricians’ friend for over 47 years and a long time supporter of contractor training programs.*

7-23-13





# Fixed Position Box Supports

For 16" and 24" wall stud spacing  
 Cat# BSB3-16 = 16" and  
 Cat# BSB4-24 = 24"

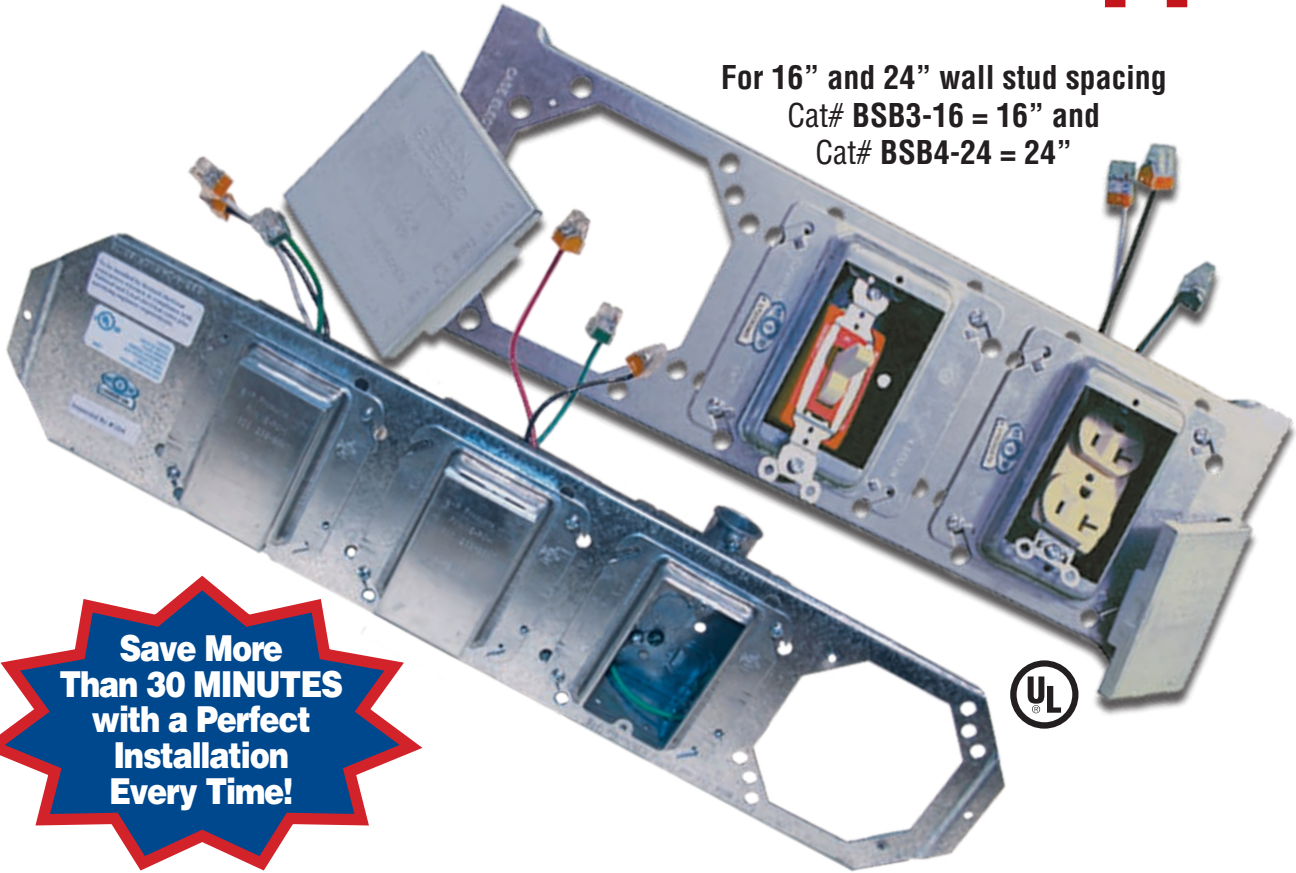

**Save More  
 Than 30 MINUTES  
 with a Perfect  
 Installation  
 Every Time!**

- Mount 4 or 4-11/16 square shallow or deep boxes in fixed positions evenly spaced evenly and at same height
- Fast – Perfectly level and spaced – Installation – Just pass screws attached to box thru holes on bracket and secure box with mud ring
- Extremely strong. Bracket will not bend or bow during installation

## Snap On/Off Protective Covers



Bend tabs out to plug in for temporary power and back in to protect device

**Available as a UL Listed Assembly with any combination of Boxes, Mud Rings, Wiring Devices, Protective Covers etc. plus with any type of other hardware or "Econo-Whips" attached to boxes. Carefully inspected, plus marked and packed.**

*Customer is responsible to determine assemblies comply with all applicable codes plus owner's and specifying engineers requirements*

**SP PRODUCTS, INC.**  
*Productivity and value thru ideas*

Made in the USA

UL c UL US PATENTED  
 Where shown

730 Pratt Boulevard • Elk Grove Village, IL 60007 • P: (847) 593-8595 • F: (847) 593-8629 • Toll-free (800) 233-8595 • E: info@spproducts.com • www.spproducts.com



*Proud to be the electricians' friend for over 47 years and a long time supporter of contractor training programs.*



# Supports for 3 1/2 Deep Boxes

Save More  
Than 30 MINUTES  
with a Perfect  
Installation  
Every Time!



Cat# **FAB-350**  
**PATENTED**

- Wide Flanges allow – supporting boxes in from 15 thru 25 inches stud span
- Automatically sets box with or without mud ring flush in one or two layers of drywall
- Ideal for fire alarm, speakers, strobes, etc.

**Also available with any depth box, devices, other hardware and “Econo-Whips” attached. Carefully inspected, plus marked and packed.**

**Customer is responsible to determine assemblies comply with all applicable codes plus owner’s and specifying engineers requirements**

**SP PRODUCTS, INC.**  
*Productivity and value thru ideas*



Where shown



730 Pratt Boulevard • Elk Grove Village, IL 60007 • P: (847) 593-8595 • F: (847) 593-8629 • Toll-free (800) 233-8595 • E: info@spproducts.com • www.spproducts.com

**PFA8C**

*Proud to be the electricians’ friend for over 47 years and a long time supporter of contractor training programs.*

7-23-13



# Custom Prefabricated Cable for Data Power Distribution Units



Provide a much lower job cost and eliminate problems

Any manufacturers' brand, type and configuration of UL Listed components

*Cables satisfy National Electrical Code article 645.5(E) and do not have to be securely fastened in place and supported every 4.5 feet as stated in article 350.30(A).*

**Tell us what you need and we'll make and ship it on time at an extremely competitive price.**

- ▶ Every assembly is carefully and thoroughly tested per customers' requirements for ground integrity, insulation leaks, proper phase rotation and all conductors are Hi-Pot tested at twice rated circuit voltage plus 1,000 volts.
- ▶ Certificate of calibration provided with each order.
- ▶ Assemblies are marked at each end with custom labels protected by clear heat shrink tubing to prevent alteration or accidental removal.
- ▶ Liquidtight conduit colors available in all sizes: black, gray, blue, red, yellow, green, orange, brown and white up thru 225 ft.
- ▶ Floor pedestal mounting hardware available
- ▶ Single or multiple circuits provided
- ▶ Specify all components and if certain manufacturers; brands are required.

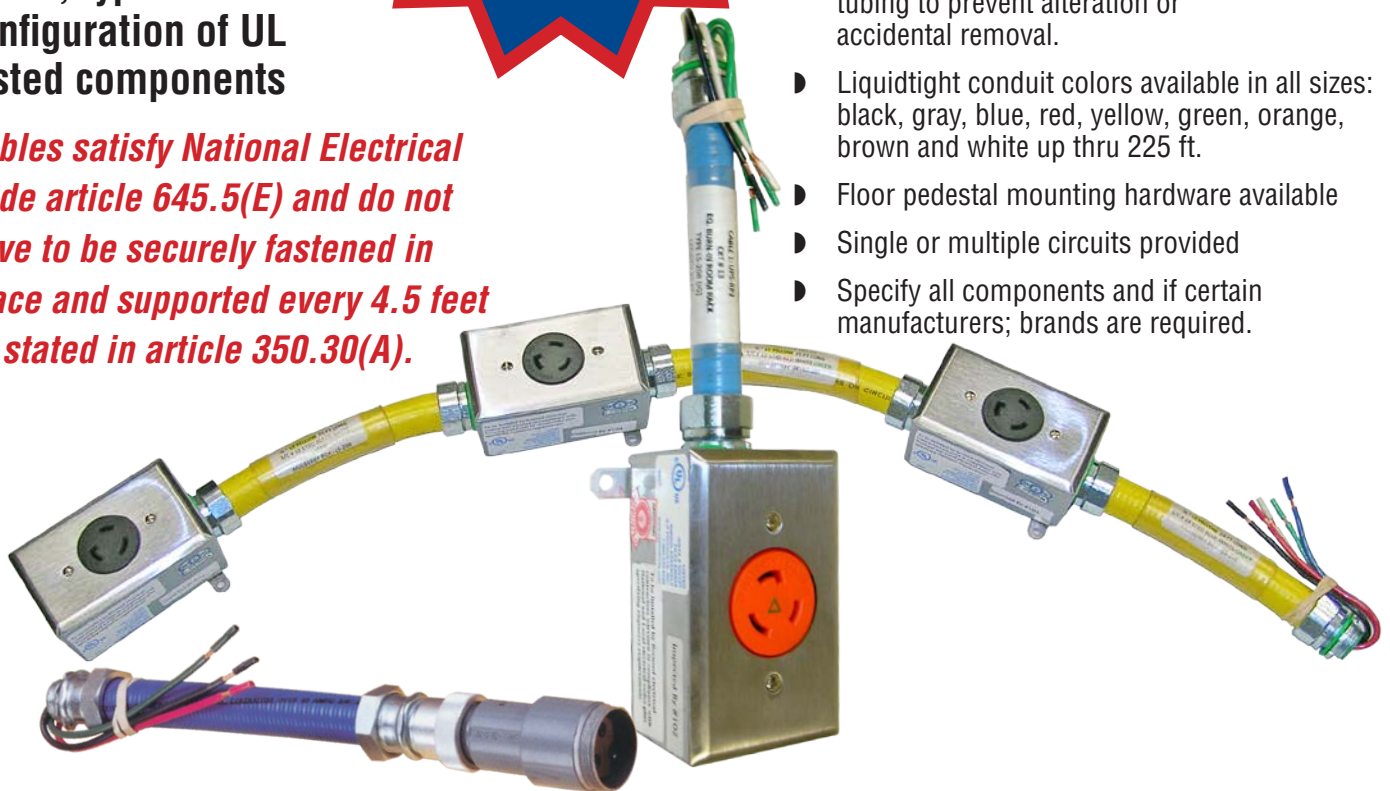

## Excellent Quality!

**All assemblies are carefully inspected, tested, marked and packed per customers specifications**

*Customer is responsible to determine assemblies comply with all applicable codes plus owner's and specifying engineers requirements*



Where shown



730 Pratt Boulevard • Elk Grove Village, IL 60007 • P: (847) 593-8595 • F: (847) 593-8629 • Toll-free (800) 233-8595 • E: info@spproducts.com • www.spproducts.com



*Proud to be the electricians' friend for over 47 years and a long time supporter of contractor training programs.*



7-23-13



The Original Since 1966...



# “Econo Whips”

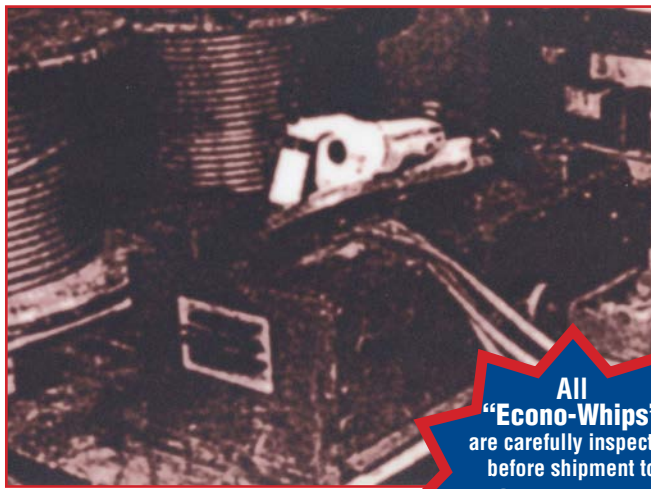

All “Econo-Whips” are carefully inspected before shipment to **Guarantee Excellent Quality**

...and 1969

Our nationally famous, automatic extremely productive whip machine, invented by a highly experienced electrician, tremendously increased productivity.

**A Giant Step Toward Increasing Productivity in Our Industry!**

Any size, length, type – steel or aluminum flexible conduit, MC cable, Liquidtite, cord Romex, etc. with or without any type connectors attached at one, both or no ends. Specify if certain manufacturers brands are required.

All conductors notched with insulation remaining for protection and easy to remove rubber bands at each end to prevent locknuts from falling off. Packed in barrels and bundles of 10 for easy, efficient handling on jobsites.



Liquidtite with any color jacket for PDUs, motors, etc.

Any type cord with or without Kellems® Grips for refrigeration and machinery drops.



Romex for commercial and residential applications.



ENT for parking structures, etc.

Customer is responsible to determine assemblies comply with all applicable codes plus owner’s and specifying engineers requirements



Where shown



730 Pratt Boulevard • Elk Grove Village, IL 60007 • P: (847) 593-8595 • F: (847) 593-8629 • Toll-free (800) 233-8595 • E: info@spproducts.com • www.spproducts.com



*Proud to be the electricians’ friend for over 47 years and a long time supporter of contractor training programs.*



# Anchor Bolt Templates

## For Poles, Beams, etc.

### Reusable for Many Jobs.



**Each Template  
Saves 100's of  
Dollars!**

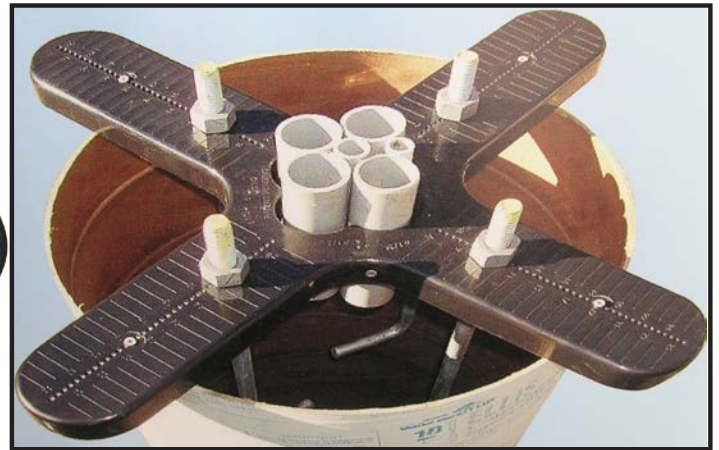

- Extremely fast, accurate installations.
- Rulers on all 4 wings allow drilling same bolt diameter holes for 5-1/2 thru 25 inch four bolt circle patterns.
- Deep recess in back allows leveling nut to be free of concrete.
- Embedded divots ensure accuracy when drilling.
- Strong non-corrosive ABS plastic.
- User can color code templates – one color for each same bolt diameter and drill different circle patterns from job to job and order from the field by color.

## Eliminate constantly purchasing and fabricating expensive plywood.

**SP PRODUCTS, INC.**  
Productivity and value thru ideas



Where shown

730 Pratt Boulevard • Elk Grove Village, IL 60007 • P: (847) 593-8595 • F: (847) 593-8629 • Toll-free (800) 233-8595 • E: info@spproducts.com • www.spproducts.com



*Proud to be the electricians' friend for over 47 years and a long time supporter of contractor training programs.*



# Live Panel Temporary Cover

## Provide Protection for Construction Workers, Visitors, and Tenants

PATENTED



- Saves a great amount of time On/Off in seconds
- Extremely durable, water resistant corrugated plastic with a long life
- Eliminates constantly finding, cutting, scribbling and taping on cardboard several times every day
- 20" wide x 48" tall = TPC 20x48  
14" wide x 48" tall = TPC 14x48  
Readily available
- Firmly held in place with strong non-conductive magnets
- For other sizes, colors, etc., consult factory

**Highly Visible – Improves Image on Jobsite**

**FOR USE AS AN ACCESS DETERRENT –  
NOT FOR PROTECTION AGAINST ELECTRICAL SHOCK!**

Meets UL 67 Panel Boards

ANSI Z535.1-1991  
ANSI Z535.4-1991

ANSI Z535.2-1991  
ANSI Z535.5-1991

ANSI Z535.3-1991  
ANSI Z535.6-2006

**SP PRODUCTS, INC.**  
Productivity and value thru ideas



Where shown



730 Pratt Boulevard • Elk Grove Village, IL 60007 • P: (847) 593-8595 • F: (847) 593-8629 • Toll-free (800) 233-8595 • E: info@spproducts.com • www.spproducts.com

**TE2**

7-23-13

*Proud to be the electricians' friend for over 47 years and a long time supporter of contractor training programs.*





# Live Panel Lockout Brackets

Completely Lock Out Live Panels for Greater Safety.  
Save a Great Amount of Time Everyday on Jobs.

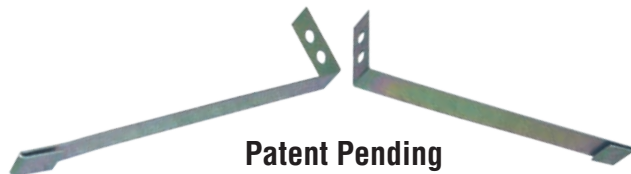

- Completely locks out panel to eliminate entry by unauthorized personnel at any time
- On/Off in seconds
- Two holes are provided on each piece of every pair for two locks – the electrician and perhaps another trade
- Pairs of brackets sold with locks and keys or available separately
- Strong 18 gauge zinc plated steel
- Reusable with a long life
- Also available for any panel width as specified



Catalog #	Dimensions
LOB20	20" width panel
LOB36	36" width panel
LOB44	44" width panel

**FOR USE AS AN ACCESS DETERRENT –  
NOT FOR PROTECTION AGAINST ELECTRICAL SHOCK!**



Where shown



730 Pratt Boulevard • Elk Grove Village, IL 60007 • P: (847) 593-8595 • F: (847) 593-8629 • Toll-free (800) 233-8595 • E: info@spproducts.com • www.spproducts.com



*Proud to be the electricians' friend for over 47 years and  
a long time supporter of contractor training programs.*

**TE3**

7-23-13

# Conduit Plug with ID Tag

## Save a Great Amount of Time on Jobs

- Fast Installation
- Prevents debris from entering conduit
- Tab allow changing detailed ID several times
- Hole for pull string provided
- Accomodates three conduit sizes per plug
- Strong, long lasting, and reuseable
- Highly visable, available in bright orange only



Catalog #	Dimensions
CP50 - 75- 100	= 1/2 - 3/4 - 1 inch conduit
CP125 - 150 - 200	= 1-1/4 - 1-1/2 - 2 inch conduit

## On/off in a few seconds



Where shown



730 Pratt Boulevard • Elk Grove Village, IL 60007 • P: (847) 593-8595 • F: (847) 593-8629 • Toll-free (800) 233-8595 • E: info@spproducts.com • www.spproducts.com



7-23-13

*Proud to be the electricians' friend for over 47 years and a long time supporter of contractor training programs.*



# Rigid Pipe Joiner

Spins 10 foot lengths together in under 10 seconds with less chance of injury and no damage to conduit

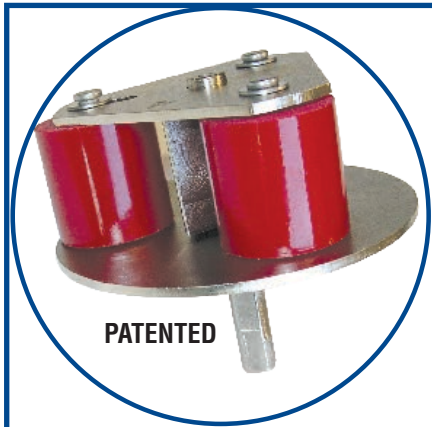

- As shaft turns grips expand to lock on inside of conduit and quickly turn it 360° to join the entire 10 foot length into the preceding coupling. If necessary, drill can be reversed to disconnect conduit.

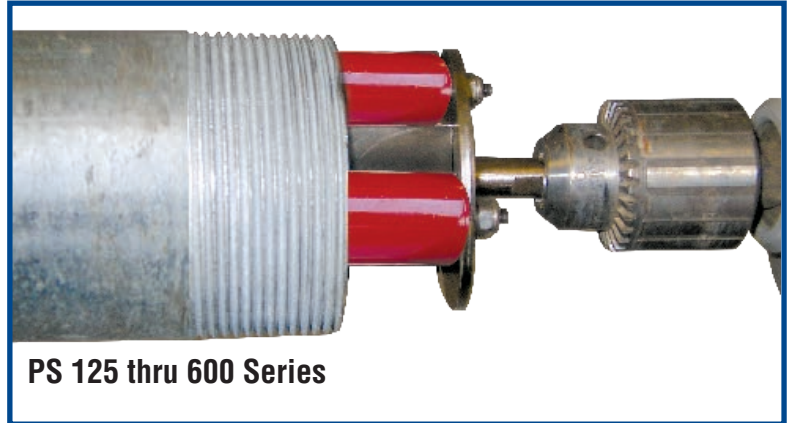

PS 125 thru 600 Series

Catalog #	Dimensions
PS125	1-1/4"
PS150	1-1/2"
PS200	2"
PS250	2-1/2"
PS300	3"
PS350	3-1/2"
PS400	4"
PS500	5"
PS600	6"

- Eliminates labor intensive ropes or chain and strap wrenches.
- Available for size 1-1/4 thru 6 inch rigid conduit
- Spinners are available in sets at reduced prices or sold separately.

SUITABLE FOR USE WITH A MILWAUKEE 0721-21 V28 VOLT RIGHT ANGLE CORDLESS DRILL/DRIVE KIT

WHEN USING CUTTING OIL, REMOVE WITH A PROPER SOLUTION. DO NOT INCLUDE OR ADD ANY MATERIALS TO PREVENT SLIPPAGE.



Prevents damage to inside and outside of conduit – especially PVC coated



730 Pratt Boulevard • Elk Grove Village, IL 60007 • P: (847) 593-8595 • F: (847) 593-8629 • Toll-free (800) 233-8595 • E: info@spproducts.com • www.spproducts.com



Proud to be the electricians' friend for over 47 years and a long time supporter of contractor training programs.





# Dry Wall Cut Out Templates

## For Fast, Perfectly Level and Accurate Location of Cut Outs with NO DAMAGE TO DRY WALL



*Extremely fast, simple and perfect installation every time*

## For Gem or Handy Boxes

Allow tracing all box and screw openings.



Cat# **COT100**  
Patent Pending

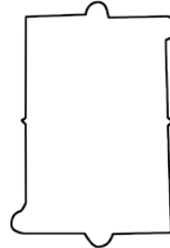

Two levels provided for perfect horizontal and/or vertical alignment.

Center lines provided for accuracy, especially when ganging cutouts.

Clear see thru blue and orange in color polycarbonate material with long life.

**NEW!**

## For Low Voltage

AVAILABLE SOON

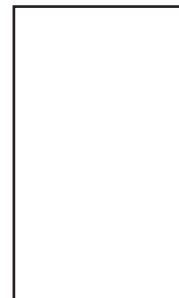

Cat# **LVCOT200**  
Patent Pending



## Extremely strong and durable, long lasting to save hundreds of dollars thru out its' life

**SP** PRODUCTS, INC.  
*Productivity and value thru ideas*



Where shown



730 Pratt Boulevard • Elk Grove Village, IL 60007 • P: (847) 593-8595 • F: (847) 593-8629 • Toll-free (800) 233-8595 • E: info@spproducts.com • www.spproducts.com

**TE6**

7-23-13

*Proud to be the electricians' friend for over 47 years and a long time supporter of contractor training programs.*



# Low Voltage Cable Guide

Prevents low voltage wire from being tangled to allow faster, installation with no damage to the cables

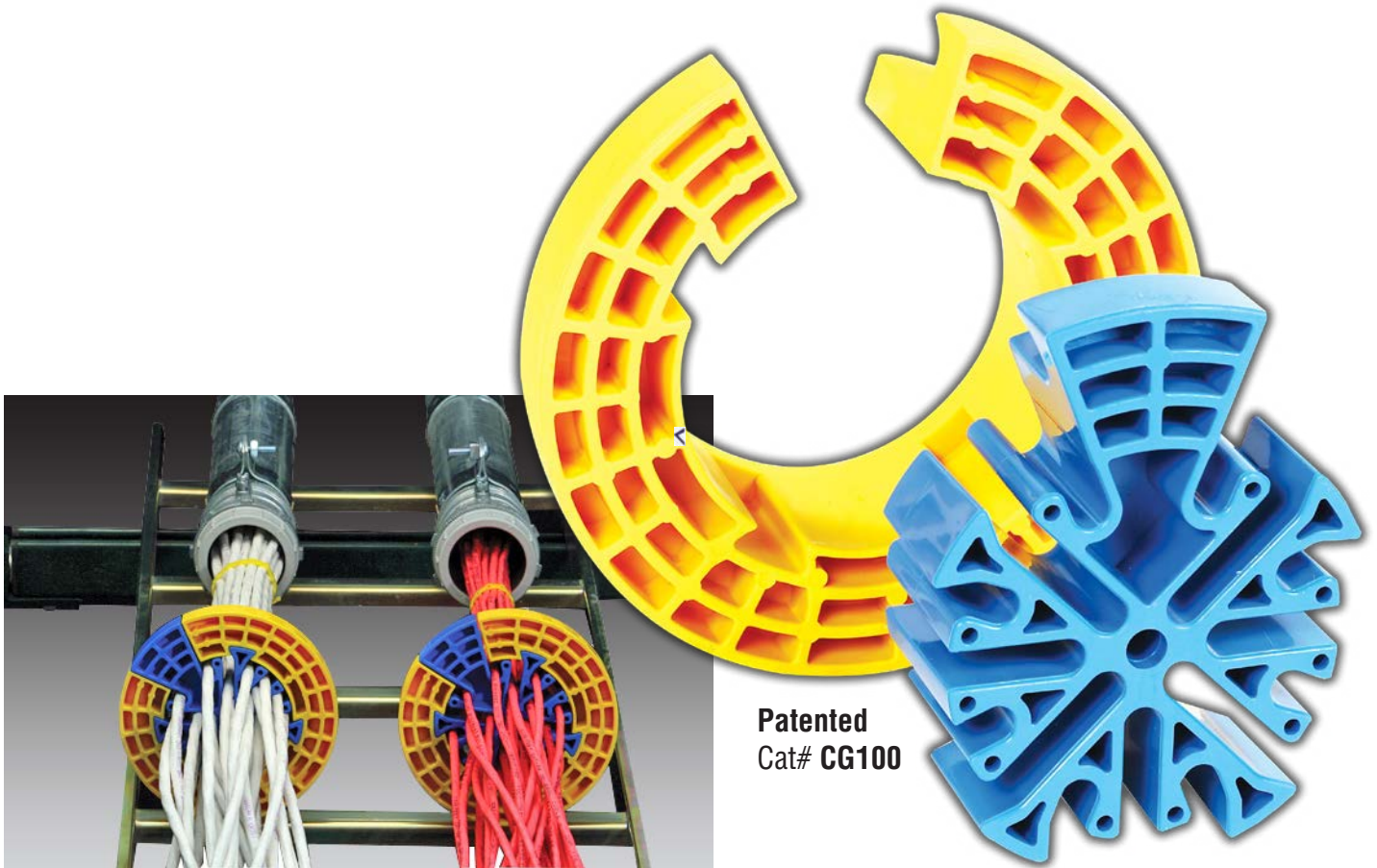

Patented  
Cat# CG100

**2-piece to allow faster loading of cables.  
Strong, long lasting, high quality plastic.**

**SP PRODUCTS, INC.**  
*Productivity and value thru ideas*

 Made in the USA

  US PATENTED

Where shown

730 Pratt Boulevard • Elk Grove Village, IL 60007 • P: (847) 593-8595 • F: (847) 593-8629 • Toll-free (800) 233-8595 • E: info@spproducts.com • www.spproducts.com



*Proud to be the electricians' friend for over 47 years and a long time supporter of contractor training programs.*



7-23-13

# Top Slide

## For MC or Low Voltage Cable Pulls Over T Bar



Cat# TS100  
PATENTED

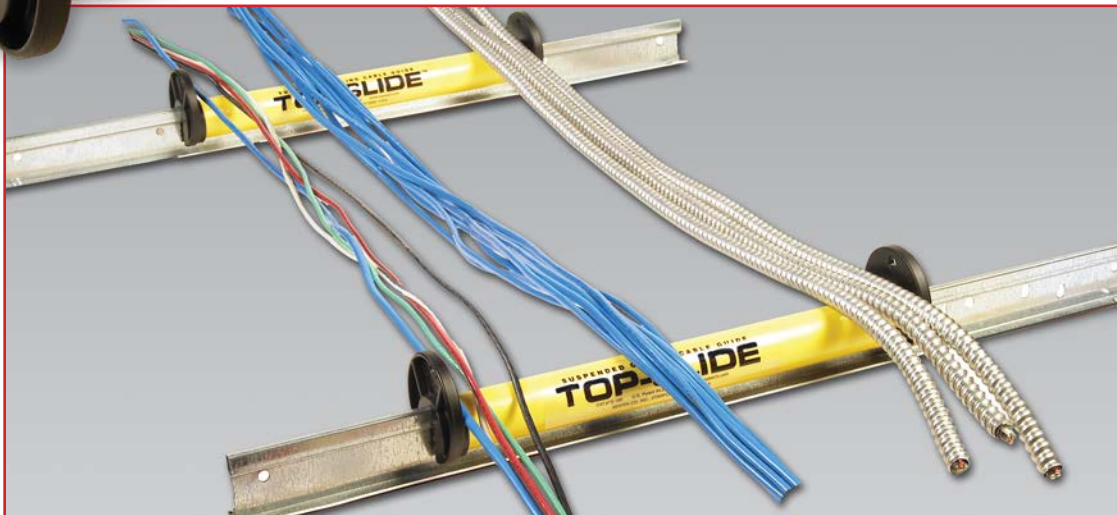

- Strong, long lasting, reusable, highly visible yellow
- Side rails contain wire for control during the pull

## Allows fast trouble free pulls to save time and prevent damage to wire or ceiling

**SP** PRODUCTS, INC.  
*Productivity and value thru ideas*



Where shown



730 Pratt Boulevard • Elk Grove Village, IL 60007 • P: (847) 593-8595 • F: (847) 593-8629 • Toll-free (800) 233-8595 • E: info@spproducts.com • www.spproducts.com

**TE8**

7-23-13

*Proud to be the electricians' friend for over 47 years and  
a long time supporter of contractor training programs.*





# Wire Pulling Pal

Only One Electrician Needed to Pull Wire  
Pays for itself in ONE DAY!

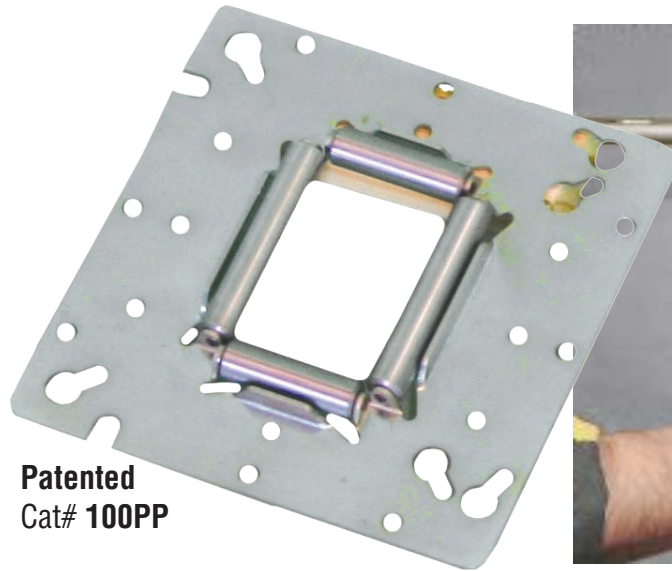

Patented  
Cat# 100PP



## Closely Spaced Rollers Prevent Damage to Wires

- Unique closely spaced roller design allows building wire and low voltage cable to be pulled faster and easier without being nicked, scraped or cut. Eliminates costly on site problems, call backs and upset customers.
- Ideal for bundled Home Runs and all types of low voltage cable including, fiber optic, CAT 5 or 6, etc.
- Per-drilled holes allow fast mounting on 4" and 4-11/16" square or handy boxes, 1 and 2 gang mud rings, larger junction boxes, panels, studs, etc.
- Strong well machined steel construction. Built to last.

Every service truck should  
have at least one.

**SP** PRODUCTS, INC.  
Productivity and value thru ideas



Where shown



730 Pratt Boulevard • Elk Grove Village, IL 60007 • P: (847) 593-8595 • F: (847) 593-8629 • Toll-free (800) 233-8595 • E: info@spproducts.com • www.spproducts.com



*Proud to be the electricians' friend for over 47 years and  
a long time supporter of contractor training programs.*

**TE9**

7-23-13

# Wire Pulling Rollers for Cable Tray

**NEW!**

## Feed Cable Safely and Smoothly Through Ball Bearing Rollers PATENTED

**Cat# CTR-6S**

6 inch "Split Box" tray roller. Unit quickly clamps to tray.



**Cat# CTR-12S**

12 inch "Split Box" tray roller. Unit quickly clamps to tray.



**Cat# CTR-9U**

"U" Shaped Roller Unit.



Combine rollers for a variety of solutions

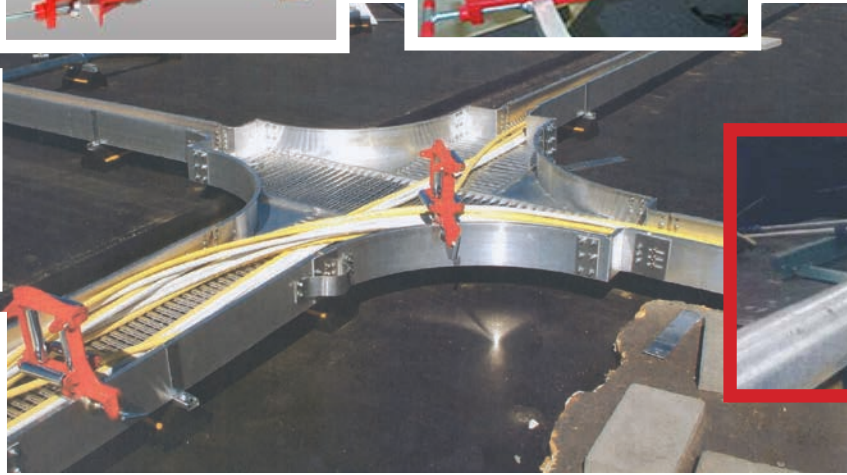

Larger sizes available to accommodate up to 5" rigid conduit or same size outer diameter of cables

**Cat# CTR-4-10x5**  
Inside Vertical Riser.

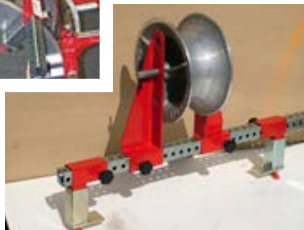

**Cat# CTR-5-10x5**  
Inside Vertical Riser.



**Cat# CTR-6-10x5**  
Inside Vertical Riser.



## Split box design allows pulled cable to be safely and quickly removed and laid into cable tray.

**SP PRODUCTS, INC.**  
Productivity and value thru ideas



Where shown



730 Pratt Boulevard • Elk Grove Village, IL 60007 • P: (847) 593-8595 • F: (847) 593-8629 • Toll-free (800) 233-8595 • E: info@spproducts.com • www.spproducts.com

**TE10**

7-23-13

*Proud to be the electricians' friend for over 47 years and a long time supporter of contractor training programs.*



# **Portable PVC Conduit Bender**

**Over 40% Faster – Eliminates Costly, Time Consuming Searching  
for and Hooking-Up Power for Hot Boxes and Heat Blankets**

**Easy  
To Carry  
Weighs Only  
20 lbs.**



## **Complete With**

- Bender • Wire Heat Guard • 25 ft. Hose • Brass Regulator

**All in strong steel carrying case**

*NOTE: Customer supplies 5 gallon propane tank*

**High velocity heated air – flame never touches the conduit  
For up to 6 inch schedule 40 and 80 PVC**

**SP PRODUCTS, INC.**  
*Productivity and value thru ideas*



*Where shown*



730 Pratt Boulevard • Elk Grove Village, IL 60007 • P: (847) 593-8595 • F: (847) 593-8629 • Toll-free (800) 233-8595 • E: info@spproducts.com • www.spproducts.com



*Proud to be the electricians' friend for over 47 years and  
a long time supporter of contractor training programs.*

**TE11**

7-23-13



# Laser Line™ Gun

## Locates Cable Pull Lines in Suspended Ceilings, Trusses, etc.



Cat# SP210-11D3	Darts 3/pkg.
Cat# SP210-12PL	Nylon Pull Line 3/2500 ft.
Cat# SP210-14C02	CO <sub>2</sub> Cartridges 5/pkg.

Cat# LG500 PATENTED

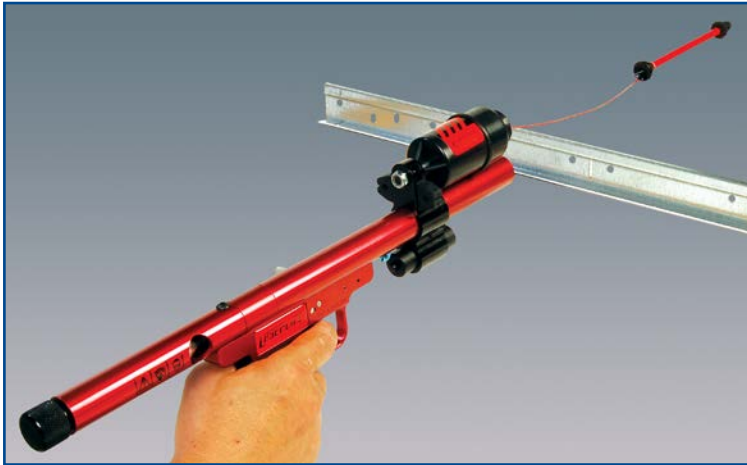

### Complete with strong plastic carrying case and.....

- Pull Line Spools (1,200 ft.)
- Sturdy carrying case with foam insert
- 12 Gram CO<sub>2</sub> cylinders (approx. 6-8 shots)
- 12 gram CO<sub>2</sub> adapter
- Line Caster
- Laser sight (uses 3-LR44 type batteries)
- Thread will also accept paint ball type CO<sub>2</sub> tanks • LaserLine Gun
- Velocity adjustment, increase or decrease
- Instruction manual

## Extremely safe, fast and accurate

## CO<sub>2</sub> cartridge propels laser guided pulling line with dart up to 200 feet to exact location desired

**SP** PRODUCTS, INC.  
Productivity and value thru ideas



Where shown



730 Pratt Boulevard • Elk Grove Village, IL 60007 • P: (847) 593-8595 • F: (847) 593-8629 • Toll-free (800) 233-8595 • E: info@spproducts.com • www.spproducts.com

**TE12**

7-23-13

*Proud to be the electricians' friend for over 47 years and  
a long time supporter of contractor training programs.*



# Step Ladder Shoulder Pad

## For 6, 8 and 10 foot Step Ladders



Cat# LP6-10  
PATENTED

- On/off in seconds
- Built in velcro straps quickly and firmly attach or remove pad from ladder
- Extremely strong, waterproof and reversible to last for many years
- Fits Louisville, Werner and other manufacturers 6 thru 10 foot step ladders
- Serves as a safety marker on end of ladder when transporting on a vehicle

## Carry ladder with no pain or injury

**SP** PRODUCTS, INC.  
Productivity and value thru ideas



Where shown



730 Pratt Boulevard • Elk Grove Village, IL 60007 • P: (847) 593-8595 • F: (847) 593-8629 • Toll-free (800) 233-8595 • E: info@spproducts.com • www.spproducts.com



*Proud to be the electricians' friend for over 47 years and  
a long time supporter of contractor training programs.*

**TE13**

7-23-13

**Prevents  
injury saves time  
& eliminates  
aggravation**

# Bit with Plug Ejector Spring

**Suitable for Wood, Metal,  
Drywall, Ceiling tile, etc.**

Catalog#	Dimensions
00100	7/8" hole size
00200	1-1/8" hole size
00300	1-3/8" hole size

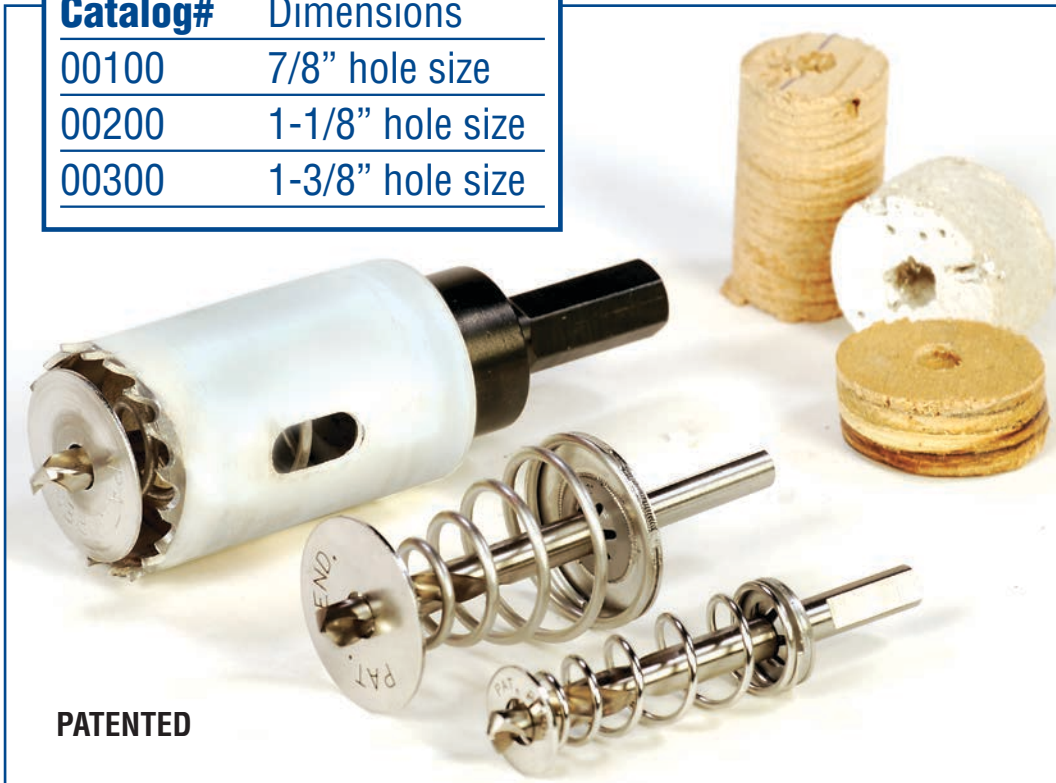

**Available Separately or as a Unit Installed  
in a Common Readily Available Hole Saw**

**Several sizes available, plus consult factory  
for replacement pilot bits and ejection springs.**

**SP PRODUCTS, INC.**  
*Productivity and value thru ideas*



Where shown



730 Pratt Boulevard • Elk Grove Village, IL 60007 • P: (847) 593-8595 • F: (847) 593-8629 • Toll-free (800) 233-8595 • E: info@spproducts.com • www.spproducts.com

**TE14**  
7-23-13

*Proud to be the electricians' friend for over 47 years and  
a long time supporter of contractor training programs.*





# Extension Cord Lock

## Save Hours on Every Job

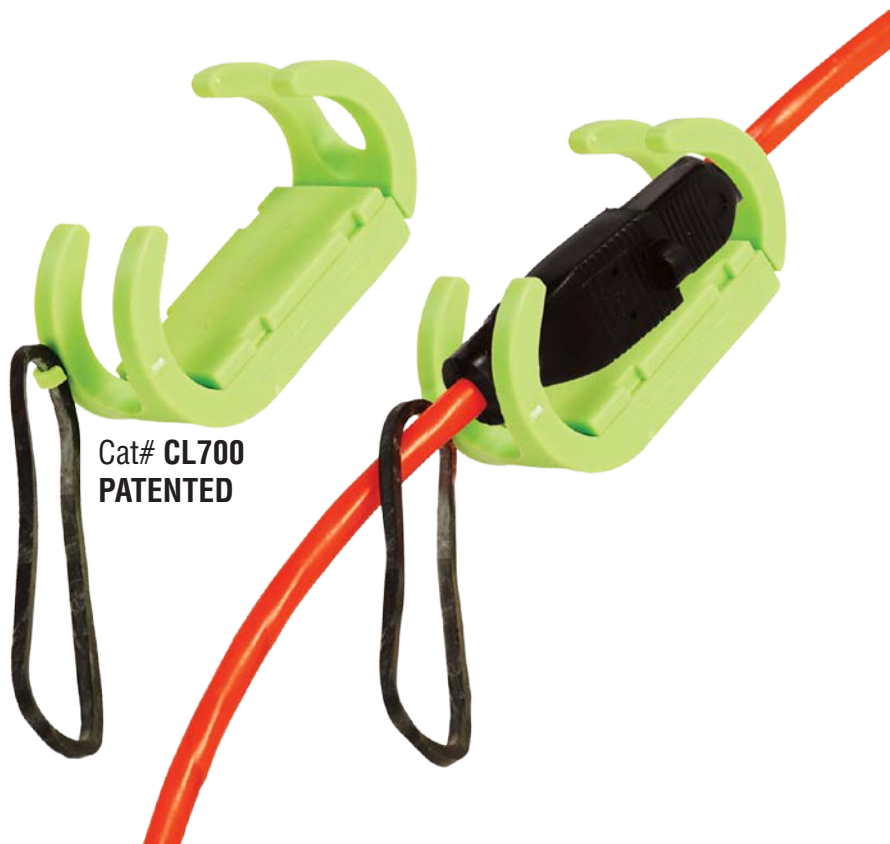

- Eliminates lost valuable production time
- No time wasted tying and untying cords which also damages them plus is not allowed by code in many areas
- Spring loaded to securely join extension cords together

**Also prevents aggravation when power cords become separated — especially during a critical installation**

**SP** PRODUCTS, INC.  
*Productivity and value thru ideas*



Where shown



730 Pratt Boulevard • Elk Grove Village, IL 60007 • P: (847) 593-8595 • F: (847) 593-8629 • Toll-free (800) 233-8595 • E: info@spproducts.com • www.spproducts.com



*Proud to be the electricians' friend for over 47 years and a long time supporter of contractor training programs.*

**TE15**

7-23-13

# Safety Vests

Soft Polyester Mesh or Vinyl coated Polyester Mesh Material  
Custom Printed with 4 x 18 inch 3M™ Scotchlite™  
Reflective Panels Attached to/or Printed Directly on the Vest

Available  
in All Sizes



**Meets Government  
and Military Specifications**  
**Excellent Quality – Competitive Pricing**

**SP** PRODUCTS, INC.  
*Productivity and value thru ideas*



730 Pratt Boulevard • Elk Grove Village, IL 60007 • P: (847) 593-8595 • F: (847) 593-8629 • Toll-free (800) 233-8595 • E: info@spproducts.com • www.spproducts.com

**TE16**

7-23-13

*Proud to be the electricians' friend for over 47 years and  
a long time supporter of contractor training programs.*



# Emergency Back Packs

## For Support During the First Critical Hours

**Customized  
to fit your  
needs!**



### STANDARD UNIT SHOWN ABOVE COMPLETE WITH:

Cat# EBP15

- |                                 |                                |                             |                              |
|---------------------------------|--------------------------------|-----------------------------|------------------------------|
| 1- Waterproof Tarp (8x10)       | 1- Red Pen                     | 1- First Aid Kit (64 piece) | 2- Highlight Marker          |
| 2- Safety Lights Sticks (12 hr) | 1- Black Pen                   | 2- Pencils                  | 1- Roll Toilet Paper         |
| 1- Emergency Rain Poncho        | 1- Pad Paper (8.5x11)          | 1- Whistle with Lanyard     | 2- Emergency Thermal Blanket |
| 6- Water Bottles (16.5 oz)      | 1- Black Permanent Marker      | 1- Safety Vest              | 30- Paper Cups (3oz)         |
| 12- Emergency Energy Bars       | 1- Handcrank L.E.D. Flashlight | 1- Clipboard                |                              |

**BACKPACK CONTENTS CAN BE MODIFIED TO YOUR REQUIREMENTS**

## Portable, lightweight, and extremely durable

**SP PRODUCTS, INC.**  
Productivity and value thru ideas



Where shown



730 Pratt Boulevard • Elk Grove Village, IL 60007 • P: (847) 593-8595 • F: (847) 593-8629 • Toll-free (800) 233-8595 • E: info@spproducts.com • www.spproducts.com



*Proud to be the electricians' friend for over 47 years and a long time supporter of contractor training programs.*

**TE17**

7-23-13





# Wire Cart

## Safer and Faster

### Reduces Injuries and Saves 100s of Hours Throughout its' Use

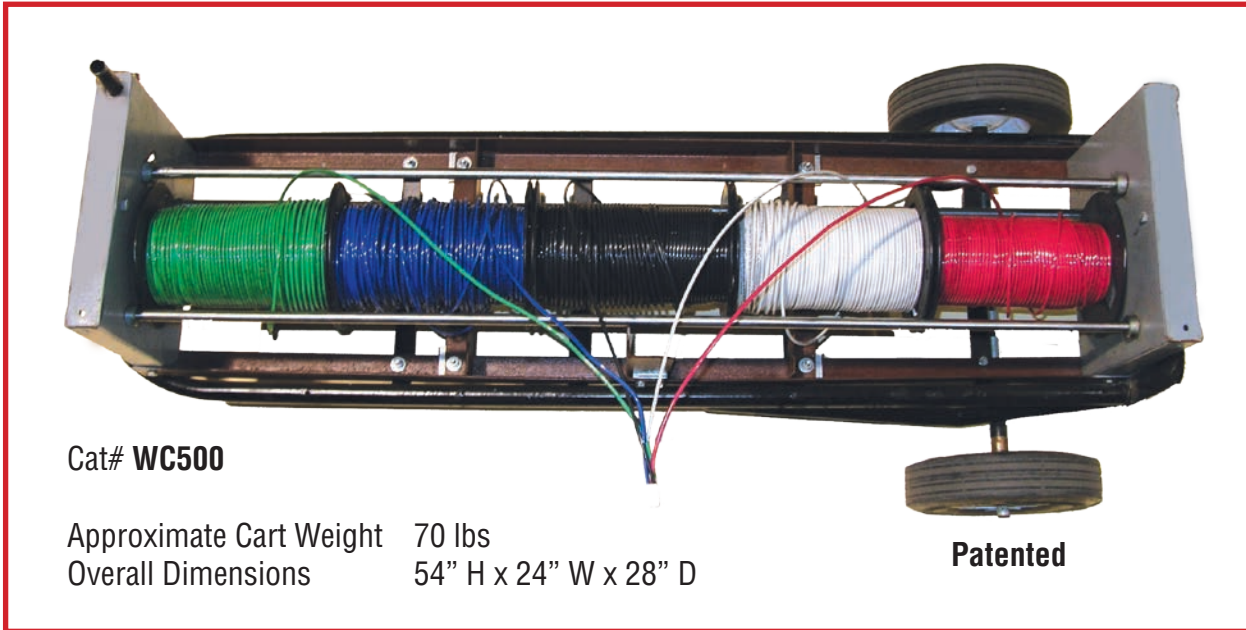

**Built-in Flexible Tensioned Retaining Bars Allow Instant Loading and Removing 500 Foot Reels Located at any Point on the Cart**

*Carts for 2,500 foot #10 and #12 AWG wire available in near future*

## Allows Greater Utilization of Partial Reels to Reduce Waste

**SP PRODUCTS, INC.**  
*Productivity and value thru ideas*

 Made in the USA

  US PATENTED

Where shown

730 Pratt Boulevard • Elk Grove Village, IL 60007 • P: (847) 593-8595 • F: (847) 593-8629 • Toll-free (800) 233-8595 • E: info@spproducts.com • www.spproducts.com



7-23-13

*Proud to be the electricians' friend for over 47 years and a long time supporter of contractor training programs.*



**NEW!**

# Hand Truck with Battery Operated Lift Reduces Risk of Injury



**One Worker  
Can Safely Lift  
500 lbs Up To  
36" Height**



Patented

- Platform set at an 89° angle to prevent load from tipping
- Base platen allows unit to be free standing, even when raised and lowered under load
- Overnight charge lasts more than 12 hours of operations
- Platform with back rest has 10 slots for securing load with bungee cords or straps

MODEL	LIFT CAPACITY	VERTICAL LIFT RANGE	PLATFORM DIMENSIONS	WEIGHT
ALT 500 P	500 lbs	36 inches	20" w X 12" deep+ 4" ramp	82 lbs

**COMPLETE WITH BUILT-IN CHARGER**

## For All Types of Material and Equipment in Any Type Business or Trade

**SP PRODUCTS, INC.**  
Productivity and value thru ideas



Where shown



730 Pratt Boulevard • Elk Grove Village, IL 60007 • P: (847) 593-8595 • F: (847) 593-8629 • Toll-free (800) 233-8595 • E: info@spproducts.com • www.spproducts.com



*Proud to be the electricians' friend for over 47 years and  
a long time supporter of contractor training programs.*

**TE19**

7-23-13



# Wire Chart EZ Peel and Stick



Patented

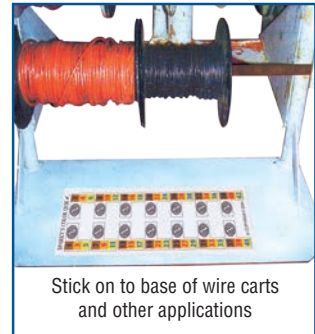
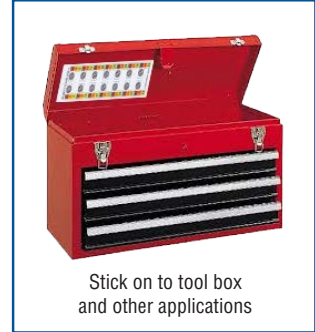

## Eliminate time lost and quickly identify phase colors



730 Pratt Boulevard • Elk Grove Village, IL 60007 • P: (847) 593-8595 • F: (847) 593-8629 • Toll-free (800) 233-8595 • E: info@spproducts.com • www.spproducts.com



7-23-13

*Proud to be the electricians' friend for over 47 years and a long time supporter of contractor training programs.*





# EZ Cable Ties

For Bundling and Storing all Types of  
Cord, Rope, Hoses, etc.

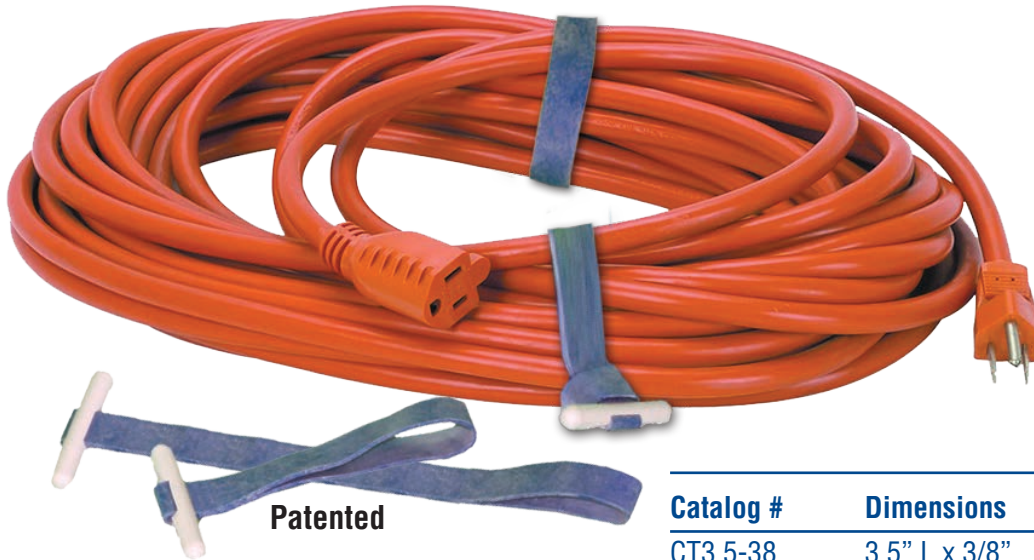

On/off in seconds for a secure installation. Just wrap around cable, rope, hoses, etc. and feed plastic head thru loop.

Catalog #	Dimensions	Qty
CT3.5-38	3.5" L x 3/8"	10/bag
CT5.0-58	5.0" L X 5/8" W	10/bag
CT7.0-58	7.0" L x 5/8" W	10/bag
CT11.0-58-5	11.0" L x 5/8" W	5/bag
CT11.0-58-10	11.0" L x 5/8" W	10/bag
Bulk Pack	Assorted Sizes	Specified



Also suitable for sensitive low voltage and other cable installations

**Extremely strong, fast and secure  
on/off in seconds**

**SP PRODUCTS, INC.**  
Productivity and value thru ideas



Where shown



730 Pratt Boulevard • Elk Grove Village, IL 60007 • P: (847) 593-8595 • F: (847) 593-8629 • Toll-free (800) 233-8595 • E: info@spproducts.com • www.spproducts.com



*Proud to be the electricians' friend for over 47 years and  
a long time supporter of contractor training programs.*



7-23-13

# Clip On/Off Phone Hanger

**NEW!** For Cell, Smart, iPhones, etc.

**12 O'Clock Position**

**6 O'Clock Position**

**PATENTED**

**Split ring enables quick attachment and release.**

**Does not interfere with functions of Cell or Smart Phones, iPods, Remotes, etc. Also suitable when using cell phone for GPS in car.**

**Clip rotates 360° in either direction and snaps in place at 12 and 6 O'Clock.**

**Extremely strong and durable. Attach and remove from belt loop, or purse for quick access throughout the day. Phone conveniently remains at users side.**

**Firmly attach to clip with extremely strong adhesive disc provided. Can be customized and later changed with any logo desired.**

*Strong and durable. Firmly attaches to phone, hardcase or purse*

## Extremely useful and unique promotional item

**SP PRODUCTS, INC.**  
Productivity and value thru ideas



730 Pratt Boulevard • Elk Grove Village, IL 60007 • P: (847) 593-8595 • F: (847) 593-8629 • Toll-free (800) 233-8595 • E: Info@spproducts.com • www.spproducts.com

**TE22**

7-23-13

*Proud to be the electricians' friend for over 47 years and a long time supporter of contractor training programs.*



# Clip On/Off Phone Hanger

**NEW!**

## For Cell, Smart, iPhones, etc.

**12 O'Clock Position**

**6 O'Clock Position**

**PATENTED**

**Split ring enables quick attachment and release.**

**Does not interfere with functions of Cell or Smart Phones, iPods, Remotes, etc. Also suitable when using cell phone for GPS in car.**

**Clip rotates 360° in either direction and snaps in place at 12 and 6 O'Clock.**

**Firmly attach to clip with extremely strong adhesive disc provided. Can be customized and later changed with any logo desired.**

**Extremely strong and durable. Attach and remove from belt loop, or purse for quick access throughout the day. Phone conveniently remains at users side.**

***Strong and durable. Firmly attaches to phone, hardcase or purse***

## **Extremely useful and unique promotional item**

**SP PRODUCTS, INC.**  
*Productivity and value thru ideas*



*Where shown*



730 Pratt Boulevard • Elk Grove Village, IL 60007 • P: (847) 593-8595 • F: (847) 593-8629 • Toll-free (800) 233-8595 • E: info@spproducts.com • www.spproducts.com

**TE22**  
7-23-13

***Proud to be the electricians' friend for over 47 years and a long time supporter of contractor training programs.***







# Quick Winder for Cable/Cord/Rope, etc.

Eliminates kinks, knots, and tangles. Neatly coils wire/cable into stackable bucket.  
Models available to handle from 50 up to 1,000 feet

## 10-Models Available

**RAP 50**

50-275 ft capacity

**RAP 100**

75-350 ft capacity

**RAP 100-OWGFI**

75-350 ft capacity

**RAP 150**

100-500 ft capacity

**RAP 200**

125-650 ft capacity

**RAP 225**

150-775 ft capacity

**RAP 600**

300-1600 ft capacity

**RAP 600-WC**

300-1600 ft capacity

**RAP 1000-WC**

500-4000 ft capacity

**RAP C410**

300-1600 ft capacity



RAP 50

RAP 100  
RAP QWGF 100

RAP 150



RAP 200



RAP 225



RAP 600



RAP 1000 WC



RAP 600 WC

**PATENTED**

## Organize cords, cables, ropes, etc. into portable stackable bucket



Where shown



730 Pratt Boulevard • Elk Grove Village, IL 60007 • P: (847) 593-8595 • F: (847) 593-8629 • Toll-free (800) 233-8595 • E: info@spproducts.com • www.spproducts.com



*Proud to be the electricians' friend for over 47 years and  
a long time supporter of contractor training programs.*



7-23-13

# **NEW!** “No-Dog” Offset Level

## **Bend Conduit Faster and Acurately Every Time**

- Precision tooled from lightweight durable aluminum

- Eliminates “Dog Legs” in offsets and saddles

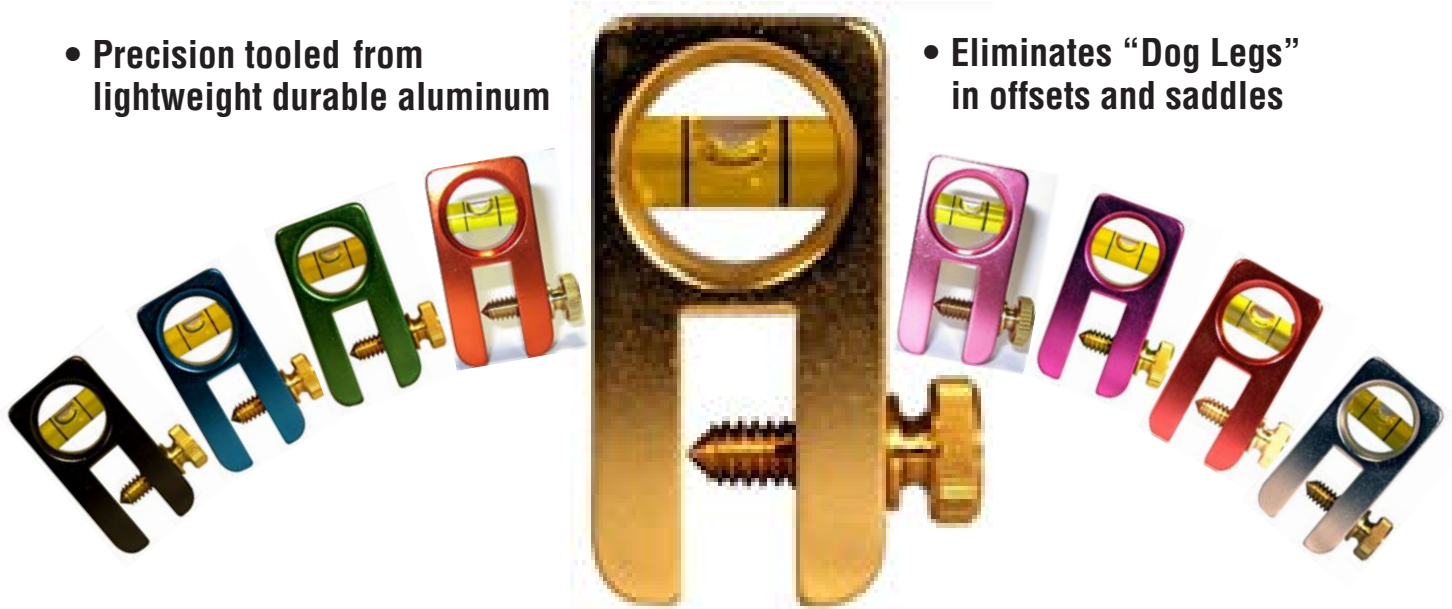

Available in the following colors for owner identification:  
Black, Blue, Gold, Green, Orange, Pink, Purple, Red and Silver.



### “No-Dog” 6 inch Level

- Houses 5 precisely hand set acrylic vials
- Three neo-dymium (rare earth) extremely strong magnets

**Extremely affordable  
Every electrician should have one**

**GP** PRODUCTS, INC.  
*Productivity and value thru ideas*



730 Pratt Boulevard • Elk Grove Village, IL 60007 • P: (847) 593-8595 • F: (847) 593-8629 • Toll-free (800) 233-8595 • E: info@spproducts.com • www.spproducts.com

**TE24**

7-23-13

*Proud to be the electricians' friend for over 47 years and  
a long time supporter of contractor training programs.*



# Portable Cable Puller for Power, Data, and Video in Light Poles etc.

Recently 2 electricians pulled a total of  
50,000 feet of #4 cable in one day!

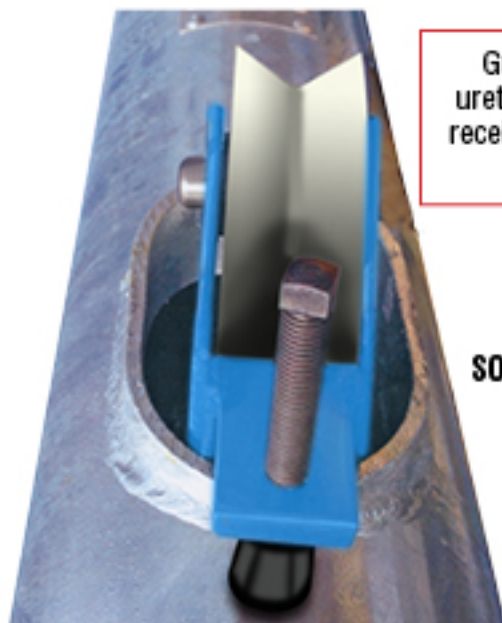

Cat# PWP 100

Grooved bearing grade urethane wheel for long life receives and controls cables during pull

4 lbs Each  
SOLD IN SETS OF 2

**NEW!**

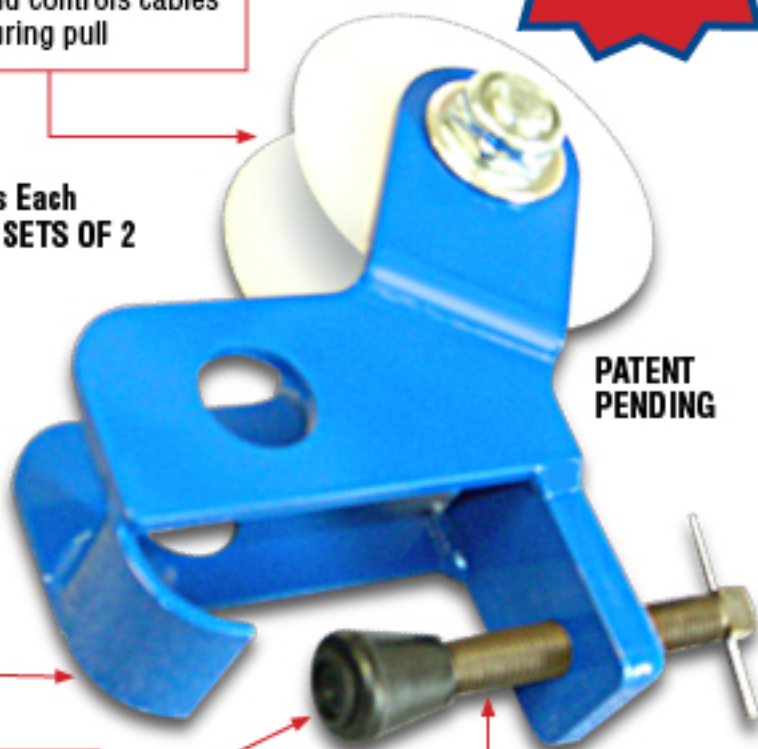

PATENT PENDING

Cable Puller hooks onto bottom edge of the hand hole

Durable plastic cap to protect pole from being damaged when attached at hand hole

Heavy duty bolt to secure cable puller to pole hand hole

Quickly attach to hand hole of each pole and  
pull wire with no damage to poles or wire

**SP** PRODUCTS, INC.  
Productivity and value thru ideas



US PATENTED



Where shown

730 Pratt Boulevard • Elk Grove Village, IL 60007 • P: (847) 593-8595 • F: (847) 593-8629 • Toll-free (800) 233-8595 • E: [Info@spproducts.com](mailto:Info@spproducts.com) • [www.spproducts.com](http://www.spproducts.com)



*Proud to be the electricians' friend for over 47 years and  
a long time supporter of contractor training programs.*

**TE25**

7-23-13



# Portable Cable Puller for Power, Data, and Video in Light Poles etc.

Recently 2 electricians pulled a total of  
50,000 feet of #4 cable in one day!

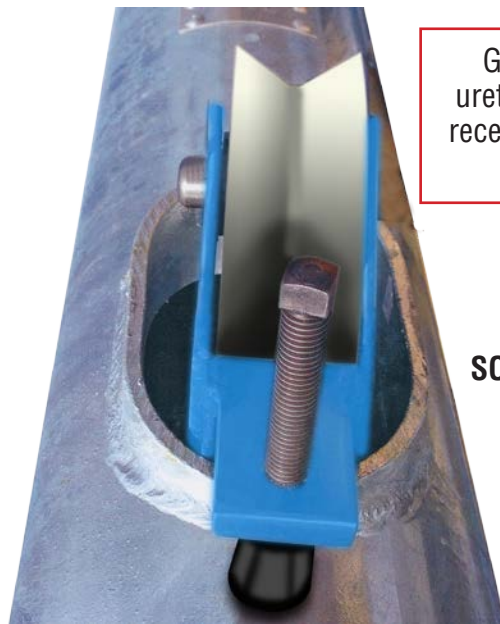

Cat# PWP 100

Grooved bearing grade urethane wheel for long life receives and controls cables during pull

4 lbs Each  
SOLD IN SETS OF 2



PATENT  
PENDING

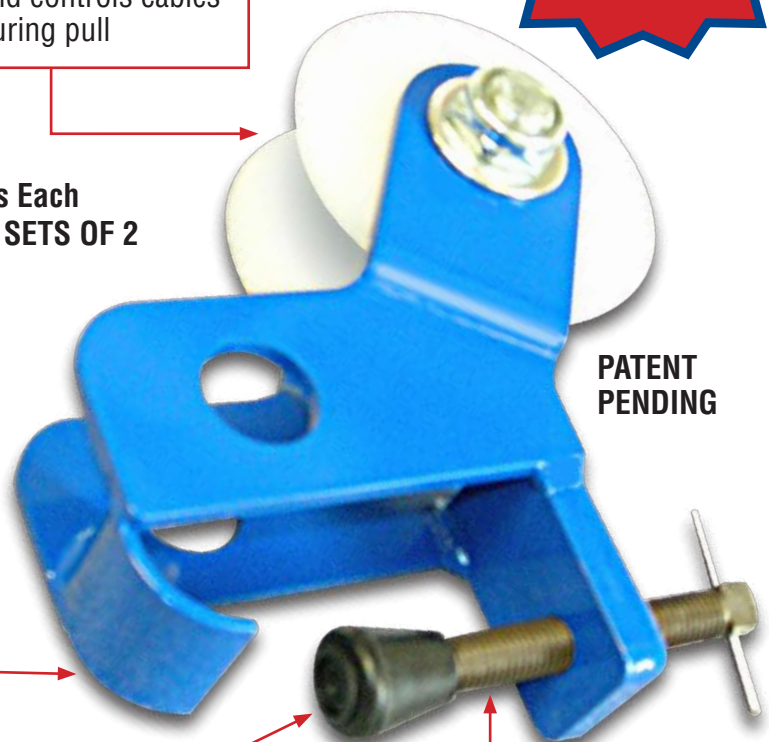

Cable Puller hooks onto bottom edge of the hand hole

Durable plastic cap to protect pole from being damaged when attached at hand hole

Heavy duty bolt to secure cable puller to pole hand hole

Quickly attach to hand hole of each pole and  
pull wire with no damage to poles or wire



Where shown



730 Pratt Boulevard • Elk Grove Village, IL 60007 • P: (847) 593-8595 • F: (847) 593-8629 • Toll-free (800) 233-8595 • E: info@spproducts.com • www.spproducts.com



*Proud to be the electricians' friend for over 47 years and  
a long time supporter of contractor training programs.*

**TE25**

7-23-13