



Light Duty, p. 3-2



General Duty, p. 3-2



Heavy Duty, p. 3-4



Stainless Steel Heavy Duty, p. 3-7

Light Duty

Fusible	3-2
Application Data and Dimensions	3-3
Standards:	
<ul style="list-style-type: none"> • UL 98 Enclosed and Dead Front Switches. UL Listed under File E2875. • NEMA Standards Publication KS1. Enclosed Switches. 	

General Duty

Fusible and Non-Fusible	3-2
Application Data and Dimensions	3-3
Standards:	
<ul style="list-style-type: none"> • UL 98 Enclosed and Dead Front Switches. UL Listed under File E2875. • NEMA Standards Publication KS1. Enclosed Switches. 	

Heavy Duty

New!

Fusible	3-4
Non-Fusible	3-6
Special Application Enclosures	3-7
Motor Disconnect and Receptacle Switches	3-8
Accessories	3-11
Application Data and Dimensions	3-13
Standards:	
<ul style="list-style-type: none"> • UL 98 Enclosed and Dead Front Switches. UL Listed under files E2875, E154828, E233505 and E317818. • UL 508 Industrial Control Equipment, file E 164864. • NEMA Standards Publication KS1 Enclosed Switches (UL98 Switches Only). 	

Double Throw

Fusible and Non-Fusible	3-15
Accessories	3-18
Standards:	
<ul style="list-style-type: none"> • UL 98 Enclosed and Dead Front Switches. UL Listed under files E2875 (unless otherwise noted). • NEMA Standards Publication KS1 Enclosed Switches (applies to Type DT and DTU series F only). 	
Application Data and Dimensions	3-19

New!

1000 Vdc Photovoltaic Heavy Duty Disconnect Switch

Standards:	
<ul style="list-style-type: none"> • UL 98 Enclosed and Dead Front Switches • UL Listed under file E343347 • IEC 60947 - 1 Electrical • IEC 60947 - 3 Mechanical • NEMA standard. Publication KS-1 Enclosed Switches • IP 63 and NEMA 3 Enclosure 	3-22

Light Duty—Visible Blades 10 kA Short Circuit Current Rating

The Square D light duty enclosed switch is ideal for home applications in disconnecting power to workshops, hobby rooms, furnaces, and garages.

Table 3.1: Fusible

System	Amperes	Fuse	NEMA 1 Indoor		Horsepower Ratings		System	Amperes	Fuse	NEMA 1 Indoor		Horsepower Ratings	
			Cat. No.	\$ Price	Std.	Max.				Cat. No.	\$ Price	Std.	Max.
2 Wire (1 Blade and Fuseholder, 1 Neutral)—120 Vac							3 Wire (2 Blades and Fuseholders, 1 Neutral)—120/240 Vac						
	30	Plug	L111N	\$54.00	1/2	2		30	Plug	L211N	72.00	1-1/2▲	3▲
								30	Cart.	L221N	98.00	1-1/2▲	3▲

▲ For single phase hp rating, use two switching poles.

General Duty—Up To 100 kA Short Circuit Current Rating With Proper Current Limiting Fusing

General duty safety switches are designed for residential and commercial applications where durability and economy are prime considerations. Typical loads are lighting, air conditioning, and appliances. They are suitable for use as service equipment when equipped with a factory- or field-installed neutral assembly or a field-installed service grounding kit, (see Table 3.6) as applicable.

General duty safety switches are UL Listed, File E2875, and meet or exceed the NEMA Standard KS1.

Table 3.2: Fusible

System	Amperes	Fuse	NEMA 1 Indoor		NEMA 3R▲ Rainproof		Class R Fuse Kits Field-Installed■		Horsepower Ratings			
			Cat. No.	\$ Price	Cat. No.	\$ Price	Cat. No.	\$ Price	Std. (Fast Acting One-Time Fuses)		Max. (Dual Element Time-Delay Fuses)	
									1Ø	3Ø	1Ø	3Ø
2 Wire (1 Blade and Fuseholder, 1 Neutral)—120 Vac												
	30	Plug	Use Light Duty Device for this Application (see below)									
	30	Cart.	Use three-wire devices for this application.									
3 Wire (2 Blades and Fuseholders, 1 Neutral)—120/240 Vac (Plug), 240 Vac (Cart.) Maximum												
	30	Plug	D211N	90.00	D211NRB	177.00	—	—	1-1/2	—	3	—
	30	Cart.	D221N	122.00	D221NRB	188.00	DRK30	25.65	1-1/2	3♦	3	7-1/2♦
	60	Cart.	D222N	206.00	D222NRB	326.00	RFK03H	25.50	3	7-1/2♦	10	15♦
	100	Cart.	D223N	426.00	D223NRB	480.00	RFK10	47.70	7-1/2	15♦	15	30♦
	200	Cart.	D224N▼	884.00	D224NRB▼	1200.00	HRK1020	47.70	15	25♦	—	60♦
	400	Cart.	D225N	2555.00	D225NR	3459.00	DRK40	111.00	—	—	—	—
600□	Cart.	D226N	5109.00	D226NR	6569.00	DRK600	111.00	—	—	—	—	
4 Wire (3 Blades and Fuseholders, 1 Neutral)—240 Vac Maximum												
	30	Cart.	D321N	188.00	D321NRB	293.00	DRK30	25.65	1-1/2	3	3	7-1/2
	60	Cart.	D322N	326.00	D322NRB	441.00	RFK03H	25.50	3	7-1/2★	10	15★
	100	Cart.	D323N	564.00	D323NRB	816.00	RFK10	47.70	7-1/2	15★	15	30★
	200	Cart.	D324N▼	1202.00	D324NRB▼	1461.00	HRK1020	47.70	15	25★	—	60★
	400	Cart.	D325N	3113.00	D325NR	3893.00	DRK40	111.00	—	50	—	125
	400△	Class T	D325NT	2994.00	D325NTR	3741.00	—	—	—	50	—	—
	600□	Cart.	D326N	5823.00	D326NR	7877.00	DRK600	111.00	—	75	—	150
	600△	Class T	D326NT	5598.00	D326NTR	7569.00	—	—	—	75	—	—
	800△	Class T	T327N	9722.00	T327NR	12438.00	—	—	—	100	—	—

▲ Bolt-on hubs—Refer to page 3-10.

■ When installed, this kit rejects all but Class R fuses.

♦ For corner grounded delta systems only. Use switching poles for ungrounded conductors. See data bulletin 2700DB0202 for additional information.

★ If corner grounded delta, use outer switching poles for ungrounded conductors.

▼ For 200% neutral, order (1) additional neutral kit SN20A and (1) neutral jumper kit SN20NI.

△ Class T 400–800 A general duty safety switches use 300 Vac Class T fuses and are UL Listed for use on systems with up to 100 kA available fault current.

□ Order Class J fuse kit: GDJK600 for Class J fuses.

Table 3.3: Non-Fusible

System	Amperes	NEMA 1 Indoor		NEMA 3R Rainproof ♦		Horsepower Ratings (Max.)	
		Cat. No.	\$ Price	Cat. No.	\$ Price	1Ø	3Ø
2 Wire (2 Blades)—240 Vac Maximum							
	30	—	—	DU221RB	177.00	3	—
	60	—	—	DU222RB	353.00	10	—
	60	QO260NATS★▼	161.00	QO200TR★▼◊	161.00	10	—
	100	QO200NS★▼	276.00	QO200NRB★◊	338.00	20	—
	200	Use 3P Switch	—	Use 3P Switch	—	—	—
	400■	Use 3P Switch	—	Use 3P Switch	—	—	—
600	Use 3P Switch	—	Use 3P Switch	—	—	—	
3 Wire (3 Blades)—240 Vac Maximum							
	30	DU321	155.00	DU321RB	293.00	3	7-1/2
	60	DU322	206.00	DU322RB	443.00	10	15
	100	DU323*	477.00	DU323RB*	816.00	15	30
	200	DU324◊	884.00	DU324RB◊	1461.00	15	60◊
	400■	DU325	2198.00	—	—	—	125
	600	DU326◊	4191.00	—	—	—	150

♦ Bolt-on hubs—Refer to page 3-10.

★ Enclosed molded case switch—Refer to page 1-24.

▼ Includes factory-installed grounding kit.

◊ Not service entrance rated—Refer to page 1-19 for more information.

* If a neutral assembly is required, order and field-install SN0610.

◊ If a neutral assembly is required, order and field install a SN20A Neutral Assembly Kit. For a 200% neutral application, order and field install (2) SN20A Neutral Assembly Kits and (1) SN20NI Neutral Jumper Kit.

◊ If a neutral assembly is required, order part number D600SN. Available for field-installation.

◊ For single phase hp rating, use two switching poles.

■ To accept J class fuses, move fuse bases to the embossed guide inside of the switch.



UL Listed Short Circuit Withstand Rating		
Switch Type	Fuse Class	Short Circuit Rating
Fusible	Plug	10 kA
	H	10 kA
	K	10 kA
	J	100 kA
	R	100 kA
Non-Fusible▲	T	100 kA
	H	10 kA
	K	10 kA
	J	100 kA
	R	100 kA■
	T	100 kA

▲ The UL Listed short-circuit current rating for Square D general duty, not fusible switches is based on the switch being used in conjunction with fuses. Evaluation of non-fusible switches in conjunction with molded case circuit breakers above 10,000 amps has not been performed. For applications requiring greater protection, consider using a heavy duty safety switch. Refer to UL Listed Maximum Short Circuit Current Ratings—AC only—on page 3-6. If a UL Listed short-circuit current rating is required, this non-fusible switch must be replaced with a Square D general duty fusible safety switch equipped with the appropriate class and size fusing. Consult the wiring diagram of the switch to verify the UL Listed short-circuit current rating.

■ 50 kA for 60 A non-fusible switch.

Table 3.4: Terminal Lug Data ▲

Amperes	Conductors Per Phase	Wire Bending Space Per NEC Table 312.6 AWG/kcmil	Lug Wire Range AWG/kcmil
30	1	12-6 (Al) or 14-6 (Cu)	12-6 (Al) or 14-6 (Cu)
60	1	10-3 (Al) or 14-3 (Cu)	10-2 (Al) or 14-2 (Cu)
100	1	12-1 (Al) or 14-1 (Cu)	12-1/0 (Al) or 14-1/0 (Cu)
200	1	6-250 (Al/Cu)	6-300 (Al/Cu)
400 NEMA 1	1 or 2	1/0-600 (Al/Cu) or 1/0-300 (Al/Cu)	(1) 1/0-750 (Al/Cu) or (2) 1/0-300 (Al/Cu)
400 NEMA 3R	2	1/0-250 (Al/Cu)	(1) 1-600 (Al/Cu) or (2) 1/0-250 (Al/Cu)
600	2	4-500 (Al/Cu)	4-600 (Al/Cu)
800	3	3/0-500 (Al/Cu)	3/0-500 (Al/Cu)

▲ 30-100 A switches suitable for 60°C or 75°C conductors. 200-800 A switches suitable for 75°C conductors.

NOTE: Field-installed lug kits are located in the Supplemental Digest page 2.2.

Field-Installed Fuse Puller Kits

Kit consists of three fuse pullers as required for a 3P, fusible, 60 and 100 A general duty switch. Kits can be installed in 60 and 100 A Series F switches.

Table 3.5: Fuse Puller Kits

Description	Cat. No.	\$ Price
Series F 60 A Fuse Puller Kit	FPK03	30.00
Series F 100 A Fuse Puller Kit	FPK0610	42.60

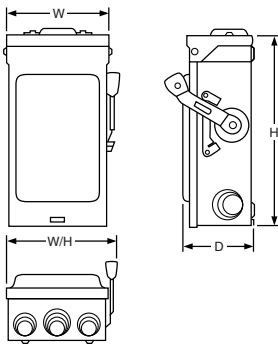

Table 3.8: Approximate Dimensions

Cat. No.	Series	H		W		W/H		D		Std. Pack
		in.	mm	in.	mm	in.	mm	in.	mm	
L111N	E2	7.63	194	5.00	127	6.13	156	4.00	102	1
L211N	E2	7.63	194	5.00	127	6.13	156	4.00	102	1
L221N	E2	7.63	194	5.00	127	6.13	156	4.00	102	1
D211N ♦	E3	9.25	235	6.75	171	7.25	184	3.63	92	5
D211NRB ♦	E2	9.63	245	7.25	184	7.75	197	3.75	95	5
D221N ♦	E3	9.25	235	6.75	171	7.25	184	3.63	92	5
D221NRB ♦	E3	9.63	245	7.25	184	7.75	197	3.75	95	5
D222N	F1	14.63	372	6.50	165	7.45	189	4.88	124	1
D222NRB	F1	14.88	378	6.63	168	7.45	189	4.88	124	1
D223N	F3	17.50	445	8.50	216	10.50	267	6.50	165	1
D223NRB	F3	17.50	445	8.50	216	10.50	267	6.50	165	1
D224N	F1	29.00	737	17.25	438	19.00	483	8.25	210	1
D224NRB	F1	29.25	743	17.25	438	19.00	483	8.25	210	1
D225N	E3	45.12	1146	24.00	610	24.88	632	8.88	226	1
D225NR	E1	30.63	778	21.38	543	22.25	565	10.13	257	1
D226N ♦	E3	49.13	1248	24.00	610	24.88	632	8.88	226	1
D226NR ♦	E1	49.13	1248	24.75	629	25.13	638	8.88	226	1
D321N ♦	E3	9.25	235	6.75	171	7.25	184	3.63	92	5
D321NRB ♦	E3	9.63	245	7.25	184	7.75	197	3.75	95	5
D322N	F1	14.63	372	6.50	165	7.45	189	4.88	124	1
D322NRB	F1	14.88	378	6.63	168	7.45	189	4.88	124	1
D323N	F3	17.50	445	8.50	216	10.50	267	6.50	165	1
D323NRB	F3	17.50	445	8.50	216	10.50	267	6.50	165	1
D324N	F1	29.00	737	17.25	438	19.00	483	8.25	210	1
D324NRB	F1	29.25	743	17.25	438	19.00	483	8.25	210	1
D325N ♦	E3	45.12	1146	24.00	610	24.88	632	8.88	226	1
D325NT ♦	E3	45.12	1146	24.00	610	24.88	632	8.88	226	1
D325NR ♦	E1	30.63	778	21.38	543	22.25	565	10.13	257	1

♦ 30-100 A switches suitable for 60°C or 75°C conductors. 200-800 A switches suitable for 75°C conductors.

Table 3.6: Field-Installed Service Grounding Kits

Amperes	Cat. No.	\$ Price	Wire Size (AWG)
30	PK3GTA1	11.40	(2) 12 Cu or (2) 10 Al or (1) 4 Al/Cu Max.
60 ▲	PK3GTA1	11.40	(2) 12 Cu or (2) 10 Al or (1) 4 Al/Cu Max.
60 ■	GTK03	11.40	(2) 12 Cu or (2) 10 Al or (1) 4 Al/Cu Max.
100	GTK0610	18.90	(2) 1/0 Al/Cu Max.
200	PKOGTA2	55.00	(2) 2/0 Al/Cu Max.
400	PKOGTA2	55.00	(2) 2/0 Al/Cu Max. Per Lug
600	(Two Required)		
800	PKOGTA3	123.00	(6) 3/0 Al/Cu Max.

▲ Series E switch only.
■ Series F switch only.

Field-Installed Electrical Interlock Kits

Electrical interlocks for Series F 100-200 A general duty safety switches and Series F 60 A fusible general duty safety switches are available in kit form for field installation. Each kit contains instructions for proper field mounting. A pivot arm operates from switch mechanism, breaking the control circuit before the main switch blades break. Switches with electrical interlocks installed are UL Listed.

Table 3.7: Electrical Interlock Kit

Switch's Amperes Rating	Series	Electrical Interlock Kit Cat. No. ▲	\$ Price
60	F ■	EIK031 or EIK032	218.00
100-200	F	EIK1 or EIK2	311.00

▲ Electrical interlock kit catalog numbers with -1 suffix indicates one normally open and one normally closed contact; -2 indicates two normally open and two normally closed contacts. Kits are UL Listed.
■ Fusible series.



NEMA 1 NEMA 3R NEMA 4, 4X and 5 NEMA 12
Stainless Steel

Visible blade heavy duty safety switches are designed for application where maximum performance and continuity of service are required. All heavy duty safety switches feature quick-make, quick-break operating mechanism, a dual cover interlock and a color coded indicator handle. They are suitable for use as service equipment when equipped with a field- or factory-installed neutral assembly or equipment grounding kit, unless a 600Y/347 V or 480 Y/277 V, 1000 A or greater, solidly grounded WYE system is used, per NEC 215-10. Heavy duty safety switches are UL Listed (except as noted), File E2875 and 154828 and meet or exceed the NEMA Standard KS1. For UL Listed short circuit current ratings, see page 3-6.

Table 3.9: 240 Volt—Single Throw Fusible

System	Amperes	NEMA 1 Indoor		NEMA 3R Rainproof (Bolt-on Hubs, page 3-10)		NEMA 4, 4X, 5, ▲ 304 Stainless Steel (for 316 stainless, see page 3-7) Dust tight, Watertight, Corrosion Resistant (Watertight Hubs, page 3-10)		NEMA 12K With Knockouts (Watertight Hubs, page 3-10)		NEMA 12, 3R ■ Without Knockouts (Watertight Hubs, page 3-10)		Horsepower Ratings				
		Cat. No. \$ Price		Cat. No. \$ Price		Cat. No. \$ Price		Cat. No. \$ Price		Cat. No. \$ Price		240 Vac		250 Vdc ♦		
												Std. (Using Fast Acting, One Time Fuses)			Max. (Using Dual Element, Time Delay Fuses)	
												1Ø	3Ø	1Ø	3Ø	
2-Wire (2 Blades and Fuseholders)—240 Vac, 250 Vdc																
	30	Use three-wire devices For two-wire applications				H221DS	1947.00	H221A	504.00	H221AWK	473.00	1-1/2	3 ★	3	7-1/2★	5
	30					—	—	—	—	H221AWK▼	588.00	1-1/2	—	3	—	5
	60					H222DS	2337.00	—	—	H222AWK	647.00	3	7-1/2★	10	15 ★	10
	100					H223DS	5094.00	H223A	1008.00	H223AWK	948.00	7-1/2	15 ★	15	30 ★	20
	200					H224DS	6960.00	H224A	1737.00	H224AWK	1643.00	15	25 ★	—	60 ★	40
	400	H225	2729.00	H225R	3884.00	H225DS	14481.00	—	—	H225AWK	4163.00	—	—	—	—	50
	600	H226	5424.00	H226R	7281.00	H226DS	20772.00	—	—	H226AWK	6543.00	—	75 ★	—	200 ★	50
	800	H227	8459.00	H227RΔ	11483.00	—	—	—	—	H227AWK	10325.00	50	—	50	—	50
1200	H228	11682.00	H228RΔ	15486.00	—	—	—	—	H228AWK	15815.00	50	—	50	—	50	
3-Wire (2 Blades and Fuseholders, 1 Neutral)—240 Vac, 250 Vdc																
	30	H221N	236.00	H221NRB	447.00	Use two-wire devices, Field-installed solid neutral assemblies Order separately. See page 3-11.					1-1/2	3 ★	3	7-1/2 ★	5	
	60	H222N	471.00	H222NRB	842.00						3	7-1/2★	10	15 ★	10	
	100	H223N	716.00	H223NRB	1086.00						7-1/2	15 ★	15	30 ★	20	
	200	H224N	1289.00	H224NRB	1562.00						15	25 ★	—	60 ★	40	
	400	H225N	3092.00	H225NR	4245.00	H225NDS	14787.00	—	—	H225NAWK	4304.00	—	50 ★	—	125 ★	50
	600	H226N	5819.00	H226NR	7677.00	H226NDS	21081.00	—	—	H226NAWK	6936.00	—	75 ★	—	200 ★	50
	800	H227N	10067.00	H227NRΔ	12216.00	—	—	—	H227NAWK	12338.00	50	—	50	—	50	
	1200	H228N	12422.00	H228NRΔ	16665.00	—	—	—	H228NAWK	17184.00	50	—	50	—	50	
3-Wire (3 Blades and Fuseholders)—240 Vac, 250 Vdc																
	30	Use four-wire devices For three-wire applications				H321DS	2049.00	H321A	639.00	H321AWK	639.00	1-1/2	3	3	7-1/2	5
	60					H322DS	2532.00	H322A	914.00	H322AWK	864.00	3	7-1/2	10	15	10
	100					H323DS	5346.00	H323A	1412.00	H323AWK	1331.00	7-1/2	15	15	30	20
	200					H324DS	7496.00	H324A	2040.00	H324AWK	1926.00	15	25	—	60	40
	400	H325	3425.00	H325R	3975.00	H325DS	14961.00	—	—	H325AWK	4253.00	—	50	—	125	50
	600	H326	6170.00	H326R	8286.00	H326DS	21399.00	—	—	H326AWK	7365.00	—	75	—	200	50
	800	H327	11456.00	H327RΔ	14849.00	—	—	—	H327AWK	14528.00	50	100	50	250	50	
	1200	H328	14517.00	H328RΔ	18728.00	—	—	—	H328AWK	17450.00	50	100	50	250	50	
4-Wire (3 Blades and Fuseholders, 1 Neutral)—240 Vac, 250 Vdc																
	30	H321N	314.00	H321NRB	555.00	Use three-wire devices, Field-installed solid neutral assemblies Order separately. See page 3-11					1-1/2	3	3	7-1/2	5	
	60	H322N	528.00	H322NRB	891.00						3	7-1/2	10	15	10	
	100	H323N	842.00	H323NRB	1278.00						7-1/2	15	15	30	20	
	200	H324N	1451.00	H324NRB	1748.00						15	25	—	60	40	
	400	H325N	3788.00	H325NR	4322.00	H325NDS	15321.00	—	—	H325NAWK	4635.00	—	50	—	125	50
	600	H326N	6519.00	H326NR	8622.00	H326NDS	21759.00	—	—	H326NAWK	7757.00	—	75	—	200	50
	800	H327N	12189.00	H327NRΔ	15563.00	—	—	—	H327NAWK	15879.00	50	100	50	250	50	
	1200	H328N	15314.00	H328NRΔ	19709.00	—	—	—	H328NAWK	20015.00	50	100	50	250	50	
4-Wire (4 Blades and Fuseholders)																
	30	Use 600 Vac devices. See page 3-5.														
	60															
	100															
	200															
	400															

- ▲ Complete rating is NEMA 3, 3R, 4, 4X, 5 and 12. For NEMA 3R applications, remove drain screw from bottom endwall.
- Also suitable for NEMA 3R application by removing drain screw from bottom endwall.
- ♦ For switching dc, use two outside switching poles.
- ★ For corner grounded delta systems only and with neutral assembly installed. Use switching poles for ungrounded conductors.
- ▼ 60 ampere switch with 30 ampere fuse spacing and clips. Must use 60 A enclosure accessories including electrical interlocks.
- Δ Suitable for NEMA 5 applications with drain screw installed.

Accessories: pages 3-10 through 3-12
 Dimensions: NEMA 1 and 3R page 3-13
 Dimensions: NEMA 4, 4X and 5 Stainless and NEMA 12 page 3-14

Table 3.10: 600 Volts—Single Throw Fusible

System	Amperes	NEMA 1 Indoor		NEMA 3R Rainproof (Bolt-on Hubs, page 3-10)		NEMA 4, 4X, 5▲ (for 316 stainless, see page 3-7) Dust tight, Watertight, Corrosion Resistant (Watertight Hubs, page 3-10)		NEMA 12K With Knockouts (Watertight Hubs, page 3-10)		NEMA 12, 3R■ Without Knockouts (Watertight Hubs, page 3-10)		Horsepower Ratings						
		Cat. No.	\$ Price	Cat. No.	\$ Price	Cat. No.	\$ Price	Cat. No.	\$ Price	Cat. No.	\$ Price	480 Vac		600 Vac		dc*		
												Std. (Using Fast Acting, One Time Fuses)	Max. (Using Dual Element, Time Delay Fuses)	Std. (Using Fast Acting, One Time Fuses)	Max. (Using Dual Element, Time Delay Fuses)			
2-Wire (2 Blades and Fuseholders)—600 Vac, 600 Vdc																		
	30																	
	60																	
	100																	
	200																	
	400	H265	4206.00	H265R	5424.00	H265DS	14961.00			H265AWK	5025.00	100♦	250♦			50	50	
	600	H266	6653.00	H266R	10686.00	H266DS	21399.00			H266AWK	7341.00	150♦	400♦			50	50	
800	H267	10365.00	H267R▲	16385.00					H267AWK	15276.00					50	50		
1200	H268	14570.00	H268R▲	17991.00					H268AWK	18044.00					50	50		
3-Wire (3 Blades and Fuseholders)—600 Vac, 600 Vdc★																		
	30	H361	528.00	H361RB	899.00	H361DS	2520.00	H361A	1014.00	H361AWK	956.00	5	15	7-1/2	20	5	15	
	30	H361-2▲	617.00	H3612RB▼	1049.00			H361-2A▼	1035.00	H3612AWK▼	977.00	5	15	7-1/2	20	—	15	
	60	H362	638.00	H362RB	1055.00	H362DS	2771.00	H362A	1047.00	H362AWK	984.00	15	30	15	50	—	30	
	100	H363	1188.00	H363RB	1644.00	H363DS	5493.00	H363A	1626.00	H363AWK	1539.00	25	60	30	75	—	50	
	200	H364	1707.00	H364RB	2259.00	H364DS	7685.00	H364A	2544.00	H364AWK	2400.00	50	125	60	150	40	50	
	400	H365	4551.00	H365R	5532.00	H365DS	15321.00			H365AWK	5462.00	100	250	125	350	50	50	
	600	H366	7649.00	H366R	10899.00	H366DS	21084.00			H366AWK	9203.00	150	400	200	500	50	50	
	800	H367	13319.00	H367R▲	16500.00					H367AWK	16352.00	200	500	250	500	50	50	
	1200	H368	17507.00	H368R▲	20009.00					H368AWK	19706.00	200	500	250	500	50	50	
	4-Wire (3 Blades and Fuseholders, 1 Neutral)—600 Vac, 600 Vdc★																	
	30	H361N	617.00	H361NRB	986.00							5	15	7-1/2	20	—	15	
	60	H362N	710.00	H362NRB	1134.00							15	30	15	50	—	30	
	100	H363N	1278.00	H363NRB	1737.00							25	60	30	75	—	50	
	200	H364N	1869.00	H364NRB	2408.00	H364NDS	7871.00	H364NA	2715.00	H364NAWK	2558.00	50	125	60	150	40	50	
	400	H365N	4898.00	H365NR	5765.00	H365NDS	15668.00			H365NAWK	5823.00	100	250	125	350	50	50	
	600	H366N	8019.00	H366NR	11054.00	H366NDS	22122.00			H366NAWK	9600.00	150	400	200	500	50	50	
	800	H367N	14043.00	H367NR▲	17205.00					H367NAWK	17253.00	200	500	250	500	50	50	
	1200	H368N	18114.00	H368NR▲	20993.00					H368NAWK	20820.00	200	500	250	500	50	50	
4-Wire (4 Blades and Fuseholders)—600 Vac, 600 Vdc□													20	20	20	20		
	30	H461	914.00			H461DS	2937.00			H461AWK	1115.00	7-1/2	20	10	25	5	15	
	60	H462	1065.00			H462DS	3069.00			H462AWK	1257.00	15	40	20	50	10	30	
	100	H463	1778.00			H463DS	8345.00			H463AWK	1932.00	25	50	30	75	20	30	
	200	H464	2957.00			H464DS	12596.00			H464AWK	3222.00	50	—	50	—	40	50	
	400	H465	6210.00							H465AWK	6807.00	100	250	125	350	50	50	
	600	H466	10104.00									150	400	200	500	50	50	
6-Wire (6 Blades and Fuseholders)—600 Vac □													30	30	30	30		
	100					H663DS	25964.00			H663AWK	5112.00	25	60	30	75	—	—	
	200					H664DS	35393.00			H664AWK	12222.00							

- ▲ Complete rating is NEMA 3, 3R, 4, 4X, 5 and 12.
- Also suitable for NEMA 3R application by removing drain screw from bottom endwall.
- ♦ For corner grounded delta systems only and with neutral assembly installed. Use switching poles for ungrounded conductors.
- ★ For switching dc use two outside switching poles.
- ▼ 60 A switch with 30 A fuse spacing and clips. Must use 60 A enclosure accessories including electrical interlocks.
- ▲ Suitable for NEMA 5 applications with drain screw installed.
- Not suitable for use as service equipment.

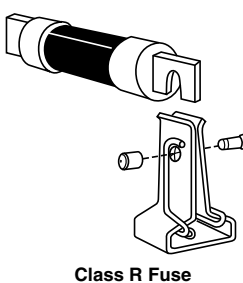

Class H Fuse Provisions:

Fusible Square D 30 through 600 A heavy duty safety switches accept Class H fuses as standard. With Class H fuses installed, the switch is UL Listed for use on systems with up to 10 kA available fault current.

Class R Fuse Provisions:

Fusible Square D 30–600 A heavy duty safety switches will accept Class R fuses as standard. A field-installed rejection kit is available which, when installed, rejects all but Class R fuses. With the installation of the rejection kit and Class R fuses, the switch is UL Listed for use on systems with up to 200 kA available fault current. See Class R fuse kits on page 3-10.

Class J Fuse Provisions:

Provisions for installing Class J fuses are included in 30 through 400 A 600 Volt, and 100 through 400 A 240 Volt, fusible heavy duty safety switches. Conversion to Class J fuse spacing requires relocating the load side fuse base assembly from the standard Class H fuse location to an alternate position as marked in the enclosure. With Class J fuses installed, the switch is UL Listed for use on systems with up to 200 kA available fault current. Switches rated 600 A, 240 or 600 Volt, require the addition of an adapter kit, H600J at \$456. One kit per 3P switch.

Class L Fuse Provisions:

Fusible 800 A and 1200 A safety switches use Class L bolt-in fuses and are rated for use on systems with up to 200 kA at 600 Vac maximum. 1200 A switches accept class L fuses from 601–1200 A, 800 A switches accept class L fuses from 601–800 A.

Accessories:pages 3-10 through 3-12
 Dimensions: NEMA 1 and 3Rpage 3-13
 Dimensions: NEMA 4, 4X and 5page 3-14

Table 3.11: 600 Volt—Single Throw Non-Fusible

System	Amperes	NEMA 1 Indoor		NEMA 3R Rainproof (Bolt-on Hubs, page 3-10)		NEMA 4, 4X, 5 ▲ 304 Stainless Steel (for 316 stainless, see page 3-7) Dust tight, Watertight Corrosion Resistant (Watertight Hubs, page 3-10)		NEMA 12K With Knockouts (Watertight Hubs, page 3-10)		NEMA 12, 3R ■ Without Knockouts (Watertight Hubs, page 3-10)		Horsepower Ratings (Max.)													
												Volts ac				dc ♦									
		Cat. No.	\$ Price	Cat. No.	\$ Price	Cat. No.	\$ Price	Cat. No.	\$ Price	Cat. No.	\$ Price	10	30	10	30	10	30	250	600						
2-Wire (2 Blades)—600 Vac, 600 Vdc																									
	30	Use three-wire devices for two-wire applications.																—	—	—	—	—	—	—	—
	60																	—	—	—	—	—	—	—	—
	100																	—	—	—	—	—	—	—	—
	200																	—	—	—	—	—	—	—	—
	400	HU265	2750.00	HU265R	3764.00	HU265DS	12812.00	—	—	HU265AWK	3212.00	—	—	—	—	—	—	50	50						
	600	HU266	4896.00	HU266R	7533.00	HU266DS	18455.00	—	—	HU266AWK	5408.00	—	—	—	—	—	—	50	50						
800	HU267	7467.00	HU267R★	12884.00	—	—	—	—	HU267AWK	12957.00	50	—	50	—	50	—	—	50							
1200	HU268	10226.00	HU268R★	17393.00	—	—	—	—	HU268AWK	17522.00	50	—	50	—	—	—	50	50							
3-Wire (3 Blades)—600 Vac, 600 Vdc																									
	30	HU361	279.00	HU361RB	488.00	HU361DS	2120.00	HU361A	689.00	HU361AWK	647.00	5	10	7-1/2	20	10	30	5	15						
	30	HU361EI▼	638.00	HU361RBEI▼	846.00	HU361DSEI▼	2480.00	HU361AEI▼	1047.00	HU361AWKEI▼	1007.00	5	10	7-1/2	20	10	30	5	15						
	30	HU3612Δ	369.00	HU3612RBΔ	638.00	—	—	HU3612AΔ	710.00	HU3612AWKΔ	666.00	5	10	7-1/2	20	10	30	5	15						
	60	HU362	488.00	HU362RB	876.00	HU362DS	2520.00	HU362A	875.00	HU362AWK	833.00	10	20	25	50	30	60	10	30						
	60	—	—	—	—	HU362DSEI▼	2972.00	—	—	—	—	10	20	25	50	30	60	10	30						
	100	HU363	783.00	HU363RB	1226.00	HU363DS	5102.00	HU363A	1265.00	HU363AWK	1194.00	20	40	40	75	40	100	20	50						
	200	HU364	1209.00	HU364RB	1485.00	HU364DS	6960.00	HU364A	1697.00	HU364AWK	1604.00	15	60	50	125	50	150	40	50						
	400	HU365	2804.00	HU365R	3840.00	HU365DS	14294.00	—	—	HU365AWK	4023.00	—	125	—	250	—	350	50	50						
	600	HU366	4992.00	HU366R	7683.00	HU366DS	19062.00	—	—	HU366AWK	6711.00	—	200	—	400	—	500	50	50						
	800	HU367	9978.00	HU367R★	13050.00	—	—	—	—	HU367AWK	13097.00	50	250	50	500	50	500	50	50						
	1200	HU368	13421.00	HU368R★	17867.00	—	—	—	—	HU368AWK	17940.00	50	250	50	500	50	500	50	50						
4-Wire (4 Blades)—600 Vac, 600 Vdc ▽																									
	30	HU461□	827.00	—	—	HU461DS	2586.00	—	—	HU461AWK◇	915.00	10	10	20	20	25	30	10★	15★						
	60	HU462□	914.00	—	—	HU462DS	3027.00	—	—	HU462AWK	1008.00	20	20	40	50	50	60	10	30						
	100	HU463□	1647.00	—	—	HU463DS	7401.00	—	—	HU463AWK	1791.00	30	40	50	75	50	75	20	30						
	200	HU464□	2399.00	—	—	HU464DS	11244.00	—	—	HU464AWK	2832.00	50	60	50	125	50	150	40	50						
	400	HU465	5201.00	—	—	—	—	—	—	HU465AWK	5672.00	—	125	—	250	—	350	50	50						
	600	HU466	9072.00	—	—	—	—	—	—	—	—	—	200	—	400	—	500	50	50						
6-Wire (6 Blades)—600 Vac ▽																									
	30	—	—	—	—	HU661DS	11903.00	—	—	HU661AWK⊙	3357.00	—	10	—	20	—	30	—	—						
	60	—	—	—	—	HU662DS	13254.00	—	—	HU662AWK⊙	3884.00	—	20	—	50	—	60	—	—						
	100	—	—	—	—	HU663DS	20643.00	—	—	HU663AWK⊙	4793.00	—	40	—	75	—	75	—	—						
	200	—	—	—	—	HU664DS	28316.00	—	—	HU664AWK⊙	10538.00	—	60	—	125	—	150	—	—						

- ▲ Complete rating is NEMA 3, 3R, 4, 4X, 5 and 12.
- ◆ Also suitable for NEMA 3R application by removing drain screw from bottom endwall.
- ◆ For switching dc, use two outside switching poles.
- ★ Suitable for NEMA 5 applications with drain screw installed.
- ▼ Switches with EI suffix are stocked with factory-installed electrical interlocks with one normally-open and one normally-closed contact.
- Δ Use 60 A enclosure accessories, including electrical interlocks.
- No knockouts are provided.
- ◇ Requires 60 A accessories. See page 3-14 for series rating..
- ★ HU461AWK (Series F6) is rated 5 hp@250 Vdc, 10 hp@600 Vdc.
- ▽ Not suitable for use as service equipment.
- ⊙ One enclosure for NEMA 1, 3, 3R or 12 applications. UL Listed.

UL Listed Maximum Short Circuit Current Ratings—AC only

NOTE: Consult the wiring diagram of the switch to verify the UL Listed short circuit current rating.

Table 3.12: Fusible Safety Switches

For the short circuit current rating, refer to the table below.

Heavy Duty Safety Switch Type	UL Listed Fuse Class	UL Listed Short Circuit Current Ratings
Fusible	H, K	10 kA
	R, J, L	200 kA*

* On 600 V, 200 A switches, 100,000 A max. on corner grounded delta when protected by Class J or R fuses.

Non-Fusible Safety Switches

Any brand of circuit breaker or fuse not exceeding the ampere rating of the switch may be used in conjunction with an non-fusible safety switch when there is up to 10 kA short circuit current available (see table below).

Above 10 kA—When applied on systems with greater than 10 kA short circuit current available, the UL Listed short circuit current rating for Square D non-fusible switches is based upon the switch being used in conjunction with fuses or Square D circuit breakers or Mag-Gard motor circuit protectors.

Table 3.13: Non-Fusible Safety Switches

Heavy Duty Safety Switch Type	Switch Rating (A) ♦	Fuse or Circuit Breaker Type ⊙	3-Phase		
			240 Vac	480 Vac	600 Vac
Non-Fusible Switches	All	Any brand circuit breaker	Up to 10 kA		
		H, K			
		R, T, J, L	200 kA	200 kA	200 kA
	30–100	H ⊙	65 kA	35 kA	35 kA
	30–100	FA	14 kA	14 kA	14 kA
	30–100	FH	18 kA	18 kA	18 kA
	200	H, J ⊙	65 kA	35 kA	35 kA
	400	LA	22 kA	22 kA	22 kA
400	LH	25 kA	25 kA	25 kA	

- ♦ Applies to NEMA 1, 3R, 4X stainless, 12 switches.
- ⊙ Ampere rating of fuse or circuit breaker not to exceed switch ampere rating.
- ⊙ All H and J circuit breakers are acceptable, but will only support the noted Short Circuit Current Ratings.



H361SS

316 Grade Stainless Steel—NEMA 3, 3R, 4, 4X, 5, 12

Type 316 stainless steel enclosure safety switches offer superior corrosion resistance to a wider range of chemicals than Type 304 stainless switches. Type 316 better resists chloride and is often used in marine, waste treatment and transportation applications. Use watertight hubs from page 3-10. Equipment grounding lugs are supplied as standard. (For Type 304 stainless switches see pages 3-4–3-6.)

Table 3.14: 3P 600 Vac, 600 Vdc

Amperes	Cat. No	\$ Price	Horsepower Ratings—3Ø▲						
			480 Vac		600 Vac		600 Vdc■		
			Std.	Max.	Std.	Max.	Max.		
Fusible									
30	H361SS	3444.00	5	15	7-1/2	20	15		
60	H362SS	3792.00	15	30	15	50	30		
100	H363SS	7562.00	25	60	30	75	50		
200	H364SS	10592.00	50	125	60	150	50		
400	H365SS	21622.00	100	250	125	350	50		
600	H366SS	30528.00	150	400	200	500	50		
Non-Fusible									
30	HU361SS	2898.00	—	20	—	30	15		
60	HU362SS	3444.00	—	50	—	60	30		
100	HU363SS	7029.00	—	75	—	100	50		
200	HU364SS	9623.00	—	125	—	150	50		
400	HU365SS	17758.00	—	250	—	350	50		
600	HU366SS	26306.00	—	400	—	500	50		



H363DF

Fiberglass Reinforced Polyester Enclosures—NEMA 4X

Fiberglass reinforced polyester enclosures are watertight, corrosion resistant, and impervious to windblown dust, rain, and splashing liquid. The molded fiberglass is extremely stable in a wide range of operating temperatures and can withstand heavy impact. Switches are furnished with hubs (page 3-14) and equipment grounding lugs. UL Listed.

Table 3.15: 3P 600 Vac, 600 Vdc

Amperes	Cat. No.	\$ Price	Class R Fuse Kits		Electrical Interlock Kits Field-Installed Cat. No.		Horsepower Ratings—3Ø▲				
			Cat. No.	\$ Price	1 NO/1 NC Contacts	2 NO/2 NC Contacts	480 Vac		600 Vac		600 Vdc■
							Std.	Max.	Std.	Max.	Max.
Fusible											
30	H361DF	3570.00	RFK06	25.50	9999TC10	9999TC20	5	15	7-1/2	20	15
60	H362DF	3968.00	RFK06H	25.50	9999TC10	9999TC20	15	30	15	50	30
100	H363DF	7613.00	RFK10	47.70	9999TC10	9999TC20	25	60	30	75	50
200	H364DF	9729.00	HRK1020	47.70	9999R8	9999R9	50	125	60	150	50
Non-Fusible											
30	HU361DF	3402.00	—	—	9999TC10	9999TC20	—	20	—	30	15
60	HU362DF	3762.00	—	—	9999TC10	9999TC20	—	50	—	60	30
100	HU363DF	7241.00	—	—	9999TC10	9999TC20	—	75	—	100	50
200	HU364DF	9695.00	—	—	9999R8	9999R9	—	125	—	—	50



H361DX

Krydon™ Enclosures—NEMA 4X

Krydon enclosures are compression molded of fiberglass reinforced polyester, specially formulated to withstand attack from almost any corrosive atmosphere found in the toughest industrial application. Switches are furnished with hubs (page 3-14) and equipment grounding lugs. UL Listed.

Table 3.16: 3P, 600 Vac, 600 Vdc

Amperes	Cat. No.	\$ Price	Class R Fuse Kits		Electrical Interlock Kits Field-Installed Cat. No.		Horsepower Ratings—3Ø▲				
			Cat. No.	\$ Price	1 NO/1 NC Contact	2 NO/2 NC Contacts	480 Vac		600 Vac		600 Vdc■
							Std.	Max.	Std.	Max.	Max.
Fusible											
30	H361DX	4161.00	RFK06	25.50	9999TC10	9999TC20	5	15	7-1/2	20	15
60	H362DX	4626.00	RFK06H	25.50	9999TC10	9999TC20	15	30	15	50	30
100	H363DX	8858.00	RFK10	47.70	9999TC10	9999TC20	25	60	30	75	50
Non-Fusible											
30	HU361DX	3960.00	—	—	9999TC10	9999TC20	—	20	—	30	15
60	HU362DX	4406.00	—	—	9999TC10	9999TC20	—	50	—	60	30
100	HU363DX	8438.00	—	—	9999TC10	9999TC20	—	75	—	100	50

NEMA 7 and 9

An enclosed automatic molded case switch for use in Divisions 1 and 2 of the following: Class I, Groups C and D; Class II, Groups E, F and G; or Class III, Hazardous Locations as defined in NEC™ Article 500. Furnished with threaded conduit openings in both top and bottom endwall (page 3-14). Suitable for use as service equipment and listed as "Raintight" for outdoor applications. cULus Listed. Equipment grounding lugs supplied as standard.

Table 3.17: 3 Pole Molded Case Switch, 600 Vac, 250 Vdc Maximum, Short Circuit Current Rating 10 kA AIR

Amperes	Enclosed Molded Case Switch ◆		Solid Neutral Assembly		Horsepower Ratings—3Ø		
	Cat. No.	\$ Price	Cat. No.	\$ Price	240 Vac	480 Vac	600 Vac■
60	H60XFA	2571.00	100SNA	143.00	15	30	50
60	H60XFA1212★	2886.00	100SNA	143.00	15	30	50
100	H100XFA	3045.00	100SNA	143.00	30	60	75
100	H100XFA1212★	3287.00	100SNA	143.00	30	60	75
225	H225XJGA	6387.00	225SNA	189.00	60	125	150
225	H225XJGAA★△	6701.00	225SNA	189.00	60	125	150

- ▲ Std.—Using fast acting one time fuses. Max.—Using dual element time delay fuses.
- For switching dc use two switching poles.
- ◆ Includes PKDB1, breather and drain kit, required for rainproof application—NEMA 7 only.
- ★ Includes auxiliary contacts.
- ▼ For available options, contact customer service prior to placing an order.
- △ Not UL listed or CSA Certified due to wire bending space.



H60XFA

New!

SAFETY SWITCHES

3



The MD motor disconnect switch is listed UL508 Suitable For Motor Control (UL File E164864). It is in a compact NEMA 4X enclosure suitable for use in NEMA Type 1, 3, 3R, 4, 4X and 12 applications. The MD's key benefits are an extremely small footprint, a more economically efficient NEMA 4X solution and a handle interlock preventing cover removal when the switch is in the ON position.

Table 3.18: MD Motor Disconnect Switch—Non Metallic NEMA 1, 3, 3R, 4, 4X and 12 Enclosure▲■◆

Amperes	Cat. No.	Maximum Horse Power Ratings			\$ Price	Height (in.)	Width (in.)	Depth (in.)
		Three Phase Vac						
		220–240	440–480	600				
30	MD3304X	7.5	20	25	121.00	6.38	3.9	4.37
60	MD3604X	20	40	40	161.00	8.27	4.94	4.37

- ▲ See table 8.9 for accessories.
- Complies with OSHA lockout/tagout requirements—accepts up to three 8 mm padlocks.
- ◆ Suitable for NEMA 1, 3R, 4, 4X and 12 enclosure applications.

Table 3.19: MD Motor Disconnect Accessories

Cat. No.	Description	\$ Price
MDSAN20	2 Normally open auxiliary contact module	57.00
MDSAN11	1 normally open and 1 normally closed auxiliary contact module	27.00
MDS30P	30 Amp Add on power pole	35.00

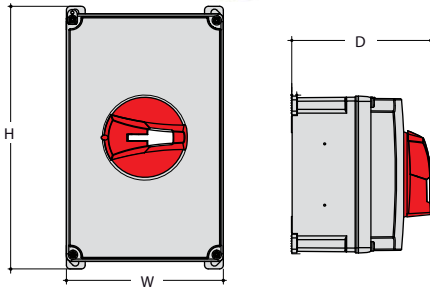

MD Motor Disconnect Switches

Interlocked Receptacle Switches

Interlocked Receptacle Switches are furnished with a factory-installed three-phase four-wire Appleton Powertite™, Crouse-Hinds Style 2 Arkrite™, or Hubbellock™ receptacle. The fourth wire is connected to the switch equipment grounding terminal and is not a neutral termination. Interlocking linkage between the receptacle and switch mechanism prevents insertion or removal of the plug while the switch is in the "ON" position or insertion of any plug other than specified. Grounding lugs are included.

Appleton Powertite Receptacle

- Devices are UL Listed and CSA Certified, suitable for use as service equipment.
- Receptacles are epoxy powder coated over copper-free cast aluminum and NEMA 3, 3R, 4, 4X and 12 rated. Appleton receptacles are UL Classified for use with the Crouse-Hinds plugs listed below.
- Short circuit rating: 10 kA when used in conjunction with Class H or K fuses; 200 kA when used in conjunction with Class R or J fuses.



H362AWA
Interlocked Receptacle
Switch with Appleton
Powertite Receptacle

Amperes	NEMA 1		NEMA 3, 3R, 4, 4X, 5, 12 304 Stainless Steel Enclosure		NEMA 12, 3R		Use with Plug ▲		Horsepower Ratings—30■						
	Cat. No.	\$ Price	Cat. No.	\$ Price	Cat. No.	\$ Price	Cat. No.	\$ Price	480 Vac		600 Vac		250 Vdc◆		
									Std.	Max.	Std.	Max.	Std.	Max.	
Fusible—3P, 600 Vac, 250 Vdc															
30	H361WA	2076.00	H361DSWA	4401.00	H361AWA	2289.00	ACP3034BC	1235.00	5	15	7-1/2	20	5	—	
60	H362WA	2412.00	H362DSWA	4668.00	H362AWA	2508.00	ACP6034BC	1295.00	15	30	15	50	10	—	
100	H363WA	3689.00	H363DSWA	8468.00	H363AWA	3758.00	ACP1034CD	1928.00	25	60	30	75	20	—	
Non-Fusible—3P, 600 Vac, 250 Vdc															
30	HU361WA	1893.00	HU361DSWA	4001.00	HU361AWA	2076.00	ACP3034BC	1235.00	—	20	—	30	—	5	
60	HU362WA	2306.00	HU362DSWA	4412.00	HU362AWA	2357.00	ACP6034BC	1295.00	—	50	—	60	—	10	
100	HU363WA	3153.00	HU363DSWA	8010.00	HU363AWA	3347.00	ACP1034CD	1928.00	—	75	—	100	—	20	

- ▲ Receptacle UL Listed for use with "Appleton ACP or CPH" plugs; UL Classified for use with Crouse-Hinds "APJ" Arkrite plugs listed on this page.
- Std.—Using fast acting one time fuses. Max.—Using dual element time delay fuses.
- ◆ For switching dc, use two switching poles.

Crouse-Hinds Arkrite Receptacle

- UL Listed, suitable for use as service equipment.
- Short circuit ratings: 10 kA when used in conjunction with Class H or K fuses; 200 kA when used in conjunction with Class R or J fuses.

Table 3.20:

Amperes	NEMA 1		NEMA 3, 3R, 4, 4X, 5, 12 304 Stainless Steel Enclosure		NEMA 12, 3R		Use with Plug		Horsepower Ratings—30★			
	Cat. No.	\$ Price	Cat. No.	\$ Price	Cat. No.	\$ Price	Cat. No.	\$ Price	480 Vac		600 Vac	
									Std.	Max.	Std.	Max.
Fusible—3P, 600 Vac Maximum												
30	H361WC	2139.00	H361DSWC	6377.00	H361AWC	2355.00	APJ3485	1235.00	5	15	7-1/2	20
60	H362WC	2751.00	H362DSWC	7749.00	H362AWC	2846.00	APJ6485	1295.00	15	30	15	50
100	H363WC	6005.00	H363DSWC	14826.00	H363AWC	6087.00	APJ10487	1928.00	—	60	—	75
Non-Fusible—3P, 600 Vac Maximum												
30	HU361WC	1952.00	HU361DSWC	5888.00	HU361AWC	2136.00	APJ3485	1235.00	—	20	—	30
60	HU362WC	2634.00	HU362DSWC	7374.00	HU362AWC	2678.00	APJ6485	1295.00	—	50	—	60
100	HU363WC	5249.00	HU363DSWC	14025.00	HU363AWC	5444.00	APJ10487	1928.00	—	60	—	100

- ★ Std.—Using fast acting one time fuses. Max.—Using dual element time delay fuses.

Hubbellock Receptacle

- UL Listed, suitable for use as service equipment.
- Short circuit rating: 10 kA.

Note: The Hubbellock receptacle switch utilizes the Square D interlocked plug SD12781 available only from Square D.

Table 3.21:

Amperes	NEMA 1		NEMA 12		Use with Plug		Horsepower Ratings—30▼			
	Cat. No.	\$ Price	Cat. No.	\$ Price	Cat. No.	\$ Price	480 Vac		600 Vac	
							Std.	Max.	Std.	Max.
Fusible—3P, 600 Vac Maximum										
60	H362WH	2351.00	H362AWH	2459.00	SD12781△	609.00	15	30	15	50
Non-Fusible—3P, 600 Vac Maximum										
60	HU362WH	2237.00	HU362AWH	2310.00	SD12781△	609.00	—	50	—	60

- ▼ Std.—Using fast acting one time fuses. Max.—Using dual element time delay fuses.
- △ Hubbell plug is furnished with a Kellems grip for 1-1/2 in. to 1-21/64 in. cable diameter.

Accessories pages 3-10 through 3-12.



H362AWC
Interlocked Receptacle
Switch with Crouse-Hinds
Arkrite Receptacle



H362AWH
Interlocked Receptacle
Switch with Hubbell™
Hubbellock Receptacle



Rainproof Bolt-On Hubs—for use on NEMA 3R Enclosure

Conduit Size	3/4	1	1-1/4	1-1/2	2	2-1/2	3	3-1/2	4	Closing Cap
Hub Cat. No.	B075	B100	B125	B150	B200	B250	B300	B350	B400	BCAP
\$ Price Each (DE1A)	33.30	33.30	33.30	33.30	61.00	102.00	186.00	300.00	368.00	3.80

Note: NEMA 3R rainproof enclosures with Cat. No. ending in RB have a bolt-on closing cap factory-installed. Order bolt-on hubs separately from table above. For more details see page 1-13. Hubs through size 2-1/2" can be directly installed on RB devices. Devices requiring three-inch or larger hubs must have holes cut in the field. Gaskets are provided on three-inch and larger hubs.

Note: All hubs are UL Listed for indoor and rainproof applications and suitable for use with conduit having ANSI standard taper pipe thread.

Watertight Hubs—for use on NEMA 4, 4X and 5 Stainless Steel and NEMA 12 Enclosures

Conduit Trade Size	1/2	3/4	1	1-1/4	1-1/2	2	2-1/2	3	3-1/2	4
Standard-Zinc Hub Cat. No.	H050	H075	H100	H125	H150	H200	H250	H300	H350	H400
Zinc \$ Price Each	31.10	45.00	47.10	54.00	83.00	120.00	138.00	177.00	282.00	381.00
Chrome Plated Hub Cat. No.	H050CP	H075CP	H100CP	H125CP	H150CP	H200CP	—	—	—	—
Chrome Plated \$ Price Each	40.70	56.00	64.00	67.00	96.00	137.00	—	—	—	—

Electrical Interlock Kits

Electrical interlocks for heavy duty 30–1200 A safety switches are available factory-installed or in kit form for field installation. Each kit contains instructions for proper field mounting. A pivot arm operates from switch mechanism, breaking the control circuit before the main switch blades break. Switches with electrical interlocks installed are UL Listed. For factory-installed electrical interlocks add EI (for one contact) or EI2 (for two contacts) suffix to catalog number. See Supplemental Digest page 2-3 for electrical interlock contact ratings.

Table 3.2.2: Electrical Interlock Kit ▲

Switch's Amperes Rating	Series Number (See pages 3-13, 3-14)	Electrical Interlock Kit Cat. No. ■	\$ Price	Factory-Installed \$ Price
30	F1, F5–F7	EIK031 ◆ ★	218.00	359.00
		EIK032 ◆ ★		
60	F1-F3 F5-F7 (600 V)	EIK1	311.00	452.00
		EIK2		
	F4 F5-F6 (240 V)	EIK031 ▼	218.00	359.00
		EIK032 ▼		
100–200	F2–F7	EIK1	311.00	452.00
		EIK2		
400–1200	E1–E4	EIK40601	533.00	674.00
		EIK40602		

- ▲ See page 3-7 for electrical interlocks on NEMA 4X fiberglass reinforced polyester and Krydon.
- Electrical interlock kit catalog numbers with 1 suffix indicates one normally open and one normally closed contact; 2 indicates two normally open and two normally closed contacts. Kits are UL Listed.
- ◆ HU461AWK uses EK3061 or EK3062.
- ★ The following Series F5–F7 devices use EIK-1, 2: H3612, H3612A, H3612AWK, H3612RB, H461, H461DS, H461AWK, HU461, HU461DS, HU661DS, HU661AWK, H361AWA, H361AWC, HU361AWA and HU361AWC.
- ▼ H362WA, HU362WA, H362WC, H362AWA, HU362AWA, H362AWC, HU362AWC, and H2212AWK use EIK1 or EIK2 electric interlock.
- △ Single-pole single-throw interlock kits are rated 1/2 hp @ 110 and 220 Vac.

Class R Fuse Kits

When installed, this kit rejects all but Class R fuses. Kits are available for field installation. For factory installation, add "CLR" suffix to catalog number.

Table 3.2.3: Class R Fuse Kits—240 V (one kit per 3P switch)

Amperes	Series Number (See pages 3-13, 3-14)	Class R Fuse Kit Cat. No.	\$ Price	Factory-Installed \$ Price
30	F5–F7	RFK03LD	25.50	195.00
60	F1, F2, F3	RFK06	25.50	195.00
60	F4–F7	RFK03H	25.50	195.00
100	F2–F7	RFK10	47.70	231.00
200	F5–F6	HRK1020	47.70	231.00
400–600	E	HRK4060	111.00	360.00

□ H221-2AWK uses RFK06 Class R fuse kit.

Table 3.2.4: Class R Fuse Kits—600 V (one kit per 3P switch)

Amperes	Series Number (See pages 3-13, 3-14)	Class R Fuse Kit Cat. No.	\$ Price	Factory-Installed \$ Price
30 ◇	F1, F5–F7	RFK03H★	25.50	293.00
30 ◇	F3	RFK06	25.50	293.00
60 ◇	F1–F7	RFK06H★	25.50	293.00
100 ◇	F2–F7	RFK10	47.70	231.00
200	F5–F6	HRK1020	47.70	231.00
400–600	E2–E4	HRK4060	111.00	360.00

- ◇ See page 3-7 for Class R Fuse Kits in NEMA 4X Fiberglass Reinforced Polyester and Krydon switches.
- ★ The following Series F5–F7 devices use RFK06: H3612, H3612A, H3612AWK, H3612RB, H461, H461DS, H461AWK, H361AWA and H361AWC.

Internal Barrier Kits

Internal Barrier Kits provide an additional barrier that helps prevent accidental contact with live parts. Field-installed transparent barriers do not restrict visual inspection of the switch. Barriers provide IEC529 IP2X "finger safe" protection when door of enclosed disconnect switch is open. Convenient door allows use of test probes without accessing fuses and replacement of fuses without removing barrier. Barrier can also be used with the skirt kit to enclose a panel mounted Type 9422 disconnect.

Cat. No.	Description	Safety Switch Application (F Series Only)	9422 Type T Disconnect Application	\$ Price
SS03	Interior Barrier for 30 A Safety Switch▼	240 / 600 Vac – 30 A	NA	150.
		240 Vac – 60 A		
SS06	Interior Barrier for 60 A Safety Switch, 30 or 60 A 9422 Switch	600 Vac – 60 A	600 Vac – 30 A	165.
			600 Vac – 60 A	
SS10	Interior Barrier for 100 A Safety Switch or 100 A 9422 Switch	240 / 600 Vac – 100 A	600 Vac – 100 A	195.
SS20	Interior Barrier for 200 A Safety Switch	240 / 600 Vac – 200 A	NA	225.
SS0306SK	Skirt Kit to Enclose 30 or 60 A 9422 Switch (requires SS06)	NA	600 Vac – 30 A	225.
			600 Vac – 60 A	
SS10SK	Skirt Kit to Enclose 100 A 9422 Switch (requires SS10)	NA	600 Vac – 100 A	255.

▼ Requires arc shield on 240 V switches be changed to 600 V arc suppressor.

Fuse Puller Kits

Kit consists of three fuse pullers as required for a 3-pole fusible 240 V or 600 V heavy duty switch. Kits can be installed in switches manufactured after February, 1980. Fuse pullers supplied as standard equipment on NEMA 12, 12K, NEMA 4, 4X, 5 stainless steel, NEMA 4X fiberglass reinforced polyester and KRYDON switches through 100 A.

Amperes	Series Number	Fuse Puller Kit Cat. No.	\$ Price
30	F1, F5–F7 F3	FPK03 ○	30.00
30		FPK0610	42.60
60	F1, F2, F3, F5–F7 (600 V) F4 ★, F5–F7 (240 V)	FPK0610	42.60
60 *		FPK03 ★	30.00
100	F2–F7	FPK0610	42.60

- 30 A 4- and 6-pole, H361-2 and H361-2RB Series F5 use FPK0610.
- * H362WA, H362WC, H362AWA, H362AWC, H362WH and H362AWH use FPK0610 fuse puller kit.

Neutral Assemblies—Field-Installed Neutral Assemblies for Fusible and Non-Fusible 240 and 600 Volt Safety Switches

Amperes	Series Number (See pages 3-13, 3-14)	Standard Neutral Kit Cat. No.	Terminal Data AWG/kcmil	\$ Price	Optional Copper Only Neutral Kit Cat. No.	Terminal Data AWG/kcmil	\$ Price
30	F1, F5-F6	SN03▲	(3) 2 Max. Al/Cu	83.00	SN03C▲	(3) 6 Max. Cu	102.00
60	F1-F3, F5-F6 (600 V)	SN0610	(2) 1/0 Max. Al/Cu (2) 6 Max. Al/Cu	107.00	SN0610C	(2) 1/0 Max. Cu (2) 6 Max. Cu	114.00
	F4, F5-F6 (240 V)	SN03▲	(3) 2 Max. Al/Cu	83.00	SN03C▲	(3) 6 Max. Cu	102.00
100	F2-F6	SN0610	(2) 1/0 Max. Al/Cu (2) 6 Max. Al/Cu	107.00	SN0610C	(2) 1/0 Max. Cu (2) 6 Max. Cu	114.00
200■	F5-F6	SN20A	(2) 250 Max. Al/Cu (1) 1/0 Max. Al/Cu	200.00	SN20C	(2) 250 Max. Cu (1) 1/0 Max. Cu	246.00
400 and 600	E1-E4	H600SN	(4) 750 Max. Al/Cu (1) 300 Max. Al/Cu	327.00	H600SNC	(2) 600 Max. Cu (2) 350 Max. Cu (1) 250 Max. Cu	452.00
800	E2-E4	H800SNE4	(6) 750 Max. Al/Cu (2) 350 Max. Al/Cu	753.00	—	—	—
1200	E2-E4	H1200SNE4	(8) 750 Max. Al/Cu (2) 350 Max. Al/Cu	1034.00	—	—	—

Note: Neutrals cannot be installed in 4P, 6P, or 200 A NEMA 4X fiberglass reinforced polyester safety switches.

- ▲ The following Series F5-F6 devices use SN0610(C): H-361-2, H-361-2RB, H-361-2A and H-361-2AWK.
- For 200% neutral, order (2) neutral kits and (1) SN20NI neutral jumper kit. (2) 350 Max. Al/Cu.

Equipment Grounding Kits□

Equipment grounding kits are field-installed and UL Listed in 30–1200 A heavy duty switches. For factory installation of equipment grounding kit, add suffix GL to standard Cat. No. (Example: H361GL). Price = Switch + Kit Price.

Equipment Grounding Kits—Field- or Factory-Installed Equipment Grounding Kits—240 and 600 V

Amperes	Series Number (See pages 3-13, 3-14)	Standard Cat. No.	Terminal Data AWG/kcmil	\$ Price	Optional Copper Only Cat. No.	Terminal Data AWG/kcmil	\$ Price
30	F1, F5-F7	GTK03◆	(2) 12 Cu or (2) 10 Al or (1) 4 Max. Al/Cu	11.40	GTK03C◆	(1) 6 Max. Cu	13.40
60★	F1-F3★, F5-F7 (600 V)	GTK0610★	(2) 1/0 Max. Al/Cu	18.90	GTK0610C★	(2) 4 Max. Cu	22.70
60	F4, F5-F6 (240 V)	GTK03	(2) 12 Cu or (2) 10 Al or (1) 4 Max. Al/Cu	11.40	GTK03C	(1) 6 Max. Cu	13.40
100	F2-F7	GTK0610	(2) 1/0 Max. Al/Cu	18.90	GTK0610C	(2) 4 Max. Cu	22.70
200	F5-F7	PKOGTA2	(2) 2/0 Max. Al/Cu	55.00	PKOGTC2	(2) 4 Max. Cu	58.00
400 and 600	E2-E4	PKOGTA2▼ (2 Required)	(2) 2/0 Max. Al/Cu	55.00	PKOGTC3	(3) 1/0 Max. Cu	107.00△
800	E2-E4	PKOGTA7	(4) 350 Max. Al/Cu	198.00△	—	—	—
1200	E2-E4	PKOGTA8	(8) 350 Max. Al/Cu	203.00△	—	—	—

- ◆ The following Series F5-F6 devices use GTK0610(C): H-361-2 and H-361-2RB.
- ★ 4- and 6-pole 30 A F Series.
- ▼ Two required if grounding conductors are run in parallel.
- △ PE1A Discount Schedule
- Equipment Ground Kits are factory-installed standard in 30–200 A series F NEMA 4-4X-5 (stainless) and 12. Equipment Ground Kits are standard on all NEMA Types, Series F 30–200 A 4 and 6 pole switches.

Table 3.25: Square D Gray Paint

Description	Cat. No.	\$ Price
16 oz. Aerosol Paint Can, Square D Gray Paint	PK49SP	39.00 ea.

Note: Shipped in quantities of 6.

Special Paint

UL Listed heavy duty switches are available painted with special safety colors. To order safety colored switches add suffixes as noted in Table 3.26 to the standard switch commercial reference number.

All colors comply with OSHA Standard 1910.144 and ANSI Specification Z535.1 for marking physical hazards.

Table 3.26: Safety Colors

Safety Color	Suffix
Black	SP0
Red	SP2
Orange	SP3
Yellow	SP4
Green	SP5
Blue	SP6
Purple	SP7
Gray	SP8
Gray ANSI 61	SP861▲
White	SP9

▲ Standard Square D ANSI 49 grey paint, when selecting this suffix, switches will receive additional coat of paint.

A minimum quantity of 10 is required. Not available for NEMA Type 7/9 or stainless steel products.

Price Adder Each Switch

Quantity	\$ Price							
	30 A	60 A	100 A	200 A	400 A	600 A	800 A	1200 A
10	242.00	278.00	434.00	479.00	1137.00	2801.00	3501.00	4376.00

Lock-Off Guard Kits★

Available factory- or field-installed the lock-off guard works by covering the lockout/tagout opening whenever the switch is in the ON position. This prevents a padlock from being inadvertently inserted into the switch lockplate. The device is designed to help prevent accidental misapplication of a lockout device. These kits are marked cURus (UL Component Recognized) for field or factory installation.

Amperes◆	Kit Cat. No.	Field-Installed \$ Price	Factory-Installed \$ Price
30 A	LOGK1	44.30	146.00
60 A 240 V			
60 A 600 V	LOGK2	45.00	177.00
100 and 200 A			

- For factory installation, add suffix "LOG" to the switch catalog number.
- ◆ For use with 30–200 Ampere Series F NEMA 1, 3R, 12 and 12K switches only.
- ★ Factory install and kits are available for NEMA 1, 3R, 12 and 12K switch enclosures only.



Key Interlock Systems



Factory-installed only on heavy duty safety switches and double throw safety switches. Interlocks are used to prevent the authorized operator from making an unauthorized operation. Not available on hazardous location devices (NEMA 7/9) or fiberglass reinforced polyester (NEMA 4X). The key interlock system is a simple and easy method of applying individual key interlock units and assemblies to the above equipment so as to require operation in a predetermined sequence. UL Listed.

Quoting:

Contact Schneider Electric for catalog number, availability, and pricing prior to quoting a job.

Detailed information is required before an order can be processed. Please see Supplemental Digest Section 2 for further information.

Use these suffixes on switch catalog numbers:

- KI = 1 lock per switch
- KI2 = 1 lock with 2 cylinders (2 keys) per switch
- KIKI = 2 separate locks per switch

Table 3.27: Price Adder Per Lock ▲

Switch Type	\$ Price
30-1200 A Heavy Duty	2055.00
30-600 A Double Throw	1988.00

▲ Prices do not apply when more than three devices are interlocked, as these schemes normally require more than one key assembly per device.

Lock-On Provisions

Lock-off provisions are standard on all heavy duty safety switches. Provision for one 3/8-inch hasp padlock is available factory-installed on NEMA 1, 3R, 4-4X-5 stainless steel and 12 switches. This modification will allow the switch to be locked in the "ON" position. UL Listed.

Table 3.28: Price Adder Per Each Switch

Safety Switch Rating	\$ Price
30-1200 A	155.00

To order, add suffix SPLO to standard catalog number. Example: H364-SPLO

Cover Viewing Window



Optional cover viewing window is positioned over the blades to allow visual verification of "ON-OFF" status. Available on 30 through 1200 A heavy duty switches, all NEMA Types. (Not available on NEMA 4X fiberglass reinforced polyester, Krydon™ enclosures, or NEMA 7 and 9 devices.)

Factory-installed only: add "VW" suffix to the Cat. No. See table below for price adder.

Table 3.29: Price Adder Per Switch—UL Listed

Class	Amperes	2- and 3-Pole	4- and 6-Pole
Heavy Duty	30-100 A	38.00	75.00
Heavy Duty	400-1200 A	2297.00	—
Double Throw	30-100 A	255.00	510.00

Switch Lubricant

Field maintenance lubricant is available for servicing blade and jaw components in switches 600 V and below. Catalog number SWLUB (list price \$24.14) consists of one tube of BG20 High Performance Synthetic Grease manufactured by Dow Corning®. SWLUB is available in warehouse stock, shipped individually or in multiples of 12 units per carton.

Copper Only Lug Kits

Heavy duty safety switches are supplied standard with Al lugs, which accept both Cu and Al wires. For field installation of copper-only lug kits, order kits below. For factory installation of copper only lugs, add suffix SLC to standard Cat. No. Note: 30 through 200 Amperes NEMA 12, 12K and stainless steel switches with factory-installed lugs bear the UL Marine Listed manifest for use on vessels over 65 feet long. 30 through 200 Amperes NEMA 12, 12K and stainless steel switches using field-installed copper only lug kits are UL Marine Listed, but do not bear the marine manifest.

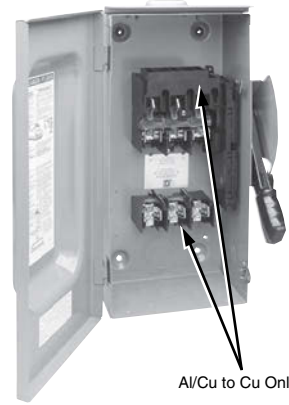

Al/Cu to Cu Only

Table 3.30: Kits—Wire size (pp 3-13)

Amperes	Lug Kit Cat. No. ■	Kit \$ Price	Factory-Installed Adder per Switch
30	CL0306F	69.00	224.00
60	CL0306F	69.00	224.00
100	CL10F	159.00	431.00
200	CL20F	264.00	717.00
400	CL40F	549.00	1490.00
600	CL60F	893.00	2426.00
800	—	—	—
1200	—	—	—

■ One kit includes all phase line/load lugs for a 3-pole switch.

Double Lug Kits

200 A heavy duty F-series switches are supplied standard with lugs listed on page 3-13 (one wire per phase). For lugs that accept two wires per phase and neutral, order the following kit:

Amperes	Lug Kit Cat. No.	Kit \$ Price★	Lug wire range per phase and neutral AWG/kcmil	Switch wire range per phase and neutral AWG/kcmil
200	AL20DTF	159.00	(2) 6-300 Cu/Al	(2) 6-250 Cu/Al

◆ Not UL Listed.

★ Kit contains 3 lugs. For double lugs for line and load, order 2 kits.

Table 3.31: 800 and 1200 A Compression Lug Kits—

Field-Installed (See page 3-13 for 100-600 A Switches)

Series E4 800 and 1200 A safety switches are equipped as standard with mechanical lugs. Alternate compression lug kits are available for field installation and are UL Listed. Each kit consists of VCEL07512H1 Versa-Crimp™ Compression Lugs and lug landing connectors capable of converting line and load side of one switch pole or neutral.

Order one field-installed kit per pole or neutral per table below.

Example: Three-pole three-wire requires three kits; three-pole, four-wire requires four kits.

Amperes	Lug Kit Cat. No.	\$ Price Per Pole or Neutral
800	H8LKE2	893.00
1200	H12LKE2	1109.00

Note: For terminal lug data, refer to table below.

Table 3.32: Factory-Installed

Series E4 800 and 1200 A safety switches are available with factory-installed VCEL-075-12H1 Versa-Crimp compression lug kits (above). For factory installation, add suffix LK to standard Cat. No. (Example: H367LK) and use price adder from table below based on system type.

Amperes	System	Factory-Installed \$ Price Adder Per Switch
800	2 Wire	2106.00
	3 Wire	2972.00
	4 Wire	3839.00
1200	2 Wire	2591.00
	3 Wire	3696.00
	4 Wire	4806.00

Note: For terminal Lug data refer to table below.

Table 3.33: Terminal Lug Data—800 and 1200 A Compression Lugs

Amperes	Conductors Per Phase	Compression Lug (VCEL-075-12H1) Wire Range
800	(3) Line and (3) Load	500-750 kcmil (Al) or 500 kcmil (Cu)
	(4) Line and (4) Load	500-750 kcmil (Al) or 500 kcmil (Cu)

Table 3.34: Terminal Lug Data (NEMA 1, 3R, 4, 4X, 5, 7, 9, 12)▲

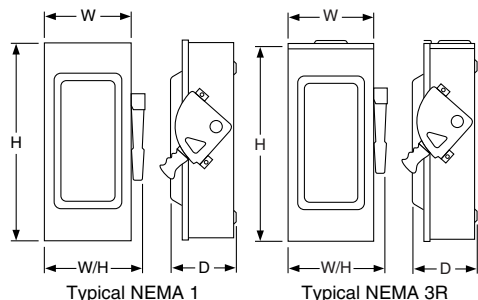

Rating (A)	Conductors Per Phase and Neutral	Wire Range Wire Bending Space Per NEC Table 312.6 AWG/kcmil	Lug Wire Range AWG/kcmil	Optional Versa-Crimp™ Compression Lug Field-Installed■
30◆	1	12–6 (Al) or 14–6 (Cu)	12–2 (Al) or 14–2 (Cu)	—
	2	14–10 (Cu) solid or 14–10 (Cu) stranded		
60★	1	14–3 (Al) or 14–3 (Cu)	12–2 (Al) or 14–2 (Cu)	—
100	1	12–1/0 (Al) or 14–1/0 (Cu)	12–1/0 (Al) or 14–1/0 (Cu)	VCELO2114S1
200▼	1	6–250 (Al/Cu)	6–300 (Al/Cu)	VCELO30516H1
400	1 or 2	1/0–750 (Al/Cu)△ or 1/0–300 (Al/Cu)	1/0–750 (Al/Cu) and 1/0–300 (Al/Cu)	VCELO7512H1 or VCELO30516H1□ and VCELO5012H1
	2	3/0–500 (Al/Cu)	3/0–500 (Al/Cu)	VCELO5012H1
800	3	3/0–750 (Al/Cu)	3/0–750 (Al/Cu)	H8LKE2◇
1200	4	3/0–750 (Al/Cu)	3/0–750 (Al/Cu)	H12LKE2◇

- ▲ 30–100 A switches suitable for 60°C or 75°C conductors. 200–1200 A switches suitable for 75°C conductors.
- For NEMA 1 and 3R only.
- ◆ HU461AWK— 14–3 AWG (Al or Cu).
- ★ H60XFA— 14–6 AWG (Cu).
- ▼ H225XKA— 4 AWG–300 kcmil (Cu).
- △ Max. wire range is (1) 600 kcmil or (2) 300 kcmil Al/Cu on NEMA 4X Stainless and NEMA 12.
- Order two PK516KN mounting kits when installing VCELO30516H1 lugs. Only one kit is required on 2-Pole switches.
- ◇ See page 3-12, 800 and 1200 A compression lug kits for additional information.

Cat. No.	Approximate Dimensions									Cat. No.	Approximate Dimensions								
	Series	H		W		D		W/H			Series	H		W		D		W/H	
		in.	mm	in.	mm	in.	mm	in.	mm			in.	mm	in.	mm	in.	mm	in.	mm
H221N	F5	14.60	371	6.50	165	4.88	124	7.55	192	H364, N	F5	29.00	737	17.13	435	8.25	210	18.50	470
H221NRB	F5	14.88	378	6.63	168	4.88	124	7.55	192	H364RB, NRB	F5	29.25	743	17.25	438	8.50	216	18.63	473
H222N	F5	14.60	371	6.50	165	4.88	124	7.55	192	H365, N	E4	50.25	1276	27.63	702	10.13	257	27.63	702
H222NRB	F5	14.88	378	6.63	168	4.88	124	7.55	192	H365R, NR	E5	50.31	1278	27.76	705	9.53	242	27.88	708
H223N	F5	21.25	540	8.50	216	6.38	162	10.50	267	H366, N	E4	50.25	1276	27.63	702	10.13	257	27.63	702
H223NRB	F5	21.25	540	8.50	216	6.38	162	10.50	267	H366NR, R	E5	50.31	1278	27.76	705	9.53	242	27.88	708
H224N	F5	29.00	737	17.13	435	8.25	210	18.50	470	H367, N	E4	69.13	1756	36.62	930	17.75	451	36.62	930
H224NRB	F5	29.25	743	17.25	438	8.50	216	18.63	473	H367NR, R	E4	69.13	1756	36.62	930	17.75	451	36.62	930
H225, N	E4	50.25	1276	27.63	702	10.13	257	27.63	702	H368, N	E4	69.13	1756	36.62	930	17.75	451	36.62	930
H225NR, R	E5	50.31	1278	27.76	705	9.53	242	27.88	708	H368NR, R	E4	69.13	1756	36.62	930	17.75	451	36.62	930
H226, N	E4	50.25	1276	27.63	702	10.13	257	27.63	702	H461	F5	20.50	521	14.75	375	6.85	174	16.13	410
H226NR, R	E5	50.31	1278	27.76	705	9.53	242	27.88	708	H462	F5	20.50	521	14.75	375	6.85	174	16.13	410
H227, N	E4	69.13	1756	36.62	930	17.75	451	36.62	930	H463	F5	20.50	521	14.75	375	6.85	174	16.13	410
H227NR, R	E4	69.13	1756	36.62	930	17.75	451	36.62	930	H464	F5	29.00	737	23.25	591	8.75	222	24.88	632
H228, N	E4	69.13	1756	36.62	930	17.75	451	36.62	930	H465	E4	50.25	1276	33.88	861	10.13	257	33.88	861
H228NR, R	E4	69.13	1756	36.62	930	17.75	451	36.62	930	H466	E4	50.25	1276	33.88	861	10.13	257	33.88	861
H265	E4	50.25	1276	27.63	702	10.13	257	27.63	702	HU265	E4	50.25	1276	27.63	702	10.13	257	27.63	702
H265R	E5	50.31	1278	27.76	705	9.53	242	27.88	708	HU265R	E5	50.31	1278	27.76	705	9.53	242	27.88	708
H266	E4	50.25	1276	27.63	702	10.13	257	27.63	702	HU266	E4	50.25	1276	27.63	702	10.13	257	27.63	702
H266R	E5	50.31	1278	27.76	705	9.53	242	27.88	708	HU266R	E5	50.31	1278	27.76	705	9.53	242	27.88	708
H267	E4	69.13	1756	36.62	930	17.75	451	36.62	930	HU267	E4	69.13	1756	36.62	930	17.75	451	36.62	930
H267R	E4	69.13	1756	36.62	930	17.75	451	36.62	930	HU267R	E4	69.13	1756	36.62	930	17.75	451	36.62	930
H268	E4	69.13	1756	36.62	930	17.75	451	36.62	930	HU268	E4	69.13	1756	36.62	930	17.75	451	36.62	930
H268R	E4	69.13	1756	36.62	930	17.75	451	36.62	930	HU268R	E4	69.13	1756	36.62	930	17.75	451	36.62	930
H321N	F5	14.60	371	6.50	165	4.88	124	7.55	192	HU361	F5	14.60	371	6.50	165	4.88	124	7.55	192
H321NRB	F5	14.88	378	6.63	168	4.88	124	7.55	192	HU361RB	F5	14.88	378	6.63	168	4.88	124	7.55	192
H322N	F5	14.60	371	6.50	165	4.88	124	7.55	192	HU361WA	F6	18.19	462	9.00	229	6.81	173	10.50	267
H322NRB	F5	14.88	378	6.63	168	4.88	124	7.55	192	HU361WC	F6	18.19	462	9.00	229	6.81	173	10.50	267
H323N	F5	21.25	540	8.50	216	6.38	162	10.50	267	HU362	F5	17.50	445	9.00	229	6.38	162	10.50	267
H323NRB	F5	21.25	540	8.50	216	6.38	162	10.50	267	HU362RB	F5	17.50	445	9.00	229	6.38	162	10.50	267
H324N	F5	29.00	737	17.13	435	8.25	210	18.50	470	HU362WA	F6	18.19	462	9.00	229	6.81	173	10.50	267
H324NRB	F5	29.25	743	17.25	438	8.50	216	18.63	473	HU362WC	F6	16.75	425	9.00	229	7.00	178	10.50	267
H325, N	E4	50.25	1276	27.88	708	10.13	257	27.88	708	HU362WH	F5	18.19	462	9.00	229	6.81	173	10.50	267
H325R, NR	E5	50.31	1278	27.76	705	9.53	242	27.88	708	HU363	F5	21.25	540	8.50	216	6.38	162	10.50	267
H326, N	E4	50.25	1276	27.63	702	10.13	257	27.63	702	HU363RB	F5	21.25	540	8.50	216	6.38	162	10.50	267
H326R, NR	E5	50.31	1278	27.76	705	9.53	242	27.88	708	HU363WA	F6	21.85	462	9.00	229	6.81	173	10.50	267
H327, N	E4	69.13	1756	36.62	930	17.75	451	36.62	930	HU363WC	F6	21.85	555	9.00	229	6.81	173	10.50	267
H327R, NR	E4	69.13	1756	36.62	930	17.75	451	36.62	930	HU364	F5	29.00	737	17.13	435	8.25	210	18.50	470
H328, N	E4	69.13	1756	36.62	930	17.75	451	36.62	930	HU364RB	F5	29.25	743	17.25	438	8.50	216	18.63	473
H328R, NR	E4	69.13	1756	36.62	930	17.75	451	36.62	930	HU365	E4	50.25	1276	27.63	702	10.13	257	27.63	702
H361, N	F5	14.60	371	6.50	165	4.88	124	7.55	192	HU365R	E5	50.31	1278	27.76	705	9.53	242	27.88	708
H361-2	F5	17.50	445	9.00	229	6.38	162	10.50	267	HU366	E4	50.25	1276	27.63	702	10.13	257	27.63	702
H361NRB, RB	F5	14.88	378	6.63	168	4.88	124	7.55	192	HU366R	E5	50.31	1278	27.76	705	9.53	242	27.88	708
H361WA	F6	18.19	462	9.00	229	6.81	173	10.50	267	HU367	E4	69.13	1756	36.62	930	17.75	451	36.62	930
H361WC	F6	18.19	462	9.00	229	6.81	173	10.50	267	HU367R	E4	69.13	1756	36.62	930	17.75	451	36.62	930
H362, N	F5	17.50	445	9.00	229	6.38	162	10.50	267	HU368	E4	69.13	1756	36.62	930	17.75	451	36.62	930
H362NRB, RB	F5	17.50	445	9.00	229	6.38	162	10.50	267	HU368R	E4	69.13	1756	36.62	930	17.75	451	36.62	930
H362WA	F6	18.19	462	9.00	229	6.81	173	10.50	267	HU461	F5	20.50	521	14.75	375	6.85	174	16.13	410
H362WC	F6	16.75	425	9.00	229	7.00	178	10.50	267	HU462	F5	20.50	521	14.75	375	6.85	174	16.13	410
H362WH	F5	18.19	462	9.00	229	6.81	173	10.50	267	HU463	F5	20.50	521	14.75	375	6.85	174	16.13	410
H363, N	F5	21.25	540	8.50	216	6.38	162	10.50	267	HU464	F5	29.00	737	23.25	591	8.75	222	24.88	632
H363NRB, RB	F5	21.25	540	8.50	216	6.38	162	10.50	267	HU465	E4	50.25	1276	33.88	861	10.13	257	33.88	861
H363WA	F6	21.85	462	9.00	229	6.81	173	10.50	267	HU466	E4	50.25	1276	33.88	861	10.13	257	33.88	861
H363WC	F6	21.85	555	9.00	229	6.81	173	10.50	267										

NEMA Type 4, 4X, 5, 7, 9 and 12

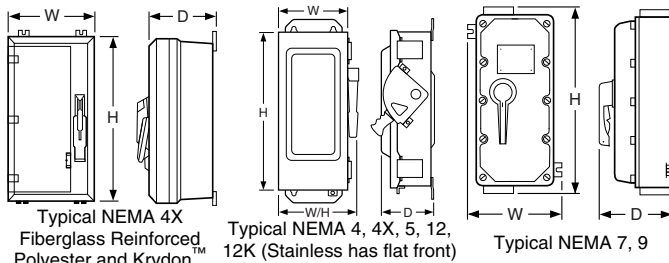

Table 3.35: Optional Copper Only Lug Kits

(See page 3-12 for pricing. See page 3-13 for terminal lug data for the series switches listed in the dimension table below.)

Amperes	Optional Lug Kit Cat. No.▲	Lug Wire Range Per Phase AWG/kcmil
30-60	CL0306F	(1) 14-8 Cu solid or 14-4 Cu strand
100	CL10F	(1) 14-8 Cu solid or 14-1/0 Cu strand
200	CL20F	(1) 6-250 Cu
400	CL40F	(1) 1-600 Cu plus (1) 6-250 Cu
600	CL60F	(2) 4-350 Cu

▲ One kit includes all phase line/load lugs for a 3-pole switch.

Table 3.36: Conduit Provisions

(NEMA 4X Fiberglass Reinforced Polyester and Krydron, NEMA 7 and 9.)

Amperes	Top and Bottom Endwall	
	NEMA 4X Fiberglass Reinforced Polyester and Krydron■	NEMA 7 and 9♦
30	3/4 in.	—
60	1-1/4 in.	3/4 in.
100	2 in.	1-1/4 in.
200	2-1/2 in.	2-1/2 in.

■ Hubs and hub drilling templates are provided for field-installation.

♦ Threaded conduit opening.

Cat. No.	Series	Approximate Dimensions							
		H		W		D		W/H	
		in.	mm	in.	mm	in.	mm		
H60XFA	E1	15.93	405	9.87	251	6.96	177	9.87	251
H100XFA	E1	15.93	405	9.87	251	6.96	177	9.87	251
H221AWK, A	F6	14.60	371	6.63	168	4.96	125	7.55	192
H221DS	F6	14.93	379	7.22	183	5.11	130	8.67	220
H221-2AWK	F6	16.50	419	9.00	229	7.00	178	10.50	267
H222AWK, A	F6	14.60	371	6.63	168	4.96	125	7.55	192
H222DS	F6	14.93	379	7.22	183	5.11	130	8.67	220
H223AWK, A	F6	20.50	521	9.00	229	7.00	178	10.50	267
H223DS	F6	20.82	529	9.36	238	6.97	177	11.25	286
H224A, AWK	F6	29.00	737	17.25	438	8.75	216	18.63	473
H224DS	F6	29.00	737	17.25	438	8.75	216	18.63	473
H225AWK, DS	E4	46.25	1175	26.25	667	10.13	259	26.25	667
H225NAWK, NDS	E4	46.25	1175	26.25	667	10.13	259	26.25	667
H225XJG	C2	22.56	573	10.88	276	7.75	197	10.88	276
H226AWK, DS	E4	46.25	1175	26.25	667	10.13	259	26.25	667
H226NAWK, NDS	E4	46.25	1175	26.25	667	10.13	259	26.25	667
H227AWK, NAWK	E4	69.13	1756	36.62	930	17.75	451	36.62	930
H228AWK, NAWK	E4	69.13	1756	36.62	930	17.75	451	36.62	930
H228AWK, DS	E4	46.25	1175	26.25	667	10.13	259	26.25	667
H228AWK, A, DS	E4	46.25	1175	26.25	667	10.13	259	26.25	667
H267AWK, NAWK	E4	69.13	1756	36.62	930	17.75	451	36.62	930
H268AWK, NAWK	E4	69.13	1756	36.62	930	17.75	451	36.62	930
H321AWK, A	F6	14.60	371	6.63	168	4.96	125	7.55	192
H321DS	F6	14.93	379	7.22	183	5.11	130	8.67	220
H322AWK, A	F6	14.60	371	6.63	168	4.96	125	7.55	192
H322DS	F6	14.93	379	7.22	183	5.11	130	8.67	220
H323AWK, A	F6	20.50	521	9.00	229	7.00	178	10.50	267
H323DS	F6	20.82	529	9.36	238	6.97	177	11.25	286
H324A, AWK	F6	29.00	737	17.25	438	8.75	216	18.63	473
H324DS	F6	29.00	737	17.25	438	8.75	216	18.63	473
H325AWK, DS	E4	46.25	1175	26.25	667	10.13	259	26.25	667
H325NAWK, NDS	E4	46.25	1175	26.25	667	10.13	259	26.25	667
H326AWK, DS	E4	46.25	1175	26.25	667	10.13	259	26.25	667
H326NAWK, NDS	E4	46.25	1175	26.25	667	10.13	259	26.25	667
H327AWK, NAWK	E4	69.13	1756	36.62	930	17.75	451	36.62	930
H328AWK, NAWK	E4	69.13	1756	36.62	930	17.75	451	36.62	930
H361AWA	F7	16.50	419	9.00	229	7.00	178	10.50	267
H361AWC	F7	16.50	419	9.00	229	7.00	178	10.50	267
H361AWK, A	F6	14.60	371	6.63	168	4.96	125	7.55	192
H361DS	F6	14.93	379	7.22	183	5.11	130	8.67	220
H361DSWA	F7	16.87	428	8.92	227	5.11	130	10.81	275
H361DSWC	F7	16.87	428	8.92	227	5.11	130	10.79	274
H361DF	F1	16.50	419	11.00	279	8.80	224	11.00	279
H361DX	F1	19.40	493	11.40	290	8.60	218	11.40	290
H361SS	F6	14.93	379	7.22	183	5.11	130	8.67	220
H361-2AWK, A	F6	16.50	419	9.00	229	7.00	178	10.50	267
H362AWA	F7	16.50	419	9.00	229	7.00	178	10.50	267
H362AWC	F7	16.50	419	9.00	229	7.00	178	10.50	267
H362AWH	F6	16.50	419	9.00	229	7.00	178	10.50	267
H362AWK, A	F6	16.50	419	9.00	229	7.00	178	10.50	267
H362DS	F6	16.87	428	8.92	227	6.97	177	10.81	275

Cat. No.	Series	Approximate Dimensions							
		H		W		D		W/H	
		in.	mm	in.	mm	in.	mm	in.	mm
H362DSWA	F7	16.87	428	8.92	227	5.11	130	10.81	275
H362DSWC	F7	16.87	428	8.92	227	5.11	130	10.79	274
H362DF	F1	16.50	419	11.00	279	8.80	224	11.00	279
H362DX	F1	19.40	493	11.40	290	8.60	218	11.40	290
H362SS	F6	16.87	428	8.92	227	6.97	177	10.81	275
H363AWA	F7	20.50	521	9.00	229	7.00	178	10.50	267
H363AWC	F7	20.50	521	9.00	229	7.00	178	10.50	267
H363AWK, A	F6	20.50	521	9.00	229	7.00	178	10.50	267
H363DS	F6	20.82	529	9.36	238	6.97	177	11.25	286
H363DSWA	F7	20.82	529	9.36	238	6.97	177	11.25	286
H363DSWC	F7	20.82	529	9.36	238	6.97	177	11.25	286
H363DF	F1	24.80	630	13.70	348	12.00	305	13.70	348
H363DX	F1	25.25	641	11.40	290	8.60	218	11.40	290
H363SS	F6	20.82	529	9.36	238	6.97	177	11.25	286
H364A, AWK	F6	29.00	737	17.25	438	8.75	216	18.63	473
H364DS, NDS	F6	29.00	737	17.25	438	8.75	216	18.63	473
H364NA, NAWK	F6	29.00	737	17.25	438	8.75	216	18.63	473
H364DF	E1	31.30	795	26.30	668	11.80	300	26.30	668
H364SS	F6	29.00	737	17.25	438	8.75	216	18.63	473
H364DS, DS, SS	E4	46.25	1175	26.25	667	10.13	259	26.25	667
H365NAWK, NDS	E4	46.25	1175	26.25	667	10.13	259	26.25	667
H366AWK, DS	E4	46.25	1175	26.25	667	10.13	259	26.25	667
H366NAWK, NDS, SS	E4	46.25	1175	26.25	667	10.13	259	26.25	667
H367AWK, NAWK	E4	69.13	1756	36.62	930	17.75	451	36.62	930
H368AWK, NAWK	E4	69.13	1756	36.62	930	17.75	451	36.62	930
H461AWK	F6	20.50	521	14.75	375	6.80	173	16.13	410
H461DS	F6	20.82	529	15.08	383	6.97	177	16.85	428
H462AWK	F6	20.50	521	14.75	375	6.80	173	16.13	410
H462DS	F6	20.82	529	15.08	383	6.97	177	16.85	428
H463AWK	F6	20.50	521	14.75	375	6.80	173	16.13	410
H463DS	F6	20.82	529	15.08	383	6.97	177	16.85	428
H464AWK	F6	29.00	737	23.25	591	8.75	222	24.88	632
H464DS	F6	29.00	737	23.25	591	8.75	222	24.88	632
H465AWK	E4	46.25	1175	32.50	826	10.13	259	32.50	826
H663AWK	F6	20.50	521	14.75	375	6.80	173	16.13	410
H663DS	F6	20.82	529	15.08	383	6.97	177	16.85	428
H664AWK	F6	29.00	737	23.25	591	8.75	222	24.88	632
H664DS	F6	29.00	737	23.25	591	8.75	222	24.88	632
HU265AWK, DS	E4	46.25	1175	26.25	667	10.13	259	26.25	667
HU266AWK, DS	E4	46.25	1175	26.25	667	10.13	259	26.25	667
HU267AWK	E4	69.13	1756	36.62	930	17.75	451	36.62	930
HU268AWK	E4	69.13	1756	36.62	930	17.75	451	36.62	930
HU361AWA	F7	16.50	419	9.00	229	7.00	178	10.50	267
HU361AWC	F7	16.50	419	9.00	229	7.00	178	10.50	267
HU361AWK, A	F6	14.60	371	6.63	168	4.96	125	7.55	192
HU361DS	F6	14.93	379	7.22	183	5.11	130	8.67	220
HU361DSWA	F7	16.87	428	8.92	227	5.11	130	10.81	275
HU361DSWC	F7	16.87	428	8.92	227	5.11	130	10.79	274
HU361DF	F1	16.50	419	11.00	279	8.80	224	11.00	279
HU361DX	F1	19.40	493	11.40	290	8.60	218	11.40	290
HU361SS	F6	14.93	379	7.22	183	5.11	130	8.67	220
HU362AWA	F7	16.50	419	9.00	229	7.00	178	10.50	267
HU362AWC	F7	16.50	419	9.00	229	7.00	178	10.50	267
HU362AWH	F6	16.50	419	9.00	229	7.00	178	10.50	267
HU362AWK, A	F6	16.50	419	9.00	229	7.00	178	10.50	267
HU362DS	F6	16.87	428	8.92	227	6.97	177	10.81	275
HU362DSWA	F7	16.87	428	8.92	227	5.11	130	10.81	275
HU362DSWC	F7	16.87	428	8.92	227	5.11	130	10.79	274
HU362DF	F1	16.50	419	11.00	279	8.80	224	11.00	279
HU362DX	F1	19.40	493	11.40	290	8.60	218	11.40	290
HU362SS	F6	16.87	428	8.92	227	6.97	177	10.81	275
HU363AWA	F7	20.50	521	9.00	229	7.00	178	10.50	267
HU363AWC	F7	20.50	521	9.00	229	7.00	178	10.50	267
HU363AWK, A	F6	20.50	521	9.00	229				



30–100 A Types DT, DTU (Series F)

- Fusible (DT) and non-fusible (DTU) switches available
- Manually-operated switch suitable for use in accordance with article 702 of the NEC, ANSI/NFPA 70
- Standards: UL 98, NEMA KS1, CSA, and NOM
- Modular design—switch handle, lock-plate, switch mechanism; line and load bases are field replaceable
- UL Listed short circuit current ratings up to 200 kA (using Class R, J, or T fuses—see table for rating)
- Load make/break rated
- Meets NEMA hp ratings
- Dual cover interlock
- May be padlocked ON (I) or OFF (O)
- Lock-off accepts up to three padlocks
- Side-opening door
- Quick make / quick break mechanism
- Meets NEMA requirements as heavy duty switch
- Field-installed electrical interlock kits
- Field-installed neutral assembly kits (2P and 3P switches)
- UL Listed as suitable for use as service equipment
- Supplied as standard for switching one load between two power sources, and may be field-converted to switch on power source between two loads.



30 (Series T4), 200–600 A Types 82,000 and 200 A DTU (Series E, A)

- Non-fusible
- Designed for manual transfer of loads from one supply to another
- UL Listed switches are suitable for use in accordance with Article 702 of the National Electrical Code, ANSI / NFPA 70
- All 82,000 and DTU double throw switches are continuous duty rated for their nameplate ampere rating
- The 82,000 and DTU (Series E, A) switches are load make/break rated
- UL Listed as suitable for use as service equipment
- Horsepower rated only as footnoted.

Field-Installed Accessories:

- Neutral
- Electrical Interlock
- Grounding Terminals

30–100 A DT, DTU (Series F)
NEMA 1



82,000 Line
NEMA 1

Table 3.37: 240 V Double Throw Safety Switches

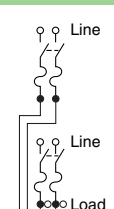
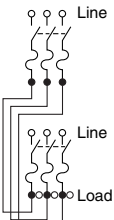
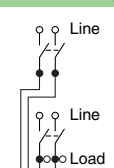
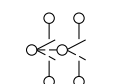
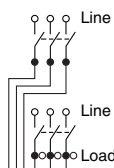
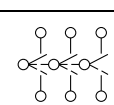
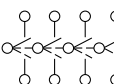
System	Amperes	Current Series	NEMA 1		NEMA 3R		NEMA 4,4X,5 304 Stainless Steel		NEMA 12 Gasketed		Horsepower Ratings ▲ ■				250 Vdc ♦
			240 Vac		240 Vac		240 Vac		240 Vac		240 Vac		240 Vac		
			Cat. No.	\$ Price	Cat. No.	\$ Price	Cat. No.	\$ Price	Cat. No.	\$ Price	1Ø	3Ø	1Ø	3Ø	
Fusible—2P, 240 Vac—250 Vdc															
	100	F	DT223	2379.00	DT223RB	3056.00	—	—	—	—	7.5	15 ★	15	30 ★	20
Fusible—3P, 240 Vac—250 Vdc															
	30	F	DT321	1646.00	DT321RB	2216.00	—	—	—	—	1.5 ▼	3 ★	3 ▼	7.5 ★	5
	60	F	DT322	1970.00	DT322RB	2612.00	—	—	—	—	3 ▼	7.5 ★	10 ▼	15 ★	10
	100	F	DT323	3104.00	DT323RB	3725.00	—	—	—	—	7.5 ▼	15 ★	15 ▼	30 ★	20
Non-Fusible—2P, 240 Vac—250 Vdc															
	60	F	DTU222	962.00	—	—	—	—	—	—	—	—	10	—	10 △
	100	F	DTU223	1371.00	DTU223RB	1347.00	—	—	—	—	—	—	15	—	20 △
	30	T4	92251 □	585.00	—	—	—	—	—	—	—	—	—	—	—
	200	E	82254 ◐	1815.00	DTU224NRB □ ◐	2177.00	—	—	H82254	4671.00	15	—	—	—	—
	400	A	82255 □	5850.00	82255R □	8715.00	—	—	H82255 □	10335.00	15	—	—	—	—
Non-Fusible—3P, 240 Vac—250 Vdc															
	30	F	DTU321	804.00	—	—	—	—	—	—	—	3 ★	5 ▼	10 ★	5 △
	60	F	DTU322	1119.00	—	—	—	—	—	—	—	10 ▼	15 ★	10 △	10 △
	100	F	DTU323	1764.00	DTU323RB	1953.00	—	—	—	—	—	15 ▼	30 ★	20 △	20 △
	30	T4	92351 □	687.00	—	—	—	—	—	—	—	—	—	—	—
	200	E	82354 □	2564.00	DTU324NRB □ ◐	3005.00	—	—	H82354 □ ☆	5408.00	15	—	—	—	—
	200	E	DTU324N □ ◐	2798.00	—	—	—	—	—	—	15	—	—	—	—
	400	A	82355 □	8040.00	82355R □	13038.00	—	—	H82355 □	11715.00	—	—	—	—	—
	600	A	DTU326	12555.00	DTU326R	13890.00	—	—	—	—	125	—	—	—	50
Non-Fusible—4P, 240 Vac															
	30	T4	92451	953.00	—	—	—	—	—	—	—	—	—	—	—
	200	E	82454 ◐	5184.00	82454R ◐	7517.00	—	—	H82454 ▼	6779.00	15 ▼	—	—	—	—
	400	A	82455	11505.00	82455R	16200.00	—	—	H82455	15975.00	—	—	—	—	—
	600	A	DTU426	20355.00	DTU426R	20595.00	—	—	—	—	125	—	—	—	50

▲ Refer to page 7-31 for additional motor application data. The starting current of motors or more than standard horsepower may require the use of fuses with appropriate time delay characteristics.
 ■ Std.—Using fast acting one time fuses. Max.—Using dual element time delay fuses.
 ♦ For switching dc, use two switching poles.
 ★ If used on corner grounded delta systems, install neutral and use outer switching pole for ungrounded conductors.
 ▼ Use outer switching poles.
 △ Maximum rating.
 □ 240 Vac only.
 ◐ Neutral included with device.
 ☆ Suitable for use as service equipment.
 ▼ Hp rating applies only to H82454.
 ◐ 250 V dc rated.

600 V Double Throw page 3-17
 Accessories page 3-18
 Application Data page 3-19
 Dimensions: 30–100 A (Series F) page 3-20
 Dimensions: 30, 200–600 A (Series E, T4, A) page 3-21

Table 3.38: 600 V Double Throw Safety Switches

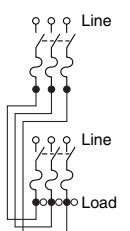
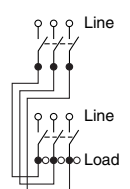
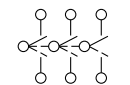
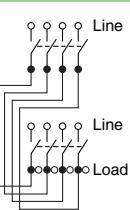
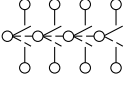
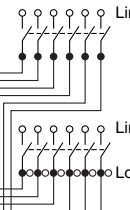
System	Amperes	Current Series	NEMA 1		NEMA 3R		NEMA 4,4X,5 304 Stainless Steel		NEMA 12 Gasketed		Horsepower Ratings ▲ □															
			Cat. No.		\$ Price		Cat. No.		\$ Price		Cat. No.		\$ Price		240 Vac		480 Vac		600 Vac		Vdc ■					
			std	max	std	max	std	max	std	max	std	max	3Ø	3Ø	3Ø	3Ø	3Ø	3Ø	250	600						
Fusible 3P, 600 Vac—600 Vdc																										
	30	F	DT361	2016.00	DT361RB	2678.00	—	—	—	—	—	—	—	—	—	5	15	7.5	20	5	15					
	60	F	DT362	2111.00	DT362RB	3135.00	—	—	—	—	—	—	—	—	—	15	30	15	50	—	30					
	100	F	DT363	3686.00	DT363RB	4427.00	—	—	—	—	—	—	—	—	—	25	60	30	75	—	50					
Non-Fusible 3P, 600 Vac—600 Vdc												1Ø	★	3Ø	■	1Ø	★	3Ø	■	1Ø	★	3Ø				
	30	F	DTU361	879.00	DTU361RB	1544.00	—	—	—	—	5	10	7.5	20	10	30	5	15								
	60	F	DTU362	1254.00	DTU362RB	2045.00	DTU362DS	6306.00	DTU362AWK	3635.00	10	20	25	50	30	60	10	30								
	100	F	DTU363	2036.00	DTU363RB	3425.00	DTU363DS	9414.00	DTU363AWK	3894.00	20	40	40	75	40	75	20	50								
	200	E	82344▽♦	2783.00	82344RB▽♦	5868.00	82344DS▽‡	11415.00	H82344*▽♦	7503.00	—	—	—	15	—	—	—	—								
	400	A	82345	8213.00	82345R	13140.00	82345DS	15675.00	H82345	12105.00	—	—	—	—	—	—	—	—								
	600	A	DTU366	13890.00	DTU366R	19800.00	—	—	DTU366AWK	21675.00	—	125	—	250	—	350	50	—								
Non-Fusible 4P, 600 Vac—600 Vdc												2Ø	3Ø	2Ø	3Ø	2Ø	3Ø									
	60	F	DTU462	3035.00	Use NEMA 12	—	DTU462DS	6683.00	DTU462AWK	4184.00	20	20	40	50	50	60	10	30								
	100	F	DTU463	3851.00	—	—	DTU463DS	9978.00	DTU463AWK	6123.00	30	40	50	75	50	75	20	30								
	200	E	82444	6143.00	82444R	8130.00	82444DS	15105.00	H82444*▽♦	7143.00	—	—	—	—	—	—	—	—								
	400	A	82445	12578.00	82445R	16800.00	—	—	H82445	16845.00	—	—	—	—	—	—	—	—								
	600	A	DTU466	20355.00	DTU466R	23475.00	—	—	—	—	—	125	—	250	—	350	50	—								
Non-Fusible 6P, 600 Vac—600 Vdc												1Ø	3Ø	1Ø	3Ø	1Ø	3Ø									
	60	F	—	—	—	—	—	—	DTU662AWK	8474.00	—	20	—	50	—	60	10	30								
	100	F	—	—	—	—	—	—	DTU663AWK	12735.00	—	40	—	75	—	75	20	50								

▲ Refer to page 7-31 for additional motor application data. The starting current of motors or more than standard horsepower may require the use of fuses with appropriate time delay characteristics.
 ■ If used on corner grounded delta systems, install neutral and use outer switching pole for ungrounded conductors.
 ♦ For switching dc, use two switching poles.
 ★ Use outer switching poles.
 ▼ Maximum Hp is 15 for corner grounded delta systems.
 △ Maximum Hp is 30 for corner grounded delta systems.
 □ Use 75°C #4 Cu or #2 Al conductors only.
 ◇ Use 75°C #1 Cu conductors only.
 ☆ Maximum Hp is 60 for corner grounded delta systems.
 ▽ 480 Vac maximum only, 250Vdc.
 ○ Standard Hp rating.
 * Not suitable for use as service equipment.
 ◇ 600 Vac max.
 ○ 250 V dc rated.
 † Std.—Using fast acting one time fuses. Max.—Using dual element time delay fuses.
 (Non-fusible switches have max rating unless noted.)
 ■ Complete rating on switch is NEMA 3R or 12.
 For 3R applications, remove drain screw from bottom endwall.
 ♦ H82 ... and H92 ... devices are NEMA 12 only, intended for use indoors only.
 ‡ Not UL Listed.
 † Copper lugs not listed or available.

240 V Double Throw page 3-16
 Accessories page 3-18
 Application Data page 3-19
 Dimensions: 30–100 A (Series F) page 3-20
 Dimensions: 30, 200–600 A (Series E, T4, A) page 3-21

Table 3.38: Neutral Assembly

Switch	Field-Installed Standard Neutral Kit Cat. No.	Terminal Data AWG/kcmil	\$ Price	Field-Installed Copper only Neutral Kit Cat. No.	Terminal Data AWG/kcmil	\$ Price
30–100 A Type DT, DTU (Series F) (2- and 3-pole switches only)	SN0310	14–1/0 Al/Cu	114.00	SN0310C	14–1/0 Cu	120.00
30 A (Series T4) (2- and 3-pole switches only)	▲	▲	908.00	—	—	—
200 A Type 82000 and DTU (Series E) ■	▲	▲	1110.00	—	—	—
400 A Type 82000	DT400N	(1) 4–600kcmil or (2) 1/0–250kcmil	105.00	—	—	—
600 A Type DTU (Series A)	DT600NKD	250–500kcmil	452.00	—	—	—

▲ For Type 82,000 switches, neutral is available factory-installed on 2P and 3P double throw switches. Not UL Listed. To order, add suffix N to the standard catalog number and add the above price to the list price of the switch. For DTU switches, neutral is factory-installed in standard device and is UL Listed.
■ Neutral assembly catalog number DT200N can be added to 4P Type 82000 switches in the field.

Table 3.39: Electrical Interlocks (For Electrical Interlock Contact Ratings, see Supplemental Digest page 2-4.)

Switch	Field-Installed Electrical Interlock Kit Cat. No. ♦	\$ Price	Factory-Installed \$ Price Adder Per Switch
30–100 A Type DT, DTU (Series F)	EIK1, EIK2 ★♦	311.00	905.00▼
200 A Type 82000 and DTU (Series E) Δ	□	—	1113.00▼
400 A Type 82000	EK400DTU2	260.00	1533.00
600 A Type DTU (Series A)	DS200EK2D	438.00	—

♦ Electrical interlock kit catalog numbers with "1" suffix indicate one normally open and normally closed contact; "2" indicates two normally open and two normally closed contacts. See page 3-10 for electrical interlock ratings.
★ 30–100 A Type DT, DTU (Series F) switches contain (2) separate switching mechanisms. Each mechanism will accept an electrical interlock. Some applications may therefore require (2) electrical interlocks.
▼ 30–100 A Type DT, DTU (Series F) switches with factory-installed electrical interlocks installed are UL Listed and interlocks are furnished with 2 N.O./2 N.C. contacts installed in both "ON" positions. To order, add suffix EI to standard catalog number.
Δ Electrical interlock EK400DTU2 can be added to 4-pole Type 82000 switches in the field.
□ Type 82000 and DTU switches are available with electrical interlock factory-installed only. Not UL listed. Electrical interlocks are furnished with 2 N.O./N.C. contacts and are installed in both "ON" positions. To order, add suffix EI to standard switch catalog number.
♦ Double throw switches 92251, 92351, and 92451 are not available with factory or field installed electrical interlocks.

Table 3.40: Service Grounding Kit (Required for service equipment use.)

Switch	Field-Installed Service Grounding Lug Kit Cat. No.	Terminal Data AWG/kcmil	\$ Price
30–100 A Type DT, DTU (Series F)	Included	Included	std.
30 A Type 92,000	DT30SG	(4) 14–4 Cu/Al	29.40
200 A Type 82000 and DTU (Series E)	DT100SG	(3) 14–1/0 Cu/Al	30.00
400 A Type 82000	PKOGTA2 (2 required)	(4) 10–2/0 Cu or (4) 6–2/0 Al	55.00
600 A Type 82000 (Series A)	DS468GKD	6–250kcmil	309.00

Table 3.41: Class R Fuse Kits

When installed, this kit rejects all but Class R fuses. Kits are available for field installation. For factory installation, add "CLR" suffix to catalog number.

Switch	Series Number	Class R Fuse Kit Cat. No.	\$ Price	Factory-Installed	\$ Price
Class R Fuse Kits—240 V (two kits per 3P switch)					
30 A	F5	RFK03	24.50		390.00
60 A	F5	RFK06	25.50		390.00
100 A	F5	RFK10	47.70		390.00
Class R Fuse Kits—600 V (two kits per 3P switch)					
30 A	F5	RFK06	25.50		390.00
60 A	F5	RFK06H	25.50		390.00
100 A	F5	RFK10	47.70		390.00

Viewing Windows

See Table 3.29 for list price. Accessory available on 30–100 A DTU switches only.

Key Interlock Systems

For factory-installed key interlocks, refer to page 3-12.

Phenolic Legend Plate

For factory-installed phenolic legend plates, refer to Supplemental Digest page 2.3.

Lock-On Provisions—UL Listed

Standard and feature on 30–100 A type DT and DTU (Series F), 82,000 (400 A only) and type 92,000 switches.

Feature available as factory installed option for Type 82,000 (200 A only) and 200 A DTU (Series E) switches. Add the suffix SPLO to the catalog number and add \$410. to the switches list price.

Table 3.42: Rainproof Bolt-On Hubs—for use on NEMA 3R Enclosures

Conduit Size	3/4	1	1-1/4	1-1/2	2	2-1/2	3	3-1/2	4	Closing Cap
Hub Cat. No.	B075	B100	B125	B150	B200	B250	B300	B350	B400	BCAP
\$ Price Each★	33.30	33.30	33.30	33.30	61.00	102.00	186.00	300.00	368.00	3.80

Note: NEMA 3R rainproof enclosures with catalog number ending in RB have a bolt-on closing cap factory-installed. Order bolt-on hubs separately from table above. For more details see page 1-13. Hubs through size 2-1/2 in. can be directly installed on RB devices. Devices requiring 3 in. or larger hubs must have holes cut in the field. Gaskets are provided on 3 in. and larger hubs.

Note: All hubs are UL Listed for indoor and rainproof applications and suitable for use with conduit having ANSI standard taper pipe thread.

★ See Discount Schedule.

Table 3.43: Watertight Hubs—for use on NEMA 4, 4X and 5 Stainless Steel and NEMA 12 Enclosures

Conduit Trade Size	1/2	3/4	1	1-1/4	1-1/2	2	2-1/2	3	3-1/2	4
Standard-Zinc Hub Cat. No.	H050	H075	H100	H125	H150	H200	H250	H300	H350	H400
Zinc \$ Price Each	31.10	45.00	47.10	54.00	83.00	120.00	138.00	177.00	282.00	381.00
Chrome Plated Hub Cat. No.	H050CP	H075CP	H100CP	H125CP	H150CP	H200CP	—	—	—	—
Chrome Plated \$ Price Each	40.70	56.00	64.00	67.00	96.00	137.00	—	—	—	—

240 V Double Throw	page 3-16
600 V Double Throw	page 3-17
Application Data	page 3-19
Dimensions: 30–100 A (Series F)	page 3-20
Dimensions: 30, 200–600 A (Series E, T4, A)	page 3-21



"RB Hub"

Situations Requiring Fuses

30–100 A Type DT (Series F):

Select DT switches from pages 3-16, 3-17, which have provisions for accepting fuses.

30 A, 200–600 A Type 82,000 (Series E, T4, A), all DTU devices:

Use the non-fusible double throw switches from pages 3-16, 3-17 in conjunction with standard fusible devices, and install them according to diagram 1 or 2, below.

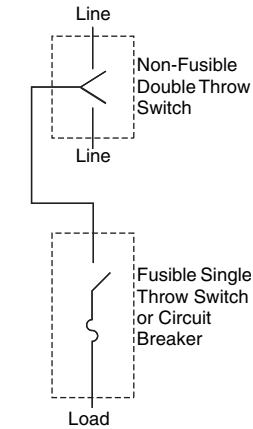

Diagram 1

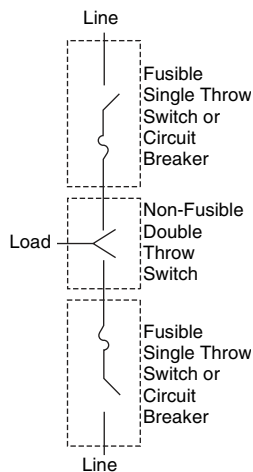

Diagram 2

Table 3.44: UL Listed Short Circuit Current Ratings

Switch Type	Amperes	Voltage Rating	UL Listed Fuse Class	Short Circuit Current Rating ▲ (A)
Type DT (Series F)	30–100 A	240 V or 600 V	H, K	10,000
			R, J	200,000
Type DTU ■ (Series F)	30–100 A	240 V or 600 V	H or K	10,000 ◆
			R, J or T	200,000
DTU224NRB and DTU324NRB (Series E)	200 A	240 V	H, K	10,000 ◆
DTU324N (Series E)			R, J	100,000
Type 82,000	all	240 V	H, K	10,000 ◆
			R, J	100,000 ★
		600 V	H, K	10,000 ◆
			R, J, T	100,000
Type DTU (A series)	600 A	240 V or 600 V	H, K	10,000
			R, J, T	100,000

- ▲ Rating applies to AC only. The UL Listed short circuit current rating for non-fusible switches is based on the switch being used in conjunction with the corresponding fuse type. Evaluation of non-fusible switches in conjunction with molded case circuit breakers has not been performed.
- The DTU361 and DTU361RB are also suitable for use on a circuit capable of delivering not more than (A) 18 kA, 600 Vac maximum when protected by Type FH circuit breaker rated 30 A maximum or (B) 14 kA, 600 Vac maximum when protected by Type FA circuit breaker rated 30 A maximum.
- ◆ Any brand of circuit breaker or fuse not exceeding the ampere rating of the switch may be used ahead of a non-fusible safety switch when there is up to 10 kA short circuit current available.
- ★ 400 A 82,000 switch is only 10 kA.

Table 3.45: Terminal Lug Data for Type DT, DTU (Series F) Double Throw Safety Switches

Switch Type	Wires per Phase	NEMA 1, 3R, 4, 4X, 12			Optional Copper Only Lug
		Wire Range Wire Bending Space Per NEC Table 373-6 AWG/kcmil	Standard Lug Wire Range AWG/kcmil	Optional Compression Lug Field-Installed	
30–60 A Type DT, DTU (Series F)	1	12–2 Al or 14–2 Cu	12–2 Al or 14–2 Cu	C10-14, D8-14, or E6-14 ▼	See pages 3-12 and 3-14 for appropriate kit. Order two kits per switch.
100 A Type DT, DTU (Series F)	1	12–1/0 Al or 14–1/0 Cu	12–1/0 Al or 14–1/0 Cu	VCEL02114S1 △	

- ▼ Thomas and Betts catalog numbers.
- △ Hubbell Versa-Crimp™ catalog numbers.

Table 3.46: Terminal Lug Data for Types 82,000 and for A and E-Series DTU devices □

Amperes	Wires per Phase	Wire Range Wire Bending Space Per NEC Table 373-6 AWG/kcmil	Lug Wire Range AWG/kcmil	Optional Compression Lugs Field-Installed
30 A (Series T4) ◇	1	14–8 Al/Cu	12–2 Al or 14–2 Cu	—
200	1	6–300 Al/Cu	6–300 Al/Cu	VCEL030516H1 ★
400	1 or 2	1/0–600 Al/Cu or 1/0–300 Al/Cu	1/0–600 Al/Cu	—
600	2	250–500 Al/Cu	250–500 Al/Cu	—

- 200–600 A switches suitable for 75°C conductors.
- ◇ 30 A switches suitable for 60°C or 75°C conductors.
- ★ Hubbell Versa-Crimp™ catalog numbers.

240 V Double Throwpage 3-16
 600 V Double Throwpage 3-17
 Accessoriespage 3-18
 Dimensions: 30–100 A (Series F)page 3-20
 Dimensions: 30, 200–600 A (Series E, T4, A)page 3-21

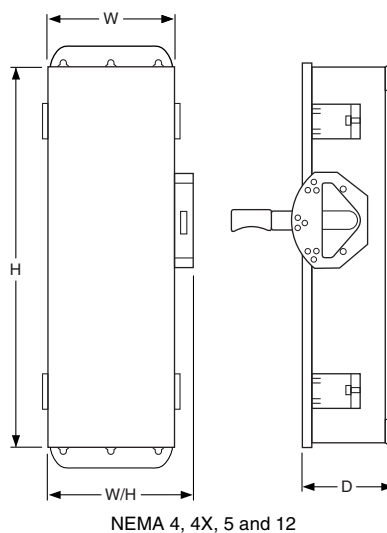
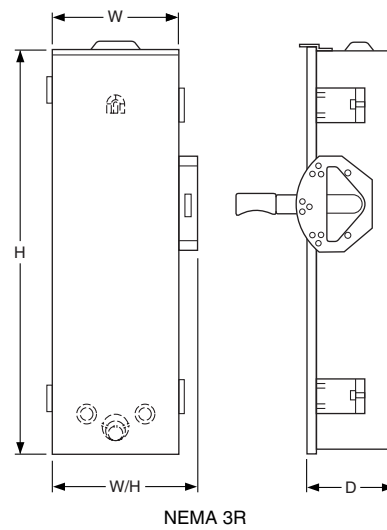
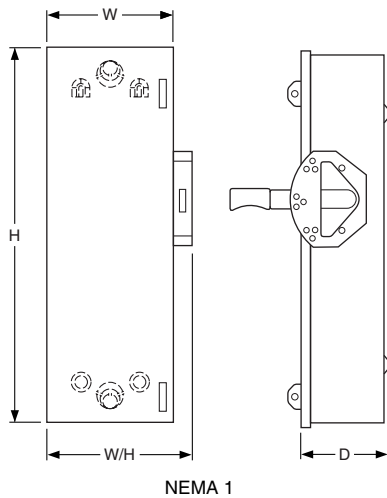
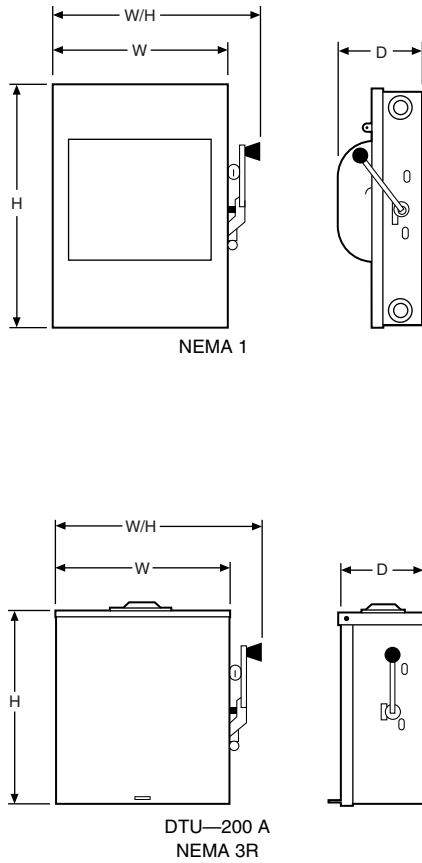

Table 3.47: 30–100 A Type DT, DTU (Series F)—Approximate Dimensions

Cat. No.	Series	H		W		W/H		D	
		in.	mm	in.	mm	in.	mm	in.	mm
DT223	F5	38.00	965	9.88	251	11.13	283	6.75	171
DT223RB	F5	38.00	965	6.87	174	8.12	206	6.60	168
DT321	F5	38.00	965	10.25	260	11.50	292	6.75	171
DT321RB	F5	38.00	965	10.25	260	11.80	300	6.60	168
DT322	F5	38.00	965	10.25	260	11.50	292	6.75	171
DT322RB	F5	38.00	965	10.25	260	11.80	300	6.60	168
DT323	F5	38.00	965	9.88	251	11.13	283	6.75	171
DT323RB	F5	38.00	965	6.87	174	8.12	206	6.60	168
DT361	F5	38.00	965	10.25	260	11.50	292	6.75	171
DT361RB	F5	38.00	965	10.25	260	11.80	300	6.60	168
DT362	F5	38.00	965	10.25	260	11.50	292	6.75	171
DT362RB	F5	38.00	965	10.25	260	11.80	300	6.60	168
DT363	F5	38.00	965	9.88	251	11.13	283	6.75	171
DT363RB	F5	38.00	965	6.87	174	8.12	206	6.60	168
DTU222	F5	29.94	760	10.25	260	11.96	304	6.93	176
DTU223	F5	29.94	760	10.25	260	11.96	304	6.93	176
DTU223RB	F5	30.50	775	10.25	260	11.96	304	6.93	176
DTU321	F5	29.94	760	10.25	260	11.96	304	6.93	176
DTU322	F5	29.94	760	10.25	260	11.96	304	6.93	176
DTU323	F5	29.94	760	10.25	260	11.96	304	6.93	176
DTU323RB	F5	30.50	775	10.25	260	11.96	304	6.93	176
DTU361	F5	29.94	760	10.25	260	11.96	304	6.93	176
DTU361RB	F5	30.50	775	10.25	260	11.96	304	6.93	176
DTU362	F5	29.94	760	10.25	260	11.96	304	6.93	176
DTU362AWK	F6	29.94	760	10.25	260	11.96	304	6.93	176
DTU362DS	F6	30.26	769	10.25	260	11.50	292	7.12	181
DTU362RB	F5	30.50	775	10.25	260	11.96	304	6.93	176
DTU363	F5	29.94	760	10.25	260	11.96	304	6.93	176
DTU363AWK	F6	29.94	760	10.25	260	11.96	304	6.93	176
DTU363DS	F6	30.26	769	10.25	260	11.50	292	7.12	181
DTU363RB	F5	30.50	775	10.25	260	11.96	304	6.93	176
DTU462	F5	29.94	760	10.25	260	11.96	304	6.93	176
DTU462AWK	F6	30.26	769	15.50	394	16.75	425	7.12	181
DTU462DS	F6	30.26	769	15.50	394	16.75	425	7.12	181
DTU463	F5	29.94	760	10.25	260	11.96	304	6.93	176
DTU463AWK	F6	30.26	769	15.50	394	16.75	425	7.12	181
DTU463DS	F6	30.26	769	15.50	394	16.75	425	7.12	181
DTU662AWK	F6	30.26	769	15.50	394	16.75	425	7.12	181
DTU663AWK	F6	30.26	769	15.50	394	16.75	425	7.12	181

240 V Double Throw page 3-16
 600 V Double Throw page 3-17
 Accessories page 3-18
 Application Data page 3-19
 Dimensions: 30, 200–600 A (Series E, T4, A) page 3-21

Table 3.48: 30, 200–600 A Types 82,000 and E-Series DTU devices, NEMA 1 and 3R—Approximate Dimensions



Cat. No.	Series	H		W		W/H		D	
		in.	mm	in.	mm	in.	mm	in.	mm
DTU224NRB ▲	E1	32.50	826	20.63	524	24.00	610	10.63	270
82254 ▲	E1	30.88	784	15.75	400	19.63	499	9.75	248
82254NW ▲	E1	30.88	784	20.00	508	23.88	607	11.75	298
82344 ▲	E2	30.88	784	20.00	508	23.88	607	11.75	298
82344RB ▲	E1	32.50	826	20.63	524	24.00	610	10.63	270
82354	E1	30.88	784	20.00	508	23.88	607	11.75	298
92251	T4	10.00	254	8.00	203	9.75	248	4.75	121
82344DS	E1	30.88	784	20.00	508	23.88	607	11.75	298
DTU324N	E1	32.50	826	24.50	622	26.25	667	10.63	270
DTU324NRB	E1	32.50	826	24.50	622	26.25	667	10.63	270
H82344	E2	32.50	826	24.50	622	26.25	667	10.63	270
H82444 ▲	E2	32.50	826	30.21	767	33.61	854	10.63	270
H82454	E3	32.50	826	30.21	767	33.61	854	10.63	270
82454	E3	38.00	965	29.62	753	33.02	839	10.63	270
82444	E3	38.00	965	29.62	753	33.02	839	10.63	270
82454R ▲	E3	38.00	965	29.62	753	33.02	839	10.63	270
82444R	E3	38.00	965	29.62	753	33.02	839	10.63	270
H82254	E3	32.50	826	24.50	622	26.25	667	10.63	270
H82354	E3	32.50	826	24.50	622	26.25	667	10.63	270
82444DS ▲	E3	38.00	965	29.62	753	33.02	839	10.63	270
82255 ▲	A1	38.50	978	26.10	663	29.51	750	10.63	270
82255R	A1	39.00	991	26.62	676	30.02	763	10.63	270
82345 ▲	A1	38.50	978	26.10	663	29.51	750	10.63	270
82345DS ▲	A1	39.00	991	26.62	676	30.02	763	10.63	270
82345R ▲	A1	39.00	991	26.62	676	30.02	763	10.63	270
82355 ▲	A1	38.50	978	26.10	663	29.51	750	10.63	270
82355R ▲	A1	39.00	991	26.62	676	30.02	763	10.63	270
82445	A1	38.50	978	30.10	765	33.50	851	10.63	270
82445R	A1	39.00	991	30.21	767	33.61	854	10.63	270
82455 ▲	A1	38.50	978	30.10	765	33.50	851	10.63	270
82455R	A1	39.00	991	30.21	767	33.61	854	10.63	270
H82255	A1	39.00	991	26.62	676	30.02	763	10.63	270
H82345	A1	39.00	991	26.62	676	30.02	763	10.63	270
H82355	A1	39.00	991	26.62	676	30.02	763	10.63	270
H82445	A1	39.00	991	30.21	767	33.61	854	10.63	270
H82455	A1	39.00	991	30.21	767	33.61	854	10.63	270
DTU326	A1	63.31	1608	23.66	601	24.46	621	8.88	226
DTU426	A1	63.31	1608	27.00	686	27.80	706	8.88	226
DTU366	A1	63.31	1608	23.66	601	24.46	621	8.88	226
DTU466	A1	63.31	1608	27.00	686	27.80	706	8.88	226
DTU326R	A1	63.76	1619	23.66	601	24.46	621	8.88	226
DTU426R	A1	63.76	1619	27.00	686	27.80	706	8.88	226
DTU366R	A1	63.76	1619	23.66	601	24.46	621	8.88	226
DTU466R	A1	63.76	1619	27.00	686	27.80	706	8.88	226
DTU366AWK	A1	63.76	1619	23.66	601	24.46	621	8.88	226

▲ 250 V dc rated.

240 V Double Throw page 3-16
 600 V Double Throw page 3-17
 Accessories page 3-18
 Application Data page 3-20
 Dimensions: 30–100 A (Series F) page 3-20



Put over 100 years of Schneider Electric's experience as a global specialist in energy management to work on your photovoltaic (PV) project. The Square D™ 1000 Vdc disconnect switch is the perfect solution for your 1000 Vdc

PV disconnect applications. It is compact and available in both a 100 and 200 amp non-fusible versions. IEC 60947-1 and 3 certified (file 136861) and UL 98 certified (file E343341).

Extended Life Expectancy

Exceeds IEC 60947-3 mechanical endurance requirements by factor of 18

Exceeds IEC 60947-1 electrical endurance requirements by factor of 10

Exceeds NEMA KS-1 mechanical endurance requirements by factor of 3.

Designed for Harsh PV Environments

NEMA Type 3 and IP63 enclosure

- Resists windblown dirt/dust
- Exceeds NEMA Type 1, 3R and 12

Operating range of -37°C to 50°C

Specially designed PV paint reduces solar gain up to 35% over standard grey enclosures

Easy to Install

Preconfigured solar solution

Familiar enclosed safety switch design

Suitable for both grounded and ungrounded PV

Table 3.49: 1000 Vdc Photovoltaic Heavy Duty Disconnect Switch Pricing and Accessories

System	NEMA 1, 3R, 12, 3 and IP63			Factory Installed Accessories										Height (in.)	Width (in.)	Depth (in.)
				Electrical Interlock Single Contact▲		Electrical Interlock Two Contacts■		Viewing Windows		Terminal Blocks (Copper)♦		3 Wire Ground Lug★				
	Amperes	Cat. No.	\$ Price	No. Suffix	\$ Price Adder	No. Suffix	\$ Price Adder	No. Suffix	\$ Price Adder	No. Suffix	\$ Price Adder	No. Suffix	\$ Price Adder			
3 Pole Grounded▼																
Three-Pole (Grounded System)																
	100	REHU393IP	1672.00	EI	452.00	EI2	496.00	VW	150.00	TBC	409.00	GL	263.00	22.13	18.63	8.75
	200	REHU394IP	2246.00	EI	452.00	EI2	496.00	VW	175.00	TBC	409.00	GL	263.00	22.13	18.63	8.75
4 Pole Ungrounded																
Four-Pole (Ungrounded System)																
	100	REHU493IP	2507.00	EI	452.00	EI2	496.00	VW	150.00	—	—	GL	263.00	29.00	18.63	8.75
	200	REHU494IP	3965.00	EI	452.00	EI2	496.00	VW	175.00	—	—	GL	263.00	29.00	18.63	8.75

- ▲ Order EIK1PV for single contact field-installed kit **\$311.00.**
- Order EIK2PV for double contact field-installed kit **\$355.00.**
- ♦ Accommodates (2) 250 max Cu or (1) 1/0 max Cu wiring; Order

- ★ Order REHGND KIT for field installable kit **\$100.00.**
- ▼ Terminal blocks standard with 3 pole switches; accommodates (2) 1/0 max Al/Cu or (2) 6 max Al/Cu wiring.

Schneider Electric gives the Photovoltaic market place the most comprehensive one stop shop for Residential and Light Commercial Photovoltaic Balance of System components. Schneider Electric's Inverters, and Square D brand DC and AC disconnect switches and Load Centers are ideal solutions to your Balance of Systems requirements. See the Balance of System solution chart below for your single phase PV system.

Table 3.50: PV Balance of System Solution Package—Grid Tie

System Voltage	Kilowatts	Amps	DC Disconnect	Inverter	AC Disconnect	Load Center Product
250 Vdc	2.8	30	HU361RB	878-2801	D221NRB	QQ130M200
250 Vdc	3.3	60	HU362RB	878-3301	D222NRB	QQ140M225
250 Vdc	3.3	100	HU363RB	878-3301	D223NRB	QONQ42MS400
600 Vdc	3.8	30	HU361RB	878-3801	D221NRB	QQ130M200
600 Vdc	5.0	60	HU362RB	878-5001	D222NRB	QQ140M225
600 Vdc	5.0	100	HU363RB	878-5001	D223NRB	QONQ42MS400

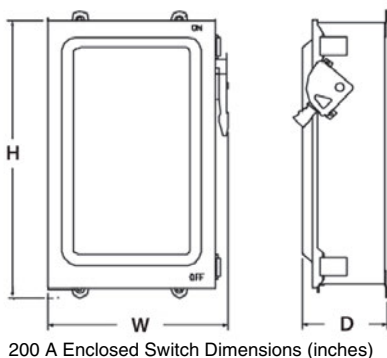

For internal 600 Vdc PV combiner box switches please see our offering of 9422 switches 600 Vdc UL98 listed in digest pages 8-14.

For our 600 Vdc PV switch offering please see digest pages 3-5-3-6.



Square D PV string combiner boxes are used to integrate multiple PV strings into one output circuit. Its tough exterior and safety features protect wiring from weather and overcurrent. The exterior coating ensures low operating temperatures and longer life of internal components. The specially engineered enclosure is designed to provide dust tight and rain tight protection; it meets or exceeds NEMA[®] 3R, 12, and 4 requirements. Traditional Square D visible blade switch architecture confirms disconnection, while touch-safe interior shielding protects against accidental contact with live components.

Features

Flexible

- Vertical, horizontal, and angled mounting options
- Flexible installation with top, bottom, and side entry
- Substantial wire-bending space

Robust

- Dust tight and rain tight engineered enclosure for outdoor use
- UV-resistant white exterior coating to reduce solar gain by 35%
- Meets or exceeds NEMA 3R, 12, and 4 requirements

Safe

- Square D traditional visible blade switch architecture for confirmation of disconnect
- Touch-safe interior shielding guards against accidental contact with current-carrying components
- Seismic-certified 100–400 amp string combiner boxes for earthquake safety
- Optional integrated 2.5 kV surge arrestor to protect PV electronics from lightning strikes

Listings

- UL 1741
- Switches tested to UL98B
- CSA C22.2 Spec 107.1

Table 3.51: 600 Vdc Photovoltaic Combiner Boxes

Catalog Number▲	Number Input Circuits (Max.)	Continuous DC Output Current (Max.)	Maximum PV Module Isc Rating (Amps)	Maximum Continuous Input Current Per String (Amps)	List Price \$	Wire Range (AWG/kcmil—Copper Only)					Outside Dimensions					
						Input Circuit (+ and -)	Output Circuit (+ and -)	Output Number of Conductors (+ or -)	Ground In	Ground Out	Height		Width		Depth	
											in.	mm	in.	mm	in.	mm
REHSC126100	12	100	10.4	13	838.00	#12–#6	#6–1/0	1	#14–4 Or 2X #14–#12	#6–2/0	20.78	528	14.50	368	6.13	156
REHSC166200	16	200			1067.00	#12–#6	#6–300 MCM	1		#6–2/0	27.78	706	20.25	514	6.13	156
REHSC246300	24	300			1378.00	#12–#6	1/0–300	2		#6–2/0	35.78	909	20.25	514	6.13	156
REHSC326400	32	400			2226.00	#12–#6	1/0–300	2		#6–2/0	35.78	909	20.25	514	6.13	156

▲ For factory installed surge protection device add the suffix “S” to the catalog number.

Table 3.52: 600 Vdc Photovoltaic Combiner Boxes With Disconnects

Catalog Number▲	Number Input Circuits (Max.)	Continuous DC Output Current (Max.)	Maximum PV Module Isc Rating (Amps)	Maximum Continuous Input Current Per String (Amps)	List Price \$	Wire Range (AWG/kcmil—Copper Only)					Outside Dimensions					
						Input Circuit (+ and -)	Output Circuit (+ and -)	Output Number of Conductors (+ or -)	Ground In	Ground Out	Height		Width		Depth	
											in.	mm	in.	mm	in.	mm
REHSC126100DU	12	100	10.4	13	1438.00	#12–#6	#6–1/0	1	#14–4 Or 2X #14–#12	#6–2/0	31.00	787	19.00	483	9.00	229
REHSC166200DU	16	200			1899.00	#12–#6	#6–300 MCM	1		#6–2/0	31.00	787	25.00	635	9.00	229
REHSC246300DU	24	300			3035.00	#12–#6	1/0–300	2		#6–2/0	41.00	1041	25.00	635	10.50	267
REHSC326400DU	32	400			3883.00	#12–#6	1/0–300	2		#6–2/0	41.00	1041	25.00	635	10.50	267

▲ For factory installed surge protection device add the suffix “S” to the catalog number.

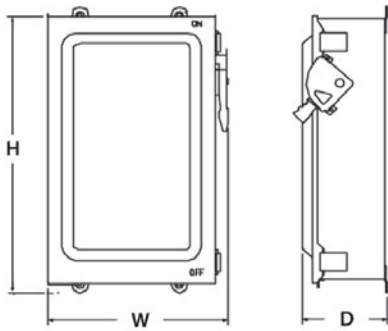

Typical String Combination Box Dimensions

Surge Protection Device

The 600 Vdc Type 2 Surge Protection Device (SPD) is for medium risk PV applications. The SPD when installed in a Square D combiner box protects solar modules, power tracking and blocking diodes from physical damage resulting from lightning induced transients. The SPD device uses Metal Oxide Varistor (MOV)/Gas-Filled Spark Gap (GSP) protection circuits for longer life and no current leakage. The devices are UL1449 ed 2 compliant Low Voltage TVSS. The SP are available as factory installed by adding the suffix “S” to the combiner box catalog number or as kits a kit: REHTYPE2SP.

Table 3.53: 600 Vdc Type 2 Surge Protection Device

Catalog Number	Network Voltage	Nominal Discharge Current per 20 micro sec	Maximum Discharge Current per 20 micro sec	Operating Current	Operating Temperature; Celsius	List Price \$	
						Kit	Factory Installed
REHTYPE2SP	600 Vdc	20kA	40kA	<0.1nA	-40 to +85	337.00	490.00

