

GE
Lighting

Spectrum Catalogue

LAMP PRODUCTS
2013/14



GE imagination at work

www.gelighting.com

GE
Lighting

Spectrum

Lamp product catalogue 2013/14



GE imagination at work

GE Lighting is constantly developing and improving its products. For this reason, all product descriptions in this catalogue are intended as a general guide, and we may change specifications from time to time in the interest of product development, without prior notification or public announcement. All descriptions in this publication present only general particulars of the goods to which they refer and shall not form part of any contract. Data in this guide has been obtained in controlled experimental conditions. However, GE Lighting cannot accept any liability arising from the reliance on such data to the extent permitted by law.

All lamp drawings are a guide, if further technical details are required please contact your nearest sales office.

General conditions of sale

GE Lighting products are supplied according to GE's General Conditions of Sale. If you require a copy of these conditions please contact your nearest GE Lighting sales office.

Prices

A price list is available from all GE Lighting sales offices.

www.gelighting.com



and General Electric are both registered trademarks
of the General Electric Company

Contents

Introduction	
LED Solutions	I.
High Intensity Discharge Lamps	II.
Linear Fluorescent Lamps	III.
Compact Fluorescent Lamps Non-Integrated	IV.
Compact Fluorescent Lamps Integrated	V.
Halogen Lamps	VI.
Incandescent	VII.
Entertainment	VIII.
Speciality	IX.
Horticulture	X.
Cap Drawings	XI.
Glossary	XII.
Sales Offices	XIII.

GE works on things that matter

Every single day, all around the world, GE is helping its customers find solutions to the toughest environmental challenges.

As such, at GE Lighting we have long pioneered advanced lighting technologies with a knowledge and technical expertise that spans more than 100 years providing a foundation for future innovation.

With lighting accounting for 20% of our global energy demand, mounting legislation and environmental pressures - now more than ever this heritage and capability is absolutely crucial.

GE Lighting continues to bring new technologies to the market to meet the global demands for high quality and low energy lighting.



LED Innovation *for a sustainable future*



Never before in its 118 year history has the craftsmanship of City of London's iconic Tower Bridge been so beautifully revealed as it is today, thanks to more than 2.5 km of flexible, architectural LED lighting provided by GE Lighting.

gelifighting.com/eu



WORLDWIDE PARTNER

As a Worldwide Partner of the Olympic Games, GE is the exclusive provider of a wide range of innovative products and services that are integral to the successful Games.



Regulatory update

In September 2013 there will be further changes in European Legislation that affect the lighting industry and are common to all manufacturers. We at GE would like to guide our customers through these changes and assist you in finding the best possible solutions.

The changes affect a number of products and involve changes to categories such as Lifetime and Switching Cycles. There are additional changes that affect the packaging, including amendments to the energy label.

As a result, some of the known products will be phased out of the market, and some new products will arrive to replace them. Please consult your sales representative for more information as to how these changes affect you and to find a solution that best fits your needs.

Based on the amount of changes and products involved, you will appreciate that the full changeover will take a period of time to complete and, therefore, some of the affected product lines will be phased in over a number of weeks/months.

What does this mean for the LED product range?

Our Retro-fit lamp range is largely compatible with new regulations covering LED Lamps, though certain ranges are being phased out or replaced with new upgraded designs to maintain market competitiveness and also regulatory compliance.

All ongoing ranges are undergoing artwork modification for DIM2 compliance, and existing inventory of phase-out ranges will be managed out of the supply chain so that new ranges can be rolled in over the course of Q3 and Q4 2012.

We at GE will do all we can to continuously provide you with the best quality service. We thank you in advance for your understanding and patience.

GE is proud to be at the forefront of bringing new technologies and greener products to the market but is also supporting this legislation that improves the performance criteria of current product to provide our customers with the choices that they demand.

The Environment:

There are a number of estimates, ranging from 24 million to 39 million tons of annual carbon dioxide emissions that will be eliminated with the full implementation of the EU regulations. GE Lighting is fully committed to reducing carbon emissions, and as member of the European Lamp Companies Federation it helped develop the new regulations that are now being implemented.

For further information please visit our Environmental Centre:

<http://www.gelighting.com/LightingWeb/emea/resources/environmental-center/index.jsp>

LED Lamp Solutions



LEDs you can trust

More than 15 years of experience in manufacturing and selling high quality LED solutions

Up to 90% energy savings compared to conventional lamps

Up to 50,000 hours of light with our R63 lamps

Reduced maintenance and related costs

Outstanding lumen performance and lumen/watt efficiency.

Low UV and IR (ultraviolet and infrared)



Home



Office



Hospitality



Retail



8&12W Energy Smart™ Omni-directional GLS Lamp

GE's LED retrofit lamps offer great possibility to replace incandescent, compact fluorescent or halogen lamps with a 2700K Extra Warm White LED lamp with wide light distribution (220°) for general lighting. GE LEDs are very economical and environmentally friendly: they are mercury free, use far less energy than halogen or incandescent lights, and last longer.

They fit into everyday light fittings and the light comes on the instant you flick the switch.



- 8W & 12W replacements for 40W and 60W
- 470 (8W) and 810 (12W) lumens
- 2700 Kelvin Colour Temperature
- E27 and B22 cap types

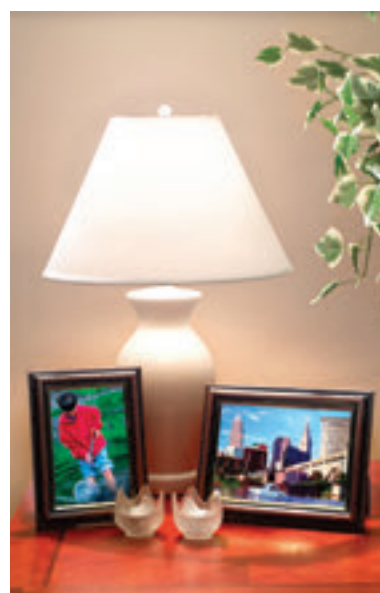

6W Energy Smart™ GU10 Dimmable Lamp

The new generation of dimmable GU10 lamps provide market leading efficiency and lumen performance providing a true replacement for GU10 halogens in a IEC Standard dimension. The range offers 300-345 lumens in 90° cone with a long life of 45,000 hours (L70/B10). The new dimmable GU10 lamps are suitable for both domestic and commercial applications.



- 300-345 Lumens in 90° cone
- IEC Standard size
- Dimming (20-100%)
- 25 degree and 35 degree beam angles
- Available in 2700K, 3000K and 4000K colour temperatures
- Reduces ongoing maintenance costs
- 45,000 hours life

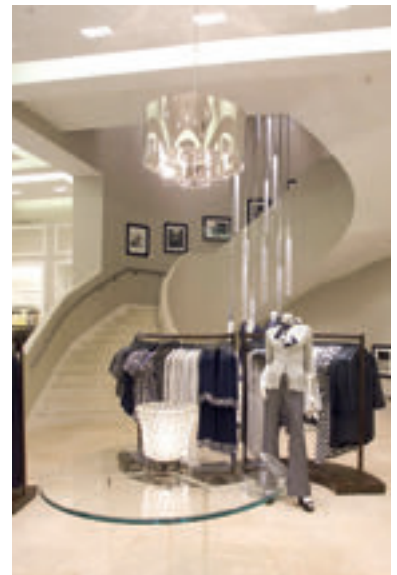

Gleneagles Hotel, UK

Our Customer

The renowned Gleneagles Hotel, set in 850 acres of Perthshire countryside, is a member of The Leading Hotels of the World.

The Challenge

Five star hotel Gleneagles wanted to replace traditional incandescent and halogen lamps, with energy efficient solution that improves the quality of light & highlights established.

Our Solution

Replacing incandescent and halogen lamps with LED GU10 & LED GLS Energy Smart lamps ensures a high efficiency & reducing running costs from £4625 to £1156 in just under a year.

Key Benefits

- Improved energy saving up to 66%
- Reduced maintenance costs
- Improved corporate sustainability
- Exceptional combination of aesthetics and economy

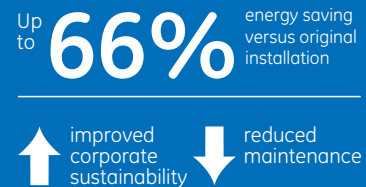

“After working closely with GE Lighting – we now have an efficient lighting scheme that has reduced energy use whilst meeting expectations for a high quality light output.”

*Bernard Murphy,
General Manager of The Gleneagles Hotel*

7W Energy Smart™ MR16 Dimmable Lamp

Introducing the new generation of 7W LED MR16. This range has been developed to replace 35W & 50W equivalent MR16 halogen lamps with offering a high level of technical performance in the form of a halogen shaped LED lamp. It is easy to replace and it offers an outstanding lumen package that ensures a relatively short payback period.

GE LED MR16 lamps are all passive cooled, providing quiet operation without an additional motorised fan.



- Significantly improved compatibility on 12V Halogen transformers
- Outstanding 50,000 switch cycles
- 15, 25, 35 degree Beam Angles
- Dimmable
- 25,000 hours life (L70)
- 827, 830, 840 colour temperature

7W ~ 35W equivalent:

- Lumens in 90° cone: from 345 to 400

7W ~ 50W replacement:

- Lumens in 90° cone: 440 to 475



Hotel Adlon Kempinski, Germany

Our Customer

Hotel Adlon Kempinski in Berlin is leading the league for Germany. The Adlon was first opened in 1907 and soon became “the” spot in Berlin and one of the leading hotels worldwide.

The Challenge

The expectation was to replace the original halogen lighting to reduce the carbon footprint and to cut down on energy consumption of the hotel. Additionally, superior lighting quality and ease of replacement were key.

Our Solution

Some 7000 of GE’s MR16 7W Energy Smart dimmable LED lamps were installed in 384 suites of the five star hotel. The lamps are available as a 35W and 50W halogen equivalent in multiple colour temperatures and suitable for track and recessed lighting.

Key Benefits

- 25,000 operating hours
- 5 times longer lifetime
- 140.000 kWh savings per year
- 80% energy savings
- Reduced carbon footprint
- Refinancing within one year



80% reduced energy consumption

5 times longer lifetime

1 year payback ↓ reduced carbon footprint

“Aside from high quality and reliability, the new lighting solution had to fit into the aesthetics of the hotel without compromising the look and original design characteristics. Therefore, we tested a variety of products for months and finally the hotel selected the product that best meets these requirements.”

*Oliver Voges,
Key Account Manager
at OBETA electro (GE distributor)*

4.5W Energy Smart™ Decorative Dimmable lamps

Create a mood and save energy with Decor LED's. GE's new premium range of LED Decorative lamps offers superb performance with high quality aesthetics and great reliability. Features such as standard IEC dimensions, 20,000 hours rated life and wide dimming compatibility combine to make this a highly desirable product range.



Available in clear and white finishes with a range of different shapes.

- Candle, Bent Tip, Spherical & Globe
- 250 lumens output
- Extra Warm White 2700K
- 20,000 hours life
- Dimmable
- 100% retro-fit

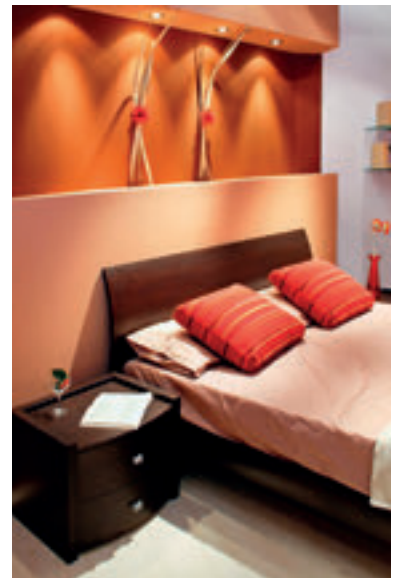

T8 Tube Energy Smart™ 60cm & 120cm Lamps

The GE LED T8 range offers safe, reliable and affordable energy saving alternatives to standard Fluorescent T8 lamps.

Available in 2'/60cm and 4'/120cm lengths, GE LED T8s can be quickly fitted onto electro-magnetic control gears or as a replacement on electronic gears with a simple re-wire.



Available from October 2013

- High energy saving range: 9W 2' and 18W 4'
- High efficiency range: 12W 2' and 23W 4'
- Two colour temperatures: 4000K & 6500K
- Long lifetime: up to 50,000 hours (L70)
- High Power Factor: 0.9
- Wide 130° light distribution
- Compatible with existing installations

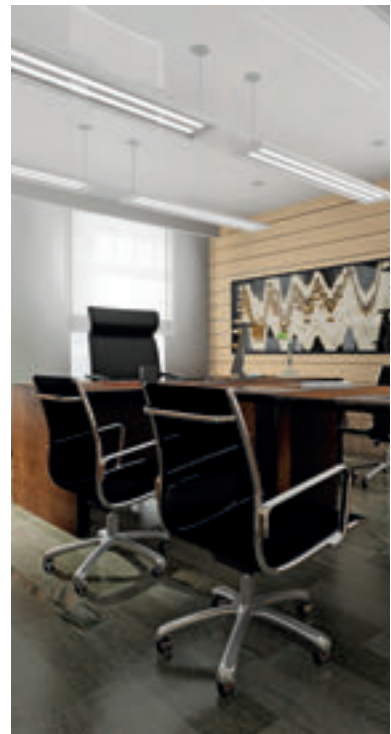

Switching from Watts to Lumens

Traditional light bulbs are being phased out and modern light technologies use different amounts of power to achieve the same amount of light. Instead of referring to watts, we now need to measure and compare light in terms of lumens.

Our LEDs can be used everywhere, from general to mood lighting and spotlighting. To assist in selecting the appropriate LED replacement for your existing Incandescent or halogen bulb, GE packaging shows relevant product lumens compared to the old wattages.

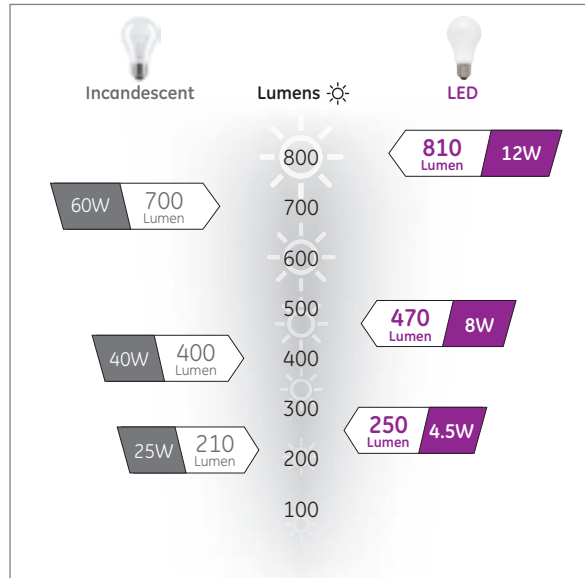

Quick guide to GE Lighting packaging

Product information box

- Clear image of lamp and base
- Product symbol
- Wattage
- Lumen value
- Application category colour code panel
- Rated lamp life in years

Rated life in hours

Energy rating illustration

Energy consumption

Selector

LED Energy Smart™ GU10



GU10 Dimmable

Cap: GU10
Wattage: 4.5-6.5W
Voltage: 220-240V
Beam Spread: 25-35°
Rated life: 20,000-45,000Hrs

Page I.13



GU10

Cap: GU10
Wattage: 3.5W
Voltage: 220-240V
Beam Spread: 35°
Rated life: 20,000Hrs

Page I.13

LED Energy Smart™ MR16 GU5,3



MR16 Dimmable

Cap: GU5.3
Wattage: 7W
Voltage: 12V
Beam Spread: 15°, 25°, 35°
Rated life: 25,000Hrs

Page I.13



MR16

Cap: GU5.3
Wattage: 4-6.5W
Voltage: 12V
Beam Spread: 15°, 25°, 35°
Rated life: 25,000Hrs

Page I.13

LED Energy Smart™ PAR30



PAR30 Dimmable

Cap: E27
Wattage: 10W
Voltage: 220-240V
Beam Spread: 20-35°
Rated life: 50,000Hrs

Page I.14

LED Energy Smart™ R63, R50



R63 Dimmable

Cap: E14, E27
Wattage: 7W
Voltage: 220-240V
Beam Spread: 20-35°
Rated life: 50,000Hrs

Page I.14



R50 Dimmable

Cap: E14, E27
Wattage: 5W
Voltage: 220-240V
Beam Spread: 35°
Rated life: 25,000Hrs

Page I.14

LED Solutions

LED Energy Smart™ GLS Bulb



Omni Dimmable

Cap: E27, B22
Wattage: 8-12W
Voltage: 220-240V
Rated life: 15,000 -
25,000Hrs

Page I.14



GLS

Cap: E27, B22
Wattage: 7, 10, 11W
Voltage: 220-240V
Rated life: 15,000Hrs

Page I.14

LED Energy Smart™ Candle



Candle Dimmable

Cap: E27, B22, E14, B15
Wattage: 4.5W
Voltage: 220-240V
Rated life: 20,000Hrs

Page I.15



Outdoor Candle

Cap: E27, B22, E14
Voltage: 220-240V
Rated life: 25,000Hrs

Page I.15

LED Energy Smart™ Spherical, Globe



Spherical Dimmable

Cap: E27, B22, E14
Wattage: 4.5W
Voltage: 220-240V
Rated life: 20,000Hrs

Page I.15



Globe Dimmable

Cap: E27, B22
Wattage: 4.5W
Voltage: 220-240V
Rated life: 20,000Hrs

Page I.15

LED Energy Smart™ T8 Tube



T8 Tube

Cap: T8
Wattage: 9, 12, 18, 23W
Voltage: 220-240V
Rated life: 40,000-
50,000Hrs

Page I.15

Product identification

The following glossary of terms will help you when selecting lamps in this section. Within each product line, lamps are divided into families – within these families, lamps are listed by wattage. The Product Description can be used as a quick reference to each product's attributes. LED lamp and system life is expressed as L70 – the point in time when light output has fallen to 70% of its initial value.

Watts:
Energy Used – Nominal Watts. To estimate energy consumption (kWh), multiply watts x hours of use and divide by 1000.

Cap:
The type of cap fitted. See page 148-149 for cap drawings

Product code:
It is important to use this code when ordering to ensure that you receive the exact product you require

Additional parameters:
Forward Voltage (Vf) Typical (V): Typical voltage drop across the LED when driven at 350mA. Value will vary at different drive currents.
Track Angle: LED Cove is available with 3 mounting options, at 0, 15 and 30 degrees to the horizontal surface.

Life (L70, h): LED lamp and system life is expressed as L70 – the point in time when light output has fallen to 70% of its initial value

CCT (K): Colour Temperature – Kelvins
A measure of the visual "warmth" or "coolness" of the light from the lamp. The higher the value the whiter or "cooler" the light appears

Peak Beam Candela:
For reflector type lamps. Luminous intensity of the lamp beam expressed in candelas

Length:
Lamp length in mm

Volts:
Lamp data is based on operation at rated voltage

Product description:
The lamp's identification code



LED Energy Smart™ Range – PAR30 dimmable

10	220-240	E27	LED10DP30S/827/20/E27	79409	3450	450	410	20	2700	80	50000	97	99	6
10	220-240	E27	LED10DP30S/827/35/E27	79410	1100	450	410	35	2700	80	50000	97	99	6
10	220-240	E27	LED10DP30S/830/20/E27	79411	3720	500	480	20	3000	80	50000	97	99	6

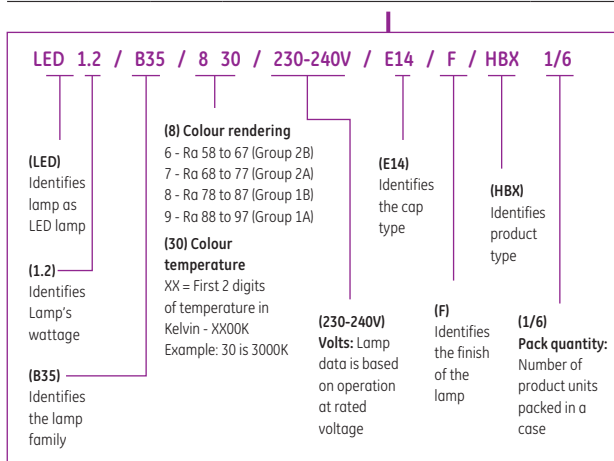

Lumens:
Initial Lumens - light output at 100 hours

Beam Spread Degrees:
For reflector type lamps. The angle of the cone of light produced by a reflector lamp at 50% of its intensity

Diameter:
Bulb diameter in mm

CRI (Ra):
Colour Rendering Index
An indication of the ability of the lamp to render object colours in a normal, natural way. The higher the number (0-100), the better the colour appearance

Pack quantity:
Number of product units packed in a case

LED Solutions

Wattage (W)	Volts (V)	Cap	Product Description	Product Code	Candela (cd)	Lumen (lm)	Useful Lumen (lm)	Beam Angle [°]	CCT (K)	CRI (Ra)	Life (L70, h)	Diameter (mm)	Length (mm)	Pack Qty
-------------	-----------	-----	---------------------	--------------	--------------	------------	-------------------	----------------	---------	----------	---------------	---------------	-------------	----------

LED Energy Smart™ Range – GU10 dimmable

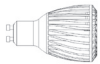
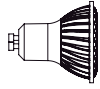

5.5	220-240	GU10	LED5.5D/GU10/827/220-240V/35/BX 1/8	85848	700	300	270	35	2700	80	20000	50	59	8
5.5	220-240	GU10	LED5.5D/GU10/830/220-240V/35/BX 1/8	85849	700	320	290	35	3000	80	20000	50	59	8
5.5	220-240	GU10	LED5.5D/GU10/840/220-240V/35/BX 1/8	85850	700	320	290	35	4000	80	20000	50	59	8
6	220-240	GU10	LED6D/GU10/827/220-240V/FL BX 1/10 H	98720	1250	320	300	25	2700	80	45000	50	57	10
6	220-240	GU10	LED6D/GU10/827/220-240V/WFL BX 1/10 H	98721	700	320	300	35	2700	80	45000	50	57	10
6	220-240	GU10	LED6D/GU10/830/220-240V/FL BX 1/10 H	98722	1280	340	320	25	3000	80	45000	50	57	10
6	220-240	GU10	LED6D/GU10/830/220-240V/WFL BX 1/10 H	98723	720	340	320	35	3000	80	45000	50	57	10
6	220-240	GU10	LED6D/GU10/840/220-240V/FL BX 1/10 H	98724	1400	360	345	25	4000	80	45000	50	57	10
6	220-240	GU10	LED6D/GU10/840/220-240V/WFL BX 1/10 H	98725	780	360	345	35	4000	80	45000	50	57	10
6.5	220-240	GU10	LED6.5D/GU10/827/220-240V/FL	65252	1600	400		25	2700	80+	45000	50	78	8
6.5	220-240	GU10	LED6.5D/GU10/827/220-240V/WFL	65255	750	380		35	2700	80+	45000	50	78	8
6.5	220-240	GU10	LED6.5D/GU10/830/220-240V/FL	65256	1600	400		25	3000	80+	45000	50	78	8
6.5	220-240	GU10	LED6.5D/GU10/830/220-240V/WFL	65257	750	380		35	3000	80+	45000	50	78	8
6.5	220-240	GU10	LED6.5D/GU10/840/220-240V/FL	65258	1800	450		25	4000	80+	45000	50	78	8
6.5	220-240	GU10	LED6.5D/GU10/840/220-240V/WFL	65259	850	430		35	4000	80+	45000	50	78	8

LED Energy Smart™ – GU10

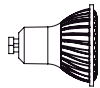

3.5	220-240	GU10	LED3.5/GU10/827/220-240V/35/BX 1/8	85844	450	200	180	35	2700	80	20000	50	59	8
3.5	220-240	GU10	LED3.5/GU10/830/220-240V/35/BX 1/8	85845	450	220	200	35	3000	80	20000	50	59	8
3.5	220-240	GU10	LED3.5/GU10/840/220-240V/35/BX 1/8	85846	450	220	200	35	4000	80	20000	50	59	8

LED Energy Smart™ Range – MR16 dimmable

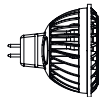

7	12	MR16	LED7D/MR16D/827/12V/25 BX1/8	99940	1800	370	350	25	2700	83	25000	50	48	8
7	12	MR16	LED7D/MR16D/827/12V/35 BX1/8	99941	1000	370	345	35	2700	83	25000	50	48	8
7	12	MR16	LED7D/MR16D/830/12V/15 BX1/8	99943	3700	390	370	15	3000	85	25000	50	48	8
7	12	MR16	LED7D/MR16D/830/12V/25 BX1/8	99965	1900	390	365	25	3000	83	25000	50	48	8
7	12	MR16	LED7D/MR16D/830/12V/35 BX1/8	99966	1100	390	355	35	3000	83	25000	50	48	8
7	12	MR16	LED7D/MR16D/840/12V/15 BX1/8	89974	4000	430	410	15	4000		25000	50	48	8
7	12	MR16	LED7D/MR16D/840/12V/25 BX1/8	99967	2100	430	400	25	4000	84	25000	50	48	8
7	12	MR16	LED7D/MR16D/840/12V/35 BX1/8	99969	1200	430	390	35	4000	84	25000	50	48	8
7	12	MR16	LED7XD/MR16D/827/12V/25 BX1/8	60962	2400	480	450	25	2700	80	25000	50	48	8
7	12	MR16	LED7XD/MR16D/827/12V/35 BX1/8	60963	1400	480	440	35	2700	80	25000	50	48	8
7	12	MR16	LED7XD/MR16D/830/12V/25 BX1/8	60964	2500	500	470	25	3000	82	25000	50	48	8
7	12	MR16	LED7XD/MR16D/830/12V/35 BX1/8	60965	1500	500	455	35	3000	82	25000	50	48	8
7	12	MR16	LED7XD/MR16D/840/12V/35 BX1/8	60966	1600	520	475	35	4000	83	25000	50	48	8

LED Energy Smart™ Range – MR16

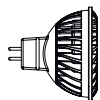

6.5	12	GU5.3	LED 6.5/MR16/830/12V/GU5.3/FL BX 1/8	98188	1600	320	280	24	3000	80	25000	50	46	8
6.5	12	GU5.3	LED 6.5/MR16/830/12V/GU5.3/WFL BX 1/8	98787	750	320	280	35	3000	80	25000	50	46	8
6.5	12	GU5.3	LED 6.5/MR16/840/12V/GU5.3/WFL BX 1/8	98788	750	320	280	35	4000	80	25000	50	46	8
6.5	12	GU5.3	LED 6.5/MR16/765/12V/GU5.3/WFL BX 1/8	99597	900	380		35	6500	70	25000	50	46	8



Wattage (W)	Volts (V)	Cap	Product Description	Product Code	Candela (cd)	Lumen (lm)	Useful Lumen (lm)	Beam Angle (°)	CCT (K)	CRI (Ra)	Life (L70, h)	Diameter (mm)	Length (mm)	Pack Qty
10	220-240	E27	LED10DP30S/827/20/E27	79409	3450	450	410	20	2700	80	50,000	97	99	6
10	220-240	E27	LED10DP30S/827/35/E27	79410	1100	450	410	35	2700	80	50,000	97	99	6
10	220-240	E27	LED10DP30S/830/20/E27	79411	3720	500	480	20	3000	80	50,000	97	99	6
10	220-240	E27	LED10DP30S/830/35/E27	79412	1130	500	480	35	3000	80	50,000	97	99	6



LED Energy Smart™ Range – R63, R50 dimmable

7	220-240	E27	LED7DR63S/827/35/E27	62582	830	300	280	35	2700	80	50,000	63	102	8
7	220-240	E27	LED7DR63S/830/20/E27	79407	2000	330	320	20	3000	80	50,000	63	102	8
7	220-240	E27	LED7DR63S/830/35/E27	79408	850	330	320	35	3000	80	50,000	63	102	8
5	220-240	E27	LED5D/R50/827/220-240V/WFL HBX 1/8	97283	500	220		35	2700	80	25,000	50	83	8

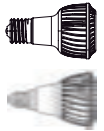

Wattage (W)	Volts (V)	Cap	Product Description	Product Code	Lumen (lm)	CCT (K)	CRI (Ra)	Life (L70, h)	Diameter (mm)	Length (mm)	Pack Qty
-------------	-----------	-----	---------------------	--------------	------------	---------	----------	---------------	---------------	-------------	----------

LED Energy Smart™ Range – Omni-directional dimmable

8	220-240	E27	LED8D/GLS OMNI/827/220-240V/E27 HBX	98783	470	2700	80	25000	60	109	6
8	220-240	B22	LED8D/GLS OMNI/827/220-240V/B22 HBX	98784	470	2700	80	25000	60	108	6
12	220-240	E27	LED12D/GLS OMNI/827/220-240V/E27 HBX	98785	810	2700	80	15000	60	109	6
12	220-240	B22	LED12D/GLS OMNI/827/220-240V/B22 HBX	98786	810	2700	80	15000	60	108	6



LED Energy Smart™ – GLS

7	220-240	E27	LED7/A60/827/220-240V/E27/F/HBX1/6	93845	400	2700	80	15,000	60	110	6
7	220-240	B22	LED7/A60/827/220-240V/B22/F/HBX1/6	93846	400	2700	80	15,000	60	110	6
7	220-240	E27	LED7/A60/765/220-240V/E27/F/HBX1/6	93851	500	6500	80	15,000	60	110	6
10	220-240	E27	LED10/A60/827/220-240V/E27/F/HBX1/6	93847	700	2700	80	15,000	60	110	6
10	220-240	B22	LED10/A60/827/220-240V/B22/F/HBX1/6	93848	700	2700	80	15,000	60	110	6
10	220-240	E27	LED10/A60/765/220-240V/E27/F/HBX1/6	93852	800	6500	80	15,000	60	110	6
11	220-240	E27	LED11/A60/827/220-240V/E27/F/HBX1/6	93849	900	2700	80	15,000	60	110	6
11	220-240	B22	LED11/A60/827/220-240V/B22/F/HBX1/6	93850	900	2700	80	15,000	60	110	6
11	220-240	E27	LED11/A60/765/220-240V/E27/F/HBX1/6	93853	1000	6500	80	15,000	60	110	6



LED Solutions

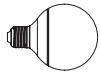

Wattage (W)	Volts (V)	Cap	Product Description	Product Code	Lumen (lm)	CCT (K)	CRI (Ra)	Life (L70, h)	Diameter (mm)	Length (mm)	Pack Qty
LED Energy Smart™ Range – Decor dimmable											
4.5	220-240	E27	LED4.5D/B35/827/E27/220-240V/FR	98204	250	2700	80	20000	36	99	10
4.5	220-240	E27	LED4.5D/B35/827/E27/220-240V/CL	98205	250	2700	80	20000	36	99	10
4.5	220-240	E14	LED4.5D/B35/827/E14/220-240V/FR	98207	250	2700	80	20000	36	104	10
4.5	220-240	E14	LED4.5D/B35/827/E14/220-240V/CL	98208	250	2700	80	20000	36	104	10
4.5	220-240	B22	LED4.5D/B35/827/B22/220-240V/FR	98213	250	2700	80	20000	36	97	10
4.5	220-240	B22	LED4.5D/B35/827/B22/220-240V/CL	98215	250	2700	80	20000	36	97	10
4.5	220-240	B15	LED4.5D/B35/827/B15/220-240V/CL	99596	250	2700	80	20000	36	103	10
4.5	220-240	E14	LED4.5D/B358T/827/E14/220-240V/FR	98217	250	2700	80	20000	36	124	6
4.5	220-240	E27	LED4.5D/P45/827/E27/220-240V/FR	98221	250	2700	80	20000	46	74	6
4.5	220-240	E14	LED4.5D/P45/827/E14/220-240V/FR	98222	250	2700	80	20000	46	80	6
4.5	220-240	B22	LED4.5D/P45/827/B22/220-240V/FR	98224	250	2700	80	20000	46	73	6
4.5	220-240	E27	LED4.5D/G80/827/E27/220-240V/FR	98225	250	2700	80	20000	81	113	6
4.5	220-240	B22	LED4.5D/G80/827/B22/220-240V/FR	98226	250	2700	80	20000	81	111	6

LED Outdoor Range – Decorative



2.4	220-240	E14	LED 2.4/B35 IO/830/220-240V/E14 1/10	98780	120	3000	80	25,000	35	100	10
2.4	220-240	E27	LED 2.4/B35 IO/830/220-240V/E27 1/10	98781	120	3000	80	25,000	35	98	10
2.4	220-240	B22	LED 2.4/B35 IO/830/220-240V/B22 1/10	98782	120	3000	80	25,000	35	97	10

Wattage (W)	Volts (V)	Cap	Product Description	Product Code	Lumen (lm)	CCT (K)	CRI (Ra)	Life (L70, h)	Diameter (mm)	Length (mm)	Pack Qty
LED Energy Smart™ Range – T8 Tube											
9	220-240	T8	LED 9/T8 600MM/840/220-240V BX1/30	90450	750	4000	80	50,000	28	604	30
9	220-240	T8	LED 9/T8 600MM/865/220-240V BX1/30	90451	800	6500	80	50,000	28	604	30
12	220-240	T8	LED 12/T8 600MM/840/220-240V BX1/30	90453	1050	4000	80	40000	28	604	30
12	220-240	T8	LED 12/T8 600MM/865/220-240V BX1/30	90454	1100	6500	80	40000	28	604	30
18	220-240	T8	LED 18/T8 1200MM/840/220-240V BX1/30	90455	1550	4000	80	50,000	28	1214	30
18	220-240	T8	LED 18/T8 1200MM/865/220-240V BX1/30	90456	1650	6500	80	50,000	28	1214	30
23	220-240	T8	LED 23/T8 1200MM/840/220-240V BX1/30	90457	2150	4000	80	40000	28	1214	30
23	220-240	T8	LED 23/T8 1200MM/865/220-240V BX1/30	90458	2250	6500	80	40000	28	1214	30





High Intensity Discharge Lamps



Boost sales with brilliant, true colour

Maximised performance and energy efficiency

Exceptional colour rendering throughout lamp life

Flexibility in form and size

Outstanding in-store experience

Attract customers and win sales

GE ConstantColor™ Ceramic Metal Halide (CMH) lighting brings the world to life in glorious colour. Our unique lamps are the lighting of choice across the retail sector – from general display to light and colour-critical applications such as fresh produce, jewellery or fashion retail. GE ConstantColor™ CMH presents merchandise in the best possible light.



New ConstantColor™ CMH Precise™*

Quality of Light

The CMH Precise™ range is an innovative lighting solution specifically designed with retail needs in mind. The range allows retailers to choose the best option that meets their visual requirements.

- Outstanding colour of Precise™ through the life of the lamp
- Further reduced lamp to lamp variance and colour shift over time
- New technology platform

Efficiency

Precise™ is a cost effective solution that offers direct retrofit in existing installations with longer life and more lumens over useful life. The range offers flexibility in form and size to meet challenging design requirements in various retail environments.

- Very efficient, up to 110LPW and offers better lumen maintenance with 30% more lumens at 15,000 hours life than standard lamps
- Reduced maintenance cycles and spot replacements with 25% more lamp service life (18,000 hours rated)
- Lamps can be used with a range of existing electronic ballasts available from GE and other major manufacturers validated by GE

*Available from October 2013



John Lewis, UK – vibrant & sustainable

Our Customer

A household name in the UK, John Lewis department stores operate throughout the UK and are owned by the John Lewis Partnership. The retailer's flagship store on Oxford Street is the largest branch in the partnership and was one of the first stores to benefit from a retrofit with GE Lighting lamps.

The Challenge

Upgrading existing CMH accent installation to enhance retail displays and optimize merchandising illumination.

Our Solution

Replacing original installation with upgraded performance 35W & 70W CMH Ultra lamps.

Key Benefits

- Superior colour rendering and improved lighting quality
- 50%+ reduction in energy consumption
- Improved look & feel
- Long maintenance cycle



50% savings of energy

Reduced maintenance

↑ bright light and appearance ↑ long service life

"By specifying GE Lighting's CMH Ultra range, visually the stores and merchandise appears more vibrant in colour, energy and maintenance costs are reduced and sustainability is optimised."

*Barry Ayling,
Lighting Design Manager
at John Lewis Partnership*

Hamley's, UK – colourful & efficient

The Challenge

Replace traditional halogen lamps with an efficient, high quality solution that provides superb colour rendering & quality of light.

Our Solution

GE's ConstantColor™ CMH Supermini lamps offer superior illumination, exceptional colour rendering and higher efficiency.

Key Benefits

- Superior colour rendering
- Extended maintenance cycles
- Long term cost savings
- Superior illumination

Up to **25%** longer lifetime
Reduced maintenance
↑ superior colour rendering **4x** more efficient



"The ConstantColor CMH Ultra lamps from GE Lighting provided us with the next generation in retail lighting, with the quality of light, colour and efficiency all optimised. These light sources offer superior illumination, conveying the quality of our goods and also a richness of colour, which is so important in an environment designed with children in mind."

*Keane Herman,
Operations Manager
for Hamleys Regent Street*

ConstantColor™ CMH AR111

Better Performance

GE's ConstantColor™ CMH AR111 are an ideal choice for energy-efficient accent and display lighting. The decorative design provides excellent beam control with low glare and superb overall light quality. Outstanding light output compared to similar solutions and premium colour rendering and consistency. Now, anyone with critical colour needs can enjoy the excellent savings that ConstantColor™ CMH AR111 lamps provide. ConstantColor™ CMH AR111 lamps offer substantial benefits that make them the clear choice for specification into new stores, or re-lamping existing store fixtures.



Features

- 35W & 70W versions with three different beam angles
- High Color Rendering Index
- Twist and Lock GX8.5 base provides secure positioning
- Lower thermal and energy output than tungsten halogen lamps
- Compatible with both electronic and magnetic HID ballasts

Key Benefits

- is the energy saving alternative to conventional halogen glare free applications
- delivers high lumen package, up to 3100 lumens, to replace 75W and 100W halogen in a compact design with low glare
- 75W halogen replaced by 35W CMH, 100W substituted with 70W CMH delivering 30%-53% energy savings
- provides 25%-49% more light than their halogen counterparts and have 3-4 times more service life (assuming L80)
- offers high color rendering index: 88 & 91



Cut costs, save energy, improve light quality

Comfort and security

delivering a light closer to natural daylight

Improved safety

colours are more real, objects are better illuminated

Retrofit replacement

white light solutions for HPS and MH lamps*

Enhancement and beautification

with advanced white light solutions

Long service life

with existing fixture and gear

It is generally observed that white light makes it easier for drivers to recognize shapes and colour, particularly in the peripheral vision. For pedestrians white light promotes a feeling of security and confidence, much more than under yellow or orange street lighting.



*additional ballast needed for mercury replacements

ConstantColor™ CMH StreetWise™



GE's new generation of CMH StreetWise™ lamps especially designed for outdoor lighting offers the best of both worlds. Bright, white, 'natural' light and low costs for both running and maintenance.

With CMH lighting, streets and other public spaces can feel safer for pedestrians. More than that, their "daylight" colour rendering improves the ability of drivers to recognise shapes and colours, especially in peripheral vision. This also promotes quicker driver response times.

StreetWise™ ceramic metal halide lamps are an excellent white light energy efficient choice, offering:

- Very efficient, up to 111LPW
- Direct retrofit to sodium sockets (ballast needed for mercury repl.)
- Outstanding Lumen Maintenance – 80% at 12,000hrs
- B10 life 12,000hrs / 16,000hrs, B50% 24,000hrs
- Wide range – 50/70/100/150W
- Dimmable (except 50W on EM) to achieve further energy saving
- Standard base for simplicity
- System flexibility – operates on both Electronic and Electro-magnetic ballasts
- Horizontal burning position, vertical validation under way
- Lowest cost new system – Standard base, standard ballast, standard optics

When to specify StreetWise™

In applications where lighting class reduction using lamps above Ra8 60 can be considered, StreetWise™ is a clear leader. Its excellent Ra8 value of 70 provides improved colour rendering over similar systems of comparable life and efficiency.



Bristol City, UK – efficient & safe

The Challenge

Replace the street lighting for one of the short-listed cities for the 2014 Green Capital Award with a new solution which makes the pedestrians feel safer and reduce the carbon footprint of the city.

Our Solution

GE Lighting has upgraded the street lighting in Bristol to deliver an energy efficient, white light solution with higher efficiency CMH Streetwise™ lamps.



Key Benefits

- Safer roads with white light
- Better facial recognition
- 24,000 hour rated lifetime
- 4.2M KWH and £500,000 saving per year
- Reduced CO₂ emissions
- High lumen maintenance
- Dimmable solution

↓ Reduced energy consumption and CO₂ emission

White light solution

↑ dimmable light ↑ safer roads

“We are delighted with the street lighting upgrade to GE’s StreetWise™ ceramic metal halide lamps. Along with other energy reduction projects financed with interest free loans from Salix & Seels the overall result is astounding and will not only make our streets safer but will enable Bristol to save 4.2M kWh and £500,000 per year on our energy bills as well as a reduction in CO₂ emissions.”

*Robbie Park,
Principal Lighting Officer
for Bristol City Council*

**ConstantColor™ CMH
(Ceramic Metal Halide)
GU6.5, TC, T, TD**



Single Ended Supermini Precise™, Ultra and Standard (GU6.5)

Cap: GU6.5
Wattages: 20-35W
Colours: 830, 930, 942
Rated life: 10,000 -18,000Hrs

Page II.14



Single Ended Mini Precise™, Ultra, Ultra White and Standard (TC)

Cap: G8.5
Wattages: 20 -70W
Colours: 830, 930, 942
Rated life: 12,000 -18,000Hrs

Page II.14



Single Ended Precise™, Ultra, Ultra White and Standard (T)

Cap: G12
Wattages: 20-150W
Colours: 830, 930, 942
Rated life: 12,000 -18,000Hrs

Page II.14



Double Ended (TD)

Cap: RX7s or RX7s-24
Wattages: 35-150W
Colours: 830
Rated life: 15,000Hrs

Page II.14

ConstantColor™ CMH (Ceramic Metal Halide) Reflectors



MR16 Precise™, Ultra and Standard

Cap: GX10
Wattages: 20-35W
Colours: 830, 930, 942
Rated life: 10,000 -16,500Hrs

Page II.15



AR11

Cap: GX8.5
Wattages: 35-70W
Colours: 930
Rated life: 10,000 -12,000Hrs

Page II.15



PAR20

Cap: E27
Wattages: 20-35W
Colours: 830, 942
Rated life: 10,000 -12,000Hrs

Page II.15



PAR30

Cap: E27
Wattages: 20-70W
Colours: 830, 942
Rated life: 10,000 -13,000Hrs

Page II.15

ConstantColor™ CMH (Ceramic Metal Halide) Elliptical and Tubular



Open Rated Elliptical

Cap: E27
Wattages: 70-150W
Colours: 942
Finish: Clear or Diffuse
Rated life: 10,000-15,000Hrs

Page II.15



Elliptical

Cap: E27, E40
Wattages: 70-400W
Colours: 830
Finish: Clear or Diffuse
Rated life: 10,000 -24,000Hrs

Page II.16



StreetWise™

Cap: E27, E40
Wattages: 50-150W
Colours: 730
Finish: Clear
Rated life: 24,000Hrs

Page II.16



Tubular

Cap: E27, E40
Wattages: 70-400W
Colours: 830, 842, 942
Finish: Clear
Rated life: 10,000 -24,000Hrs

Page II.16



Open Rated Tubular

Cap: E40
Wattages: 150W
Colours: 830, 942
Finish: Clear
Rated life: 12,000Hrs

Page II.16

High Intensity Discharge Lamps

CMH Ballasts



CMH Standard Ballasts
A range of standard ballasts for 35-70W CMH lamps

Page II.16



CMH Miniature Ballasts
A range of miniature ballasts for 20-35W CMH lamps

Page II.16

Arcstream Metal Halide

Operates on suitable metal halide/high pressure sodium ballast and metal halide ignitor



Single Ended
Cap: G12
Wattages: 70-150W
Colours: 3000-4200K
CRI: 70-80
Rated life: 6,000Hrs

Page II.17



Double Ended
Cap: Rx7s-Fc2
Wattages: 70-250W
Colours: 3000-6500K
CRI: 75-90
Rated life: 8,000-12,000Hrs

Page II.17



Double Ended Coloured
Cap: RX7s-24
Wattages: 150W
Colours: Green, Blue, Orange, Magenta
Rated life: 6,000Hrs

Page II.17



Tubular
Cap: E40
Wattages: 250-400W
Colours: 4200-6000K
CRI: 70-90+
Finish: Clear
Rated life: 12,000Hrs

Page II.17



Elliptical
Cap: E40
Wattages: 250W
Colours: 4000-6000K
CRI: 70-90
Finish: Clear or Diffuse
Rated life: 12,000-14,000Hrs

Page II.18

Multi-Vapour Metal Halide

Operates from CWA Control Gear



Standard - Elliptical
Cap: E40
Wattages: 250-1000W
Colours: 3700-4200K
CRI: 65-70
Finish: Clear or Diffuse
Rated life: 10,000-20,000Hrs

Page II.18



High Output - Elliptical
Cap: E40
Wattages: 250-400W
Colours: 3200-4200K
CRI: 65-70
Finish: Clear or Diffuse
Rated life: 20,000Hrs

Page II.18

Kolorarc™ Metal Halide

Operates from suitable mercury or metal halide ballast rated 3.5A and metal halide ignitor



Tubular
Cap: E40
Wattages: 400W
Colours: 6000K
CRI: 90
Finish: Clear
Rated life: 14,000Hrs

Page II.18



Elliptical
Cap: E40
Wattages: 400W
Colours: 4000-6000K
CRI: 65-90
Finish: Clear or Diffuse
Rated life: 14,000Hrs

Page II.18

Selector

Sportlight™ Metal Halide For sports and floodlighting



Linear

Cap: RX7s - spec
Wattages: 1500-2000W
Colours: 5200K
CRI: 65
Rated life: 6,000Hrs

Page II.19



Tubular Clear

Cap: E40
Wattages: 1000-2000W
Colours: 4000-6000K
CRI: 65-93
Rated life: 2,000-8,000Hrs

Page II.19



Internal Ignitor

Cap: E40
Wattages: 2000W
Colours: 4000-6000K
CRI: 65-93
Rated life: 2,000-5,000Hrs

Page II.19

Lucalox™ High Pressure Sodium



Lucalox™ XO Superlife

Cap: E27, E40
Wattages: 50-400W
Feature: Extra high lumen output and Twin Arc tubes for extra life
Finish: Tubular Clear or Elliptical Diffuse
Rated life: 40,000-60,000Hrs

Page II.19



Lucalox™ XO

Cap: E27, E40
Wattages: 50-600W
Feature: Extra high lumen output
Finish: Tubular Clear or Elliptical Diffuse
Rated life: 32,000-40,000Hrs

Page II.19



Lucalox Superlife

Cap: E40
Wattages: 250-400W
Feature: Twin Arc tubes for extra life
Finish: Elliptical Diffuse
Rated life: 55,000Hrs

Page II.20



Lucalox™ Standard

Cap: E27, E40
Wattages: 70-1000W
Finish: Tubular Clear or Elliptical Diffuse
Rated life: 24,000-28,500Hrs

Page II.20



Lucalox Start

Cap: E27, E40
Wattages: 70-400W
Finish: Tubular clear
Rated life: 12,000-24,000Hrs

Page II.20



Lucalox™ Internal Ignitor

Cap: E27
Wattages: 50-70W
Feature: Internal ignitor
Finish: Elliptical Clear or Diffuse
Rated life: 12,000-17,500Hrs

Page II.20

Mercury Lamps



Kolorlux™ Mercury Standard

Cap: E27, E40
Wattages: 50-400W
Rated life: 16,000-20,000Hrs

Page II.21



Kolorlux™ Mercury Deluxe

Cap: E27, E40
Wattages: 50-400W
Rated life: 16,000-20,000Hrs

Page II.21



Kolorlux™ Mercury Start

Cap: E27
Wattages: 125W
Rated life: 12,000 Hrs

Page II.21



Mixed Light

Cap: E27, E40
Wattages: 160-500W
Voltage: 230-240V or 240-250V
Rated life: 8,000Hrs

Page II.21

High Intensity Discharge Lamps

Product identification

The following glossary of terms will help you when selecting lamps in this section. Within each product line, lamps are divided into families – within these families, lamps are listed by wattage. The Product Description can be used as a quick reference to each product's attributes. Where Life or Average Life are stated we refer to the industry standard definition of how many hours of operation 50% of a given installation will exceed.

Additional parameters:

CCT [K]: Colour Temperature - Kelvins

A measure of the visual "warmth" or "coolness" of the light from the lamp. The higher the value the whiter or "cooler" the light appears.

CRI [Ra]: Colour Rendering Index

An indication of the ability of the lamp to render object colours in a normal, natural way. The higher the number (0-100), the better the colour appearance.

Watts:

Energy Used -
Nominal Watts.

To estimate energy consumption (kWh), multiply watts x hours of use and divide by 1000

Cap:

The type of cap fitted. See page 148-149 for cap drawings

Nominal Volts:

Lamp data is based on operation at rated voltage

Product description:
The lamp's identification code

Lumens:

Initial Lumens - light output at 100 hours

Operating position:

U - Universal
HOR - Horizontal
BU - Base Up
VBU - Vertical Base Up

Life (Horizontal):

Rated average life in horizontal burning position

EEC:

Energy Efficiency Class

Wattage [W]

Volts [V]

Cap

Product Description

Product Code

Lumen [lm]

Colour

Operating position

Rated life (Vertical) [h]

Rated life (Horizontal) [h]

Length [mm]

Diameter:

Bulb diameter in mm

Energy Consumption [kWh]

EEC

Pack Qty

ConstantColor™ - CMH Supermini

20	95	GU6.5	CMH20/T/UVC/830/GU6.5	40399	1615	830	U	12,000	12,000	52	13	21.78	A+	12
35	95	GU6.5	CMH35/T/UVC/930/GU6.5	88656	3400	930	U	10000*	10,000*	52	13	44.24	A+	12

CMH 70 / T / UVC / U / 9 30 / G12 ULTRA

(70)
Identifies Lamp's wattage

(UVC) UV Control

(U) Operating Position

(G12):
Identifies the cap type

(CMH) Product Family

CMH - ConstantColor™ CMH
ARC - Arcstream™
KRC - Kolorarc™
MPR/MVR - Multi-Vapor™
SPL - Sportlight™
LU - Lucalox™
H - Mercury
ML - Blended Light
BLS - Ballast

(T) Identifies the lamp format.

TD - Double Ended
E - Elliptical Clear
D - Elliptical Diffused
L - Linear
PARxx - PAR + size
T - Tubular Clear

(9) Colour rendering

6 - nom 60, min 57 (Group 2B)
7 - nom 70, min 67 (Group 2A)
8 - nom 80, min 77 (Group 1B)
9 - nom 90, min 87 (Group 1A)

(30) Colour temperature

XX = First 2 digits of temperature in Kelvin - XX00K
Example: 30 is 3000K

Colour:

Combination of colour rendering and colour temperature

Length:

Lamp length in mm

Energy Consumption:
kWh/1000h

Product code:

It is important to use this code when ordering to ensure that you receive the exact product you require

Life (Vertical):

Rated average life in vertical burning position

Pack quantity:

Number of product units packed in a case



ConstantColor™ CMH Lamps

Wattage [W]	Volts [V]	Cap	Product Description	Product Code	Lumen [lm]	Colour	Operating position	Rated life (Vertical) [h]	Rated life (Horizontal) [h]	Length [mm]	Diameter [mm]	Energy Consumption [kWh]	EEC	Pack Qty
ConstantColor™ - CMH Supermini														
20	95	GU6.5	CMH20/TC/UVC/830/GU6.5	40399	1615	830	U	12,000	12,000	52	13	21.93	A	12
35	80-105	GU6.5	CMH35/T/UVC/930/U/GU6.5 PRECISE™**	67685	4000	930	U*	18,000*	18,000*	52	12	TBD	TBD	12
35	93	GU6.5	CMH35/T/UVC/U/930/GU6.5 ULTRA	76122	3500	930	U	16,500	16,500	52	13	43.05	A+	12
35	95	GU6.5	CMH35/T/UVC/930/GU6.5	88656	3400	930	U	10,000	10,000	52	13	42.20	A+	12
35	95	GU6.5	CMH35/T/UVC/942/GU6.5	88657	3400	942	U	12,000	12,000	52	13	42.36	A	12



ConstantColor™ - CMH Single Ended Mini

20	90	G8.5	CMH20/TC/UVC/U/830/G8.5 PLUS	39858	1650	830	U	12,000	12,000	85	14.5	21.78	A	12
35	90	G8.5	CMH35/T/UVC/U/830/G8.5 Plus	43273	3400	830	U	16,500	16,500	85	14.5	43.40	A+	12
35	90	G8.5	CMH35/TC/UVC/U942/G8.5	26348	3200	942	U	18,000	18,000	85	14.5	44.24	A	12
35	80-105	G8.5	CMH35/TC/UVC/U/930/G8.5 PRECISE™**	67683	4000	930	U*	18000*	18000*	85	14.5	TBD	TBD	12
35	92	G8.5	CMH35/TC/U/UVC/930/G8.5 ULTRA	76120	3600	930	U	16,500	16,500	85	14.5	43.08	A+	12
70	90	G8.5	CMH70/TC/UVC/U/942/G8.5	26349	6200	942	U	15,000	15,000	85	14.5	80.43	A	12
70	85	G8.5	CMH70/TC/UVC/U/830/G8.5 PLUS	67698	7000	830	U	15,000	15,000	85	14.5	79.20	A+	12
70	90	G8.5	CMH70/TC/UVC/U/930/G8.5 PRECISE™**	67681	7800	930	U*	18000*	18000*	85	14.5	TBD	TBD	12
70	90	G8.5	CMH70/TC/UVC/U/930/G8.5 ULTRA WHITE	63595	6700	930	U	18,000	18,000	85	14.5	80.61	A+	12
70	90	G8.5	CMH70/TC/UVC/U/930/G8.5 ULTRA	96751	6200	930	U	18,000	18,000	85	14.5	79.94	A+	12



ConstantColor™ - CMH Single Ended

20	90	G12	CMH20/T/UVC/U/830/G12 PLUS	42708	1650	830	U	12,000	12,000	90	14.5	21.78	A	12
35	90	G12	CMH35/T/UVC/U/830/G12 PLUS	43272	3400	830	U	16,500	16,500	90	14.5	43.37	A+	12
35	80-105	G12	CMH35/T/UVC/U/930/G12 PRECISE™**	67684	4000	930	U*	18000*	18000*	100	19	TBD	TBD	12
35	92	G12	CMH35/T/UVC/U/930/G12 ULTRA	76121	3600	930	U	16,500	16,500	90	19	43.06	A+	12
35	90	G12	CMH35/T/UVC/U/942/G12	92141	3200	942	U	18,000	18,000	90	14.5	44.57	A	12
70	90	G12	CMH70/T/UVC/U/830/G12	20005	6400	830	U	15,000	15,000	90	19	76.48	A+	12
70	90	G12	CMH70/T/UVC/U/942/G12	20013	6000	942	U	15,000	15,000	90	19	80.09	A+	12
70	90	G12	CMH70/T/UVC/U/930/G12 PRECISE™**	67682	7800	930	U*	18000*	18000*	100	19	TBD	TBD	12
70	95	G12	CMH70/T/UVC/U/930/G12 ULTRA WHITE	63596	6600	930	U	18,000	18,000	90	19	81.31	A+	12
70	95	G12	CMH70/T/UVC/U/930/G12 ULTRA	96752	6400	930	U	18,000	18,000	90	19	80.08	A+	12
150	90	G12	CMH150/T/UVC/U/830/G12	20012	14000	830	U	12,000	12,000	100	19	160.27	A+	12
150	90	G12	CMH150/T/UVC/U/942/G12	20014	13000	942	U	12,000	12,000	100	19	164.22	A	12



ConstantColor™ - CMH Double Ended

35	90	RX7s	CMH35/TD/UVC/830/RX7s	43278	3400	830	HOR±45°	-	15,000	118	21	41.99	A	12
70	90	RX7s	CMH70/TD/UVC/830/RX7s	36910	7000	N/A	HOR±45°	-	15,000	118	21	80.73	A+	12
70	90	RX7s	CMH70/TD/UVC/942/RX7s	38698	6200	N/A	HOR±45°	-	15,000	118	21	79.42	A+	12
150	96	RX7s-24	CMH150/TD/UVC/830/RX7s-24	36912	14500	N/A	HOR±45°	-	15,000	135	27	158.73	A+	12
150	96	RX7s-24	CMH150/TD/UVC/942/RX7s-24	38692	12500	N/A	HOR±45°	-	15,000	135	27	155.26	A+	12



* Target performance
 ** Expected availability in Q3 2013

High Intensity Discharge Lamps

Wattage (W)	Volts (V)	Cup	Product Description	Product Code	Candela (cd)	Beam Angle (°)	Colour	Operating position	Rated life (Vertical) (h)	Rated life (Horizontal) (h)	Length (mm)	Diameter (mm)	Energy Consumption (kWh)	EEC	Pack Qty
-------------	-----------	-----	---------------------	--------------	--------------	----------------	--------	--------------------	---------------------------	-----------------------------	-------------	---------------	--------------------------	-----	----------

ConstantColor™ - CMH MR16 Precise

20	95	GX10	CMH20/MR16/UVC/830/GX10/SP	40400	9000	12	830	U	12,000	12,000	54.5	51	21.73	A	12
20	95	GX10	CMH20/MR16/UVC/830/GX10/FL GX10	40401	2900	25	830	U	12,000	12,000	54.5	51	21.70	A	12
20	95	GX10	CMH20/MR16/UVC/830/GX10/WFL GX10	42691	1500	40	830	U	12,000	12,000	54.5	51	21.76	A	12
35	80-105	GX10	CMH35/MR16/U/930/GX10/SP PRECISE***	67686	2500	12	930	U*	18,000*	18,000*	54.5	50	TBD	TBD	12
35	80-105	GX10	CMH35/MR16/U/930/GX10/FL PRECISE***	67687	2500	25	930	U*	18,000*	18,000*	54.5	50	TBD	TBD	12
35	80-105	GX10	CMH35/MR16/U/930/GX10/WFL PRECISE***	67697	2500	40	930	U*	18,000*	18,000*	54.5	50	TBD	TBD	12
35	93	GX10	CMH35/MR16/U/UVC/930/GX10/SP Ultra	76123	16000	12	930	U	16,500	16,500	54.5	51	43.00	A	12
35	93	GX10	CMH35/MR16/U/UVC/930/GX10/FL Ultra	76124	5500	25	930	U	16,500	16,500	54.5	51	43.00	A	12
35	93	GX10	CMH35/MR16/U/UVC/930/GX10/WFL Ultra	76125	3000	40	930	U	16,500	16,500	54.5	51	43.00	A	12
35	90	GX10	CMH35/MR16/UVC/930/GX10/SP GX10	88658	16000	12	930	U	10,000	10,000	54.5	51	42.21	A	12
35	90	GX10	CMH35/MR16/UVC/930/GX10/FL GX10	88659	5500	25	930	U	10,000	10,000	54.5	51	42.17	A	12
35	90	GX10	CMH35/MR16/UVC/930/GX10/WFL GX10	88660	3000	40	930	U	10,000	10,000	54.5	51	42.21	A	12
35	90	GX10	CMH35/MR16/UVC/942/GX10/SP GX10	88661	16000	12	942	U	12,000	12,000	54.5	51	42.26	A	12
35	90	GX10	CMH35/MR16/UVC/942/GX10/FL GX10	88662	5500	25	942	U	12,000	12,000	54.5	51	42.24	A	12
35	90	GX10	CMH35/MR16/UVC/942/GX10/WFL GX10	88663	3000	40	942	U	12,000	12,000	54.5	51	42.20	A	12



ConstantColor™ - CMH AR111

35	90	GX8.5	CMH35/R111/UVC/930/GX8.5/SP10	99989	44000	10	930	U	10,000	10,000	95	111	34.32	A	6
35	90	GX8.5	CMH35/R111/UVC/930/GX8.5/FL24	99990	10000	24	930	U	10,000	10,000	95	111	34.32	A	6
35	90	GX8.5	CMH35/R111/UVC/930/GX8.5/FL40	99991	5000	40	930	U	10,000	10,000	95	111	34.32	A	6
70	95	GX8.5	CMH70/R111/UVC/930/GX8.5/SP10	99992	50000	10	930	U (ECG)/V60 (EM)	12,000	12,000	95	111	64.24	A	6
70	95	GX8.5	CMH70/R111/UVC/930/GX8.5/FL24	99993	18000	24	930	U (ECG)/V60 (EM)	12,000	12,000	95	111	64.24	A	6
70	95	GX8.5	CMH70/R111/UVC/930/GX8.5/FL40	99994	8500	40	930	U (ECG)/V60 (EM)	12,000	12,000	95	111	64.24	A	6

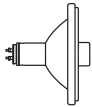

ConstantColor™ - CMH PAR 20

20	95	E27	CMH20PAR20/UVC/830/E27/SP10	26478	13000	10	830	U	12,000	12,000	92	64	21.67	A	15
20	95	E27	CMH20/PAR20/UVC/830/E27/FL25	26481	3750	25	830	U	12,000	12,000	92	64	21.85	A	15
35	90	E27	CMH35/PAR20/UVC/830/E27/SP10	21684	22000	10	830	U	10,000	10,000	92	64	42.68	A	15
35	90	E27	CMH35/PAR20/UVC/830/E27/FL25	21685	7500	25	830	U	10,000	10,000	92	64	42.68	A	15
35	90	E27	CMH35/PAR20/UVC/942/E27/SP10	44890	19450	10	942	U	10,000	10,000	92	64	42.36	A	15
35	90	E27	CMH35/PAR20/UVC/942/E27/FL25	44919	6950	25	942	U	10,000	10,000	92	64	43.75	A	15



ConstantColor™ - CMH PAR 30

20	95	E27	CMH20PAR30/UVC/830/E27/SP10	26497	19800	10	830	U	12,000	12,000	124	95.5	21.73	A	6
20	95	E27	CMH20PAR30/UVC/830/E27/FL25	26518	4900	25	830	U	12,000	12,000	124	95.5	21.71	A	6
35	90	E27	CMH35/PAR30/UVC/830/E27/SP10	21689	39600	10	830	U	10,000	10,000	124	95.5	43.46	A	6
35	90	E27	CMH35/PAR30/UVC/830/E27/FL 25	21690	11000	25	830	U	10,000	10,000	124	95.5	43.35	A	6
35	90	E27	CMH35/PAR30/UVC/942/E27/SP10	44939	36700	10	942	U	10,000	10,000	124	95.5	43.70	A	6
35	90	E27	CMH35/PAR30/UVC/942/E27/FL25	44942	10200	25	942	U	10,000	10,000	124	95.5	43.54	A	6
70	90	E27	CMH70/PAR30/UVC/830/E27/SP15	21683	42800	15	830	U	13,000	13,000	124	95.5	81.79	A	6
70	90	E27	CMH70/PAR30/UVC/830/E27/FL40	21682	10000	40	830	U	13,000	13,000	124	95.5	81.72	A	6
70	90	E27	CMH70/PAR30/UVC/942/E27/SP15	74620	33500	15	942	U	10,000	10,000	124	95.5	82.62	A	6
70	90	E27	CMH70/PAR30/UVC/942/E27/FL40	74619	9000	40	942	U	10,000	10,000	124	95.5	82.62	A	6



ConstantColor™ - CMH Elliptical Clear

70	97	E27	CMH70/E/UVC/U/830/E27/C	97982	6300	-	830	U	15,000	15,000	138	54	77.70	A+	6
100	102	E27	CMH100/E/UVC/U/830/E27/C	97984	9200	-	830	U	15,000	15,000	138	54	110.92	A+	6



* Target performance
** Expected availability in Q3 2013

Wattage (W)	Volts (V)	Cap	Product Description	Product Code	Lumen (lm)	Colour	Operating position	Rated life (Vertical) (h)	Rated life (Horizontal) (h)	Length (mm)	Diameter (mm)	Energy Consumption (kWh)	EEC	Pack Qty
-------------	-----------	-----	---------------------	--------------	------------	--------	--------------------	---------------------------	-----------------------------	-------------	---------------	--------------------------	-----	----------

ConstantColor™ - CMH Elliptical Clear, Open Rated

150	95	E27	CMH150/UVC/O/U/942/E27/C	43285	13200	942	U	15,000	15,000	138	55	163.27	A	6
-----	----	-----	--------------------------	-------	-------	-----	---	--------	--------	-----	----	--------	---	---

ConstantColor™ - CMH Elliptical Diffuse

70	97	E27	CMH70/E/UVC/U/830/E27/D	97979	6000	830	U	15,000	15,000	138	54	78.85	A	6
100	102	E27	CMH100/E/UVC/U/830/E27/D	97985	8700	830	U	10,000	10,000	138	54	110.37	A+	6
250	117	E40	CMH250/E/UVC/U/830/E40/D	10591	23500	830	U	24,000	24,000	227	90	289.38	A+	12
400	120	E40	CMH400/E/UVC/U/830/E40/D	13087	39000	830/836	U	20,000	20,000	282	120	453.86	A+	6



ConstantColor™ - CMH Elliptical Diffuse, Open Rated

70	97	E27	CMH70/UVC/O/U/940/E27/D	43282	5300	940	U	15,000	15,000	138	54	83.98	A	6
150	95	E27	CMH150/UVC/O/U/940/E27/D	43286	12300	940	U	15,000	15,000	138	55	164.63	A	6

ConstantColor™ - CMH Tubular Clear StreetWise

50	85	E27	CMH50/TT/UVC/730/E27 STREETWISE ECG	64982	5000	730	HOR±15°**	-	24,000*	156	39	55.00	A+	12
50	85	E27	CMH50/TT/UVC/730/E27 STREETWISE EM	77400	4500	730	HOR±15°**	-	24,000*	156	39	57.20	A+	12
70	95	E27	CMH70/TT/UVC/730/E27 STREETWISE	77401	7640	730	HOR±15°**	-	24,000*	156	39	78.10	A+	12
100	100	E40	CMH100/TT/UVC/730/E40 STREETWISE	77399	10900	730	HOR±15°**	-	24,000*	211	48	107.80	A+	12
150	100	E40	CMH150/TT/UVC/730/E40 STREETWISE	77402	16200	730	HOR±15°**	-	24,000*	211	48	165.00	A+	12



*Testing is still on-going to determine final design life
 ** Universal burning position to be available in Q3 2013

ConstantColor™ - CMH Tubular Clear

70	95	E27	CMH70/TT/UVC/830/E27	38752	6400	830	U	15,000	20,000	156	37	80.71	A+	12
100	109	E40	CMH100/TT/UVC/830/E40	92478	9200	830	U	10,000	15,000	209	48	110.28	A+	12
150	95	E40	CMH150/UVC/T/U/842/E40	21514	14500	842	U	15,000	15,000	209	48	160.27	A+	12
150	100	E40	CMH150/TT/UVC/830/E40	38749	14000	830	U	15,000	20,000	209	48	164.51	A+	12
250	117	E40	CMH250/TT/UVC/U/830/E40	10589	25000	830	U	24,000	24,000	260	48	288.20	A+	12
250	110	E40	KRC250/CMH/830/T/H/E40	20302	20000	830	HOR	-	24,000	260	48	241.52	A	12
250	107	E40	CMH250/T/U/942/E40	62356	25000	942	U	16,000*	16,000*	260	48	285.53	A+	12
400	120	E40	CMH400/TT/UVC/U/830/E40	13067**	41000	830/836	U	20,000	20,000	278	60	454.14	A+	12



*Testing is still on-going to determine final design life
 ** 830 in horizontal burning position, 836 in vertical burning position

ConstantColor™ - CMH Tubular Clear, Open Rated

150	100	E40	CMH150/UVC/O/T/U/830/E40	21516	14000	830	U	12,000	12,000	209	48	161.06	A+	12
150	100	E40	CMH150/UVC/O/T/U/942/E40	21517	14000	942	U	12,000	12,000	209	48	163.36	A	12



CMH Standard Ballast

35	220-240	BLS/E/35W/CMH	61487	integral	350	10
35	220-240	BLS/E/35W/CMH /R CC	61488	remote cable clamp	370	10
70	220-240	BLS/E/70W/CMH	61376	integral	350	10
70	220-240	BLS/E/70W/CMH/R CC	61569	remote cable clamp	370	10

CMH Miniature Ballast

20	220-240	BLS/E/20W/CMH	78711	integral	165	12
20	220-240	BLS/E/20W/CMH/R/CC	78712	remote cable clamp	180	12
20	220-240	BLS/E/20W/CMH/R/LP	78713	remote with lead	240	12
35	220-240	BLS/E/35W/CMH	78714	integral	165	12
35	220-240	BLS/E/35W/CMH/R/CC	78715	remote cable clamp	180	12
35	220-240	BLS/E/35W/CMH/R/LP	78716	remote with lead	240	12

High Intensity Discharge Lamps

Metal Halide Lamps



Wattage [W]	Volts [V]	Cap	Product Description	Product Code	Lumen [lm]	CCT [K]	CRI [Ra]	Operating position	Rated life (Vertical) [h]	Rated life (Horizontal) [h]	Length [mm]	Diameter [mm]	Energy Consumption [kWh]	EEC	Pack Qty
Arcstream™ Single Ended RG-2															
150	95	G12	ARC150/G12/830	88654	12000	3000	80	U	6,000	6,000	76	21.5	165.00	A	10
150	95	G12	ARC150/G12/842	88655	11500	4200	80	U	6,000	6,000	76	21.5	165.00	A	10

WARNING: UV emitted from lamps in Risk Group 2 and 3. Avoid eye and skin exposure to unshielded product.

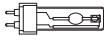

Wattage [W]	Volts [V]	Cap	Product Description	Product Code	Lumen [lm]	CCT [K]	CRI [Ra]	Operating position	Rated life (Horizontal) [h]	Length [mm]	Diameter [mm]	Weighted Energy Cons. [kWh/1000h]	Energy Efficiency Class (EEC)	Pack Qty	
Arcstream™ Single Ended UVC															
70	95	G12	ARC70/T/U/730/G12	97286	5200	3000	70	U	6,000	6,000	87	23	77.00	A	10
70	95	G12	ARC70/T/U/742/G12	97287	5200	4200	75	U	6,000	6,000	87	23	77.00	A	10



Wattage [W]	Volts [V]	Cap	Product Description	Product Code	Lumen [lm]	CCT [K]	CRI [Ra]	Operating position	Rated life (Horizontal) [h]	Length [mm]	Diameter [mm]	Weighted Energy Cons. [kWh/1000h]	Energy Efficiency Class (EEC)	Pack Qty
Arcstream™ Double Ended UVC														
70	95	RX7s	ARC70/UVC/TD/730/Rx7s	34530	5500	3000	75	HOR±45°	12,000	114	19	82.50	A	12
70	95	RX7s	ARC70/UVC/TD/742/Rx7s	34536	5500	4200	75	HOR±45°	12,000	114	22	82.50	A	12
150	95	RX7s-24	ARC150/UVC/TD/732/Rx7s-24	34527	12000	3200	75	HOR±45°	12,000	132	22	165.00	A	12
150	95	RX7s-24	ARC150/UVC/TD/742/Rx7s-24	34535	12000	4200	75	HOR±45°	12,000	132	25	165.00	A	12



Wattage [W]	Volts [V]	Cap	Product Description	Product Code	Lumen [lm]	CCT [K]	CRI [Ra]	Operating position	Rated life (Horizontal) [h]	Length [mm]	Diameter [mm]	Weighted Energy Cons. [kWh/1000h]	Energy Efficiency Class (EEC)	Pack Qty
Arcstream™ Double Ended RG-3														
150	95	RX7s-24	ARC150/AQUA/TD/865/Rx7s-24	35284	11000	6500	85	HOR±45°	8,000	132	25	165.00	A	12
150	110	RX7s-24	ARC150/TD/952/Rx7s-24	93772	11000	5200	90	HOR±45°	8,000	132	25	165.00	A	12
250	114	Fc2	ARC250/TD/832/Fc2	30099	20000	3200	75	HOR±45°	12,000	163	25	275.00	A	12
250	115	Fc2	ARC250/TD/842/Fc2	30101	20000	4200	75	HOR±45°	8,000	163	25	275.00	A	12

WARNING: UV emitted from lamps in Risk Group 2 and 3. Avoid eye and skin exposure to unshielded product.



Colour	Wattage [W]	Volts [V]	Cap	Product Description	Product Code	Operating position	Rated life (Horizontal) [h]	Length [mm]	Diameter [mm]	Weighted Energy Cons. [kWh/1000h]	Energy Efficiency Class (EEC)	Pack Qty
Arcstream™ Double Ended Coloured UVC												
green	150	95	RX7s-24	ARC150/UVC/TD/GREEN/RX7S-24	12181	HOR±45°	6,000	132	25	165.00	B	12
blue	150	95	RX7s-24	ARC150/UVC/TD/BLUE/RX7S-24	12182	HOR±45°	6,000	132	25	165.00	C	12
orange	150	95	RX7s-24	ARC150/UVC/TD/ORANGE/RX7S-24	12183	HOR±45°	6,000	132	25	165.00	B	12
magenta	150	95	RX7s-24	ARC150/UVC/TD/MAGENTA/RX7S-24	12184	HOR±45°	6,000	132	25	165.00	B	12



Wattage [W]	Volts [V]	Cap	Product Description	Product Code	Lumen [lm]	CCT [K]	CRI [Ra]	Operating position	Rated life (Vertical) [h]	Rated life (Horizontal) [h]	Length [mm]	Diameter [mm]	Weighted Energy Cons. [kWh/1000h]	Energy Efficiency Class (EEC)	Pack Qty
Arcstream™ Tubular Clear															
250	100	E40	ARC250/T/H/960/E40	32664	19000	6000	90	HOR±45°	-	12,000	220	47	299.58	A	12
250	100	E40	ARC250/T/VBU/960/E40	32665	19000	6000	90	BU±45°	12,000	-	220	47	295.64	A	12
250	112	E40	ARC250/T/H/742/E40	42357	21000	4200	70	HOR±15°	-	12,000	220	48	294.89	A	12
400	105	E40	ARC400/T/H/742/E40	42369	35000	4200	70	HOR±15°	-	12,000	260	47	444.20	A	12

 The lamp shall be operated only in a luminaire provided with a protective shield.

Wattage (W)	Volts (V)	Cap	Product Description	Product Code	Lumen (lm)	CCT (K)	CRI (Ra)	Operating position	Rated life (Vertical) (h)	Rated life (Horizontal) (h)	Length (mm)	Diameter (mm)	Energy Consumption (kWh)	EEC	Pack Qty
Arcstream™ Elliptical Diffuse															
250	100	E40	ARC250/D/H/740/E40	16870	19500	4000	70	HOR±15°	-	14,000	227	90	294.12	A	10
250	100	E40	ARC250/D/H/960/E40	30047	17000	6000	90	HOR±45°	-	12,000	227	91	294.94	B	12
250	100	E40	ARC250/D/VBU/960/E40	32666	17000	6000	90	VBU±45°	12,000	-	227	90	294.71	A	12

Operating from suitable metal halide / high pressure sodium (HPS) ballast and metal halide ignitor. Arcstream™ lamps are only suitable for operation in fully enclosed fixtures where lens/diffuser material must be able to contain fragments of hot quartz or glass (up to 1100°C)

Multi-Vapor™ Elliptical Clear

250**	133	E40	MVR250/U/40*	44542	20800	4200	65	U	10,000	10,000	216	89	274.89	A	12
400**	135	E40	MVR400/U/40*	43907	40000	4000	65	U	20,000	20,000	295	118	440.00	A+	6
1000**	V250 H245	E40	MVR1000/U/40	41828	108000	4000	65	U	15,000	15,000	385	178	1188.00	A+	6

*Non EU Product

**Performance data claimed for vertical position

Multi-Vapor™ Elliptical Diffuse

250**	133	E40	MVR250/C/U/40*	44543	20000	3900	70	U	10,000	10,000	216	89	275.00	A	12
400**	135	E40	MVR400/C/U/40	43908	40000	3700	70	U	20,000	20,000	295	117	440.00	A+	6

*Non EU Product

**Performance data claimed for vertical position

Multi-Vapor™ High Output Elliptical Clear

250	133	E40	MVR250/VBU/40	98777	22000	4200	65	VBU±15°	10,000	-	216	89	275.00	A	12
400	135	E40	MVR400/VBU/40	49860	41000	4000	65	VBU±15°	20,000	-	295	117	440.00	A+	6

Multi-Vapor™ High Output Elliptical Diffuse

250	133	E40	MVR250/C/VBU/40	98778	20000	4000	65	VBU±15°	10,000	-	216	89	275.00	A	12
400*	135	E40	MPR400/C/VBU/0/40	27738	38000	3200	70	VBU±15°	20,000	-	295	117	440.00	A+	6
400	135	E40	MVR400/C/VBU/40	49857	40000	3700	70	VBU±15°	20,000	-	295	117	440.00	A+	6

Operating from CWA control gear. Initial lumen values and Rated Average Life based on vertical orientation for Universal types. Multi-Vapor™ lamps must operated in fully enclosed fixtures except those marked *when used VBU or VBD +/-15°. For lamps requiring enclosed fixtures, lens/diffuser material must be able to contain fragments of hot quartz or glass (up to 1100 °C). Lamps operated in the vertical position that are not designated "Enclosed Fixtures only" lamp may be used in an open or enclosed lighting fixture depending upon the application and operating environment. For example, if the lamp is located near combustible material or in an area which is unoccupied for extended periods, an enclosed fixture which can contain fragments of hot quartz or glass is recommended. For more information contact your fixture manufacturer.

Kolorarc™ Tubular Clear

400	130	E40	KRC400/T/H/960/E40	30052	28400	6000	90	HOR±45°	-	14,000	270	58	418.43	A	12
400	130	E40	KRC400/T/VBU/960/E40	30704	27000	6000	90	VBU±45°	14,000	-	270	58	404.76	A	12

Kolorarc™ Elliptical Clear

400	135	E40	KRC400/E/VBU/645/E40	16871	33500	4500	65	VBU±30°	14,000	-	286	122	413.23	A	10
-----	-----	-----	----------------------	-------	-------	------	----	---------	--------	---	-----	-----	--------	---	----

Kolorarc™ Elliptical Diffuse

400	130	E40	KRC400/D/H/960/E40	10834	26800	6000	90	HOR±45°	-	14,000	282	121	408.00	B	6
400	130	E40	KRC400/D/VBU/960/E40	10837	25400	6000	90	VBU±45°	14,000	-	282	121	405.66	A	6
400	135	E40	KRC400/D/VBU/740/E40	16872	33500	4000	70	VBU±30°	14,000	-	286	122	412.21	A	10
400	135	E40	KRC400/D/H/740/E40	16875	38000	4000	70	HOR±15°	-	14,000	286	120	419.74	A+	10

Operating from suitable mercury or metal halide ballast rated 3.5A and metal halide ignitor. Low loss ballast recommended for 400W 6000K (960) products - see lamp data sheet for details. * Enhanced lumen performance operating from special "High Output" ballast rated 3.8A - see lamp data sheet for details. Kolorarc™ lamps are only suitable for operation in fully enclosed fixtures where lens/diffuser material must be able to contain fragments of hot quartz or glass (up to 1100 °C)



High Intensity Discharge Lamps

Metal Halide Lamps (continued)

Wattage (W)	Volts (V)	Cap	Product Description	Product Code	Lumen (lm)	CCT (K)	CRI (Ra)	Operating position	Rated life (Vertical) (h)	Rated life (Horizontal) (h)	Length (mm)	Diameter (mm)	Energy Consumption (kWh)	EEC	Pack Qty
-------------	-----------	-----	---------------------	--------------	------------	---------	----------	--------------------	---------------------------	-----------------------------	-------------	---------------	--------------------------	-----	----------

Sportlight™ Linear



1500	250	RX7SM	SPL1500/L/H/652/Rx75M	16920	120000	5200	65	HOR±15°	-	6,000	256	24	1672.00	A	1
2000	230	spec.	SPL2000/L/H/651/SPEC	16922	200000	5200	65	HOR±15°	-	6,000	311	26	2339.36	A	1

Sportlight™ Tubular Clear



1000	120	E40	SPL1000/T/H/960/E40	88882	80000	6000	93	HOR±60°	-	8,000	334	65	1147.07	A	4
2000	125	E40	SPL2000/220V/T/H/640/E40	36078	189000	4000	65	HOR±75°	-	2,000	430	102	2090.00	A+	4
2000	225	E40	SPL2000/380V/T/H/960/E40	30102	170000	6000	93	HOR±60°	-	5,000	430	102	2294.78	A	4

Sportlight™ Internal Ignitor



2000	225	E40	SPL2000/380V/I/T/H/960/E40	30103	170000	6000	93	HOR±60°	-	5,000	430	101	2291.96	A	4
2000	235	E40	SPL2000/380V/I/T/H/640/E40	33148	190000	4000	65	HOR±75°	-	2,000	430	101	2182.21	A+	4

Please refer to technical data sheet for appropriate ballast and ignitors. Sportlight™ lamps are only suitable in fully enclosed fixtures, where fixture lens/diffuser material must be able to contain fragments of hot quartz or glass (up to 1100° C)

Internal Ignitor

Wattage (W)	Volts (V)	Cap	Product Description	Product Code	Lumen (lm)	CCT (K)	CRI (Ra)	Operating position	Rated Life (h)	Length (mm)	Diameter (mm)	Energy Consumption (kWh)	EEC	Pack Qty
-------------	-----------	-----	---------------------	--------------	------------	---------	----------	--------------------	----------------	-------------	---------------	--------------------------	-----	----------

Lucalox™ XO Superlife Tubular Clear



70	90	E27	LU 70/XO/SBY/T/E27	88258	6600	2000	25	U	50,000	156	39	83.06	A+	25
100	100	E40	LU 100/XO/SBY/T/E40	88256	10500	2000	25	U	60,000	211	48	110.24	A+	12
150	100	E40	LU 150/XO/SBY/T/E40	78737	17500	2000	25	U	60,000	211	48	168.90	A+	12
250	100	E40	LU 250/XO/SBY/T/E40	78738	33000	2000	25	U	55,000	260	48	288.68	A+	12
400	100	E40	LU 400/XO/SBY/T/E40	78739	55800	2000	25	U	55,000	283	48	450.56	A++	12

Lucalox™ XO Superlife Elliptical Diffuse



50	85	E27	LU50/85/XO/SBY/D/E27	97238	3500	2000	25	U	40,000	156	72	58.30	A	12
70	90	E27	LU70/XO/SBY/D/E27	88257	6000	2000	25	U	50,000	156	71	80.28	A	12
100	100	E40	LU100/XO/SBY/D/E40	88255	10000	2000	25	U	60,000	186	75	113.30	A+	12

Lucalox™ XO Tubular Clear



50	85	E27	LU50/85/XO/T/27	93373	4400	2100	25	U	35,000	156	39	59.63	A	25
70	90	E27	LU70/90/XO/T/27	93375	6600	2100	25	U	40,000	156	39	80.43	A+	25
100	100	E40	LU100/100/XO/T/40	93376	10700	2100	25	U	40,000	211	48	111.89	A+	12
150	100	E40	LU150/150/XO/T/40	93377	17500	2100	25	U	40,000	211	48	168.30	A+	12
250	100	E40	LU250/XO/T/40	93378	33200	2100	25	U	40,000	260	48	285.73	A+	12
400	100	E40	LU400/XO/T/40	93269	56500	2100	25	U	32,000	292	48	448.34	A++	12
600	115	E40	LU600/XO/T/40	93270	88500	2100	25	U	32,000	292	48	667.21	A++	12

Lucalox™ XO Elliptical Diffuse



50	85	E27	LU50/85/XO/D/27	45696	3600	2100	25	U	35,000	156	72	58.31	A	12
70	90	E27	LU70/90/XO/D/27	45697	6000	2100	25	U	40,000	156	72	83.83	A	12
100	100	E40	LU100/100/XO/D/40	93379	10200	2100	25	U	40,000	186	76	112.19	A+	12
150	100	E40	LU150/100/XO/D/40	93380	16900	2100	25	U	40,000	227	91	170.14	A+	12
250	100	E40	LU250/XO/D/40	93381	31200	2100	25	U	40,000	227	91	285.67	A+	12
400	105	E40	LU400/XO/D/40	93296	54000	2100	25	U	32,000	292	122	443.02	A+	6

External Ignitor, Internal Ignitor

Wattage (W)	Volts (V)	Cap	Product Description	Product Code	Lumen (lm)	CCT (K)	CRI (Ra)	Operating position	Rated Life (h)	Length (mm)	Diameter (mm)	Energy Consumption (kWh)	EEC	Pack Qty
Lucalox™ Superlife Elliptical Diffuse 														
250	100	E40	LU250/SBY/D/E40*	35590	26000	2000	25	U	55,000	227	91	275.65	A+	12
400	105	E40	LU400/SBY/D/E40*	35591	48000	2000	25	U	55,000	282	122	456.21	A+	6

* Non EU product

Lucalox™ Standard Tubular Clear 														
70	90	E27	LU 70/90/MO/T/E27	46221	6100	2000	25	U	28,500	156	39	77.98	A+	25
100	100	E40	LU100/100/MO/T/40	93767	9600	2000	25	U	28,500	211	48	107.57	A+	12
150	100	E40	LU150/100/HO/T/E40	97241	17500	2000	25	U	24,000	283	48	172.70	A+	12
150	100	E40	LU150/100/40*	44244	15000	2000	25	U	28,500	211	48	163.71	A+	12
250	100	E40	LU250/T/40*	22453	28500	2000	25	U	28,500	260	48	276.78	A+	12
400	100	E40	LU400/HO/T/E40	97240	56500	2000	25	U	24,000	260	48	444.40	A++	12
400	100	E40	LU400/T/40*	11678	48000	2000	25	U	28,500	278	48	431.83	A+	12
1000	250	E40	LU1000/40	44059	130000	2100	22	U	24,000	383	79	1100.00	A+	6
1000	110	E40	LU1000/110/T/40	45751	130000	2000	25	U	24,000	374	68	1067.10	A++	4

* Non EU product

Lucalox™ Standard Elliptical Diffuse 														
70	90	E27	LU70/90/MO/D/E27	46217	5750	2000	25	U	28,500	156	72	77.79	A	12
100	100	E40	LU100/100/MO/D/40*	93766	9200	2000	25	U	28,500	186	76	114.72	A+	12
150	100	E40	LU150/100/D/40*	44245	14500	2000	25	U	28,500	227	91	163.68	A+	12
250	100	E40	LU250/D/40*	44052	26000	2000	25	U	28,500	227	91	276.44	A+	12
400	105	E40	LU400/D/40*	44057	48000	2000	25	U	28,500	282	122	444.01	A+	6

* Non EU product



Lucalox™ Start Tubular Clear 														
70	90	E27	LU70/90/T12/27 START*	96815	5100	2000	21	U	12,000	156	39	81.63	A	25
150	100	E40	LU150/100/T/40 START*	96808	15000	2000	21	U	24,000	211	48	163.61	A+	12
250	100	E40	LU250/T/40 START*	96810	28000	2000	21	U	24,000	260	48	279.61	A+	12
400	105	E40	LU400/T/40 START*	96813	48000	2000	21	U	24,000	292	48	439.26	A+	12

* Non EU product

Lucalox™ Internal Ignitor Elliptical Clear 														
70	90	E27	LU 70/90/MO/I/E27	46209	6100	2000	25	U	17,500	156	72	79.39	A+	12

Lucalox™ Internal Ignitor Elliptical Diffuse 														
50	85	E27	LU50/85/MO/D/I/E27*	88556	3300	2000	25	U	12,000	156	72	56.22	A	12
70	90	E27	LU70/90/MO/D/I/E27	46186	5750	2000	25	U	17,500	156	72	78.17	A	12

* Non EU product

 External Ignitor,  Internal Ignitor



High Intensity Discharge Lamps

High Pressure Mercury Lamps

Wattage (W)	Volts (V)	Cap	Product Description	Product Code	Lumen (lm)	CCT (K)	CRI (Ra)	Operating position	Rated Life (h)	Length (mm)	Diameter (mm)	Energy Consumption (kWh)	EEC	Pack Qty
Kolorlux™ Mercury Standard														
50	95	E27	H50/27	74171	1800	4000	40	U	16,000	130	55	57.27	B	24
80	115	E27	H80/27	74172	3800	4000	45	U	20,000	156	70	90.73	B	24
125	125	E27	H125/27	73736	6300	4000	45	U	20,000	170	75	141.64	B	24
250	130	E40	H250/40	73737	13000	4000	40	U	20,000	227	90	275.58	B	12
400	135	E40	H400/40	74174	22500	4000	40	U	20,000	292	120	441.21	B	12
Kolorlux™ Mercury Deluxe														
50	95	E27	H50 DX E27	77055	1800	3700	52	U	16,000	130	55	57.42	B	24
80	115	E27	H80 DX E27	77056	3800	3600	53	U	20,000	156	70	90.75	B	24
125	125	E27	H125 NDX E27	77057	6500	3500	53	U	20,000	170	75	139.98	B	24
250	130	E40	H250 NDX E40	77058	13800	3400	45	U	20,000	227	90	275.37	B	12
400	135	E40	H400 DX E40	77061	24400	3400	47	U	20,000	292	120	440.99	A	12
Kolorlux™ Mercury Start														
125	125	E27	H125/E27/GE/START	44180	5800	4000	40	U	12,000	178	76	139.53	B	24
Mixed Light														
160	230-240	E27	ML160/230-240V E27	96724	3100	4200	52	VBU±30	8,000	170	76	185.34	D	24
160	240-250	E27	ML160/240-250V E27	96728	3100	4200	52	VBU±30	8,000	170	76	187.88	D	24
250	230-240	E40	ML250/230-240V E40	96723	5500	3800	52	U	8,000	227	91	277.44	C	12
250	230-240	E27	ML250/230-240V E27	96725	5500	3800	52	U	8,000	227	91	277.44	C	12
250	240-250	E40	ML250/240-250V E40	96726	5500	3800	52	U	8,000	227	91	288.58	C	12
500	230-240	E40	ML500/230-240V E40	96713	14000	3800	45	U	8,000	292	121	545.37	B	10



Brand cross reference

The following pages show GE and alternative brand Order Codes. These cross references are provided as a quick guide and may only represent a near equivalent to other brands. The table contains data from alternative brands' catalogues and website.

GE	OSRAM	PHILIPS	Havells Sylvania	Venture
ConstantColor CMH™				
CMH20/TC/UVC/830/GU6.5	HCI-TF 20W/830 WDL PB GU6.5	CDM-Tm Mini GU6.5 20W/830	CMi-Tmini 20W/WDL UVS	-
CMH35/T/UVC/930/GU6.5	HCI-TF 35/930 WDL PB GU6.5	-	-	-
CMH35/T/UVC/930/GU6.5 Ultra	-	CDM-Tm Elite Mini GU6.5 35W/930	-	-
CMH35/T/UVC/942/GU6.5	-	-	-	-
CMH20/TC/UVC/U/830/G8.5 Plus	HCI-TC 20W/830 WDL PB G8.5	CDM-TC 20W/830 G8.5	-	-
CMH35/TC/UVC/U/830/G8.5 Plus	HCI-TC 35W/830 WDL PB G8.5	CDM-TC 35W/830 G8.5	CMi-TC 35W/WDL UVS	-
CMH35/TC/UVC/U/930/G8.5 Ultra	HCI-TC 35/930 WDL PB Shop G8.5	CDM-TC Elite 35W/930 G8.5	-	-
CMH35/TC/UVC/U/942/G8.5	HCI-TC 35W/942 NDL PB UVS G8.5	CDM-TC 35W/942 G8.5	-	-
CMH70/TC/UVC/U/830/G8.5 Plus	HCI-TC 70W/830 WDL PB G8.5	CDM-TC 70W/830 G8.5	-	-
CMH70/TC/UVC/U/942/G8.5	HCI-TC 70W/942 NDL PB G8.5	CDM-TC 70W/942 G8.5	CMi-TC 70W/WDL UVS	-
CMH70/TC/UVC/U/930/G8.5 Ultra / Ultra White	HCI-TC 70/930 WDL PB Shop G8.5*	CDM-TC Elite 70W/930 G8.5	-	-
CMH20/T/UVC/U/830/G12 Plus	-	CDM-T 20W/830 G12	-	-
CMH35/T/UVC/U/830/G12 Plus	HCI-T 35W/830 WDL PB G12	CDM-T 35W/830 G12	CMi-T 35W/WDL UVS	CM-PLUS T 35W/U/UVS/G12/830
CMH35/T/UVC/U/930/G12 Ultra	HCI-T 35/930 WDL PB Shop G12	CDM-T Elite 35W/930 G12	-	-
CMH35/T/UVC/U/942/G12	HCI-T 35W/942 NDL PB UVS G12	CDM-T 35W/942 G12	CMi-T 70W/WDL UVS	CM-PLUS T 35W/U/UVS/G12/942
CMH70/T/UVC/U/830/G12	HCI-T 70W/830 WDL PB G12	CDM-T 70W/830 G12	CMi-T 70W/NDL UVS	CM-PLUS T 70W/U/UVS/G12/830
CMH70/T/UVC/U/942/G12	HCI-T 70W/942 NDL PB UVS G12	CDM-T 70W/942 G12	-	CM-PLUS T 70W/U/UVS/G12/942
CMH70/T/UVC/U/930/G12 Ultra / Ultra White	HCI-TC 70/930 WDL PB Shop G12	CDM-T Elite 70W/930 G12	-	-
CMH150/T/UVC/U/830/G12	HCI-T 150W/830 WDL PB G12	CDM-T 150W/830 G12	CMi-T 150W/WDL UVS	CM-PLUS T 150W/U/UVS/G12/830
CMH150/T/UVC/U/942/G12	HCI-T 150/NDL PB UVS G12	CDM-T 150W/942 G12	CMi-T 150W/NDL UVS	CM-PLUS T 150W/U/UVS/G12/942
CMH35/TD/UVC/830/RX7s	-	-	CMi-T 35W/WDL UVS	-
CMH70/TD/UVC/830/RX7s	HCI-TS 70W/830 WDL PB UVS RX7S	CDM-TD 70W/830 RX7s	CMi-T 70W/WDL UVS	CM-PLUS TD 70W/U/UVS/RX7s/830
CMH70/TD/UVC/942/RX7s	HCI-TS 70W/942 NDL PB UVS RX7S	CDM-TD 70W/942 RX7s	CMi-T 70W/NDL UVS	CM-PLUS TD 70W/U/UVS/RX7s/942
CMH150/TD/UVC/830/RX7s-24	HCI-TS 150W/830 WDL PB RX7S-24	CDM-TD 150W/830 RX7s-24	CMi-T 150W/WDL UVS	CM-PLUS TD 150W/U/UVS/RX7s/830
CMH150/TD/UVC/942/RX7s-24	HCI-TS 150W/942 NDL PB RX7S-24	CDM-TD 150W/942 RX7s-24	CMi-T 150W/NDL UVS	CM-PLUS TD 150W/U/UVS/RX7s/942
CMH20/MR16/UVC/830/GX10/SP12	-	CDM-Rm Mini 20W/830 GX10 MR16 10D	-	-
CMH20/MR16/UVC/830/GX10/FL25	-	CDM-Rm Mini 20W/830 GX10 MR16 25D	-	-
CMH20/MR16/UVC/830/GX10/WFL40	-	CDM-Rm Mini 20W/830 GX10 MR16 40D	-	-
CMH35/MR16/UVC/930/GX10/SP 12	-	-	-	-
CMH35/MR16/UVC/930/GX10/FL 25	-	-	-	-
CMH35/MR16/UVC/930/GX10/WFL40	-	-	-	-
CMH35/MR16/UVC/930/GX10/SP12 Ultra	-	CDM-Rm Elite Mini 35W/930 GX10 MR16 10D	-	-
CMH35/MR16/UVC/930/GX10/FL25 Ultra	-	CDM-Rm Elite Mini 35W/930 GX10 MR16 25D	-	-
CMH35/MR16/UVC/930/GX10/WFL40 Ultra	-	CDM-Rm Elite Mini 35W/930 GX10 MR16 40D	-	-
CMH35/MR16/UVC/942/GX10/SP12	-	-	-	-
CMH35/MR16/UVC/942/GX10/FL25	-	-	-	-
CMH35/MR16/UVC/942/GX10/WFL40	-	-	-	-
CMH20/PAR20/UVC/830/E27/SP10	-	-	-	-
CMH20/PAR20/UVC/830/E27/FL25	-	-	-	-
CMH35/PAR20/830/E27/SP	HCI-PAR20 35W/830 WDL SP E27	CDM-R 35W/830 E27 PAR20L10D	-	-
CMH35/PAR20/830/E27/FL	HCI-PAR20 35W/830 WDL FL E27	CDM-R 35W/830 E27 PAR20L30D	-	-
CMH35/PAR20/UVC/942/E27/SP10	-	CDM-R 35W/942 E27 PAR20L10D	-	-
CMH35/PAR20/UVC/942/E27/FL25	-	CDM-R 35W/942 E27 PAR20L30D	-	-
CMH20/PAR30/UVC/830/E27/SP10	HCI-PAR30 20W/830 WDL SP E27	-	-	-
CMH20/PAR30/UVC/830/E27/FL25	HCI-PAR30 20W/830 WDL FL E27	-	-	-
CMH35/PAR30/UVC/830/E27/SP10	HCI-PAR30 35W/830 WDL SP E27	CDM-R 35W/830 E27 PAR20L10D	-	-
CMH35/PAR30/UVC/830/E27/FL25	HCI-PAR30 35W/830 WDL FL E27	CDM-R 35W/830 E27 PAR20L30D	-	-
CMH35/PAR30/UVC/942/E27/SP10	-	-	-	-
CMH35/PAR30/UVC/942/E27/FL25	-	-	-	-
CMH70/PAR30/UVC/830/E27/SP	HCI-PAR30 70W/830 WDL SP E27	CDM-R 70W/830 E27 PAR30L10D	-	-
CMH70/PAR30/UVC/830/E27/FL	HCI-PAR30 70W/830 WDL FL E27	CDM-R 70W/830 E27 PAR30L40D	-	-
CMH70/E/UVC/U/830/E27/C	HCI-E/P 70/830 WDL PB E27 clear	CDM-ET 70W /830 E27	-	CM-PLUS ED 70W/U/UVS/830
CMH100/E/UVC/U/830/E27/C	HCI-E/P 100/830 WDL PB clear	CDM-ET 100W /830 E40	-	CM-PLUS ED 100W/U/UVS/830
CMH150/UVC/O/U/942/E27/C	HCI-E/P 150W/942 NDL PBMO CL E27	-	-	-
CMH70/E/UVC/U/830/E27/D	HCI-E/P 70W/830 NDL PB COE27	CDO-ET Coated 70W/828 E27	-	-
CMH70/UVC/O/U/940/E27/D	HCI-E/P 70W/942 NDL Coated E27	-	-	-
CMH100/E/UVC/U/830/E27/D	HCI-E/P 100W/830 WDL PB Coated E27	CDO-ET Coated 100W/828 E40	-	-
CMH150/UVC/O/U/940/E27/D	HCI-E/P 150W/942 NDL PB MO E27	CDO-ET Coated 150W/828 E40	-	-
CMH250/E/UVC/U/830/E40/D	HCI-E 250W/830 WDL PB E40	-	-	-
CMH400/E/UVC/U/830/E40/D	-	-	-	-

High Intensity Discharge Lamps

GE	OSRAM	PHILIPS	Havells Sylvania	Venture
ConstantColor CMH™				
CMH50/TT/UVC/730/E27 STREETWISE	-	CDO-TT 50W/828 E27	-	-
CMH70/TT/UVC/830/E27	HCI-T/P 70W/830 WDL PB E27	-	-	CM-PLUS TT 70W/U/UVS/830
CMH70/TT/UVC/730/E27 STREETWISE	-	CDO-TT 70W /828 E27	-	-
CMH100/TT/UVC/830/E40	HCI-TT 100/830 WDL PB E40	-	-	CM-PLUS TT 100W/U/UVS/830
CMH100/TT/UVC/730/E40 STREETWISE	-	CDO-TT 100W /828 E27	-	-
CMH150/TT/UVC/830/E40	HCI-T/P 150W/830 WDL PB E40	-	-	CM-PLUS TT 150W/U/UVS/830
CMH150/TT/UVC/730/E40 STREETWISE	-	CDO-TT 150W/828 E40	-	-
CMH150/UVC/T/U/842/E40	HCI-TT 150/830 WDL PB E40	-	-	CM-PLUS TT 150W/U/UVS/942
CMH150/UVC/O/T/U/830/E40	HCI-T/P 150W/830 NDL PB E40	-	-	-
CMH150/T/UVC/O/U/942/E40	HCI-T/P 150W/942 NDL PB E40	-	-	-
CMH250/TT/UVC/U/830/E40	HCI-T 250W/830 WDL PB E40	CDO-TT 250W /828 E27	-	-
KRC250/CMH/830/T/H/E40	-	-	-	-
CMH400/TT/UVC/U/830/E40	-	-	-	-
Arcstream™				
ARC70/T/U/730/G12	HQI T 70/WDL	-	HSI-T 70W/WDL	-
ARC70/T/U/742/G12	HQI T 70/NDL	-	HSI-T 70W/NDL	-
ARC150/G12/830	HQI T 150/WDL	-	HSI-T 150W/WDL	HIT 150W/G12/UVS/3K
ARC150/G12/842	HQI T 150/NDL	-	HSI-T 150W/NDL	HIT 150W/G12/UVS/4K
ARC70/UVC/TD/730/Rx7s	HQI TS 70/WDL UVS	-	HSI-TD 75W/WDL 3K UVS	MH-DE 70W/UVS/3K
ARC70/UVC/TD/742/Rx7s	HQI TS 70/NDL UVS	-	HSI-TD 75W/NDL 4K UVS	MH-DE 70W/UVS/4K
ARC150/UVC/TD/732/Rx7s-24	HQI TS 150/WDL UVS	-	HSI-TD 150W/WDL 3K UVS	MH-DE 150W/UVS/3K
ARC150/UVC/TD/742/Rx7s-24	HQI TS 150/NDL UVS	-	HSI-TD 150W/NDL 4K UVS	MH-DE 150W/UVS/4K
ARC150/TD/952/Rx7s-24	HQI TS 150/D UVS	-	HSI-TD 150W/D 5K UVS	-
ARC150/UVC/AQUA/TD/865/Rx7s-24	-	-	-	MH-DE 150W/UVS/FS/6K
ARC250/TD/832/Fc2	HQI TS 250/WDL UVS	-	HSI-TD 250W/NDL 3K UVS	MH-DE 250W/UVS/3K/Fc2
ARC250/TD/842/Fc2	HQI TS 250/NDL UVS	-	HSI-TD 250W/NDL 4K UVS	MH-DE 250W/UVS/4K/Fc2
ARC150/UVC/TD/GREEN/RX7S-24	-	-	-	MH-DE 150W/UVS/GDX
ARC150/UVC/TD/BLUE/RX7S-24	-	-	-	MH-DE 150W/UVS/BDX
ARC150/UVC/TD/ORANGE/RX7S-24	-	-	-	-
ARC150/UVC/TD/MAGENTA/RX7S-24	-	-	-	MH-DE 150W/UVS/MDX
ARC250/T/VBU/960/E40	HQI-T 250/D*	-	HSI-T 250W / 6K*	-
ARC250/T/H/960/E40	-	-	HSI-T 250W / 6K*	-
ARC400/T/H/742/E40	HQI-T 400/N*	MASTER HPI-T Plus 400W/645 E40 1SL*	HSI-TSX 400W*	HIT 400W/U/EURO/4K*
ARC250/D/H/740/E40	-	MASTER HPI Plus 250W/745 BU E40 1SL*	HSI-SX 250W/CO*	-
ARC250/D/H/960/E40	HQI-E 250/D*	-	-	-
ARC250/D/VBU/960/E40	HQI-E 250/D*	MASTER HPI Plus 250W/767 BU E40 1SL*	-	-
Kolorarc™				
KRC400/T/H/960/E40	HQI-BT 400/D*	-	HSI-T 400W / 6K*	HIT 400W/U/LU/6.5K*
KRC400/T/VBU/960/E40	HQI-BT 400/D*	-	HSI-T 400W / 6K*	HIT 400W/U/LU/6.5K*
KRC400/E/VBU/645/E40	HQI-E 400/N CLEAR*	-	HSI-HX 400W CL*	HIE 400W/BU/EURO/4K*
KRC400/D/VBU/740/E40	HQI-E 400/N*	MASTER HPI Plus 400W/745 BU E40 1SL*	HSI-HX 400W CO*	HIE 400W/CV/DU/4.5K*
KRC400/D/H/740/E40	HQI-E 400/N*	-	HSI-HX 400W CO*	HIE 400W/C/U/EURO/4K*
KRC400/D/VBU/960/E40	-	MASTER HPI Plus 250W/767 BU E40 1SL*	-	-
KRC400/D/H/960/E40	-	-	-	-
Multi-vapor™				
MVR250/U/40	-	-	-	-
MVR400/U/40	-	-	-	-
MVR1000/U/40	-	-	-	HIE 1000W/U/4K*
MVR250/C/U/40	-	-	-	-
MVR400/C/U/40	-	-	-	-
MVR400/VBU/40	-	-	-	-
MVR400/C/VBU/40	-	-	-	-
MVR400/C/VBU/0/40	-	-	-	-
Sportlight™				
SPL1500/L/H/652/Rx7SM	-	-	-	-
SPL2000/L/H/654	-	-	-	-
SPL2000/T/H/960/E40	HQI-T 2000/D*	-	-	-
SPL2000/I/T/H/640/E40	HQI-T 2000 /N*	HPI-T 2000W/642 E40 380V CRP*	HSI-T 2000W-S4K 380V/I*	-
SPL2000/I/T/H/960/E40	HQI-T 2000 /D/I*	-	-	-
SPL1000/T/H/960/E40 1/4	HQI-T 1000/D*	-	-	-



Brand cross reference

GE	OSRAM	PHILIPS	Havells Sylvania	Venture
Mixed Light				
ML 160/230-240V E27	HWL 160 235V	ML 160W E27 235-245	HSB-BW 160W 230V E27	-
ML 160/240-250V	HWL 160 240V	ML 160W E27 235-245	HSB-BW 160W 240	-
ML 250/230-240V E40	HWL 250 235V	ML 250W E27 225-235	HSB-BW 250W 240V E40	-
ML 250/230-240V E27	-	ML 250W E40 225-235	HSB-BW 250W 240V E27	-
ML 250/ 240-250V E40	HWL 250 240V	ML 250W E40 235-245	HSB-BW 250W 240	-
ML 500/230-240V E40	HWL 500 235V	ML 500W E40 225-235	HSB-BW 500W 240V E40	-
Lucalox™ Standard				
LU70/90/D/27	NAV-E 70/E	SON E 70W	SHP 70W/CO-E	-
LU100/100/MO/D/40	NAV-E 100	SON E 100W	SHP 100W	-
LU150/100/D/40	NAV-E 150	SON E 150W	SHP 150W	-
LU250/D/40	NAV-E 250	SON E 250W	SHP 250W	-
LU400/D/40	NAV-E 400	SON E 400W	SHP 400W	-
LU70/90/T12/27	NAV-T 70	SON- T 70W	SHP-T 70W	-
LU100/100/MO/T/40	NAV-T 1000	SON- T 100W	-	-
LU150/100/T /40	NAV-T 150	SON-T 150W	SHP-T 150W	-
LU250/T/40	NAV-T 250	SON-T 250W	SHP-T 150W	-
LU400/T/40	NAV-T 400	SON-T 400W	SHP-T 400W	-
LU1000/110/T/40	NAV-T 1000	SON-T 1000W	SHP-T 1000W	-
Lucalox™ XO				
LU50/85/XO/D/27	NAV-T 50 SUPER 4Y	-	SHP S 50W	-
LU70/90/XO/D/27	NAV-T 70 SUPER 4Y	MASTER SON PIA PLUS 70W	SHP S 70W	-
LU100/100/XO/D/40	NAV-E 100 SUPER 4Y	MASTER SON PIA PLUS 100W	SHP S 100W	-
LU250/XO/D/40	NAV-E 250 SUPER 4Y	MASTER SON PIA PLUS 250W	SHP S 250W	-
LU400/XO/D/40	NAV-E 400 SUPER 4Y	MASTER SON PIA PLUS 400W	SHP S 400W	-
LU50/85/XO/T/27	NAV-T 50 SUPER 4Y	MASTER SON-T PIA PLUS 50W	SHP TS 50W	-
LU70/90/XO/T/27	NAV-T 70 SUPER 4Y	MASTER SON-T PIA PLUS 70W	SHP TS 70W	-
LU100/100/XO/T/40	NAV-T 100 SUPER 4Y	MASTER SON-T PIA PLUS 100W	SHP TS 100W	-
LU150/150/XO/T/40	NAV-T 150 SUPER 4Y	MASTER SON-T PIA PLUS 150W	SHP TS 150W	-
LU250/XO/T/40	NAV-T 250 SUPER 4Y	MASTER SON-T PIA PLUS 250W	SHP TS 250W	-
LU400/XO/T/40	NAV-T 400 SUPER 4Y	MASTER SON-T PIA PLUS 400W	SHP TS 400W	-
LU600/XO/T/40	NAV-T 600 SUPER 4Y	MASTER SON-T PIA PLUS 600W	SHP TS 600W	-
Lucalox™ I				
LU50/85/D/I/27	NAV-E 50/I	SON 50W I	SHP 50W/CO-I	-
LU70/90/D/I/27	NAV-E 70/I	SON 70W I	SHP 70W/CO-I	-
LU70/90/I/27	-	-	SHP 70W/CL-I	-
Lucalox™ E-Z lux				
LUH110/D/27 - SHx	NAV-E 110	SON-H Pro 110W	Shx 110W E27	-
Lucalox™ SUPERLIFE				
LU70/90/XO/SBY/T12/E27	-	-	SHP-TS 70W TWinarc	-
LU100/100/XO/SBY/T/E40	-	-	SHP-TS 100W TWinarc	-
LU150/XO/SBY/T/E41	-	-	SHP-TS 150W TWinarc	-
LU250/XO/SBY/T/E42	-	-	SHP-TS 250W TWinarc	-
LU400/XO/SBY/T/E43	-	-	SHP-TS 400W TWinarc	-
LU50/85/XO/SBY/D/27	-	-	-	-
LU70/90/XO/SBY/D/E27	-	-	SHP-S 70W TWinarc	-
LU100/100/XO/SBY/D/E40	-	-	SHP-S 100W TWinarc	-
LU250/SBY/D/40	-	-	SHP-S 250W TWinarc	-
LU400/SBY/D/40	-	-	SHP-S 400W TWinarc	-
Kolorlux Standard				
H50/27	HQL 50	HPL-N 50W	HSL-BW 50W E27	-
H80/27	HQL 80	HPL-N 80W	HSL-BW 80W E27	-
H125/27	HQL 125	HPL-N 125W	HSL-BW 125W E27	-
H250/40	HQL 250	HPL-N 250W	HSL-BW 250W E40	-
H400/40	HQL 400	HPL-N 400W	HSL-BW 400W E40	-

*Similar product, please contact your local sales representative for more details

Linear Fluorescent Lamps

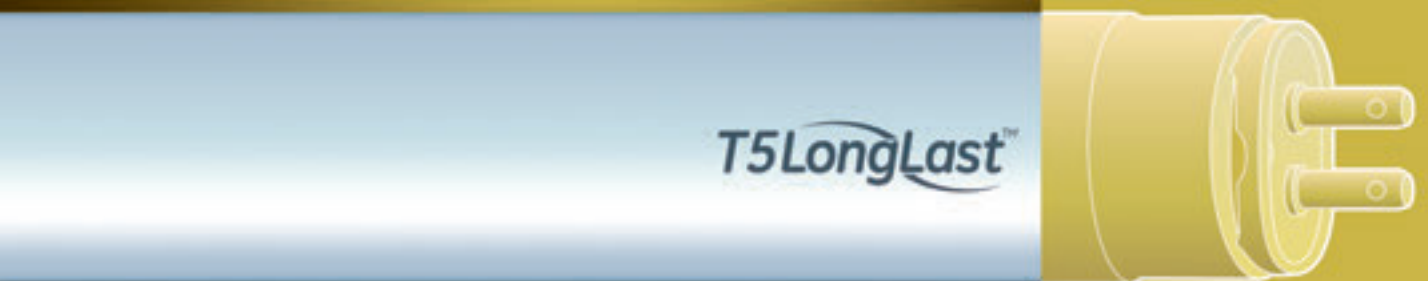

Discover GE's LFL solutions WattMiser™ for extra energy savings LongLast™ for extra long life

Remarkable light distribution, less shadow than point source lamps

Flexibility of wattage and length for every application

Up to 46,000 hours of life with our T8 LongLast™ lamps at 12-hour burning cycles

85 CRI high colour rendering and high lumen maintenance

5-10% energy savings with WattMiser lamps versus traditional LFL lamps

Dimmability for additional cost savings





Office



Retail



Education



Industrial



Main application areas

Education and Office

Classrooms and office areas need a creative and stimulating environment. Minimum glare on screens, low luminance contrasts around the desk, and energy cost reduction are just a few of the key requirements. Many schools and offices have already discovered the benefits of replacing their outdated light sources with our new-generation LFL lamps.

Retail

LFL lamps are the perfect complement of directional light sources, as they provide an excellent level of lighting distribution. In a retail environment, directed light is indispensable to highlight the merchandise however it needs additional light sources with a good light distribution to elevate the brilliance in the entire store, so less point source lamp is needed. Directed light sources and LFL lamps together provide a perfect and economic solution for the illuminance of a retail environment.

Industrial

For industrial and commercial environments, the use of appropriate illumination systems help promote safety in the workplace, improved productivity and reduced error rates. We recommend our LongLast lamps to cover all these needs.

Linear Fluorescent Lamps

T5 & T8 Watt-Miser™ For reduced electricity costs

T5WattMiser™

T5 Watt-Miser™ uses 5% less energy than other T5 lamps in the range, with the same lumen output. T5 Watt-Miser™ is ideal for any indoor application from a single fitting to large scale installations such as offices, retail outlets and public buildings hence, very significant energy savings can be achieved.

T5WattMiser™

- 5% energy saving with existing fittings on current controlled gear
- Reduced CO₂ and other greenhouse gas emissions
- Energy saving without loss of light output
- Excellent lumen maintenance
- Product life up to 36,000 hours at 12-hour burning cycle
- Complies with RoHS Directive 2011/65/EU and contains recyclable components

T5 coating

Our T5 LFL lamps use an advanced coating technology, which improves lamp efficiency by increasing phosphor efficiency.

GE's T5 coating technology gives the option for either longer life or energy saving lamps due to the improvement in lamp performance.





All of GE's T8 range offers excellent service life and high quality light but with the addition of Watt-Miser™ technology. Cost savings of up to 10% can also be achieved with T8 WattMiser.

T8 Watt-Miser™ is ideal for retail, property management, commercial and industrial applications where lighting cycles are typically very long.

T8 WattMiser™

- Retrofittable – with existing fittings and control gear
- Excellent colour quality – Ra 80+
- Exceptional lumen maintenance
- Product life 23,000 hours – at 12-hour burning cycle with electronic gear
- Significantly reduced CO₂ emission – 0.5kg/kWh
- Short payback – less than a year
- Complies with RoHS Directive 2011/65/EU and contains recyclable components

Energy-saving example: 32W

Annual savings from a typical installation of 1000 lamps used for 4000 hours a year with energy costs of 0,1 €/kWh	Regular T8	T8 Watt-Miser™
Power at 25°C (W/lamp)	36	32
Annual energy (kWh)	144	128
Annual energy saving (kWh/lamp)	-	16
Annual energy cost saving with WattMiser™ T8 (€)	1600	
Annual replacement cost saving (€)	356	
CO ₂ saved in a year (tons)*	6.9	

*CO₂ emission per kWh 0,37 kg which can vary by country.
Best result is achieved with optimal lamp, ballast and fitting combination used at 30°C ambient temperature.

Linear Fluorescent Lamps

T5&T8 LongLast™

For reduced relamping costs

LongLast™

All businesses look to achieve cost reductions, which is why GE's LongLast range has been designed to meet this requirement. Our LongLast lamps offer reliability and an extended service life, without compromising on other key features, such as initial lumen and lumen maintenance. LongLast lamps with extra long relamping cycles are perfect for facilities where lumiares are hard to reach. LongLast lamps also reduce the total cost of ownership and the environmental footprint of your buildings.

T5LongLast™

- Very long and reliable product life – up to 36,000 hours at 12-hour burning cycle
- Up to 7000 lumens per lamp – same illumination with fewer fittings
- High colour quality – CRI 85Ra
- High efficiency for ongoing cost savings
- Smaller physical dimensions
- Complies with RoHS Directive 2011/65/EU and contains recyclable components

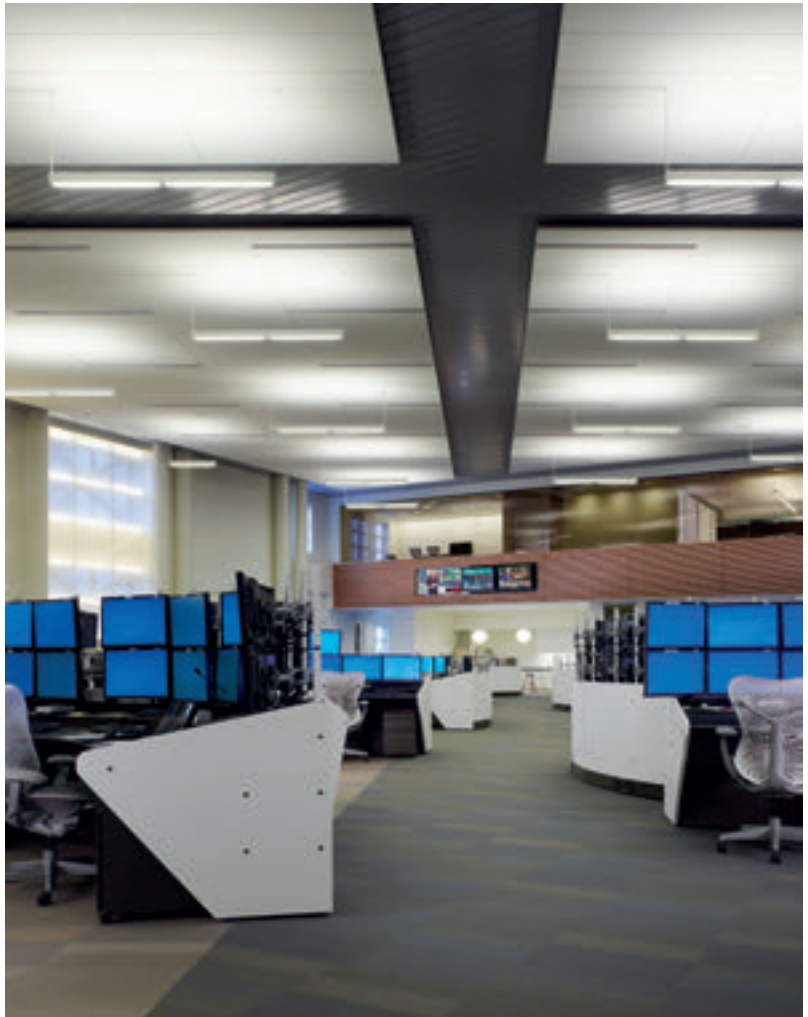

Which to use?

T5 Watt-Miser™ or T5 LongLast™?
Here's some help to choose.

	Rated Life 3 hour cycle	Rated Life 12 hour cycle	Energy saving
Regular T5	25,000	28,000	-
GE T5 LongLast™	30,000	36,000	-
GE T5 Watt-Miser™	25,000/30,000	30,000/36,000	5%





T8LongLast™

- Very long reliable product life – 46,000 hours at 12-hour burning cycle with electronic gear
- Same lumen output as regular T8 and excellent lumen maintenance
- Excellent colour rendering – CRI 80+ Ra
- Can be used on existing control gears and fixtures
- Complies with RoHS Directive 2011/65/EU and contains recyclable components



Linear Fluorescent Lamps

T5 Tubes Long



High Efficiency Watt-Miser™

Wattages: 13-33W
 Colours: Warm White to Cool White
 CRI (Ra): 85
 Rated life: 25,000Hrs

Page III.10



High Output Watt-Miser™

Wattages: 21-76W
 Colours: Warm White to Cool White
 CRI (Ra): 85
 Rated life: 25,000(30,000)hrs

Page III.10



High Efficiency LongLast™

Wattages: 14-35W
 Colours: Extra Warm White to Daylight
 CRI (Ra): 85
 Rated life: 30,000Hrs

Page III.10



High Output LongLast™

Wattages: 24-80W
 Colours: Warm White to Daylight
 CRI (Ra): 85
 Rated life: 30,000Hrs

Page III.11

T5 Tubes Short



Specfill Triphosphor

Wattages: 6-8W
 Colours: Cool White and Daylight
 CRI (Ra): 80+
 Rated life: 8,000Hrs

Page III.11



Specfill Standard

Wattages: 6-8W
 Colours: Cool White and White
 CRI (Ra): 52-60
 Rated life: 8,000Hrs

Page III.11



Triphosphor

Wattages: 8-13W
 Colours: Extra Warm White to Cool White
 CRI (Ra): 80+
 Rated life: 5,000Hrs

Page III.11



Standard

Wattages: 4-13W
 Colours: Warm White to Cool White
 CRI (Ra): 51-58
 Rated life: 5,000Hrs

Page III.11

Circular Tubes



T5 Circline™

Wattages: 22-55W
 Colours: Extra Warm White to Daylight
 CRI (Ra): 82
 Rated life: 12,000Hrs

Page III.12

Selector

T8 Tubes



Watt-Miser™

Wattages: 16-51W
Colours: Warm White
to Daylight
CRI [Ra]: 80+
Rated life: 15,000Hrs

Page III.12



Polylux XLR™ LongLast™

Wattages: 18-58W
Colours: Warm White
and Cool White
CRI [Ra]: 80+
Rated life: 28,000Hrs

Page III.12



Polylux XLR™

Wattages: 15-70W
Colours: Extra Warm
White to Daylight
CRI [Ra]: 80+
Rated life: 15,000Hrs

Page III.13

T8 Shatter-proof



covRguard™ PolyLux XLR™

Wattages: 18-58W
Colours: White
and Cool White
CRI [Ra]: 80+
Rated life: 15,000Hrs

Page III.13

Starters



Glow Starters

For wattages: 4-125W

Page III.13

Where "Rated Life" or "Average Rated Life" is stated, we refer to the industry standard definition of how many hours of operation on standard electromagnetic gear 50% of a given installation will exceed (at 3-hours burning cycle). Rated Average Life for all linear fluorescent products is provided on standard electromagnetic gear except for T5 long tubes and T5 Circline tubes.

Linear Fluorescent Lamps

Product identification

The following glossary of terms will help you when selecting lamps in this section. Within each product line, lamps are divided into families – within these families, lamps are listed by wattage. The Product Description can be used as a quick reference to each product's attributes. Where "Life" or "Average Rated Life" is stated, we refer to the industry standard definition of how many hours of operation on standard electromagnetic gear 50% of a given installation will exceed. Rated Average Life for all linear fluorescent products is provided on standard electromagnetic ballast except for T5 long tubes and T5 Circline tubes.

Additional parameters:

Cap: The type of cap fitted. See the "Cap Drawings" chapter for more information.

Watts:

Energy Used – To estimate energy consumption (kWh), multiply watts x hours of use and divide by 1000

Diameter:
Tube diameter in mm

Initial Lumen (at 25 or 35°C):
Light output after the initial 100 hours of operation

Rated Average Life (3-hr cycle):
The point in time when 50% of installed lamps are still burning

Length:
Lamp length (cap to cap) in mm

Product description:
Lamp reference – describes the lamp's main characteristics

CCT:
Colour temperature – Kelvin [K]. The visual warmth or coolness of the light. The higher the number the whiter or cooler the light appears

EEC:
Energy Efficiency Class

Energy Consumption:
kWh/1000h

Wattage [W]

Length [mm]

Diameter [mm]

Product Description

Product Code

Initial Lumen (at 35°C) [lm]

Colour Type

CCT [K]

CRI [Ra]

Rated Average Life (3-hr cycle) [h]

EEC

Energy Consumption [kWh]

Pack Qty

T5 Watt-Miser™ - High Efficiency, G5 Cap

26	1,149	16	F26W/T5/830/WM	97231	2640	Warm White	3000	85	25,000	A+	29	30
26	1,149	16	F26W/T5/840/WM	61078	2640	Cool White	4000	85	25,000	A+	29	30
33	1,449	16	F33W/T5/830/WM	79417	3320	Warm White	3000	85	25,000	A+	38	30

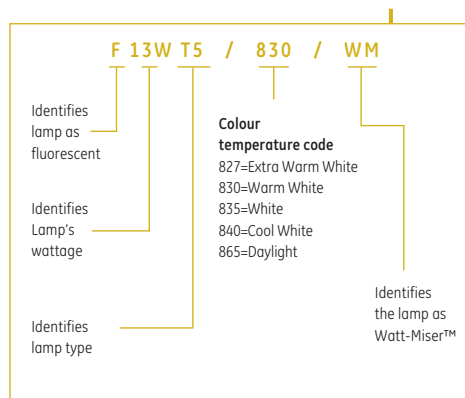

Colour Type:
Extra Warm White
Warm White
White
Natural White
Cool White
Northlight
Daylight

Product code:
It is important to use this code when ordering to ensure that you receive the exact product you require

CRI:
Colour rendering index, the higher the number (1-100), the more natural the lit subject appears

Pack quantity:
The number of lamps in one outer case

Wattage [W]	Length [mm]	Diameter [mm]	Product Description	Product Code	Initial Lumen (at 35°C) [lm]	Colour Type	CCT [K]	CRI [Ra]	Rated Average Life (3-hr cycle) [h]	EEC	Energy Consumption [kWh]	Pack Qty
13	549	16	F13W/T5/830/WM	79418	1,350	Warm White	3,000	85	25,000	A+	14	30
13	549	16	F13W/T5/840/WM	61080	1,350	Cool White	4,000	85	25,000	A+	14	30
20	849	16	F20W/T5/840/WM	61079	2,100	Cool White	4,000	85	25,000	A+	22	30
26	1,149	16	F26W/T5/830/WM	97231	2,900	Warm White	3,000	85	25,000	A+	29	30
26	1,149	16	F26W/T5/840/WM	61078	2,900	Cool White	4,000	85	25,000	A+	29	30
33	1,449	16	F33W/T5/830/WM	79417	3,650	Warm White	3,000	85	25,000	A+	36	30
33	1,449	16	F33W/T5/840/WM	61077	3,650	Cool White	4,000	85	25,000	A+	36	30

T5 Watt-Miser™ - High Output, G5 Cap

21	549	16	F21W/T5/840/WM	61076	2,000	Cool White	4,000	85	25,000	A+	23	30
36	849	16	F36W/T5/840/WM	61075	3,500	Cool White	4,000	85	25,000	A+	39	30
46	1,449	16	F46W/T5/830/WM	97232	4,900	Warm White	3,000	85	25,000	A+	51	30
46	1,449	16	F46W/T5/840/WM	61073	4,900	Cool White	4,000	85	25,000	A+	51	30
51	1,149	16	F51W/T5/830/WM	97966	5,000	Warm White	3,000	85	30,000	A+	56	30
51	1,149	16	F51W/T5/840/WM	61074	5,000	Cool White	4,000	85	30,000	A+	56	30
76	1,449	16	F76W/T5/830/WM	97965	7,000	Warm White	3,000	85	25,000	A+	83	30
76	1,449	16	F76W/T5/840/WM	61072	7,000	Cool White	4,000	85	25,000	A+	83	30

T5 LongLast™ - High Efficiency, G5 Cap

14	549	16	F14W/T5/827/LL	61086	1,350	Extra Warm White	2,700	85	30,000	A+	15	30
14	549	16	F14W/T5/830/LL	61087	1,350	Warm White	3,000	85	30,000	A+	15	30
14	549	16	F14W/T8/830/LL/BULK	61066	1,350	Warm White	3,000	85	30,000	A+	15	40
14	549	16	F14W/T5/835/LL	61090	1,350	White	3,500	85	30,000	A+	15	30
14	549	16	F14W/T5/840/LL	61091	1,350	Cool White	4,000	85	30,000	A+	15	30
14	549	16	F14W/T8/840/LL/BULK	61067	1,350	Cool White	4,000	85	30,000	A+	15	40
14	549	16	F14W/T5/865/LL	61088	1,250	Daylight	6,500	85	30,000	A+	15	30
21	849	16	F21W/T5/827/LL	61089	2,100	Extra Warm White	2,700	85	30,000	A+	23	30
21	849	16	F21W/T5/830/LL	61092	2,100	Warm White	3,000	85	30,000	A+	23	30
21	849	16	F21W/T5/840/LL	61093	2,100	Cool White	4,000	85	30,000	A+	23	30
21	849	16	F21W/T8/840/LL/BULK	61068	2,100	Cool White	4,000	85	30,000	A+	23	40
21	849	16	F21W/T5/865/LL	61094	1,950	Daylight	6,500	85	30,000	A+	23	30
28	1,149	16	F28W/T5/827/LL	61095	2,900	Extra Warm White	2,700	85	30,000	A+	31	30
28	1,149	16	F28W/T5/830/LL	61096	2,900	Warm White	3,000	85	30,000	A+	31	30
28	1,149	16	F28W/T5/830/LL/BULK	61069	2,900	Warm White	3,000	85	30,000	A+	31	40
28	1,149	16	F28W/T5/840/LL	61102	2,900	Cool White	4,000	85	30,000	A+	31	30
28	1,149	16	F28W/T5/840/LL/BULK	61070	2,900	Cool White	4,000	85	30,000	A+	31	40
28	1,149	16	F28W/T5/865/LL	61098	2,700	Daylight	6,500	85	30,000	A+	31	30
35	1,449	16	F35W/T5/827/LL	61099	3,650	Extra Warm White	2,700	85	30,000	A+	38	30
35	1,449	16	F35W/T5/830/LL	61100	3,650	Warm White	3,000	85	30,000	A+	38	30
35	1,449	16	F35W/T5/835/LL	61101	3,650	White	3,500	85	30,000	A+	38	30
35	1,449	16	F35W/T5/840/LL	61103	3,650	Cool White	4,000	85	30,000	A+	38	30
35	1,449	16	F35W/T5/840/LL/BULK	61071	3,650	Cool White	4,000	85	30,000	A+	38	40
35	1,449	16	F35W/T5/865/LL	61104	3,400	Daylight	6,500	85	30,000	A+	38	30

T5 LongLast™ range was formerly called Starcoat™ range after the GE's T5 coating technology.

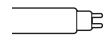
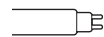

Linear Fluorescent Lamps

Wattage (W)	Length (mm)	Diameter (mm)	Product Description	Product Code	Initial Lumen (at 35°C) (lm)	Colour Type	CCT (K)	CRI (Ra)	Rated Average Life (3-hr cycle) (h)	EEC	Energy Consumption (kWh)	Pack Qty
T5 LongLast™ - High Output, G5 Cap												
24	549	16	F24W/T5/830/LL	61105	2,000	Warm White	3,000	85	30,000	A+	25	30
24	549	16	F24W/T5/835/LL	61106	2,000	White	3,500	85	30,000	A+	25	30
24	549	16	F24W/T5/840/LL	61097	2,000	Cool White	4,000	85	30,000	A+	25	30
24	549	16	F24W/T5/840/LL/BULK	61081	1,750	Cool White	4,000	85	30,000	A+	25	40
24	549	16	F24W/T5/865/LL	61107	1,900	Daylight	6,500	85	30,000	A	25	30
39	849	16	F39W/T5/830/LL	61108	3,500	Warm White	3,000	85	30,000	A+	42	30
39	849	16	F39W/T5/840/LL	61109	3,500	Cool White	4,000	85	30,000	A+	42	30
39	849	16	F39W/T5/840/LL/BULK	61082	3,500	Cool White	4,000	85	30,000	A+	42	40
49	1,449	16	F49W/T5/830/LL	61119	4,900	Warm White	3,000	85	30,000	A+	54	30
49	1,449	16	F49W/T5/835/LL	61121	4,900	White	3,500	85	30,000	A+	54	30
49	1,449	16	F49W/T5/840/LL	61122	4,900	Cool White	4,000	85	30,000	A+	54	30
49	1,449	16	F49W/T5/840/LL/BULK	61084	4,900	Cool White	4,000	85	30,000	A+	54	40
49	1,449	16	F49W/T5/865/LL	78707	4,650	Daylight	6,500	85	30,000	A+	54	30
54	1,149	16	F54W/T5/830/LL	61110	5,000	Warm White	3,000	85	30,000	A+	59	30
54	1,149	16	F54W/T5/840/LL	61111	5,000	Cool White	4,000	85	30,000	A+	59	30
54	1,149	16	F54W/T5/840/LL/BULK	61083	5,000	Cool White	4,000	85	30,000	A+	59	40
54	1,149	16	F54W/T5/865/LL	61118	4,750	Daylight	6,500	85	30,000	A+	59	30
80	1,449	16	F80W/T5/830/LL	78708	7,000	Warm White	3,000	85	30,000	A	89	30
80	1,449	16	F80W/T5/840/LL	78709	7,000	Cool White	4,000	85	30,000	A	89	30
80	1,449	16	F80W/T5/840/LL/BULK	61085	7,000	Cool White	4,000	85	30,000	A	89	40

T5 LongLast™ range was formerly called Starcoat™ range after the GE's T5 coating technology.

T5 Miniature - Specfill Triphosphor - Emergency Lighting, G5 Cap

6	212.1	16	F6W/T5/840/SPECFILL/IND	40327	300	Cool White	4,000	80+	8,000	A	6	100
8	288.3	16	F8W/T5/840/SPECFILL/IND	40331	460	Cool White	4,000	80+	8,000	A	8	100
8	288.3	16	F8W/T5/865/SPECFILL/IND	45034	430	Daylight	6,500	80+	8,000	A	8	100

T5 Miniature - Specfill Standard - Emergency Lighting, G5 Cap

6	212.1	16	F6W/T5/33/SPECFILL/IND	40307	260	Cool White	4,040	60	8,000	A	6	100
8	288.3	16	F8W/T5/35/SPECFILL	27027	400	White	3,450	54	8,000	A	8	25
8	288.3	16	F8W/T5/35/SPECFILL/IND	91451	400	White	3,450	54	8,000	A	8	100
8	288.3	16	F8W/T5/33/SPECFILL	27011	400	Cool White	4,040	60	8,000	A	8	25
8	288.3	16	F8W/T5/33/SPECFILL/IND	91450	400	Cool White	4,040	60	8,000	A	8	100

T5 Miniature - Triphosphor, G5 Cap

8	288.3	16	F8W/T5/827/IND	37008	460	Extra Warm White	2,700	80+	5,000	A	8	100
8	288.3	16	F8W/T5/840/IND	37009	460	Cool White	4,000	80+	5,000	A	8	100
13	517.9	16	F13W/T5/827	39447	970	Extra Warm White	2,700	80+	8,000	A	14	25

Wattage [W]	Length [mm]	Diameter [mm]	Product Description	Product Code	Initial Lumen (at 25°C) [lm]	Colour Type	CCT [K]	CRI [Ra]	Rated Average Life (3-hr cycle) [h]	EEC	Energy Consumption [kWh]	Pack Qty
4	150.9	16	F4W/T5/35	39446	130	White	3,450	54	5,000	B	5	25
4	150.9	16	F4W/T5/33	39441	130	Cool White	4,040	60	5,000	B	5	25
6	226.1	16	F6W/T5/35	39442	260	White	3,450	54	5,000	A	6	25
6	226.1	16	F6W/T5/33	39445	260	Cool White	4,040	60	5,000	A	6	25
8	302.3	16	F8W/T5/29	37754	400	Warm White	2,940	52	5,000	A	8	25
8	302.3	16	F8W/T5/35	37756	395	White	3,450	54	5,000	A	8	25
8	302.3	16	F8W/T5/33	37755	395	Cool White	4,040	60	5,000	A	8	25
13	531.9	16	F13W/T5/29	39437	850	Warm White	2,950	52	5,000	A	14	25
13	531.9	16	F13W/T5/35	39439	850	White	3,450	54	5,000	A	14	25
13	531.9	16	F13W/T5/33	39440	850	Cool White	3,450	60	5,000	A	14	25

T5 Circline™ – 2Gx13 Cap

22	230	16	FC22W/T5/827	75707	1,900	Extra Warm White	2,700	82	12,000	A	25	10
22	230	16	FC22W/T5/830	75709	1,900	Warm White	3,000	82	12,000	A	25	10
22	230	16	FC22W/T5/840	75720	1,900	Cool White	4,000	82	12,000	A	25	10
22	230	16	FC22W/T5/865	75710	1,800	Daylight	6,500	82	12,000	A	25	10
40	305	16	FC40W/T5/827	75711	3,300	Extra Warm White	2,700	82	12,000	A	45	10
40	305	16	FC40W/T5/830	75712	3,300	Warm White	3,000	82	12,000	A	45	10
40	305	16	FC40W/T5/840	75713	3,300	Cool White	4,000	82	12,000	A	45	10
40	305	16	FC40W/T5/865	75715	3,150	Daylight	6,500	82	12,000	A	44	10
55	305	16	FC55W/T5/827	75716	4,200	Extra Warm White	2,700	82	12,000	A	61	10
55	305	16	FC55W/T5/830	75717	4,200	Warm White	3,000	82	12,000	A	61	10
55	305	16	FC55W/T5/840	75718	4,200	Cool White	4,000	82	12,000	A	61	10
55	305	16	FC55W/T5/865	75719	3,900	Daylight	6,500	82	12,000	A	61	10

T8 Watt-Miser™ – G13 Cap

16	589.8	26	F16W/T8/830/WM	73605	1,300	Warm White	3,000	80+	15,000	A	20	25
16	589.8	26	F16W/T8/840/WM	73607	1,300	Cool White	4,000	80+	15,000	A	20	25
16	589.8	26	F16W/T8/860/WM	73608	1,230	Daylight	6,400	80+	15,000	A	20	25
32	1,199.4	26	F32W/T8/830/WM	96748	2,750	Warm White	3,000	80+	15,000	A	37	25
32	1,199.4	26	F32W/T8/840/WM	96750	2,750	Cool White	4,000	80+	15,000	A	37	25
32	1,199.4	26	F32W/T8/860/WM	96747	2,600	Daylight	6,400	80+	15,000	A	38	25
51	1,500	26	F51W/T8/830/WM	73609	4,320	Warm White	3,000	80+	15,000	A	59	25
51	1,500	26	F51W/T8/840/WM	73611	4,320	Cool White	4,000	80+	15,000	A	59	25
51	1,500	26	F51W/T8/860/WM	73613	4,120	Daylight	6,400	80+	15,000	A	60	25

T8 PolyLux XLR™ LongLast™ – G13 Cap

18	589.8	26	F18W/T8/830/LL	70980	1350	Warm White	3,000	80+	28,000	A	22	25
18	589.8	26	F18W/T8/840/LL	70981	1350	Cool White	4,000	80+	28,000	A	22	25
36	1,199.4	26	F36W/T8/830/LL	43508	3350	Warm White	3,000	80+	28,000	A	42	25
36	1,199.4	26	F36W/T8/840/LL	43509	3350	Cool White	4,000	80+	28,000	A	42	25
58	1,500	26	F58W/T8/830/LL	43510	5200	Warm White	3,000	80+	28,000	A	67	25
58	1,500	26	F58W/T8/840/LL	43511	5200	Cool White	4,000	80+	28,000	A	67	25

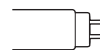
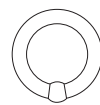

Linear Fluorescent Lamps

Wattage [W]	Length [mm]	Diameter [mm]	Product Description	Product Code	Initial Lumen (at 25°C) [lm]	Colour Type	CCT [K]	CRI [Ra]	Rated Average Life (3-hr cycle) [h]	EEC	Energy Consumption [kWh]	Pack Qty
15	437.4	26	F15W/T8/830/POLYLUX	23248	950	Warm White	3,000	80+	15,000	B	19	25
15	437.4	26	F15W/T8/835 POLYLUX	78133	950	White	3,500	80+	15,000	B	19	25
15	437.4	26	F15W/T8/840/POLYLUX	23249	950	Cool White	4,000	80+	15,000	B	19	25
15	437.4	26	F15W/T8/860/POLYLUX	78131	900	Daylight	6,400	80+	15,000	B	18	25
18	589.8	26	F18W/T8/827/POLYLUX	62560	1,350	Extra Warm White	2,700	80+	15,000	A	22	25
18	589.8	26	F18W/T8/830/POLYLUX	62559	1,350	Warm White	3,000	80+	15,000	A	22	25
18	589.8	26	F18W/T8/835/POLYLUX	62534	1,350	White	3,500	80+	15,000	A	22	25
18	589.8	26	F18W/T8/840/POLYLUX	62558	1,350	Cool White	4,000	80+	15,000	A	22	25
18	589.8	26	F18W/T8/860/POLYLUX	62557	1,250	Daylight	6,400	80+	15,000	A	22	25
30	894.6	26	F30W/T8/830/POLYLUX	18141	2,450	Warm White	3,000	80+	15,000	A	37	25
30	894.6	26	F30W/T8/835/POLYLUX	78132	2,450	White	3,500	80+	15,000	A	37	25
30	894.6	26	F30W/T8/840/POLYLUX	18142	2,450	Cool White	4,000	80+	15,000	A	37	25
30	894.6	26	F30W/T8/860/POLYLUX	12607	2,300	Daylight	6,400	80+	15,000	A	36	25
36	1,199.4	26	F36W/T8/827/POLYLUX	62554	3,350	Extra Warm White	2,700	80+	15,000	A	42	25
36	1,199.4	26	F36W/T8/830/POLYLUX	62553	3,350	Warm White	3,000	80+	15,000	A	42	25
36	1,199.4	26	F36W/T8/835/POLYLUX	62532	3,350	White	3,500	80+	15,000	A	42	25
36	1,199.4	26	F36W/T8/840/POLYLUX	62551	3,350	Cool White	4,000	80+	15,000	A	42	25
36	1,199.4	26	F36W/T8/860/POLYLUX	62552	3,250	Daylight	6,400	80+	15,000	A	43	25
58	1,500	26	F58W/T8/827/POLYLUX	62550	5,200	Extra Warm White	2,700	80+	15,000	A	68	25
58	1,500	26	F58W/T8/830/POLYLUX	62549	5,200	Warm White	3,000	80+	15,000	A	68	25
58	1,500	26	F58W/T8/835/POLYLUX	62531	5,200	White	3,500	80+	15,000	A	68	25
58	1,500	26	F58W/T8/840/POLYLUX	62548	5,200	Cool White	4,000	80+	15,000	A	68	25
58	1,500	26	F58W/T8/860/POLYLUX	62547	5,000	Daylight	6,400	80+	15,000	A	68	25
70	1,763.8	26	F70W/T8/835/POLYLUX	62572	6,000	White	3,500	80+	15,000	A	81	25
70	1,763.8	26	F70W/T8/840/POLYLUX	62573	6,000	Cool White	4,000	80+	15,000	A	81	25



T8 covGuard™ PolyLux XLR™ - G13 Cap

18	589.8	26	F18W/T8/835 CVG	17204	1,310	White	3,500	80+	15,000	A	22	25
18	589.8	26	F18W/T8/840 CVG	17205	1,300	Cool White	4,000	80+	15,000	A	22	25
36	1,199.4	26	F36W/T8/835 CVG	17202	3,250	White	3,500	80+	15,000	A	42	25
36	1,199.4	26	F36W/T8/840 CVG	17209	3,250	Cool White	4,000	80+	15,000	A	42	25
58	1,500	26	F58W/T8/835 CVG	99590	5,050	White	3,500	80+	15,000	A	68	25
58	1,500	26	F58W/T8/840 CVG	99591	5,050	Cool white	4,000	80+	15,000	A	68	25



T8 covGuard lamps can be used both in open and closed fixtures.

Wattage [W]	Volt [V]	Product Description	Rated Life (switching cycles)	Product Code	Pack Qty
Single 4-65W	110-130V	155/501/4/65W/UNIV/BX	10,000	36536	250
Single 4-65W	110-130V	155/501/4/65W/UNIV/IND	10,000	36537	2,000
Series 4-8W, 15-22W	220-240V	155/200/4-22W/TANDEM/BX	10,000	36711	250
Series 4-8W, 15-22W	220-240V	155/200/4-22W/TANDEM/IND	10,000	36714	2,000
Single 75-125W	110-130V	155/800/75-125W/BX	10,000	37864	250
Single 75-115W	110-130V	155/801/75-115W/BX	10,000	37975	250
Single 75-115W	110-130V	155/801/75-115W/IND	10,000	37974	2,000
Series 4-8W, 15-22W	220-240V	155/200 4-22W/TANDEM/BX	8,000	64085	250
Series 4-8W, 15-22W	220-240V	155/200 4-22W/TANDEM/IND	8,000	64086	2,000
Single 4-65W	110-130V	155/500 4-65W/UNIV/BX	8,000	64087	250
Single 4-65W	110-130V	155/500 4-65W/UNIV/IND	8,000	64088	2,000



Brand cross reference

The following pages show GE and alternative brand Order Codes. These cross references are provided as a quick guide and may only represent a near equivalent to other brands. The table contains data from alternative brands' catalogues and website.

GE	OSRAM	PHILIPS	Havells Sylvania
T5 Watt-Miser™ High Efficiency	Lumilux T5 HE ES	Master TL5 HE Eco	
F13W/T5/830/WM	-	13W/830	-
F13W/T5/840/WM	13W/840	13W/840	-
F20W/T5/840/WM	-	-	-
F26W/T5/830/WM	25W/830	25W/830	-
F26W/T5/840/WM	25W/840	25W/840	-
F33W/T5/830/WM	32W/830	32W/830	-
F33W/T5/840/WM	32W/840	32W/840	-
T5 Watt-Miser™ High Output	Lumilux T5 HO ES	Master TL5 HO Eco	
F21W/T5/840/WM	-	-	-
F36W/T5/840/WM	-	-	-
F46W/T5/830/WM	45W/830	45W/830	-
F46W/T5/840/WM	45W/840	45W/840	-
F51W/T5/830/WM	50W/830	50W/830	-
F51W/T5/840/WM	50W/840	50W/840	-
F76W/T5/830/WM	73W/830	73W/830	-
F76W/T5/840/WM	73W/840	73W/840	-
T5 LongLast™ High Efficiency	Lumilux T5 HE	Master TL5 HE	T5 Luxline Plus FHE
F14W/T5/827/LL	FH14W/827HE	14W/827	FHE14W/827
F14W/T5/830/LL	FH14W/830HE	14W/830	FHE14W/830
F14W/T5/835/LL	FH 14W/835HE	-	FHE14W/835
F14W/T5/840/LL	FH14W/840HE	14W/840	FHE14W/840
F14W/T5/865/LL	FH14W/865HE	14W/865	FHE14W/860
F21W/T5/827/LL	FH21W/827HE	21W/827	FHE21W/827
F21W/T5/830/LL	FH21W/830HE	21W/830	FHE21W/830
F21W/T5/840/LL	FH21W/840HE	21W/840	FHE21W/840
F21W/T5/865/LL	FH21W/865HE	21W/865	FHE21W/860
F28W/T5/827/LL	FH28W/827HE	28W/827	FHE28W/827
F28W/T5/830/LL	FH28W/830HE	28W/830	FHE28W/830
F28W/T5/840/LL	FH28W/840HE	28W/840	FHE28W/840
F28W/T5/865/LL	FH28W/865HE	28W/865	FHE28W/860
F35W/T5/827/LL	FH35W/827HE	35W/827	FHE35W/827
F35W/T5/830/LL	FH35W/830HE	35W/830	FHE35W/830
F35W/T5/835/LL	FH35W/835HE	-	FHE35W/835
F35W/T5/840/LL	FH35W/840HE	35W/840	FHE35W/840
F35W/T5/865/LL	FH35W/865HE	35W/865	FHE35W/860
T5 LongLast™ High Output	Lumilux T5 HO	Master TL5 HO	T5 Luxline Plus FHO
F24W/T5/830/LL	FH24W/830HO	24W/830	FHO24W/830
F24W/T5/835/LL	FH24W/835HO	-	FHO24W/835
F24W/T5/840/LL	FH24W/840HO	24W/840	FHO24W/840
F24W/T5/865/LL	FH24W/865HO	24W/865	FHO24W/860
F39W/T5/830/LL	FH39W/830HO	39W/830	FHO39W/830
F39W/T5/840/LL	FH39W/840HO	39W/840	FHO39W/840
F49W/T5/830/LL	FH49W/830HO	49W/830	FHO49W/830
F49W/T5/835/LL	-	-	FHO49W/835
F49W/T5/840/LL	FH49W/840HO	49W/840	FHO49W/840
F49W/T5/865/LL	FH49W/885HO	49W/865	FHO49W/860
F54W/T5/830/LL	-	54W/830	FHO54W/830
F54W/T5/840/LL	FH54W/840HO	54W/840	FHO54W/840
F54W/T5/865/LL	FH54W/865HO	54W/865	FHO54W/860
F80W/T5/830/LL	FH80W/830HO	80W/830	FHO80W/830
F80W/T5/840/LL	FH80W/840HO	80W/840	FHO80W/840

Linear Fluorescent Lamps

GE	OSRAM	PHILIPS	Havells Sylvania
T5 Miniature Standard	Energy Saver (Basic) T5 short	TL Mini	T5 Standard
F4W/T5/35	-	-	F4W/135
F4W/T5/33	L4W/640	4W/33-640	F4W/133
F6W/T5/35	-	-	F6W/135
F6W/T5/33	L6W/640	6W/33-640	F6W/133
F8W/T5/29	-	-	F8W/129
F8W/T5/35	L8W/535	-	F8W/135
F8W/T5/33	L8W/640	8W/33-640	F8W/133
F13W/T5/29	-	-	F13W/129
F13W/T5/35	-	-	F13W/135
F13W/T5/33	L13W/640	13W/33-640	F13W/133
T5 Miniature Triphosphore	Lumilux T5 short	Master TL Mini Super	T5 Luxline Plus
F8W/T5/827	L8W/827	8W/827	-
F8W/T5/840	L8W/840	8W/840	F8W/840
F13W/T5/827	L13W/840	13W/840	-
T5 Miniature Specfill Standard - Emergency Lighting	Emergency Lighting (Basic) T5 short	-	T5 Emergency
F6W/T5/33/SPECFILL	L6W/640	-	F6W/133 Emergency
F8W/T5/35/SPECFILL	-	-	-
F8W/T5/33/SPECFILL	L8W/640	-	F8W/133 Emergency
T5 Miniature Specfill Triphosphore - Emergency Lighting	-	-	T5 Emergency
F6W/T5/840/SPECFILL	-	-	-
F8W/T5/840/SPECFILL	-	-	F8W/1840 Emergency
F8W/T5/865/SPECFILL	-	-	-
T5 Circline™	Lumilux T5 FC	Master TL5 Circular	
FC22W/T5/827	FC22W/827	22W/827	
FC22W/T5/830	FC22W/830	22W/830	-
FC22W/T5/840	FC22W/840	22W/840	-
FC22W/T5/865	FC22W/865	-	
FC40W/T5/827	FC40W/827	40W/827	-
FC40W/T5/830	FC40W/830	40W/830	-
FC40W/T5/840	FC40W/840	40W/840	-
FC40W/T5/865	FC40W/865	-	
FC55W/T5/827	FC55W/827	-	
FC55W/T5/830	FC55W/830	55W/830	-
FC55W/T5/840	FC55W/840	55W/840	-
FC55W/T5/865	FC55W/865	-	
T8 Watt-Miser™	Lumilux T8 ES	Master TL-D Eco	T8 Luxline Eco
F16W/T8/830/WM	16W/830	16W/830	F16W/830
F16W/T8/840/WM	16W/840	16W/840	F16W/840
F16W/T8/860/WM	-	16W/865	-
F32W/T8/830/WM	32W/830	32W/830	F32W/830
F32W/T8/840/WM	32W/840	32W/840	F32W/840
F32W/T8/860/WM	-	32W/865	F32W/865
F51W/T8/830/WM	51W/830	51W/830	F51W/830
F51W/T8/840/WM	51W/840	51W/840	F51W/840
F51W/T8/860/WM	-	51W/865	F51W/865
T8 PolyLux XLR™ LongLast™	Lumilux XT T8	Master TL-D Xtra	-
F18W/T8/830/POLYLUX/LL	L18W/830XT	18W/830	-
F18W/T8/840/POLYLUX/LL	L18W/840XT	18W/840	-
F36W/T8/830/POLYLUX/LL	L36W/830XT	36W/830	-
F36W/T8/840/POLYLUX/LL	L36W/840XT	36W/840	-
F58W/T8/830/POLYLUX/LL	L58W/830XT	58W/830	-
F58W/T8/840/POLYLUX/LL	L58W/840XT	58W/840	-



Brand cross reference

GE	OSRAM	PHILIPS	Havells Sylvania
T8 Polylux XLR™	Lumilux T8	Master TL-D Super 80	T8 Luxline Plus
F15W/T8/830/POLYLUX	L15W/830	15W/830	F15W/830
FF15W/T8/835 POLYLUX	-	-	F15W/835
F15W/T8/840/POLYLUX	L15W/840	15W/840	F15W/840
F15W/T8/860/POLYLUX	L15W/860	15W/865	F15W/865
F18W/T8/827/POLYLUX	L18W/827	18W/827	F18W/827
F18W/T8/830/POLYLUX	L18W/830	18W/830	F18W/830
F18W/T8/835/POLYLUX	L18W/835	18W/835	F18W/835
F18W/T8/840/POLYLUX	L18W/840	18W/840	F18W/840
F18W/T8/860/POLYLUX	L18W/865	18W/865	F18W/865
F30W/T8/830/POLYLUX	L30W/830	30W/830	F30W/830
F30W/T8/835/POLYLUX	-	30W/835	F30W/835
F30W/T8/840/POLYLUX	L30W/840	30W/840	F30W/840
F30W/T8/860/POLYLUX	L30W/865	30W/865	F30W/865
F36W/T8/827/POLYLUX	L36W/827	36W/827	F36W/827
F36W/T8/830/POLYLUX	L36W/830	36W/830	F36W/830
F36W/T8/835/POLYLUX	L36W/835	36W/835	F36W/835
F36W/T8/840/POLYLUX	L36W/840	36W/840	F36W/840
F36W/T8/860/POLYLUX	L36W/865	36W/865	F36W/865
F58W/T8/827/POLYLUX	L58W/827	58W/827	F58W/827
F58W/T8/830/POLYLUX	L58W/830	58W/830	F58W/830
F58W/T8/835/POLYLUX	L58W/835	58W/835	F58W/835
F58W/T8/840/POLYLUX	L58W/840	58W/840	F58W/840
F58W/T8/860/POLYLUX	L58W/865	58W/865	F58W/860
F70W/T8/835/POLYLUX	L70W/835	70W/835	F70W/840
F70W/T8/840/POLYLUX	L70W/840	70W/840	-

Compact Fluorescent Lamps Non-Integrated



The smart way to reduce costs

Extra energy saving up to 12% with WattMiser™ lamps compared to regular plug-in lamps

Up to 20,000 hours of extended service life with LongLast™ lamps

Wide range of colour and wattage (2700-6500K, 5-70W)

Dimmability for additional cost savings

Motion detection available with selected drivers

Extra low relamping cost with LongLast™ lamps



Office



Industrial



Biax™ D/T/Q/L LongLast™ for reduced relamping costs

GE Lighting's compact fluorescent LongLast™ lamps provide increased service life, which significantly reduces replacement and maintenance costs.

They are compact energy saving fluorescent lamps with double, triple and quad tube designs, providing an ideal light source for small fixtures and downlighters.

GE Biax™ T and Biax™ Q LongLast™ guarantees the same light output in any burning position. It can be used in both closed luminaires and outdoor applications without significant light loss due to GE Amalgam technology providing stable lumen performance within a wide colour temperature range.

LongLast™

- Retrofit – can be used with existing fittings and control gears*
- Reduces replacement and maintenance costs
- Further energy saving with dimming possibilities
- Available in warm to cool colour temperatures (2700 – 6500K)

*Recommended control gear list available in the data sheets (www.gelighting.com/eu)

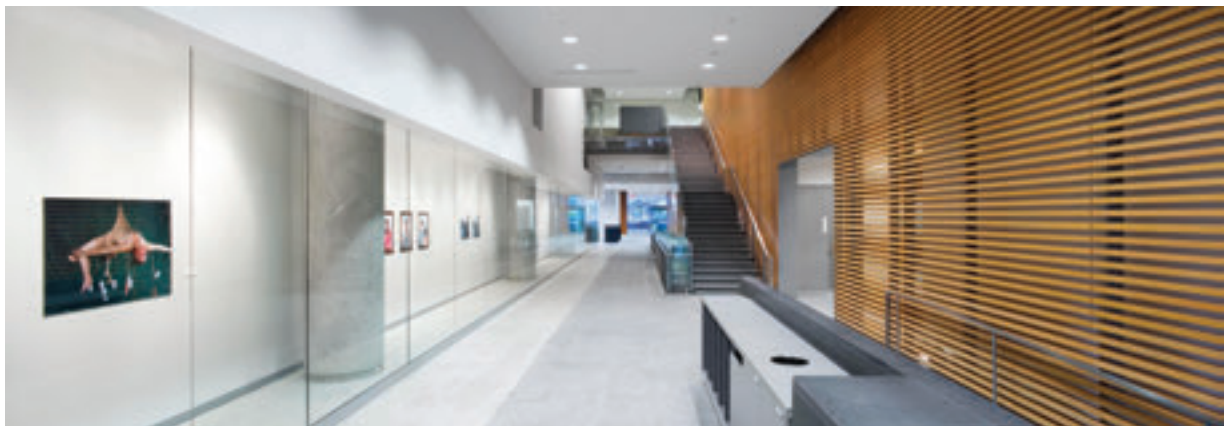

Compact Fluorescent Lamps Non-Integrated

2D™ Watt-Miser™ *for reduced electricity bills*

GE 2D™ Watt-Miser™ lamps are energy saving compact fluorescent tubes formed into a '2D' shape. All types are available with a 4-pin cap, which allows the lamps to be used with conventional or electronic control gears, dimming and emergency lighting circuits.

The lamps offer additional energy savings, even when used with a standard control gear. GE 2D™ Watt-Miser™ lamps deliver market leading life performance and remarkable energy saving performance that is unique to GE Lighting.



2DWattMiser™

- Direct replacements for 16-21-28-38W standard 2D™ lamps
- Unique shape suitable for broad range of applications
- Interchangeable – can be used with existing fittings and control gear
- Very good for circular light distribution
- 5-12% extra energy saving compared to conventional plug-in lamps
- The only 'A' class energy 2D™ lamp on the market



Selector

Biax™ S



Biax™ S – 2pin

Cap: G23
Wattages: 5-7-9-11W
Colours: 2700 - 6500K
Rated life: 10,000Hrs

Page IV.6



Biax™ S/E – 4pin

Cap: 2G7
Wattages: 5-7-9-11W
Colours: 2700 - 6500K
Rated life: 10,000Hrs
11W version available in Red/Green/Blue colours.

Page IV.6

Biax™ D



Biax™ D – 2pin

Cap: G24d
Wattages: 10-13-18-26W
Colours: 2700 - 6500K
Rated life: 12,000Hrs

LongLast™ Page IV.6-7



Biax™ D/E – 4pin

Cap: G24q
Wattage: 10-13-18-26W
Colours: 2700 - 6500K
Rated life: 20,000Hrs

LongLast™ Page IV.7

Biax™ T



Biax™ T – 2pin

Cap: GX24d
Wattages: 13-18-26W
Colours: 2700 - 4000K
Rated life: 12,000Hrs

LongLast™ Page IV.7



Biax™ T/E – 4pin

Cap: GX24q
Wattages: 13-18-26-32-42W
Colours: 2700 - 4000K
Rated life: 12,000 - 20,000Hrs

LongLast™ Page IV.7-8

Biax™ Q



Biax™ Q/E – 4pin

Cap: GX24q
Wattages: 57-70W
Colours: 2700 - 4000K
Rated life: 20,000Hrs

LongLast™ Page IV.8

Biax™ Q/E – Electronic Ballast

Volts: 220-240V
Wattages: 57-70W

Biax™ L



Biax™ L – 4pin

Cap: 2G11
Wattages: 18-55W
Colours: 2700 - 6500K
Rated life: 10,000 - 22,500Hrs

LongLast™ * Page IV.8

2D™



2D™

Cap: GR8, GR10q
Wattages: 16-38W
Colours: 2700 - 6000K
Rated life: 12,000-15,000Hrs

WattMiser™ Page IV.9



Biax 2D™

Cap: GR10q, GR10q-3
Wattages: 10-55W
Colours: 2700 - 3500K
Rated life: 8,000 - 10,000Hrs

Page IV.9



Biax™ 2D™ Intergral

Cap: GR210d
Wattages: 18W
Colours: 2700 - 4000K
Rated life: 10,000Hrs

WattMiser™ Page IV.9

*the 40-55W versions are LongLast types

Compact Fluorescent Lamps Non-Integrated

Product identification

The following glossary of terms will help you when selecting lamps in this section. Within each product line, lamps are divided into families – within these families, lamps are listed by wattage. The Product Description can be used as a quick reference to each product's attributes. Where Rated Life is stated we refer to the industry standard definition of how many hours of operation 50% of a given installation will exceed.

All Biax™ CFL lamps are manufactured with the high quality Polylux triphosphor technology.

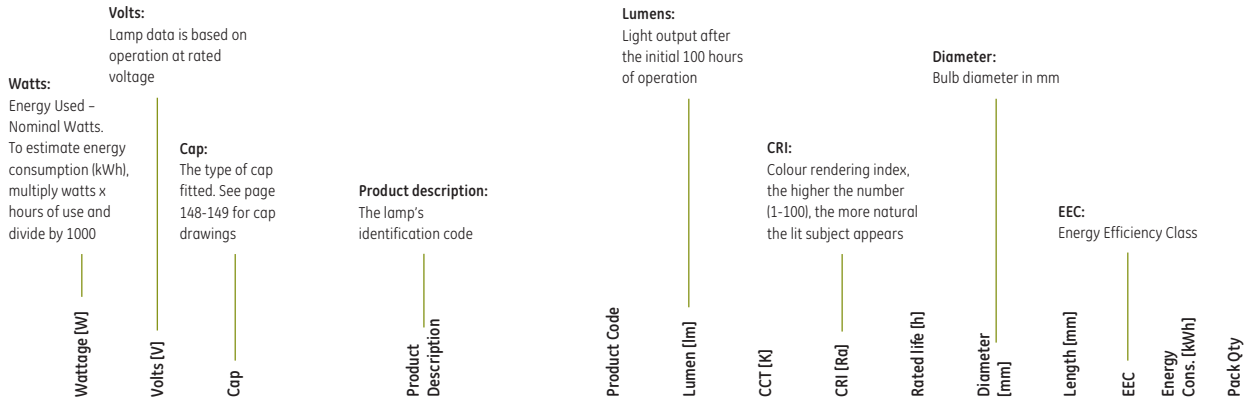

Biax™ S 2-pin, Internal Starter

5	35	G23	F5BX/SPX27/827	37654	265	2700	82	10,000	32	107.5	A	14,69	10
5	35	G23	F5BX/SPX41/840	37661	265	4000	82	10,000	32	107.5	A	14,69	10
7	47	G23	F7BX/SPX27/827	37846	425	2700	82	10,000	32	136.5	A	14,69	10

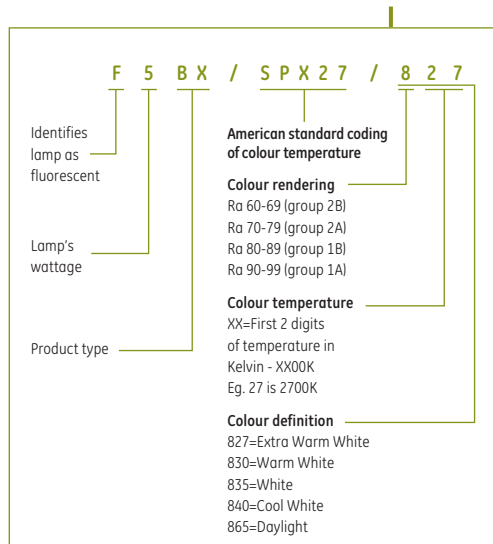

CCT: Colour temperature – Kelvin [K]. The visual warmth or coolness of the light. The higher the number the whiter or cooler the light appears

Length: Total length including the length of the pin in mm

Energy Consumption: kWh/1000h

Product code: It is important to use this code when ordering to ensure that you receive the exact product you require

Rated Life: The point in time when 50% of installed lamps are still burning with 3h cycling. With HF gear used with 12h cycling.

Pack quantity: Number of product units packed in a case

Wattage (W)	Volts (V)	Cap	Product Description	Product Code	Lumen (lm)	CCT (K)	CRI (Ra)	Rated life (h)	Diameter (mm)	Length (mm)	EEC	Energy Cons. (kWh)	Pack Qty
Biax™ S 2-pin, Internal Starter													
5	35	G23	F58X/SPX27/827	37654	265	2700	82	10,000	32	107.5	B	7.15	10
5	35	G23	F58X/SPX41/840	37661	265	4000	82	10,000	32	107.5	B	7.15	10
7	47	G23	F78X/SPX27/827	37846	425	2700	82	10,000	32	136.5	A	9.18	10
7	47	G23	F78X/830	38930	425	3000	82	10,000	32	136.5	A	9.18	10
7	47	G23	F78X/SPX35/835	37659	425	3500	82	10,000	32	136.5	A	9.18	10
7	47	G23	F78X/SPX41/840	37660	425	4000	82	10,000	32	136.5	A	9.18	10
7	47	G23	F78X/865	38984	425	6500	82	10,000	32	136.5	A	9.18	10
9	60	G23	F98X/827	37651	600	2700	82	10,000	32	167	A	11.05	10
9	60	G23	F98X/830	38929	600	3000	82	10,000	32	167	A	11.05	10
9	60	G23	F98X/SPX35/835	37652	600	3500	82	10,000	32	167	A	11.05	10
9	60	G23	F98X/SPX41/840	37653	600	4000	82	10,000	32	167	A	11.05	10
9	60	G23	F98X/865	38985	600	6500	82	10,000	32	167	A	11.05	10
11	91	G23	F118X/827	37663	900	2700	82	10,000	32	237	A	14.69	10
11	91	G23	F118X/830	38928	900	3000	82	10,000	32	237	A	14.69	10
11	91	G23	F118X/835	37666	900	3500	82	10,000	32	237	A	14.69	10
11	91	G23	F118X/840	37664	900	4000	82	10,000	32	237	A	14.69	10
11	91	G23	F118X/865	38986	900	6500	82	10,000	32	237	A	14.69	10



Biax™ S/E 4-pin, External Starter Required

5	35	2G7	F58X/827/4P	37714	265	2700	82	10,000	37.5	92	A	5.50	10
5	35	2G7	F58X/840/4P	37715	265	4000	82	10,000	37.5	92	A	5.50	10
7	47	2G7	F78X/827/4P	37658	425	2700	82	10,000	37.5	121	A	7.15	10
7	47	2G7	F78X/840/4P	37716	425	4000	82	10,000	37.5	121	A	7.15	10
9	60	2G7	F98X/827/4P	37710	600	2700	82	10,000	37.5	151	A+	8.80	10
9	60	2G7	F98X/830/4P	97926	900	3000	82	10,000	37.5	151	A+	8.80	10
9	60	2G7	F98X/840/4P	37711	600	4000	82	10,000	37.5	151	A+	8.80	10
11	91	2G7	F118X/827/4P	37717	900	2700	82	10,000	37.5	222	A+	12.10	10
11	91	2G7	F118X/830/4P	97925	600	3000	82	10,000	37.5	222	A+	12.10	10
11	91	2G7	F118X/840/4P	37713	900	4000	82	10,000	37.5	222	A+	12.10	10
11	91	2G7	F118X/865/4P	12603	900	6500	82	10,000	37.5	222	A+	12.10	10
11	91	2G7	F118X/GREEN/2G7	98311	1200	GREEN	N/A	10,000	37.5	222	N/A	N/A	10
11	91	2G7	F118X/BLUE/2G7	98313	250	BLUE	N/A	10,000	37.5	222	N/A	N/A	10
11	91	2G7	F118X/RED/2G7	98314	600	RED	N/A	10,000	37.5	222	N/A	N/A	10



Biax™ D 2-pin, Internal Starter

10	64	G24D-1	F10DBX/T3/827/2P	78211	600	2700	82	12,000	34.4	108	B	12.70	10
10	64	G24D-1	F10DBX/T3/830/2P	78212	600	3000	82	12,000	34.4	108	B	12.70	10
10	64	G24D-1	F10DBX/T3/835/2P	78213	600	3500	82	12,000	34.4	108	B	12.70	10
10	64	G24D-1	F10DBX/T3/840/2P	78214	600	4000	82	12,000	34.4	108	B	12.70	10
10	64	G24D-1	F10DBX/T3/865/2P	78215	600	6500	82	12,000	34.4	108	B	12.70	10
13	91	G24D-1	F13DBX/T3/827/2P	78221	900	2700	82	12,000	34.4	139	A	16.18	10
13	91	G24D-1	F13DBX/T3/830/2P	78222	900	3000	82	12,000	34.4	139	A	16.18	10
13	91	G24D-1	F13DBX/T3/835/2P	78223	900	3500	82	12,000	34.4	139	A	16.18	10
13	91	G24D-1	F13DBX/T3/840/2P	78224	900	4000	82	12,000	34.4	139	A	16.18	10
13	91	G24D-1	F13DBX/T3/865/2P	78225	900	6500	82	12,000	34.4	139	A	16.18	10
18	100	G24d-2	F18DBXT4/SPX27/827	12860	1200	2700	82	12,000	34.4	154	B	22.10	10
18	100	G24d-2	F18DBXT4/SPX30/830	12861	1200	3000	82	12,000	34.4	154	B	22.10	10
18	100	G24d-2	F18DBXT4/SPX35/835	12863	1200	3500	82	12,000	34.4	154	B	22.10	10
18	100	G24d-2	F18DBXT4/SPX41/840	12864	1200	4000	82	12,000	34.4	154	B	22.10	10
18	100	G24d-2	F18DBXT4/SPX65/865	13017	1200	6500	82	12,000	34.4	154	B	22.10	10
26	105	G24d-3	F26DBXT4/SPX27/827	35250	1800	2700	82	12,000	34.4	169.5	B	31.35	10
26	105	G24d-3	F26DBXT4/SPX30/830	35237	1800	3000	82	12,000	34.4	169.5	B	31.35	10
26	105	G24d-3	F26DBXT4/SPX35/835	35251	1800	3500	82	12,000	34.4	169.5	B	31.35	10



Compact Fluorescent Lamps Non-Integrated

Wattage (W)	Volts (V)	Cap	Product Description	Product Code	Lumen (lm)	CCT (K)	CRI (Ra)	Rated life (h)	Diameter (mm)	Length (mm)	EEC	Energy Cons. (kWh)	Pack Qty
Biax™ D 2-pin, Internal Starter													
26	105	G24d-3	F26DBXT4/SPX41/840	35252	1800	4000	82	12,000	34.4	169.5	B	31.35	10
26	105	G24d-3	F26DBXT4/SPX65/865	35305	1710	6500	82	12,000	34.4	169.5	B	31.42	10

Biax™ D/E LongLast™ 4-pin, External Starter Required													
10	64	G24q-1	F10DBX/T3/827/4P	78217	600	2700	82	20,000	34.4	100.5	A	10.45	10
10	64	G24q-1	F10DBX/T3/830/4P	78218	600	3000	82	20,000	34.4	100.5	A	10.45	10
10	64	G24q-1	F10DBX/T3/835/4P	78219	600	3500	82	20,000	34.4	100.5	A	10.45	10
10	64	G24q-1	F10DBX/T3/840/4P	78220	600	4000	82	20,000	34.4	100.5	A	10.45	10
10	64	G24q-1	F10DBX/T3/865/4P	78231	600	6500	82	20,000	34.4	100.5	A	10.45	10
13	91	G24q-1	F13DBX/T3/827/4P	78226	900	2700	82	20,000	34.4	131.5	A	13.75	10
13	91	G24q-1	F13DBX/T3/830/4P	78227	900	3000	82	20,000	34.4	131.5	A	13.75	10
13	91	G24q-1	F13DBX/T3/835/4P	78228	900	3500	82	20,000	34.4	131.5	A	13.75	10
13	91	G24q-1	F13DBX/T3/840/4P	78229	900	4000	82	20,000	34.4	131.5	A	13.75	10
13	91	G24q-1	F13DBX/T3/865/4P	78232	900	6500	82	20,000	34.4	131.5	A	13.75	10
18	100	G24q-2	F18DBX/SPX27/827/4P	12865	1200	2700	82	20,000	34.4	146.5	A	18.15	10
18	100	G24q-2	F18DBX/SPX30/830/4P	12866	1200	3000	82	20,000	34.4	146.5	A	18.15	10
18	100	G24q-2	F18DBX/SPX35/835/4P	12869	1200	3500	82	20,000	34.4	146.5	A	18.15	10
18	100	G24q-2	F18DBX/SPX41/840/4P	12870	1200	4000	82	20,000	34.4	146.5	A	18.15	10
26	105	G24q-3	F26DBX/SPX27/827/4P	35247	1800	2700	82	20,000	34.4	162	A	26.40	10
26	105	G24q-3	F26DBX/SPX30/830/4P	35235	1800	3000	82	20,000	34.4	162	A	26.40	10
26	105	G24q-3	F26DBX/SPX35/835/4P	35248	1800	3500	82	20,000	34.4	162	A	26.40	10
26	105	G24q-3	F26DBX/SPX41/840/4P	35236	1800	4000	82	20,000	34.4	162	A	26.40	10
26	105	G24q-3	F26DBX/SPX65/865/4P	42798	1710	6500	82	20,000	34.4	162	A	26.40	10



Biax™ T 2-pin with Amalgam, Internal Starter													
13	91	GX24d-1	F13TBX/827/A/2P	35940	900	2700	82	12,000	49.3	112.9	B	16.18	10
13	91	GX24d-1	F13TBX/SPX30/830/A/2P	35966	900	3000	82	12,000	49.3	112.9	B	16.18	10
13	91	GX24d-1	F13TBX/SPX41/A/2P	35941	900	4000	82	12,000	49.3	112.9	B	16.18	10
18	100	GX24d-2	F18TBX/SPX27/827/A/2P	35945	1200	2700	82	12,000	49.3	127.4	B	22.10	10
18	100	GX24d-2	F18TBX/SPX30/830/A/2P	35944	1200	3000	82	12,000	49.3	127.4	B	22.10	10
18	100	GX24d-2	F18TBX/SPX41/840/A/2P	35939	1200	4000	82	12,000	49.3	127.4	B	22.10	10
26	105	GX24d-3	F26TBX/SPX27/827/A/2P	35959	1800	2700	82	12,000	49.3	139.9	B	32.79	10
26	105	GX24d-3	F26TBX/SPX30/830/A/2P	35952	1800	3000	82	12,000	49.3	139.9	B	32.79	10
26	105	GX24d-3	F26TBX/SPX41/840/A/2P	35964	1800	4000	82	12,000	49.3	139.9	B	32.79	10



Biax™ T/E LongLast™ 4-pin with Amalgam, External Starter Required													
13	91	GX24q-1	F13TBX/SPX27/827/A/4P	34391	900	2700	82	12,000	49.3	106.2	A	13.75	10
13	91	GX24q-1	F13TBX/SPX30/830/A/4P	34395	900	3000	82	12,000	49.3	106.2	A	13.75	10
13	91	GX24q-1	F13TBX/SPX35/835/A/4P	34400	900	3500	82	12,000	49.3	106.2	A	13.75	10
13	91	GX24q-1	F13TBX/SPX41/840/A/4P	34387	900	4000	82	12,000	49.3	106.2	A	13.75	10
18	100	GX24q-2	F18TBX/SPX27/827/A/4P	34392	1200	2700	82	20,000	49.3	120.7	A	18.15	10
18	100	GX24q-2	F18TBX/SPX30/830/A/4P	34396	1200	3000	82	20,000	49.3	120.7	A	18.15	10
18	100	GX24q-2	F18TBX/SPX35/835/A/4P	34405	1200	3500	82	20,000	49.3	120.7	A	18.15	10
18	100	GX24q-2	F18TBX/SPX41/840/A/4P	34385	1200	4000	82	20,000	49.3	120.7	A	18.15	10
26	105	GX24q-3	F26TBX/SPX27/827/A/4P	34393	1800	2700	82	12,000	49.3	133.2	A	26.40	10
26	105	GX24q-3	F26TBX/SPX30/830/A/4P	34397	1800	3000	82	12,000	49.3	133.2	A	26.40	10
26	105	GX24q-3	F26TBX/SPX35/835/A/4P	34406	1800	3500	82	12,000	49.3	133.2	A	26.40	10
26	105	GX24q-3	F26TBX/SPX41/840/A/4P	34381	1800	4000	82	12,000	49.3	133.2	A	26.40	10



Wattage (W)	Volts (V)	Cap	Product Description	Product Code	Lumen (lm)	CCT (K)	CRI (Ra)	Rated life (h)	Diameter (mm)	Length (mm)	EEC	Energy Cons. (kWh)	Pack Qty
Biax™ T/E LongLast™ 4-pin with Amalgam, External Starter Required with HF gear*													
32	100	GX24q-3	F32TBX/SPX27/827/AP4P	94520	2400	2700	82	20,000	49.3	147	A	35,20	10
32	100	GX24q-3	F32TBX/SPX30/830/AP4P	94521	2400	3000	82	20,000	49.3	147	A	35,20	10
32	100	GX24q-3	F32TBX/SPX35/835/A/4P	94522	2400	3500	82	20,000	49.3	147	A	35,20	10
32	100	GX24q-3	F32TBX/SPX41/840/A/4P	94523	2400	4000	82	20,000	49.3	147	A	35,20	10
42	135	GX24q-4	F42TBX/827/A/4P	46312	3200	2700	82	20,000	49.3	163.2	A	47,30	10
42	135	GX24q-4	F42TBX/830/A/4P	46313	3200	3000	82	20,000	49.3	163.2	A	47,30	10
42	135	GX24q-4	F42TBX/835/A/4P	46314	3200	3500	82	20,000	49.3	163.2	A	47,30	10
42	135	GX24q-4	F42TBX/841/A/4P	46315	3200	4000	82	20,000	49.3	163.2	A	47,30	10



Biax™ Q/E LongLast™ 4-pin with Amalgam, External Starter Required with HF gear*													
57	175	GX24q-5	F57QBX/827/A/4P/LL	45213	4300	2700	82	20,000	58.3	180.7	A	61,60	10
57	175	GX24q-5	F57QBX/830/A/4P/LL	45204	4300	3000	82	20,000	58.3	180.7	A	61,60	10
57	175	GX24q-5	F57QBX/835/A/4P/LL	45202	4300	3500	82	20,000	58.3	180.7	A	61,60	10
57	175	GX24q-5	F57QBX/840/A/4P/LL	45201	4300	4000	82	20,000	58.3	180.7	A	61,60	10
70	219	GX24q-6	F70QBX/830/A/4P/LL	45208	5200	3000	82	20,000	58.3	208.2	A	77,00	10
70	219	GX24q-6	F70QBX/835/A/4P/LL	45219	5200	3500	82	20,000	58.3	208.2	A	77,00	10
70	219	GX24q-6	F70QBX/840/A/4P/LL	45218	5200	4000	82	20,000	58.3	208.2	A	77,00	10



Biax™ L LongLast™ 4-pin, External Starter Required with HF gear*													
40	126	2G11	F40BX/830	41171	3500	3000	82	22,500	43.8	538.8	A	44,00	25
40	126	2G11	F40BX/835	41172	3500	3500	82	22,500	43.8	538.8	A	44,00	25
40	126	2G11	F40BX/840	41173	3500	4000	82	22,500	43.8	538.8	A	44,00	25
55	101	2G11	F55BX/830	41174	4800	3000	82	22,500	43.8	538.8	A	60,50	25
55	101	2G11	F55BX/835	41260	4800	3500	82	22,500	43.8	538.8	A	60,50	25
55	101	2G11	F55BX/840	41298	4800	4000	82	22,500	43.8	538.8	A	60,50	25
55	101	2G11	F55BX/865	75695	4550	6500	82	22,500	43.8	538.8	A	60,50	25



Biax™ L 4-pin, External Starter Required													
18	58	2G11	F18BX/827	41087	1250	2700	82	10,000	43.8	231.3	A	17,60	25
18	58	2G11	F18BX/830	41088	1250	3000	82	10,000	43.8	231.3	A	17,60	25
18	58	2G11	F18BX/835	41089	1250	3500	82	10,000	43.8	231.3	A	17,60	25
18	58	2G11	F18BX/840	41090	1250	4000	82	10,000	43.8	231.3	A	17,60	25
24	87	2G11	F24BX/827	41128	1800	2700	82	10,000	43.8	326.8	A	24,20	25
24	87	2G11	F24BX/830	41134	1800	3000	82	10,000	43.8	326.8	A	24,20	25
24	87	2G11	F24BX/835	41145	1800	3500	82	10,000	43.8	326.8	A	24,20	25
24	87	2G11	F24BX/840	41155	1800	4000	82	10,000	43.8	326.8	A	24,20	25
34	120	2G11	F34BX/830	41163	2800	3000	82	10,000	43.8	538.8	A+	33,00	25
34	120	2G11	F34BX/835	41166	2800	3500	82	10,000	43.8	538.8	A+	33,00	25
34	120	2G11	F34BX/840	41167	2800	4000	82	10,000	43.8	538.8	A+	33,00	25
36	106	2G11	F36BX/827	41307	2900	2700	82	10,000	43.8	421.8	A+	36,52	25
36	106	2G11	F36BX/830	41168	2900	3000	82	10,000	43.8	421.8	A+	36,52	25
36	106	2G11	F36BX/835	41169	2900	3500	82	10,000	43.8	421.8	A+	36,52	25
36	106	2G11	F36BX/840	41170	2900	4000	82	10,000	43.8	421.8	A+	36,52	25
36	106	2G11	F36BX/865	75694	2750	6500	82	10,000	43.8	421.8	A	36,52	25



*Life test: If HF gear used with 12h cycling, otherwise with 3h cycling.

Compact Fluorescent Lamps Non-Integrated



Wattage [W]	Volts [V]	Cap	Product Description	Product Code	Lumen [lm]	CCT [K]	CRI [Ra]	Rated life [h]	Diameter [mm]	Length [mm]	EEC	Energy Cons. [kWh]	Pack Qty
2D™ Watt-Miser™													
16	103	GR8	F162D/827	41744	1100	2700	82	12,000	138	142	A	18,74	20
16	103	GR8	F162D/835	41745	1100	3500	82	12,000	138	142	A	18,74	20
16	103	GR10q	F162D/827/4P	41746	1100	2700	82	12,000	138	142	A	15,40	20
16	103	GR10q	F162D/830/4P	75066	1100	3000	82	12,000	138	142	A	15,40	20
16	103	GR10q	F162D/835/4P	41747	1100	3500	82	12,000	138	142	A	15,40	20
16	103	GR8	F162D/860	41749	1050	6000	82	12,000	138	142	A	18,78	20
21	103	GR10q	F212D/827/4P	41794	1375	2700	82	12,000	138	142	A	20,90	20
21	103	GR10q	F212D/835/4P	41806	1375	3500	82	12,000	138	142	A	20,90	20
21	103	GR10q	F212D/860/4P	41808	1305	6000	82	12,000	138	142	A	20,90	20
28	108	GR8	F282DT5/827/2P	10546	2150	2700	82	15,000	202	204	A	31,71	20
28	108	GR10q	F282DT5/827/4P	10547	2150	2700	82	15,000	202	204	A	26,95	20
28	108	GR10q	F282DT5/830/4P	75068	2150	3000	82	15,000	202	204	A	26,95	20
28	108	GR10q	F282DT5/835/4P	10567	2150	3500	82	15,000	202	204	A	26,95	20
28	108	GR10q	F282DT5/840/4P	10548	2150	4000	82	15,000	202	204	A	26,95	20
38	110	GR10q	F382DT5/827/4P	10550	3020	2700	82	15,000	202	204	A	37,95	20
38	110	GR10q	F382DT5/830/4P	75067	3020	3000	82	15,000	202	204	A	37,95	20
38	110	GR10q	F382DT5/835/4P	10566	3020	3500	82	15,000	202	204	A	37,95	20



Wattage [W]	Volts [V]	Cap	Product Description	Product Code	Lumen [lm]	CCT [K]	CRI [Ra]	Rated life [h]	Diameter [mm]	Length [mm]	EEC	Energy Cons. [kWh]	Pack Qty
Biax™ 2D™													
10	60	GR10q	F10W/2D/827/4P	88105	650	2700	82	8,000	92	95	A	10,45	20
10	60	GR10q	F10W/2D/835/4P	88106	650	3500	82	8,000	92	95	A	10,45	20
55	98	GR10q-3	F552D/T5/827/A/4P	78337*	3900	2700	80	10,000	202	204	A	61,60	20
55	98	GR10q-3	F552D/T5/830/4P	78339*	3900	3000	80	10,000	202	204	A	61,60	20
55	98	GR10q-3	F552D/T5/835/A/4P	78340*	3900	3500	80	10,000	202	204	A	61,60	20



Wattage [W]	Volts [V]	Cap	Product Description	Product Code	Lumen [lm]	CCT [K]	CRI [Ra]	Rated life [h]	Diameter [mm]	Length [mm]	EEC	Energy Cons. [kWh]	Pack Qty
Biax™ 2D™ Watt-Miser™ with Integral Control Gear													
18	220-240	GRZ10d	FLE18W2D/827 GRZ10D	18122	1200	2700	82	10,000	138	142	A	16,00	10
18	220-240	GRZ10d	FLE18W2D/835 GRZ10D	18123	1200	3500	82	10,000	138	142	A	16,00	10
18	220-240	GRZ10d	FLE18W2D/840 GRZ10D	18120	1200	4000	82	10,000	138	142	A	16,00	10

Wattage [W]	Volts [V]	Product Description	Product Code	Diameter [mm]	Length [mm]	Pack Qty
Biax™ Q/E Electronic Ballast						
57-70	220-240	BLS/E/1X57-70W/QBX220-240V	13248	79	123	12

*With 50Hz gear.

Brand cross reference

The following pages show GE and alternative brand Order Codes. These cross references are provided as a quick guide and may only represent a near equivalent to other brands. The table contains data from alternative brands' catalogues and website.

GE			OSRAM	PHILIPS	Havells Sylvania
	Biax™S 2pin	Colour temperature	Dulux S	Master PL-S 2	Lynx-S
5W	F5BX/827	2700	DULUX S 5W/827	PL-S 5W/827/2P	Lynx S 5W/827
	F5BX/840	4000	DULUX S 5W/840	-	Lynx S 5W/840
7W	F7BX/827	2700	DULUX S 7W/827	PL-S 7W/827/2P	Lynx S 7W/827
	F7BX/830	3000	DULUX S 7W/830	-	Lynx S 7W/830
	F7BX/835	3500	DULUX S 7W/835	-	-
	F7BX/840	4000	DULUX S 7W/840	PL-S 7W/840/2P	Lynx S 7W/840
	F7BX/865	6500	DULUX S 7W/865	-	-
9W	F9BX/827	2700	DULUX S 9W/827	PL-S 9W/827/2P	Lynx S 9W/827
	F9BX/830	3000	DULUX S 9W/830	PL-S 9W/830/2P	Lynx S 9W/830
	F9BX/835	3500	DULUX S 9W/835	-	-
	F9BX/840	4000	DULUX S 9W/840	PL-S 9W/840/2P	Lynx S 9W/840
	F9BX/865	6500	DULUX S 9W/865	-	-
11W	F11BX/827	2700	DULUX S 11W/827	PL-S 11W/827/2P	Lynx S 11W/827
	F11BX/830	3000	DULUX S 11W/830	-	Lynx S 11W/830
	F11BX/835	3500	-	-	-
	F11BX/840	4000	DULUX S 11W/840	PL-S 11W/840/2P	Lynx S 11W/840
	F11BX/865	6500	DULUX S 11W/865	-	-
	-	-	DULUX S 9W/Red	-	-
	-	-	DULUX S 9W/Green	-	-
	-	-	DULUX S 9W/Blue	-	-
	Biax™S/E 4pin		Dulux-SE	Master PL-S 4	Lynx - SE
5W	F5BX/827/4P	2700	-	PL-S 5W/827/4P	Lynx SE 5W/827
	F5BX/840/4P	4000	-	PL-S 5W/840/4P	Lynx SE 5W/840
7W	F7BX/827/4P	2700	DULUX S/E 7W/827	PL-S 7W/827/4P	Lynx SE 7W/827
	F7BX/840/4P	4000	DULUX S/E 7W/840	PL-S 7W/840/4P	Lynx SE 7W/840
9W	F9BX/827/4P	2700	DULUX S/E 9W/827	PL-S 9W/827/4P	Lynx SE 9W/827
	F9BX/830/4P	3000	DULUX S/E 9W/830	-	Lynx SE 9W/830
	F9BX/840/4P	4000	DULUX S/E 9W/840	PL-S 9W/840/4P	Lynx SE 9W/840
11W	F11BX/827/4P	2700	DULUX S/E 11W/827	PL-S 11W/827/4P	Lynx SE 11W/827
	F11BX/827/4P	3000	DULUX S/E 11W/830	-	Lynx SE 11W/830
	F11BX/840/4P	4000	DULUX S/E 11W/840	PL-S 11W/840/4P	Lynx SE 11W/840
	F11BX/865/4P	6500	-	-	-
	F11BX/Red	-	-	-	-
	F11BX/Green	-	-	-	-
	F11BX/Blue	-	-	-	-
	Biax™D 2pin		Dulux-D	Master PL-C	Lynx-D
10W	F10DBX/827	2700	DULUX D 10W/827	PL-C 10W/827/2P	Lynx D 10W/827
	F10DBX/830	3000	DULUX D 10W/830	PL-C 10W/830/2P	Lynx D 10W/830
	F10DBX/835	3500	DULUX D 10W/835	-	Lynx D 10W/835
	F10DBX/840	4000	DULUX D 10W/840	PL-C 10W/840/2P	Lynx D 10W/840
	F10DBX/865	6500	DULUX D 10W/865	-	Lynx D 10W/860
13W	F13DBX/827	2700	DULUX D 13W/827	PL-C 13W/827/2P	Lynx D 13W/827
	F13DBX/830	3000	DULUX D 13W/830	PL-C 13W/830/2P	Lynx D 13W/830
	F13DBX/835	3500	DULUX D 13W/835	-	Lynx D 13W/835
	F13DBX/840	4000	DULUX D 13W/840	PL-C 13W/840/2P	Lynx D 13W/840
	F13DBX/865	6500	DULUX D 13W/865	-	Lynx D 13W/860
18W	F18DBX/827	2700	DULUX D 18W/827	PL-C 18W/827/2P	Lynx D 18W/827
	F18DBX/830	3000	DULUX D 18W/830	PL-C 18W/830/2P	Lynx D 18W/830
	F18DBX/835	3500	DULUX D 18W/835	-	Lynx D 18W/835
	F18DBX/840	4000	DULUX D 18W/840	PL-C 18W/840/2P	Lynx D 18W/840
	F18DBX/865	6500	DULUX D 18W/865	-	Lynx D 18W/860
26W	F26DBX/827	2700	DULUX D 26W/827	PL-C 26W/827/2P	Lynx D 26W/827
	F26DBX/830	3000	DULUX D 26W/830	PL-C 26W/830/2P	Lynx D 26W/830
	F26DBX/835	3500	DULUX D 26W/835	PL-C 26W/835/2P	Lynx D 26W/835

Compact Fluorescent Lamps Non-Integrated

GE		OSRAM		PHILIPS		Havells Sylvania	
	Biax™D/E 4pin	Colour temperature	Dulux-DE	Master PL-C	Lynx-DE		
10W	F10DBX/827/4P/EOL	2700	DULUX D/E 10W/827	PL-C 10W/827/4P	Lynx DE 10W/827		
	F10DBX/830/4P/EOL	3000	DULUX D/E 10W/830	PL-C 10W/830/4P	Lynx DE 10W/830		
	F10DBX/835/4P/EOL	3500	DULUX D/E 10W/835	-	-		
	F10DBX/840/4P/EOL	4000	DULUX D/E 10W/840	PL-C 10W/840/4P	Lynx DE 10W/840		
	F10DBX/865/4P/EOL	6500	-	-	Lynx DE 10W/860		
13W	F13DBX/827/4P/EOL	2700	DULUX D/E 13W/827	PL-C 13W/827/4P	Lynx DE 13W/827		
	F13DBX/830/4P/EOL	3000	DULUX D/E 13W/830	PL-C 13W/830/4P	Lynx DE 13W/830		
	F13DBX/835/4P/EOL	3500	DULUX D/E 13W/835	-	Lynx DE 13W/835		
	F13DBX/840/4P/EOL	4000	-	PL-C 13W/840/4P	Lynx DE 13W/840		
	F13DBX/865/4P/EOL	6500	-	-	Lynx DE 13W/860		
18W	F18DBX/827/4P/EOL	2700	DULUX D/E 18W/827	PL-C 18W/827/4P	Lynx DE 18W/827		
	F18DBX/830/4P/EOL	3000	DULUX D/E 18W/830	PL-C 18W/830/4P	Lynx DE 18W/830		
	F18DBX/835/4P/EOL	3500	DULUX D/E 18W/835	-	Lynx DE 18W/835		
	F18DBX/840/4P/EOL	4000	DULUX D/E 18W/840	PL-C 18W/840/4P	Lynx DE 18W/840		
	F26DBX/827/4P/EOL	2700	DULUX D/E 26W/827	PL-C 26W/827/4P	Lynx DE 26W/827		
26W	F26DBX/830/4P/EOL	3000	DULUX D/E 26W/830	PL-C 26W/830/4P	Lynx DE 26W/830		
	F26DBX/835/4P/EOL	3500	DULUX D/E 26W/835	PL-C 26W/835/4P	Lynx DE 26W/835		
	F26DBX/840/4P/EOL	4000	DULUX D/E 26W/840	PL-C 26W/840/4P	Lynx DE 26W/840		
	F26DBX/865/4P/EOL	6500	DULUX D/E 26W/865	-	Lynx DE 26W/860		
	Biax™T 2pin		Dulux T Plus	Master PL-T	Lynx-T		
13W	F13TBX/827/A/2P	2700	-	PL-T 13W/827/2P	-		
	F13TBX/830/A/2P	3000	DULUX T 13W/830	PL-T 13W/830/2P	-		
	F13TBX/840/A/2P	4000	DULUX T 13W/840	PL-T 13W/840/2P	-		
18W	F18TBX/827/A/2P	2700	DULUX T 18W/827	PL-T 18W/827/2P	-		
	F18TBX/830/A/2P	3000	DULUX T 18W/830	PL-T 18W/830/2P	Lynx T 18W/830		
	F18TBX/840/A/2P	4000	DULUX T 18W/840	PL-T 18W/840/2P	Lynx T 18W/840		
26W	F26TBX/827/A/2P	2700	DULUX T 26W/827	PL-T 26W/827/2P	-		
	F26TBX/830/A/2P	3000	DULUX T 26W/830	PL-T 26W/830/2P	Lynx T 26W/830		
	F26TBX/840/A/2P	4000	DULUX T 26W/840	PL-T 26W/840/2P	Lynx T 26W/840		
	Biax™T/E 4pin		Dulux T/E Plus	Master PL-T 4pin	Lynx- TE		
13W	F13TBX/827/A/4P/EOL	2700	DULUX T/E 13W/827	PL-T 13W/827/4P	-		
	F13TBX/830/A/4P/EOL	3000	DULUX T/E 13W/830	PL-T 13W/830/4P	-		
	F13TBX/835/A/4P/EOL	3500	-	-	-		
	F13TBX/840/A/4P/EOL	4000	DULUX T/E 13W/840	PL-T 13W/840/4P	-		
18W	F18TBX/827/A/4P/EOL	2700	DULUX T/E 18W/827	PL-T 18W/827/4P	-		
	F18TBX/830/A/4P/EOL	3000	DULUX T/E 18W/830	PL-T 18W/830/4P	Lynx TE 18W/830		
	F18TBX/835/A/4P/EOL	3500	-	-	-		
	F18TBX/840/A/4P/EOL	4000	DULUX T/E 18W/840	PL-T 18W/840/4P	Lynx TE 18W/840		
26W	F26TBX/827/A/4P/EOL	2700	DULUX T/E 26W/827	PL-T 26W/827/4P	-		
	F26TBX/830/A/4P/EOL	3000	DULUX T/E 26W/830	PL-T 26W/830/4P	Lynx TE 26W/830		
	F26TBX/835/A/4P/EOL	3500	-	-	-		
	F26TBX/840/A/4P/EOL	4000	DULUX T/E 26W/840	PL-T 26W/840/4P	Lynx TE 26W/840		
32W	F32TBX/827/A/4P/EOL	2700	DULUX T/E 32W/827	PL-T 32W/827/4P	-		
	F32TBX/830/A/4P/EOL	3000	DULUX T/E 32W/830	PL-T 32W/830/4P	Lynx TE 32W/830		
	F32TBX/835/A/4P/EOL	3500	-	-	-		
	F32TBX/840/A/4P/EOL	4000	DULUX T/E 32W/840	PL-T 32W/840/4P	Lynx TE 32W/840		
42W	F42TBX/827/A/4P/EOL	2700	DULUX T/E 42W/827	PL-T 42W/827/4P	-		
	F42TBX/830/A/4P/EOL	3000	DULUX T/E 42W/830	PL-T 42W/830/4P	Lynx TE 42W/830		
	F42TBX/841/A/4P/EOL	3500	-	-	-		
	F42TBX/835/A/4P/EOL	4000	DULUX T/E 42W/840	PL-T 42W/830/4P	Lynx TE 42W/840		



Brand cross reference

GE		OSRAM	PHILIPS	Havells Sylvania
Biax™Q/E 4pin		Colour temperature	Dulux T/E	PL-T
				Lynx- TE
57W	F57QBX/827/A/4P/EOL	2700	-	PL-T 57W/827/4P
	F57QBX/830/A/4P/EOL	3000	-	PL-T 57W/830/4P
	F57QBX/835/A/4P/EOL	3500	-	-
	F57QBX/840/A/4P/EOL	4000	-	PL-T 57W/840/4P
70W	F70QBX/830/A/4P/EOL	3000	-	-
	F70QBX/835/A/4P/EOL	3500	-	-
	F70QBX/840/A/4P/EOL	4000	-	-
Biax™L 4pin			Dulux-L	PL-L
				Lynx L & Lynx-LE
18W	F18BX/827	2700	DULUX L 18W/827	-
	F18BX/830	3000	DULUX L 18W/830	PL-L 18W/830/4P
	F18BX/835	3500	DULUX L 18W/835	PL-L 18W/835/4P
	F18BX/840	4000	DULUX L 18W/840	PL-L 18W/840/4P
24W	F24BX/827	2700	DULUX L 24W/827	-
	F24BX/830	3000	DULUX L 24W/830	PL-L 24W/830/4P
	F24BX/835	3500	DULUX L 24W/835	PL-L 24W/835/4P
	F24BX/840	4000	DULUX L 24W/840	PL-L 24W/840/4P
34W	F34BX/830	3000	-	-
	F34BX/835	3500	-	-
	F34BX/840	4000	-	-
36W	F36BX/827	2700	DULUX L 36W/827	-
	F36BX/830	3000	DULUX L 36W/830	PL-L 36W/830/4P
	F36BX/835	3500	DULUX L 36W/835	-
	F36BX/840	4000	DULUX L 36W/840	PL-L 36W/840/4P
	F36BX/865	6500	DULUX L 36W/865	PL-L 36W/865/4P
40W	F40BX/830	3000	DULUX L 40W/830	PL-L 40W/830/4P
	F40BX/835	3500	DULUX L 40W/835	PL-L 40W/835/4P
	F40BX/840	4000	DULUX L 40W/840	PL-L 40W/840/4P
55W	F55BX/830	3000	DULUX L 55W/830	PL-L 55W/830/4P
	F55BX/835	3500	DULUX L 55W/835	PL-L 55W/835/4P
	F55BX/840	4000	DULUX L 55W/840	PL-L 55W/840/4P
	F55BX/854	6500	DULUX L 55W/865	PL-L 55W/865/4P
Biax™ 2D 2pin				PL-Q 2pin
				Lynx-Q (GR8 base) 2 pin
16W	F162D/827 GE 20PK WM	2700	CFL Square 16W/827	PLQ 16W/827/2P
	F162D/835 GE 20PK	3500	CFL Square 16W/835	PLQ 16W/835/2P
	F162D/860 GE 20PK	6000	-	-
28W	F282DT5/827/2P BL 1/20 WM	2700	CFL Square 28W/827	-
Biax™ 2D 4pin				PL-Q 4pin
				Lynx-QE 4 pin
10W	OT F10W/2D/827/4P GE BL 1/20	2700	-	-
	OT F10W/2D/835/4P GE BL 1/20	3500	-	-
16W	F162D/827/4P GE 20PK	2700	CFL Square 16W/827	PLQ 16W/827/4P
	F162D/830/4P BL1/20 WM	3000	-	PLQ 16W/830/4P
	F162D/835/4P GE 20PK	3500	CFL Square 16W/835	PLQ 16W/835/4P
21W	F212D/827/4P GE 20PK	2700	-	-
	F212D/835/4P GE 20PK	3500	-	-
	F212D/860/4P GE 20PK	6000	-	-
28W	F282DT5/827/4P BL 1/20 WM	2700	CFL Square 28W/827	PLQ 28W/827/4P
	F282D/830/4P BL1/20 WM	3000	-	PLQ 28W/830/4P
	F282DT5/835/4P BL 1/20 WM	3500	CFL Square 28W/835	PLQ 28W/835/4P
	F282DT5/840/4P BL 1/20 WM	4000	-	PLQ 28W/840/4P
38W	F382DT5/827/4P BL 1/20 WM	2700	CFL Square 38W/827	PLQ 38W/827/4P
	F382D/830/4P BL1/20 WM	3000	-	PLQ 38W/830/4P
	F382DT5/835/4P BL 1/20 WM	3500	-	PLQ 38W/835/4P
55W	F55 2D/827/A 4P BL20 MIH	2700	-	-
	F55 2D/830/A 4P BL20 MIH	3000	-	-
	F55 2D/835/A 4P BL20 MIH	3500	-	-
Biax™ 2D Integral				
18W	FLE18W2D/827 GRZ10D 1/10	2700	-	-
	FLE18W2D/835 GRZ10D 1/10	3500	-	-
	FLE18W2D/840 GRZ10D 1/10	4000	-	-

Regulatory update

In 2013 September there will be further changes in European Legislation that affect the lighting industry and are common to all manufacturers. We at GE would like to guide our customers through these changes and assist you in finding the best possible solutions.

The changes affect a number of products and involve changes to categories such as Lifetime and Switching Cycles. There are additional changes that affect the packaging, including amendments to the energy label.

As a result, some of the known products will be phased out of the market, and some new products will arrive to replace them. Please consult your sales representative for more information as to how these changes affect you and to find a solution that best fits your needs.

Based on the amount of changes and products involved, you will appreciate that the full changeover will take a period of time to complete and, therefore, some of the affected product lines will be phased in over a number of weeks/months.

What does this mean for the Compact Fluorescent Lamps Integrated product range?

GE Lighting EMEA will stay on the market with the Household portfolio. For CFLi to be able to do so, we have to upgrade the performance of the complete CFLi range. To accomplish this, a pre-requisite is to rationalize the existing range, followed by the technical validation of the upgraded performance product range. GE is in the process of executing these changes.

The new products are expected to arrive in multiple waves throughout 2013 and 2014. Customers can order old and new products from stock, subject to availability.

We at GE will do all we can to continuously provide you with the best quality service. We thank you in advance for your understanding and patience.

GE is proud to be at the forefront of bringing new technologies and greener products to the market but is also supporting this legislation that improves the performance criteria of current product to provide our customers with the choices that they demand.

The Environment:

There are a number of estimates, ranging from 24 million to 39 million tons of annual carbon dioxide emissions that will be eliminated with the full implementation of the EU regulations. GE Lighting is fully committed to reducing carbon emissions, and as a member of the European Lamp Companies Federation it helped develop the new regulations that are now being implemented.

For further information please visit our Environmental Center:

<http://www.gelighting.com/LightingWeb/emea/resources/environmental-center/index.jsp>

Compact Fluorescent Lamps Integrated



Compact Fluorescent Lamps Integrated

Save money on energy bills and maintain quality

Longer life from 6,000 to 15,000 hours

Quick start Flicker-free and fast warm-up

Fit almost everywhere stick, spiral, small incandescent shapes

Environmentally friendly solutions – with reduced mercury content

Special options high switching cycles up to 100,000

Energy efficient and economic 80% efficiency vs. traditional incandescent *

GE Lighting's integrated compact fluorescent lamps combine energy saving benefits with high quality lighting.

Integrated compact fluorescent lamps are suitable for a variety of applications, available in decor incandescent sizes and look-a-like shapes, with both ES and BC caps.

Outstanding light quality is guaranteed throughout the life of the lamps with colour temperatures from 2600 to 6500K.



Home



Office



*from our 'A' energy labelled products



V.1

Switching from Watts to Lumens

Traditional light bulbs are being phased out as modern light technologies use different amounts of power to achieve the same amount of light. Instead of referring to watts anymore, we now need to measure and compare light in terms of lumens.

Save money on bills yet lose nothing in quality with GE's new electronic compact fluorescent (eCFL) lamps. Ideal for ambient light, eCFLs combine energy saving benefits with high quality lighting.

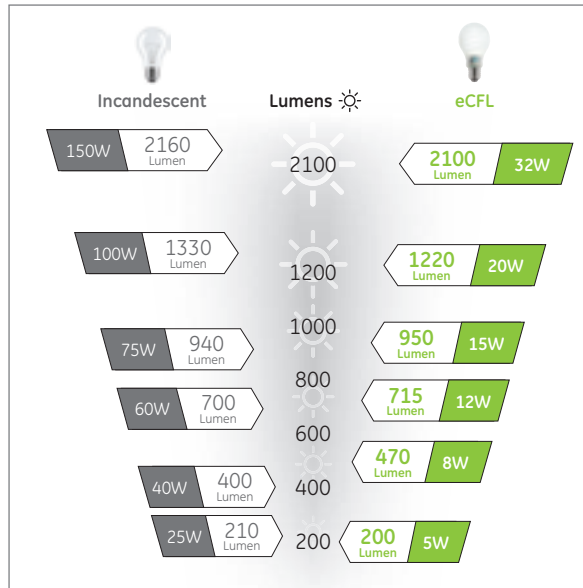

Quick guide to GE Lighting packaging

- Product information box**
- Cap type**
- Clear Image of lamp and base**
- Product symbol**
- Wattage comparison**
- Lumen output and colour temperature**
- Energy rating illustration**
- Rated life in hours**
- Energy consumption**
- Safety and warning notices**

LongLast™ Spiral T2

The LongLast™ T2 Spiral Compact Fluorescent Lamp (CFL) is the smallest size long life CFL lightbulb on the market.

This unique lamp offers excellent light quality over its 15,000 hours rated life and can be used in indoor or outdoor applications.

With continuing technological advancements and miniaturisation, today's T2 CFL lamps are even smaller than the incandescent lamps that they replace to ensure that they are discreet – yet high performing.

LongLast™

- 15,000 hours rated life
- Small dimensions
- Fast warm-up
- 20,000 high switching cycle endurance
- Low mercury content <1 mg
- 'A' energy class

Product range:

LongLast™ T2 Spiral lamps are available in a full range of:

- 8, 12, 15, 20 and 23 wattages
- E27 and B22 caps
- Warm (2700K) and Cool (4000K) colours



Stick T3 Mini

The T3 10,000 hours Mini stick range offers low energy consumption in a compact size, along with additional benefits such as instant light-on and fast warm-up. Stick shaped lamps provide an energy saving alternative for almost all applications where incandescent bulbs are currently used – ensuring excellent light quality and reliable energy savings.



- 10,000 hours rated life
- Fast warm-up
- Instant switch on feature
- 'A' energy class
- Small dimensions

Product range:

Stick T3 Mini 10,000 hours lamps are available in:

- 9W, 11W, 15W, 20W and 23W
- E14, E27, B22 caps
- Warm (2700K), Cool (4000K) and Daylight (6500K) colours

Compact Fluorescent Lamps Integrated

Stick



T3 Mini

Cap: E27, E14, B22
Wattages: 9-23W
Colours: 2700-6500K
Rated life: 10,000Hrs

Page V.8



T3 Mini Economy

Cap: E27, E14, B22
Wattages: 9-23W
Colours: 2700K
Rated life: 6,000-7,000Hrs

Page V.8

Spiral



LongLast T2

Cap: E27, B22
Wattages: 8-23W
Colours: 2700-4000K
Rated life: 15,000Hrs

Page V.9



T2

Cap: E27, E14, B22
Wattages: 8-23W
Colours: 2700-6500K
Rated life: 8,000 -
10,000Hrs

Page V.9



T3

Cap: E27
Wattages: 11-20W
Colours: 2700-6500K
Rated life: 8,000Hrs

Page V.10



T4 High Power Factor (HPF)

Cap: E27
Wattages: 32W
Colours: 2700K
Rated life: 10,000Hrs

Page V.10

Selector

Decor



GLS T2/T3

Cap: E27, E14, B22
Wattages: 8-20W
Colours: 2700K
Rated life: 6,000Hrs

Page V.10



Spherical T2

Cap: E27, E14, B22
Wattages: 5-7W
Colours: 2700K
Rated life: 6,000Hrs

Page V.11



Candle T2/T3

Cap: E27, E14, B22
Wattages: 7-11W
Colours: 2700-4000K
Rated life: 6,000 - 8,000Hrs

Page V.11

Globe



Globe T3

Cap: E27
Wattages: 20-23W
Colours: 2700K
Rated life: 8,000Hrs

Page V.12

Reflector



Genura

Cap: E27
Wattages: 23W
Colours: 2700-3000K
Rated life: 15,000Hrs

Page V.12

Compact Fluorescent Lamps Integrated

Product identification

The following glossary of terms will help you when selecting lamps in this section. Within each product line, lamps are divided into families – within these families, lamps are listed by wattage. The Product Description can be used as a quick reference to each product's attributes. Where "rated life" or "median life" are stated we refer to the industry standard definition of how many hours of operation 50% of a given installation will exceed.

Watts:

Energy Used – Nominal Watts.

To estimate energy consumption (kWh), multiply watts x hours of use and divide by 1000

Cap:

See cap drawings in the end of the catalogue.

Lumens:

Light output after the initial 100 hours of operation

Diameter:

Bulb diameter in mm

Volts:
Lamp data is based on operation at rated voltage

Product description:
The lamp's identification code

CRI:
Colour rendering index, the higher the number (1-100), the more natural the lit subject appears

EEC:
Energy Efficiency Class

Wattage [W]

Volts [V]

Cap

Product Description

Product Code

Lumen [lm]

CCT [K]

CRI [Ra]

Rated life [h]

Diameter [mm]

Length [mm]

EEC

Energy Cons. [kWh]

Pack Qty

Spiral T2 - 15,000 hours

9	220-240	B22	FLE9TBX/T3/827/B22	71100	470	2700	82	10,000	110	45	A	8.96	8
9	220-240	E27	FLE9TBX/T3/827/E27	71297	470	2700	82	10,000	111	45	A	8.96	8
9	220-240	E14	FLE9TBX/T3/827/E14	71298	470	2700	82	10,000	120	45	A	8.96	8

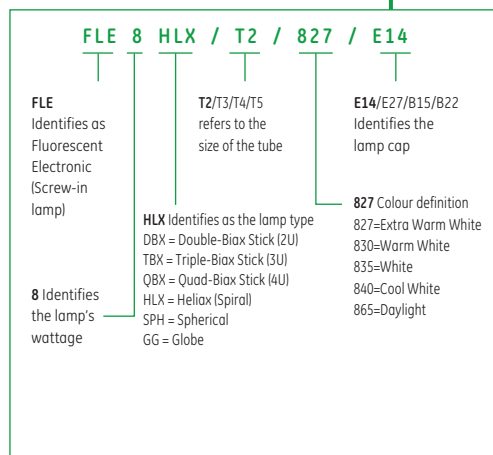

CCT:

Colour temperature – Kelvin [K]. The visual warmth or coolness of the light. The higher the number the whiter or cooler the light appears

Product code:

It is important to use this code when ordering to ensure that you receive the exact product you require

Length:

Lamp length in mm

Energy Consumption:

kWh/1000h

Rated life:

The point in time when 50% of installed lamps are still burning

Pack quantity:

Number of product units packed in a case

Wattage (W)	Volts (V)	Cap	Product Description	Product Code	Lumen (lm)	CCT (K)	CRI (Ra)	Rated life (h)	Length (mm)	Diameter (mm)	EEC	Energy Cons. (kWh)	Pack Qty
9	220-240	B22	FLE9TBX/T3/827/B22	71100	470	2700	82	10,000	110	45	A	8.96	8
9	220-240	E27	FLE9TBX/T3/827/E27	71297	470	2700	82	10,000	111	45	A	8.96	8
9	220-240	E14	FLE9TBX/T3/827/E14	71298	470	2700	82	10,000	120	45	A	8.96	8
9	220-240	E27	FLE9TBX/T3/840/E27	71299	470	4000	82	10,000	111	45	A	9.10	10
9	220-240	E27	FLE9TBX/T3/865/E27	71300	450	6500	82	10,000	111	45	A	8.97	10
9	220-240	E14	FLE9TBX/T3/865/E14	71382	450	6500	82	10,000	120	45	A	8.97	10
11	220-240	E27	FLE11TBX/T3/827/E27	71117	590	2700	82	10,000	123	45	A	10.54	8
11	220-240	B22	FLE11TBX/T3/827/B22	71118	590	2700	82	10,000	122	45	A	10.54	8
11	220-240	E14	FLE11TBX/T3/827/E14	71296	590	2700	82	10,000	132	45	A	10.54	8
11	220-240	E27	FLE11TBX/T3/840/E27	71500	590	4000	82	10,000	123	45	A	10.56	10
11	220-240	E27	FLE11TBX/T3/865/E27	71125	560	6500	82	10,000	123	45	A	10.71	8
11	220-240	E14	FLE11TBX/T3/865/E14	71501	560	6500	82	10,000	132	45	A	10.71	10
15	220-240	E27	FLE15TBX/T3/827/E27	71116	850	2700	82	10,000	134	45	A	14.38	8
15	220-240	E27	FLE15TBX/T3/840/E27	72375	850	4000	82	10,000	134	45	A	14.46	10
15	220-240	E27	FLE15TBX/T3/865/E27	72376	810	6500	82	10,000	134	45	A	14.55	10
20	220-240	E27	FLE20TBX/T3/827/E27	72379	1185	2700	82	10,000	146	45	A	18.20	8
20	220-240	B22	FLE20TBX/T3/827/B22	72380	1185	2700	82	10,000	145	45	A	18.20	8
20	220-240	E27	FLE20TBX/T3/840/E27	72381	1155	4000	82	10,000	146	45	A	18.04	10
20	220-240	E27	FLE20TBX/T3/865/E27	72382	1155	6500	82	10,000	146	45	A	18.32	10
23	220-240	B22	FLE23QBX/T3/827/B22	71119	1400	2700	82	10,000	152	51	A	22.15	8
23	220-240	E27	FLE23QBX/T3/827/E27	71124	1400	2700	82	10,000	153	51	A	22.15	8
23	220-240	E27	FLE23QBX/T3/840/E27	72383	1400	4000	82	10,000	153	51	A	22.19	8

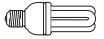

Stick T3 Mini Economy - 6,000-7,000 hours

9	220-240	B22	FLE9DBX/T3/827/B22	63908	435	2700	80	6,000	123	40.0	A	N/A	8
9	220-240	E14	FLE9DBX/T3/827/E14	63965	435	2700	80	6,000	123	40.0	A	N/A	8
11	220-240	E27	FLE11DBX/T3/827/E27	61502	600	2700	80	6,000	142	44.5	A	N/A	10
11	220-240	B22	FLE11DBX/T3/827/B22	63909	600	2700	80	6,000	141	44.5	A	N/A	8
11	220-240	E27	FLE11DBX/T3/827/E27	63968	600	2700	80	6,000	142	44.5	A	N/A	8
15	220-240	E27	FLE15TBX/T3/827/E27	71108	820	2700	82	7,000	136	44.5	A	13.76	10
20	220-240	E27	FLE20TBX/T3/827/E27	71115	1152	2700	82	7,000	154	44.5	A	18.69	10
20	220-240	B22	FLE20TBX/T3/827/B22	72385	1152	2700	82	7,000	153	44.5	A	18.69	8
20	220-240	E27	FLE20TBX/T3/827/E27	72387	1152	2700	82	7,000	154	44.5	A	18.69	8

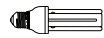

Compact Fluorescent Lamps Integrated

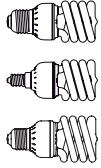

Wattage (W)	Volts (V)	Cap	Product Description	Product Code	Lumen (lm)	CCT (K)	CRI (Ra)	Rated life (h)	Length (mm)	Diameter (mm)	EEC	Energy Cons. (kWh)	Pack Qty
LongLast™ Spiral T2 – 15,000 hours**													
8	220-240	E27	FLE8HLX/T2/827/E27	76154	470	2700	80	15,000	85	45	A	8.10	8
12	220-240	E27	FLE12HLX/T2/827/E27	98887	715	2700	80	15,000	98	52	A	13.10	6
12	220-240	B22	FLE12HLX/T2/827/B22	98891	715	2700	80	15,000	98	52	A	13.10	6
15	220-240	E27	FLE15HLX/T2/827/E27	98888	950	2700	80	15,000	98	52	A	14.21	6
15	220-240	E27	FLE15HLX/T2/840/E27	78196	950	4000	80	15,000	98	52	A	14.15	6
20	220-240	E27	FLE20HLX/T2/827/E27	98889	1220	2700	80	15,000	118	56	A	20.19	6
23	220-240	E27	FLE23HLX/T2/827/E27	98890	1500	2700	80	15,000	126	56	A	22.39	6

**New product codes for upgraded performance will be published in 2014's catalogue.

Spiral T2 – 8,000-10,000 hours



8	220-240	E14	FLE8HLX/T2/827/E14	85637	470	2700	82	8000	93	46	A	8.00	8
8	220-240	E27	FLE8HLX/T2/827/E27	85638	470	2700	82	8000	89.5	46	A	8.00	10
8	220-240	E14	FLE8HLX/T2/865/E14	85633	430	6500	82	8000	93	46	A	8.00	8
8	220-240	E27	FLE8HLX/T2/865/E27	85634	430	6500	82	8000	89.5	46	A	8.00	8
12	220-240	E14	FLE12HLX/T2/827/E14	85639	715	2700	82	10000	102	46	A	11.13	6
12	220-240	E27	FLE12HLX/T2/827/E27	85640	715	2700	82	10000	100	46	A	11.13	6
12	220-240	B22	FLE12HLX/T2/827/B22	85641	715	2700	82	10000	99	46	A	11.13	6
12	220-240	E27	FLE12HLX/T2/865/E27	85635	665	6500	82	10000	100	46	A	11.23	10
15	220-240	E27	FLE15HLX/T2/865/E27	85636	900	6500	82	10000	107	49.5	A	14.94	10
15	220-240	E27	FLE15HLX/T2/827/E27	85642	950	2700	82	10000	107	49.5	A	15.19	10
15	220-240	B22	FLE15HLX/T2/827/B22	85643	950	2700	82	10000	106	49.5	A	15.19	6
20	220-240	E27	FLE20HLX/T2/827/E27	85644	1220	2700	82	10000	108	55	A	19.00	6
20	220-240	B22	FLE20HLX/T2/827/B22	85645	1220	2700	82	10000	107	55	A	19.00	10
20	220-240	E27	FLE20HLX/T2/840/E27	85646	1200	4000	82	10000	108	55	A	18.95	6
20	220-240	E27	FLE20HLX/T2/865/E27	85647	1200	6500	82	10000	108	55	A	19.05	6
23	220-240	E27	FLE23HLX/T2/827/E27	85648	1450	2700	82	10000	115	60	A	22.30	10
23	220-240	B22	FLE23HLX/T2/827/B22	85649	1450	2700	82	10000	114	60	A	22.30	10
23	220-240	E27	FLE23HLX/T2/840/E27	85650	1380	4000	82	10000	115	60	A	21.96	6
23	220-240	E27	FLE23HLX/T2/865/E27	85651	1380	6500	82	10000	115	60	A	22.83	6

Wattage (W)	Volts (V)	Cap	Product Description	Product Code	Lumen (lm)	CCT (K)	CRI (Ra)	Rated life (h)	Length (mm)	Diameter (mm)	EEC	Energy Cons. (kWh)	Pack Qty
Spiral T3 – 8,000 hours													
11	220-240	E27	FLE11HLX/T3/827/E27	89746	580	2700	82	8,000	112	42	A	10.31	10
11	220-240	E27	FLE11HLX/T3/865/E27	89740	560	6500	82	8,000	112	42	A	10.71	10
20	220-240	E27	FLE20HLX/T3/827/E27	89748	1200	2700	82	8,000	124	59	A	19.50	10
20	220-240	E27	FLE20HLX/T3/865/E27	89739	1152	6500	82	8,000	124	59	A	19.10	10
24	220-240	E27	FLE24HLX/T3/827/E27	89743	1700	2700	82	8,000	135	59	A	24.67	10
24	220-240	E27	FLE24HLX/T3/865/E27	89745	1650	6500	82	8,000	135	59	A	24.86	10



Spiral T4 High Power Factor (HPF) – 10,000 hours**

32	220-240	E27	FLE32HLX/T4/827E27/HPF	76152	2100	2700	80	10,000	172	66	A	N/A	6
----	---------	-----	------------------------	-------	------	------	----	--------	-----	----	---	-----	---



**New product codes for upgraded performance will be published in 2014's catalogue.

Wattage (W)	Volts (V)	Cap	Product Description	Product Code	Lumen (lm)	CCT (K)	CRI (Ra)	Rated life (h)	Length (mm)	Diameter (mm)	EEC	Pack Qty
GLS T2/T3 – 6,000 hours**												
8	220-240	E14	FLE8GLS/T2/827/E14	88178	370	2700	80	6,000	103.5	52.5	A	8
8	220-240	E27	FLE8GLS/T2/827/E27	88180	370	2700	80	6,000	100	52.5	A	8
12	220-240	E14	FLE12GLS/T2/827/E14	88177	625	2700	80	6,000	113.5	56	A	6
12	220-240	E27	FLE12GLS/T2/827/E27	88209	625	2700	80	6,000	110	56	A	6
12	220-240	B22	FLE12GLS/T2/827/B22	88208	625	2700	80	6,000	109	56	A	6
15	220-240	E27	FLE15GLS/T3/827/E27	88176	830	2700	80	6,000	121	61	A	6
15	220-240	B22	FLE15GLS/T3/827/B22	88175	830	2700	80	6,000	120	61	A	6
20	220-240	E27	FLE20GLS/T3/827/E27	82151	1160	2700	80	6,000	152	75	A	6

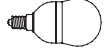
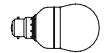

**New product codes for upgraded performance will be published in 2014's catalogue.

Compact Fluorescent Lamps Integrated

Wattage (W)	Volts (V)	Cap	Product Description	Product Code	Lumen (lm)	CCT (K)	CRI (Ra)	Rated life (h)	Length (mm)	Diameter (mm)	EEC	Pack Qty
-------------	-----------	-----	---------------------	--------------	------------	---------	----------	----------------	-------------	---------------	-----	----------

Spherical T2 – 6,000 hours**

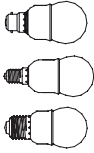

5	220-240	E14	FLE5SPH/T2/827/E14	88839	200	2700	80	6,000	100	45	A	8
5	220-240	B22	FLE5SPH/T2/827/B22	88841	200	2700	80	6,000	88	45	A	8
7	220-240	E14	FLE7SPH/T2/827/E14	88842	310	2700	80	6,000	100	45	A	8
7	220-240	B22	FLE7SPH/T2/827/B22	88844	310	2700	80	6,000	88	45	A	8
7	220-240	E27	FLE7SPH/T2/827/E27	75313	310	2700	80	6,000	89	45	A	8

**New product codes for upgraded performance will be published in 2014's catalogue.

Candle T2/T3 – 6,000-8,000 hours**

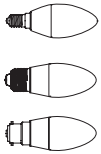

7	220-240	E14	FLE7CDL/T2/827/E14	75677	300	2700	80	6,000	108	37	A	8
7	220-240	E27	FLE7CDL/T2/827/E27	75311	300	2700	80	6,000	105	37	A	8
7	220-240	B22	FLE7CDL/T2/827/B22	88856	300	2700	80	6,000	104	37	A	10
7	220-240	E14	FLE7CDL/T2/840/E14	73451	300	4000	80	6,000	108	37	A	10
9	220-240	E14	FLE9CDL/T2/827/E14	63623	405	2700	82	8,000	113	37	A	8
9	220-240	E27	FLE9CDL/T2/827/E27	63624	405	2700	82	8,000	110.5	37	A	8
9	220-240	B15	FLE9CDL/T2/827/B15	97145	405	2700	82	8,000	111.5	37	A	8
9	220-240	B22	FLE9CDL/T2/827/B22	63625	405	2700	82	8,000	109.5	37	A	8
11	220-240	E14	FLE11CDL/T3/827/E14	76198	580	2700	80	6,000	141	50	A	6

**New product codes for upgraded performance will be published in 2014's catalogue.

Wattage [W]	Volts [V]	Cap	Product Description	Product Code	CCT [K]	Lumen [lm]	Candela [Cd]	Beam Angle [°]	CRI [Ra]	Rated life [h]	Length [mm]	Diameter [mm]	EEC	Energy Consumption [kWh]	Pack Qty
Reflector Genura R80 - 15,000 hours															
23	220-240	E27	EFL23W/827/R80/E27	82174	2700	580	270	100	80	15,000	130	83	B	22.50	6
23	220-240	E27	EFL23W/830/R80/E27	92246	3000	580	270	100	80	15,000	130	83	B	22.50	6



Wattage [W]	Volts [V]	Cap	Product Description	Product Code	Lumen [lm]	CCT [K]	CRI [Ra]	Rated life [h]	Length [mm]	Diameter [mm]	EEC	Pack Qty
Globe T3 - 8,000 hours**												
20	220-240	E27	FLE20GG/827/E27	96780	1152	2700	80	8,000	145	89	A	6
23	220-240	E27	FLE23GG/827/E27	96793	1371	2700	80	8,000	150	100	A	6

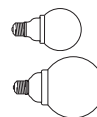

**New product codes for upgraded performance will be published in 2014's catalogue.

Regulatory update

In 2013 September there will be further changes made to European Legislation that affect the lighting industry. At GE Lighting we have the experience to guide our customers through these changes and assist in finding the best possible solutions.

The changes affect a number of products and involve changes to categories such as Lifetime and Switching Cycles. There are additional changes that affect the packaging, including amendments to the energy label.

As a result, some of the known products will be phased out of the market, and some new products will arrive to replace them. Please consult your sales representative for more information as to how these changes affect you and to find a solution that best fits your needs.

Based on the amount of changes and products involved, you will appreciate that the full changeover will take a period of time to complete and, therefore, some of the affected product lines will be phased in over a number of weeks/months.

What does this mean for the Halogen product range?

As a result of the new European Energy-Efficiency Labeling regulation, the non-directional Mains Voltage Halogen lamps are going to be moving from class C to class D.

However, these products won't be phased out from the EU market from 1st September 2013, as this regulation is not equivalent to Ecodesign – the change will only impact the displayed energy class on the packaging.

GE Lighting will do all we can to continuously provide you with the best quality service and thank you in advance for your understanding and patience.

GE Lighting is proud to be at the forefront of bringing new technologies and greener products to the market and as such is supporting this legislation that improves the performance criteria of current product to provide our customers with the choices that they demand.

The Environment:

There are a number of estimates, ranging from 24 million to 39 million tons of annual carbon dioxide emissions that will be eliminated with the full implementation of the EU regulations. GE Lighting is fully committed to reducing carbon emissions, and as member of the European Lamp Companies Federation, has it helped develop the new regulations that are now being implemented.

For further information please visit our Environmental Center:

<http://www.gelighting.com/LightingWeb/emea/resources/environmental-center/index.jsp>

Halogen Lamps



Halogen Lamps

Instant powerful bright light. Invented in 1958 by GE.

Up to 30% energy savings compared to conventional lamps

Instant re-start full light output immediately

Crisp white light, CCT up to 3000K

100% dimmable for additional cost savings

Remarkable colour rendering, close to natural light (100% CRI)

0% mercury and lead Environmentally friendly technology

Halogen lights are the ideal replacement for inefficient incandescent lamps, as their way of operation is exactly the same but they have a smaller physical size.

GE halogen lighting is perfect for accent, display and general lighting in a wide variety of commercial, industrial and residential uses.

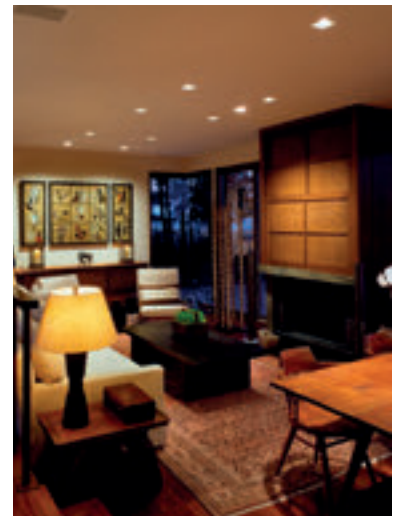

Home



Hospitality



Switching from Watts to Lumens

Traditional light bulbs are being phased out and modern light technologies use different amounts of power to achieve the same amount of light. Instead of referring to watts anymore, we now need to measure and compare light in terms of lumens.

GE's halogen lamps look just the same as traditional bulbs, with the same bright quality light, but cut down on energy consumption by up to 30%. Available in standard candle, spherical and reflector shapes, our lamps create a stunning light, and can also be used with dimming switches for a cosier atmosphere.

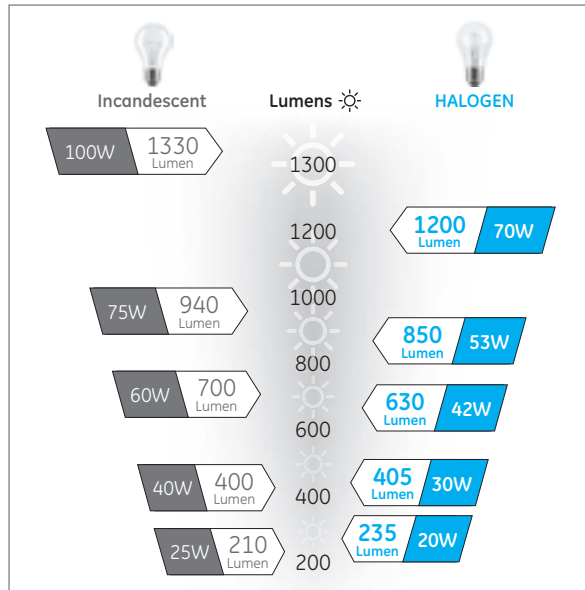

Quick guide to GE Lighting packaging

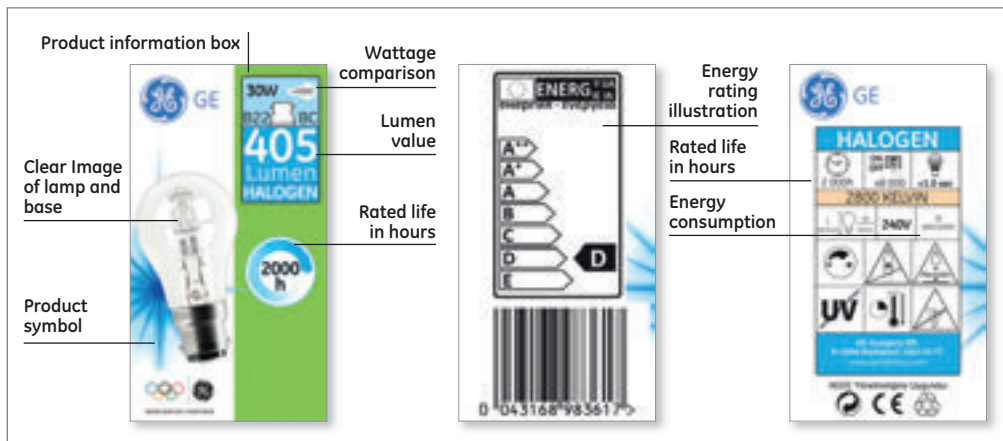

Halogen Lamps

Precise™ ConstantColor™ MR16 IR *Energy efficient low voltage halogen reflector lamps with dichroic mirror*

GE's halogen IR (infrared) range of low voltage reflector lamps provide up to 43% energy savings over conventional MR16 lamps and – with the addition of the patented GE reflector coating technology – unparalleled colour rendering throughout life.

Incandescent and halogen lamps lose approximately 76% of the input energy by radiating heat, and convert only 8% into useful light. The Precise™ IR halogen capsule has multiple layers of very durable, thin, interference film which redirects heat back onto the lamp filament. This allows it to give off more visible light for the same input power.



- Up to 43% energy savings compared to standard products
- very good white light and cool beam characteristics
- Long 5000 hour life, 2.5x longer than standard MR16's
- UV control reduces fading and discolouration

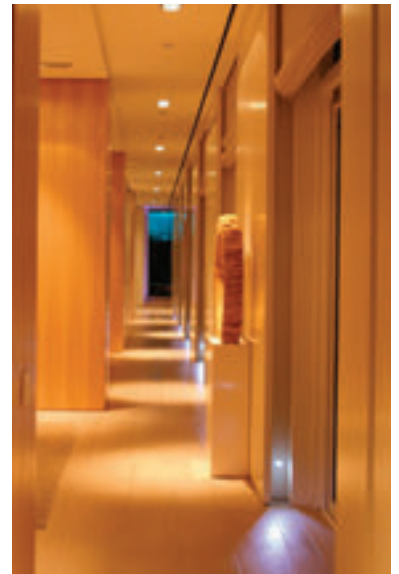

Decor HaloGLS

Familiar shape and light

GE's retrofit halogen lamp range is a direct replacement for regular incandescent lamps offering a crisp white light.



- EEH lamps are 100% retrofit
- Last twice as long as incandescent lamps
- Can be used with dimming switches
- Instant-on, full light output at start-up
- Environmentally friendly with no lead and mercury

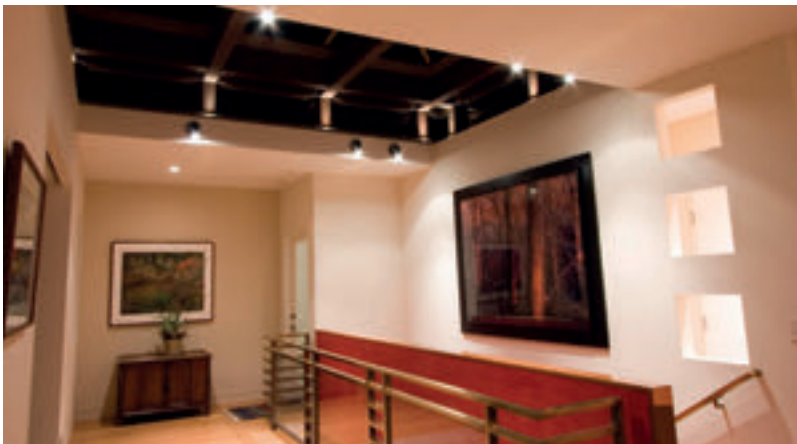

Halogen Lamps

Low Voltage Reflectors



MR11
 Cap: GU4
 Wattages: 12-35W
 Volts: 12
 Rated life: 2,000 - 3,500Hrs

Page VI.8



**Precise™
 ConstantColor™
 MR16 IR**
 Cap: GU5.3
 Wattages: 20-45W
 Volts: 12
 Rated life: 5,000Hrs

Page VI.8



Precise™ MR16 IR
 Cap: GU5.3
 Wattages: 20-35W
 Volts: 12
 Rated life: 5,000Hrs

Page VI.8



**Precise™
 ConstantColor™
 MR16**
 Cap: GU5.3
 Wattages: 20-71W
 Volts: 12
 Rated life: 4,000-6,000Hrs

Page VI.8



**Precise™ Bright
 5000 MR16**
 Cap: GU5.3
 Wattages: 20-50W
 Volts: 12
 Beam Spread: 18-60°
 Rated life: 5,000Hrs

Page VI.9



MR16 Start
 Cap: GU5.3
 Wattages: 20-100W
 Volts: 12
 Rated life: 2,000Hrs

Page VI.9



**AR111 Aluminium
 Reflector**
 Cap: G53
 Wattages: 35-75W
 Volts: 12
 Rated life: 2,000-3,000Hrs

Page VI.9

Mains Voltage Reflectors



**MR16 Mains
 Alutech™**
 Cap: GU10
 Wattages: 20-50W
 Volts: 230-240
 Rated life: 2,000Hrs

Page VI.9



**MR16 Mains
 Alutech™ -
 Coloured**
 Cap: GU10
 Wattages: 50W
 Volts: 240
 Rated life: 1,500Hrs

Page VI.10



**PAR Reflector 16,
 20, 25, 30**
 Cap: E27
 Wattages: 50-100W
 Volts: 230, 240
 Rated life: 2,000-3,000Hrs

Page VI.10

Capsules



**Mains Voltage
 Capsule G9**
 Cap: G9
 Wattages: 20-42W
 Volts: 230, 240
 Rated life: 1,000-2,000Hrs

Page VI.10



**Low voltage
 capsule - Transversal
 Filament**
 Cap: G4 or GY6.35
 Wattages: 5-100W
 Volts: 6, 12, 24
 Rated life: 100-4,000Hrs

Page VI.11



**Low voltage
 capsule - Axial
 Filament**
 Cap: G4 or GY6.35
 Wattages: 10-100W
 Volts: 6, 12
 Rated life: 2,000-4000Hrs

Page VI.11

Selector

Linear



Linear 117 mm

Cap: R7s
Wattages: 130-330W
Volts: 230, 240
Rated life: 2,000Hrs

Page VI.11



Linear 78 mm

Cap: R7s
Wattages: 100W
Rated life: 2,000Hrs

Page VI.11



Linear - High Watt

Cap: R7s
Wattages: 1000-2000W
Rated life: 2,000Hrs

Page VI.12

Decor



GLS

Cap: E27, B22
Wattages: 20-100W
Volts: 230, 240
Rated life: 2,000Hrs

Page VI.12



Candle

Cap: E14, E27, B15, B22
Wattages: 20-42W
Volts: 230, 240
Rated life: 2,000Hrs

Page VI.12



Spherical

Cap: E14, B15, E27, B22
Wattages: 20-42W
Volts: 230, 240
Rated life: 2,000Hrs

Page VI.13



Reflector

Cap: E14, E27
Wattages: 28-70W
Rated life: 2,000Hrs

Page VI.13

Tubular



Tubular T38

Cap: E40
Wattage: 1000
Volts: 230, 240
Rated life: 2,000

Page VI.13

Halogen Lamps

Product identification

The following glossary of terms will help you when selecting lamps in this section. Within each product line, lamps are divided into families – within these families, lamps are listed by wattage. The Product Description can be used as a quick reference to each product's attributes. Where Rated Life is stated we refer to the industry standard definition of how many hours of operation 50% of a given installation will exceed.

Additional parameters:

Lumens: Light output
Open/Closed: Open/closed design

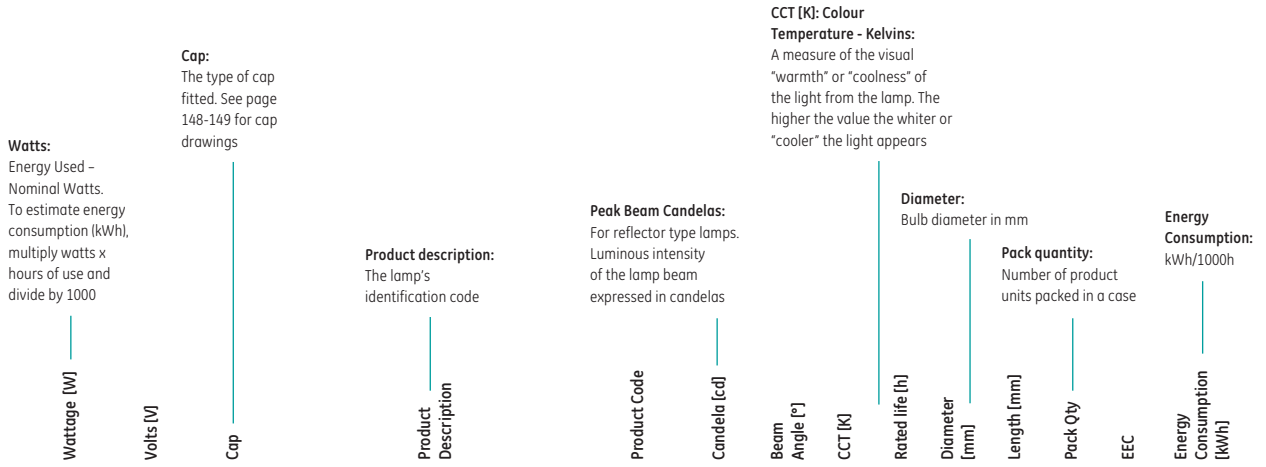

Precise™ MR11 - Open

Watts	Volts [V]	Cap	Product Description	Product Code	Candela [cd]	Beam Angle [°]	CCT [K]	Rated life [h]	Diameter [mm]	Length [mm]	Pack Qty	EEC	Energy Consumption [kWh]
20	12	GU4	M62/FTD	19626	550	26	2900	3,500	35.3	40	10	A	54,41
35	12	GU4	M66/FTF	19635	2300	21	2900	3,500	35.3	40	10	A	54,24
35	12	GU4	M199/FTH	19634	1300	26	2900	3,500	35.3	40	10	A	54,29

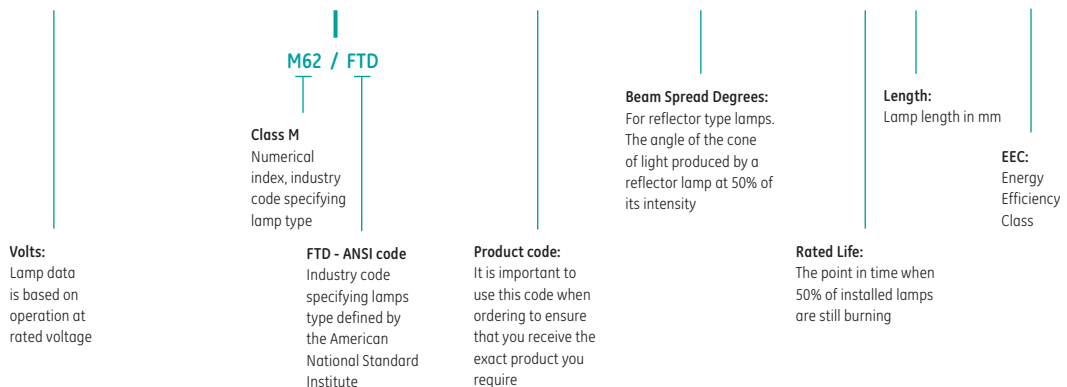

Wattage [W]	Volts [V]	Cap	Product Description	Product Code	Lumen [lm]	Candela [cd]	Beam Angle [°]	CCT [K]	Rated life [h]	Diameter [mm]	Length [mm]	Pack Qty	EEC	Energy Consumption [kWh]	Open/Closed
12	12	GU4	M264/FTA/CG	19639	120	3960	8	2900	2,000	35.3	45	10	B	13,28	closed
20	12	GU4	M251/FTC/CG	19636	205	1800	17	2900	3,500	35.3	45	10	C	20,96	closed
20	12	GU4	M62/FTD	19626	205	550	26	2900	3,500	35.3	40	10	C	20,96	open
20	12	GU4	M262/FTD/CG	19625	170	490	26	2900	3,500	35.3	45	10	C	20,96	closed
20	12	GU4	FTD/M262/CG	17200	205	490	26	2900	2,000	35	40	10	C	21,12	closed
35	12	GU4	M66/FTF	19635	460	2300	21	2900	3,500	35.3	40	10	B	38,34	open
35	12	GU4	M266/FTF/CG	19627	430	2070	21	2900	3,500	35.3	45	10	C	38,34	closed
35	12	GU4	M199/FTH	19634	430	1300	26	2900	3,500	35.3	40	10	C	38,34	open
35	12	GU4	FTF/M199/CG	17201	315	1150	26	2900	2,000	35	40	10	D	37,08	closed



Wattage [W]	Volts [V]	Cap	Product Description	Product Code	Lumen [lm]	Candela [cd]	Beam Angle [°]	CCT [K]	Rated life [h]	Diameter [mm]	Length [mm]	Pack Qty	EEC	Energy Consumption [kWh]
-------------	-----------	-----	---------------------	--------------	------------	--------------	----------------	---------	----------------	---------------	-------------	----------	-----	--------------------------

Precise™ ConstantColor™ MR16 IR

20	12	GU5.3	Q20MR16HIR/CCG36 CE	99638	300	1000	36	2900	5,000	50	46	10	B	22,84
35	12	GU5.3	Q35MR16HIR/CCG10CE	99639	520	12000	10	2950	5,000	50	46	10	B	39,01
35	12	GU5.3	Q35MR16HIR/CCG36 CE	99640	560	2000	36	2950	5,000	50	46	10	B	39,02
45	12	GU5.3	Q45MR16HIR/CCG36 CE	99641	860	2300	36	3000	5,000	50	46	10	B	50,26



Precise™ MR16 IR

20	12	GU5.3	MR16 IR 20W 12V FL	77657	270	1000	36	2900	5,000	50.7	50.5	10	B	22,47
20	12	GU5.3	MR16 IR 20W 12V FL	77659	270	1000	36	2900	5,000	50	46	10	B	22,47
30	12	GU5.3	MR16 IR 30W 12V FL	62163	470	1600	36	2950	5,000	50	46	10	B	33,60
35	12	GU5.3	MR16 IR 35W 12V FL	77658	560	2000	36	2950	5,000	50.7	50.5	10	B	38,27
35	12	GU5.3	MR16 IR 35W 12V FL	77670	560	2000	36	2950	5,000	50	46	10	B	38,27



Wattage [W]	Volts [V]	Cap	Product Description	Product Code	Lumen [lm]	Candela [cd]	Beam Angle [°]	CCT [K]	Rated life [h]	Diameter [mm]	Length [mm]	Pack Qty	EEC	Energy Consumption [kWh]	Open/Closed
-------------	-----------	-----	---------------------	--------------	------------	--------------	----------------	---------	----------------	---------------	-------------	----------	-----	--------------------------	-------------

Precise™ ConstantColor™ MR16



20	12	GU5.3	BAB/CG 12V CE	99630	220	475	40	2900	5000	50	46	10	B	20,30	closed
35	12	GU5.3	FMW/CG 12V CE	99631	450	1000	40	3000	5000	50	46	10	B	38,10	closed
50	12	GU5.3	FNV/CG 12V CE	99632	720	850	55	3050	6000	50	46	10	B	54,41	closed
50	12	GU5.3	EXN/CG 12V CE	99633	760	1500	40	3050	6000	50	46	10	B	54,24	closed
50	12	GU5.3	EXZ/CG 12V CE	99634	720	2900	25	3050	6000	50	46	10	B	54,29	closed
50	12	GU5.3	EXT/CG 12V CE	99635	680	8400	14	3050	6000	50	46	10	C	54,26	closed
71	12	GU5.3	EYC/CG 12V CE	99636	1050	2000	42	3050	4000	50	46	10	C	76,82	closed
71	12	GU5.3	EYJ/CG 12V CE	99637	1050	4550	25	3050	4000	50	46	10	C	76,57	closed





Halogen Lamps

Wattage [W]	Volts [V]	Cap	Product Description	Product Code	Lumen [lm]	Candela [cd]	Beam Angle [°]	CCT [K]	Rated life [h]	Diameter [mm]	Length [mm]	Pack Qty	EEC	Energy Consumption [kWh]	Open/Closed
-------------	-----------	-----	---------------------	--------------	------------	--------------	----------------	---------	----------------	---------------	-------------	----------	-----	--------------------------	-------------

Precise™ Bright 5000 MR16

	20	12	GU5.3	M69/BAB	88231	210	480	36	2900	5,000	50.7	46	10	B	20,83	open
	20	12	GU5.3	M269/BAB/CG	88235	205	450	36	2900	5,000	50.7	50.5	10	C	20,83	closed
	35	12	GU5.3	M81/FMW	88229	450	1390	36	2900	5,000	50.7	46	10	B	37,26	open
	35	12	GU5.3	M281/FMW/CG	88236	370	1300	36	2900	5,000	50.7	50.5	10	C	37,26	closed
	50	12	GU5.3	M58/EXN	88234	720	2250	36	2900	5,000	50.7	46	10	B	53,83	open
	50	12	GU5.3	M250/EXZ/CG	88237	675	4750	18	2900	5,000	50.7	50.5	10	C	53,83	closed
	50	12	GU5.3	M258/EXN/CG	88239	680	2100	36	2900	5,000	50.7	50.5	10	C	53,83	closed
	50	12	GU5.3	M280/FNV/CG	88238	750	950	60	2900	5,000	50.7	50.5	10	B	53,83	closed
	50	12	GU5.3	M80/FNV	88232	770	1070	60	2900	5,000	50.7	46	10	B	53,83	open

MR16 Start

	20	12	GU5.3	M268/ESX/CG/EC	38012	210	3150	12	2900	2,000	50.7	50.5	20	B	21,43	closed
	20	12	GU5.3	M269/BAB/CG/EC	38006	205	450	36	2900	2,000	50.7	50.5	20	B	21,08	closed
	35	12	GU5.3	M81/FMW/EC	38001	430	925	36	2900	2,000	50.7	47.6	20	C	37,17	open
	35	12	GU5.3	FRB/CG/EC	38013	350	6750	12	2900	2,000	50.7	50.5	20	C	37,33	closed
	35	12	GU5.3	M281/FMW/CG/EC	38007	430	830	36	2900	2,000	50.7	50.5	20	C	37,09	closed
	50	12	GU5.3	M249/EXT/CG/EC	38014	675	8550	12	2900	2,000	50.7	50.5	20	C	55,66	closed
	50	12	GU5.3	M250/EXZ/CG/EC	39611	680	2700	24	2900	2,000	50.7	50.5	20	C	54,30	closed
	50	12	GU5.3	M258/EXN/CG/EC	38011	680	1350	36	2900	2,000	50.7	50.5	20	C	53,78	closed
	50	12	GU5.3	M58/EXN/EC	38002	680	1500	36	2900	2,000	50.7	47.6	20	C	53,69	open
	50	12	GU5.3	M280/FNV/CG/EC	39236	680	630	55	2900	2,000	50.7	50.5	20	C	51,91	closed

Wattage [W]	Volts [V]	Cap	Product Description	Product Code	Lumen [lm]	Candela [cd]	Beam Angle [°]	CCT [K]	Rated life [h]	Diameter [mm]	Length [mm]	Pack Qty	EEC	Energy Consumption [kWh]
-------------	-----------	-----	---------------------	--------------	------------	--------------	----------------	---------	----------------	---------------	-------------	----------	-----	--------------------------

AR111 - Aluminium Reflector

	35	12	G53	AR111 35W12V FL	10775	290	2500	24	2900	2,000	111	67	10	D	36,90
	50	12	G53	AR111 50W12V FL	10767	510	3500	24	2900	3,000	111	67	10	D	52,31
	75	12	G53	AR111 75W12V FL	10769*	800	5300	24	2900	3,000	111	67	10	D	78,68

MR16 Mains Alutech™

	20	230	GU10	Q20MR16/230/FL	10898	90	200	36	2700	2,000	51	55	10	D	20,55
	35	230	GU10	Q35MR16/230/FL	10896	200	400	36	2700	2,000	51	55	10	D	35,56
	50	230	GU10	Q50MR16/230/FL	92729	340	600	36	2700	2,000	51	55	10	D	50,71
	20	240	GU10	Q20MR16/240/FL	10859	90	200	36	2700	2,000	51	55	10	D	20,80
	35	240	GU10	Q35MR16/240/FL	10857	200	400	36	2700	2,000	51	55	10	D	36,30
	50	240	GU10	Q50MR16/240/FL	92730	340	600	36	2700	2,000	51	55	10	D	51,20

*Can't be sold in EU, Turkey and EFTA.

Colour	Wattage [W]	Volts [V]	Cap	Product Description	Lumen [lm]	Product Code	Candela [cd]	Beam Angle [°]	CCT [K]	Rated life [h]	Diameter [mm]	Length [mm]	EEC	Energy Consumption [kWh]	Pack Qty
Red	50	240	GU10	Q50MR16/240/FL	N/A	12988	600	36	2700	1,500	51	55	D	51,2	10
Blue	50	240	GU10	Q50MR16/240/FL	N/A	12995	600	36	2700	1,500	51	55	D	51,2	10
Yellow	50	240	GU10	Q50MR16/240/FL	N/A	13003	600	36	2700	1,500	51	55	D	51,2	10

MR16 Mains Alutech™ – coloured



Wattage [W]	Volts [V]	Cap	Product Description	Product Code	Lumen [lm]	Candela [cd]	Beam Angle [°]	CCT [K]	Rated life [h]	Diameter [mm]	Length [mm]	Pack Qty	EEC	Energy Consumption [kWh]
-------------	-----------	-----	---------------------	--------------	------------	--------------	----------------	---------	----------------	---------------	-------------	----------	-----	--------------------------

PAR Reflector

50	230	E27	50PAR20/230/FL	40362	350	1000	25	2800	2,000	64.5	91	15	D	50,10
50	240	E27	50PAR20/240/FL	40365	350	1000	25	2800	2,000	64.5	91	15	D	50,30
75	240	E27	75PAR25/240/FL	92165	670	1300	25	2800	3,000	81	108	15	D	76,00
75	230	E27	75PAR30/230/FL	40349	650	2000	30	2800	2,000	97	90.5	15	D	74,30
75	240	E27	75PAR30/240/SP	40367	650	6200	10	2800	2,000	97	90.5	15	D	75,48
75	240	E27	75PAR30/240/FL	40361	650	2000	30	2800	2,000	97	90.5	15	D	75,20
100	230	E27	100PAR30/230/FL	32484	980	3100	30	2800	3,000	97	90.5	15	D	101,80
100	240	E27	100PAR30/240/FL	32482	980	3100	30	2800	3,000	97	90.5	15	D	100,70

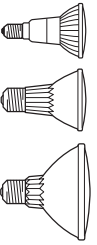

Wattage [W]	Volts [V]	Cap	Product Description	Product Code	Lumen [lm]	CCT [K]	Rated life [h]	Diameter [mm]	Length [mm]	Pack Qty	EEC	Energy Consumption [kWh]
-------------	-----------	-----	---------------------	--------------	------------	---------	----------------	---------------	-------------	----------	-----	--------------------------

Mains voltage capsule G9

20	230	G9	SHORTG9 20W CL 230V	98415	235	2800	1,000	13	43	10	TBA*	TBA*
20	240	G9	SHORTG9 20W CL 240V	98441	235	2800	1,000	13	43	10	TBA*	TBA*
33	240	G9	SHORTG9 33W CL 240V	97278	460	2800	2,000	13	43	10	D	34,00
33	230	G9	SHORTG9 33W CL 230V	97279	460	2800	2,000	13	43	10	D	33,94
42	230	G9	SHORTG9 42W CL 230V	64126	630	2800	2,000	13	43	10	D	42,93



*To be announced

Halogen Lamps

Wattage (W)	Volts (V)	Cap	Product Description	Product Code	Lumen (lm)	CCT (K)	Rated life (h)	Diameter (mm)	Length (mm)	Pack Qty	EEC	Energy Consumption (kWh)
Low voltage capsule - Transversal Filament												
10	6	G4	M29/Q10 G4**	34720	200	2800	100	9	33	20	B	11,28
20	6	G4	M30/ESB/Q20 G4**	34718	450	2900	100	9	33	20	B	22,57
20	6	G4	M34/FHE/Q20 G4	34719	350	2900	2,000	9	33	20	C	22,71
5	12	G4	M9/H5 G4	42959	60	2800	2,000	9	33	20	B	5,37
10	12	G4	M11/H10 G4	34674	140	2800	2,000	9	33	20	C	10,77
20	12	G4	M35/Q20 G4	34714	400	2900	250	9	33	20	B	22,06
20	12	G4	M47/Q20 G4	34715	380	2900	2,000	9	33	100	C	22,61
35	12	GY6.35	M95/Q35/GY6.35	34708	550	2900	3,000	11	44	100	C	38,10
50	12	GY6.35	M32/Q50 GY6.35	34702	930	2900	4,000	11	44	100	C	55,84
75	12	GY6.35	M313/Q75/GY6.35	34682	1350	2900	2,000	11	44	20	D	85,59
100	12	GY6.35	M28/Q100 GY6.35	34676	2200	2900	3,000	11	44	100	C	110,40
100	24	GY6.35	M67/Q100 GY6.35 24V	34663	2000	2900	2,000	11	44	100	D	104,66

Wattage (W)	Volts (V)	Cap	Product Description	Product Code	Lumen (lm)	CCT (K)	Rated life (h)	Diameter (mm)	Length (mm)	Pack Qty	EEC	Energy Consumption (kWh)
Low voltage capsule - Axial Filament												
10	12	G4	Q10T2,5/12V G4	35705	140	2800	2,000	9	33	20	B	22,57
20	12	GY6.35	M76/Q20/GY6.35	34712	300	2900	3,000	11	44	100	C	22,71
20	12	G4	Q20T2,5/12V G4	35710	320	2900	2,000	9	33	20	B	5,37
20	12	GY6.35	Q20T3/12V GY6.35	35696	300	2900	2,000	11	44	20	C	10,77
35	12	GY6.35	M75/Q35/GY6.35	34710	600	2900	4,000	11	44	100	B	22,06
35	12	GY6.35	Q35T3/12V GY6.35	35699	600	2900	2,000	11	44	20	C	22,61
50	12	GY6.35	M74/Q50/GY6.35	34703	900	2900	4,000	11	44	100	C	38,10
50	12	GY6.35	Q50T3/12V GY6.35	35700	900	2900	2,000	11	44	20	C	55,84
75	12	GY6.35	Q75T3/12V GY6.35	35701	1350	2900	2,000	11	44	20	D	85,59
75	12	GY6.35	M73/Q75/GY6.35	34683	1350	2900	4,000	11	44	20	C	110,40
100	12	GY6.35	M180/Q100/GY6.35	34664	2150	2900	4,000	11	44	20	D	104,66

** Projector lamp

Wattage (W)	Volts (V)	Cap	Product Description	Product Code	Lumen (lm)	CCT (K)	Rated life (h)	Diameter (mm)	Length (mm)	Pack Qty	EEC	Energy Consumption (kWh)
Linear 78mm												
100	230	R7s	K12 C100W 230V R7S 78MM	76210	1800	2900	2,000	8	80.1	10	D	104,20
100	240	R7s	K12 C100W 240V R7S 78MM	76530	1800	2900	2,000	8	80.1	10	D	104,30
100	230	R7s	K12 C100W 230V R7S 78MM	89979	1800	2900	2,000	8	80.1	10	D	104,20
100	240	R7s	K12 C100W 240V R7S 78MM	89981	1800	2900	2,000	8	80.1	10	D	104,30

Wattage (W)	Volts (V)	Cap	Product Description	Product Code	Lumen (lm)	CCT (K)	Rated life (h)	Diameter (mm)	Length (mm)	Pack Qty	EEC	Energy Consumption (kWh)
Linear 117mm												
330	230	R7s	K1 C330W 230V R7S 117MM	64967	7000	3000	2,000	10	119	10	D	349,41
200	230	R7s	K9 C200W 230V R7S 117MM	64968	4000	3000	2,000	8	119	10	D	210,60
330	240	R7s	K1 C330W 240V R7S 117MM	64970	7000	3000	2,000	8	119	10	D	351,10
200	240	R7s	K9 C200W 240V R7S 117MM	64971	4000	3000	2,000	8	119	10	D	212,67
130	230	R7s	K11 C130W 230V R7S 117MM	64973	2440	2900	2,000	8.8	119	10	D	136,53
130	240	R7s	K11 C130W 240V R7S 117MM	64974	2440	2900	2,000	8.8	119	10	D	137,93

*Notice: Please note that the rated life of those lamps under this SKU number placed on the market on or before 31 August 2013 can be either 1,000 hours or 2,000 hours. The rated life of those lamps placed on the market on or after 1 September 2013 is exclusively 2,000 hours.

Wattage (W)	Volts (V)	Cap	Product Description	Product Code	Lumen (lm)	CCT (K)	Rated life (h)	Diameter (mm)	Length (mm)	Pack Qty	EEC	Energy Consumption (kWh)
1000	230	R7s	K4 1000W 230V R7S 189MM BX	29180	21000	3,000	2,000	10	190.5	10	D	1008,0
1000	240	R7s	K4 1000W 240V R7S 189MM BX	29181	21000	3,000	2,000	10	190.5	10	D	1018,9
1500	230	R7s	K5 1500W 230V R7S 254MM BX	29184	32000	3,000	2,000	10	255.5	10	D	1539,4
1500	240	R7s	K5 1500W 240V R7S 254MM BX	29187	32000	3,000	2,000	10	255.5	10	D	1504,1
2000	230	R7s	K8 2000W 230V R7S 331MM BX	30886	44000	3,000	2,000	10	332.2	10	D	1996,1



GLS

30	240	B22	30W HALO A CL B22 240V	98361	405	2800	2,000	50	89.5	8	D	31,53
30	230	E27	30W HALO A CL E27 230V	98362	405	2800	2,000	50	89.5	10	D	31,70
30	240	E27	30W HALO A CL E27 240V	98406	405	2800	2,000	50	89.5	8	D	31,53
42	240	B22	42W HALO A CL B22 240V	62575	630	2800	2,000	50	89.5	8	D	43,65
42	230	E27	42W HALO A CL E27 230V	63613	630	2800	2,000	50	89.5	10	D	43,03
42	240	E27	42W HALO A CL E27 240V	79422	630	2800	2,000	50	89.5	8	D	43,65
53	240	B22	53W HALO A CL B22 240V	64993	850	2900	2,000	50	89.5	8	D	56,35
53	230	E27	53W HALO A CL E27 230V	63959	850	2900	2,000	50	89.5	10	D	54,96
53	240	E27	53W HALO A CL E27 240V	63961	850	2900	2,000	50	89.5	8	D	56,35
70	240	B22	70W HALO A CL B22 240V	62576	1200	2900	2,000	50	89.5	8	D	73,33
70	230	E27	70W HALO A CL E27 230V	63612	1200	2900	2,000	50	89.5	10	D	72,45
70	240	E27	70W HALO A CL E27 240V	79423	1200	2900	2,000	50	89.5	8	D	73,33
100	230	E27	100W HALO A CL E27 230V	97246	1800	2900	2,000	50	89.5	10	D	102,56
100	240	E27	100W HALO A CL E27 240V	97243	1800	2900	2,000	50	89.5	8	D	102,08
100	240	B22	100W HALO A CL B22 240V	97244	1800	2900	2,000	50	89.5	8	D	102,08

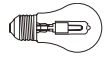

Candle

20	230	E14	20W HALO C CL E14 230V	98402	235	2900	2,000	36	100	10	D	21,46
30	230	E14	30W HALO C CL E14 230V	98398	405	2900	2,000	36	100	10	D	31,70
42	230	E14	42W HALO C CL E14 230V	76575	630	2900	2,000	36	100	10	D	43,03
30	230	E27	30W HALO C CL E27 230V	98396	405	2900	2,000	36	100	10	D	31,70
42	230	E27	42W HALO C CL E27 230V	76573	630	2900	2,000	36	100	10	D	43,03
20	240	E14	20W HALO C CL E14 240V	98399	235	2900	2,000	36	100	12	D	21,15
30	240	E14	30W HALO C CL E14 240V	98392	405	2900	2,000	36	100	12	D	31,53
42	240	E14	42W HALO C CL E14 240V	76569	630	2900	2,000	36	100	12	D	43,65
30	240	E27	30W HALO C CL E27 240V	98391	405	2900	2,000	36	100	12	D	31,53
42	240	E27	42W HALO C CL E27 240V	76568	630	2900	2,000	36	100	12	D	43,65
30	240	B15	30W HALO C CL B15 240V	98394	405	2900	2,000	36	100	12	D	31,53
42	240	B15	42W HALO C CL B15 240V	76571	630	2900	2,000	36	100	12	D	43,65
20	240	B22	20W HALO C CL B22 240V	98400	235	2900	2,000	36	100	12	D	21,15
30	240	B22	30W HALO C CL B22 240V	98393	405	2900	2,000	36	100	12	D	31,53
42	240	B22	42W HALO C CL B22 240V	76570	630	2900	2,000	36	100	12	D	43,65



Halogen Lamps

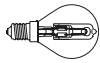

Wattage [W]	Volts [V]	Cap	Product Description	Product Code	Lumen [lm]	CCT [K]	Rated life [h]	Diameter [mm]	Length [mm]	Pack Qty	EEC	Energy Consumption [kWh]
20	230	E14	20W HALO S CL E14 230V	98390	235	2900	2,000	45	78	10	D	21,46
30	230	E14	30W HALO S CL E14 230V	98384	405	2900	2,000	45	78	10	D	31,70
42	230	E14	42W HALO S CL E14 230V	76553	630	2900	2,000	45	78	10	D	43,03
20	230	E27	20W HALO S CL E27 230V	98388	235	2900	2,000	45	78	10	D	21,46
30	230	E27	30W HALO S CL E27 230V	98382	405	2900	2,000	45	78	10	D	31,70
42	230	E27	42W HALO S CL E27 230V	76551	630	2900	2,000	45	78	10	D	43,03
20	240	E14	20W HALO S CL E14 240V	98385	235	2900	2,000	45	78	12	D	21,15
30	240	E14	30W HALO S CL E14 240V	98378	405	2900	2,000	45	78	12	D	31,53
42	240	E14	42W HALOS CL E14 240V	76548	630	2900	2,000	45	78	12	D	43,65
30	240	E27	30W HALO S CL E27 240V	98377	405	2900	2,000	45	78	12	D	31,53
42	240	E27	42W HALOS CL E27 240V	76547	630	2900	2,000	45	78	12	D	43,65
30	240	B15	30W HALO S CL B15 240V	98380	405	2900	2,000	45	78	12	D	31,53
20	240	B22	20W HALO S CL B22 240V	98386	235	2900	2,000	45	78	12	D	21,15
30	240	B22	30W HALO S CL B22 240V	98379	405	2900	2,000	45	78	12	D	31,53
42	240	B22	42W HALOS CL B22 240V	76549	630	2900	2,000	45	78	12	D	43,65



Wattage [W]	Volts [V]	Cap	Product Description	Product Code	Candela [cd]	CCT [K]	Rated life [h]	Diameter [mm]	Length [mm]	Pack Qty	EEC	Energy Consumption [kWh]
28	240	E14	28W HALO R50 E14 240V	76544	220	2900	2,000	50	86	8	E	28,87
28	230	E14	28W HALO R50 E14 230V	76546	220	2900	2,000	50	86	10	E	28,58
42	240	E27	42W HALO R63 E27 240V	76541	600	2900	2,000	63.5	101	6	TBA***	TBA***
42	230	E27	42W HALO R63 E27 230V	76543	600	2900	2,000	63.5	101	10	TBA***	TBA***
42	230	E27	42W HALO R80 E27 230V	76540	230	2900	2,000	80	121	10	TBA***	TBA***
70	230	E27	70W HALO R80 E27 230V	76537	350	2900	2,000	80	121	10	TBA***	TBA***
42	240	E27	42W HALO R80 E27 240V	76538	230	2900	2,000	80	121	6	TBA***	TBA***



Wattage [W]	Volts [V]	Cap	Product Description	Product Code	Lumen [lm]	CCT [K]	Rated life [h]	Diameter [mm]	Length [mm]	Pack Qty	EEC	Energy Consumption [kWh]
1000	230	E40	Halo T38/1000W/E40/230	32108	21000	2900	2,000	38	280	10	D	1008,89
1000	240	E40	Halo T38/1000W/E40/240	32109	21000	2900	2,000	38	280	10	D	1018,43

***To be announced



Incandescent



Incandescent Lamps

We invented incandescent technology. We know how to replace it.

From Thomas Edison's first commercially viable light bulb to the first X-ray machines, we've continued to innovate what has yet to be imagined.

GE was born from the invention of the world's first affordable incandescent lamp. More than a century later, our lighting business still brings light to the world, helping to advance new technologies, that operate with more efficiency, less cost and less environmental impact than ever before.

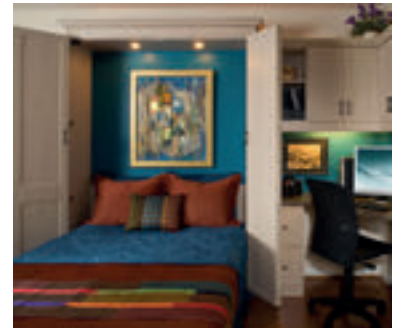

Since March 2009 a regulation was adopted in all EU countries and inefficient non-directional lamps have been gradually phased out from the EU market.

GE Lighting, as member of ELC (European Lamp Companies Federation), is fully committed to this regulation and has a complete range of new energy efficient products to replace old incandescent lamps.



Home

Switching from Watts to Lumens

How to choose your light bulb strength

Traditional light bulbs are being phased out and modern light technologies use different amounts of power to achieve the same amount of light. Instead of referring to watts anymore, we now need to measure and compare light in terms of lumens.

What are Lumens?

A lumen (lm) is a measure of the total 'amount' of visible light emitted by a source; the higher the number, the brighter the light. Choosing the right kind of light bulb depends on the strength and type of light you want.



This chart shows an example how the wattage of traditional 60W incandescent bulb with 700 lumens equals a 42W Halogen bulb emitting 630 lumens. This is equivalent to a 12W eCFL bulb emitting 625 lumens or a 12W LED bulb emitting 810 lumens.

The way forward

GE offers the very best options on the market, in a wide variety of fittings, shapes and sizes. Many have the option of warm light and are even dimmable. Most also switch on instantly.

Energy efficient light bulbs use less electricity than standard bulbs to do the same job. One energy saving light bulb could save around £2.50 a year, depending on how long you use your lights every day, and last around 10 times* longer.

*Source: Energy Saving Trust

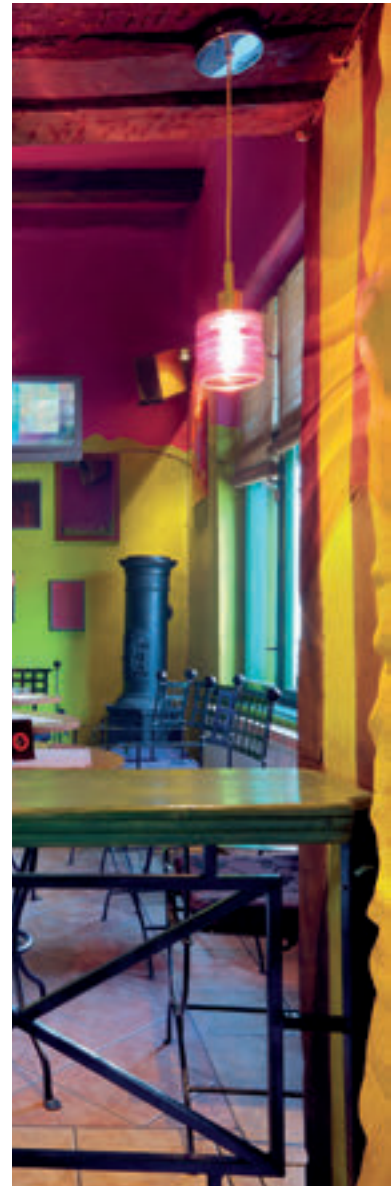

Incandescent Lamps

GLS



Standard

Cap: E27, B22 or E40
Wattages: 25-300W
Finish: Clear or Frosted
Rated life: 1,000Hrs

Page VII.6



Low Volt

Cap: E27
Wattages: 25-100W
Voltage: 24V
Finish: Clear or Frosted
Rated life: 1,000Hrs

Page VII.6



Rough Service

Cap: E27 or B22
Wattages: 40-100W
Voltage: 120, 230-240V
Finish: Frosted
Rated life: 1,500-3,000Hrs

Page VII.6



Traffic Light

Cap: E27
Wattages: 60-100W
Finish: Clear
Rated life: 3,000Hrs

Page VII.7

Spherical



Standard

Cap: E14, E27 or B22
Wattages: 40-60W
Finish: Clear or Frosted
Rated life: 1,000Hrs

Page VII.7



Coloured

Cap: E14, E27
Wattages: 15W
Finish: 5 colours
Rated life: 1,000Hrs

Page VII.7



T45

Cap: E14, E27
Wattages: 25-60W
Finish: Softlight
Rated life: 1,000Hrs

Page VII.7



Oven

Cap: E14 or E27
Wattages: 25, 40W
Finish: Clear
Rated life: 300Hrs

Page VII.8

Candle



Standard

Cap: E14, E27
Wattages: 25-60W
Finish: Opal, Frosted or Clear
Rated life: 1,000Hrs

Page VII.8



Twisted

Cap: E14
Wattages: 16-60W
Finish: Clear or Frosted
Rated life: 1,000Hrs

Page VII.8

Selector

Reflector



R39
Cap: E14
Wattages: 25-30W
Rated life: 1,000Hrs

Page VII.9



R50
Cap: E14
Wattages: 25-60W
Rated life: 1,000Hrs

Page VII.9



R63
Cap: E27
Wattages: 40-60W
Rated life: 1,000Hrs

Page VII.9



R80
Cap: E27
Wattages: 40-100W
Rated life: 1,000Hrs

Page VII.9



R95
Cap: E27
Wattages: 75-150W
Rated life: 1,000Hrs

Page VII.9



**Coloured
R50, R63, R80**
Cap: E14, E27
Wattage: 40-60W
Rated life: 1,000Hrs

Page VII.9

Infrared Reflector



**Infrared
Hard Glass**
Cap: E27
Wattages: 150-275W
Beam: Clear, Red or
Satin
Rated life: 5,000Hrs

Page VII.10

Pygmy



**Standard and
Appliance**
Cap: E14, B22
Wattages: 15-25W
Finish: Clear
Rated life: 1,000Hrs

Page VII.11

Tubular



T25
Cap: E14
Wattage: 15W
Finish: Clear
Rated life: 1,000

Page VII.10



T28
Cap: E14
Wattage: 25-60W
Finish: Clear
Rated life: 1,000

Page VII.10

Incandescent Lamps

Product identification

The following glossary of terms will help you when selecting lamps in this section. Within each product line, lamps are divided into families – within these families, lamps are listed by wattage. The Product Description can be used as a quick reference to each product’s attributes. Where Rated Life is stated we refer to the industry standard definition of how many hours of operation 50% of a given installation will exceed.

Additional parameters:

Beam Spread Degrees: For reflector type lamps. The angle of the cone of light produced by a reflector lamp at 50% of its intensity
Peak Beam Intensity: For reflector type lamps. Luminous intensity of the lamp beam expressed in candelas

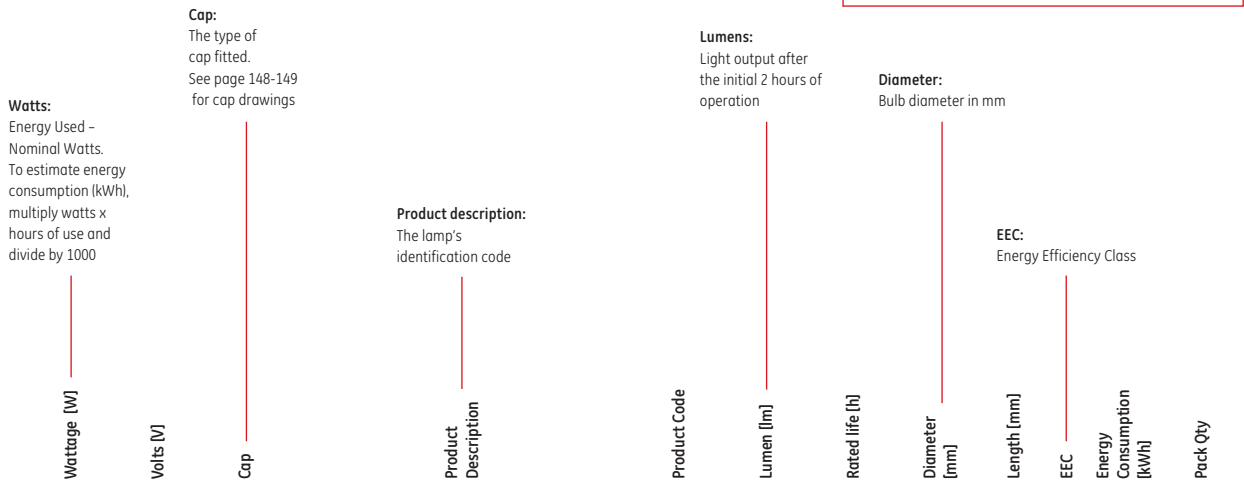

Low Volt GLS - Frosted

60	24	E27	60A1/F/E27 24V	91875	930	1,000	60	104.5	D	64.08	1/10/100
100	24	E27	100A1/F/E27 24V	91873	1740	1,000	60	104.5			1/10/100

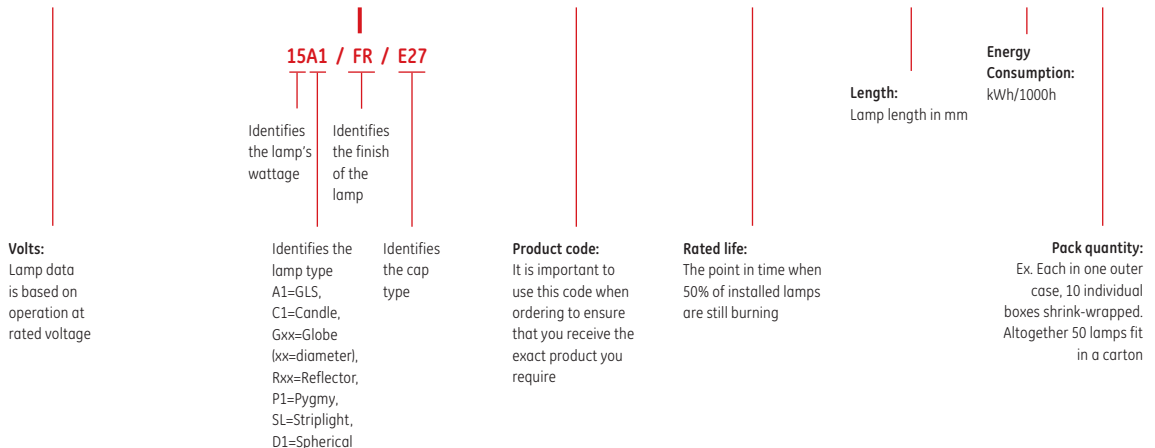

Wattage [W]	Volts [V]	Cap	Product Description	Product Code	Lumen [lm]	Rated life [h]	Diameter [mm]	Length [mm]	EEC	Energy Consumption [kWh]	Pack Qty
Standard GLS - Frosted											
40	240	E27	40A1/F/E27	19952*	410	1,000	50	88.5	E	N/A	1/10/120
60	240	E27	60A1/F/E27	19954*	700	1,000	50	88.5	E	N/A	1/10/120
100	240	E27	100A1/F/E27	19956*	1330	1,000	50	88.5	E	N/A	1/10/120
150	230	E27	150A65/FR/E27	22568*	2160	1,000	65	123	E	N/A	1/20
60	230	B22	60A1/F/B22	21663*	710	1,000	50	88.5	E	N/A	1/10/60
75	230	B22	75A1/F/B22	21664*	940	1,000	50	88.5	E	N/A	1/10/60

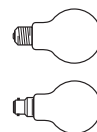

Standard GLS - Clear											
25	240	E27	25A1/CL/E27	19944*	225	1,000	50	88.5	E	N/A	1/120
40	240	E27	40A1/CL/E27	19946*	410	1,000	50	88.5	E	N/A	1/10/120
60	240	E27	60A1/CL/E27	19947*	700	1,000	50	88.5	E	N/A	1/10/120
75	240	E27	75A1/CL/E27	19948*	930	1,000	50	88.5	E	N/A	1/10/120
100	240	E27	100A1/CL/E27	19949*	1330	1,000	50	88.5	E	N/A	1/10/120
150	230	E27	150A65/CL/E27	22566*	2160	1,000	65	123	E	N/A	1/20
200	230	E27	200A1/CL/E27	91127*	3040	1,000	80	142	E	N/A	1/20
300	230-240	E27	300A1/CL/E27	91226*	4850	1,000	90	168	E	N/A	1/20
300	230-240	E40	300A1/CL/E40	91724*	4850	1,000	90	180	E	N/A	1/20
40	240	B22	40A1/CL/B22	19958*	410	1,000	50	88.5	E	N/A	1/10/120
60	240	B22	60A1/CL/B22	19962*	700	1,000	50	88.5	E	N/A	1/10/120
75	240	B22	75A1/CL/B22	19965*	930	1,000	50	88.5	E	N/A	1/10/120
100	240	B22	100A1/CL/B22	19967*	1330	1,000	50	88.5	E	N/A	1/10/120

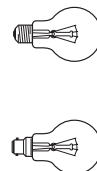

Low Volt GLS - Clear											
25	24	E27	25A1/CL/E27 24V	35178	320	1,000	60	104.5	D	25.42	1/10/100
40	24	E27	40A1/CL/E27 24V	91876	580	1,000	60	104.5	D	44.49	1/10/100
60	24	E27	60A1/CL/E27 24V	91877	930	1,000	60	104.5	D	64.00	1/10/100
100	24	E27	100A1/CL/E27 24V	35174	1740	1,000	60	104.5	D	107.39	1/10/100



Low Volt GLS - Frosted											
60	24	E27	60A1/F/E27 24V	91875	930	1,000	60	104.5	D	64.08	1/10/100
100	24	E27	100A1/F/E27 24V	91873	1740	1,000	60	104.5	D	106.64	1/10/100



Rough Service GLS - Frosted											
60	120	E27	60A1/P/VRS/E27	31546	450	1,500	60	105	E	57.52	1/20
100	120	E27	100A1/P/GRS/E27	31573	820	3,000	60	105	E	99.01	1/20
40	230-240	E27	40A1/F-RS/E27	91228	250	2,500	60	105	E	40.81	1/20
60	230-240	E27	60A1/F-RS/E27	91229	450	2,500	60	105	E	62.05	1/20
100	230-240	E27	100A1/F-RS/E27	91227	880	2,500	60	105	E	98.79	1/20
60	120	B22	60A1/P/VRS/B22	31535	450	1,500	60	103.5	E	58.06	1/20
100	120	B22	100A1/P/GRS/B22	31560	820	3,000	60	103.5	E	98.19	1/20

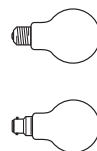

*Can't be sold in EU, Turkey and EFTA

Incandescent Lamps

Wattage (W)	Volts (V)	Cap	Product Description	Product Code	Lumen (lm)	Rated life (h)	Diameter (mm)	Length (mm)	EEC	Energy Consumption (kWh)	Pack Qty
Traffic Light GLS - Clear											
70	230	E27	70A1/CL/E27	35238	420	3,000	60	105	E	67.67	1/10/100
60	230	E27	60A1/CL/E27/TSR	35239	380	3,000	60	105	E	59.60	1/10/100
100	230	E27	100A65/CL/E27	22620	880	3,000	60	105	E	100.23	1/10



Wattage (W)	Volts (V)	Cap	Product Description	Product Code	Lumen (lm)	Rated life (h)	Diameter (mm)	Length (mm)	EEC	Energy Consumption (kWh)	Pack Qty
Spherical - Clear											
25	240	E14	25D1/CL/E14	19775*	210	1,000	45	74	E	N/A	1/10/100
40	240	E14	40D1/CL/E14	19782*	400	1,000	45	74	E	N/A	1/10/100
60	240	E14	60D1/CL/E14	19784*	660	1,000	45	74	E	N/A	1/10/100
15	230	E27	15D1/CL/E27	91917*	100	1,000	45	71	E	N/A	1/10/50
25	230	E27	25D1/CL/E27	90564*	210	1,000	45	71	E	N/A	1/10/50
40	230	E27	40D1/CL/E27	90565*	400	1,000	45	71	E	N/A	1/10/50
60	230	E27	60D1/CL/E27	91593*	660	1,000	45	71	E	N/A	1/10/50
15	230	B22	15D1/CL/B22	91911*	100	1,000	45	70	E	N/A	1/10/50
40	230	B22	40D1/CL/B22	91989*	400	1,000	45	70	E	N/A	1/10/50



Wattage (W)	Volts (V)	Cap	Product Description	Product Code	Lumen (lm)	Rated life (h)	Diameter (mm)	Length (mm)	EEC	Energy Consumption (kWh)	Pack Qty
Spherical - Frosted											
25	240	E14	25D1/FR/E14	19777*	210	1,000	45	74	E	N/A	1/10/100
40	240	E14	40D1/FR/E14	19778*	400	1,000	45	74	E	N/A	1/10/100
60	240	E14	60D1/FR/E14	19786*	660	1,000	45	74	E	N/A	1/10/50
40	230	E27	40D1/F/E27	90567*	400	1,000	45	69.5	E	N/A	1/10/50
60	230	E27	60D1/F/E27	90568*	660	1,000	45	69.5	E	N/A	1/10/50



Colour	Wattage (W)	Volts (V)	Cap	Product Description	Product Code	Lumen (lm)	Rated life (h)	Diameter (mm)	Length (mm)	EEC	Energy Consumption (kWh)	Pack Qty
Coloured Spherical												
Red	15	230	E14	15D1/R/E14	90525	N/A	1,000	45	74	E	14.21	1/10/50
Red	15	230	E27	15D1/R/E27	90531	N/A	1,000	45	71	E	14.21	1/10/50
Orange	15	230	E27	15D1/ORANGE/E27	90528	N/A	1,000	45	71	E	14.21	1/10/50
Yellow	15	230	E14	15D1/Y/E14	90526	N/A	1,000	45	74	E	14.21	1/10/50
Yellow	15	230	E27	15D1/Y/E27	90527	N/A	1,000	45	71	E	14.21	1/10/50
Green	15	230	E14	15D1/G/E14	92004	N/A	1,000	45	74	E	14.21	1/10/50
Green	15	230	E27	15D1/G/E27	91521	N/A	1,000	45	71	E	14.21	1/10/50
Blue	15	230	E14	15D1/B/E14	92001	N/A	1,000	45	74	E	14.21	1/10/50
Blue	15	230	E27	15D1/B/E27	91522	N/A	1,000	45	71	E	14.21	1/10/50



Wattage (W)	Volts (V)	Cap	Product Description	Product Code	Lumen (lm)	Rated life (h)	Diameter (mm)	Length (mm)	EEC	Energy Consumption (kWh)	Pack Qty	
Spherical T45 - Softlight												
Softlight	40	230	E14	40T45/SL/E14	90562*	350	1,000	45	74	F	N/A	1/10/50
Softlight	60	230	E14	60T45/SL/E14	91952*	600	1,000	45	74	F	N/A	1/10/50



*Can't be sold in EU, Turkey and EFTA

Wattage (W)	Volts (V)	Cap	Product Description	Product Code	Lumen (lm)	Rated life (h)	Diameter (mm)	Length (mm)	EEC	Pack Qty
Spherical Oven - Clear										
25	230	E27	25D1/CL/E27	12513	140	300	45	71	E	1/10/100
40	230	E14	40D1/CL/E14	12462	320	300	45	74	E	1/10/50
40	230	E27	40D1/CL/E27	12515	320	300	45	71	E	1/10/100

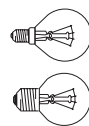

Candle - Clear										
25	240	E14	25C1/CL/E14	90478*	210	1,000	35	97	E	1/10/50
40	240	E14	40C1/CL/E14	91673*	400	1,000	35	97	E	1/10/50
60	240	E14	60C1/CL/E14	91677*	660	1,000	35	97	E	1/10/50
40	240	E27	40C1/CL/E27	10879*	400	1,000	35	93	E	1/10/100
60	240	E27	60C1/CL/E27	10880*	660	1,000	35	93	E	1/10/100



Candle - Frosted										
25	240	E14	25C1/FR/E14	91680*	210	1,000	35	97	E	1/10/50
40	240	E14	40C1/FR/E14	91682*	400	1,000	35	97	E	1/10/50
60	240	E14	60C1/FR/E14	91683*	660	1,000	35	97	E	1/10/50



Candle - Opal										
25	230	E14	25C1/SL/E14	90483*	180	1,000	35	97	F	1/10/50
40	230	E14	40C1/SL/E14	90482*	360	1,000	35	97	F	1/10/50
60	230	E14	60C1/SL/E14	90481*	600	1,000	35	97	F	1/10/50
25	230	E27	25C1/O/E27	10875*	180	1,000	35	93	F	1/10/50
40	230	E27	40C1/O/E27	10877*	360	1,000	35	93	F	1/10/50
60	230	E27	60C1/O/E27	10878*	600	1,000	35	93	F	1/10/50



Decor Candle - Twisted Clear										
15	230	E14	15TC1/CL/E14	10823*	100	1,000	35	97	E	1/10/50
25	230	E14	25TC1/CL/E14	10826*	210	1,000	35	97	E	1/10/50
40	230	E14	40TC1/CL/E14	10827*	400	1,000	35	97	E	1/10/50
60	230	E14	60TC1/CL/E14	10828*	660	1,000	35	97	E	1/10/50



Decor Candle - Twisted Frosted										
25	230	E14	25TC1/F/E14	10831*	210	1,000	35	97	E	1/10/50
40	230	E14	40TC1/F/E14	10832*	400	1,000	35	97	E	1/10/50
60	230	E14	60TC1/F/E14	10833*	660	1,000	35	97	E	1/10/50



*Can't be sold in EU, Turkey and EFTA

Incandescent Lamps



Wattage [W]	Volts [V]	Cap	Product Description	Product Code	Lumen [lm]	Candela [cd]	Beam Angle [°]	Rated life [h]	Diameter [mm]	Length [mm]	EEC	Energy Consumption [kWh]	Pack Qty
Reflector - R39													
25	230	E14	25R39/E14	91523	N/A	65	65	1,000	39	64.5	E	25,86	1/10/100
30	230	E14	30R39/E14	91524	N/A	80	65	1,000	39	64.5	E	30,46	1/10/100



Reflector - R50													
25	230	E14	25R50/E14	92373	N/A	200	35	1,000	50	86	E	24,98	1/10/50
40	230	E14	40R50/E14	92366	N/A	300	35	1,000	50	86	E	40,22	1/10/50
60	230	E14	60R50/E14	91327	N/A	600	35	1,000	50	86	E	60,20	1/10/50



Reflector - R63													
40	230	E27	40R63/E27	91079	N/A	250	35	1,000	63.5	101	E	40,30	1/10/40
60	230	E27	60R63/E27	91080	N/A	410	35	1,000	63.5	101	E	60,62	1/10/40



Reflector - R80													
40	230	E27	40R80S/E27	92858	N/A	200	35	1,000	80	121	E	40,38	1/10
60	230	E27	60R80S/E27	92839	N/A	450	35	1,000	80	121	E	60,62	1/10
75	230	E27	75R80S/E27	92859*	N/A	600	35	1,000	80	121	N/A	N/A	1/10
100	230	E27	100R80S/E27	92860*	N/A	800	35	1,000	80	121	N/A	N/A	1/10



Reflector - R95													
75	230	E27	75R95/E27	91351*	N/A	1000	35	1,000	95	129	N/A	N/A	1/32
100	230	E27	100R95/E27	91366*	N/A	1350	35	1,000	95	129	N/A	N/A	1/32
150	230	E27	150R95/E27	91367	N/A	2250	35	1,000	95	129	N/A	N/A	1/32

Colour	Wattage [W]	Volts [V]	Cap	Product Description	Product Code	Rated life [h]	Diameter [mm]	Length [mm]	EEC	Energy Consumption [kWh]	Pack Qty
--------	-------------	-----------	-----	---------------------	--------------	----------------	---------------	-------------	-----	--------------------------	----------



Coloured Reflector - R50											
Red	40	230	E14	40R50/R/E14	91386	1,000	50	86	E	39,20	1/25
Yellow	40	230	E14	40R50/Y/E14	91388	1,000	50	86	E	39,20	1/25
Green	40	230	E14	40R50/G/E14	91389	1,000	50	86	E	39,20	1/25
Blue	40	230	E14	40R50/B/E14	91387	1,000	50	86	E	39,20	1/25



Coloured Reflector - R63											
Red	40	230	E27	40R63/R/E27	91532	1,000	63.5	100	E	39,36	1/25
Yellow	40	230	E27	40R63/Y/E27	91531	1,000	63.5	100	E	39,36	1/25
Green	40	230	E27	40R63/G/E27	91533	1,000	63.5	100	E	39,36	1/25
Blue	40	230	E27	40R63/B/E27	91530	1,000	63.5	100	E	39,36	1/25



Coloured Reflector - R80											
Red	60	230	E27	60R80/R/E27	91528	1,000	80	109.5	E	57,25	1/40
Yellow	60	230	E27	60R80/Y/E27	91527	1,000	80	109.5	E	57,25	1/40
Green	60	230	E27	60R80/G/E27	91526	1,000	80	109.5	E	57,25	1/40
Blue	60	230	E27	60R80/B/E27	91525	1,000	80	109.5	E	57,25	1/40

*Can't be sold in EU, Turkey and EFTA

Wattage (W)	Volts (V)	Cap	Product Description	Product Code	Lumen (lm)	Rated life (h)	Diameter (mm)	Length (mm)	Pack Qty
Infrared Reflector Hard Glass - Clear									
150	230-240	E27	150R/IR/CL/E27	28720	5,000	125	173	173	1/9
250	230-240	E27	250R/IR/CL/E27	28724	5,000	125	173	173	1/9
275	230-240	E27	275R/IR/CL/E27	32569	5,000	125	173	173	1/9



Wattage (W)	Volts (V)	Cap	Product Description	Product Code	Lumen (lm)	Rated life (h)	Diameter (mm)	Length (mm)	Pack Qty
Infrared Reflector Hard Glass - Red Front									
150	240	E27	150R/IR/R/E27	91372	5,000	125	173	173	1/10
250	240	E27	250R/IR/R/E27	91391	5,000	125	173	173	1/10



Wattage (W)	Volts (V)	Cap	Product Description	Product Code	Lumen (lm)	Rated life (h)	Diameter (mm)	Length (mm)	Pack Qty
Infrared Reflector Hard Glass - Satin									
150	240	E27	150/IR/F/E27	91288	5,000	125	173	173	1/10
250	240	E27	250R/IR/F/E27	91390	5,000	125	173	173	1/10
275	230-240	E27	275R/IR/SA/E27	32296	5,000	125	173	173	1/9



Wattage (W)	Volts (V)	Cap	Product Description	Product Code	Lumen (lm)	Rated life (h)	Diameter (mm)	Length (mm)	EEC	Energy Consumption (kWh)	Pack Qty
Pygmy - Clear											
15	110	E14	15P1/CL/E14	31821	65	1,000	28	60	E	13.39	1/50
15	110	B22	15P1/CL/B22	31811	65	1,000	28	55	E	13.41	1/50
15	230	E14	15P1/CL/E14	12512	90	1,000	28	60	E	15.53	1/10/50
25	230	E14	25P1/CL/E14	91955	190	1,000	28	60	E	24.77	1/10/50
15	240	E14	15P1/CL/E14	91950	85	1,000	26	55	E	15.22	1/10/50
25	240	E14	25P1/CL/E14	34420	190	1,000	28	60	E	24.61	1/50



Wattage (W)	Volts (V)	Cap	Product Description	Product Code	Lumen (lm)	Rated life (h)	Diameter (mm)	Length (mm)	EEC	Energy Consumption (kWh)	Pack Qty
Pygmy Fridge - Clear											
15	230	E14	15P1/CL/E14	92046	85	1,000	26	55	E	15.21	1/10/50
15	230-240	E14	15P1/CL E14	73478	90	1,000	26	60	E	15.20	500
25	230-240	E14	25P/E14/CL	73479	190	1,000	26	60	E	25.26	500



Wattage (W)	Volts (V)	Cap	Product Description	Product Code	Lumen (lm)	Rated life (h)	Diameter (mm)	Length (mm)	EEC	Energy Consumption (kWh)	Pack Qty
Pygmy Oven - Clear											
15	230	E14	15P1/OVEN22/CL/E14	12447	85	1,000	22	48	E	15.09	1/50
15	230-240	E14	15P1/RS/CL/E14	93301	90	1,000	22	60	E	15.04	300
25	230	E14	25P1/OVEN25/CL/E14	43381	160	1,000	25	55	E	23.59	1/50
25	230-240	E14	25P1/OVEN/T25/CL	45330	190	1,000	25	60	E	23.59	250



Wattage (W)	Volts (V)	Cap	Product Description	Product Code	Lumen (lm)	Rated life (h)	Diameter (mm)	Length (mm)	EEC	Energy Consumption (kWh)	Pack Qty
Tubular T25 - Clear											
15	230	E14	15T25/CL/E14	13118	100	1,000	25	67.5	E	15.02	1/50



Wattage (W)	Volts (V)	Cap	Product Description	Product Code	Lumen (lm)	Rated life (h)	Diameter (mm)	Length (mm)	EEC	Energy Consumption (kWh)	Pack Qty
Tubular T28 - Clear											
25	230	E14	25T28/CL/E14	13109*	210	1,000	29	93.5	E	N/A	1/50
60	230	E14	60T28/CL/E14	13111*	660	1,000	29	93.5	E	N/A	1/50



*Can't be sold in EU, Turkey and EFTA

Entertainment Solutions



Entertainment lighting solutions

Range of lamp technologies incandescent, halogen, discharge and fluorescent

Multiple applications including Film, TV, Studio, Theatre, Disco, Event and many more

Extensive range from low watt up to 24,000W with a variety of bases

Variety of bases large range of bases to fit most known fixtures

Performance consistent lamp to lamp performance

Output up to 2.1 million lumens



SHOWBIZ®

for stage, studio, film and event lighting



Film and Broadcast



Event and Tour



Club and Disco



Theatre



Other applications



Main application areas

GE Lighting is a leading supplier to the entertainment industry offering a range of lamp technologies for use in applications including stage, studio, film and event lighting. GE entertainment lamps are sold under the SHOWBIZ® brand.

Film and Broadcast

Lamps for use in film and studio production.

Event and Tour

Lamps primarily used in events and concert tours, although some of this range may also be used in Club/Disco applications.

Club and Disco

Lamps primarily used in clubs and discos, although some of this range may also be used in Event/Tour applications. Also, other sealed beam applications are included in this section.

Theatre

Lamps that are primarily used in theatrical applications or indoor events.

Other applications

The technology used in GE's entertainment range also has applications in the field of architectural lighting where long life is required. There is also a range for specialist projection and photography.



SHOWBIZ® Film and Broadcast

GE has a wide range of halogen and metal halide lamps for use in film and broadcast lighting for both studio and location lighting. GE also offers a low energy compact fluorescent lighting solution for soft lighting in studios.

CSR UltraViolet-Control range

With rising awareness of UV emissions, GE leads the way with its SHOWBIZ® UV-Control lamps. Using a specially designed absorbing quartz these products offer greatly reduced UV emissions over standard products with no compromise to performance - there is simply much less UV: 98% in the UVC band. GE offers the largest range of UV-Control lamps from 200W to 12,000W. The significant reduction in UV can help extend the life of components of fixtures and protect users from any light spill from the back of the fixture.

The International Commission on Illumination (CIE) defines the UV bands as UV-A (315-400nm); UV-B (280-315nm) and UV-C (100-280nm). GE uses a UV blocking titanium-cerium doped clear fused quartz for the lamp's outer jacket. This absorbs much of the UV-B and UV-C radiation while maintaining transmittance efficiency in the visible spectrum range.

UV control

The spectra shown here are for the CSR575/SE/HR, for both standard and UV-Control lamps and shows a 98% reduction in UV-C, 99% in UV-B and a 64% reduction in UV-A across the product line.

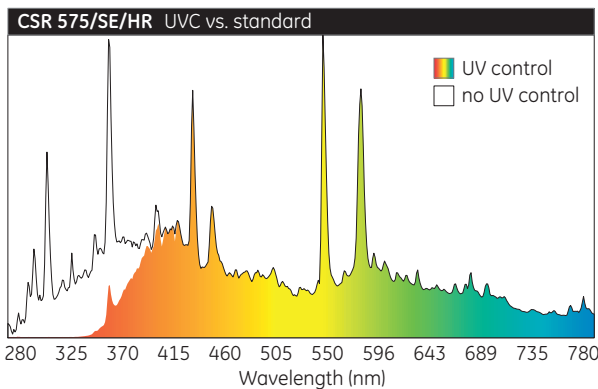

Performance & colour point

CSR UV-Control lamps perform just the same as the industry standard counterparts. UV-C lamps have the same high lumen output and colour rendering as standard products.

UV-C lamp identification

GE UV-Control lamps are easy to identify. The titanium-cerium doped outer jacket quartz fluoresces blue under black light. If no black light is available the blue tint in the quartz is visible under normal lighting conditions. The lamps also have a distinctive blue base.



Single ended hot restrike

Compact, single ended metal halide hot restrike lamps for a variety of applications requiring high luminance, reliability and excellent colour characteristics.

- Excellent colour rendering, Ra>90, and high CCT 6000K with superior colour stability
- Universal burn position with hot restrike capability
- High efficiency with excellent lumen maintenance
- Available with UV blocking



Double ended hot restrike

Double ended compact source rare earth metal halide hot restrike lamps from GE can be used in a variety of applications requiring high luminance, reliability and excellent colour characteristics.

- Industry Standard outline with hot restrike capability
- Excellent colour rendering Ra>90 and high CCT (6000–9000K) with superior colour stability
- Dimmable with stable colour
- High efficiency with excellent lumen maintenance



High watt halogen

Extensive range of single ended halogen lamps for use in film fixtures for location and studio use.

- Lower wattage lamps are available in the theatre section
- From 1250 to 24,000W
- Compatible with all known film fixtures
- Chromised seal protection

Cinema fluorescent

GE offers 55W high lumen lamps called Cinema Plus and Studio Biax for TV studio and video applications. Both lamps are colour tuned to match tungsten and daylight lamp sources.

Cinema Plus is recommended for film use. This "film friendly" lamp matches the spectral sensitivity of tungsten or daylight film stock. This full-spectrum design has a CRI up to 95 and is a gel-free light source.

Studio Biax is a perfect solution for TV and Video applications where high light output, long life and great lumen maintenance are the key needs. The Studio Biax is a triphosphor lamp colour tuned to 3200°K and 5500°K to match tungsten and daylight sources in a studio setting.



SHOWBIZ® *Event and Tour*



GE lighting has a wide range of lamps for events and tours where high light output and high colour temperature is required to give the best light effect for the performing artists and audiences.

A variety of lamps can be used for events. In this section we focus on the metal halide CSR / CSD range of lamps, however many of the sealed beam lamps in the next section are still extensively used at events and tours.

This section features the new CSR TAL lamps which give users a lamp that can be changed quickly on location - just Turn And Lock.





Single ended cold start

Compact, single ended metal halide cold start lamps for a variety of applications requiring high luminance, reliability and excellent colour characteristics.

- Excellent colour rendering Ra from 70 – 90+
- High CCT 7200 - 9000K with superior colour stability
- Universal burn position
- Dimmable with stable colour
- High efficiency with excellent lumen maintenance



CSR TAL

These single-ended metal halide lamps are especially useful for moving-light applications that call for high colour temperatures and brighter light sources. The 'Turn And Lock' technology provides easy installation.

A very short arc gap allows for higher beam intensity. This enables good system performance, colour stability and superior lumen maintenance over life.

- Easy release base (Turn And Lock) enabling quick lamp change at events
- High lumen output



Double ended hot restrike

Double ended compact source rare earth metal halide hot restrike lamps from GE can be used in a variety of applications requiring high luminance, reliability and excellent colour characteristics.

- Industry Standard outline with hot restrike capability
- Excellent colour rendering Ra>90 and high CCT (6000 K – 9000K) with superior colour stability
- Dimmable with stable colour
- High efficiency with excellent lumen maintenance

CSR single ended short arc

Metal halide short arc lamps. The special chromised seal protection allows an increased maximum operating temperature at the base of 500° C for added reliability and consistent performance.

- RA 75+
- 5600 – 7200K
- Dimmable with stable colour
- High efficiency with excellent lumen maintenance



Club and Disco



This section highlights the extensive range of GE PAR lamps available, from PAR36 to PAR64.

Some lamps in this section may not normally be used in night club or disco applications but they have been included to provide a full picture of all the possibilities that are available.

Europe and USA manufacturing

GE PAR lamps provide tried and tested quality that can be relied on. The most popular 1000W types, CP60, 61, 62 are manufactured in Europe, while most of the PAR36 and PAR56 and many of the other PAR64 types are US manufactured.

Other applications

The other applications include swimming pool lamps where the 300W PAR56 12V lamp is commonly used, locomotive lamps where the 200W PAR56 30V lamp is used, and the extensive range of ANSI PAR lamps that are used in aircraft applications.





PAR36



PAR46



PAR56



PAR64

PAR36/46/56/64

PAR lamps provide a robust and flexible design solution for a wide range of applications.

- Choice of PAR36, PAR46, PAR56 or PAR64
- 3000 K or 4200 K colour temperature
- Choice of beam widths
- Excellent colour rendering
- High efficiency combined with low operating costs
- Robust and reliable
- UV control
- Easy retrofit
- Colour consistent throughout life
- Colour blends with halogen and fluorescent

PAR lamp caps

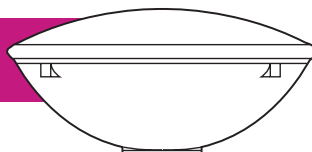

Cap



Theatre



In this section we highlight GE's extensive range of halogen lamps in both single and double ended format that are primarily used in theatre applications. With the increasing number of spectacular musicals there are a number of moving lights used in theatres, so you may also find lamps in our event section.

HPL

GE offers an extensive range of Quartzline® HPL lamps, especially designed for applications in entertainment and architectural lighting where ETC Source Four™ * fixtures are used.

**Source Four™ is a registered trademark of Electronic Theatre Controls*





Single ended halogen HPL

Developed using GE Six Sigma process, these lamps encompass modern halogen technology and high production standards.

- HPL optical system for superior field smoothness and cosine distribution
- Integral heat sink base reduces seal temperature, increases durability and maximises life
- Shock resistant filament array and patented gas chemistry minimises arc-out risk during alignment and focusing



Single ended halogen

Quartzline® lamps designed for optimum performance in today's precision range of stage, studio and architectural luminaires.

- Full range up to 3000W
- Range of bases to meet the needs of OEMs
- Chromised seal protection up to 500°C



Double ended halogen

Precision range of Quartzline® lamps widely used in theatre and many other applications.

- A range from 350W to 2,000W
- 3200K



Other applications



Architainment, Projection and Photography

The technology used in GE's entertainment range also has applications in the field of architectural lighting where long life is required. There is also a range for specialist projection and photography.



CMH PAR

The GE CMH PAR range of lamps combines constant colour ceramic metal halide with the benefits of a sealed beam. Based on the 150W single-ended CMH format, the addition of a PAR reflector provides a controlled, accurate light source for entertainment, architectural and retail lighting where making a big impression is what counts most.

The CMH PAR is also a good choice for stage use where long life is desirable, and is a great way to add drama to exhibition and museum displays.



CMH 400/GX 9.5

A long life, compact Ceramic Metal Halide lamp designed for entertainment/architectural applications. The CMH 400/GX 9.5 is a single ended lamp that provides 40,000 lumens, 90+ Ra in two colour temperatures, 3200K and 4100K. Rated life is over 6000 hours with excellent lumen maintenance.



Photo and projection

Precisely manufactured, tailored filaments which optimise source brightness, giving high performance in many applications.

High light-generating efficacy to help reduce power consumption and heat generation.

Prefocus-type caps or precision rim mounting to position the filament accurately in relation to the optics.

Product identification

Additional parameters:

LIF Code: common lamp ID within Europe

ANSI Code: common lamp ID within North America

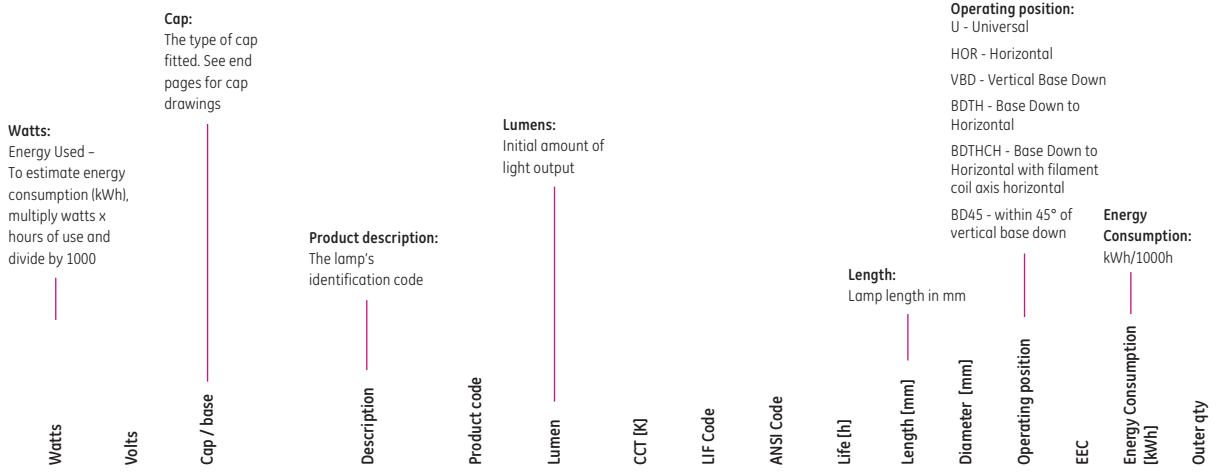

Single Ended Halogen (Lower wattages are shown in the Theatre section)

1250+650	230-240	GX38q	CP105	1250/650W	230-240V	88880	27,000+13,000	3050	CP105	-	250	220	-	BD45	D	1919.00	1
1250+1250	230-240	GX38q	CP30	230-240V		88877	27,000+27,000	3200	CP30	-	300	220	-	BD45	D	2518.00	1

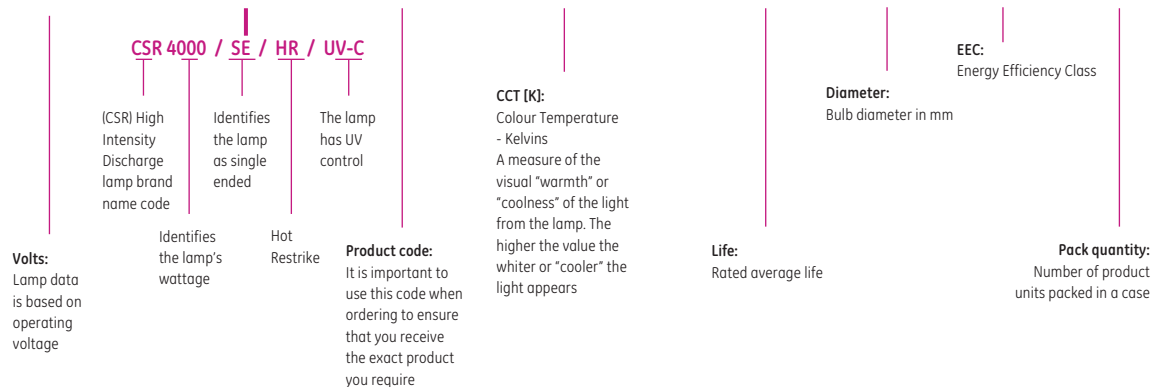

Entertainment Lamps

Film and Broadcast



Single-ended hot restrike

Watts: 125-18,000W
Lumens: 9800-1,650,000
CCT: 6000
Life: Up to 750h

Page VIII.15



Double-ended hot restrike

Watts: 200-4,000W
Lumens: 15,000-2,100,000
CCT: 5600-6000
Life: Up to 750h

Page VIII.15



Cinema Studio Biax™

Watts: 55W
Lumens: 2400-4100
CCT: 3200 & 5600
Life: Up to 8000h

Page VIII.16



Single-ended halogen

Watts: 1250-24,000W
Volts: 230-240
Lumens: 13,000-800,000
CCT: 3050-3400
Life: Up to 500h

Page VIII.16

Event and Tour



Single ended cold start

Watts: Up to 1200W
Lumens: Up to 110,000
CCT: 6500-9000
Life: 800-3000h

Page VIII.17



TAL

Watts: Up to 1500W
Lumens: Up to 129000
CCT: 5600-9800
Life: Up to 2000h

Page VIII.17



Double-ended hot restrike

Watts: 575 - 1500W
Lumens: Up to 130,000
CCT: 5800 - 7500
Life: 500 - 750h

Page VIII.17



Short arc

Watts: 700 -1200W
Lumens: Up to 100,000
CCT: 5800-7500
Life: 500-750h

Page VIII.17



Halogen TAL

Watts: 750W
Volts: 100
Lumens: 21,500
CCT: 5600-9800
Life: 200h

Page VIII.17

Club and Disco



PAR

Range: PAR36, 46, 56, 64
Watts: Up to 1200W
Candelas: Up to 765,000
Life: Up to 4000h

Page VIII.18

Selector

Theatre



Single-ended halogen -HPL

Watts: 375-750W
Volts: 115-240
Cap: G9.5/Heat Sink
Lumens: Up to 19,750

Page VIII.21



Single-ended halogen

Watts: 500-3000W
Volts: 115-240
Lumens: Up to 82,000
CCT: 2900-3200
Life: Up to 2000h

Page VIII.21



Double-ended quartzline

Watts: 350-2000W
Volts: 120-240
Lumens: Up to 57,000
CCT: 2950-3275
Life: Up to 400h

Page VIII.24

Other applications



ConstantColor™ CMH single-ended

Watts: 400W
Lumens: 40,000
CCT: 3200/4100
Life: 5000h

Page VIII.25



ConstantColor™ CMH PAR64

Watts: 150W
CCT: 3000/4200
Life: 8000h

Page VIII.25



CSS/CSI/CID

Watts: 140-1000W
Lumens: 10,000 - 1,350,000
CCT: 3800-5000
Life: 500-3500h

Page VIII.25



Special purpose lamps.
Not suitable for household illumination.

Entertainment Lamps

Film and Broadcast

Watts	Volts	Cap / base	Description	Product code	Lumen	CCT (K)	Life (h)	Length (mm)	Operating position	EEC	Energy Consumption (kWh)	Outer qty	Osram	Philips
Discharge - Single Ended Hot Restrike													Cross Reference	
125	80	GZX9.5	CSR125/SE/HR	48461	9800	6000	200	75	U	A	137.50	10	HMI125W	MSR125/HR
200	70	GZY9.5	CSR200/SE/HR/UV-C	48462	17,500	6000	200	80	U	A	220.00	10	HMI200W/SE	MSR200/HR
400	70	GZ29.5	CSR 400SE/HR/UV-C	21853	32,000	6000	750	110	U	A	440.00	10	HMI400W/SE	MSR400/HR
575	95	G22	CSR 575/SE/HR/UV-C	40460	49,000	6000	750	145	U	A	632.50	10	HMI575W/SE	MSR575/HR
800	95	G22	CSR800/SE/HR/UV-C	22495	64,000	6000	750	145	U	A	880.00	6	HMI800W/SEL	-
1200	100	G38	CSR 1200 SE/HR/UV-C	27764	110,000	6000	750	200	U	A+	1320.00	6	HMI1200W/SE	MSR1200/HR
1600	150	G38	CSR 1600/SE/HR/UV-C	65754	150,000	6000	500	175	U	A+	1760.00	6	-	-
1800	150	G38	CSR 1800/SE/HR	77390	165,000	6000	750	200	U	A+	1980.00	6	HMI1800W/SE/XS	-
2500	115	G38	CSR 2500/SE/HR/UV-C	40482	220,000	6000	500	240	U	A	2750.00	6	HMI2500W/SE	MSR2500/HR
4000	200	G38	CSR 4000SE/HR/UV-C	27765	380,000	6000	500	260	U	A+	4400.00	6	HMI4000W/SE	MSR4000/HR
6000	130	G38	CSR 6000/SE/HR/UV-C	40492	540,000	6000	300	360	U	A+	6600.00	6	HMI6000W/SE	MSR6000/HR
9000	160	G38	CSR9000/SE/HR/UV-C*	65852	875,000	6000	400	360	U	TBD	TBD	6	HMI 9000W/ SE	-
12,000	225	G38	CSR12000/SE/HR/UV-C	97272	1,150,000	6000	300	450	U	A+	13200.00	4	HMI12000W/SE	MSR12000/HR
18,000	225	G51	CSR18000/SE/HR	22496	1,650,000	6000	250	470	U	A+	19800.00	1	HMI18000W/SE	MSR18000/HR

Discharge - Double Ended Hot Restrike														
200	80	X515	CSR200/DE	48450	15000	5600	300	75	HOR±15°	A	220.00	10	HMI200W	-
1200	100	SFc 10-5-6 SI/M6	CSR1200/DE	48453	110000	6000	750	220	HOR±15°	A+	1320.00	10	HMI1200W/GS	MSI1200
2500	115	Sta21-12	CSR2500/DE	48454	240000	6000	500	355	HOR±15°	A+	2750.00	6	HMI2500W/GS	MSI2500
4000	200	Sta21-12	CSR4000/DE	48455	410000	6000	500	405	HOR±15°	A+	4400.00	6	HMI4000W/GS	MSI4000
6000	125	25X51 Cyl 165mm	CSR6000/DE	48456	570000	6000	300	450	HOR±15°	A+	6600.00	10	HMI6000W	MSI6000
12,000	160	30x70 Cyl 165mm	CSR12000/DE	48457	1100000	6000	300	470	HOR±15°	A+	13200.00	10	HMI12000W/GS	MSI12000
18,000	225	30x70 Cyl 165mm	CSR18000/DE	48459	1650000	6000	500	500	HOR±15°	A+	19800.00	4	HMI18000W	-
24,000	270	30x70 Cyl 165mm	CSR24000/DE	78710	2100000	6000	500	500	HOR±15°	A	26400.00	1	HMI24000W/DXS	-

* Available later in 2013

Single Ended Hot Restrike

Double Ended Hot Restrike



Film and Broadcast

Watts	Volts	Cap / base	Description	Product code	Lumen	CCT (K)	LIF Code	ANSI Code	Life [h]	Length [mm]	Diameter [mm]	Operating position	EEC	Energy Consumption [kWh]	Outer qty
1250+650	230-240	GX38q	CP105 1250/650W 230-240V	88880	27,000+13,000	3050	CP105	-	250	220	-	BD45	D	1919.00	1
1250+1250	230-240	GX38q	CP30 230-240V	88877	27,000+27,000	3200	CP30	-	300	220	-	BD45	D	2518.00	1
1250+2500	230-240	GX38q	CP58 230-240V	88878	27,000+59,000	3200	CP58	-	300	220	-	BD45	C	3795.00	1
2500+2500	230-240	GX38q	CP32 230-240V	88879	59,000+59,000	3200	CP32	-	300	220	-	BD45	C	5059.00	1
5000	230	G38	CP29 230V	88875	13,500	3200	CP29	-	375	279	-	BDTH	C	5040.00	12
5000	240	G38	CP29 240V	88876	13,000	3200	CP29	-	375	279	-	BDTH	C	5040.00	12
5000	240	G38	HX5000/240V	71379	133,000	3200	-	-	200	270	65	U	C	4652.57	6
10,000	220-230	G38	CP83 220-230V	12036	280,000	3200	CP83	-	500	405	-	BDTH	C	9965.00	1
10,000	240	G38	CP83 240V	12037	280,000	3200	CP83	-	500	405	-	BDTH	C	9777.33	1
12,000	230	GX38	Q12MT26/CL 230V	48771	400,000	3400	-	-	130	410	-	BD45	B	12600.37	1
12,000	240	GX38	Q12MT26/CL 240V	48779	400,000	3400	-	-	130	410	-	BD45	C	11659.73	1
12,000	240	G51	HX12000/240V	65316	324,000	3200	-	-	300	410	85	U	C	12201.20	6
20,000	220	GX38	Q20MT32/CL 230V	48773	580,000	3200	-	BCM	400	560	-	BD45	C	18762.33	1
20,000	240	GX38	Q20MT32/CL 240V	48774	580,000	3200	-	BCM	400	560	-	BD45	C	19727.93	1
24,000	240	GX38	Q24MT32/CL 240V	48777	800,000	3400	-	-	150	560	-	BD45	B	23778.40	1

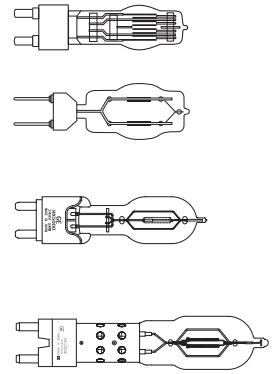

Cinema Studio Biax™

55	-	2G11-4 PIN	F55BX/STUDIOBIAX32	41869	4100	3200	-	-	8000	55	-	U	A	60.50	10
55	-	2G11-4 PIN	F55BX/STUDIOBIAX56	41873	4100	5600	-	-	8000	55	-	U	A	60.50	10
55	-	2G11-4 PIN	F55BX/CINPLUS/32	41903	2400	3200	-	-	2000	55	-	U	B	60.50	10
55	-	2G11-4 PIN	F55BX/CINPLUS/55	41911	2400	5600	-	-	2000	55	-	U	B	60.50	10

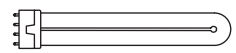

Single Ended Halogen



G38



G51

Cinema Studio Biax™



2G11-4 PIN

Entertainment Lamps

Event and Tour

Watts	Volts	Cap / base	Description	Product code	Lumens	CCT (K)	Life (h)	Length (mm)	Operating position	EEC	Energy Consumption (kWh)	Outer qty	Osram	Philips
-------	-------	------------	-------------	--------------	--------	---------	----------	-------------	--------------------	-----	--------------------------	-----------	-------	---------

Discharge - Single Ended Cold Start

Cross reference

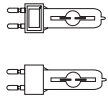

250	95	GY9.5	CSD 250/2 SE	10744	18,000	8500	3000	108	U	A	275.00	10	HSD250/80	MSD250/2
575	97	GX9.5	CSR575/2/T/SE	49492	42,000	7600	1000	125	U	A	632.50	10	-	-
575	97	GX9.5	CSR575/2/SE	15378	46,000	7200	1000	125	U	A	632.50	10	HSR575/2	MSR575/2
700	70	G22	CSR700/2/SE	49491	55,000	6500	1000	155	U	A	770.00	10	HSR700/2	MSR700/2
1200	100	G22	CSR1200/2/SE	49490	110,000	7000	800	175	U	A+	1320.00	6	HSR1200/2	MSR1200/2

Discharge - CSR Turn and Lock (TAL)

300	100	PGJX28	CSR300/2/TAL	76160	23,000	7700	750	126	U	A	330.00	4	-	MSR 300/2 MiniFastFit
700	70	PGJX50	CSR700/TAL	76161	50,000	7400	750	128	U	A	770.00	4	HTI 700W/75/P50	MSR 700 FastFit
700	70	PGJX28	CSR700/TAL	78718	50,000	7400	750	122	U	A	770.00	4	HTI 700W/75/P28	MSR 700/2 MiniFastFit
1500	95	PGJX50	CSR1500/TAL	74873	129,000	5600	750	128	U	A	1650.00	4	HTI 1500W/60/P50	MSR 1500 FastFit

Discharge - Double Ended Hot Restrike



575	95	SfC 10-4 SI/M4	CSR575/S/DE/70	70979	40,000	7000	750	138	U	A	632.50	10	-	-
575	100	SfC 10-4 SI/M4	CSR575/SS/DE/75	45231	44,000	7500	500	92	HOR±15°	A	632.50	10	-	-
700	70	SfC 10-4 SI/M4	CSR700/S/DE/60	22493	59,000	6000	750	138	U	A	770.00	10	HTI700W/D4/60	-
700	70	SfC 10-4 SI/M4	CSR700/S/DE/72	41357	51,000	7200	750	138	U	A	770.00	10	HTI700W/D4/75	MSR700/SA/2/DE
1200	100	SfC 10-4 SI/M4	CSR1200/S/DE/60	22494	110,000	6000	750	138	U	A+	1320.00	10	HTI1200W/D7/60	MSR1200/SA/DE
1200	100	SfC 10-4 SI/M4	CSR1200/S/DE/75	41361	103,000	7500	750	138	U	A	1320.00	10	HTI1200W/D7/75	MSR1200/SA/2/DE
1500	115	SfC 10-4 SI/M4	CSR1500/S/DE/60	96800	130,000	5800	500	138	HOR±15°	A	1650.00	10	HTI1500 D7/60	-

Discharge - Short Arc



700	70	GY9.5	CSR 700 SA	15380	58,000	5600	500	85	U	A	770.00	10	HTI705W/SE	MSR700/SA
1200	100	GY22	CSR 1200/SA	21849	100,000	5800	750	135	U	A	1320.00	6	HTI1200W/SE	MSR1200/SA

Halogen - CSR Turn and Lock (TAL)

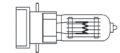

750	100	PGJX28	Q750 100V TAL*	64966	21,500	3200	200	104	BDTH	C	793.69	24	-	-
-----	-----	--------	----------------	-------	--------	------	-----	-----	------	---	--------	----	---	---

* TAL lamp can be used in specified moving light fixtures, however the 3200K colour temperature is for theatrical use.

Single Ended Cold Start



GX9.5

G22

TAL



PGJX28

PGJX28

PGJX50

Short Arc



GX9.5

Double Ended Hot Restrike



SfC 10-4 SI/M4

Club and Disco

Watts	Volts	Description	Product code	CCT (K)	U/F Code	ANSI Code	Cap / base	Life (h)	Candelas	Beam type	Beam 10%	Beam 50%	Length (mm)	Diameter (mm)	Operating position	EEC	Energy Consumption (kWh)	Outer qty
PAR 36																		
25	5.5	25PAR36 5.5V	14553	3000	-	-	Screw Term.	1000	30,000	VNSP	-	5 x 5	69.8	114.3	U	E	26.43	12
25	12	25PAR36/WFL 12V	14555	-	-	-	Screw Term.	2000	500	WFL	49 x 41	37 x 26	69.8	114.3	U	E	26.01	12
30	12.8	4405 12.8V	24425	-	-	-	Screw Term.	100	50,000	VNSP	6 x 5	-	69.8	114.3	U	Exempt	Exempt	12
30	6.2	4511 6.2V	24663	-	-	-	Screw Term.	300	2300	-	-	-	69.8	114.3	U	Exempt	Exempt	12
30	6.4	H4515 6.4V	15133	-	-	-	Screw Term.	100	67,000	VNSP	5.5 x 4	-	69.8	114.3	U	E	31.53	12
30	6.4	4515 6.4V	24673	-	-	-	Screw Term.	100	55,000	VNSP	5 x 5	-	69.8	114.3	U	E	31.58	12
50	12.8	H7604 12.8V	43576	-	-	-	Screw Term.	100	100,000	NSP	7 x 5	-	69.8	114.3	U	Exempt	Exempt	12
50	12	50PAR36/VNSP 12V	12892	-	-	-	Screw Term.	2000	25,000	VNSP	-	6 x 6	69.8	114.3	U	E	52.11	12
50	12	50PAR36/NSP 12V	16540	-	-	-	Screw Term.	2000	9200	NSP	-	10 x 10	69.8	114.3	U	E	51.98	12
50	12	50PAR36/WFL 12V	16541	-	-	-	Screw Term.	2000	1300	WFL	48 x 41	36 x 28	69.8	114.3	U	E	51.98	12
50	12	50PAR36/WFL/H 12V	19880	3050	-	-	Screw Term.	4000	1300	WFL	-	30 x 30	69.8	114.3	U	E	51.33	12
50	12	50PAR36/VWFL 12V	16542	-	-	-	Screw Term.	2000	600	VWFL	-	55 x 55	69.8	114.3	U	E	51.98	12
50	28	4502 28.0V	24627	-	-	-	Screw Term.	400	10,000	WFL	40 x 7	-	69.8	114.3	U	Exempt	Exempt	12
50	28	4505 28.0V	24640	-	-	-	Screw Term.	400	45,000	NSP	11 x 5	-	69.8	114.3	U	Exempt	Exempt	12
50	28	4589 28V 50W	24873	-	-	-	Screw Terminals	400	5000	-	-	-	69.8	114.3	U	Exempt	Exempt	12
100	13	4509 13.0V	24650	-	-	-	Screw Term.	25	110,000	NSP	12 x 6	-	69.8	114.3	U	Exempt	Exempt	12
100	13	4509X 13.0V	41503	-	-	-	Screw Term.	25	110,000	NSP	12 x 6	-	69.8	114.3	U	Exempt	Exempt	12
100	28	4591 28.0V	24882	-	-	-	Screw Terminals	25	90,000	-	-	-	69.8	114.3	U	Exempt	Exempt	12
50	28	4593 28.0V	24887	-	-	-	Screw Term.	400	1500	VWFL	80 x 30	-	69.8	114.3	U	Exempt	Exempt	12
100	28	4594 28.0V	24891	-	-	-	Screw Term.	300	70,000	NSP	13 x 7	-	69.8	114.3	U	Exempt	Exempt	12
150	28	4626 28.0V	24964	-	-	-	Screw Term.	300	25,000	WFL	40 x 9	-	69.8	114.3	U	Exempt	Exempt	12
100	28	4627 28.0V	24966	-	-	-	Screw Term.	300	3000	VWFL	80 x 30	-	69.8	114.3	U	Exempt	Exempt	12
250	28	4587 28.0V	24867	-	-	-	Screw Term.	25	4000	WFL	40 x 13	-	69.8	114.3	U	Exempt	Exempt	12
250	28	4596 28.0V	24898	3000	-	-	Screw Term.	25	150,000	NSP	11 x 12	-	69.8	114.3	U	Exempt	Exempt	12
650	120	DWE Q650PAR36/1 120V	41667	3200	-	DWE	Screw Term.	100	24,000	MFL	-	40 X 30	69.8	114.3	HOR±15°	D	692.40	12
650	120	FBO-Q650/PAR36/5 120V	41671	3400	-	FBO	Screw Term.	30	75,000	SP	-	25 X 15	69.8	114.3	HOR±15°	D	692.40	12
650	120	FCX-Q650PAR36/7 120V	41673	3200	-	FCX	Ferrule	100	24,000	MFL	-	40 X 30	69.8	114.3	HOR±15°	D	692.40	12
750	13	Q4632 13.0V	39112	-	-	-	Screw Terminals	500	75,000	-	-	-	69.8	114.3	U	Exempt	Exempt	12



PAR36



Entertainment Lamps

Club and Disco

Watts	Volts	Description	Product code	CCT (K)	LIF Code	ANSI Code	Cap / base	Life (h)	Candelas	Beam type	Beam 10%	Beam 50%	Length (mm)	Diameter (mm)	Operating position	EEC	Energy Consumption (kWh)	Outer qty
PAR 46																		
50	12.8	H7635 12.8V	43591	-	-	-	Screw Terminals	100	160,000	VNSP	-	6.5 x 4	95.2	146	U	Exempt	Exempt	12
60	28	4578 28.0V	25005	-	-	-	3 Contact Lugs	800	1600	-	-	-	95.2	146	U	Exempt	Exempt	12
80	28	4579 28V 80W	25009	-	-	-	3 Contact Lugs	400	24,000	-	-	-	95.2	146	U	Exempt	Exempt	12
100	13	4537-2 13.0V	40822	-	-	-	Screw Terminals	25	200,000	SP	-	11 x 6	95.2	146	U	Exempt	Exempt	12
250	28	4551 28.0V	24795	-	-	-	Screw Terminals	25	75,000	-	-	-	95.2	146	U	Exempt	Exempt	12
250	28	4553 28.0V	24799	-	-	-	Screw Terminals	25	300,000	SP	-	11 x 12	95.2	146	U	Exempt	Exempt	12
450	16.5	4635	33284	-	-	-	Screw Terminals	25	325,000	-	-	-	95.2	146	U	Exempt	Exempt	12
450	28	4580 28.0V	24859	-	-	-	Screw Terminals	10	400,000	SP	-	13 x 14	95.2	146	U	Exempt	Exempt	12
450	28	Q4554 28.0V	37706	-	-	-	Screw Terminals	100	65,000	WFL	-	50 x 11	95.2	146	U	Exempt	Exempt	12
450	28	Q4681 28.0V	36271	-	-	-	Screw Terminals	50	310,000	SP	-	15 x 9	95.2	146	U	Exempt	Exempt	12
PAR 56																		
100	12	4545 100W 12V	24768	-	-	-	Screw Terminals	100	225,000	NSP	-	9 x 5	127	177.8	U	Exempt	Exempt	12
120	12	120PAR56WFL 12V	19025	-	-	-	Screw Terminals	2000	5625	WFL	35 x 18	50 x 25	127	177.8	U	D	125.19	12
200	30	200PAR 30V	20122	-	-	-	Screw Terminals	350	270,000	SP	-	9 x 9	127	177.8	U	Exempt	Exempt	12
240	12	240PAR56/VNSP 12V	20575	-	-	-	Screw Terminals	2000	140,000	VNSP	9 x 6	7 x 10	127	177.8	U	E	260.08	12
240	12	240PAR56/WFL 12V	20577	-	-	-	Screw Terminals	2000	13,000	WFL	35 x 18	50 x 27	127	177.8	U	E	260.08	12
300	12	300PAR56/WFL 12V	23427	-	-	-	Screw Terminals	1000	-	WFL	-	-	127	177.8	U	C	309.51	12
300	120	300PAR56/NSP 120V	20803	2750	-	-	Mog End Pr GX16d	2000	68,000	NSP	10 x 8	20 x 14	127	177.8	U	E	313.36	12
300	120	300PAR56/MFL 120V	20836	2750	-	-	Mog End Pr GX16d	2000	24,000	MFL	23 x 11	34 x 19	127	177.8	U	E	318.70	12
300	120	300PAR56/WFL 120V	20849	2750	-	-	Mog End Pr GX16d	2000	11,000	WFL	37 x 18	57 x 27	127	177.8	U	E	318.70	12
300	230	300PAR56/MFL 230V	20852	-	-	-	ExMogEndPr GX16d	2000	30,000	MFL	-	-	127	177.8	U	E	293.19	12
300	230	300PAR56/NSP 230V	20853	-	-	-	ExMogEndPr GX16d	2000	40,000	NSP	-	-	127	177.8	U	E	293.19	12
300	230	300PAR56/WFL 230V	20854	-	-	-	ExMogEndPr GX16d	2000	10,000	WFL	-	-	127	177.8	U	E	293.19	12
300	240	300PAR56/NSP 240V	18676	-	-	-	ExMogEndPr GX16d	2000	40,000	NSP	-	-	127	177.8	U	E	285.58	12
300	240	300PAR56/MFL 240V	18677	-	-	-	ExMogEndPr GX16d	2000	30,000	MFL	-	-	127	177.8	U	E	285.58	12
300	240	300PAR56/WFL 240V	18678	-	-	-	ExMogEndPr GX16d	2000	10,000	WFL	-	-	127	177.8	U	E	285.58	12
500	120	Q500PAR56MFL 120V	43495	2950	-	-	Mog End Pr GX16d	4000	43,000	MFL	26 x 10	42 x 20	127	177.8	U	D	550.11	6
500	120	Q500PAR56WFL 120V	43496	2950	-	-	Mog End Pr GX16d	4000	19,000	WFL	44 x 20	66 x 34	127	177.8	U	D	550.11	6
500	120	Q500PAR56NSP 120V	43494	2950	-	-	Mog End Pr GX16d	4000	96,000	NSP	13 x 8	32 x 15	127	177.8	U	D	550.11	6

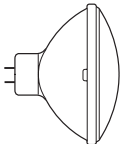
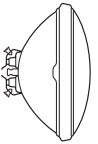
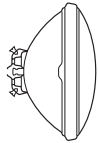

PAR46



PAR56



Club and Disco

Watts	Volts	Description	Product code	CCT (K)	LIF Code	ANSI Code	Cap / base	Life (h)	Candelas	Beam type	Beam 10%	Beam 50%	Length (mm)	Diameter (mm)	Operating position	EEC	Energy Consumption (kWh)	Outer qty
PAR 64																		
250	28	4552 28.0V	40576	-	-	-	Screw Terminals	25	500,000	SP	-	7 X 8	152.4	203.2	U	Exempt	Exempt	12
600	28	4559 28.0V	40578	-	-	-	Screw Terminals	25	600,000	SP	-	11 X 12	152.4	203.2	U	Exempt	Exempt	12
600	28	Q4559 28.0V	40579	-	-	-	Screw Terminals	100	600,000	SP	-	12 X 8	152.4	203.2	U	Exempt	Exempt	12
600	28	Q4559X 28.0V	42552	-	-	-	Screw Terminals	100	765,000	SP	11x7.5	-	152.4	203.2	U	Exempt	Exempt	12
500	230	CP86 - Q500PAR64/VNSP 230V	73581	3200	CP86	-	GX16d	300	240,000	VNSP	16x13	10x7	152.4	203.2	U	D	496.62	6
500	240	CP86 - Q500PAR64/VNSP 240V	99944	3200	CP86	-	GX16d	300	240,000	VNSP	16x13	10x7	152.4	203.2	U	C	507.66	6
500	230	CP87 - Q500PAR64/NSP 230V	99945	3200	CP87	-	GX16d	300	140,000	NSP	19x16	11x9	152.4	203.2	U	D	499.88	6
500	240	CP87 - Q500PAR64/NSP 240V	99946	3200	CP87	-	GX16d	300	140,000	NSP	19x16	11x9	152.4	203.2	U	C	512.64	6
500	230	CP88 - Q500PAR64/MFL 230V	99947	3200	CP88	-	GX16d	300	65,000	MFL	32x19	21x10	152.4	203.2	U	D	498.86	6
500	240	CP88 - Q500PAR64/MFL 240V	99948	3200	CP88	-	GX16d	300	65,000	MFL	32x19	21x10	152.4	203.2	U	C	498.86	6
500	230	500PAR64/MFL 230V	39411	2700	-	-	ExMogEndPr GX16d	2000	-	MFL	21 X 10	32 x 19	152.4	203.2	U	E	504.90	12
500	230	500PAR64/WFL 230V	39414	2700	-	-	ExMogEndPr GX16d	2000	-	WFL	42 X 20	55 x 32	152.4	203.2	U	E	504.90	12
400/1000	28	4557 28/28V	40581	3350	-	-	3 Screw Terminals	25	540,000	-	-	-	152.4	203.2	U	Exempt	Exempt	12
1000	230	SUPER CP60 EXC VNS 230V	88425	3200	CP60	-	GX16d	300	352,000	VNSP	20x17	12x9	152.4	203.2	U	C	1024.70	6
1000	240	SUPER CP60 EXC VNS 240V	88551	3200	CP60	-	GX16d	300	352,000	VNSP	20x17	12x9	152.4	203.2	U	C	1036.20	6
1000	230	SUPER CP61 EXD NS 230V	88535	3200	CP61	-	GX16d	300	297,000	NSP	22x20	14x10	152.4	203.2	U	C	1030.70	6
1000	240	SUPER CP61 EXD NS 240V	88550	3200	CP61	-	GX16d	300	297,000	NSP	22x20	14x10	152.4	203.2	U	C	1039.92	6
1000	230	SUPER CP62 EXE MF 230V	88549	3200	CP62	-	GX16d	300	138,000	MFL	38x20	24x11	152.4	203.2	U	C	1061.92	6
1000	240	SUPER CP62 EXE MF 240V	88536	3200	CP62	-	GX16d	300	138,000	MFL	24x11	38x20	152.4	203.2	U	C	1037.14	6
1000	230	CP95 230V	88511	3200	CP95	-	ExMogEndPr GX16d	300	15,000	VWFL	125 x 95	70 X 70	152.4	203.2	U	C	993.02	6
1000	240	CP95 240V	88510	3200	CP95	-	ExMogEndPr GX16d	300	15,000	VWFL	125 x 95	70 X 70	152.4	203.2	U	C	999.82	6
1000	230	EXG PAR64/1000W/230V/WFL	88480	3200	-	EXG	ExMogEndPr GX16d	300	49,300	WFL	59 x 36	44 X 22	152.4	203.2	U	C	995.78	6
1000	240	EXG PAR64/1000W/240V/WFL	88479	3200	-	EXG	ExMogEndPr GX16d	300	49,300	WFL	59 x 36	44 X 22	152.4	203.2	U	C	1006.14	6
500	120	500PAR64/MFL 120V	39409	2800	-	-	ExMogEndPr GX16d	2000	37,000	MFL	23 X 11	35 x 19	152.4	203.2	U	E	549.97	12
1000	120	FFN 120V	13233	3200	-	FFN	ExMogEndPr GX16d	800	40,000	VNSP	12 X 6	24 x 10	152.4	203.2	U	E	1083.58	6
1000	120	FFP 120V	13229	3200	-	FFP	ExMogEndPr GX16d	800	330,000	NSP	14 X 7	26 x 14	152.4	203.2	U	E	1083.58	6
1000	120	FFR 120V	13228	3200	-	FFR	ExMogEndPr GX16d	800	125,000	MFL	28 X 12	44 x 21	152.4	203.2	U	E	1083.58	6
1000	120	FFS 120V	13227	3200	-	FFS	ExMogEndPr GX16d	800	40,000	WFL	48 X 24	71 x 45	152.4	203.2	U	E	1083.58	6
1000	120	Q1000PAR64NSP 120V	43497	3000	-	-	ExMogEndPr GX16d	4000	200,000	NSP	15 X 8	31 X 14	152.4	203.2	U	D	1053.24	6
1000	120	Q1000PAR64MFL 120V	43498	3000	-	-	ExMogEndPr GX16d	4000	80,000	MFL	28 X 12	45 x 22	152.4	203.2	U	D	1053.24	6
1000	120	Q1000PAR64WFL 120V	43499	3000	-	-	ExMogEndPr GX16d	4000	33,000	WFL	48 X 24	72 x 45	152.4	203.2	U	D	1053.24	6
1200	120	GFC 1200W 120V VNSP	88487	3200	-	GFC	ExMogEndPr GX16d	400	540,000	VNSP	8x10	14x16	152.4	203.2	U	D	1288.85	6

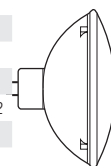
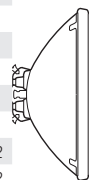

PAR64



Entertainment Lamps

Theatre

Watts	Volts	Cap / base	Description	Product code	Lumens	CCT (K)	LIF Code	ANSI Code	Life (h)	Length (mm)	Operating position	EEC	Energy Consumption (kWh)	Outer qty
Single Ended Halogen - HPL (19 mm diameter)														
375	115	G9.5/Heat Sink	HPL375-C 115V	88540	10,540	3050	-	-	300	106	U	C	418.52	12
375	115	G9.5/Heat Sink	HPL375-LL-C 115V	88539	8000	3200	-	-	1000	106	U	E	420.07	12
575	230	G9.5/Heat Sink	HPL 575W 230V	88478	14,900	3200	-	-	300	106	U	C	599.98	12
575	240	G9.5/Heat Sink	HPL 575W 240V	88477	14,900	3200	-	-	300	106	U	D	597.77	12
575	120	G9.5/Heat Sink	HPL 575-C 120V	88436	16,520	3250	-	-	300	106	U	C	594.55	12
575	115	G9.5/Heat Sink	HPL 575-C 115V	88438	16,520	3250	-	-	300	106	U	C	617.98	12
575	230	G9.5/Heat Sink	HPL 575W LL 230V	88476	11,780	3050	-	-	1500	106	U	D	594.48	12
575	240	G9.5/Heat Sink	HPL 575W LL 240V	88475	11,780	3050	-	-	1500	106	U	D	591.13	12
575	120	G9.5/Heat Sink	HPL 575-X LL-C 120V	88434	12,360	3050	-	-	2000	106	U	D	621.63	12
575	115	G9.5/Heat Sink	HPL 575-X LL-C 115V	88435	12,360	3050	-	-	2000	106	U	D	622.46	12
750	230	G9.5/Heat Sink	HPL 750W 230V	88474	19,750	3200	-	-	300	106	U	C	776.97	12
750	240	G9.5/Heat Sink	HPL 750W 240V	88473	19,750	3200	-	-	300	106	U	C	773.78	12
750	115	G9.5/Heat Sink	HPL 750-C 115V	88437	22,000	3250	-	-	300	106	U	C	819.39	12
750	115	G9.5/Heat Sink	HPL 750W-XLL-C 115V	88428	16,400	3050	-	-	2000	106	U	D	808.07	12
750	230	G9.5/Heat Sink	HPL 750W LL 230V	88430	15,600	3050	-	-	1500	106	U	D	771.10	12
750	240	G9.5/Heat Sink	HPL 750W LL 240V	88429	15,600	3050	-	-	1500	106	U	D	759.59	12

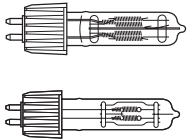

Single Ended Halogen

500	120	G9.5	EHD 120V	88624	10,000	2900	-	EHD	2000	105	U	D	547.84	24
500	120	G9.5	EHC Q500/5CL/P	88628	12,700	3150	-	EHC	500	105	U	C	510.33	24
575	115	G9.5	FLK 575W 115V G9.5	88548	16,500	3200	-	FLK	300	105	U	C	629.65	24
575	115	G9.5	HX601 FLK/LL 575W/115-120V	88452	10,000	3100	-	EHD	2000	105	U	D	611.86	50
575	115	G9.5	GLC 575W HP 115V	88423	14,500	3200	-	GLC	300	105	U	D	608.92	24
575	115	G9.5	GLA 575W HP 115V LL	88424	13,000	3050	-	GLA	1500	105	U	D	622.67	24
600	230	G9.5	GKV 600W 230V G9.5	88448	14,000	3200	-	GKV	250	105	U	C	584.62	24
600	240	G9.5	GKV 600W 240V G9.5	88447	14,000	3200	-	GKV	250	105	U	C	585.81	24
600	230	G9.5	GKV LL 230V 600W	88446	11,000	3000	-	GKV	1500	105	U	D	593.64	24
600	240	G9.5	GKV LL 240V 600W	88445	11,000	3000	-	GKV	1500	105	U	D	587.77	24
650	230-240	G9.5	FKR 230-240V	88450	15,000	3100	-	FKR	300	105	U	C	652.78	24
750	115	G9.5	GLE 115V	88426	17,400	3050	-	GLE	1500	105	U	D	817.20	24
750	115	G9.5	GLD 115V	88427	19,000	3200	-	GLD	300	105	U	C	806.46	24
750	120	G9.5	EHF Q750/4CL	88627	20,000	3200	-	EHF	300	105	U	C	804.03	24
750	120	G9.5	EHG Q750/CL/TP 750W 120V	88626	16,500	3000	-	FLK	300	105	U	E	801.44	24

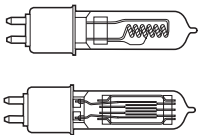

HPL



GY9.5



Theatre

Watts	Volts	Cap/ base	Description	Product code	Lumens	CCT [K]	LIF Code	ANSI Code	Life (h)	Length (mm)	Operating position	EEC	Energy Consumption [KWh]	Outer qty
800	230-240	G9.5	GKV 800W 230-240V	88432	20,000	3200	HX800	-	250	105	U	C	785.61	24
1000	120	G9.5	FEL Q1000/4CL 120V	88625	27,500	3200	CP77	FEL	300	105	U	C	1012.88	24
1000	230-240	G9.5	CP77 FEP 230- 240V	88449	25,000	3200	CP77	FEP	300	105	U	C	980.89	24
300	120	GY9.5	CP81 FKW 120V	88443	6900	3200	CP81	FKW	50	90	BDTH	D	322.92	24
300	230	GY9.5	CP81 FSL 230V	88433	6900	3200	CP81	FSL	150	90	BDTH	C	317.74	24
300	240	GY9.5	CP81 FSK 240V	88444	6900	3200	CP81	FSK	150	90	BDTH	D	290.29	24
500	120	GY9.5	CP82 FRG 120V	88467	13,000	3200	CP82	FRG	150	90	BDTH	C	541.56	24
500	230	GY9.5	CP82 FRH 230V	88466	12,500	3200	CP82	FRH	150	90	BDTH	C	519.00	24
500	240	GY9.5	CP82 FRJ 240V	88464	12,500	3200	CP82	FRJ	150	90	BDTH	C	523.78	24
500	230-240	GY9.5	T18 GCW 230- 240V	88465	11,000	3050	T18	GCW	400	90	BDTH	C	507.85	24
500	230-240	GY9.5	T25 230-240V	88470	11,000	3000	T25	GCW	360	90	BDTH	C	498.33	24
600	120	GY9.5	FMR 120V	88504	12,600	3050	FMR	-	2000	85	BDTHCH	D	623.50	24
650	230-240	GY9.5	T27 230-240V	88469	14,500	3050	T27	GCS	400	90	BDTH	C	648.58	24
650	230-240	GY9.5	T26 GCS 230- 240V	88463	15,500	3100	T26	GCS	400	90	BDTH	C	662.84	24
650	120	GY9.5	CP89 FRK 120V	88462	16,900	3200	CP89	-	200	90	BDTH	C	722.27	24
650	230-240	GY9.5	CP89 FRM 230- 240V	88461	16,250	3200	CP89	FRM	150	90	BDTH	C	664.69	24
650	230-240	GX9.5	T12 230-240V	88431	13,500	3000	T12	-	750	110	BDTH	D	668.16	12
650	230	GX9.5	CP23 230V	72680	16,900	3200	CP23	-	100	110	BDTH	C	641.64	12
650	230-240	GX9.5	CP23 230-240V	88455	16,900	3200	CP23	-	100	110	BDTH	C	647.62	12
1000	230-240	GX9.5	CP24 230-240V	88459	26,000	3200	CP24	-	200	110	BDTH	C	1015.60	12
1000	115/120	GX9.5	T11 115-120V	88515	23,500	3050	T11	-	750	110	BDTH	D	1065.51	24
1000	240	GX9.5	T11 230-240V	88456	23,000	3050	T11	-	750	110	BDTH	C	1002.41	12
1000	230-240	GX9.5	T19 FWR 230-240V	88457	21,000	3050	T19	FWR	750	110	BDTH	D	991.31	12
1000	230	GX9.5	CP70 FVA 230V	88472	25,000	3200	CP70	FVA	200	110	BDTH	C	996.20	12
1000	240	GX9.5	CP70 FVA 240V	88471	25,000	3200	CP70	FVB	200	110	BDTH	C	996.80	12
1200	230-240	GX9.5	T29 FWT 230-240V	88454	29,000	3050	T29	FWT	400	110	BDTH	C	1193.38	12
1200	230-240	GX9.5	CP90 230-240V	88453	33,000	3200	CP90	-	200	110	BDTH	C	1187.33	12
2000	230-240	GY16	CP43 FTM 230V	96735	54,000	3200	CP43	FTM	400	145	BDTH	C	2014.80	12
2000	230-240	GY16	CP43 FTL 230-240V	88533	54,000	3200	CP43	FTL	400	145	BDTH	C	2024.69	12
2000	230-240	GY16	CP79 230-240V	88503	54,000	3200	CP79	-	350	145	BDTH	C	2034.10	12
2000	120	GY16	CP79 120V	88440	-	-	CP79	-	-	145	BDTH	C	2186.99	12
1200	80	G22	CP110 OC-1200 80V	88439	37,500	3300	-	-	300	140	BDTH	C	1303.38	12
500	120	G22	EGN 120V	88509	13,000	3200	-	EGN	150	140	BDTH	C	544.52	12
650	230-240	G22	CP39 FKH 230- 240V	88531	16,900	3200	CP39	FKH	100	140	BDTH	C	644.16	12
750	120	G22	EGR-Q750T7/4CL 120	88621	21,000	3200	-	EGR	200	127	BDTH	C	810.49	12

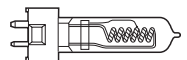
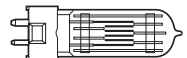
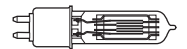
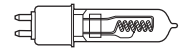
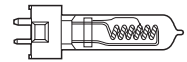
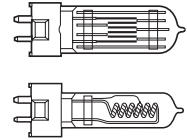

GY16

GY22



Entertainment Lamps



Theatre

Watts	Volts	Cap / base	Description	Product code	Lumens	CCT [K]	LIF Code	ANSI Code	Life [h]	Length [mm]	Operating position	EEC	Energy Consumption [kWh]	Outer qty
1000	120	G22	EGT-Q1000T7/4CL 120V	88622	28,500	3200	-	EGT	250	127	BDTH	C	1044.52	12
1000	230	G22	CP40 FKJ 230V	88458	26,000	3200	CP40	FKJ	200	140	BDTH	C	1002.22	12
1000	240	G22	CP40 FKJ 240V	88538	26,000	3200	CP40	FKJ	200	140	BDTH	C	1008.77	12
1200	230-240	G22	CP93 230-240V	88508	33,000	3200	CP93	-	200	140	BDTH	C	1255.78	12
2000	120	G22	CP92 120V	88507	55,000	3200	CP92	-	400	175	BDTH	C	2151.38	12
2000	230-240	G22	CP92 230-240V	88506	52,000	3200	CP92	-	400	175	BDTH	C	2028.00	12
2500	230-240	G22	CP91 230-240V	88505	67,500	3200	CP91	-	400	175	BDTH	D	588.21	12
500	120	P28s	EGE-Q500/CL/P 120V	88617	10,450	2950	-	EGE	2000	152	U	D	546.37	12
500	120	P28s	BTM 120V	88546	13,000	3200	-	BTM	150	130	BDTH	C	542.61	12
500	120	P28s	BTL-Q500T6/CL/P 120V	88547	11,000	3000	-	BTL	500	133	BDTH	D	532.92	12
500	230-240	P28s	T17 FKF 230- 240V	88498	9500	2950	T17	-	750	130	BDTH	D	504.08	12
500	230-240	P28s	T28 230-240V	88451	11,000	3000	T28	-	300	130	BDTH	C	510.97	12
650	230-240	P28s	T13 FKB 230- 240V	88497	13,500	3000	T13	-	750	130	BDTH	D	663.46	12
750	120	P28s	EGF-Q750/4CL/P 750W/120V	88618	20,400	3200	-	EGF	300	152	BDTH	C	801.78	12
750	120	P28s	EGG-Q750/CL/P120	88619	15,750	3000	-	EGG	2000	152	BDTH	E	801.25	12
750	120	P28s	BTN-Q750T7/CL/2P 120	88605	17,600	3050	-	BTN	500	121	BDTH	C	814.46	12
750	120	P28s	BTP-Q750T7/4CL/2P 120	88606	21,000	3200	-	BTP	200	121	BDTH	C	808.05	12
1000	120	P28s	EGJ-Q1000/4CL/P120V	88615	27,500	3200	-	EGJ	500	152	U	C	1068.59	12
1000	230-240	P28s	T14 FKD 230- 240V	88529	23,000	3050	T14	-	750	130	BDTH	C	1004.06	12
1000	230-240	P28s	FKE 230-240V	88499	23,000	3050	T15	FKE	750	160	BDTH	C	999.50	12
1000	230-240	P28s	CP52 FKN 230-240V	88496	26,000	3200	CP52	FKN	200	121	BDTH	C	1010.60	12
1000	120	P28s	BTR-Q1000T7/4CL/2P120	88607	28,500	3200	-	BTR	250	121	BDTH	C	1041.66	12
1000	120	P28s	EGK-Q1000/4/P 1000W/120V	88614	26,500	3200	-	EGK	300	152	BDTH	C	1067.31	12
1000	120	G38	CYV-Q1000T7/4CL/BP 1000W/120V	88630	28,500	3200	-	CYV	200	127	BDTH	C	1039.33	6
1500	120	G38	CXZ-Q1500T10/4CL 1500W/120V	88612	44,500	3200	-	CXZ	400	216	BDTH	C	1610.99	6
2000	120	G38	CYX-Q2000T10/4CL 120V	88610	59,000	3200	HX270	CYX	400	216	BDTH	C	2137.17	6
2000	230	G38	CP41 FKK 230V	88489	54,000	3200	CP41	FKK	400	216	BDTH	C	2020.00	12
2000	240	G38	CP41 FKK 240V	88488	54,000	3200	CP41	FKK	400	216	BDTH	C	2066.90	12
2500	230-240	G38	CP94 230-240V	88502	67,500	3200	CP94	-	400	210	BDTH	C	2507.19	12
3000	230-240	G38	HX48 230-240V	88874	82,000	3200	HX48	-	400	210	BDTH	C	2922.00	12
1000	120	E40	DKZ/DSE Q1000	19926	28,000	3200	-	DSE	750	330	U	C	995.43	10
1500	120	E40	DKX/DSF Q1500T10	19927	41,000	3200	-	DSF	1000	330	BDTH	C	1509.58	10
2000	120	E40	BWF-Q2000/4CL 120V	88611	54,000	3200	-	BWF	500	191	BDTH	C	2134.31	6
2000	240	E40	CP59 230-240V	88512	16,500	3200	-	-	100	191	U	C	1959.30	1
1000	120	P40s	BVV-Q1MT7/4CL/MP	88631	28,500	3200	-	BVV	200	184	BDTH	C	1043.46	6
1000	120	P40s	BVT-Q1MT7/CL/MP 120V	88608	24,500	3050	-	BVT	500	184	BDTH	C	1051.41	6
1500	120	P40s	DTA 120V	88500	41,000	3200	T16	DTA	750	180	BDTH	C	1639.40	6
2000	120	P40s	BVW-Q2MT10/4CL/MP	88609	59,000	3200	-	BVW	350	215	BDTH	C	2134.31	6
2000	230-240	P40s	CP53 230-240V	88532	54,000	3200	CP53	-	400	200	BDTH	C	2066.04	12

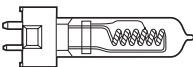
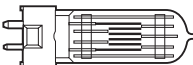
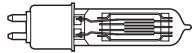
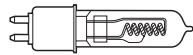

P28s

P28s

P40s

G38

E40



Watts	Volts	Cap / base	Description	Product code	Lumens	CCT [K]	LIF Code	ANSI Code	Life (h)	Length (mm)	Operating position	EEC	Energy Consumption [kWh]	Outer qty
500	120	R7s	TU FDN Q500T3/4	23734	12,800	3200	P2/31	FDN	400	119	BDTH	C	545.90	12
500	120	R7s	TU FDF Q500T3/4CL	23735	13,250	3200	P2/30	FDF	400	119	BDTH	C	543.56	12
625	230	R7s	TU P2/10 Q625T3/4CL 220/230V	19697	16,900	3200	P2/10	-	300	189	HOR±15°	C	651.43	12
625	240	R7s	TU P2/10 Q625T3/4CL 240/250V	19698	16,900	3200	P2/10	-	300	189	HOR±15°	C	621.29	12
650	120	R7s	FAD Q650T4/CL P2/6	30325	16,500	3200	P2/6	FAD	100	80	U	C	675.27	24
750	120	R7s	TU EMD Q750T3/4	23755	19,500	3200	-	EMD	400	119	U	C	814.39	12
750	120	R7s	TU EJJ Q750T3/4CL	23756	20,600	3200	-	EJJ	400	119	HOR±15°	C	815.07	12
800	230	R7s	DXX800-T4-4CL 230V	36952	21,400	3200	P2/13	DXX	75	80	U	C	792.40	24
800	240	R7s	DXX 800-T4-4CL 240V	36953	21,400	3200	P2/13	DXX	75	80	U	C	788.20	24
800	240	R7s	TU P2/11 EME Q800T3/4CL 240V	23760	22,000	3200	P2/11	EME	150	119	HOR±15°	C	826.06	12
800	240	R7s	TU P2/11 EMF Q800T3/4	23761	21,400	3200	P2/11	EMF	150	119	HOR±15°	C	825.38	12
1000	120	R7s	DXW	30157	28,000	3200	-	DXW	150	95	U	C	1042.51	24
1000	120	R7s	TU FHM Q1000T3/4	23792	27,300	3200	P2/29	FHM	400	119	U	C	1083.85	12
1000	120	R7s	TU FFT Q1000T3/1CL	33280	26,400	3200	-	FFT	400	167	U	D	1087.56	12
1000	230	R7s	TU P2/7 EKM Q1MT3/4CL 220/230V	20249	28,000	3200	P2/7	EKM	300	189	HOR±15°	C	1013.60	12
1000	240	R7s	TU P2/7 EKM Q1MT3/4CL 240/250V	20253	28,000	3200	P2/7	EKM	300	189	HOR±15°	C	1007.20	12
1000	120	R7s	TU FCM P2/28 Q1000T3/4CL	23797	28,000	3200	P2/28	FCM	400	119	HOR±15°	C	1081.09	12
1250	230	R7s	TU P2/12 Q1250T3/4CL 220/230V	19695	35,000	3200	P2/12	-	300	189	HOR±15°	C	1286.30	12
1250	240	R7s	TU P2/12 Q1250T3/4CL 240/250V	19696	35,000	3200	P2/12	-	300	189	HOR±15°	C	1281.60	12
2000	230	R7s	P2/27 FEX 230V	88482	50,000	3200	P2/27	FEX	300	143	HOR±15°	C	1965.54	12
2000	240	R7s	P2/27 FEX 240V	88481	50,000	3200	P2/27	FEX	300	143	HOR±15°	C	1975.92	12
2000	120	R7s	FEY Q2000 T8/4CL	88629	57,000	3200	P2/27	FEY	400	143	HOR±15°	C	2175.97	12

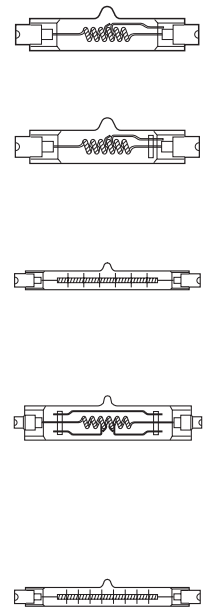

R7s



Entertainment Lamps

Other applications

Watts	Volts	Cap / base	Description	Product code	Lumens	CCT [K]	Life (h)	Candela	BEAM TYPE	Beam 10%	Beam 50%	MPBC	Length (mm)	Operating position	EEC	Energy Consumption [kWh]	Outer qty
-------	-------	------------	-------------	--------------	--------	---------	----------	---------	-----------	----------	----------	------	-------------	--------------------	-----	--------------------------	-----------

ConstantColor™ - CMH Single Ended GX9.5

400	135	GX9.5	CMH400/932/GX9.5	73579	40,000	3200	5000	-	-	-	-	-	135	U	A+	440.00	4
-----	-----	-------	------------------	-------	--------	------	------	---	---	---	---	---	-----	---	----	--------	---



ConstantColor™ CMH -PAR64

150	95	GX16d	CMH150/PAR64/830/GX16D/MFL	88537	-	3000	8000	47,000	Medium	18x15	13x11	80,000	152	U	C	165.00	6
150	100	GX16d	CMH150/PAR64/842/GX16D/MFL	88542	-	4200	8000	47,000	Medium	18x15	13x11	80,000	152	U	C	165.00	6

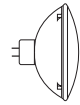

CSS

140	85	GY9.5	CSS150/CAP/50	88485	9,000	5000	1000	-	48	22	30	-	48	VBD±90	A	154.00	10
-----	----	-------	---------------	-------	-------	------	------	---	----	----	----	---	----	--------	---	--------	----

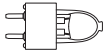

CSI/CID

400	100	Special	CSI400 99-0201	88495	32,000	4000±400	500	-	-	-	-	-	55	VBD±90	A	440.00	1
400	100	Special	CSI400/G22 99-0202	88412	32,000	4000±400	500	-	-	-	-	-	87	VBD±90	C	440.00	1
1000	80	G22	CSI1000/G22 99-02	88494	90,000	4000±400	500	-	-	-	-	-	115	VBD±90	A+	1100.00	1
1000	80	G38	CSI1000/PAR64/G38	88514	76,000	3800±500	3500	-	-	18	6	1,350,000	175	U	C	1100.00	1
1000	80	G38	CSI1000/PAR64/HR/G38 99-1422	88513	76,000	3800±500	3500	-	-	18	6	1,350,000	175	U	C	1100.00	1
1000	80	G22	CID1000/G22 99-0222	88493	70,000	5500±400	500	-	-	-	-	-	115	BDTH	A	1100.00	1

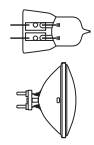

Watts	Volts	Cap / base	Description	Product code	Lumens	CCT [K]	LIF Code	ANSI Code	Life (h)	Application	Length (mm)	Operating position	EEC	Energy Consumption [kWh]	Outer qty
-------	-------	------------	-------------	--------------	--------	---------	----------	-----------	----------	-------------	-------------	--------------------	-----	--------------------------	-----------

Specialist Projector

50	12	G6.35	BRL A1/220 12V Q50/G6.35-15	18234	1400	3400	A1/220	BRL	50	-	44	BDTH	B	56.21	100
100	12	GY6.35	FCR A1/215 12V	14876	3500	3300	A1/215	FCR	50	-	44	BDTH	B	113.83	100
150	24	G6.35	FCS A1/216 24V Q150/G6.35-15	13598	4500	3300	A1/216	FCS	50	-	51	BDTH	B	166.07	100
250	24	G6.35	EHJ A1/223 24V Q250/G-15	14874	9000	3400	A1/223	EHJ	50	-	57	BDTH	B	273.13	100
400	36	GY6.35	EVD 36V 400W	41164	16,000	3200	A1/239	EVD	50	-	60	BDTH	B	457.46	25
650	240	G29.5	DYR 650W 240V	26895	16,500	3200	A1/233	DYR	50	-	64	U	C	667.89	24
800	230-240	GX9.5	HX185 800W 230-240V	88484	19,000	3050	HX185	-	300	-	100	BDTH	C	818.84	24
150	230-240	G6.35	A1/248 230-240V	88492	3000	-	A1/248	-	50	-	62	BDTH	D	152.55	50
300	230-240	G6.35	A1/249 230-240V	88491	7200	-	A1/249	-	50	-	62	BDTH	C	300.35	50
500	230-240	GY9.5	A1/244 230-240V	88460	13,000	-	A1/244	-	75	-	62	BDTH	C	507.25	24

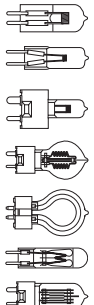

ConstantColor™ - CMH Single Ended GX9.5



ConstantColor™ - CMH PAR64



CSI/CID



Other applications

Watts	Volts	Cap / base	Description	Product code	Lumens	CCT [K]	LIF Code	ANSI Code	Life (h)	Application	Length (mm)	Operating position	EEC	Energy Consumption [kWh]	Outer qty
Single Ended Tungsten Halogen															
250	24	G6.35	M36 24V 250W GY6.35	88516	5750	3000	M36	-	2000	-	58	BDTH	C	270.07	100
300	230-240	GY9.5	M38 230-240V	88442	5000	2900	M38	-	2000	-	80	BDTH	E	297.52	24
300	120	GY9.5	M38 120V	78343	5500	2900	M38	-	2000	-	80*	BDTH	E	322.43	24
500	230-240	GY9.5	M40 230-240V	88468	8500	2900	M40	-	2000	-	85	BDTH	E	495.25	24
Multi-Mirror® Quartzline® Projection – MR11															
28	13.8	GZ4	FLT 13.8 28W	25261	-	3050	-	FLT	500	Microfilm	-	BDTH	B	29.53	10
Multi-Mirror® Quartzline® Projection – MR16															
50	12	GX5.3	ENL	25475	-	3050	-	ENL	4000	Fibre optics, Enlarger & Printer, Equipment, Colour printer	-	BDTH	B	53.04	20
85	13.8	GX5.3	DED 13.8V	43950	-	3150	-	DED	1000	Microfilm	-	BDTH	C	90.10	20
150	20	GX5.3	DDL 20V 150W MR16	43537	-	3150	-	DDL	500	Microfilm	-	BDTH	B	147.87	20
150	21	GX5.3	EKE 21V	35200	-	3250	-	EKE	200	8mm projection	-	BDTH	B	159.68	20
250	24	GX5.3	ELC A1/259 24V	37462	-	3400	A1/259	ELC	50	16mm, Colour printer	-	BDTH	B	263.37	20
250	24	GY5.3	ELC / 500 24V 250W	15377	-	3250	-	ELC500	500	Disco	-	BDTH	B	260.77	20
360	82	GY5.3	ENX	41705	-	3300	-	ENX	75	Overhead projection	-	BDTH	B	389.85	10
42	10.8	GX5.3	EPT 10.8V	41729	-	2900	-	EPT	8000	Fibre optics	-	BDTH	B	45.07	20

*Diameter 24mm

Multi-Mirror® Quartzline® Projection



Compliance and warnings



Special purpose lamps.
Not suitable for household illumination.

DISCHARGE

Compliance

Standards

- IEC 60061-1: Lamp Caps and Holders together with Gauges for the Control of Interchangeability and Safety – Part 1: Lamp Caps
- CIE S 009/E:2002: Photobiological Safety of Lamps and Lamp Systems

Directives

- CE mark: Directive 73/23/EEC, 2004/108/EC and 93/68/EEC
- RoHS II: Directive 2011/65/EU on the Restriction of the use of certain Hazardous Substances
- REACH: Directive 2006/1907/EC on Registration, Evaluation, Authorisation and Restriction of Chemicals (REACH)
- Hg: Directive 2002/96/EC (WEEE) Article 10 (3)
- UN2911: IAEA Pub 1384-2009 Safety Sec 544 (d)
- Der Grüne Punkt: Directive 94/62/EC Packaging and Packaging Waste

Warning

Risk of electric shock

- Turn power off before inspection, installation or removal
- Do not use where directly exposed to water or outdoors without an enclosed fixture

Risk of fire

- Keep combustible materials away from lamp
- Use in enclosed fixture rated for this product

Lamp emits UV radiation which may cause eye/skin injury. RG-3

- Avoid exposure of eyes and skin to unshielded lamp

Unexpected lamp rupture may cause injury, fire, or property damage

- Do not exceed rated wattage or voltage
- Do not touch glass with bare hands
- Use in enclosed fixture rated for this product
- Do not use lamp if outer glass is scratched or broken
- Use only properly rated ballast
- Operate lamp only in specified position
- Do not store flammable materials near/below lamp
- Do not use beyond rated life
- Do not turn on lamp until fully installed

Caution

Risk of burn

- Allow lamp to cool before handling
- Do not turn on lamp until fully installed

Lamp may shatter and cause injury if broken

- Do not use lamp if outer glass is scratched or broken
- Dispose of lamp in a closed container
- Do not use excessive force when installing lamp

Cut hazard - possible jagged glass

- Wear gloves when handling

HALOGEN

Compliance

Standards

- IEC60061-1 Lamp caps and holders together with gauges for the control of interchangeability and safety – Part 1: Lamp Caps
- IEC60432-3 Incandescent lamps - Safety specifications - Part 3: Tungsten-halogen lamps (non-vehicle)
- CIE S 009:2002 Photobiological safety of lamps and lamp systems

Directives

- Safety (LVD): 2006/95/EC
- RoHS: Directive 2011/65/EU on Restrictions of the use of certain Hazardous Substances (RoHS)
- REACH: Directive 453/2010/EC on Registration, Evaluation, Authorisation and Restriction of Chemicals (REACH)
- ErP household: Directive 2009/125/EC on ecodesign requirements (of Energy-related Products) and its Implementing Measure for non-directional Household Lamps: 244/2009/EC

Warning

These lamps are not intended for household room illumination. Their intended purpose is Stage/Studio lighting.

Risk of electric shock

- Turn power off before inspection, installation or removal

Risk of fire

- Keep combustible materials away from lamp
- Use in fixture rated for this product

Pressurised lamp - unexpected rupture may cause injury, fire, or property damage

- Do not exceed 110% of rated voltage
- Do not touch glass with bare hands
- Use in enclosed fixture rated for this product
- Do not use lamp if outer glass is scratched or broken
- Operate lamp only in specified position

Caution

Risk of burn

- Allow lamp to cool before handling
- Turn power off before installing lamp

Lamp emits UV radiation, IR and blue light which may cause eye/skin irritation. RG-2

- Limit unshielded exposure to less than 15 minutes per day
- Optical elements of the fixture may concentrate UV, blue light and IR radiation of the lamp. Do not stare in the direct light

Lamp may shatter and cause injury if broken

- Wear safety glasses and gloves when handling lamp
- Do not use lamp if outer glass is scratched or broken
- Dispose of lamp in a closed container

Specialty Lighting Solutions



Special applications

Range of lamp technologies fluorescent and halogen

Multiple applications UV, safety, Heat and Air

Extensive range low watt to high watt

Variety of bases for specific applications

Performance consistent lamp performance

Output high output for required application



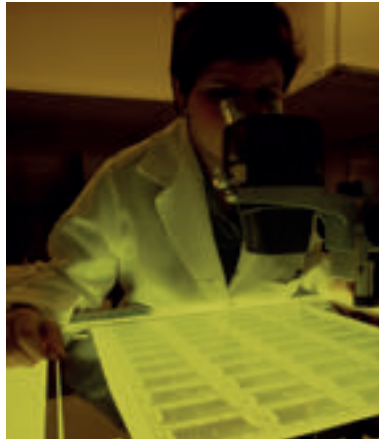

GE's lighting expertise extends into many specialised areas of industry, including manufacturing, health and safety, space heating and airfield lighting.

Products for these applications include black light inspection lamps, UV germicidal lamps and halogen heaters.

GE Lighting is also a leading supplier to the entertainment industry, offering a range of lamp technologies for use in stage, studio, film and event lighting as well as archtainment, projection and photography. There is separate information covering these.



Health and Safety



Insect control



Industrial heating



Airfield

Main application areas

HEALTH AND SAFETY

Bacterial destruction

- UVC 200-280 nm
- For water, air and surface sterilisation
- Destroys micro-organisms via absorption of UV light

Shatter protection

- Lamp encased in high quality plastic sleeve
- Used where avoidance of glass contamination is critical

INSECT CONTROL

- Special Phosphor – Black Light (BL)
- UVA 315-400nm
- Lamps to attract flies and insects
- Effect UV irradiance over life
- For use in fly traps
- Common use in food production areas

INDUSTRIAL HEATING

- Turning light to heat
- Directional instant radiant heat
- Heats objects and people not the air between
- Many industrial applications from paint drying to plastic bottle making

AIRFIELD

- Range of lamps for use on airfields
- Runway and taxiway lighting

Specialty lamps

Product identification

The following glossary of terms will help you when selecting lamps in this section. Within each product line, lamps are divided into families – within these families, lamps are listed by wattage. The Product Description can be used as a quick reference to each product's attributes. Where Life or Average Life are stated we refer to the industry standard definition of how many hours of operation 50% of a given installation will exceed.

Additional parameters:

UV Output (Watts): The initial UV Output at 100 hours
Initial UVA Irradiance (mW/cm² @ 20cm): UV Output at 1 m after 100 hours
Lumens: Initial amount of light output
CCT [K]: Colour Temperature - Kelvins
 A measure of the visual "warmth" or "coolness" of the light from the lamp. The higher the value the whiter or "cooler" the light appears.
CRI [Ra]: Colour Rendering Index
 An indication of the ability of the lamp to render object colours in a normal, natural way. The higher the number (0-100), the better the colour appearance.

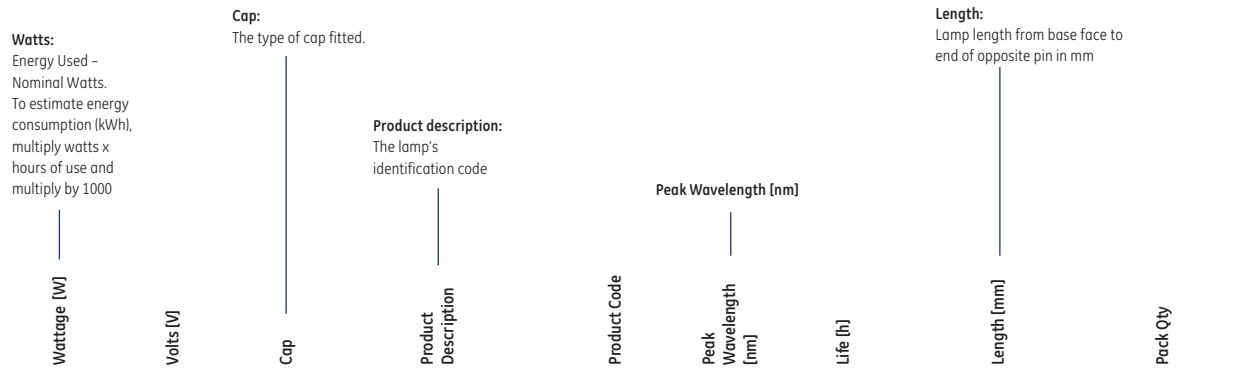

Black Light T8							Min	Max	
15	55	G13	F15T8/BL 368	98447	368	7500	442.1	444.5	25

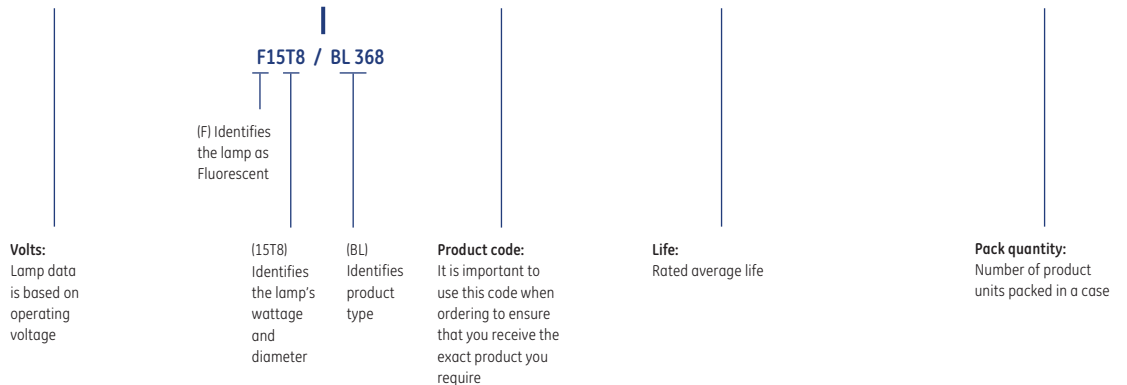

Selector

Health and Safety



UVC Germicidal T5/T8
 Lamp volts: 29-155V
 Watts: 4-65W
 Cap: T5: G5, Fa8
 T8: G13
 Life: 7000-9000h
 Packing: 24

Page IX.5



**covRguard™
 Polylux XLR™**
 Wattages: 18-58W
 Colours: White
 and Cool White
 CRI [Ra]: 80+
 Rated life: 15,000Hrs

Page IX.5

Insect control



Black Light T8
 Lamp volts: 55V
 Watts: 15W
 Cap: G13
 Life: 7500h
 Packing: 25

Page IX.6



UVA Blacklight Biax™
 Lamp volts: 60V
 Watts: 9W
 Cap: G23
 Life: 167h
 Packing: 10

Page IX.6



UVA Blacklight Biax™ L
 Lamp volts: 106V
 Watts: 36W
 Cap: 2G11
 Life: 1280h
 Packing: 10

Page IX.6

Industrial heating



Quartz Heat
 Lamp volts: 120-600V
 Watts: 500-3800W
 Cap: Slv, R7s, CER
 Life: 5000h
 Packing: 6, 12

Page IX.6

Airfield



Airfield
 Lamp volts: 6.6A to 120V
 Watts: 30-1000W
 Cap: Various
 Life: 30-1000h
 Packing: Various

Page IX.7



Special purpose lamps.
 Not suitable for household illumination.

Specialty lamps

Health and Safety



Wattage [W]	Volts [V]	Cap	Product Description	Product Code	UV Output [Watts]	Peak Wavelength [nm]	Life [h]	Length [mm]		Pack Qty
								Min.	Max.	
UVC Germicidal T5										
4	29	G5	G4 T5	63599	0.8	254	7000	140.6	143	24
6	40	G5	G6 T5	63601	1.6	254	9000	216.8	219.2	24
8	55	G5	G8 T5	63602	2.1	254	9000	293	295.4	24
11	37	G5	G11 T5	63603	2.2	254	9000	216.7	219.2	24
65	155	Fa8	G64 T5	63606	18	254	9000	1559	1563	24
16	54	G5	G16 T5	63604	4	254	9000	293	295.4	24



Wattage [W]	Volts [V]	Cap	Product Description	Product Code	UV Output [Watts]	Life [h]	Length [mm]		Pack Qty	
							Min.	Max.		
UVC Germicidal T8										
15	49	G13	G15 T8	63607	4.8	9000	442	444.4	24	
25	43	G13	G25 T8	63608	7.2	9000	442	444.4	24	
30	98	G13	G30 T8	63609	11.3	9000	899.2	901.6	24	
55	87	G13	G55 T8 HO	63610	19	9000	899.2	901.6	24	



Wattage [W]	Length [mm]	Diameter [mm]	Product Description	Product Code	Initial Lumen (at 25°C) [lm]	Colour Type	CCT [K]	CRI [Ra]	Rated Average Life [3-hr cycle] [h]	EEC	Energy Cons. [kWh]	Pack Qty
T8 covRguard™ PolyLux XLR™ - G13 Cap												
18	589.8	26	F18W/T8/835 CVG	17204	1,310	White	3,500	80+	15,000	A	22	25
18	589.8	26	F18W/T8/840 CVG	17205	1,300	Cool White	4,000	80+	15,000	A	22	25
36	1,199.4	26	F36W/T8/835 CVG	17202	3,250	White	3,500	80+	15,000	A	42	25
36	1,199.4	26	F36W/T8/840 CVG	17209	3,250	Cool White	4,000	80+	15,000	A	42	25
58	1,500	26	F58W/T8/835 CVG	99590	5,050	White	3,500	80+	15,000	A	68	25
58	1,500	26	F58W/T8/840 CVG	99591	5,050	Cool white	4,000	80+	15,000	A	68	25

T8 covRguard lamps can be used both in open and closed fixtures.



Insect control

Wattage [W]	Volts [V]	Cap	Product Description	Product Code	Peak Wavelength [nm]	Life [h]	Length [mm]	Min.	Max.	Pack Qty
Black Light T8										
15	55	G13	F15T8/BL 368	98447	368	7500	442.1	444.5		25



Wattage [W]	Volts [V]	Cap	Product Description	Product Code	Initial UVA Irradiance [mW/cm2 @ 20cm]	Peak Wavelength [nm]	Life [h]	Length [mm]	Pack Qty	
UVA Blacklight Biax™ - Internal Starter										
9	60	G23	F9BX BL G23	42935	440	368	167	440	10	



UVA Blacklight Biax™ L - External Starter										
36	106	2G11	F36BX BL 2G11	42940	1280	368	1,280	421.8	10	



Industrial heating

Wattage [W]	Volts [V]	Cap	Product Description	Product Code	CCT [K]	Life [h]	Length [mm]	Pack Qty	
Quartz Heat									
500	120	Slv	QH500T3/CL	21788	2400	5000	223.8	12	
500	120	R7S	QH500T3/CL/7	21787	2400	5000	220.5	12	
1000	200-220	Slv	QH1000T3/CL	22355	2400	5000	351	12	
1000	230-250	Slv	QH1000T3/CL	22357	2400	5000	351	12	
1200	144	Slv	QH1200T3/CL	22531	2450	5000	223.8	12	
1200	144	Slv	QH1200T3/CL/HT	22532	2450	5000	223.8	12	
1600	230-250	R7S	QH1600T3/CL/7	22691	2400	5000	498.4	12	
1600	230-250	Slv	QH1600T3/CL	22688	2400	5000	503	12	
2000	230-250	Slv	QH2M/T3/1CL/HT/VB	15551	2450	5000	303	12	
2000	220-250	Slv	QH2MT3/CL/VB	18668	2450	5000	350.5	12	
2000	230-250	Slv	QH2M/T3/CL/HT	22790	2450	5000	350.8	12	
2000	230-250	CER	QH2MT3/CL/HT/R	12716	2450	5000	352.5	12	
2500	460-500	Slv	QH2500T3/CL	22838	2400	5000	731	12	
2500	460-500	R7s	QH2500T3/CL/7	22837	2400	5000	727	12	
3650	480	Slv	QH3650/CL/5	10872	2500	5000	1057	6	
3800	550-600	Slv	QH3800/CL	22875	2500	5000	1062	6	



UVA Biax L



Quartz Heat

Specialty lamps



Wattage [W]	Volts [V]	Cap	Product Description	Product Code	Lumen [lm]	Life [h]	Length [mm]	Pack Qty
Airfield Lighting								
30	6.6A	Gz9.5 2 Pin	EXL	11478	375	1000	44.5	24
45	6.6A	Gz9.5 2 Pin	EXM	11482	750	1000	44.5	24
45	6.6A	Mycalex cap & Prefocus collar	AF6/2 6.6A 45W	88420	760	600	54	100
65	6.6A	Special	Q65T2 1/2/1/CL	32917	1200	1000		200
100	6.6A	Mycalex cap & Prefocus collar	AF 6/5T 6.6A 100W	88417	2100	600	60	100
100	6.6A	PK30d	Q6.6A100PK30d male	80584	2700	1000	13.5	10
200	6.6A	PK30d	Q6.6A200PK30d male	80586	4800	1000	13.5	10
200	6.6A	PK30d	Q6.6A200PK30d female	80590	4800	1000	13.5	10
200	6.6A	Special 1" Ribbon Leads	Q6.6A/T4/5CL	23857	5000	500	76	12
200	6.6A	D.C.Bay	Q6.6AT4/DCR	23860	5150	500	64	12
200	6.6A	Scrw Term	Q6.6A/PAR56/3	33279	NA	1000	114	12
200	6.6A	Mycalex cap & Prefocus collar	AF7/2 6.6A 200W	88413	4800	600	54	100
300	20A	Mog End Pr GX16d	Q20A/PAR56/C	15482	NA	500	127	12
499	20A	Scrw Term	Q20A/PAR56/3	23863	NA	500	114	12
1000	120	G38 Mog BiPost	IM T20BP	88525	22000	500	241	12





Photosynthesis Light for Horticulture



Lighting for growth Lamps and lighting for horticulture

Properly balanced blue and red colours to optimise growth

Improves the yield and quality of greenhouse crops

Specially developed for horticulture

More PAR on average compared to standard HPS

Stable PAR performance

Wide range 250 - 1000W





Horticulture

Main application area

Greenhouses

Growers of food plants find artificial light just as important as it is for flowering plants. GE's specially-developed range of horticultural lamps enable growers to use artificial lighting to improve the yield and quality of greenhouse crops and time growth to meet market demands.

Light output and lumen maintenance on their own are not enough to create plant growth. Plants require a certain radiation level to help with the photosynthesis that enables them to grow, and others factors such as day length also play an important part. Photosynthetically Active Radiation (PAR), measured in micromole/sec, is essential for plant growth. Lucalox™ Photosynthesis Lamps (PSL) are high pressure sodium lamps with a spectrum that gives the best possible PAR, with stable lumen and micromole maintenance, in a greenhouse lighting regime.

Lucalox™ PSL lamps are available in 230V with 250W, 400W and 750W options, and in 400V with 600W, 750W and 1000W.

New to the range are the 600W 400V electronic single ended and 1000W 400V double ended products.

Lucalox™ PhotoSynthesis Lamp (PSL) range

GE's range of horticultural lamps has been extended with the recent addition of 600W electronic and 1000W double ended products, so the range now spans 250 - 1000 watts with 230 and 400 volt options, to suit both OEMs and growers.



NEW PRODUCT

600W 400V Electronic PSL

- High initial mean PAR 1120 μ Mol
- Long service life of 12,000 HOURS (B10)



NEW PRODUCT

1000W Double Ended PSL

- High initial mean PAR 1970 μ Mol
- Long service life of 10,000 hours (B10)



1000W PSL Lamp Features

- High initial mean PAR of 1970 μ Mol
- Over 1900 μ Mol average PAR over life
- Long service life of 10,000 hours (B10)
- Electronic ballast system efficiency versus electromagnetic ballast
- Improved electrical load on the installation
- Compatible with known ballasts
- Output power of ballast constant
- Less fixtures required in greenhouse



PSL technology

Performance and reliability

- GE's advanced sodium resistant ceramic helps eliminate early failures to give a rated service life of 10,000 to 12,000 hours for Lucalox™ PSL products.
- In order to achieve maximum performance, GE recommends lamp replacement when the Rated Service Life is reached.
- The lamps use extra rugged monolithic arc tubes equipped with GE Reliable Starting Technology which provides continuous high performance.

Photosynthetically Active Radiation to extend daylight

The effect of optical radiation on plants has been studied extensively. Generally, photons emitted in the spectral region of 400 - 700nm are particularly effective. Therefore the simple measurement of the quantity of light (Lux) is not sufficient for the horticultural market. Photosynthetically Active Radiation (PAR) and Photosynthetic Photon Flux (PPF) are more useful measurements.

PPF is defined as flux of the photons emitted in the 400 - 700nm wavelength range by the light source. It is expressed in micromoles/second ($\mu\text{mol/s}$), where 1 micromole means 6×10^{17} photons.

The Lucalox™ PSL range from GE has optimised spectra for greenhouse use, with an enhanced red portion of the light output.

- Plants can be used over a longer period
- In winter, fruit can be produced with taste to match summer fruit
- Production can start earlier
- Year-round cultivation is possible

High xenon-fill gas

- Extra light and PAR (Photosynthetically Active Radiation) output.
- More resistance to mains voltage fluctuations.

Zirconium gettering system

- Improves PAR maintenance that drives constant and uniform plant growth.
- The diameter of the frame wire in the lamp has been minimised to reduce shading in the installation without affecting the robustness of the lamp.
- Monolithic arc tube construction for durability and lumen maintenance.

Spectral range

Plants respond to light of varying colour. In general, red light causes plants to become tall and "leggy" while blue light, when used alone, can cause low, stocky growth. A proper balance of red and blue energy produces plants that have normal growth and shape.

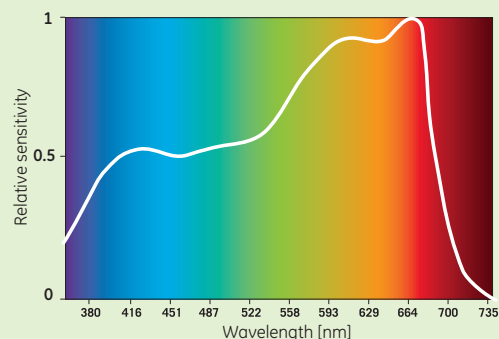

Plants have different sensitivity to different wavelengths.

Day and night Photoperiodism

The relative length of day and night and the seasons is important to plants. The number of hours of darkness in a 24-hour cycle is an important factor in determining blossoming and growing time.

Night length triggers seed germination, tuber and bulb formation, and other growth characteristics such as colour, enlargement of leaves and stem size and shape. This rhythmic characteristic is called photoperiodism and is of great value to growers.

Plants can be classified according to photoperiodicity.

Short day (long night)



The perennial Chrysanthemum and the Poinsettia, which flower in the autumn, are examples of *short-day (long-night)* plants. They fail to flower when the day length, or period of light, is extended beyond a critical value.

Long day



Long-day plants, such as the China Aster and Tuberous Rooted Begonia, flower only with a day length longer than a critical value.

Day neutral



Day-neutral plants, such as the Rose and Carnation, are not limited by photoperiod.

Understanding these principles enables commercial growers to use artificial light profitably, so that flowering and vegetable harvesting can be timed for markets.

Timing

Slow down

The *Perennial Chrysanthemum* is a short-day length plant that will not flower when the day is long (short-night). To postpone flowering Chrysanthemum growers, instead of lengthening the day, interrupt the night for about four hours. This makes the night appear short to plants, which then continue to grow vegetatively instead of starting to flower.

A more economical method of postponing flowering of Chrysanthemums is to apply cycles of light, switching light on for 10 minutes and off for 50 minutes, for four hours during the night, instead of applying light continuously. This is cyclic lighting. It is an effective way of growing flowers. If lighting levels are higher then the grower will see better stem and flower quality and less opportunity for disease.

Speed up

The *China Aster* is a typical long-day (short-night) plant. Long-day plants can be brought to flower ahead of the normal time by lengthening the day. Relatively low intensities of light are enough to induce flowering, when applied early in the morning or at the end of the day. A dark-period interruption - from a few minutes to a few hours - as with other long-day plants, effectively induces flowering just as it inhibits flowering of short-day plants.

Poinsettias must have complete and continuous darkness for about 12 hours a day in order to flower. Even 1 minute of light in the middle of the dark period will prevent their flowering.

Tuberous Begonias flower only when daily dark periods are short - less than 12 hours - but they require long dark periods for best production of tubers. Flowering of tomatoes, however, is not influenced by photoperiod.

Setting the clock



Add

Use Lucalox™ PSL as an additional daytime source of light, boosting existing light levels and aiding photosynthesis.



Extend

Use Lucalox™ PSL as a means of extending the growth time per day. Lights can be switched on at dusk or other non daylight hours.



Extend

Use Lucalox™ PSL as an extension to the growing season through usage during the winter months.



Substitute

Use Lucalox™ PSL as a complete natural light substitute for total environmental control in growing rooms and biological research establishments.

Plant colour and leaf formation

Photoperiod also influences plant responses such as colour and formation of the leaves.

Coleus, for example, under continuous lighting, produces dark red leaves with bright green edges. Less than 10 hours of light per day results in less sturdy plants and paler colours. The tulip bulb is the main source of food reserve, and the light is needed mainly to develop the plants' green colour. Stems attain their greatest length if grown under lighting.

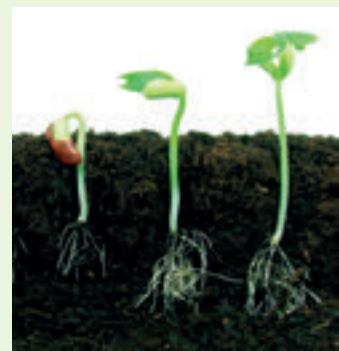

Quality from start to finish

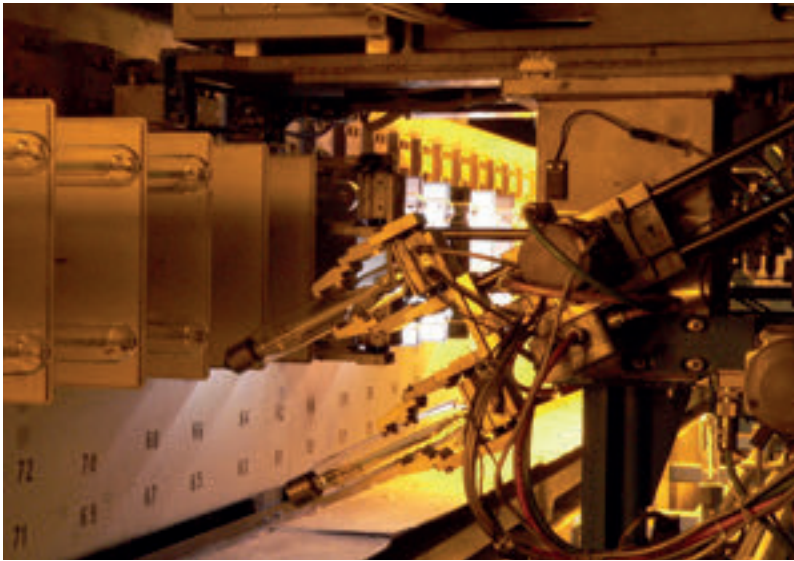

Reliable performance

While light quality is paramount, reliability and performance have also been key factors in the development of the Lucalox™ PSL lamp range.

Robust construction, reliable starting technology and improved lumen maintenance ensure peace of mind against early lamp failures and provide the consistency demanded for perfect growing conditions.

Guaranteed

GE is constantly engaged in a global quality process. A statistical quality system, designated SIX SIGMA, is applied in all areas of the company from manufacturing through to sales. The lamps comply with the IEC/EN 62035 standards.

GE offers warranties to distributors of its Lucalox™ PSL lamps. The warranty comprises two parts:

- Warranty on lamp reliability (Lamp Survival).
- Warranty on PAR (Photosynthetically Active Radiation) maintenance.

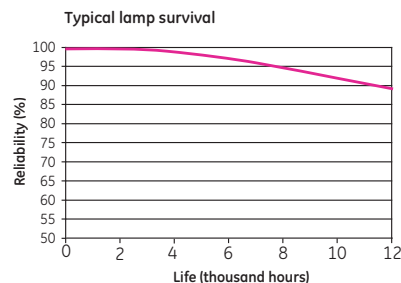
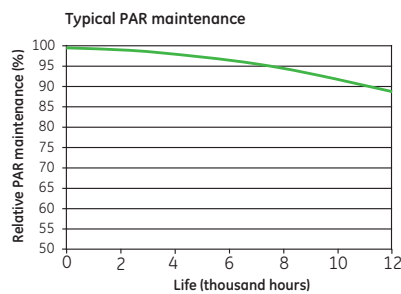

Selector

Single ended 230V



230V 250W

Lamp volts: 115V
 Current: 2.7A
 Watts: 250W
 100 h lumens: 33,000
 100 h PAR: 430 $\mu\text{mole/sec}$
 Packing: 12 or 63

Page X.10



230V 400W

Lamp volts: 110V
 Current: 4.3A
 Watts: 420W
 100 h lumens: 56,500
 100 h PAR: 710 $\mu\text{mole/sec}$
 Packing: 12 or 63

Page X.10



230V 600W

Lamp volts: 115V
 Current: 6.0A
 Watts: 615W
 100 h lumens: 90,000
 100 h PAR: 1080 $\mu\text{mole/sec}$
 Packing: 12 or 63

Page X.10



230V 750W

Lamp volts: 115V
 Current: 7.4A
 Watts: 755W
 100 h lumens: 112,000
 100 h PAR: 1320 $\mu\text{mole/sec}$
 Packing: 12 or 63

Page X.10

Single ended 400V



400V 600W

Lamp volts: 200V
 Current: 3.6A
 Watts: 620W
 100 h lumens: 85,000
 100 h PAR: 1120 $\mu\text{mole/sec}$
 Packing: 12 or 63

Page X.10



400V 600W EL

Lamp volts: 200V
 Current: 3.6A
 Watts: 620W
 100 h lumens: 85,000
 100 h PAR: 1120 $\mu\text{mole/sec}$
 Packing: 12 or 63
 (Electronic ballast)

Page X.10



400V 750W

Lamp volts: 205V
 Current: 4.4A
 Watts: 765W
 100 h lumens: 104,000
 100 h PAR: 1390 $\mu\text{mole/sec}$
 Packing: 12 or 63

Page X.10

Double ended 400V



400V 1000W

Lamp volts: 220-240V
 Current: 4.5A
 Watts: 1000W
 100 h lumens: 140,000
 100 h PAR: 1970 $\mu\text{mole/sec}$
 Packing: 12 or 32

Page X.10



Special purpose lamps.
 Not suitable for household illumination.

Horticulture Lamps

Product identification

The following glossary of terms will help you when selecting lamps in this section. Within each product line, lamps are divided into families – within these families, lamps are listed by wattage. The Product Description can be used as a quick reference to each product's attributes. Where Life or Average Life are stated we refer to the industry standard definition of how many hours of operation 50% of a given installation will exceed.

Volts (V)	Current (A)	Power (W)	Product Description Lamp reference – describes the lamp's main characteristics	Product Code [12 pack] GE SKU code. Choose code according to pack quantity.	Product Code [63 pack]	Dimensions: In mm. See diagram.	Performance: This gives an indication of the lamp's brightness and its effect on plant growth.	Cap	100 hour lumens (Lumens)	100 hour PAR (µmole/sec)	Bulb glass	Operating position
200	3.6	620	LU400V/600W/PSL/T	43440	43439	292 124.5 169 48	E40/45	85,000	1120	Hard	Universal	

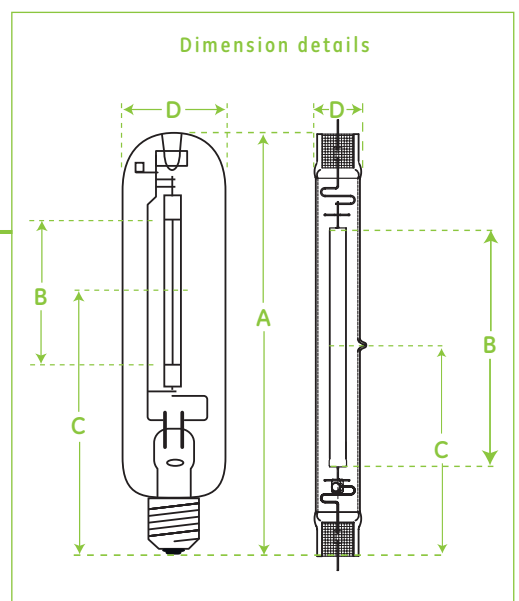
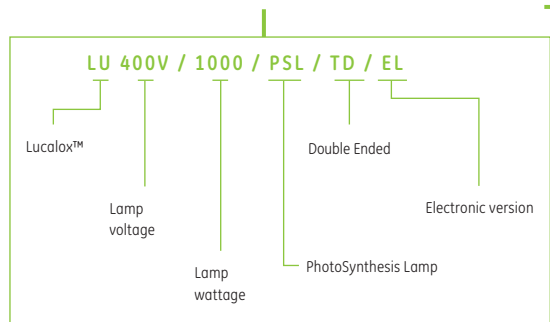

Volts [V]	Current [A]	Power [W]	Product Description	Product Code [12 pack]	Product Code [63 pack]	Max Length A [mm]	Arc gap B [mm]	LCL C [mm]	Diameter D [mm]	Cap	100 hour lumens [Lumens]	100 hour PAR [$\mu\text{mole}/\text{sec}$]	Bulb glass	Operating position
230V - E40 Cap														
115	2.7	250	LU250W/PSL/T	88665	N/A	260	64	158	48	E40/45	33,000	430	Hard	Universal
110	4.3	420	LU400W/PSL/T	17106	44304	292	87	175	48	E40/45	56,500	710	Hard	Universal
115	6.0	615	LU600W/PSL/T	17107	44305	292	125	169	48	E40/45	90,000	1080	Hard	Universal
115	7.4	755	LU750W/PSL/T	17108	44306	293	130	178	51	E40/45	112,000	1320	Hard	Universal
400V - E40 Cap														
200	3.6	620	LU400V/600W/PSL/T	43440	43439	292	124.5	169	48	E40/45	85,000	1120	Hard	Universal
200	3.6	620	LU400V/600/PSL/T/EL**	63919	63922	292	124.5	169	48	E40/45	85,000	1120	Hard	Universal
205	4.4	765	LU400V/750W/PSL/T	43438	43437	293	143	175	51	E40/45	104,000	1390	Hard	Universal
400V - Double ended														
220-240	4.5	1000	LU400V/1000/PSL/TD/EL**	63921	63924***	327	160	150-160	34	K12x30S	140,000	1970	Hard	Universal

* Depending on system conditions, lamp power can vary by $\pm 2.5\%$

** Electronic ballast

** 32 bulk pack not 63

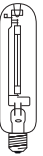

Brand cross reference

The following table shows GE and alternative brand Product Descriptions. These cross references are provided as a quick guide and may only represent a near equivalent to other brands. The table contains data from alternative brands' catalogues and website.

GE	PHILIPS	Osram	Sylvania
LU250W/PSL/T		Plantastar Inter 250	
LU400W/PSL/T	MASTER GreenPower 400W EM 230V	Plantastar 400	SHP-TS GroLux 400W
LU600W/PSL/T	MASTER GreenPower 600W EM 230V	Plantastar 600	SHP-TS GroLux 600W
LU750W/PSL/T			
LU400V/600W/PSL/T	MASTER GreenPower 600W EM 400V		SHP-TS GroLux 600W-400V
LU400V/600/PSL/T/EL	MASTER GreenPower 600W EL 400V		
LU400V/750W/PSL/T			
LU400V/1000/PSL/TD/EL	MASTER GreenPower TD 1000W EL 400V		

Cap drawings

All cap drawings are a guide, if further technical details are required please contact your nearest sales office.

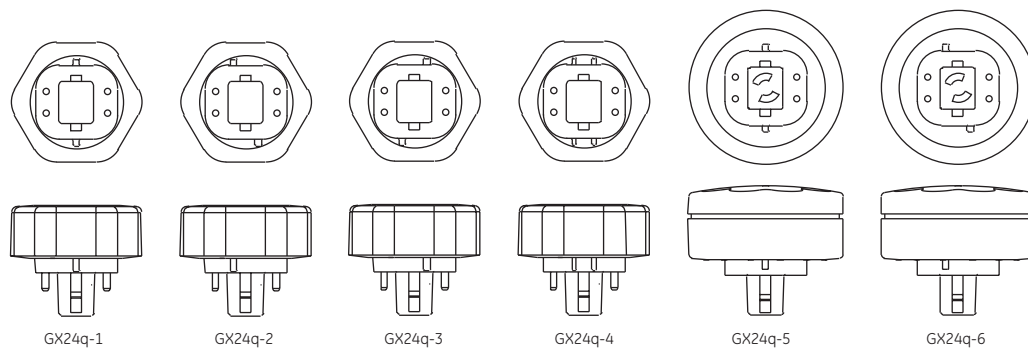
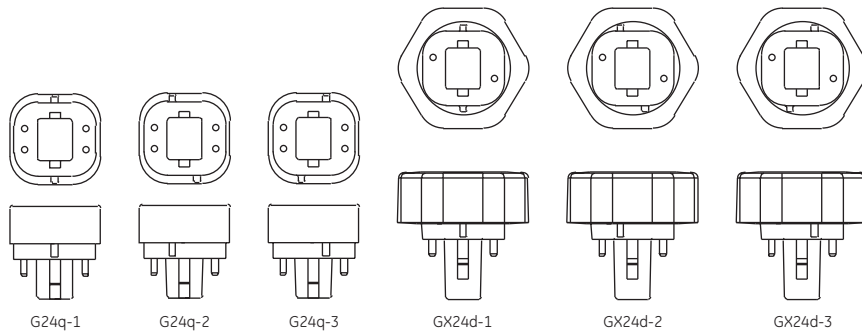
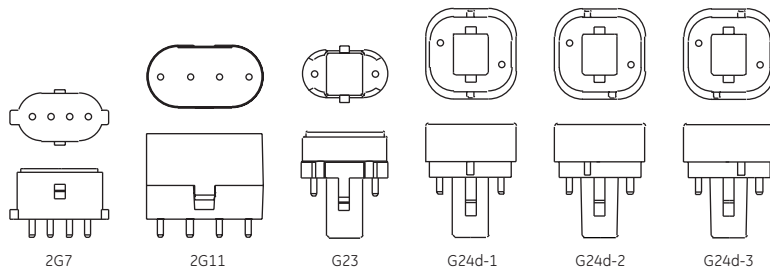
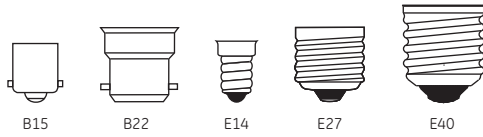

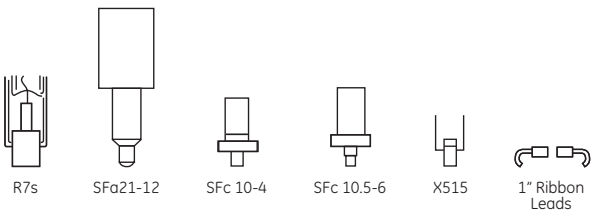
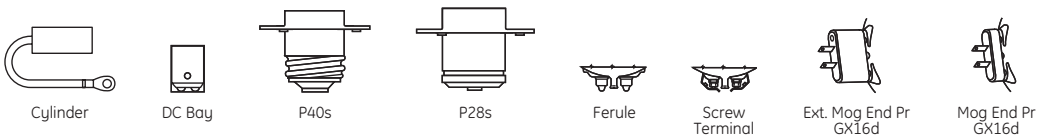
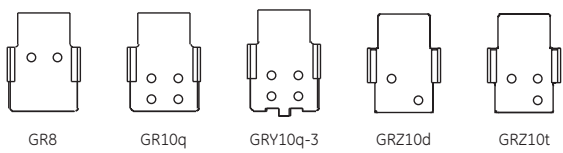
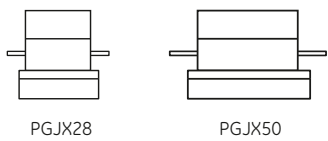
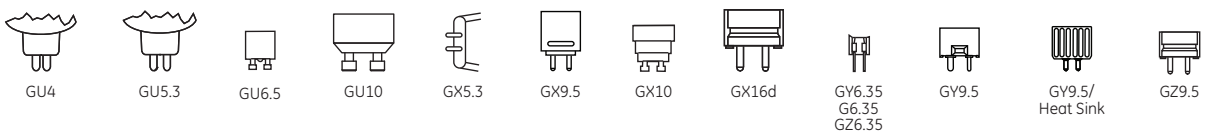
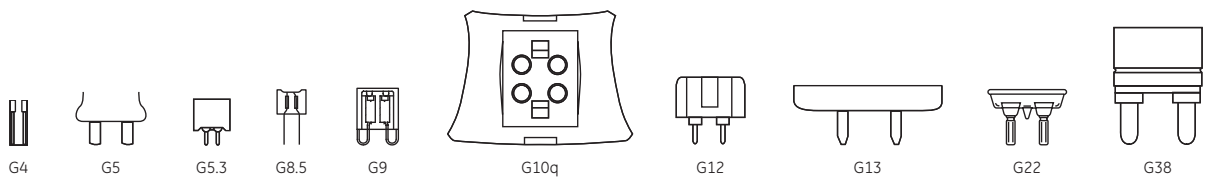

Glossary

A

Accent Lighting

Directional lighting to emphasize a particular object or draw attention to a display item.

Adaptation

The process by which the human eye adjusts to a change in light level.

Ambient Lighting

The general lighting present in an area -excluding task lighting and accent lighting but including general lighting and daylight streaming in.

Ambient Temperature

The surrounding temperature within an environment.

Amperes ("Amps.")

A measure of electrical current. In incandescent lamps, the current is related to voltage and power as follows: Watts (power) = Volts x Amps (current).

American National Standards Institute (ANSI)

A consensus-based organization which coordinates voluntary standards for the physical, electrical and performance characteristics of lamps, ballasts, luminaires and other lighting and electrical equipment.

Anode

The "positive" terminal of a diode.

ANSI Ballast Type

Ballast type used to operate lamp in accordance with ANSI standard.

ANSI Codes

These are 3-letter codes assigned by the American National Standards Institute. They provide a system of assuring mechanical and electrical interchangeability among similarly coded lamps from various manufacturers. General Electric uses the assigned ANSI Codes as Lamp Ordering Codes for most Projection Lamps.

Application

Also called "lighting application," it refers to the particular use the lamp is being put to. (e.g. high-bay industrial application or retail lighting application.) The term can also refer in a general way to "application engineering" which deals with specific parameters and usage of light sources. (e.g. how to do a lighting layout, where to place fixtures and so on.)

Arc

A general term for a high intensity electrical discharge occurring between two electrodes in a gaseous medium, usually accompanied by the generation of heat and the emission of light (See ELECTRICAL DISCHARGE).

Arc Lamp

A light source containing an arc (see above). Also called a discharge lamp, or an arc discharge lamp (See ELECTRICAL DISCHARGE).

Arc Length

In High Intensity Discharge lamps this is the distance between the electrode tips, which represents the physical length of the electrical discharge.

Atmosphere

This field designates the type of gas or vacuum filling a volume or chamber of the lamp. This chamber might contain a filament or it might refer to the bulb which contains the arc tube.

Auto Reset Shutdown Circuit

Circuit senses lamp end life and will automatically shut off power to the lamp(s). When a new lamp is inserted in the socket, the ballast resets, and turns on the lamp automatically. Some shutdown circuits require the power to be cycled before a new lamp will re-light.

B

Ballast

An auxiliary piece of equipment required to start and to properly control the flow of current to gas discharge light sources such as fluorescent and high intensity discharge (HID) lamps.

Ballast Efficacy Factor (BEF)

Defined as ballast factor x 100 divided by input watts. The value is used to evaluate various lighting systems based on light output and power input. The BEF can only be used to compare systems operating the same type and quantity of lamps.

Ballast Factor (BF)

This is the percentage of a lamp's rated lumen output that can be expected when operated on a specific, commercially available ballast. For example, a ballast with a ballast factor of 0.93 will result in the lamp's emitting 93% of its rated lumen output. A ballast with a lower BF results in less light output and also generally consumes less power.

Ballast Hum

Sound generated by the vibration of laminations in the iron core of the transformer or inductor present in the ballast.

Ballast Losses

Power or energy dissipated in the ballast as heat and not converted to lamp energy.

Base or Socket

The socket is the receptacle connected to the electrical supply; the base is the end of the lamp that fits into the socket. There are many types of bases used in lamps, screw bases being the most common for incandescent and HID lamps, while bipin bases are common for linear fluorescent lamps.

Base Temperature (Maximum)

The maximum operating temperature permitted for the base in Celsius. Fixture manufacturers need to ensure that these conditions are satisfied in their fixture.

Bayonet

A style of bulb base which uses keyways instead of threads to connect the bulb to the fixture base. The bulb is locked in place by pushing it down and turning it clockwise.

Beam Angle

The angular dimension of the cone of light from reflectorized lamps (such as R and PAR types) encompassing the central part of the beam out to the angle where the intensity is 50% of maximum. The beam angle sometimes called "beam spread" is often part of the ordering code for the reflectorized lamps. Example: The 50PAR30/HIR/NFL25 is a 50 watt PAR30 narrow flood lamp with a beam angle of 25 degrees (See FIELD ANGLE).

Beam Lumens

The total lumens present within the portion of the beam contained in the beam angle.

Beam Spread (Approximate)

For reflector type lamps. The total angle of the directed beam (in degrees horizontal or vertical) to where the intensity of the beam falls to 50% or 10% of the maximum candlepower value as indicated.

Bi-Pin

Any base with two metal pins for electrical contact. This is the typical base for a fluorescent tube of 1 to 4 feet in length. It consists of 2 prong contacts which connect into the fixture. Medium bi-pins are used with type T-8 and T-12 tubular fluorescent lamps, and miniature bi-pins are used for tubular T-5 fluorescent lamps.

Biax™

GE trademark for its biaxial family of high-efficiency and long-life compact fluorescent lamps. DBX (Double Biax), TBX (Triple Biax) and QBX (Quad Biax) refer to the number of U-shaped legs present in the lamp.

Blackbody

A hot body with an incandescent black surface at a certain temperature used as a standard for comparison. Note that a black surface is the best radiator possible. A tungsten filament will emit slightly less radiation than a blackbody at the same temperature.

Black Light

A popular term referring to a light source emitting mostly near UV (320 to 400 nm) and very little visible light.

Blacktop

Whether or not the top of the miniature lamp has a blacktop coating. The coating is used to control unwanted brightness or glare.

Bollard

A short, thick post with a light at its top, used for grounds and outdoor walkway lighting.

Bottom Exit Studs (BES)

(LFL plug-in ballasts) A configuration with screw studs mounted on the base plate or bottom of the ballast. The screws are 3/8" inches long with a #8-32 thread size (#8-32 nut). They are mounted on a two-inch center. The studs are usually used to mount the ballast directly onto a junction box plate.

Bulb

A loose way of referring to a lamp. "Bulb" refers to the outer glass bulb containing the light source.

Bulb Material or Coating

The type of glass (or quartz) used in the glass envelope surrounding the light source. The material can also have coatings applied to achieve particular performances.

Bulb Size

Bulb shape followed by its size (the maximum diameter of the bulb expressed in eighths of an inch). For Compact Fluorescent products, "S", "D", "T", and "Q" are used to represent Single, Double, Triple and Quad Biax® sizes. The code also includes a reference such as T4 to represent the size of the tube. Rectangular headlamps are designated as "Rect" and the number of millimeters horizontally.

C

Canadian Energy Standards

Indicates ballast complies with Canadian Energy Standards and meets the requirements of CAN/CSA C654-M91.

Canadian Standards Association (CSA)

An organization that writes standards and tests lighting equipment for performance as well as electrical and fire safety. Canadian provincial laws generally require that all products sold for consumer use in Canada must have CSA or equivalent approval.

Candela [cd]

The measure of luminous intensity of a source in a given direction. The term has been retained from the early days of lighting when a standard candle of a fixed size and composition was defined as producing one candela in every direction. A plot of intensity versus direction is called a candela distribution curve and is often provided for reflectorized lamps and for luminaires with a lamp operating in them.

Candlepower

An obsolete term for luminous intensity; current practice is to refer to this simply as candelas (see CANDELA).

Candlepower (Mean Spherical)

Initial mean spherical candlepower at the design voltage. Mean spherical candlepower is the generally accepted method of rating the total light output of miniature lamps. To convert this rating to lumens, multiply it by 12.57 (4 pi).

Candlepower Distribution Curve

A graphical presentation of the distribution of light intensity of a light source, usually a reflector lamp or luminaire.

Capacitor

Device in an electronic circuit (part of ballast or a separate element) that stores electrical energy. Often used for power factor correction and lamp regulation.

Cathode

The "negative" terminal of a diode/arc.

Cathode Resistance

Resistance of the cathode in a Fluorescent lamp. It is measured "cold" before the lamp is turned on (Rc) or "hot" after the lamp is turned on (Rh). The ratio of the hot resistance to the cold resistance is also measured (Rh/Rc).

Center Beam Candlepower (CBCP)

Refers to the luminous intensity at the center of the beam of a blown or pressed reflector lamp (such as a PAR lamp). Measured in candelas.

Ceramic Metal Halide (CMH)

A type of metal halide lamp that uses a ceramic material for the arc tube instead of glass quartz, resulting in better colour rendering (>80 CRI) and improved lumen maintenance. GE ConstantColor™ CMH lamps feature a 3-piece arc tube design that delivers excellent colour consistency and lamp reliability.

Chip

A very small square of semi-conducting material. Also known as a "die," it is the "active" light-emitting component of an LED.

Chromaticity

Measure to identify the colour of a light source, typically expressed as (x,y) coordinates on a chromaticity chart (See COLOUR TEMPERATURE).

Chromaticity Coordinates

A system for measuring the colour of the light emitted from a light source—either a primary source like a lamp or a secondary source like an illuminated object. Usually two numbers, x and y coordinates ranging from 0 to 1 specify the chromaticity.

Class P Thermal Protector

A switching device sensitive to current and heat that automatically disconnects ballast if the temperature exceeds UL temperature limitations.

Coefficient of Utilization (CU)

In general lighting calculations, the fraction of initial lamp lumens that reach the work plane. CU is a function of luminaire efficiency, room surface reflectances and room shape.

Coil

Windings of copper or aluminum wire surrounding the steel core in ballast. Also refers to the entire assembly comprising the inductor or transformer.

Colour Bin

LEDs are often sorted according to their CIE chromaticity coordinates into different groupings or "bins."

Glossary

Colour Rendering Index (CRI)

An international system used to rate a lamp's ability to render object colours. The higher the CRI (based upon a 0-100 scale) the richer colours generally appear. CRI ratings of various lamps may be compared, but a numerical comparison is only valid if the lamps are close in colour temperature. CRI differences among lamps are not usually significant (visible to the eye) unless the difference is more than 3-5 points.

Colour Rendering Indicator

Draws attention to the fact that this is a lamp with high colour rendering, which helps objects and persons illuminated to appear more true to life.

Colour Temperature (Correlated Colour Temperature - CCT)

A number indicating the degree of "yellowness" or "blueness" of a white light source. Measured in Kelvins, CCT represents the temperature an incandescent object (like a filament) must reach to mimic the colour of the lamp. Yellowish-white ("warm") sources, like incandescent lamps, have lower colour temperatures in the 2700K-3000K range; white and bluish-white ("cool") sources, such as cool white (4100K) and natural daylight (6000K), have higher colour temperatures. The higher the colour temperature the whiter, or bluer, the light will be (See CHROMATICITY).

Compact Fluorescent Lamp (CFL)

The general term applied to fluorescent lamps that are single-ended and that have smaller diameter tubes that are bent to form a compact shape. Some CFLs have integral ballasts and medium or candelabra screw bases for easy replacement of incandescent lamps.

ConstantColor™

A GE registered name for lamp families that show very little colour shift over life, such as GE's Precise™ MR16 lamps and GE's ceramic metal halide (CMH) lamps.

Coolbeam

(See DICHROIC REFLECTOR)

Cool White

A term loosely used to denote a colour temperature of around 4100 K or higher. The Cool White (CW) designation is used specifically for T12 and other fluorescent lamps using halophosphors and having a CRI of 62.

Core

Component of electromagnetic ballast that is surrounded by the coil. Core is comprised of steel laminations or solid ferrite material.

Core & Coil Ballast

A ballast that uses a "Core & Coil" assembly to operate fluorescent or HID lamps. Refers to copper or aluminum windings on a steel core.

Cosine-Corrected

An illuminance meter that measures the light level correctly irrespective of the angle the light is coming from. (See ILLUMINANCE METER)

Cost of Light

Usually refers to the cost of operating and maintaining a lighting system on an ongoing basis. The 88-8-4 rule states that (typically) 88% is the cost of electricity, 8% is labor and only 4% is the cost of lamps.

covRguard™

A lamp encased by a plastic sleeve or coating to help contain glass fragments if the lamp breaks.

Crest Factor (Max Current)

The ratio of the peak lamp current to average lamp operating current (RMS). The lower the current crest factor is, the gentler the ballast is on the lamp.

Current Type (AC/DC)

Whether the operational voltage is based on Alternating Current or Direct Current.

D

Daylight Harvesting

Lighting design for building interiors that makes of daylight as a way of reducing energy consumption.

Daylight Lamp

A lamp resembling the colour of daylight, typically with a colour temperature of 5500 K to 6500K.

Declaration of Conformity (DoC)

A self-declaration of a product on its compliance to the Electromagnetic Compatibility Directive and the Low Voltage Directive and it can bare CE conformity marking (EU).

Dichroic Reflector (or Filter)

A reflector (or filter) that reflects one region of the spectrum while allowing the other region(s) to pass through. A reflector lamp with a dichroic reflector will have a "cool beam" i.e. most of the heat has been removed from the beam by allowing it to pass through the reflector while the light has been reflected.

Die

See Chip.

Dimmable

Whether or not the lamp lumens can be varied while maintaining reliability.

Dimmer, Dimming Control

A device used to lower the light output of a source, usually by reducing the wattage it is being operated at. Dimming controls are increasing in popularity as energy conserving devices.

Discharge Lamp

A lamp where light is emitted from an electrical discharge between two electrodes as opposed to a filament lamp. Examples are: Fluorescent lamps and HID (High Intensity Discharge) lamps like Metal Halide, Mercury and High Pressure Sodium.

All discharge lamps require some kind of current limiting device, e.g. a ballast, to operate them.

Driver

Control gear for LED-based products. Can be either constant current or constant voltage. For LED lamps the driver is often integral (see 'Self-Ballasted Lamps').

E

Eccentricity (Maximum)

In High Intensity Discharge lamps the Bulb to Arc Angle is the angle off of center between electrodes and bulb. The Bulb to Base Angle is the angle off of center that the bulb is from the base.

Edison Award

An annual competition where lighting designers submit their best projects. The entries are judged by an international panel and awards are presented at a banquet accompanying Light Fair, the North American trade show for the lighting industry.

Efficacy

A measurement of how effective the light source is in converting electrical energy to LUMENS of visible light. Expressed in LUMENS-PER-WATT [LPW] this measure gives more weight to the yellow region of the spectrum and less weight to the blue and red region where the eye is not as sensitive.

Efficiency

The efficiency of a light source is simply the fraction of electrical energy converted to light, i.e. watts of visible light produced for each watt of electrical power with no concern about the wavelength where the energy is being radiated. For example, a 100 watt incandescent lamp converts 7% of the electrical energy into light; discharge lamps convert 25% to 40% into light.

The efficiency of a luminaire or fixture is the percentage of the lamp lumens that actually comes out of the fixture (See LUMINOUS EFFICACY).

Efficiency of Ballast

The ratio of output power divided by input power. A premium ballast would have an electrical efficiency greater than 90%. The efficiency of a luminaire or fixture is the percentage of the lamp lumens that actually comes out of the fixture.

e-HID ballast

(see ELECTRONIC HID BALLAST).

ELC (European Lamp Companies Federation)

Created in 1985, the European Lamp Companies Federation (ELC) is both the forum and the voice of the lamp industry in Europe. It represents the leading European lamp manufacturers, which collectively directly employ 50,000 people, and account for 95 percent of total European production, with an annual turnover in Europe of €5 billion. From the outset, ELC objectives have been to promote efficient lighting practice for a sustainable environment and the advancement of human comfort, health and safety. To this end, ELC monitors, advises and co-operates with legislative bodies in developing European Directives and Regulations relevant to the European lamp industry.

Electrical Discharge

A condition under which a gas becomes electrically conducting and becomes capable of transmitting current, usually accompanied by the emission of visible and other radiation. An electric spark in air is an example of an electrical discharge, as is a welder's arc and a lightning bolt. (See ARC, ELECTRODELESS LAMPS)

Electrical Testing Laboratory (ETL)

Independent testing laboratory that performs ballast tests and certifies accuracy of performance data.

Electrode

Any metal terminal emitting or collecting charged particles, typically inside the chamber of a gas discharge lamp. In a fluorescent lamp, the electrodes are typically metal filaments coated with special powders called emission mix. Negatively charged free electrons emitted by one electrode are attracted to the positive electrode (anode), creating an electric current and arc between electrodes.

Electrodeless Lamps

Light sources where the discharge occurs in a chamber with no electrodes (no metal). The energy for the discharge is supplied by radio frequency excitation, e.g. microwaves (See GENURA).

Electromagnetic Ballast

(See MAGNETIC BALLASTS).

Electromagnetic Interference (EMI)

High frequency electronic ballasts and other electronic devices can produce a small amount of radio waves which can interfere with radio and TV. Federal mandated requirements must be met for EMI levels before an electronic device is considered FCC compliant (US). (FCC is the Federal Communications Commission).

Electromagnetic Spectrum

A continuum of electric and magnetic radiation that can be characterized by wavelength or frequency. Visible light encompasses a small part of the electromagnetic spectrum in the region from about 380 nanometers (violet) to 770 nanometers (red) by wavelength.

Electronic Ballast

A short name for a fluorescent high frequency electronic ballast. Electronic ballasts use solid state electronic components and typically operate fluorescent lamps at frequencies in the range of 25-35 kHz. The benefits are: increased lamp efficacy, reduced ballast losses and lighter, smaller ballasts compared to electromagnetic ballasts. Electronic ballasts may also be used with HID (high intensity discharge) lamps (See ELECTROMAGNETIC BALLAST).

Electronic HID Ballast

An electronic ballast capable of operating an HID lamp. GE's UltraMax® (electronic HID ballast) operates PulseArc® (metal halide) and CMH (ceramic metal halide) lamps between 250W and 400W and provides higher efficiency and significantly improved lumen maintenance over magnetic ballasts.

Elliptical Reflector (ER) Lamp

An incandescent lamp with a built-in elliptically-shaped reflecting surface. This shape produces a focal point directly in front of the lamp which reduces the light absorption in some types of luminaires. It is particularly effective at increasing the efficacy of baffled downlights.

Enclosed Fixtures

(See OPEN FIXTURE RATED)

Energy Policy Act (EPACT)

Comprehensive energy legislation passed by the U. S. Congress in 1992. The lighting portion includes lamp labeling and minimum energy efficacy (lumens/watt) requirements for many commonly used incandescent and fluorescent lamp types. Federal Canadian legislation sets similar minimum energy efficacy requirements for incandescent reflector lamps and common linear fluorescent lamps.

Energy Policy Act (EPACT) Indicator

Means this lamp is Federally regulated for Energy Efficiency (US) (See ENERGY POLICY ACT).

EoL (End-of-Life Protection)

A circuit that senses that a lamp has reached end of life (compact fluorescent lamps and small diameter linear fluorescent lamps) and turns off power to the lamp. Continuing to power the lamp beyond end of life can result in overheating of the lamp ends.

Energy-Using Products (EuP)

The EuP Directive establishes a framework for the setting of eco-design requirements for energy-using products. It aims to improve the environmental performance of products throughout the life-cycle, by systematic integration of environmental aspects at a very early stage in the product design.

Eye Sensitivity

A curve depicting the sensitivity of the human eye as a function of wavelength (or colour). The peak of human eye sensitivity is in the yellow-green region of the spectrum. The normal curve refers to photopic vision or the response of the cones. (See Photopic, Scotopic, Fovea, Foveal vision)

Glossary

F

Federal Communications Commission (FCC)

The U. S. Federal agency that regulates emissions in the radio frequency portion of the electromagnetic spectrum. Part 18 of the FCC rules specifies electromagnetic interference (EMI) from lighting devices operating at frequencies greater than 9 kilohertz (kHz). Typical electronically-ballasted compact fluorescent lamps operate in the 24 - 100 kHz frequency range.

Field Angle

The angular dimension of the cone of light from reflectorized lamps (such as R and PAR types) encompassing the central part of the beam out to the angle where the intensity is 10% of maximum (See BEAM ANGLE).

Filament Design

Filaments are designated by a letter combination in which C is a coiled wire filament, CC is a coiled wire that is itself wound into a larger coil, and SR is a straight ribbon filament. Numbers represent the type of filament-support arrangement.

Fixture Requirements

Describes fixture requirements for HID lamps.
O = Open or Enclosed Fixtures
E = Enclosed Fixtures Only
S = Lamps operated in a vertical position (Base Up or Down) $\pm 15^\circ$, can be used in an open fixture. Lamps burned in any other orientation must be used in "enclosed fixtures only".

Flicker

The periodic variation in light level caused by AC operation that can lead to strobe effects.

Flood

Used to refer to the beam pattern of a reflector lamp, which disperses the light over a wide beam angle, typically 20 degrees or more. ("Flood" as opposed to "Spot")

Floodlight

A luminaire used to light a scene or object to a level much brighter than its surroundings. Usually floodlights can be aimed at the object or area of interest.

Fluorescence

A physical phenomenon whereby an atom of a material absorbs a photon of light and immediately emits a photon of longer wavelength. If there is a significant delay the phenomenon is called phosphorescence rather than fluorescence. It is interesting that "phosphors" used in lamps exhibit "fluorescence," not "phosphorescence." (See PHOSPHOR).

Fluorescent HO

Fluorescent HO and VHO lamps require special ballasts that generate higher currents than standard ballasts and operate the lamps at higher wattage than standard lamps. These lamps are generally less efficient than the standard product. Metal Halide HO and XHO lamps operate on the same ballasts as standard lamps and at the same wattage but are more efficient and produce higher light output than standard lamps.

Fluorescent Lamp

A high efficiency lamp utilizing an electric discharge through low pressure mercury vapour to produce ultraviolet (UV) energy. The UV excites phosphor materials applied as a thin layer on the inside of a glass tube which makes up the structure of the lamp. The phosphors transform the UV to visible light.

Footcandle (fc)

A unit of illuminance or light falling onto a surface. It stands for the light level on a surface one foot from a standard candle. One footcandle is equal to one lumen per square foot. See also Lux.

Footcandle Meter

(See ILLUMINANCE METER).

Footlambert

An obsolete term referring to a luminance of 1/7 candelas per square foot.

Forward Current

Current through an LED in the direction of its greatest conduction.

Forward Voltage (VF)

The voltage across an LED for a given forward current.

Four-Pin Compact Fluorescent Lamps

A "plug-in" compact fluorescent lamp with 4 pins in the base to make electrical contact with the ballast. Four-pin lamps can be dimmed on appropriate dimming ballasts while two-pin lamps cannot.

Frequency

Rate of alternation in an AC current. Expressed in cycles per second or Hertz (Hz).

Fovea, Foveal Vision

A small region of the retina corresponding to what an observer is looking straight at. This region is populated almost entirely with cones, while the peripheral region has increasing numbers of rods. Cones have a sensitivity peaking in the yellow and corresponding to the eye response curve (See PHOTOPIC, SCOTOPIC, EYE SENSITIVITY).

Full Spectrum Lighting

A marketing term, typically associated with light sources that are similar to some forms of natural daylight (5000K and above, 90+ CRI), but sometimes more broadly used for lamps that have a smooth and continuous colour spectrum.

G

Genura™

GE's electrodeless compact fluorescent lamp, Genura™, uses induction to power the discharge. The chamber generates UV (just like a discharge in a regular fluorescent lamp) that is converted by phosphors to visible light. Because Genura™ uses no electrodes, the life of this unique reflector lamp is longer than typical compact fluorescent products (see INDUCTION LIGHTING).

Glare

Visual discomfort caused by excessive brightness is called discomfort glare. If task performance is affected it is called disability glare. Glare can be direct glare or indirect (reflected) glare (See VEILING REFLECTIONS and VISUAL COMFORT PROBABILITY).

Group Relamping

The practice of replacing all the lamps at an installation at one time with new lamps when the lamps have operated for (typically) 65% to 70% of rated life. The two benefits of group relamping are: (1) reduced maintenance costs because of the expense and inconvenience of replacing failing lamps one at a time, and (2) improved appearance and performance since older lamps are often degrading in brightness and colour as they age.

H

Halogen Lamp

A halogen lamp is an incandescent lamp with a filament that is surrounded by halogen gases, such as iodine or bromine. Halogen gases allow the filaments to be operated at higher temperatures and higher efficacies. The halogen participates in a tungsten transport cycle, returning tungsten to the filament and prolonging lamp life.

Halogen-IR (HIR™) Lamp

GE designation for high-efficiency tungsten halogen lamps. HIR lamps utilize shaped filament tubes coated with numerous layers of materials that transmit light but reflect the heat (infrared) back into the filament. This reduces the power needed to keep the filament hot.



High-Efficiency (Energy Saving)

Electromagnetic Ballast

Ballast with core & coils, designed to minimize ballast losses compared to the "standard" ballast.

High-Bay Lighting

Lighting designed for (typically) industrial locations with a ceiling height of 25 feet and above.

High Intensity Discharge (HID) Lamp

A general term for mercury, metal halide and high-pressure sodium lamps. HID lamps contain compact arc tubes which enclose various gases and metal salts operating at relatively high pressures and temperatures.

High Output/Very High Output (HO, VHO) Lamps

Designation for lamps generating more light than standard lamps.

High Power Factor

A ballast or lamp with integral electronics whose power factor is corrected to 90% or greater.

High-Pressure Sodium (HPS) Lamp

HPS lamps are high intensity discharge light sources that produce light by an electrical discharge through sodium vapor operating at relatively high pressures and temperatures. GE markets these lamps under the trade name of Lucalox™.

Hot Restart Time

Time it takes for a High Intensity Discharge lamp to reach 90% of light output after going from on to off to on.

I-Line

A GE designation for a family of metal halide lamps which will operate on a mercury ballast. Designed as a simple retrofit for mercury lamp.

Ignitor

An electronic device providing a high voltage pulse to initiate an electrical discharge. Typically, the ignitor is paired with or is a part of the ballast (See STARTER).

Illuminance

The "density" of light (lumens/area) incident on a surface; i.e. the light level on a surface. Illuminance is measured in footcandles or lux.

Illuminance Meter

A device that measures the illuminance at a location calibrated either in footcandles or in lux. (Also know as a light meter - See COSINE CORRECTED).

Incandescent Lamp

A light source that generates light utilizing a thin filament wire (usually of tungsten) heated to white heat by an electric current passing through it.

Indirect Lighting

The method of lighting a space by directing the light from luminaires upwards towards the ceiling. The light scattered off the ceiling produces a soft, diffuse illumination for the entire area.

Induction Lighting

Gases can be excited directly by radio-frequency or microwaves from a coil that creates induced electromagnetic fields. This is called induction lighting and it differs from a conventional discharge, which uses electrodes to carry current into the arc. Induction lamps have no electrodes inside the chamber and generally, therefore, have longer life than standard lamps.

Infrared Radiation

Electromagnetic energy radiated in the wavelength range of about 770 to 1,000,000 nanometers. Energy in this range cannot be seen by the human eye, but can be sensed as heat by the skin.

Input Voltage

Power supply voltage required for proper operation of fluorescent or HID ballast.

Input Watts

The total power input to the ballast that includes lamp watts and ballast losses. The total power input to the fixture is the input watts to the ballast or ballasts and is the value to be used when calculating cost of energy and air conditioning loads. More than 90% of the input watts is wattage or power delivered to the lamp load with typical ballast.

Instant Start

A type of ballast designed to start fluorescent lamps as soon as the power is applied. Most T8 fluorescent lamps are being operated on electronic instant-start ballasts. Slimline fluorescent lamps operate only on instant-start circuits.

Instant-Start Lamp

A fluorescent lamp, usually with a single pin at each end, approved to operate on instant-start ballasts. The lamp is ignited by a high voltage without any filament heating.

Integral

A popular term for a lamp which includes a built-in ballast (CFL or HID), driver (LED) or transformer (halogen).

Intensity Bin

LEDs are often sorted according to their luminous intensity values into different groupings or "bins".

Inverse Square Law

Formula stating that if you double the distance from the light source, the light level goes down by a factor of 4, if you triple the distance, it goes down by a factor of 9, and so on.

Isocandela Plot

A plot with lines connecting points of equal luminous intensity around a source.

Isolux Plot (or Isofootcandle Plot)

A line plotted to show points of equal illuminance (lux or footcandles) on a surface illuminated by a source or sources.

K

Kelvin

A unit of temperature starting from absolute zero, parallel to the Celsius (or Centigrade) scale. 0C is 273K.

Kilowatt [kW]

The measure of electrical power equal to 1000 watts.

Kilowatt Hour [kWh]

The standard measure of electrical energy and the typical billing unit used by electrical utilities for electricity use. A 100-watt lamp operated for 10 hours consumes 1000 watt-hours (100 x 10) or one kilowatt-hour. If the utility charges \$.10/kWh, then the electricity cost for the 10 hours of operation would be 10 cents (1 x \$.10)

L

Laminations

Layers of steel, making up the "core" that is surrounded by the coils in a core & coil ballast.

Glossary

Lamp

The term used to refer to the complete light source package, including the inner parts as well as the outer bulb or tube. "Lamp", of course, is also commonly used to refer to a type of small light fixture such as a table lamp.

Lamp Current Crest Factor

Ratio of peak lamp current to RMS or average lamp operating current.

Lamp Height

Referenced by IEC as Dimension C. Also referred to as "Base Face to Top of Lamp".

Lamp Types

Filament lamps: Incandescent, Halogen, Halogen-IR.

Discharge Lamps: Fluorescent, HID (High Intensity Discharge)

HID Lamps: Mercury, HPS (High Pressure Sodium), MH (Metal Halide) and CMH (Ceramic Metal Halide)

LED Lamps

Lamp Width

Referenced by IEC as Dimension A.

Leadframe

A metallic frame used for mounting and connecting LED chips. The leadframe functions as the electrical leads of the device.

Lens

A transparent or semi-transparent element which controls the distribution of light by redirecting individual rays. Luminaires often have lenses in addition to reflectors.

Life

(See RATED LAMP LIFE).

Light

Radiant energy that can be sensed or seen by the human eye. Visible light is measured in lumens.

Light Center Length (L.C.L.)

The distance between the center of the filament, or arc tube, and a reference plane - usually the bottom of the lamp base. Refer to the following chart for reference plane locations.

Base type	L.C.L Reference Plane Location
All screw bases (except Mini-Can)	Bottom of base contact
Mini-Can	Where diameter of ceramic base insulator is .531 inches
3-Contact Medium	Bottom of base contact
Mogul Medium Prefocus	Top of base fins
Mogul Prefocus	Top of base fins
Medium BiPost	Base end of bulb (Glass lamps) Bottom of ceramic base (Quartz lamps)
Mogul BiPost	Shoulder of posts (Glass lamps) Bottom of ceramic base (Quartz lamps)
2-Pin Prefocus	Bottom of ceramic base
S.C. or D.C. Bayonet Candelabra	Top of base pins
Medium Bayonet	Top of base pins
S.C. or D.C. Prefocus	Plane of locating bases on prefocus collar
Medium 2-Pin	Bottom of metal base shell

Light Emitting Diode (LED)

A solid that directly converts electrical impulses into light. Most white light LEDs incorporate phosphors to change the colour characteristics of the emitted light.

Lighting Industry Federation (LIF) Code

For Stage & Studio lamps, these are assigned by the Lighting Federation of London U.K. They ensure electrical and mechanical interchangeability of similarly coded lamps. LIF codes are divided into groups according to the primary application of the lamps.

Light Loss Factor

The product of all factors that contribute to lowering the illumination level including reflector degradation, dirt, lamp depreciation over time, voltage fluctuations, etc.

Light Meter

(See ILLUMINANCE METER)

Light Pollution

Light that is directed to areas where it is not needed, and thereby interferes with some visual act. Light pollution directed or reflected into the sky creates a "dome" of wasted light and makes it difficult to see stars above cities.

Light Trespass (Spill Light)

Light that is not aimed properly or shielded effectively can spill out at into areas that don't want it: it can be directed towards drivers, pedestrians or neighbors. It is distracting and annoying and can sometimes be disabling.

Lucalox™

The GE brand name for high-pressure sodium lamps.

Lumens

A measure of the luminous flux or quantity of light emitted by a source. For example, a dinner candle provides about 12 lumens. A 60-watt Soft White incandescent lamp provides about 840 lumens.

Lumen Depreciation, Lumen Maintenance

A measure of how well a lamp maintains its light output over time. It may be expressed numerically or as a graph of light output vs. time. The "mean lumens" of a lamp is the lumens at 40% of rated life (50% for HPS lamp).

Lumens Per Watt (LPW)

A ratio expressing the luminous efficacy of a lightsource.

Typical lamp efficacies:

Edison's first lamp	1.4 LPW
Incandescent lamps	10-20
Halogen lamps	15-30
Fluorescent lamps	35-105
Mercury lamps	50-60
Metal halide lamps	60-120
High-pressure sodium lamps	60-140

Note: The values above for discharge lamps do not include the effect of the ballasts, which must be used with those lamps. Taking ballast losses into account reduces "system" or lamp ballast efficacies typically by 10-20% depending upon the type of ballast used.

Luminaire

A complete lighting unit consisting of a lamp (or lamps), ballast (or ballasts) as required together with the parts designed to distribute the light, position and protect the lamps and connect them to the power supply. A luminaire is often referred to as a fixture.

Luminaire Efficiency

The ratio of total lumens emitted by a luminaire to those emitted by the lamp or lamps used in that luminaire. Also commonly referred to as 'Light Output Ratio' or LOR.

Luminance

A measure of “surface brightness” when an observer is looking in the direction of the surface. It is measured in candelas per square meter (or per square foot) and was formerly referred to as “photometric brightness.”

Luminous Efficacy

The light output (lumens) of a light source divided by the total power input (watts) to that source. It is expressed in lumens per watt (see LUMENS PER WATT).

Luminous Intensity

A measure of the visibility of a light source generally expressed in candelas. It is defined as luminous flux per unit solid angle (steradian) in a given direction.

Lux (lx)

A unit of illuminance or light falling onto a surface. One lux is equal to one lumen per square meter. Ten lux approximately equals one footcandle. (See FOOTCANDLE)

M

Magnetic Ballast

A ballast used with discharge lamps that consists primarily of transformer-like copper or aluminum windings on a steel or iron core. Also called “Core & Coil” (see ELECTRONIC BALLASTS).

Maximum Overall Length (M.O.L.)

The end-to-end measurement of a lamp, expressed in inches or millimeters.

Mean Lumens

The average light output of a lamp over its rated life. Based on the shape of the lumen depreciation curve, for fluorescent and metal halide lamps, mean lumens are measured at 40% of rated lamp life. For mercury, high-pressure sodium and incandescent lamps, mean lumen ratings refer to lumens at 50% of rated lamp life (See LUMEN MAINTENANCE).

Medium Base

Usually refers to the screw base typically used in household incandescent lamps. There is also the medium bipin base commonly used in T12 and T8 fluorescent lamps.

Mercury Lamp

A high-intensity discharge light source operating at a relatively high pressure (about 1 atmosphere) and temperature in which most of the light is produced by radiation from excited mercury vapor. Phosphor coatings on some lamp types add additional light and improve colour rendering.

Metal Cases

Case design used in both magnetic and electronic ballasts. These ballasts are grounded once they are mounted to the fixture. They meet all safety codes, some of which do not allow plastic in open plenum areas.

Metal Halide Lamp

A high-intensity discharge light source in which the light is produced by the radiation from mercury, plus halides of metals such as sodium, scandium, indium and dysprosium. Some lamp types may also utilize phosphor coatings.

Mesopic

Typically referring to nighttime outdoor lighting conditions, the region between PHOTOPIC and SCOTOPIC vision (See SCOTOPIC).

Mogul Base

A screw base used on larger lamps, e.g. many HID lamps.

Monochromatic Light

Light with only one wavelength (i.e. colour) present.

Mortality Curve

Lamps have a rated or expected life but individual failures occur earlier and some lamps will last longer. The mortality curve depicts the expected percent surviving in a group of lamps at various points between zero hours and rated life or beyond. The curve starts with 100% at zero hours and goes to 50% surviving at the rated life (e.g. 3000 hours or 20,000 hours, etc.) However, the shape of the curve between these two end points can vary depending on the lamp type.

Mounting Height

Distance from the bottom of the fixture to either the floor or work plane, depending on usage.

Multi-Vapor™

A GE brand name for metal halide lamps.

N

Nanometer

A unit of wavelength equal to one billionth of a meter.

National Energy Standards for Fluorescent Ballasts

A federal law enacted in 1988 that sets energy standards for ballasts consistent throughout the United States.

National Electric Code (NEC)

A nationally accepted electrical installation code to reduce the risk of fire, developed by the National Fire Protection Association (US).

National Stock Number

The standardized part number used by the US Government for procurement.

Non-PCB Capacitor

Capacitor used in ballasts to help provide power factor correction. Contains no polychlorinated biphenyls and meets EPA requirements.

Normal Power Factor

Ballasts with power factor less than .90 and do not incorporate any means of Power Factor Correction.

O

Open Circuit Voltage (OCV)

Open Circuit Voltage measured across the socket the lamp screws into, with the ballast powered on. It is dangerous to stick a voltmeter into such a socket without precise knowledge of the ballast because exceedingly high voltages could be present.

Open Fixture Rated

Lamps that are approved for burning in open fixtures (as opposed to enclosed fixtures which have an acrylic lens or plate glass enclosure).

Operating Position or Burn Position

Mercury and High Pressure Sodium lamps may be operated in any burn position and will still maintain their rated performance specifications. Metal Halide and Low Pressure Sodium lamps, however, are optimized for performance in specific burn positions, or may be restricted to certain burn positions for safety reasons.

U = Universal burning position

HBU = Horizontal -15° to Base Up

HBD = Horizontal +15° to Base Down

HOR = Horizontal ±15°

H45 = Horizontal to -45° only

VBU = Vertical Base Up ±15°

VBD = Vertical Base Down ±15°

If no special burn position is noted, the burn position is universal.

Operating Voltage

For electrical discharge lamps, this is the voltage measured across the discharge when the lamp is operating. It is governed by the contents of the chamber and is somewhat independent of the ballast and other external factors.

Glossary

P

PAR Lamp

PAR is an acronym for parabolic aluminized reflector. A PAR lamp, which may utilize either an incandescent filament, a halogen filament tube or a HID arc tube, is a precision pressed-glass reflector lamp. PAR lamps rely on both the internal reflector and prisms in the lens for control of the light beam.

Parallel Lamp Operation/Parallel Wiring

Refers to ballasts that employ multiple output current paths from a single ballast to allow lamps to operate independent of one another, allowing other lamps operated by the ballast to remain lit should companion lamp(s) fail (see SERIES LAMP OPERATION).

PCB (Polychlorinated Biphenyls)

Chemical pollutant formerly used in ballast capacitors that were part of ballasts. It is now illegal to use PCBs and most such ballasts have been replaced over time.

Peak Wavelength

The maximum wavelength of an LED.

Phosphor

An inorganic chemical compound processed into a powder and deposited on the inner glass surface of fluorescent tubes and some mercury and metal-halide lamp bulbs. Phosphors are designed to absorb short wavelength ultraviolet radiation and to transform and emit it as visible light (See FLUORESCENCE). Phosphors are also used in LED devices to create white light when used in combination with LEDs of certain wavelengths.

Photometry

The measurement of light and related quantities.

Photopic

Vision for which the cones in the eye are responsible; typically at high brightness and in the foveal or central region (See SCOTOPIC, FOVEA, FOVEAL VISION).

Plug-In

(See CFL).

Potting

Material used to completely surround and cover components of some magnetic and electronic ballasts. Potting compound fulfills functions of protecting components, dampening sound, and dissipating heat.

Power Factor (PF)

A measure of the phase difference between voltage and current drawn by an electrical device, such as a ballast or motor. Power factors can range from 0 to 1.0, with 1.0 being ideal. Power factor is sometimes expressed as a percent. Incandescent lamps have power factors close to 1.0 because they are simple "resistive" loads. The power factor of a fluorescent and HID lamp system is determined by the ballast used. "High" power factor usually means a rating of 0.9 or greater. Power companies may penalize users for using low power factor devices.

Power Factor Corrected

Ballasts that incorporate a means of Power Factor Correction yielding power factor of 90% or greater.

Precise™

The GE trade name for the compact MR-16 and MR-11 low-voltage halogen dichroic cool beam reflectorized spot and flood lamps.

Preheat Circuit

A type of fluorescent lamp-ballast circuit used with the first commercial fluorescent lamp products. A push button or automatic switch is used to preheat the lamp cathodes to a glow state. Starting the lamp can then be accomplished using simple "choke" or reactor ballasts.

Product Code

It is important to use this five-digit code when ordering to ensure that you receive the exact product you require.

Programmed Rapid Start

Lamp starting method which preheats the lamp filaments while not allowing the lamp to ignite and then applies the open circuit voltage (OCV) to start the lamp. The user may experience a half- to one-second delay after turning on the lamps while the preheating takes place. This type of starting circuit keeps lamp end blackening to a minimum and improves lamp life performance, especially in applications where the lamps are frequently switched on and off.

Pulse Start

An HID ballast with a high voltage ignitor to start the lamp.

Q

Quad

Generally refers to a compact fluorescent lamp containing 4 U-shaped tubes.

Quartz

A name for fused silica or melted sand from which many high-temperature containers are fashioned in the lighting industry. Quartz looks like glass but can withstand the high temperatures needed to contain high intensity arc discharges.

Quartz-Halogen Lamp

(See HALOGEN LAMPS).

Quartzline®

A GE registered trademark term for some types of halogen lamps.

R

Radiation

A general term for the release of energy in a "wave" or "ray" form. All light is radiant energy or radiation, as is heat, UV, microwaves, radio waves, etc.

Rapid Start

Lamp starting method in which lamp filaments are heated while open circuit voltage (OCV) is applied to facilitate lamp ignition. A Rapid Start fluorescent lamp has two pins at each end connected to the filament. Some rapid start lamps may be instant-started without filament heat, for example, the F32T8 lamp.

Rapid Start Circuit

A fluorescent lamp-ballast circuit that utilizes continuous cathode heating, while the system is energized, to start and maintain lamp light output at efficient levels. Rapid start ballasts may be either electromagnetic, electronic or of hybrid designs. Full-range fluorescent lamp dimming is only possible with rapid start systems (See INSTANT START).

Rated Lamp Life

For most lamp types, rated lamp life is the length of time of a statistically large sample between first use and the point when 50% of the lamps have died. It is possible to define "useful life" of a lamp based on practical considerations involving lumen depreciation and colour shift and also on the need to reduce lamp replacement costs (See GROUP RELAMPING).

For GE LED products, rated life is quoted (unless where indicated otherwise), as the 'L70' value. This refers to the time taken to reach 70% of initial lumen output. This is the emerging industry standard for LED products.

Reflectance

The ratio of light reflected from a surface to that incident upon it.

Reflector Lamp (R)

A light source with a built-in reflecting surface. Sometimes, the term is used to refer specifically to blown bulbs like the R and ER lamps; at other times, it includes all reflectorized lamps like PAR and MR. Most LED lamps are also replacements for reflector lamps, even if they do not physically have a reflector as part of their construction.

Reverse Voltage (VR)

Voltage across the diode for a given reverse current.

RoHS (Restriction of Hazardous Substances)

The Restriction of Hazardous Substances (RoHS) Directive aims to minimise the environmental impact of waste electrical and electronic equipment by reducing the quantities of four heavy metals and two brominated flame retardants that it may contain.

Room Cavity Ratio (RCR)

A shape factor (for a room, etc.) used in lighting calculations.

$RCR = 5H (L+W) / L \times W$, or, alternately,

$RCR = (2.5) \text{ Total Wall Area} / \text{Floor Area}$.

Where H = height, L = length and W = width of the room. A cubical room will have an RCR of 10; the flatter the room the lower the RCR.

S

State and County Code (SCC)

The full 14 digit case code used on GE's content label.

Scotopic

Vision where the rods of the retina are exclusively responsible for seeing, typically like the light levels in the countryside on a moonless, starlit night (See also PHOTOPIC, FOVEA, FOVEAL VISION MESOPIC).

Scotopic/Photopic (S/P) Ratio

This measurement accounts for the fact that of the two light sensors in the retina, rods are more sensitive to blue light (scotopic vision) and cones to yellow light (photopic vision). The

scotopic/photopic (S/P) ratio is an attempt to capture the relative strengths of these two responses. S/P is calculated as the ration of scotopic lumens to photopic lumens for the light source on an ANSI reference ballast. Cooler sources (higher colour temperatures lamps) tend to have higher values of the S/P ratio compared to warm sources.

Screw-In

(See CFL).

Seal Temperature (Maximum)

The maximum operating temperature of the seal of the lamp in Celsius.

Self-Ballasted Lamps

A lamp with an integral ballasting device allowing the lamp to be directly connected to a socket providing line voltage (See CFL).

Series Lamp Operation

Refers to ballasts that employ a single current path passing through all lamps operated by the ballast. If one lamp should fail, companion lamps operated by the same ballasts will also extinguish or dim.

Source Size

For Projection lamps, this is defined as the dimensions of the rectangular area, centered on the lamp axis, within which all luminous parts of the filament lie, when viewed perpendicular to the axis of the filament coil or to the plane of C-13 and C-13D filaments.

Spacing to Mounting Height Ratio

Ratio of fixture spacing (distance apart) to mounting height above the work plane; sometimes called spacing criterion. It is OK to have fixture spaced closer than the spacing criterion suggested by the manufacturer but not farther, or you will get dark spots in-between fixtures.

Specification Series (SP) Colours

Energy-efficient, all-purpose, tri-phosphor fluorescent lamp colours that provide good colour rendering. The CRI for SP colours is 70 or above and varies by specific lamp type.

Specification Series Deluxe (SPX) Colours

Energy-efficient, all-purpose, tri-phosphor fluorescent lamp colours that provide better colour rendering than Specification Series (SP) colours. The CRI for SPX colours is 80 or above and varies by specific lamp type. All GE CFL products use SPX phosphors.

Specification Series Deluxe eXtreme (SPXX) Colours

A colour designation for GE ceramic metal halide lamps with superior colour rendering ~ 90.

Spectral Power Distribution (SPD)

A graph of the radiant power emitted by a light source as a function of wavelength. SPDs provide a visual profile or "finger print" of the colour characteristics of the source throughout the visible part of the spectrum.

Spectrum

See SPECTRAL POWER DISTRIBUTION (SPD).

Specular Reflection

Reflection from a smooth, shiny surface, as opposed to diffuse reflection.

Spiral™ Lamp

GE trademark for its helical family of high efficiency, long-life compact fluorescent lamps.

Spot

A colloquial term referring to a reflector lamp with a tight beam of light, typically around 10 degrees or less. It comes from the fact that such a lamp produces a narrow spot of light as opposed to a wide flood of light.

SPXX

A Colour Designation for GE Ceramic Metal Halide Lamps with superior Colour Rendering ~ 90.

Starcoat™

GE's special barrier coating applied on the inside of all GE T8 fluorescent lamps, as well as some other lamp types, to enhance lamp life and deliver superior lumen maintenance.

Starter

An electronic module or device used to assist in starting a discharge lamp, typically by providing a high-voltage surge (See IGNITOR).

Starting Temperature (Minimum)

The minimum ambient temperature at which the lamp will start reliably.

Sunburn

Skin reddening and inflammation caused by overexposure to sources containing UV-B and/or UV-C.

System

A term referring to the lamp and ballast combination, and sometimes to the entire lighting delivery system including the fixture, the optics, the thermal management system, the particular layout and the lighting controls.

Glossary

T

T12, T8, T5

A designation for the diameter of a tubular bulb in eighths of an inch; T12 is 12 eighths of an inch, or 1-1/2 inches; T8 is 1 inch, and so on.

Task Lighting

Supplemental lighting provided to assist in performing a localized task, e.g. a table lamp for reading or an inspection lamp for fabric inspection.

Terminal-to-Terminal Starting Lamp Voltage (VRMS) (Minimum or Maximum)

The minimum or maximum voltage allowed into lamp from ballast under varying conditions as specified.

Total Harmonic Distortion (THD)

A measure of the distortion caused by ballasts and other inductive loads of the input current on alternating current (AC) power systems caused by higher order harmonics of the fundamental frequency (60Hz in North America). THD is expressed in percent and may refer to individual electrical loads (such as ballast) or a total electrical circuit or system in a building. ANSI C82.77 recommends THD not exceed 32% for individual commercial electronic ballasts, although some electrical utilities may require lower THDs on some systems. Excessive THDs on electrical systems can cause efficiency losses as well as overheating and deterioration of system components.

Transients

High voltage surges through an electrical system caused by lightning strikes to nearby transformers, overhead lines or the ground. May also be caused by switching of motors or compressors, as well as by short circuits or utility system switching. Can lead to premature ballast failure (see TVSS).

Troffer

A long, recessed lighting unit, usually installed in an opening in the ceiling.

Tungsten-Halogen Lamp

(See HALOGEN LAMP).

TVSS

Transient Voltage Surge Suppressors, which will protect ballasts and other electronic equipment from transient high-voltage spikes that may be present in the power line.

Two-Pin Compact Fluorescent Lamps

Type of lamps that have the glow bottle starter built into the base of the lamp. Traditionally 2-pin lamps are designed to work with electromagnetic ballasts (see FOUR-PIN COMPACT FLUORESCENT LAMPS).

U

Uniform Code Council (UCC)

The 12 digit case code derived from the last 12 digits of the 14 digit SCC code on GE's case content label.

Uniform Product Code (UPC)

The 12 digit code on the saleable unit that is used for scanning at the register.

Ultra

A common way of referring to high-efficiency.

Ultraviolet (UV) Radiation

For practical purposes, any radiant energy within the range of 100–380 nanometers. It is beyond the blue or violet region of the spectrum, and is invisible to the eye just like the silent "ultrasound" dog whistle is inaudible to the ear.

UV is divided into 3 regions:

UVA	100 to 280 nm
UVB	280 to 315 nm
UVC	315 to 400 nm

Some wavelengths (180–220) produce ozone, some (220–300) are bactericidal, some (280–320) erythemal (redden human skin); others (320–400) cause secondary luminance (black light).

V

Valance Lighting

Lighting from light sources on a wall typically above eye level, shielded by horizontal panels. The light may be upward or downward directed.

Veiling Reflection

Effective reduction in contrast between task and its background caused by the reflection of light rays; sometimes called "reflected glare". You might have dealt with veiling reflections when you have to tilt a shiny magazine to avoid glare so as to read it, or struggled with reading a computer monitor because of the reflection of a window or a light fixture (See GLARE).

Vio™

GE's unique LED platform that provides best in class quality and stability of light from LED's, due to its unique use of violet chips combined with proprietary phosphors.

Visual Comfort Probability (VCP)

For a given lighting scheme, VCP is a ratio expressed as a percent of people who, when viewing from a specific location and in a specified direction, find the system acceptable in terms of glare (See GLARE).

Visual Task

The task associated with seeing; objects and details that must be seen to perform an activity.

Volt

A measure of "electrical pressure" between two points. The higher the voltage, the more current will be pushed through a resistor connected across the points. The volt specification of an incandescent lamp is the electrical "pressure" required to drive it at its designed point. The "voltage" of a ballast (e.g. 277 V) refers to the line voltage it must be connected to.

Voltage

A measurement of the electromotive force in an electrical circuit or device expressed in volts. Voltage can be thought of as being analogous to the pressure in a waterline.

Voltage (Design)

For Automotive lamps, voltage at which the lamp is designed to provide the amperes, candlepower, and laboratory life characteristics. For Projection lamps, the voltage shown is the design voltage of the lamp, on which the life and wattage ratings are based. Lamps for which 115-120 is shown in the Volts column are designed at 118 volts. Lamps are available only in the design voltage(s) shown. When ordering lamps listed for more than one voltage, be sure to specify the voltage required. (Supply voltage variation can significantly affect lamp life.)

Voltage Surge

Transient spikes in line voltage that can be harmful to electronic equipment like computers and electronic ballasts. Surge suppressors are often used to protect against such transients.

W

Wall Temperature (Maximum Bulb)

The maximum operating bulb wall temperature in Celsius.

Warm-Up Time

HID lamps typically take a few minutes to warm up to full brightness after starting.

Warm Up Time to 90%

The time it takes for a High Intensity Discharge lamp to reach 90% of light output after being turned on.

Warm White

Refers to a colour temperature around 3000K, providing a yellowish-white light.

Watt

A unit of electrical power. Lamps are rated in watts to indicate the rate at which they consume energy (See KILOWATT HOUR).

Wattage Indicator Reduced

Indicates that this is a reduced wattage option for lamps normally used in this application. Be sure to check wattage, lumens and life to determine which lamp is best suited to your needs.

Watt-Miser™

A Watt-Miser™ lamp is a term used by GE to indicate a reduced-wattage lamp with performance characteristics (life, light output, etc.) such that it can usually directly replace a higher-wattage product. Watt-Miser™ lamps are available in a wide range of incandescent and fluorescent lamp types.

Wavelength

The distance between two neighboring crests of a traveling wave. The wavelength of light is between 400 and 700 nanometers.

WEEE (Waste Electrical and Electronic Equipment)

The Waste Electrical and Electronic Equipment Directive (WEEE Directive) aims to minimise the impact of electrical and electronic goods on the environment, by increasing re-use and recycling and reducing the amount of WEEE going to landfill. It seeks to achieve this by making producers responsible for financing the collection, treatment, and recovery of waste electrical equipment, and by obliging distributors to allow consumers to return their waste equipment free of charge.

Work Plane

Plane at which work is done and at which illumination is specified and measured; unless otherwise indicated, it is assumed to be a horizontal plane 30 inches above the floor (table-top height) having the same area as the floor.

Working Distance (Typical)

The Working Distance shown is the distance from the front surface of the reflector rim to the film plane, in the optical system for which the lamp was first designed. In most cases, it provides a uniform plane of light for the intended aperture.

Sales offices

AFRICA

NORTH & CENTRAL AFRICA

GE Hungary
Váci út 77
1044 Budapest
Hungary
Tel: (36) 1 231 5280
Fax: (36) 1 231 5121

SOUTH AFRICA

GE South Africa - Consumer and Industrial
Unit 4, 130 Gazelle Avenue,
Corporate Park
Midrand 1685
South Africa
Tel: (27) 11 237 0000
Fax: (27) 11 314 7518

AMERICAS

ARGENTINA, URUGUAY & PARAGUAY

GE Iluminacion S.A.
Valentín Virasoro 2656
(B1643HDB) Beccar, Buenos Aires
Edificio Uruguay III, 2º Piso
Argentina
Tel: (54) 11 5556 3300
Fax: (54) 11 4736 6616

BRAZIL

GE Iluminação do Brasil Comércio de Lâmpadas Ltda
Av Maria Coelho Aguiar, 215
Bloco G - Piso Jardim
Jd São Luiz - São Paulo/SP
05804-900 Brazil
Tel: (55) 11 3614-1833
Fax: (55) 11 3614-1825
SAC : 0800-333-4448

CANADA

GE Lighting Canada
2300 Meadowvale Blvd C63
Mississauga, Ontario L5N 5P9
Tel: 905-858-6601
Fax: 905-858-6602

CARIBBEAN & CENTRAL AMERICA

General Electric Company
790 N.W. 107 Avenue, Suite 204
Miami, Florida 33172
USA
Tel: (1) 305 551 5114
Fax: (1)305 551 5116

CHILE & BOLIVIA

General Electric de Chile S.A.
Av Isidora Goyenechea 2800. Las Condes
Edificio Titanium, Piso 21
Zip Code: 75500647
Santiago
Chile
Tel: (56) 2 652 6500
Fax: (56) 2 652

COLOMBIA

General Electric International Inc.
Calle 113 N°7 - 80 Oficina 1001
Torre AR
Bogotá
Colombia
Tel: (57) 1 742 5660
Fax: (57) 1 742 5569

JAPAN

GE Consumer Products Japan, Ltd.
12F Akasaka Park Bldg., 5-2-20
Akasaka, Minatoku,
Tokyo 107-6112
Japan
Tel: (81) 3 5544 6700
Fax: (81) 3 5544 6760

MEXICO

GE Lighting Mexico, SA de CV
Av. Churubusco No 3900 Norte
Apartado Postal 216
64510 Monterrey, N.L. Mexico
Mexico
Tel: (52) 8 318 5600
Fax: (52) 8 318 5693

PERU & ECUADOR

GE Lighting Peru SA
Amador Merino Reina 267 Of.902
San Isidro
Lima
Peru
Tel: (511) 610-4347
Fax: (511) 610-4330

UNITED STATES OF AMERICA

GE Lighting
Nela Park, 1975 Noble Road
Cleveland, Ohio 44112
USA
Tel: (1) 216 266 2121
Fax: (1) 216 266 2780

VENEZUELA

Av. Guaicaipuro con Ppal de las Mercedes
Torre Forum Piso 15 Municipio Chacao-El Rosal
CARACAS
Venezuela
Tel: (58) 212 902 5131
Fax: (58) 212 902 5138

ASIA PACIFIC

AUSTRALIA

GE Lighting Australia Ltd.
125-127 Long Street
Smithfield, NSW 2164
Australia
Tel: (61) 2 8788 6911
Fax: (61) 2 8788 7224

CHINA

GE Consumer & Industrial
Shanghai Office
(GE Enterprise Development Co., Ltd)
(GE Lighting Co., Ltd)
22F~24F, Building C, Hi-Tech
Building, 900 Yishan Road,
PC: 200233
Shanghai
P.R. China
Tel: (86) 21 24013333
Fax: (86) 21 64857177

HONG KONG

GE International Operations Co.Inc.
8th Floor, The Lee Gardens
33 Hysan Avenue
Causeway Bay
Hong Kong
Tel: (852) 2100 6900
Fax: (852) 2376 0013

INDIA, SRI LANKA

GE India Industrial Pvt Ltd.
42/1, Electronic City Phase 2
Bangalore - 560100
Karnataka
India
Tel: (91) 80 41113000
Fax: (91) 80 28528366

INDONESIA

PT.GE Lighting Indonesia
Gedung BRI II, 27 th Floor
Jl. Jenderal Sudirman Kav.
44-46, Jakarta 10210
Indonesia
Tel: (62) 21 574 5240
Fax: (62) 21 574 5241

KAZAKHSTAN

GE International Inc. Branch in
Kazakhstan
Prime Business Center
Ul. Furmanova, 100G, Office 302
480091, Almaty
Kazakhstan
Tel: (7) 3272 588 010
Fax: (7) 3272 588 011

KOREA

GE Lighting Korea
9th Floor, POBA Gangnam Tower, 343,
Hakdong-ro (Nonhyundong 119)
Kangnam-Gu, Seoul,
135-820, Korea
Tel: (82) 2 6201 4300
Fax: (82) 2-6201-4343, 4344

NEW ZEALAND

GE Lighting New Zealand
8 Tangihua St
Auckland 1010
New Zealand
Tel: (64) 9 353 6706
Fax: (64) 9 353 6707

PHILIPPINES

GE Lighting Philippines
1873 P. Domingo Street
1207 Makati City, Metro Manila
POB 2087 MCC
Philippines
Tel: (63) 2 895 7051
Fax: (63) 2 890 8186

SINGAPORE & BRUNEI

GE Pacific Pte. Ltd.
240 Tanjong Pagar Road
#06-00 GE Tower
Singapore 088540
Singapore
Tel: (65) 6326 3319
Fax: (65) 6326 3015

THAILAND, CAMBODIA & LAOS

GE Lighting (Thailand) Ltd.
1126/2 Vanit Building II, 16th Floor,
Room No. 1603, New Petchburi
Road, Makkasan, Rajchthewi,
Bangkok 10400
Thailand
Tel: (66) 2 255 8721-31
Fax: (66) 2 255 8733

TAIWAN

GE Lighting Taiwan
7FL, No 8, Sec 3, Min Sheng E. Rd,
Taipei, 104,
Taiwan
Tel: (886) 2 21837000
Fax: (886) 2 25167356

TURKEY

General Elektrik Turk Ltd.
Maslak Mah. Dereboyu Cad.
Bilim Sok. Sun Plaza No:5/6
34398 Sisli Istanbul
Turkey
Tel: (90) 212 366 28 00
Fax: (90) 212 366 28 40

VIETNAM

GE Consumer & Industrial
7fl, Saigon Centre, 65 Le Loi blv, Dist.1,
Hochiminh City,
Vietnam
Tel: (84) 4 8251016
Fax: (84) 4 8250551

EUROPE

ALBANIA & MACEDONIA

VSD Merkur d.o.o
ul.Vasil Glavinov 7b/3
1000 Skopje
Macedonia
Tel: + 389 2 3244 790
Fax: + 389 2 3244 797

Austria, Germany & Switzerland

GE Germany
Thomas-Edison-Platz 1
63263 Neu-Isenburg
Germany
Tel: +49 (0)6102 36-1383
Fax: +49 (0)6102 36-1393

BULGARIA

VSD Merkur
Sales Representative of
GE Hungary Kft.
Office 31, entr. 4
2 Nikolai Haitov str.
1113 Sofia, Bulgaria
T +359 2 8705586
F +359 2 9733325

**BOSNIA AND HERZEGOVINA,
CROATIA & SLOVENIA**

Media Light d.o.o.
Exclusive agent of GE Hungary Kft.
Lighting and Power Protection
Cesta na Brdo 109
1000 Ljubljana
Slovenia
Tel: (386) 1 530 4366
Fax: (386) 1 530 4361

CYPRUS, GREECE & MALTA

General Electric Medical Systems SA
156 Kyprou Av. & 91
Konstantinoupoleos Str.
164 51 Argypoulos, Athens
Greece
Tel: (30) 210 9690 669
Fax: (30) 210 9625 931

CZECH REPUBLIC & SLOVAKIA

GE Hungary Kft.
1044 Budapest
Váci út 77.
Tel: (36) 1 399 1100
Fax: (36) 1 399 1672

DENMARK

GE Lighting A/S
Park Alle 295
DK-2605 Brøndby
Denmark
Tel: (45) 8040 4945
Fax: (45) 8040 4947

FINLAND

GE Consumer & Industrial Oy
Kuortaneenkatu 2
00510 Helsinki
Finland
Tel: (358) 103942507
Fax: (358) 103942515

FRANCE & BENELUX

GE Lighting SARL
ZAC Paris Nord II
13, rue de la Perdrix
B.P. 50073
95947 Roissy CDG Cedex
France
Tel: (33) 1 48 63 68 00
Fax: (33) 1 48 63 68 08

HUNGARY

GE Hungary Kft.
1044 Budapest
Váci út 77.
Tel: (36) 1 399 1100
Fax: (36) 1 399 1672

IRELAND

GE Lighting Ltd.
280 Holly Road
Western Industrial Estate
Naas Road
Dublin 12
Ireland
Tel: (353) 1 456 5591
Fax: (353) 1 450 4142

ITALY

GE Lighting Srl
Centro Dir. Colleone
Palazzo Andromeda B1 - 3° P
via Paracelso 16
20864 - Agrate Brianza (MB)
N. Verde Nord 800977820
N. Verde Centro - Sud 800977821
Tel: (39) 02 37027700
Fax: (39) 02 37027777

NORWAY

GE Lighting AS
Karenslyst Allé 2,
Postboks 589
0214 Oslo
Norway
Tel: (47) 80011321
Fax: (47) 80011048

**POLAND, ESTONIA, LITHUANIA
& LATVIA**

Ul. Odrowąza 15
03-310 Warszawa
Phone for Poland:
(48) 601 999 071
Phone for Baltics
(48) 601 999 836

PORTUGAL & SPAIN

GE Lighting Appliances España, s.a.
Av Galileo Galilei 11
Parque Empresarial La Carpetania
28906 getafe, Madrid
Spain
Tel: (800) 836 010
Fax: (800) 836 007

ROMANIA & MOLDOVA

SC VSD Merkur Lighting Group SRL
Sales Representative of GE Hungary Kft.
0407280 Floresti, Jud. Cluj
Str. Gheorghe Doja, Bl. 13, Ap. 1
Romania
Tel.: (40) 726 279 722
Fax: (40) 727 599 235

RUSSIA

GE Rus LLC
10 Presnenskaya nab.
Moscow 123317, Russia
T 7 495 739 6811
F 7 495 739 6801

SERBIA & MONTENEGRO

VSD MERKUR dooel Exclusive Agent
of GE Hungary Kft.
Bul. Mihajla Pupina 10D/105
11070 Novi Beograd
Serbia
Tel: (381) 11 3119256
Fax: (381) 11 3119257

SWEDEN

GE Lighting & Industrial AB
Vendevägen 89,
182 82 Stockholm
Sweden
Tel: (46) 8 51 99 22 12
Fax: (46) 8 51 99 22 14

UKRAINE

General Electric Co.
Horizont Tower
42/44 Shovkovichna str., 8 Floor
Kiev 01004
Ukraine
Tel: (380) 44 490 69 83
Fax: (380) 44 490 69 82

UNITED KINGDOM

GE Lighting Ltd.
Houghton Centre
Northampton
NN4 7EX
United Kingdom
Tel: (44) 800 169 8290
Fax: (44) 800 169 8284

MIDDLE-EAST**BAHRAIN, IRAQ, JORDAN,
KUWAIT, LEBANON, OMAN,
PAKISTAN, QATAR, UAE, YEMEN**

GE International Inc.
City Tower II, Sheikh Zayed Rd
P.O.Box 52905
Dubai
UAE
Tel: (971) 4 3310 444
Fax: (971) 4 3315 930

ISRAEL

GE Hungary
Váci út 77
1044 Budapest
Hungary
Tel: (36) 1 231 5280
Fax: (36) 1 231 5121

MALAYSIA

General Electric International Inc.
Level 6, 1 Sentral,
Jalan Travers,
Kuala Lumpur Sentral,
50470 Kuala Lumpur
Malaysia
Tel: (60) 3 2273 9788
Fax: (60) 3 2273 3473

SAUDI ARABIA

GE International Inc.CO
5th Floor, Tatweer Towers
King Fahad Road,
PO Box: 10211
Riyadh 11433
Saudi Arabia
Tel: (966 1) 207-3800
Fax: (966 1) 207-3900 & 207-3901

Notes

www.gelighting.com



and General Electric are both registered trademarks of the General Electric Company.