

# Structured Media Components

Leviton Integrated Networks™

## INDEX

### Structured Media™ Components

Overview . . . . .	J2
Enclosures . . . . .	J3–J5
Media Versatile™ Panel . . . . .	J5
Enclosure for Multiple Dwelling Units (MDUs) . . . . .	J6
Cabling Panels . . . . .	J7–J10
Stand-Alone Modules and Boards . . . . .	J10, J11
Mounting Brackets . . . . .	J11, J12
Power and Surge Protective . . . . .	J13, J14
Networking and Internet Sharing . . . . .	J15
Video Distribution . . . . .	J16–J18
Home Video Monitoring System . . . . .	J19–J21
Residential Intercom System . . . . .	J22

### Home Entertainment Components

#### Leviton/JBL Products and Systems

Indoor Speakers . . . . .	J23
Outdoor Speakers . . . . .	J24
Home Theater Speakers . . . . .	J24–J25
Harman/Kardon Entertainment Center Components and Accessories . . . . .	J26

#### Leviton Architectural Edition™ Products

Multi-Room Audio Amplifiers and Keypad System Accessories . . . . .	J27
Audio Volume Controls . . . . .	J28–J30
Audio Distribution Products . . . . .	J31–J32

#### SpecGrade Sound™ Products

Indoor Speakers . . . . .	J33
Outdoor Speakers . . . . .	J33

#### Other Home Entertainment Products

Decora Media System . . . . .	J34
Multi-Room IR Repeater System . . . . .	J35
Decora Recessed Receptacles . . . . .	J35





## STRUCTURED MEDIA COMPONENTS

### STRUCTURED MEDIA™ COMPONENTS—LEVITON INTEGRATED NETWORKS™

*The information and communication revolution will have as much impact on America's homes and businesses as did the electrical revolution of the 20th Century. To fully enable the modern home, Leviton has developed Leviton Integrated Networks as the upgrade path to the future. Leviton Integrated Network's Structured Media components and systems deliver the capacity, bandwidth and speed that today's and tomorrow's information and entertainment technologies will demand.*

### Innovative Technology Blends Multiple Options Into One System

*Leviton Integrated Networks takes the concept of structured cabling, as practiced in demanding commercial applications, and combines it with multimedia. This blending accommodates the convergence of telephone communications, computer and Internet services and much more. An innovative series of modules and media centers—configured for either essential platforms or more customized enhanced platforms—manage and distribute voice, data, audio and video in flexible configurations that best suit each homeowner's individual requirements. These requirements can range from something as simple as cable TV and telephone in several rooms, to a local area network (LAN) for a small office or home-based business.*

*Entertainment products built into the home should have no compromises — in quality, performance, reliability or value. That's why Leviton offers a wide variety of state-of-the-art residential entertainment products that represent today's most advanced audio/video technologies, including indoor and outdoor speakers, on-wall home theater systems, A/V entertainment center products, controls and distribution components.*





47605-140 Panel Enclosure with Cover



Series 140 Panel Premium Hinged Cover

### Series 140 Structured Media Enclosure

This 14" professional-grade whole-house media enclosure creates one distribution point in the home for all low voltage cables. It will accommodate two Pre-Configured Structured Cabling Panels. The sturdy design and functionality facilitate installation, reducing job-site labor costs, and making it ideal for essential home networking.

#### SPECIFICATIONS

<b>Dimensions:</b>	
Enclosure:	14.38"H x 14.38"W x 3.60"D
Cover:	16.10"H x 16.10"W
<b>Materials:</b>	White, powder-coated enclosure (20 gauge steel), cover (18 gauge steel)
<b>Standards Compliance:</b>	ACA and cULus Listed. UL Listed for fire and burglary

#### Series 140 Structured Media Enclosures and Covers

DESCRIPTION	CAT. NO.
Series140 Enclosure and Flush-Mount Cover, empty	47605-140
Series140 Enclosure only	47605-14E
Series 140 Flush Mount Cover	47605-14C
Series 140 Hinged Cover–Economy	47605-14D
Series 140 Hinged Cover–Premium	47605-14P
Series140 Enclosure only (6 per pack)	47605-14G
Series 140 Flush Mount Cover (6 per pack)	47605-14B

#### SPECIFICATIONS AND FEATURES

- Accommodates up to two full-width Pre-Configured Structured Cabling Panels—delivering audio/ video, voice and data to any room of the home or office.
- Positive “stops” on housing sidewalls prevent the enclosure from falling through studs during installation.
- One piece white steel unit holds full and half-width expansion modules.
- Can be surface-mounted or recessed. Ideal for new installations or retrofits.
- Mounting guides on the cover align screw-holes and reduce the chances of dropping during attachment.
- Powder-coated white cover features a 3/4" overlap to hide irregular drywall cuts.
- Combine two or more enclosures for larger installations or future expansion.
- Multiple knock-outs on top and bottom including two new 2" knockouts on top, facilitate cable entry and routing.
- Cut-out in base of enclosure for mounting single gang J-Box kit
- Six 3" square self-healing foam grommets accommodate cable bundles



# STRUCTURED MEDIA™ CENTERS

## Series 280 and 420 Structured Media Enclosures

Command central for home media convergence, Leviton's SMC-280 and SMC-420 home technology enclosures put the home or small office on the cutting edge of the Information Age. By bringing every conceivable technology distribution point together in one place, they make running cable and managing media both simple and more cost-effective. Designed to incorporate a hospital-grade power quality module for maximum protection from line surges, the 28" and 42" high units accommodate all the latest in functions such as home networking, fax, internet (including high speed services such as DSL, cable modems and ISDN), multi-line telephones, security camera, coaxial cable and satellite video distribution, and speaker and volume controls, when equipped with the correct accessories.

The Series 280 enclosure can comfortably accommodate up to 8 different Distribution Modules, depending on selection and density, and the 420 enclosure, with its generous size and capacity for up to 12 modules, can simultaneously manage many diverse functions. Perfect for home office and home entertainment. Make sure you plan all modules before starting the project, and specify the correct size media center.

*Note: Module count will depend on the type used; some are larger than others.*

### SPECIFICATIONS

#### Dimensions:

SMC-280 Enclosure:	28"H x 14.38"W x 3.00"D
SMC-280 Cover:	29.25"H x 15.62"W
SMC-420 Enclosure:	42"H x 14.38"W x 3.60"D
SMC-420 Cover:	43.25"H x 15.62"W

**Materials:** White, powder-coated enclosure (20 gauge steel), cover (18 gauge steel)

**Standards Compliance:** ACA and CULUS Listed. UL Listed for fire and burglary



Series 280 Panel enclosure with cover



Series 280 Premium Hinged Cover



Series 420 Premium Hinged Cover

## Series 280 and 420 Structured Media Enclosures and Covers

DESCRIPTION	CAT. NO.
Series 280 Enclosure and Flush-Mount Cover, empty	47605-28W
Series 280 Enclosure, only	47605-28N
Series 280 Flush-Mount Cover	47605-F28
Series 280 Hinged Cover—Economy	47605-28D
Series 280 Hinged Cover—Premium	47605-28P
Series 280 Enclosure, only (3 per pack)	47605-28G
Series 280 Flush-Mount Cover (3 per pack)	47605-28B
Series 420 Enclosure and Flush-Mount Cover, empty	47605-42W
Series 420 Enclosure, only	47605-42N
Series 420 Flush-Mount Cover	47605-F42
Series 420 Hinged Cover—Economy	47605-42D
Series 420 Hinged Cover—Premium	47605-42P
Lock and Key for Structured Media Centers	5L000-LOK

### SPECIFICATIONS AND FEATURES

- Multiple knock-outs (up to 2") on top, bottom, sides and back, including two new 2" knock-outs on top, facilitate cable entry and routing from every desired room.
- Six 3" square self-healing foam grommets accommodate cable bundles and protect them from being cut
- Sturdy, one-piece white steel construction.
- Combine two or more enclosures for larger installations or future expansions.
- Holds 1/4, 1/2 and full-width expansion modules with the ability to mount most modules vertically or horizontally.
- Large capacity provides multiple functionality for "wired" homes.
- Powder-coated white cover features a 3/4" overlap to hide irregular drywall cuts.

- Mounting hooks on the cover align screw-holes and reduce the chances of dropping during attachment.
- Holds a broad range of current and future distribution modules, delivering audio, video, voice, data, security, and more to any room of the home or office.
- Threaded inserts added to enclosure to ensure accurate threading of screws when mounting cover
- Can be surface-mounted or recessed. Ideal for new installations or retrofits.
- Knock-out in base of enclosure for mounting of either a single gang J-Box kit or an AC power module
- Designed to accommodate safe, high-quality hospital-grade power module with surge suppression.



### Extender Brackets for Leviton Series 280 and 420 Structured Media Centers

The Extender Brackets provide an additional 2" of depth and enhanced ventilation with Leviton's Series 280 and 420 Structured Media Centers (SMCs). The Extender Brackets, which are attached between the enclosure and the cover, form a frame assembled from four 2"-deep sheet metal rails with louvers on each side. The greater depth allows for better cable management and for larger modules, such as audio amplifiers, to be mounted within the Structured Media Centers.

#### Series 280 and 420 Structured Media Enclosures

DESCRIPTION	CAT. NO.
Extender Bracket 2" depth extension package for Series 280 Structured Media Centers	47612-28B
Extender Bracket 2" depth extension package for Series 420 Structured Media Centers	47612-42B

#### SPECIFICATIONS AND FEATURES

##### Extender Brackets

- Made of sturdy white powder-coated 18-gauge sheet metal
- Louvers in the Extender Brackets enhance ventilation for added protection against heat build-up from installed modules
- Two-Year Product Warranty



### Media Versatile Panel— For Custom Retrofits and Remodeling

Ideal for custom retrofits and remodeling applications, the Media Versatile™ Panel with 3/8" plywood backing allows an open architecture for consolidating low voltage electronics and distribution components for phone, fax/modem, data, home networking, audio, video and home control. The 24" high cold-rolled steel panel with securable door will accommodate a wide variety of Structured Media Distribution Modules by simply removing the Push-Lock Pins and attaching directly to the plywood backing. The sturdy construction is built to industrial-grade standards, and the panel can be surface mounted or recessed in the wall. (Optional mounting brackets may be used for non-standard stud spacing). Ideal for custom retrofits and remodeling applications. Available in black powder coat finish. UL Listed.

#### SPECIFICATIONS

Dimensions:	24"H x 14"W x 6"D
Materials:	Powder-coated 18 gauge steel with 3/8" plywood backing
Standards Compliance:	UL Listed.

#### Media Versatile Panel

DESCRIPTION	CAT. NO.
Media Versatile Panel	47602-24E
Mounting Brackets—(set of 4)	47602-BKE

#### SPECIFICATIONS AND FEATURES

- Eight 1" or 1.5" conduit fittings on top and bottom facilitate cable entry and routing
- Wall-mount or recess. Ideal for new installations or retrofits
- Securable door provides maximum protection from dust and abuse
- Plywood backing allows open architecture for customizing layout and can accommodate a wide variety of Structured Media Distribution Modules.



### Compact Structured Media Enclosure—For Multi-Dwelling Units (MDU's)

Leviton's new Compact Structured Media Enclosure for Multi-Dwelling Units offers a compact, cost-effective distribution point for basic telephone and video to owners/managers of multi-unit buildings. The unit accommodates a variety of telephone/video distribution configurations by hosting up to three Telephone Expansion Boards and one Passive Video Splitter.

#### SPECIFICATIONS

<b>Dimensions:</b> (Enclosure)	8.03"(204.0) H x 14.40"(365.6) W x 3.71"(94.2) D
(Cover)	9.01"(228.9) H x 15.39"(390.8) L
<b>Materials:</b>	ABS molded plastic
<b>Standards Compliance:</b>	UL94 VO flame-retardant fire rating

#### Compact Structured Media Enclosure for MDU's

DESCRIPTION	CAT. NO.
Compact Structured Media Enclosure and Cover, empty	47605-MDU
MDU Kit (Compact Structured Media Enclosure & Cover plus 1x6 Telephone Expansion Board)	47604-F6
MDU Kit (Compact Structured Media Enclosure & Cover plus 1x6 Telephone Expansion Board and 6-Way Splitter)	47604-F6S

#### SPECIFICATIONS AND FEATURES

- Unique modular design has fewer parts and is made exclusively from ABS molded plastic to provide customers with cost savings in installation time
- Flexibility to accommodate a variety of telephone/video distribution configurations
- Snap-on cover requires no tools or fasteners
- Molded-in brackets provide quick snap-in convenience for Telephone Expansion Boards
- Angled video splitter shelf for easy installation
- Hosts up to three Telephone Expansion Boards and one Passive Video Splitter
- Available empty with cover or in two kitted versions with a 1x6 Telephone Expansion Board or with a 1x6 Telephone Expansion Board and a 6-Way Splitter













## Pre-Configured Structured Cabling Panels

Route telephone, data and video services throughout your home or office with one simple panel. Leviton's Pre-configured Structured Cabling Panels combine some of our most popular voice, data and RF modules to create an economical one-stop home and office media distribution point. See the following pages for available configurations. Some modules are available in expansion styles to fill unused panel slots (see this page). Choose the pre-configured combination that best meets your needs, and enhance with expansion boards or stand-alone brackets.

### Panel Components and Expansion Boards

Pre-configured Panels are assembled at the factory and will contain one or more of the following distribution modules.

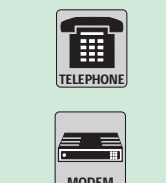





COMPONENTS	APPLICATION	FEATURES	AVAILABLE AS
 <p><b>1x9 Bridged Telephone Board</b></p> <p>Basic telephone distribution</p>		<ul style="list-style-type: none"> <li>Bridge up to 4 telephone lines to 9 locations</li> <li>Connect up to 9 separate telephones per line</li> <li>Printed circuit board module</li> <li>4-pair 110-type IDC punchdowns</li> </ul>	<ul style="list-style-type: none"> <li>Part of a Pre-configured Panel</li> <li>Stand-alone module with bracket</li> <li>Expansion board without bracket</li> </ul>
 <p><b>Category 5e Voice &amp; Data Board</b></p> <p>Basic home networking</p>		<ul style="list-style-type: none"> <li>Patch phone or data connections to 6 locations</li> <li>Combine with a TLDM, key system, or network hubs for additional applications</li> <li>Printed circuit board module</li> <li>4-pair 110-type IDC punchdowns and 6 CAT 5e RJ-45 ports</li> </ul>	<ul style="list-style-type: none"> <li>Part of a Pre-configured Panel</li> <li>Stand-alone module with bracket</li> <li>Expansion board without bracket</li> </ul>
 <p><b>Category 6 Voice &amp; Data Board</b></p> <p>Basic home networking</p>		<ul style="list-style-type: none"> <li>Patch phone or data connections to 6 locations</li> <li>Combine with a TLDM, key system, or network hubs for additional applications</li> <li>Printed circuit board module</li> <li>4-pair 110-type IDC punchdowns and 6 CAT 6 RJ-45 ports</li> </ul>	<ul style="list-style-type: none"> <li>Part of a Pre-configured Panel</li> <li>Stand-alone module with bracket</li> <li>Expansion board without bracket</li> </ul>
 <p><b>Telephone Patching Board</b></p> <p>Expanded 4-line telephone distribution</p>		<ul style="list-style-type: none"> <li>Bridge up to 4 telephone lines to 7 locations</li> <li>Printed circuit board module</li> <li>One incoming 4-pair 110-type IDC punchdown and 7 outgoing RJ-45 jack connections</li> <li>Combine with a Category 5e Board to route telephone to remote locations</li> </ul>	<ul style="list-style-type: none"> <li>Part of a Pre-configured Panel</li> <li>Expansion board without bracket</li> </ul>
 <p><b>Telephone Security Board</b></p> <p>Route simple telephone with security interface</p>		<ul style="list-style-type: none"> <li>Bridge up to 4 telephone lines to 6 locations</li> <li>Connect up to 6 separate telephones per line</li> <li>Connect to security system</li> <li>Printed circuit board module</li> <li>4-pair 110-type IDC punchdowns</li> </ul>	<ul style="list-style-type: none"> <li>Stand-alone module with bracket</li> </ul>
 <p><b>DSL Filter Board</b></p> <p>Filters DSL signal from telephone line</p>		<ul style="list-style-type: none"> <li>Filters DSL signal from phone line before distribution throughout a home or office.</li> <li>Eliminates need for individual filters at each wallplate.</li> <li>Use with any phone distribution module.</li> <li>Printed circuit board module with RJ-45 jack and 110 punchdowns</li> </ul>	<ul style="list-style-type: none"> <li>Stand-alone module with bracket</li> <li>Expansion board without bracket</li> </ul>



# STRUCTURED MEDIA™ PANELS/MODULES

## Panel Components and Expansion Boards (continued)

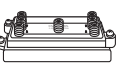
Pre-configured Panels are assembled at the factory and will contain one or more of the following distribution modules.

COMPONENTS	APPLICATION	FEATURES	AVAILABLE AS
 <p><b>Telephone Line Distribution Board (TLDM)</b></p> <p>Enhanced telephone distribution</p>		<ul style="list-style-type: none"> <li>• 19 multi-line telephone connections in combinations of 2 or 4 lines</li> <li>• Bridge "Line 1" service to 12 locations and 4-line service to 8 locations</li> <li>• Connect to CAT 5e Voice &amp; Data Board(s) or additional panels for more connections and easier adds/moves/changes</li> <li>• Independent RJ-45 jack and punchdown security interface to accommodate alarm systems</li> </ul>	<ul style="list-style-type: none"> <li>• Part of a Pre-configured Panel ONLY</li> <li>• Expansion board with bracket</li> </ul>
 <p><b>4x12 Telephone Distribution Board</b></p>		<ul style="list-style-type: none"> <li>• Fits easily into any Leviton Structured Media enclosure, or can be used as a stand-alone unit.</li> <li>• Distribute up to 4 telephone lines through 12 telephone connections</li> <li>• Links with other distribution boards, modules, or panels to expand the system</li> <li>• 12 modular RJ-45 jack outputs.</li> <li>• 4-pair 110 type IDC inputs.</li> </ul>	<ul style="list-style-type: none"> <li>• Part of a Pre-configured Panel ONLY</li> </ul>
 <p><b>Video Splitters</b></p> <p>Basic video distribution</p>		<ul style="list-style-type: none"> <li>• Cable TV or off-air antenna signals</li> <li>• 4-way or 6-way RF Splitter</li> <li>• Die-cast housing</li> <li>• Available in 1GHz and 2GHz models</li> </ul>	<ul style="list-style-type: none"> <li>• Part of a Pre-configured Panel</li> <li>• Stand-alone module with bracket</li> </ul>

Structured Media Components



47606-BTV



47606-BNP

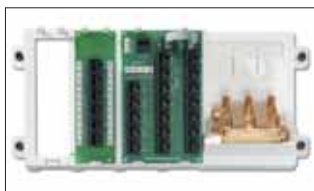

47606-AHT

## Pre-configured Structured Cabling Panels—Full Width

Leviton has a Pre-Configured Structured Cabling Panel to fit any application. See opposite for explanations of individual boards. Use the Panels as they are, expand with easy snap-in Expansion Boards, or combine with other Panels or Stand-alone Modules to create a Structured Media solution tailored to your specific needs. Ideal for all installations, from basic to high-end. The new non-conductive synthetic bracket features a rugged construction and a "shelf-style" design with enhanced cable management and easier installation. Boards quickly snap on and off for easy adds/moves/changes.

DESCRIPTION	CAT. NO.	CONSISTS OF
Basic Telephone and Video Panel (BTV)	<b>47606-BTV</b>	<ul style="list-style-type: none"> <li>• (1) 1x9 Bridged Telephone Board</li> <li>• (1) 6-way 2GHz Video Splitter</li> <li>• Bridge up to 4 telephone lines to 9 locations</li> <li>• Route video to 6 locations</li> </ul>
Basic Home Networking Plus Panel (BNP)	<b>47606-BNP</b>	<ul style="list-style-type: none"> <li>• (1) Telephone Patching Board</li> <li>• (1) Category 5e Voice &amp; Data Module</li> <li>• (1) 6-way 2GHz Video Splitter</li> <li>• 6 4-line telephone connections</li> <li>• Route video to 6 locations</li> <li>• Patch data or telephone service to 6 remote locations</li> <li>• Comes with 6 8-inch 8p8c Flat Patch Cords</li> </ul>
Advanced Home Telephone & Video Panel (AHT)	<b>47606-AHT</b>	<ul style="list-style-type: none"> <li>• (1) Telephone Line Distribution Module</li> <li>• (1) Category 5e Voice &amp; Data Board</li> <li>• (1) 6-way 2GHz Video Splitter</li> <li>• 19 multi-line telephone connections (in various combinations of 2 or 4 lines)</li> <li>• Route video to 6 locations</li> <li>• Patch data or telephone service to 6 remote locations</li> <li>• Comes with 6 8-inch 8p8c Flat Patch Cords</li> </ul>

Full-width panel dimensions: 6.25"H x 13.06"W x 2.50"D

For detailed features and dimensions, please consult individual specification sheets at [www.leviton.com](http://www.leviton.com)





DESCRIPTION	CAT. NO.	CONSISTS OF
Advanced Home Office Panel	<b>47606-ASO</b>	<ul style="list-style-type: none"> <li>• (1) Telephone Line Distribution Module</li> <li>• (2) Category 5e Voice &amp; Data Boards</li> <li>• (1) 6-Way 2GHz Video Splitter</li> <li>• (1) 19 multi-line telephone connections (in various combinations of 2 or 4 lines)</li> <li>• Route video to 6 locations</li> <li>• Patch data or telephone service to 6 remote locations</li> <li>• Comes with (6) 8-inch 8p8c Flat Patch Cords</li> </ul>
12-Port Structured Media Panel (12P)	<b>47603-12P</b>	<ul style="list-style-type: none"> <li>• (1) Telephone Line Distribution Module</li> <li>• (2) Category 5e Voice &amp; Data Boards</li> <li>• 19 multi-line telephone connections (in various combinations of 2 or 4 lines)</li> <li>• Patch data or telephone service to 12 remote locations</li> <li>• Comes with 12 8-inch 8p8c Flat Patch Cords</li> </ul>
18-Port Structured Media	<b>47603-18P</b>	<ul style="list-style-type: none"> <li>• (1) Telephone Line Panel (18P) Distribution Module</li> <li>• (3) Category 5e Voice &amp; Data Boards</li> <li>• 19 multi-line telephone connections (in various combinations of 2 or 4 lines)</li> <li>• Patch data or telephone service to 18 remote locations</li> <li>• Comes with 18 8-inch 8p8c Flat Patch Cords</li> </ul>
24-Port Structured Media Panel (24P)	<b>47603-24P</b>	<ul style="list-style-type: none"> <li>• (1) Telephone Line Distribution Module</li> <li>• (4) Category 5e Voice &amp; Data Boards</li> <li>• 19 multi-line telephone connections (in various combinations of 2 or 4 lines)</li> <li>• Patch data or telephone service to 24 remote locations</li> <li>• Comes with 24 8-inch 8p8c Flat Patch Cords</li> </ul>
4 x 12 Telephone Distribution Panel	<b>47603-12M</b>	<ul style="list-style-type: none"> <li>• (1) 4 x 12 Telephone Dist. Board</li> <li>• Handles up to 4 telephone lines through 12 connections</li> </ul>
4 x 12 Telephone Distribution Panel w/ Splitter	<b>47603-412</b>	<ul style="list-style-type: none"> <li>• (1) 4 x 12 Telephone Dist. Board</li> <li>• (1) 8-way 2GHz Video Splitter</li> <li>• Handles up to 4 telephone lines through 12 connections</li> <li>• Features output for up to 8 video connections</li> </ul>
4 x 18 Telephone Distribution Panel	<b>47603-18M</b>	<ul style="list-style-type: none"> <li>• (1) 4 x 18 Telephone Dist. Board</li> <li>• Handles up to 4 telephone lines through 18 connections</li> </ul>
4 x 18 Telephone Distribution Panel w/CAT 5e Board	<b>47603-8C1</b>	<ul style="list-style-type: none"> <li>• (1) 4 x 18 Telephone Dist. Board</li> <li>• (1) Category 5e Voice &amp; Data Module</li> <li>• Handles up to 4 telephone lines through 18 connections</li> <li>• Provides voice and data service to 6 remote locations via CAT 5e voice and data boards</li> </ul>

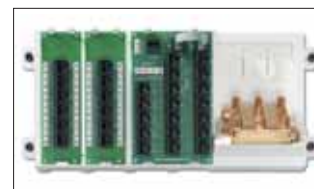

47606-ASO

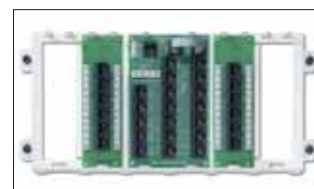

47603-12P

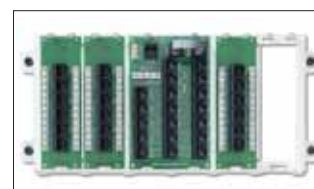

47603-18P

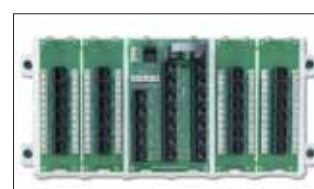

47603-24P

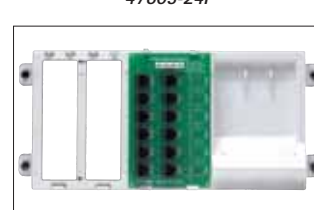

47603-12M

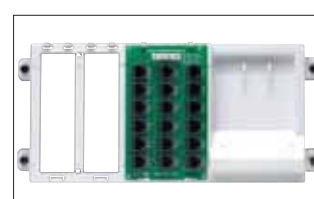

47603-18M

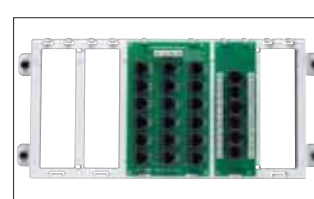

47603-8C1

Full-width panel dimensions: 6.25"H x 13.06"W x 2.50"D

For detailed features and dimensions, please consult individual specification sheets at [www.leviton.com](http://www.leviton.com)



# STRUCTURED MEDIA™ PANELS and BOARDS



47603-1G4



47603-1G6



47603-TSV



47603-1G8

## Pre-Configured Structured Cabling Panels—Compact Series

Leviton's simple solution for basic telephone and video distribution. These compact panels, with their space-saving profile provide simple bridged telephone to 9 locations and 1GHz video to four or six locations, respectively. Compact Series Panels are ideal for MDUs and apartments, installations with space constraints and/or installations where budget is the driving concern.

DESCRIPTION	CAT. NO.	CONSISTS OF
Telephone & 4-Way Video	47603-1G4	<ul style="list-style-type: none"> <li>• (1) 1x9 Bridged Telephone Board</li> <li>• (1) 4-way 1GHz Video Splitter</li> <li>• Bridge up to 4 telephone lines to 9 locations</li> <li>• Route video to 4 locations</li> </ul>
Telephone & 6-Way Video	47603-1G6	<ul style="list-style-type: none"> <li>• (1) 1x9 Bridged Telephone Board</li> <li>• (1) 6-way 1GHz Video Splitter</li> <li>• Bridge up to 4 telephone lines to 9 locations</li> <li>• Route video to 6 locations</li> </ul>
Telephone Security & 6-Way Video	47603-TSV	<ul style="list-style-type: none"> <li>• (1) Telephone Security Board</li> <li>• (1) 6-way 1GHz Video Splitter</li> <li>• Bridge up to 4 telephone lines to 6 locations</li> <li>• RJ-45 Port for Security Interface</li> <li>• Route video to 6 locations</li> </ul>
Telephone & 8-Way Video	47603-1G8	<ul style="list-style-type: none"> <li>• (1) 1x9 Bridged Telephone Board</li> <li>• (1) 8-way 1GHz Video Splitter</li> <li>• Bridge up to 4 telephone lines to 9 locations</li> <li>• Route video to 8 locations</li> </ul>

Compact panel dimensions: 6.5"H x 6.5"W

For detailed features and dimensions, please consult individual specification sheets at [www.levitonvoicedata.com](http://www.levitonvoicedata.com)

## Stand-Alone Modules and Expansion Boards

### Stand-Alone Modules

DESCRIPTION—MODULE with BRACKET	CAT. NO.
A—1x9 Bridged Telephone Module	47689-00B
B—Category 5e Voice and Data Module	47605-C5B
C—Telephone Security Module	47609-TSV
D—DSL Filter Module	47616-DSB
Category 6 Voice and Data Module	47616-C6B

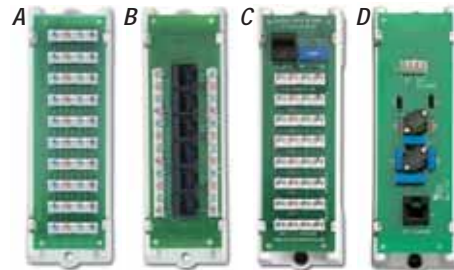

### Expansion Boards

DESCRIPTION	CAT. NO.
E—1x9 4-Line Bridged Telephone Board	47603-110
F—1 x 6 4-Line Bridged Telephone Expansion Board	47609-F6
G—1 x 4 6-Line Bridged telephone Expansion Board	47609-S4
H—1 x 10 6-Line Bridged Telephone Security Expansion Board	47609-S10
I—1x5 4-Line Bridged Phone w/Data Pass Through Expansion Board	47609-D5P
J—1x4 4-Line Bridged Phone and 4-Port CAT 5e Expansion Board	47609-4DP
K—1x4 Bridged Phone Board	47609-004
L—Category 5e Voice and Data Expansion Board	47603-C5
Category 6 Voice and Data Expansion Board	47611-C6

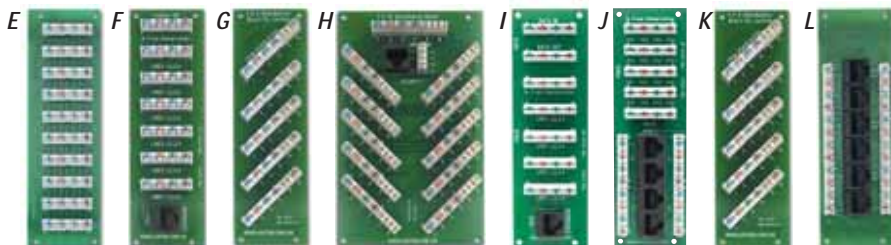



## Expansion Boards

DESCRIPTION	CAT. NO.
M-Telephone Patching Expansion Board	47609-EMP
N-DSL Filter Board	47616-DSF
O-Telephone Line Distribution Module and 19 Multi-Line Connections (in various combinations of 2 or 4 lines) Board	47603-TDM
P-4x12 Telephone Distribution Board	47603-12B
Q-4x18 Telephone Distribution Board	47603-18B

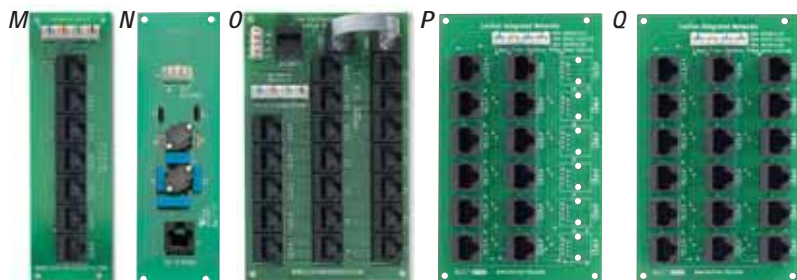

## Plastic Mounting Brackets for Leviton Structured Media Centers

The Single Plastic Bracket accepts mounting of any single Leviton phone, data, security or DSL Filter Board within the Structured Media Center to enhance an existing system, for use as a stand-alone solution for voice (with or without security), data and DSL filtering services. The Expansion Plastic Bracket is a full-width bracket that can be populated with up to five Leviton phone, data, security or DSL Filter Expansion Boards in a Leviton Series 140, 280 or 420 Structured Media Center. This unit offers a universal design that accommodates installation of a variety of manufacturers' products.

DESCRIPTION	CAT. NO.
A-Single Plastic Bracket for mounting a single Leviton phone, data, security or DSL Filter Expansion Board in a Leviton Series 140, 280 or 420 Structured Media Center	47612-SBK
B-Expansion Plastic Bracket for mounting up to five Leviton phone, data, security or DSL Filter Expansion Boards in a Leviton Series 140, 280 or 420 Structured Media Center	47612-EBK
C-Half Plastic Bracket for mounting up to 3 Leviton Phone, Data, Security or DSL Filter Expansion Boards in Series 140, 280 or 420 SMC	47612-HBK
D-Data Plastic Bracket for mounting switches, routers, and modems within a Leviton Series 140, 280 or 420 Structured Media Center	47612-DBK

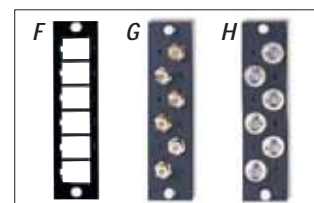
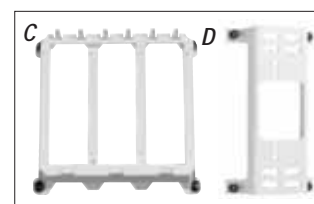
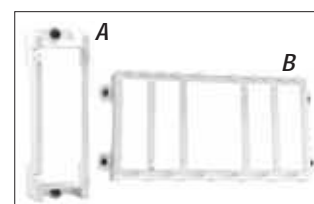

## Multimedia Adapter Bracket and Mounting Plates

Create a custom audio/video, copper or fiber mini-panel in your Structured Media Center with the Multi-Media Adapter Bracket. The bracket supports your choice of two 6-pack mounting plates, and snaps easily into any of Leviton's Structured Media Centers with push-pins. Pre-loaded mounting plates are available for BNC and F-connectors, or create a custom configuration with unloaded 6-pack QuickPort® plates. QuickPort plates accept any combination of the following QuickPort adapters or connectors: BNC, F-Connector, ST, FC, SC and MT-RJ Fiber Optics, Banana Jacks, Speaker Binding Posts, RCA, S-Video, Voice Grade, and Category 5, 5e or 6. Bracket mounts vertically or horizontally.

DESCRIPTION	CAT. NO.
E-Multimedia Bracket	47612-MMA
F-BNC Mounting plate, 6-pack, loaded	5F100-BNC
G-F-Connector Mounting plate, 6-pack, loaded	5F100-6VF
H-QuickPort Mounting plate, 6-pack, unloaded	5F100-6QP

## Accessories

DESCRIPTION	CAT. NO.
8-Conductor Flat Telephone Patch Cord, 8" long ((1 each)	42400-8FG

### SPECIFICATIONS AND FEATURES

#### All Plastic Brackets

- Made of sturdy white ABS plastic
- Come with push-lock pins
- Snap-in installation in any Leviton series 140, 280 or 420 Structured Media Center
- Allow for cable management via routing under bracket



# STRUCTURED MEDIA™ BRACKETS

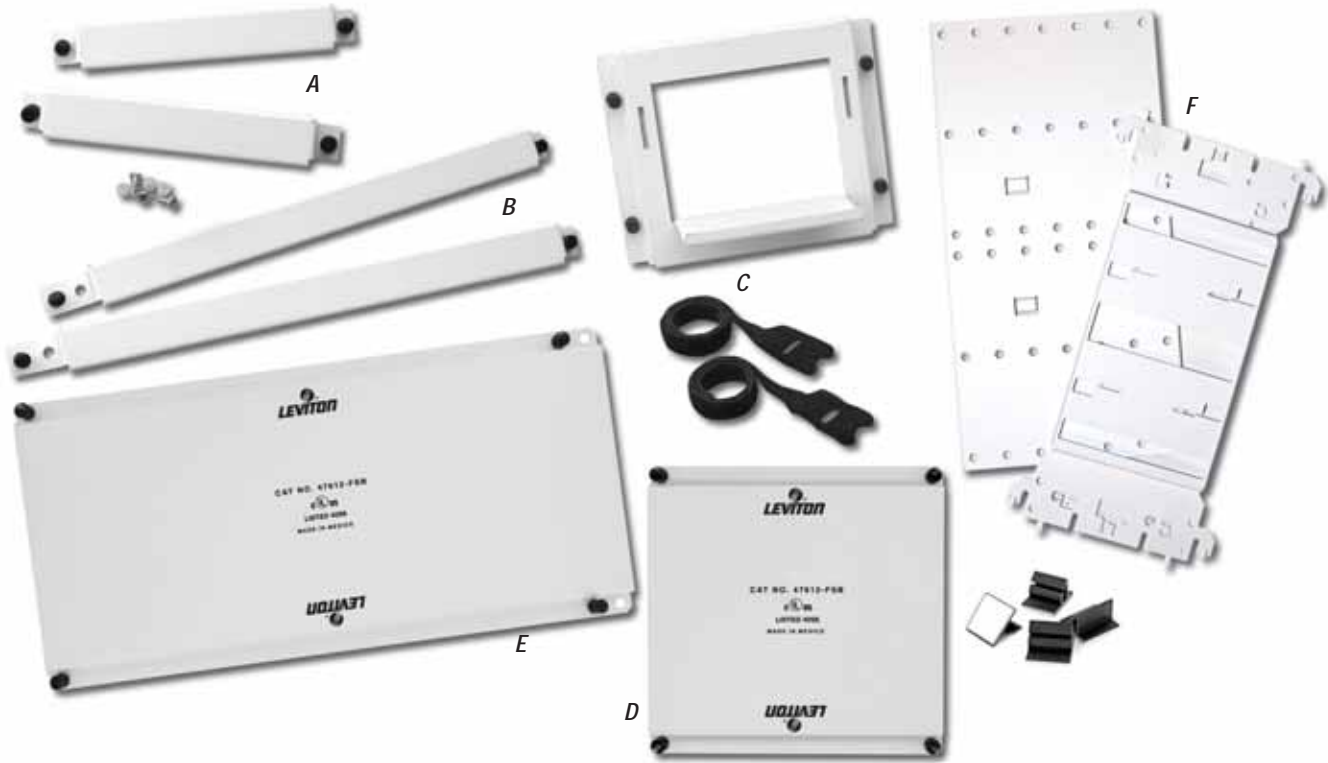

Structured Media Components

## Universal Security & Shelf Brackets for Leviton Structured Media Centers

The Universal Security Brackets allow for consolidation and integration of security products into any of Leviton's Series 140, 280 or 420 Structured Media Center enclosures. The 6" and 12" Universal Security Brackets accommodate the widest variety of security alarm panels. These 1"-wide brackets are sold in pairs with self-tapping screws and insulating spacers for easy attachment to the panels. The Universal Shelf Bracket provides space for security batteries of various sizes as well as other products to be mounted within Leviton's Series 140, 280 or 420 Structured Media Centers. The bracket comes with four 8" long Velcro® strips to strap down products to the shelf, ensuring both vertical and horizontal stability.

### Universal Security & Shelf Brackets for Leviton 140, 280 or 420 Structured Media Centers

DESCRIPTION	CAT. NO.
A-6" Universal Security Bracket. Comes a set of two 6"-long, 1"-wide brackets with self-tapping screws and spacers for mounting within Leviton's Series 140, 280 or 420 Structured Media Centers	47612-6SB
B-12" Universal Security Bracket. Comes a set of two 12"-long, 1"-wide brackets with self-tapping screws and spacers for mounting within Leviton's Series 140, 280 or 420 Structured Media Centers	47612-1SB
C-Universal Shelf Bracket. Comes with four 8"-long Velcro strips to strap down security batteries of various sizes as well as other products to be mounted within Leviton's Series 140, 280 or 420 Structured Media Centers	47612-UBK
D-Half-Width Universal Security Plate. Comes with a 6" long plate with four adhesive clips for mounting with Leviton's Series 140, 280 or 420 Structured Media Centers	47612-HSB
E-Full-Width Universal Security Plate. Comes with a 12" long plate with four adhesive clips for mounting with Leviton's Series 140, 280 or 420 Structured Media Centers	47612-FSB
F-Combo Bracket is designed to accommodate Leviton products to be installed in most structured wiring enclosures on the market	47612-CBK

#### SPECIFICATIONS AND FEATURES

##### All Brackets

- Made of white powder-coated 18 gauge sheet metal
- Come with push-lock pins

##### Universal Security Brackets

- Allow an unlimited number of upgrades (limited only by the enclosure's size) to be added to an existing security system terminated within any Leviton Structured Media Center
- Sold in pairs with self-tapping screws and spacers to easily connect the largest number of security alarm manufacturers' panels

##### Universal Shelf Bracket

- Allows security batteries and other products to be mounted inside any Leviton Structured Media Center
- Vertical and horizontal slots on bracket to accommodate Velcro strips, ensuring vertical and horizontal stability

##### Combo Bracket

- Allows Leviton products to be installed in most non-Levton structured wiring enclosures



### Surge-Protective and Standard AC Power Modules and J-Box Kits

Surge AC Power Module or J-Box kit models add clean, safe power to the Series 280 or 420 Structured Media Enclosures (Series 140 enclosure only accepts J-Box kits). Two non-surge protected AC Power Module or J-Box kit units offer an economical method of providing power to distribution modules and, except for built-in surge suppression, offer the same features as the respective surge-protected units. In extremely excessive surge conditions, an alarm will sound to warn the user that power is unprotected. Consists of one (J-Box kit) or two (AC Power Module) 15 Amp Hospital Grade duplex receptacles housed in a powder-coated steel enclosure. They feature EMI/RFI filtering and meet UL 1449 standards.

#### AC Power Modules for 280 and 420 Series Structured Media Enclosures

**SPECIFICATIONS**

Dimensions:	10"H x 2.8"W x 2.3"D
Standards Compliance (Surge model only):	UL 1449
Input:	2 @ 15A 120V AC

#### AC Power Modules for 280 and 420 Series Structured Media Enclosures

DESCRIPTION	CAT. NO.
Surge AC Power Module, Two Duplex Receptacle	47605-DP
Non-Surge AC Power Module, Two Duplex Receptacles	47605-NDP

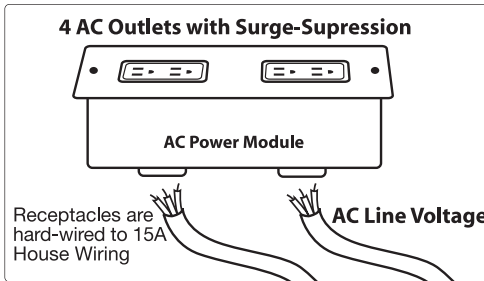

#### J-Box Kits for 140, 280 and 420 Series Structured Media Enclosures

**SPECIFICATIONS**

Dimensions:	3"H.x 2"W.x 2.5"D.
Standards Compliance (Surge model only):	UL 1449
Input:	1 @ 15A 120V AC

#### J-Box Kits for 140, 280 and 420 Series Structured Media Enclosures

DESCRIPTION	CAT. NO.
Surge J-Box Kit, One Duplex Receptacle	47605-ACS
Non-Surge J-Box Kit, One Duplex Receptacle	47605-ACN

### Universal Mini DC Power Supplies

These compact units are designed specifically to fit into Leviton's Series 140, 280 and 420 Structured Media enclosures. They are compatible with any incoming AC voltage in the range of 90 to 264V. The 47605-PSA's 9 12VDC connectors provide up to 40 watts of power and the 47605-PSB's 3 12VDC connectors provide up to 10 watts of power while providing short circuit overload and surge protection as well as EMI/RFI filtering to connected equipment.

DESCRIPTION	CAT. NO.
Universal DC Power Supply, 9 12VDC connectors	47605-PSA
Universal Mini DC Power Supply, 3 12VDC connectors	47605-PSB



47605-ACN Non-Surge J-Box Kit



47605-PSB, 47605-PSA  
Universal Mini DC Power Supplies

**SPECIFICATIONS AND FEATURES**

- Hospital grade surge-protected units provide greater protection for line-voltage modules, including multi-stage defense (L-N, L-G, N-G)
- Non-surge suppressor units provide an economical method of providing power to active components
- Available with one (J-Box kits) or two (AC Power Modules) 15 Amp duplex receptacles
- Safety clips protect outlets against dust, dirt and debris
- One (J-Box kits) or two (AC Power Modules) cable knock-outs on bottom for power service connection
- Saves valuable real estate by mounting on outside of Structured Media Enclosures
- Meets UL 1449 standards



## MEDIA CENTER POWER



Snap-In Surge Protection Modules

### SPECIFICATIONS AND FEATURES

- Interchangeable modules accommodate changing surge protection needs
- All modules easily snap in to the Cat. No. 3950 Surge Module Bracket
- User-friendly design—no wiring required
- Telephone/Fax/Modem Module acts as a splitter, allowing the connection of two devices



3950-BKT



### SPECIFICATIONS AND FEATURES

- Contains six removable double screw terminal jacks.
- Each jack utilizes slot-drive screws.
- Shipped with 6 wires containing 18 gauge connectors and 2.1 mm power plugs.
- Fully regulated (12 volt DC regulated output).

## Snap-In Modules for Structured Media Enclosure Surge Module Bracket

Leviton's snap-in surge protective modules provide customized surge protection for all low-voltage communication and data lines in the Structured Media Enclosure. All Series 5950 modules can snap-in to the Cat. No. 3950-BKT Surge Module Bracket. The bracket, allows you to add and change modules to fit specific protection needs. Choose from a selection of protection modules for Digital Satellite Systems, Ethernet systems, Cable TV, Telephone/Fax/Modem and DSL/ADSL equipment. All devices attached to the modules are covered under the Leviton \$50,000 Connected Equipment Warranty.

DESCRIPTION	CAT. NO.
Satellite System/Cable TV Protection Module—4 Standard F-connectors. 3-Amp fuse for over-current. Max. line voltage: 75V DC. Breakdown Voltage Range: 70.4-110 Volts/Sec	Beige—5951-SA Gray—5951-SAT Ice—5951-SAC
Ethernet Protection Module (10 Base-T Applications)—Two RJ45 connectors to protect two pair of transmit/receive lines. 10-Amp automatic Resettable PTC fuses. Max. operating voltage: 16.6V DC. Breakdown Voltage Range: 2.62-19.2 Volts/Sec	Beige—5952-ET Gray—5952-ETH
Cable TV System Protection Module—Two Standard F-type connectors. 3-Amp fuse for over-current. Max. line voltage: 75V DC. Breakdown Voltage Range: 70.4-110 Volts/Sec	Beige—5953-PC Gray—5953-PCG Ice—5953-PCC
Telephone/Fax/Modem Protection Module—Three RJ11, 4-wire/2-pair connectors. 3-Position splitter allows for connection to a common line. 3-Amp fuse for over-current protection. Max. operating voltage: 150V rms (including ring voltage). Breakdown Voltage Range: 162-331 Volts/Sec	Beige—5954-AT4 Gray—5954-PT4 Ice—5954-CT4
DSL/ADSL Subscriber Equipment Protection Module—Three RJ11, 4-wire/2pair connectors. 3-Amp fuse for over-current protection. Max. operating voltage: 150V rms (including ring voltage). Breakdown Voltage Range: 162-331 Volts/Sec	Beige—5955-DT Gray—5955-DTG
Cat. 5 Ethernet Module Two RJ45 Connectors with Ground Pin for Ethernet - Cat. 5	Beige—5957-OCS Gray—5957-C5G
Two Line Telephone Module One Input, One Output RJ11 Connector for 4-Wire POTS	Beige—5958-AT4 Gray—5958-PT4
Four Line Telephone Module One Input, One Output RJ45 Connector for 8-Wire POTS	Beige—5959-BT8 Gray—5959-GT8
Surge Module Bracket	3950-BKT

### TESTING AND CODE COMPLIANCE

CAT. NO.	MCOV (VDC)	CLAMPING VOLTAGE (VDC)	TESTED TO	MEET STANDARDS
5951	60	388	UL 452	ANSI/IEEE
5952	16.6	23	UL497B	C-62.36
5953	60	388	UL452	
5954	288	715	UL497A	CSA
5955	205	210	UL497A	(#LR-94773)
5957	16.6	23	UL497B	
5958	288	715	UL497A	
5959	288	715	UL497A	

## DC Power Distribution Module

The DC Power Distribution Module is a unique solution to the need for high quality electrical power for the separate DC-powered components in the Structured Media Enclosure. This module reduces clutter and opens-up space in the Structured Media Enclosure by eliminating the need for multiple DC transformers. Powered by a single DC power supply, the Power Distribution module provides fully-regulated 12 VDC power for up to 6 devices.

### SPECIFICATIONS

Input:	110V AC
Output:	Provides 13V DC power for up to 6 devices 1500mA
Compliance (Surge model only):	UL 1449
Dimensions:	6.58"H x 2.5"W x 1.5"D
Wire Gauge:	Up to 12 gauge

## DC Power Distribution Module

DESCRIPTION	CAT. NO.
DC Power Distribution Module	48212-ODC



## Structured Media™ Modules—Internet Connection Sharing and Multi-Location Networking

### 10/100 Internet Gateway Cable/DSL Broadband Router\*

Leviton's 10/100Mbps Internet Gateway (a.k.a router) allows multiple users to securely share a single, protected high-speed Internet connection.

### 10/100 base-t switches\*

At 10/100Mbps speeds, these units are excellent choices for networking PC's to meet a wide range of residential needs such as sharing files, printers and other peripherals.

\*Networked PC's and peripherals require compatible networking cards or adapters and associated software.



Cat No. 47611-GT4  
10/100Mbps Internet Gateway Router

### 10/100 Base-T Switches and 10/100 Base-T Internet Gateway Router

SPECIFICATIONS	10/100BASE-T 5-PORT (OR 8-PORT) SWITCHES	10/100 BASE-T INTERNET GATEWAY ROUTER
Data Transfer Rate	10/100 Mbps	
Connectors	5 (or 8) ports, 1 AC Power Adapter Jack	4 LAN ports, 1 WAN port, 1 Uplink port, 1 AC Power Adapter Jack
Cabling Requirements	Standard Cat 5/5e UTP	
LED Indicators	One Power Indicator, 5 (or 8) Link/Activity and 5 (or 8) 100Mbps	One Power Indicator, one Diagnostic Indicator, five Link/Activity, five FDX/Col and five 10/100Mbps
Power Supply	12VDC, 1000mA	
Dimensions	5.85" x 3.2" x 1.03"	5.54" x 3.92" x 1.05"
Standards Compliance	IEEE 802.3 10 Base-T Ethernet IEEE 802.3u 100 Base-TX Fast Ethernet, and FCC Class B	

### 10/100 Base-T Switches and 10/100 Base-T Internet Gateway Router

DESCRIPTION	CAT. NO.
10/100 Base-T 5-Port Ethernet Switch, with Power Adapter	47611-5PT
10/100 Base-T 8-Port Ethernet Switch, with Power Adapter	47611-8PT
10/100 Base-T Internet Gateway Router, with Power Adapter	47611-GT4

### Cable Distribution—Modem Outside the Structured Media Center

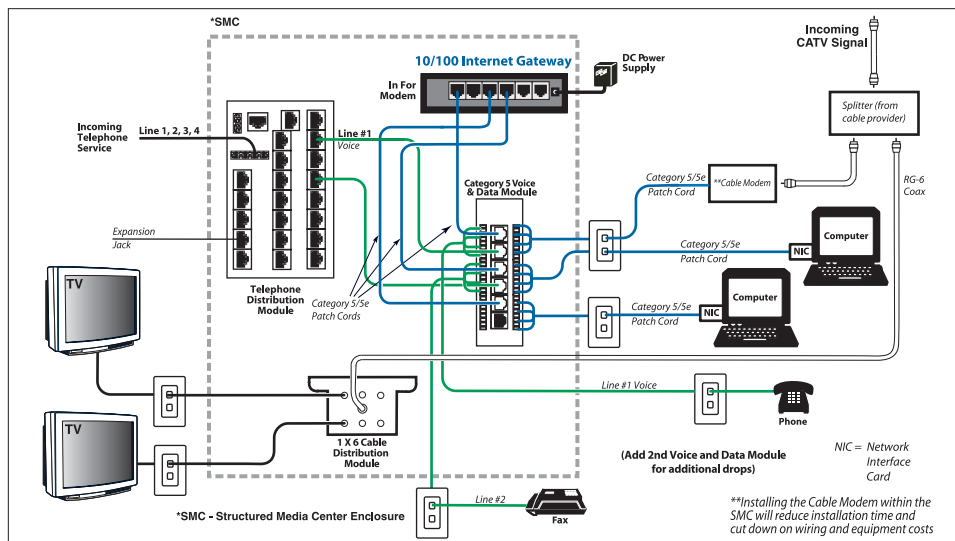

47611-5PT



47611-8PT

#### SPECIFICATIONS AND FEATURES

- Connects up to 4 devices directly (up to 253 computers via a series of cascaded devices) to the Internet using a single shared high-speed DSL, cable modem, or Satellite connection
- Allows fast Internet access at up to 100 Mbps
- Permits creation of a private high-speed home area network (HAN) or local area network (LAN) in small office/home office (SOHO) environments for all connected computers with its fast, integral 10/100Mbps auto-sensing Ethernet ports
- High performance suitable for demanding home office and telecommuting applications, including sharing of high-speed and high-capacity devices such as storage devices and back-up systems.
- Network Address Translation technology (NAT) creates a firewall that securely cloaks the private network from outside access
- Pass-through IPSEC and ISAKMP protocols allow attached LAN users to implement secure Virtual Private Network (VPN) communication applications on their PC's.
- Built-in DHCP server for easy setup and allocation of IP addresses on the LAN.
- Connections are made by running cable from desired locations to a Category 5e Voice and Data Module (either a stand-alone module page J10, or one of the units in the Pre-Configured Structured Cabling Panels page J9). From there, Category 5 or 5e patch cord can be used to connect the Gateway to the Category 5e Module.
- Network protocols: TCP/IP, DHCP, DNS, NAT, TFTP, HTTP, PPOE. Not PPOA
- Auto detect uplink: Use any port to cascade additional switches, hubs or routers



47693-ESM



47693-GSM



47693-3BY



47693-G3Y

## CATV 1GHz Video Distribution Modules

Cable service providers are converting to digital systems. These new systems will squeeze hundreds of channels plus Internet service onto the coax line. Leviton's high-performance CATV modules can support these new systems while limiting noise and other artifacts. Modules can distribute standard inputs such as CATV and antennas, and modulated inputs such as VCR's, DVD's and security camera/CCTV on coaxial cable throughout the house. Signals can be precisely controlled through the modules' built-in amplifier/attenuator (-5 to +15db) to compensate for variations in incoming signal strength for the clearest possible reception\*.

Incorporates state-of-the-art bi-directional signal paths to support cable modem or cable box communications throughout a home or office. Choose from one or three-input models; both come with 8 outputs. One and three-input models come in both nickel-plated and gold-plated connector versions.

Dimensions: 3.50"H x 6.50"W x 3.20"D, Connector: F-Type, Impedance: 75 Ohm, Power Input: 12 VDC, 500 mA (1x8 & 3x8).

\*Not for use in-line between 1 satellite dish (LNB) and DBS satellite TV receiver.

### 1x8 CATV Distribution Modules (1GHz)

Parameter	Bandwidth	Forward Path	Return Path
Band	--	52-1000MHz	5-42MHz
Gain (Loss)	--	4dB	(-0.5dB)
Flatness	--	±0.75dB	±1.5dB
Return Loss – Input	--	22.0dB	21.0dB
Return Loss – Output	--	22.0dB	21.0dB
Port Isolation – Output	--	25.0dB	27.0dB
Group Delay (span 3.58MHz)	54-60MHz	15ns	--
	61-1000MHz	7ns	--
Group Delay (span 1MHz)	5-42 MHz	--	17ns
	10-40 MHz	--	10ns
Power to RF Input Isolation	5-1000 MHz	100dB (min)	
RFI Isolation	5-1000 MHz	-110dBc	
Noise Figure	5-1000 MHz	3.5dB	
Distortions*	CSO	-65dBc	
	CTB	-74dBc	
	Xmod	-75dBc	

\* Input level at +10dBmV flat 77 channels & 200MHz noise for QAM test from 550 to 790MHz

Operating Temperature: -40°C to +60 °C

### 3x8 CATV Distribution Modules (1GHz)

Parameter	Bandwidth	Forward Path	Return Path
Band	--	52-1000MHz	5-42MHz
Gain (Loss)	--	3.5dB	(-11.0dB)
Flatness	--	±1.0dB	±1.5dB
Return Loss – Input	--	22.0dB	21.0dB
Return Loss – Output	--	20.0dB	21.0dB
Port Isolation – Output	--	25.0dB	25.0dB
Group Delay (span 3.58MHz)	54-60MHz	15ns	--
	61-1000MHz	7ns	--
Group Delay (span 1MHz)	5-42 MHz	--	17ns
	10-40 MHz	--	10ns
Power to RF Input Isolation	5-1000 MHz	100dB (min)	
RFI Isolation	5-1000 MHz	-110dBc	
Noise Figure	5-1000 MHz	6.5dB	
Distortions*	CSO	-65dBc	
	CTB	-74dBc	
	Xmod	-75dBc	

\* Input level at +10dBmV flat 77 channels & 200MHz noise for QAM test from 550 to 790MHz

Operating Temperature: -40°C to +60 °C

### CATV Distribution Modules

DESCRIPTION	CAT. NO.
1x8 CATV Module, 1 GHz, Nickel-plated Connectors	47693-ESM
1x8 CATV Module, 1 GHz, Gold-plated Connectors	47693-GSM
3x8 CATV Module, 1 GHz, Nickel-plated Connectors	47693-3BY
3x8 CATV Module, 1 GHz, Gold-plated Connectors	47693-G3Y





### Video Amplifier

Run cable TV and other video service signals, such as antenna or other modulated input through this Video Amplifier Module and boost video signal strength up to 25 dB. Features a variable attenuator for signal amplification level setting, and an FM trap to eliminate unwanted FM interference.

**SPECIFICATIONS**

Dimensions:	6.58"H x 3.67"W x 4.4"D
Frequency Range MHz:	50-1000
Gain Control Range dB:	10-25dB
FM Trap dB:	25
Impedance:	75 Ohm
Connector Type:	F-type
Power Source:	12 VDC 500 mA

### Video Amplifier

DESCRIPTION	CAT. NO.
Video Amplifier Module	48210-VA



48210-VA

**SPECIFICATIONS AND FEATURES**

- Run cable TV or other video signals through the Video Amplifier before splitting and distributing throughout the home or office.
- Boost signal strength by up to 25 dB.

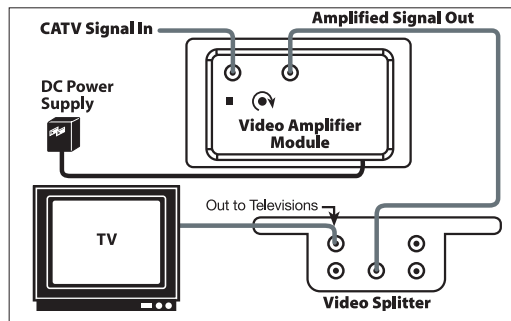



## VIDEO DISTRIBUTION



1 GHz Modules



1 GHz Video Splitters

### SPECIFICATIONS AND FEATURES

- Splits video signals. Outputs for up to 4, 6 or 8 televisions.
- Provide digital cable, cable TV and other video services, via coaxial cable, to any room in the house.
- Die-cast housing and printed circuit board.
- Use with the Video Amplifier for increased signal strength.
- Units for SMC 140, 280, 420 come with mounting bracket.
- Gold-flashed contacts on 2 GHz units provide lowest conductive resistance.



47691-3MS



47691-5MS

### SPECIFICATIONS AND FEATURES

- Distributes digital satellite signals to up to 4 TVs (47691-3MS) or 8 TVs (47691-5MS).
- Combines signals from digital satellite with off-air antenna onto single coax cable.
- DSS 75 Ohm and 2.0 GHz Combiner/Diplexer with DC Blocking, Cat. No. 40856-DSS, is available to separate antenna and cable signals.

## Passive Components

Use 4-, 6- and 8-way Passive Video Splitters to split digital cable, quality cable TV and off-air antenna signals to 4, 6, or 8 televisions throughout the home or office. They feature die-cast housing and printed circuit board construction. Use with the Video Amplifier for increased signal strength.

### 1x4, 1x6, 1x8 Passive Video Splitters

ITEM	CAT NO.	DIMENSION	RANGE
1x4	47690-4C	2.14"H x 6.58"W x 1.40"D	1 GHz
	47690-004	1.65"H x 3.34"W x 1.14"D	1 GHz
	47690-4C2	2.14"H x 6.58"W x 1.40"D	2 GHz
	47690-G4	1.65"H x 3.34"W x 1.14"D	2 GHz
1x6	47690-6C	3.00"H x 6.58"W x 1.40"D	1 GHz
	47690-006	2.64"H x 3.34"W x 1.14"D	1 GHz
	47690-6C2	3.00"H x 6.58"W x 1.40"D	2 GHz
	47690-G6	2.64"H x 3.34"W x 1.14"D	2 GHz
1x8	47690-8C	3.00"H x 6.58"W x 1.40"D	1 GHz
	47690-008	2.64"H x 3.34"W x 1.14"D	1 GHz
	47690-8C2	3.00"H x 6.58"W x 1.40"D	2 GHz
	47690-G8	2.64"H x 3.34"W x 1.14"D	2 GHz

### 1x4, 1x6, 1x8 Passive Video Splitters

1x4 Passive Video Splitter Module for SMC 140, 280, 420 (1 GHz)	47690-4C
1x4 Passive Video Splitter For Compact Structured Media Enclosure	47690-004
1x6 Passive Video Splitter Module for SMC 140, 280, 420 (1 GHz)	47690-6C
1x6 Passive Video Splitter For Compact Structured Media Enclosure	47690-006
1x8 Passive Video Splitter Module for SMC 140, 280, 420 (1 GHz)	47690-8C
1x8 Passive Video Splitter For Compact Structured Media Enclosure	47690-008
1x4 Passive Video Splitter Module for SMC 140, 280, 420 (2 GHz)	47690-4C2
1x4 Passive Video Splitter For Compact Structured Media Enclosure (2GHz)	47690-G4
1x6 Passive Video Splitter Module for SMC 140, 280, 420 (2 GHz)	47690-6C2
1x6 Passive Video Splitter For Compact Structured Media Enclosure (2GHz)	47690-G6
1x8 Passive Video Splitter Module for SMC 140, 280, 420 (2 GHz)	47690-8C2
1x8 Passive Video Splitter For Compact Structured Media Enclosure (2GHz)	47690-G8

## Satellite Distribution Components

**3x4 Multi-Switch**—Passive module combines signals from dual incoming LNB digital satellite systems with off-air antenna signals on a single coaxial cable, enabling distribution to up to 4 TV's. Module incorporates a separate input for TV antenna signals (best used in combination with a video amplifier).

**5x8 Multi-Switch**—Active module combines signals from two dual incoming LNB digital satellite systems with an off-air antenna or cable signals on a single coaxial cable, enabling distribution to up to 8 TV's. Works with HDTV or standard receivers and with integrated multi-switches at the satellite dish; also works with DirecTV® systems. Equipped with built-in low noise amplifier and 24VDC power supply.

SPECIFICATIONS	CAT. NO. 47691-3MS
<b>3x4 Multi-Switch</b>	
<b>Dimensions:</b>	4.77"H x 6.58"W x 2.37"D
<b>Frequency:</b>	Terrestrial: 40-860 MHz Satellite: 950-2150 MHz Receiver Output: 40-2150 MHz
<b>Connectors:</b>	F-type, 75 Ohms
<b>LNB Input Selection:</b>	LNBA: 13/14VDC LNBB: 17/18VDC
<b>Insertion Loss (typical):</b>	Terrestrial: -7dB Satellite: -3dB
<b>Return Loss (typical):</b>	Terrestrial: -10dB Satellite: -10dB
<b>Isolation (typical):</b>	Output to Opposite Input -22dB
<b>DC Power Passing:</b>	500ma (max.)

SPECIFICATIONS	CAT. NO. 47691-5MS
<b>5x8 Multi-Switch</b>	
<b>Dimensions:</b>	7.14"H x 13.25"W x 2.33"D
<b>Frequency:</b>	Terrestrial: 54-806 MHz Satellite: 950-2150 MHz Receiver Output: 54-2150 MHz
<b>Connectors:</b>	F-type, 75 Ohms
<b>LNB Input Selection:</b>	13/18VDC or 22kHz tone
<b>Insertion Loss (typical):</b>	Terrestrial: -2dB Satellite: -5dB
<b>Rejection:</b>	Satellite-Terrestrial: 30dB Terrestrial-Satellite: 20dB Receiver-Receiver: 30dB
<b>Switching Isolation:</b>	Terrestrial: N/A Satellite: 30dB
<b>Noise Figure:</b>	Terrestrial: 5dB Satellite: 4.8dB
<b>Max. Current to LNBS:</b>	500mA
<b>DC Power:</b>	24VDC, 600mA

DESCRIPTION	CAT. NO.
3x4 Multi-Switch	47691-3MS
5x8 Multi-Switch	47691-5MS



## Leviton Video Monitoring System

Leviton's easy-to-install, high-resolution color video cameras only require one CAT 5e cable for video and power connections, both of which are supplied by a Camera Hub in the SMC. The Camera Hub installs in a single Leviton bracket space in the SMC and the cameras mount with only two screws on a low voltage ring (Indoor Camera) or outdoor electrical box (Outdoor Camera). Standard 110 IDC terminations and 8P8C jacks make the UTP cable connections quick, simple and reliable. Indoor Camera fits in a Decora style wallplate and comes with clear and tinted lens covers. The Outdoor Camera provides 0 Lux operation with IR illumination.

The Leviton IP/Quad Module enables users to view a full-screen single Indoor or Outdoor camera view or multiple cameras, up to four at once in the same "quad" view, on one or more TV sets in the home, or via the Internet from any location using an Internet browser on a PC. Mount s directly in SMC with integral mounting bracket.

### Video Monitoring System Components

DESCRIPTION	CAT. NO.
Indoor Color Camera	VSIND-OSC
Outdoor Color Camera	VSOUT-00W
Camera Hub	VSHUB-000
IP/Quad Module	VSQIP-000



VSIND-OSC



VSOUT-00W



VSHUB-000



VSQIP-000

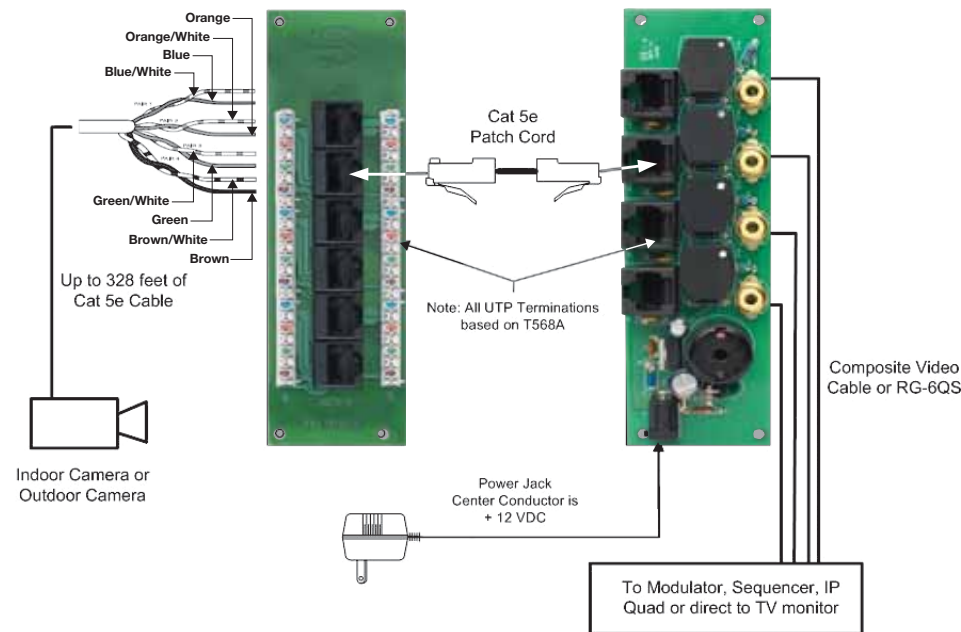

### SPECIFICATIONS AND FEATURES

#### Camera Hub

- Powers camera engines over UTP connection up to 100 meters

#### Indoor Camera

- Includes balun for clear video over UTP cable
- Includes 15VDC input power terminals for separate power cable where UTP run exceeds 100 meter limit
- Internal strap allows viewing angle adjustment
- Fits standard Decora plate with snap-in clear or smoked inserts

#### Outdoor camera

- Auto-on infrared LEDs for B&W video images in zero Lux conditions
- Includes balun for clear video over UTP cable

- Includes 15VDC input power terminals for separate power cable where UTP run exceeds 100 meter limit
- Mounts via special single-gang wallplate.
- Ball-joint strut allows 360° rotation and +/- 90° tilt viewing angle adjustment

#### IP/Quad Module

- Mounts directly to the SMC with integral mounting bracket
- Enables user to view Indoor and Outdoor Cameras on one or more TV sets in the home or via the Internet from any location using an Internet browser on a PC
- Easy browser setup and control of all cameras, including camera name, sensitivity, brightness, contrast, saturation, hue, and single or multiple camera display mode



# HOME VIDEO MONITORING SYSTEM



## Media Center Modulator

The Media Center Modulator takes the signal from a video device such as a security camera (or multiple cameras using the Video Sequencer) and modulates the signal to one unused cable TV channel, which can then be combined with the CATV signal to multiple locations anywhere in the home, effectively providing a whole-house security channel.

Select the broadcast channel to be programmed via dip-switch button programming. The modulator provides 0, 10, 20 or 30 dBmV RF output.

*Note: Modulator broadcasts mono audio only. In a Structured Media System, when used with Structured Media Video Distribution modules, the Modulator must be used with a Leviton Notch Filter (PN 47690-NFA) to clear the target cable channel and avoid interference.*



48213-VMA

### SPECIFICATIONS AND FEATURES

- RCA video and audio inputs.
- F-Connector output: 14-69 UHF; 70-94, 100-125 CATV.
- DC power supply.

### SPECIFICATIONS

Dimensions:	3.2"H x 2.25"W x 1"D
Inputs:	RCA video, RCA audio inputs
Outputs:	1 F-connector for RF signal
Operational channels:	14-69 UHF; 70-94, 100-125 CATV
Bandwidth:	50MHZ-860MHZ
Power:	12V DC 400mA

## Media Center Modulator

DESCRIPTION	CAT. NO.
Media Center Modulator	48213-VMA



48213-CVS

### SPECIFICATIONS AND FEATURES

- Inputs for up to four video cameras and audio sources.
- Automatic switching between cameras.
- 1-30 second variable time setting between cameras.
- RCA composite audio/video inputs and outputs.

## Video Sequencer

The Structured Media Video Sequencer, which automatically switches between video cameras, is a security product engineered for long-term home use. With the Video Sequencer, up to four Decora Cameras\* may be monitored sequentially. The Sequencer allows a variable time-interval setting from 1-30 seconds on each camera to allow thorough surveillance of any perimeter or interior. The Video Sequencer has four composite RCA audio/video inputs and two sets of RCA outputs to connect with a monitor or modulator. It snaps into a 280 or 420 Structured Media Center.

### SPECIFICATIONS

Dimensions:	7.4"H x 4.75"W x 2"D
Power:	12 VDC @ 300mA
Inputs:	Four RCA video; Eight RCA left/right audio
Outputs:	2 RCA video and 4 RCA left/right audio
Time interval:	1-30 seconds, variable/adjustable
Signal to Noise Ratio:	<1.2dB
Bandwidth:	5MHz

## Video Sequencer

DESCRIPTION	CAT. NO.
Video Sequencer	48213-CVS

*\*Not for use with Indoor/Outdoor B&W Camera with built-in modulator (Cat. No. 48213-BMC).*



## Indoor/Outdoor B&W Camera with Built-in Modulator

The Indoor/Outdoor B&W Camera allows monitoring of front doors, back yards, and anywhere an extra eye is desirable. It is designed to withstand temperature and environmental extremes when mounted in a suitable location.\* The camera uses a single wire for power and video making installation easy. Output is controlled by a dip-switch inside the camera housing. Permits 360° horizontal adjustment and 180° vertical adjustment.

*\*Recommended mounting is in a sheltered location such as under an eave or overhang and away from direct exposure to rain and snow.*

*Not for use with video sequencer*

### SPECIFICATIONS

<b>Dimensions:</b>	Base 5.5" x 4.5"
<b>Power:</b>	12 VDC, 300mA
<b>Output Connection:</b>	F-Connector, 75 Ohm
<b>Camera Lens:</b>	3.6 mm
<b>Resolution:</b>	350+ lines
<b>Minimum Illumination:</b>	0.7 lux
<b>Output Level:</b>	27 dBmV
<b>Output Frequency:</b>	UHF 14-69, CATV 70-94, 100-125
<b>Cable Type:</b>	RG 59, RG6 or better



48213-BMC

## Indoor/Outdoor B&W Camera with Built-in Modulator

DESCRIPTION	CAT. NO.
Indoor/Outdoor B&W Camera with Built-in Modulator	48213-BMC

## RF Notch Filter

The RF Notch Filter is an essential element of Home Security Monitoring and Multi-Room Video. It blocks incoming cable TV channels 75-80, allowing the Media Center Modulator or Component Modulator to broadcast an in-house "security" or "entertainment" channel over the coaxial cable system without interference. The Notch Filter simply couples to the coaxial cable TV input on either a splitter or an active video distribution device. Once installed, it filters out six cable channels to make room for any home security or entertainment video application. It also blocks outgoing signals, such as cameras, from being broadcast outside the home.

### SPECIFICATIONS

<b>Dimensions/Weight:</b>	3"L x .9"W – 2lbs
<b>Type:</b>	Passive RF filter
<b>Bandwidth:</b>	CATV channels 75-80
<b>Input:</b>	Female F-connector
<b>Output:</b>	Male F-connector

## RF Notch Filter

DESCRIPTION	CAT. NO.
RF Notch Filter	47690-NFA



47690-NFA



# RESIDENTIAL INTERCOM SYSTEM



A



C, D, E

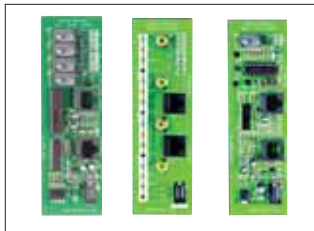

F, G, H

## RESIDENTIAL INTERCOM SYSTEM

Leviton brings the home intercom into the 21st century with the introduction of its new Residential Intercom system for Structured Media™ installations. Available as a series of easy-to-install components, the Residential Intercom system is designed to incorporate easily into the category 5-based modular structured wiring systems that have become a standard feature of today's high-tech homes.

DESCRIPTION	CAT. NO.
A-Intercom Kit (includes Main Controller Board, 1 Interface Board on a bracket with 1 Outdoor station)	47000-MKB
B-Main Controller Board	47000-00M
C-Outdoor Station (Brushed nickel finish)	47000-0D1
D-Indoor Station (White)	47000-0W1
E-Indoor Station (Black)	47000-0E1
F-Door Strike Module	47000-STR
G-Interface Board with 4 additional ports	47000-PRT
H-Door Chime Module	47000-CHM

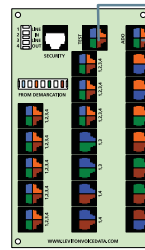

47000-MKB includes Main Controller Board and Bracket with one Outdoor Station and Interface Board. No additional products are required for communication over the telephone. Simply run a single Cat5e cable from the SMC to each additional wall station, if desired.

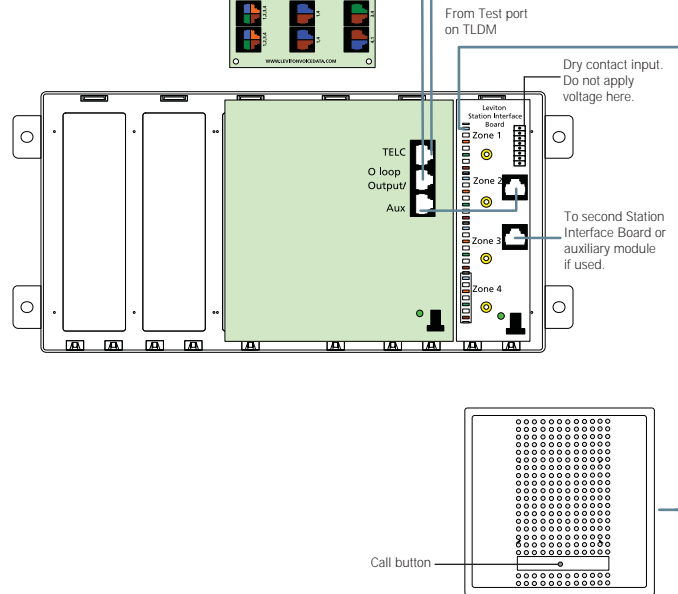

### SPECIFICATIONS AND FEATURES

- Main controller board installs easily in SMC
- System integrates with other services in SMC (phone system, door strike, lighting controls, door bell, dry contact security devices and Indoor and Outdoor Stations)
- Supports up to 12 wall station locations in four zones
- Onboard firmware for music-on-hold
- Answering machine function for message and message taking for intercom activations
- Allows call-on-hold for hang-up at one location and pick-up at another
- Allows whole-house paging, including phone-to-phone paging
- CCTV capability integrated in Interface Board



**Leviton Architectural Edition™ powered by JBL Products and Systems**

When music and film professionals who create and record sound for a living have to “get it right,” they insist on JBL. Because they know JBL systems will faithfully deliver all the clarity, accuracy and impact of the original performance. When it comes to entertaining at home, why settle for less than the recording industry’s best? Especially when Leviton makes it easy to build premium JBL sound right into the home and enjoy music, movies and more with the same legendary quality heard in concerts, clubs, recording studios, and from behind the screens of the best theaters in the world.

The Leviton Architectural Edition powered by JBL program transforms a living room into a cinema, a deck into an outdoor concert, a kitchen into an elegant bistro, a dining room into a dance hall. Even a master bath turns into a luxurious private retreat. Most important, Leviton/JBL systems are the product of precision engineering, advanced audio technology, painstaking craftsmanship and the latest advances in materials— the same technologies, features and performance that make JBL the first choice of professionals. And they are offered through a select network of quality homebuilders and trained installation professionals working with Leviton, the leader in residential connectivity and home networking systems.

**Leviton Architectural Edition™ powered by JBL Indoor In-Wall and In-Ceiling Speakers**

Leviton/JBL multi-room In-Wall and In-Ceiling Speakers can deliver a professional listening experience in the home because they incorporate the same features and technologies found in JBL’s renowned family of professional studio monitors, including an Elliptical Oblate Spheroidal™ (EOS) Waveguide for improved high-frequency dispersion throughout a listening area, Titanium-laminate drivers to ensure musical accuracy and clarity, and HeatScape™ magnetic structures for impact and bass realism.

**6.5-Inch (170mm) Two-Way In-Wall Loudspeaker**

Acoustically transparent paintable baffles and grilles. 1” (25mm) Titanium laminate dome tweeter and 6.5” (170mm) Titanium-laminate woofer, Frequency Response (-10dB): 38 Hz-20 kHz, Sensitivity (2.83V/1m): 88 dB, Power Handling: 80 Watts, Impedance: Nominal 8 Ohms, Dimensions: 11” (279mm) H x 8.5” (226mm) W x 3.87” (98mm) D. Weight: 5 lb/2.3 kg per speaker. Sold in pairs.

DESCRIPTION	CAT NO.
6.5-Inch Two-Way In-Wall Loudspeaker	AEI65

**8-Inch (200mm) Two-Way In-Wall Loudspeaker**

Acoustically transparent paintable baffles and grilles. 1” (25mm) Titanium laminate dome tweeter and 8” (200mm) Titanium-laminate woofer, Frequency Response (-10dB): 30 Hz-20 kHz, Sensitivity (2.83V/1m): 89 dB, Power Handling: 100 Watts, Impedance: Nominal 8 Ohms, Dimensions: 13.12” (333mm) H x 10.12” (257mm) W x 4” (102mm) D. Weight: 7.8 lb/3.5kg per speaker. Sold in pairs.

DESCRIPTION	CAT NO.
8-Inch Two-Way In-Wall Loudspeaker	AEI80

**6.5-Inch (170mm) Two-Way In-Ceiling Loudspeaker**

Acoustically transparent paintable baffles and grilles. 1” (25mm) Titanium laminate dome tweeter and 6.5” (170mm) Titanium-laminate woofer, Frequency Response (-10dB): 40 Hz-20 kHz, Sensitivity (2.83V/1m): 88dB, Power Handling: 80 Watts, Impedance: Nominal 8 Ohms, Dimensions: 9.18” (233mm) Diameter x 4.25” (108mm) Depth. Weight: 4.5 lb/2.0 kg per speaker. Sold in pairs.

DESCRIPTION	CAT NO.
6.5-Inch Two-Way In-Ceiling Loudspeaker	AEC65

**8-Inch (200mm) Two-Way In-Ceiling Loudspeaker**

Acoustically transparent paintable baffles and grilles. 1” (25mm) Titanium laminate dome tweeter and 8” (200mm) Titanium-laminate woofer, Frequency Response (-10dB): 32 Hz-20 kHz, Sensitivity (2.83V/1m): 89 dB, Power Handling: 100 Watts, Impedance: Nominal 8 Ohms, Dimensions: 10.87” (275mm) Diameter x 4.25” (108mm) Depth. Weight: 5.3 lb/2.5 kg per speaker. Sold in pairs.

DESCRIPTION	CAT NO.
8-Inch Two-Way In-Ceiling Loudspeaker	AEC80

**6.5-Inch (170mm) Two-Channel/Single Location Two-Way In-Ceiling Loudspeaker**

Acoustically transparent paintable baffles and grilles. Reproduces two channels of stereo from one location. Dual .75” (19mm) Titanium laminate dome tweeters and 6.5” (170mm) Dual voice-coil Titanium-laminate woofer, Frequency Response (-10dB): 40 Hz-20 kHz, Sensitivity (2.83V/1m): 88 dB with both channels driven, Power Handling: 100 Watts total, Impedance: Nominal 8 Ohms, Dimensions: 9.8” (233mm) Diameter x 4.25” (108mm) Depth. Weight: 4 lb/1.8kg per speaker. Sold individually.

DESCRIPTION	CAT NO.
6.5-Inch Two-Channel/Single Location Two-Way In-Ceiling Loudspeaker	AEM65

Note: See page J24 for In-Wall and In-Ceiling Preconstruction Kits



AEI65



AEI80



AEC65



AEC80



AEM65



AEN24



AES36



AEI55



AECCS



AESUB

**Pre-Construction Kits for Leviton/JBL In-Wall and In-Ceiling Speakers**

DESCRIPTION	CAT NO.
Pre-Construction Kit - 6.5" In-Ceiling Speakers	PCC55-KIT
Pre-Construction Kit - 8" In-Ceiling Speakers	AEPC8-KIT
Pre-Construction Kit - 6.5" In-Wall Speakers	AEPI6-KIT
Pre-Construction Kit - 8" In-Wall Speakers	AEPI8-KIT
In-Wall Shelf Pre-Construction (for use with AAEI55)	AEPI5-KIT

**Leviton Architectural Edition™ powered by JBL Outdoor/All-Weather Speakers**

As the brand delivering sound in more concert venues than any other (including all three Woodstock festivals) JBL is extremely qualified to bring premium sound outdoors. These outdoor speakers are engineered to withstand long-term exposure to the elements right down to their weatherized grilles and input connectors. They are also ideal for indoor pools, atriums and other large open spaces where enclosure speakers with large-area coverage are desired.

**Outdoor/All-Weather Two-Way Loudspeaker**

Professional-grade injection-molded weather-resistant ported base-reflex enclosure with metal-mesh grille, .75" (19mm) Titanium laminate dome tweeter and 4" (100mm) WeatherPlas™ (polymer-coated cellulose fiber cone) woofer with rubber surround, high-temperature/oversized Kapton® voice coil and HeatScape™ motor structure, Frequency Response (-3dB): 75 Hz-20 kHz, Sensitivity (2.83V/1m): 86 dB, Power Handling: 100 Watts, Impedance: Nominal 8 Ohms, Dimensions: 9.5" (241mm) H x 6.25" (159mm) W x 4.75" (121mm) D. Weight: 4.5 lb/2.1 kg per speaker. Sold in pairs.

DESCRIPTION	CAT NO.
Outdoor/All-Weather Two-Way Loudspeaker	AEN24

**Outdoor/All-Weather Three-Way Loudspeaker**

"Extreme performance" three-way professional-grade sealed enclosure speaker with all-metal, gold-plated binding posts for outdoor applications and for music and home theater installations (as a satellite with a subwoofer system). 1" (25mm) Pure Titanium laminate dome tweeter, 4" (100mm) WeatherPlas™ shielded midrange with Linear Field Proximity (LFP) bezel and 6" (150mm) WeatherPlas™ (polymer-coated cellulose fiber cone) woofer with rubber surround, high-temperature/oversized Kapton® voice coil, Frequency Response (-3dB): 60 Hz-20 kHz, Sensitivity (2.83V/1m): 90 dB, Power Handling: 150 Watts, Impedance: Nominal 8 Ohms, Dimensions: 10.25" (260mm) H x 14.62" (371mm) W x 5" (127mm) D. Weight: 11 lb/5 kg per speaker. Sold in pairs

DESCRIPTION	CAT NO.
Outdoor/All-Weather Three-Way Loudspeaker	AES36*

\* See Leviton.com for current Leviton part number.

**Leviton Architectural Edition™ powered by JBL Home Theater Speaker Components**

JBL systems measure-up to higher standards than "home" theater, because more JBL speakers are found in film recording studios and behind the screens of the worlds best movie theaters than any other brand. This select group of installed and enclosed speakers for residential home-theater applications can bring cinema realism to any living room.

**Two-Way In-Wall Center Channel Speaker**

Can be used in front-speaker home theater applications either singly with Leviton/JBL In-Wall left and right speakers or in a matched set of three left/right/center speaker in ultra-premium installations. Acoustically-transparent paintable baffle and grille. 1" (25mm) Pure Titanium dome tweeter and two 5" (125mm) Polymer-coated aluminum woofers, Frequency Response (-10dB): 40 Hz-20 kHz, Sensitivity (2.83V/1m): 88 dB, Power Handling: 120 Watts, Impedance: Nominal 8 Ohms, Dimensions: 7.5" (191mm) H x 15.37" (391mm) W x 3.87" (98mm) D. Weight: 5.7 lb/2.5 kg per speaker. Sold individually

DESCRIPTION	CAT NO.
Two-Way In-Wall Center Channel Speaker	AEI55

**Dual 5-Inch (125mm) Two-Way Shelf-Mount Center Channel Loudspeaker**

Enclosed free-standing, shelf-mounted center-channel speaker to accompany in-wall installed left and right speakers like the Leviton/JBL AEI65, AEI80 and AEI55. .75" (19mm) Titanium laminate dome shielded tweeter and two 5" (130mm) PolyPlas™ shielded woofers, Frequency response (-3dB): 75 Hz-20 kHz, Sensitivity (2.83V/1m): 90 dB, Power Handling: 75 Watts, Impedance: Nominal 8 Ohms, Dimensions: 6.5" (165mm) H x 20.25" (514mm) W x 9.62" (244mm) D. Weight: 9.6 lb/4.4 kg per speaker. Sold individually..

DESCRIPTION	CAT NO.
Dual 5-Inch (130mm) Two-Way Shelf-Mount Center Channel Loudspeaker	AECCS





**Powered 12-Inch Subwoofer**

Freestanding front firing, powered (amplified) subwoofer to reinforce in-wall and in-ceiling installed systems in home theater viewing. High-efficiency, high current switched amplifier. Variable low-pass crossover and output level (volume) control. 12" (300mm) PolyPlas™ woofer with heat-resistant voice coil, front-firing enclosure. Amplifier output (RMS): 300 Watts, Dynamic power (peak): 600 Watts, Frequency response (+/- 3dB): 25 Hz low-pass crossover setting (variable), Dimensions: 19.75" (502mm) H x 14.37" (365mm) W x 18" (457mm) D. Weight: 39.5 lb/18 kg. Sold individually.

DESCRIPTION	CAT NO.
Powered 12" Subwoofer	AESUB

**Leviton Architectural Edition™ powered by JBL On-Wall Home Cinema Speaker System**

An ideal solution for home theater locations where an in-wall/ in-ceiling installed home theater speaker solution is impractical but full performance is desired (such as in room corner installations). This is a 5-channel surround-sound package that is expandable to 6.1 or 7.1 surround-sound operation with the addition of optional matched AESS5 Expansion Satellite Speaker(s). Includes 5 mounting brackets and subwoofer input RCA cable. Available in White or black finish



**Home Cinema Speaker System**

Speaker Complement: Five 2-way magnetically shielded satellite speakers with high-output 2.5" (63.5mm) woofer and precision .5" (12.7mm) tweeter, and one 8" (200mm) 100 watt powered subwoofer with LFE input, adjustable level control, and built-in crossover network for use with speaker-level outputs. Enclosure: Bass-reflex with FreeFlow™ flared port, Recommended power range: 10-100 Watts, Subwoofer Frequency Response (+/- 3dB): 150 Hz-20kHz, Satellite Speaker Sensitivity (2.83V/1m): 86dB, Satellite Impedance: Nominal 8 Ohms, Dimensions (Subwoofer): 16.25" (413mm) H x 11" (279mm) W x 13.75" (349mm) D, Dimensions (Satellite Speaker): 5" (127mm) H x 3.5" (88mm) W x 3.5" (88mm) D Subwoofer weight: 28 lb/12.7 kg.

**Expansion Satellite Speaker**

One 2-way magnetically shielded satellite speaker with high-output 2.5" (63.5mm) woofer and precision .5" (12.7mm) tweeter. Recommended power range: 10-100 Watts, Frequency Response (+/- 3dB): 150 Hz-20kHz, Speaker Sensitivity (2.83V/1m): 86dB, Impedance: Nominal 8 Ohms, Dimensions (Satellite Speaker): 5" (127mm) H x 3.5" (88mm) W x 3.5" (88mm) D Weight: 1.8lb/0.8kg per speaker.

DESCRIPTION	CAT NO.
5-Channel Surround-Sound Home Cinema Speaker System with 100 Watt Powered subwoofer and 5 Satellite Speakers - Black	AEH50-BL
5-Channel Surround-Sound Home Cinema Speaker System with 100 Watt Powered subwoofer and 5 Satellite Speakers - White	AEH50-WH
Optional AEH50 System matched satellite Speaker for 6.1 and 7.1 surround-sound operation – Black	AESS5-BL
Optional AEH50 System matched satellite Speaker for 6.1 and 7.1 surround-sound operation – White	AESS5-WH

**Rough-In Kit/Adapter Wallplate for JBL Satellite Speaker**

Decorative Satellite Speaker Adapter Wallplate. Dimensions: 4.5" (114mm) H x 2.75" (70mm) W x .25" (6mm) D Weight : 1 oz./0.3 kg

DESCRIPTION	CAT NO.
Rough-In Kit/Adapter Wallplate for JBL Satellite Speaker - White	AEPHK-WH
Rough-In Kit/Adapter Wallplate for JBL Satellite Speaker - Black	AEPHK-BL



HKAVR-XXX



HKDVD-038



HKDC-000



HKPOD-000



HKABV-000

### Audio/Video Entertainment Center Components and Accessories from Harman/Kardon™

There is no better way to assure the highest performance and value from a state-of-the-art Leviton/JBL than to power it with matched Harman/Kardon Entertainment Center. The Harman/Kardon components available as part of the Leviton/JBL program represent a summary of today's most advanced analog and digital audio and video technologies—and ensure full compatibility with the home entertainment formats and platforms of the future.

#### Harman/Kardon Audio/Video Receivers

Harman/Kardon 7.1-channel digital audio/video receivers offer a wealth of listening and viewing options, including high-current amplifier design for accurate tracking of musical and audio/video source information, the latest HDMI audio/video input and switching, auto speaker calibration for surround sound perfection, multi-room audio, XM Satellite Radio and I-Pod capability, and much more, all in a elegant package.

DESCRIPTION	CAT NO.
7.1 Channel Surround Sound A/V Receiver, w/HDMI™ Switching and A-BUS®	HKAVR-XXX*
7.1 Channel Surround Sound A/V Receiver, w/HDMI™ Switching	HKAVR-XXX*

#### High-Performance Single-Disc DVD Player

Advanced video performance requires a maximum resolution source, because the best TV screen is only as good as what's fed into it. The Harman/Kardon progressive-scan DVD Player is equal to the task, with HDMI output, DCDi by Faroudja video processing, and up-scaling to 1080i high-definition playback.

DESCRIPTION	CAT NO.
High-Performance Single-Disc DVD Player with HDMI Output and 1080i Upscaling	HKDVD-038*

#### High-Definition 5-Disc CD Carousel Changer

The Harman/Kardon Changer compliments your multi-room audio system by delivering hours of music with a wide range of programming options to customize the mix – and advanced digital signal processors and digital output capability to ensure that every musical note is delivered free from distortion.

DESCRIPTION	CAT NO.
High-Definition 5-Disc CD Carousel Changer	HKDC-000*

#### The Bridge™ iPod Docking Station

The Bridge docking station allows your favorite iPod tracks and playlists to be controlled and heard through an entire home entertainment system when used with a compatible Harman/Kardon A/V Receiver.

DESCRIPTION	CAT NO.
The Bridge™ iPod Docking Station	HKPOD-000*

#### Infrared Remote Sensor

The low-profile IR remote sensor can be placed conveniently to control audio and video components with a compatible receiver's remote control even when they are in a cabinet or entertainment center. All Harman/Kardon AV products can be connected together so that one IR Sensor can operate them all.

DESCRIPTION	CAT NO.
IR Remote Sensor	HKRMS-000*

#### Harman/Kardon™ A-BUS® System

Multi-room music is easy with these amplified volume controls and distribution hub. The hub simply plugs into the back of an A-BUS Ready® Harman/Kardon (or other brand) A/V Receiver, and sends a selected sound source to up to four rooms/zones where the amplified volume controls take over. The system is ideal for background and casual indoor audio entertaining applications.

#### Amplified In-Wall A-BUS Volume Control

A Decora up/down amplified rocker-style volume control for dedicated speakers in a single room/zone for use with any A-BUS Ready Harman/Kardon A/V Receiver. Also accepts control commands to A/V receiver or other compatible components via a built-in IR sensor.

DESCRIPTION	CAT NO.
Amplified In-Wall A-BUS® Volume Control	HKABV-000*

#### A-BUS® Hub 4-Zone System Expansion

When used with the A-BUS interface on compatible HKAVR A/V Receivers, it allows the A/V Receiver to operate up to four rooms/zones of distributed audio (with HKABV Volume Controls and connected speakers).

DESCRIPTION	CAT NO.
A-BUS® Hub 4-Zone System Expansion	HKABH-000*

\* See Leviton.com to confirm current Leviton part number. Check with your Leviton salesperson for product availability.



### Leviton Architectural Edition™ Multi-Room Audio Amplifiers

Leviton's AE6MA and AE6MC Architectural Edition Multi-Room Audio Amplifiers combine advanced audio engineering, high-current performance and tremendous value in a single low-profile chassis that delivers superior multi-channel amplification to meet the needs of the most demanding residential multi-zone systems. Combining "audiophile" sound quality with commercial reliability, these amplifiers are a no-compromise solution for large, high-output multi-room listening systems. The amplifiers are designed for long-term use with advanced circuit protection and a thermostatically-controlled cooling fan. The AE6MA is a perfect balance of performance and simplicity, with input source flexibility through a unique "electronic channel link" feature that enables different single sources to be assigned to different rooms/zones. The AE6MC is the ultimate in listening flexibility, with advanced LCD keypads that enable the selection of up to seven different audio sources in any room with full independent control.



AE6MA



AE6MA-back

#### Single-Source 12 Channel (6 Stereo Pairs) Six-Room/Zone Multi-Channel Power Amplifier

Output power: 50 Watts nominal (40 watts per channel 20Hz to 20kHz @ <0.2% THD, all channels driven into 8 ohms); Peak output power: 100 watts per channel; Inputs: Gold-plated RCA jacks with adjustable input gain; Outputs: 5-way gold-plated binding posts; Total Harmonic Distortion (THD): Less than 0.1% 20 Hz to 20 kHz; Signal-to-noise ratio: Over 105 dB; Fan noise: Quiet 28 dB; Dimensions: 3.5 in (89mm) H x 17 in (432mm) W x 11.5 in (292mm) D

DESCRIPTION	CAT NO.
12 Channel (6 Stereo Pairs) Power Amplifier	AE6MA



AE6MC



AE6MC-back

#### Seven-Source 12 Channel (6 Stereo Pairs) Six-Room/Zone Multi-Channel Power Controller/Amplifier

Output power: 50 Watts nominal (40 watts per channel 20Hz to 20kHz @ <0.2% THD, all channels driven into 8 ohms); Peak output power: 100 watts per channel; Inputs: 14 gold-plated RCA jacks with adjustable input gain and a fully buffered RCA jack output for each; Outputs: Removable screw terminal, accepts 12-20 gauge wire; Total Harmonic Distortion (THD): Less than 0.1% 20 Hz to 20 kHz; Signal-to-noise ratio: Over 105 dB; Fan noise: Quiet 26 dB; Dimensions: 3.5 in (89mm) H x 17 in (432mm) W x 11.5 in (292mm) D

DESCRIPTION	CAT NO.
Seven-Source, Six-Room Multi-Channel Controller-Amplifier	AE6MC
Keypad Controller for AE6MC	AE6MC-PAD
Remote Control for AE6MC	AE6MC-RMT



AE6MC-PAD

#### SPECIFICATIONS AND FEATURES

##### Single-Source 12 Channel (6 Stereo Pairs) Six-Room/Zone Multi-Channel Power Amplifier

- Automatic protection circuitry
- Individual input gain adjustment
- External power ON/OFF through external controllers
- Channel Link allows channels to have individual sources or share a common source
- Cooling fan prevents overheating and maximizes energy efficiency

##### Single-Source 12 Channel (6 Stereo Pairs) Six-Room/Zone Multi-Channel Power Amplifier

- Seven source input selection for each amplifier

- RS-232 port for use with whole-house and PC-based compatible control systems
- Six internal 80+ position stereo volume controls
- High efficiency/small space.
- Automatic protection circuitry
- Individual bass, treble and balance adjustment of speakers in each room
- External power ON/OFF through external controllers
- All-zone control through use of AE6MC keypad
- Cooling fan prevents overheating and maximizes energy efficiency



An entertainment system is like a chain – it can only be as strong as its weakest link. The Leviton Architectural Edition series of products was developed to make sure that every link in the system—volume controls, distribution and connection components, even multi-room amplifiers—have no weak points and are as “state-of-the-art” in performance as the systems’ speakers. The Leviton Architectural Edition is a complete solution for entertainment system designers and installers. Leviton’s award-winning System Matching module and Strauss™ Transformer-Free volume controls use advanced aerospace technology to deliver ruler-flat frequency response to every zone of a multi-room audio system. The Architectural Edition multi-room audio amplifiers combine advanced audio engineering, high-current performance and tremendous value in a single low-profile chassis that delivers superior multi-channel amplification to meet the needs of the most demanding residential multi-zone systems. The advanced circuit engineering inside Leviton’s home theater and multi-room wallplates means that audiophile-grade connectivity can be easy and quick to install.

## Composer Series Volume Controls

Leviton’s Composer Series controls are built to a single quality standard, which means system designers can specify them for any distributed sound application with total confidence. (Leviton’s Strauss and Chopin Digital Volume controls use the same heat-dissipation technology used on the space shuttle and resistive switching to achieve ruler-flat frequency response.) On the Brahms rotary controls, tapped auto-transformer design provides a stable interface between high-current amplification and speakers of virtually any type while resisting contamination from dust and dirt. All audio power ratings are UL referenced. All volume controls feature screw connectors for long-term connection integrity.

## Decora® Strauss™ Transformer-Free™ and Impedance Matching Transformer-Free™ Volume Controls

In multi-room distributed audio systems, the source of undesirable speaker coloration (usually perceived as a “muffled” sound) is often the volume control itself, because the audio transformers (AKA: autoformers) used in conventional controls can actually filter the bass and treble frequencies. The Decora Strauss Transformer-Free Volume Controls use audio-grade Cermetile resistors to change volume levels while leaving the audio signal unaffected, resulting in ruler-flat frequency response across the entire audible frequency range. Moreover, Decora Strauss Transformer-Free Volume Controls eliminate the problem of “saturation” associated with conventional volume controls and can handle tremendous amounts of music power. Available in standard and impedance-matched versions.



SGVST-00W

### SPECIFICATIONS

Speaker Impedance:	2-16 Ohms (nominal 8 Ohms)
Power Handling:	200W peak/100W RMS
Frequency Response:	20Hz-20KkHz +/- 1dB
Dimensions:	4.06"(103.1) H x 1.32"(33.5) W x 2.5"(63.5) D
Mounting:	Standard single-gang design with a mounting depth of 2.5"
Wire Gauge:	Detachable cable connectors are compatible with all standard speaker wire sizes (14-18 gauge)
Color:	White (Optional color change kits available)

### Decora Strauss Transformer-Free Volume Control

DESCRIPTION	CAT NO.–WHITE
Decora Strauss Transformer-Free Impedance-Matched Volume Control	SGVSM-00W
Decora Strauss Transformer-Free Volume Control	SGVST-00W
Color change kit converts to Ivory and Almond	SGVCK-IA
Color change kit converts to Ebony	SGVCK-00E
Color change kit converts to Light Almond	SGVCK-OLA

### SPECIFICATIONS AND FEATURES

- Decora slide control with precision 12-position switch (including fully-OFF position)
- Transformer-Free™ volume controls deliver rich, full sound at any volume level in any room
- Aerospace-grade Cermetile resistors replace conventional autoformers to maintain audio signal purity
- Detachable cable connector is compatible with all standard speaker wire (14-18 gauge)



## Decora Digital™ Chopin™ Volume Control

Fill a room with high-quality audio at the touch of a button, replacing traditional transformers and rotary controls with this advanced interface module and one-touch Decora Chopin Rocker-Switch Wall Unit. Attractive Decora styling and transformer-less design delivers simplicity and superior sound-quality, and enables “three-way” volume control operation in larger rooms/zones. The Volume Control mounts in a standard wall box or low-voltage mounting bracket and connects via Category 5 cable to the Interface Module.

### SPECIFICATIONS

Peak RMS Power Rating:	200 Watts per channel
Continuous Power Rating:	100 Watts RMS per channel
Frequency Response, all rated power levels, +/-0.1 dB:	DC-50,000 Hz
Speaker Impedance:	4-16 Ohms nominal
Speaker/Amplifier Connection:	Removable, snap-in audio monoblock w/screw terminals
Power:	12 Volts DC, 200 mA

## Decora Digital Volume Control Systems

DESCRIPTION	CAT. NO.
Decora Digital Volume Control Kit (Includes Interface Module and Wall Unit with Power Supply)	48211-WVK
Decora Digital Volume Control Wall Unit	48211-WVC

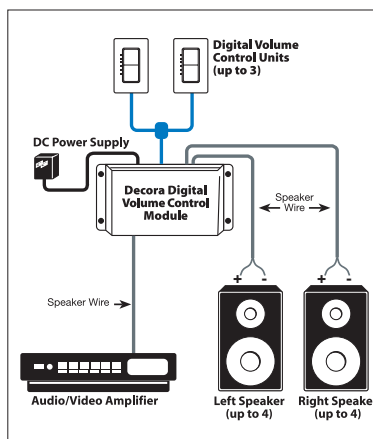

48211-WVK



48211-WVC

## Brahms Autoformer Volume Controls

On the Brahms series of rotary controls, tapped auto-transformer design provides a stable interface between high-current amplification and speakers of virtually any type while resisting contamination from dust and dirt.

### Brahms™ Stereo Volume Controls—75 Watt Audio

The 75 Watt Brahms series (25 Watts RMS) of volume controls is designed for low to moderate power installations in the home. The units accommodate 4, 8 or 16 Ohm speakers and amplifiers up to 75 Watts. All controls are impedance matching.

Attenuation: -34 dB in 12 steps. Attenuator Type: Tapped auto transformer. Power Rating: UL Listed @ 75 Watts audio, 25 Watts RMS continuous. Frequency Response: 35 Hz–20 kHz. Screw type connections, 12 position rotary switch.

### Decora® Brahms™ Stereo Volume Controls—75 Watt Audio

Control stereo volume from convenient wall-mounted location.

DESCRIPTION	CAT NO.—WHITE
Decora Brahms Stereo Volume Control, 75 Watt, 25 Watt RMS with insert, knob and plate. Boxed unit pack, rack pack carton	40841-ODW



40841-ODW

### SPECIFICATIONS AND FEATURES

#### Decora Digital Chopin Volume Control

- Connects to Interface Module with a single RJ-45 connection. No direct speaker/amplifier connections required at the controller.
- Microprocessor-controlled relays for silent switching.
- Provides impedance matching with speakers from 4–16 Ohms.
- Terminates all amplifier and speaker connections using high-quality audio connection block.
- Digital, transformer-free design uses aerospace-quality ceramic resistors for proper heat dissipation and superior performance.
- Each audio zone requires one Digital Volume Control module.
- Each Digital Volume Control module can support up to three volume control units.
- Each Digital Volume Control module can control up to 4 pairs of speakers.
- Tap mute feature activated when center of rocker panel is pressed.



## OTHER HOME ENTERTAINMENT PRODUCTS



40905-25W

### Decora® Brahms™ Stereo Volume Control with ON/OFF Switch—75 Watt Audio

Control of ON/OFF, as well as volume control.

DESCRIPTION	CAT NO.—WHITE
Decora Brahms Stereo Volume Control, 75 Watt, 25 Watt RMS with insert, knob and plate. Boxed unit pack, rack pack carton	40905-25W

### Decora® Brahms™ Stereo Volume Controls—216 Watt Audio

The 216 Watt Audio (72 Watt RMS) Strauss volume control series is designed for higher power installations in the home. Their heavy-duty autoformer construction is designed to resist saturation and degradation even after years of high-volume use. The units accommodate 4, 8 or 16 Ohm speakers and amplifier systems rated up to 216 Watts. All controls are impedance matching.

Attenuation: -34 dB in 12 steps. Attenuator Type: Tapped auto transformer. Power Rating: UL Listed @ 216 Watts Audio, 72 Watts RMS continuous. Frequency Response: 35 Hz–20 kHz. Screw type connectors, 12 position rotary switch.

### Decora® Brahms™ Stereo Control with ON/OFF Switch—216 Watt Audio

Convenience of ON/OFF, as well as volume control.

DESCRIPTION	CAT NO.—WHITE
Decora Brahms Stereo Volume Control, 216 Watt, 72 Watt RMS with two-gang plate. Boxed unit pack, rack pack carton	40888-72W



40888-72W



## Leviton Architectural Edition System Matching Module with AutoSurge™ Technology

The System Matching Module is used to match the impedance of all speakers and volume controls automatically at a central wiring point. It allows connecting up to six rooms of speakers to a stereo amplifier, and is a cost-effective way to design a passive, impedance-matched multi-room music system.

**NOTE: Do not use the System Matching Module with impedance-matched volume controls.**

### SPECIFICATIONS

<b>Dimensions:</b>	2.57"(68.6) H x 6.38"(161.9) W x 5.38"(136.5) D
<b>Mounting Location:</b>	Mounts in Leviton Structured Media™ Centers
<b>Power Handling:</b>	150W RMS per channel/225W peak
<b>Frequency Response:</b>	10Hz-40kHz, +/- .5dB
<b>Wire Gauge:</b>	Detachable cable connectors are compatible with all standard speaker wire sizes (18-14 AWG)



SGAMP-000

### System Matching Module

DESCRIPTION	CAT NO.-WHITE
System Matching Module with AutoSurge Technology	SGAMP-000

### 1x6 Passive Audio Module

Easy, centralized audio system distribution module connects up to six pairs of speakers from an entertainment center or amplifier. Note: To ensure a correct impedance match with an amplifier, only use the passive audio module with impedance-matched volume controls.

### SPECIFICATIONS

<b>Dimensions:</b>	6.58"H x 2.89"W x 1.42"D
<b>Wire Gauge:</b>	18-14 AWG
<b>Requirements:</b>	Product should be used with impedance-matched volume controls



48211-06A

### 1x6 Passive Audio Module

DESCRIPTION	CAT. NO.
1x6 Passive Audio Module	48211-06A

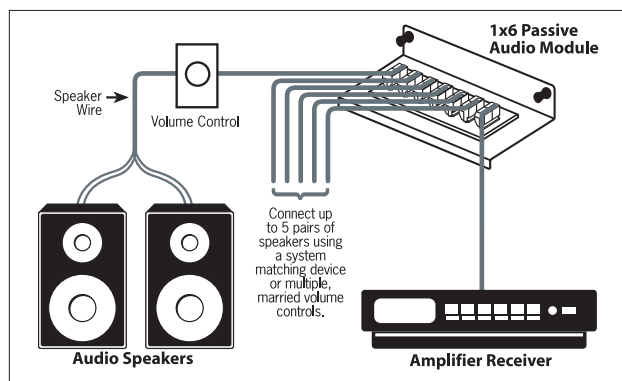

### SPECIFICATIONS AND FEATURES

#### System Matching Module

- Connects up to six rooms/zones
- Convenient single-point connection for all speakers
- Combine with Decora® Strauss™ Transformer-Free-Volume™ Controls or equivalent to control up to six locations of speakers from one amplifier or receiver\*
- User-removable connectors facilitate installation
- Transformer-Free impedance-matching design ensures linear frequency response, signal integrity and high power handling capacity

#### 1x6 Passive Audio Module

- Supports up to six pairs of speakers.
- Parallel connection scheme insures the best sound quality.
- User-removable connectors facilitate installation.
- Connects with standard fire-rated speaker wire.



## Home Theater and Multi-Room Integrated Wallplates

Both integrated wallplates combine the convenience of a ready-made plate with pre-configured wiring terminations with the performance and connection quality of "audiophile-grade" connectors. These plates are complete and ready-to-use, and make a "custom quality" statement in any installed entertainment system.

### Home Theater Interface Wallplate

Connector Type (Front of module): 14 audiophile-grade, gold-plated black and red spring clips, 2 RCA connectors, 2 QuickPort openings; Connector Type (Back of module): 8-pin and 6-pin in-line pluggable screw terminals; Wallplate: High quality impact-resistant white plastic, standard 3-gang with matching painted screws; Mounting Depth: 2.5" (64mm); Wiring: 14-16 gauge speaker wire



AEHTK-000

DESCRIPTION	CAT NO.
Home Theater Interface Wallplate	AEHTK-000

### Multi-Room Stereo Speaker Wallplate

Connector Type (Front of module): 4 audiophile-grade, gold-plated black and red spring clips, 2 QuickPort openings; Connector Type (Back of module): Two 2-pin in-line pluggable screw terminals; Wallplate: High quality impact-resistant white plastic, standard single-gang with matching painted screws; Mounting Depth: 2.5" (64mm); Wiring: 14-16 gauge speaker wire



AEMRK-000

DESCRIPTION	CAT NO.
Multi-Room Stereo Speaker Wallplate	AEMRK-000

## Specialized Audio/Video Wallplates

These high-value plates are quick to install and intuitive to use when connecting a multi-room entertainment system.

### Single Spring Clip Wallplate

Equipped with spade terminals. Mounted on break resistant polymer wallplate.



40951-1PW

DESCRIPTION	CAT NO.-WHITE	CAT NO.-IVORY
Single Spring Clip Wallplate. Carded unit pack, rack pack carton	40951-1PW	40951-1PI

### Double Spring Clip Wallplate

Equipped with spade terminals. Mounted on break resistant polymer wallplate.



40952-2PW

DESCRIPTION	CAT NO.-WHITE	CAT NO.-IVORY
Double Spring Clip Wallplate. Carded unit pack, rack pack carton	40952-2PW	40952-2PI

### SPECIFICATIONS AND FEATURES

#### Home Theater Interface Wallplate

- Accommodates from 5.1 to 7.1 channel surround-sound systems
- For use with low voltage rings and standard low voltage junction boxes
- Features RCA connectors for connecting subwoofers
- Two extra openings for additional QuickPort connectors

#### Multi-Room Stereo Speaker Wallplate

- Integrated wallplate for connecting left and right audio speakers (+/- connections)
- For use with low voltage rings and standard low voltage junction boxes
- Two extra openings for additional QuickPort connectors





SGC65-00W



SGI65-00W



SG180-00W



SGO99-00W

## Spec Grade Sound™ Indoor and Outdoor Speakers

Leviton's award-winning\* Spec-Grade Sound™ indoor and outdoor speaker line takes installed home audio to a new level in both technical innovation and value. Leviton's Spec-Grade Sound™ indoor and outdoor speakers can be used with Leviton's innovative, exclusive Decora® Strauss™ Transformer-Free™ Volume Controls and Leviton's System Matching Module and other audio distribution products to form complete systems. All of Leviton Spec Grade Sound™ indoor speakers incorporate exceptionally strong, light and rigid AeroNylon tweeters and Kevlar®-composite woofers for exceptional clarity, detail and impact. They come with built-in AutoSurge protection to help protect the speakers from possible damage due to overdriving. The outdoor/utility speaker is constructed of weather resistant materials inside and out.

\*Electronic House Magazine "Product of the Year"

Kevlar is a registered trademark of E.I. du Pont de Nemours and company

### 6.5-inch Two-Way In-Ceiling Loudspeaker\*

Paintable grill and frame. 6.5-inch Composite Kevlar cone low-frequency transducer, .5-inch AeroNylon dome high-frequency transducer, 2-way balanced precision crossover network with AutoSurge circuit protection, Frequency Response: 50-20kHz +/- 3dB, Sensitivity: 87.0 dB SPL @ 1Watt/1 Meter, Power Handling: 120W peak/60W RMS, Impedance: Nominal 8 Ohms/Minimum 6 Ohms, Dimensions: Diameter: 9.03 in (229.4mm); Depth: 4.06 in (103.1mm)

DESCRIPTION	CAT NO.-WHITE ONLY
6.5-inch Two-Way In-Ceiling Loudspeaker	SGC65-00W

### 6.5-inch Two-Way In-Wall Loudspeaker\*

Paintable grill and frame. 6.5-inch Composite Kevlar cone low-frequency transducer, .5-inch AeroNylon dome high-frequency transducer, 2-way balanced precision crossover network with AutoSurge circuit protection, Frequency Response: 50-20kHz +/- 3dB, Sensitivity: 88.0 dB SPL @ 1Watt/1 Meter, Power Handling: 120W peak/60W RMS, Impedance: Nominal 8 Ohms/Minimum 6 Ohms, Dimensions: 12.31 in (312.8mm) H x 9.02 in (229mm) W x 4.06 in (103mm) D

DESCRIPTION	CAT NO.-WHITE ONLY
6.5-inch Two-Way In-Wall Loudspeaker	SGI65-00W

### 8-inch Two-Way In-Wall Loudspeaker\*

Paintable grill and frame. 8-inch Composite Kevlar cone low-frequency transducer, 1-inch AeroNylon dome high-frequency transducer with phase/time alignment guide, 2-way balanced precision crossover network with AutoSurge circuit protection, Frequency Response: 44-20kHz +/- 3dB, Sensitivity: 86.5 dB SPL @ 1Watt/1 Meter, Power Handling: 160W peak/80W RMS, Impedance: Nominal 8 Ohms/Minimum 6 Ohms, Dimensions: 14.25 in (362mm) H x 10.24 in (260mm) W x 4.06 in (103mm) D

DESCRIPTION	CAT NO.-WHITE ONLY
8-Inch Two-Way In-Wall Loudspeaker	SG180-00W

\*Require separate back box for use in fire rated applications

### Outdoor/Utility Two-Way Loudspeaker

5.25-inch Silicate-fiber cone low-frequency transducer with butyl surround, .5-inch Polydome high-frequency transducer, 2-way balanced precision crossover network with AutoSurge circuit protection, Element-resistant polypropylene enclosure, gold-plated binding posts, and aluminum mounting, Frequency Response: 50-20kHz +/- 3dB, Sensitivity: 87 dB SPL @ 1Watt/1 Meter, Power Handling: 120W peak/60W RMS, Impedance: Nominal 8 Ohms/Minimum 6 Ohms, Dimension: 8.75 in (222.3mm) H x 6.33 in (161mm) W x 5.5 in (140mm) D (without bracket)

DESCRIPTION	CAT NO.-WHITE ONLY
Outdoor/Utility Two-Way Loudspeaker	SGO99-00W

### Spec Grade Sound Pre-Construction Brackets

The Spec Grade Sound Speaker rough in brackets are designed to save time during the rough-in and trim-out phases. The built-in wire management loops ensure that the wire is securely placed and easily located during speaker installation.

DESCRIPTION	CAT NO.-WHITE ONLY
Pre-Construction kit for 6.5" In-Ceiling Speaker	PCC55-KIT
Pre-Construction kit for 6.5" In-Wall Speaker	PCI65-KIT
Pre-Construction kit for 8" In-Wall Speaker	PCI80-KIT

### Spec Grade Sound Speaker Grills

DESCRIPTION	CAT NO.-WHITE ONLY
Speaker Grill for Speaker SGC65	SGC65-GRL
Speaker Grill for Speaker SGI65	SGI65-GRL
Speaker Grill for Speaker SG180	SG180-GRL



## OTHER HOME ENTERTAINMENT PRODUCTS



### Decora Media™ System

Send analog audio and video signals through up to 1,000 feet (300 meters) of Category-5 cable with no discernible distortion. The Decora Media System is ideal for connecting source components back to a multi-room audio amplifier located elsewhere in a system. DMS is comprised of: a Send Unit for transmitting audio/video signals, a Receive Unit for receiving signals and a Media Hub. The DMS can operate several ways: in a "hub" configuration with one Send unit sending a single audio/video signal to up to six Receiver units, and point-to-point where Send and Receive units are linked directly together to replace expensive specialized cables or baluns with simple Category-5 cabling..

Send and receive units run on 12VDC, hub runs on 15VDC and can be powered independently or through the Media Hub.

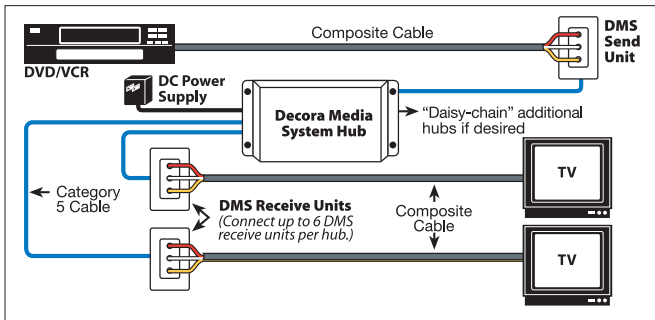

SPECIFICATIONS	SEND UNIT	RECEIVE UNIT	MEDIA HUB
Dimensions:	4.1"H x 1.4"W x 2.0"D	4.1"H x 1.4"W x 2.0"D	6.5"H x 3.4"W x 1.75"D
Video Bandwidth:	50 M Hz @ -3 dB	50 M Hz @ -3 dB	50 M Hz @ -3 dB
Video THD:	75 dBc	-75 dBc	-75 dBc
Video Input:	—	0.5V to 2V composite	0.5V to 2V composite
Video Output:	0.5V to 2V composite	—	—
Slew Rate:	800V/us	800V/us	800V/us
Audio Input Impedance:	—	20k Ohms, max 3Vp-p	20k Ohms, max 3Vp-p
Audio Output Impedance:	51 Ohms, max 2Vp-p	—	—
Audio Freq. Response:	5 Hz-100k Hz, ±3 dB	5 Hz-100k Hz, ±3 dB	5 Hz-100k Hz, ±3 dB
Audio THD:	0.002% 20 Hz-20k Hz	0.004% 20 Hz-20k Hz	0.002% 20 Hz-20k Hz
Audio S/N Ratio:	100 dB typical, 80 dB min 20 Hz-20k Hz	100 dB typical, 80 dB min 20 Hz-20k Hz	100 dB typical, 80 dB min 20 Hz-20k Hz
Input Noise:	4.5nV/( Hz), 1/2 typical @ 1k Hz	6nV/( Hz), 1/2 typical @ 1k Hz	4.5nV/( Hz), 1/2 typical @ 1k Hz
Input and Outputs:	3 RCA input jacks 1 set RJ-45 in/out jacks 1 110 punchdown out 1 DC power input	3 RCA output jacks 1 set RJ-45 in/out jacks 1 110 punchdown out 1 DC power input	3 RCA input jacks 1 RJ-45 input jack 6 RJ-45 output jacks 1 DC power input
Power:	12VDC	12VDC	15VDC

### Decora Media System

DESCRIPTION	CAT. NO.
Decora Media System Media Hub with Power Supply	48210-MCH
Decora Media System Send and Receive Unit Pair with Power Supply	48210-SRU
Decora Media System Send Unit with Power Supply	48210-MSU
Decora Media System Receive Unit	48210-MRU

#### SPECIFICATIONS AND FEATURES

- Cascade hub units to distribute audio/video signals to over 20 locations.
- Send and Receive units are equipped with RJ-45 jacks and 110 punchdown blocks for maximum flexibility in installation.
- Composite RCA inputs for connectivity directly from A/V source.
- Send and Receive units fit standard wallboxes and Decora wallplates.
- Advanced circuitry with automatic equalization streams analog stereo audio and video signals over long distances with less distortion.
- Stereo audio input/output handles Dolby® ProLogic™ surround signals.
- RJ-45 input for Send unit.



### Multi-Room Infrared (IR) Repeater System

The IR Repeater System consists of three pieces: an IR Target, IR Emitter and a distribution block for distributing control signals to multiple emitters. The IR Target takes the signal from a remote control for an audio/video component and converts it to a low-voltage electrical signal, sending it back to a component to be controlled by the IR emitter. The flush-mount IR Target easily installs in a ceiling or wall, and connects with Category 5 cable to the IR Emitter. Multiple IR Emitters connect to controlled A/V components through the distribution block in the Structured Media Enclosure. Distribution block (Cat. No. 47689-B) available separately. Dimensions: 2"L x 1"W, Power: 12V DC @200mA, Target Output: 4 signal leads, Target Input: 2 power leads (DC + and -), Emitter Output: Infrared to control source component, Emitter Input: 2 signal leads, Power Supply (included): 12V DC @5mA

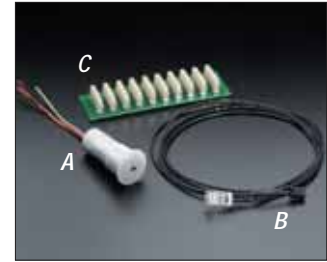

#### IR Repeater System

DESCRIPTION	CAT. NO.
A-Target	47621-CMS
B-Emitter	47621-MIE
C-1x9 Bridged Telephone Module for IR Repeater, w/o bracket. Individ. boxed unit pack, rack pack carton.	47603-110

### Recessed Entertainment Box

DESCRIPTION	CAT. NO.	COLOR*
REB Box with Low-Profile Frame	47617-REB	White
High-Profile Cover	47617-HPC	White
Low-Profile Frame	47617-LPF	White
Replacement Snap-In Plates (2/Bag)	47617-PLT	White
REB Box with High-Profile Cover	47617-RBH	White

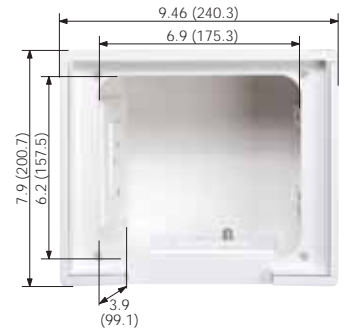

### Decora Recessed Receptacles

#### Duplex Recessed Receptacles 15A-125V AC, 2-Pole, 3-Wire, NEMA 5-15R UL®

DESCRIPTION	CAT. NO.	COLOR*	NEMA CONFIG.
Two-Gang Duplex Receptacle with Openings for 6 QuickPort Connectors (4 blank inserts included)†	690	I, W, T, E	5-15R
One-Gang Duplex Receptacle	689	I, W, T, E	

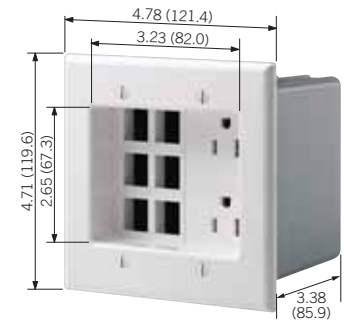

#### Single Recessed Receptacles

#### Side-Wired 15A-125V AC, 2-Pole, 3-Wire, NEMA 5-15R UL®

DESCRIPTION	CAT. NO.	COLOR*	NEMA CONFIG.
One-Gang Single Receptacle with Clock Hanger Hook	688	I, W	5-15R
One-Gang Single Receptacle with Clock Hanger Hook	5261-CH	Stainless Steel	

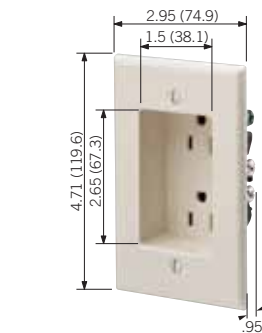

#### Side-Wired 20A-125V AC, 2-Pole, 3-Wire, NEMA 5-20R UL®

DESCRIPTION	CAT. NO.	COLOR*	NEMA CONFIG.
One-Gang Single Receptacle with Clock Hanger Hook	5361-CH	Stainless Steel	5-20R



† QuickPort Connectors not included.

#### SPECIFICATIONS AND FEATURES

##### Recessed Entertainment Box

- Provides single location for line and low-voltage connections
- Stud- and wall-mountable
- Neat, clean recessed installation
- Optional high-profile cover includes sliding plastic front panel and channels all wires through the bottom of the REB
- Paintable white ABS plastic

##### Recessed Two-Gang Duplex Receptacle with QuickPort Openings

- Provides 2 15A/125V AC NEMA 5-15R power outlets and openings for any 6 installer-selected QuickPort connectors or blank inserts (4 inserts included)
- Includes plastic electrical box and a barrier to separate line and low-voltage conductors
- Wallplate built into device

##### Recessed One-Gang Duplex Receptacle

- Installs invisibly behind wall units, signature artwork and wall-mounted flat-panel TVs
- Supplies AC power for two components

- Fits most common electrical boxes available (electrical box not included)

##### Recessed One-Gang Single Receptacles

- Includes clock-hanger hook
- Flush mount with square recess

#### TESTING AND CODE COMPLIANCE

##### Recessed Receptacles

- cULus Listed
- NOM Certified (#057)

##### All Recessed Devices

- Backed by a Limited Two-Year Warranty

#### \*COLOR

For color selection, add suffix to catalog number as follows: Ivory (-I), White (-W), Light Almond (-T) and Black (-E).

#### MATERIAL CHARACTERISTICS

Environmental: Flammability UL-94, V2 Rating  
Operating Temperature: -40° to 120°C

# HOW TO USE THIS CATALOG

The L-101 Leviton Wiring Device Catalog is designed to help you find the device you're seeking in the quickest and easiest way possible. Most product sections are divided into three distinct categories in the following sequence—Industrial Grade, Commercial Grade and Residential Grade—and grouped according to amperage and voltage, lowest to highest. For example, if you need to order 15 Amp, 125 Volt Industrial Grade straight-blade duplex receptacles, begin your search with the main Table of Contents at the front of the book. Here you'll see that all straight blade receptacles are listed in Section G. Turn to Section G for a more detailed Table of Contents on the first page. Each section page contains product descriptions, ratings and catalog numbers. There are also helpful highlights including Specifications and Features, Testing and Code Compliance, Color listing, Material Characteristics and dimensioned color product photos. Any product page in the L-101 Catalog can be clearly copied or faxed to customers and prospects for use as a specifier sheet or as part of a presentation.

The Quick Reference Guide follows the main Table of Contents to help you pinpoint and locate specific products. Technical Section V provides general product and test data, industry standards, NEMA configuration charts, a glossary of wiring device terms, ANSI architectural symbols and other related information. Specific catalog numbers are listed in the exhaustive index at the back of the catalog.

## 15 AMP 125 and 250V • 20 AMP 125 and 250V

### Industrial Grade Straight Blade Receptacles

**Back and Side Wired** (Basic Cat. No. Denotes Brown Device\*)

DESCRIPTION	CAT. NO./COLOR 15A/125V	CAT. NO./COLOR 15A/250V	CAT. NO./COLOR 20A/125V	CAT. NO./COLOR 20A/250V
LEVSPEC® Duplex Receptacle, Brass Strap	5262 I, W, GY, R, E	5662 I	5362 I, W, GY, R, E	5462 I, GY
Single Receptacle	5261 I, W, GY	5661 I	5361 I, W, A, T, GY	5461 I, A, T, GY
Narrow Body Duplex Receptacle	5252 I, W, A, T, GY, R, BU		5352 I, W, A, T, GY, R,	

**For complete wallplate selection, see Section E.**

80703-IG 80703-I 80704-GY 80716-R

84003-40 84004-40 84016-40

**SPECIFICATIONS AND FEATURES**

**Back & Side Wired Duplex**

- Impact-resistant thermoplastic nylon cover and body
- Smooth face does not collect dirt
- Four corner latches securely fasten face
- Single-piece brass mounting strap on LEVSPEC devices, multi-piece steel strap on other devices
- Large, triple-wipe, brass "T" contacts for superior contact and conductivity
- Back and side-wiring options
- Brass terminal screws to reduce conductor oxidation
- Break-off tabs for easy two-circuit conversion
- Apron barrier to prevent accidental contact between terminal screw heads and metal box
- Exclusive V-shaped, serrated back-wiring clamp for superior contact and conductivity

**TESTING AND CODE COMPLIANCE**

- UL Listed 498 (UL File #13399); UL Federal Specification WC-596

**\*COLOR**

Basic Cat. Nos. shown above denote Brown device, except for Isolated Ground (-IG) devices Basic Cat. No. denotes Orange. Isolated Ground Receptacle is distinguished by an orange triangle on its face. For other color selections, add suffix to the catalog number as follows: Ivory (-I), White (-W), Brown (For IG devices only, add -A), Almond (-A), Light Almond (-T), Gray (-G or -GY), Black (-E), Red (-R) and Blue (-BU); for IG devices only, add -BIG)

**MATERIAL CHARACTERISTICS**

Environmental: Flammability, Rated V2  
Operating Temperature: From -40° C (without impact) to 60°C maximum continuous

- |                                       |                                              |                                      |
|---------------------------------------|----------------------------------------------|--------------------------------------|
| <b>A</b> RATING                       | <b>E</b> CATALOG NUMBER                      | <b>I</b> SPECIFICATIONS & FEATURES   |
| <b>B</b> Choose GRADE, if appropriate | <b>F</b> DESCRIPTION                         | <b>J</b> TESTING AND CODE COMPLIANCE |
| <b>C</b> DIMENSIONED PHOTOGRAPH       | <b>G</b> Check for NEMA CONFIGURATION        | <b>K</b> COLOR LISTING               |
| <b>D</b> WIRING/CERTIFICATIONS        | <b>H</b> WALLPLATE REFERENCE, if appropriate | <b>L</b> MATERIAL CHARACTERISTICS    |