



Pocket Pro



IPEX

www.ipexelectrical.com

ELECTRICAL SYSTEMS

Scepter[®]
Rigid PVC Conduit & Fittings

SceptaCon[™]
Trenchless Raceways Systems

Sceptalight[™]
Nonmetallic Light Fixtures

KWIKON[®]
ELECTRICAL NONMETALLIC FITTINGS

KWIKPATH[®]
COMMUNICATION RACEWAY SYSTEMS

COR-LINE[®]
ELECTRICAL NONMETALLIC TUBING

MONOBLOC[®]

FIBERTEL[®]
HDPE Innerduct

SUPER DUCT[®]
Power & Communication Duct

| Type Designation | UL Underwriters Laboratories Inc. (UL 50 and UL 508) |
|------------------|--|
| 1 | Indoor use primarily to provide protection against contact with the enclosed equipment and against a limited amount of falling dirt. |
| 2 | Indoor use to provide a degree of protection against limited amounts of falling water and dirt. |
| 3 | Outdoor use to provide a degree of protection against windblown rain; undamaged by the formation of ice on the enclosure. |
| 4 | Either indoor or outdoor use to provide a degree of protection against falling rain, splashing water, and hose-directed water; undamaged by the formation of ice on the enclosure. |
| 4X | Either indoor or outdoor use to provide a degree of protection against falling rain, splashing water, and hose-directed water; undamaged by the formation of ice on the enclosure; resists corrosion. |
| 6P | Indoor or outdoor use primarily to provide a degree of protection against hose-directed water, the entry of water during prolonged submersion at a limited depth, and be undamaged by the formation of ice on the enclosure. |
| 12 | Indoor use to provide a degree of protection against dust, dirt, fiber flyings, dripping water, and external condensation of noncorrosive liquids. |
| 13 | Indoor use to provide a degree of protection and spraying of water, oil, and noncorrosive liquids. |

This material is reproduced with permission from Underwriters Laboratories Inc. Standard for Safety for Cabinets and Boxes, UL 50, Copyright 1988 and Industrial Control Equipment, UL 508, Copyright 1994 by Underwriters Laboratories Inc.

Underwriters Laboratories Inc. (UL) shall not be responsible to anyone for the use of or reliance upon a UL Standard by anyone. UL shall not incur any obligation or liability for damages, including consequential damages, arising out of or in connection with the use, interpretation of, or reliance upon a UL Standard.

Introduction2

Applications3

Advantages4

Scepter® Rigid PVC Conduit7

Installation8

Expansion and Contraction10

Conduit Dimensions15

Scepter® PVC Conduit Fittings17

Fittings18

Cover Plates33

Weatherproof Covers34

Boxes41

Conduit Cements & Primers42

Conduit Repair Kit43

EPR Kits43

EPR Kit Adapters43

Sceptalight™: Nonmetallic Light Fixtures45

Cor-Line® ENT & Kwikon® Fittings53

Cor-Line Tubing56

Dimensions56

Kwikon Fittings57

Kwikon Accessories61

Super Duct®63

Advantages/Engineering Data64

Installation65

Pipe70

Fittings71

Vertical-Lok Spacers76

Monobloc® Spacers77

SceptaCon™ Trenchless Raceway Systems ...79

Kwikpath® Communication Raceway Systems ..81

SCEPTER PVC CONDUIT

SCEPTER PVC FITTINGS

CONDUIT REPAIR KIT

SCEPTALIGHT

CORLINE ENT & KWIKON FITTINGS

SUPERDUCT

SCEPTACON

KWIKPATH





Pocket Pro provides the most comprehensive information about PVC systems – from basic raw material to installation characteristics of the finished product. Written with the engineer, contractor and distributor in mind, it is based on laboratory test results and IPEX's many years of field experience.

At IPEX, we have been extruding PVC conduit and molding fittings since 1951. We formulate our own compounds, maintain strict quality control during production, and offer one of the most comprehensive lines of nonmetallic electrical products throughout North America.

More important, our commitment to customers extends beyond the sale. Quality control and thorough jobsite field reports have earned IPEX a reputation for product quality and service excellence.

Engineers, electricians, contractors, specifiers and utilities have realized for many years the advantages of PVC. Today, IPEX electrical systems include Scepter® PVC conduit and fittings, Super Duct® power and communication ducts, Cor-Line® ENT, Kwikon® ENT fittings and FiberTel® high density polyethylene innerduct. These brands are the number-one choice for power, communication and data needs. Whether exposed, concealed in walls, encased in concrete, or directly buried, IPEX electrical products are preferred *For The Long Run*.

Only when you specify IPEX branded products by name are you guaranteed our commitment to excellence.

Applications

Typical industrial/commercial and residential applications for IPEX electrical systems include:

- Utilities
- Cable
- Communications
- Street and highway lighting
- Residential applications
- Water treatment plants
- Airports
- Subways
- Sewage treatment plants
- Pulp and paper industries
- Parking garages
- Car washes
- Fish plants
- Marinas
- Agricultural, dairy, hogs, cattle, chicken, etc.
- Bridges and tunnels
- Food processing plants
- Steel mills
- Mines



Labour Savings

Compared to metal, PVC products reduce labour on a typical installation by up to two-thirds. The reason? PVC is easy to work with. It can also be cut and joined without pipe vises, cutters, threading equipment and reamers associated with metal conduit.

Lightweight Conduit

Scepter Rigid PVC Conduit is one-half the weight of aluminum and one-sixth the weight of steel. As a result, handling and installation are easier and faster, reducing labour costs.

Sunlight Resistant

The 2006 Canadian Electrical Code rule 2-130 is intended to ensure that totally enclosed nonmetallic raceways are properly protected against adverse effects from direct exposure to UV rays. Electrical nonmetallic raceways marked for such applications are suitable for installation and use in direct exposure to the rays of the sun. Scepter rigid PVC Conduit meets the criteria for sunlight resistance, is approved for the purpose, and is appropriately marked.

Easy Joining

Solvent cementing is all that is required, eliminating the need for power-threading machines, pipe vises and cutting equipment. A hacksaw or carpenter's saw is the only equipment required.

Strength

Scepter Rigid PVC Conduit offers both high impact and high tensile strength, even in cold temperatures. Scepter Rigid PVC Conduit and fittings meet and exceed all CSA and UL standards.

| Scepter Rigid PVC Conduit | | CSA Impact Test | | UL Impact Test | |
|---------------------------|-----------|-----------------|-------------|----------------|--------------|
| Size (in) | Size (mm) | @ -29°F (-34°C) | | @ 72°F (23°C) | |
| 1/2 | 12 | 8.9 ft.lbs. | (12 joules) | 50 ft.lbs. | (68 joules) |
| 3/4 | 20 | 8.9 ft.lbs. | (12 joules) | 80 ft.lbs. | (109 joules) |
| 1 | 25 | 8.9 ft.lbs. | (12 joules) | 100 ft.lbs. | (136 joules) |
| 1 1/4 | 32 | 8.9 ft.lbs. | (12 joules) | 120 ft.lbs. | (163 joules) |
| 1 1/2 | 40 | 8.9 ft.lbs. | (12 joules) | 150 ft.lbs. | (204 joules) |
| 2 | 50 | 8.9 ft.lbs. | (12 joules) | 190 ft.lbs. | (258 joules) |
| 2 1/2 | 65 | 8.9 ft.lbs. | (12 joules) | 210 ft.lbs. | (285 joules) |
| 3 – 6 | 75 – 150 | 8.9 ft.lbs. | (12 joules) | 220 ft.lbs. | (298 joules) |

Easy Wire Pulls

PVC's exceptionally smooth interior surface greatly reduces the amount of friction while pulling conductors/wires through long runs, even with 90° bends. A large pull-rope and wire-pulling compound should be used when pulling all conductors and wires.

Noncorroding

PVC is immune to damage from naturally corrosive soil conditions, as well as electrochemical and galvanic corrosion. This ensures lower maintenance costs and superior performance *For The Long Run*.

Nonconducting

Scepter Rigid PVC conduit pipe and fittings are nonsparking and nonconducting, thereby eliminating the most dangerous 'second point of contact' and 'phase to ground' faults. The use of a separate grounding conductor provides a complete and positive ground for the whole system.

Chemical Resistance

One of the greatest benefits of PVC is its excellent chemical resistance. It resists attack by acids, alkalies, salt solutions, and many other types of chemicals. For more information on PVC and chemical resistance, refer to the IPEX Chemical Resistance Guide.

Long Life

Scepter Rigid PVC Conduit pipe and fittings retain their original properties after years of exposure to heat and weather. In addition, resistance to fungi, bacterial action, rodents, termites and corrosive agents ensures a long, trouble-free life for PVC conduit installed indoors or outdoors.

Concrete Tight

Scepter Rigid PVC Conduit pipe and fittings are designed and engineered to be concrete tight in all weather conditions.



Fire Resistant

IPEX's proprietary PVC compound used to manufacture Scepter products is a self-extinguishing material and will not support combustion. Samples taken from an actual fire show the outer surface of the conduit was blistered and charred. The interior of the conduit, however, was unaffected. Additionally, the undamaged conductors were then removed and reinstalled in new conduit.

Fire-resistant characteristics when tested to CAN ULC S102.2 are as follows:

| IPEX Compound | Flame Spread | Smoke Developed | Fuel Contribution |
|-------------------------|--------------|-----------------|-------------------|
| 0.080" (2mm) thickness | 10 – 20 | 225 – 270 | 0 |
| 0.630" (16mm) thickness | 10 – 20 | 300 – 390 | 0 |



FT-4 Rating

Scepter Rigid PVC conduit is certified to meet the requirements of FT-4 allowing its use in noncombustible construction per Section 3.1.5.20 of the National Building Code, which reads:

1.) *Subject to the limits on the size of elements that penetrate fire separations as stated in Sentence 3.1.9.3.(2), within a fire compartment of a building required to be of noncombustible construction, totally enclosed nonmetallic raceways not more than 175mm in outside diameter, or of an equivalent rectangular area, are permitted to be used to enclose optical fibre cables and electrical wires and cables, provided the raceways exhibit a vertical char not more than 1.5m when tested in conformance with the Vertical Flame Test (FT - 4) Conduit or Tubing on Cable Tray in Clause 6.16 of CSA C22.2 No. 211.0, "General Requirements and Methods of Testing for Nonmetallic conduit."*

Suitable for Direct Burial

PVC is suitable for direct burial and requires no extra protection when installed in accordance with the Canadian Electrical Code and the local inspection authority guidelines. The usual care regarding trenches and backfilling should be respected.

One-Source Specification

IPEX offers a full range of PVC fittings and accessories. As a result, it is easy to specify a single source PVC system.

Quality Control

In addition to IPEX's quality control testing, all Scepter electrical products carry third-party certification by CSA, UL and NRTL.



This section covers the most comprehensive design and installation of Scepter Rigid PVC Conduit pipe and fittings. Always consult the authority having jurisdiction for specific installation procedures.



CSA C22.2 No. 211.2
CSA C22.2 No. 211.0
FT-4 for 1/2" to 6"



NEMA TC-2
Corps. of Engineers Spec.
CE 303:01
Military Spec, Federal Spec.
WC 1094A



Support

Due to PVC's light weight, support spacing is different than that used with metal conduits. Supporting straps should NOT be firmly tightened, so that linear movement of the pipe is possible. The maximum allowable support spacing, as per Canadian Electrical Code (CEC), is as follows:

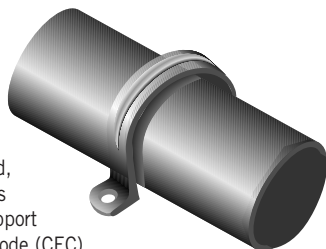

Support Spacing For Scepter Rigid PVC Conduit Pipe

| Nominal Conduit Diameter | | Maximum Support Spacing | |
|--------------------------|-----|-------------------------|--------|
| inches | mm | feet | metres |
| 1/2 | 12 | 2-1/2 | 0.75 |
| 3/4 | 20 | 2-1/2 | 0.75 |
| 1 | 25 | 2-1/2 | 0.75 |
| 1-1/4 | 32 | 4 | 1.2 |
| 1-1/2 | 40 | 4 | 1.2 |
| 2 | 50 | 5 | 1.5 |
| 2-1/2 | 65 | 6 | 1.8 |
| 3 | 75 | 6 | 1.8 |
| 3-1/2 | 90 | 7 | 2.1 |
| 4 | 100 | 7 | 2.1 |
| 5 | 125 | 7 | 2.1 |
| 6 | 150 | 8 | 2.5 |

Maximum Operating Temperature

The Canadian Electrical Code (CEC) allows the use of Scepter Rigid PVC Conduit up to a maximum ambient temperature of 167°F (75°C).

Cutting

Scepter Rigid PVC conduit can be easily cut on the jobsite by using a hacksaw, carpenter's saw or PVC conduit cutters. For larger sizes of conduit, the use of a mitre box is also recommended to ensure a square cut.



Solvent Cementing

After cutting Scepter Rigid PVC conduit, sharp edges or burrs from inside the conduit should be removed with a knife. Thoroughly clean the end of the pipe and inside the fitting with a pipe cleaner. Apply a generous amount of IPEX solvent cement to both surfaces; slide together and give a quarter turn to ensure the solvent is spread evenly on the material. Hold together for a few seconds until the joint is made.

Usually the solvent-cemented joint will be strong enough to install immediately. However, in climates with low temperatures or areas with high humidity, extra time may be required before moving the pipe for permanent installation. Solvent-cemented joints appear to "set up" instantly, but will take 24 hours to cure properly. After this time, the solvent-cemented joint has completely cured and is waterproof. For extreme cold weather installations, the use of IPEX PVC Primer is recommended. IPEX cements and primers are available in quarter-pint (125ml), half-pint (250ml), pint (500ml), quart (1-litre) and gallon (4-litre) containers.

Bending

PVC is a thermoplastic material that, when heated, becomes soft and pliable. As a result, its shape can be altered.

A flameless heat source is recommended to heat the pipe. AN OPEN FLAME SHOULD NOT BE USED. Either an electric unit or an infra-red propane unit is recommended.

The necessary temperature for bending pipe is 260°F (127°C). The pipe must be heated evenly over an area approximately ten times the diameter of the pipe before any attempt at bending is made. Bending the pipe when it has not been thoroughly heated will cause the pipe to "kink." With proper care and a little practice, the bend will form easily.

Cooling the pipe with cold air or water will cause "spring back." Allow a few extra degrees of overbending to compensate. Maximum bending radius shall be six times the internal diameter according to the Canadian Electrical Code.



Using Expansion Joints

It's just as important to know when to use an expansion joint as it is to know how to install it correctly. Expansion joints are required when the temperature change is greater than 25°F (14°C). Scepter Rigid PVC conduit has a coefficient of linear expansion of 3.6×10^{-4} in./ft./°F (.054mm/m/°C.) Generally, a 100 ft. (30.48m) run of PVC conduit will undergo a change in length of 3.6 inches (91.44mm) for every 100°F (56°C) temperature change.

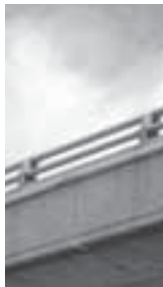

For conduit installed indoors, the range of expansion and contraction can be calculated using the maximum air temperature plus the heat contributed by the conductors inside the conduit and minimum air temperature expected. Expansion joints are not required indoors unless there are widely varying temperatures such as the attic of a building.

Conduit installed outdoors, exposed to direct sunlight, will be considerably hotter than the air temperature. As a guideline in this case, add 27°F (15°C) to the temperature change. Expansion joints should be installed to allow for all anticipated temperature changes.

Expansion Formula

By using the following formulas and the charts below, the total expected expansion in a run can be easily determined:

°F

Total Expansion (in.)
= length of run (ft.)
x temperature change
(°F) x 0.00036

or

°C

Total Expansion (mm)
= length of run (m)
x temperature change
(°C) x 0.054

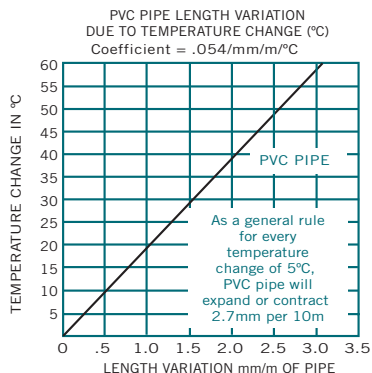
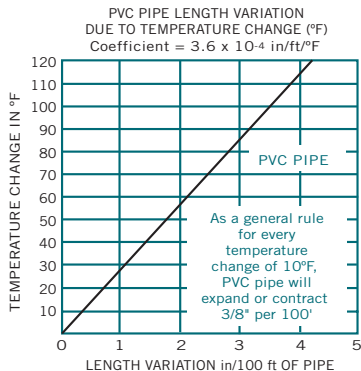

Number of Expansion Joints Required

Use the following equation to determine the number of expansion joints needed for a Scepter Rigid PVC Conduit installation:

$$\text{Number of joints} = \frac{\text{total expansion (mm or in)}}{E}$$

E = Expansion joint travel length 101.6mm (4") or 203.2mm (8") depending on diameter.

Always round up to the next whole number.

Setting the Piston Opening

The expansion joint must be installed to allow for expansion and contraction of the conduit run. On a cold day, if an expansion joint is installed completely closed with the piston bottomed, there is no room for expansion when the conduit is warmed. If it is installed open to the maximum on a hot day, the expansion joint will pull apart when cooled.

The correct piston opening for any installation condition can be easily determined using the formula below:

Piston setting =

$$\text{Compressed length} + \left(\frac{\text{max. temp.} - \text{installation temp.}}{\text{max. temp.} - \text{min. temp.}} \right) \times E$$

Formula can be used for both metric and imperial measurements.

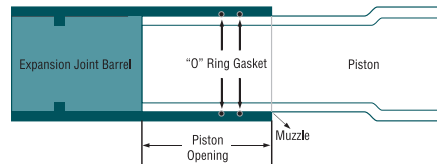

| Size (mm) | Size (in) | Compressed Length (mm) | Compressed Length (in) | Travel (mm) | Travel (in) |
|-----------|-----------|------------------------|------------------------|-------------|-------------|
| 13 | 1/2 | 203.2 | 8.00 | 101.6 | 4 |
| 20 | 3/4 | 203.2 | 8.00 | 101.6 | 4 |
| 25 | 1 | 215.9 | 8.50 | 101.6 | 4 |
| 32 | 1-1/4 | 228.6 | 9.00 | 101.6 | 4 |
| 38 | 1-1/2 | 228.6 | 9.00 | 101.6 | 4 |
| 51 | 2 | 235.0 | 9.25 | 101.6 | 4 |
| 64 | 2-1/2 | 235.0 | 9.25 | 101.6 | 4 |
| 76 | 3 | 362.0 | 14.25 | 203.2 | 8 |
| 89 | 3-1/2 | 362.0 | 14.25 | 203.2 | 8 |
| 102 | 4 | 362.0 | 14.25 | 203.2 | 8 |
| 127 | 5 | 362.0 | 14.25 | 203.2 | 8 |
| 152 | 6 | 362.0 | 14.25 | 203.2 | 8 |



Location of Expansion Joints

Proper functioning of an expansion joint depends on three procedures:

1. The correct placement of the expansion joint.
2. The proper installation of Scepter Rigid PVC conduit and the expansion joint.
3. The proper placement and fastening of support straps.

One Expansion Joint

Figure 1

If only one expansion joint is needed between two boxes, the barrel of the joint is rigidly fastened close to the first box. Scepter Rigid PVC conduit should then be loosely supported with straps, allowing the conduit to move freely as it expands and contracts.

Two Expansion Joints

Figure 2

If two expansion joints are needed, the joints should be firmly fastened back to back at the centre of the run. Scepter Rigid PVC conduit is loosely supported with straps, allowing the conduit to move freely as it expands and contracts.

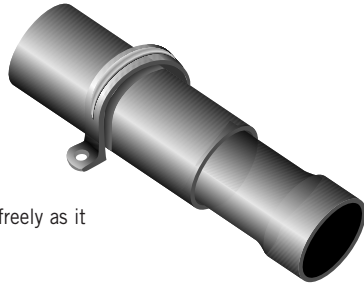

Two Expansion Joints (Alternative)

Figure 3

Alternatively, the centre of the run and the two expansion joints (located at the boxes) should be rigidly fastened. All other support straps should be loosely fastened.

Three or More Expansion Joints

Figure 4

If more than two joints are needed in a very long run, they should be put in a series, one after the other. Each barrel must be rigidly fastened while conduit is loosely supported with straps allowing the conduit to move freely as it expands and contracts. When installed in a series, each section acts independently of the other. Spacing of conduit supports must be in accordance with Section 12-1114 of the Canadian Electrical Code (CEC).

Figure 1

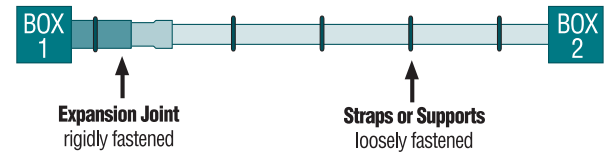

Figure 2

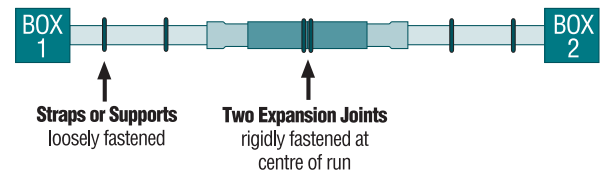

Figure 3

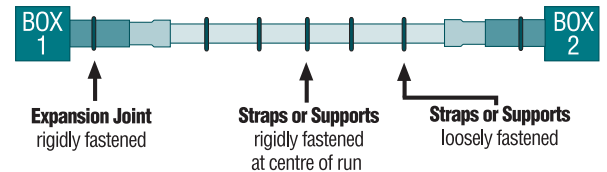
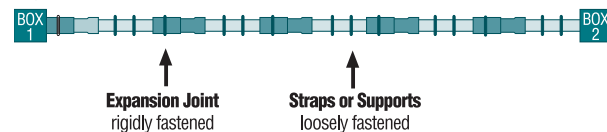

Figure 4



Installation of Expansion Joints

Installation recommendations:

- Expansion joints should be mounted so the piston can travel in a straight line in the barrel. If the alignment is not straight, the piston will bind, preventing the joint from functioning correctly.
- The expansion joint barrel should be clamped tight, but the conduit mounted loose enough in its hangers to allow for movement as it expands and contracts.
- Scepter nonmetallic straps are correctly sized and designed for proper support, and must be used to secure the conduit.
- When expansion joints are used in a vertical position, the piston should be mounted in a downward position so dirt cannot deposit between the barrel and piston at the muzzle of the expansion joints.

WARNING

Common Mistakes

Three common mistakes are:

1. Forgetting to use expansion joints.
2. Not using enough expansion joints.
3. Overtightening of support straps.

It is more cost effective to use more expansion joints than needed, rather than too few. It is difficult to correct the problem after conductors are installed and in service. Failure to accommodate expansion/contraction may result in pipe fracture.

Scepter Rigid PVC Conduit Dimensions (inches)

| Nominal Size | Product Code | OD | ID | Min. Wall | Weight lbs/100' | Standard ft/crate |
|--------------|--------------|-------|-------|-----------|-----------------|-------------------|
| 1/2 | (10') 032105 | 0.840 | 0.622 | 0.109 | 15 | 6,000 |
| | (20') 032106 | | | | | 12,000 |
| 3/4 | (10') 032107 | 1.050 | 0.824 | 0.113 | 21 | 4,400 |
| | (20') 032108 | | | | | 8,800 |
| 1 | (10') 032110 | 1.315 | 1.049 | 0.133 | 31 | 3,600 |
| | (20') 032111 | | | | | 7,200 |
| 1-1/4 | (10') 032112 | 1.660 | 1.380 | 0.140 | 42 | 3,300 |
| | (20') 032114 | | | | | 6,600 |
| 1-1/2 | (10') 032115 | 1.900 | 1.610 | 0.145 | 53 | 2,250 |
| | (20') 032116 | | | | | 4,500 |
| 2 | (10') 032120 | 2.375 | 2.067 | 0.154 | 71 | 1,400 |
| | (20') 032121 | | | | | 2,800 |
| 2-1/2 | (10') 032125 | 2.875 | 2.469 | 0.203 | 112 | 780 |
| | (20') 032126 | | | | | 1,560 |
| 3 | (10') 032130 | 3.500 | 3.068 | 0.216 | 166 | 780 |
| | (20') 032131 | | | | | 1,560 |
| 3-1/2 | (10') 032135 | 4.000 | 3.548 | 0.226 | 200 | 630 |
| | (20') 032136 | | | | | 1,260 |
| 4 | (10') 032140 | 4.500 | 4.026 | 0.237 | 236 | 600 |
| | (20') 032141 | | | | | 1,200 |
| 5 | (10') 032150 | 5.563 | 5.047 | 0.258 | 321 | 230 |
| | (20') 032151 | | | | | 460 |
| 6 | (10') 032160 | 6.625 | 6.065 | 0.280 | 417 | 260 |
| | (20') 032161 | | | | | 520 |

Scepter Rigid PVC Conduit Dimensions (mm)

| Nominal Size | OD | ID | Min. Wall | Weight kgs/100' |
|--------------|-------|-------|-----------|-----------------|
| 12 | 21.3 | 15.8 | 2.8 | 22.6 |
| 20 | 26.7 | 20.9 | 2.9 | 31.2 |
| 25 | 33.4 | 26.6 | 3.4 | 46.2 |
| 32 | 42.2 | 35.1 | 3.6 | 63.0 |
| 40 | 48.3 | 40.9 | 3.7 | 78.4 |
| 50 | 60.3 | 52.5 | 3.9 | 105.5 |
| 65 | 73.0 | 62.7 | 5.2 | 167.2 |
| 75 | 88.9 | 77.9 | 5.5 | 247.8 |
| 90 | 101.6 | 90.1 | 5.7 | 297.7 |
| 100 | 114.3 | 102.3 | 6.0 | 352.4 |
| 125 | 141.3 | 128.2 | 6.6 | 478.5 |
| 150 | 168.3 | 154.1 | 7.1 | 621.0 |



Weight Comparison of Scepter Rigid PVC Conduit - lbs./100 ft.

| Nominal Size (in) | Rigid PVC | Aluminum | Rigid Steel |
|-------------------|-----------|----------|-------------|
| 1/2 | 15 | 28 | 79 |
| 3/4 | 21 | 27 | 105 |
| 1 | 31 | 53 | 153 |
| 1-1/4 | 42 | 70 | 201 |
| 1-1/2 | 53 | 86 | 249 |
| 2 | 71 | 116 | 334 |
| 2-1/2 | 112 | 183 | 527 |
| 3 | 166 | 239 | 690 |
| 3-1/2 | 200 | 288 | 831 |
| 4 | 236 | 340 | 982 |
| 5 | 321 | 465 | 1,334 |
| 6 | 417 | 613 | 1,771 |

Weight Comparison of Scepter Rigid PVC Conduit - kg/100 m

| Nominal Size (in) | Rigid PVC | Aluminum | Rigid Steel |
|-------------------|-----------|----------|-------------|
| 12 | 23 | 41 | 118 |
| 20 | 31 | 54 | 157 |
| 25 | 46 | 79 | 228 |
| 32 | 63 | 104 | 300 |
| 40 | 78 | 129 | 371 |
| 50 | 106 | 173 | 498 |
| 65 | 167 | 272 | 786 |
| 75 | 248 | 356 | 1,029 |
| 90 | 298 | 429 | 1,239 |
| 100 | 352 | 507 | 1,464 |
| 125 | 479 | 694 | 1,989 |
| 150 | 621 | 914 | 2,641 |



CSA C22.2 No. 211.2
FT-4 for 1/2" to 6"



NEMA TC2
Corps. of Engineers Spec.
CE 303:01
Military Spec, Federal Spec.
WC 1094A

Scepter

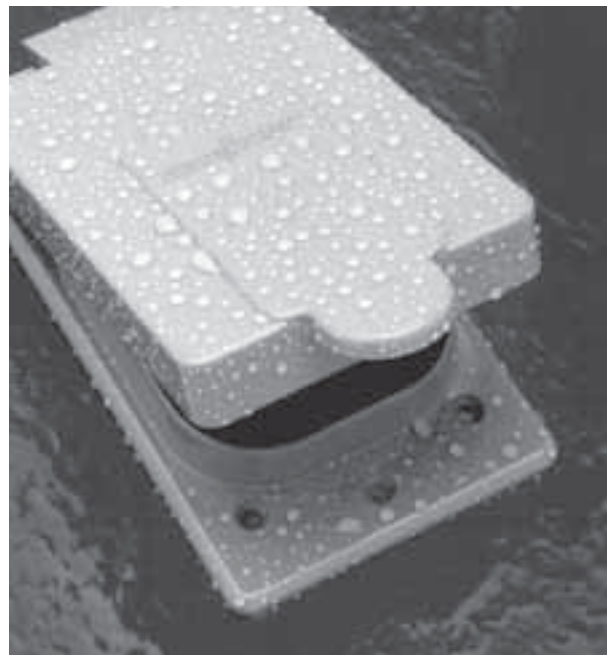

Industry leaders specify Scepter PVC fittings by name. For years, Scepter PVC fittings have set the standard for quality and value-added features not normally available from other suppliers. Features such as our threaded brass inserts, brass screws, and superior PVC gasketing system make a real difference.



C22.2 No. 85



UL Listed
UL514B - UL514C



NEMA TC-2, 3



Couplings

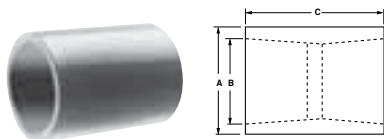

| Size (in) | Part Number | Product Code | A (in) | B (in) | C (in) |
|-----------|-------------|--------------|--------|--------|--------|
| 1/2 | EC10 | 077001 | 1.080 | 0.840 | 1.437 |
| 3/4 | EC15 | 077002 | 1.300 | 1.050 | 2.200 |
| 1 | EC20 | 077003 | 1.590 | 1.315 | 2.031 |
| 1-1/4 | EC25 | 077004 | 2.000 | 1.660 | 2.156 |
| 1-1/2 | EC30 | 077005 | 2.230 | 1.900 | 2.281 |
| 2 | EC35 | 077006 | 2.720 | 2.375 | 2.406 |
| 2-1/2 | EC40 | 077007 | 3.320 | 2.875 | 3.187 |
| 3 | EC45 | 077008 | 4.000 | 3.500 | 3.437 |
| 3-1/2 | EC50 | 077009 | 4.500 | 4.000 | 3.625 |
| 4 | EC55 | 077010 | 5.000 | 4.500 | 3.750 |
| 5 | EC60 | 077011 | 6.120 | 5.563 | 4.187 |
| 6 | EC65 | 077012 | 7.370 | 6.625 | 4.562 |

Terminal Adapters

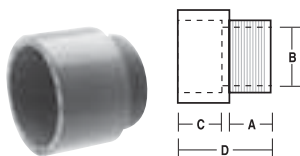

| Size (in) | Part Number | Product Code | A (in) | B (in) | C (in) | D (in) |
|-----------|-------------|--------------|--------|--------|--------|--------|
| 1/2 | TA10 | 077021 | 0.700 | 0.591 | 0.750 | 1.550 |
| 3/4 | TA15 | 077022 | 0.675 | 0.790 | 1.000 | 1.750 |
| 1 | TA20 | 077023 | 0.625 | 1.000 | 1.115 | 1.860 |
| 1-1/4 | TA25 | 077024 | 0.640 | 1.311 | 1.300 | 2.125 |
| 1-1/2 | TA30 | 077025 | 0.725 | 1.530 | 1.425 | 2.250 |
| 2 | TA35 | 077026 | 0.800 | 1.970 | 1.150 | 2.100 |
| 2-1/2 | TA40 | 077027 | 0.800 | 2.346 | 1.900 | 2.930 |
| 3 | TA45 | 077028 | 0.815 | 2.915 | 2.000 | 3.055 |
| 3-1/2 | TA50 | 077029 | 1.000 | 3.385 | 1.715 | 3.055 |
| 4 | TA55 | 077030 | 0.815 | 3.850 | 1.990 | 3.215 |
| 5 | TA60 | 077031 | 1.725 | 5.015 | 2.000 | 5.985 |
| 6 | TA65 | 077032 | 1.875 | 6.025 | 2.130 | 6.500 |

Note: 1/2" to 1-1/4" TA – tapered thread.
1-1/2" to 6" TA – non-tapered thread.

Female Adapters

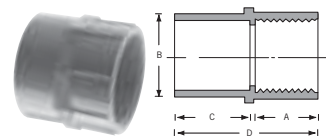

| Size (in) | Part Number | Product Code | A (in) | B (in) | C (in) | D (in) |
|-----------|-------------|--------------|--------|--------|--------|--------|
| 1/2 | FA10 | 076544 | 0.620 | 1.080 | 0.800 | 1.725 |
| 1/2 | FA10 | 077041 | 0.620 | 1.080 | 0.800 | 1.725 |
| 3/4 | FA15 | 077042 | 0.820 | 1.300 | 0.800 | 1.900 |
| 1 | FA20 | 077043 | 1.065 | 1.590 | 1.000 | 2.300 |
| 1-1/4 | FA25 | 077044 | 1.395 | 2.000 | 1.015 | 2.425 |
| 1-1/2 | FA30 | 077045 | 1.575 | 2.230 | 1.050 | 2.440 |
| 2 | FA35 | 077046 | 2.050 | 2.720 | 1.075 | 2.550 |
| 2-1/2 | FA40 | 077047 | 1.020 | 3.250 | 1.500 | 2.700 |
| 3 | FA45 | 077048 | 3.090 | 4.000 | 1.630 | 4.100 |
| 3-1/2 | FA50 | 077049 | 3.540 | 4.500 | 1.800 | 3.895 |
| 4 | FA55 | 077050 | 4.025 | 5.000 | 1.755 | 4.210 |
| 5 | FA60 | 077051 | 5.035 | 6.120 | 2.065 | 5.240 |
| 6 | FA65 | 077052 | 6.045 | 7.370 | 2.065 | 5.235 |

Note: All female adapters have NPT-tapered threads.

5° Couplings



| Size (in) | Part Number | Product Code | L (in) |
|-----------|-------------|--------------|--------|
| 2 | 5EC35 | 077100 | 4.0 |
| 2-1/2 | 5EC40 | 077101 | 5.5 |
| 3 | 5EC45 | 077103 | 6.0 |
| 3-1/2 | 5EC50 | 077102 | 7.0 |
| 4 | 5EC55 | 077104 | 7.0 |
| 5 | 5EC60 | 077105 | 7.5 |
| 6 | 5EC65 | 077106 | 11.0 |

Threaded Reducer Bushings



| Size (in) | Part Number | Product Code |
|-----------|-------------|--------------|
| 3/4 x 1/2 | 1825 | 077314 |
| 1 x 1/2 | 1826 | 077315 |
| 1 x 3/4 | 1827 | 077316 |





Reducer Bushings

| Size (in) | Part Number | Product Code |
|---------------|-------------|--------------|
| 3/4 x 1/2 | 1805 | 077300 |
| 1 x 1/2 | 1805-1 | 077301 |
| 1 x 3/4 | 1806 | 077302 |
| 1-1/4 x 3/4 | 1807-1 | 077303 |
| 1-1/4 x 1 | 1807 | 077304 |
| 1-1/2 x 1 | 1808-1 | 077305 |
| 1-1/2 x 1-1/4 | 1808 | 077306 |
| 2 x 1 | 1809-1 | 077313 |
| 2 x 1-1/4 | 1809 | 077307 |
| 2 x 1-1/2 | 1810 | 077308 |
| 2-1/2 x 2 | 1811 | 077309 |
| 3 x 2 | 1812-1 | 077310 |
| 3 x 2-1/2 | 1812 | 077311 |
| 4 x 2 | 1813-1 | 077319 |
| 4 x 3 | 1813 | 077312 |
| 4 x 3-1/2 | 1814 | 077317 |

*Additional sizes of reducer bushings are available upon request.



End Caps

| Size (in) | Part Number | Product Code |
|-----------|-------------|--------------|
| 1/2 | CAP10 | 077421 |
| 3/4 | CAP15 | 077422 |
| 1 | CAP20 | 077423 |
| 1-1/4 | CAP25 | 077424 |
| 1-1/2 | CAP30 | 077425 |
| 2 | CAP35 | 077426 |
| 2-1/2 | CAP40 | 077427 |
| 3 | CAP45 | 077428 |
| 3-1/2 | CAP50 | 077429 |
| 4 | CAP55 | 077430 |
| 5 | CAP60 | 077431 |
| 6 | CAP65 | 077432 |

“O” Ring Expansion Joints

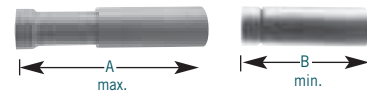

| Size (in) | Part Number | Product Code | A (in) max. | B (in) min. |
|-----------|-------------|--------------|-------------|-------------|
| 1/2 | EJ10 | 077381 | 12.00 | 8.00 |
| 3/4 | EJ15 | 077382 | 12.00 | 8.00 |
| 1 | EJ20 | 077383 | 12.50 | 8.50 |
| 1-1/4 | EJ25 | 077384 | 13.00 | 9.00 |
| 1-1/2 | EJ30 | 077385 | 13.00 | 9.00 |
| 2 | EJ35 | 077386 | 13.25 | 9.25 |
| 2-1/2 | EJ40 | 077387 | 13.25 | 9.25 |
| 3 | EJ45 | 077388 | 22.25 | 14.25 |
| 3-1/2 | EJ50 | 077389 | 22.25 | 14.25 |
| 4 | EJ55 | 077390 | 22.25 | 14.25 |
| 5 | EJ60 | 077391 | 22.25 | 14.25 |
| 6 | EJ65 | 077392 | 22.25 | 14.25 |

Expansion and Deflection Fitting Assemblies



| Size (in) | Part Number | Description | Product Code |
|-----------|-------------|-------------------|--------------|
| 2 | SE-J-35 | Complete Assembly | 077889 |
| 3 | SE-J-45 | Complete Assembly | 077890 |
| 4 | SE-J-55 | Complete Assembly | 077891 |

Utility 90° Elbows c/w Solvent Bell End

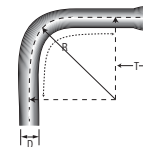

| Size (in) | Part Number | Product Code | D (in) | T (in) | R (in) |
|-----------|-------------|--------------|--------|--------|--------|
| 2 | NSL 2-24 | 069257 | 2.375 | 41.20 | 24 |
| 2 | NSL 2-36 | 069260 | 2.375 | 31.70 | 36 |
| 3 | NSL 3-24 | 069265 | 3.500 | 41.20 | 24 |
| 3 | NSL 3-36 | 069261 | 3.500 | 31.70 | 36 |
| 4 | NSL 4-36 | 069267 | 4.500 | 31.70 | 36 |
| 4 | NSL 4-48 | 069266 | 4.500 | 22.25 | 48 |
| 5 | NSL 5-36 | 069263 | 5.563 | 31.70 | 36 |
| 6 | NSL 6-36 | 069264 | 6.625 | 31.70 | 36 |

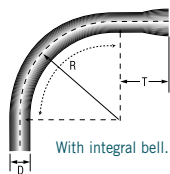

90° Elbows c/w Solvent Bell End

| Size (in) | Part Number | Product Code | D (in) | T (in) | R (in) |
|-----------|-------------|--------------|--------|--------|--------|
| 1/2 | EE1090 | 069081 | 0.840 | 1.500 | 4.00 |
| 3/4 | EE1590 | 069082 | 1.050 | 1.500 | 4.50 |
| 1 | EE2090 | 069083 | 1.315 | 1.875 | 5.75 |
| 1-1/4 | EE2590 | 069084 | 1.660 | 2.000 | 7.25 |
| 1-1/2 | EE3090 | 069085 | 1.900 | 2.000 | 8.25 |
| 2 | EE3590 | 069086 | 2.375 | 2.000 | 9.50 |
| 2-1/2 | EE4090 | 069087 | 2.875 | 3.000 | 10.50 |
| 3 | EE4590 | 069088 | 3.500 | 3.125 | 13.00 |
| 3-1/2* | EE5090 | 069089 | 4.000 | 3.250 | 15.00 |
| 4 | EE5590 | 069090 | 4.500 | 3.375 | 16.00 |
| 5 | EE6090 | 069091 | 5.563 | 3.625 | 24.00 |
| 6 | EE6590 | 069092 | 6.625 | 3.750 | 30.00 |

* Plain end only

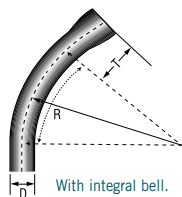

45° Elbows c/w Solvent Bell End

| Size (in) | Part Number | Product Code | D (in) | T (in) | R (in) |
|-----------|-------------|--------------|--------|--------|--------|
| 1/2 | EE1045 | 069201 | 0.840 | 1.500 | 4.00 |
| 3/4 | EE1545 | 069202 | 1.050 | 1.500 | 4.50 |
| 1 | EE2045 | 069203 | 1.315 | 1.875 | 5.75 |
| 1-1/4 | EE2545 | 069204 | 1.660 | 2.000 | 7.25 |
| 1-1/2 | EE3045 | 069205 | 1.900 | 2.000 | 8.25 |
| 2 | EE3545 | 069206 | 2.375 | 2.000 | 9.50 |
| 2-1/2 | EE4045 | 069207 | 2.875 | 3.000 | 10.50 |
| 3 | EE4545 | 069208 | 3.500 | 3.125 | 13.00 |
| 3-1/2* | EE5045 | 069209 | 4.000 | 3.250 | 15.00 |
| 4 | EE5545 | 069210 | 4.500 | 3.375 | 16.00 |
| 5 | EE6045 | 069211 | 5.563 | 3.625 | 24.00 |
| 6 | EE6545 | 069212 | 6.625 | 3.750 | 30.00 |

* Plain end only

30° Elbows (Plain End x Plain End)

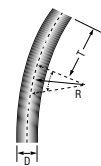

| Size (in) | Part Number | Product Code | D (in) | T (in) | R (in) |
|-----------|-------------|--------------|--------|--------|--------|
| 1/2 | EE1030 | 069241 | 0.840 | 1.500 | 4.00 |
| 3/4 | EE1530 | 069242 | 1.050 | 1.500 | 4.50 |
| 1 | EE2030 | 069243 | 1.315 | 1.875 | 5.75 |
| 1-1/4 | EE2530 | 069244 | 1.660 | 2.000 | 7.25 |
| 1-1/2 | EE3030 | 069245 | 1.900 | 2.000 | 8.25 |
| 2 | EE3530 | 069246 | 2.375 | 2.000 | 9.50 |
| 2-1/2 | EE4030 | 069247 | 2.750 | 3.000 | 10.50 |
| 3 | EE4530 | 069248 | 3.500 | 3.125 | 13.00 |
| 3-1/2 | EE5030 | 069249 | 4.000 | 3.250 | 15.00 |
| 4 | EE5530 | 069250 | 4.500 | 3.375 | 16.00 |
| 5 | EE6030 | 069251 | 5.563 | 3.625 | 24.00 |
| 6 | EE6530 | 069252 | 6.625 | 3.750 | 30.00 |

Utility 90° Elbows c/w Solvent Bell End

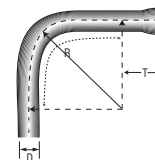

| Size (in) | Part Number | Product Code | D (in) | T (in) | R (in) |
|-----------|-------------|--------------|--------|--------|--------|
| 2 | NSL 2-24 | 069257 | 2.375 | 10.200 | 24.00 |
| 2 | NSL 2-36 | 069260 | 2.375 | 31.700 | 36.00 |
| 3 | NSL 3-24 | 069265 | 3.500 | 41.200 | 24.00 |
| 3 | NSL 3-36 | 069261 | 3.500 | 31.700 | 36.00 |
| 4 | NSL 4-36 | 069267 | 4.500 | 31.700 | 36.00 |
| 4 | NSL 4-48 | 069266 | 4.500 | 31.700 | 48.00 |
| 5 | NSL 5-36 | 069263 | 5.563 | 31.700 | 36.00 |
| 6 | NSL 6-36 | 069264 | 6.625 | 31.700 | 36.00 |

90° Elbows Extended bend

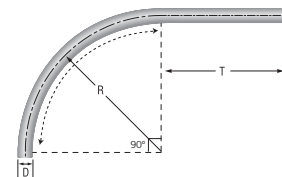

| Size (in) | Part Number | Product Code | D (in) | T (in) | R (in) |
|-----------|-------------|--------------|--------|--------|--------|
| 1-1/4 | EE2590E | 069096 | 1.66 | 10.24 | 6.73 |
| 1-1/2 | EE3090E | 069097 | 1.90 | 12.80 | 8.25 |
| 2 | EE3590E | 069098 | 2.38 | 11.02 | 13.00 |

Pipe Straps PVC, 2 Hole



| Size (in) | Part Number | Product Code |
|-----------|-------------|--------------|
| 1/2 | PS10 | 077811 |
| 3/4 | PS15 | 077812 |
| 1 | PS20 | 077813 |
| 1-1/4 | PS25 | 077814 |
| 1-1/2 | PS30 | 077815 |
| 2 | PS35 | 077816 |

Polyethylene (PE), 2 Hole



| Size (in) | Part Number | Product Code |
|-----------|-------------|--------------|
| 2-1/2 | PS40 | 077262 |
| 3 | PS45 | 077263 |
| 4 | PS55 | 077264 |

PVC Coated Steel, 2 Hole



| Size (in) | Part Number | Product Code |
|-----------|-------------|--------------|
| 2 | CS35 | 077818 |
| 2-1/2 | CS40 | 077819 |
| 3 | CS45 | 077820 |
| 3-1/2 | CS50 | 077821 |
| 4 | CS55 | 077822 |
| 5 | CS60 | 077824 |
| 6 | CS65 | 077823 |

PVC Coated Steel, 1 Hole



| Size (in) | Part Number | Product Code |
|-----------|-------------|--------------|
| 1/2 | CS10-1 | 077831 |
| 3/4 | CS15-1 | 077832 |
| 1 | CS20-1 | 077833 |
| 1-1/4 | CS25-1 | 077834 |
| 1-1/2 | CS30-1 | 077835 |
| 2 | CS35-1 | 077836 |
| 2-1/2 | CS40-1 | 077837 |
| 3 | CS45-1 | 077838 |
| 3-1/2 | CS50-1 | 077839 |
| 4 | CS55-1 | 077840 |

Conduit Clamps & Spacers



| Size (in) | Part Number | Product Code | X (in) | Y (in) | Z (in) |
|------------|-------------|--------------|--------|--------|--------|
| 1/2 | CCS10 | 077794 | 1.191 | 2.414 | 1.824 |
| 3/4 | CCS15 | 077796 | 1.195 | 2.660 | 2.106 |
| 1 | CCS20 | 077797 | 1.215 | 2.962 | 2.443 |
| 1-1/4 | CCS25 | 077798 | 1.182 | 3.300 | 2.855 |
| 1-1/2 | CCS30 | 077799 | 1.193 | 3.600 | 3.170 |
| 2 | CCS35 | 077800 | 1.195 | 4.135 | 3.785 |
| Strut Base | CCS-B | 077343 | - | - | - |

* CCS-B are sold individually, two pieces are required to create one base unit.

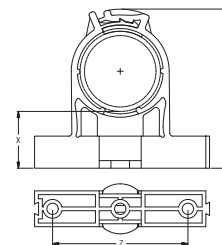

Access Fittings* Type LB

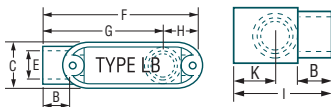

| Size (in) | Part Number | Product Code |
|-----------|-------------|--------------|
| 1/2 | SLB10S | 077541 |
| 3/4 | SLB20S | 077542 |
| 1 | SLB30S | 077543 |
| 1-1/4 | SLB40S | 077544 |
| 1-1/2 | SLB50S | 077545 |
| 2 | SLB60S | 077546 |
| 2-1/2 | SLB70S | 077547 |
| 3 | SLB80S | 077548 |
| 3-1/2 | SLB90S | 077549 |
| 4 | SLB100S | 077550 |

Access Fittings* Type LR

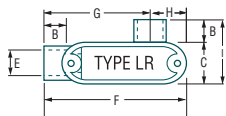

| Size (in) | Part Number | Product Code |
|-----------|-------------|--------------|
| 1/2 | SLR10S | 077481 |
| 3/4 | SLR20S | 077482 |
| 1 | SLR30S | 077483 |
| 1-1/4 | SLR40S | 077484 |
| 1-1/2 | SLR50S | 077485 |
| 2 | SLR60S | 077486 |
| 2-1/2 | SLR70S | 077480 |
| 3 | SLR80S | 077488 |
| 3-1/2 | SLR90S | 077487 |
| 4 | SLR100S | 077489 |

Access Fittings* Type LL

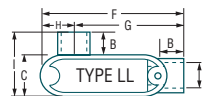

| Size (in) | Part Number | Product Code |
|-----------|-------------|--------------|
| 1/2 | SLL10S | 077521 |
| 3/4 | SLL20S | 077522 |
| 1 | SLL30S | 077523 |
| 1-1/4 | SLL40S | 077524 |
| 1-1/2 | SLL50S | 077525 |
| 2 | SLL60S | 077526 |
| 2-1/2 | SLL70S | 077527 |
| 3 | SLL80S | 077528 |
| 3-1/2 | SLL90S | 077530 |
| 4 | SLL100S | 077529 |

Access Fittings* Type C

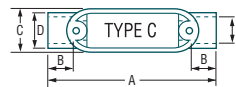

| Size (in) | Part Number | Product Code |
|-----------|-------------|--------------|
| 1/2 | SC10S | 077501 |
| 3/4 | SC20S | 077502 |
| 1 | SC30S | 077503 |
| 1-1/4 | SC40S | 077504 |
| 1-1/2 | SC50S | 077505 |
| 2 | SC60S | 077506 |
| 2-1/2 | SC70S | 077507 |
| 3 | SC80S | 077508 |
| 3-1/2 | SC90S | 077510 |
| 4 | SC100S | 077509 |

* All access fittings are CSA and UL listed for wet locations. Supplied with threaded brass inserts, combination brass head screws and PVC gasketing.

**Stainless steel screws are available upon request.

**Not UL Listed.

Access Fittings* Type T

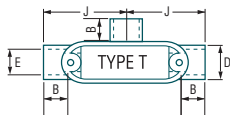

| Size (in) | Part Number | Product Code |
|-----------|-------------|--------------|
| 1/2 | ST10S | 077461 |
| 3/4 | ST20S | 077462 |
| 1 | ST30S | 077463 |
| 1-1/4 | ST40S | 077464 |
| 1-1/2 | ST50S | 077465 |
| 2 | ST60S | 077466 |
| 2-1/2 | ST70S | 077467 |
| 3 | ST80S | 077468 |
| 3-1/2 | ST90S | 077571 |
| 4 | ST100S | 077572 |

Access Fittings* Type E

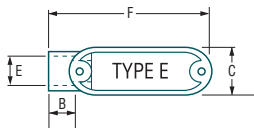

| Size (in) | Part Number | Product Code |
|-----------|-------------|--------------|
| 1/2 | SE10S | 077561 |
| 3/4 | SE20S | 077562 |
| 1 | SE30S | 077563 |
| 1-1/4 | SE40S | 077564 |
| 1-1/2 | SE50S | 077565 |
| 2 | SE60S | 077566 |
| 2-1/2 | SE70S | 077567 |
| 3 | SE80S | 077568 |
| 3-1/2 | SE90S | 077569 |
| 4 | SE100S | 077570 |

* All access fittings are CSA and UL listed for wet locations. Supplied with threaded brass inserts, combination brass head screws and PVC gasketing.

* Stainless steel screws are available upon request.

**Not UL Listed.

Access Fittings* Type TB**

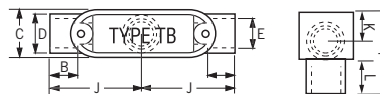

| Size (in) | Part Number | Product Code |
|-----------|-------------|--------------|
| 1/2 | STB10S | 077451 |
| 3/4 | STB20S | 077452 |
| 1 | STB30S | 077453 |
| 1-1/4 | STB40S | 077454 |
| 1-1/2 | STB50S | 077455 |
| 2 | STB60S | 077456 |

Access Fitting Dimensions*

| Size (in) | A (in) | B (in) | C (in) | D (in) | E (in) | F (in) |
|-----------|--------|--------|--------|--------|--------|--------|
| 1/2 | 5.606 | 0.639 | 1.268 | 1.100 | 0.840 | 4.337 |
| 3/4 | 5.606 | 0.810 | 1.536 | 1.325 | 1.050 | 5.395 |
| 1 | 6.500 | 0.910 | 1.700 | 1.600 | 1.335 | 6.250 |
| 1-1/4 | 7.900 | 1.050 | 2.300 | 2.250 | 1.660 | 7.625 |
| 1-1/2 | 8.500 | 1.125 | 2.675 | 2.250 | 1.900 | 8.250 |
| 2 | 10.875 | 1.160 | 3.188 | 2.820 | 2.375 | 10.531 |
| 2-1/2 | 14.600 | 1.750 | 4.500 | 3.950 | 2.870 | 13.630 |
| 3 | 14.600 | 1.900 | 4.500 | 3.950 | 3.510 | 13.630 |
| 3-1/2 | 17.040 | 2.125 | 5.536 | 5.000 | 4.000 | 16.000 |
| 4 | 17.040 | 2.125 | 5.536 | 5.000 | 4.530 | 16.000 |

| Size (in) | G (in) | H (in) | I (in) | J (in) | K (in) | L (in) |
|-----------|--------|--------|--------|--------|--------|--------|
| 1/2 | 4.095 | 1.297 | 2.487 | 2.280 | 1.005 | 0.750 |
| 3/4 | 4.095 | 1.297 | 2.487 | 2.803 | 1.005 | 0.810 |
| 1 | 4.750 | 1.500 | 2.075 | 3.250 | 1.125 | 1.115 |
| 1-1/4 | 5.750 | 1.750 | 3.575 | 3.950 | 1.562 | 1.300 |
| 1-1/2 | 6.500 | 1.750 | 3.938 | 4.250 | 1.656 | 1.425 |
| 2 | 8.156 | 2.344 | 4.535 | 5.438 | 1.968 | 1.160 |
| 2-1/2 | 9.825 | 3.805 | 6.240 | 7.300 | 2.610 | - |
| 3 | 10.897 | 2.733 | 6.240 | 7.300 | 2.610 | - |
| 3-1/2 | 11.465 | 4.535 | 7.500 | 8.535 | 2.975 | - |
| 4 | 11.465 | 4.535 | 7.500 | 8.535 | 2.975 | - |

* All access fittings are CSA and UL listed for wet locations. Supplied with threaded brass inserts, combination brass head screws and PVC gasketing.

* Stainless steel screws are available upon request.

**Not UL Listed.



End Bells

| Size (in) | Part Number | Product Code |
|-----------|-------------|--------------|
| 1/2 | EB-10 | 077406 |
| 3/4 | EB-15 | 077085 |
| 1 | EB-20 | 077323 |
| 1-1/4 | EB-25 | 077324 |
| 1-1/2 | EB-30 | 077325 |
| 2 | EB-35 | 077326 |
| 2-1/2 | EB-40 | 077327 |
| 3 | EB-45 | 077328 |
| 3-1/2 | EB-50 | 077329 |
| 4 | EB-55 | 077330 |
| 5 | EB-60 | 077331 |
| 6 | EB-65 | 077332 |



Service Entrance Fittings

| Size (in) | Part Number | Product Code |
|-----------|-------------|--------------|
| 1/2 | EF10 | 077281 |
| 3/4 | EF15 | 077282 |
| 1 | EF20 | 077283 |
| 1-1/4 | EF25 | 077284 |
| 1-1/2 | EF30 | 077285 |
| 2 | EF35 | 077286 |
| 2-1/2 | EF40 | 077287 |
| 3 | EF45 | 077288 |
| 3-1/2 | EF50 | 077289 |
| 4 | EF55 | 077290 |



Meter Offsets

| Size (in) | Part Number | Product Code |
|-----------|-------------|--------------|
| 1-1/4 | M025 | 077941 |
| 2 | M035 | 077942 |

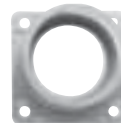

Meter Hubs

| Size (in) | Part Number | Product Code |
|-----------|-------------|--------------|
| 1-1/4 | MHU25 | 077961 |
| 1-1/2 | MHU30 | 077963 |
| 2 | MHU35 | 077965 |
| 2-1/2 | MHU40 | 077967 |
| 3 | MHU45 | 077968 |

Long Meter Offsets (Fabricated)



| Size (in) | Part Number | Product Code |
|-----------|-------------|--------------|
| 1-1/4 | LM025 | 069641 |
| 1-1/2 | LM030 | 069645 |
| 2 | LM035 | 069646 |

“Two in One” Pull Elbow

The “two in one” access pull elbow reduces inventory costs & increases installation flexibility (3/4" hub fitting supplied with 3/4" x 1/2" reducers). The pull elbow is approved for wet location use and is manufactured from high impact, nonconducting and noncorroding PVC.

| Size (in) | Part Number | Product Code |
|------------|-------------|--------------|
| 1/2 or 3/4 | PE15/10 | 077491 |



Nonmetallic Threaded Strain Relief Connector c/w "O" Ring, Locknut & 6 Grommets









| Size (in) | Part Number | Product Code |
|-----------|-------------|--------------|
| 1/2 | TSRC10 | 077754 |
| 3/4 | TSRC15 | 077756 |

Strain Relief Connectors c/w 6 Grommets



| Size (in) | Part Number | Product Code |
|-----------|-------------|--------------|
| 3/4 | SRC15 | 077985 |

Strain Relief Connectors Grommet Dimensions

| Grommet | From | To |
|---|------------------------|------------------------|
|  | W = .195" L = .450" | W = .285" L = .530" |
|  | W = .220" L = .516" | W = .291" L = .565" |
|  | Ø = .240" | Ø = .300" |
|  | Ø = .290" | Ø = .385" |
|  | Ø = .405" | Ø = .500" |
|  | Ø = .525" | Ø = .625" |

Note: All grommets are supplied with TSRC10, TSRC15 and SRC15.

F Series - Single Gang Plates

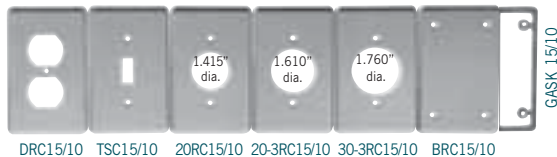

| Description | Part Number | Product Code |
|-------------------|-------------|--------------|
| Duplex Receptacle | DRC15/10 | 077617 |
| Toggle Switch | TSC15/10 | 077616 |
| Single Receptacle | 20RC15/10 | 077618 |
| Single Receptacle | 20-3RC15/10 | 077619 |
| Single Receptacle | 30RC15/10 | 077620 |
| Blank c/w Gasket | BRC15/10 | 077611 |
| PVC Gasket | GASK15/10 | 077621 |

F Series - Double Gang Plates



| Description | Part Number | Product Code |
|--------------------------|-------------|--------------|
| Blank Cover c/w Gasket | BRC20-2 | 077614 |
| Double Switch | TSC20-2 | 077738 |
| Double Duplex Receptacle | DRC20-2 | 077740 |
| Combo Switch Duplex Rec. | TSDC20-2 | 077739 |
| PVC Gasket | GASK20-2 | 077743 |

F Series - Triple Gang Plates



| Description | Part Number | Product Code |
|-------------------------|-------------|--------------|
| Triple Receptacle | DRC20-3 | 077747 |
| Combo Switch Receptacle | DSDR20-3 | 077745 |
| Triple Switch | TSC20-3 | 077744 |
| Combo Switch Receptacle | TSDC20-3 | 077746 |
| Blank Cover c/w Gasket | BRC20-3 | 077748 |
| PVC Gasket | GASK20-3 | 077749 |



Weatherproof Covers - Single Gang

| | Description | (in) | Part Number | Product Code |
|---|--|-------|-------------|--------------|
|  | Plunger-style Switch Cover | | VPT15/10 | 077630 |
|  | Toggle Switch Cover | | VSC15/10 | 077612 |
|  | Grey Toggle Switch Cover | | WTG15/10 | 077606 |
|  | Grey Duplex Receptacle | | WDR15/10 | 077993 |
|  | White Duplex Receptacle | | RWDR15/10 | 077786 |
|  | Grey Ground Fault Receptacle | | WGF15/10 | 077785 |
|  | White Ground Fault Receptacle | | RWGF15/10 | 077787 |
|  | Single Receptacle Device 15 AMP | 1.375 | WTL15 | 077992 |
|  | Single Receptacle Device 20 AMP | 1.625 | WTL20 | 077994 |
|  | Single Receptacle Device 30 AMP | 1.722 | WTL30 | 077991 |
|  | Single Receptacle Device 50 AMP | 2.187 | WTL50 | 077951 |
|  | Grey Double Door Duplex Receptacle | | WDRE15/10 | 077087 |
| | White Double Door Duplex Receptacle | | RWDR15/10 | 077408 |
| | Gasket for W Series Cover (except WDRE & RWDR) | | GASKW | 077755 |
| | Gasket for WDRE & RWDR Covers | | GASKDD | 072225 |

Note: Weatherproof covers, with lids closed, are CSA and UL Listed for wet locations.

Weatherproof Covers - Double Gang

| | Description | Part Number | Product Code |
|--|--|-------------|--------------|
|  | Toggle Switch Cover | VSC20-2 | 077741 |
|  | Combination Switch & GFI Receptacle | VSRC20-2 | 077742 |
|  | Combination Switch & Duplex Receptacle | VSDR20-2 | 077752 |
|  | Combination Switch & Single Receptacle Cover | VSRR20-2 | 077753 |
|  | Double Door GFCI Cover | VSGG20-2 | 077096 |
|  | Double Door Duplex Cover | VSDD20-2 | 077097 |
| | Gasket for 2-Gang 'F' Boxes (except VSGG20-2 & VSDD20-2) | GASK20-2 | 077743 |
| | Gasket for VSGG20-2 & VSDD20-2 Double Gangs | GASKV20-2 | 072227 |

F Series Single Gang Boxes

Outside Dimensions:

Height, $4\frac{9}{16}$ " – Width, $2\frac{13}{16}$ " – Depth 2", Cubic Inches = 25.67

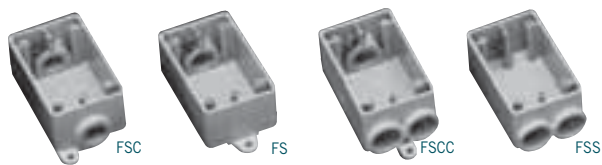

| Size (in) | Part Number | Product Code |
|-----------|-------------|--------------|
| 1/2 | FSC10 | 077607 |
| 3/4 | FSC15 | 077608 |
| 1/2 | FS10 | 077601 |
| 3/4 | FS15 | 077602 |
| 1/2 | FSCC10 | 077622 |
| 3/4 | FSCC15 | 077623 |
| 1/2 | FSS10 | 077604 |
| 3/4 | FSS15 | 077605 |

Note: 10 = 1/2" Hub, 15 = 3/4" Hub

FD Series Single Gang Deep Boxes

Outside Dimensions:

Height, $4\frac{9}{16}$ " – Width, $2\frac{13}{16}$ " – Depth $2\frac{3}{4}$ ", Cubic Inches = 35.30

With the exception of the FD Blank Box, Scepter FD Series Single Gang Deep Boxes are molded with 1" conduit hubs and supplied with reducer bushings. The conduit hub(s) are field modified as 1/2", 3/4" or 1" to accommodate job-site requirements. The appropriate quantity of 1" x 3/4" and 3/4" x 1/2" reducers to create the desired hub size are packaged with each FD Series Single Gang Deep Box.

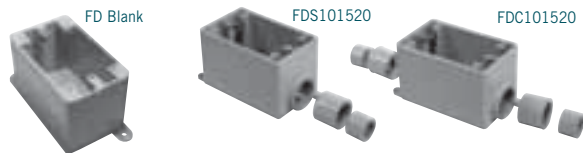

| Size (in) | Part Number | Product Code |
|-------------|-------------|--------------|
| 1/2, 3/4, 1 | FDC101520 | 077291 |
| 1/2, 3/4, 1 | FDS101520 | 077299 |
| BLANK | FD BLANK | 077603 |
| 347 VOLT | FD347 | 077610 |

F Series Double Gang Boxes

FS-2 cu.in = 39.5, FSC-2 & FSS-2 cu.in. = 37.0, FSCC-2 cu.in.= 36.0

| Hub Size (in) | Part Number | Product Code | OD (inches) | | |
|---------------|---------------|--------------|-------------|------|-----|
| | | | H | W | D |
| 1/2, 3/4, 1 | FS-2-101520 | 077440 | 4.5 | 4.75 | 2.5 |
| 1/2, 3/4, 1 | FSC-2-101520 | 077441 | 4.5 | 4.75 | 2.5 |
| 1/2, 3/4, 1 | FSS-2-101520 | 077442 | 4.5 | 4.75 | 2.5 |
| 1/2, 3/4, 1 | FSCC-2-101520 | 077443 | 4.5 | 4.75 | 2.5 |
| Blank | FD-2 | 077734 | 4.75 | 4.75 | 3.0 |

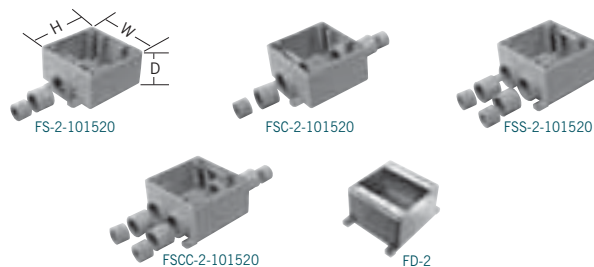

F Series Triple Gang Boxes

| Hub Size (in) | Part Number | Product Code | OD (inches) | | |
|---------------|--------------|--------------|-------------|-----|-----|
| | | | H | W | D |
| 1/2, 3/4, 1 | FS-3-101520 | 077337 | 4.5 | 6.6 | 2.5 |
| 1/2, 3/4, 1 | FSC-3-101520 | 077438 | 4.5 | 6.6 | 2.5 |
| Blank | FD-3 | 077737 | 4.5 | 6.6 | 3.0 |

Note: All F series boxes are supplied with integral mounting feet, threaded brass inserts and grounding clips.

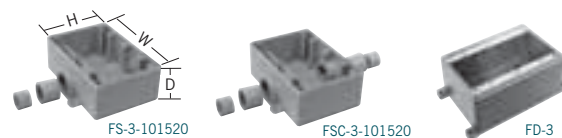

Octagonal Boxes*

Octagonal Boxes are shipped complete with cover, gasket, 4 reducing bushings (3/4" x 1/2") and 4 sealing caps to be installed from inside box to seal off unused entry hubs.



| Size (in) | Part Number | Hub Size (in) | Product Code |
|-----------|-------------|---------------|--------------|
| 4 x 1-1/2 | OB15/10 | 1/2 - 3/4 | 077983* |
| 4 x 2-1/8 | OB20 | 1 | 077984* |

Octagonal Box Extension Rings

| Size (in) | Part Number | Product Code |
|------------|-------------|--------------|
| 4 x 1 deep | XR20 | 077989* |
| 4 x 2 deep | XR35 | 077990* |



* Octagonal Boxes are not designed for supporting luminaires.

PVC Molding Junction Boxes

Junction boxes are supplied with threaded brass inserts, brass screws, PVC gasketing and mounting feet. Nylon and stainless steel screws, as well as larger sizes of fabricated junction boxes, are available upon request.



(F = Threaded brass insert size.)

Scepter PVC junction boxes are:

NEMA 1, 2, 3, 4, 4x, 6P, 12, 13
UL listed for wet locations

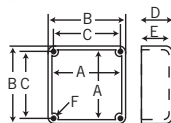

| Part Number | Product Code | A (in) | B (in) | C (in) | E (in) | E (in) | F (in) |
|-------------|--------------|--------|--------|--------|--------|--------|--------|
| JB442 | 077659 | 3.675 | 4.000 | 3.450 | 2.125 | 2.000 | 8-32 |
| JB444 | 077696 | 3.675 | 4.000 | 3.450 | 4.188 | 3.750 | 8-32 |
| JB446 | 077669 | 3.675 | 4.000 | 3.450 | 6.225 | 6.000 | 8-32 |
| JB552 | 077670 | 4.680 | 5.000 | 4.485 | 2.000 | 1.845 | 8-32 |
| JB664 | 077697 | 6.000 | 6.375 | 5.813 | 4.188 | 4.000 | 10-32 |
| JB666 | 077698 | 6.000 | 6.375 | 5.813 | 6.188 | 6.000 | 10-32 |
| JB884 | 077664 | 8.075 | 8.625 | 7.966 | 4.230 | 4.005 | 1/4-20 |
| JB887 | 077671 | 8.100 | 8.625 | 7.966 | 7.250 | 7.035 | 1/4-20 |
| JB12124 | 077672 | 12.085 | 12.580 | 11.874 | 4.256 | 4.030 | 1/4-20 |
| JB12126 | 077666 | 12.085 | 12.580 | 11.874 | 6.240 | 6.025 | 1/4-20 |
| JB12128 | 077668 | 12.085 | 12.580 | 11.874 | 8.250 | 8.025 | 1/4-20 |

Flanged Box with Fibre-Reinforced Safety Tread Cover

Scepter's Flanged 'H' Series Junction Boxes provide H10 Highway Loading. The fiber-reinforced safety tread cover secures using recessed Hex Key fastening hardware offering a simple installation while reducing the opportunity for tampering.

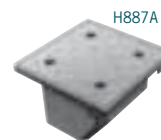
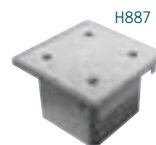
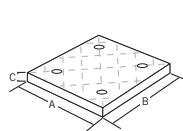

| Size (in) | Part Number | Box ID (in) | | | Lid Dimensions (in) | | |
|-----------|-------------|-------------|---|-------|---------------------|------|------|
| | | L | W | D | A | B | C |
| H664 | 077685 | 6 | 6 | 4-1/4 | 9.0 | 9.0 | 0.60 |
| H666 | 077686 | 6 | 6 | 6-1/4 | 9.0 | 9.0 | 0.60 |
| H884 | 077687 | 8 | 8 | 4-1/4 | 11.5 | 11.5 | 0.75 |
| H886 | 077688 | 8 | 8 | 6-1/4 | 11.5 | 11.5 | 0.75 |
| H887 | 077689 | 8 | 8 | 7-1/4 | 11.5 | 11.5 | 0.75 |
| H887-A | 077692 | 8 | 8 | 7-1/4 | 11.5 | 11.5 | 0.75 |

Fabricated Boxes

Unflanged PVC fabricated boxes of any size may be made to customers' specifications and come complete with lids, gaskets and screws. These boxes are not CSA Certified and are not returnable.

Junction Box Adapters

| Size (in) | Part Number | Product Code |
|-----------|-------------|--------------|
| 1/2 | JBA10 | 077721 |
| 3/4 | JBA15 | 077722 |
| 1 | JBA20 | 077723 |
| 1-1/4 | JBA25 | 077724 |
| 1-1/2 | JBA30 | 077725 |
| 2 | JBA35 | 077726 |
| 2-1/2 | JBA40 | 077727 |
| 3 | JBA45 | 077728 |
| 3-1/2 | JBA50 | 077729 |
| 4 | JBA55 | 077730 |

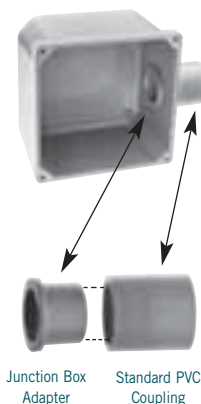

Junction Box Adapter

Standard PVC Coupling

Nonmetallic Floor Box, Cover & Metal Cover Adapter

Installation is quick and simple with our nonmetallic floor box and covers, saving both time and money over similar metallic assemblies.

Scepter's floor box and duplex receptacle covers are constructed from high impact, noncorroding and nonconducting PVC.

The flush-mount covers are available in custom colours and are shipped with a leveling ring complete with a grounding clip. Metal cover adapter kits are also available, allowing you to adapt to metal floor plates. Our 6" deep floor box allows flexibility for various concrete floor pours, while the 4 3/4" width offers easy access and ample wire room. Scepter's FB box is molded with 2 - 1" and 2 - 3/4" hub openings.

All boxes are shipped complete with reducer plugs for added versatility.

One Kit, Four Heights, One Low Cost!

This simple yet innovative **Round Floor Box Stand** is equipped with several height brackets which accommodate the different rebar and post-tension cable heights and slab depths found from job-site to job-site. When installed together, the Floor Box and Stand can be used in 5-1/2" to 10" slab depths.



Sold as a Kit, IPEX offers the Round Floor Box and Stand conveniently packaged together as one complete product offering.

FEATURE & BENEFITS

- Four Adjustable Heights
- Withstands Tough Job Site Conditions
- Raises Entrance Hubs to Rebar
- Easy to Install
- Minimizes Footprint on Concrete Form
- Cost Effective

For more information, visit our NEW website www.ipexelectrical.com

| Description | Part Number | Product Code |
|-------------|-------------|--------------|
|-------------|-------------|--------------|

Floor Box Base

(Includes disposable protective cap & reducer plugs)

076954 FB



FB

Floor Box Base c/w Leveling Ring Adapter

(includes disposable protective cap, reducer plugs & leveling ring adapter)

077068 FBKIT



FB-KIT

Floor Box Stand Kit (includes FB Box)

(is equipped with several height brackets which accommodate the different rebar and post-tension cable heights and slab depths found from job-site to job-site.)

077700 FBS-KIT



FBS-KIT

Metal Cover Adapter Kit

(includes leveling ring, metal cover adapter & 2 gaskets)

076953 AFMC



AFMC

Universal Leveling Ring Adapter

076606 LRA-U



LRA-U

Floor Box Duplex Receptacle Cover (Nonmetallic)

(includes flush mount cover, blank cover & gasket)

| | | |
|---------------------|--------|---------|
| Brown | 076943 | FBDRCB |
| Gold | 076942 | FBDRCG |
| Grey | 076941 | FBDRCGr |
| Light Almond | 076940 | FBDRCA |



FBDRC

Tri-Service Universal Divider Kit

(includes upper & lower dividers, riser tube & two grommets)

077948 FBUDK



FBUDK

Y Connector (3/4")

077499 FBYC



FBYC

Brass Cover Plates

(offers a one-piece design measuring 5-3/4" diameter. Are available in a variety of styles accommodating power and communication needs. Install to the FB box using the universal leveling ring adapter.

| | | |
|--------------------------|---------|--------|
| Duplex Screw Cover | DSC | 178091 |
| Duplex Screw Cover | DSC-P/C | 178092 |
| Single Screw Cover | SSC | 178093 |
| Single Screw Cover | SSC-P/C | 178094 |
| Duplex Flip Lid (single) | DFL-1 | 178095 |
| Duplex Flip Lid (double) | DFL-2 | 178096 |



Conduit Cement c/w Applicator Cap



| Size | Part Number | Product Code |
|-------|-------------|--------------|
| 125ml | S100PT25 | 074717 |
| 250ml | S100PT5 | 074713 |
| 500ml | S100PT | 074714 |
| 1L | S100QT | 074715 |
| 4L | S100GAL | 074716 |

Primer



| Size | Part Number | Product Code |
|-------|-------------|--------------|
| 250ml | C100PT5 | 074306 |
| 500ml | C100PT | 074307 |
| 1L | C100QT | 074308 |

Average # of Joints per Pint or Quart of Cement

| Nominal Pipe Size | | # of Joints | | Nominal Pipe Size | | # of Joints | |
|-------------------|----|-------------|--------|-------------------|----|-------------|--------|
| inches | mm | /Pint | /Quart | inches | mm | /Pint | /Quart |
| 1/2 | 12 | 350 | 700 | 2-1/2 | 12 | 40 | 80 |
| 3/4 | 19 | 200 | 400 | 3 | 19 | 35 | 70 |
| 1 | 25 | 150 | 300 | 3-1/2 | 25 | 30 | 60 |
| 1-1/4 | 32 | 110 | 220 | 4 | 32 | 24 | 48 |
| 1-1/2 | 38 | 80 | 160 | 5 | 38 | 10 | 20 |
| 2 | 50 | 45 | 90 | 6 | 50 | 8 | 16 |

Conduit Repair Kit

EPR Kit for Conduit Repair

EPR Kits from IPEX are the first total repair systems for broken and damaged PVC conduit. They offer fast and easy repairs for damaged conduit caused by actions such as earth excavation, horizontal and core drilling. All sizes are 24 inches in length.



| Size (in) | Part Number | Product Code |
|-----------|-------------|--------------|
| 1-1/4 | EPR25 | 077976 |
| 1-1/2 | EPR30 | 077971 |
| 2 | EPR35 | 077972 |
| 2-1/2 | EPR40 | 077973 |
| 3 | EPR45 | 077974 |
| 4 | EPR55 | 077975 |
| 5 | EPR60 | 077977 |
| 6 | EPR65 | 077979 |

EPR Kit Adapters for Duct Repair

EPR Conduit Repair Kits allow contractors to repair a broken section of DB-II duct while leaving the cables inside. The Adapters are pre-cut allowing each to open around existing cabling and are then solvent cemented onto the outside diameter of the broken duct. Using standard PVC solvent cement, an EPR Kit is then easily assembled and connected to the Adapters, restoring the duct to its original form.



| Size (in) | Part Number | Product Code |
|-----------|-------------|--------------|
| 2 | EPRA35 | 077852 |
| 3 | EPRA45 | 077853 |
| 4 | EPRA55 | 077854 |
| 5 | EPRA60 | 077855 |
| 6 | EPRA65 | 077856 |



Bookmark Our New Website

www.ipexelectrical.com



**PRODUCT INFO,
TECHNICAL
DOCUMENTS,
ONLINE TRAINING
& MUCH MORE ...**



**OUR SCEPTER ELECTRICAL
CATALOGUE & ELECTRICAL
POCKET PRO INCLUDE MORE
INFORMATION ON:**

- Conduit & Fittings
- Light Fixtures
- ENT Tubing & Fittings
- Duct
- Trenchless Raceways
- and much more ...

available at www.ipexelectrical.com

SCEPTALIGHT: The Light That Lasts



Sceptalight fixtures from IPEX prove themselves to be all-round performers in a variety of indoor and outdoor applications.

Sceptalight fixtures are made from a glass-reinforced thermoplastic polyester resin, which enable them to stand up better to corrosive elements than metal. This thermoplastic design marries an unrivaled balance of strength, stiffness and toughness with all the benefits users appreciate of Scepter rigid PVC conduit and fittings - long life, easy servicing and high impact-resistance.

Sceptalight's thermoplastic construction offers outstanding corrosion and chemical resistance. And its interior and exterior silicone gaskets create a watertight seal, the reason it performs equally well indoors and outside.

Features and Benefits

- Stable Construction
- Watertight seal with weather-resistant silicone gaskets
- Corrosion Resistant
- Durable and Impact Resistant

Mounting Options

CEILING MOUNT



Box with four 3/4" threaded hubs and integral mounting feet.

WALL MOUNT



Box with four 3/4" threaded hubs, 90° wall bracket and integral mounting feet.

PENDANT MOUNT



Pendant cap with 3/4" threaded hub and a locking set screw.



Globe Options

Sceptalight offers a variety of globe options to suit a wide range of applications and environments. Our standard clear glass globes are ideal for general purpose area lighting for either indoor or outdoor use. Polycarbonate globes offer impact resistance in case of accidental contact and the assurance that work areas are not contaminated by broken glass. Coloured globes - available in red, blue, green or amber - can transform the light to an indicator or warning light.



Clear
Polycarbonate



Standard or Heat-treated
Clear Glass



Heat-treated
Red Glass



Heat-treated
Blue Glass



Heat-treated
Green Glass



Heat-treated
Amber Glass

Light Options

Fluorescents

Our compact fluorescent fixtures work four to five times more efficiently per watt than incandescents and provide 10-20 times the lamp life, yet use approximately 75% less energy. In this way, Sceptalight fluorescents lower energy and maintenance costs without sacrificing light levels.

Incandescents

With their low initial cost, Sceptalight incandescent fixtures make the most practical choice to meet the daily needs of commercial, industrial, marine and agricultural applications. Our incandescents are ideal for short burn times as well as flashing and dimming applications.



Wet Locations

C22.2 No. 250
UL 1598

Ceiling Mount

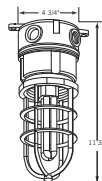

Ceiling Mount

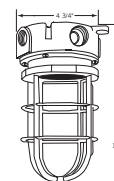

Ceiling Mount

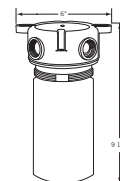

Ceiling Mount
Polycarbonate Globe

| Ceiling Mount with Standard Clear Glass Globe | | Part Number | Product Code |
|--|-------------------------|----------------|-----------------|
| 150W | Incandescent | LVPF150C | 077225 |
| 150W | Incandescent less guard | LVPF150LG | 077237 |
| 26W | Compact Fluorescent | LVPL26C | 077170 |
| 18W | Compact Fluorescent | LVPL18C | 077210 |
| 13W | Compact Fluorescent | LVPL13C | 077122 |
| 9W | Compact Fluorescent | LVPL9C | 077121 |
| 7W | Compact Fluorescent | LVPL7C | 077120 |
| Ceiling Mount with Clear Polycarbonate Glass Globe (no guard) | | Part Number | Product Code |
| 26W | Compact Fluorescent | LVPL26PCC | 077176 |
| 18W | Compact Fluorescent | LVPL18PCC | 077211 |
| 13W | Compact Fluorescent | LVPL13PCC | 077165 |
| 9W | Compact Fluorescent | LVPL9PCC | 077155 |
| 7W | Compact Fluorescent | LVPL7PCC | 077145 |



Pendant Mount

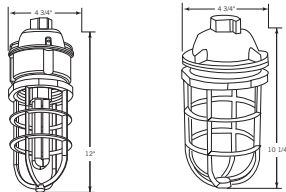

| Pendant Mount with Standard Clear Glass Globe | | Part Number | Product Code |
|---|---------------------|-------------|--------------|
| 150W | Incandescent | LPMF150C | 077231 |
| 26W | Compact Fluorescent | LPPL26C | 077184 |
| 18W | Compact Fluorescent | LPPL18C | 077212 |
| 13W | Compact Fluorescent | LPPL13C | 077185 |
| 9W | Compact Fluorescent | LPPL9C | 077183 |
| 7W | Compact Fluorescent | LPPL7C | 077182 |
| Pendant Mount with Clear Polycarbonate Globe (no guard) | | Part Number | Product Code |
| 26W | Compact Fluorescent | LPPL26PCC | 077375 |
| 18W | Compact Fluorescent | LPPL18PCC | 077273 |
| 13W | Compact Fluorescent | LPPL13PCC | 077365 |
| 9W | Compact Fluorescent | LPPL9PCC | 077355 |
| 7W | Compact Fluorescent | LPPL7PCC | 077345 |

Wall Mount

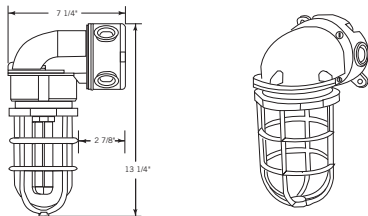

| Description | Part Number | Product Code |
|---|-------------|--------------|
| For wall mount fixtures select and order the appropriate style (wattage and globe) ceiling mount fixture from above and add LWB150 Wall Mount bracket | LWB150 | 077233 |



Hazardous Locations

Class I, Div 2 Groups A, B, C & D
Class II, Div 2 Groups F & G

Ceiling Mount

| Ceiling Mount with Heat Resistant Glass Globe | Part Number | Product Code |
|---|----------------|--------------|
| 150W Incandescent clear | LVPF150HRC-HAZ | 077414 |
| 150W Incandescent red | LVPF150HRR-HAZ | 077415 |
| 150W Incandescent blue | LVPF150HRB-HAZ | 077416 |
| 150W Incandescent green | LVPF150HRG-HAZ | 077417 |
| 150W Incandescent amber | LVPF150HRA-HAZ | 077494 |
| 26W Compact Fluorescent clear | LVPL26HRC-HAZ | 077377 |
| 26W Compact Fluorescent red | LVPL26HRR-HAZ | 077378 |
| 26W Compact Fluorescent blue | LVPL26HRB-HAZ | 077379 |
| 26W Compact Fluorescent green | LVPL26HRG-HAZ | 077399 |
| 26W Compact Fluorescent amber | LVPL26HRA-HAZ | 077400 |
| 18W Compact Fluorescent clear | LVPL18HRC-HAZ | 077347 |
| 18W Compact Fluorescent red | LVPL18HRR-HAZ | 077348 |
| 18W Compact Fluorescent blue | LVPL18HRB-HAZ | 077349 |
| 18W Compact Fluorescent green | LVPL18HRG-HAZ | 077353 |
| 18W Compact Fluorescent amber | LVPL18HRA-HAZ | 077354 |

Pendant Mount

| Pendant Mount with Heat Resistant Glass Globe | Part Number | Product Code |
|---|----------------|--------------|
| 150W Incandescent clear | LPMF150HRC-HAZ | 077495 |
| 150W Incandescent red | LPMF150HRR-HAZ | 077496 |
| 26W Compact Fluorescent clear | LPPL26HRC-HAZ | 077407 |
| 26W Compact Fluorescent red | LPPL26HRR-HAZ | 077409 |
| 18W Compact Fluorescent clear | LPPL18HRC-HAZ | 077500 |
| 18W Compact Fluorescent red | LPPL18HRR-HAZ | 077498 |

Wall Mount

| Description | Part Number | Product Code |
|---|-------------|--------------|
| For wall mount fixtures select and order the appropriate style (wattage and globe) ceiling mount fixture from above and add LWB150 Wall Mount bracket | LWB150 | 077233 |



Nonmetallic Utility Light Fixture

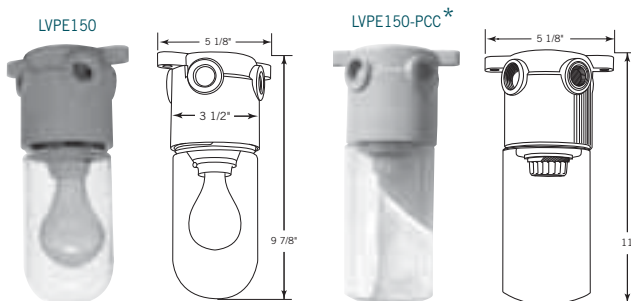

LVPE150

LVPE150-1015G



| Description | Part Number | Hub Size | Product Code |
|--|---------------|-------------|--------------|
| Fixture c/w Clear Glass Globe | LVPE150-10/15 | 1/2" - 3/4" | 077493 |
| Fixture c/w Clear Polycarbonate Globe | LVPE150-PCC* | 1/2" - 3/4" | 077181 |
| Fixture c/w Heat Resistant Clear Globe | LVPE150-HRC | 1/2" - 3/4" | 077578 |
| Fixture c/w Heat Resistant Red Globe | LVPE150-HRR | 1/2" - 3/4" | 077599 |
| Fixture c/w Heat Resistant Blue Globe | LVPE150-HRB | 1/2" - 3/4" | 077579 |
| Fixture c/w Heat Resistant Green Globe | LVPE150-HRG | 1/2" - 3/4" | 077597 |
| Fixture c/w Heat Resistant Amber Globe | LVPE150-HRA | 1/2" - 3/4" | 077598 |
| Replacement Clear Glass Globe | LGC150 | | 077247 |
| Nonmetallic Clamp-on Guard | LVPE150 | | 077558 |
| Fixture c/w Clear Glass Globe & Clamp-on guard | LVPE150-1015G | 1/2" - 3/4" | 077402 |

* Maximum 60W incandescent lamp with polycarbonate globe

Accessories & Components

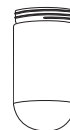

Standard Glass Globes

| Description | Part Number | Product Code |
|-------------|-------------|--------------|
| Clear | LGC150 | 077247 |



Heat Resistant Globes

| Description | Part Number | Product Code |
|-------------|-------------|--------------|
| Clear | LG150T | 077909 |
| Red | LCGR150T | 077239 |
| Blue | LCGB150T | 077910 |
| Green | LCGG150T | 077241 |
| Amber | LCGA150T | 077242 |

Polycarbonate Globes (for use with compact fluorescent or maximum 60W incandescent lamp)



| Description | Part Number | Product Code |
|-------------|-------------|--------------|
| Clear | LPCC18 | 077911 |
| Red | LPCR18 | 077912 |
| Blue | LPCB18 | 077913 |
| Green | LPCG18 | 077914 |
| Amber | LPCA18 | 077915 |

Threaded Junction Boxes



| Part Number | Product Code |
|-------------|--------------|
| LFB150C | 077250 |
| LFB150T * | 077251 |

*LFB150T complete with 1/2 threaded" hole in center of cover

Accessories & Components con't

Fixture Components (LVPF, LVPL, LPMF, LPPL)

| Description | Part Number | Product Code |
|--------------------------------|-------------|--------------|
| Ceiling Mount Box | LVPB 150 | 077243 |
| Pendant Mount Cap | LPC 150 | 077246 |
| 90 Wall Bracket | LWB 150 | 077233 |
| Socket Base Assembly | LSBA 150 | 077245 |
| Medium Base Replacement Socket | LSOC 150 | 077249 |
| Screw-on Guard | LVPG 150 | 077978 |

Replacement Lamps

| Description | Part Number | Product Code |
|----------------|-------------|--------------|
| 7 Watt | LD/E 7 | 072841 |
| 9 Watt | LD/E 9 | 072844 |
| 13 Watt | LD/E 13 | 072847 |
| 18 Watt (Quad) | LD/E 18 | 077947 |
| 26 Watt (Quad) | LD/E 26 | 077081 |

Replacement Lamp Holders

| Description | Part Number | Product Code |
|-----------------------------|-------------|--------------|
| 7/9 Watt Lamp Holder | LLH 7/9 | 072843 |
| 13 Watt Lamp Holder | LLH 13 | 072849 |
| 18 Watt Lamp Holder (4 Pin) | LLH 18 | 072818 |
| 26 Watt Lamp Holder (4 Pin) | LLH 26 | 077082 |

Ballasts

| Description | Part Number | Product Code |
|----------------------------------|-------------|--------------|
| 7/9 Watt Magnetic Ballast (NPF) | LEB 7/9 | 072842 |
| 13 Watt Magnetic Ballast (NPF) | LEB 13 | 072848 |
| 18 Watt Electronic Ballast (HPF) | LEB 18 | 077224 |
| 26 Watt Electronic Ballast (HPF) | LEB 26 | 077080 |

Gaskets

| Description | Part Number | Product Code |
|-------------|-------------|--------------|
| Box Gasket | LBGASK 150 | 072820 |
| Lamp Gasket | LLGASK 150 | 076971 |

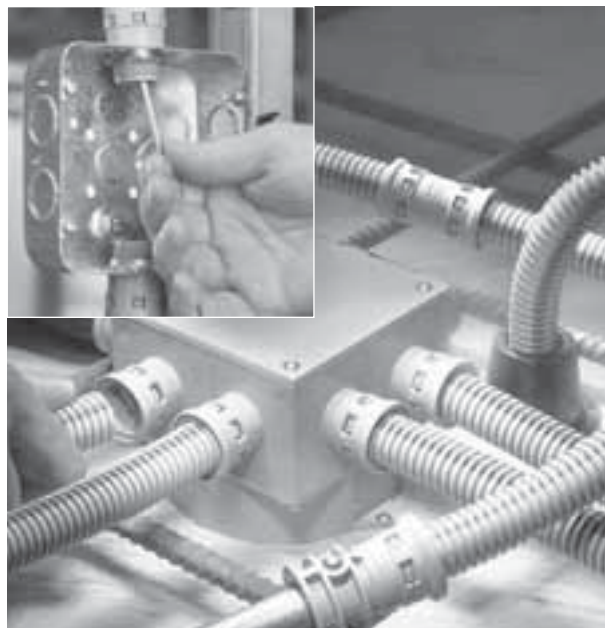

Cor-Line ENT – Savings for the Long Run

Noncorroding and nonconducting, Cor-Line Electrical Nonmetallic Tubing and fittings are designed *For The Long Run*. Coiled in lengths up to 1,500 feet, the Cor-Line system can span the longest run. Encased in concrete, concealed in walls or ceilings, Cor-Line offers the best alternative to the labour-intensive, 10' lengths of metal conduit with its couplings and scrap. The Cor-Line System is the right choice!

Kwikon Fittings

Our unique Kwikon couplings, transition couplings and connectors are designed with six 360° locking tabs to ensure a secure concrete-tight connection.

Time-consuming taping and solvent cementing are eliminated.



C22.2 – No. 227.1



Ease of Installation

Engineered for the rugged day-to-day challenges of the construction industry, Cor-Line has already established itself as a market leader. Requiring no special tools for bending or cutting, Cor-Line is easily installed.



Bending & Cutting

Cor-Line's corrugated construction allows it to be easily bent by hand, no longer requiring special bending equipment traditionally required with metal conduit systems. When bending, ensure the radius of the curve is at least six times the internal diameter of the tubing.



Pre-Assembly of Kwikon Slab Boxes

IPEX's Kwikon slab boxes are available with or without molded connectors. For boxes without molded connectors, pre-assembly is quick and simple using our snap-in connector or threaded male adapter with locknuts. Both provide a secure concrete-tight connection.



Pre-Assembly of Metallic Boxes

Metallic slab boxes can be quickly pre-assembled with Kwikon connectors. Secured with a locknut, Kwikon connectors provide a concrete-tight connection.



Installation in Sheer Walls, Interior Walls & Block Walls

Cor-Line's flexibility, lightweight and ease of handling in metal, wood, or block walls, combined with Kwikon connectors and couplings, substantially reduce time and labour needed to install electrical raceways.



Pulling Wire

Kwikon's interior corrugated surface greatly reduces the amount of friction while pulling conductors through long runs, even with 90° bends.



CSA Certified

Cor-Line Electrical nonmetallic tubing and Kwikon fittings are certified to CSA C22.2 No. 227.1.

FT-4 Approved

IPEX Cor-Line ENT tubing meets and exceeds the requirements of CSA's vertical char test as described in Clause 4.11.4 of CSA C22.2 No. 0.3M.



Direct Burial

The Canadian Electrical Code approves ENT for direct earth burial. Rules governing installation of Cor-Line ENT are covered in the CEC Part 1, Rule 12-1500 through 12-1516.

Installation in Noncombustible/Combustible Construction

Refer to Section 3.1.5.19 of the National Building Code for rules governing the use of combustible conduit in noncombustible and/or combustible buildings. Where provincial codes vary, please consult with the building authority having jurisdiction.

Nonmetallic Raceways for Fire Alarm System Conductors

Rule 32-102 of the CEC allows Cor-Line ENT to be used for fire alarm systems in noncombustible or combustible buildings provided: (1) the raceway is embedded in at least 50mm (2 in.) of masonry or poured concrete, and (2) where electrical nonmetallic tubing (ENT) is used, the transition from ENT to metal raceways is made in the concrete using a transition fitting or other acceptable means. (Kwikon transition fittings are specifically designed for this application.)





Reel & Coil Size

| | Size (in) | Length (ft) | Product Code | Weight lbs/pkg |
|------|-----------|-------------|--------------|----------------|
| Reel | 1/2 | 1500 | 012004 | 185 |
| | 3/4 | 1000 | 012009 | 145 |
| | 1 | 750 | 012019 | 155 |
| | 1-1/4 | 1000 | 012047 | 205 |
| | 1-1/2 | 750 | 012033 | 180 |
| | 2 | 500 | 012044 | 160 |
| Coil | 1/2 | 370 | 012000 | 37 |
| | 3/4 | 240 | 012008 | 30 |
| | 1 | 160 | 012018 | 28 |
| | 1-1/4 | 500 | 012046 | 102 |
| | 1-1/2 | 300 | 012032 | 72 |
| | 2 | 225 | 012043 | 62 |

Wrapped in plastic, coils are easily dispensed from the centre.

10' Sticks

| Size (in) | Length (ft) | Product Code | Weight lbs/pkg |
|-----------|-------------|--------------|----------------|
| 1/2 x 10' | 3600 | 012005 | 345 |
| 3/4 x 10' | 2200 | 012006 | 315 |
| 1 x 10' | 1800 | 012007 | 345 |

Cor-Line Dimensions

| Size (in) | ID (in) | OD (in) |
|-----------|---------|---------|
| 1/2 | 0.574 | 0.840 |
| 3/4 | 0.778 | 1.050 |
| 1 | 1.000 | 1.315 |
| 1-1/4 | 1.340 | 1.660 |
| 1-1/2 | 1.574 | 1.900 |
| 2 | 2.020 | 2.375 |

Weight Comparison of Cor-Line ENT vs EMT

| Size (in) | ENT lbs/1000' | EMT lbs/1000' |
|-----------|---------------|---------------|
| 1/2 | 100 | 295 |
| 3/4 | 125 | 440 |
| 1 | 175 | 668 |
| 1-1/4 | 185 | 970 |
| 1-1/2 | 220 | 1,100 |
| 2 | 319 | 1,517 |

Kwikon Coupling



| Size (in) | Part Number | Product Code | Package Qty |
|-----------|-------------|--------------|-------------|
| 1/2 | KC10 | 089000 | 150 |
| 3/4 | KC15 | 089001 | 100 |
| 1 | KC20 | 089002 | 50 |
| 1-1/4 | KC25 | 189670 | 30 |
| 1-1/2 | KC30 | 189671 | 30 |
| 2 | KC35 | 189672 | 20 |

Kwikon Connector For Concrete Encasement



| Size (in) | Part Number | Product Code | Package Qty |
|-----------|-------------|--------------|-------------|
| 1/2 | KTA10 | 089006 | 150 |
| 3/4 | KTA15 | 089007 | 100 |
| 1 | KTA20 | 089008 | 50 |
| 1-1/4 | KTA25 | 189680 | 30 |
| 1-1/2 | KTA30 | 189681 | 30 |
| 2 | KTA35 | 189682 | 20 |

Kwikon Snap-in Connector



| Size (in) | Part Number | Product Code | Package Qty |
|-----------|-------------|--------------|-------------|
| 1/2 | KTS10 | 089146 | 150 |
| 3/4 | KTS15 | 089147 | 100 |
| 1 | KTS20 | 089148 | 50 |

Kwikon Transition Coupling



| Size (in) | Part Number | Product Code | Package Qty |
|-----------|-------------|--------------|-------------|
| 1/2 | KTC10 | 089012 | 125 |
| 3/4 | KTC15 | 089013 | 100 |
| 1 | KTC20 | 089014 | 50 |

Kwikon 90° Stub Down Fittings

KT90 Stub Down Fittings (Kwikon x Threaded)



| Size (in) | Part Number | Product Code | Package Qty |
|-----------|-------------|--------------|-------------|
| 1/2 | KT90-10 | 089060 | 40 |
| 3/4 | KT90-15 | 089059 | 35 |
| 1 | KT90-20 | 089058 | 25 |

KK90 Stub Down Fittings (Kwikon x Kwikon)



| Size (in) | Part Number | Product Code | Package Qty |
|-----------|-------------|--------------|-------------|
| 1/2 | KK90-10 | 089055 | 40 |
| 3/4 | KK90-15 | 089056 | 35 |
| 1 | KK90-20 | 089057 | 25 |

Kwikon ENT Form Stubby



| Size (in) | Part Number | Product Code | Package Qty |
|-----------|-------------|--------------|-------------|
| 1/2 | KSTB-10 | 089330 | 150 |
| 3/4 | KSTB-15 | 089331 | 150 |
| 1 | KSTB-20 | 089332 | 150 |
| 1-1/4 | KSTB-25 | 089333 | 150 |

Kwikon ENT Multi-Link™ Form Stubby



| Size (in) | Part Number | Product Code | Package Qty |
|-----------|-------------|--------------|-------------|
| 1/2 | MSTB-10 | 089031 | 75 |
| 3/4 | MSTB-15 | 089026 | 75 |
| 1 | MSTB-20 | 089025 | 50 |

Kwikon ENT Angled Form Stubby



| Size (in) | Part Number | Product Code | Package Qty |
|-----------|-------------|--------------|-------------|
| 1/2 | KASTB-10 | 089233 | 50 |
| 3/4 | KASTB-15 | 089234 | 50 |
| 1 | KASTB-20 | 089235 | 50 |
| 1-1/4 | KASTB-25 | 089236 | 50 |
| 1-1/2 | KASTB-30 | 089238 | 50 |

Kwikon Slab Box

Engineered to be rugged and durable, IPEX's boxes will withstand construction's harshest environments.

Designed by contractors for contractors, Kwikon slab boxes are available in two unique styles, with or without molded connectors. Now you can provide a complete, nonmetallic slab system. Priced competitively with traditional steel mud boxes, Kwikon slab boxes increase labour efficiencies, reducing costs.

Features

- Approved for use with ceiling fans up to 35 lbs. and luminaries up to 50 lbs.
- Concrete tight
- All molded connectors have 360° locking tabs that exceed CSA and UL requirements for pull-out
- Molded connectors are also approved for use with Scepter Rigid PVC Conduit
- Manufactured from high impact PVC
- Nonmetallic / Nonconducting / Noncorroding
- Threaded brass inserts

Slab Box w/ Molded Connectors



| Hub Size (in) | Part Number | Product Code | Package Qty |
|-------------------------|-------------|--------------|-------------|
| 8 x 1/2 | SMB-H-10 | 089455 | 25 |
| 4 x 1/2, 2 x 3/4, 2 x 1 | SMB-H-10/20 | 089456 | 25 |
| 4 x 1/2, 4 x 3/4 | SMB-H-10/15 | 089457 | 25 |
| 8 x 3/4 | SMB-H-15 | 089459 | 25 |
| 4 x 3/4, 4 x 1 | SMB-H-15/20 | 089463 | 25 |

Slab Box w/o Molded Connectors

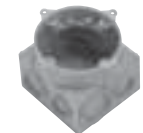

| Knockout Size (in) | Part Number | Product Code | Package Qty |
|-------------------------|-------------|--------------|-------------|
| 8 x 1/2 | SMB-10 | 089450 | 25 |
| 4 x 1/2, 2 x 3/4, 2 x 1 | SMB-10/20 | 089451 | 25 |

Slab Box Extension Ring



| Part Number | Product Code | Standard Packaging |
|-------------|--------------|--------------------|
| SMBR | 089494 | 20 |

Adjusts height of SMB/SMBH series slab boxes by 1"

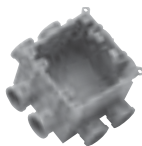

4" Square Slab Box

| Hub Size (in) | Part Number | Product Code | Package Qty |
|-------------------|-------------|--------------|-------------|
| 8 x 1/2 | SSBH-10 | 089452 | 25 |
| 8 x 3/4 | SSBH-15 | 089453 | 25 |
| 4 x 1/2 & 4 x 3/4 | SSBH-10/15 | 089454 | 25 |

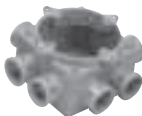

Shallow Slab Box

| Hub Size (in) | Part Number | Product Code | Package Qty |
|-------------------------|--------------|--------------|-------------|
| 8 x 1/2 | SMBS-H-10 | 089485 | 20 |
| 4 x 1/2 & 4 x 3/4 | SMBS-H-10/15 | 089486 | 20 |
| 8 x 3/4" | SMBS-H-15 | 089487 | 20 |
| 4 x 1/2, 2 x 3/4, 2 x 1 | SMBS-H-10/20 | 089488 | 20 |
| 4 x 3/4 & 4 x 1 | SMBS-H-15/20 | 089489 | 20 |

Concrete Wall Boxes

- Fully assembled and installation ready
- Perfectly suited for deep or shallow construction preferences
- Concrete-tight poly film covering the box opening
- Kwikon hubs do not protrude inside the box



Kwikon Concrete 3-1/2" Deep Concrete Wall Box

| Hub Size (in) | Part Number | Product Code |
|-------------------------|--------------|--------------|
| 4 x 1/2, 4 x 3/4 | SVDB-H-10/15 | 089496 |
| 4 x 3/4, 4 x 1 | SVDB-H-15/20 | 089049 |
| 4 x 1/2, 2 x 3/4, 2 x 1 | SVDB-H-10/20 | 089052 |
| 8 x 3/4 | SVDB-H-15 | 089065 |

Kwikon 2" Shallow Concrete Wall Box



| Hub Size (in) | Part Number | Product Code |
|---------------|-------------|--------------|
| 4 x 1/2 | SVSB-H-10 | 089054 |
| 4 x 3/4 | SVSB-H-15 | 089053 |

The NEW ENT Support Unit (ESU)

raises the tubing or conduit up off the concrete form during the concrete pour maintaining a level raceway and allows for maximum aggregate flow and concrete consolidation.



Easy to use, the ESU snaps around any size of ENT. It is perfect for use in high rise buildings constructed with post-tensioned (PT) concrete slabs.

Features

- One size fits all 1/2" - 2"
- Saves time and labour
- Easy locking mechanism
- Securable to the concrete form
- Minimal footprint reduces amount of surface contact

| Part Number | Product Code |
|-------------|--------------|
| ESU-10-35 | 089149 |

Accessories

ENT 4" Square Box Flat Cover

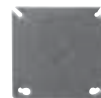

| Size (in) | Part Number | Product Code |
|-----------|-------------|--------------|
| 1/2 KO | KWBC-10 | 089500 |

Tapered Plugs



| Size (in) | Part Number | Product Code | Package Qty |
|-----------|-------------|--------------|-------------|
| 1/2 | TP10 | 089003 | 100 |
| 3/4 | TP15 | 089004 | 100 |
| 1 | TP20 | 089005 | 100 |

Kwikon Cutter & Blades



| Description | Part Number | Product Code |
|--------------------|-------------|--------------|
| Cutter (1/2" - 1") | CLC20 | 089066 |
| Blades for CLC20 | SSB | 089067 |
| Cutter (1/2" - 2") | CLC35 | 089068 |
| Blades for CLC35 | SB35 | 089069 |

Visit our website:

www.ipexelectrical.com

PRODUCT INFO

TECHNICAL DOCUMENTS

ONLINE TRAINING

& MUCH MORE ...



+ **DOWNLOAD**

OUR SCEPTER ELECTRICAL
CATALOGUE OR OUR
ELECTRICAL POCKET PRO



Super Duct Pipe and Fittings

Super Duct is recognized by major utilities, contractors and engineering firms as the premier ducting product available on the market.

Super Duct is manufactured with a specialized compound and engineered for high impact and crush strength specifically required by utilities for underground duct. This compound enhances the friction coefficient of Super Duct for easier pulling of conductors/wires through long runs.

Rigid Super Duct (Type DB-2) conforms to the testing requirements of CSA Standard C22.2 No. 211.1 both for encasement in concrete/masonry and for direct burial.



CSA C22.2
No. 211.1



Lightweight

Super Duct is easy to carry and install, reducing labour and costs.

Long Lengths

Super Duct is available in 10' and 20' lengths, minimizing the number of connections needed.

Bell Ends

Super Duct is bell-ended, allowing for easy assembly in the field.

High Compressive Strength

Super Duct's specially formulated compound is designed to withstand high loads.

Low Coefficient of Friction

The smooth bore of Super Duct facilitates cable pulling and eliminates costly cable damage.

Quality Control

Stringent, continuous testing ensures that Super Duct is a consistently high quality product.

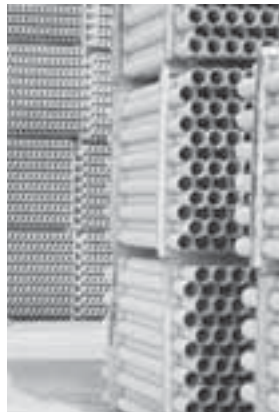

Field Bending

The natural flexibility of IPEX Super Duct allows field bending, so minor changes in elevation or direction can often be accommodated without the use of special sweeps or fittings. The following table indicates typical maximum offset bends that can be achieved by "cold bending."

Allowable Offset for Super Duct

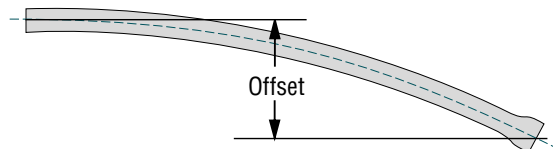

| Size | Max Allowable Offset 10' Length | | Max Allowable Offset 20' Length | | |
|-------|------------------------------------|----|------------------------------------|----|-------|
| | in. | mm | in. | mm | |
| 2 | 50 | 20 | 508 | 79 | 2 007 |
| 3 | 75 | 14 | 356 | 56 | 1 422 |
| 3-1/2 | 90 | 12 | 305 | 49 | 1 245 |
| 4 | 100 | 11 | 279 | 43 | 1 092 |
| 5 | 125 | 7 | 178 | 35 | 889 |
| 6 | 150 | 7 | 178 | 29 | 737 |

NOTES:

1. Axial deflection should not be attempted at the joints.
2. The above values were established for ambient temperatures above the freezing point. Increased radii may be desirable at below-freezing temperatures.

Super Duct (Type DB-2)

| Description | CSA Requirements | Reference |
|---------------------|---|---------------------|
| Pipe Stiffness @ 5% | 43.5 psi (300 kPa) | CSA C22.2 No. 211.1 |
| Crush Resistance | 198 lbs. @ 73°F (90 kg @ 23°C) 10% max. residual deflection | CSA C22.2 No. 211.1 |
| Impact Resistance | 45 ft. lbf @ 73°F (61J @ 23°C) 25 ft. lbf @ 0°F (34J @ -18°C) | CSA C22.2 No. 211.1 |
| Residual Stress | 149°F (65°C) for 4 hours. Allow to cool to 73°F (23°C). 0.5% shrinkage allowed. | CSA C22.2 No. 211.1 |
| Joint Tightness | 5 psi (35 kPa) internal water pressure applied for 24 hours. | CSA C22.2 No. 211.1 |

Note: Super Duct meets or exceeds all CSA requirements.



Bends

Standard 90°, 45° and 22 1/2° bends are available from sizes 2" through to 6" in 24", 36", 42" and 60" radius. All bends are supplied with 6" (15.2cm) tangents. The centre line lay length (L) can be calculated using;

$$L = \left(\pi r \times \frac{\xi}{180} \right) + 2 (\text{tangent})$$

Where: $\pi = 3.14$

L = centre line lay length

r = radius of bend

ξ = angle of bend

tangent = 6"

Example: for a 3" 90° bend with a 36" radius - calculate the lay length:

$$L = \left(3.14 \times 36 \times \frac{90^\circ}{180^\circ} \right) + 2 (6)$$

L = 69 inches

$$L (\text{metres}) = \frac{L \text{ imperial}}{12 \times 3.281} = \frac{69"}{39.37} = 1.75\text{m}$$

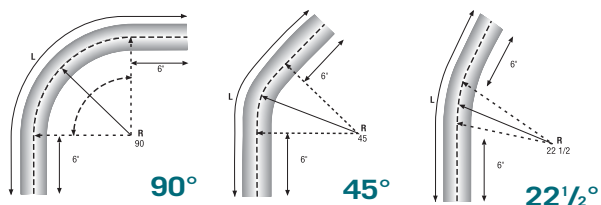

90°

45°

22 1/2°

Static Friction Coefficient

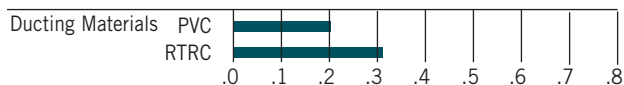

Concrete Encased Duct Installation

For multipurpose power cable and communication duct banks, spacing between ducts is critical for optimum performance. IPEX has designed the Monobloc and Vertical Lok Spacer systems to accommodate all specification and field installations.

These light weight spacers provide the vertical and horizontal separation required in a trench.

With spacers in place on the trench bottom, lay the first tier of ducts. When using a concrete base, lay the bottom tier before the base has taken initial set. Place subsequent tiers of spacers on top of the tier until the required number of ducts are installed. Then tie the entire assembly together. It is not necessary to weight or brace the bank unless the concrete mix is very wet.



The Concrete Pour

Do not allow a heavy mass of concrete to fall directly onto the duct. If this is a possibility, use a plank to direct the concrete down the sides of the bank assembly to the trench bottom. The concrete will flow to the centre of the bank and rise up in the middle, uniformly filling all open spaces. Voids can be eliminated by carefully working a long, flat slicing bar or spatula up and down between the vertical rows of ducts. Concrete should then flow between and under all of the ducts.

Duct Bank Elevation

Monobloc spacers should be staggered. It is recommended that spacers be located approximately one-fifth of duct length from each end. Vertical Lok spacers should be located to a maximum of every 5.5 ft. (1.7m).

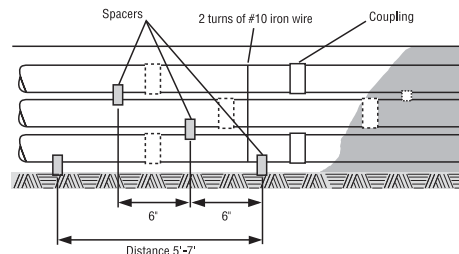

Backfilling

Backfill with regular excavated soil after the concrete has set.

Concrete Encased Tier-by-Tier Installation

The advantage of this method is the production of a solid, void-free concrete envelope. Simply pour each tier independently.

Trench Bottom

After grading the trench, place a foundation of 3" of concrete on the bottom. It should be smooth and graded.

Bank Assembly

Lay the bottom tier of ducts on the concrete base. Ducts should be spaced with wooden combs (two per duct length). Concrete the first tier level to the top of the comb. Remove combs and fill the voids. Light tamping will ensure an even surface. Repeat this sequence until the bank is built up.

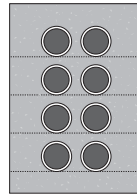

Cross-section of tier-by-tier method.

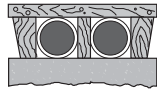

Type of wood comb used.

Concreting

If the concrete is allowed to set before assembling the next tier, the concrete will be stronger and more dense and the ducts will be aligned straighter. One problem with this method is that the bank will be in a series of layers and therefore more likely to heave and separate under frost conditions. If successive tiers are laid before the concrete has set, a satisfactory bond will be achieved by tamping the dry concrete.

Backfilling

Backfill with regular excavated soil when the bank is complete.

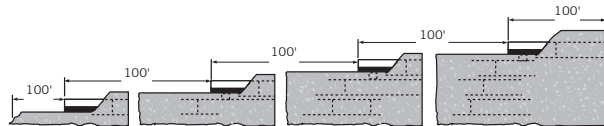

Duct is usually laid in 100' sections once the trench is excavated. Therefore, concreting can be a continuous process.

Direct Burial Installation

Trench Bottom

The trench bottom should provide a continuous, firm and uniform support for the duct bank construction. Care should be taken to avoid lumps, ridges, depressions and stones causing "point" contacts or uneven bearing.

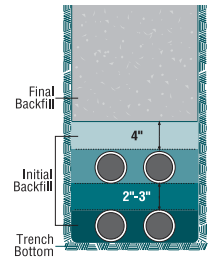

Rock or Shale

Excavate 3" below the desired depth and bring the trench back to grade with selected tamped soil. This will provide the duct with a uniform bedding surface.

Unstable Soils

Tests should be conducted to establish the soil strength in marshy or swampy areas. It may be necessary in these conditions to dig deeper and refill with crushed stone or gravel, or to employ mats, timbers or a concrete base.

Placement of Duct

After the first tier of ducts is installed, backfill and compact as outlined below. If wood combs are employed for spacing, remove them as the backfill is placed and tamped. Then begin the next tier.

Initial Backfilling

1. Fit side and centre to the top of the ducts. Use a hand tamper only to tamp firmly.
2. Backfill over the duct to the required thickness (see note) and tamp firmly, using only a hand tamper.

Final Backfilling

When the last tier is placed, hand-place the backfill to 4" over the duct with soil that does not contain stones larger than 3/8". Hand-tamping of this layer is optional, depending on the specifications.

From this point, backfill may be completed by hand or by pneumatic tamping in layers from 4" to 12" depending on the degree of compaction desired.

When placing backfill by machine, avoid the use of large rocks until a protective layer (minimum of 12") is established.

Note: In direct burial, no spacer should be used with Type 2; spacers provide "point" support instead of the continuous bed required. Backfill thickness between ducts is usually 2" to 3".



CSA Type II

| Dimension (in) | 10' L Belled Product Code | Ft/Crate | 20' L Belled Product Code | Ft/Crate | Weight/100' (lbs) |
|----------------|---------------------------|----------|---------------------------|----------|-------------------|
| 2 | 008220 | 2,460 | 08221 | 4,920 | 33.7 |
| 3 | 008230 | 1,120 | 08231 | 2,240 | 61.2 |
| 3-1/2 | 008235 | 810 | 08236 | 1,620 | 77.3 |
| 4 | 008240 | 630 | 08241 | 1,260 | 99.2 |
| 5 | 008250 | 430 | 08251 | 860 | 159.6 |
| 6 | 008260 | 280 | 08261 | 560 | 226.6 |

CSA Type II Split Duct

| Dimension (in) | Product Code | Ft/Crate | Weight/100' (lbs) |
|----------------|--------------|----------|-------------------|
| 2 | 008222 | 2,460 | 33.7 |
| 3 | 008232 | 1,120 | 61.2 |
| 3-1/2 | 008237 | 810 | 77.3 |
| 4 | 008242 | 630 | 99.2 |
| 5 | 008252 | 430 | 159.6 |
| 6 | 008262 | 280 | 226.6 |

Super Duct Dimensions in Inches

| Duct Diameter | Minimum ID | Nominal Wall | Average OD |
|---------------|------------|--------------|------------|
| 2 | 2.001 | .082 | 2.250 |
| 3 | 3.000 | .097 | 3.250 |
| 3-1/2 | 3.480 | .109 | 3.730 |
| 4 | 3.941 | .120 | 4.216 |
| 5 | 4.974 | .153 | 5.299 |
| 6 | 5.896 | .180 | 6.275 |

Super Duct Dimensions in Millimetres

| Duct Diameter | Minimum ID | Nominal Wall | Average OD |
|---------------|------------|--------------|------------|
| 50 | 50.83 | 2.08 | 57.15 |
| 75 | 76.20 | 2.46 | 82.55 |
| 90 | 88.39 | 2.77 | 94.74 |
| 100 | 100.10 | 3.05 | 107.09 |
| 125 | 126.34 | 3.89 | 134.60 |
| 150 | 149.76 | 4.57 | 159.39 |

PVC Coupling - Solvent Weld



| Dimension (in) | Part Number | Product Code |
|----------------|-------------|--------------|
| 2 | SWC020 | 029001 |
| 2 (long) | SWC020L | 029009 |
| 3 | SWC030 | 029002 |
| 3-1/2 | SWC035 | 029003 |
| 4 | SWC040 | 029004 |
| 5 | SWC050 | 029005 |
| 6 | SWC060 | 029006 |

Polyethylene Coupling – Push Fit



| Dimension (in) | Part Number | Product Code |
|----------------|-------------|--------------|
| 2 | PFC020 | 029011 |
| 3 | PFC030 | 029012 |
| 3-1/2 | PFC035 | 029013 |
| 4 | PFC040 | 029014 |
| 5 | PFC050 | 029015 |
| 6 | PFC060 | 029016 |

PVC 5° Coupling – Solvent Weld



| Dimension (in) | Part Number | Product Code |
|----------------|-------------|--------------|
| 2 | 5ACS20 | 029041 |
| 3 | 5ACS30 | 029042 |
| 3-1/2 | 5ACS35 | 029043 |
| 4 | 5ACS40 | 029044 |
| 5 | 5ACS50 | 029045 |
| 6 | 5ACS60 | 029046 |

Polyethylene 5° Coupling – Push Fit



| Dimension (in) | Part Number | Product Code |
|----------------|-------------|--------------|
| 3 | 5APF30 | 029030 |
| 3-1/2 | 5APF35 | 029502 |
| 4 | 5APF40 | 029998 |
| 5 | 5APF50 | 029050 |

Expansion Joint



| Dimension (in) | Part Number | Product Code |
|----------------|-------------|--------------|
| 2 | EXPJ20 | 029151 |
| 3 | EXPJ30 | 029152 |
| 3-1/2 | EXPJ35 | 029153 |
| 4 | EXPJ40 | 029154 |

Reducer Coupling – Solvent Weld



| Dimension (in) | Part Number | Product Code |
|----------------|-------------|--------------|
| 3 x 2 | RC3020 | 029021 |
| 3-1/2 x 2 | RC3520 | 029039 |
| 3-1/2 x 3 | RC3530 | 029022 |
| 4 x 2 | RC4020 | 029023 |
| 4 x 3 | RC4030 | 029024 |
| 4 x 3-1/2 | RC4035 | 029025 |
| 5 x 4 | RC5040 | 029026 |
| 6 x 4 | RC6040 | 029027 |

Split Wye – Solvent Weld

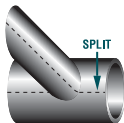

| Dimension (in) | Part Number | Product Code |
|----------------|-------------|--------------|
| 2 | SPLY20 | 029051 |
| 3 | SPLY30 | 029052 |
| 3-1/2 | SPLY35 | 029053 |
| 4 | SPLY40 | 029054 |

PVC Bell Ends

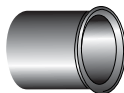

| Dimension (in) | Part Number | Product Code |
|----------------|-------------|--------------|
| 2 | BELL20 | 029061 |
| 3 | BELL30 | 029062 |
| 3-1/2 | BELL35 | 029063 |
| 4 | BELL40 | 029064 |
| 5 | BELL50 | 029065 |
| 6 | BELL60 | 029066 |

Terminator with Knock-Out Plugs



| Dimension (in) | Part Number | Product Code |
|----------------|-------------|--------------|
| 3 | TERM30 | 029826 |
| 3 1/2 | TERM35 | 029523 |
| 4 (with holes) | TERM40H | 029822 |
| 4 (no holes) | TERM40W | 029827 |

Cap – Solvent Weld



| Dimension (in) | Part Number | Product Code |
|----------------|-------------|--------------|
| 2 | SWCA20 | 029071 |
| 3 | SWCA30 | 029072 |
| 3-1/2 | SWCA35 | 029073 |
| 4 | SWCA40 | 029074 |
| 5 | SWCA50 | 029075 |
| 6 | SWCA60 | 029076 |

90° Long Sweep Bend

| Dimension (in) | Part Number | Product Code |
|----------------|-------------|--------------|
| 2 x 24 R | 902024 | 029091 |
| 2 x 36 R | 902036 | 029092 |
| 2 x 60 R | 902060 | 029036 |
| 3 x 24 R | 903024 | 029055 |
| 3 x 36 R | 903036 | 029093 |
| 3 x 60 R | 903060 | 029134 |
| 3-1/2 x 24 R | 903524 | 029123 |
| 3-1/2 x 36 R | 903536 | 029094 |
| 3-1/2 x 60 R | 903560 | 029135 |
| 4 x 24 R | 904024 | 029047 |
| 4 x 36 R | 904036 | 029095 |
| 4 x 60 R | 904060 | 029096 |
| 5 x 42 R | 905042 | 029097 |
| 5 x 60 R | 905060 | 029037 |
| 6 x 60 R | 906060 | 029098 |

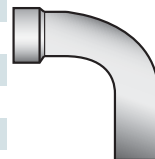

45° Long Sweep Bend

| Dimension (in) | Part Number | Product Code |
|----------------|-------------|--------------|
| 2 x 24 R | 452024 | 029111 |
| 2 x 36 R | 452036 | 029112 |
| 3 x 24 R | 453024 | 029082 |
| 3 x 36 R | 453036 | 029113 |
| 3-1/2 x 36 R | 453536 | 029114 |
| 4 x 24 R | 454024 | 029128 |
| 4 x 36 R | 454036 | 029115 |
| 4 x 60 R | 454060 | 029116 |
| 5 x 42 R | 455042 | 029117 |
| 6 x 60 R | 456060 | 029118 |



22 1/2° Long Sweep Bend

| Dimension (in) | Part Number | Product Code |
|----------------|-------------|--------------|
| 3 x 36 R | 223036 | 029085 |
| 4 x 36 R | 224036 | 029204 |
| 5 x 42 R | 225042 | 029249 |



Note: Special radius bends are available upon request.

Tapered Plug



| Dimension (in) | Part Number | Product Code |
|----------------|-------------|--------------|
| 2 | PLUG20 | 029131 |
| 3 | PLUG30 | 029132 |
| 3-1/2 | PLUG35 | 029133 |
| 4 | PLUG40 | 029078 |
| 5 | PLUG50 | 029079 |
| 6 | PLUG60 | 029136 |

Universal Pipe Plug



| Dimension (in) | Part Number | Product Code |
|----------------|-------------|--------------|
| 2 & 2-1/2 | UPP35 | 077433 |
| 3 & 3-1/2 | UPP45 | 077434 |
| 4 | UPP55 | 077435 |
| 5 | UPP60 | 077436 |
| 6 | UPP65 | 077437 |

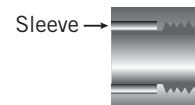

Female Adapter

| Dimension (in) | Part Number | Product Code |
|----------------|-------------|--------------|
| 2 | FEMA20 | 029141 |
| 3 | FEMA30 | 029142 |
| 3-1/2 | FEMA35 | 029143 |
| 4 | FEMA40 | 029144 |
| 5 | FEMA50 | 029145 |
| 6 | FEMA60 | 029146 |

Conduit to Duct Adapter

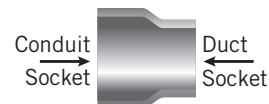

| Dimension (in) | Part Number | Product Code |
|----------------|-------------|--------------|
| 2 | ARIG20 | 029181 |
| 2 (long) | ARIG20L | 029188 |
| 3 | ARIG30 | 029182 |
| 3-1/2 | ARIG35 | 029183 |
| 4 | ARIG40 | 029184 |
| 5 | ARIG50 | 029185 |
| 6 | ARIG60 | 029186 |

Note: Duct to RTRC Conduit Adapters are available on request.

Reducing Adapter Coupling – Duct to PVC Conduit



| Dimension (in) | Part Number | Product Code |
|----------------|-------------|--------------|
| 3 x 2 | ARIG3020 | 029191 |
| 4 x 2 | ARIG4020 | 029192 |
| 4 x 3 | ARIG4030 | 029187 |

PVC Adapter Coupling – Asbestos Cement or Bituminous Fibre

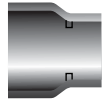

| Dimension (in) | Part Number | Product Code |
|----------------|-------------|--------------|
| 3-1/2 | ACFB35 | 029163 |
| 4 | ACFB40 | 029164 |

Vertical-Lok Spacers

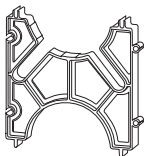

Intermediate

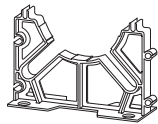

Base

| Dimension (in) | Part Number | Product Code | Part Number | Product Code |
|----------------|-------------|--------------|-------------|--------------|
| 2 x 1-1/2 | IS3530 | 029550 | BS3530 | 029566 |
| 2 x 2 | IS3535 | 029551 | BS3535 | 029567 |
| 2 x 3 | IS3545 | 029552 | BS3545 | 029568 |
| * 3 x 1-1/2 | IS4530 | 029553 | BS4530 | 029569 |
| 3 x 2 | IS4535 | 029554 | BS4535 | 029570 |
| 3 x 3 | IS4545 | 029555 | BS4545 | 029571 |
| * 4 x 1 | IS5520 | 029556 | BS5520 | 029572 |
| 4 x 1-1/2 | IS5530 | 029557 | BS5530 | 029573 |
| 4 x 2 | IS5535 | 029558 | BS5535 | 029574 |
| 4 x 3 | IS5545 | 029559 | BS5545 | 029575 |
| * 5 x 1-1/2 | IS6030 | 029560 | BS6030 | 029576 |
| 5 x 2 | IS6035 | 029561 | BS6035 | 029577 |
| 5 x 3 | IS6045 | 029562 | BS6045 | 029578 |
| 6 x 1-1/2 | IS6530 | 029563 | BS6530 | 029579 |
| 6 x 2 | IS6535 | 029564 | BS6535 | 029580 |
| 6 x 3 | IS6545 | 029565 | BS6545 | 029581 |
| * 8 x 2 | IS8035 | 029294 | BS8035 | 029293 |

* Do not have rebar slots or base holes

Monobloc Spacer Benefits for Telephone Duct:

- lightweight; easy to handle and install
- weatherproof
- resilient at extremely low temperatures
- flexible, yet tough
- readily available in a wide range of sizes and configurations
- economical
- immune to corrosion attack
- approved by Bell Canada
- versatile, as they can be used as both a base & intermediate spacer

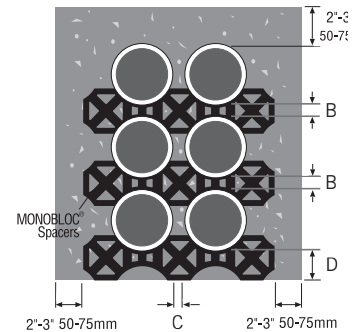

Selection Table (in inches)

| Nominal Size (A) | Vertical Spacing (B) | Horizontal Spacing (C) | Ground Clearance (D) | Number of Ways (E) |
|---------------------|-------------------------|---------------------------|-------------------------|-----------------------|
| 2 | 1-1/2 | 1-1/2 | 3 | 2 |
| 3 | 1-1/2 | 1-1/2 | 3 | 2 |
| 3-1/2 | 1 | 1 | 2 | 2 - 3 - 4 |
| 4 | 1 | 1 | 2 | 1 - 2 - 3 - 4 |
| 4 | 1-1/2 | 1-1/2 | 3 | 2 - 3 - 4 |
| 4 | 2 | 2 | 3 | 1 - 2 - 3 - 4 |
| 4 | 3 | 3 | 3 | 2 - 3 - 4 |
| 4 | 3 | 3 | 4 | 2 - 3 - 4 |
| 4-1/2 | 2 | 2 | 3 | 1 - 2 - 3 |
| 5 | 1-1/2 | 2-1/8 | 3-5/8 | 1 |
| 5 | 1-1/2 | 1-1/2 | 3 | 2 - 3 - 4 |

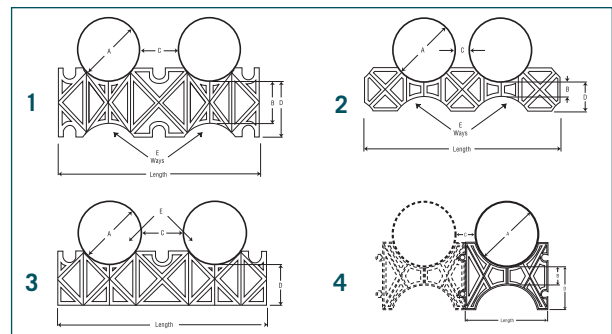

Monobloc Duct Spacers

| Description (in) A, B, C, D | E | Product Code | Dimensional Drawing | F length (in) |
|--------------------------------|-------|-----------------|------------------------|------------------|
| 2 x 1-1/2 x 1-1/2 x 3 | 2 way | 029473 | 2 | 7.9 |
| 3 x 1-1/2 x 1-1/2 x 3 | 2 way | 029474 | 2 | 10.3 |
| 3-1/2 x 1 x 1 x 2 | 2 way | 029860 | 2 | 12.4 |
| 3-1/2 x 1 x 1 x 2 | 3 way | 029861 | 2 | 17.3 |
| 3-1/2 x 1 x 1 x 2 | 4 way | 029479 | 2 | 20.9 |
| 4 x 1 x 1 x 2 | 1 way | 029475 | 2 | 8.3 |
| 4 x 1 x 1 x 2 | 2 way | 029476 | 2 | 13.5 |
| 4 x 1 x 1 x 2 | 3 way | 029477 | 2 | 18.8 |
| 4 x 1 x 1 x 2 | 4 way | 029478 | 2 | 24.2 |
| 4 x 1-1/2 x 1-1/2 x 3 | 2 way | 029470 | 1 | 14.2 |
| 4 x 1-1/2 x 1-1/2 x 3 | 3 way | 029471 | 1 | 20.0 |
| 4 x 1-1/2 x 1-1/2 x 3 | 4 way | 029472 | 1 | 26.0 |
| 4 x 2 x 2 x 3 | 1 way | 029480 | 2 | 8.3 |
| 4 x 2 x 2 x 3 | 2 way | 029464 | 1 | 14.5 |
| 4 x 2 x 2 x 3 | 3 way | 029465 | 1 | 20.7 |
| 4 x 2 x 2 x 3 | 4 way | 029499 | 1 | 27.0 |
| 4 x 3 x 3 x 3 (Base) | 2 way | 029466 | 3 | 15.0 |
| 4 x 3 x 3 x 3 (Base) | 3 way | 029488 | 3 | 22.5 |
| 4 x 3 x 3 x 3 (Base) | 4 way | 029489 | 3 | 30.0 |
| 4 x 3 x 3 x 4 | 2 way | 029469 | 1 | 15.0 |
| 4 x 3 x 3 x 4 | 3 way | 029497 | 1 | 22.5 |
| 4 x 3 x 3 x 4 | 4 way | 029498 | 1 | 30.1 |
| 4-1/2 x 2 x 2 x 3 | 1 way | 029485 | 2 | 8.7 |
| 4-1/2 x 2 x 2 x 3 | 2 way | 029486 | 2 | 15.5 |
| 4-1/2 x 2 x 2 x 3 | 3 way | 029487 | 2 | 22.2 |
| 5 x 1-1/2 x 2-1/8 x 3-5/8 | 1 way | 029455 | 4 | 7.0 |
| 5 x 1-1/2 x 1-1/2 x 3 | 2 way | 029494 | 2 | 16.2 |
| 5 x 1-1/2 x 1-1/2 x 3 | 3 way | 029495 | 2 | 23.1 |
| 5 x 1-1/2 x 1-1/2 x 3 | 4 way | 029496 | 2 | 30.0 |



SceptaCon™ Trenchless Raceway Systems

SceptaCon is one of the first PVC systems designed for the rigors of trenchless applications. It links seamlessly to existing PVC conduit infrastructures and allows utility companies to standardize on PVC throughout their entire electrical systems.

SceptaCon's slide-in locking system and pre-installed, pre-lubricated gaskets allow contractors to create a water-tight seal by hand in seconds - in all temperatures - without having to worry about solvents or chemicals freezing or drying too quickly.

Its unique spline-lock snaps into a recessed opening, ensuring the spline won't get snagged during pull-through. SceptaCon's rounded bell shoulders slide easily past roots, rocks and other debris in the borehole, ensuring a smooth, easy installation. And because SceptaCon is made to the same high standards as our Scepter rigid PVC conduit, contractors and electrical utilities can be assured of the same level of quality - above ground and below.



No Cementing or Lubrication

SceptaCon's slide-in locking system and pre-installed, pre-lubricated gaskets allow contractors to create a water-tight seal by hand in seconds.

Outperforms Other PVC Products

SceptaCon's unique spline-lock snaps into a recessed opening, ensuring the spline won't get snagged during pull-through. SceptaCon's rounded bell shoulders slide easily past roots, rocks and other debris in the borehole, ensuring a smooth, easy installation.

No Fusion Required

Because SceptaCon's joints can be quickly joined by hand in seconds, crews don't need large, expensive fusion equipment or special training to create water-tight joints. In addition, SceptaCon can be assembled one pipe length at a time, then pulled underground, eliminating the need for long strings of pipe on the job.

Superior Performance

SceptaCon is made from durable schedule 40 PVC that's resistant to creasing, scoring or flattening when pulled past obstructions in the borehole, yet flexible enough to bend with underground twists and turns. SceptaCon remains round, unlike HDPE which can stretch and become oval.

Easy to Handle

SceptaCon is available in convenient 10' and 20' lengths that are light-weight, easy to handle and no problem to work with in all types of weather.

SceptaCon™ Raceway

| Length | Product Code |
|----------|--------------|
| 3" x 10' | 106330 |
| 3" x 20' | 106331 |
| 4" x 10' | 106340 |
| 4" x 20' | 106341 |
| 5" x 10' | 106350 |
| 5" x 20' | 106351 |
| 6" x 10' | 106360 |
| 6" x 20' | 106361 |



Kwikpath® Optical Fibre & Communication Cable Raceway Systems

Kwikpath comes together faster and easier than other raceway systems, thanks largely to a patented "snap-on" design that ensures fittings and raceway assemble and terminate easily with no special tools or handling equipment needed. The six locking tabs keep the fitting tightly connected with tremendous pull-out resistance. All without messy cementing or screws to tighten.

With its handy coil lengths delivered in dual purpose protective packaging/pull box, Kwikpath makes home-run systems easy and economical, letting you run cable from your telecommunications box directly to a workstation outlet with fewer couplings. Being able to cut to length on the job site ensures that you don't run short or have wasted conduit left over.

Whether in narrow shafts or tight plenums, its lightweight and fast, trouble-free installation make Kwikpath the number one choice for commercial and residential cable management.

Codes & Standards

- EIA/TIA
- CEC 2002/NBC
- NFPA
- Plenum FT6
- Riser FT4
- General Purpose FT1



Compliance to Building Regulations

Kwikpath meets all building regulations and is the only fully approved raceway and fitting combination on the market.



A Fitting Choice

The Kwikpath fitting system reduces the need for pulling long runs of raceway around awkward corners and tight spaces. And the industry first Y-Coupler reduces the number of pull boxes required in your system design.



Installation Friendly Packaging

200' coils are packaged individually in corrugated boxed cartons for ease of handling and dispensing. Designed into the cartons are packaging features that assist with moving and dispensing the product. By using the dispensing method, only the necessary product amount is withdrawn from the carton with the balance being contained and easily managed.

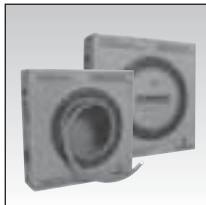

Reduces Costs Now and Over Long Term

Kwikpath is designed to allow easier cable installation and removal than other careway systems. Simply pull cables through the raceway – no more fishing new cables blindly through walls or ceilings. Kwikpath also reduces renovation costs by eliminating the need to remove existing cabling in retrofit applications.



Protects Cable Integrity and Performance

Kwikpath prevents cables from being damaged on edges or snags as they're pulled through the raceway. Once cables are installed, Kwikpath offers flame resisting properties and its protective shell prevents damage to cables when renovations cause tradesmen to enter or change the walls or ceilings.



Kwikpath Plenum Raceway

Kwikpath Plenum is made from a UL approved compound and like Kwikpath Riser, forms nonmetallic, flexible corrugated cable raceways. Vibrant orange in colour, Kwikpath Plenum meets the UL tests on flame propagation and smoke density with values well below the standard requirements. This heat/smoke-resistance makes it an ideal raceway to run Optical Fiber Cables (OFPN) and/or Communication Cables (CMP/CMP-OF) through plenums and other spaces used for environmental air. Kwikpath Plenum comes with sequential markers every foot.



Plenum Coil with Pull Tape

| Size | Length | Part Number | Product Code |
|--------|--------|-------------|--------------|
| 3/4" | 200' | KPP075TC | 124020 |
| 1" | 200' | KPP100TC | 124011 |
| 1-1/4" | 200' | KPP125TC | 124012 |
| 1-1/2" | 200' | KPP150TC | 124013 |
| 2" | 200' | KPP200TC | 124014 |

Also available without pull tape - minimum quantity required.



Plenum Reel with Pull Tape

| Size | Length | Part Number | Product Code |
|--------|--------|-------------|--------------|
| 3/4" | 1000' | KPP075TR | 124021 |
| 1" | 1000' | KPP100TR | 124015 |
| 1" | 2500' | KPP100TR48 | 124022 |
| 1" | 5000' | KPP100TR72 | 124023 |
| 1-1/4" | 1000' | KPP125TR | 124016 |
| 1-1/4" | 4000' | KPP125TR72 | 124024 |
| 1-1/2" | 750' | KPP150TR | 124017 |
| 2" | 500' | KPP200TR | 124018 |

Also available without pull tape - minimum quantity required.



Kwikpath Plenum Fittings

Kwikpath Plenum fittings are molded from approved material to be used with Kwikpath Plenum raceway meeting all Standards requirements.

Plenum Coupling



| Size | Part Number | Product Code |
|--------|-------------|--------------|
| 3/4" | KPPC075 | 132650 |
| 1" | KPPC100 | 132651 |
| 1-1/4" | KPPC125 | 132652 |
| 1-1/2" | KPPC150 | 132653 |
| 2" | KPPC200 | 132654 |

Plenum Terminal Adapter c/w Lockout



| Size | Part Number | Product Code |
|--------|-------------|--------------|
| 3/4" | KPTA075 | 132660 |
| 1" | KPTA100 | 132661 |
| 1-1/4" | KPTA125 | 132662 |
| 1-1/2" | KPTA150 | 132663 |
| 2" | KPTA200 | 132664 |

Kwikpath Riser Raceway

The backbone of the structured cabling system, Kwikpath Riser is a nonmetallic, flexible PVC corrugated product manufactured and tested specifically for riser applications. Easily identified by its mandarin orange color, it's available in convenient coil or reel packaging with sequential markers every foot.



Riser Coil with Pull Tape

| Size | Length | Part Number | Product Code |
|--------|--------|-------------|--------------|
| 3/4" | 200' | KPR075TC | 125026 |
| 1" | 200' | KPR100TC | 125011 |
| 1-1/4" | 200' | KPR125TC | 125012 |
| 1-1/2" | 200' | KPR150TC | 125013 |
| 2" | 200' | KPR200TC | 125014 |

Also available without pull tape - minimum quantity required.



Riser Reel with Pull Tape

| Size | Length | Part Number | Product Code |
|--------|--------|-------------|--------------|
| 3/4" | 1000' | KPR075TR | 124027 |
| 1" | 1000' | KPR100TR | 125015 |
| 1" | 2500' | KPR100TR48 | 125023 |
| 1" | 5000' | KPR100TR72 | 125025 |
| 1-1/4" | 1000' | KPR125TR | 125016 |
| 1-1/4" | 4000' | KPR125TR72 | 125024 |
| 1-1/2" | 750' | KPR150TR | 125017 |
| 2" | 500' | KPR200TR | 125018 |

Also available without pull tape - minimum quantity required.



Kwikpath Riser Fittings

Made from the same material as Kwikpath Riser Raceway.

Riser Coupling



| Size | Part Number | Product Code |
|--------|-------------|--------------|
| 3/4" | KPRC075 | 132655 |
| 1" | KPRC100 | 132656 |
| 1-1/4" | KPRC125 | 132657 |
| 1-1/2" | KPRC150 | 132658 |
| 2" | KPRC200 | 132659 |

Riser Terminal Adapter c/w Lockout



| Size | Part Number | Product Code |
|--------|-------------|--------------|
| 3/4" | KRTA075 | 132665 |
| 1" | KRTA100 | 132666 |
| 1-1/4" | KRTA125 | 132667 |
| 1-1/2" | KRTA150 | 132668 |
| 2" | KRTA200 | 132669 |

Kwikpath Resi Raceway

Kwikpath Resi is a flexible raceway system created especially for residential communications systems, arranging and organizing telephone, ethernet, satellite, internet, video, security and sound cabling.



Resi Coil Empty

| Size | Length | Part Number | Product Code |
|--------|--------|-------------|--------------|
| 3/4" | 200' | KPH075C | 127001 |
| 1" | 200' | KPH100C | 127002 |
| 1-1/4" | 200' | KPH125C | 127003 |
| 1-1/2" | 200' | KPH150C | 127004 |
| 2" | 200' | KPH200C | 127005 |

Resi Reel Empty

| Size | Length | Part Number | Product Code |
|--------|--------|-------------|--------------|
| 3/4" | 1000' | KPH075R | 127006 |
| 1" | 1000' | KPH100R | 127007 |
| 1-1/4" | 1000' | KPH125R | 127008 |
| 1-1/2" | 750' | KPH150R | 127009 |
| 2" | 500' | KPH200R | 127010 |

Kwikpath Resi Fittings

Kwikpath Resi couplings and terminal adapters are available in 3/4" to 2" sizes and are also Kwikpath Riser fittings.

Refer to Kwikpath Riser Part Numbers.



Kwikpath Y-Coupler

The Y-Coupler is a fitting designed to allow contractors to branch off from any size (3/4" to 2") – new or existing – corrugated communication raceway. Manufactured in traditional Kwikpath vibrant orange, the Y-Coupler is ideal for use in high-rise residential and commercial building applications.

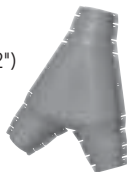

| Size | Part Number | Product Code |
|------------|-------------|--------------|
| 3/4" to 2" | KPPY075-200 | 132011 |

Seal End Plugs

For temporary and long-term closure of raceway ends, the insertion of sealing end plugs ensures the raceway conduit remains clean and ready for future needs.



| Size | Part Number | Product Code |
|--------|-------------|--------------|
| 3/4" | SEP075 | 132000 |
| 1" | SEP100 | 132001 |
| 1-1/4" | SEP125 | 132002 |
| 1-1/2" | SEP150 | 132003 |
| 2" | SEP200 | 132004 |

Riser / Resi Straps

Manufactured of the same material as Riser/RESI raceway, Kwikpath pipe straps allow for compliance with installation requirements providing for the proper support of Riser/RESI raceways.



| Size | Part Number | Product Code |
|--------|-------------|--------------|
| 3/4" | KPS075 | 132006 |
| 1" | KPS100 | 132007 |
| 1-1/4" | KPS125 | 132008 |
| 1-1/2" | KPS150 | 132009 |
| 2" | KPS200 | 132010 |



IPEX

Register your Pocket Pro today!

Fax this form to (905) 403-1124 and we'll add you to our mailing list.



Toll Free: (866) 473-9462



IPEX



Fax: (905) 403-1124

2441 Royal Windsor Drive
Mississauga, Ontario
L5J 4C7



Website: www.ipxelectrical.com

PLEASE PRINT

Company

Name

Title

Address

City

Province

Postal Code

Phone

ext.

Fax

Email / Website

This is a:

- Home Address
- Business Address
- Jobsite Address

Business Type:

(check 1 or 2 that best apply)

Company classification:

- Distributor/Wholesaler
- Engineering Firm
- Contractor
- Government
- OEM - Products manufactured: _____
- Other _____

SIC or industry sector:

My primary markets are (check all that apply):

- Commercial
- Residential
- Industrial
- Other _____
- Utility
- OEM
- Institutional

CUSTOMER SERVICE CENTRES

Vancouver

Tel (604) 534-8631
Fax (604) 534-7616

Calgary

Tel (403) 236-8333
Fax (403) 279-8443

Edmonton

Tel (780) 415-5300
Fax (780) 415-5358

Winnipeg

Tel (204) 633-3111
Fax (204) 633-3075

Toronto

Tel (905) 670-7676
Fax (905) 670-5295

Montreal

Tel (514) 337-2624
Fax (514) 337-7886

Saint John

Tel (506) 633-7473
(PIPE)
Fax (506) 633-8720

St. John's

Tel (709) 747-7473
(PIPE)
Fax (709) 368-9111

Toll Free 1-866-473-9462 (IPEXINC)

About the IPEX Group of Companies

As leading suppliers of thermoplastic piping systems, the IPEX Group of Companies provides our customers with some of the world's largest and most comprehensive product lines. All IPEX products are backed by more than 50 years of experience. With state-of-the-art manufacturing facilities and distribution centers across North America, we have established a reputation for product innovation, quality, end-user focus and performance.

Markets served by IPEX group products are:

- Electrical systems
- Telecommunications and utility piping systems
- PVC, PVCO, CPVC, PP, ABS, PEX, FR-PVDF & PE pipe & ftgs (1/4" to 48")
- Industrial process piping systems
- Municipal pressure and gravity piping systems
- Plumbing and mechanical piping systems
- PE Electrofusion systems for gas and water
- Industrial, plumbing and electrical cements
- Irrigation systems

Products are manufactured by IPEX Electrical Inc.

Cor-Line®, FiberTel®, Kwikon®, Kwikpath®, Monobloc®, SceptaCon™, Sceptalight™ and SuperDuct® are trademarks of IPEX Branding Inc.

www.ipexelectrical.com

This literature is published in good faith and is believed to be reliable. However, it does not represent and/or warrant in any manner the information and suggestions contained in this brochure. Data presented is the result of laboratory tests and field experience.

A policy of ongoing product improvement is maintained. This may result in modifications of features and/or specifications without notice.

