



Semiconductor (AC) fuses



Semiconductor (AC) fuses



American Round Fuses Form 101 Range A15QS

Semiconductor Protection Fuses

A15QS Amp-trap® Form 101 Semiconductor Protection fuses were designed for the specific protection of diodes and other semiconductor devices rated 150VAC/DC. The A15QS product line's compact design is perfect for those applications that have limitations on available space.

Features/Benefits

- Low I²t minimizes damage to protected components on short circuit
- Controlled arc voltage reduces stress to circuit components during fuse clearing
- Choice of mounting types provides options for unique termination requirements

Ratings

- AC: 1-6000A
150VAC, 100kA I.R.
- DC: 1-6000A
150VDC, 100kA I.R.

Approvals

- UL Recognized Component
- AC: UL Guide No. JFHR2 (1-4000A)
- DC Tested to UL Standard 198L parameters (1-4000A)

Highlights

- Fast Acting
- Current Limiting
- Low I²t
- Indicator Options Available

Applications

- Protection of heavy duty devices such as electrochemical rectifiers



Single Pole Fuse Blocks for A15QS Fuses



Fuse Ampere Rating	Fuse block	
	Catalog Number	Reference Number
1-30	30311	A212405
31-60	60306J	J211884
61-100	P243D	C219560
101-200	P243D	C219560
201-450	P243D	C219560
500-600	P243G	H222762

Catalog Numbering System

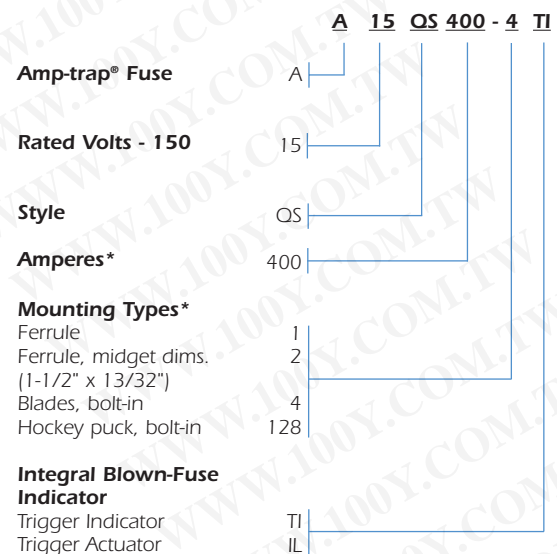

* For ampere ratings and types not listed, consult the factory.



Semiconductor (AC) fuses

American Round Fuses Form 101 Range A15QS

Semiconductor Protection Fuses

I²t Data-150VAC

I²t Data-150VDC ; L/R=10ms

Ampere Rating	Melting (A ² s X 10 ³)			Max Clearing I ² t @ 150VAC (A ² s X 10 ³)
	Body Style			
	Type 2	Type 1	Type 4	
1	0.0001			0.0002
2	0.0007			0.001
3	0.002			0.003
4	0.005			0.007
5	0.008			0.012
6	0.015			0.022
7	0.001			0.011
8	0.001			0.015
10	0.002			0.019
12	0.003			0.030
15	0.005			0.042
20	0.009			0.072
25	0.017			0.14
30	0.032			0.25
35		0.045		0.21
40		0.060		0.28
45		0.074		0.34
50		0.10		0.47
60		0.18		0.80
20			0.01	0.10
25			0.02	0.16
30			0.03	0.21
35			0.04	0.29
40			0.05	0.39
45			0.06	0.47
50			0.08	0.64
60			0.12	0.94
70			0.16	2.0
80			0.21	2.5
90			0.27	3.1
100			0.33	3.6

Ampere Rating	Melting (A ² s X 10 ³)		Max Clearing I ² t @ 150VAC (A ² s X 10 ³)
	Body Style		
	Type 4	Type 128	
125	0.49		5.0
130	0.53		5.3
150	0.72		6.8
175	1.0		9.0
200	1.3		11
225	1.7		14
250	1.9		15
275	2.4		19
300	2.9		22
350	4.1		32
400	5.1		40
450	6.4		50
500	15		90
550	18		108
600	20		130
700	25		220
800	34		290
900	46		400
1000	58		520
750		40	300
800		46	340
1000		72	540
1200		90	680
1500		160	1200
1600		160	1200
1800		202	1500
2000		250	1900
2500		422	3200
3000		640	4800
3500		1200	6500
4000		1400	8500

Ampere Rating	Clearing I ² t @ 150 VDC L/R =10ms (A ² s X 10 ³)	
	Type 4	Type 128
20	0.07	
25	0.11	
30	0.15	
35	0.20	
40	0.27	
45	0.33	
50	0.45	
60	0.66	
70	1.4	
80	1.8	
90	2.2	
100	2.5	
125	3.5	
130	3.7	
150	4.7	
175	6.3	
200	7.7	
225	9.8	
250	11	
275	13	
300	15	
350	22	
400	28	
450	35	
500	63	
550	76	
600	91	
700	150	
750		210
800	200	240
900	280	
1000	360	380
1200		470
1500		840
1600		840
1800		1000
2000		1300
2500		2200
3000		3400
3500		5200
4000		6800

Clearing I²t vs Working Voltage

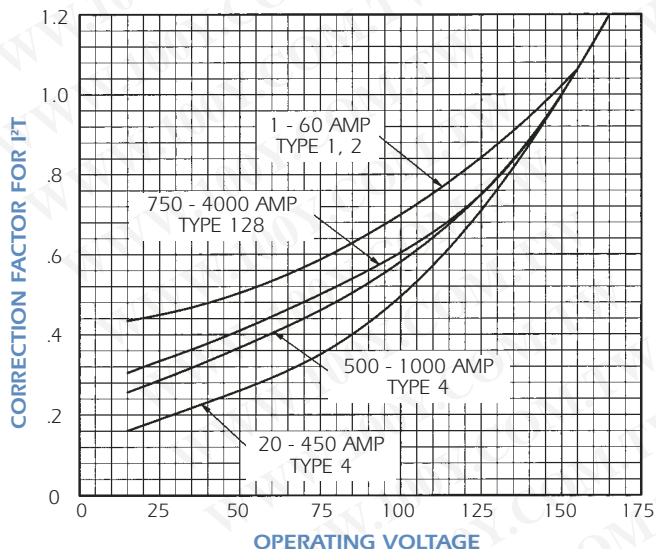

DC Voltage vs Time Constant (L/R)

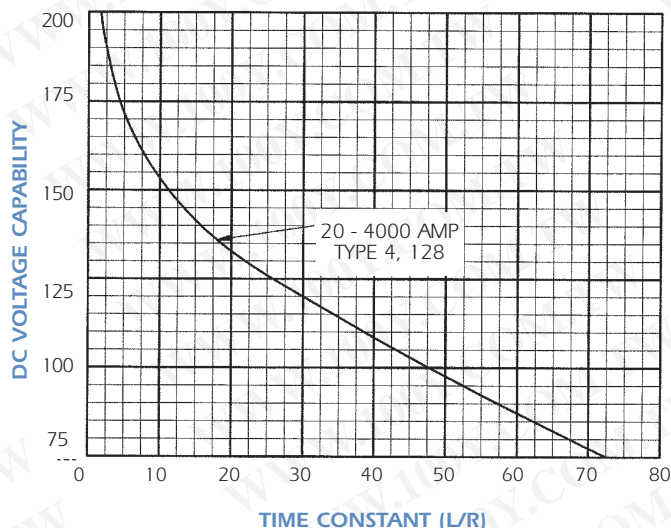

Semiconductor (AC) fuses



American Round Fuses Form 101 Range A15QS

勝特力材料 886-3-5753170
 勝特力电子(上海) 86-21-34970699
 勝特力电子(深圳) 86-755-83298787
[Http://www.100y.com.tw](http://www.100y.com.tw)

Semiconductor Protection Fuses

Watts Loss @ Rated Current

Ampere Rating	Watts Loss @ Rated Current (W)			Ampere Rating	Watts Loss @ Rated Current (W)	
	Type 2	Type 1	Type 4		Type 4	Type 128
1	0.68			100	10	
2	1.3			125	13	
3	1.7			130	14	
4	2.1			150	16	
5	2.8			175	20	
6	3.1			200	22	
7	2.2			225	25	
8	2.5			250	27	
10	2.6			275	30	
12	3.0			300	33	
15	3.0			350	40	
20	4.0			400	45	
25	5.2			450	50	
30	5.6			500	30	
35		9		550	33	
40		10		600	35	
45		12		700	50	
50		13		750		66
60		14		800	57	71
20			1.5	900	67	
25			2.0	1000	75	88
30			2.2	1200		100
35			2.6	1500		130
40			3.1	1600		132
45			3.4	1800		149
50			4.0	2000		165
60			4.7	2500		195
70			5.6	3000		240
80			8.0	3500		260
90			9.0	4000		270

Watts Loss vs % Rated Current

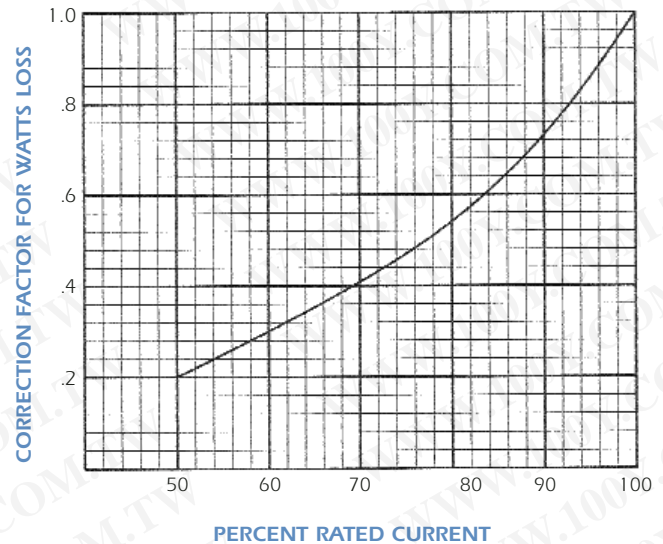

Max ARC Voltage vs System Voltage

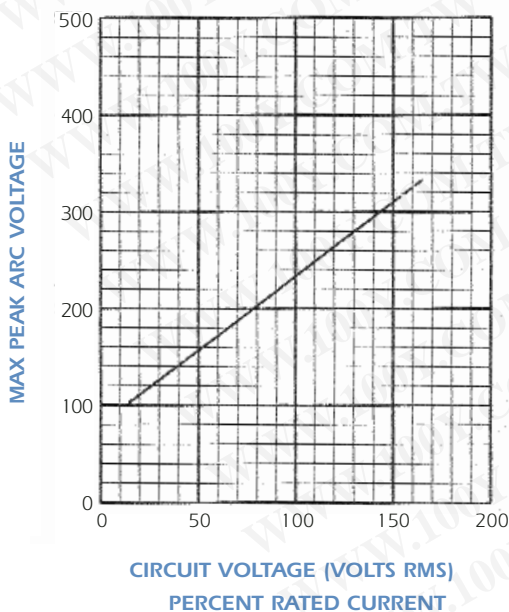

Peak Let Thru Data A15QS 1 to 4000

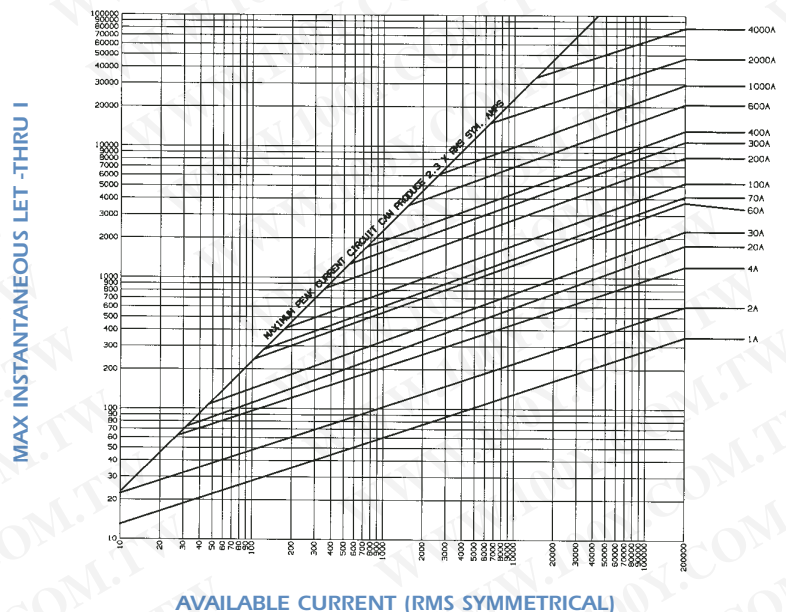



Semiconductor (AC) fuses

American Round Fuses Form 101 Range A15QS

Semiconductor Protection Fuses

Melt Time - Current Data A15QS 1 to 30

Melt Time - Current Data A15QS 20 to 100

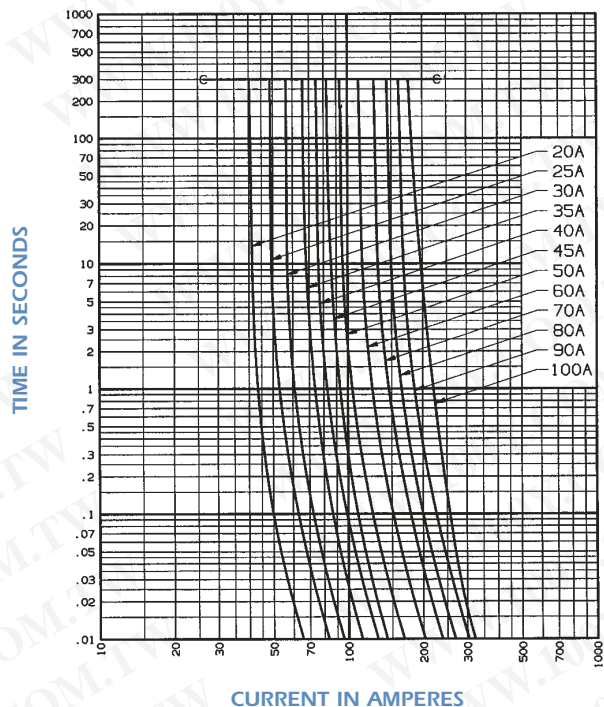
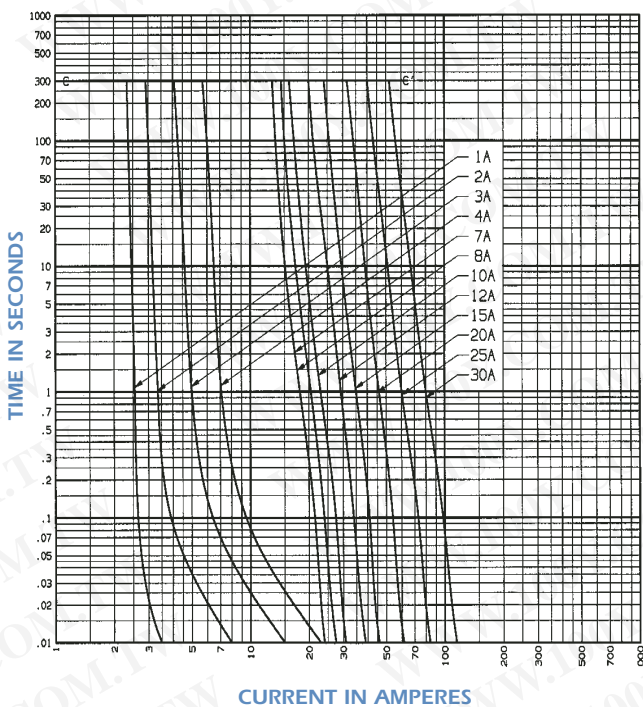

Melt Time - Current Data A15QS 125 to 1000

Melt Time - Current Data A15QS 750 to 4000

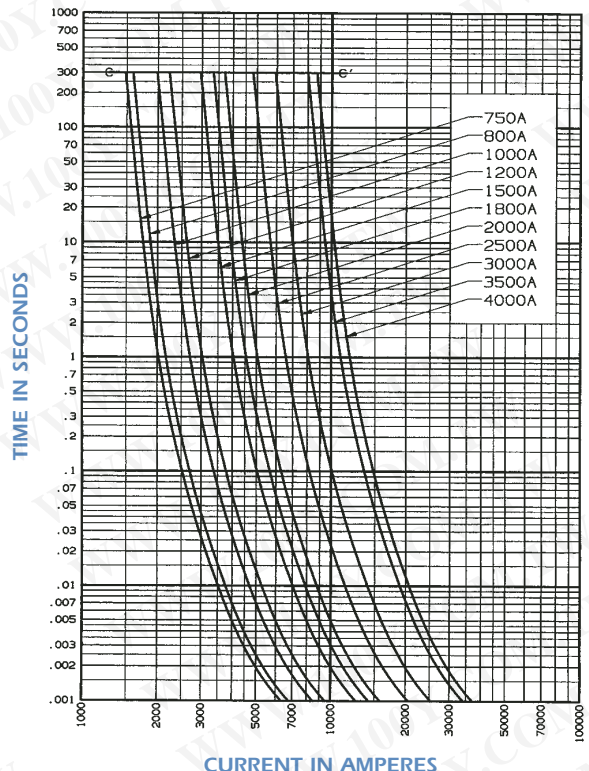
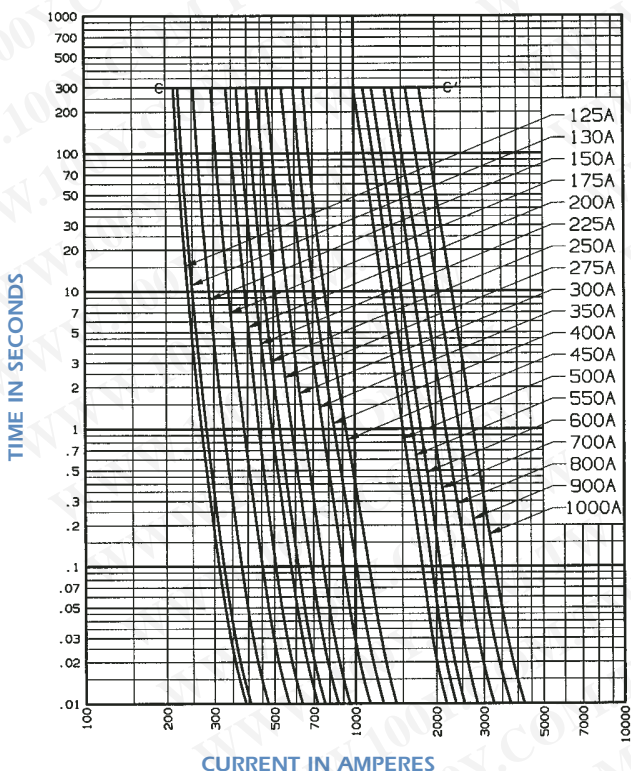

Semiconductor (AC) fuses



American Round Fuses Form 101 Range A15QS

Semiconductor Protection Fuses Standard Fuse Ampere Ratings, Catalog Numbers

Ampere Rating	Catalog Number	Ref Number	Outline Fig.	Ampere Rating	Catalog Number	Ref Number	Outline Fig.	Ampere Rating	Catalog Number	Ref Number	Outline Fig.
1	A15QS1-2	D230072J	1	90	A15QS90-4	F232282J	2	2500	A15QS2500-128	R232361A	6
2	A15QS2-2	E230073J	1	100	A15QS100-4	J232285J	2	3000	A15QS3000-128	T232363C	6
3	A15QS3-2	F230074J	1	125	A15QS125-4	M232288J	2	3500	A15QS3500-128	W232365A	6
4	A15QS4-2	G230075J	1	130	A15QS130-4	O232291J	2	4000	A15QS4000-128	Y232367A	6
5	A15QS5-2	H230076J	1	150	A15QS150-4	T232294J	2	5000	A15QS5000-128	B232370A	6
6	A15QS6-2	J230077J	1	200	A15QS200-4	Z232299J	2	6000	A15QS6000-128	A232369A	6
7	A15QS7-2	K230078J	1	250	A15QS250-4	C232302J	2				
8	A15QS8-2	L230079J	1	300	A15QS300-4	D232303J	2				
10	A15QS10-2	N230081J	1	400	A15QS400-4	V232318J	2				
12	A15QS12-2	P230082J	1	450	A15QS450-4	Y232321J	2				
15	A15QS15-2	Q230083J	1	500	A15QS500-4	B232324E	2				
20	A15QS20-2	R230084J	1	600	A15QS600-4	H232330E	2				
25	A15QS25-2	S230085J	1	700	A15QS700-4	L232333E	2				
30	A15QS30-2	T230086J	1	800	A15QS800-4	R232338E	2				
35	A15QS35-1	V230087J	1	900	A15QS900-4	X232343E	2				
40	A15QS40-1	W230088J	1	1000	A15QS1000-4	A232346E	2				
45	A15QS45-1	X230089J	1	750	A15QS750-128	P232336A	6				
50	A15QS50-1	Y230090J	1	800	A15QS800-128	V232341A	6				
55	A15QS55-1	Z230091J	1	1000	A15QS1000-128	D232349A	6				
60	A15QS60-1	A230092J	1	1200	A15QS1200-128	F232351A	6				
70	A15QS70-4	Z230076J	2	1500	A15QS1500-128	H232353A	6				
80	A15QS80-4	C230079J	2	2000	A15QS2000-128	P232359A	6				

For Trigger Indicator (TI) and Trigger Actuator (IL) versions, please call us.

For Ampere Rating and styles not listed, call Technical Services

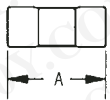

Figure 1

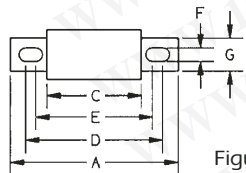
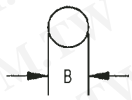

Figure 2

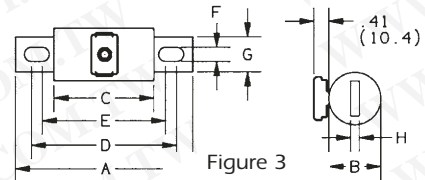
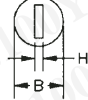

Figure 3

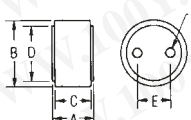

Figure 4

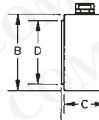

Figure 5

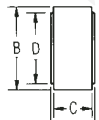
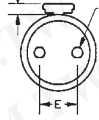

Figure 6

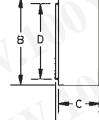
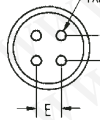

Figure 7

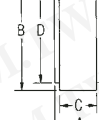
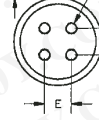

Figure 8

Dimensions

Outline Ref.	Mounting Type	Fig.	Dimensions - Inches (mm)								Tap	
			A	B	C	D	E	F	G	H		
A15QS1 to 30	2	1	1.50 (38.1)	.41 (10.4)	-	-	-	-	-	-	-	-
A15QS35 to 60	1	1	2.00 (50.8)	.81 (20.6)	-	-	-	-	-	-	-	-
A15QS70 to 450	4, 4TI*, 4IL*	2, 3*	2.66 (67.6)	1.13 (28.7)	1.16 (29.5)	2.19 (55.6)	1.91 (48.5)	.31 (7.9)	.74 (22.4)	.13 (4.8)	-	-
A15QS500 to 1000	4, 4TI*, 4IL*	2, 3*	3.50 (88.9)	1.50 (38.1)	1.25 (31.8)	2.56 (65.0)	1.94 (49.3)	.41 (10.4)	1.00 (25.4)	.25 (6.4)	-	-
A15QS750 to 2000	128, 128IL*	4, 5*	1.88 (47.8)	2.00 (50.8)	1.63 (41.4)	1.75 (44.5)	1.00 (25.4)	-	-	-	3/8-24-1/2 Deep	-
A15QS2500 to 3000	128, 128IL*	4, 5*	1.88 (47.88)	3.00 (76.2)	1.63 (41.4)	2.50 (63.5)	1.50 (38.1)	-	-	-	1/2-20-1/2 Deep	-
A15QS3500 to 4000	128, 128IL*	6, 7*	1.88 (47.88)	3.50 (88.9)	1.63 (41.4)	3.00 (76.2)	1.06 (27.0)	1.06 (27.0)	-	-	1/2-20-1/2 Deep	-
A15QS5000 to 6000	128	8	2.38 (60.5)	5.75 (146)	1.88 (47.7)	5.00 (127)	1.50 (38.1)	1.50 (38.1)	-	-	1/2-20-1/2 Deep	-

* Optional Trigger Actuator (IL)

Semiconductor (AC) fuses

American Round Fuses Form 101 Range A30QS



Semiconductor Protection Fuses

A30QS Amp-Trap® Semiconductor Protection fuses are intended for the protection of Power Semiconductor devices such as Diodes, Phase Control SCR's and other Power Semiconductor devices. The A30QS is recommended for new applications providing solutions for your critical protection needs at 300V and less semiconductors.

Features/Benefits

- Low I²t minimizes damage to protected components on short circuit
- Controlled arc voltage reduces stress to circuit components during fuse clearing
- Choice of mounting types helps in equipment design

Ratings

- AC: 1-4500A
300VAC, 200KA I.R.
- DC: 300VDC,
100KA I.R.
L/R= 10ms



Approvals

- UL Recognized Component
- AC: UL Guide No. JFHR2 (35-4500A) CSA

Highlights

- Fast Acting
- Current Limiting
- Low I²t
- Indicator Options Available
- Superior DC Capabilities

Applications

- Protection of 300 volts (or less) heavy duty rectifiers and similar heavy duty power supplies

Single Pole Fuse Blocks for A30QS Fuses



Fuse Ampere Rating	Fuse block	
	Catalog Number	Reference Number
1-30	70316	B223308
31-60	P243G	H222762
61-100	P243	T218517
101-200	P243	T218517
201-400	P243G	H222762
401-700	P243G	H222762

Catalog Numbering System

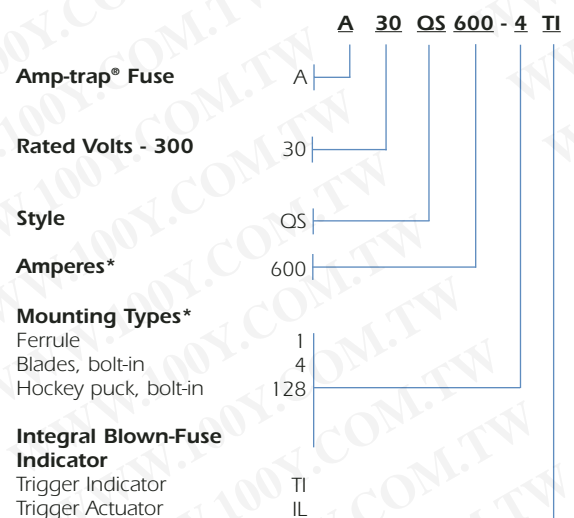

* For ampere ratings and types not listed, call Technical services.

Semiconductor (AC) fuses



American Round Fuses Form 101 Range A30QS

Semiconductor Protection Fuses

Standard Fuse Ampere Ratings, Catalog Numbers

Ampere Rating	Catalog Number	Ref Number	Outline Fig.	Ampere Rating	Catalog Number	Ref Number	Outline Fig.	Ampere Rating	Catalog Number	Ref Number	Outline Fig.
1	A30QS1-1	A230000	1	125	A30QS125-4	L226905	3	1600	A30QS1600-128	W226914	6
2	A30QS2-1	B230001	1	130	A30QS130-4	N226907	3	1800	A30QS1800-128	N230265	6
3	A30QS3-1	C230002	1	150	A30QS150-4	Q226909	3	2000	A30QS2000-128	D226921	6
4	A30QS4-1	D230003	1	175	A30QS175-4	Y226916	3	2500	A30QS2500-128	L226928	6
5	A30QS5-1	E230004	1	200	A30QS200-4	A226918	3	3000	A30QS3000-128	Q226932	6
6	A30QS6-1	F230005	1	225	A30QS225-4	F226923	3	3500	A30QS3500-128	V226936	6
7	A30QS7-1	G230006	1	250	A30QS250-4	H226925	3	4000	A30QS4000-128	B226942	6
8	A30QS8-1	H230007	1	275	A30QS275-4	A230276	3	4500	A30QS4500-128	F226946	6
10	A30QS10-1	K230009	1	300	A30QS300-4	W226937	3	5000	A30QS5000-128	G226970	6
12	A30QS12-1	L230010	1	350	A30QS350-4	S226934	3				
15	A30QS15-1	M230011	1	400	A30QS400-4	Y226939	3				
20	A30QS20-1	N230012	1	450	A30QS450-4	N226953	3				
25	A30QS25-1	P230013	1	500	A30QS500-4	H226948	3				
30	A30QS30-1	Q230014	1	550	A30QS550-4	L226948	3				
35	A30QS35-4	R230015	2	600	A30QS600-4	D226944	3				
40	A30QS40-4	S230016	2	700	A30QS700-4	V226959	3				
50	A30QS50-4	T230017	2	800	A30QS800-4	C226966	3				
60	A30QS60-4	V230018	2	700	A30QS700-128	T226958	5				
70	A30QS70-4	R226956	3	800	A30QS800-128	A226964	5				
80	A30QS80-4	Y226962	3	1000	A30QS1000-128	G226901	5				
90	A30QS90-4	E226968	3	1200	A30QS1200-128	J226903	5				
100	A30QS100-4	D226898	3	1500	A30QS1500-128	T226912	6				

For Trigger Indicator (TI) and Trigger Actuator (TA) versions, please call us.

For Ampere Rating and styles not listed, call Technical Services

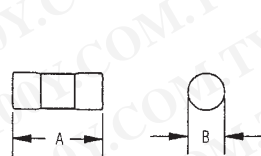

Figure 1

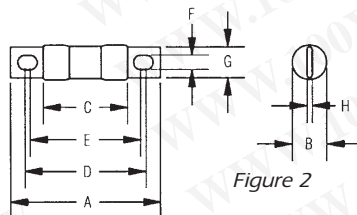

Figure 2

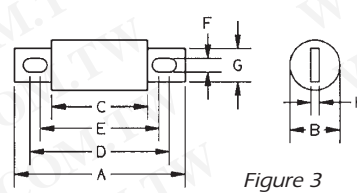

Figure 3

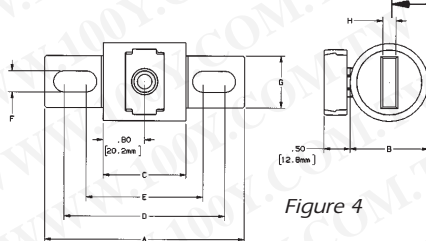

Figure 4

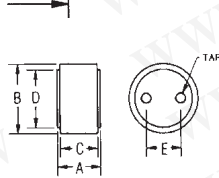

Figure 5

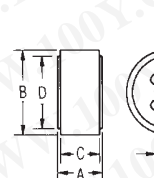

Figure 6

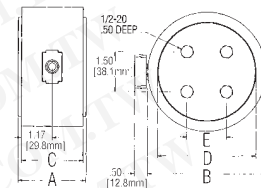

Figure 7

Dimensions

Outline Ref.	Mounting Type	Fig.	Dimensions - Inches (mm)								Tap	
			A	B	C	D	E	F	G	H		
A30QS1 to 30	1		2.00 (51)	0.56 (14)	-	-	-	-	-	-	-	-
A30QS35 to 60	4	2	3.19 (81)	.081 (21)	1.63 (41)	2.50 (64)	2.25 (58)	0.34 (9)	.72 (18)	0.13 (3)	-	-
A30QS70 to 800	4	3	3.13 (80)	1.22 (31)	1.63 (41)	2.44 (62)	2.31 (59)	0.31 (8)	1.00 (3)	0.19 (5)	-	-
A30QS225 70 700	4, 4IL*	3,4*	3.84 (98)	1.50 (38)	1.59 (40)	2.91 (74)	2.28 (58)	0.41 (10)	1.00 (25)	0.25 (6)	-	-
A30QS700 to 1200	128	5	2.59 (66)	3.00 (76)	2.34 (59)	2.50 (64)	1.50 (38)	-	-	-	-	3/8-24-1/2 Deep (2)
A30QS1500 to 2500	128, 128IL*	6, 7*	2.59 (66)	3.50 (89)	2.34 (59)	3.00 (76)	1.50 (38)	1.50 (38)	-	-	-	3/8-24-1/2 Deep (4)
A30QS3000 to 4500	128, 128IL*	6, 7*	2.59 (66)	4.50 (114)	2.34 (59)	3.75 (95)	1.50 (38)	1.50 (38)	-	-	-	1/2-20-1/2 Deep (4)

* Optional (IL) Actuator
07/05



Semiconductor (AC) fuses

American Round Fuses Form 101 Range A30QS

I²t Data

Ampere Rating	Melting I ² t (A ² s X 10 ³)	Max Clearing I ² t	
		@ 250VAC (A ² s X 10 ³)	@ 300VAC (A ² s X 10 ³)
1	0.0001	0.0002	0.0003
2	0.0004	0.0009	0.001
3	0.001	0.0018	0.002
4	0.002	0.0035	0.004
5	0.004	0.007	0.008
6	0.001	0.007	0.010
7	0.001	0.007	0.010
8	0.002	0.010	0.013
10	0.003	0.013	0.018
12	0.004	0.018	0.025
15	0.006	0.032	0.045
20	0.009	0.053	0.075
25	0.017	0.09	0.13
30	0.027	0.15	0.21
35	0.09	0.61	0.90
40	0.13	0.83	1.2
45	0.15	1.0	1.5
50	0.21	1.4	2.0
60	0.29	1.9	2.7
70	0.24	1.2	1.6
80	0.42	1.9	2.6
90	0.53	2.3	3.2
100	0.74	3.0	4.1
125	1.2	4.6	6.3
130	1.2	4.6	6.3
150	1.9	6.8	9.3

Ampere Rating	Melting I ² t (A ² s X 10 ³)	Max Clearing I ² t	
		@ 250VAC (A ² s X 10 ³)	@ 300VAC (A ² s X 10 ³)
175	2.1	7.6	10
200	3.0	11	15
225	3.6	16	22
250	4.4	19	25
275	5.6	23	31
300	6.9	27	37
350	12	45	62
400	16	61	83
450	25	95	130
500	30	120	160
550	36	140	190
600	47	170	230
700	50	190	260
800	67	240	330
900	83	290	380
1000	100	350	460
1200	200	680	880
1500	330	1100	1400
1600	390	1300	1690
1800	450	1500	2000
2000	590	2000	2600
2500	920	3100	4000
3000	1200	3600	4700
3500	1700	5000	6500
4000	2200	6600	8600
4500	2800	8400	11000

Peak Arc Voltage

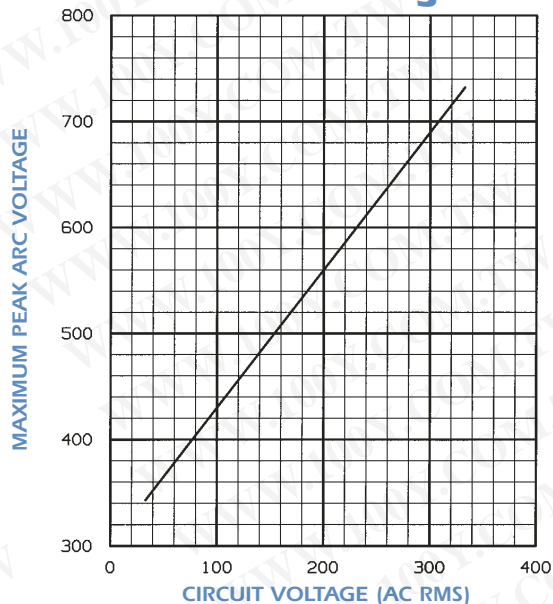

I²t vs. Working Voltage

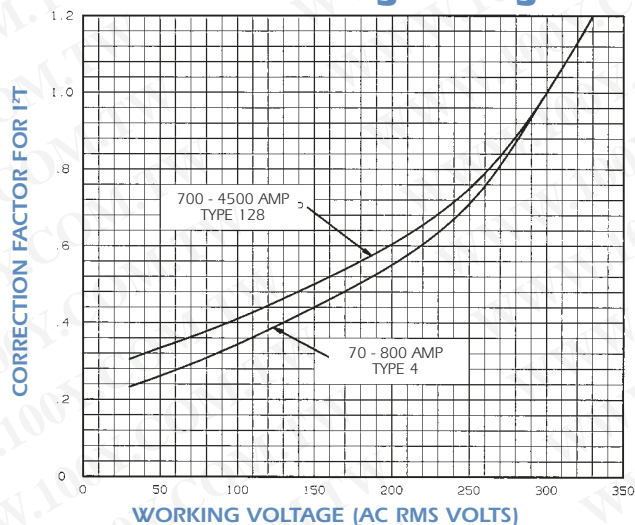

I²t vs. Working Voltage

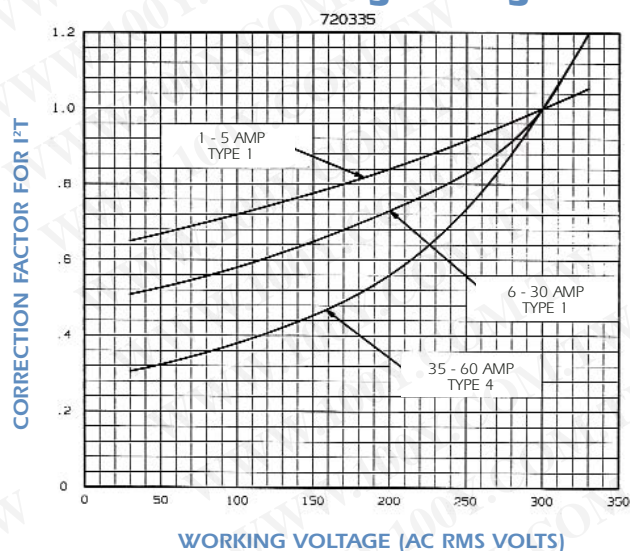

Semiconductor (AC) fuses



American Round Fuses Form 101 Range A30QS

Semiconductor Protection Fuses

Watts Loss at Rated Current

Ampere Rating	Watts Loss (W)		Ampere Rating	Watts Loss (W)	
	Type 1	Type 4		Type 4	Type 128
1	0.9		175	27	
2	1.0		200	30	
3	1.4		225	33	
4	1.7		250	41	
5	2.0		275	44	
6	2.3		300	47	
7	2.6		350	49	
8	3.0		400	56	
10	4.0		450	53	
12	4.9		500	59	
15	6.4		550	65	
20	8.8		600	69	
25	10.5		700	90	73
30	12.4		800	108	84
35		6.4	900		94
40		7.0	1000		105
45		9.0	1200		110
50		9.9	1500		140
60		11.6	1600		150
70		11	1800		170
80		11	2000		190
90		13	2500		230
100		13	3000		340
125		16	3500		380
130		16	4000		450
150		19	4500		500

Clearing I²t at 300VDC, 100kA, L/R = 10ms

Ampere Rating	Clearing I ² t (A ² s X 10 ³)	Ampere Rating	Clearing I ² t (A ² s X 10 ³)
35	0.45	450	100
40	0.58	500	130
50	0.96	550	150
60	1.3	600	190
70	1.3	700	200
80	2.1	800	260
90	2.5	900	300
100	3.3	1000	360
125	5.0	1200	710
130	5.0	1500	1200
150	7.5	1600	1400
175	8.3	1800	1600
200	12	2000	2100
225	18	2500	3300
250	20	3000	4300
275	25	3500	5900
300	29	4000	7700
350	50	4500	9900
400	66		

Watts loss vs. Percent Rated Current

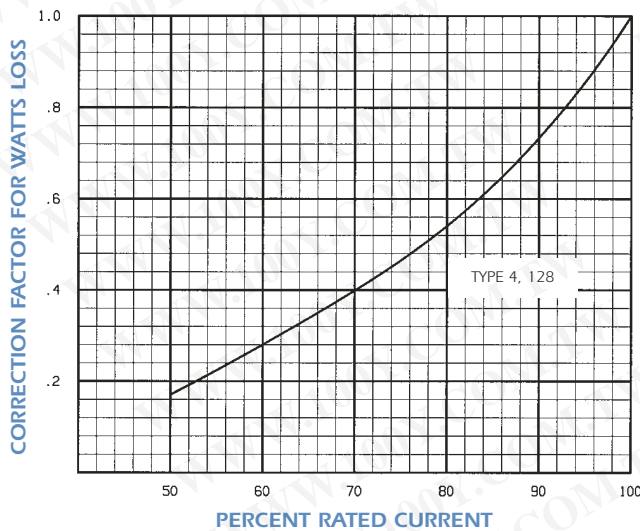

DC Voltage Capability vs. Circuit Time Constant (ms)

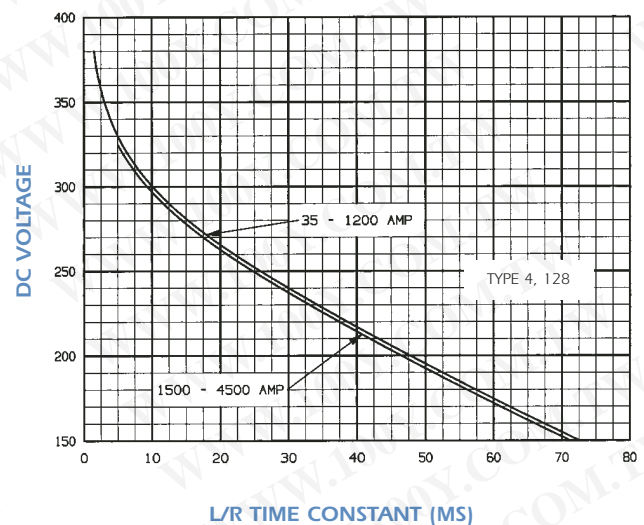



Semiconductor (AC) fuses

American Round Fuses Form 101 Range A30QS

Semiconductor Protection Fuses

Melting Time - Current Data A30QS 1 to 60

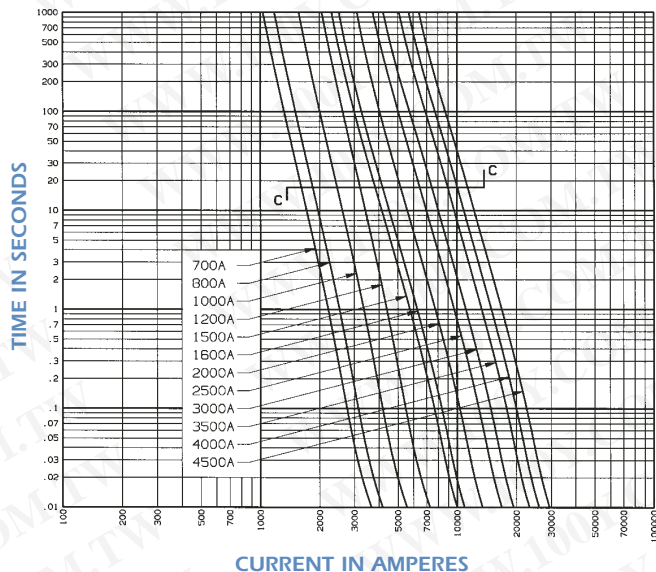

Melting Time - Current Data A30QS 70 to 800

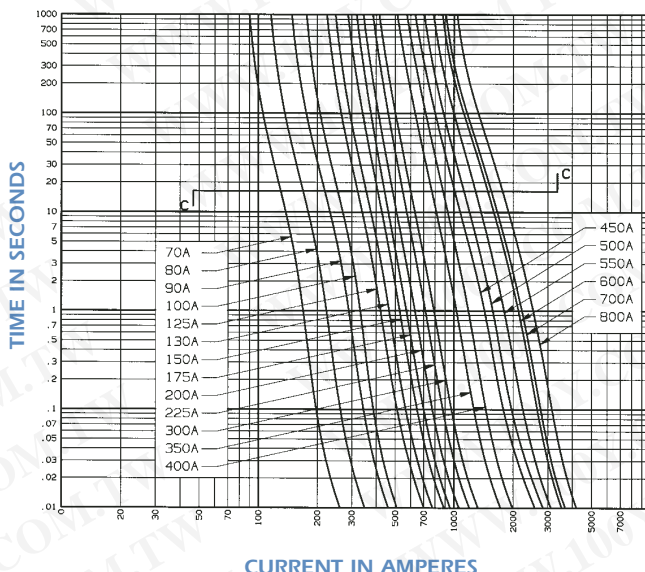

Melting Time - Current Data A30QS 700 to 4500

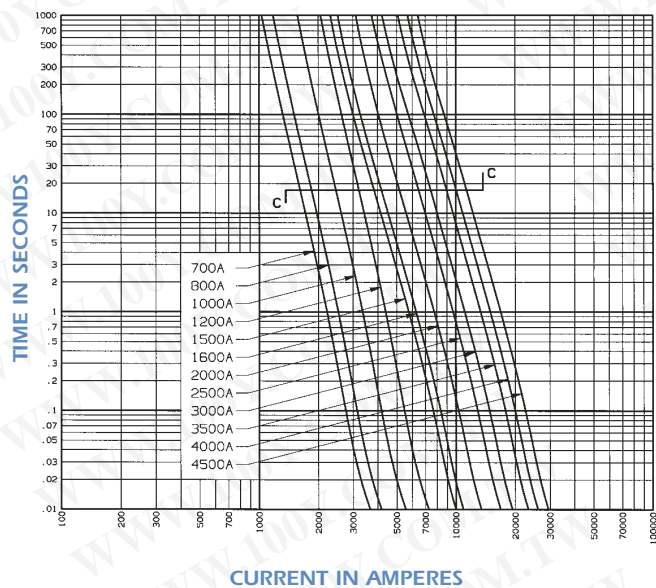

Peak Let Thru Data

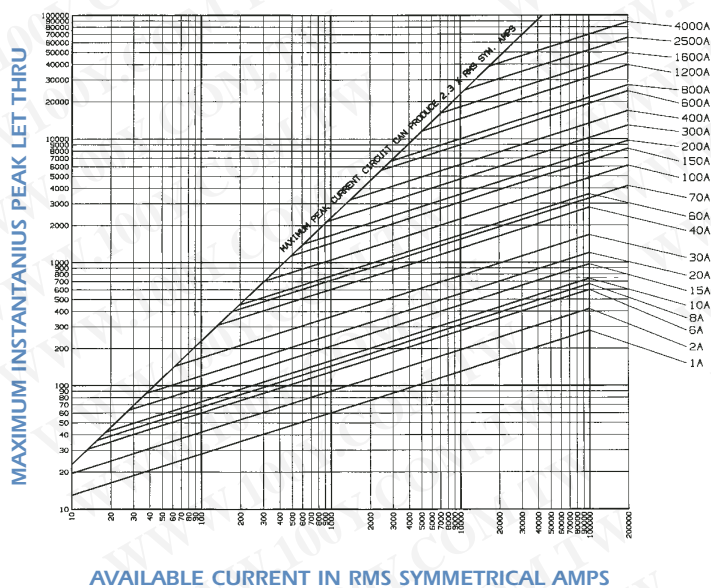

Semiconductor (AC) fuses

American Round Fuses Form 101 Range A50QS



Semiconductor Protection Fuses

A50QS Amp-trap® Form 101 fuses grew out of the need to improve the overall performance of semiconductor fuses in response to new equipment requirements. The A50QS encompasses the best protection features - lower I²t to provide better protection for equipment, longer life when subjected to cyclic loading and lower watts loss. A50QS is today's best choice for the protection of dynamic solid state equipment such as motor drives, inverters, UPS, etc

Features/Benefits

- Lowest I²t for greatest protection of semiconductor circuits
 - low watt loss for cooler operation
- Superior cycling ability gives an equipment design advantage
 - State of the art protection for 500 volt equipment
- ultra compact sizes allow down-sizing of existing equipment

Ratings

- AC: 35-60A
500VAC, 200kA I.R.
- 70-1200A
500VAC, 200kA I.R.
- DC: 35-1200A
500VDC, 100kA I.R.

Approvals

- UL Recognized Component
- AC: UL Guide No. JFHR2
- DC Tested to UL Standard 198L parameters (70-1200A)
- CSA Certified LR12636

Highlights

- 500V AC/DC Rated
- Lowest I²t
- Low Watts Loss
- Superior Cycling Ability

Applications

- Protection of 500V or less motor drives, UPS, inverters, etc.



Single Pole Fuse Blocks for A50QS Fuses



Fuse Ampere Rating	Mounting type	Fuse block	
		Catalog Number	Reference Number
35-200	4	P243E	X222016
225-600	4	P266C	K212897

Catalog Numbering System

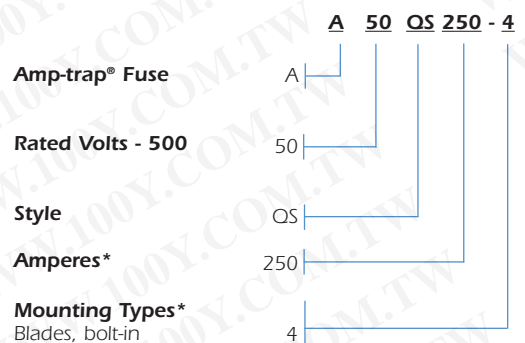

* For ampere ratings and types not listed, call Technical services.

Semiconductor (AC) fuses



American Round Fuses Form 101 Range A50QS

Semiconductor Protection Fuses

Standard Fuse Ampere Ratings, Catalog Numbers

Ampere Rating	Catalog Number	Reference Number	Ampere Rating	Catalog Number	Reference Number
35	A50QS35-4	Q214834	250	A50QS250-4	W211251
40	A50QS40-4	Y215853	300	A50QS300-4	D212799
50	A50QS50-4	W217392	350	A50QS350-4	T215343
60	A50QS60-4	A218937	400	A50QS400-4	B216362
70	A50QS70-4	B222664	450	A50QS450-4	E216871
80	A50QS80-4	L201513	500	A50QS500-4	L218418
90	A50QS90-4	X211252	600	A50QS600-4	Q219457
100	A50QS100-4	A216361	700	A50QS700-4	N223181
125	A50QS125-4	K218417	800	A50QS800-4	C202287
150	A50QS150-4	P219456	900	A50QS900-4	R212282
175	A50QS175-4	A222663	1000	A50QS1000-4	V217391
200	A50QS200-4	T200968	1200	A50QS1200-4	C217904
225	A50QS225-4	K201512			

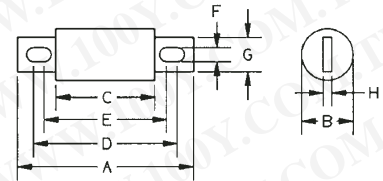

For ampere ratings and styles not listed, call Technical Services.

Dimensions

Catalog Number	Mounting Type	Dimensions - Inches (mm)							
		A	B	C	D	E	F	G	H
A50QS35 to 100	4	3.63 (92.2)	1.00 (25.4)	2.13 (54.1)	2.94 (74.7)	2.75 (69.9)	0.31 (7.9)	0.75 (19.1)	0.13 (3.3)
A50QS125 to 200	4	3.63 (92.2)	1.22 (31.0)	2.13 (54.1)	2.94 (74.7)	2.81 (71.4)	0.31 (7.9)	1.00 (25.4)	0.19 (4.8)
A50QS225 to 400	4	4.34 (110)	1.50 (38.1)	2.09 (53.1)	3.41 (86.6)	2.78 (70.6)	0.41 (10.4)	1.00 (25.4)	0.25 (6.4)
A50QS450 to 600	4	4.47 (114)	2.00 (50.8)	2.22 (56.4)	3.53 (89.7)	2.91 (73.9)	0.41 (10.4)	1.50 (38.1)	0.25 (6.4)
A50QS700 to 800	4	6.47 (164.3)	2.50 (63.5)	2.22 (56.4)	5.00 (127.0)	3.44 (87.3)	.53 (13.5)	1.50 (38.1)	.25 (6.4)
A50QS900 to 1200	4	6.97 (177.0)	3.00 (76.2)	3.22 (81.8)	5.47 (138.9)	4.47 (113.5)	.63 (15.9)	2.38 (60.3)	.44 (11.1)

Watts Loss vs. Percent Rated Current

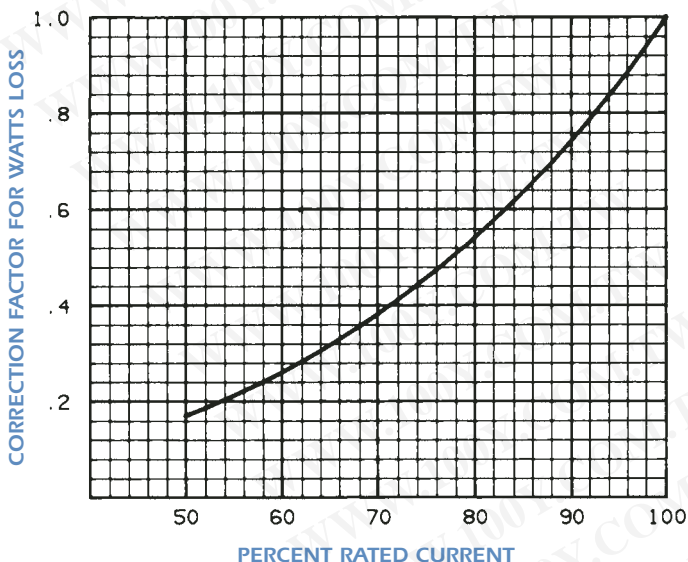

Watts Loss at Rated Current

Ampere Rating	Watts Loss (W)	Ampere Rating	Watts Loss (W)
35	6	250	41
40	7	300	49
50	8	350	57
60	10	400	65
70	12	450	69
80	14	500	77
90	15	600	92
100	17	700	110
125	21	800	130
150	25	900	140
175	29	1000	160
200	33	1200	175
225	37		

Correction factor example:
At 80% rated current, watts loss equals .54 times watts loss at rated current.



Semiconductor (AC) fuses

American Round Fuses Form 101 Range A50QS

Semiconductor Protection Fuses

A50QS35 to 1200 Melting Time - Current Data, 500V Fuses

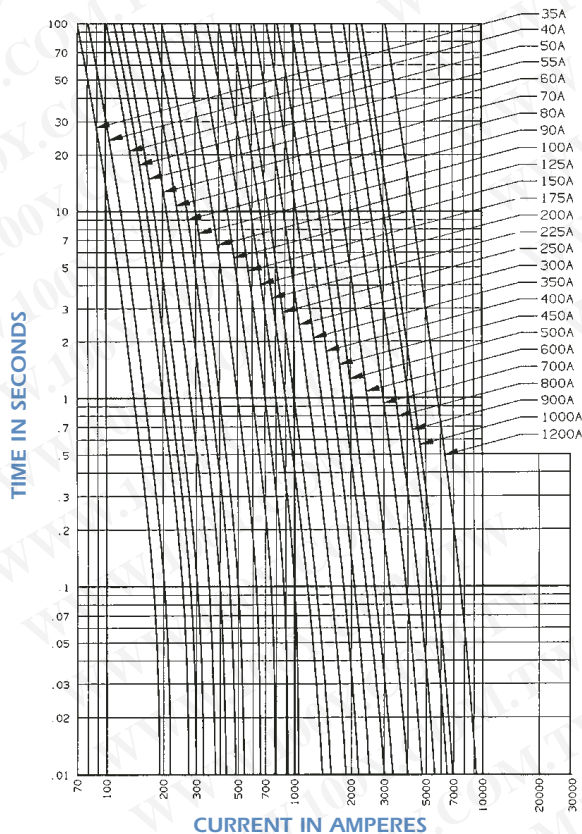

Peak Let-Thru Current Data - A50QS35 to 1200, 500 Volts AC

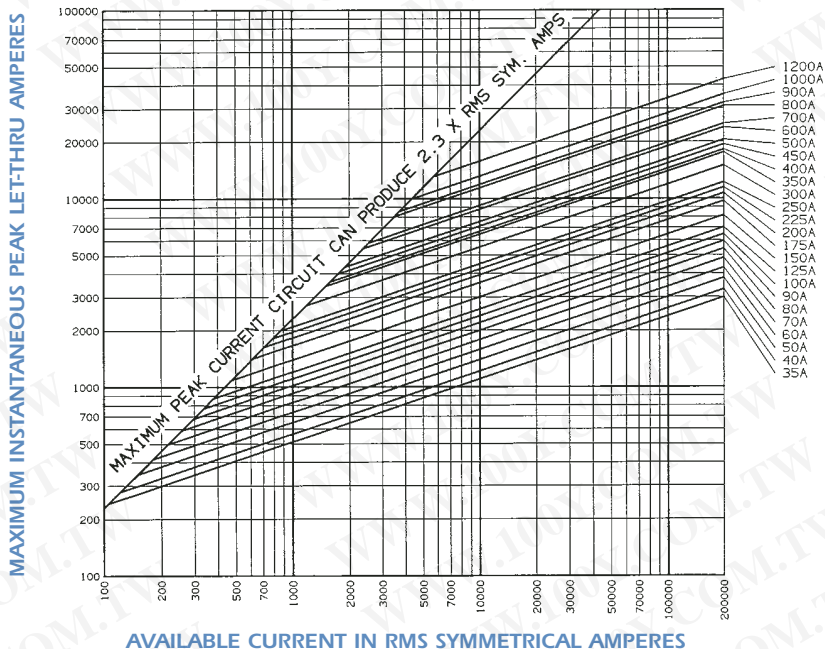
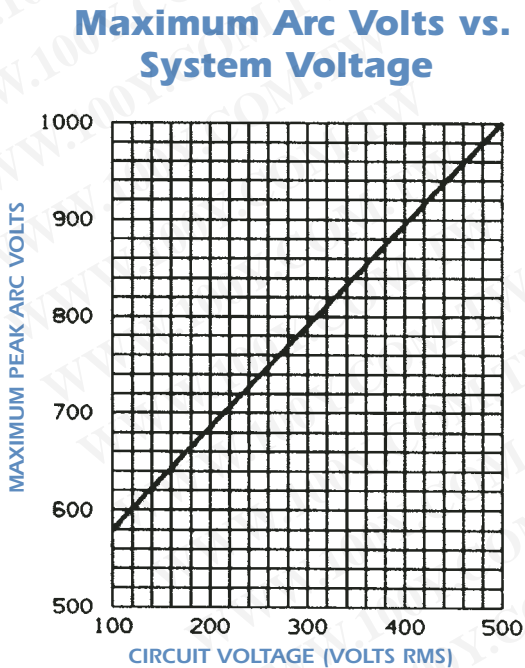

Semiconductor (AC) fuses



American Round Fuses Form 101 Range A50QS

Semiconductor Protection Fuses

I²t Data – 500 Volts AC

Fuse Ampere Rating	Melting I ² t (A ² s X 10 ³)	I ² t data	
		Max Clearing I ² t @ 500 VAC	
		1 fuse (fig A) (A ² s X 10 ³)	2 Fuses in series (A ² s X 10 ³)(fig B)
35	.09	.56	.34
40	.11	.69	.4
50	.18	1.1	.68
60	.25	1.6	.94
70	.31	1.9	1.1
80	.43	2.6	1.5
90	.57	3.6	2.1
100	.74	4.4	2.7
125	.94	5.6	3.4
150	1.5	9	5.4
175	2.5	15	9
200	3.3	20	12
225	4.1	25	15
250	4.9	29	18
300	9.2	55	33
350	15	88	53
400	16	98	59
450	21	130	76
500	26	160	94
600	37	220	130
700	53	270	160
800	72	360	220
900	98	500	300
1000	112	560	330
1200	200	930	550

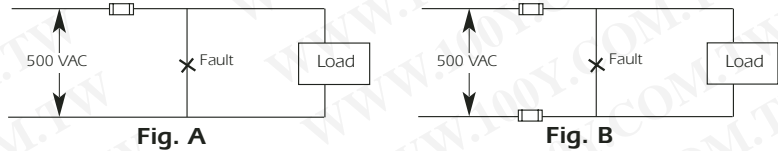

Clearing I²t vs. AC Operating Voltage

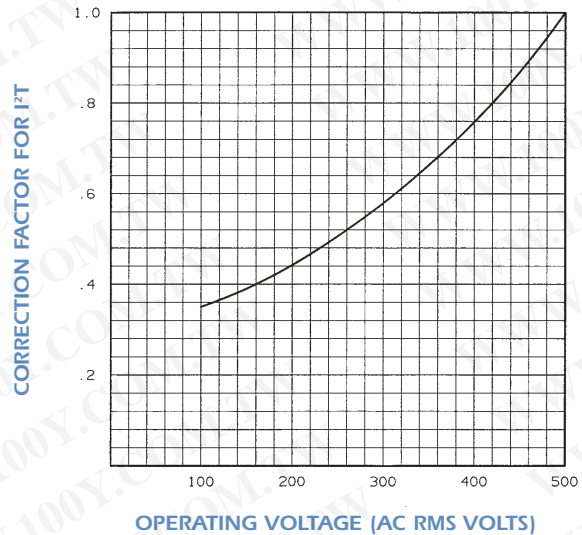

Clearing I²t at 500V DC, 100kA, L/R = 10 ms

Ampere Rating	Clearing I ² t (A ² s X 10 ³)	Ampere Rating	Clearing I ² t (A ² s X 10 ³)
35	.48	250	25
40	.58	300	47
50	1.0	350	75
60	1.3	400	83
70	1.6	450	110
80	2.2	500	130
90	3.0	600	190
100	3.8	700	220
125	4.8	800	260
150	7.7	900	350
175	13	1000	430
200	17	1200	660

DC Application: A50QS Fuses have been designed for both AC and DC operation. A50QS fuses (70-600) have UL Component Recognition at 500V DC and have been tested to circuit parameters as defined in Standard 198L.

DC Voltage Capability vs. Time Constant

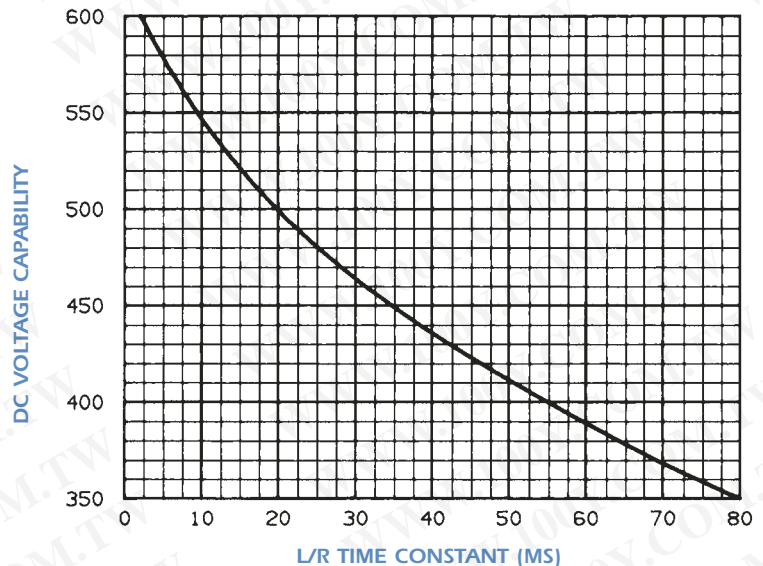



Semiconductor (AC) fuses

American Round Fuses Form 101 Range A50P



Semiconductor Protection Fuses

A50P Amp-trap® Form 101 Semiconductor Protection fuses were developed for DC drives, uninterruptable power supplies and similar applications requiring better protection (lower I^2t) and superior reliability. The A50P is typically used for replacement.

Features/Benefits

- Low I^2t minimizes damage to protected components on short circuit
- Controlled arc voltage reduces stress to circuit components during fuse clearing
- Choice of mounting types provides helps in equipment design

Ratings

- AC: 10-1200A
500VAC, 100kA I.R.
- DC: 35-1000A
450VDC, 79kA I.R.
L/R = 10ms

Approvals

- UL Recognized Component
- AC: UL Guide No. JFHR2 (10-800A)
- DC : UL Guide No. JFHR2 (35-800A)

Highlights

- Very Fast Acting
- Current Limiting
- Lowest I^2t
- Indicator Options Available

Applications

- Protection of DC drives, UPS and other equipment of 500 volts or less

* Contact technical services for applications data.



Single Pole Fuse Blocks for A50P Fuses



Fuse Ampere Rating	Mounting type	Fuse block	
		Catalog Number	Reference Number
10-30	1	70306	W219071
35-60	4	P243G	H222762
70-200	4	P243E	X222016
225-600	4	P266C	K212897

Catalog Numbering System

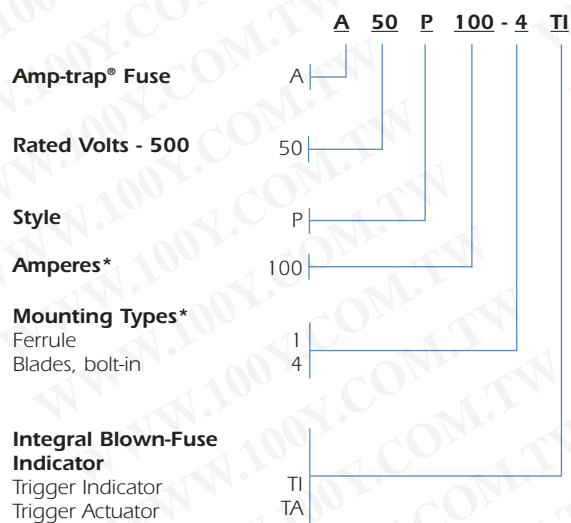

* For ampere ratings and types not listed, consult the factory.

Semiconductor (AC) fuses



American Round Fuses Form 101 Range A50P

Semiconductor Protection Fuses Standard Fuse Ampere Ratings, Catalog Numbers

Ampere Rating	Catalog Number	Ref Number	Outline Fig.
10	A50P10-1	C216869	1
15	A50P15-1	B217903	1
20	A50P20-1	Y218935	1
25	A50P25-1	G219978	1
30	A50P30-1	Z222662	1
35	A50P35-4	W202281	2
40	A50P40-4	E211765	2
50	A50P50-4	C212798	2
60	A50P60-4	P214833	2

For ampere ratings from 70 to 1200 see A50QS series

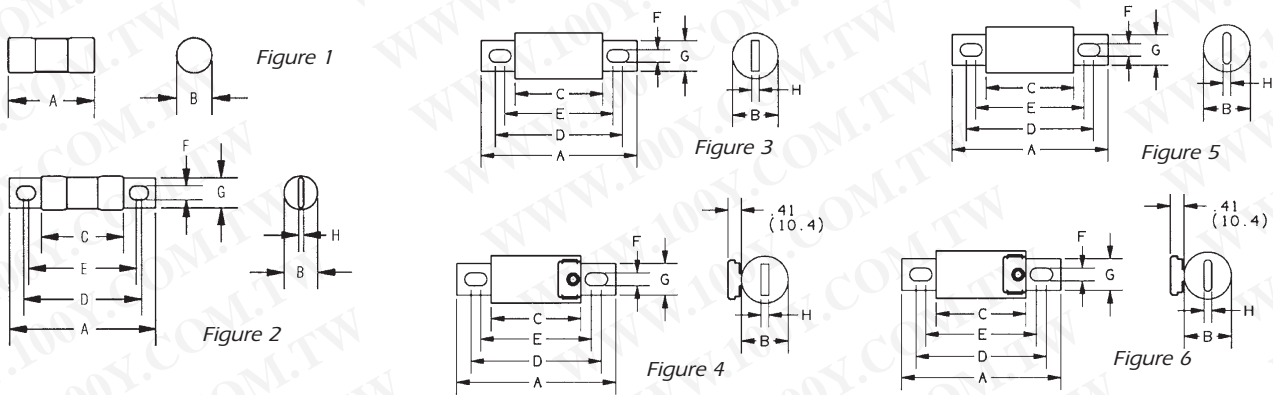

Dimensions

Catalog Number	Mounting Type	Fig.	Dimensions - Inches (mm)								
			A	B	C	D	E	F	G	H	
A50P10 to 30	1	1	2.00 (50.8)	0.56 (14.2)	-	-	-	-	-	-	-
A50P35 to 60	1DS*	1	2.25 (57.2)	0.81 (20.6)	-	-	-	-	-	-	-
A50P35 to 60	4	2	3.19 (81.0)	0.81 (20.6)	1.63 (41.4)	2.50 (63.5)	2.25 (57.2)	0.34 (8.6)	0.72 (18.3)	0.13 (3.3)	
A50P70 to 100	4	3	3.63 (92.2)	1.00 (25.4)	2.13 (54.1)	2.94 (74.7)	2.81 (71.4)	0.31 (7.9)	0.75 (19.1)	0.13 (3.3)	
A50P125 to 200	4, 4TA**	3, 4**	3.63 (92.2)	1.22 (31.0)	2.13 (54.1)	2.94 (74.7)	2.81 (71.4)	0.31 (7.9)	1.00 (25.4)	0.19 (4.8)	
A50P225 to 400	4, 4TA**	3, 4**	4.34 (110)	1.50 (38.1)	2.09 (53.1)	3.41 (86.6)	2.78 (70.6)	0.41 (10.4)	1.00 (25.4)	0.25 (6.4)	
A50P450 to 600	4, 4TA**	3, 4**	4.47 (114)	2.00 (50.8)	2.22 (56.4)	3.53 (89.7)	2.91 (73.9)	0.41 (10.4)	1.50 (38.1)	0.25 (6.4)	
A50P700 to 800	4, 4TA**	5, 6**	6.47 (164)	2.50 (63.5)	2.22 (56.4)	4.63 (118)	4.31 (109)	0.53 (13.5)	2.00 (50.8)	0.38 (9.7)	
A50P900 to 1200	4	3	6.97 (177)	3.00 (76.2)	3.22 (81.8)	4.97 (126)	*** ***	0.63 (16.0)	2.38 (60.5)	0.44 (11.1)	

* Use with 60306J fuse block.

** Optional Trigger Actuator (TA)

*** Mounting hole is round, diameter F.

Semiconductor (AC) fuses

American Round Fuses Form 101 Range A60Q



Semiconductor Protection Fuses

A60Q Amp-trap® Form 101 Semiconductor Protection fuses feature the only 600 volt AC/DC rating in the industry of similar size (1-1/2" x 13/32") fuses protecting semiconductors. A60Q also has the lowest I²t of all similar fuses and excellent cycling ability. Applications include inverters and small equipment requiring extremely fast response to faults, without the need to carry sustained heavy overloads.

Features/Benefits

- Lowest I²t of any fuse this size for greater protection
- Excellent cycling ability gives advantage in equipment design
- 600V AC/DC rated

Ratings

- AC: 5-40A
600VAC, 200kA I.R.
- DC: 5-40A
600VDC, 100kA I.R.
L/R = 10ms

Approvals

- UL Recognized Component
- AC: UL Guide JFHR2
File E60314
- DC : UL File
E60314

Highlights

- 600VAC/DC Rated
- Extremely Fast Acting
- Current Limiting
- Lowest I²t
- Excellent Cycling Ability

Applications

- Protection of small inverters and drives, and equipment requiring the highest degree of protection

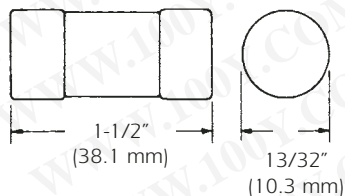

Fuse holders for A60Q fuses

- USM Series .Ultrasafe™ Fuse Holders
- 303 Series .Midget Fuse Blocks

Catalog Numbering System

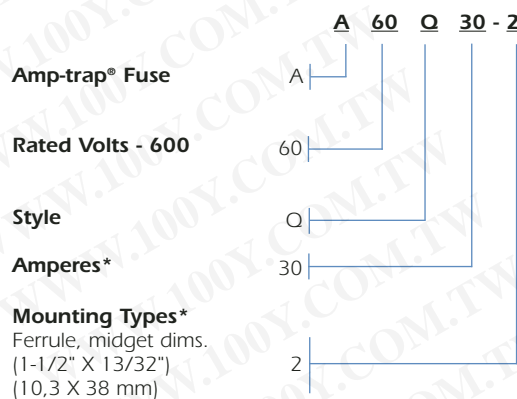

Semiconductor (AC) fuses



American Round Fuses Form 101 Range A60Q

Semiconductor Protection Fuses

**I²t at 600VDC,
100kA, L/R = 10 ms**

Ampere Rating	Clearing I ² t (A ² s)
5	40
8	42
10	70
12	90
15	110
20	200
25	260
30	520
35	780
40	1100

**I²t at 600VAC,
100kA**

Ampere Rating	Melting I ² t (A ² s)	Clearing I ² t (A ² s)
5	5	60
8	6.5	70
10	10	110
12	17	150
15	26	180
20	41	330
25	69	440
30	132	860
35	197	1300
40	276	1800

Watts Loss Data

Ampere Rating	Watts Loss @ 80% Rating (W)	Watts Loss @ 100% Rating (W)
5	0.5	0.7
8	0.7	1.1
10	0.9	1.5
12	1.3	2.0
15	1.9	3.0
20	2.6	4.4
25	2.9	5.3
30	3.0	5.8
35	3.3	6.4
40	3.6	7.0

5 to 40A Melting Time - Current Data, 600V Fuses

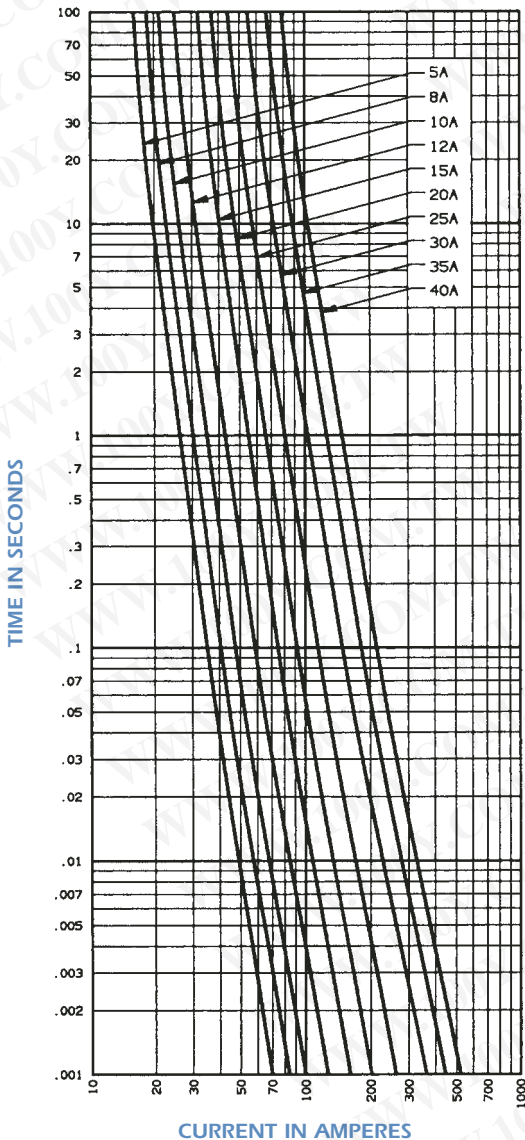

Standard Fuse Ampere ratings, catalog and reference Numbers

Ampere Rating	Catalog Number	Reference Number	Ampere Rating	Catalog Number	Reference Number
5	A60Q5-2	E217400	20	A60Q20-2	B214338
6	A60Q5-2	E217400	25	A60Q25-2	Z214842
8	A60Q8-2	T218425	30	A60Q30-2	E215859
10	A60Q10-2	Z212289	35	A60Q35-2	J216369
12	A60Q12-2	M212807	40	A60Q40-2	E218879
15	A60Q15-2	X213322			

For ampere ratings and styles not listed, ask sales agent

Peak Let-Thru Current Data - 5 to 40A, 600 Volts AC

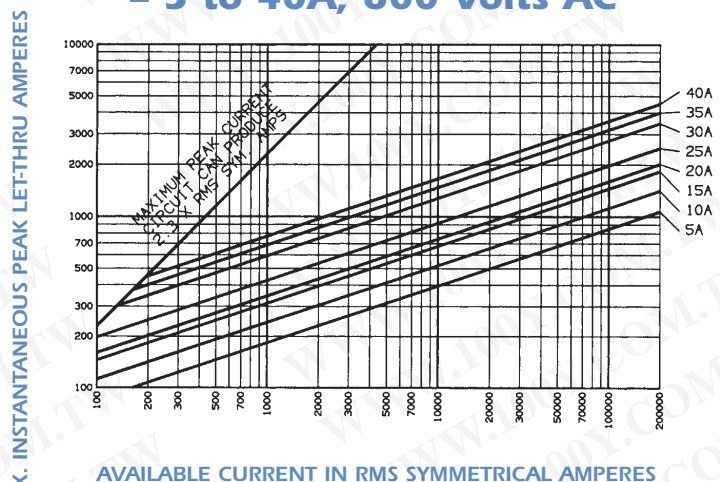



Semiconductor (AC) fuses

American Round Fuses Form 101 Range A60X



Semiconductor Protection Fuses

A60X Amp-trap® Form 101 Semiconductor Protection fuses are popular for the protection of higher voltage heavy rectifiers such as traction rectifiers. They can carry long sustained overloads common with heavy duty apparatus. 700A through 2000A sizes are of compact, hockey-puck design, able to provide high power protection in a small space.

Features/Benefits

- Low I²t minimizes damage to protected components on short circuit
- Controlled arc voltage reduces stress to circuit components during fuse clearing
- Choice of mounting types helps in equipment design

Ratings

- AC: 1-2000A
600V, 100kA I.R.

Approvals

- UL Recognized Component
- AC: UL Guide No.JFHR2 (35-800A)

Highlights

- Fast Acting
- Current Limiting
- Low I²t
- Indicator Options Available

Applications

- Protection of heavy traction and electro chemical as well as rectifiers and other heavy-duty equipment



Single Pole Fuse Blocks for A60X Fuses



Fuse Ampere Rating	Fuse block	
	Catalog Number	Reference Number
1-30	60306	V211871
31-60	P243C	M219040
61-100	P243C	M219040
101-200	P243C	M219040
201-400	P266A	Y212380
401-600	P266A	Y212380

Catalog Numbering System

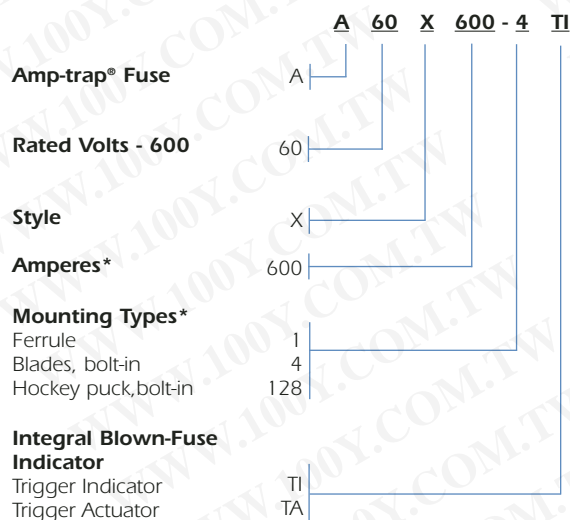

* For ampere ratings and types not listed, consult the factory.

Semiconductor (AC) fuses



American Round Fuses Form 101 Range A60X

勝特力材料 886-3-5753170
勝特力电子(上海) 86-21-34970699
勝特力电子(深圳) 86-755-83298787
[Http://www.100y.com.tw](http://www.100y.com.tw)

Semiconductor Protection Fuses Standard Fuse Ampere Ratings, Catalog Numbers

Ampere Rating	Catalog Number	Ref Number	Outline Fig.	Ampere Rating	Catalog Number	Ref Number	Outline Fig.	Ampere Rating	Catalog Number	Ref Number	Outline Fig.
1	A60X1-1	R201518	1	70	A60X70-4	Y214335	3	400	A60X400-4	B215856	3
2	A60X2-1	Y212288	1	80	A60X80-4	B217397	3	400	A60X400-4TA	A217396	4
3	A60X3-1	P213821	1	80	A60X80-4TA	Q218422	4	450	A60X450-4	P218421	3
4	A60X4-1	A215349	1	90	A60X90-4	Q201517	3	450	A60X450-4TA	V219461	4
5	A60X5-1	L217912	1	100	A60X100-4	D202288	3	500	A60X500-4	E222667	3
6	A60X6-1	Q219986	1	100	A60X100-4TA	G211767	4	500	A60X500-4TA	P201516	4
7	A60X7-1	C200976	1	125	A60X125-4	S214836	3	600	A60X600-4	K211770	3
8	A60X8-1	S201519	1	125	A60X125-4TA	D216364	4	600	A60X600-4TA	J212804	4
10	A60X10-1	D202633	1	150	A60X150-4	G216873	3	700	A60X700-4	G216367	5
12	A60X12-1	D211258	1	150	A60X150-4TA	N218420	4	700	A60X700-128	C215857	7
15	A60X15-1	M211772	1	175	A60X175-4	Q223183	3	800	A60X800-4	T223186	5
20	A60X20-1	L212806	1	200	A60X200-4	H211768	3	800	A60X800-4TA	A200974	6
25	A60X25-1	W213321	1	200	A60X200-4TA	G212802	4	800	A60X800-128	F218942	7
30	A60X30-1	A214337	1	225	A60X225-4	T214837	3	1000	A60X1000-128	S212283	8
35	A60X35-4	Y214841	2	250	A60X250-4	Z217395	3	1200	A60X1200-128	Q213316	8
40	A60X40-4	M216878	2	250	A60X250-4TA	D218940	4	1500	A60X1500-128	C218939	8
45	A60X45-4	D217399	2	300	A60X300-4	N201515	3	1600	A60X1600-128	L219982	8
50	A60X50-4	S218424	2	300	A60X300-4TA	V212285	4	1800	A60X1800-128	Z211254	8
55	A60X55-4	Y219464	2	350	A60X350-4	X214334	3	2000	A60X2000-128	K213817	8
60	A60X60-4	G222669	2	350	A60X350-4TA	X215346	4				

For ampere ratings and styles not listed, call Technical Services.

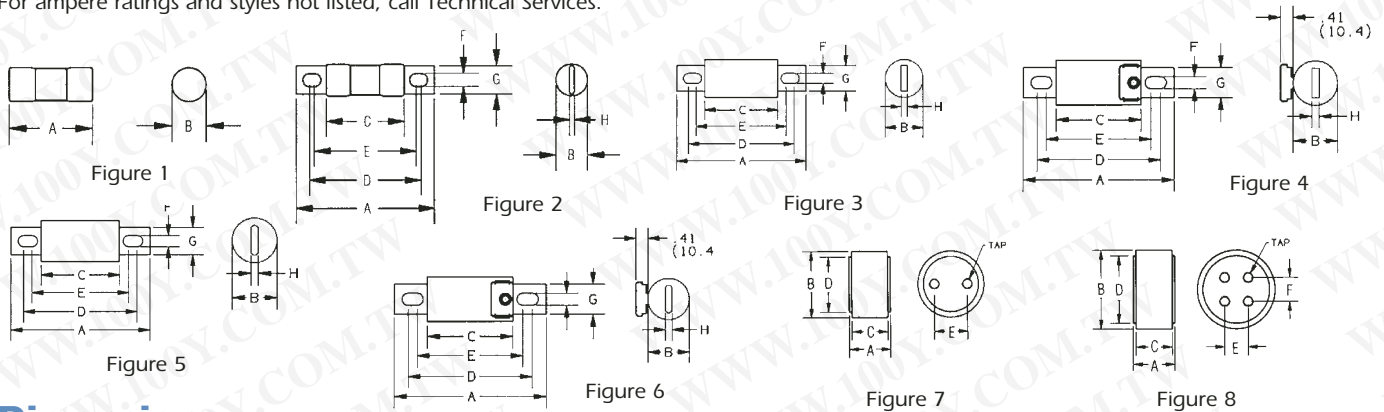

Dimensions

Outline Reference	Mounting Type	Fig.	Dimensions - Inches (mm)								Tap	
			A	B	C	D	E	F	G	H		
A60X1 to 30	1	1	5.00 (127)	.81 (20.6)	-	-	-	-	-	-	-	-
A60X35 to 60	4	2	4.38 (111)	.81 (20.6)	2.78 (70.6)	3.69 (93.7)	3.44 (87.4)	.34 (8.6)	.72 (18.3)	.13 (3.3)	-	-
A60X70 to 100	4, 4TI*, 4TA	3, 4*	4.41 (112)	1.00 (25.4)	2.91 (73.9)	3.72 (94.5)	3.59 (91.2)	.31 (7.9)	.75 (19.1)	.13 (3.3)	-	-
A60X125 to 200	4, 4TI*, 4TA	3, 4*	4.41 (112)	1.22 (31.0)	2.91 (73.9)	3.72 (94.5)	3.59 (91.2)	.31 (7.9)	1.00 (25.4)	.19 (4.8)	-	-
A60X225 to 400	4, 4TI*, 4TA	3, 4*	5.13 (130)	1.50 (38.1)	2.88 (73.2)	4.19 (106)	3.56 (90.4)	.41 (10.4)	1.00 (25.4)	.25 (6.4)	-	-
A60X450 to 600	4, 4TI*, 4TA	3, 4*	5.13 (130)	2.00 (50.8)	2.88 (73.2)	4.06 (103)	3.69 (93.7)	.41 (10.4)	1.50 (38.1)	.25 (6.4)	-	-
A60X700 to 800	4, 4TA*	5, 6*	7.25 (184)	2.50 (63.5)	3.00 (76.2)	5.94 (151)	4.56 (116)	.53 (13.5)	2.00 (50.8)	.38 (9.7)	-	-
A60X700 to 800	128	7	4.00 (102)	3.00 (76.2)	3.75 (95.3)	2.50 (63.5)	1.50 (38.1)	-	-	-	-	3/8-24-1/2 Deep
A60X1000 to 1200	128	8	4.00 (102)	3.50 (88.9)	3.75 (95.3)	3.00 (76.2)	1.50 (38.1)	1.50 (38.1)	-	-	-	3/8-24-1/2 Deep
A60X1500 to 2000	128	8	4.00 (102)	4.50 (114)	3.75 (95.3)	3.75 (95.3)	1.50 (38.1)	1.50 (38.1)	-	-	-	3/8-20-1/2 Deep

* Optional Trigger Actuator (TA)



Semiconductor (AC) fuses

American Round Fuses Form 101 Range A60X

Semiconductor Protection Fuses A60X1 to 2000

Melting Time - Current Data, 600V Fuses

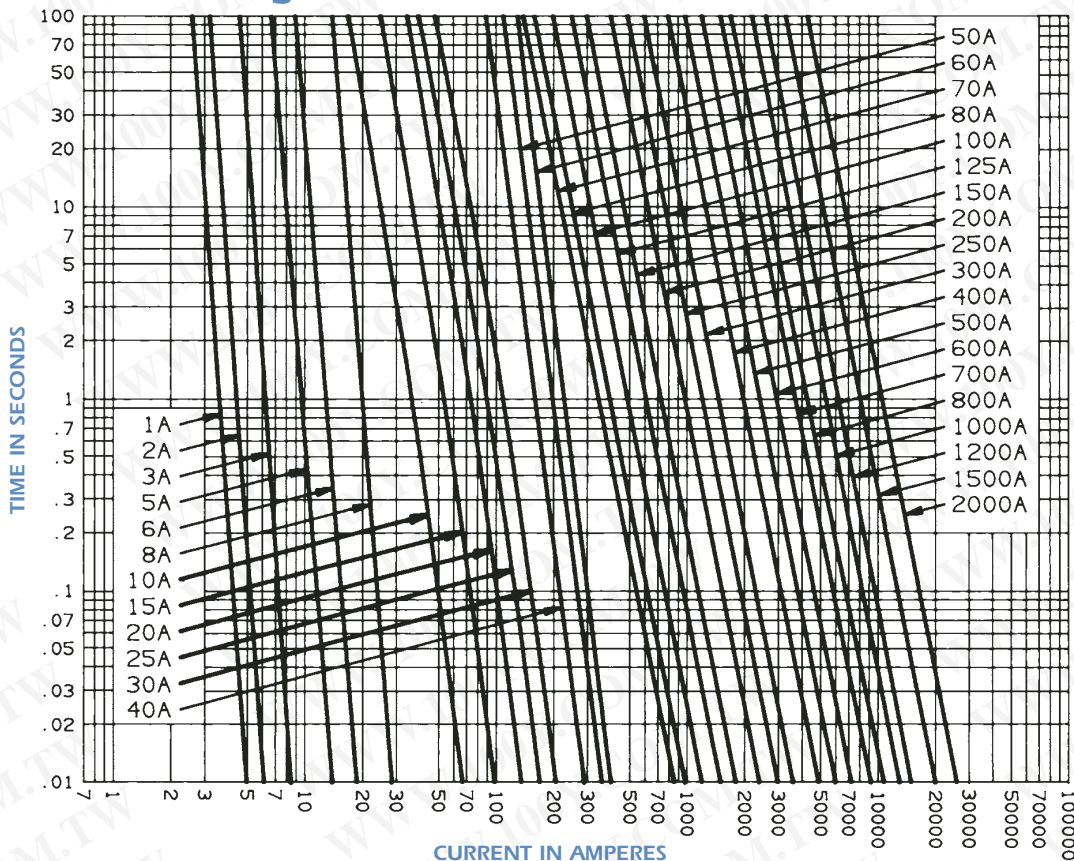

Peak Let-Through Current Data - A60X60 to 2000, 600 Volts AC

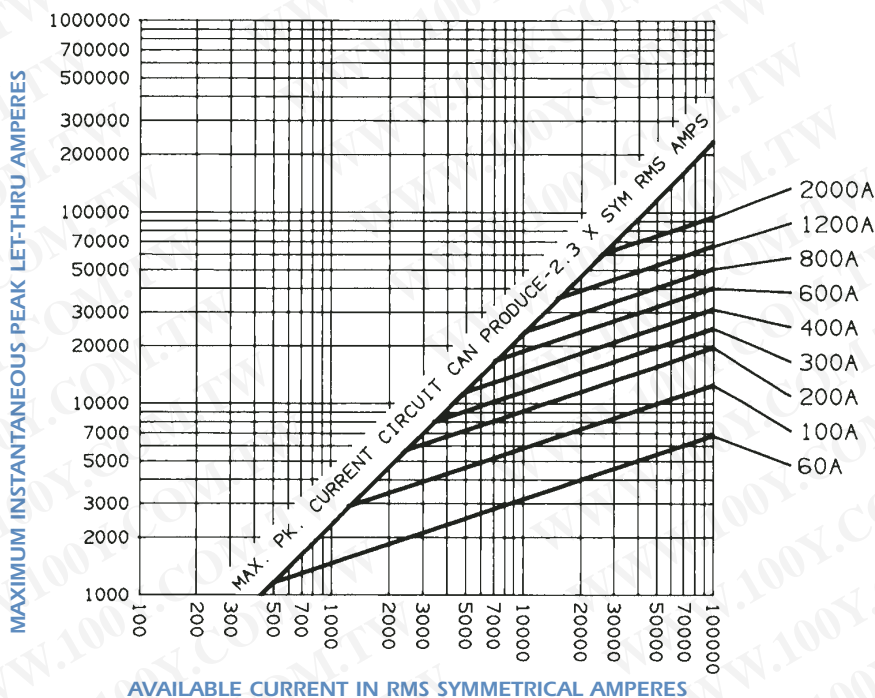

Semiconductor (AC) fuses



American Round Fuses Form 101 Range A60X

Semiconductor Protection Fuses

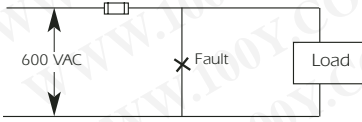

Fig. A

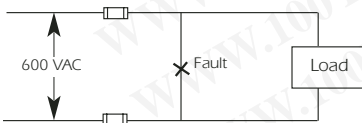

Fig. B

I²t Data – 600 Volts AC, 100kA

Fuse Ampere Rating	Melting (A ² s)	I ² t data Clearing at 600V	
		1 Fuse (Fig. A) (A ² s)	2 Fuses in series (Fig. B) (A ² s)
1	.06	.11	.09
2	.22	.45	.36
3	.50	1.0	.80
4	.90	1.8	1.4
5	1.4	2.8	2.2
6	2.0	4.0	3.2
7	2.7	5.4	4.3
8	3.6	7.1	5.7
10	16	40	30
12	22	64	48
15	35	100	70
20	60	170	130
25	95	275	210
30	140	400	290
35	270	1,800	1,200
40	350	2,400	1,600
45	450	3,000	2,000
50	550	3,600	2,400
60	800	5,400	3,600
70	4,000	13,000	9,800
80	5,300	17,000	13,000
90	6,700	22,000	16,000
100	8,300	27,000	20,000
125	13,000	42,000	31,000
150	19,000	60,000	45,000
175	25,000	80,000	61,000
200	33,000	110,000	80,000
225	42,000	140,000	100,000
250	52,000	170,000	125,000
300	75,000	240,000	180,000
350	100,000	340,000	240,000
400	130,000	490,000	320,000
450	170,000	620,000	400,000
500	210,000	770,000	500,000
600	300,000	1,100,000	720,000
700	430,000	1,700,000	1,000,000
800	560,000	2,250,000	1,400,000
1000	875,000	3,500,000	2,200,000
1200	1,250,000	5,000,000	3,100,000
1500	2,000,000	7,900,000	4,900,000
1600	2,200,000	9,000,000	5,600,000
1800	2,800,000	11,000,000	7,100,000
2000	3,500,000	14,000,000	8,900,000

Watts Loss @ Rated Current

Ampere Rating	Watts Loss (W)	Ampere Rating	Watts Loss (W)	Ampere Rating	Watts Loss (W)
10	3.8	100	11	700*	57
15	4.5	125	12	700**	52
20	4.0	150	14	800*	67
25	7.3	175	16	800**	59
30	8.7	200	19	1000	72
35	5.2	225	21	1200	86
40	6.3	300	29	1500	107
50	7.4	350	35	1600	117
60	9.1	400	37	1800	133
70	7.6	450	42	2000	148
80	8.9	500	47	2500	183
90	9.7	600	56		

*Type 4 **Type 128

Watts Loss vs. % Rated Current (Types 1 & 4)

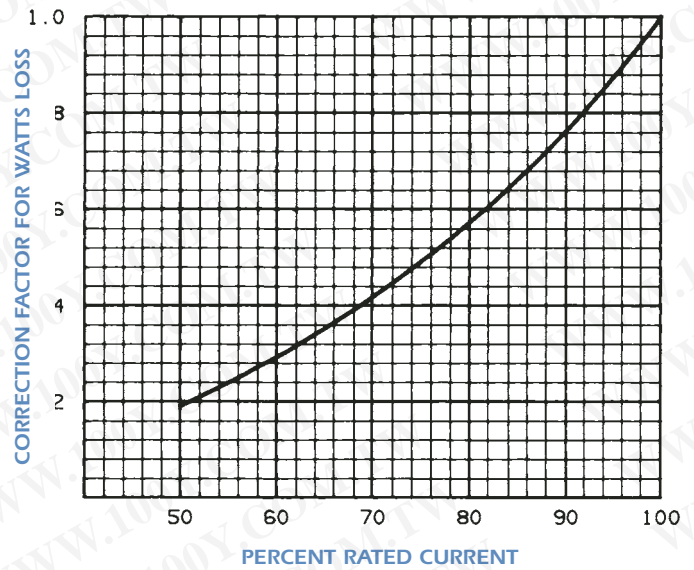

Watts Loss vs. % Rated Current (Type 128)

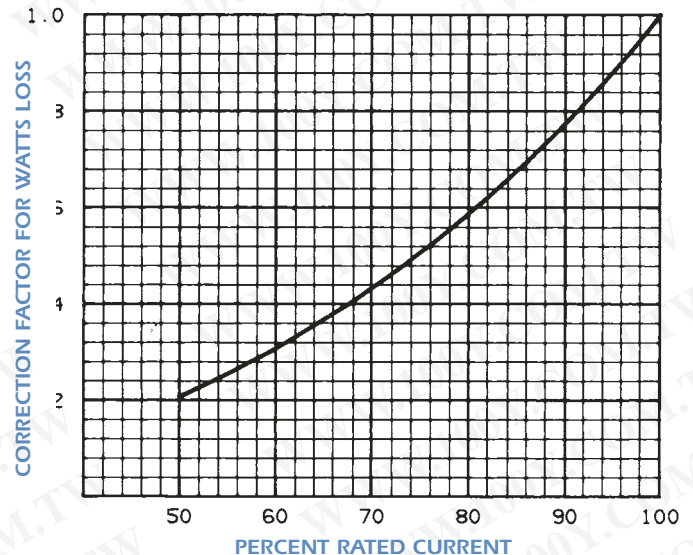

Semiconductor (AC) fuses

American Round Fuses Form 101 Range A70QS



Semiconductor Protection Fuses

A70QS Amp-trap® Semiconductor Protection fuses were developed in response to the need for improved overall performance of 700 volt semiconductor fuses for new equipment requirements. A70QS fuses have lower I^2t for better protection, longer life when subjected to cyclic loading, plus lower watts loss. A70QS is the best choice to protect dynamic solid state equipment such as motor drives, UPS, etc.

Features/Benefits

- Very Low I^2t for improved protection of equipment
 - Superior cycling ability for long, reliable life on high cyclic loading
 - Low watts loss for cooler operation
- 700V AC/DC rating gives greater design versatility
 - Ultra compact sizes allow down-sizing of existing equipment

Ratings

- AC: 35-800A
700VAC, 200kA I.R.
- DC: 35-800A
700VDC, 100kA I.R.
L/R = 10ms

Approvals

- UL Recognized
Component AC/DC
- AC: GuideNo.JFHR2
- DC: Tested to UL
Standard 198L
Parameters (35-800A)
- CSA Certified
File LR 12636

Highlights

- 700V AC/DC Rated
- Very low I^2t
- Low Watts Loss
- Superior Cycling Ability

Applications

- Protection of 700V
less motor drives,
UPS, inverters, etc.



Single Pole Fuse Blocks for A70QS Fuses



Fuse Ampere Rating	Fuse block	
	Catalog Number	Reference Number
35-200	P243C	M219040
225-600	P266A	Y212380
700-800	15C 375	

Catalog Numbering System

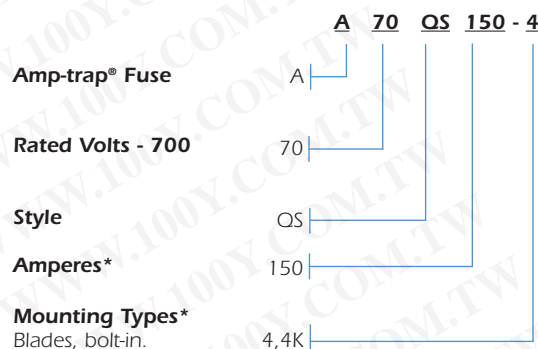

* for ampere ratings and types not listed, consult the factory.

Semiconductor (AC) fuses



American Round Fuses Form 101 Range A70QS

Semiconductor Protection Fuses

Standard Fuse Ampere Ratings, Catalog and Reference Numbers

Ampere Rating	Catalog Number	Ref. Number	Ampere Rating	Catalog Number	Ref. Number	Ampere Rating	Catalog Number	Ref. Number	Ampere Rating	Catalog Number	Ref. Number
35	A70QS35-4	D202748	100	A70QS100-4	G214343	200	A70QS200-4	V212814	450	A70QS450-4K	H215356
40	A70QS40-4	Y213829	125	A70QS125-4	L215865	200	A70QS200-4K	E213329	500	A70QS500-4	A218431
50	A70QS50-4	T217919	125	A70QS125-4K	Q216375	250	A70QS250-4	L217406	500	A70QS500-4K	R218952
60	A70QS60-4	H219473	150	A70QS150-4	P218950	300	A70QS300-4	Q218951	600	A70QS600-4	Y219993
70	A70QS70-4	B201527	150	A70QS150-4K	F219471	350	A70QS350-4	M211266	600	A70QS600-4K	P222676
80	A70QS80-4	X212816	175	A70QS175-4	A223192	400	A70QS400-4	J214345	700	A70QS700-4	E202772
90	A70QS90-4	K214346	175	A70QS175-4K	J200982	450	A70QS450-4	F214848	800	A70QS800-4	Z213830

For ampere ratings and styles not listed, ask sales agent. Mounting Type 4; note exception 4k

Dimensions

Catalog Number	Mounting Type	Dimensions - Inches (mm)								
		A	B	C	D	E	F	G	H	
A70QS35 to 100	4	4.38 (111)	1.00 (25.4)	2.88 (73.0)	3.69 (93.6)	3.50 (88.9)	0.31 (7.9)	0.75 (19.0)	0.13 (3.2)	
A70QS125 to 200	4	4.38 (111)	1.22 (31.0)	2.88 (73.0)	3.69 (93.6)	3.56 (90.5)	0.31 (7.9)	1.00 (25.4)	0.19 (4.8)	
A70QS125 to 200	4K	5.09 (129)	1.22 (31.0)	2.88 (73.0)	4.19 (106)	3.50 (88.0)	0.41 (10.3)	1.00 (25.4)	0.19 (4.8)	
A70QS225 to 400	4	5.09 (129)	1.50 (38.1)	2.84 (72.2)	4.16 (106)	3.53 (89.7)	0.40 (10.3)	1.50 (38.1)	0.25 (6.4)	
A70QS450 to 600	4	5.09 (129)	2.00 (50.8)	2.84 (72.2)	4.16 (106)	3.53 (89.7)	0.41 (10.3)	1.50 (38.1)	0.25 (6.4)	
A70QS450 to 600	4K	7.09 (180)	2.00 (50.8)	2.84 (72.2)	6.16 (156)	3.53 (89.7)	0.53 (13.5)	1.50 (38.1)	0.25 (6.4)	
A70QS700 to 800	4	7.09 (180)	2.50 (63.5)	2.84 (72.2)	5.28 (134)	4.91 (125)	0.53 (13.5)	2.00 (50.8)	0.38 (9.5)	

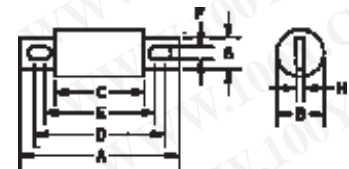

I²t Data - 700 Volts AC, 100kA

Fuse Ampere Rating	Melting $\times 10^3 A^2s$	I ² t data clearing at 700V AC	
		1 Fuse (Fig. A) $\times 10^3 A^2s$	2 Fuses in series (Fig. B) $\times 10^3 A^2s$
35	0.13	0.47	0.27
40	0.16	0.58	0.33
50	0.24	0.86	0.49
60	0.32	1.2	0.69
70	0.50	1.8	1.0
80	0.65	2.3	1.3
90	0.83	3.0	1.7
100	1.0	3.6	2.1
125	2.1	6.9	4.0
150	3.3	11	6.3
175	4.2	14	8.0
200	5.9	19	11
225	9.0	30	17
250	12.6	42	24
300	16.7	55	32
350	21.5	72	41
400	29.7	99	57
450	36.7	125	72
500	47.1	160	92
600	65.2	222	127
700	103.6	332	190
800	135.3	433	248

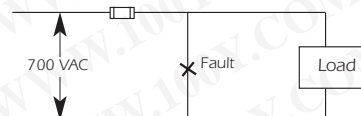

Fig. A

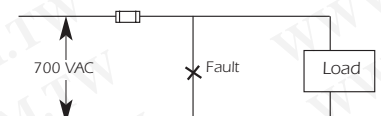
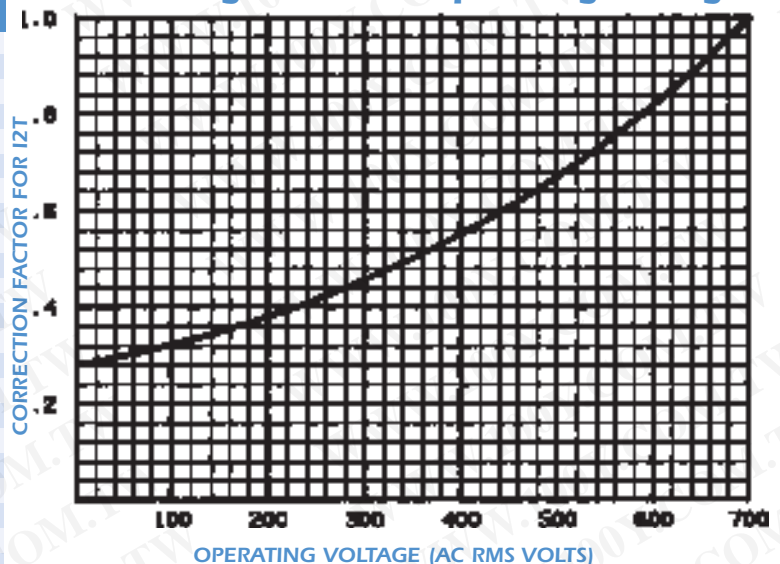

Fig. B

Clearing I²t vs. AC Operating Voltage





Semiconductor (AC) fuses

American Round Fuses Form 101 Range A70QS

Semiconductor Protection Fuses

A70QS35 to 800

Melting Time - Current Data, 700V Fuses

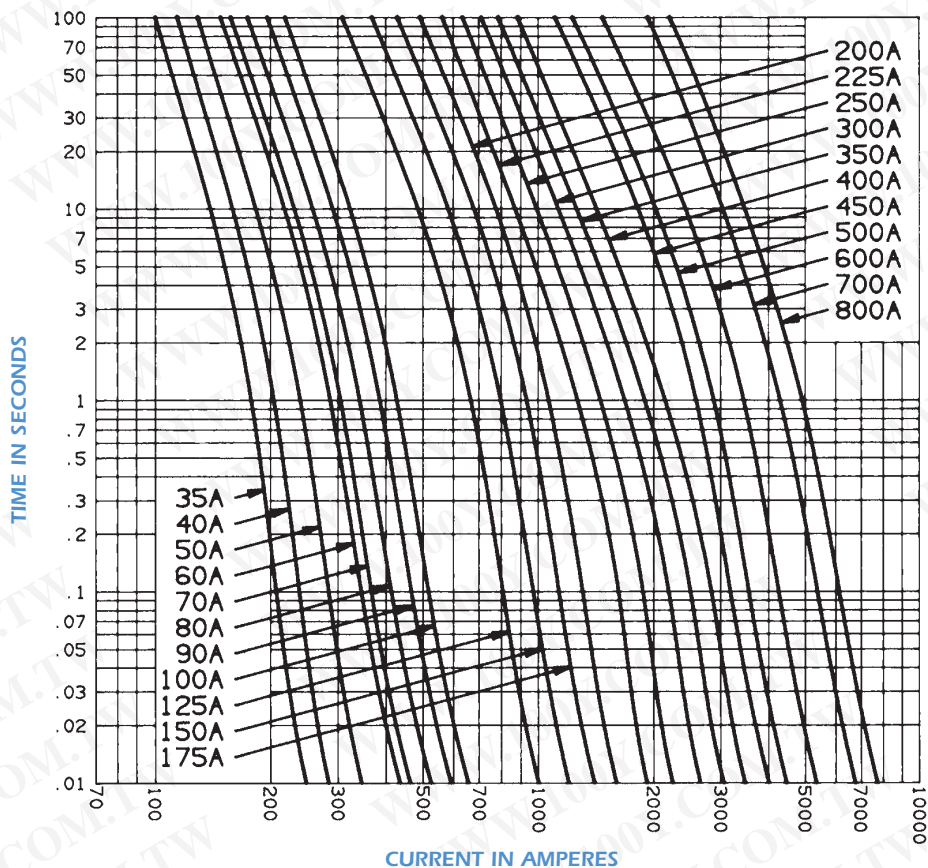

Peak Let-Thru Current Data - A70QS35 to 800, 700 Volts AC

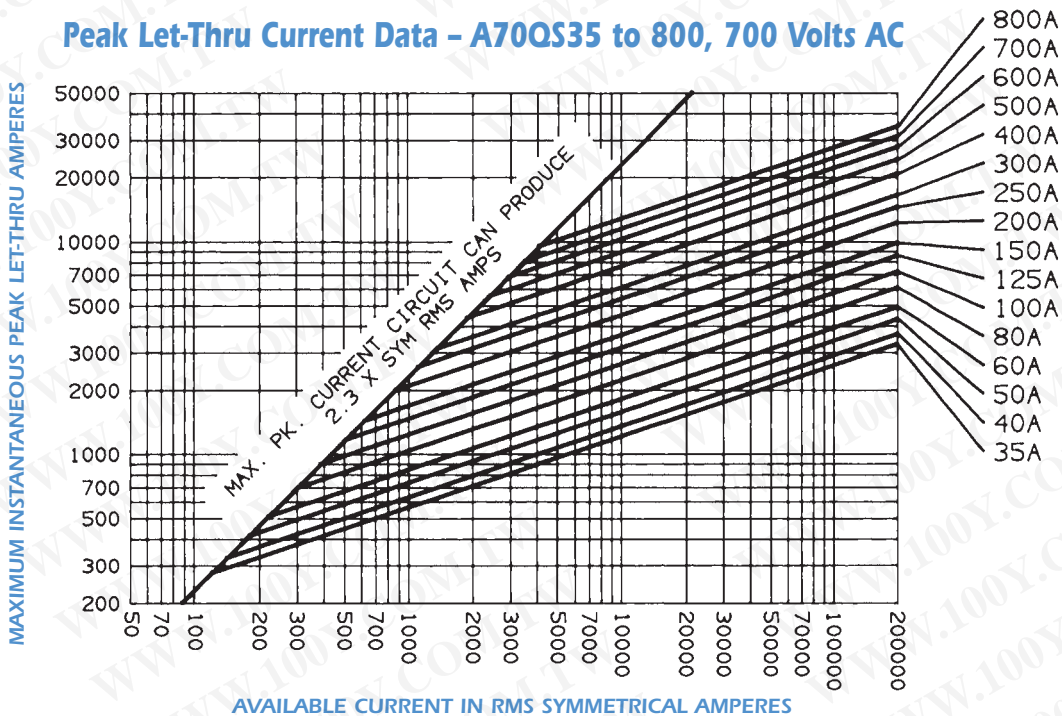

Semiconductor (AC) fuses



American Round Fuses Form 101 Range A70QS

Semiconductor Protection Fuses

Clearing I^2t at 700V DC,
100kA, L/R = 10 ms

Ampere Rating	Clearing I^2t ($A^2s \times 10^3$)
35	0.25
40	0.35
50	0.60
70	1.3
80	1.8
90	2.4
100	3.1
125	5.3
150	8.1
175	12
200	16
225	21.5
250	27.5
300	42
350	63
400	85
450	115
500	150
600	201
700	325
800	450

Maximum Arc Volts vs. System Voltage

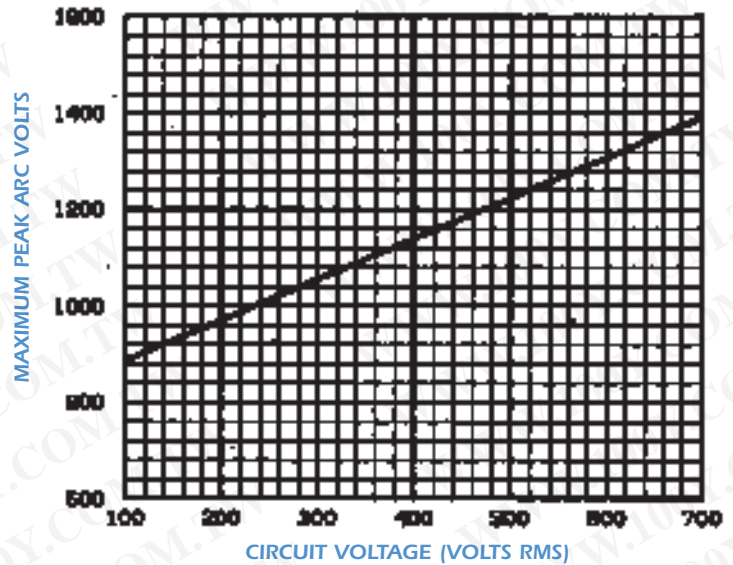

Watts Loss at Rated Current

Ampere Rating	Watts Loss (W)	Ampere Rating	Watts Loss (W)
35	6.2	200	41
40	7.5	225	37
50	9.8	250	42
60	12	300	53
70	15	350	64
80	18	400	75
90	20	450	78
100	24	500	92
125	22	600	116
150	29	700	125
175	35	800	143

DC Voltage Capability vs. Time Constant

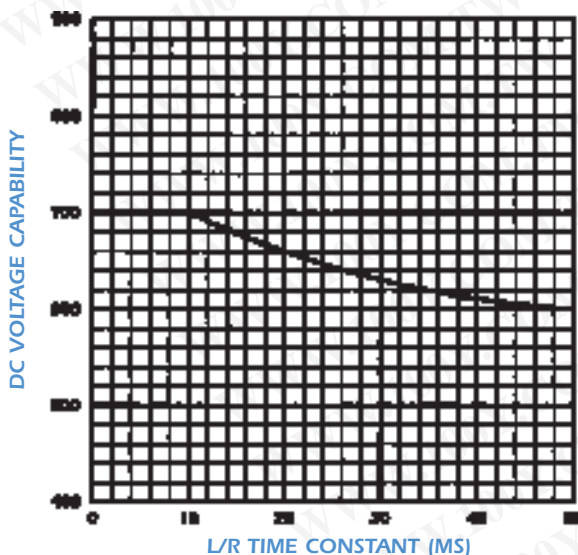

Watts Loss vs. % Rated Current

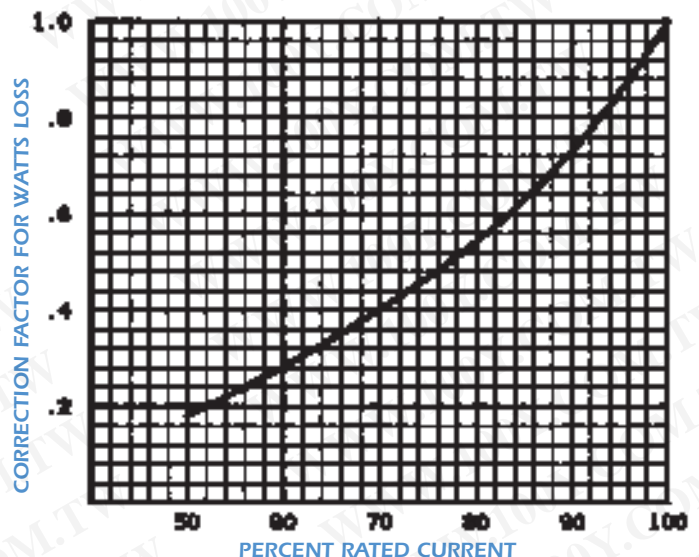

Semiconductor (AC) fuses

American Round Fuses Form 101 Range A70P



Semiconductor Protection Fuses

A70P Amp-trap® Form 101 Semiconductor Protection fuses were developed for higher voltage AC and DC drives, UPS systems, reduced voltage motor starters and similar applications where lower I²t and superior reliability were needed. A70P is a very popular fuse, available in a wide range of ratings.

Features/Benefits

- Low I²t minimizes damage to protected components on short circuit
- Controlled arc voltage reduces stress to circuit components during fuse clearing
- Choice of mounting types helps in equipment design

Ratings

- AC: 10-1000A
700VAC, 100kA I.R.
- DC: 10-800A
650VDC, 100kA I.R.
L/R = 10ms

Approvals

- UL Recognized Component
- AC: GuideNo.JFHR2 (10-1000A)
- DC: Tested to UL Standard 198L Parameters (10-800A)

Highlights

- Very Fast Acting
- Current Limiting
- Low I²t
- Indicator Options Available

Applications

- Protection of 700V or less DC drives, UPS, inverters, reduced voltage starters, etc.



Single Pole Fuse Blocks for A70P Fuses



Catalog Numbering System

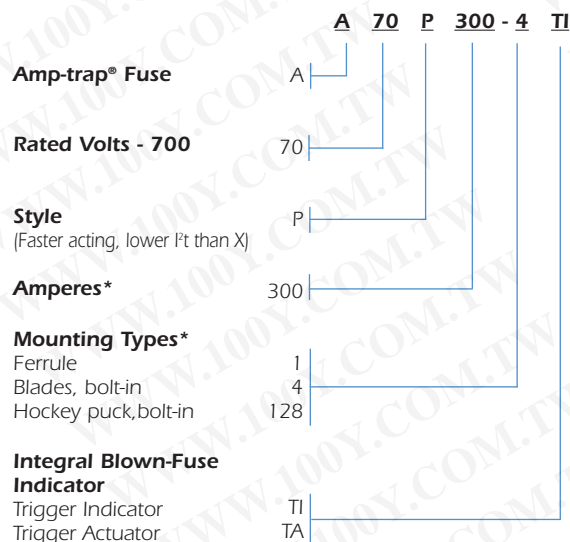

Fuse Ampere Rating	Fuse block	
	Catalog Number	Reference Number
10-30 (Type 1)	70316	B223308
31-60	P243C	M219040
61-100	P243C	M219040
101-200	P266A	Y212380
201-400	P266A	Y212380
401-600	P266F	S213410
601-800	1SC375	Q210579B

* For ampere ratings and types not listed, ask sales agent.

Semiconductor (AC) fuses



American Round Fuses Form 101 Range A70P

Semiconductor Protection Fuses Standard Fuse Ampere Ratings

Ampere Rating	Catalog Number	Ref Number	Outline Fig.	Ampere Rating	Catalog Number	Ref Number	Outline Fig.	Ampere Rating	Catalog Number	Ref Number	Outline Fig.
10	A70P10-1	R212811	1	80	A70P80-4	V219990	3	300	A70P300-4	P212809	3
10	A70P10-4	B213326	2	80	A70P80-4TA	L222673	4	350	A70P350-4	C215351	3
15	A70P15-1	F214342	1	80	A70P80-4TI	Z223191	3	400	A70P400-4	L218947	3
15	A70P15-4	C214845	2	90	A70P90-4	J211263	3	400	A70P400-4TA	Y223190	4
20	A70P20-1	D215352	1	100	A70P100-4	J218945	3	400	A70P400-4TI	F200979	3
25	A70P25-1	N216373	1	100	A70P100-4TA	R219987	4	450	A70P450-4	W201522	3
25	A70P25-4	S216883	2	125	A70P125-4	P211774	3	500	A70P500-4	H211262	3
30	A70P30-1	J217404	1	125	A70P125-4TA	N212808	4	600	A70P600-4	C219468	3
30	A70P30-4	R217917	2	150	A70P150-4	A214843	3	600	A70P600-4TA	M216372	4
35	A70P35-4	D214340	3	150	A70P150-4TA	B215350	4	600	A70P600-4TI	R216882	3
40	A70P40-4	Q216881	3	150	A70P150-4TI	F215860	3	700	A70P700-4	M218948	5
40	A70P40-4TA	P217915	4	175	A70P175-4	N217914	3	700	A70P700-4TI	C219468	5
40	A70P40-4TI	W218427	3	200	A70P200-4	K218946	3	800	A70P800-4	G200980	5
50	A70P50-4	W202695	3	200	A70P200-4TA	A219466	4	800	A70P800-4TI	X202696	5
60	A70P60-4	A213325	3	200	A70P200-4TI	S219988	3	900	A70P900-4	D212293	6
60	A70P60-4TA	S213824	4	225	A70P225-4	E200978	3	1000	A70P1000-4	D200977	6
60	A70P60-4TI	E214341	3	250	A70P250-4	V201521	3	1200	A70P1200-4	F211260	7
70	A70P70-4	H217403	3	250	A70P250-4TA	G211261	4				
70	A70P70-4TI	Q217916	3	250	A70P250-4TI	Q211775	3				

For ampere ratings and styles not listed, call Technical Services.



Figure 1

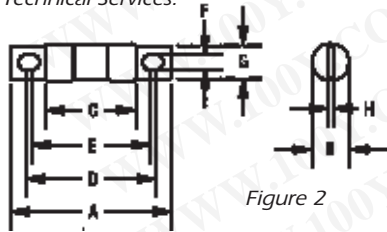

Figure 2

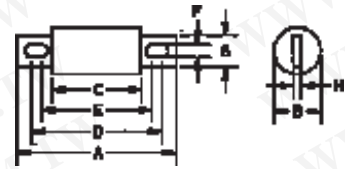

Figure 3

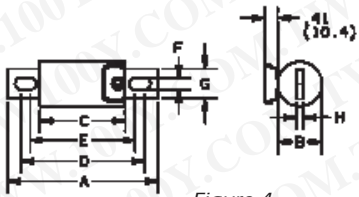

Figure 4

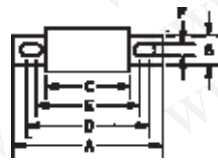

Figure 5

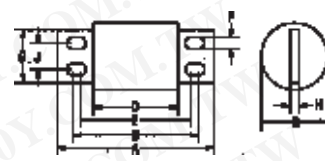

Figure 6

Dimensions

Outline Reference.	Mounting Type	Fig.	Dimensions - Inches (mm)									
			A	B	C	D	E	F	G	H	J	K
A70P10 to 30	1	1	2.00 (50.8)	.56 (14.2)	-	-	-	-	-	-	-	-
A70P10 to 30	4	2	2.88 (73.2)	.56 (14.2)	1.88 (47.8)	2.50 (63.5)	-	.27 (6.9)	.41 (10.4)	-	-	-
A70P35 to 60	4, 4TA*, 4TI	3, 4*	4.38 (111)	1.00 (25.4)	2.88 (73.2)	3.69 (93.7)	3.56 (90.4)	.31 (7.9)	.75 (19.1)	.06 (1.5)	-	-
A70P70 to 100	4, 4TA*, 4TI	3, 4*	4.38 (111)	1.22 (31.0)	2.88 (73.2)	3.69 (93.7)	3.56 (90.4)	.31 (7.9)	1.00 (25.4)	.19 (4.8)	-	-
A70P125 to 200	4, 4TA*, 4TI	3, 4*	5.09 (129)	1.50 (38.1)	2.84 (72.1)	4.16 (106)	3.53 (89.7)	.41 (10.4)	1.00 (25.4)	.25 (6.4)	-	-
A70P225 to 400	4, 4TA*, 4TI	3, 4*	5.09 (129)	2.00 (50.8)	2.84 (72.1)	4.16 (106)	3.53 (89.7)	.41 (10.4)	1.50 (38.1)	.24 (6.4)	-	-
A70P450 to 600	4, 4TA*, 4TI	3, 4*	7.09 (180)	2.50 (63.5)	2.84 (72.1)	5.25 (133)	4.94 (125)	.53 (13.5)	2.00 (50.8)	.38 (9.7)	-	-
A70P700 to 800	4, 4TI	5	6.81 (173)	2.88 (73.2)	3.31 (84.1)	5.31 (135)	-	.63 (16.0)	2.00 (50.8)	.38 (9.7)	.31 (7.9)	-
A70P900 to 1000	4, 4TI	6	7.59 (193)	3.50 (88.9)	3.84 (97.5)	5.97 (152)	5.22 (133)	.63 (16.0)	2.75 (69.9)	.50 (12.7)	1.38 (35.1)	-
A70P1200	4	7	10.84 (275.4)	4.5 (114.3)	3.84 (97.6)	6.84 (173.7)	5.84 (148.3)	9.34 (237.3)	9.59 (243.6)	3.5 (88.9)	.63 (15.9)	.75 (19.1)

* Optional Trigger Actuator (TA)

Semiconductor (AC) fuses

American Round Fuses Form 101 Range A70Q



Semiconductor Protection Fuses

A70Q Amp-trap® Semiconductor Protection fuses were developed for inverter applications requiring extremely low I²t. A70Q fuses provide the most responsive protection for applications not required to sustain heavy overloads.

Features/Benefits

- Lowest I²t of any fuse in this voltage rating for best overall protection
- 700V AC, 650V DC rating allows protection of greater variety of circuits
- Solid fill technology for extra reliability in performance

Ratings

- AC: 35-600A
700VAC, 100kA I.R.
- DC: 35-600A
650VDC, 100kA I.R.
L/R = 10ms

Approvals

- UL Recognized Component
- AC: GuideNo.JFHR2
- DC: Tested to UL Standard 198L Parameters (35-600A)

Highlights

- Extremely Fast Acting
- Current Limiting
- Lowest I²t

Applications

- Protection of inverters and other equipment requiring the best AC or DC protection in this voltage range



Single Pole Fuse Blocks for A70Q Fuses



Fuse Ampere Rating	Fuse block	
	Catalog Number	Reference Number
35-100	P243C	M219040
125-400	P266A	Y212380
450-600	P266F	S213410

Catalog Numbering System

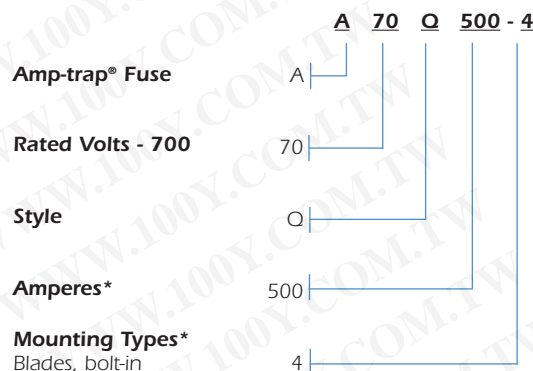

* For ampere ratings and types not listed, ask sales agent.

Semiconductor (AC) fuses



American Round Fuses Form 101 Range A70Q

Semiconductor Protection Fuses

Standard Fuse Ampere Ratings

Ampere Rating	Catalog Number	Reference Number
35	A70Q35-4	D214846
40	A70Q40-4	T216884
50	A70Q50-4	N218949
60	A70Q60-4	W219991
70	A70Q70-4	R202714
80	A70Q80-4	K211264
90	A70Q90-4	V211779
100	A70Q100-4	Y218429
125	A70Q125-4	D219469
150	A70Q150-4	H200981
175	A70Q175-4	Y202697
200	A70Q200-4	T211778
250	A70Q250-4	S212812
300	A70Q300-4	V213826
350	A70Q350-4	E215353
400	A70Q400-4	K217405
450	A70Q450-4	S217918
500	A70Q500-4	E219470
600	A70Q600-4	M222674

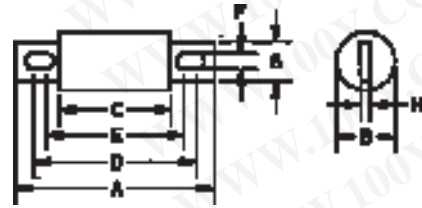

Figure 1

For ampere ratings and styles not listed, call Technical Services.

Dimensions

Catalog Number	Mounting Type	Dimensions - Inches (mm)							
			A	B	C	D	E	F	G
A70Q35 to 60	4	4.37 (111)	1.22 (31.0)	1.96 (49.8)	3.69 (93.7)	2.91 (73.9)	.34 (8.6)	1.00 (25.4)	.19 (4.8)
A70Q70 to 100	4	4.37 (111)	1.22 (31.0)	1.96 (49.8)	3.69 (93.7)	2.91 (73.9)	.41 (10.4)	1.00 (25.4)	.19 (4.8)
A70Q125 to 200	4	5.09 (129)	1.50 (38.1)	1.96 (49.8)	4.16 (106)	2.91 (73.9)	.41 (10.4)	1.00 (25.4)	.25 (6.4)
A70Q250 to 400	4	5.09 (129)	2.00 (50.8)	1.96 (49.8)	4.00 (102)	2.94 (74.7)	.56 (14.2)	1.50 (38.1)	.25 (6.4)
A70Q450 to 600	4	7.09 (180)	2.50 (63.5)	1.96 (49.8)	5.72 (145)	3.25 (82.6)	.56 (14.2)	2.00 (50.8)	.38 (9.7)

Semiconductor (AC) fuses

American Round Fuses Form 101 Range A100P



Semiconductor Protection Fuses

A100P Amp-trap® Form 101 Semiconductor Protection fuses are rated 1000V, extending the range of protection for UPS systems, AC and DC drives, reduced voltage motor starters and similar applications where lower I²t and superior reliability are needed. With ratings from 15 through 1000 amperes, a wide range of high voltage applications can be served.

Features/Benefits

- Low I²t minimizes damage to protected components on short circuit
- Controlled arc voltage reduces stress to circuit components during fuse clearing
 - Wide range of ampere ratings

Ratings

- AC: 15-30A
1000VAC, 100kA I.R.
35-1000A
1000VAC, 100kA I.R.
- DC: 15-1000A
750VDC, 100kA I.R.

Approvals

- UL Recognized Component
- AC: UL Guide No. JFHR2 (60-800A)
- DC: Ferraz Shawmut Certified

Highlights

- Fast Acting
- Current Limiting
- Low I²t
- Optional Trigger Indicator

Applications

- Protection of UPS systems AC/DC drives, reduced voltage motor starters and other 1000V or less semiconductor devices
- Spare markets only for new installations, refer to PC range



Single Pole Fuse Blocks for A100P Fuses

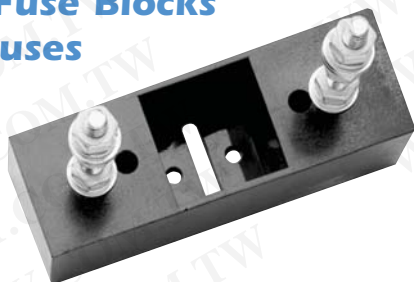

Fuse Ampere Rating	Fuse block	
	Catalog Number	Reference Number
35-100	P266G	Z214428
125-400	P266L	J215955

Catalog Numbering System

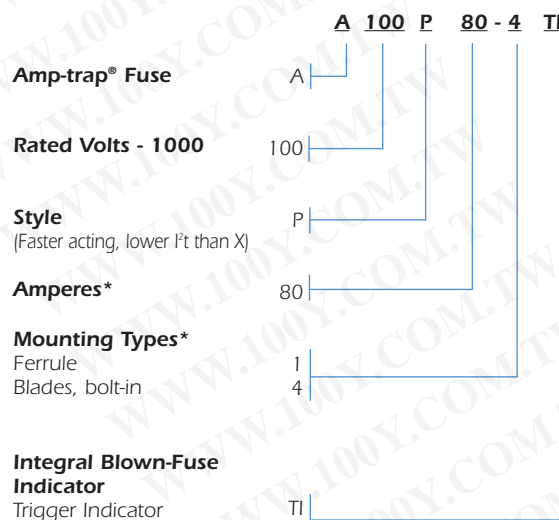

Semiconductor (AC) fuses



American Round Fuses Form 101 Range A100P

Semiconductor Protection Fuses

Standard Fuse Ampere Ratings, Catalog and Reference Numbers

Ampere Rating	Catalog Number	Ref Number	Outline Fig.	Ampere Rating	Catalog Number	Ref Number	Outline Fig.	Ampere Rating	Catalog Number	Ref Number	Outline Fig.
15	A100P15-1	D222643	1	80	A100P80-4TI	Y202191	2	350	A100P350-4	Q201494	2
20	A100P20-1	Y212265	1	100	A100P100-4	A215832	2	350	A100P350-4TI	X202190	2
25	A100P25-1	J216852	1	100	A100P100-4TI	E216342	2	400	A100P400-4	Z212266	2
30	A100P30-1	E218918	1	125	A100P125-4	D218917	2	400	A100P400-4TI	Y213300	2
35	A100P35-4	S223162	2	125	A100P125-4TI	-	2	500	A100P500-4	W214816	3
40	A100P40-4	A211232	2	150	A100P150-4	R223161	2	500	A100P500-4TI	C215834	3
50	A100P50-4	Q213799	2	150	A100P150-4TI	Y200949	2	600	A100P600-4	A217373	3
50	A100P50-4TI	Y214312	2	200	A100P200-4	J212781	2	600	A100P600-4TI	Q218399	3
60	A100P60-4	G216344	2	200	A100P200-4TI	X213299	2	650	A100P650-4	F218919	4
60	A100P60-4TI	K216853	2	225	A100P225-4	F216343	2	700	A100P700-4	T223163	4
65	A100P65-4	-	2	250	A100P250-4	Z217372	2	800	A100P800-4	B211233	4
70	A100P70-4TI	-	2	300	A100P300-4	T219437	2	800	A100P800-4TI	L212783A	4
80	A100P80-4	R201495	2	300	A100P300-4TI	E222644	2	1000	A100P1000-4	Y217371	5

For ampere ratings and styles not listed, ask sales agent. All of these catalog and reference numbers are without TI



Figure 1

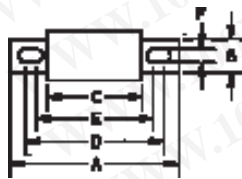

Figure 2

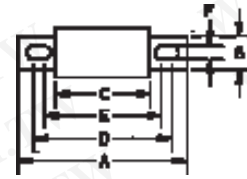

Figure 3

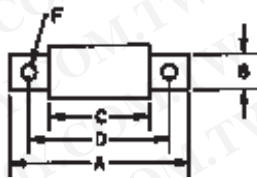

Figure 4

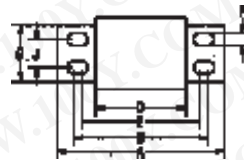

Figure 5

Dimensions

Catalog Number	Mounting Type	Fig.	Dimensions - Inches (mm)								
			A	B	C	D	E	F	G	H	J
A100P15 to 30	1	1	2.63 (66.8)	0.56 (14.2)	-	-	-	-	-	-	-
A100P35 to 60	4, 4TI	2	5.00 (127)	1.00 (25.4)	3.50 (173)	4.31 (109)	4.19 (106)	0.31 (7.9)	0.75 (19.1)	0.13 (3.3)	-
A100P65 to 100	4, 4TI	2	5.00 (127)	1.22 (31.0)	3.50 (173)	4.31 (109)	4.19 (106)	0.31 (7.9)	1.00 (25.4)	0.19 (4.8)	-
A100P125 to 200	4, 4TI	2	5.72 (145)	2.00 (38.1)	3.47 (88.1)	4.78 (121)	4.16 (106)	0.41 (10.4)	1.00 (25.4)	0.25 (6.4)	-
A100P225 to 400	4, 4TI	2	5.72 (145)	2.00 (50.8)	3.47 (88.1)	4.78 (121)	4.16 (106)	0.41 (10.4)	1.50 (25.4)	0.25 (6.4)	-
A100P500 to 600	4, 4TI	3	7.72 (196)	2.50 (63.5)	3.47 (88.1)	5.88 (149)	5.56 (141)	0.53 (13.5)	2.00 (50.8)	0.38 (9.7)	-
A100P650 to 800	4, 4TI	4	7.44 (189)	2.88 (73.2)	3.94 (100)	5.94 (151)	-	0.63 (16.0)	2.00 (50.8)	0.38 (9.7)	0.31 (7.9)
A100P1000	4	5	8.22 (209)	3.50 (88.9)	4.47 (114)	6.59 (167)	5.84 (148)	0.63 (16.0)	2.75 (69.9)	0.50 (12.7)	1.38 (35.1)



Semiconductor (AC) fuses

American Round Fuses Form 101 Range A100P

Semiconductor Protection Fuses

A100P15 to 1000

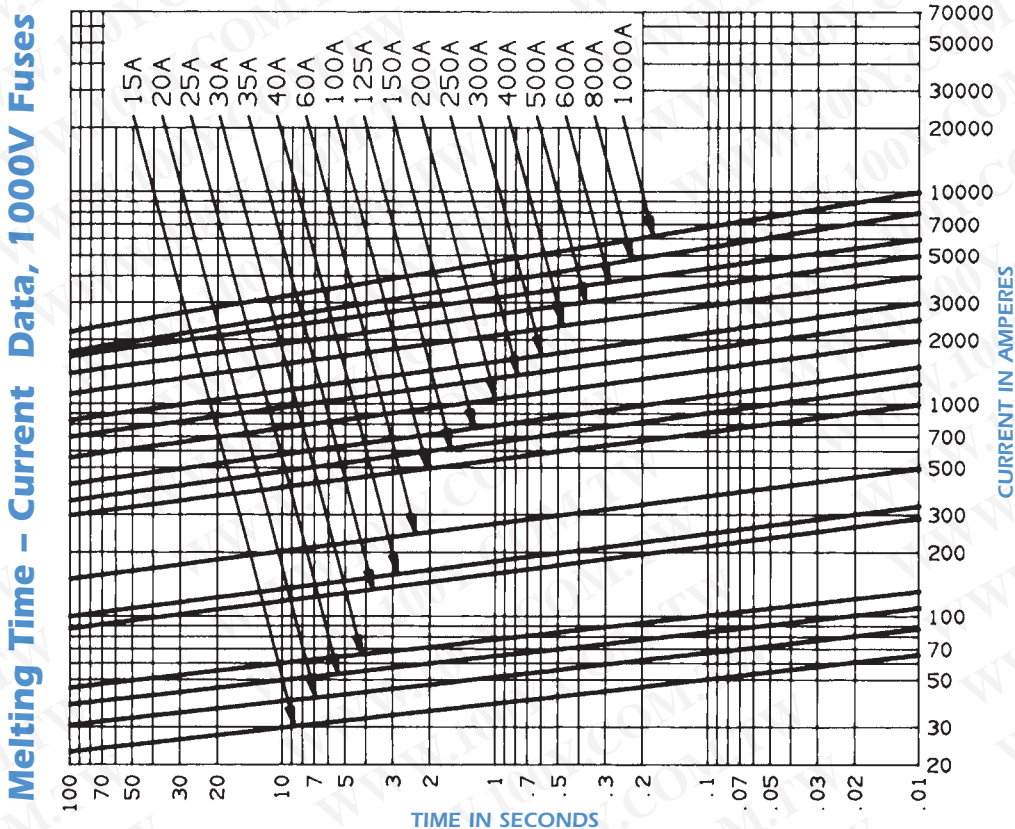

Peak Let-Thru Current Data - A100P30 to 1000, 1000 Volts AC

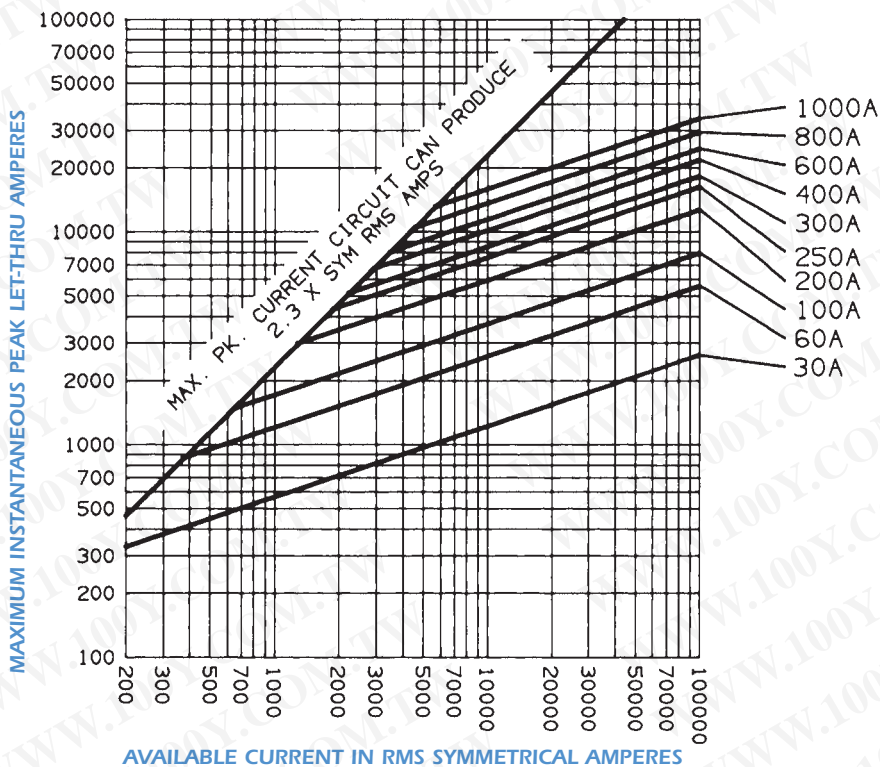

Semiconductor (AC) fuses



American Round Fuses Form 101 Range A100P

Semiconductor Protection Fuses

I²t Data – 1000 Volts AC, 100kA

Ampere Rating	I ² t Data	
	Melting (A ² x 10 ³)	Clearing @1000VAC (fig A) (A ² x 10 ³)
15	.023	.6
20	.03	.8
25	.047	1.3
30	.057	1.5
35	.29	2.2
40	.38	2.9
50	.60	4.5
60	.86	6.5
65	1.0	7.6
70	1.2	8.8
80	1.5	12
100	2.4	18
125	3.8	28
150	5.4	41
200	9.6	72
225	12	91
250	15	110
300	22	160
350	29	220
400	38	290
500	60	450
600	86	650
650	100	760
700	120	880
800	150	1,200
1,000	240	1,900

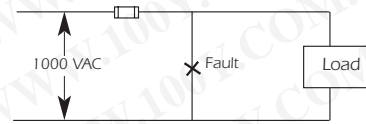
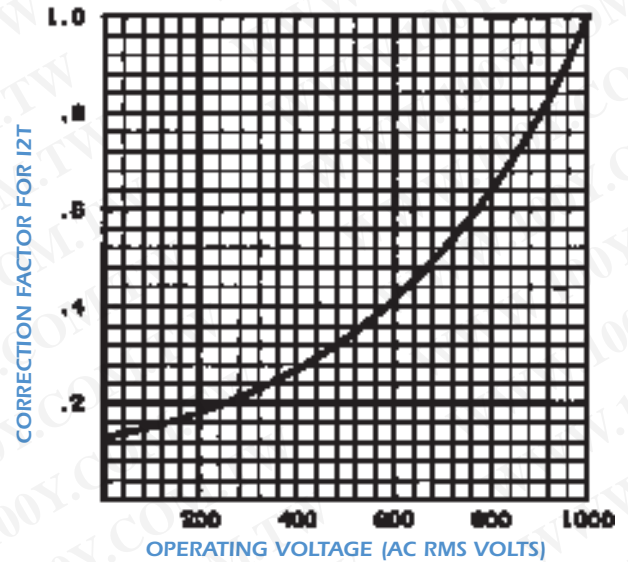

Fig. A

Clearing I²t vs. AC Operating Voltage



Watts Loss at Rated Current

Ampere Rating	Watts Loss (W)	Ampere Rating	Watts Loss (W)
15	3.4	225	40
20	5.9	250	45
25	9	300	55
30	12.8	350	65
35	7.3	400	70
40	8.3	500	90
50	11	600	110
60	13	650	120
70	13	700	125
80	14	800	140
100	18	1000	190
125	23		
150	28		
200	36		

Watts Loss vs. % Rated Current

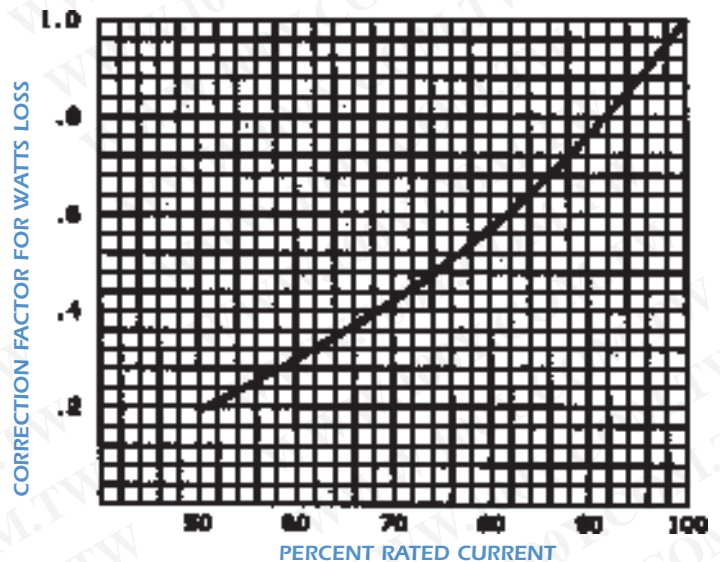

Semiconductor (AC) fuses

American Round Fuses Form 101 Range A120X



Semiconductor Protection Fuses

A120X Amp-trap® Form 101 Semiconductor Protection fuses, rated 1/2A through 30A, 1200VAC are popular for use in traction drive auxiliary circuits and similar applications.

A120X fuses are also suitable for use on 1000VDC auxiliary circuits with low time constants.

Features/Benefits

- 1000 Volt DC rated for wide range of circuits
- Compact size fits in where competitive sizes will not fit

Ratings

- AC: 1/2-30A
1200VAC, 100kA I.R.
- DC: 1/2-30A
1000VDC, 100kA I.R.
L/R = 10ms

Approvals

- Ferraz Shawmut Certified

Highlights

- Fast Acting
- Current Limiting
- Low I²t
- Compact Size

Applications

- Protection of traction drive auxiliary circuits, etc.

Dimensions - In (mm)

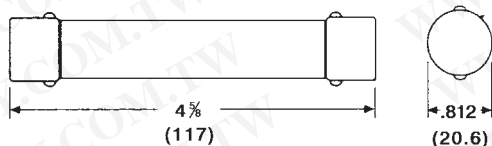

Single Pole Fuse Blocks for A120X Fuses

Fuse Ampere Rating	Fuse block	
	Catalog Number	Reference Number
1/2-30	P292	T216976

Catalog Numbering System

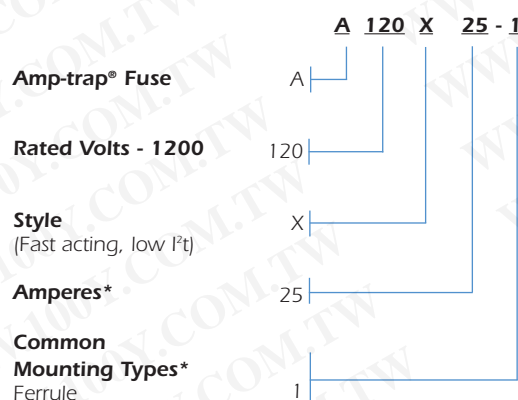

* For ampere ratings and types not listed, ask sales agent.

Standard Fuse Ampere Ratings, Catalog and Reference Numbers

Ampere Rating	Catalog Number	Reference Number	Ampere Rating	Catalog Number	Reference Number
1/2	A120X1/2-1	T218954	6	A120X6-1	W216380
1	A120X1-1	C218433	10	A120X10-1	K219475
2	A120X2-1	E223196	15	A120X15-1	R222678
3	A120X3-1	P211268	20	A120X20-1	M200985
4	A120X4-1	Z212818	25	A120X25-1	E202864
5	A120X5-1	J214851	30	A120X30-1	Z211783

Semiconductor (AC) fuses



American Round Fuses Form 101 Range A120X

Semiconductor Protection Fuses

A120X1/2 to 30

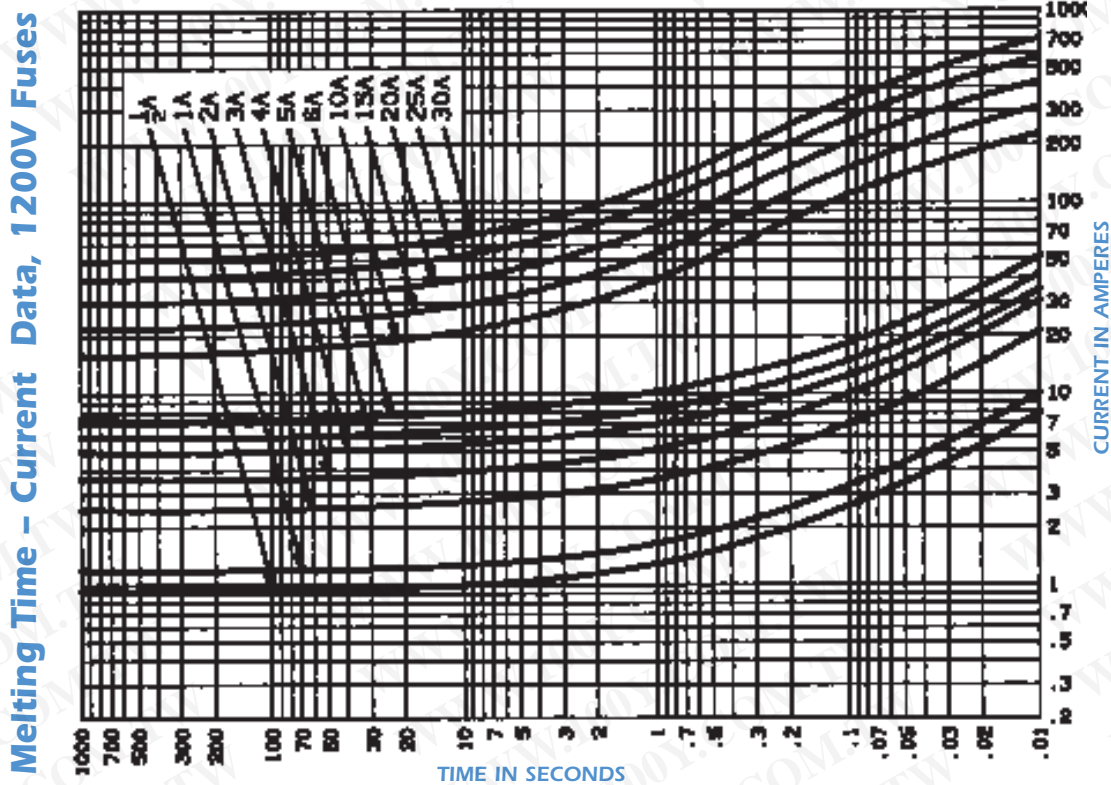

Peak Let-Thru Current Data - A120X2 to 30, 1200 Volts AC

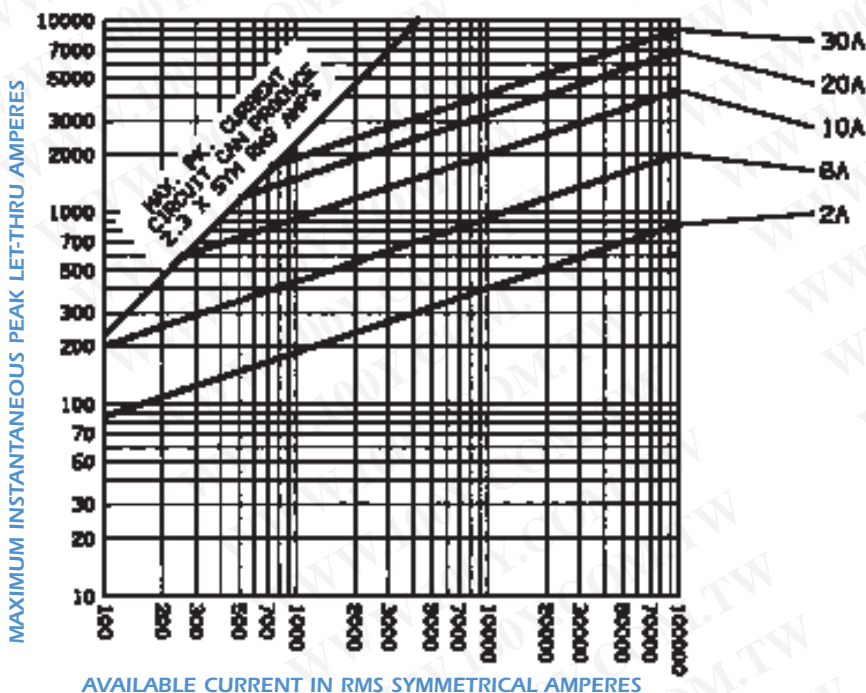

I²t at 1200VAC, 100kA

Fuse Ampere Rating	I ² t data	
	Melting (A ² s)	Clearing (A ² s)
1/2	.10	1.9
1	.40	7.5
2	4.3	30
3	8.9	69
4	10	120
5	18	190
6	29	280
10	500	970
15	1100	2100
20	2000	3700
25	3100	5700
30	4400	8300

Semiconductor (AC) fuses

American Round Fuses Form 101 Range A150X



Semiconductor Protection Fuses

A150X Amp-trap® Form 101 Semiconductor Protection fuses, rated up to 1000A, 1500VAC are suitable for Traction drive and auxiliary circuits and for High Voltage Heavy duty rectifier applications. A150X fuses are suitable for use up to 1500VDC on circuits depending on time constant.

Features/Benefits

- 1500 Volt AC rated for wide range of applications
 - Heavy Duty Links
 - Rugged Fiberglass Body

Ratings

- AC: 1A to 1000A
1500VAC, 100kA I.R.
- DC: 1A to 1000A
1000VDC, 100kA I.R.
L/R = 1000ms

Approvals

- Ferraz Shawmut Certified

Highlights

- Fast Acting
- Current Limiting
- Low I²t

Applications

- Protection of traction drive auxiliary circuits, etc.

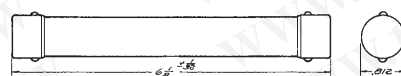

Figure 1

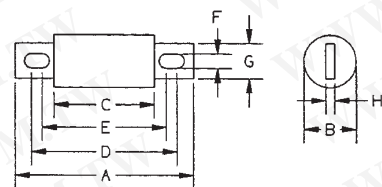

Figure 2

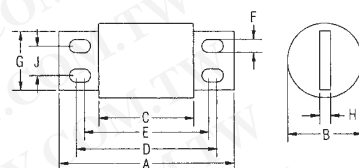

Figure 3

Outline Ref.	Mounting Type	Fig	Dimensions - Inches (mm)												
			A	B	C	D	E	F	G	H	J				
A150X1 to 30	1	1													
A150X15 to 60	4	2	7.15 (182)	1.21 (31)	5.62 (143)	6.46 (164)	6.34 (161)	0.31 (8)	1.00 (25)	0.18 (3)	-				
A150X70 to 100	4	2	7.87 (127)	1.50 (31)	5.62 (173)	6.93 (176)	6.31 (160)	0.40 (10)	1.00 (25)	.025 (6)	-				
A150X125 to 300	4	2	7.87 (145)	2.00 (38)	5.62 (88)	6.93 (176)	6.31 (160)	0.40 (10)	1.50 (38)	0.25 (6)	-				
A150X400 to 600	4	2	9.75 (145)	2.50 (51)	6.62 (88)	8.31 (211)	8.06 (205)	0.56 (14)	2.00 (51)	0.25 (6)	-				
A150X800 to 1000	4	3	9.87 (251)	3.50 (89)	6.12 (155)	8.03 (204)	7.71 (196)	0.56 (14)	2.75 (70)	0.37 (9)	1.37 (35)				

Standard Fuse Ampere Ratings, Catalog Numbers

Ampere Rating	Catalog Number	Ref. Number	Outline Fig.	Ampere Rating	Catalog Number	Ref. Number	Outline Fig.
1	A150X1-1	J213333	1	90	A150X90-4	R215364	2
15	A150X15-1	Q200988	1	100	A150X100-4	Q215869	2
15	A150X15-4	F201531	2	125	A150X125-4	M219477	2
20	A150X20-1	R215870	1	150	A150X150-4	K213334	2
20	A150X20-4	C216892	2	175	A150X175-4	C213833	2
25	A150X25-4	E218435	2	200	A150X200-4	A217925	2
30	A150X30-1	V222681	1	250	A150X250-4	N219478	2
30	A150X30-4	J223200	2	300	A150X300-4	G21532	2
35	A150X35-4	C211786	2	400	A150X400-4	Q214351	2
40	A150X40-4	D213834	2	450	A150X450-4	Y216382	2
50	A150X50-4	S217412	2	500	A150X500-4	B217926	2
60	A150X60-4	D219998	2	600	A150X600-4	K223201	2
70	A150X70-4	N212302	2	800	A150X800-4	N214855	2
80	A150X80-4	E213835	2	1000	A150X1000-4		2

Semiconductor (AC) fuses



American Round Fuses Form 101 Range A150X

Semiconductor Protection Fuses

Melting Time - Current Data, 1500V Fuses

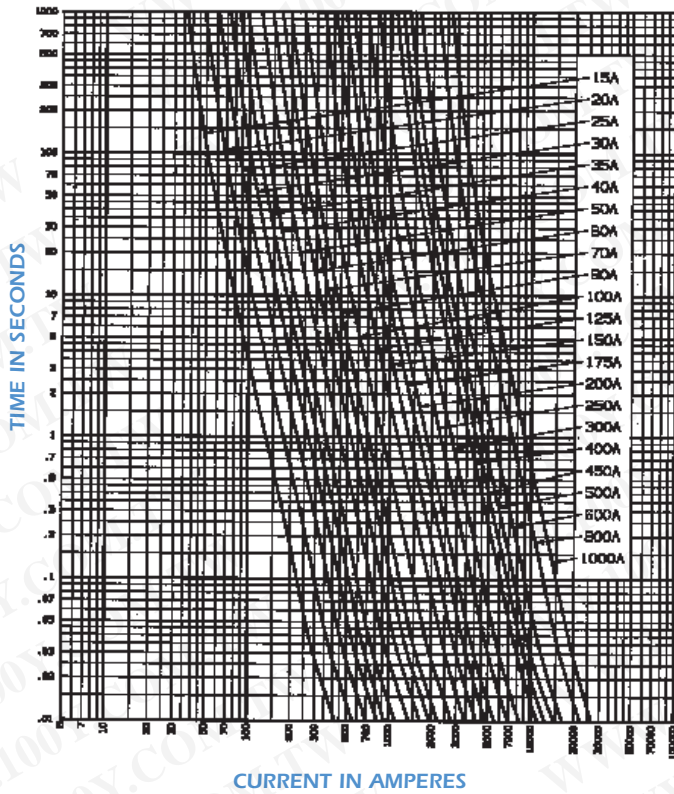

Peak Let-Through Data - A150X15 to 1000, 1500 VAC

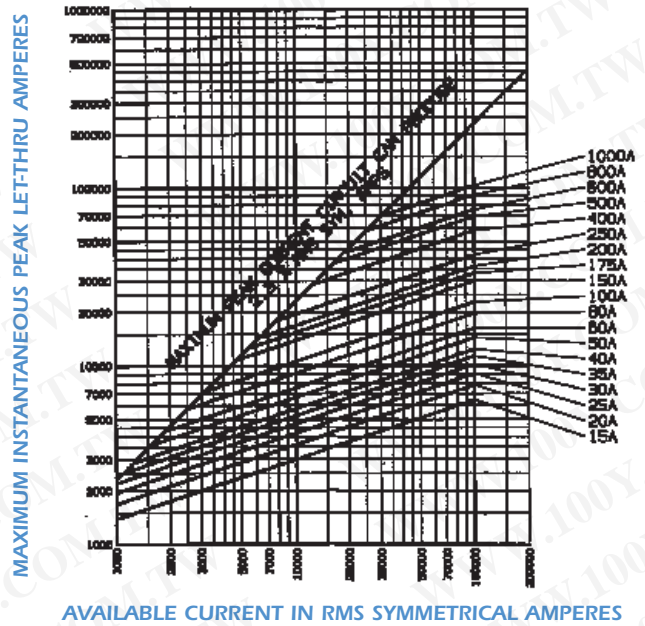

I²t Data - 1500 VAC, 100kA

Ampere Rating	Pre-arc I ² t (A ² x 10 ³)	Total I ² t Data at 1500VAC (A ² S x 10 ³)
15	1.4	2.94
20	2.5	5.25
25	3.8	8.04
30	5.5	11.6
35	7.5	15.8
40	9.8	20.6
50	15.3	32.1
60	22	46.2
70	31	62
80	40	80
90	50	100
100	61	128
125	100	215
150	138	290
175	188	395
200	245	515
250	383	804
300	551	1157
400	980	2057
450	1240	2603
500	1530	3213
600	2204	4629
800	3918	8829
1000	6122	12860

DC Voltage Capacity VS. Time constant

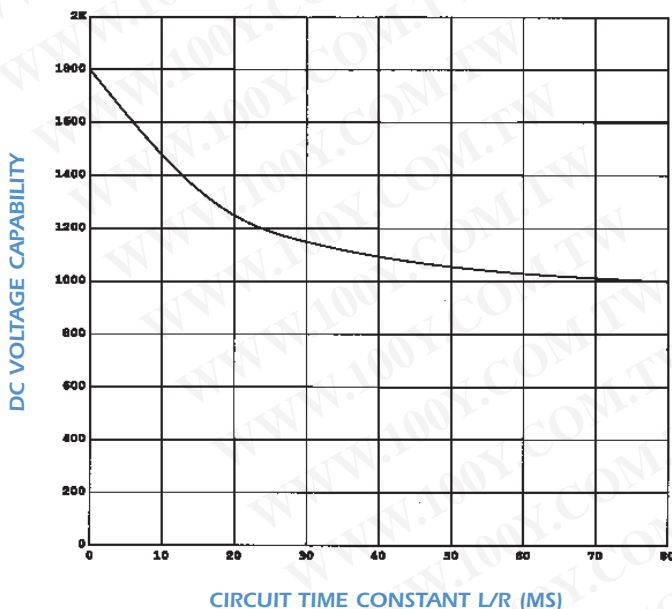

Semiconductor (AC) fuses

American Round Fuses Other American Fuses A25Z-2



Semiconductor Protection Fuses

A25Z "Type 2" Amp-trap® midget fuses are primarily used for semiconductor protection. They have a 300 volt rating and are highly current-limiting fuses, with midget dimensions. (Not for Branch Circuit Protection).

Features/Benefits

- Extremely fast acting for upgrades of existing circuit protection
- Low I²t for semiconductor protection
- Can be used with ULTRASAFE™ fuse holders

Ratings

- AC: 1-30A
300VAC, 100kA I.R.

Approvals

- Ferraz Shawmut Certified

Highlights

- 300 Volt Rated
- Current Limiting
- I²t Rated

Applications

- Semiconductor Protection

Melting Time - Current Data 1 - 30 Amperes, 300 Volts AC

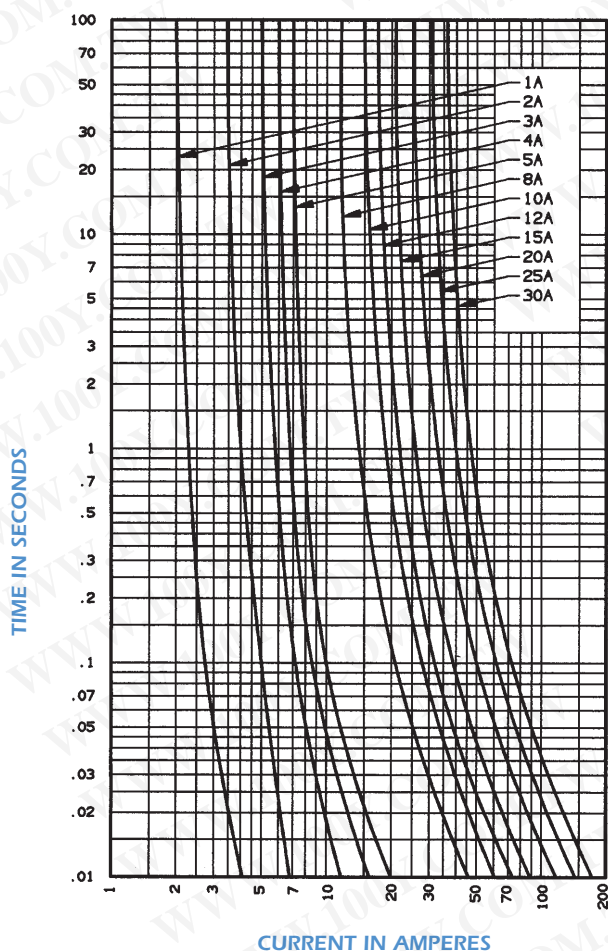

Standard Fuse Ampere Ratings, Clearing I²t

Ampere Rating	Catalog Number	Reference Number	Clearing I ² t AT 250V
1	A25Z1-2	S211133	.27
2	A25Z2-2	R213202	1.5
3	A25Z3-2	S214721	3.4
4	A25Z4-2	A215740	6.9
5	A25Z5-2	G216252	8.7
8	A25Z8-2	E216756	26
10	A25Z10-2	J211654	40
12	A25Z12-2	Q212166	58
15	A25Z15-2	G212687	90
20	A25Z20-2	J213701	160
25	A25Z25-2	P214212	250
30	A25Z30-2	W215230	360

Semiconductor (AC) fuses

American Round Fuses Other American Fuses A070gRB



Semiconductor Protection Fuses

The A070gRB is a fast acting, full range fuse utilized in the protection of inverters, UPS and other discrete semi-conductor devices

Features/Benefits

- International 10 X 38 mm (1 1/2 X 13/32) size for worldwide acceptance
- Ferrule mount 1 to 30A for design versatility
- Low I²t for improved semiconductor protection
- gR Class according to VDE 636-23 and IEC 269.4

Ratings

- AC: 1-30A
160kA, 700V
- DC: 550VDC,
L/R = 10ms

Approvals

- UL Recognized Component
- IEC 269-4 Compliance
- AC: UL Guide No. JFHR2

Highlights

- Extremely Fast Acting
- Current Limiting
- Low I²t
- Excellent Cycling Capability
- gR

Applications

- Protection of small inverters, UPS systems, motor drives and similar 700v or less equipment



Dimensions

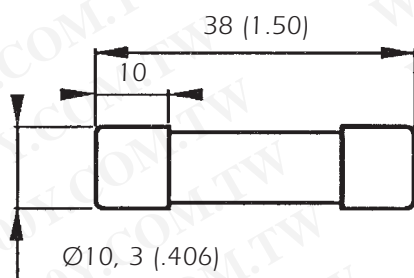

Note: Fuses labels have both European and American references.

Fuse holders for A070gRB fuses

USM SeriesULTRASAFE™ Fuse Holders
303 SeriesMidget Fuse Blocks

Semiconductor (AC) fuses



American Round Fuses Other American Fuses A070gRB

Semiconductor Protection Fuses

Body Size (mm)	Ampere Rating	Rated Voltage (VAC)	Melting I ² t (A ² s)	Clearing I ² t @ Rated Voltage (A ² s)	Watts Loss		Catalog Number	Reference Number
					@ 80% Rated Current	@ 100% Rated Current		
10 X 38	1	700	0.066	0.32	0.57	1	A070GRB01T13	W330000
	1.25		0.115	0.4	0.7	1.25	A070GRB1.25T13	X330001
	1.5		0.185	0.63	0.81	1.5	A070GRB1.5T13	Y330002
	2		0.42	1.43	1.1	2	A070GRB2T13	Z330003
	2.5		0.88	3	1.15	2.1	A070GRB02.5T13	A330004
	3		1.55	5.1	1.25	2.3	A070GRB03T13	B330005
	4		4	13.2	1.35	2.6	A070GRB04T13	C330006
	5		8.6	27.5	1.4	2.7	A070GRB05T13	D330007
	6		15	48.5	1.5	2.9	A070GRB06T13	E330008
	8		3.3	36.3	1.35	2.4	A070GRB08T13	F330009
	10		5.4	60.5	1.85	3.4	A070GRB10T13	G330010
	12.5		8.5	90.2	1.9	3.4	A070GRB12.5T13	H330011
	16		16	160	2.3	4.1	A070GRB16T13	J330012
	20		30	275	2.4	4.3	A070GRB20T13	K330013
25	58	520	2.7	4.7	A070GRB25T13	L330014		
30	96	815	2.9	5	A070GRB30T13	M330015		



Semiconductor (AC) fuses

American Round Fuses Other American Fuses A070gRB

Semiconductor Protection Fuses

Melting Time Current Data (1 to 6A)

Peak Let Thru Current Data (1 to 6A)

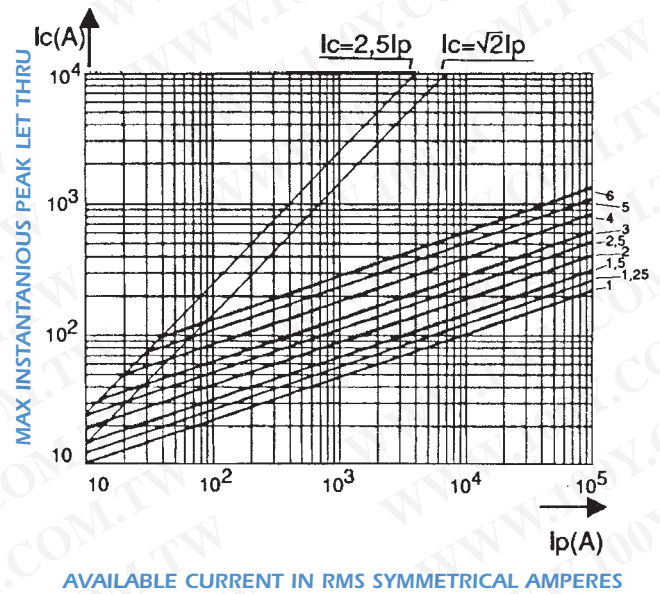
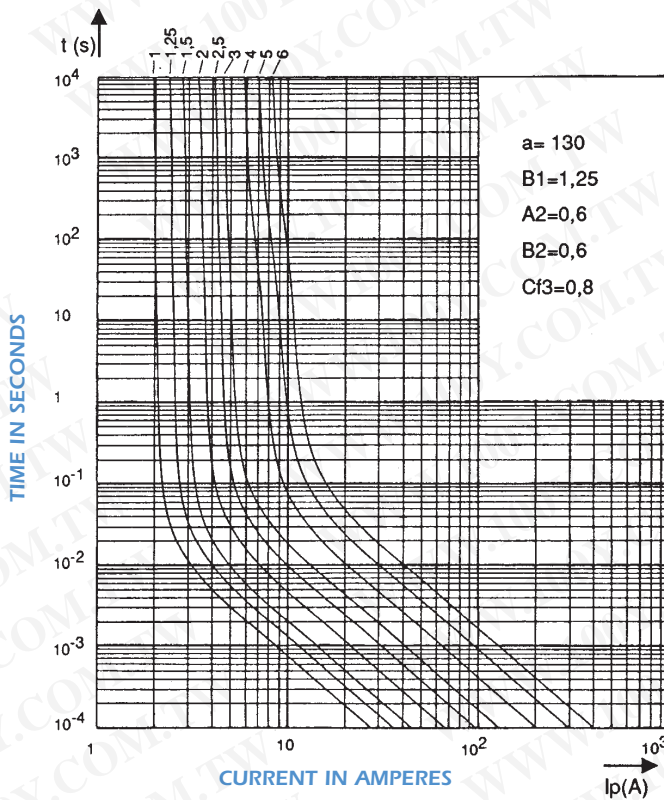

Melting Time Current Data (8 to 30A)

Peak Let Thru Current Data (8 to 30A)

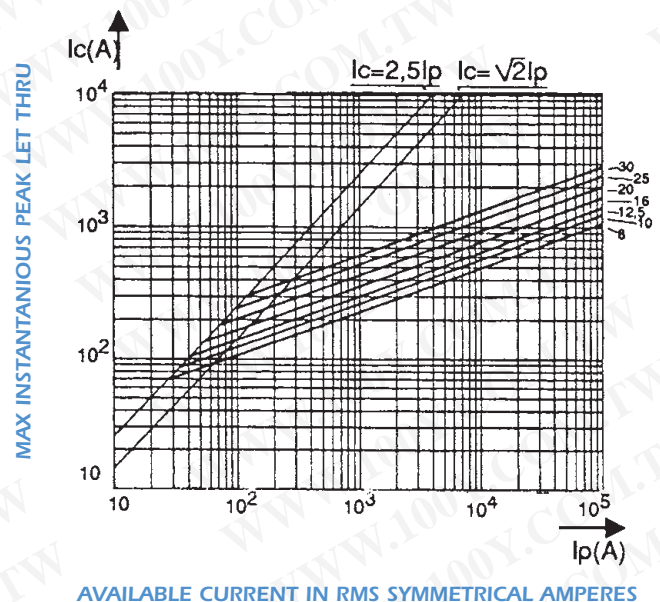
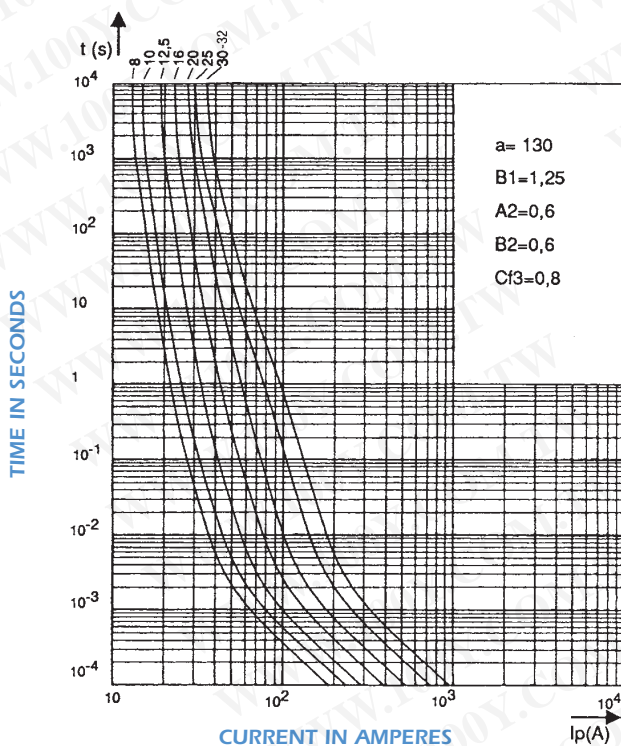

Semiconductor (AC) fuses



American Round Fuses Other American Fuses A070gRB

Semiconductor Protection Fuses

DC Voltage Capability vs. Time Constant

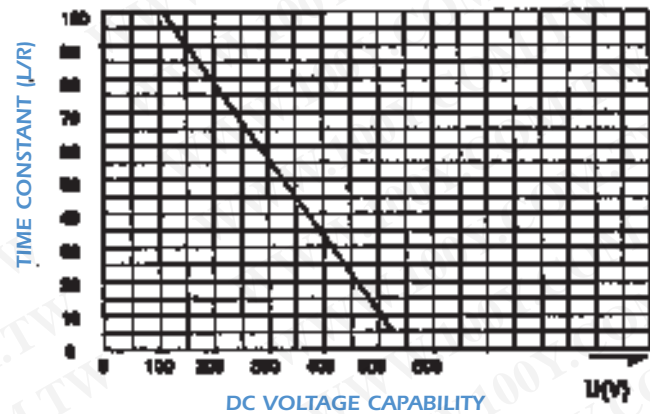

DC Peak Arc Voltage

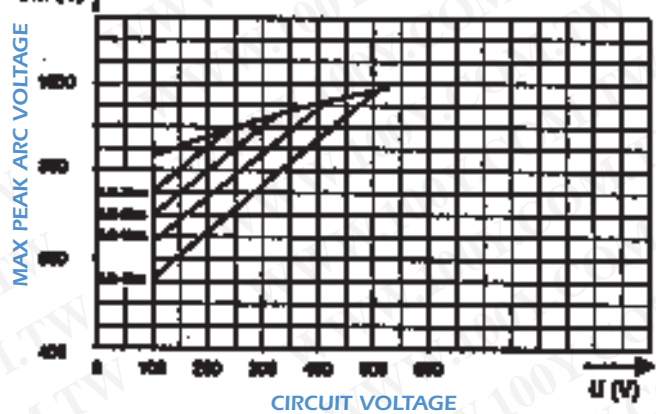

Maximum Arc Volts vs. System Voltage

1 TO 6A

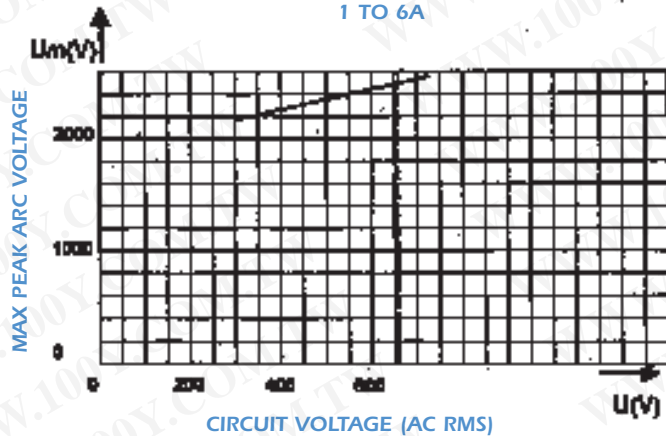

8 TO 30A

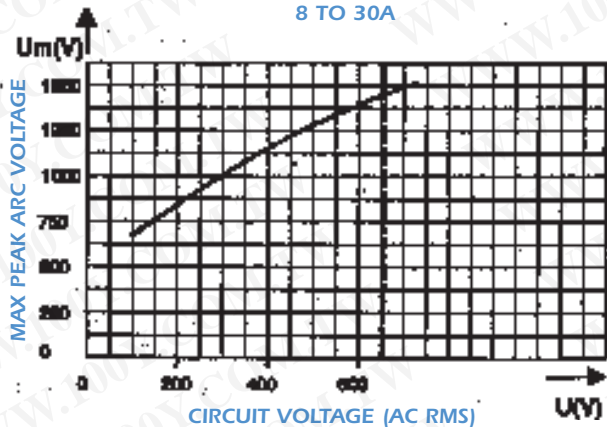

Determines the peak arc voltage across fuse terminals as a function of applied voltage

Clearing I^2t vs. AC operating voltage

1 TO 30A

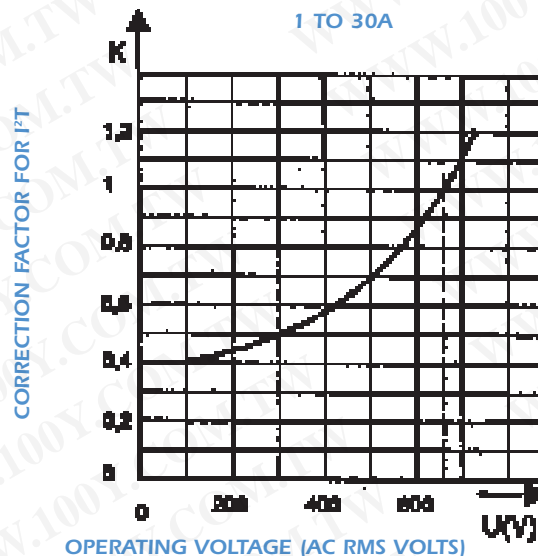

Correction factor to determine clearing I^2t of a fuse below its related voltage.



Semiconductor (AC) fuses

American Round Fuses Other American Fuses A70QS



French Cylindrical Semiconductor Protection Fuses

These Premium Amp-trap® French Cylindrical Semiconductor Fuses are an extension of the popular A70QS product line. They are solid-fill 14mm and 22mm fuses, IEC rated 690VAC, 200kA Interrupting and 700VDC, 100kA interrupting at 10ms time constant. In addition, these fuses have an 890 VDC rating for capacitor discharge applications up to 2.5ms time constant. All ampere ratings are available with a striker. Applications include small inverter drives and UPS systems, with superior I²t for improved protection and performance.

Features/Benefits

- International 14x51mm (2"x9/16") and 22x58mm (2-1/4"x13/16") sizes for worldwide acceptance
- Ferrule mount up to 100A for design versatility
- Very low I²t for improved semiconductor protection
- 690V IEC rated, tested at 760VAC; can be used up to 750VAC in U.S.
- 700VDC rated for dc protection of equipment with L/R ≤ 10ms/c
- Superior cycling ability for longer life on difficult cyclic loading applications
- aR characteristic for semiconductor short-circuit protection

Ratings

- AC: 10-100A
690VAC, 200kA I.R.
- IEC tested at 760VAC
- DC: 700VDC, 100kA I.R.
L/R=10ms
890VDC, 127kA I.R.
L/R=2.5ms

Approvals

- UL Recognized Component
- CSA Certified
- IEC 269-4 Compliance

Highlights

- 14 x 51 and 22 x 58 sizes
- 690VAC IEC Rated (760VAC Max.)
- 700VDC rated
- Superior Cycling Ability
- Low Watts Loss
- Optional Striker for Visual/Remote Indication

Applications

- Small inverters, UPS systems, motor drives and similar 700V or less equipment



Mounting:

- US14 or US22 "finger-safe" IP 20 grade holders, DIN rail or screw mount, with striker actuated microswitch indication available.
- 703 Series open fuse blocks

Catalog Numbering System

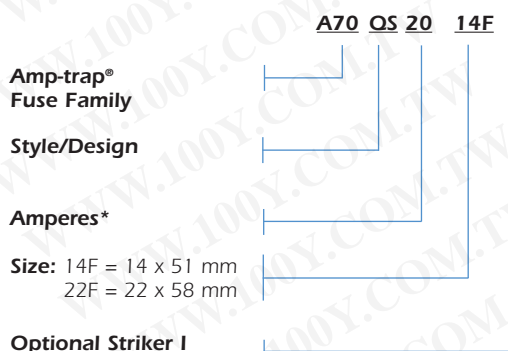

Semiconductor (AC) fuses



American Round Fuses Other American Fuses A70QS

French Cylindrical Semiconductor Protection Fuses

Ratings and Application Data

Body Size (mm)	Ampere Rating (A)	Melting I ² t (A ² s X 10 ³)	Max. Clearing I ² t @ 700VAC (A ² s X 10 ³)	Watts Loss @ Rated Current (W)	Catalog Number	
					No Striker	With Striker
14 x 51	6	0.0013	0.017	2.0	A70QS6-14F	A70QS6-14FI
	8	0.0024	0.027	2.8	A70QS8-14F	A70QS8-14FI
	10	0.0043	0.04	3.5	A70QS10-14F	A70QS10-14FI
	12	0.0054	0.06	4.4	A70QS12-14F	A70QS12-14FI
	16	0.0132	0.10	4.8	A70QS16-14F	A70QS16-14FI
	20	0.027	0.16	5.2	A70QS20-14F	A70QS20-14FI
	25	0.053	0.27	5.8	A70QS25-14F	A70QS25-14FI
	32	0.098	0.50	7.0	A70QS32-14F	A70QS32-14FI
	40	0.13	0.70	10.7	A70QS40-14F	A70QS40-14FI
	50	0.28	1.50	11.6	A70QS50-14F	A70QS50-14FI
22 x 58	10	0.0043	0.025	4.0	A70QS10-22F	A70QS10-22FI
	15	0.008	0.049	6.2	A70QS15-22F	A70QS15-22FI
	20	0.013	0.076	8.0	A70QS20-22F	A70QS20-22FI
	25	0.02	0.125	10.0	A70QS25-22F	A70QS25-22FI
	32	1.04	0.27	11.0	A70QS32-22F	A70QS32-22FI
	40	1.09	0.48	13.0	A70QS40-22F	A70QS40-22FI
	50	0.16	0.80	14.9	A70QS50-22F	A70QS50-22FI
	63	0.35	1.85	16.0	A70QS63-22F	A70QS63-22FI
	70	0.52	2.80	16.5	A70QS70-22F	A70QS70-22FI
	80	0.73	3.80	17.8	A70QS80-22F	A70QS80-22FI
90	1.10	5.64	17.0	A70QS90-22F	A70QS90-22FI	
100	1.56	8.00	19.0	A70QS100-22F	A70QS100-22FI	

*100kA, L/R = 11.6ms

No Striker

Fuse Size	Dimensions-mm		
	A	B	C
14 X 51	14	51	14
22 X 58	22	58	16

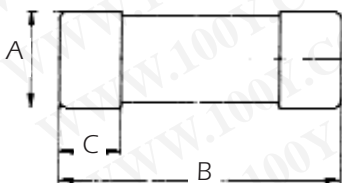

With Striker

Fuse Size	Dimensions-mm				
	A	B	C	D	E
14 X 51	14	51	14	7.5	3.8
22 X 58	22	58	16	7.5	3.8

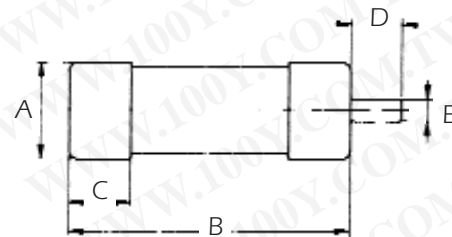

勝特力材料 886-3-5753170
 勝特力电子(上海) 86-21-34970699
 勝特力电子(深圳) 86-755-83298787
[Http://www.100y.com.tw](http://www.100y.com.tw)



Semiconductor (AC) fuses

American Round Fuses Other American Fuses A70QS

French Cylindrical Semiconductor Protection Fuses

Melting Time-Current Data

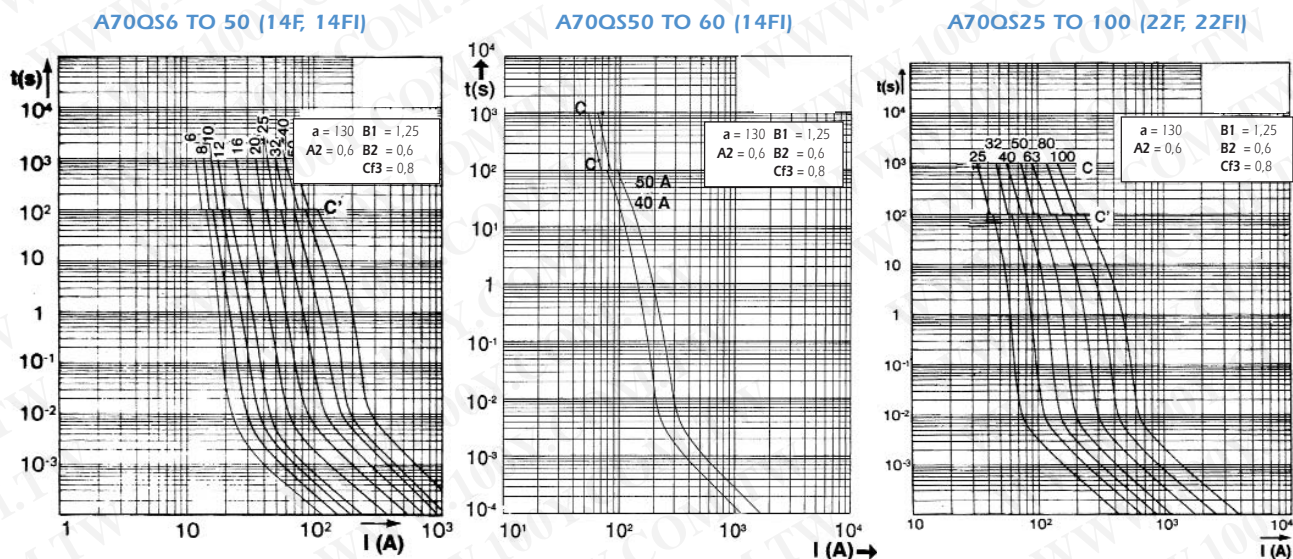

These curves indicate, for each rated current, the pre-arcing (melting) time vs. the R.M.S. current.

Clearing I^2t vs. Operating Voltage

Peak arc voltage vs. Operating Voltage

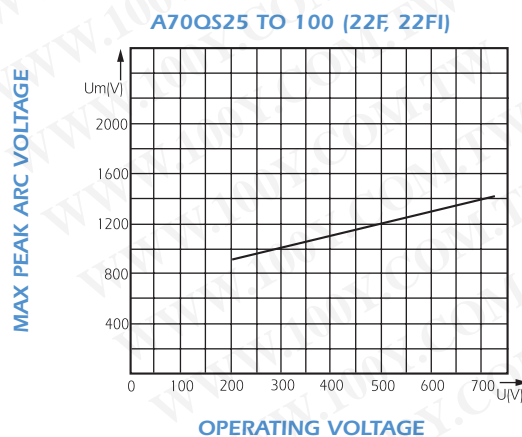
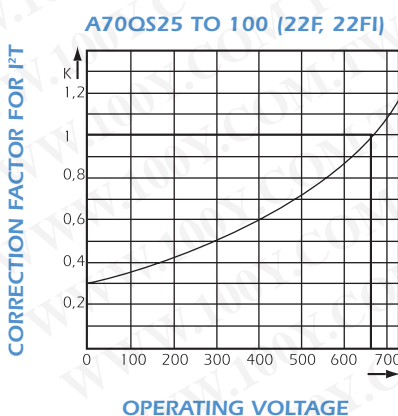
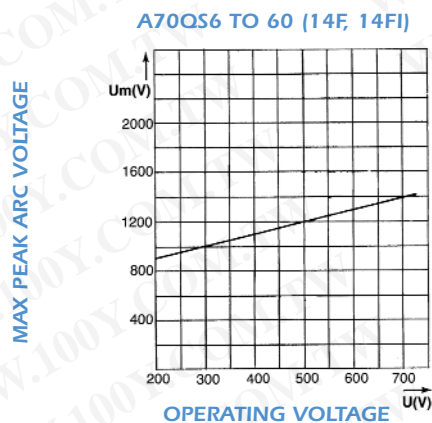
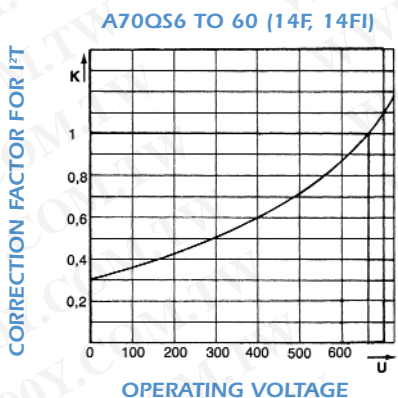

Semiconductor (AC) fuses



American Round Fuses Other American Fuses A70QS

French Cylindrical Semiconductor Protection Fuses

D.C. Applications Data DC Voltage Capabilities vs. Time Constant

Peak Arc voltage vs. DC circuit voltage

A70QS6 TO 60 (14F, 14FI)

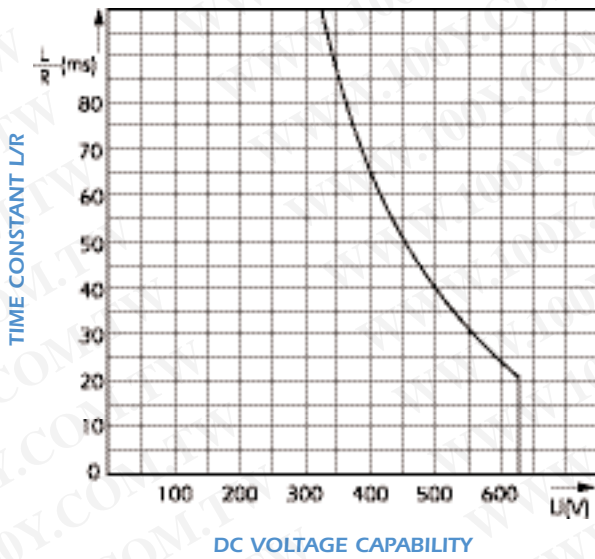

A70QS6 TO 60 (14F, 14FI)

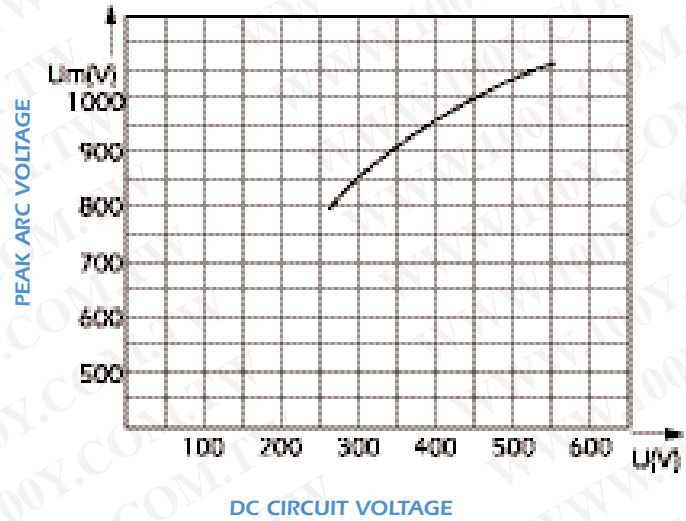

SEE MELTING-TIME CURRENT DATA FOR MINIMUM BREAKING CURRENT.

DC Voltage Capabilities vs. Time Constant

Peak Arc voltage vs. DC circuit voltage

A70QS25 TO 100 (22F, 22FI)

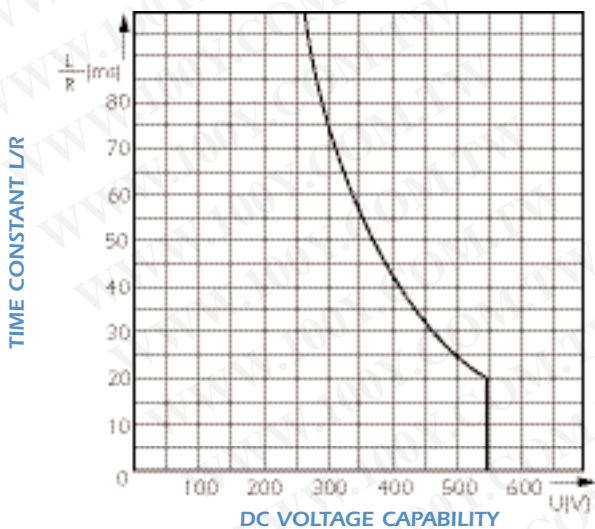

A70QS25 TO 100 (22F, 22FI)

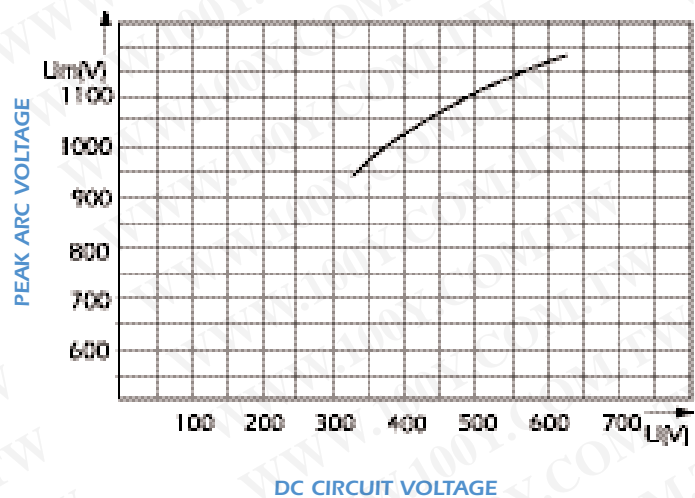

These curves provide the DC voltage capability of the fuse as a function of circuit time constant.

(L/R ratio)

These curves show the peak value U_{lim} of the arc voltage which appears across the fuse link as a function of the operating voltage U .

Semiconductor (AC) fuses

Protistor® Square-body Fuses PSC gR/aR sizes 000/00 gR/aR - 500 to 690 VAC DIN 000

GERMAN STANDARD
gRB - URB from 20 to 400 A
Size: 000

- EXTREMELY HIGH BREAKING CAPACITY FUSES: PROTECTION OF POWER SEMICONDUCTORS ACCORDING TO IEC 60269-1 and 4
- 690V VOLTAGE RATING (RATING 20 TO 400 A)
- gR CLASS (gRB RATINGS 20 TO 125 A) ACCORDING TO VDE 636-23
- CLEARING ALL OVERLOADS
- IMPROVING SAFETY AND PROTECTION
- ENABLING SELECTIVE COORDINATION WITH ALL FUSES
- aR CLASS (URB RATINGS 80 TO 400 A) ACCORDING TO VDE 636-23 AND IEC 60269.4
- ALL MODELS COMPLYING WITH DIN 43653-00C ARE WITH OR WITHOUT BLOWN FUSE INDICATION WITH TRIP INDICATOR
- MODEL COMPLYING WITH DIN 43620 (00C) STANDARD WITH BLOWN FUSE INDICATION - WITH TRIP INDICATOR



Main Characteristics

Voltage rating U_N (VAC)	Class	Current rating I_N (A)	Pre-arcing $I^2t @ 1 \text{ ms}$ I^2tp (A ² s)	Total clearing $I^2t @ 660V$ I^2tt (A ² s)	Watts loss		Tested Breaking Capacity	Estimated Breaking Capacity
					0.8 IN	IN		
690	gRB	16	8,2	60	-	5,6	200 k A @ 690 V	300 k A @ 690 V
		20	12	80	3.8	7		
		25	20	150	5.0	9		
		32	39	270	5.5	10		
		40	70	460	6.6	12		
		50	102	730	7.7	14		
		63	210	1500	8.8	16		
		80	475	2900	9.9	18		
		100	970	6000	11	20		
		125	1900	11800	11.6	21		
690	URB	80	390	2500	11.6	21	200 k A @ 690 V	300 k A @ 690 V
		100	690	4200	12.7	23		
		125	1300	8900	14.3	26		
		160	2700	16000	17.0	31		
		200	5250	31500	19.8	36		
		250	9900	52000	24.8	45		
500	URB	315	15500	82000	31.9	58	120 k A @ 500 V	
		350	22400	110000*	31.9	58		
		400	33200	160000*	36.3	66		

* @ U_n

Minimum operating voltage for blown fuse indicator: 20 V

Minimum operating voltage for trip-indicator: 20 V

Semiconductor (AC) fuses



Protistor® Square-body Fuses PSC gR/aR sizes 000/00 gR/aR - 500 to 690 VAC DIN 000

German standard blade-type DIN 43620 with trip-indicator

Current rating	Designation	Ref. Number	I/N*	Catalog Number
16	6,9 GRB 000 PV016	Y210609	1	PC000GB69V16PV
20	6,9 GRB 000 PV020	Z210610	1	PC000GB69V20PV
25	6,9 GRB 000 PV025	A210611	1	PC000GB69V25PV
32	6,9 GRB 000 PV032	B210612	1	PC000GB69V32PV
40	6,9 GRB 000 PV040	C210613	1	PC000GB69V40PV
50	6,9 GRB 000 PV050	D210614	1	PC000GB69V50PV
63	6,9 GRB 000 PV063	E210615	1	PC000GB69V63PV
80	6,9 GRB 000 PV080	F210616	1	PC000GB69V80PV
100	6,9 GRB 000 PV100	G210617	1	PC000GB69V100PV
125	6,9 GRB 000 PV125	H210618	0,9	PC000GB69V125PV

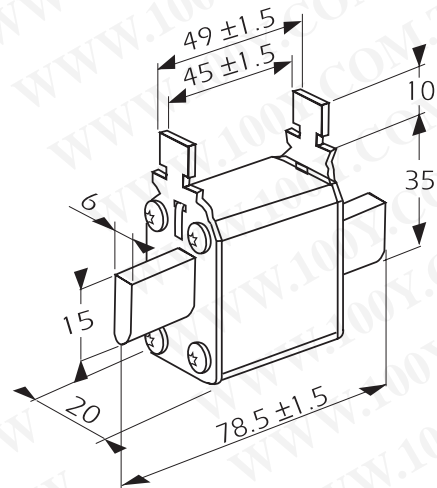

Microswitches
MS 4L 2-5 B6 + PRES Ref. F210156
MS 4L 2-5 B2 + PRES Ref. G210157

Weight: 150g
Packaging: 3 pieces

* Fuse base: 00-EP Ref Number F215170
Pull out grip handle: Ref Number K217244

German standard without blown fuse indicator



Current rating	Designation	Ref. Number	I/N*	Catalog Number
16	6,9 GRB 000 D08/016	L330060	1	DN000GB69V16
20	6,9 GRB 000 D08/020	D330030	1	DN000GB69V20
25	6,9 GRB 000 D08/025	E330031	1	DN000GB69V25
32	6,9 GRB 000 D08/032	F330032	1	DN000GB69V32
40	6,9 GRB 000 D08/040	G330033	1	DN000GB69V40
50	6,9 GRB 000 D08/050	H330034	1	DN000GB69V50
63	6,9 GRB 000 D08/063	J330035	1	DN000GB69V63
80	6,9 GRB 000 D08/080	A330073	1	DN000GB69V80
100	6,9 GRB 000 D08/100	S330112	1	DN000GB69V100
125	6,9 GRB 000 D08/125	T330113	0,9	DN000GB69V125
80	6,9 URB 000 D08/080	K330036	1	DN000UB69V80
100	6,9 URB 000 D08/100	L330037	1	DN000UB69V100
125	6,9 URB 000 D08/125	M330038	0,9	DN000UB69V125
160	6,9 URB 000 D08/160	N330039	0,85	DN000UB69V160
200	6,9 URB 000 D08/200	P330040	0,85	DN000UB69V200
250	6,9 URB 000 D08/250	Q330041	0,8	DN000UB69V250
315	6,9 URB 000 D08/315	R330042	0,7	DN000UB69V315
350	5 URB 000 D08/350	V330114	0,7	DN000UB50V350
400	5 URB 000 D08/400	D330191	0,65	DN000UB50V400

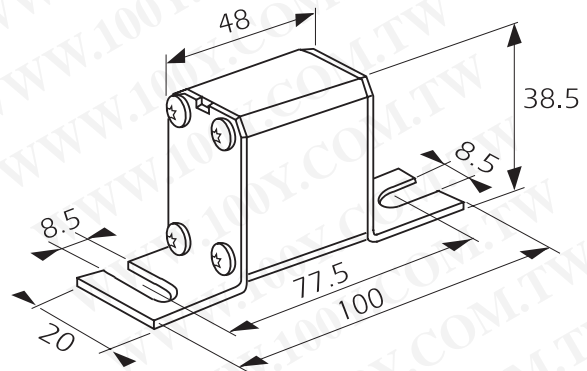

* Fuse base: SI 000 DIN 80
Ref. Number: C220710

Weight: 130 g
Packaging: 6 pieces

Semiconductor (AC) fuses

Protistor® Square-body Fuses PSC gR/aR sizes 000/00 gR/aR - 500 to 690 VAC DIN 000

German standard with blown fuse indicator



Current rating	Designation	Ref. Number	I/I _N * fuse base	Catalog Number
16	6,9 gRB 000 D08V/016	C330190	1	DN000GB69V16V
20	6,9 gRB 000 D08V/020	P330017	1	DN000GB69V20V
25	6,9 gRB 000 D08V/025	Q330018	1	DN000GB69V25V
32	6,9 gRB 000 D08V/032	R330019	1	DN000GB69V32V
40	6,9 gRB 000 D08V/040	S330020	1	DN000GB69V40V
50	6,9 gRB 000 D08V/050	T330021	1	DN000GB69V50V
63	6,9 gRB 000 D08V/063	V330022	1	DN000GB69V63V
80	6,9 gRB 000 D08V/080	G330102	1	DN000GB69V80V
100	6,9 gRB 000 D08V/100	Q330110	1	DN000GB69V100V
125	6,9 gRB 000 D08V/125	R330111	0,9	DN000GB69V125V
80	6,9 URB 000 D08V/080	W330023	1	DN000UB69V80V
100	6,9 URB 000 D08V/100	X330024	1	DN000UB69V100V
125	6,9 URB 000 D08V/125	Y330025	0,95	DN000UB69V125V
160	6,9 URB 000 D08V/160	Z330026	0,85	DN000UB69V160V
200	6,9 URB 000 D08V/200	A330027	0,85	DN000UB69V200V
250	6,9 URB 000 D08V/250	B330028	0,8	DN000UB69V250V
315	6,9 URB 000 D08V/315	C330029	0,7	DN000UB69V315V
350	5 URB 000 D08V/350	W330115	0,7	DN000UB69V350V
400	5 URB 000 D08V/400	E330192	0,65	DN000UB69V400V

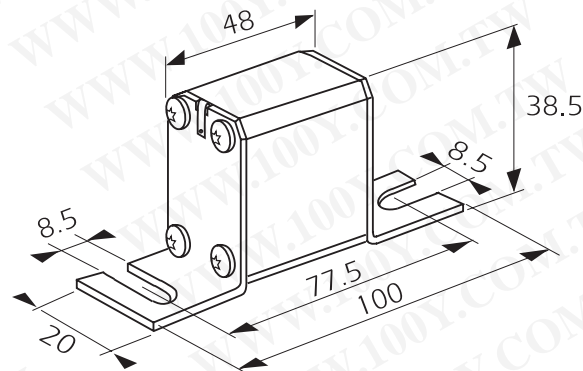

Weight: 130 g
Packaging: 6 pieces

Fuse base: SI 000 DIN 80 Ref. Number : C 20710

German standard with trip-indicator



Current rating	Designation	Ref. Number	I/I _N * fuse base	Catalog Number
16	6,9 gRB 000 D08L/016	X330277	1	DN000GB69V16L
20	6,9 gRB 000 D08L/020	J330173	1	DN000GB69V20L
25	6,9 gRB 000 D08L/025	K330174	1	DN000GB69V25L
32	6,9 gRB 000 D08L/032	L330175	1	DN000GB69V32L
40	6,9 gRB 000 D08L/040	M330176	1	DN000GB69V40L
50	6,9 gRB 000 D08L/050	N330177	1	DN000GB69V50L
63	6,9 gRB 000 D08L/063	P330178	1	DN000GB69V63L
80	6,9 gRB 000 D08L/080	Q330179	1	DN000GB69V80L
100	6,9 gRB 000 D08L/100	R330180	1	DN000GB69V100L
125	6,9 gRB 000 D08L/125	S330181	0,9	DN000GB69V125L
80	6,9 URB 000 D08L/080	T330182	1	DN000UB69V80L
100	6,9 URB 000 D08L/100	V330183	1	DN000UB69V100L
125	6,9 URB 000 D08L/125	W330184	0,95	DN000UB69V125L
160	6,9 URB 000 D08L/160	X330185	0,85	DN000UB69V160L
200	6,9 URB 000 D08L/200	Y330186	0,85	DN000UB69V200L
250	6,9 URB 000 D08L/250	Z330187	0,8	DN000UB69V250L
315	6,9 URB 000 D08L/315	A330188	0,7	DN000UB69V315L
350	5 URB 000 D08L/350	B330189	0,7	DN000UB69V350L
400	5 URB 000 D08L/400	F330193	0,65	DN000UB69V400L

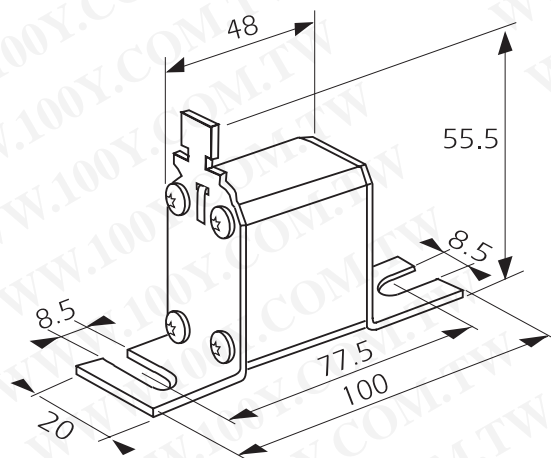

Weight: 130 g
Packaging: 6 pieces

Microswitch
MC 4L 2-5 B6 + PRES Ref. Number : F210156
MC 4L 2-5 B2 + PRES Ref. Number : G210157
Fuse base: SI 000 DIN 80 Ref. Number : C 20710

Semiconductor (AC) fuses



Protistor® Square-body Fuses PSC gR/aR sizes 000/00 gR/aR - 500 to 690 VAC DIN 000

Total clearing I²t

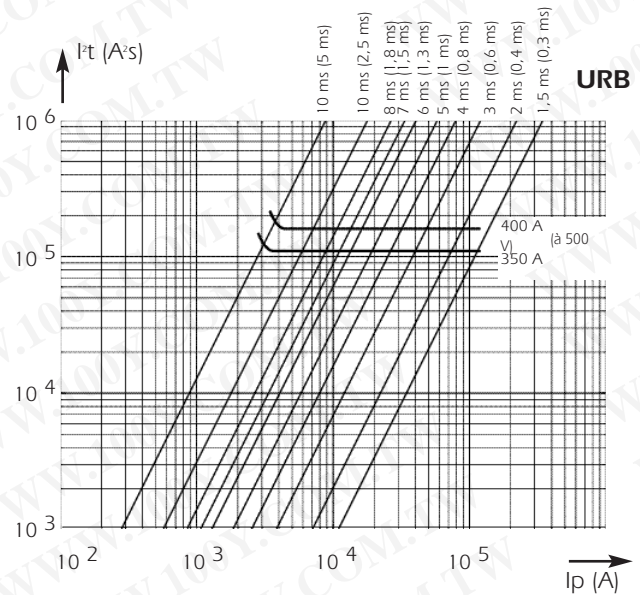
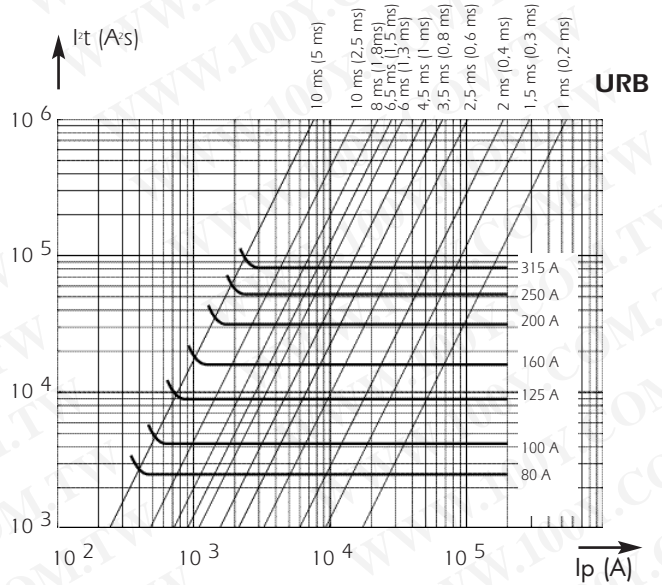
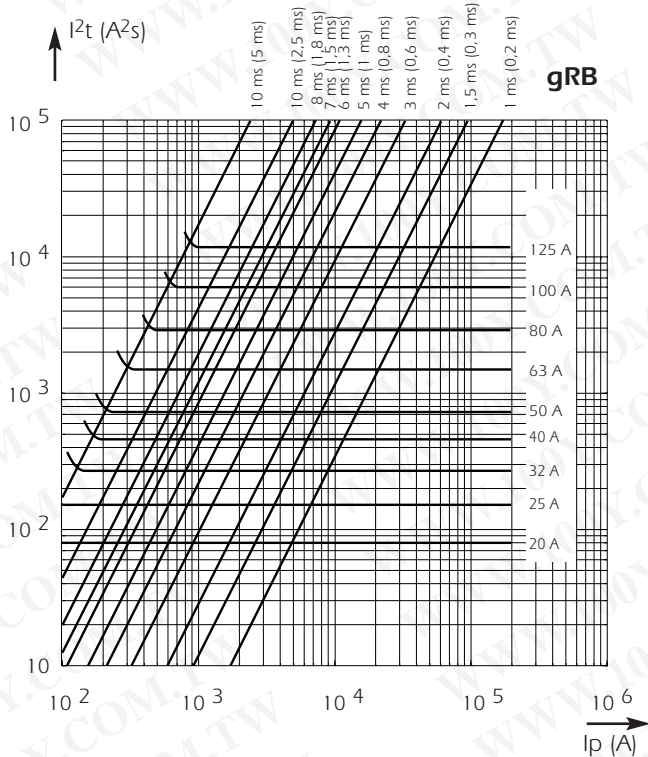

Above: Horizontal curves show, for each rated current, values of total clearing I^2t (I^2t_t) as a function of prospective current I_p . @ UN with $\cos \phi = 0.15$. Oblique lines indicate total clearing duration T_t , with associated pre-arcing duration in brackets.

I²t corrective factor

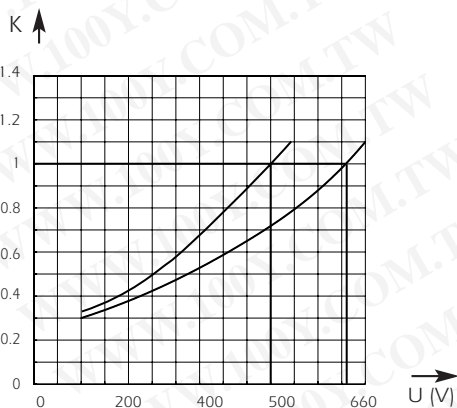

Above: Mean curves show variation of total clearing time (I^2t_t) and total clearing duration T_t as a function of operating voltage U .

Peak arc voltage

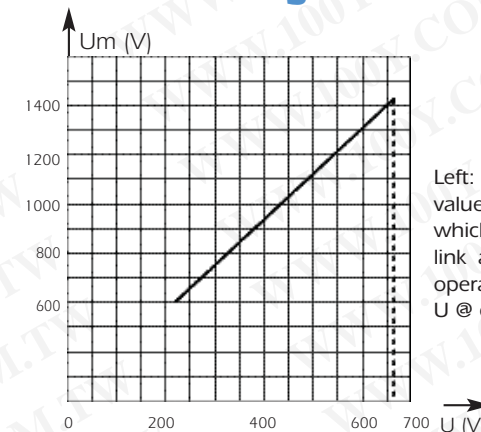

Left: Curve shows peak value U_m of arc voltage which appears across fuse link as a function of the operating voltage U @ $\cos \phi = 0.15$

Semiconductor (AC) fuses

Protistor® Square-body Fuses PSC gR/aR sizes 000/00 gR/aR - 500 to 690 VAC DIN 000

DC Application data

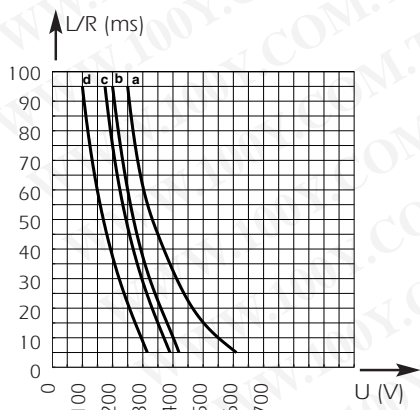

Above: Curves indicate permissible value of time constant L/R as a function of DC working voltage.

Curve a: Ratings from 20 to 160 A
Curve b: Rating 200 A
Curve c: Ratings from 250 to 315 A
Curve d: Ratings from 350 to 400 A

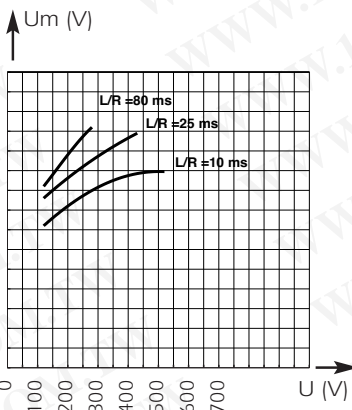

Above: Curves indicates peak arc voltage U_m which may appear across fuse terminals at working voltage U .

Rated current (A)	Curve	I_{pm} (A)
20	a	60
25	a	65
32	a	90
40	a	120
50	a	150
63	a	200
80	a	270
100	a	370
125	a	500
160	a	700
200	b	1200
250	c	1800
315	c	2200
350	d	2600
400	d	3100

I_{pm} values give minimum DC interrupting current in amps.

Current limitation curves

Below: Curves show, for each rating, value of peak let-through current I_c as a function of available fault current I_p .

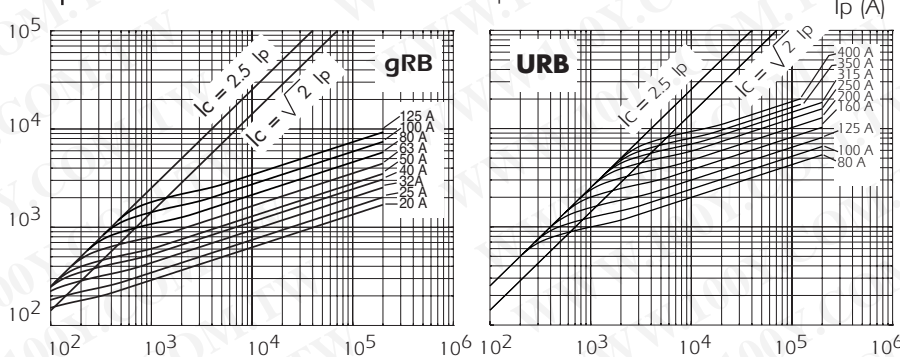

Watts loss

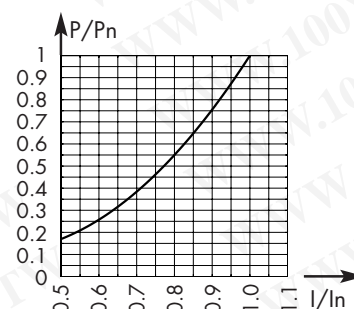

Above: Curve enables computation of power losses P for an IN-rated fuse as a function of R.M.S. current I (as a multiple of I_N for steady state operation)

Time vs current characteristics

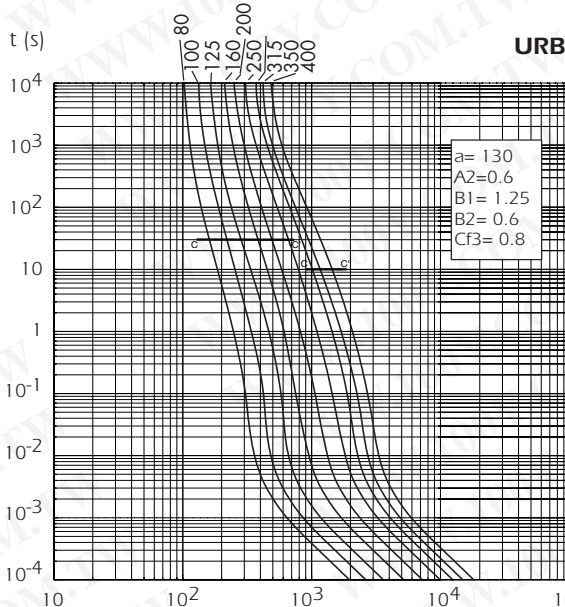
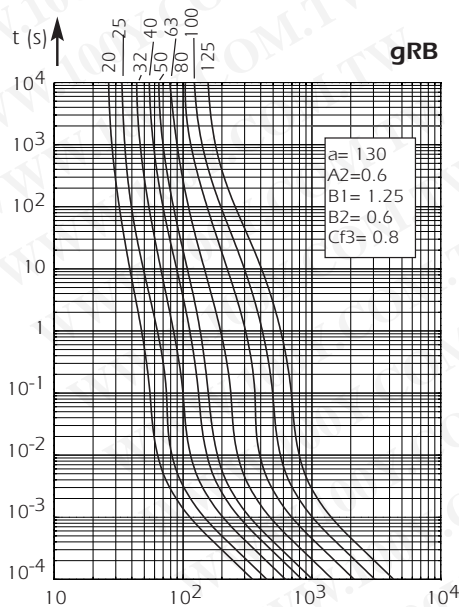

Left: Curves show, for each rated current, pre-arcing time vs. R.M.S. pre-arcing current

Tolerance for mean pre-arcing current $\pm 8\%$.

Semiconductor (AC) fuses



Protistor® Square-body Fuses PSC gR/aR sizes 000/00 gR/aR - 600 to 690 VAC DIN 00

gRB-URB from 16 to 450 A
Size: 00



EXTREMELY HIGH BREAKING CAPACITY FUSES:
PROTECTION OF POWER SEMICONDUCTORS
AS PER IEC STANDARD 60269.1 AND 4

690 V VOLTAGE RATING

gR CLASS (gRB RATINGS 16 to 160 A) AS PER VDE 636-23
- CLEARING ALL OVERLOADS
- IMPROVING SAFETY AND PROTECTION
- ENABLING SELECTIVE COORDINATION WITH ALL FUSES

aR CLASS (URB RATINGS 16 TO 450 A) ACCORDING TO
VDE 636-23 AND IEC 60269-4

CONNECTIONS ACCORDING TO
- DIN 43653/00 80 AND 110 mm BETWEEN AXES
- DIN 43620/00 SOLID BLADES

WITH AN INDICATING PAWL ACTIVATING A MICROSWITCH IF NEEDED



Main Characteristics

Voltage rating U_N (V)	Class	Current rating I_N (A)	Pre-arcing I_t' @ 1 ms $I_t'p$ (A,s)	Total clearing I_t' total@ UN $I_t'tt$ (A,s)	Watts loss		Tested Breaking Capacity	Estimated Breaking Capacity				
					0.8 IN	IN						
690	gRB	16	8	61	2.7	5	200 kA @ 690 V	300 kA @ 690 V				
		20	12	86	3.3	6						
		25	18	140	4.4	8						
		32	39	250	6.0	11						
		40	68	450	7.1	13						
		50	116	750	8.8	16						
		63	210	1400	9.9	18						
		80	525	3000	10.5	19						
		100	970	5400	10.7	19.5						
		125	1710	9600	13.2	24						
		160	4270	22400	13.7	25						
		600	URB	16	7	52			3.8	7	200 kA @ 690 V	300 kA @ 690 V
				20	10	75			5.0	9		
				25	15	120			6.0	11		
32	32			210	8.2	15						
40	61			400	9.9	18						
50	102			700	11.5	21						
63	177			1200	12.6	23						
80	390			2200	13.8	25						
100	692			3900	15.4	28						
125	1170			6600	18.1	33						
160	2680			14 000	19.8	36						
200	4690			24 000	23.1	42						
250	8300			42 500	27.5	50						
315	17 520			81 000	31.9	58						
350	25 450	118 000	33.0	60								
400	33 200	150 000	38.5	70								
600	URB	450 **	51 850	196 000	40.7	74	200 kA @ 600 V	300 kA @ 600 V				

NOTE: voltage rating of 350-400-450 A rated fuses is defined with a CC' curve at 1 second limited by minimum breaking current.

■ Voltage rating: 690 V with CC' at 1s - 450 V with CC' at 10 s
** Voltage rating: 600 V with CC' at 1s - 450 V with CC' at 10 s

Minimum operating voltage for trip indicator = 20 V

Semiconductor (AC) fuses

Protistor® Square-body Fuses PSC gR/aR sizes 000/00 gR/aR - 600 to 690 VAC DIN 00

German standard as per DIN43653/00C - DIN 80 & 110

gRB - DIN 80

Current rating	Designation	Ref. Number	I _N * fuse base	Catalog Number
16	6,9 gRB 00 D08L 016	S330273	1	DN00GB69V16L
20	6,9 gRB 00 D08L 020	S330227	1	DN00GB69V20L
25	6,9 gRB 00 D08L 025	T330228	1	DN00GB69V25L
32	6,9 gRB 00 D08L 032	V330229	1	DN00GB69V32L
40	6,9 gRB 00 D08L 040	W330230	1	DN00GB69V40L
50	6,9 gRB 00 D08L 050	X330231	1	DN00GB69V50L
63	6,9 gRB 00 D08L 063	Y330232	1	DN00GB69V63L
80	6,9 gRB 00 D08L 080	Z330233	1	DN00GB69V80L
100	6,9 gRB 00 D08L 100	A330234	1	DN00GB69V100L
125	6,9 gRB 00 D08L 125	B330235	0.9	DN00GB69V125L
160	6,9 gRB 00 D08L 160	C330236	0.9	DN00GB69V160L

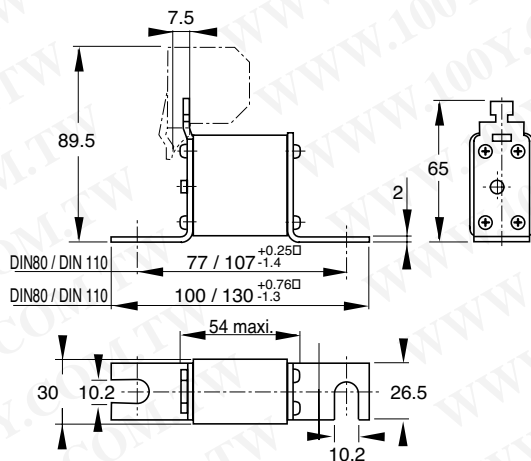

Weight: 140 g[D08] - 190 g[D11]

Packaging: 3 pieces

Microswitches: MC 4L 2.5 B6 + PRES - Ref. Number: F210156

MC 4L 2.5 B2 + PRES - Ref. Number: G210157

Fuse-base: SI 00 DIN 80 - Ref. Number: Q098040

URB - DIN 80

Current rating	Designation	Ref. Number	I _N * fuse base	Catalog Number
16	6,9 URB 00 D08L 016	V330275	1	DN00UB69V16L
20	6,9 URB 00 D08L 020	T330274	1	DN00UB69V20L
25	6,9 URB 00 D08L 025	M330268	1	DN00UB69V25L
32	6,9 URB 00 D08L 032	N330269	1	DN00UB69V32L
40	6,9 URB 00 D08L 040	P330270	1	DN00UB69V40L
50	6,9 URB 00 D08L 050	Q330271	1	DN00UB69V50L
63	6,9 URB 00 D08L 063	R330272	1	DN00UB69V63L
80	6,9 URB 00 D08L 080	D330237	1	DN00UB69V80L
100	6,9 URB 00 D08L 100	E330238	1	DN00UB69V100L
125	6,9 URB 00 D08L 125	F330239	0.9	DN00UB69V125L
160	6,9 URB 00 D08L 160	G330240	0.85	DN00UB69V160L
200	6,9 URB 00 D08L 200	H330241	0.85	DN00UB69V200L
250	6,9 URB 00 D08L 250	J330242	0.80	DN00UB69V250L
315	6,9 URB 00 D08L 315	K330243	0.75	DN00UB69V315L
350	6,9 URB 00 D08L 350	L330244	0.75	DN00UB69V350L
400	6,9 URB 00 D08L 400	M330245	0.70	DN00UB69V400L
450	6 URB 00 D08L 450	N330246	0.65	DN00UB60V450L

gRB - DIN 110

16	6,9 gRB 00 D11L 016	W330276	1	DN00GB69V16D1L
20	6,9 gRB 00 D11L 020	P330247	1	DN00GB69V20D1L
25	6,9 gRB 00 D11L 025	Q330248	1	DN00GB69V25D1L
32	6,9 gRB 00 D11L 032	R330249	1	DN00GB69V32D1L
40	6,9 gRB 00 D11L 040	S330250	1	DN00GB69V40D1L
50	6,9 gRB 00 D11L 050	T330251	1	DN00GB69V50D1L
63	6,9 gRB 00 D11L 063	V330252	1	DN00GB69V63D1L
80	6,9 gRB 00 D11L 080	W330253	1	DN00GB69V80D1L
100	6,9 gRB 00 D11L 100	X330254	1	DN00GB69V100D1L
125	6,9 gRB 00 D11L 125	Y330255	0.9	DN00GB69V125D1L
160	6,9 gRB 00 D11L 160	Z330256	0.9	DN00GB69V160D1L

URB - DIN 110

80	6,9 URB 00 D11L 80	A330257	1	DN00UB69V80D1L
100	6,9 URB 00 D11L 100	B330258	1	DN00UB69V100D1L
125	6,9 URB 00 D11L 125	C330259	0.9	DN00UB69V125D1L
160	6,9 URB 00 D11L 160	D330260	0.85	DN00UB69V160D1L
200	6,9 URB 00 D11L 200	E330261	0.85	DN00UB69V200D1L
250	6,9 URB 00 D11L 250	F330262	0.80	DN00UB69V250D1L
315	6,9 URB 00 D11L 315	G330263	0.75	DN00UB69V315D1L
350	6,9 URB 00 D11L 350	H330264	0.75	DN00UB69V350D1L
400	6,9 URB 00 D11L 400	J330265	0.70	DN00UB69V400D1L
450	6 URB 00 D11L 450	K330266	0.65	DN00UB60V450D1L

German standard as per DIN43620/00

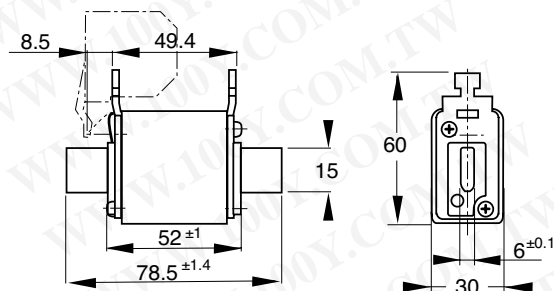

Weight: 210 g

Packaging: 3 pieces

Microswitches: MC 4L 2.5 B2 + PRES - Ref Number: G210157 or

MC 4L 2.5 B6 + PRES - Ref Number: F210156

Fuse-base: 00EP - Ref. Number : F215170

Current rating	Designation	Ref. Number	I _N * fuse base	Catalog Number
16	6,9 gRB 00 PV/016	L330267	1	PC00GB69V16PV
20	6,9 gRB 00 PV/020	W330207	1	PC00GB69V20PV
25	6,9 gRB 00 PV/025	X330208	1	PC00GB69V25PV
32	6,9 gRB 00 PV/032	Y330209	1	PC00GB69V32PV
40	6,9 gRB 00 PV/040	Z330210	1	PC00GB69V40PV
50	6,9 gRB 00 PV/050	A330211	1	PC00GB69V50PV
63	6,9 gRB 00 PV/063	B330212	0.90	PC00GB69V63PV
80	6,9 gRB 00 PV/080	C330213	0.90	PC00GB69V80PV
100	6,9 gRB 00 PV/100	D330214	0.90	PC00GB69V100PV
125	6,9 gRB 00 PV/125	E330215	0.85	PC00GB69V125PV
160	6,9 gRB 00 PV/160	F330216	0.85	PC00GB69V160PV

For curves see pages

I_N : Ratio RMS steady current / current rating for fuses in base.

Semiconductor (AC) fuses



Protistor® Square-body Fuses PSC gR/aR sizes 000/00 gR/aR - 600 to 690 VAC DIN 00

Total clearing I^2t

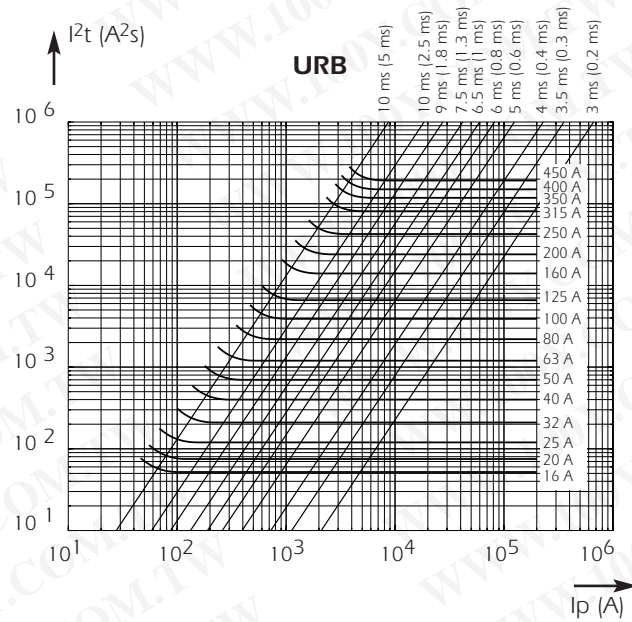
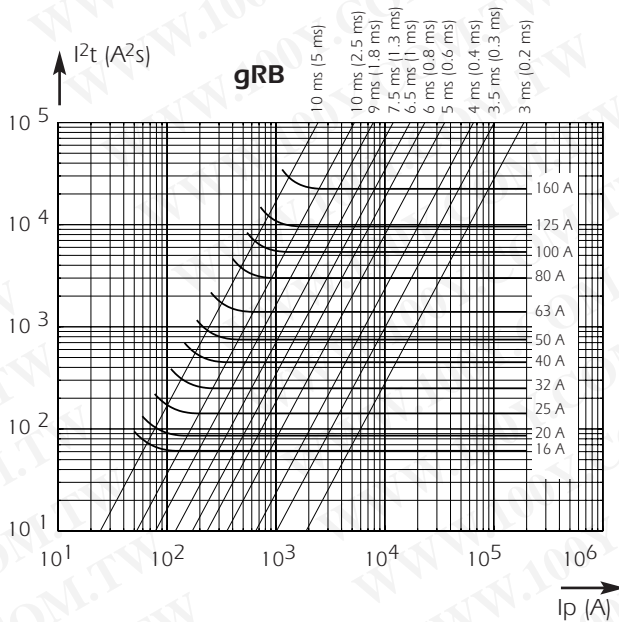

Above: horizontal curves show, for each rated current, maximum values of total clearing I^2t as a function of prospective current I_p . @ UN with $\cos\phi = 0.15$.
Oblique lines indicate total clearing duration T_t , with associated pre-arcing duration shown in brackets.

I^2t corrective factor

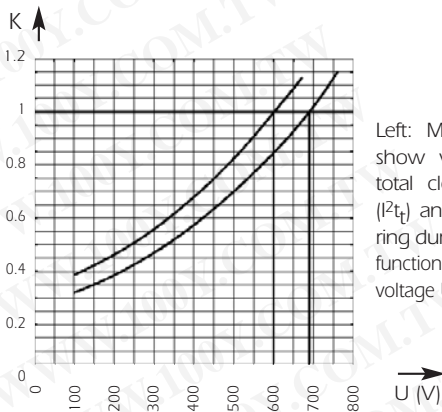

Left: Mean curves show variation of total clearing time (I^2t_t) and total clearing duration T_t as a function of operating voltage U.

Peak arc voltage

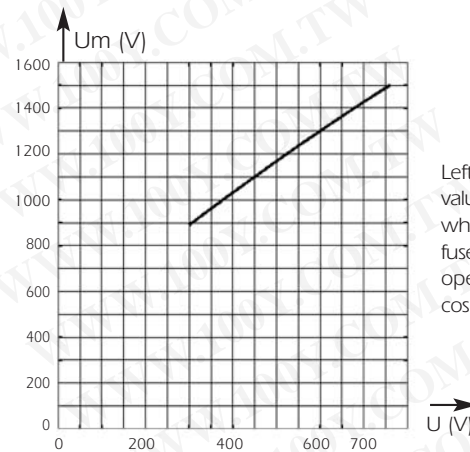

Left: Curve shows peak value U_m of the arc voltage which appears across fuse-link as a function of operating voltage U @ $\cos\phi = 0.15$

Watts loss

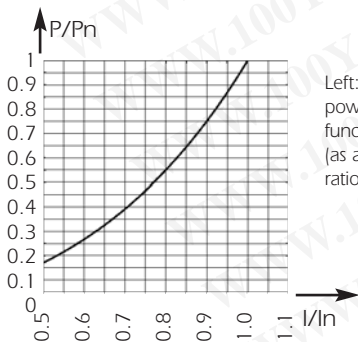

Left: Curve enables computation of power losses P for a I_n -rated fuse as a function of R.M.S. current I (as a multiple of I_n for steady state operation)

勝特力材料 886-3-5753170
勝特力电子(上海) 86-21-34970699
勝特力电子(深圳) 86-755-83298787
[Http://www.100y.com.tw](http://www.100y.com.tw)

Semiconductor (AC) fuses

Protistor® Square-body Fuses PSC gR/aR sizes 000/00 gR/aR - 600 to 690 VAC DIN 00

DC Application data

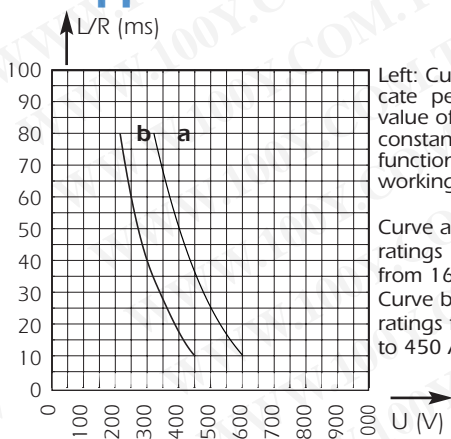

Rated current	Curve	IpM (A) gRB	IpM (A) URB
16	a	32	32
20	a	40	40
25	a	50	50
32	a	64	64
40	a	80	80
50	a	100	100
63	a	126	126
80	a	160	170
100	a	200	220
125	a	250	280
160	a	320	390
200	a	510	510
250	a	650	650
315	b	840	840
350	b	1770	1770
400	b	2040	2040
450	b	2250	2250

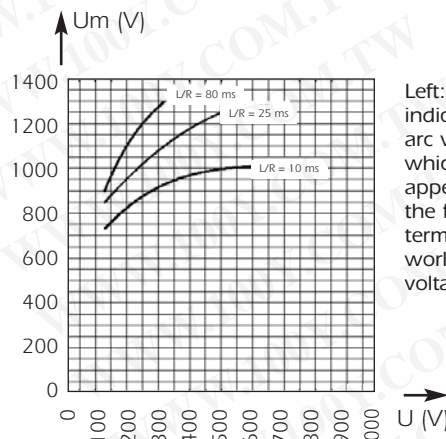

IpM values give minimum DC interrupting current in amps.

Current limitation curves

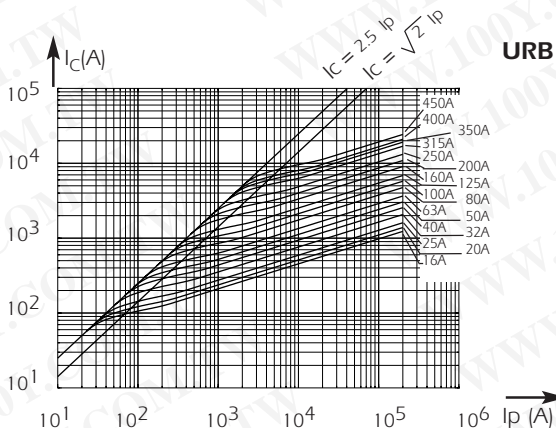
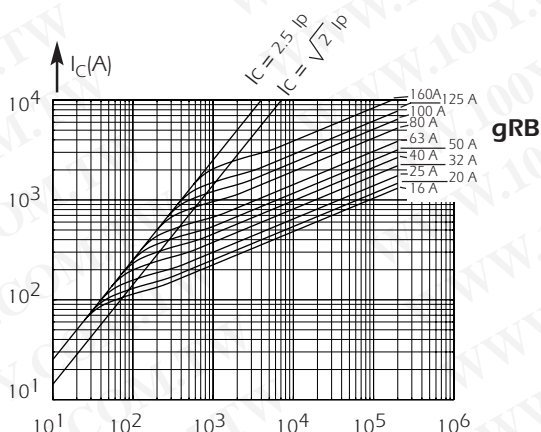

Above: Curves show, for each rating, value of peak let-through current I_c as a function of available fault current I_p .

Time vs current characteristics

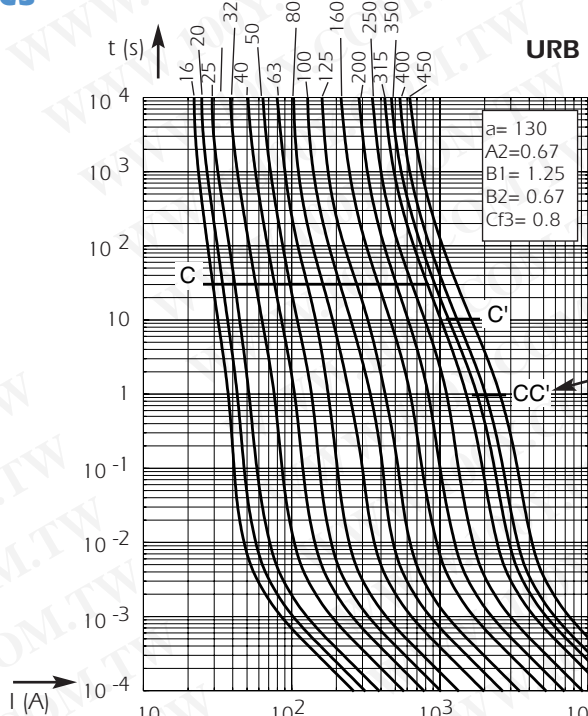
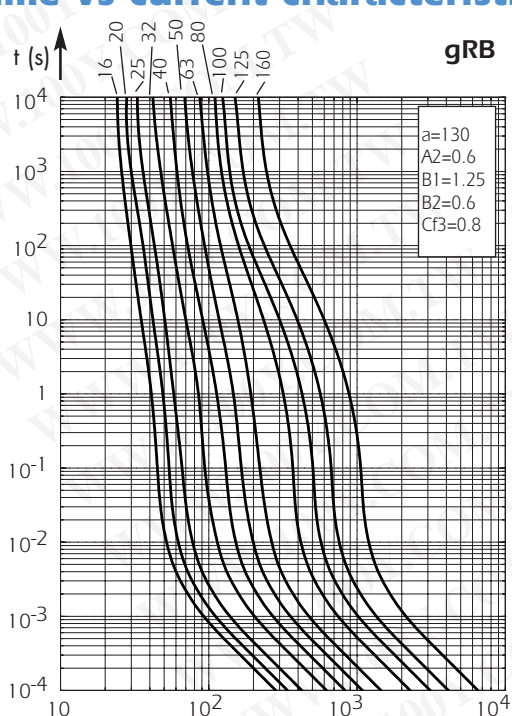

Semiconductor (AC) fuses



Protistor® Square-body Fuses

PSC gR/aR sizes 000/00

Microswitches for PSC sizes 000/00 and NH Fuses

MICROSWITCH SYSTEMS ADAPTED TO THE FOLLOWING FUSES:

- PSC sizes 000/00 (brackets) DIN43653
- NH Fuses (plain blades) see details in "General Purpose IEC Fuses" section
- NH plain blades 690 VAC Protistor square-body Fuses

MS 4L 2-5

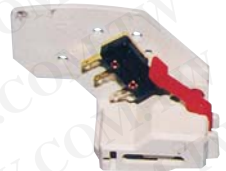

Main Characteristics

Code	AC Insulation voltage rating (***)	Positive operating voltage/current	Current rating	Current	Interrupting rating						AC voltage withstand test (*)	Impulse voltage test Uimp1.2/50 µs (**)	Fire class according to UL 94
					Non inductive circuit			Inductive circuit : L/R = 25ms					
					30V	110V	250V	30V	110V	250V			
MS 4L 2-5 B2 + Pres	1000 V	20 V 100 mA	5 A	50 Hz DC	4A -	4A -	5A -	- -	5A 2 A	5 A 0,4 A	12 kV 8 kV	16 kV 13 kV	V0
MS 4L 2-5 B6 + Pres	1000 V	20 V 50 mA	10 A	50/60 Hz DC	10 A 8 A	10 A 0,4 A	10 A 0,2 A	10 A 4 A	10 A 0,2 A	10 A 0,1 A	8 kV	10 kV	V0

* Between power circuit and microswitch terminals as per IEC 60 and 694 and NFC 64010 (50/60 Hz 1 min duration in dry air)

** Between power circuit and microswitch terminals Uimp: impulse voltage as per IEC 60947-1

*** Between power circuit and microswitch terminals

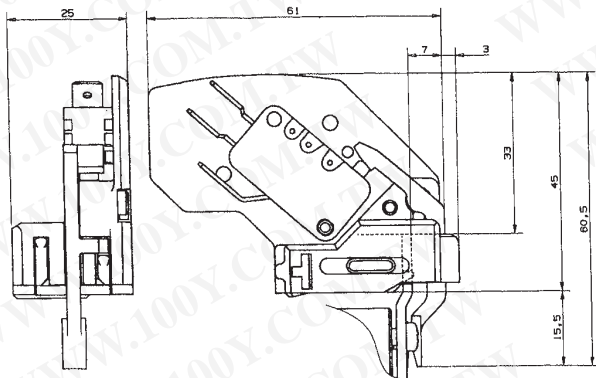

Designation	Ref. Number	Weight (g)	Pack.	Catalog Number
MS 4L 2-5 B6 + PRES (Fig. 1) (1)	F210156	30	3	MS 4L2-5B6PRES
MS 4L 2-5 B2 + PRES (Fig. 2) (2)	G210157	26	3	MS 4L2-5B2PRES

Automatically resettable, these microswitch systems indicate fuse presence (PRES) and proper mounting.

In case of improper mounting or fuse melting, this is indicated (terminal 1-4 closed)

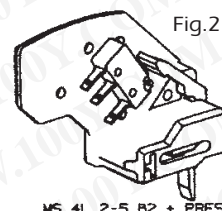
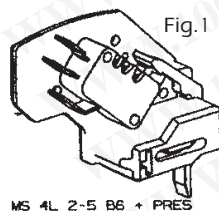
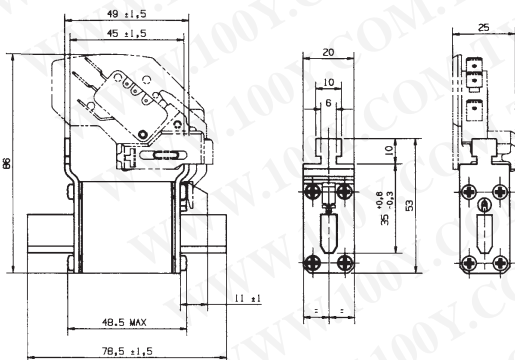

- (1) 6.3 mm clips
- (2) 2.8 mm clips

Protistor® Square-body Fuses PSC gGR sizes 000/00 gGR - 690 VAC DIN 00/000 (full range)



F : Réf. D302108
MC: Réf. F210156C

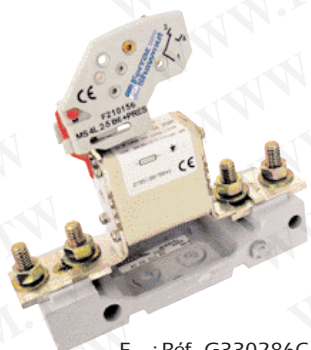

F : Réf. G330286C
PF : Réf. Q098040C
MC: Réf. F210156C

gGr: two functions

A combination of: Power supply cable protection (gG curve)

- Compliance with the standardized gate values for gG curves as per EN 60269-2,
- Low power dissipation, similar to a gG fuse, no current derating in holders,
- No derating for variable currents,
- Good withstand to overloads,
- Same thermal definition as a gG curve,
- Unnecessary to dimension the cable cross sectional area large in comparison to UR protection,
- Range designed for the new voltage of 690V \pm 10%.

Power semi-conductor protection (Fast R curve)

- Fast curve for fault currents and short-circuit currents under 20 In,
- Tested breaking capacity 100 kA (00) or 170 kA (000) at 690 V,
- Very current limiting, which in turn limits electrodynamic forces in the circuit downstream,
- Low I²t
- Compact footprint: only one fuse instead of two or a relay plus a fuse,
- DC performances 360 to 550V for I/R = 10 ms,
Semi-conductor protection checked in the same way as a fuse.

Applications: "off-board" protection

- AC and DC speed governor,
- Soft starter,
- Static relay,
- Current regulator,
- Inverter (IGBT module disconnecter in parallel),
Battery.

Connection technologies offered

- Solid blades (as per DIN 43620) with visual blown fuse indicator and striker to actuate a microswitch, MS4L2-5B + PRES (ref. F210156C or G210157C),
- DIN 80 brackets (as per DIN 43653) with visual blown fuse indicator and striker indicator to actuate a microswitch, MS4L2-5B + PRES.
- With these two technologies the designer can choose a fuse according to the types of holders desired.

Semiconductor (AC) fuses



Protistor® Square-body Fuses PSC gGR sizes 000/00 gGR - 690 VAC DIN 00/000 (full range)

- EN 60269-2-1 compliant
- Compliance with gG gate values on melting and not melting
- Low dissipated power
- No derating for variable current
- Good withstand to repeated overloading
- Withstand to exceptional overloads (same as Protistor fuses)
- Cable protection



Functionalities

Two functions:

- to protect cables from overloads,
- to protect semi-conductors from short-circuits.

Electrical characteristics

Size 000

Voltage Rating (VAC)	Size	Current Rating In (A)	Prearcing Pt @ 1 ms Ptp (A ² s)	Total Pt (A ² s)		Power losses @ In (W)	Tested breaking capacity	Estimated breaking capacity
				@ Un	@ 400V			
690	000	16	45	280	230	2.5		
		20	60	380	310	3		
		25	130	830	700	3.5		
		32	210	1350	1150	4	100 kA	200 kA
		40	350	2200	1900	5	@	@
		50	550	3500	3000	6	690 V	690 V
		63	1000	6100	5150	7		
		80	1700	11000	9200	8		
		100	3900	25000	21000	9		

Size 00

Voltage Rating (VAC)	Size	Current Rating In (A)	Prearcing Pt @ 1 ms Ptp (A ² s)	Total Pt (A ² s)		Power losses @ In (W)	Tested breaking capacity	Estimated breaking capacity
				@ Un	@ 400V			
690	00	16	45	280	230	2.5		
		20	60	390	290	3.2		
		25	120	750	560	4		
		32	240	1550	1150	5		
		40	350	2250	1680	5.5		
		50	540	3500	2600	6.5	100 kA	200 kA
		63	1060	6750	5000	7.6	@	@
		80	1900	12100	9000	9.5	690 V	690 V
		100	3900	24150	18000	11		
		125	6950	45000	33500	13		
		160	13500	82000	61000	16		
		200	27600	160000	120000	18		

Semiconductor (AC) fuses

Protistor® Square-body Fuses PSC gGR sizes 000/00 gGR - 690 VAC DIN 00/000 (full range)

Size 000

German standard
DIN 43653/000
DIN 80

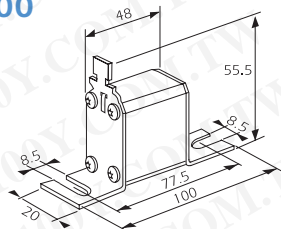

German blade-style
fuse standard
DIN 43620/000

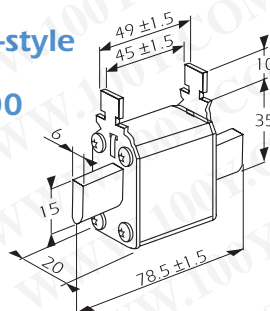

Size 00

German standard
43653/00 - DIN 80

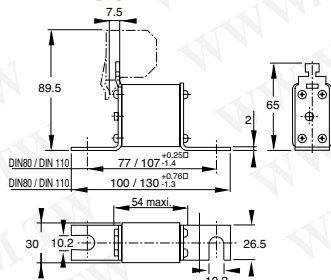

German blade-style
fuse standard 43620/00

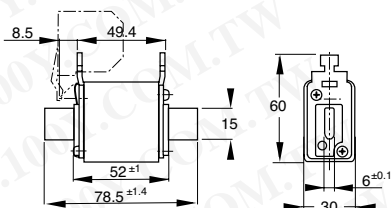

No derating:

I/in = I rms of use/fuse rating
In the different holders = no derating

Microswitches:

Ref. F210156: 6.3 mm clips
Ref. G210156: 2.8 mm clips

690 V gGR fuse holders and supports

Current [A]	Designation	Ref. Number	I/in*	Weight [g]	Pack.	Catalog Number
16	6,9 gGR 000 D08L 016	H302112	1	120	3	DN000GR69V16L
20	6,9 gGR 000 D08L 020	J302113	1	120	3	DN000GR69V20L
25	6,9 gGR 000 D08L 025	K302114	1	120	3	DN000GR69V25L
32	6,9 gGR 000 D08L 032	L302115	1	120	3	DN000GR69V32L
40	6,9 gGR 000 D08L 040	M302116	1	120	3	DN000GR69V40L
50	6,9 gGR 000 D08L 050	N302117	1	120	3	DN000GR69V50L
63	6,9 gGR 000 D08L 063	P302118	1	120	3	DN000GR69V63L
80	6,9 gGR 000 D08L 080	Q302119	1	120	3	DN000GR69V80L
100	6,9 gGR 000 D08L 100	R302120	1	120	3	DN000GR69V100L
Microswitch		F210156				MS4L2-5B6PRES
		G210157				MS4L2-5B2PRES
16	6,9 gGR 000 PV 016	X302102	1	150	3	NH000GR69V16PV
20	6,9 gGR 000 PV 020	Y302103	1	150	3	NH000GR69V20PV
25	6,9 gGR 000 PV 025	Z302104	1	150	3	NH000GR69V25PV
32	6,9 gGR 000 PV 032	A302105	1	150	3	NH000GR69V32PV
40	6,9 gGR 000 PV 040	B302106	1	150	3	NH000GR69V40PV
50	6,9 gGR 000 PV 050	C302107	1	150	3	NH000GR69V50PV
63	6,9 gGR 000 PV 063	D302108	1	150	3	NH000GR69V63PV
80	6,9 gGR 000 PV 080	E302109	1	150	3	NH000GR69V80PV
100	6,9 gGR 000 PV 100	F302110	1	150	3	NH000GR69V100PV
Microswitch		F210156				MS4L2-5B6PRES
		G210157				MS4L2-5B2PRES
Extractor handle		P215592			1	NH HANDLE
20	6,9 gGR 00 D08L 020	T330297	1	140	3	DN00GR69V20L
25	6,9 gGR 00 D08L 025	V330298	1	140	3	DN00GR69V25L
32	6,9 gGR 00 D08L 032	W330299	1	140	3	DN00GR69V32L
40	6,9 gGR 00 D08L 040	X330300	1	140	3	DN00GR69V40L
50	6,9 gGR 00 D08L 050	Y330301	1	140	3	DN00GR69V50L
63	6,9 gGR 00 D08L 063	G330286	1	140	3	DN00GR69V63L
80	6,9 gGR 00 D08L 080	H330287	1	140	3	DN00GR69V80L
100	6,9 gGR 00 D08L 100	J330288	1	140	3	DN00GR69V100L
125	6,9 gGR 00 D08L 125	K330289	1	140	3	DN00GR69V125L
160	6,9 gGR 00 D08L 160	L330290	1	140	3	DN00GR69V160L
200	6,9 gGR 00 D08L 200	M330291	1	140	3	DN00GR69V200L
Microswitch		F210156				MS4L2-5B6PRES
		G210157				MS4L2-5B2PRES
20	6,9 gGR 00 PV 020	N330292	1	210	3	NH00GR69V20PV
25	6,9 gGR 00 PV 025	P330293	1	210	3	NH00GR69V25PV
32	6,9 gGR 00 PV 032	Q330294	1	210	3	NH00GR69V32PV
40	6,9 gGR 00 PV 040	R330295	1	210	3	NH00GR69V40PV
50	6,9 gGR 00 PV 050	S330296	1	210	3	NH00GR69V50PV
63	6,9 gGR 00 PV 063	A330280	1	210	3	NH00GR69V63PV
80	6,9 gGR 00 PV 080	B330281	1	210	3	NH00GR69V80PV
100	6,9 gGR 00 PV 100	C330282	1	210	3	NH00GR69V100PV
125	6,9 gGR 00 PV 125	D330283	1	210	3	NH00GR69V125PV
160	6,9 gGR 00 PV 160	E330284	1	210	3	NH00GR69V160PV
200	6,9 gGR 00 PV 200	F330285	1	210	3	NH00GR69V200PV
Microswitch		F210156 (only)				MS4L2-5B6PRES
Extractor handle		P215592			1	NH HANDLE

Type of fuse	Nb. poles	References for mounting on 35 mm DIN rail	References for panel mounting
Solid blades size 000/00 IPXX	1	R216192	F215170
	2	F218758	A217212
	3	V219277	F217723
	4	Z223007	S219275
Solid blades size 000/00 IP20 w/o microswitch	1	S218240	-
	3	S229119	-
	1	-	C220710
DIN 80 bracket size 000 IPXX	1	-	O098040
DIN 80 bracket size 00 IPXX	1	-	-
DIN 80 blades size 000 IP20 w/o microswitch	1	B227218	-
DIN 80 blades size 000 IP20 for microswitch	1	C227219	-
DIN 80 blades size 00 IP20 w/o microswitch	1	V227672	-
DIN 80 blades size 00 IP20 for microswitch	1	W227673	-
ITCP range	1	-	-

Semiconductor (AC) fuses



Protistor® Square-body Fuses PSC gGR sizes 000/00 gGR - 690 VAC DIN 00/000 (full range)



F : Réf. D302108C
MC: Réf. F210156C

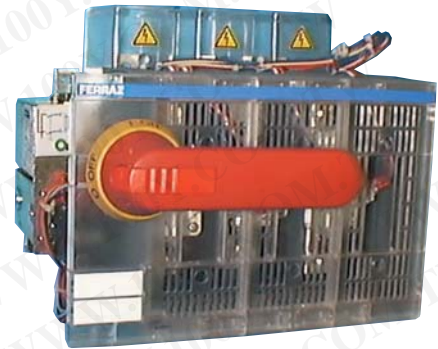

F : Réf. G330286C
PF : Réf. Q098040C
MC: Réf. F210156C

ITCP : Réf. G210410A
F : Réf. M330291C

Choice and references of gGR fuse holders

	Type of support	Characteristics	Nb. Poles	Solid blade size 000/00		DIN 80 bracket		Fuse microswitch (2)
				Reference Number	Fuse extraction handle	Size 000	Size 00	
CEI 60269-2	Fuse holders	No protection (1) Screw connection for eye lug or bar for 35 mm DIN rail	1	R216192	P215592			F2101546 or G210157
			2	F218758				
			3	V219277				
			4	Z223007				
		No protection (1) Screw connection for eye lug or bar on panels	1	F215170	P215592	C220710	Q098040	F210156 or G210157
			2	A217212				
		Protect led to IP20 Screw connection for eye lug or bar for DIN rail	1	S218240	P215592	W/o microswitch B227218 C227219		
			3	S229119		For microswitch V227672 W227673		
			1					
CEI 60947-3	Switch disconnecter	Horizontal Lincur AC23	2	N216626 N222882 B218685 C201781 Y212035 W213574	P215592			F210156 or G210157
			3		P215592			
					P215592			
	Switch with front control handle	ITC 160M III 00 Front handle Inside/outside Complete	3	K227824	P215592			
			3	F210409	P215592			
Switch with side control handle	ITC 160M III 00 Side handle Outside Complete	3	J227823	P215592				
ITCP	ITCP	3		P215592				G210410

(1) No protection against accidental contact with live parts IPXX.

(2) F210156C microswitch: 6.3 mm clips
G210157C microswitch: 2.8 mm clips

Semiconductor (AC) fuses

Protistor® Square-body Fuses PSC gGR sizes 000/00 gGR - 690 VAC DIN 00/000 (full range)

Amplitude of current interrupted

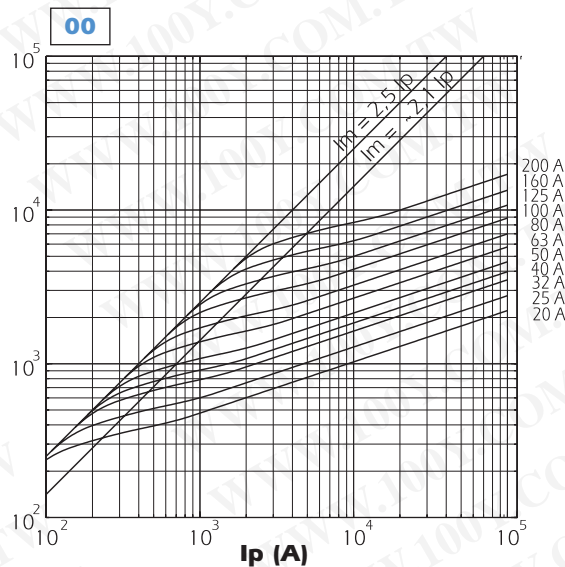
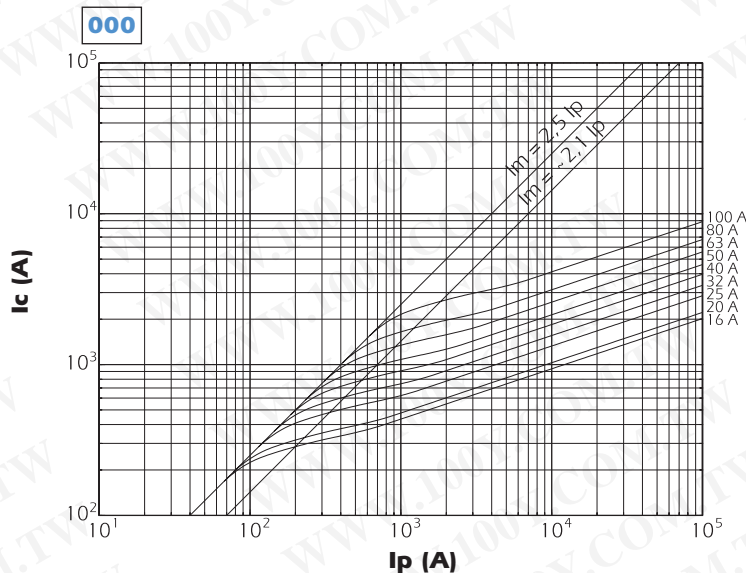

DC working voltage possibilities

Size 00

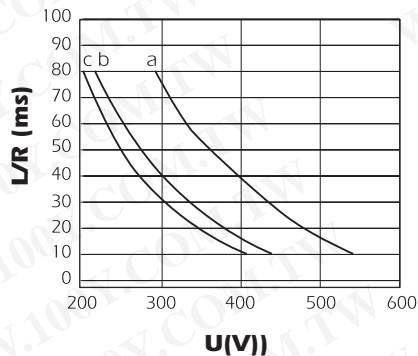

In	Curve
16 A	a
20 A	a
25 A	a
32 A	a
40 A	a
50 A	a
63 A	a
80 A	b
100 A	c
125 A	c
160 A	b
200 A	c

Size 000

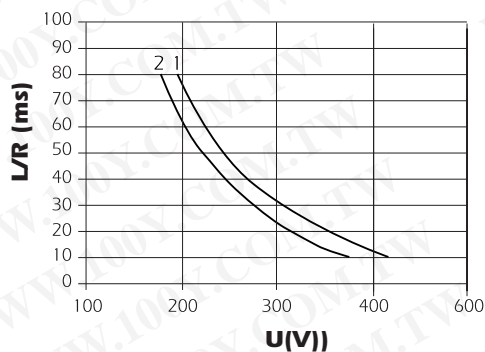

In	Curve
16 A	1
20 A	1
25 A	1
32 A	1
40 A	1
50 A	1
63 A	2
80 A	2
100 A	2

Size 00 and Size 000

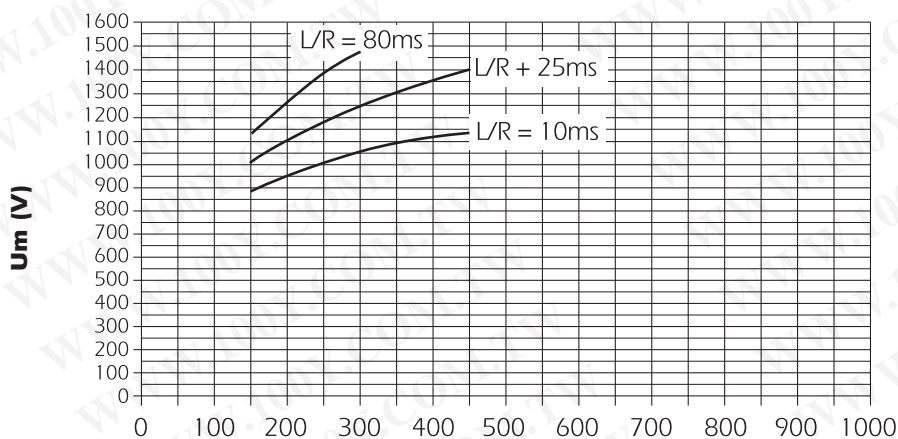

Semiconductor (AC) fuses



Protistor® Square-body Fuses PSC gGR sizes 000/00 gGR - 690 VAC DIN 00/000 (full range)

Time/current characteristics

TOLERANCE ON PRE-ARCING CURRENT +/- 8%

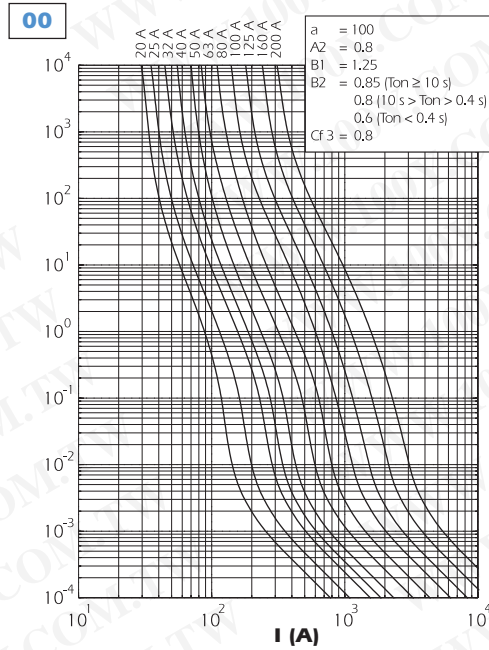
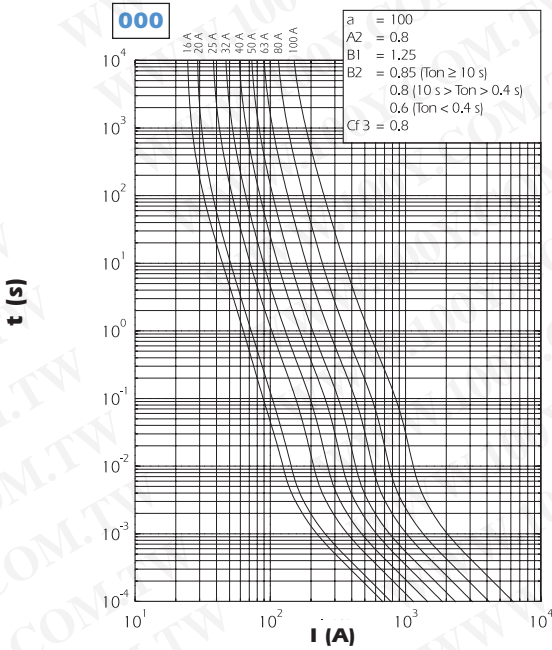

Dissipated power

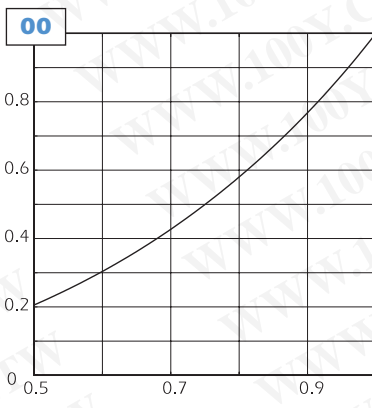
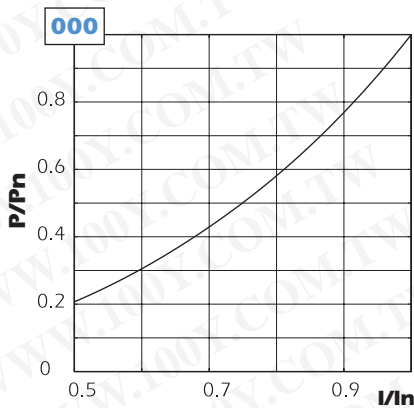

Breaking voltage

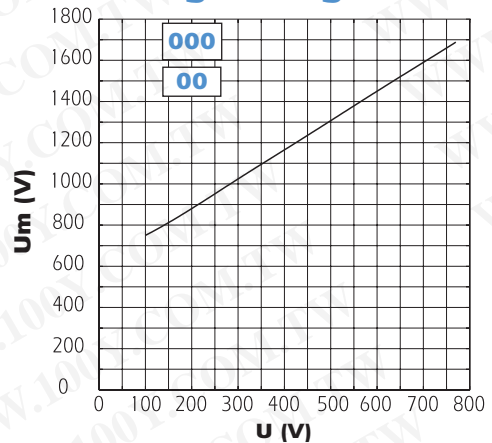

Maximum total operating I²t and total operating time

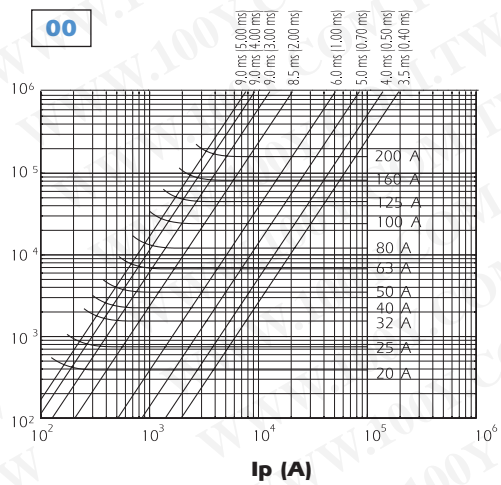
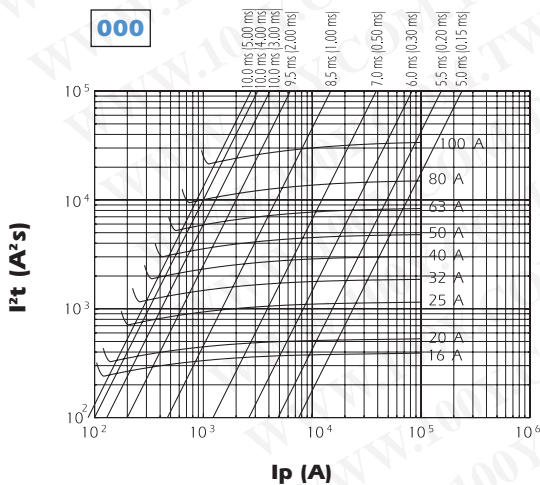

Semiconductor (AC) fuses

Protistor® Square-body Fuses PSC gR/aR sizes 000/00 Microswitches for PSC sizes 000/00 and NH

MICROSWITCH SYSTEMS ADAPTED TO THE FOLLOWING FUSES:

- PSC sizes 000/00 (brackets) DIN43653
- NH Fuses (plain blades) see details in "General Purpose IEC Fuses" section
- NH plain blades 690 VAC Protistor square-body Fuses

MS 4L 2-5



Main Characteristics

Code	AC Insulation voltage rating (***)	Positive operating voltage/current	Current rating	Current	Interrupting rating						AC voltage withstand test (*)	Impulse voltage test Uimp1.2/50 µs (**)	Fire class according to UL 94
					Non inductive circuit			Inductive circuit : L/R = 25mS					
					30V	110V	250V	30V	110V	250V			
MS 4L 2-5 B2 + Pres	1000 V	20 V / 100 mA	5 A	50 Hz DC	4A	4A	5A	-	5A	5 A	12 kV	16 kV	V0
MS 4L 2-5 B6 + Pres	1000 V	20 V / 50 mA	10 A	50/60 Hz DC	10 A	10 A	10 A	10 A	10 A	10 A	8 kV	10 kV	V0
					8 A	0,4 A	0,2 A	4 A	0,2 A	0,1 A			

- * Between power circuit and microswitch terminals as per IEC 60 and 694 and NFC 64010 (50/60 Hz 1 min duration in dry air)
- ** Between power circuit and microswitch terminals Uimp: impulse voltage as per IEC 60947-1
- *** Between power circuit and microswitch terminals

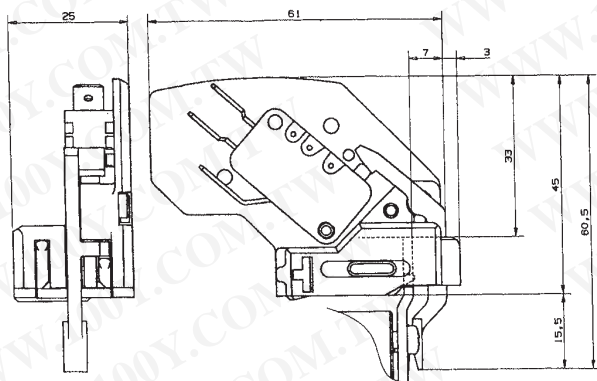

Designation	Ref. Number	Weight (g)	Pack.	Catalog Number
MS 4L 2-5 B6 + PRES (Fig. 1) (1)	F210156	30	3	MS 4L2-5B6PRES
MS 4L 2-5 B2 + PRES (Fig. 2) (2)	G210157	26	3	MS 4L2-5B2PRES

Automatically resettable, these microswitch systems indicate fuse presence (PRES) and proper mounting. In case of improper mounting or fuse melting, this is indicated (terminal 1-4 closed)

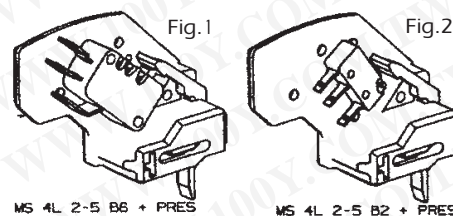
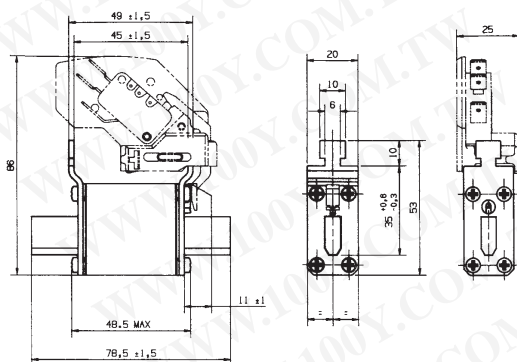

- (1) 6.3 mm clips
- (2) 2.8 mm clips

Protistor® Square-body Fuses PSC aR sizes 3x - 450V to 700 VAC Main characteristics

450 TO 700VAC / 63 TO 2800A

 Recognized

Exceptionally low I^2t , Watt losses.
Non-magnetic construction,
Highly reliable low voltage
Trip-indicator system, conformity to UL,
IEC, DIN and VDE standards.

Increased technical performance

- Higher ratings
- Reduction in volume and weight



This fuse preselection table indicates, for each size:

- rated current (or rating) I_n
- pre-arcing I^2t (I^2t_p) at 1 ms
- total operating I^2t (I^2t_{tt}) at 660 V, $f=50\text{Hz}$ $\cos \varphi=0.15$, and for a total operating time from 8 to 10 ms
- dissipated power P_n at the rated current I_n , and at $0.8 I_n$, in steady state
- breaking capacity at various voltages, checked by tests made in accordance with IEC and American standards.

Semiconductor (AC) fuses



Protistor® Square-body Fuses PSC aR sizes 3x - 450V to 700 VAC Main characteristics

Estimated breaking capacity: 300kA

Size	Nominal Voltage (VAC)		Ampere Rating (A)	Pre-arcing I ² t @ 1ms (kA ² s)	Total I ² t @ 660V (*) @ Un (kA ² s)	Power Pn (W)		Tested Breaking capacity (kA)					
	IEC	USA				End contact	Blades	IEC @ 690V (*) @ Un	USA @ 700V (*) @ Un				
30	690	700	50	0,116	0,62	9	9	200	200				
			63	0,2	1,1	14	14						
			80	0,33	1,8	19	19						
			100	0,47	2,5	26	26						
			125	0,85	4,5	30	30						
			160	1,6	8,5	37	37						
			200	3	15,5	42	43						
			250	5,8	30	48	50						
			315	12	62	53	55						
			350	15,5	80	57	60						
			400	23	120	60	65						
			450	26	150	80	88						
			500	41	240	80	88						
			550	52	300	80	90						
31	600	650	630	84	450(*)	85	95	200(*)	200(*)				
			160	1,3	7	35	35						
			200	2,6	13,5	45	45						
			250	4,7	25	52	52						
			315	7,5	40	65	65						
			350	10,5	55	67	67						
	690	700	400	19	100	68	68	200	200				
			450	26,5	140	70	70						
			500	37	195	70	72						
			550	52	280	70	75						
			630	75	390	75	85						
			700	95	490	85	95						
			800	140	800	105	120						
			900	170	900	110	120						
32	690	700	315	5,2	28,9	71	71	200	200				
			350	8,9	48,8	71	74						
			400	15	80	72	75						
			450	22	115	77	80						
			500	28	145	85	90						
			550	37	195	90	95						
			630	54	280	95	105						
			700	76	400	100	110						
			800	115	600	110	120						
			900	170	900	110	125						
			1000	240	1250	115	135						
			600	650	1100	270	1450(*)			140	165	160(*)	160(*)
					1250	410	1950(*)			150	180		
					1400	555	2300(*)			160	200		
1600	870	3600(*)			165	205							
1800	1100	4500(*)			195	230							
2000	1400	6000(*)			230	280							
33	690	700	450	13,45	74,1	84	88	200	200				
			500	19	100	105	105						
			550	27	140	105	110						
			630	40	210	110	120						
			700	55	300	115	125						
			800	95	490	120	130						
			900	135	700	120	135						
			1000	170	900	135	155						
			1100	240	1260	135	160						
			1250	350	1850	150	180						
			1400	480	2500	160	200						
			600	650	1500	500	2500(*)			210	240	160(*)	160(*)
					1600	555	2900(*)			210	240		
					1800	720	3870(*)			225	260		
2000	950	4500(*)			250	290							
2250	1250	5160(*)			280	320							
2500	1870	6540(*)			280	330							
2X32	690	700	800	60	320	144	144	200	200				
			1000	110	590	165	165						
			1250	220	1100	190	190						
			1400	300	1600	200	200						
			1600	450	2400	220	220						
			1800	700	3500	225	225						
			2000	950	5000	235	235						
			550	600	2200	1100	5250(*)			280	280	150(*)	150(*)
					1000	76	395			220	220		
					1250	160	850			230	230		
1400	225	1200			240	240							
1600	375	1900			250	250							
1800	530	2800			250	250							
2x33	690	700	2000	700	3100(*)	280	280	170	170				
			2200	950	4400(*)	280	280						
			2500	1400	6600(*)	310	310						
			2800	1900	8800(*)	330	330						
			600	650	1000	76	395			220	220	160(*)	160(*)
					1250	160	850			230	230		
1400	225	1200			240	240							
1600	375	1900			250	250							
1800	530	2800			250	250							
2000	700	3100(*)			280	280							

For others Ampere ratings consult us
12/04

Semiconductor (AC) fuses

Protistor® Square-body Fuses PSC aR sizes 3x - 450V to 700 VAC American Terminals - 30 - 33 End contacts



Size	Designation			Reference Number	Weight (g)	Packaging	Catalog Number	
30	A070 URD	30	TTI	0050	V302744	245	3	A070UD30TTI 50
	A070 URD	30	TTI	0063	A301967			A070UD30TTI 63
	A070 URD	30	TTI	0080	V301962			A070UD30TTI 80
	A070 URD	30	TTI	0100	W300744			A070UD30TTI100
	A070 URD	30	TTI	0125	G300708			A070UD30TTI125
	A070 URD	30	TTI	0160	N300576			A070UD30TTI160
	A070 URD	30	TTI	0200	P300577			A070UD30TTI200
	A070 URD	30	TTI	0250	Q300578			A070UD30TTI250
	A070 URD	30	TTI	0315	R300579			A070UD30TTI315
	A070 URD	30	TTI	0350	S300580			A070UD30TTI350
	A070 URD	30	TTI	0400	T300581			A070UD30TTI400
	A070 URD	30	TTI	0450	V300582			A070UD30TTI450
	A070 URD	30	TTI	0500	W300583			A070UD30TTI500
	A070 URD	30	TTI	0550	X300584			A070UD30TTI550
	A065 URD	30	TTI	0630	A302703			A065UD30TTI630
	31	A070 URD	31	TTI	0160			-
A070 URD		31	TTI	0200	A300472	A070UD31TTI250		
A070 URD		31	TTI	0250	B300473	A070UD31TTI315		
A070 URD		31	TTI	0315	C300474	A070UD31TTI350		
A070 URD		31	TTI	0350	D300475	A070UD31TTI400		
A070 URD		31	TTI	0400	E300476	A070UD31TTI450		
A070 URD		31	TTI	0450	F300477	A070UD31TTI500		
A070 URD		31	TTI	0500	G300478	A070UD31TTI550		
A070 URD		31	TTI	0550	H300479	A070UD31TTI630		
A070 URD		31	TTI	0700	J300480	A070UD31TTI700		
A070 URD	31	TTI	0800	K300481	A070UD31TTI800			
32	A070 URD	32	TTI	0315	-	510	3	A070UD32TTI400
	A070 URD	32	TTI	0350	-			A070UD32TTI450
	A070 URD	32	TTI	0400	Q300463			A070UD32TTI500
	A070 URD	32	TTI	0450	N300461			A070UD32TTI550
	A070 URD	32	TTI	0500	P300462			A070UD32TTI630
	A070 URD	32	TTI	0550	R300464			A070UD32TTI700
	A070 URD	32	TTI	0630	S300465			A070UD32TTI800
	A070 URD	32	TTI	0700	T300466			A070UD32TTI900
	A070 URD	32	TTI	0800	V300467			A070UD32TTI1000
	A070 URD	32	TTI	0900**	W300468			A065UD32TTI1100
	A070 URD	32	TTI	1000**	X300469			A060UD32TTI1250
	A065 URD	32	TTI	1100**	M301081			A055UD32TTI1400
	A060 URD	32	TTI	1250**	N301082			A055UD32TTI1600
	A055 URD	32	TTI	1400**	P301083			A050UD32TTI1800
A055 URD	32	TTI	1600**	Q301084				
A050 URD	32	TTI	1800**	R301085				
33	A070 URD	33	TTI	0450	X302171	790	3	A070UD33TTI450
	A070 URD	33	TTI	0500	X300446			A070UD33TTI500
	A070 URD	33	TTI	0550	Y300447			A070UD33TTI550
	A070 URD	33	TTI	0630	Z300448			A070UD33TTI630
	A070 URD	33	TTI	0700	A300449			A070UD33TTI700
	A070 URD	33	TTI	0800	T300443			A070UD33TTI800
	A070 URD	33	TTI	0900	B300450			A070UD33TTI900
	A070 URD	33	TTI	1000	C300451			A070UD33TTI1000
	A070 URD	33	TTI	1100	D300452			A070UD33TTI1100
	A070 URD	33	TTI	1250**	E300453			A070UD33TTI1250
	A070 URD	33	TTI	1400**	F300454			A070UD33TTI1400
	A065 URD	33	TTI	1500**	F302064			A065UD33TTI1500
	A065 URD	33	TTI	1600**	S301086			A065UD33TTI1600
	A065 URD	33	TTI	1800**	T301087			A065UD33TTI1800
	A060 URD	33	TTI	2000**	V301088			A060UD33TTI2000
	A055 URD	33	TTI	2250**	W301089			A055UD33TTI2250
A050 URD	33	TTI	2500**	Y300838	A050UD33TTI2500			

Rated Voltage as per American standard

Semiconductor (AC) fuses

Protistor® Square-body Fuses PSC aR sizes 3x - 450V to 700 VAC American Terminals - 30 - 33 End contacts

勝特力材料 886-3-5753170
 勝特力电子(上海) 86-21-34970699
 勝特力电子(深圳) 86-755-83298787
[Http://www.100y.com.tw](http://www.100y.com.tw)

Size	A	B	C	D	E±1	d	G±0.1	P±0.1
30	40 1-19/32"	46.5 1-27/32"	82 3-7/32"	26 1"	50.6 2"	5/16"-18	9 23/64"	6 15/64"
31	51 2"	56.5 2-7/32"	91 3-37/64"	30 1-3/16"	50.6 2"	5/16"-18	9 23/64"	9 23/64"
32	60 2-3/8"	65.5 2-37/64"	100 3-15/16"	38 ; (42 **) 1-1/2" ; (1-21/32" **)	50.6 2"	3/8"-16	15 19/32"	9 23/64"
33	74.5 2-15/16"	79.5 3-1/8"	114 4-1/2"	46 ; (52 **) 1-13/16" ; (2-1/16" **)	50.6 2"	1/2"-13	15 19/32"	9 23/64"

Note:
 dimensions in mm
 dimensions in inches

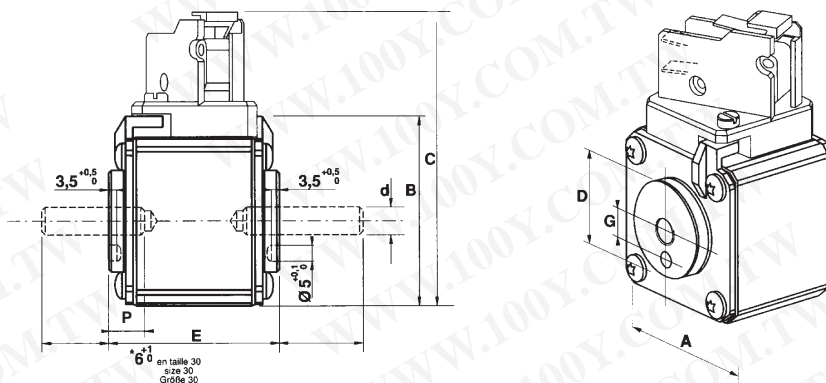

Microswitches are supplied separately see microswitches PSC 3x & 7x section

Semiconductor (AC) fuses

Protistor® Square-body Fuses PSC aR sizes 3x - 450V to 700 VAC American Terminals - 30 - 33 Blades



Rated voltage as per American standard.

Size	Designation				Reference Number	Weight (g)	Pack.	Catalog Number	
					K				
30	A 070	URD 30 KI	0050		E301925	290	3	A070UD30KI050	
	A 070	URD 30 KI	0063		B300128			A070UD30KI63	
	A 070	URD 30 KI	0080		C300129			A070UD30KI080	
	A 070	URD 30 KI	0100		D300130			A070UD30KI100	
	A 070	URD 30 KI	0125		E300131			A070UD30KI125	
	A 070	URD 30 KI	0160		F300132			A070UD30KI160	
	A 070	URD 30 KI	0200		G300133			A070UD30KI200	
	A 070	URD 30 KI	0250		H300134			A070UD30KI250	
	A 070	URD 30 KI	0315		J300135			A070UD30KI315	
	A 070	URD 30 KI	0350		K300136			A070UD30KI350	
	A 070	URD 30 KI	0400		L300137			A070UD30KI400	
	A 070	URD 30 KI	0450		T301064			A070UD30KI450	
	A 070	URD 30 KI	0500		V301065			A070UD30KI500	
	A 070	URD 30 KI	0550		W301066			A070UD30KI550	
	A 065	URD 30 KI	0630		-				
	31	A 070	URD 31 KI	0160				F300385	430
A 070		URD 31 KI	0200		S300028	A070UD31KI200			
A 070		URD 31 KI	0250		T300029	A070UD31KI250			
A 070		URD 31 KI	0315		V300030	A070UD31KI315			
A 070		URD 31 KI	0350		R300050	A070UD31KI350			
A 070		URD 31 KI	0400		W300031	A070UD31KI400			
A 070		URD 31 KI	0450		X300032	A070UD31KI450			
A 070		URD 31 KI	0500		Y300033	A070UD31KI500			
A 070		URD 31 KI	0550		Z300034	A070UD31KI550			
A 070		URD 31 KI	0630		A300035	A070UD31KI630			
A 070		URD 31 KI	0700		B300036	A070UD31KI700			
A 070		URD 31 KI	0800		A301070	A070UD31KI800			
32	A 070	URD 32 KI	0400		Z300195	590	3	A070UD32KI400	
	A 070	URD 32 KI	0450		A300196			A070UD32KI450	
	A 070	URD 32 KI	0500		B300197			A070UD32KI500	
	A 070	URD 32 KI	0550		C300198			A070UD32KI550	
	A 070	URD 32 KI	0630		D300199			A070UD32KI630	
	A 070	URD 32 KI	0700		E300200			A070UD32KI700	
	A 070	URD 32 KI	0800		F300201			A070UD32KI800	
	A 070	URD 32 KI	0900		G300202			A070UD32KI900	
	A 070	URD 32 KI	1000		H300203			A070UD32KI1000	
	A 065	URD 32 KI	1100		-				
	A 060	URD 32 KI	1250		-			660	
	A 055	URD 32 KI	1400		-				
	A 055	URD 32 KI	1600		-				
	A 050	URD 32 KI	1800		-				
33	A 070	URD 33 KI	0500		W300238	860	3	A070UD33KI500	
	A 070	URD 33 KI	0550		X300239			A070UD33KI550	
	A 070	URD 33 KI	0630		Y300240			A070UD33KI630	
	A 070	URD 33 KI	0700		Z300241			A070UD33KI700	
	A 070	URD 33 KI	0800		A300242			A070UD33KI800	
	A 070	URD 33 KI	0900		B300243			A070UD33KI900	
	A 070	URD 33 KI	1000		C300244			A070UD33KI1000	
	A 070	URD 33 KI	1100		D300245			A070UD33KI1100	
	A 070	URD 33 KI	1250		E300246			A070UD33KI1250	
	A 070	URD 33 KI	1400		F300247			A070UD33KI1400	
	A 065	URD 33 KI	1600		E302063			A065UD33KI1600	
	A 065	URD 33 KI	1800		-				
	A 060	URD 33 KI	2000		-				
	A 055	URD 33 KI	2250		-				
	A 050	URD 33 KI	2500		-				
								1070	

Semiconductor (AC) fuses



Protistor® Square-body Fuses PSC aR sizes 3x - 450V to 700 VAC American Terminals - 30 - 33 Blades



Rated voltage as per American standard.

Size	Designation				Reference Number	Weight (g)	Pack.	Catalog Number
					L			
30	A 070	URD 30 LI	0050	A301921	290	3	A070UD30LI050	
	A 070	URD 30 LI	0063	M300138			A070UD30LI63	
	A 070	URD 30 LI	0080	N300139			A070UD30LI080	
	A 070	URD 30 LI	0100	P300140			A070UD30LI100	
	A 070	URD 30 LI	0125	Q300141			A070UD30LI125	
	A 070	URD 30 LI	0160	R300142			A070UD30LI160	
	A 070	URD 30 LI	0200	S300143			A070UD30LI200	
	A 070	URD 30 LI	0250	T300144			A070UD30LI250	
	A 070	URD 30 LI	0315	V300145			A070UD30LI315	
	A 070	URD 30 LI	0350	W300146			A070UD30LI350	
	A 070	URD 30 LI	0400	X300147			A070UD30LI400	
	A 070	URD 30 LI	0450	K300527			A070UD30LI450	
	A 070	URD 30 LI	0500	L300528			A070UD30LI500	
	A 070	URD 30 LI	0550	M300529			A070UD30LI550	
A 060	URD 30 LI	0630	P302003	A060UD30LI630				
31	A 070	URD 31 LI	0160	D301924	430	3	A070UD31LI160	
	A 070	URD 31 LI	0200	V300697			A070UD31LI200	
	A 070	URD 31 LI	0250	W300698			A070UD31LI250	
	A 070	URD 31 LI	0315	X300699			A070UD31LI315	
	A 070	URD 31 LI	0350	Y300700			A070UD31LI350	
	A 070	URD 31 LI	0400	Z300701			A070UD31LI400	
	A 070	URD 31 LI	0450	A300702			A070UD31LI450	
	A 070	URD 31 LI	0500	B300703			A070UD31LI500	
	A 070	URD 31 LI	0550	C300704			A070UD31LI550	
	A 070	URD 31 LI	0630	D300705			A070UD31LI630	
	A 070	URD 31 LI	0700	E300706			A070UD31LI700	
A 070	URD 31 LI	0800	F300707	A070UD31LI800				
32	A 070	URD 32 LI	0400	J300204	590	3	A070UD32LI400	
	A 070	URD 32 LI	0450	K300205			A070UD32LI450	
	A 070	URD 32 LI	0500	L300206			A070UD32LI500	
	A 070	URD 32 LI	0550	M300207			A070UD32LI550	
	A 070	URD 32 LI	0630	N300208			A070UD32LI630	
	A 070	URD 32 LI	0700	P300209			A070UD32LI700	
	A 070	URD 32 LI	0800	Q300210			A070UD32LI800	
	A 070	URD 32 LI	0900	R300211			A070UD32LI900	
	A 070	URD 32 LI	1000	S300212			A070UD32LI1000	
	A 065	URD 32 LI	1100	B301071			A065UD32LI1100	
	A 060	URD 32 LI	1250	C301072			A060UD32LI1250	
	A 055	URD 32 LI	1400	D301073			A055UD32LI1400	
	A 055	URD 32 LI	1600	E301074			A055UD32LI1600	
	A 050	URD 32 LI	1800	F301075			A050UD32LI1800	
33	A 070	URD 33 LI	0500	K300228	860	3	A070UD33LI500	
	A 070	URD 33 LI	0550	L300229			A070UD33LI550	
	A 070	URD 33 LI	0630	M300230			A070UD33LI630	
	A 070	URD 33 LI	0700	N300231			A070UD33LI700	
	A 070	URD 33 LI	0800	P300232			A070UD33LI800	
	A 070	URD 33 LI	0900	Q300233			A070UD33LI900	
	A 070	URD 33 LI	1000	R300234			A070UD33LI1000	
	A 070	URD 33 LI	1100	S300235			A070UD33LI1100	
	A 070	URD 33 LI	1250	T300236			A070UD33LI1250	
	A 070	URD 33 LI	1400	V300237			A070UD33LI1400	
	A 065	URD 33 LI	1600	G301076			A065UD33LI1600	
	A 065	URD 33 LI	1800	H301077			A065UD33LI1800	
	A 060	URD 33 LI	2000	J301078			A060UD33LI2000	
	A 055	URD 33 LI	2250	K301079			A055UD33LI2250	
	A 050	URD 33 LI	2500	L301080			A050UD33LI2500	
							1070	

Semiconductor (AC) fuses

Protistor® Square-body Fuses PSC aR sizes 3x - 450V to 700 VAC American Terminals - 30 - 33 Blades



Rated voltage as per American standard.

Size	Designation				Reference Number	Weight (g)	Pack.	Catalog Number
					LL			
31	A 070	URD 31	LLI 0160		C301923	290		A070UD31LLI160
	A 070	URD 31	LLI 0200		J300158			A070UD31LLI200
	A 070	URD 31	LLI 0250		K300159			A070UD31LLI250
	A 070	URD 31	LLI 0315		L300160			A070UD31LLI315
	A 070	URD 31	LLI 0350		M300161			A070UD31LLI350
	A 070	URD 31	LLI 0400		N300162			A070UD31LLI400
	A 070	URD 31	LLI 0450		P300163			A070UD31LLI450
	A 070	URD 31	LLI 0500		Q300164			A070UD31LLI500
	A 070	URD 31	LLI 0550		R300165			A070UD31LLI550
	A 070	URD 31	LLI 0630		S300166			A070UD31LLI630
	A 070	URD 31	LLI 0700		T300167			A070UD31LLI700
	A 070	URD 31	LLI 0800		J300526			A070UD31LLI800

Semiconductor (AC) fuses



Protistor® Square-body Fuses PSC aR sizes 3x - 450V to 700 VAC American Terminals - 30 - 33 Blades

	Size	A	B	C	D	E ₁ ^{±1,1}	E ₂ ^{±1,1}	F	H	J	K	L	e
K	30	40 1-19/32"	46,5 1-27/32"	82 3-7/32"	47,5 1-7/8"	68 2-11/16"	107 4-7/32"	21 53/64"	25 1"	10,5 13/32"	30 1-3/16"	129 5-5/64"	6 15/64"
	31	51 2"	56,5 2-7/32"	91 3-37/64"	47,5 1-7/8"	68 2-11/16"	107 4-7/32"	25,5 1"	25 1"	10,5 13/32"	30 1-3/16"	129 5-5/64"	6 15/64"
	32	60 2-3/8"	65,5 2-37/64"	100 3-15/16"	47,5 1-7/8"	74,5 2-59/64"	109 4-9/32"	30 1-3/16"	32 1-1/4"	14,6 9/16"	32 1-1/4"	134 5-9/32"	6 15/64"
	33	74,5 2-15/16"	79,5 3-1/8"	114 4-1/2"	48,5 1-29/32"	75,4 2-31/32"	107,6 4-15/64"	37,2 1-15/32"	40 1-9/16"	15,9 5/8"	32 1-1/4"	134 5-9/32"	6 15/64"
L	30	40 1-19/32"	46,5 1-27/32"	82 3-7/32"	47,5 1-7/8"	87,6 3-7/16"	126,6 5"	21 53/64"	25 1"	10,5 13/32"	30 1-3/16"	148,5 5-27/32"	6 15/64"
	31	51 2"	56,5 2-7/32"	91 3-37/64"	47,5 1-7/8"	91,6 3-19/32"	122,4 4-13/16"	25,5 1"	25 1"	14,6 9/16"	30 1-3/16"	148,6 5-27/32"	6 15/64"
	32	60 2-3/8"	65,5 2-37/64"	100 3-15/16"	47,5 1-7/8"	94,2 3-45/64"	129 5-5/64"	30 1-3/16"	32 1-1/4"	14,6 9/16"	32 1-1/4"	153 5-9/32"	6 15/64"
	33	74,5 2-15/16"	79,5 3-1/8"	114 4-1/2"	48,5 1-29/32"	94,4 3-23/32"	126,6 5"	37,2 1-15/32"	40 1-9/16"	15,9 5/8"	32 1-1/4"	153 6"	6 15/64"
LL	31 2"	51 2-7/32"	56,5 3-37/64"	91 1-7/8"	47,5 3-7/16"	87,6 5"	126,6 1"	25,5 1"	25 1"	10,5 13/32"	30 1-3/16"	148,6 5-27/32"	6 15/64"

Note:
dimensions in mm
dimensions in inches

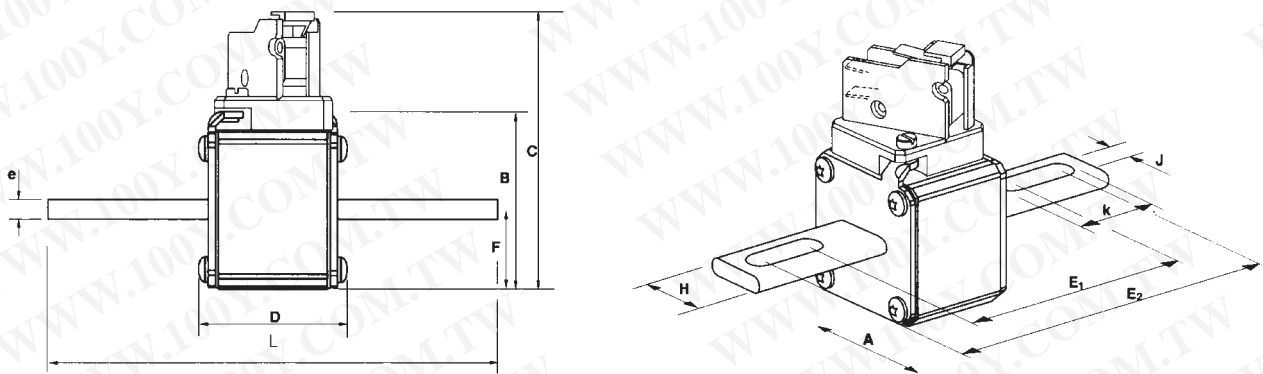

Microswitches supplied separately see microswitches for PSC 3x & 7x section

Semiconductor (AC) fuses

Protistor® Square-body Fuses PSC aR sizes 3x - 450V to 700 VAC IEC Terminals French - 30 - 33 End contacts

Size	Designation	Reference Number	Weight (g)	Packaging	Catalog Number
30	6,9 URD 30 TTF 0050	S300373	245	3	PC30UD69V50TF
	6,9 URD 30 TTF 0063	M300000			PC30UD69V63TF
	6,9 URD 30 TTF 0080	S300051			PC30UD69V80TF
	6,9 URD 30 TTF 0100	T300052			PC30UD69V100TF
	6,9 URD 30 TTF 0125	V300053			PC30UD69V125TF
	6,9 URD 30 TTF 0160	W300054			PC30UD69V160TF
	6,9 URD 30 TTF 0200	X300055			PC30UD69V200TF
	6,9 URD 30 TTF 0250	Y300056			PC30UD69V250TF
	6,9 URD 30 TTF 0315	Z300057			PC30UD69V315TF
	6,9 URD 30 TTF 0350	A300058			PC30UD69V350TF
	6,9 URD 30 TTF 0400	B300059			PC30UD69V400TF
	6,9 URD 30 TTF 0450	V300398			PC30UD69V450TF
	6,9 URD 30 TTF 0500	W300399			PC30UD69V500TF
	6,9 URD 30 TTF 0550	X300400			PC30UD69V550TF
	6 URD 30 TTF 0630	L301770			PC30UD60V630TF
31	6,9 URD 31 TTF 0160	M300299	370	3	PC31UD69V160TF
	6,9 URD 31 TTF 0200	N300001			PC31UD69V200TF
	6,9 URD 31 TTF 0250	P300002			PC31UD69V250TF
	6,9 URD 31 TTF 0315	Q300003			PC31UD69V315TF
	6,9 URD 31 TTF 0350	M300046			PC31UD69V350TF
	6,9 URD 31 TTF 0400	R300004			PC31UD69V400TF
	6,9 URD 31 TTF 0450	S300005			PC31UD69V450TF
	6,9 URD 31 TTF 0500	T300006			PC31UD69V500TF
	6,9 URD 31 TTF 0550	V300007			PC31UD69V550TF
	6,9 URD 31 TTF 0630	W300008			PC31UD69V630TF
	6,9 URD 31 TTF 0700	X300009			PC31UD69V700TF
	6,9 URD 31 TTF 0800	Y300401			PC31UD69V800TF
32	6,9 URD 32 TTF 0315	M302162	510	3	PC32UD69V315TF
	6,9 URD 32 TTF 0350	N302163			PC32UD69V350TF
	6,9 URD 32 TTF 0400	H300065			PC32UD69V400TF
	6,9 URD 32 TTF 0450	J300066			PC32UD69V450TF
	6,9 URD 32 TTF 0500	K300067			PC32UD69V500TF
	6,9 URD 32 TTF 0550	L300068			PC32UD69V550TF
	6,9 URD 32 TTF 0630	M300069			PC32UD69V630TF
	6,9 URD 32 TTF 0700	N300070			PC32UD69V700TF
	6,9 URD 32 TTF 0800	P300071			PC32UD69V800TF
	6,9 URD 32 TTF 0900 **	Q300072			PC32UD69V900TF
	6,9 URD 32 TTF 1000 **	S300074			PC32UD69V1000TF
	6 URD 32 TTF 1100 **	M300759			PC32UD60V100TF
	5,5 URD 32 TTF 1250 **	P301060			PC32UD55V1250TF
	5 URD 32 TTF 1400 **	Q301061			PC32UD50V1400TF
	5 URD 32 TTF 1600 **	H300893			PC32UD50V1600TF
4,5 URD 32 TTF 1800 **	R301062	PC32UD45V1800TF			
33	6,9 URD 33 TTF 0450	W302170	790	3	PC33UD69V450TF
	6,9 URD 33 TTF 0500	V300076			PC33UD69V500TF
	6,9 URD 33 TTF 0550	W300077			PC33UD69V550TF
	6,9 URD 33 TTF 0630	X300078			PC33UD69V630TF
	6,9 URD 33 TTF 0700	Y300079			PC33UD69V700TF
	6,9 URD 33 TTF 0800	Z300080			PC33UD69V800TF
	6,9 URD 33 TTF 0900	A300081			PC33UD69V900TF
	6,9 URD 33 TTF 1000	B300082			PC33UD69V1000TF
	6,9 URD 33 TTF 1100	C300083			PC33UD69V1100TF
	6,9 URD 33 TTF 1250 **	D300084			PC33UD69V1250TF
	6,9 URD 33 TTF 1400 **	E300085			PC33UD69V1400TF
	6 URD 33 TTF 1500 **	Y300585			PC33UD60V1500TF
	6 URD 33 TTF 1600 **	Z300586			PC33UD60V1600TF
	6 URD 33 TTF 1800 **	A300587			PC33UD60V1800TF
	5,5 URD 33 TTF 2000 **	B300588			PC33UD55V2000TF
	5 URD 33 TTF 2250 **	K300757			PC33UD50V2250TF
	4,5 URD 33 TTF 2500 **	L300758			PC33UD45V2500TF

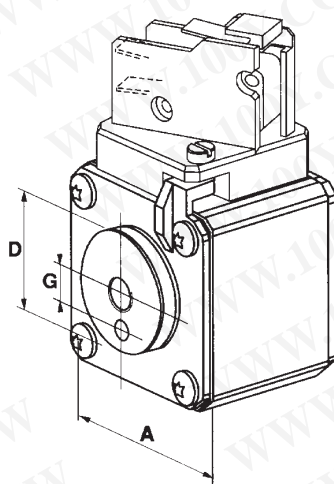
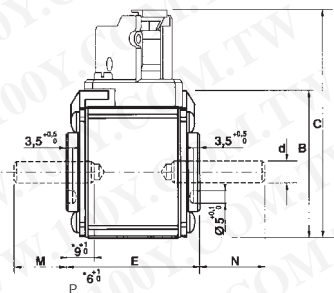

Note:
dimensions in mm
dimensions in inches

Threaded studs and microswitches
supplied separately
see microswitches PSC 3x & 7x and
Metric studs sections

Size	A	B	C	D	M*	N*	E±1	d	G±0.1	P
30	40 1-9/16"	46,5 1-27/32"	82 3-7/32"	26 1-1/64"	22	27	50,6 2"	M8	9 23/64"	6 15/64"
31	51 2"	56,5 2-7/32"	91 3-37/64"	30 1-3/16"	19	24	50,6 2"	M8	9 23/64"	9 23/64"
32	60 2-3/8"	65,5 2-37/64"	100 3-15/16"	38 ; (42mm **) 1-1/2" ; (1-21/32" **)	19	39	50,6 2"	M10	15 19/32"	9 23/64"
33	74,5 2-15/16"	79,5 3-1/8"	114 4-1/2"	46 ; (52mm **) 1-13/16" ; (2-1/16" **)	24	39	50,6 2"	M12	15 19/32"	9 23/64"

Semiconductor (AC) fuses



Protistor® Square-body Fuses PSC aR sizes 3x - 450V to 700 VAC IEC Terminals French - 30 - 33 End contacts

Size	Designation					Reference Number	Weight (g)	Packaging	Catalog Number
2 x 32	6,9	URD	232	TTF	0800	T300305	1240	1	PC232UD69V8CTF
	6,9	URD	232	TTF	1000	T300213			PC232UD69V10CTF
	6,9	URD	232	TTF	1250	V300214			PC232UD69V13CTF
	6,9	URD	232	TTF	1400	G300087			PC232UD69V14CTF
	6,9	URD	232	TDF	1600	W300215	3300		PC232UD69V16CTD
	6,9	URD	232	TDF	1800	X300216			PC232UD69V18CTD
	6,9	URD	232	TDF	2000	Y300217			PC232UD69V20CTD
	5,5	URD	232	TDF	2200	D301993			PC232UD55V22CTD
2 x 33	6,9	URD	233	TTF	1000	B301186	1900		PC233UD69V10CTF
	6,9	URD	233	TTF	1250	D300268			PC233UD69V13CTF
	6,9	URD	233	TTF	1400	E300269			PC233UD69V14CTF
	6,9	URD	233	TTF	1600	F300270			PC233UD69V16CTF
	6,9	URD	233	PLAF	1800	B300427		1	PC36UD69V18CP11
	6	URD	233	PLAF	2000	R302235			PC36UD60V20CP11
	6	URD	233	PLAF	2200	O302234			PC36UD60V22CP11
	6	URD	233	PLAF	2500	P302233			PC36UD60V25CP11
	6	URD	233	PLAF	2800	N302232	2000		PC36UD60V28CP11
	5,5	URD	233	PLAF	3000*	L301977			PC36UD55V30CP11
	5,5	URD	233	PLAF	3200*	M301978			PC36UD55V32CP11
	5	URD	233	PLAF	3600*	N301979			PC36UD50V36CP11
	5	URD	233	PLAF	4000*	P301980			PC36UD50V40CP11
	4	URD	233	PLAF	4500*	O301981			PC36UD40V45CP11
4	URD	233	PLAF	5000*	R301982	PC36UD40V50CP11			

*Consult us

Size	A	B	C	D	E	F	G	H	J	K	d	e	L	M	N
2x32 TT	60	138,5	172	11	67,6	66,5	100	35	61	40	M 10	4	107,5	48	72
2x33 TT	74,5	167	200	13	67,6	81	114	50	80	40	M 12	4	107,5	54	86
2x32 TD	65,5	147	182	-	91,5	-	-	30	-	60	M 10	12	140	-	-
2x33 PLAF	75	171,5	207	-	55,5	-	115	40	-	71	M 10	15	81	-	-

TT

TD

PLAF

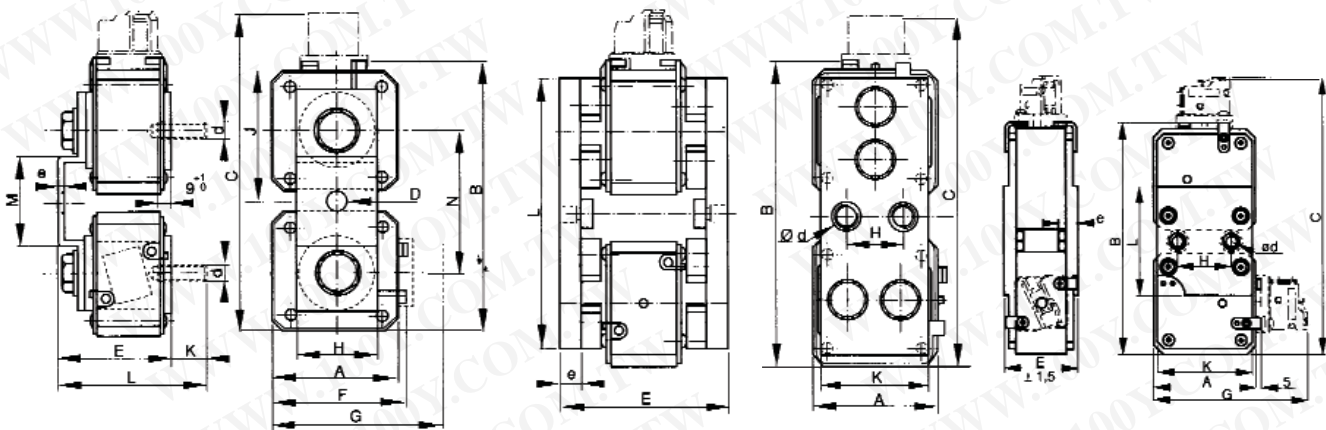

Semiconductor (AC) fuses

Protistor® Square-body Fuses PSC aR sizes 3x - 450V to 700 VAC IEC Terminals French - 30 - 33 End contacts

33 PPAF Standard Press-Pack

Size	Designation	Reference Number	Weight (g)	Packaging	Catalog Number
33	6,9 URD 33 PPAF 1250	D301855	910	3	PC33UD69V13CPP
	6,9 URD 33 PPAF 1400	E301856			PC33UD69V14CPP
	6 URD 33 PPAF 1600	G301927			PC33UD60V16CPP
2x33	6,9 URD 233 PPAF 1800	R300694	2450	1	PC36UD60V18CP12
	6 URD 233 PPAF 2000	H302250			PC36UD60V20CP12
	6 URD 233 PPAF 2200	K302252			PC36UD60V22CP13
	6 URD 233 PPAF 2500	M302254			PC36UD60V25CP12
	6 URD 233 PPAF 2800	L302253			PC36UD60V28CP13
	5,5 URD 233 PPAF 3000	to be given - contact us			to be given - contact us
	5,5 URD 233 PPAF 3200	V301985			PC36UD55V32CP12
	5,5 URD 233 PPAF 3600	to be given - contact us			to be given - contact us
	5 URD 233 PPAF 4000	X301987			PC36UD50V40CP12
	4,5 URD 233 PPAF 4500	to be given - contact us			to be given - contact us
	4 URD 233 PPAF 5000	M301932			PC36UD40V50CP12

Studs and microswitches supplied separately

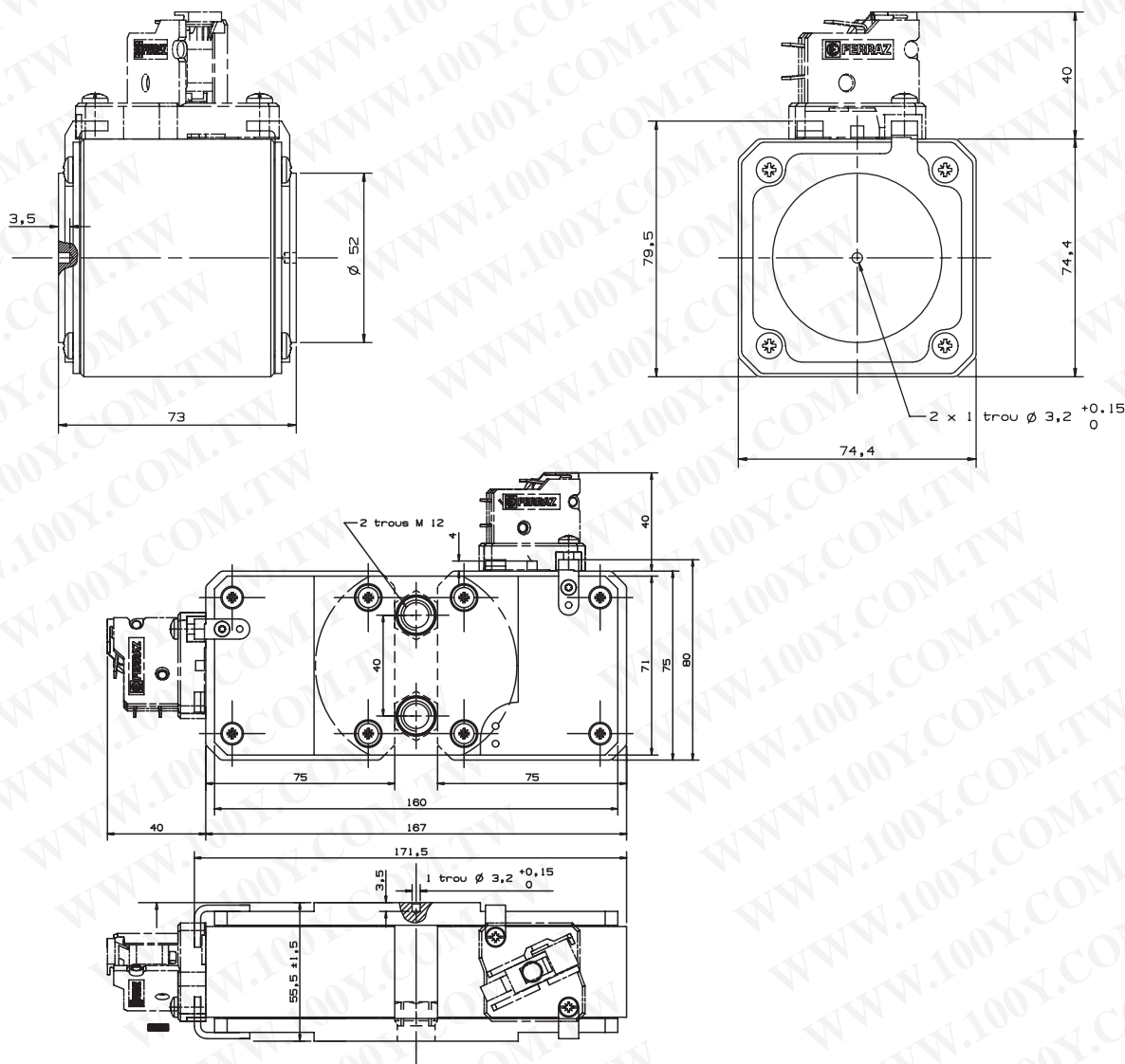

Semiconductor (AC) fuses

Protistor® Square-body Fuses PSC aR sizes 3x - 450V to 700 VAC IEC Terminals French - 30 - 33 Blades

Size	Designation	Reference Number	Weight (g)	Packaging	Base	I/I _N *	Catalog Number					
30	6,9 URD 30 E F 0050	R300372	290	3	SP30	1	PC30UD69V50EF					
	6,9 URD 30 E F 0063	H300088					PC30UD69V63EF					
	6,9 URD 30 E F 0080	J300089					PC30UD69V80EF					
	6,9 URD 30 E F 0100	K300090					PC30UD69V100EF					
	6,9 URD 30 E F 0125	L300091					PC30UD69V125EF					
	6,9 URD 30 E F 0160	M300092					0,95 PC30UD69V160EF					
	6,9 URD 30 E F 0200	N300093					0,90 PC30UD69V200EF					
	6,9 URD 30 E F 0250	P300094					0,85 PC30UD69V250EF					
	6,9 URD 30 E F 0315	O300095					0,80 PC30UD69V315EF					
	6,9 URD 30 E F 0350	R300096					0,80 PC30UD69V350EF					
	6,9 URD 30 E F 0400	S300097					0,75 PC30UD69V400EF					
	31	6,9 URD 31 E F 0160					B301922	430	3	SE31	1	PC31UD69V160EF
6,9 URD 31 E F 0200		C300037	PC31UD69V200EF									
6,9 URD 31 E F 0250		D300038	PC31UD69V250EF									
6,9 URD 31 E F 0315		E300039	0,95 PC31UD69V315EF									
6,9 URD 31 E F 0350		N300047	0,95 PC31UD69V350EF									
6,9 URD 31 E F 0400		F300040	0,95 PC31UD69V400EF									
6,9 URD 31 E F 0450		G300041	0,95 PC31UD69V450EF									
6,9 URD 31 E F 0500		H300042	0,95 PC31UD69V500EF									
6,9 URD 31 E F 0550		J300043	0,90 PC31UD69V550EF									
6,9 URD 31 E F 0630		K300044	0,90 PC31UD69V630EF									
6,9 URD 31 E F 0700		L300045	0,85 PC31UD69V700EF									
32		6,9 URD 32 E F 0400	V300168	590	3	SE32	0,95					PC32UD69V400EF
	6,9 URD 32 E F 0450	W300169	0,95 PC32UD69V450EF									
	6,9 URD 32 E F 0500	X300170	0,90 PC32UD69V500EF									
	6,9 URD 32 E F 0550	Y300171	0,90 PC32UD69V550EF									
	6,9 URD 32 E F 0630	Z300172	0,85 PC32UD69V630EF									
	6,9 URD 32 E F 0700	A300173	0,85 PC32UD69V700EF									
	6,9 URD 32 E F 0800	B300174	0,80 PC32UD69V800EF									
	6,9 URD 32 E F 0900	C300175	0,80 PC32UD69V900EF									
	6,9 URD 32 E F 1000	D300176	0,80 PC32UD69V1000EF									
	33	6,9 URD 33 E F 0500	Z300218					860	3	SF33	0,95	PC33UD69V500EF
		6,9 URD 33 E F 0550	A300219									0,95 PC33UD69V550EF
		6,9 URD 33 E F 0630	B300220									0,90 PC33UD69V630EF
6,9 URD 33 E F 0700		C300221	0,90 PC33UD69V700EF									
6,9 URD 33 E F 0800		D300222	0,90 PC33UD69V800EF									
6,9 URD 33 E F 0900		E300223	0,85 PC33UD69V900EF									
6,9 URD 33 E F 1000		F300224	0,85 PC33UD69V1000EF									
6,9 URD 33 E F 1100		G300225	0,80 PC33UD69V1100EF									
6,9 URD 33 E F 1250		H300226	0,80 PC33UD69V1250EF									
6,9 URD 33 E F 1400		J300227	0,80 PC33UD69V1400EF									



*I/I_N: Ratio "maximum continuous permissible RMS current I_N" for a fuse fitted into the bases.

Connections defined as per IEC 60269-1 and for a calm ambience of 30°C.

Use the pullout grip PM3 (T097675) for fuse sizes 30, 31, 32.

Fuse holders and microswitches supplied separately. (see Fuse Holders and microswitches PSC 3x & 7x sections)

Size	A	B	C	D	E ^{+1,1}	L	F	H	J	K	e
30	40	62	96	44,6	76,6	100	38	18	9	11	6
31	51	69	103	44,6	86,6	110	39	25	10,5	16	6
32	60	78	112	44,6	91	126	43	32	13	21,2	6
33	74,5	92,5	127	44,6	91	126	57	40	13	19,5	6

Dimensions in mm

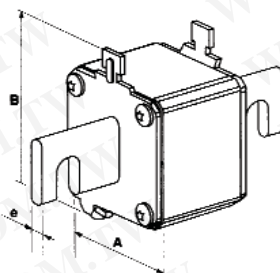
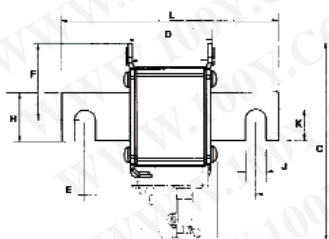

Semiconductor (AC) fuses



Protistor® Square-body Fuses

PSC aR sizes 3x - 450V to 700 VAC

IEC Terminals German - 30 - 33 Blades (Din 80)

Size	Designation	Reference Number	Weight (g)	I/IN Base		Catalog Number DIN 80		
				L98772 F98031	F98560 L91941			
30	6,9 URD 30 D08A 0050	F301926	290	1	1	PC30UD69V50A		
	6,9 URD 30 D08A 0063	E300108		1	1	PC30UD69V63A		
	6,9 URD 30 D08A 0080	F300109		1	1	PC30UD69V80A		
	6,9 URD 30 D08A 0100	G300110		1	1	PC30UD69V100A		
	6,9 URD 30 D08A 0125	H300111		1	1	PC30UD69V125A		
	6,9 URD 30 D08A 0160	J300112		1	1	PC30UD69V160A		
	6,9 URD 30 D08A 0200	K300113		1	1	PC30UD69V200A		
	6,9 URD 30 D08A 0250	L300114		1	1	PC30UD69V250A		
	6,9 URD 30 D08A 0315	M300115		1	1	PC30UD69V315A		
	6,9 URD 30 D08A 0350	N300116		1	1	PC30UD69V350A		
	6,9 URD 30 D08A 0400	P300117		1	1	PC30UD69V400A		
	6,9 URD 30 D08A 0450	A300403		0,95	1	PC30UD69V450A		
	6,9 URD 30 D08A 0500	B300404		0,95	1	PC30UD69V500A		
	6,9 URD 30 D08A 0550	C300405		0,95	1	PC30UD69V550A		
31	6,9 URD 31 D08A 0160	M300322	430	1	1	PC31UD69V160A		
	6,9 URD 31 D08A 0200	Y300010		1	1	PC31UD69V200A		
	6,9 URD 31 D08A 0250	Z300011		1	1	PC31UD69V250A		
	6,9 URD 31 D08A 0315	A300012		1	1	PC31UD69V315A		
	6,9 URD 31 D08A 0350	Q300049		1	1	PC31UD69V350A		
	6,9 URD 31 D08A 0400	B300013		1	1	PC31UD69V400A		
	6,9 URD 31 D08A 0450	C300014		1	1	PC31UD69V450A		
	6,9 URD 31 D08A 0500	D300015		1	1	PC31UD69V500A		
	6,9 URD 31 D08A 0550	E300016		1	1	PC31UD69V550A		
	6,9 URD 31 D08A 0630	F300017		1	1	PC31UD69V630A		
	6,9 URD 31 D08A 0700	G300018		0,95	1	PC31UD69V700A		
	6,9 URD 31 D08A 0800	D300406		0,85	0,90	PC31UD69V800A		
	32	6,9 URD 32 D08A 0315		H302158	590	1	1	PC32UD69V315A
		6,9 URD 32 D08A 0350		J302159		1	1	PC32UD69V350A
6,9 URD 32 D08A 0400		E300177	1	1		PC32UD69V400A		
6,9 URD 32 D08A 0450		F300178	1	1		PC32UD69V450A		
6,9 URD 32 D08A 0500		G300179	1	1		PC32UD69V500A		
6,9 URD 32 D08A 0550		H300180	0,95	1		PC32UD69V550A		
6,9 URD 32 D08A 0630		J300181	0,95	1		PC32UD69V630A		
6,9 URD 32 D08A 0700		K300182	0,90	1		PC32UD69V700A		
6,9 URD 32 D08A 0800		L300183	0,90	0,95		PC32UD69V800A		
6,9 URD 32 D08A 0900		M300184	0,90	0,95		PC32UD69V900A		
6,9 URD 32 D08A 1000		N300185	0,85	0,95		PC32UD69V1000A		
6 URD 32 D08A 1100	W302101	0,80	0,85	PC32UD60V1100A				
5 URD 32 D08A 1250	G300409	0,80	0,85	PC32UD50V1250A				
33	6,9 URD 33 D08A 0450	T302168	860	0,95	1	PC33UD69V450A		
	6,9 URD 33 D08A 0500	G300248		0,95	1	PC33UD69V500A		
	6,9 URD 33 D08A 0550	H300249		0,90	1	PC33UD69V550A		
	6,9 URD 33 D08A 0630	J300250		0,90	0,95	PC33UD69V630A		
	6,9 URD 33 D08A 0700	K300251		0,90	0,95	PC33UD69V700A		
	6,9 URD 33 D08A 0800	L300252		0,85	0,95	PC33UD69V800A		
	6,9 URD 33 D08A 0900	M300253		0,85	0,95	PC33UD69V900A		
	6,9 URD 33 D08A 1000	N300254		0,80	0,90	PC33UD69V1000A		
	6,9 URD 33 D08A 1100	P300255		0,80	0,90	PC33UD69V1100A		
	6,9 URD 33 D08A 1250	Q300256		0,75	0,85	PC33UD69V1250A		
	6,9 URD 33 D08A 1400	R300257		0,75	0,80	PC33UD69V1400A		
6 URD 33 D08A 1600	X301803	0,70	0,75	PC33UD60V1600A				

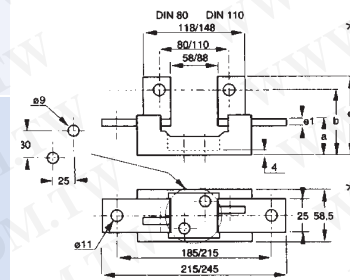
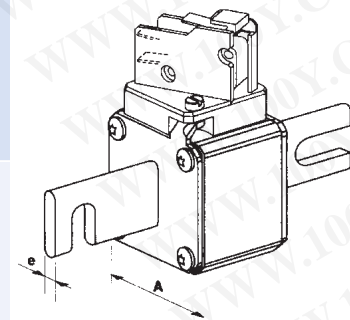
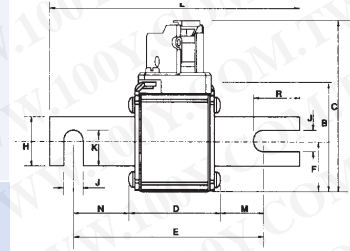

Fuse holders and microswitches supplied separately (see page, and Fuse Blocks and Fuse Holders section)

Dimensions in mm

Fuse Size	A	B	C	D	E	F	G	J	K	L	M	N	R	e
30 DIN 80	40	46,5	82	47,5	77	21	25	10,5	17,7	110	11,5	18,5	25,2	6
31 DIN 80	51	56,5	91	47,5	77	25,5	25	10,5	17,7	110	11,5	18,5	25,2	6
32 DIN 80	60	65,5	100	47,5	77	30	32	10,5	21,2	110	11,5	18,5	25,2	6
33 DIN 80	74,5	79,5	114	48,5	77	37,2	40	10,5	25,2	110	11	18	25,2	6

Fuse holders	Ref. Number	a	b	c	e1	x	y	Weight (g) *
SI DIN 80 630 A	L098772	40	68	82	5	185	215	660
SI DIN 80 1250 A	F098560	45	73	87	10	185	215	890

Use the pullout grip PM3 (T097675) for fuse sizes 30, 31, 32

Semiconductor (AC) fuses

Protistor® Square-body Fuses PSC aR sizes 3x - 450V to 700 VAC IEC Terminals German - 30 - 33 Blades (Din110)

Size	Designation	Reference Number	Weight (g)	I/IN Base		Catalog Number DIN 110
				L98772 F98031	F98560 L91941	
30	6,9 URD 30 D11A 0050	G301191	290	1	1	PC30UD69V50D1A
	6,9 URD 30 D11A 0063	Q300118		1	1	PC30UD69V63D1A
	6,9 URD 30 D11A 0080	R300119		1	1	PC30UD69V80D1A
	6,9 URD 30 D11A 0100	S300120		1	1	PC30UD69V100D1A
	6,9 URD 30 D11A 0125	T300121		1	1	PC30UD69V125D1A
	6,9 URD 30 D11A 0160	V300122		1	1	PC30UD69V160D1A
	6,9 URD 30 D11A 0200	W300123		1	1	PC30UD69V200D1A
	6,9 URD 30 D11A 0250	X300124		1	1	PC30UD69V250D1A
	6,9 URD 30 D11A 0315	Y300125		1	1	PC30UD69V315D1A
	6,9 URD 30 D11A 0350	Z300126		1	1	PC30UD69V350D1A
	6,9 URD 30 D11A 0400	A300127		1	1	PC30UD69V400D1A
	6,9 URD 30 D11A 0450	S300695		0,95	1	PC30UD69V450D1A
	6,9 URD 30 D11A 0500	Y301091		0,95	1	PC30UD69V500D1A
	6,9 URD 30 D11A 0550	Z301092		0,95	1	PC30UD69V550D1A
31	6,9 URD 31 D11A 0160	-	430	1	1	PC31UD69V200D1A
	6,9 URD 31 D11A 0200	H300019		1	1	PC31UD69V250D1A
	6,9 URD 31 D11A 0250	J300020		1	1	PC31UD69V315D1A
	6,9 URD 31 D11A 0315	K300021		1	1	PC31UD69V350D1A
	6,9 URD 31 D11A 0350	P300048		1	1	PC31UD69V400D1A
	6,9 URD 31 D11A 0400	L300022		1	1	PC31UD69V450D1A
	6,9 URD 31 D11A 0450	M300023		1	1	PC31UD69V500D1A
	6,9 URD 31 D11A 0500	N300024		1	1	PC31UD69V550D1A
	6,9 URD 31 D11A 0550	P300025		1	1	PC31UD69V630D1A
	6,9 URD 31 D11A 0630	Q300026		1	1	PC31UD69V630D1A
	6,9 URD 31 D11A 0700	R300027		0,95	1	PC31UD69V700D1A
6,9 URD 31 D11A 0800	H300079	0,85	0,90	PC31UD69V800D1A		
32	6,9 URD 32 D11A 0315	K302160	590	1	1	PC32UD69V350D1A
	6,9 URD 32 D11A 0350	L302161		1	1	PC32UD69V400D1A
	6,9 URD 32 D11A 0400	P300186		1	1	PC32UD69V450D1A
	6,9 URD 32 D11A 0450	Q300187		1	1	PC32UD69V500D1A
	6,9 URD 32 D11A 0500	R300188		1	1	PC32UD69V550D1A
	6,9 URD 32 D11A 0550	S300189		0,95	1	PC32UD69V630D1A
	6,9 URD 32 D11A 0630	T300190		0,95	1	PC32UD69V630D1A
	6,9 URD 32 D11A 0700	V300191		0,90	1	PC32UD69V700D1A
	6,9 URD 32 D11A 0800	W300192		0,90	0,95	PC32UD69V800D1A
	6,9 URD 32 D11A 0900	X300193		0,90	0,95	PC32UD69V900D1A
	6,9 URD 32 D11A 1000	Y300194		0,85	0,95	PC32UD69V10CD1A
6 URD 32 D11A 1100	-	0,80	0,85			
5 URD 32 D11A 1250	-	0,80	0,85			
33	6,9 URD 33 D11A 0450	V302169	860	0,95	1	PC33UD69V450D1A
	6,9 URD 33 D11A 0500	S300258		0,95	1	PC33UD69V500D1A
	6,9 URD 33 D11A 0550	T300259		0,90	1	PC33UD69V550D1A
	6,9 URD 33 D11A 0630	V300260		0,90	0,95	PC33UD69V630D1A
	6,9 URD 33 D11A 0700	W300261		0,90	0,95	PC33UD69V700D1A
	6,9 URD 33 D11A 0800	X300262		0,85	0,95	PC33UD69V800D1A
	6,9 URD 33 D11A 0900	Y300263		0,85	0,95	PC33UD69V900D1A
	6,9 URD 33 D11A 1000	Z300264		0,80	0,90	PC33UD69V10CD1A
	6,9 URD 33 D11A 1100	A300265		0,80	0,90	PC33UD69V11CD1A
	6,9 URD 33 D11A 1250	B300266		0,75	0,85	PC33UD69V12CD1A
	6,9 URD 33 D11A 1400	C300267		0,75	0,80	PC33UD69V14CD1A
6 URD 33 D11A 1600	Z301437	0,70	0,75	PC33UD60V16CD1A		

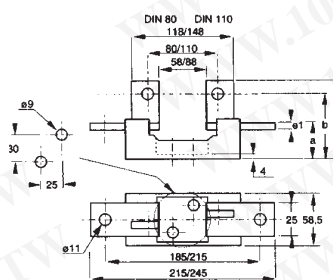
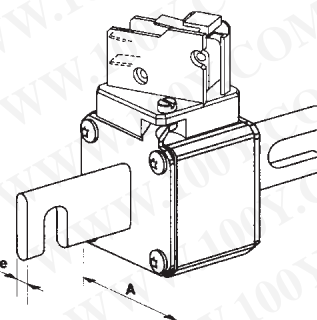
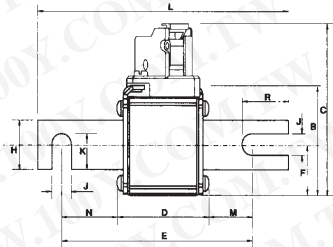

Fuse holders and microswitches supplied separately (see Fuse Holders and microswitches 3x & 7x sections)

Dimensions in mm

fuse Size	A	B	C	D	E	F	G	H	J	K	d	e	L	M
30 DIN 110	40	46,5	82	47,5	101,6	21	25	10,5	17,7	134,6	23,8	30,8	25,2	6
31 DIN 110	51	56,5	91	47,5	101,6	25,5	25	10,5	17,7	134,6	23,8	30,8	25,2	6
32 DIN 110	60	65,5	100	47,5	101,6	30	32	10,5	21,2	134,6	23,8	30,8	25,2	6
33 DIN 110	74,5	79,5	114	48,5	101,6	37,2	40	10,5	25,2	134,6	23,3	30,3	25,2	6

Fuse holders	Ref. Number	a	b	c	e1	x	y	Weight (g)
SI DIN 110 630 A	F098031	40	68	82	5	215	245	1060
SI DIN 110 1250 A	L091941	45	73	87	10	215	245	1320

Use the pullout grip PM3 (T097675) for fuse sizes 30, 31, 32

Semiconductor (AC) fuses

Protistor® Square-body Fuses PSC aR sizes 3x - 450V to 700 VAC Curves set

Sizes 30 - 31 - 32 - 33

I²t Multiplier coefficient

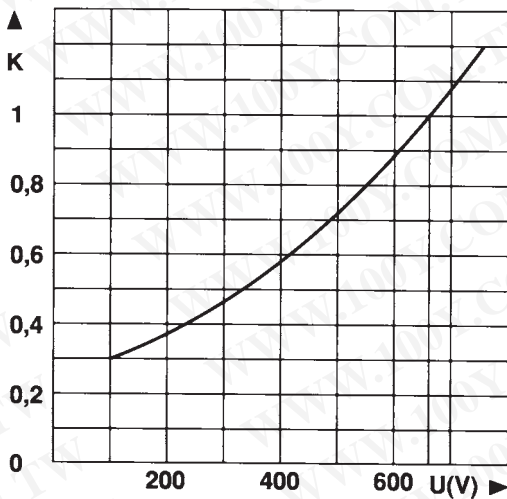

Mean curve indicating variation of total I²t (I²t_t) and total operating time T_t in accordance with working voltage U.

Example:

Fuse 350 A in size 30.
I_p = 10 000 A U = 500 V

At 660 V
I²t_t = 80 000 A²s T_t = 6 ms

At 500 V
I²t_t = 80 000 × 0.72 = 57 600 A²s
T_t = 6 × 0.72 = 4.3 ms

Dissipated power

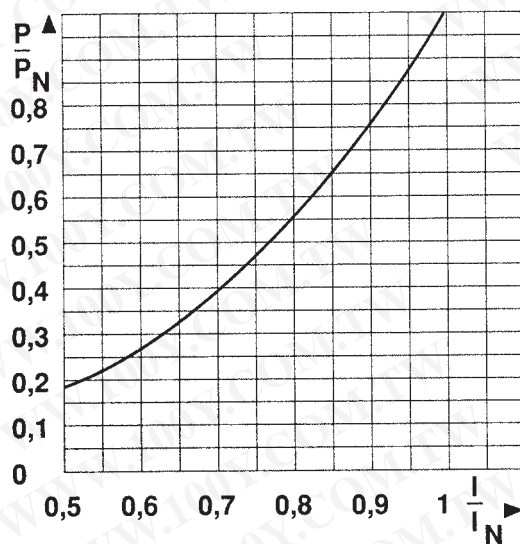

Curve enabling calculation of dissipated power P by a fuse rated I_N, as a function of the RMS current I, in multiples of I_N, in a steady state.

Arc voltage

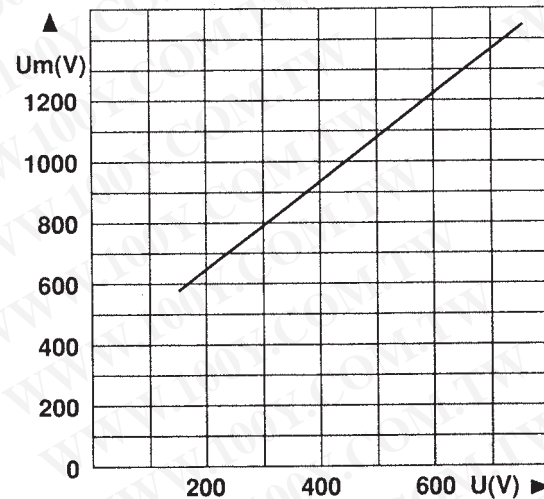

Curve indicating peak arc voltage U_m which may appear across fuse terminals as function of working voltage U at cos φ = 0.15

Semiconductor (AC) fuses



Protistor® Square-body Fuses PSC aR sizes 3x - 450V to 700 VAC Curves set

勝特力材料 886-3-5753170
 勝特力电子(上海) 86-21-34970699
 勝特力电子(深圳) 86-755-83298787
[Http://www.100y.com.tw](http://www.100y.com.tw)

Size 30

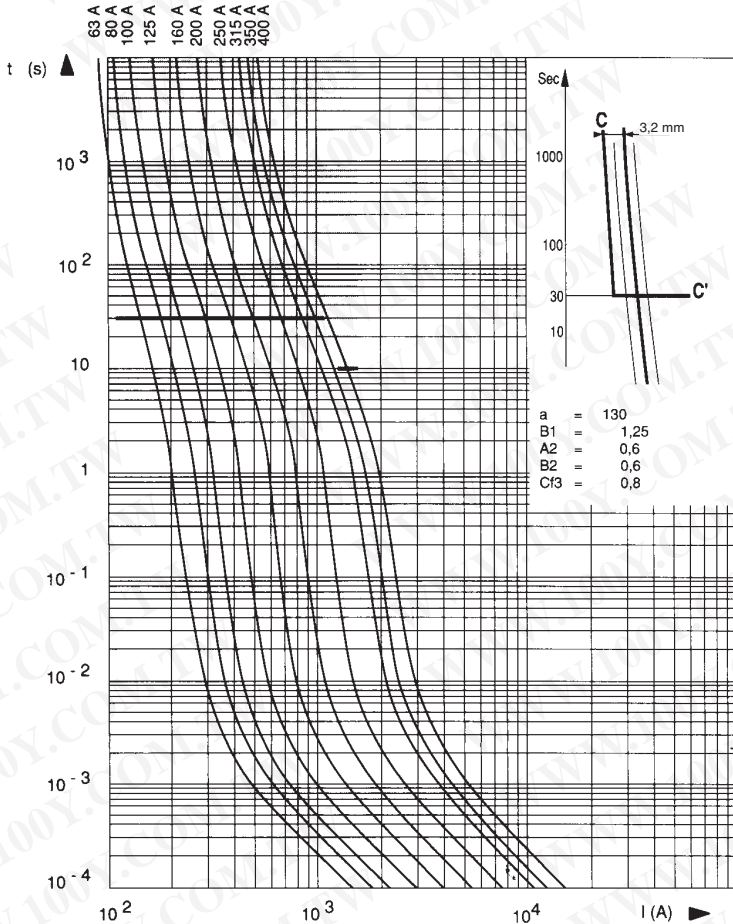

↓ Cut-off characteristics

Below, right: Curves indicating for each rated-current the peak value I_C that the current may reach as a function of the prospective fault current I_p .

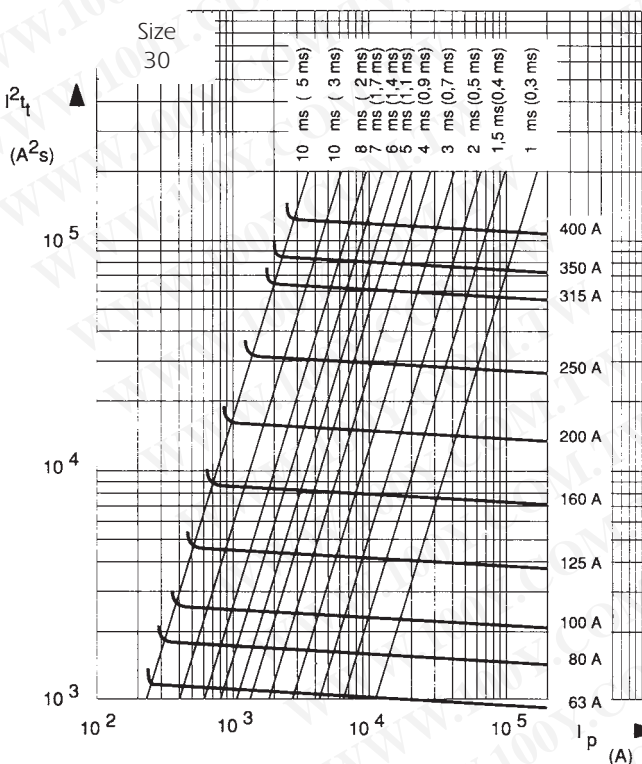
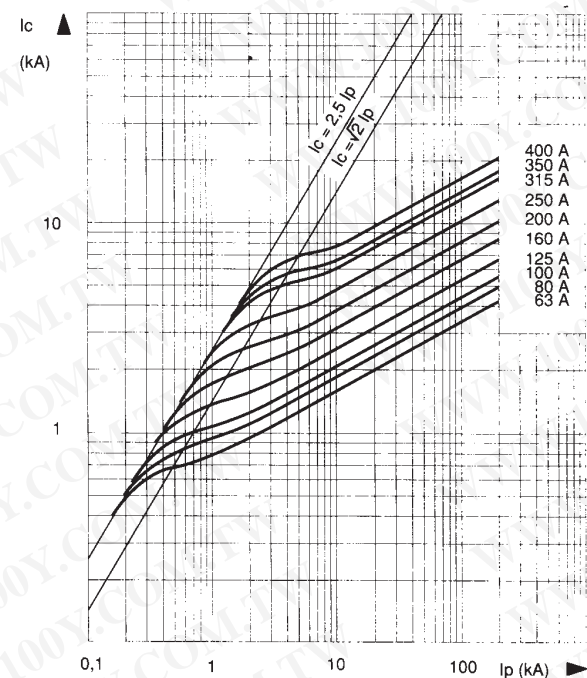

↑ Time-current characteristics

Above, left: Curves indicating pre-arcing time for each rated current as a function of RMS value of pre-arcing current I .

- Tolerances on this current $\pm 8\%$.
- Beyond 30 sec or 10 sec, small overloads must be eliminated by another device.
- Curve CC' represents the maximum times taken by the associated device to clear small overloads; only its horizontal line is represented. Its oblique line must be plotted according to sketch, top right corner.
- The intersection of the fuse and CC' curves indicates the minimum breaking current I_{pm} of the fuse.

← Maximum values of total operating I^2t and total operating times

Left: Horizontal curves indicating the maximum values of total operating I^2t (I^2t_t) as function of the prospective current I_p at 660 V, $\cos \varphi = 0.15$. The oblique lines indicate the corresponding total operating time T_T , with pre-arcing time in brackets.

Semiconductor (AC) fuses

Protistor® Square-body Fuses PSC aR sizes 3x - 450V to 700 VAC Curves set

Size 31

↓ Cut-off characteristics

Below, right: Curves indicating for each rated current the peak value I_C that the current may reach as a function of the prospective fault current I_p .

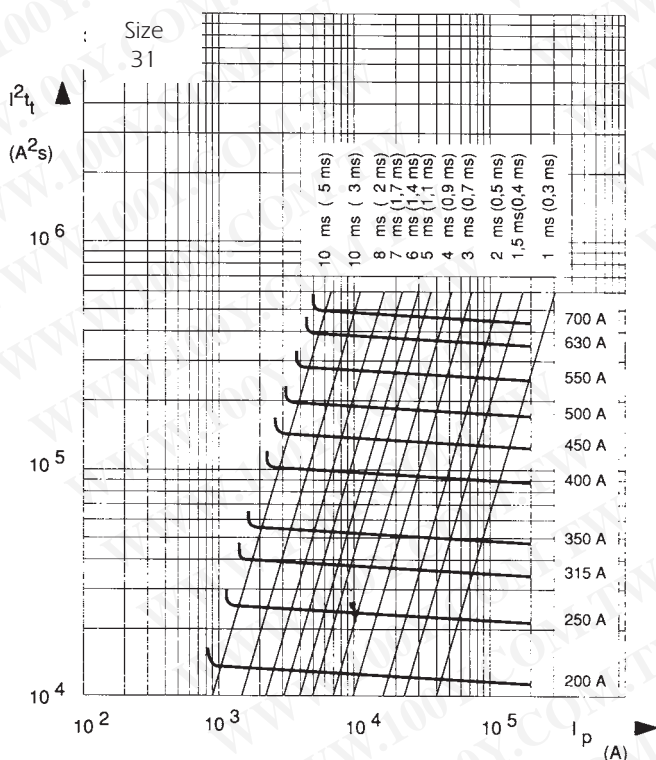
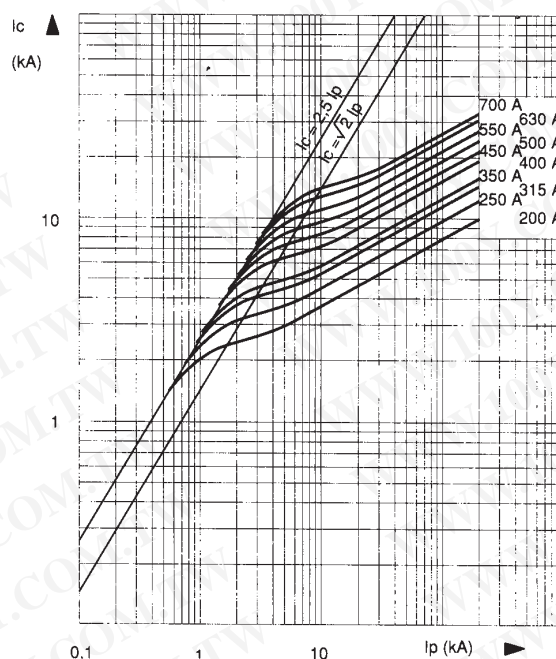
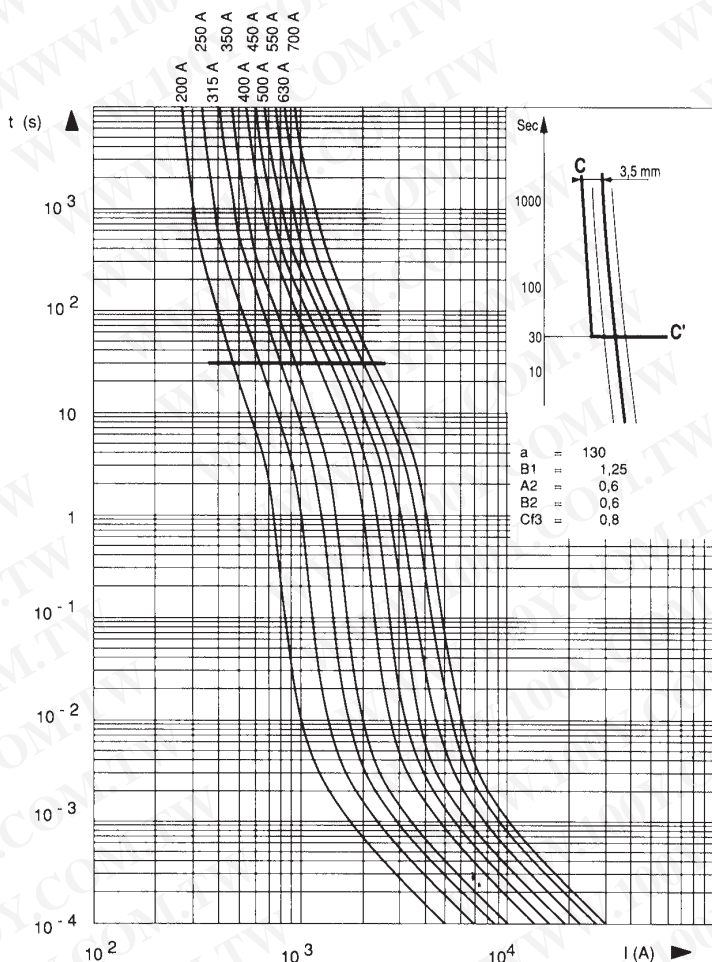

↑ Time-current characteristics

Above, left: Curves indicating pre-arcing time for each rated current as a function of RMS value of pre-arcing current I .

- Tolerances on this current $\pm 8\%$.
- Beyond 30 sec or 10 sec, small overloads must be eliminated by another device.
- Curve CC' represents the maximum times taken by the associated device to clear small overloads; only its horizontal line is represented. Its oblique line must be plotted according to sketch, top right corner.
- The intersection of the fuse and CC' curves indicates the minimum breaking current I_{pm} of the fuse.

← Maximum values of total operating I^2t and total operating times

Left: Horizontal curves indicating the maximum values of total operating I^2t (I^2t_t) as function of the prospective current I_p at 660 V, $\cos \varphi = 0.15$. The oblique lines indicate the corresponding total operating time T_t , with pre-arcing time in brackets.

Semiconductor (AC) fuses



Protistor® Square-body Fuses PSC aR sizes 3x - 450V to 700 VAC Curves set

Size 32

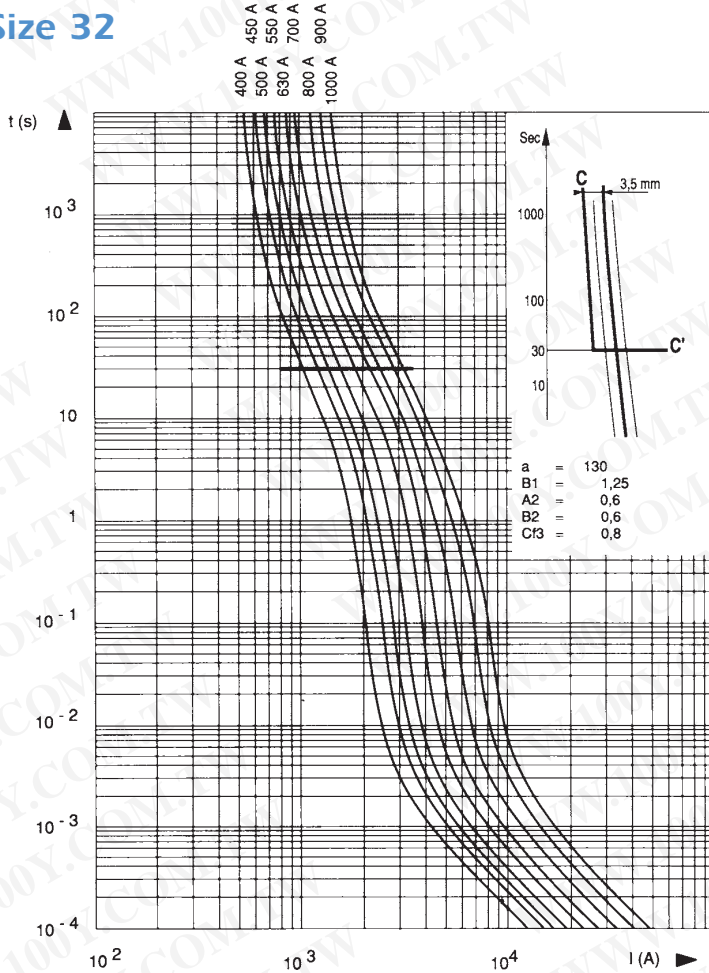

↓ Cut-off characteristics

Below, right: Curves indicating for each rated-current the peak value I_c that the current may reach as a function of the prospective fault current I_p .

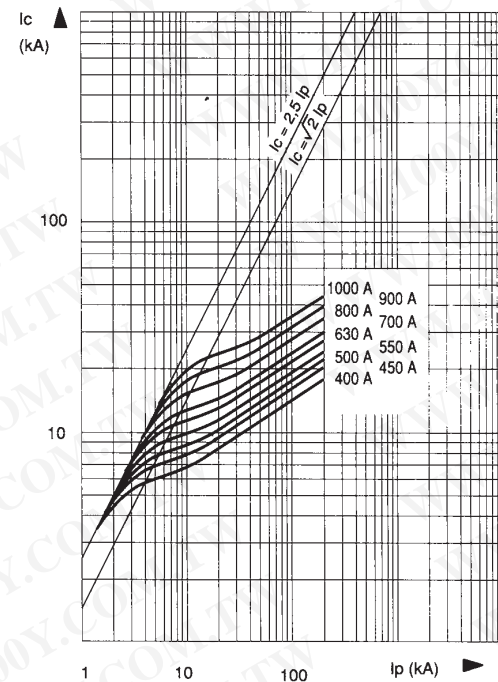

↑ Time-current characteristics

Above, left: Curves indicating pre-arcing time for each rated current as a function of RMS value of pre-arcing current I .

- Tolerances on this current $\pm 8\%$.
- Beyond 30 sec or 10 sec, small overloads must be eliminated by another device.
- Curve CC' represents the maximum times taken by the associated device to clear small overloads; only its horizontal line is represented. Its oblique line must be plotted according to sketch, top right corner.
- The intersection of the fuse and CC' curves indicates the minimum breaking current I_{pm} of the fuse.

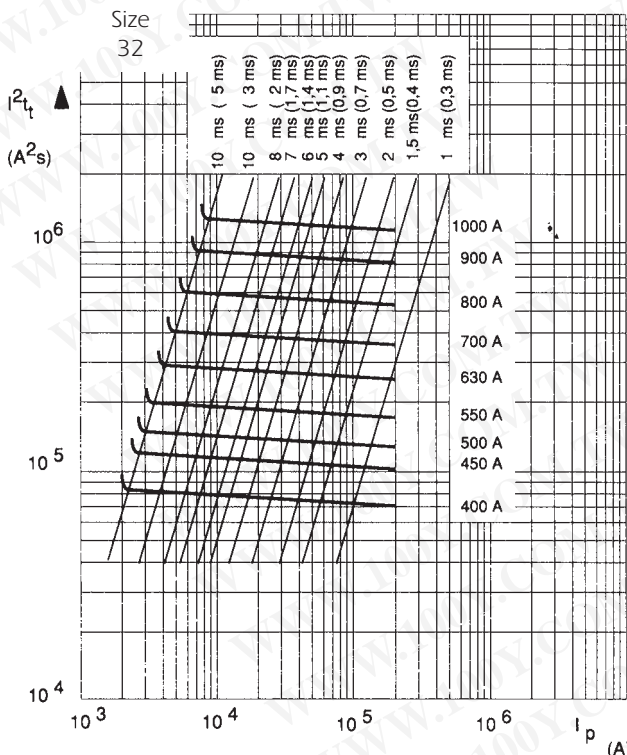

← Maximum values of total operating I^2t and total operating times

Left: Horizontal curves indicating the maximum values of total operating I^2t (I^2t_t) as function of the prospective current I_p at 660 V, $\cos \varphi = 0.15$. The oblique lines indicate the corresponding total operating time T_t , with pre-arcing time in brackets.

Semiconductor (AC) fuses

Protistor® Square-body Fuses PSC aR sizes 3x - 450V to 700 VAC Curves set

Size 33

↓ Cut-off characteristics

Below, right: Curves indicating for each rated current the peak value I_C that the current may reach as a function of the prospective fault current I_p .

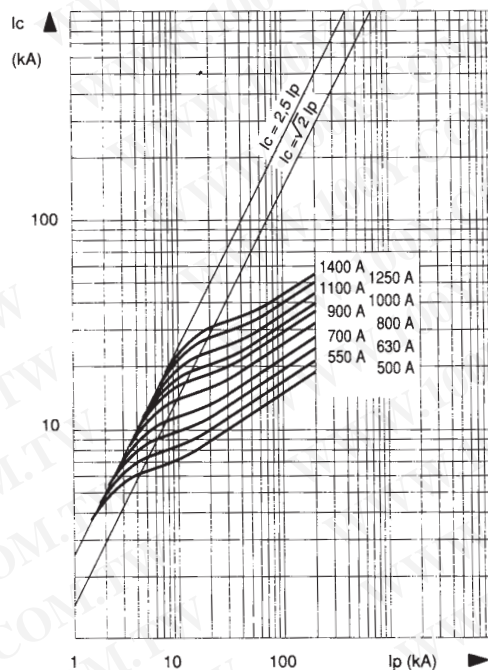
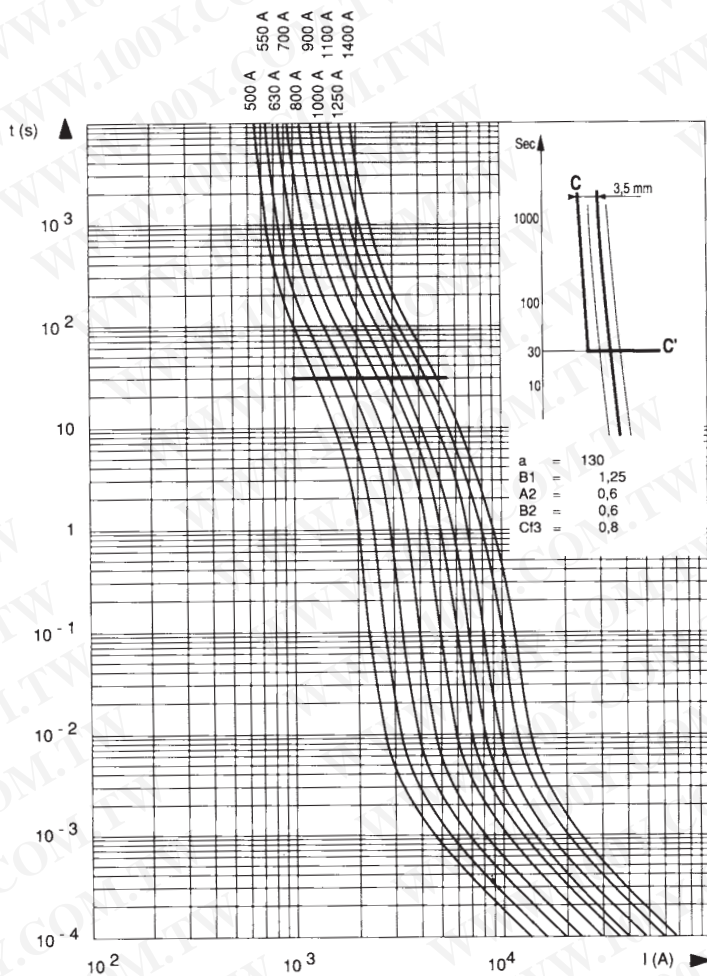

↑ Time-current characteristics

Above, left: Curves indicating pre-arcing time for each rated current as a function of RMS value of pre-arcing current I .

- Tolerances on this current $\pm 8\%$.
- Beyond 30 sec or 10 sec, small overloads must be eliminated by another device.
- Curve CC' represents the maximum times taken by the associated device to clear small overloads; only its horizontal line is represented. Its oblique line must be plotted according to sketch, top right corner.
- The intersection of the fuse and CC' curves indicates the minimum breaking current I_{pm} of the fuse.

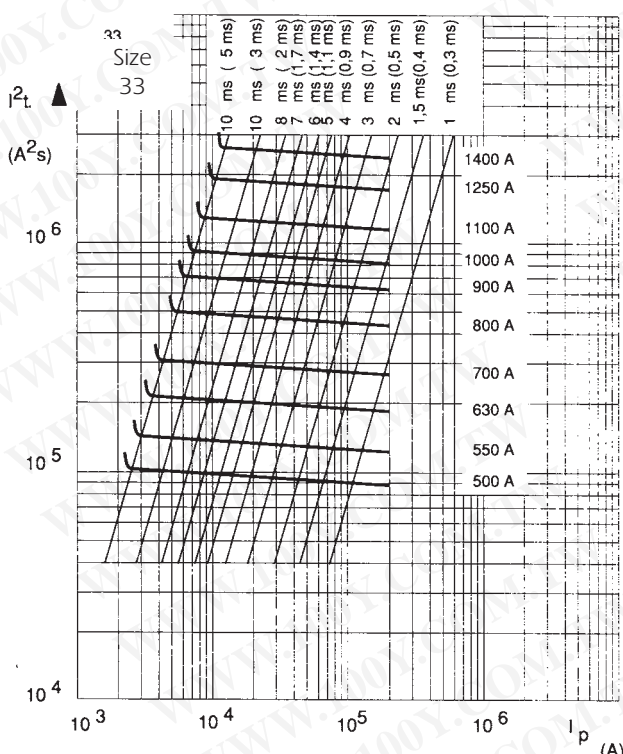

← Maximum values of total operating I^2t and total operating times

Left: Horizontal curves indicating the maximum values of total operating I^2t (I^2t_t) as function of the prospective current I_p at 660 V, $\cos \varphi = 0.15$. The oblique lines indicate the corresponding total operating time T_t , with pre-arcing time in brackets.

Semiconductor (AC) fuses



Protistor® Square-body Fuses PSC aR sizes 3x - 450V to 700 VAC Curves set

Sizes 2x32

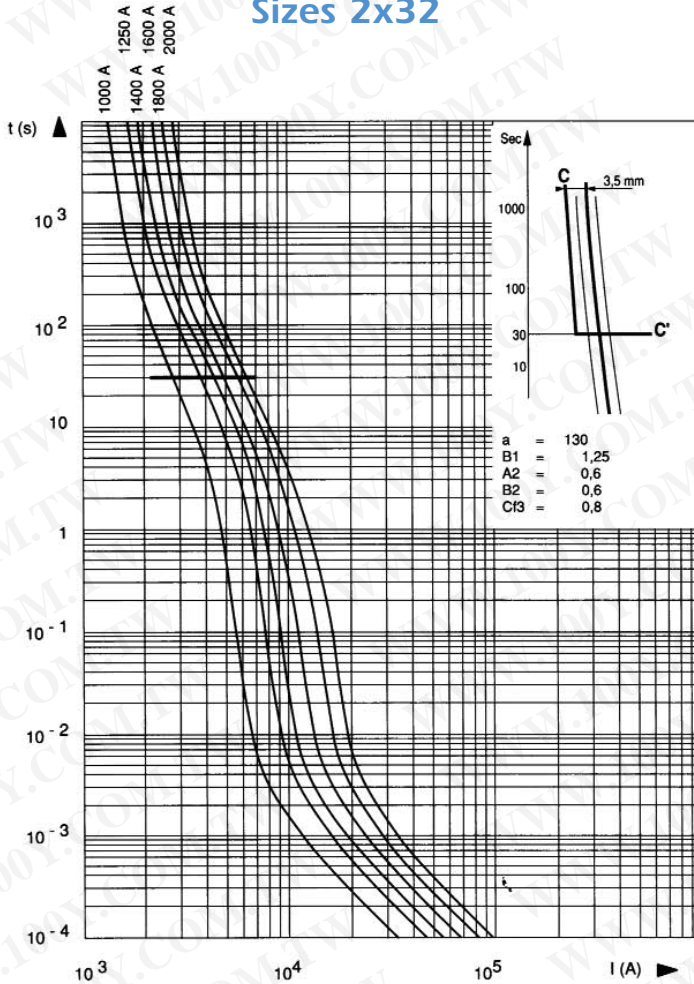

↓ Cut-off characteristics

Below, right: Curves indicating for each rated-current the peak value I_C that the current may reach as a function of the prospective fault current I_p .

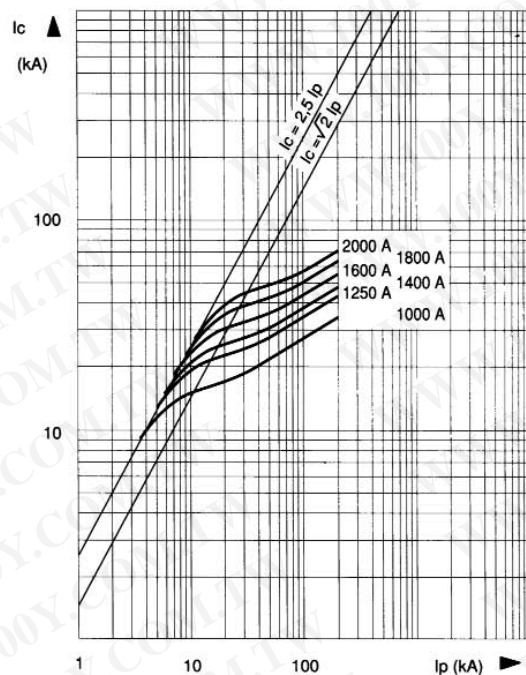

↑ Time-current characteristics

Above, left: Curves indicating pre-arcing time for each rated current as a function of RMS value of pre-arcing current I .

- Tolerances on this current $\pm 8\%$.
- Beyond 30 sec or 10 sec, small overloads must be eliminated by another device.
- Curve CC' represents the maximum times taken by the associated device to clear small overloads; only its horizontal line is represented. Its oblique line must be plotted according to sketch, top right corner.
- The intersection of the fuse and CC' curves indicates the minimum breaking current I_{pm} of the fuse.

← Maximum values of total operating I^2t and total operating times

Left: Horizontal curves indicating the maximum values of total operating I^2t (I^2t_t) as function of the prospective current I_p at 660 V, $\cos \varphi = 0.15$. The oblique lines indicate the corresponding total operating time T_t , with pre-arcing time in brackets.

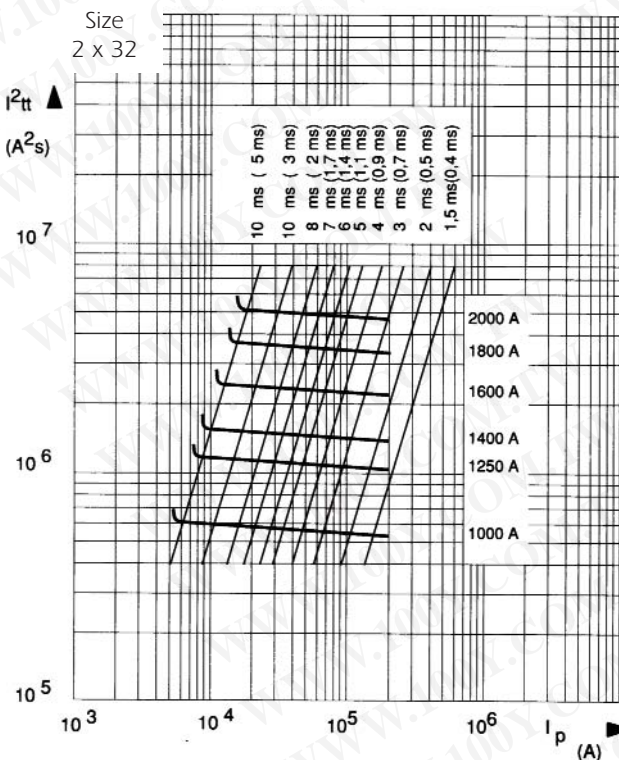

Semiconductor (AC) fuses

Protistor® Square-body Fuses PSC aR sizes 3x - 450V to 700 VAC Curves set

Size 2x33

↓ Cut-off characteristics

Below, right: Curves indicating for each rated current the peak value I_C that the current may reach as a function of the prospective fault current I_p .

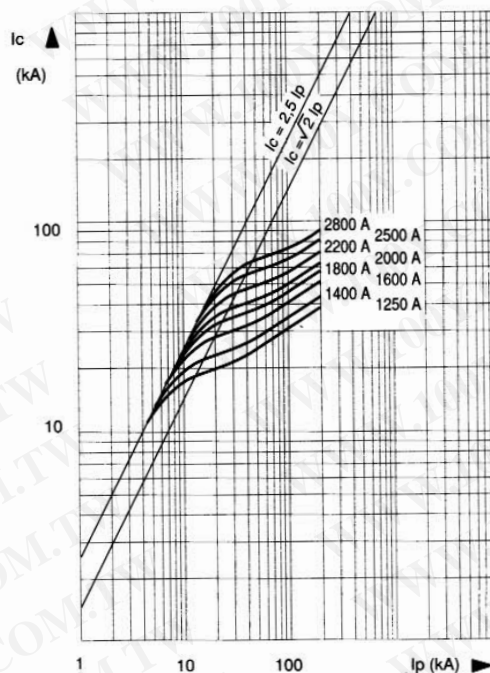
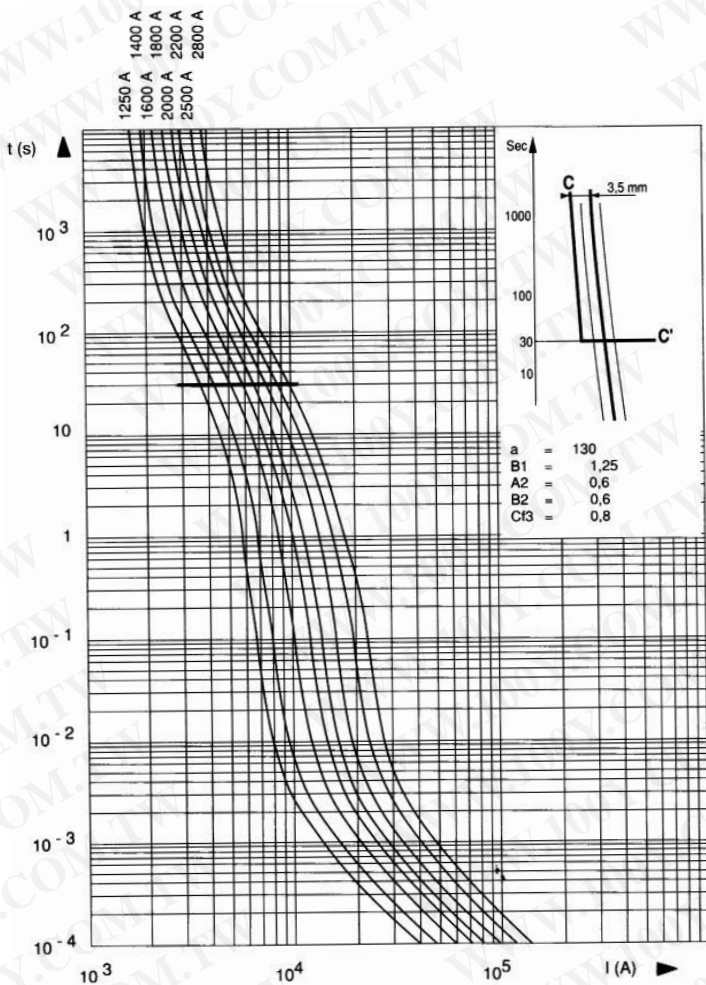

↑ Time-current characteristics

Above, left: Curves indicating pre-arcing time for each rated current as a function of RMS value of pre-arcing current I .

- Tolerances on this current $\pm 8\%$.
- Beyond 30 sec or 10 sec, small overloads must be eliminated by another device.
- Curve CC' represents the maximum times taken by the associated device to clear small overloads; only its horizontal line is represented. Its oblique line must be plotted according to sketch, top right corner.
- The intersection of the fuse and CC' curves indicates the minimum breaking current I_{pm} of the fuse.

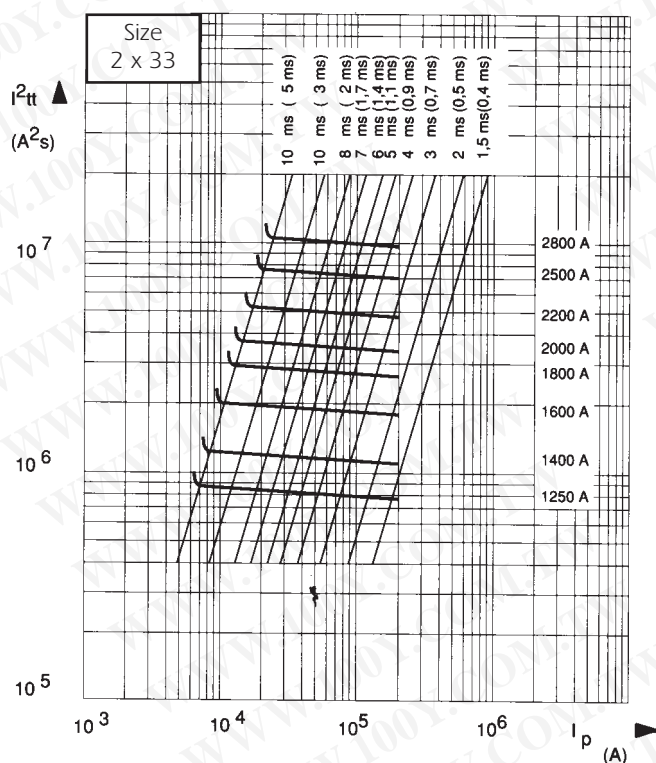

← Maximum values of total operating I^2t and total operating times

Left: Horizontal curves indicating the maximum values of total operating I^2t (I^2t_t) as function of the prospective current I_p at 660 V, $\cos \varphi = 0.15$. The oblique lines indicate the corresponding total operating time T_t , with pre-arcing time in brackets.

Semiconductor (AC) fuses



Protistor® Square-body Fuses PSC aR sizes 3x - 450V to 700 VAC Curves set

Sizes 30 - 31 - 32 - 33

DC working voltage possibilities

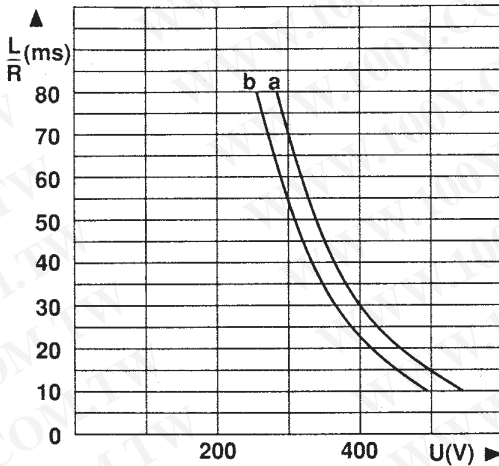

Rated current In (A)	Curves (*) and Ipm (1) corresponding to the rating					
	30 * Ipm (A)	31 * Ipm (A)	32 * Ipm (A)	33 * Ipm (A)	2 x 32 * Ipm (A)	2 x 33 * Ipm (A)
63	a 230					
80	a 300					
100	a 360					
125	a 460					
160	a 650					
200	a 880	a 850				
250	a 1300	a 1150				
315	a 1700	a 1450				
350	a 1900	a 1600				
400	a 2300	a 2200	a 2000			
450		a 2500	a 2300			
500		a 3000	a 2600	a 2300		
550		a 3400	a 3150	a 2500		
630		a 5000	a 3700	a 3250		
700		a 5600	a 4300	a 3900		
800			a 5300	a 4800		
900			a 7800	a 5600		
1000			b 9000	a 6600	a 5200	
1100				a 7700		
1250				b 11000	a 7400	a 6500
1400				b 12500	a 8600	a 7800
1600					a 10600	a 9600
1800					a 15600	a 11200
2000					b 18000	a 13200
2200						a 15400
2500						b 22000
2800						b 25000

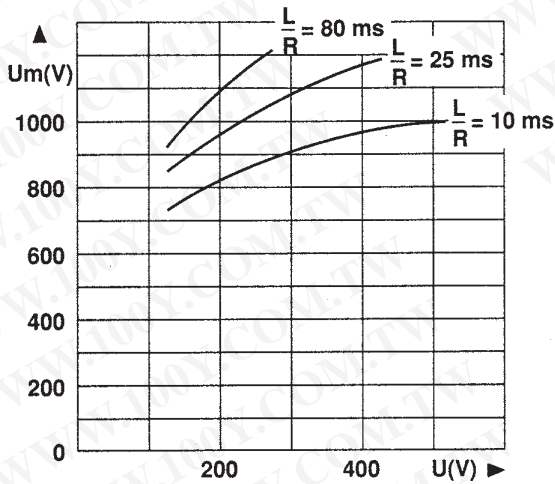

Top: Curves indicating the maximum time constant L/R of the fault path as a function of the DC voltage U for the rated currents in the sizes indicated in the table.

Ipm (1) values indicate the minimum breaking current in Amperes (A).

Remark:

When the fault current di/dt is very large, this condition can be exceeded. This is the case for faults occurring in voltage commutated inverters.

Below: Curves indicating peak arc voltage U_m which may appear across fuse terminals as a function of the DC working voltage U , for various time constant L/R of fault path.

Protistor® Square-body Fuses PSC aR sizes 3x - 450V to 700 VAC Microswitches PSC 3x & 7x

- MICROSWITCH SYSTEMS ADAPTED TO THE FOLLOWING FERRAZ SHAWMUT FUSES ONLY:
- PSC sizes 30, 31, 32, 33, 2x32, 2x33 / 70, 71, 72, 73, 272, 273 except plain blades
- PSC LR sizes 33, 233, 73, 273
- PERMANENT INDICATION OF FUSE STATE: CONDUCTIVE
BLOWN
- MANUAL RESETTING
- STANDARD AND LOW ELECTRICAL LEVEL WITH DIFFERENT INSULATION LEVELS
- BS TYPE FOR USE IN CORROSIVE ATMOSPHERE
- MS 3V 1-5 UR AND MS 7V 1-5 UR TYPE UL ARE RECOGNIZED



MS 7V 1-5

Main Characteristics

Code	AC Insulation voltage rating (***)	Positive operating voltage/current	Current rating	Current	Breaking Capacity						AC voltage withstand test (*)	Impulse voltage test Uimp1.2/50 µs (**)	Fire class according to UL 94
					Non inductive circuit			Inductive circuit : L/R = 25ms					
					30V	110V	250V	30V	110V	250V			
MS 3V 1-5	1000 V	20 V 50 mA	10 A	50/60 Hz	10 A	10 A	10 A	10 A	10 A	10 A	8,5 kV	14 kV	H.B
MS 3V 1-5 UR				DC	8 A	0,4 A	0,2 A	4 A	0,2 A	0,1 A	12 kV	20 kV	
MS 7V 1-5	1500V	10 V 10 mA	3 A	50/60 Hz	3 A	3 A	3 A	2 A	1 A	1 A	8,5 kV	14 kV	
MS 7V 1-5 UR				DC	3 A	0,5 A	0,25 A	3 A	0,2 A	0,1 A	12 kV	20 kV	
MS 3V 1-5 BS	1000 V	10 V 10 mA	3 A	50/60 Hz	3 A	3 A	3 A	2 A	1 A	1 A	8,5 kV	14 kV	
MS 3V 1-9 BS				DC	3 A	0,5 A	0,25 A	3 A	0,2 A	0,1 A	12 kV	20 kV	
MS 7V 1-5 BS	1500V	10 V 10 mA	3 A	50/60 Hz	3 A	3 A	3 A	2 A	1 A	1 A	8,5 kV	14 kV	
MS 7V 1-9 BS				DC	3 A	0,5 A	-	2 A	0,2 A	-	12 kV	20 kV	
MS 3V 1-5 ET	1000V	10 V	3 A	50/60 Hz	3 A	3 A	3 A	2 A	1 A	1 A	8,5 kV	14 kV	
MS 7V 1-5 ET	1500V	10 mA		DC	3 A	0,5 A	-	2 A	0,2 A	-	12 kV	20 kV	

* Between power circuit and microswitch terminals as per IEC 60 and 694 and NFC 64010 (50/60 Hz 1 min duration in dry air)

** Between power circuit and microswitch terminals Uimp: impulse voltage as per IEC 60947-1

*** Between power circuit and microswitch terminals

Warning: microswitch systems exclusively designed for FERRAZ SHAWMUT.
PSC Fuses fitted a patented trip-indicator, saving use of EDV

Semiconductor (AC) fuses



Protistor® Square-body Fuses PSC aR sizes 3x - 450V to 700 VAC Microswitches for PSC 3x & 7x

Indication systems for PSC Fuse sizes 30 to 73 MS 3V...

These patented indication systems are exclusively hand resettable.

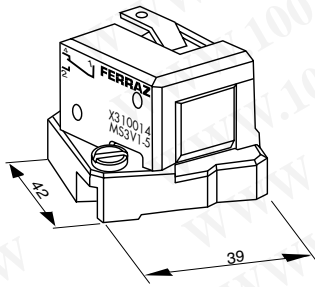

(fig. 1)

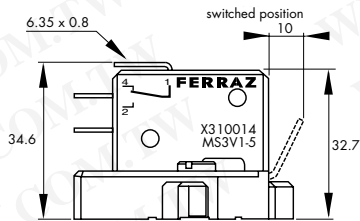

Fuse size	Designation	Ref. Number	Indication style	Weight (g)	Pack.	Catalog Number
30, 31 32, 33	MS 3V 1-5 (fig.1)	X310014	Standard NO-NC	34	3 pieces	MS3 V1-5
	MS 3V 1-5 UR	Y310038				MS3 V1-5-UR
	MS 3V 1-5 BS (3)	K310013	Low level NO-NC	34	3 pieces	MS3-V1-5BS
	MS 3V 1-9 BS (4)	P310011	Double pole Low level	44	3 pieces	MS3V1-9BS
	MS 3V 1-5 ET (fig.2)	S310009	Low level NO-NC IP 50 (9)	34	3 pieces	MS3V1-5 ETANCHE

(3) Same as fig.1

(4) Same dimensions as figure 1
but with 2 microswitches side by side

(9) Watertightness class

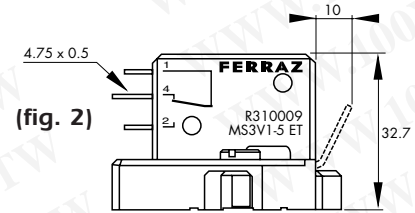

(fig. 2)

MS 7V...

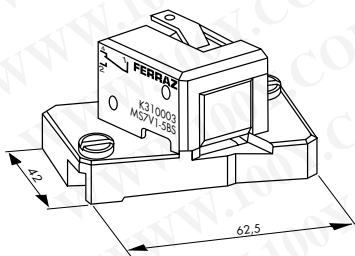

(fig. 5)

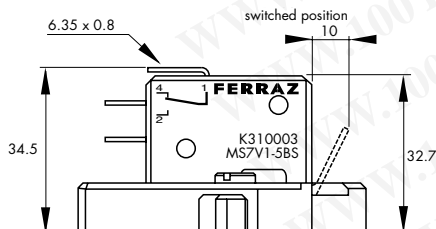

Fuse size	Designation	Ref. Number	Indication style	Weight (g)	Pack.	Catalog Number
70, 71 72, 73	MS 7V 1-5 (fig.5)	J310002	Standard NO-NC	45	3 pieces	MS7 V1-5
	MS 7V 1-5 UR	Z310039				MS7 V1-5-UR
	MS 7V 1-5 BS (3)	K310003	Low level NO-NC	45	3 pieces	MS7-V1-5BS
	MS 7V 1-9 BS (4)	P310007	Double pole Low level	55	3 pieces	MS7V1-9BS
	MS 7V 1-5 ET (fig.6)	S310010	Low level NO-NC IP 50 (9)	55	3 pieces	MS7V1-5 ETANCHE

(7) Same as fig. 5

(8) Same dimensions as figure 5 but with 2 microswitches side by side

(9) Watertightness class

Warning: Microswitch systems exclusively designed for FERRAZ SHAWMUT PSC fuses fitted with a patented trip-indicator, saving use of EDV.

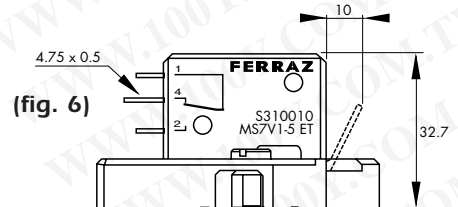



(fig. 6)

Semiconductor (AC) fuses

Protistor® Square-body Fuses PSC aR sizes 3x - 450V to 700 VAC Metric-studs

Metric studs for threaded terminal fuses



Type and fuse size	Designation	Ref. Number	Unit weight (g)	Pack.	Catalog Number
 Sizes 0 and 1	HC stud pair M8x30 & M8x35	S098801	23	6 pairs	STUM8x30M8x35
	Size 2 HC stud pair M10x30 & M10x50	T098802	40	6 pairs	STUM10x30M10x50
	Size 3 HC stud pair M12x35 & M12x50	V098803	60	6 pairs	STUM12x35M12x50
 Size 2	HC stud pair M10x50	W098804	45	6 pairs	STUM10x50
	Size 3 HC stud pair M12x50	X098805	45	6 pairs	STUM12x50

We recommend the use of studs, whose quality is suited to all FERRAZ SHAWMUT square-body fuses with terminals

勝特力材料 886-3-5753170
胜特力电子(上海) 86-21-34970699
胜特力电子(深圳) 86-755-83298787
[Http://www.100y.com.tw](http://www.100y.com.tw)

Stud mounting

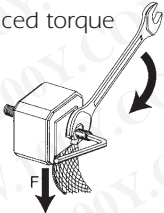
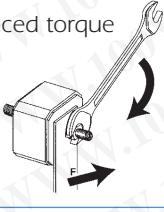
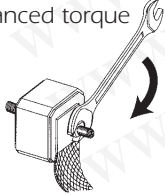
Torque type	Stud type	Maximum stud tightning torque (Nm) (1)	Maximum nut tightning torque (Nm) (1)
Balanced torque 	M8x30 & M8x35	10	13.5
	M10x30 & M10x50	15	26
	M12x35 & M12x50	15	46
Balanced torque 	M8x30 & M8x35	10	13.5
	M10x30 & M10x50	15	26
	M12x35 & M12x50	15	46
Unbalanced torque 	M8x30 & M8x35	10	13.5
	M10x30 & M10x50	15	26
	M12x35 & M12x50	15	46



Protistor® Square-body Fuses NH Plain Blades - 690 VAC gR - 690 VAC sizes 000 to 3 (full range)

Ferraz Shawmut PROTISTOR® NH gRB 690 VAC fuse-links provide maximum flexibility in equipment design and ultimate protection for today's power conversion equipment. This range is a full range, engineered to provide state of the art protection for power semiconductor such as diodes, thyristors, triacs.

These square body fuse-links are available in various body sizes with a broad range of ampere ratings allowing the greatest flexibility in equipment design.

They have pure silver fuse elements which provides optimized I^2t and high breaking capacity. All contact surfaces are silver plated and all hardware non-magnetic.

All fuses are standard with a low voltage dual blown fuse indicator. This indicator can operate a microswitch which is easily mounted directly on to the fuse in service.

Features/Benefits

Broad range of ampere ratings in each body size for design flexibility

IEC 60269-1 and 4 compliance for fuses for worldwide semiconductor applications

Ratings

AC: up to 800 A
690 VAC
80-170 kA IR
DC: Consult Factory

Features

- Full range fast acting
- Highly current limiting.
- High breaking capacities
- Low I^2t
- Worldwide mounting acceptance.
- Superior cycling ability.
- High withstanding in rush current and overloads

Approvals

AC: Tested to IEC 60269-1 and 4

Applications

Protection of rectifiers, inverters, static switch, AC & DC drives and UPS systems.

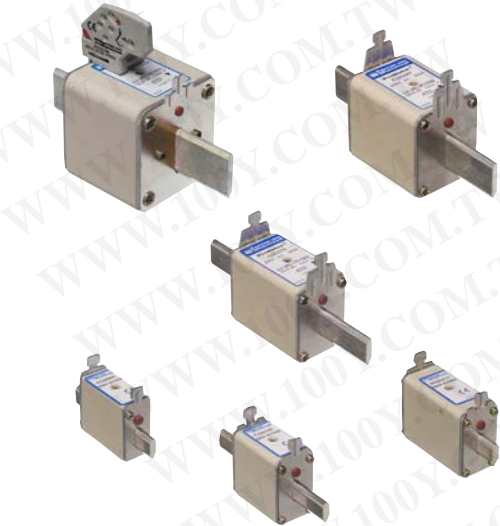

Beige melted



Red non melted

Innovations

- Double indicator (Visual and mechanical).
- Largest range of the market
- Connexion improvement between trip indicator - Micro switch
- Cd / Pb free
- Low voltage indicator - 50V

Semiconductor (AC) fuses

Protistor® Square-body Fuses NH Plain Blades - 690 VAC gR - 690 VAC sizes 000 to 3 (full range)

Voltage	Size	Type	Rating In (A)	Pre-Arcing I ² t @ 1ms (A ² s)	Total I ² t @ 690 V kA ² s	Pn: Power losses (W) PV 43620 0,8In	Breaking capacities @ Un (kA)
690 V	000	gRB	16				
		gRB	20				
		gRB	25				
		gRB	32				
		gRB	40				
		gRB	50				
		gRB	63				
		gRB	80				
		gRB	100				
		gRB	125				
690 V	00	gRB	20				
		gRB	25				
		gRB	32				
		gRB	40				
		gRB	50				
		gRB	63				
		gRB	80				
		gRB	100				
		gRB	125				
		gRB	160				
690 V	0	gRB	200				
		gRB	32				
		gRB	40				
		gRB	50				
		gRB	63				
		gRB	80				
		gRB	100				
		gRB	125				
		gRB	160				
		gRB	200				

Consult us

Time/current characteristics
Cut off characteristics
Total I²t and total operating time
Other curves
Fuse holder derating

} Consult us

Semiconductor (AC) fuses



Protistor® Square-body Fuses NH Plain Blades - 690 VAC gR - 690 VAC sizes 000 to 3 (full range)

Voltage	Size	Type	Rating In (A)	Pre-Arcing I ² t @ 1ms (A ² s)	Total I ² t @ 690 V kA ² s	Pn: Power losses (W) PV 43620 0,8In	Breaking capacities @ Un (kA)
690 V	16	gRB	63				
		gRB	80				
		gRB	100				
		gRB	125				
		gRB	160				
		gRB	200				
		gRB	250				
		gRB	315				
		gRB	350				
690 V	2	gRB	160			Consult US	
		gRB	200				
		gRB	250				
		gRB	315				
		gRB	350				
		gRB	400				
		gRB	450				
		gRB	500				
690 V	3	gRB	315				
		gRB	350				
		gRB	400				
		gRB	450				
		gRB	500				
		gRB	560				
		gRB	630				
		gRB	700				
		gRB	800				

Semiconductor (AC) fuses

Protistor® Square-body Fuses NH Plain Blades - 690 VAC gR - 690 VAC sizes 000 to 3 (full range)

Size	Designation	Reference Number	Catalog Number	Weight	Pack. (g)
000	6,9 gRB 000 PV 0016	N322035	NH000GB69V16PV	135	3
	6,9 gRB 000 PV 0020	Q322037	NH000GB69V20PV		
	6,9 gRB 000 PV 0025	S322039	NH000GB69V25PV		
	6,9 gRB 000 PV 0032	X322043	NH000GB69V32PV		
	6,9 gRB 000 PV 0040	B322047	NH000GB69V40PV		
	6,9 gRB 000 PV 0050	F322051	NH000GB69V50PV		
	6,9 gRB 000 PV 0063	K322055	NH000GB69V63PV		
	6,9 gRB 000 PV 0080	P322059	NH000GB69V80PV		
	6,9 gRB 000 PV 0100	T322063	NH000GB69V100PV		
	6,9 gRB 000 PV 0125	W322065	NH000GB69V125PV		
	Neutral	Z218269	NH00NEUTRAL		10
	Extraction puller	P215592	NHHANDLE		1
00	6,9 gRB 00 PV 0020	Z322137	NH00GB69V20PV	200	3
	6,9 gRB 00 PV 0025	B322139	NH00GB69V25PV		
	6,9 gRB 00 PV 0032	F322143	NH00GB69V32PV		
	6,9 gRB 00 PV 0040	K322147	NH00GB69V40PV		
	6,9 gRB 00 PV 0050	P322151	NH00GB69V50PV		
	6,9 gRB 00 PV 0063	T322155	NH00GB69V63PV		
	6,9 gRB 00 PV 0080	Y322159	NH00GB69V80PV		
	6,9 gRB 00 PV 0100	C322163	NH00GB69V100PV		
	6,9 gRB 00 PV 0125	E322165	NH00GB69V125PV		
	6,9 gRB 00 PV 0160	J322169	NH00GB69V160PV		
	Neutral	Z218269	NH00NEUTRAL		10
	Extraction puller	P215592	NHHANDLE		1
0	6,9 gRB 0 PV 0032	P322243	NH0GB69V32PV	250	3
	6,9 gRB 0 PV 0040	T322247	NH0GB69V40PV		
	6,9 gRB 0 PV 0050	Y322251	NH0GB69V50PV		
	6,9 gRB 0 PV 0063	C322255	NH0GB69V63PV		
	6,9 gRB 0 PV 0080	G322259	NH0GB69V80PV		
	6,9 gRB 0 PV 0100	L322263	NH0GB69V100PV		
	6,9 gRB 0 PV 0125	N322265	NH0GB69V125PV		
	6,9 gRB 0 PV 0160	S322269	NH0GB69V160PV		
	6,9 gRB 0 PV 0200	V322271	NH0GB69V200PV		
	6,9 gRB 0 PV 0250	Z322275	NH0GB69V250PV		
	Neutral	Z219304	NH0NEUTRAL		10
	Extraction puller	P215592	NHHANDLE		1

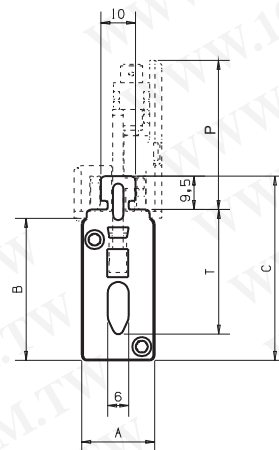
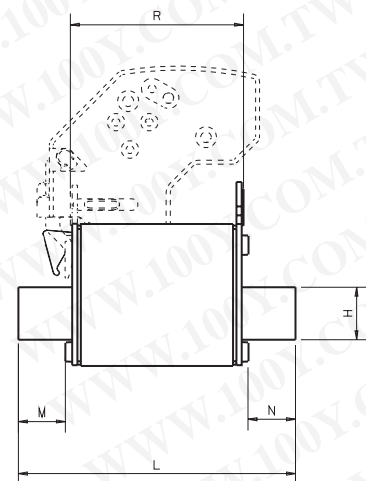

Microswitches

MS 4L 2-5 B6 + PRES F210156 (6,3mm clips)

MS 4L 2-5 B2 + PRES G210157 (2.8 mm clips)

Automatically resettable, these microswitch systems indicate fuse presence (PRES) and proper mounting

In case of improper mounting or fuse melting, this is indicated (terminal 1-4 closed)

Microswitches supplied separately

Size	A	B	C	H	L	M	N	P	R	T
000	20,8	40,5	52,5	15	79	13,5	13,5	43,4	49,5	35
	0.82"	1.59"	2.07"	0.59"	3.11"	0.53"	0.53"	1.71"	1.95"	1.38"
00	29,5	47,5	59,5	15	79	13,1	13,1	43,4	50	35
	1.16"	1.87"	2.34"	0.59"	3.11"	0.52"	0.52"	1.71"	1.97"	1.38"
0	29,5	47,5	59,5	15	125	29,1	29,1	43,4	66	35
	1.16"	1.87"	2.34"	0.59"	4.92"	1.15"	1.15"	1.71"	2.60"	1.38"

Fuse holder solution, see gear and Fuse gear section



Protistor® Square-body Fuses NH Plain Blades - 690 VAC gR - 690 VAC sizes 000 to 3 (full range)

Size	Designation	Reference Number	Catalog Number	Weight	Pack. (g)
1	6,9 gRB 1 PV 0063	L322355	NH1GB69V63VP	430	3
	6,9 gRB 1 PV 0080	J322399	NH1GB69V80PV		
	6,9 gRB 1 PV 0100	V322363	NH1GB69V100PV		
	6,9 gRB 1 PV 0125	X322365	NH1GB69V125PV		
	6,9 gRB 1 PV 0160	B322369	NH1GB69V160PV		
	6,9 gRB 1 PV 0200	D322371	NH1GB69V200PV		
	6,9 gRB 1 PV 0250	H322375	NH1GB69V250PV		
	6,9 gRB 1 PV 0315	M322379	NH1GB69V315PV		
	6,9 gRB 1 PV 0350	N322380	NH1GB69V350PV		
	Neutral	A219834	NH1NEUTRAL		10
	Extraction puller	P215592	NHHANDLE	1	
2	6,9 gRB 2 PV 0160	K322469	NH2GB69V160PV	600	3
	6,9 gRB 2 PV 0200	M322471	NH2GB69V200PV		
	6,9 gRB 2 PV 0250	R322475	NH2GB69V250PV		
	6,9 gRB 2 PV 0315	W322479	NH2GB69V315PV		
	6,9 gRB 2 PV 0350	X322480	NH2GB69V350PV		
	6,9 gRB 2 PV 0400	A322483	NH2GB69V400PV		
	6,9 gRB 2 PV 0450	C322485	NH2GB69V450PV		
	6,9 gRB 2 PV 0500	E322487	NH2GB69V500PV		
Neutral	N222514	NH2NEUTRAL	10		
	Extraction puller	P215592	NHHANDLE	1	
3	6,9 gRB 3 PV 0315	E322579	NH3GB69V315PV	750	3
	6,9 gRB 3 PV 0350	F322580	NH3GB69V350PV		
	6,9 gRB 3 PV 0400	J322583	NH3GB69V400PV		
	6,9 gRB 3 PV 0450	L322585	NH3GB69V450PV		
	6,9 gRB 3 PV 0500	N322587	NH3GB69V500PV		
	6,9 gRB 3 PV 0550	P322588	NH3GB69V550PV		
	6,9 gRB 3 PV 0630	O322589	NH3GB69V630PV		
	6,9 gRB 3 PV 0700	R322590	NH3GB69V700PV		
	6,9 gRB 3 PV 0850	S322591	NH3GB69V850PV		
	Neutral	E223035	NH3NEUTRAL		10
	Extraction puller	P215592	NHHANDLE	1	

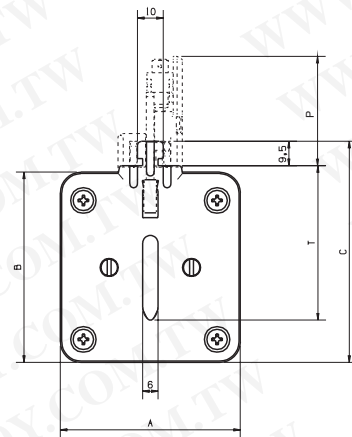
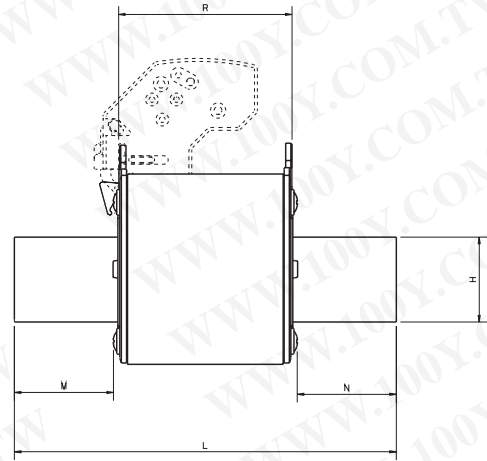

Microswitches

MS 4L 2-5 B6 + PRES

F210156

(6,3mm clips)

MS 4L 2-5 B2 + PRES

G210157

(2.8 mm clips)

Automatically resettable, these microswitch systems indicate fuse presence (PRES) and proper mounting

In case of improper mounting or fuse melting, this is indicated (terminal 1-4 closed)

Microswitches supplied separately

Size	A	B	C	H	L	M	N	P	R	T
1	39,5	52,5	64,5	20	135	32,1	32,1	43,4	68	40
	1.56"	2.07"	2.54"	0.79"	5.32"	1.26"	1.26"	1.71"	2.68"	1.57"
2	51	60	72	26	150	38,85	38,85	43,4	68	48
	2.01"	2.36"	2.85"	1.02"	5.91"	1.53"	1.53"	1.71"	2.68"	1.89"
3	70	74	86	33	150	38,85	38,85	43,4	68	60
	2.76"	2.91"	3.39"	1.30"	5.91"	1.53"	1.53"	1.71"	2.68"	2.36"

Fuse holder solution, see Gear and Fuse Gear

Protistor® Square-body Fuses NH Plain Blades - 690 VAC gR - 690 VAC sizes 000 to 3 (full range)

Fuse holders and switch-disconnector



Fuse holder
unprotect



Fuse holder
finger safe



Switch
Disconnector



Fuse switch
Disconnector
fast handle

Type	Characteristics	Poles	Size 000/00	Size 0	Size 1	Size 2	Size 3
Fuse holder	Unprotected (4) screw connection for hole and bar terminals for 35mm Din rail	1	R216192	T218241	A223008	E211075	X213644
		2	F218758	G218759	G200796	V211595	B214154
		3	V219277	W219278	Y201340	D212109	F214664
		4	Z223007	H222486	H201855	R212627	K215174
	Unprotected (4) screw connection for holes or bar terminals for panels	1	F215170	N216695	E218757	F201853	W213643
		2	A217212	B217213	F222484	S211593	D214662
		3	F217723	G217724	Y223006	B212107	H215172
		4	S219275	R218239	X201339	C213143	L215681
	Finger Safe Protected screw connection for hole and bar terminals for DIN rail	1	S218240	G226717	P226724	R226726	T226728
		3	G222485	J226719A	Q226725	S226727	V226729
Switch- disconnector	Horizontal Linocur AC23	1	N216626 N222882				
		2	B218685 C201781				
		3	Y212035 W213574				
Fused switch- disconnector front handle	ITCP 160 III(4)	3	F210409				
	ITC 63 III complete (5)	3	G210824				
	ITC 160 III complete (5)	3	K227824				
	ITC 250 III complete (5)	3			N210830 + Y210770 (3)		
	ITC 400 III complete(5)	3				Q210832 + Y210770 (3)	
	ITC 630 III complete(5)	3					P210831 + Y210770 (3) W229674 + Y210770 (3)
ITC 800 III complete(5)	3						

(1) Impossible to use microswitch

(2) The axis of operation must be fragmented if the heighten (Y210770A) is not used - Internal or external control.

(3) Necessary heighten for the use of microswitch (F210156C or G210157C)

(4) Unprotected against accidental contact-not finger safe

(5) Finger safe

Warning: for all holders, please check maximum fuse and fuse holder operating limit".



Protistor® Square-body Fuses NH Plain Blades - 690 VAC aR - 690 VAC sizes 000 to 3

Ferraz Shawmut PSC-URD 690 VAC fuse-links provide maximum flexibility in equipment design and ultimate protection for today's power conversion equipment. This range is a fast acting, engineered to provide state of the art protection for power semiconductors such as diodes, thyristors.

These square body fuse-links are available in various body sizes with a broad range of ampere ratings allowing the greatest flexibility in equipment design.

They have pure silver fuse elements embedded in solidified sand which provides optimized I^2t and high breaking capacity. All contact surfaces are plated and all hardware non-magnetic. All fuses are standard with a low voltage blown fuse indicator. This indicator can operate a microswitch which is easily mounted directly on to the fuse in service.

Features/Benefits

Broad range of ampere ratings in each body size for design flexibility

IEC 60269-4 compliance for fuses for worldwide semiconductor applications

Ratings

AC: up to 1000 A
500 - 690 VAC
80-170 kA IR

DC: Consult Factory

Features

- Ultra fast acting
- Highly current limiting.
- High breaking capacities
- Very low I^2t
- Worldwide mounting acceptance.
- Superior cycling ability.
- High withstanding in rush current and overloads

Approvals

AC: Tested to IEC 269.4

Applications

Protection of rectifiers, inverters, static switch, AC & DC drives and UPS systems.

Innovations

- Double indicator (Visual and mechanical).
- Largest range of the market
- Connexion improvement between trip indicator - Micro switch
- Cd / Pb free
- Low voltage indicator - 50V



Beige melted



Red non melted

Semiconductor (AC) fuses

Protistor® Square-body Fuses NH Plain Blades - 690 VAC aR - 690 VAC sizes 000 to 3

Voltage	Size	Type	Rating In (A)	Pre-Arcing I ² t @ 1ms (A ² s)	Total I ² t @ 690 V (A ² s)	Pn: Power losses (W) PV 43620 0,8In	Breaking capacities @ Un kA
690 V CEI 700V UL	000	URD	16	10	48	1,0	80
		URD	20	15	90	1,5	
		URD	25	22	130	2,0	
		URD	32	45	270	2,5	
		URD	40	69	400	4,0	
		URD	50	107	630	5,0	
		URD	63	220	1 300	6,0	
		URD	80	350	2 000	8,0	
		URD	100	720	4 300	9,5	
		URD	125	1 400	8 200	10,5	
		URD	160	2 100	12 200	15,0	
		URD	200	3 900	22 700	18,0	
URD	250	7 600	44 400	22,0			
500V CEI 550V UL		URD	315	15 400	90 700	30,0	
690 V CEI 700V UL	00	URD	20	15	90	1,5	170
		URD	25	22	130	2,0	
		URD	32	45	270	2,5	
		URD	40	69	400	4,0	
		URD	50	110	630	5,0	
		URD	63	220	1 300	6,0	
		URD	80	350	2 000	8,0	
		URD	100	720	4 300	8,5	
		URD	125	1 390	8 200	10,0	
		URD	160	2 100	12 200	14,0	
		URD	200	3 900	22 700	17,0	
		URD	250	7 600	44 400	20,0	
690 V CEI 700V UL	0	URD	315	15 400	90 700	29,0	170
		URD	32	32	170	9,5	
		URD	40	53	280	10,0	
		URD	50	87	470	10,5	
		URD	63	130	700	11,5	
		URD	80	180	970	12,5	
		URD	100	390	2 080	15,0	
		URD	125	720	3 890	18,0	
		URD	160	1 550	8 320	22,0	
		URD	200	2 950	15 900	27,0	
URD	250	5 560	29 900	33,0			
URD	315	11 600	62 300	40,0			

Time/current characteristics
Cut off characteristics
Total I²t and total operating time
Other curves
Fuse holder derating

} See following pages



Protistor® Square-body Fuses NH Plain Blades - 690 VAC aR - 690 VAC sizes 000 to 3

Voltage	Size	Type	Rating In (A)	Pre-Arcing I ² t @ 1ms (A ² s)	Total I ² t @ 690 V (A ² s)	Pn: Power losses (W) PV 43620 0,8In	Breaking capacities @ Un kA
690 V CEI 700V UL	1	URD	63	130	700	18	170
		URD	80	220	1 170	21,5	
		URD	100	290	1 570	23,0	
		URD	125	620	3 320	26,0	
		URD	160	1 170	6 270	29,0	
		URD	200	2 470	13 300	33,0	
		URD	250	4 670	25 100	37,0	
		URD	315	9 570	51 400	42,0	
		URD	350	13 400	72 300	44,0	
690 V CEI 700V UL	2	URD	400	19 500	105 000	48,0	170
		URD	160	960	5 180	38	
		URD	200	1 710	9 220	42	
		URD	250	3 480	18 700	46,5	
		URD	315	6 860	36 900	54,0	
		URD	350	9 570	51 400	58,0	
		URD	400	13 400	72 300	62,5	
		URD	450	21 000	113 000	69,0	
		URD	500	27 400	147 000	73,0	
690 V CEI 700V UL	3	URD	550	38 300	206 000	78,0	170
		URD	630	58 700	315 000	85,0	
		URD	700	78 100	420 000	87,0	
		URD	315	5 251	28 200	57,0	
		URD	350	7 562	40 600	58,0	
		URD	400	10 500	56 500	65,5	
		URD	450	15 700	84 300	70,0	
		URD	500	22 200	119 000	75,0	
		URD	560	30 200	163 000	80,0	
690 V CEI 700V UL	3	URD	630	42 000	226 000	89,0	170
		URD	700	61 700	332 000	100,0	
		URD	800	88 900	478 000	112,0	
		URD	900	123 900	666 000	125,0	
		URD	1000	178 400	959 000	140,0	

Semiconductor (AC) fuses

Protistor® Square-body Fuses NH Plain Blades - 690 VAC aR - 690 VAC sizes 000 to 3

Size	Designation	Reference Number	Catalog Number	Weight	Pack. (g)			
000	6,9 URD 000 PV 0016	P320035	NH000UD 69V 16PV	135	3			
	6,9 URD 000 PV 0020	R320037	NH000UD 69V 20PV					
	6,9 URD 000 PV 0025	T320039	NH000UD 69V 25PV					
	6,9 URD 000 PV 0032	Y320043	NH000UD 69V 32PV					
	6,9 URD 000 PV 0040	C320047	NH000UD 69V 40PV					
	6,9 URD 000 PV 0050	G320051	NH000UD 69V 50PV					
	6,9 URD 000 PV 0063	L320055	NH000UD 69V 63PV					
	6,9 URD 000 PV 0080	O320059	NH000UD 69V 80PV					
	6,9 URD 000 PV 0100	V320063	NH000UD 69V 100PV					
	6,9 URD 000 PV 0125	X320065	NH000UD 69V 125PV					
	6,9 URD 000 PV 0160	B320069	NH000UD 69V 160PV					
	6,9 URD 000 PV 0200	D320071	NH000UD 69V 200PV					
	6,9 URD 000 PV 0250	H320075	NH000UD 69V 250PV					
	5 URD 000 PV 0315	M320079	NH000UD 50V 315PV					
	Neutral	Z218269				10		
	Extraction puller	P215592	NH HANDLE			1		
	00	6,9 URD 00 PV 0020	A320137			NH00UD 69V 20PV	200	3
6,9 URD 00 PV 0025		C320139	NH00UD 69V 25PV					
6,9 URD 00 PV 0032		G320143	NH00UD 69V 32PV					
6,9 URD 00 PV 0040		L320147	NH00UD 69V 40PV					
6,9 URD 00 PV 0050		O320151	NH00UD 69V 50PV					
6,9 URD 00 PV 0063		V320155	NH00UD 69V 63PV					
6,9 URD 00 PV 0080		Z320159	NH00UD 69V 80PV					
6,9 URD 00 PV 0100		D320163	NH00UD 69V 100PV					
6,9 URD 00 PV 0125		F320165	NH00UD 69V 125PV					
6,9 URD 00 PV 0160		K320169	NH00UD 69V 160PV					
6,9 URD 00 PV 0200		M320171	NH00UD 69V 200PV					
6,9 URD 00 PV 0250		R320175	NH00UD 69V 250PV					
6,9 URD 00 PV 0315		W320179	NH00UD 69V 315PV					
Neutral		Z218269		10				
Extraction puller		P215592	NH HANDLE	1				
0		6,9 URD 0 PV 0032	O320243	NH0UD 69V 32PV	250	3		
		6,9 URD 0 PV 0040	V320247	NH0UD 69V 40PV				
	6,9 URD 0 PV 0050	Z320251	NH0UD 69V 50PV					
	6,9 URD 0 PV 0063	D320255	NH0UD 69V 63PV					
	6,9 URD 0 PV 0080	H320259	NH0UD 69V 80PV					
	6,9 URD 0 PV 0100	M320263	NH0UD 69V 100PV					
	6,9 URD 0 PV 0125	P320265	NH0UD 69V 125PV					
	6,9 URD 0 PV 0160	T320269	NH0UD 69V 160PV					
	6,9 URD 0 PV 0200	W320271	NH0UD 69V 200PV					
	6,9 URD 0 PV 0250	A320275	NH0UD 69V 250PV					
	6,9 URD 0 PV 0315	E320279	NH0UD 69V 315PV					
	Neutral	Z219304		10				
	Extraction puller	P215592	NH HANDLE	1				

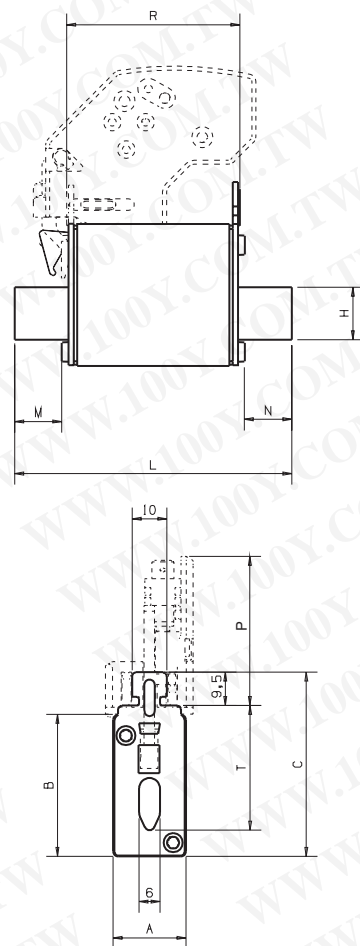

Microswitches

MS 4L 2-5 B6 + PRES	F210156	(6,3mm clips)
MS 4L 2-5 B2 + PRES	G210157	(2.8 mm clips)

Automatically resettable, these microswitch systems indicate fuse presence (PRES) and proper mounting
In case of improper mounting or fuse melting, this is indicated (terminal 1-4 closed)

Microswitches supplied separately

Size	A	B	C	H	L	M	N	P	R	T
000	20,8	40,5	52,5	15	79	13,5	13,5	43,4	49,5	35
	0.82"	1.59"	2.07"	0.59"	3.11"	0.53"	0.53"	1.71"	1.95"	1.38"
00	29,5	47,5	59,5	15	79	13,1	13,1	43,4	50	35
	1.16"	1.87"	2.34"	0.59"	3.11"	0.52"	0.52"	1.71"	1.97"	1.38"
0	29,5	47,5	59,5	15	125	29,1	29,1	43,4	66	35
	1.16"	1.87"	2.34"	0.59"	4.92"	1.15"	1.15"	1.71"	2.60"	1.38"

Fuse holder solution, see Gear and Fuse gear section.



Protistor® Square-body Fuses NH Plain Blades - 690 VAC aR - 690 VAC sizes 000 to 3

Size	Designation	Reference Number	Catalog Number	Weight	Pack. (g)	
1	6,9 URD 1 PV 0063	M320355	NH1UD 69V 63PV	430	3	
	6,9 URD 1 PV 0080	K320399	NH1UD 69V 80PV			
	6,9 URD 1 PV 0100	W320363	NH1UD 69V 100PV			
	6,9 URD 1 PV 0125	Y320365	NH1UD 69V 125PV			
	6,9 URD 1 PV 0160	C320369	NH1UD 69V 160PV			
	6,9 URD 1 PV 0200	E320371	NH1UD 69V 200PV			
	6,9 URD 1 PV 0250	J320375	NH1UD 69V 250PV			
	6,9 URD 1 PV 0315	N320379	NH1UD 69V 315PV			
	6,9 URD 1 PV 0350	P320380	NH1UD 69V 350PV			
	6,9 URD 1 PV 0400	S320383	NH1UD 69V 400PV			
	Neutral	A219834				5
	Extraction puller	P215592	NHHANDLE			1
	2	6,9 URD 2 PV 0160	L320469			NH2UD 69V 160PV
6,9 URD 2 PV 0200		N320471	NH2UD 69V 200PV			
6,9 URD 2 PV 0250		S320475	NH2UD 69V 250PV			
6,9 URD 2 PV 0315		X320479	NH2UD 69V 315PV			
6,9 URD 2 PV 0350		Y320480	NH2UD 69V 350PV			
6,9 URD 2 PV 0400		B320483	NH2UD 69V 400PV			
6,9 URD 2 PV 0450		D320485	NH2UD 69V 450PV			
6,9 URD 2 PV 0500		F320487	NH2UD 69V 500PV			
6,9 URD 2 PV 0550		G320488	NH2UD 69V 550PV			
6,9 URD 2 PV 0630		H320489	NH2UD 69V 630PV			
6,9 URD 2 PV 0700		J320490	NH2UD 69V 700PV			
Neutral		N222514		5		
Extraction puller		P215592	NHHANDLE	1		
3	6,9 URD 3 PV 0315	F320579	NH3UD 69V 315PV	750	3	
	6,9 URD 3 PV 0350	G320580	NH3UD 69V 350PV			
	6,9 URD 3 PV 0400	K320583	NH3UD 69V 400PV			
	6,9 URD 3 PV 0450	M320585	NH3UD 69V 450PV			
	6,9 URD 3 PV 0500	P320587	NH3UD 69V 500PV			
	6,9 URD 3 PV 0550	Q320588	NH3UD 69V 550PV			
	6,9 URD 3 PV 0630	R320589	NH3UD 69V 630PV			
	6,9 URD 3 PV 0700	S320590	NH3UD 69V 700PV			
	6,9 URD 3 PV 0800	T320591	NH3UD 69V 800PV			
	6,9 URD 3 PV 0900	V320592	NH3UD 69V 900PV			
	6,9 URD 3 PV 1000	W320593	NH3UD 69V 1000PV			
	Neutral	E223035				51
	Extraction puller	P215592	NHHANDLE			

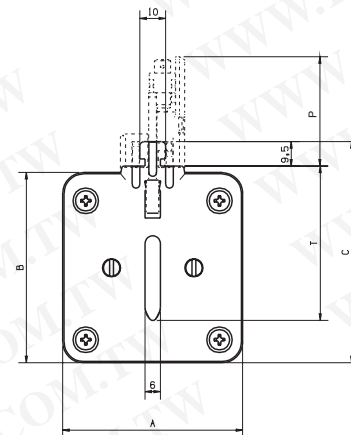
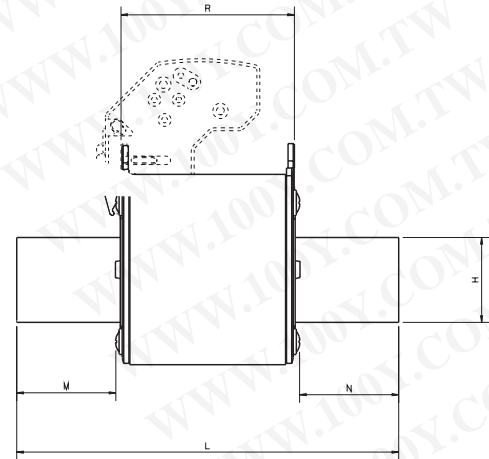

Microswitches

MS 4L 2-5 B6 + PRES	F210156	(6,3mm clips)
MS 4L 2-5 B2 + PRES	G210157	(2.8 mm clips)

Automatically resettable, these microswitch systems indicate fuse presence (PRES) and proper mounting
In case of improper mounting or fuse melting, this is indicated (terminal 1-4 closed)

Microswitches supplied separately

Size	A	B	C	H	L	M	N	P	R	T
1	39,5	52,5	64,5	20	135	32,1	32,1	43,4	68	40
	1.56"	2.07"	2.54"	0.79"	5.32"	1.26"	1.26"	1.71"	2.68"	1.57"
2	51	60	72	26	150	38,85	38,85	43,4	68	48
	2.01"	2.36"	2.85"	1.02"	5.91"	1.53"	1.53"	1.71"	2.68"	1.89"
3	70	74	86	33	150	38,85	38,85	43,4	68	60
	2.76"	2.91"	3.39"	1.30"	5.91"	1.53"	1.53"	1.71"	2.68"	2.36"

Fuse holder solution, see Gear and Fuse gear section.

Semiconductor (AC) fuses

Protistor® Square-body Fuses NH Plain Blades - 690 VAC aR - 690 VAC sizes 000 to 3

Times/Current Characteristics

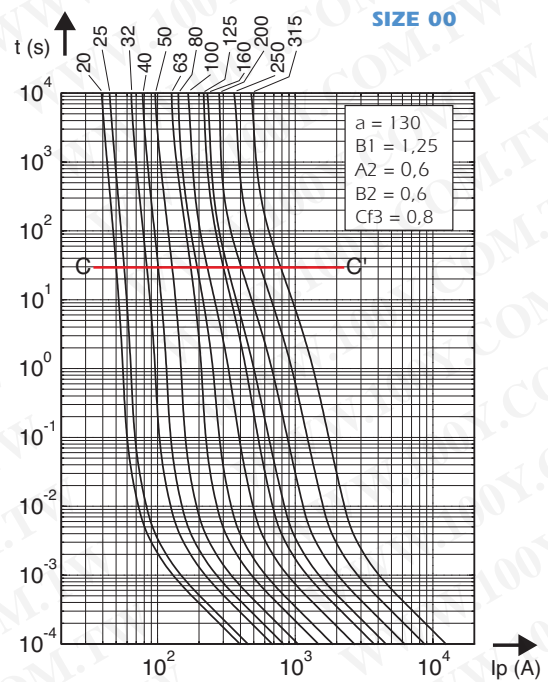
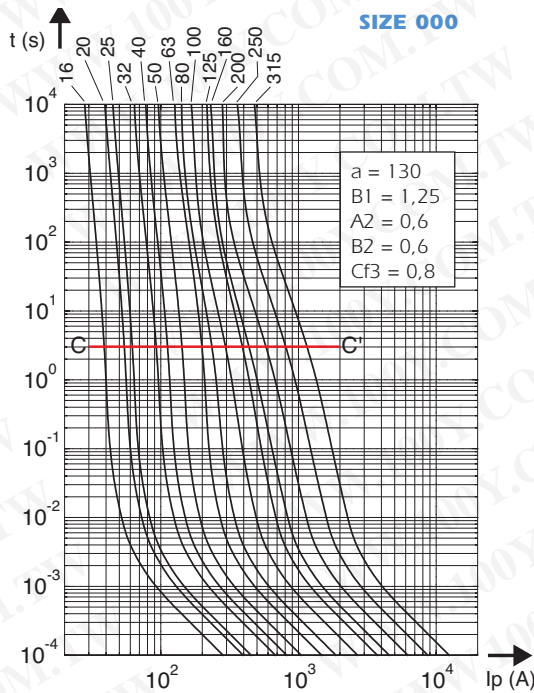

Cut off characteristics - Peak let thru current

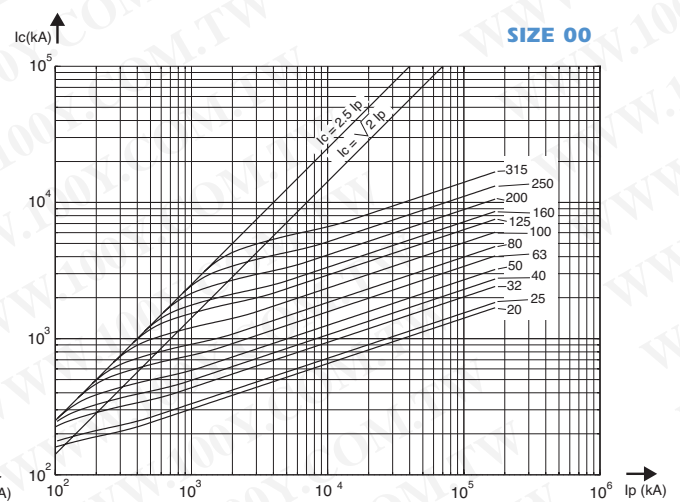
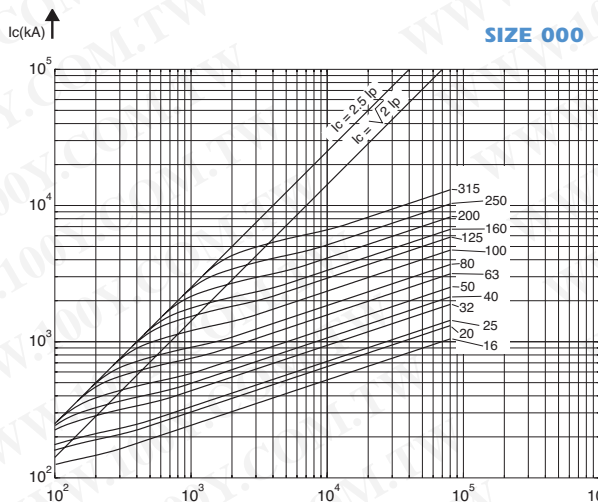

Total I²t and total operating time @ 690 V

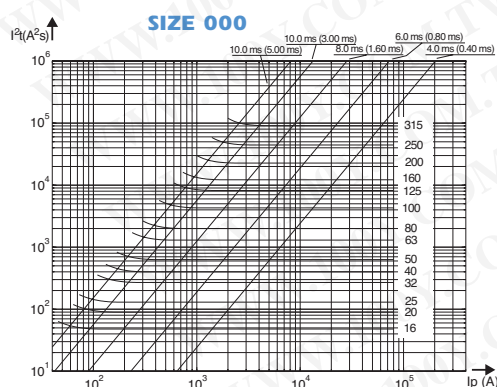

Value between parentheses pertain to prearcing I²t

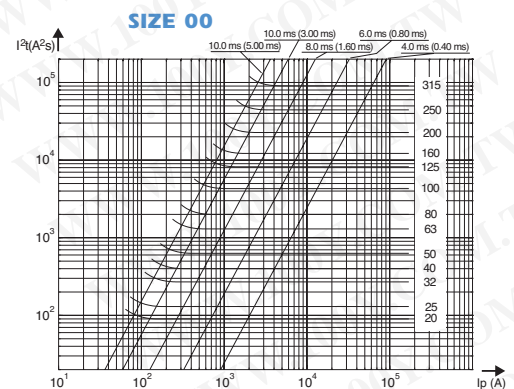

Semiconductor (AC) fuses



Protistor® Square-body Fuses NH Plain Blades - 690 VAC aR - 690 VAC sizes 000 to 3

Times/Current Characteristics

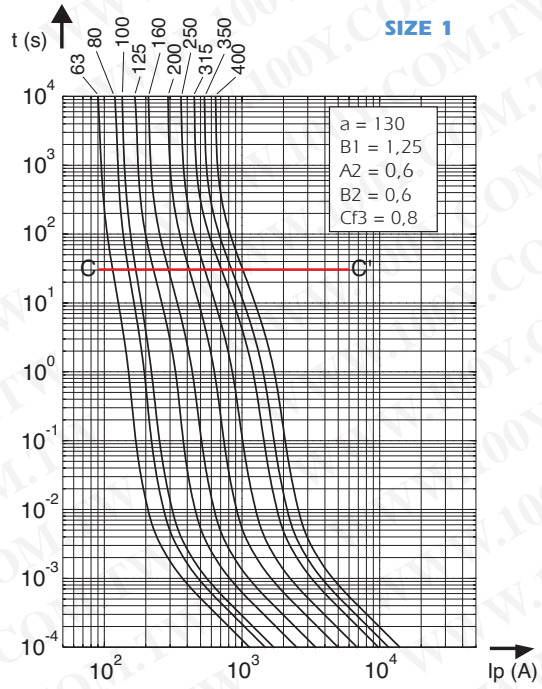
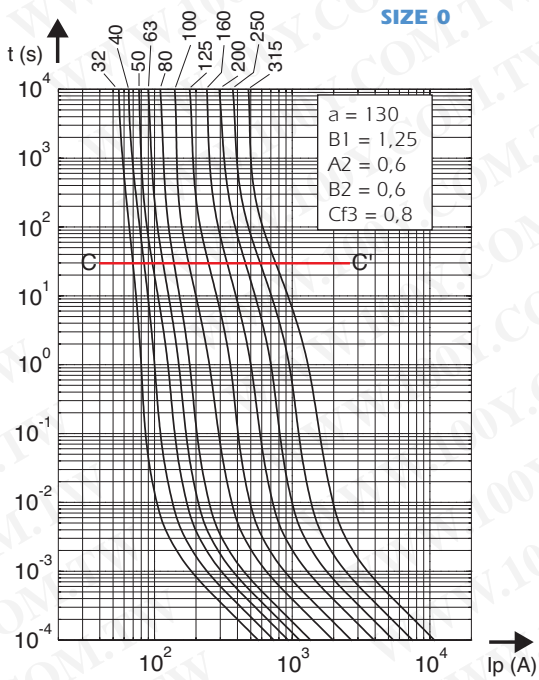

Cut off characteristics - Peak let thru current

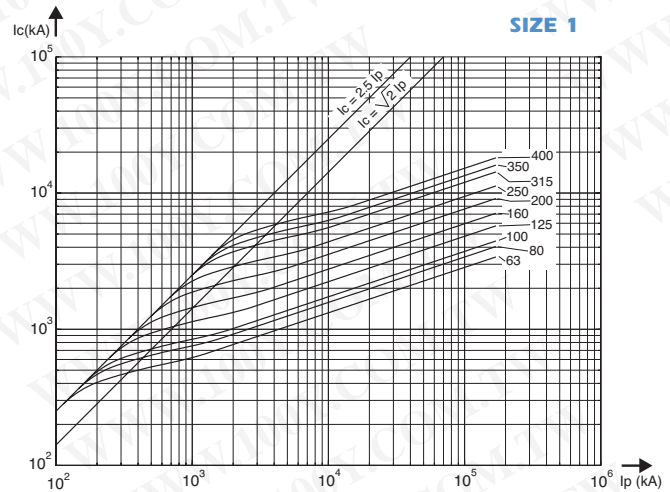
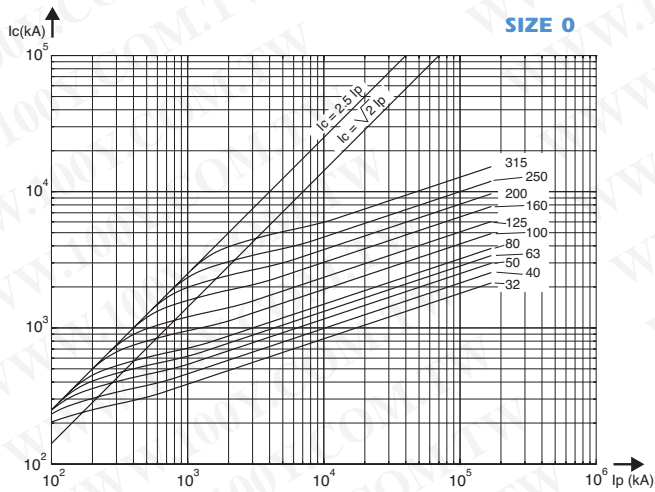

Total I²t and total operating time @ 690 V

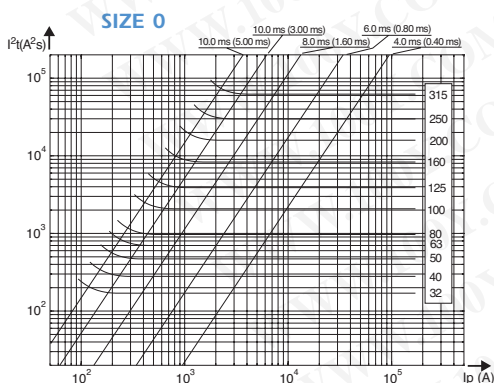

Value between parentheses pertain to prearcing I²t

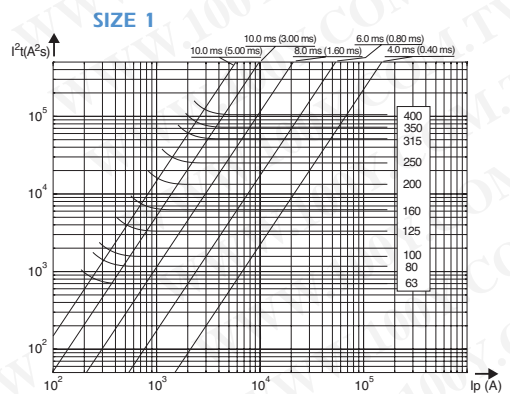

Semiconductor (AC) fuses

Protistor® Square-body Fuses NH Plain Blades - 690 VAC aR - 690 VAC sizes 000 to 3

Times/Current Characteristics

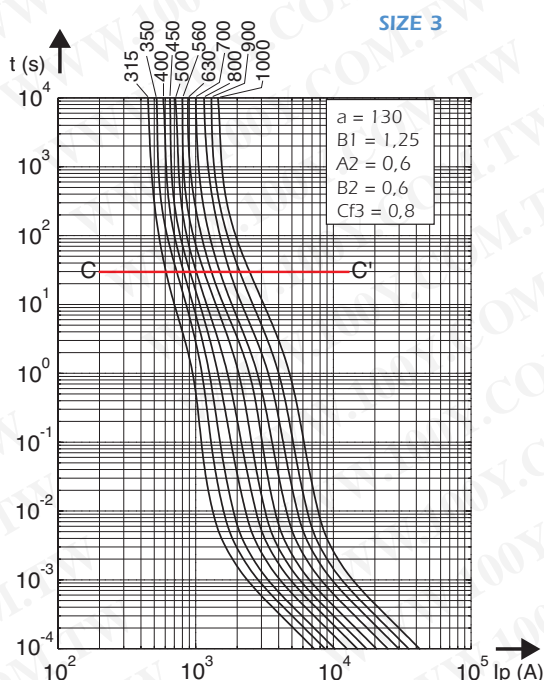
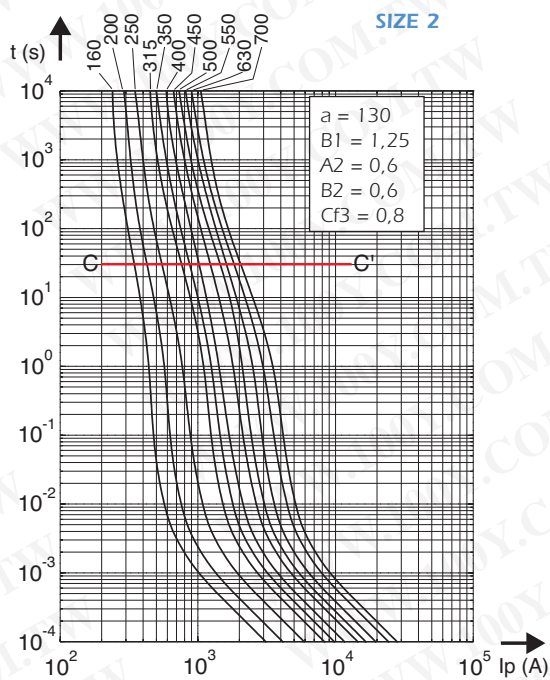

Cut off characteristics - Peak let thru current

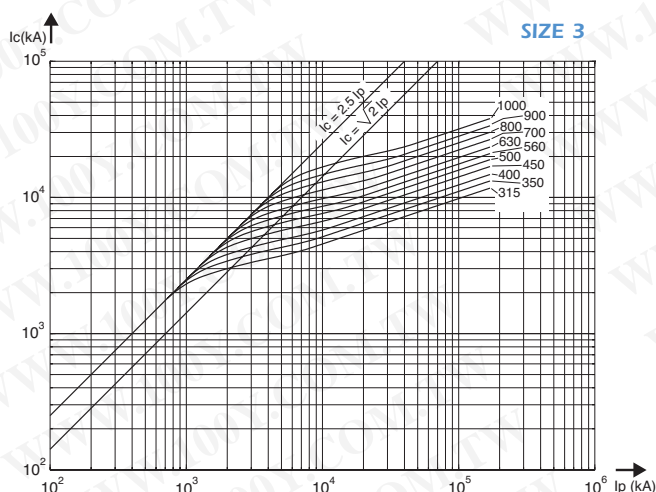
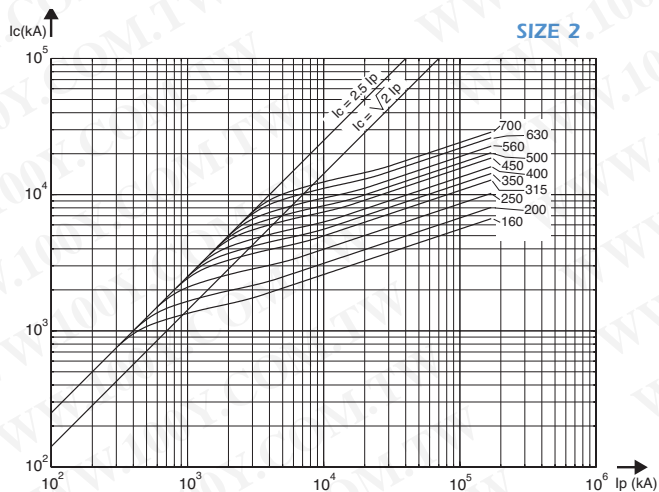

Total I²t and total operating time @ 690 V

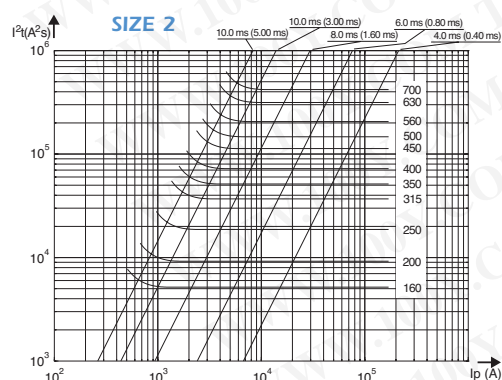

Value between parentheses pertain to pre-arcing I²t

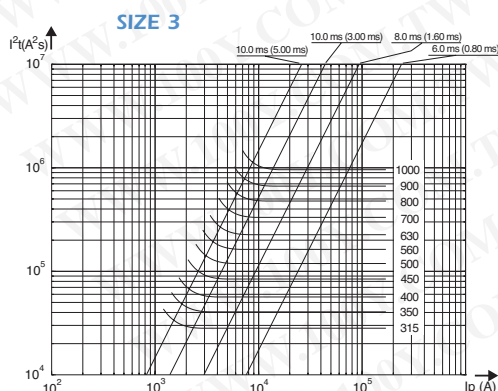



Protistor® Square-body Fuses NH Plain Blades - 690 VAC aR - 690 VAC sizes 000 to 3

$k=f(U)$
Multiplier coefficient
to calculate total I^2t
and total operating time

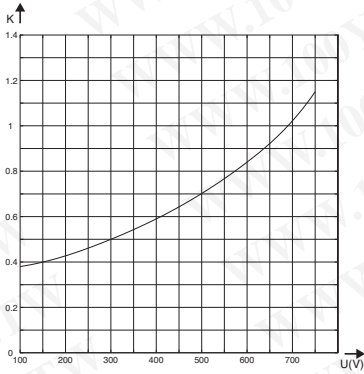

P/PN
Multiplier coefficient
to calculate the power
losses at various currents

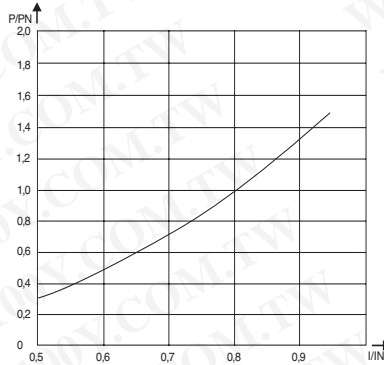

Peak arc voltage

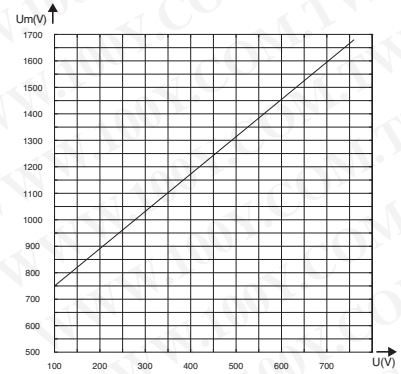

Derating in fuse holders

- 1- Derating for fuse holder unprotected
- 2- Derating for finger safe fuseholders and switch disconnecter Linocur
- 3- Derating for fused switch-disconnectors ITC
- 4- Derating for fused switch-disconnectors ITC with finger safe protection

	In	1	2	3	4
Size 000	16	1,00	1,00	1,00	1,00
	20	1,00	1,00	1,00	1,00
	25	1,00	1,00	1,00	1,00
	32	1,00	1,00	1,00	1,00
	40	1,00	1,00	1,00	1,00
	50	1,00	1,00	0,90	0,90
	63	1,00	1,00	0,90	0,90
	80	1,00	0,90	0,75	0,75
	100	1,00	0,90	0,75	0,75
	125	1,00	0,85	0,70	0,70
	160	0,90	0,75	0,60	0,60
	200	0,85	0,70	0,55	0,55
250	0,75	0,60	0,50	0,50	
315	0,70	0,55	0,45	0,45	
Size 00	20	1,00	1,00	1,00	1,00
	25	1,00	1,00	1,00	1,00
	32	1,00	1,00	1,00	1,00
	40	1,00	1,00	1,00	1,00
	50	1,00	1,00	1,00	1,00
	63	1,00	1,00	1,00	1,00
	80	1,00	0,95	0,95	0,95
	100	1,00	0,90	0,90	0,90
	125	1,00	0,85	0,85	0,85
	160	0,90	0,75	0,75	0,75
	200	0,85	0,70	0,70	0,70
	250	0,80	0,65	0,65	0,65
315	0,70	0,55	0,55	0,55	
Size 0	32	1,00			
	40	1,00			
	50	1,00			
	63	1,00			
	80	0,95			
	100	0,95			
	125	0,85			
	160	0,85			
	200	0,80			
250	0,75				
315	0,65				

	In	1	2	3	4	
Size 1	63	1,00	0,95	1,00	1,00	
	80	0,95	0,85	0,95	0,90	
	100	0,85	0,75	0,85	0,80	
	125	0,85	0,75	0,85	0,80	
	160	0,80	0,70	0,80	0,75	
	200	0,80	0,70	0,80	0,70	
	250	0,75	0,70	0,75	0,70	
	315	0,75	0,65	0,75	0,70	
	350	0,70	0,65	0,70	0,65	
	400	0,65	0,60	0,65	0,60	
	Size 2	160	0,90	0,80	0,90	0,85
		200	0,85	0,75	0,85	0,80
250		0,85	0,70	0,80	0,75	
315		0,75	0,65	0,70	0,65	
350		0,70	0,65	0,70	0,65	
400		0,70	0,60	0,70	0,60	
450		0,70	0,60	0,65	0,60	
500		0,70	0,60	0,65	0,60	
550		0,65	0,60	0,65	0,60	
630		0,65	0,55	0,65	0,60	
700		0,60	0,55	0,60	0,55	
Size 3		315	0,85	0,75	0,80	0,75
	350	0,85	0,75	0,80	0,75	
	400	0,80	0,70	0,75	0,70	
	450	0,80	0,70	0,75	0,70	
	500	0,75	0,65	0,75	0,70	
	550	0,75	0,65	0,75	0,70	
	630	0,70	0,60	0,70	0,65	
	700	0,70	0,60	0,65	0,60	
	800	0,65	0,55	0,60	0,55	
	900	0,60	0,50	0,60	0,55	
	1000	0,60	0,50	0,55	0,50	

Protistor® Square-body Fuses NH Plain Blades - 690 VAC aR - 690 VAC sizes 000 to 3

Fuse holders and switch-disconnector



Fuse holder
unprotect



Fuse holder
finger safe



Fuse switch
Disconnecter
fast handle



Switch
Disconnecter



Type	Characteristics	Poles	Size 000/00	Size 0	Size 1	Size 2	Size 3
Fuse holder	Unprotected (4) screw connection for hole and bar terminals for 35mm Din rail	1	R216192	T218241	A223008	E211075	X213644
		2	F218758	G218759	G200796	V211595	B214154
		3	V219277	W219278	Y201340	D212109	F214664
		4	Z223007	H222486	H201855	R212627	K215174
	Unprotected (4) screw connection for holes or bar terminals for panels	1	F215170	N216695	E218757	F201853	W213643
		2	A217212	B217213	F222484	S211593	D214662
		3	F217723	G217724	Y223006	B212107	H215172
		4	S219275	R218239	X201339	C213143	L215681
	Finger Safe Protected screw connection for hole and bar terminals for DIN rail	1	S218240	G226717	P226724	R226726	T226728
		3	G222485	J226719A	Q226725	S226727	V226729
Switch- disconnecter	Horizontal Linocur AC23	1	N216626 N222882				
		2	B218685 C201781				
		3	Y212035 W213574				
Fused switch- disconnecter front handle	ITCP 160 III(4)	3	F210409				
	ITC 63 III complete (5)	3	G210824				
	ITC 160 III complete (5)	3	K227824				
	ITC 250 III complete (5)	3			N210830 + Y210770 (3)		
	ITC 400 III complete(5)	3				Q210832 + Y210770 (3)	
	ITC 630 III complete(5)	3					P210831 + Y210770 (3) W229674 + Y210770 (3)
ITC 800 III complete(5)	3						

(1) Impossible to use microswitch

(2) The axis of operation must be fragmented if the heighten (Y210770A) is not used - Internal or external control.

(3) Necessary heighten for the use of microswitch (F210156C or G210157C)

(4) Unprotected against accidental contact-not finger safe

(5) Finger safe

Warning : for all holders, please check maximum fuse and fuse holder operating limit".

勝特力材料 886-3-5753170
 勝特力电子(上海) 86-21-34970699
 勝特力电子(深圳) 86-755-83298787
[Http://www.100y.com.tw](http://www.100y.com.tw)



Protistor® Square-body Fuses PSC gR/aR sizes 000/00 Microswitches for PSC sizes 000/00 for NH

MICROSWITCH SYSTEMS ADAPTED TO THE FOLLOWING FUSES:

- PSC sizes 000/00 (brackets) DIN43653
- NH Fuses (plain blades) see details in "General Purpose IEC Fuses" section
- NH plain blades 690 VAC Protistor square-body Fuses



Main Characteristics

Code	AC Insulation voltage rating (***)	Positive operating voltage/current	Current rating	Current	Interrupting rating						AC voltage withstand test (*)	Impulse voltage test Uimp1.2/50 µs (**)	Fire class according to UL 94
					Non inductive circuit			Inductive circuit : L/R = 25ms					
					30V	110V	250V	30V	110V	250V			
MS 4L 2-5 B2 + Pres	1000 V	20 V 100 mA	5 A	50 Hz DC	4A	4A	5A	-	5A	5 A	12 kV 8 kV	16 kV 13 kV	V0
MS 4L 2-5 B6 + Pres	1000 V	20 V 50 mA	10 A	50/60 Hz DC	10 A	10 A	10 A	10 A	10 A	10 A	8 kV	10 kV	V0

- * Between power circuit and microswitch terminals as per IEC 60 and 694 and NFC 64010 (50/60 Hz 1 min duration in dry air)
- ** Between power circuit and microswitch terminals Uimp: impulse voltage as per IEC 60947-1
- *** Between power circuit and microswitch terminals

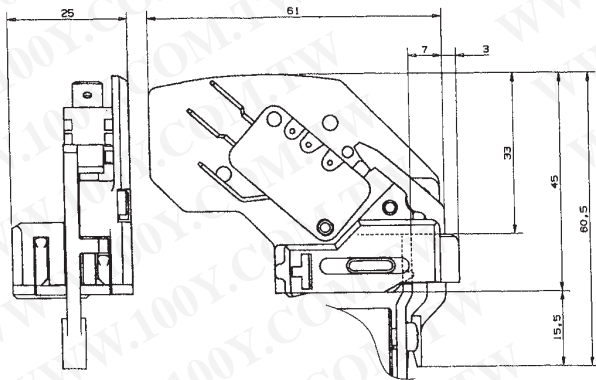

Designation	Ref. Number	Weight (g)	Pack.	Catalog Number
MS 4L 2-5 B6 + PRES (Fig. 1) ⁽¹⁾	F210156	30	3	MS 4L2-5B6PRES
MS 4L 2-5 B2 + PRES (Fig. 2) ⁽²⁾	G210157	26	3	MS 4L2-5B2PRES

Automatically resettable, these microswitch systems indicate fuse presence (PRES) and proper mounting.
In case of improper mounting or fuse melting, this is indicated (terminal 1-4 closed)

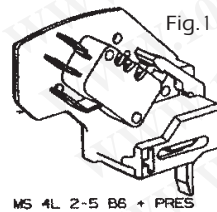
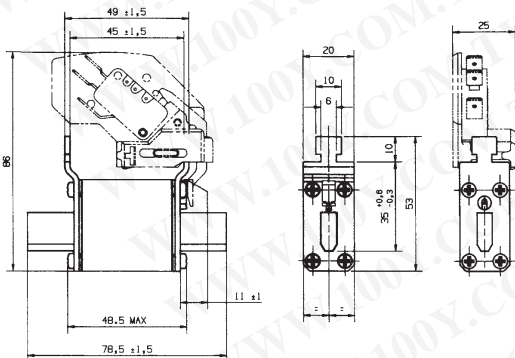

(1) 6.3 mm clips

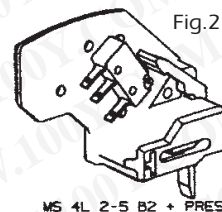

(2) 2.8 mm clips

Protistor® Square-body Fuses PSC gR sizes 7x - 690 VAC Main characteristics



6,9 gRB 71 PA 200



6,9 gRB 73 TTF 1000
+ MS7V1-5 UR



6,9 gRB 70 EF 400



6,9 gRB 73 DIIA 1000

Ferraz Shawmut PSC-gRB 690 VAC fuse-links provide maximum flexibility in equipment design and ultimate protection for today's power conversion equipment.

This range is a fast acting, full range fuses engineered to provide state of the art protection for power semiconductor such as diodes, thyristors.

These square body fuse-links are available in various body sizes with a broad range of ampere ratings allowing the greatest flexibility in equipment design.

They have pure silver fuse elements embedded in solidified sand which provides optimized I^2t and high breaking capacity. All contact surfaces are plated and all hardware non-magnetic.

All fuses are standard with a low voltage blown fuse indicator. This indicator can operate a microswitch which is easily mounted directly on to the fuse in service.

Feature

- Full range (gR curve), fast acting
- Highly current limiting.
- High breaking capacities
- Very low I^2t
- Worldwide mounting acceptance.
- Superior cycling ability.
- High withstanding in rush current and overloads

Ratings

AC: up to 1000 A 690 VAC
150 kA IR

DC: Consult Factory

Applications

Protection of rectifiers, inverters, static switch, AC & DC drives and UPS systems.

AC: Tested to IEC 60269.4

approvals

Features/Benefits

Wide range of mounting styles

Broad range of ampere ratings in each body size for design flexibility

IEC 60269-4 compliance for fuses for worldwide semiconductor applications



Protistor® Square-body Fuses PSC gR sizes 7x - 690 VAC Main characteristics

Voltage	Size	Type	Rating In (A)	Pre-Arcing I ² t @ 1ms kA ² s	Total I ² t @ 690V kA ² s	PN: Power losses (W)				Breaking capacities (kA)
						End contacts		Blades		
						0,8 In	In	0,8In	In	
690V	70	gRB	50	0,12	0,7	9	17	9	17	150
		gRB	63	0,27	1,6	9	18	9	18	
		gRB	80	0,47	2,8	11	22	11	22	
		gRB	100	1,06	6,2	12	23	12	23	
		gRB	125	1,9	11,2	13	26	13	26	
		gRB	160	4,2	25	15	29	15	29	
		gRB	200	7,5	44	17	33	17	34	
		gRB	250	13,5	79	20	39	20	40	
		gRB	315	24	142	23	46	24	47	
	gRB	350	41	240	23	46	24	47		
	71	gRB	125	1,06	6,2	18	35	18	35	
		gRB	160	2,4	14	19	38	19	38	
		gRB	200	5	29,5	21	41	21	42	
		gRB	250	9,5	56	23	46	24	48	
		gRB	315	18,5	108	27	53	27	54	
		gRB	350	23	140	29	58	30	60	
		gRB	400	38	225	30	59	31	61	
		gRB	450	62	360	30	59	31	61	
		gRB	500	78	460	32	64	34	67	
	72	gRB	200	4,2	25	23	45	23	45	
		gRB	250	8,5	50	25	49	25	50	
		gRB	315	17	100	28	55	29	57	
		gRB	350	23	140	29	58	30	60	
		gRB	400	34	200	32	63	33	65	
		gRB	450	47	280	34	67	35	70	
		gRB	500	68	400	35	69	36	72	
		gRB	550	84	495	38	75	39	78	
		gRB	630	124	730	41	81	43	86	
	73	gRB	700	155	910	45	89	48	95	
		gRB	315	12	69	33	66	34	67	
		gRB	350	17	100	34	68	35	69	
		gRB	400	27	160	36	71	37	73	
		gRB	450	34	200	40	79	41	82	
		gRB	500	47	280	42	84	43	86	
		gRB	550	68	400	42	84	44	87	
		gRB	630	102	600	45	89	47	94	
gRB		700	139	820	47	94	50	100		
gRB	800	227	1330	48	96	52	104			
gRB	900	280	1640	55	109	60	119			
gRB	1000	385	2270	58	115	64	127			

Time/current characteristics
Cut off characteristics
Total I²t and total operating time
Other curves

} see following pages

Semiconductor (AC) fuses

Protistor® Square-body Fuses PSC gR sizes 7x - 690 VAC French 70-73 End contacts

Size	Designation	Reference Number	Weight (g)	Catalog Number
70	6,9 gRB 70 TTF 050	C301279	340	PC70GB69V50TF
	6,9 gRB 70 TTF 063	D301280		PC70GB69V63TF
	6,9 gRB 70 TTF 080	E301281		PC70GB69V80TF
	6,9 gRB 70 TTF 100	F301282		PC70GB69V100TF
	6,9 gRB 70 TTF 125	G301283		PC70GB69V125TF
	6,9 gRB 70 TTF 160	L301310		PC70GB69V160TF
	6,9 gRB 70 TTF 200	M301311		PC70GB69V200TF
	6,9 gRB 70 TTF 250	N301312		PC70GB69V250TF
	6,9 gRB 70 TTF 315	P301313		PC70GB69V315TF
6,9 gRB 70 TTF 350				
71	6,9 gRB 71 TTF 125	Q301314	520	PC71GB69V125TF
	6,9 gRB 71 TTF 160	R301315		PC71GB69V160TF
	6,9 gRB 71 TTF 200	S301316		PC71GB69V200TF
	6,9 gRB 71 TTF 250	T301317		PC71GB69V250TF
	6,9 gRB 71 TTF 315	N301427		PC71GB69V315TF
	6,9 gRB 71 TTF 350	V301318		PC71GB69V350TF
	6,9 gRB 71 TTF 400	W301319		PC71GB69V400TF
	6,9 gRB 71 TTF 450	X301320		PC71GB69V450TF
	6,9 gRB 71 TTF 500	S301707		PC71GB69V500TF
6,9 gRB 72 TTF 200	F301328	810	PC72GB69V200TF	
6,9 gRB 72 TTF 250	G301329		PC72GB69V250TF	
6,9 gRB 72 TTF 315	H301330		PC72GB69V315TF	
6,9 gRB 72 TTF 350	W301710		PC72GB69V350TF	
6,9 gRB 72 TTF 400	J301331		PC72GB69V400TF	
6,9 gRB 72 TTF 450	X301711		PC72GB69V450TF	
6,9 gRB 72 TTF 500	K301332		PC72GB69V500TF	
6,9 gRB 72 TTF 550	L301333		PC72GB69V550TF	
6,9 gRB 72 TTF 630	M301334		PC72GB69V630TF	
6,9 gRB 72 TTF 700	Y301712	PC72GB69V700TF		
73	6,9 gRB 73 TTF 315	W301342	1220	PC73GB69V315TF
	6,9 gRB 73 TTF 350	B301715		PC73GB69V350TF
	6,9 gRB 73 TTF 400	X301343		PC73GB69V400TF
	6,9 gRB 73 TTF 450	Y301344		PC73GB69V450TF
	6,9 gRB 73 TTF 500	C301716		PC73GB69V500TF
	6,9 gRB 73 TTF 550	Z301345		PC73GB69V550TF
	6,9 gRB 73 TTF 630	A301346		PC73GB69V630TF
	6,9 gRB 73 TTF 700	B301347		PC73GB69V700TF
	6,9 gRB 73 TTF 800	D301717		PC73GB69V800TF
6,9 gRB 73 TTF 900	S301638	PC73GB69V900TF		
6,9 gRB 73 TTF 1000	F301719	PC73GB69V100TF		

Packaging: 3 pieces sizes 70 and 71 / 1 piece size 72 and 73

Microswitches: MS 7V 1-5

MS 7V 1-5 UR

MS 7V 1-5 BS

MS 7V 1-9 BS

MS 7V 1-5 ET



Réf.J310002

Réf.Z310039

Réf.K310003

Réf.P310007

Réf.S310010

Standard NO-NC

Standard NO-NC

Low level NO-NC

Double pole NO-NC-low level

Low level NO-NC-IP 50

Threaded studs and Microswitches supplied separately

Size	A	B	C	D	L	d	G ²	P
70	39,8	41,8	46,5	26	74	M 8	6	81,8
	1.57"	1.65"	1.83"	1.02"	2.91"		0.24"	3.22"
71	51	51	56,5	30	74	M 8	9	85.5
	2.00"	2.00"	2.22"	1.18"	2.91"		0.35"	3.37"
72	60	60	65.5	38	74	M 10	9	93.6
	2.36"	2.36"	2.58"	1.50"	2.91"		0.35"	3.69"
73	74,4	74,4	78,5	46	74	M 12	9	107.6
	2.93"	2.93"	3.09"	1.81"	2.91"		0.35"	4.24"

Fuse holder solution, see Fuse gear section.

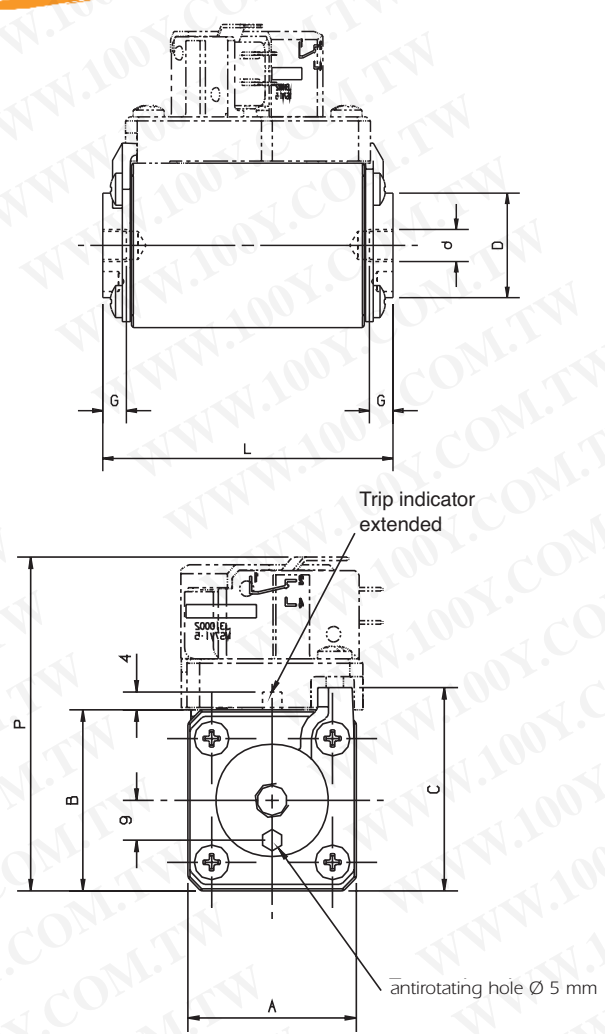

Threaded studs :

- M8 x 20 mm: Réf.V099171
 - M10 x 30 mm: Réf.M099946
 - M12 x 35 mm: Réf.J099966
- exists in other length

Semiconductor (AC) fuses



Protistor® Square-body Fuses PSC gR sizes 7x - 690 VAC French 70-73 Blades

Size	Designation	Reference Number	Weight (g)	Catalog Number
70	6,9 gRB 70 EF 050	P301405	370	PC70GB69V50EF
	6,9 gRB 70 EF 063	Q301406		PC70GB69V63EF
	6,9 gRB 70 EF 080	R301407		PC70GB69V80EF
	6,9 gRB 70 EF 100	S301408		PC70GB69V100EF
	6,9 gRB 70 EF 125	T301409		PC70GB69V125EF
	6,9 gRB 70 EF 160	V301410		PC70GB69V160EF
	6,9 gRB 70 EF 200			
	6,9 gRB 70 EF 250			
	6,9 gRB 70 EF 315			
71	6,9 gRB 71 EF 125	Y301321	540	PC71GB69V125EF
	6,9 gRB 71 EF 160	Z301322		PC71GB69V160EF
	6,9 gRB 71 EF 200	A301323		PC71GB69V200EF
	6,9 gRB 71 EF 250	B301324		PC71GB69V250EF
	6,9 gRB 71 EF 315			
	6,9 gRB 71 EF 350	C301325		PC71GB69V350EF
	6,9 gRB 71 EF 400	D301326		PC71GB69V400EF
	6,9 gRB 71 EF 450	E301327		PC71GB69V450EF
	6,9 gRB 71 EF 500	G301858		PC71GB69V500EF
72	6,9 gRB 72 EF 200	N301335	810	PC72GB69V200EF
	6,9 gRB 72 EF 250	P301336		PC72GB69V250EF
	6,9 gRB 72 EF 315	Q301337		PC72GB69V315EF
	6,9 gRB 72 EF 350			
	6,9 gRB 72 EF 400	R301338		PC72GB69V400EF
	6,9 gRB 72 EF 450			
	6,9 gRB 72 EF 500	S301339		PC72GB69V500EF
	6,9 gRB 72 EF 550	T301340		PC72GB69V550EF
	6,9 gRB 72 EF 630	V301341		PC72GB69V630EF
73	6,9 gRB 73 EF 315	C301348	1150	PC73GB69V315EF
	6,9 gRB 73 EF 350			
	6,9 gRB 73 EF 400	D301349		PC73GB69V400EF
	6,9 gRB 73 EF 450	E301350		PC73GB69V450EF
	6,9 gRB 73 EF 500			
	6,9 gRB 73 EF 550	F301351		PC73GB69V550EF
	6,9 gRB 73 EF 630	G301352		PC73GB69V630EF
	6,9 gRB 73 EF 700	H301353		PC73GB69V700EF
	6,9 gRB 73 EF 800			
6,9 gRB 73 EF 900				
6,9 gRB 73 EF 1000				

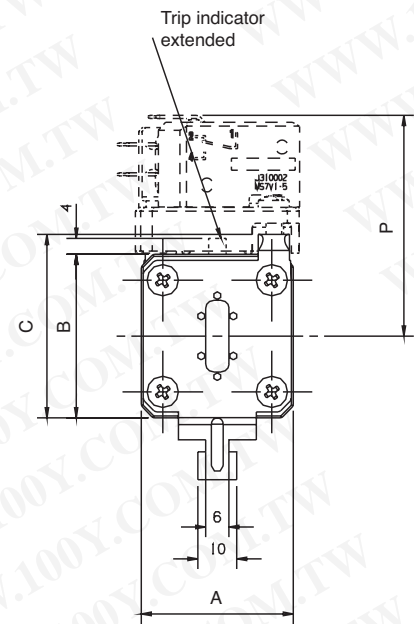
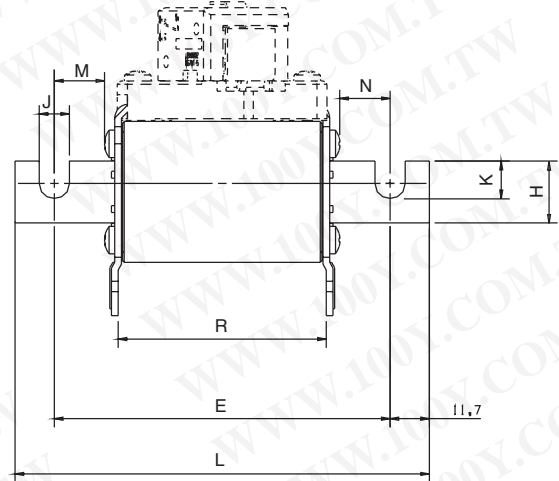

Packaging: 3 pieces sizes 70 and 71 / 1 piece size 72 and 73

Microswitches: MS 7V 1-5		Réf.J310002	Standard NO-NC
MS 7V 1-5 UR		Réf.Z310039	Standard NO-NC
MS 7V 1-5 BS		Réf.K310003	Low level NO-NC
MS 7V 1-9 BS		Réf.P310007	Double pole NO-NC-low level
MS 7V 1-5 ET		Réf.S310010	Low level NO-NC-IP 50

Microswitches supplied separately

Size	A	B	C	E ^{±1,3}	H	J	K	L ^{±1,5}	M	N	P	R
70	39,8	41,8	46,5	100	18	9	11	123,4	28,2	28,2	77	68
	1.57"	1.65"	1.83"	3.94"	0.71"	0.35"	0.43"	4.86"	1.11"	1.11"	3.03"	2.68"
71	51	51	56,5	110	25	10,5	16	133,4	32,7	32,7	91	68
	2.00"	2.00"	2.22"	4.33"	0.98"	0.41"	0.63"	5.25"	1.29"	1.29"	3.58"	2.68"
72	60	60	65,5	114,4	32	13	21,2	149,4	40,7	40,7	100	68
	2.36"	2.36"	2.58"	4.50"	1.26"	0.51"	0.83"	5.88"	1.60"	1.60"	3.93"	2.68"
73	74,4	74,4	78,5	114,4	40	13	19,5	149,4	40,7	40,7	114,4	68
	2.93"	2.93"	3.09"	4.50"	1.58"	0.51"	0.77"	5.88"	1.60"	1.60"	4.50"	2.68"

Reinforced and longer knives available under designation ESF
Fuse holder solution, see Fuse gear section.

Semiconductor (AC) fuses

Protistor® Square-body Fuses PSC gR sizes 7x - 690 VAC German 70-73 End contacts

Size	Designation	Reference Number	Weight (g)	Catalog Number
70*	6,9 gRB 70 D11A 050			
	6,9 gRB 70 D11A 063			
	6,9 gRB 70 D11A 080			
	6,9 gRB 70 D11A 100	Q302027		PC70GB69V100D1A
	6,9 gRB 70 D11A 125			
	6,9 gRB 70 D11A 160	R301591	370	PC70GB69V160D1A
	6,9 gRB 70 D11A 200	S301592		PC70GB69V200D1A
	6,9 gRB 70 D11A 250	Z301943		PC70GB69V250D1A
	6,9 gRB 70 D11A 315	J301584		PC70GB69V315D1A
	6,9 gRB 70 D11A 350	W302124		PC70GB69V350D1A
	6,9 gRB 71 D11A 125	B302658		PC71GB69V125D1A
	6,9 gRB 71 D11A 160	C302659		PC71GB69V160D1A
	6,9 gRB 71 D11A 200	C302682		PC71GB69V200D1A
	6,9 gRB 71 D11A 250	R302143		PC71GB69V250D1A
	6,9 gRB 71 D11A 315			
71*	6,9 gRB 71 D11A 350	T302214	540	PC71GB69V350D1A
	6,9 gRB 71 D11A 400			
	6,9 gRB 71 D11A 450	R301637		PC71GB69V450D1A
	6,9 gRB 71 D11A 500	A301737		PC71GB69V500D1A
	6,9 gRB 72 D11A 200			
72**	6,9 gRB 72 D11A 250	T302697		
	6,9 gRB 72 D11A 315	V302698		
	6,9 gRB 72 D11A 350	E302500		PC72GB69V350D1A
	6,9 gRB 72 D11A 400	V302215		PC72GB69V400D1A
	6,9 gRB 72 D11A 450	Q302671	800	PC72GB69V450D1A
	6,9 gRB 72 D11A 500			
	6,9 gRB 72 D11A 550	L301724		PC72GB69V550D1A
	6,9 gRB 72 D11A 630			
	6,9 gRB 72 D11A 700			
	73**	6,9 gRB 73 D11A 315		
6,9 gRB 73 D11A 350				
6,9 gRB 73 D11A 400				
6,9 gRB 73 D11A 450				
6,9 gRB 73 D11A 500		W302216		PC73GB69V500D1A
6,9 gRB 73 D11A 550		R302672	1150	PC73GB69V550D1A
6,9 gRB 73 D11A 630				
6,9 gRB 73 D11A 700		F301765		PC73GB69V700D1A
6,9 gRB 73 D11A 800				
6,9 gRB 73 D11A 900				
6,9 gRB 73 D11A 1000	S302673		PC73GB69V10CD1A	

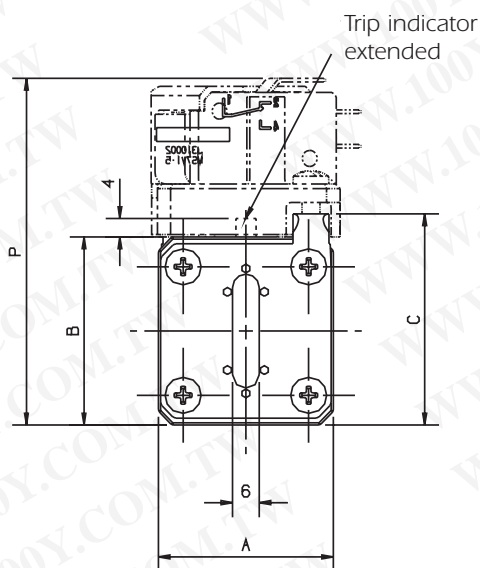
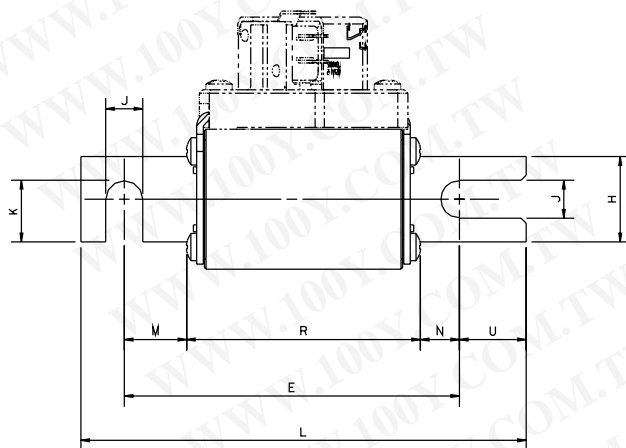

Packaging: *3 pieces
** 1 piece

Microswitches: MS 7V 1-5
MS 7V 1-5 UR
MS 7V 1-5 BS
MS 7V 1-9 BS
MS 7V 1-5 ET



Réf.J310002
Réf.Z310039
Réf.K310003
Réf.P310007
Réf.S310010

Standard NO-NC
Standard NO-NC
Low level NO-NC
Double pole NO-NC-low level
Low level NO-NC-IP 50

Microswitches supplied separately

Size	A	B	C	E ^{1,3}	H	J	K	L	M	N	P	R
70	39,8	41,8	46,5	100,4	25	10,5	17,7	133,4	18,5	11,5	81,4	70,4
	1.57"	1.65"	1.83"	3.95"	0.98"	0.41"	0.70"	5.25"	0.73"	0.43"	3.20"	2.77"
71	51	51	56,5	100,4	25	10,5	17,7	133,4	18,5	11,5	91	70,4
	2.00"	2.00"	2.22"	3.95"	0.98"	0.41"	0.70"	5.25"	0.73"	0.45"	3.68"	2.77"
72	60	60	65,5	100,4	32	11,1	21,2	133,4	18,5	11,5	93,6	70,4
	2.36"	2.36"	2.58"	3.95"	1.26"	0.44"	0.83"	5.25"	0.73"	0.45"	3.69"	2.77"
73	74,4	74,4	78,5	100,4	40	10,5	25,2	133,4	18	11	114,4	70,4
	2.93"	2.93"	3.09"	3.95"	1.58"	0.41"	1.00"	5.25"	0.71"	0.43"	4.50"	2.77"

Fuse holder solution, see Fuse gear section.

Semiconductor (AC) fuses



Protistor® Square-body Fuses PSC gR sizes 7x - 690 VAC IEC Terminals 70-73 Plain Blades

Size	Designation	Reference Number	Weight (g)	Catalog Number
70*	6,9 gRB 70 PA 050	Q301245	340	PC70GB69V50PA
	6,9 gRB 70 PA 063	R301246		PC70GB69V63PA
	6,9 gRB 70 PA 080	S301247		PC70GB69V80PA
	6,9 gRB 70 PA 100	T301248		PC70GB69V100PA
	6,9 gRB 70 PA 125	T301179		PC70GB69V125PA
	6,9 gRB 70 PA 160	F301190		PC70GB69V160PA
	6,9 gRB 70 PA 200	S301178		PC70GB69V200PA
	6,9 gRB 70 PA 250	V301249		PC70GB69V250PA
	6,9 gRB 70 PA 315	W301250		PC70GB69V315PA
71*	6,9 gRB 70 PA 350	X301251	550	PC70GB69V350PA
	6,9 gRB 71 PA 125	Y301252		PC71GB69V125PA
	6,9 gRB 71 PA 160	Z301253		PC71GB69V160PA
	6,9 gRB 71 PA 200	A301254		PC71GB69V200PA
	6,9 gRB 71 PA 250	B301255		PC71GB69V250PA
	6,9 gRB 71 PA 315	R301177		PC71GB69V315PA
	6,9 gRB 71 PA 350	E301258		PC71GB69V350PA
	6,9 gRB 71 PA 400	V301226		PC71GB69V400PA
	6,9 gRB 71 PA 450	C301256		PC71GB69V450PA
72*	6,9 gRB 71 PA 500	D301257	820	PC71GB69V500PA
	6,9 gRB 72 PA 200	F301259		PC72GB69V200PA
	6,9 gRB 72 PA 250	G301260		PC72GB69V250PA
	6,9 gRB 72 PA 315	H301261		PC72GB69V315PA
	6,9 gRB 72 PA 350	J301262		PC72GB69V350PA
	6,9 gRB 72 PA 400	K301263		PC72GB69V400PA
	6,9 gRB 72 PA 450	L301264		PC72GB69V450PA
	6,9 gRB 72 PA 500	M301265		PC72GB69V500PA
	73**	6,9 gRB 72 PA 550		N301266
6,9 gRB 72 PA 630		P301267	PC72GB69V630PA	
6,9 gRB 72 PA 700		Q301268	PC72GB69V700PA	
6,9 gRB 73 PA 315		R301269	PC73GB69V315PA	
6,9 gRB 73 PA 350		S301270	PC73GB69V350PA	
6,9 gRB 73 PA 400		T301271	PC73GB69V400PA	
6,9 gRB 73 PA 450		V301272	PC73GB69V450PA	
6,9 gRB 73 PA 500		W301273	PC73GB69V500PA	
6,9 gRB 73 PA 550		N301404	PC73GB69V550PA	
	6,9 gRB 73 PA 630	X301274		PC73GB69V630PA
	6,9 gRB 73 PA 700	Y301275		PC73GB69V700PA
	6,9 gRB 73 PA 800	Z301276		PC73GB69V800PA
	6,9 gRB 73 PA 900	A301277		PC73GB69V900PA
	6,9 gRB 73 PA 1000	B301278		PC73GB69V1000PA

Packaging: *3 pieces - ** 1 piece

Size Fuses	Microswitches
70	MS PA 2-5T70 Réf.T210398 OF Standard
	MS PA 2-9T70 Réf.V210399 Double OF side by side
	MS PA 2-5 B2T70 Réf.W210400 OF Terminals 2.8 mm
71-72-73	MS PA 2-5 Réf.H210158 OF Standard
	MS PA 2-9V Réf.J210159 Double OF side by side
	MS PA 2-5 B2 Réf.C210160 OF Terminals 2.8 mm

Microswitches supplied separately

Size	A	B	C	H	L ^{±1.5}	M	N	P	R
70	39,8	41,8	57	18	123,4	26,2	26,2	90	67
	1.57"	1.65"	2.24"	0.71"	4.86"	1.03"	1.03"	3.54"	2.64"
71	51	51	63	25	133,4	26,2	26,2	96	68
	2.00"	2.00"	2.48"	0.98"	5.25"	1.03"	1.03"	3.79"	2.68"
72	60	60	72	32	149,4	39,2	39,2	105	68
	2.36"	2.36"	2.84"	1.26"	5.88"	1.54"	1.54"	4.15"	2.68"
73	74,4	74,4	87,5	40	149,4	39,2	39,2	121	68
	2.93"	2.93"	3.45"	1.58"	5.88"	1.54"	1.54"	4.76"	2.68"

180° position trip indicator available under PV designation but no microswitch possible Fuse holder solution, see Gear and Fuse gear section

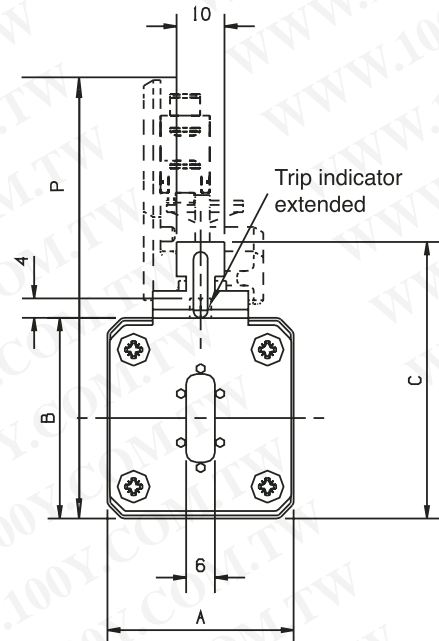
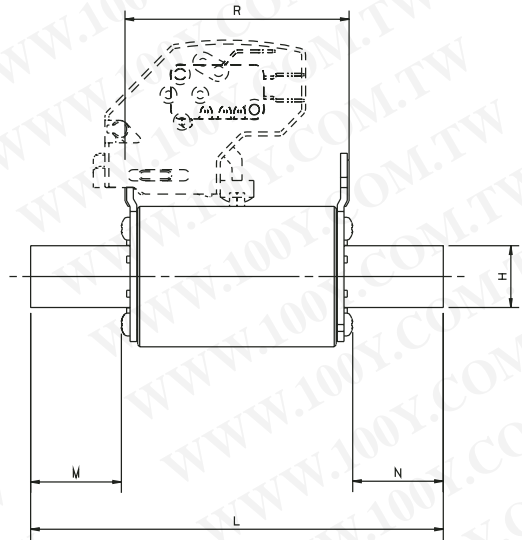

Semiconductor (AC) fuses

Protistor® Square-body Fuses PSC gR sizes 7x - 690 VAC Curves set

Times/Current Characteristics

Size 70

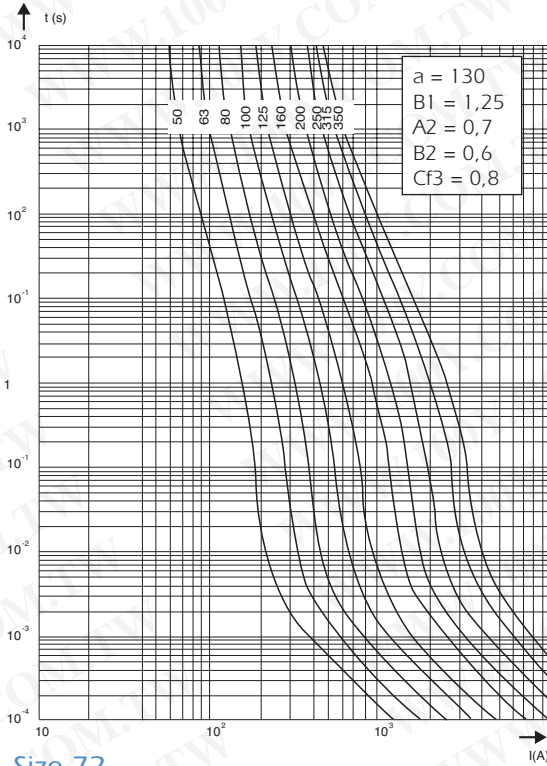

Size 71

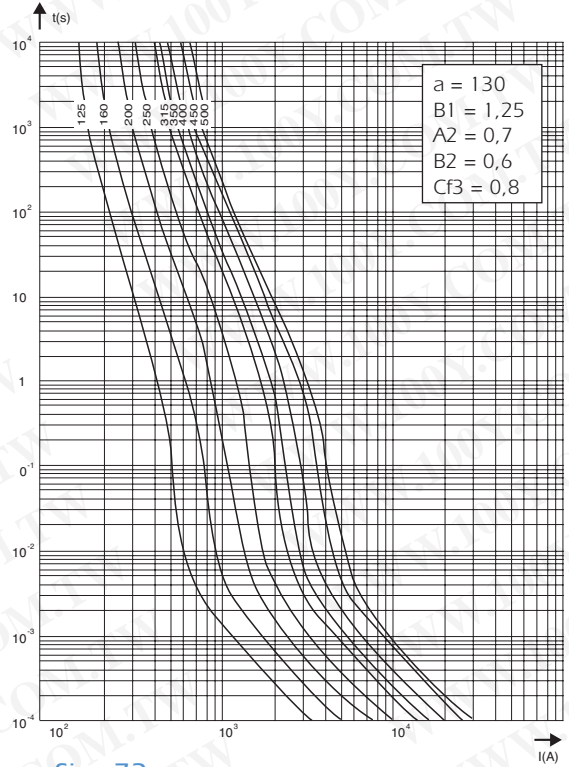

Size 72

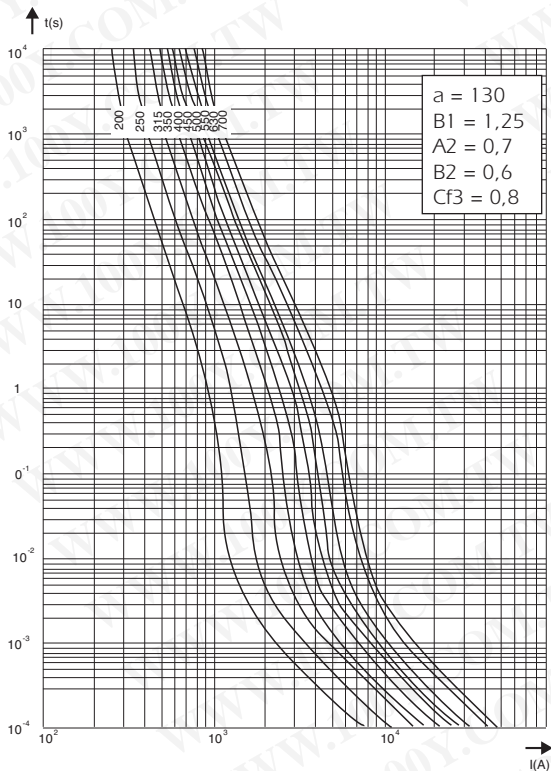

Size 73

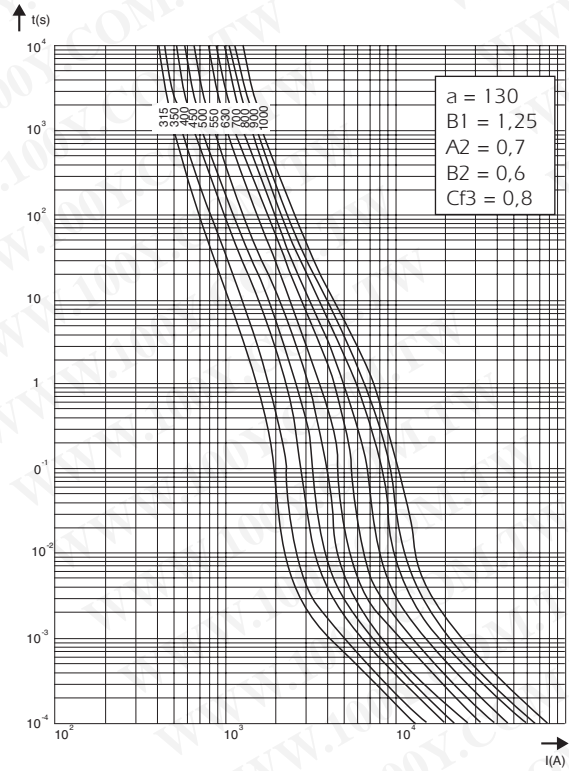

Semiconductor (AC) fuses



Protistor® Square-body Fuses PSC gR sizes 7x - 690 VAC Curves set

Cut off characteristics Peak let thru current

Size 70

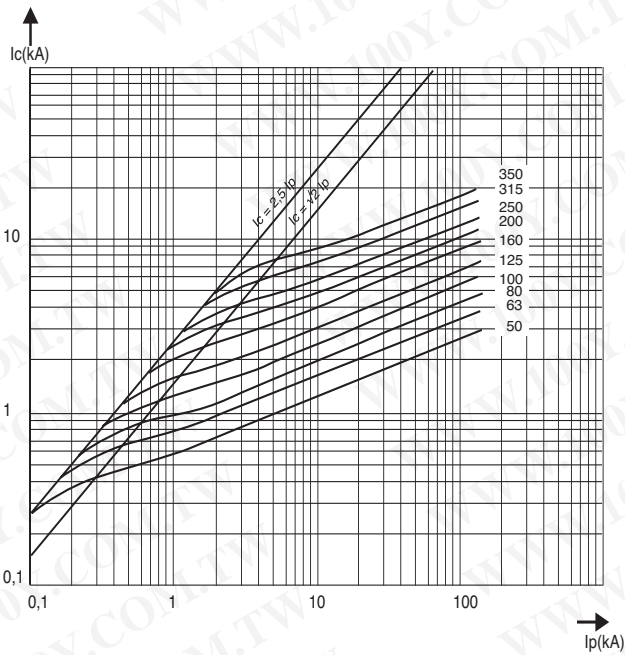

Size 71

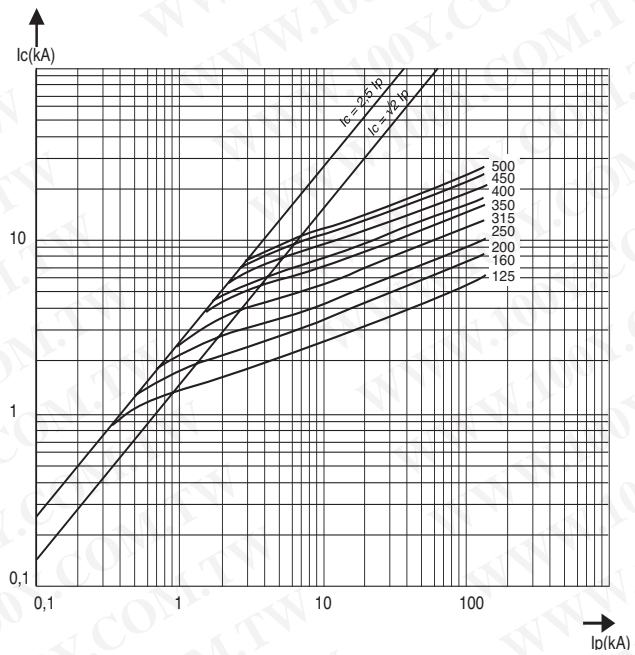

Size 72

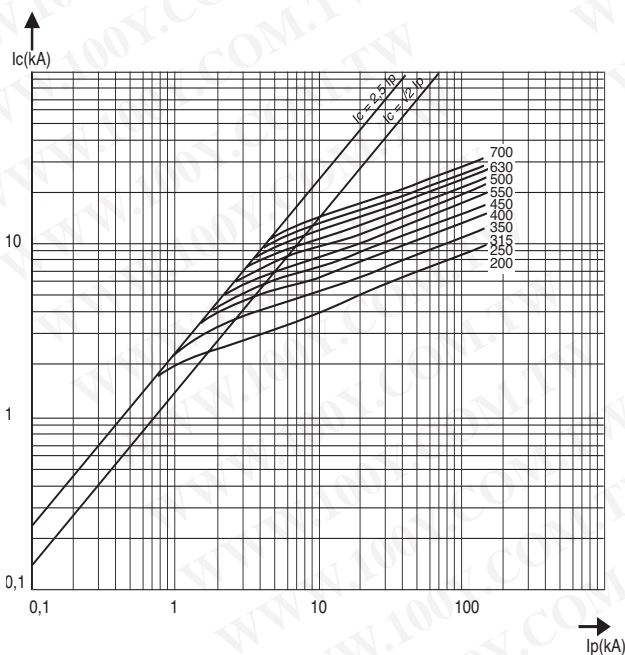

Size 73

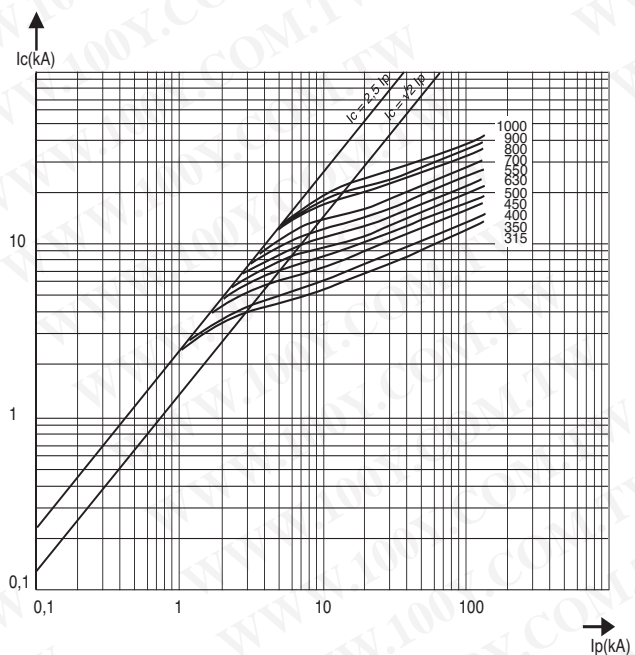

Semiconductor (AC) fuses

Protistor® Square-body Fuses PSC gR sizes 7x - 690 VAC Curves set

Total I²t and total operating time @ 690 V

Size 70

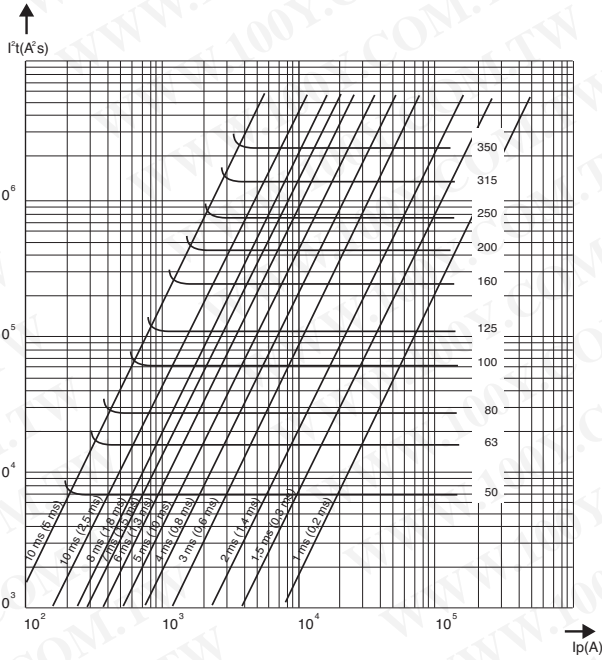

Value between parentheses pertain to pre-arcing I²t

Size 71

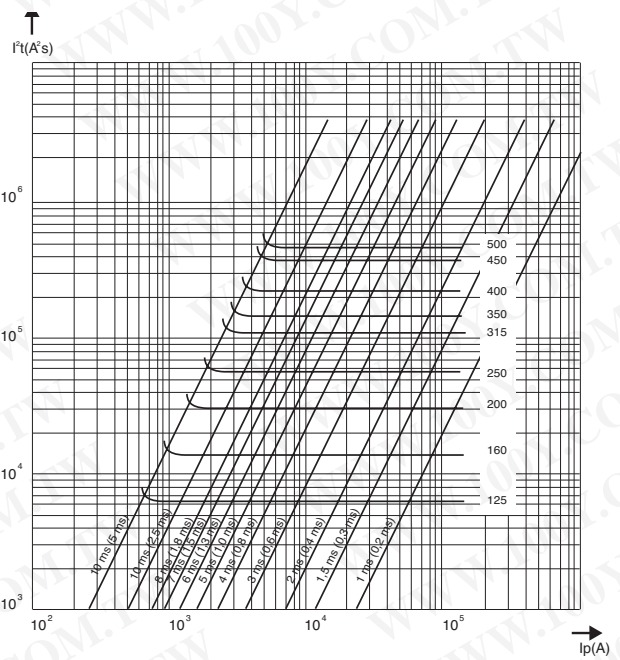

Size 72

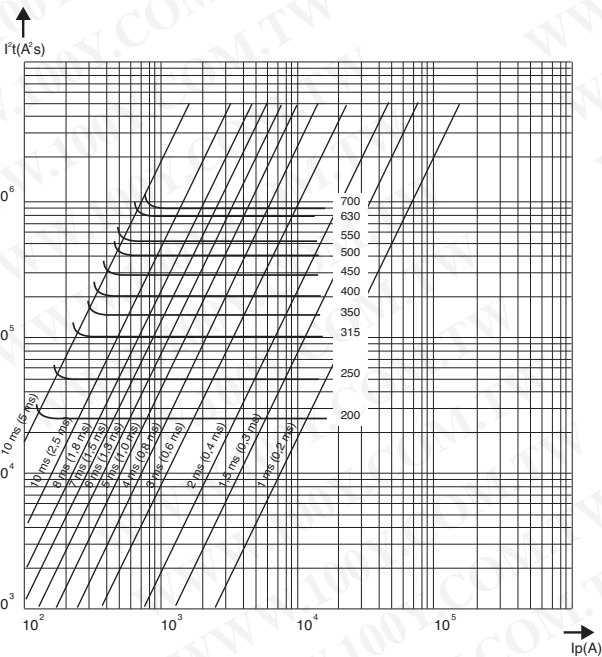

Value between parentheses pertain to pre-arcing I²t

Size 73

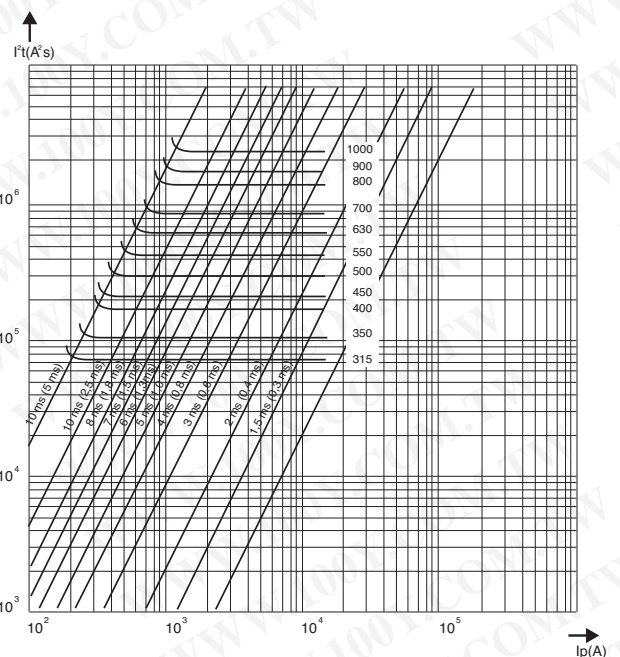

Semiconductor (AC) fuses



Protistor® Square-body Fuses PSC gR sizes 7x - 690 VAC Curves set

$k=f(U)$
Multiplier coefficient
to calculate total I^2t
and total operating time

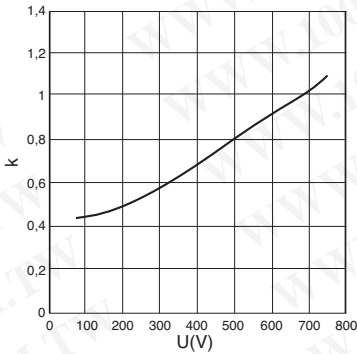

P/PN
Multiplier coefficient
to calculate the power
losses at various currents

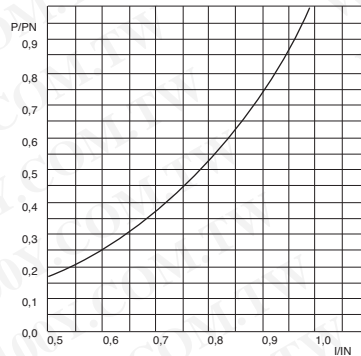

Peak arc voltage

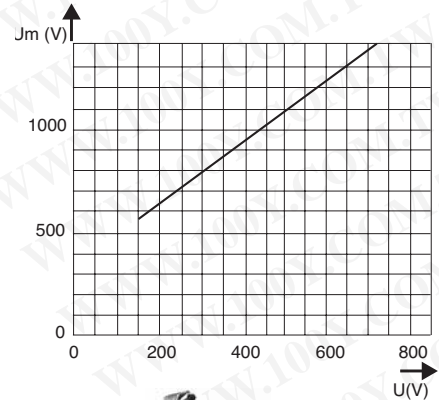

PA terminals fuse holder

Size	1 pole	2 poles	3 poles	4 poles	wall	separators	fuse shields
70	T218241	G218759	W219278	H222486	Z213669	V216724	K200822
71	A223008	G200796	Y201340	H201855	J214690	N217753	M222513
72	E211075	V211595	D212109	R212627	J214690	N217753	Y211621
73	X213644	B214154	F214664	K215174	Q215708	M218787	X212655



End contacts TTF terminal fuse holders

Size	1 pole
70/71	C301233
72/73	E301235



French blades EF terminal fuse holders

Size	SP/SE/SF
70	F096099
71	V098711
72	W098712
73	C209187



Din blades 110 mm DI N 43653 terminal fuse holders

Size	Fuses holders
70/71/72/73	L091941

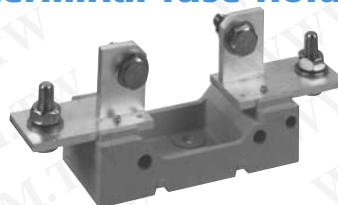

Warning: for all holders, please check maximum fuse and fuse holders operating limit. in Gear and Fuse gear section
Tightning torque see Gear and Fuse gear section.

Protistor® Square-body Fuses PSC gR sizes 7x - 690 VAC Microswitches PSC 3x & 7x

- MICROSWITCH SYSTEMS ADAPTED TO THE FOLLOWING FERRAZ SHAWMUT FUSES ONLY:
- PSC sizes 30, 31, 32, 33, 2x32, 2x33 / 70, 71, 72, 73, 272, 273 except plain blades
- PSC LR sizes 33, 233, 73, 273
- PERMANENT INDICATION OF FUSE STATE: CONDUCTIVE
BLOWN
- MANUAL RESETTING
- STANDARD AND LOW ELECTRICAL LEVEL WITH DIFFERENT INSULATION LEVELS
- BS TYPE FOR USE IN CORROSIVE ATMOSPHERE
- MS 3V 1-5 UR AND MS 7V 1-5 UR TYPE UL ARE RECOGNIZED



MS 7V 1-5

Main Characteristics

Code	AC Insulation voltage rating (***)	Positive operating voltage/current	Current rating	Current	Breaking Capacity						AC voltage withstand test (*)	Impulse voltage test Uimp1.2/50 µs (**)	Fire class according to UL 94
					Non inductive circuit			Inductive circuit : L/R = 25ms					
					30V	110V	250V	30V	110V	250V			
MS 3V 1-5	1000 V	20 V 50 mA	10 A	50/60 Hz	10 A	10 A	10 A	10 A	10 A	10 A	8,5 kV	14 kV	H.B
MS 3V 1-5 UR				DC	8 A	0,4 A	0,2 A	4 A	0,2 A	0,1 A			
MS 7V 1-5	1500V	10 V 10 mA	3 A	50/60 Hz	3 A	3 A	3 A	2 A	1 A	1 A	12 kV	20 kV	
MS 7V 1-5 UR				DC	3 A	0,5 A	0,25 A	3 A	0,2 A	0,1 A			
MS 3V 1-5 BS	1000 V	10 V 10 mA	3 A	50/60 Hz	3 A	3 A	3 A	2 A	1 A	1 A	8,5 kV	14 kV	
MS 3V 1-9 BS				DC	3 A	0,5 A	0,25 A	3 A	0,2 A	0,1 A			
MS 7V 1-5 BS	1500V	10 V 10 mA	3 A	50/60 Hz	3 A	3 A	3 A	2 A	1 A	1 A	8,5 kV	14 kV	
MS 7V 1-9 BS				DC	3 A	0,5 A	-	2 A	0,2 A	-			
MS 3V 1-5 ET	1000V	10 V	3 A	50/60 Hz	3 A	3 A	3 A	2 A	1 A	1 A	8,5 kV	14 kV	
MS 7V 1-5 ET	1500V	10 mA		DC	3 A	0,5 A	-	2 A	0,2 A	-	12 kV	20 kV	

* Between power circuit and microswitch terminals as per IEC 60 and 694 and NFC 64010 (50/60 Hz 1 min duration in dry air)

** Between power circuit and microswitch terminals Uimp: impulse voltage as per IEC 60947-1

*** Between power circuit and microswitch terminals

Warning: microswitch systems exclusively designed for FERRAZ SHAWMUT.
PSC Fuses fitted a patented trip-indicator, saving use of EDV



Protistor® Square-body Fuses PSC gR sizes 7x - 690 VAC Microswitches for PSC 3x & 7x

Indication systems for PSC Fuse sizes 30 to 73 MS 3V...

These patented indication systems are exclusively hand resettable.

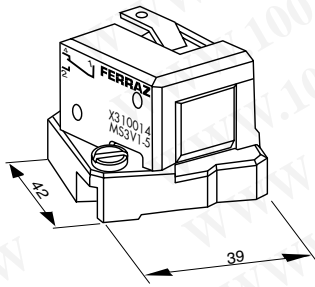

(fig. 1)

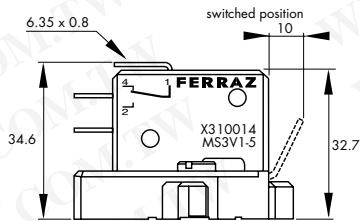

Fuse size	Designation	Ref. Number	Indication style	Weight (g)	Pack.	Catalog Number
30, 31 32, 33	MS 3V 1-5 (fig.1)	X310014	Standard NO-NC	34	3 pieces	MS3 V1-5
	MS 3V 1-5 UR	Y310038				MS3 V1-5-UR
	MS 3V 1-5 BS (3)	W310013	Low level NO-NC	34	3 pieces	MS3-V1-5BS
	MS 3V 1-9 BS (4)	T310011	Double pole Low level	44	3 pieces	MS3V1-9BS
	MS 3V 1-5 ET (fig.2)	R310009	Low level NO-NC IP 50 (9)	34	3 pieces	MS3V1-5 ETANCHE

(3) Same as fig.1

(4) Same dimensions as figure 1
but with 2 microswitches side by side

(9) Watertightness class

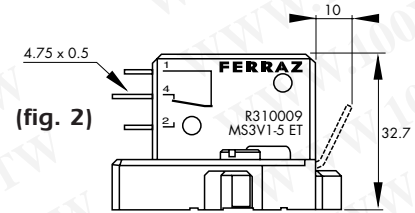

(fig. 2)

MS 7V...

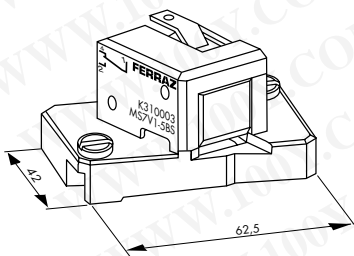

(fig. 5)

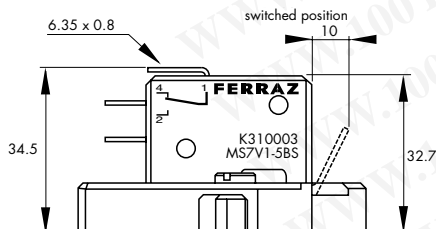

Fuse size	Designation	Ref. Number	Indication style	Weight (g)	Pack.	Catalog Number
70, 71 72, 73	MS 7V 1-5 (fig.5)	J310002	Standard NO-NC	45	3 pieces	MS7 V1-5
	MS 7V 1-5 UR	Z310039				MS7 V1-5-UR
	MS 7V 1-5 BS (3)	K310003	Low level NO-NC	45	3 pieces	MS7-V1-5BS
	MS 7V 1-9 BS (4)	P310007	Double pole Low level	55	3 pieces	MS7V1-9BS
	MS 7V 1-5 ET (fig.6)	S310010	Low level NO-NC IP 50 (9)	55	3 pieces	MS7V1-5 ETANCHE

(7) Same as fig. 5

(8) Same dimensions as figure 5 but with 2 microswitches side by side

(9) Watertightness class

Warning: Microswitch systems exclusively designed for FERRAZ SHAWMUT PSC fuses fitted with a patented trip-indicator, saving use of EDV.

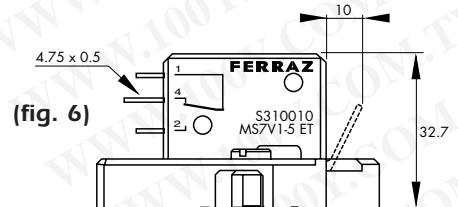

(fig. 6)

Semiconductor (AC) fuses

Protistor® Square-body Fuses PSC gR sizes 7x - 690 VAC Microswitches for PSC 70-73 Plain blades (PA)

MICROSWITCH SYSTEMS ADAPTED TO THE FOLLOWING FERRAZ SHAWMUT FUSES ONLY:

PSC sizes 70, 71, 72, 73 PLAIN BLADES (PA)

MS PA 2-5

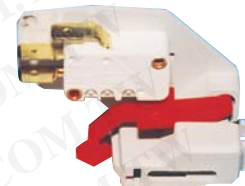

Main Characteristics

Code	AC Insulation voltage rating (***)	Positive operating voltage/current	Current rating	Current	Breaking Capacity						AC voltage withstand test (*)	Impulse voltage test Uimp1.2/50 µs (**)	Fire class according to UL 94
					Non inductive circuit			Inductive circuit : L/R = 25ms					
					30V	110V	250V	30V	110V	250V			
MS PA 2-5	1500 V	20 V	10 A	50/60 Hz	10 A	10 A	10 A	10 A	10 A	10 A	9 kV	13 kV	V0
MS PA 2-9		50 mA		DC	8 A	0,4 A	0,2 A	4 A	0,2 A	0,1 A			
MS PA 2-5 B2	1500 V	20 V/100 mA	5 A	50 Hz	4 A	4 A	5 A	-	5 A	5 A	12 kV	16 kV	V0

* Between power circuit and microswitch terminals as per IEC 60 and 694 and NFC 64010 (50/60 Hz 1 min duration in dry air)

** Between power circuit and microswitch terminals Uimp: impulse voltage as per IEC 60947-1

*** Between power circuit and microswitch terminals

Exclusive "MS PA" indication systems are automatically resettable

Fuse size	Code	Ref. Number	Indication style	Weight (g)	Pack.	Catalog Number
71-72-73	MS PA 2-5	H210158	OF Standard (fig. 7)	32,5	1	MSPA 2-5
	MS PA 2-9V	J210159	Double (fig.7) OF side by side	39,5	1	MSPA 2-9
	MS PA 2-5 B2	C210360	OF Terminals 2,8 (fig. 8)	27	1	MSPA 2-5B2
70	MS PA 2-5	T210398	OF Standard (fig.7)	31	1	MSPA 2-5T70
	MS PA 2-9	V210399	Double (fig.7) OF side by side	37	1	MSPA 2-9T70
	MS PA 2-5 B2	W210400	OF Terminals 2,8 (fig.8)	27	1	MSPA 2-5B2T70

MS PA...

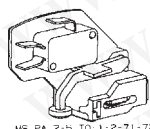
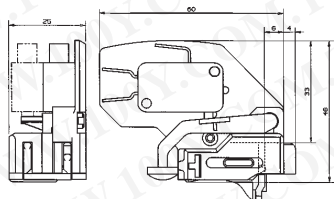

Fig.7

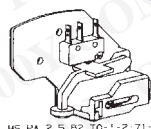

Fig.8

MS PA 2-5 TO 1-2-71-72

MS PA 2-5 B2 TO 1-2-71-72

勝特力材料 886-3-5753170
勝特力电子(上海) 86-21-34970699
勝特力电子(深圳) 86-755-83298787
[Http://www.100y.com.tw](http://www.100y.com.tw)

Semiconductor (AC) fuses

Protistor® Square-body Fuses PSC gR sizes 7x - 690 VAC Metric-studs

Metric studs for threaded terminal fuses



Type and fuse size	Designation	Ref. Number	Unit weight (g)	Pack.	Catalog Number
 Sizes 0 and 1	HC stud pair M8x30 & M8x35	S098801	23	6 pairs	STU M8x30 M8x35
	Size 2 HC stud pair M10x30 & M10x50	T098802	40	6 pairs	STU M10x30 M10x50
Size 3 HC stud pair M12x35 & M12x50	V098803	60	6 pairs	STU M12x35 M12x50	
 Size 2	HC stud pair M10x50	W098804	45	6 pairs	STU M10x50
	Size 3 HC stud pair M12x50	X098805	45	6 pairs	STU M12x50

We recommend the use of studs, whose quality is suited to all FERRAZ SHAWMUT square-body fuses with terminals

Stud mounting

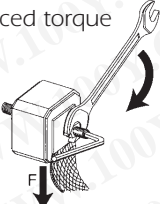
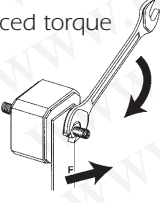
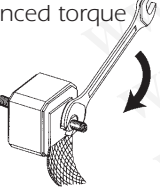
Torque type	Stud type	Maximum stud tightning torque (Nm) (1)	Maximum nut tightning torque (Nm) (1)
Balanced torque 	M8x30 & M8x35	10	13.5
	M10x30 & M10x50	15	26
	M12x35 & M12x50	15	46
Balanced torque 	M8x30 & M8x35	10	13.5
	M10x30 & M10x50	15	26
	M12x35 & M12x50	15	46
Unbalanced torque 	M8x30 & M8x35	10	13.5
	M10x30 & M10x50	15	26
	M12x35 & M12x50	15	46

(1) Factory limit on torque at 20°C ambient: +0, -2Nm; except on 46Nm value (+0, -4Nm)

Semiconductor (AC) fuses

Protistor® Square-body Fuses PSC aR sizes 7x - 650 V to 1300 VAC Main characteristics

 Recognized

650 to 1300VAC / 63 to 2800A.

- Exceptionally low I^2t , Watt losses.
- Non-magnetic construction, highly reliable low voltage.
- Indicator system.
- Conformity to UL, CSA investigated, IEC, DIN and VDE standards.
- Increased technical performance
- Higher ratings.
- Reduction in volume and weight.
- This fuse preselection table indicates, for each size:
 - rated current (or rating) I_n
 - pre-arcing I^2t (I^2t_p) at 1 ms
 - total operating I^2t (I^2t_t) at 1000 V and 850V(I)f=50Hz, $\cos \varphi = 0.15$, and for a total operating time from 8 to 10 ms
 - dissipated power P_n at the rated current I_n , and at 0.8 I_n , in steady state
 - breaking capacity at various voltages, checked by tests made in accordance with IEC and American standards.



Estimated breaking capacity: 300 kA

PSC 650 to 1300VAC US and European standard

Size	Nominal Voltage U_N (VAC)		Ampere Rating (A)	Pre-arcing I^2t @ 1ms (kA ² s)	Total I^2t @ 1000V (*) @ U_n (kA ² s)	Power (W)		Tested Breaking capacity		
	IEC	UL				End contacts	Blades	IEC	USA	
70	1250	1300	50	0,116	0,7	16	16	100kA @ 1250V	100kA @ 1300V	
			63	0,210	1,2	26	26			
			80	0,470	2,7	27	27			
			100	0,830	4,8	30	30			
			125	1,30	7,5	38	38			
	1200	1300	160	2,55	15	45	45	100kA @ 1200V	100kA @ 1300V	
			200	4,7	27	54	56			
			250	9,6	55	58	61			
			280	14	82	61	64			
			315	20	115	66	72			
1100	1200	350	28	158	68	75	150kA @ 1100V	150kA @ 1200V		
		400	39	224	81	90				
		450	62	356	82	82				
		500	84	483	83	83				
		800	900	550	128	576(*)			83	83
750	800	630	176	730(*)	91	91	100kA @ 800V	100kA @ 900V		
		750	800	630	176	730(*)	91	91	100kA @ 750V	100kA @ 800V
71	1250	1300	160	2,6	15	46	46	100kA @ 1250V	100kA @ 1300V	
			200	4,7	27	54	54			
			250	8,9	51	61	61			
			280	12	68	68	70			
			315	16	92	73	76			
			350	22	127	76	80			
			400	38	220	76	80			
	1100	1300 (TTI)	450	47	270	87	95	150kA @ 1100V	150kA @ 1200V	
			500	68	390	90	X			150kA @ 1300V
			500	68	390	X	100			
	1000	1100	550	84	485	98	112	150kA @ 1000V	150kA @ 1100V	
			630	125	725	105	X			
			630	125	725	X	120			
			700	180	1040	105	105			
			900	950	800	290	1540(*)			116
	800	850	900	446	2010(*)	120	120	100kA @ 800V	100kA @ 850V	

(1) at 850 V

(2) does not exist with blades

Semiconductor (AC) fuses



Protistor® Square-body Fuses PSC aR sizes 7x - 650 V to 1300 VAC Main characteristics

PSC 650 to 1300VAC US and European standard

Size	Nominal Voltage U _N (VAC)		Ampere Rating (A)	Pre-arcing I _t @ 1ms (kA _{2s})	Total I ² t @ 1000V (*) @ U _N (kA _{2s})	Power (W)		Tested Breaking capacity Estimated B.C 300 kA	
	IEC	UL				End contacts	Blades	IEC	USA
72	1250	1300	280	10	60	72	72	100kA @ 1250V	100kA @ 1300V
			315	15	87	76	76		
			350	21	120	77	77		
			400	32,5	190	80	80		
			450	44	255	87	89		
			500	57	330	94	98		
	550	68	390	110	120				
	630	105	610	113	X				
	1100	1200	630	105	610	X	125	150kA @ 1100V	150kA @ 1200V
			700	145	815	122	140		
			800	215	1240	125	146		
	1000	1100	700	145	815	X	140	150kA @ 1000V	150kA @ 1100V
800			215	1240	X	146			
900			312	1800	130	152			
850	900	1000	439	2150(*)	136	136	100kA @ 850V	100kA @ 900V	
73	1250	1300	315	12	68	84	84	100kA @ 1250V	100kA @ 1300V
			350	17	100	86	86		
			375	19	110				
			400	25	145	93	93		
			450	35,5	205	99	100		
			500	44	255	110	112		
			550	57	330	116	120		
			630	84	485	125	132		
			700	110	640	135	X		
	800	190	1090	136	X				
	1200	1300	700	110	640	X	146	100kA @ 1200V	100kA @ 1300V
			900	250	1090	150	X		
			800	190	1090	X	148	150kA @ 1100V	150kA @ 1200V
	1100	1200	900	250	1440	X	170	150kA @ 1000V	150kA @ 1100V
			1000	370	2130	152	168		
	1000	1100	1100	445	2555	168	208		
			950	445	2430(*)	168	X	150kA @ 950V	150kA @ 1000V
	900	1000	1000	370	1920(*)	X	174		
1100			445	2280(*)	X	208			
1250			585	3080(*)	186	X	150kA @ 900V	150kA @ 1000V	
1400	1000	1400	755	4100(*)	210	X			
		1400	755	3700(*)	210	X	150kA @ 850V	150kA @ 900V	
850	900	1500	1180	4750(*)	200	X	180kA @ 690V	180kA @ 700V	
		1600	1430	5740(*)	203	X			
690	700	1800	2040	7150(*)	206	X	120kA @ 600V	120kA @ 650V	
		600	650						
2 x 72	1250	1300	630	60	348	160		100kA @ 1250V	
			700	84	480	162			
			800	130	760	168			
			900	176	1020	183			
			1000	228	1320	197			
			1100	272	1560	231			
	1100	1200	1250	426	2440	237		100kA @ 1100V	
			1400	568	3260	256			
			1600	860	4895	262		100kA @ 1000V	
	1000	1100	1800	1250	6350(*)	275		100kA @ 900V	
			2000	1760	7570(*)	285		100kA @ 750V	
	900	1000	2200	2410	8350(*)	320		100kA @ 650V	
2500			3470	12000(*)	340				
2 x 73	1250	1300	800	100	580	195		100kA @ 1250V	
			900	142	820	208			
			1000	176	1000	231			
			1100	228	1300	244			
			1250	336	1900	262			
			1400	440	2600	283			
	1100	1200	1600	760	4400	286		100kA @ 1100V	
			1800	1000	5800	315			
			2000	1480	8500	319		120kA @ 1000V	
	1000	1100	2200	1780	9632(*)	353		100kA @ 950V	
			2500	2340	12075(*)	390		110kA @ 900V	
	950	1000	2800	3000	15000(*)	440		100kA @ 850V	
3000			4980	15700(*)	405				
900	1000	3200	5720	19030(*)	426		200kA @ 600V		
		3600	8160	25200(*)	430		200kA @ 550V		

(1) at 850 V

(2) does not exist with blades

Semiconductor (AC) fuses

Protistor® Square-body Fuses PSC aR sizes 7x - 650 V to 1300 VAC American Terminals - 70 - 73 End contacts

Size	Designation	Reference Number	Weight (g)	Packaging	Catalog Number
70	A130URD 70 TTI 0063	Q301015	350	3	A130UD70TTI63
	A130URD 70 TTI 0080	R301016			A130UD70TTI80
	A130URD 70 TTI 0100	S301017			A130UD70TTI100
	A130URD 70 TTI 0125	T301018			A130UD70TTI125
	A130URD 70 TTI 0160	V301019			A130UD70TTI160
	A130URD 70 TTI 0200	W301020			A130UD70TTI200
	A130URD 70 TTI 0250	X301021			A130UD70TTI250
	A130URD 70 TTI 0280	Y301022			A130UD70TTI280
	A130URD 70 TTI 0315	Z301023			A130UD70TTI315
	A120URD 70 TTI 0350	A301024			A120UD70TTI350
71	A130URD 71 TTI 0160	B301025	500	3	A130UD71TTI160
	A130URD 71 TTI 0200	C301026			A130UD71TTI200
	A130URD 71 TTI 0250	D301027			A130UD71TTI250
	A130URD 71 TTI 0280	E301028			A130UD71TTI280
	A130URD 71 TTI 0315	F301029			A130UD71TTI315
	A130URD 71 TTI 0350	G301030			A130UD71TTI350
	A130URD 71 TTI 0400	H301031			A130UD71TTI400
	A130URD 71 TTI 0450	J301032			A130UD71TTI450
	A130URD 71 TTI 0500	K301033			A130UD71TTI500
	A120URD 71 TTI 0550	L301034			A120UD71TTI550
72	A120URD 71 TTI 0630	M301035	850	3	A120UD71TTI630
	A130URD 72 TTI 0280	N301036			A130UD72TTI280
	A130URD 72 TTI 0315	P301037			A130UD72TTI315
	A130URD 72 TTI 0350	Q301038			A130UD72TTI350
	A130URD 72 TTI 0400	R301039			A130UD72TTI400
	A130URD 72 TTI 0450	S301040			A130UD72TTI450
	A130URD 72 TTI 0500	T301041			A130UD72TTI500
	A130URD 72 TTI 0550	V301042			A130UD72TTI550
	A130URD 72 TTI 0630	W301043			A130UD72TTI630
	A120URD 72 TTI 0700	X301044			A120UD72TTI700
73	A120URD 72 TTI 0800	Y301045	1250	3	A120UD72TTI800
	A130URD 73 TTI 0315	Z301046			A130UD73TTI315
	A130URD 73 TTI 0350	A301047			A130UD73TTI350
	A130URD 73 TTI 0400	B301048			A130UD73TTI400
	A130URD 73 TTI 0450	C301049			A130UD73TTI450
	A130URD 73 TTI 0500	D301050			A130UD73TTI500
	A130URD 73 TTI 0550	E301051			A130UD73TTI550
	A130URD 73 TTI 0630	F301052			A130UD73TTI630
	A130URD 73 TTI 0700	G301053			A130UD73TTI700
	A130URD 73 TTI 0800	H301054			A130UD73TTI800
A130URD 73 TTI 0900 **	J301055	A130UD73TTI900			
A110URD 73 TTI 1000 **	K301056	A110UD73TTI1000			
A100URD 73 TTI 1100 **	L301057	A100UD73TTI1100			
A100URD 73 TTI 1250 **	M301058	A100UD73TTI1250			
A090URD 73 TTI 1400 **	N301059	A090UD73TTI1400			
A070URD 73 TTI 1600 **	O300877	A070UD73TTI1600			
A065URD 73 TTI 1800 **	R300878	A065UD73TTI1800			

Size	A	B	C	D	E±1	d	G±0.1	P±0.1
70	40 1-9/16"	46,5 1-27/32"	82 3-7/32"	26 1-1/64"	74 2-29/32"	5/16"-18	9 23/64"	6 15/64"
71	51 2"	56,5 2-7/32"	91 3-37/64"	30 1-3/16"	74 2-29/32"	5/16"-18	9 23/64"	9 23/64"
72	60 2-3/8"	65,5 2-37/64"	100 3-15/16"	38 ; (42mm **) 1-1/2" ; (1-21/32" **)	74 2-29/32"	3/8"-16	15 19/32"	9 23/64"
73	74,5 2-15/16"	79,5 3-1/8"	114 4-1/2"	46 ; (52mm **) 1-13/16" ; (2-1/16" **)	74 2-29/32"	1/2"-13	15 19/32"	9 23/64"

Note:

Dimensions in mm
Dimensions in inches

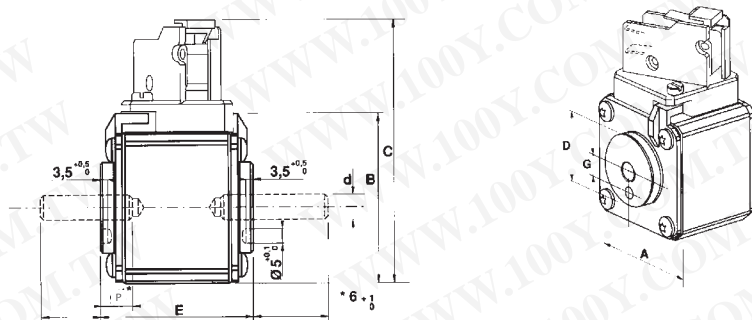

Microswitches and threaded studs supplied separately

Semiconductor (AC) fuses



Protistor® Square-body Fuses PSC aR sizes 7x - 650 V to 1300 VAC American Terminals - 70 - 73 Blades

Size	Designation	Reference Number	Weight (g)	Packaging	Catalog Number
70	A 130 URD 70 LI 0050	-	380	3	-
	A 130 URD 70 LI 0063	W300652			A130UD70LI063
	A 130 URD 70 LI 0080	X300653			A130UD70LI080
	A 130 URD 70 LI 0100	Y300654			A130UD70LI100
	A 130 URD 70 LI 0125	Z300655			A130UD70LI125
	A 130 URD 70 LI 0160	A300656			A130UD70LI160
	A 130 URD 70 LI 0200	B300657			A130UD70LI200
	A 130 URD 70 LI 0250	C300658			A130UD70LI250
	A 130 URD 70 LI 0280	Q300716			A130UD70LI280
	A 130 URD 70 LI 0315	D300659			A130UD70LI315
	A 120 URD 70 LI 0350	E300660			A120UD70LI350
71	A 130 URD 71 LLI0160	E300752	630	3	A130UD71LI160
	A 130 URD 71 LLI0200	F300661			A130UD71LI200
	A 130 URD 71 LLI0250	G300662			A130UD71LI250
	A 130 URD 71 LLI0280	R300717			A130UD71LI280
	A 130 URD 71 LLI0315	H300663			A130UD71LI315
	A 130 URD 71 LLI0350	J300664			A130UD71LI350
	A 130 URD 71 LLI0400	K300665			A130UD71LI400
	A 130 URD 71 LLI0450	L300666			A130UD71LI450
	A 120 URD 71 LLI0500	M300667			A120UD71LI500
	A 120 URD 71 LLI0550	N300668			A120UD71LI550
	A 110 URD 71 LLI0630	P300669			A110UD71LI630
72	A 130 URD 72 LI 0280	Q300670	860	3	A130UD72LI280
	A 130 URD 72 LI 0315	R300671			A130UD72LI315
	A 130 URD 72 LI 0350	S300672			A130UD72LI350
	A 130 URD 72 LI 0400	T300673			A130UD72LI400
	A 130 URD 72 LI 0450	V300674			A130UD72LI450
	A 130 URD 72 LI 0500	W300675			A120UD72LI500
	A 130 URD 72 LI 0550	X300676			A130UD72LI550
	A 120 URD 72 LI 0630	Y300677			A120UD72LI630
	A 110 URD 72 LI 0700	Z300678			A110UD72LI700
	A 110 URD 72 LI 0800	A300679			A110UD72LI800
	73	A 130 URD 73 LI 0315			B300680
A 130 URD 73 LI 0350		C300681	A130UD73LI350		
A 130 URD 73 LI 0400		D300682	A130UD73LI400		
A 130 URD 73 LI 0450		E300683	A130UD73LI450		
A 130 URD 73 LI 0500		F300684	A120UD73LI500		
A 130 URD 73 LI 0550		G300685	A130UD73LI550		
A 130 URD 73 LI 0630		H300686	A130UD73LI630		
A 130 URD 73 LI 0700		J300687	A130UD73LI700		
A 120 URD 73 LI 0800		K300688	A120UD73LI800		
A 110 URD 73 LI 0900		L300689	A110UD73LI900		
A 100 URD 73 LI 1000		M300690	A100UD73LI1000		
A 100 URD 73 LI 1100	N300691	A100UD73LI1100			
A 100 URD 73 LI 1250	J301193	A100UD73LI1250			
A 90 URD 73 LI 1400	K301194	A90UD73LI1400			

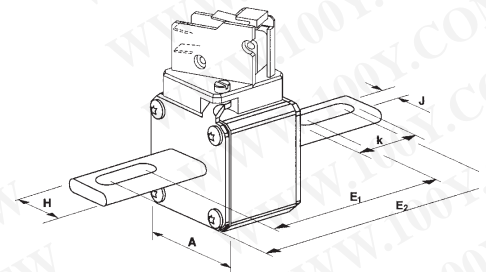
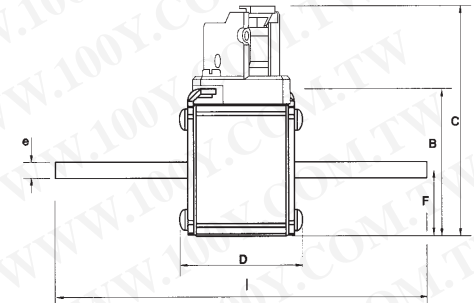

Rated voltage 900 V to 1300 V as per American standard.

Microswitches supplied separately

Size	A	B	C	D	E1±1,3	E2±1,3	F	H	J	k	I±1,5	e
70	40	46,5	82	71	91,4	130,4	21	25	10,5	30	152,4	6
	1-9/16"	1-27/32"	3-7/32"	2-5/32"	3-13/32"	5-1/8"	53/64"	1"	13/32"	1-3/16"	6"	15/64"
71	51	56,5	91	71	91,4	130,4	25,5	25	10,5	30	152,4	6
	2"	2-7/32"	3-37/64"	2-25/32"	3-19/32"	5-1/8"	1"	1"	13/32"	1-3/16"	6"	15/64"
72	60	65,5	100	71	97,6	132,4	30	32	14,6	32	157,4	6
	2-23/64"	2-37/64"	3-15/16"	2-25/32"	3-23/32"	5-13/64"	1-3/16"	1-1/4"	9/16"	1-1/4"	6-3/16"	15/64"
73	74,5	79,5	114	72	98,8	131,4	37,2	40	15,9	32	157,4	6
	2-15/16"	3-1/8"	4-1/2"	2-53/64" (2-15/16")	3-57/64"	5-11/64"	1-15/32"	1-9/16"	5/8"	1-1/4"	6-3/16"	15/64"

Note:
Dimensions in mm
Dimensions in inches

Semiconductor (AC) fuses

Protistor® Square-body Fuses PSC aR sizes 7x - 650 V to 1300 VAC IEC Terminals - French 70 - 73 End contacts

Size	Designation	Reference Number	Weight (g)	Packaging	Catalog Number				
70	12,5 URD 70 TT F 0050	C301095	350	3	PC70UD13C50TF PC70UD13C63TF PC70UD13C80TF PC70UD13C100TF PC70UD13C125TF PC70UD13C160TF PC70UD13C200TF PC70UD13C250TF PC70UD11C350TF PC70UD11C400TF PC70UD11C450TF PC70UD10C500TF PC70UD80V550TF PC71UD13C160TF PC71UD13C200TF PC71UD13C250TF PC71UD13C280TF PC71UD13C315TF PC71UD13C350TF PC71UD13C400TF PC71UD13C450TF PC71UD11C500TF PC71UD11C550TF PC71UD11C630TF PC71UD10C700TF PC71UD90V800TF PC71UD80VC900TF				
	12,5 URD 70 TT F 0063	M300483							
	12,5 URD 70 TT F 0080	N300484							
	12,5 URD 70 TT F 0100	P300485							
	12,5 URD 70 TT F 0125	Q300486							
	12,5 URD 70 TT F 0160	R300487							
	12,5 URD 70 TT F 0200	S300488							
	12,5 URD 70 TT F 0250	T300489							
	12 URD 70 TT F 0280	N300714							
	12 URD 70 TT F 0315	V300490							
	11 URD 70 TT F 0350	W300491							
	11 URD 70 TT F 0400	E300867							
	11 URD 70 TT F 0450	H301284							
	10 URD 70 TT F 0500	J301285							
	8 URD 70 TT F 0550	K301286							
	71	12,5 URD 71 TT F 0160				B300749	520	3	PC72UD13C250TF PC72UD13C280TF PC72UD13C315TF PC72UD13C350TF PC72UD13C400TF PC72UD13C450TF PC72UD11C500TF PC72UD11C550TF PC72UD11C630TF PC72UD10C900TF PC72UD85V1000TF PC73UD13C315TF PC73UD13C350TF PC73UD13C400TF PC73UD13C450TF PC73UD13C500TF PC73UD13C550TF PC73UD13C630TF PC73UD11C700TF PC73UD11C800TF PC73UD10C900TF PC73UD85V1000TF PC73UD95V800TFB PC73UD90V13CTF PC73UD85C14CTF PC73UD69V16CTF PC73UD60V18CTF
		12,5 URD 71 TT F 0200				Z300517			
		12,5 URD 71 TT F 0250				A300518			
12,5 URD 71 TT F 0280		P300715							
12,5 URD 71 TT F 0315		B300519							
12,5 URD 71 TT F 0350		C300520							
12,5 URD 71 TT F 0400		D300521							
12,5 URD 71 TT F 0450		E300522							
11 URD 71 TT F 0500		F300523							
11 URD 71 TT F 0550		G300524							
11 URD 71 TT F 0630		H300525							
10 URD 71 TT F 0700		M301288							
9 URD 71 TT F 0800		Z300862							
8 URD 71 TT F 0900		N301289							
72		12,5 URD 72 TT F 0250	X301573	800	3	PC73UD13C500TF PC73UD13C550TF PC73UD13C630TF PC73UD13C700TF PC73UD11C800TF PC73UD10C900TF PC73UD85V1000TF PC73UD95V800TFB PC73UD90V13CTF PC73UD85C14CTF PC73UD69V16CTF PC73UD60V18CTF			
		12,5 URD 72 TT F 0280	Y300493						
		12,5 URD 72 TT F 0315	Z300494						
		12,5 URD 72 TT F 0350	A300495						
	12,5 URD 72 TT F 0400	B300496							
	12,5 URD 72 TT F 0450	C300497							
	12,5 URD 72 TT F 0500	D300498							
	12,5 URD 72 TT F 0550	E300499							
	12,5 URD 72 TT F 0630	F300500							
	11 URD 72 TT F 0700**	G300501							
	11 URD 72 TT F 0800**	H300502							
	10 URD 72 TT F 0900**	G300869							
	8,5 URD 72 TT F 1000**	T301294							
	73	12,5 URD 73 TT F 0315	J300503				1250	1	PC73UD13C500TF PC73UD13C550TF PC73UD13C630TF PC73UD13C700TF PC73UD13C800TF PC73UD12C900TF PC73UD10C1000TF PC73UD95V800TFB PC73UD90V13CTF PC73UD85C14CTF PC73UD69V16CTF PC73UD60V18CTF
		12,5 URD 73 TT F 0350	K300504						
		12,5 URD 73 TT F 0400	L300505						
		12,5 URD 73 TT F 0450	M300506						
		12,5 URD 73 TT F 0500	N300507						
12,5 URD 73 TT F 0550		P300508							
12,5 URD 73 TT F 0630		Q300509							
12,5 URD 73 TT F 0700		R300510							
12,5 URD 73 TT F 0800		S300511							
12 URD 73 TT F 0900**		T300512							
10 URD 73 TT F 1000**		V300513							
9,5 URD 73 TT F 1100**		W300514							
9 URD 73 TT F 1250**		T300696							
8,5 URD 73 TT F 1400**		S300718							
6,9 URD 73 TT F 1600**		B301301							
6 URD 73 TT F 1800**		C301302							

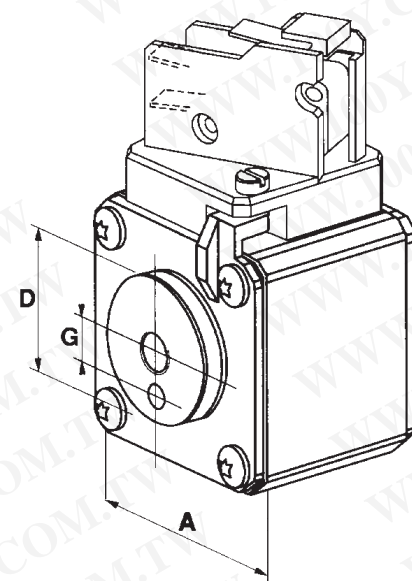
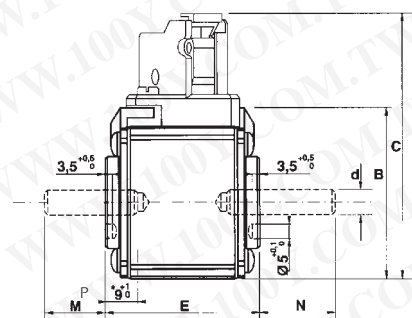

Microswitches and threaded studs supplied separately

Note:
Dimensions in mm
Dimensions in inches

Size	A	B	C	D	M*	N*	E±1	d	G±0.1	P±0.1
70	40 1-9/16"	46,5 1-27/32"	82 3-7/32"	26 1-1/64"	22	27	74 2-29/32"	M8	9 23/64"	6 15/64"
71	51 2"	56,5 2-7/32"	91 3-37/64"	30 1-3/16"	19	24	74 2-29/32"	M8	9 23/64"	9 23/64"
72	60 2-3/8"	65,5 2-37/64"	100 3-15/16"	38 ; (42mm **) 1-1/2" ; (1-21/32" **)	19	39	74 2-29/32"	M10	15 19/32"	9 23/64"
73	74,5 2-15/16"	79,5 3-1/8"	114 4-1/2"	46 ; (52mm **) 1-13/16" ; (2-1/16" **)	24	39	74 2-29/32"	M12	15 19/32"	9 23/64"

Semiconductor (AC) fuses



Protistor® Square-body Fuses

PSC aR sizes 7x - 650 V to 1300 VAC

IEC Terminals - French 272 - 273 End contacts

Size	Designation	Reference Number	Weight (g)	Packaging	Catalog Number
73	12,5 URD 73 PPAF 0315	H300640	1250	1	PC73UD13C315PP4
	12,5 URD 73 PPAF 0350	J300641			PC73UD13C350PP4
	12,5 URD 73 PPAF 0400	K300642			PC73UD13C405PP4
	12,5 URD 73 PPAF 0450	L300643			PC73UD13C450PP4
	12,5 URD 73 PPAF 0500	M300644			PC73UD13C500PP4
	12,5 URD 73 PPAF 0550	N300645			PC73UD13C550PP4
	12,5 URD 73 PPAF 0630	P300646			PC73UD13C630PP4
	12,5 URD 73 PPAF 0700	Q300647			PC73UD13C700PP4
	12,5 URD 73 PPAF 0800	R300648			PC73UD13C800PP4
	12 URD 73 PPAF 0900	S300649			PC73UD12C900PP4
	10 URD 73 PPAF 1000	T300650			PC73UD10C10CP4
	9,5 URD 73 PPAF 1100	V300651			PC73UD95V11CPP4
	9 URD 73 PPAF 1250	T300719			PC73UD90V13CP4
8,5 URD 73 PPAF 1400	V300720	PC73UD85V14CP4			
2 x 72	12,5 URD 272 TTF 0630	W300721	1900	1	PC272UD13C630TF
	12,5 URD 272 TTF 0700	X300722			PC272UD13C700TF
	12,5 URD 272 TTF 0800	Y300723			PC272UD13C800TF
	12,5 URD 272 TTF 0900	Z300724			PC272UD13C900TF
	12,5 URD 272 TTF 1000	A300725			PC272UD13C10CTF
	12,5 URD 272 TTF 1100	B300726			PC272UD13C11CTF
	11 URD 272 TTF 1250	M302231			PC272UD11C13CTF
	11 URD 272 TTF 1400	D300728			PC272UD11C14CTF
	10 URD 272 TTF 1600	L302230			PC272UD10C16CTF
	9 URD 272 TTF 1800	E301994			PC272UD90V18CTF
	7,5 URD 272 TTF 2000	F301995			PC272UD75V20CTF
	6,5 URD 272 TTF 2200	G301996			PC272UD65V22CTF
	6,5 URD 272 TTF 2500	H301997			PC272UD65V25CTF
2 x 73	12,5 URD 273 TTF 0800	F300730	2600	1	PC273UD13C800TF
	12,5 URD 273 TTF 0900	G300731			PC273UD13C900TF
	12,5 URD 273 TTF 1000	H300732			PC273UD13C10CTF
	12,5 URD 273 TTF 1100	J300733			PC273UD13C11CTF
	12,5 URD 273 TTF 1250	K300734			PC273UD13C13CTF
	11 URD 273 TTF 1400	K302229			PC273UD11C14CTF
	11 URD 273 TTF 1600	J302228			PC273UD11C16CTF
	11 URD 273 TTF 1800	S302236			PC273UD11C18CTF
	10 URD 273 TTF 2000	P300738			PC273UD10C20CTF
	9,5 URD 273 TTF 2200	Q300739			PC273UD95V22CTF
	9,5 URD 273 PLAF 2200	M301909			PC76UD95V22CP11
	9 URD 273 PLAF 2500	R300740			PC76UD90V25CP11
	8,5 URD 273 PLAF 2800	S300741			PC76UD85V28CP11
6 URD 273 PLAF 3000	K301999	PC76UD60V30CP11			
6 URD 273 PLAF 3200	M302001	PC76UD60V32CP11			
5,5 URD 273 PLAF 3600	N302002	PC76UD55V36CP11			

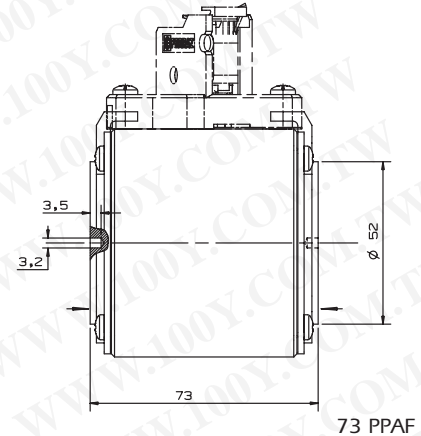

73 PPAF

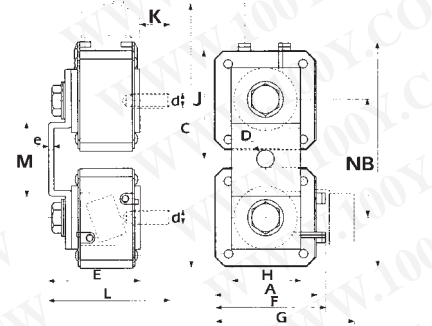

272 & 273 TTF

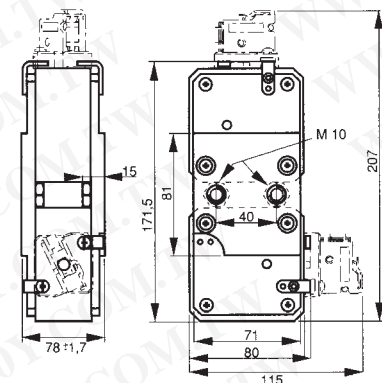

273 PLAF

Microswitches and threaded studs supplied separately

	A	B	C	D	E	F	G	H	J	K	d	e	L	M	N
2 x 72 TTF	60	138,5	172	11	91	65,5	100	35	66	39	M 10	4	131	48	72
2 x 73 TTF	74,5	167	200	13	91	79,5	114	50	80	39	M 12	4	131	54	86

Note:
Dimensions in mm

Semiconductor (AC) fuses

Protistor® Square-body Fuses PSC aR sizes 7x - 650 V to 1300 VAC IEC Terminals - French 70 - 73 Blades

Size	Designation	Reference Number	Weight (g)	Pack.	Base	I/I _N *	Catalog Number				
70	12,5 URD 70 E F 0063	P300600	380	3	SP 70	1	PC70UD13C63EF				
	12,5 URD 70 E F 0080	Q300601				1	PC70UD13C80EF				
	12,5 URD 70 E F 0100	R300602				1	PC70UD13C100EF				
	12,5 URD 70 E F 0125	S300603				0,95	PC70UD13C125EF				
	12,5 URD 70 E F 0160	T300604				0,90	PC70UD13C160EF				
	12,5 URD 70 E F 0200	V300605				0,85	PC70UD13C200EF				
	12,5 URD 70 E F 0250	W300606				0,80	PC70UD13C250EF				
	12 URD 70 E F 0280	L300712				0,80	PC70UD12C280EF				
	12 URD 70 E F 0315	X300607				0,75	PC70UD12C315EF				
	11 URD 70 E F 0350	Y300608				0,75	PC70UD11C350EF				
	71	12,5 URD 71 E F 0160				C300750	570	3	SE 71	1	PC71UD13C160EF
		12,5 URD 71 E F 0200				Z300609				1	PC71UD13C200EF
12,5 URD 71 E F 0250		A300610	1	PC71UD13C250EF							
12,5 URD 71 E F 0280		M300713	0,95	PC71UD13C280EF							
12,5 URD 71 E F 0315		B300611	0,95	PC71UD13C315EF							
12,5 URD 71 E F 0350		C300612	0,90	PC71UD13C350EF							
12,5 URD 71 E F 0400		D300613	0,90	PC71UD13C400EF							
12,5 URD 71 E F 0450		E300614	0,85	PC71UD13C450EF							
11 URD 71 E F 0500		F300615	0,85	PC71UD11C500EF							
11 URD 71 E F 0550		G300616	0,80	PC71UD11C550EF							
10 URD 71 E F 0630		H300617	0,80	PC71UD10C630EF							
72		12,5 URD 72 E F 0280	J300618	800	3	SE 72				1	PC72UD13C280EF
	12,5 URD 72 E F 0315	K300619	1				PC72UD13C315EF				
	12,5 URD 72 E F 0350	L300620	1				PC72UD13C350EF				
	12,5 URD 72 E F 0400	M300621	1				PC72UD13C400EF				
	12,5 URD 72 E F 0450	N300622	0,95				PC72UD13C450EF				
	12,5 URD 72 E F 0500	P300623	0,90				PC72UD13C500EF				
	12,5 URD 72 E F 0550	Q300624	0,85				PC72UD13C550EF				
	11 URD 72 E F 0630	R300625	0,85				PC72UD11C630EF				
	10 URD 72 E F 0700	S300626	0,80				PC72UD10C700EF				
	10 URD 72 E F 0800	T300627	0,80				PC72UD10C800EF				
	73	12,5 URD 73 E F 0315	V300628				1150	1	SF50-73	1	PC73UD13C315EF
		12,5 URD 73 E F 0350	W300629							1	PC73UD13C350EF
12,5 URD 73 E F 0400		X300630	1	PC73UD13C400EF							
12,5 URD 73 E F 0450		Y300631	1	PC73UD13C450EF							
12,5 URD 73 E F 0500		Z300632	1	PC73UD13C500EF							
12,5 URD 73 E F 0550		A300633	0,95	PC73UD13C550EF							
12,5 URD 73 E F 0630		B300634	0,95	PC73UD13C630EF							
12 URD 73 E F 0700		C300635	0,90	PC73UD12C700EF							
11 URD 73 E F 0800		D300636	0,90	PC73UD11C800EF							
10 URD 73 E F 0900		E300637	0,85	PC73UD10C900EF							
9 URD 73 E F 1000		F300638	0,85	PC73UD90V10CEF							
9 URD 73 E F 1100		G300639	0,80	PC73UD90V11CEF							

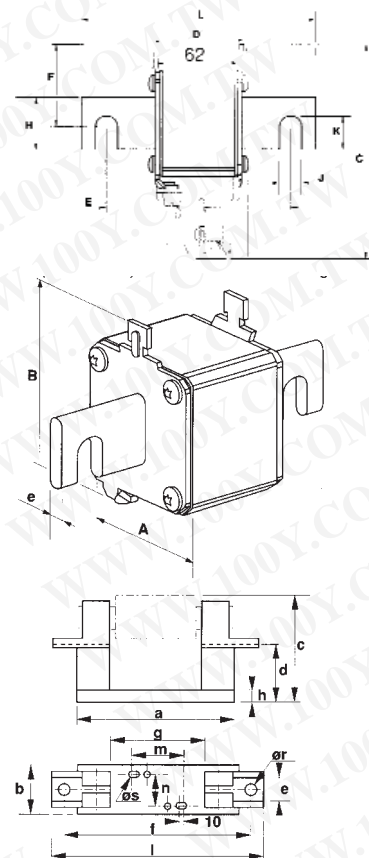

Pull out grip PM7 (V097676) in size 70-71-72

* I/I_N : Ratio "maximum continuous permissible RMS current I_N" for a fuse fitted into the bases.

Connections defined as per IEC 60269-1 and for a calm ambience of 30°C.

Fuse holders and microswitches supplied separately

	A	B	C	D	E ^{±1,3}	L ^{±1,3}	F	H	J	k	e
70	40	62	96	67	100	123,4	38	18	9	11	6
71	51	69	103	68	110	133,4	39	25	10,5	16	6
72	60	78	112	68	114,4	149,4	43	32	13	21,2	6
73	74,5	92,5	127	68	114,4	149,4	57	40	13	19,5	6

Note: dimensions in mm

Fuse holders	Ref. N°	Cat. N°	a	b	c	d	e	f	g	h	l	m	n	r	s	Weight (g)
SP 70	F096099	SP70	148	42	92	47,5	26	168	88	10	188	60	28	8,5	5,5	400
SE 51-71	V098711	SE71	148	42	103	47	32	182	85	8,5	214	60	28	10,5	5,5	470
SE 52-72	W098712	SE72	150	54	114	49	42	204	80	10	240	45	35	12,5	8,5	940
SF 53-73	C209187	SF50-73	160	60	142	55	40	210	80	10	250	40	35	18	9	2000

Semiconductor (AC) fuses



Protistor® Square-body Fuses

PSC aR sizes 7x - 650 V to 1300 VAC

IEC Terminals - German 70 - 73 Blades (DIN 110)

Size	Designation	Reference Number	Weight (g)	Pack.	*I/In Base		Catalog Number
					F098031	L091941	
70	12,5 URD 70 D 11 A 0063	V300536	380	3	1	1	PC70UD13C63D1A
	12,5 URD 70 D 11 A 0080	W300537			1	1	PC70UD13C80D1A
	12,5 URD 70 D 11 A 0100	X300538			1	1	PC70UD13C100D1A
	12,5 URD 70 D 11 A 0125	Y300539			1	1	PC70UD13C125D1A
	12,5 URD 70 D 11 A 0160	Z300540			1	1	PC70UD13C160D1A
	12,5 URD 70 D 11 A 0200	A300541			1	1	PC70UD13C200D1A
	12,5 URD 70 D 11 A 0250	B300542			1	1	PC70UD13C250D1A
	12 URD 70 D 11 A 0280	J300710			1	1	PC70UD12C280D1A
	12 URD 70 D 11 A 0315	C300543			1	1	PC70UD12C315D1A
	11 URD 70 D 11 A 0350	D300544			1	1	PC70UD11C350D1A
	12,5 URD 71 D 11 A 0160	D300751			1	1	PC71UD13C160D1A
71	12,5 URD 71 D 11 A 0200	E300545	570	3	1	1	PC71UD13C200D1A
	12,5 URD 71 D 11 A 0250	F300546			1	1	PC71UD13C250D1A
	12,5 URD 71 D 11 A 0280	K300711			1	1	PC71UD12C280D1A
	12,5 URD 71 D 11 A 0315	G300547			1	1	PC71UD12C315D1A
	12,5 URD 71 D 11 A 0350	H300548			1	1	PC71UD13C350D1A
	12,5 URD 71 D 11 A 0400	J300549			1	1	PC71UD13C400D1A
	12,5 URD 71 D 11 A 0450	K300550			0,95	1	PC71UD13C450D1A
	11 URD 71 D 11 A 0500	L300551			0,95	1	PC71UD11C500D1A
	11 URD 71 D 11 A 0550	M300552			0,90	1	PC71UD13C550D1A
	10 URD 71 D 11 A 0630	N300553			0,90	0,95	PC71UD10C630D1A
	12,5 URD 72 D 11 A 0280	P300554			800	3	1
12,5 URD 72 D 11 A 0315	Q300555	1	1	PC72UD13C315D1A			
12,5 URD 72 D 11 A 0350	R300556	1	1	PC72UD13C350D1A			
12,5 URD 72 D 11 A 0400	S300557	1	1	PC72UD13C400D1A			
12,5 URD 72 D 11 A 0450	T300558	1	1	PC72UD13C450D1A			
12,5 URD 72 D 11 A 0500	V300559	0,95	1	PC72UD13C500D1A			
12,5 URD 72 D 11 A 0550	W300560	0,90	0,95	PC72UD13C550D1A			
11 URD 72 D 11 A 0630	X300561	0,90	0,95	PC72UD11C630D1A			
10 URD 72 D 11 A 0700	Y300562	0,85	0,90	PC72UD10C700D1A			
10 URD 72 D 11 A 0800	Z300563	0,85	0,90	PC72UD10C800D1A			
12,5 URD 73 D 11 A 0315	A300564	1150	3	1			1
12,5 URD 73 D 11 A 0350	B300565			1	1	PC73UD13C350D1A	
12,5 URD 73 D 11 A 0400	C300566			0,95	1	PC73UD13C400D1A	
12,5 URD 73 D 11 A 0450	D300567			0,95	1	PC73UD13C450D1A	
12,5 URD 73 D 11 A 0500	E300568			0,90	1	PC73UD13C500D1A	
12,5 URD 73 D 11 A 0550	F300569			0,90	0,95	PC73UD13C550D1A	
12,5 URD 73 D 11 A 0630	G300570			0,85	0,95	PC73UD13C630D1A	
12 URD 73 D 11 A 0700	H300571			0,85	0,90	PC73UD12C700D1A	
11 URD 73 D 11 A 0800	J300572			0,85	0,90	PC73UD11C800D1A	
10 URD 73 D 11 A 0900	K300573			0,80	0,85	PC73UD10C900D1A	
9 URD 73 D 11 A 1000	L300574			0,80	0,85	PC73UD90V10CD1A	
9 URD 73 D 11 A 1100	M300575	0,75	0,80	PC73UD90V11CD1A			

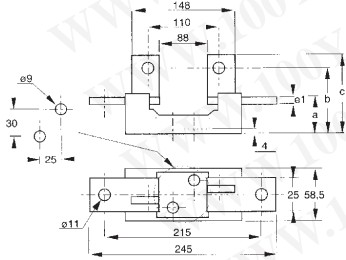
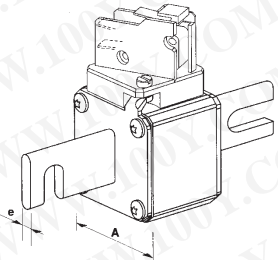
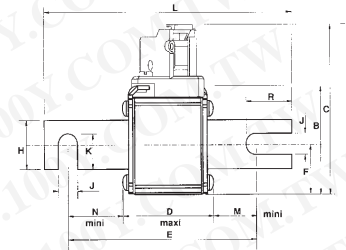

Pull out grip PM7
(V097676)
in size 70-71-72

Microswitches
supplied separately

	A	B	C	D	E±1,1	F	H	J	K	L±1,5	M	N	R	e
70	40	46,5	82	71	100,4	21	25	10,5	17,7	133,4	11,5	18,5	25,2	6
71	51	56,5	91	71	100,4	25,5	25	10,5	17,7	133,4	11,5	18,5	25,2	6
72	60	65,5	100	71	100,4	30	32	10,5	21,2	133,4	11,5	18,5	25,2	6
73	74,5	79,5	114	72	100,4	37,2	40	10,5	25,2	133,4	11	18	25,2	6

Fuse holders	Ref. N°	Cat. N°	a	b	c	e1	Weight (g)
SI DIN 110 630 A	F098031	SIDN110630A	40	68	82	5	1060
SI DIN 110 1250 A	L091941	SIDN1101250A	45	73	87	10	1320

Semiconductor (AC) fuses

Protistor® Square-body Fuses PSC aR sizes 7x - 650 V to 1300 VAC Curves set

Multiplier coefficient

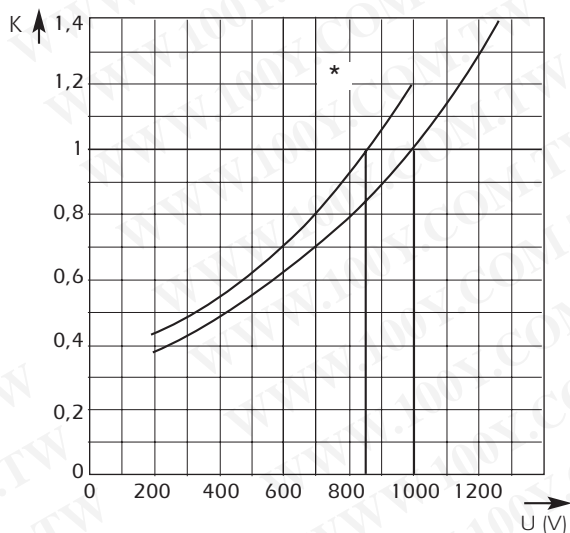

Left: Mean curve indicating variation of total I^2t (I^2t_t) and total operating time T_t in accordance with working voltage U .

Example:

Fuse 350 A in size 70.

$I_p = 10\,000\text{ A}$ $U = 1100\text{ V}$

At 1000 V

$I^2t_t = 115\,000\text{ A}^2\text{s}$ $T_t = 7\text{ ms}$

At 1100 V

$I^2t_t = 115\,000 \times 1.13 = 130\,000\text{ A}^2\text{s}$

$T_t = 7 \times 1.13 = 7.9\text{ ms}$

* curve for fuses with I^2t published at 850VAC

Dissipated power

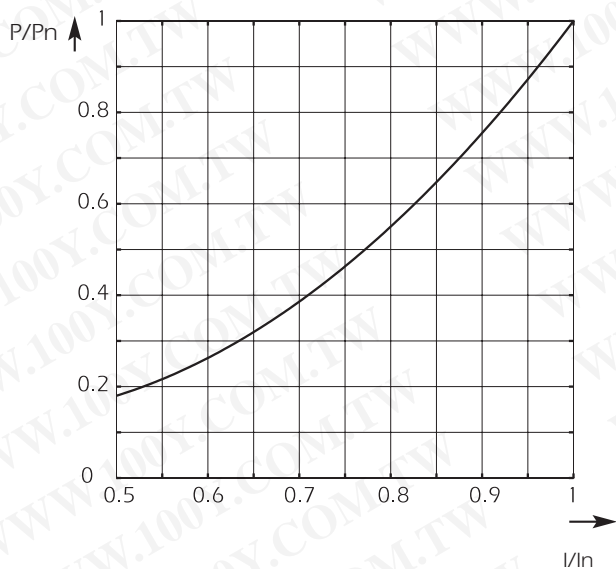

Above left: Curve enabling calculation of dissipated power P by a fuse rated I_{Nr} , as a function of the RMS current I , in multiples of I_{Nr} , in steady state.

Arc voltage

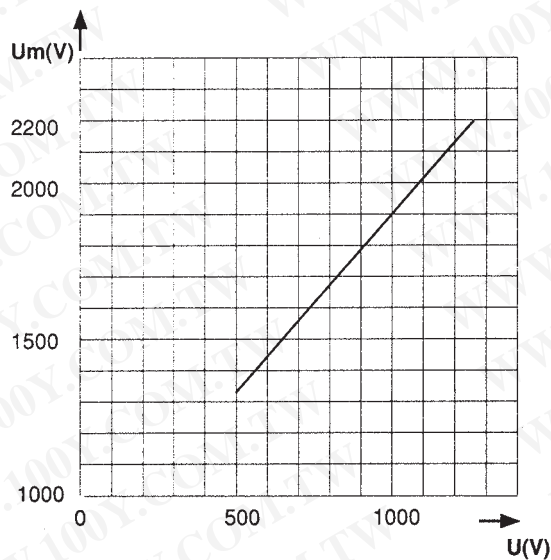

Above right: Curve indicating peak arc voltage U_m which may appear across fuse terminals as a function of working voltage U at $\cos \varphi = 0.15$

Semiconductor (AC) fuses



Protistor® Square-body Fuses PSC aR sizes 7x - 650 V to 1300 VAC Curves set

Size 70

Cut-off characteristics

Curves indicating for each rated current the peak value I_C that the current may reach as a function of the prospective fault current I_p .

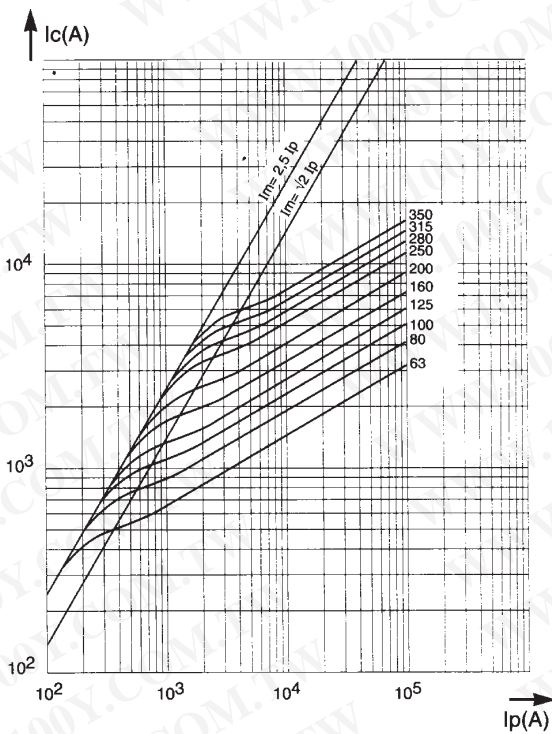

Time-current characteristics

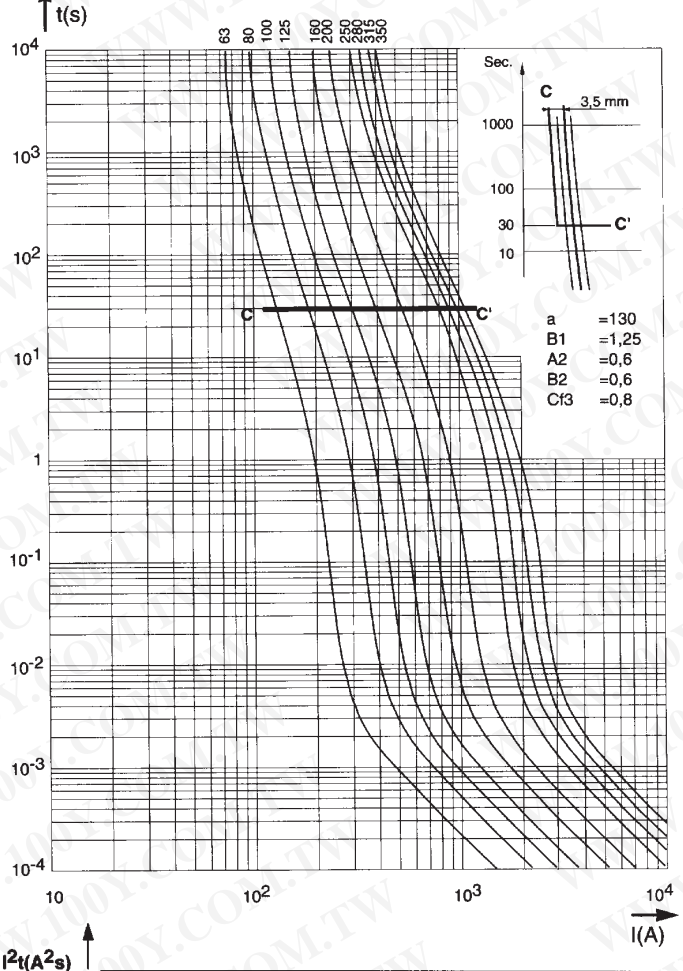

Time-current characteristics

- Curves indicating pre-arcing time for each rated current as a function of RMS value of pre-arcing current I_p .
- Tolerances on this current $\pm 8\%$.
- Beyond 30 sec, small overloads must be eliminated by another device.
- Curve CC' represents the maximum times taken by the associated device to clear small overloads; only its horizontal line is represented. Its oblique line must be plotted according to sketch, top right corner.
- The intersection of the fuse and CC' curves indicates the minimum breaking current I_{pm} of the fuse.

Maximum values of total operating I^2t and total operating times

Horizontal curves indicating the maximum values of total operating I^2t (I^2t_t) as function of the prospective current I_p at 1000V or 850 V(*), $\cos \varphi = 0.15$.
The oblique lines indicate the corresponding total operating time T_t with pre-arcing time in brackets.

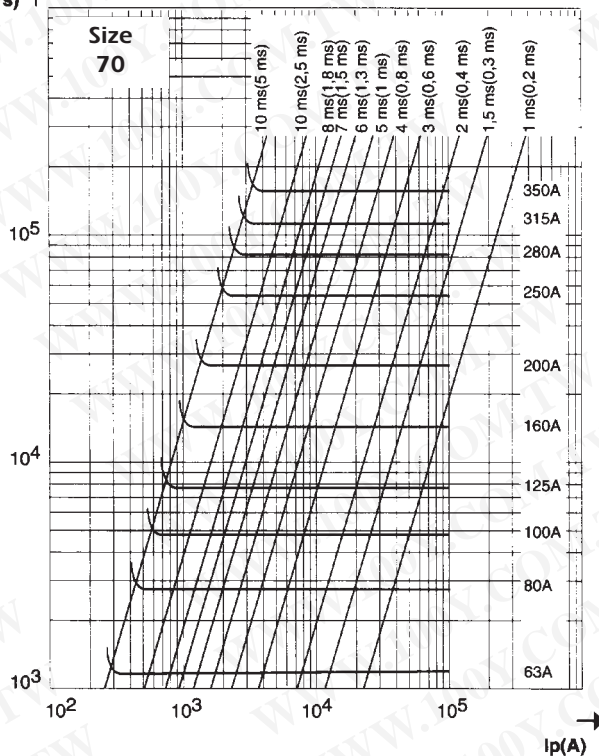

Semiconductor (AC) fuses

Protistor® Square-body Fuses PSC aR sizes 7x - 650 V to 1300 VAC Curves set

Cut-off characteristics

Curves indicating for each rated current the peak value I_C that the current may reach as a function of the prospective fault current I_p .

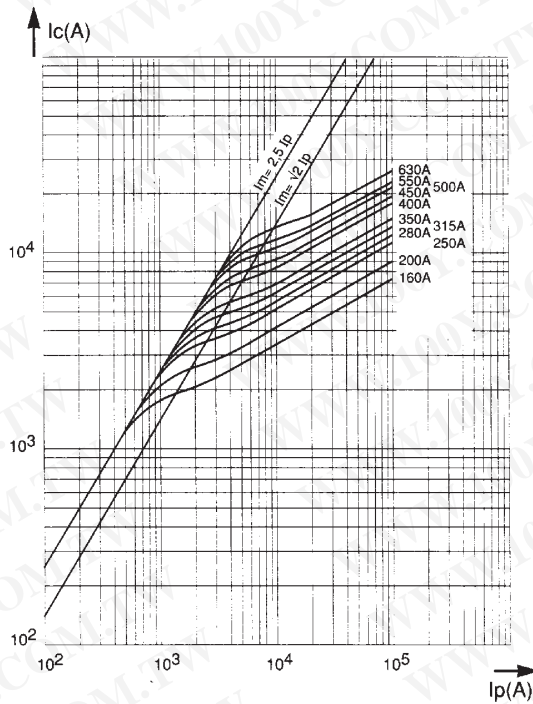

Size 71

Time-current characteristics

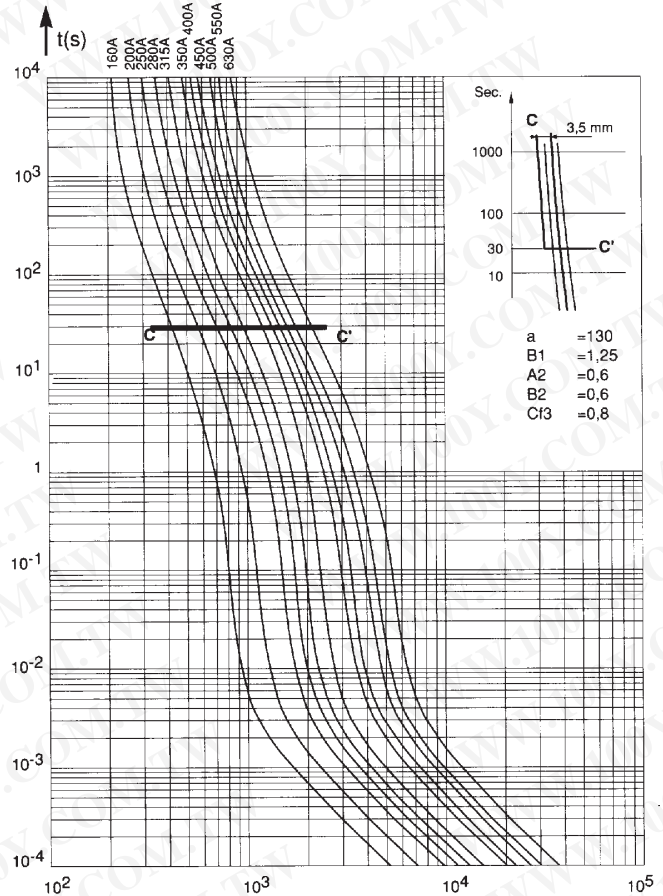

Time-current characteristics

Curves indicating pre-arcing time for each rated current as a function of RMS value of pre-arcing current I .

- Tolerances on this current $\pm 8\%$.
- Beyond 30 sec, small overloads must be eliminated by another device.
- Curve CC' represents the maximum times taken by the associated device to clear small overloads; only its horizontal line is represented. Its oblique line must be plotted according to sketch, top right corner.
- The intersection of the fuse and CC' curves indicates the minimum breaking current I_{pm} of the fuse.

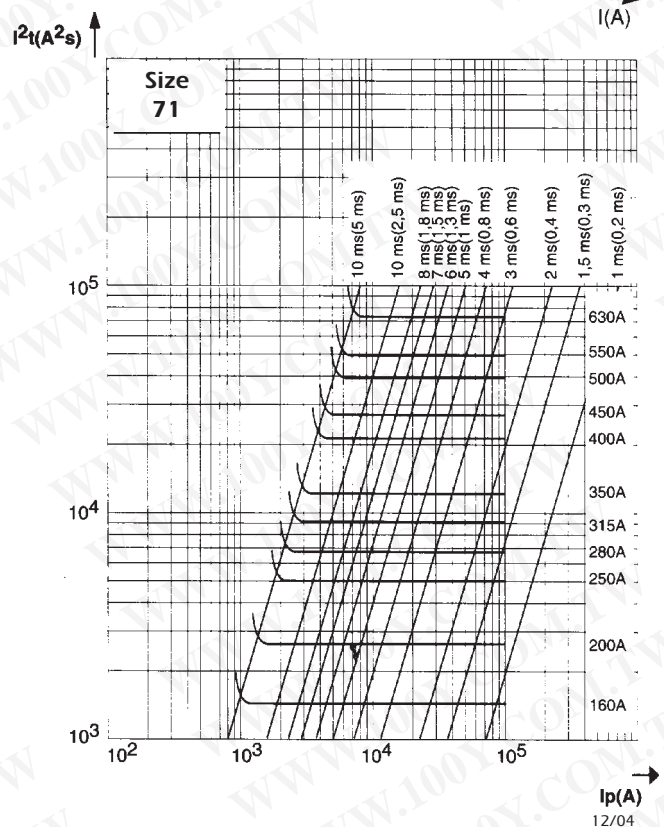

Maximum values of total operating $I^2 t$ and total operating times

Horizontal curves indicating the maximum values of total operating $I^2 t$ ($I^2 t_t$) as function of the prospective current I_p at 1000V or 850 V(*), $\cos \varphi = 0.15$.

The oblique lines indicate the corresponding total operating time T_t with pre-arcing time in brackets.

Semiconductor (AC) fuses



Protistor® Square-body Fuses PSC aR sizes 7x - 650 V to 1300 VAC Curves set

Size 72

Cut-off characteristics

Below, right: Curves indicating for each rated current the peak value I_C that the current may reach as a function of the prospective fault current I_p .

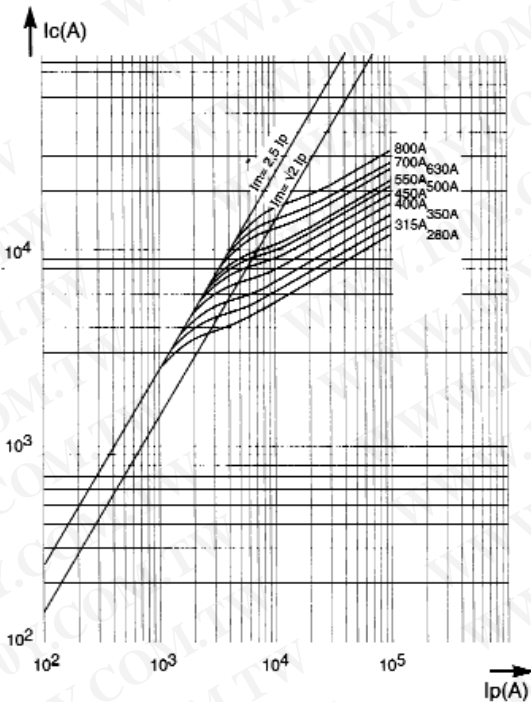

Time-current characteristics

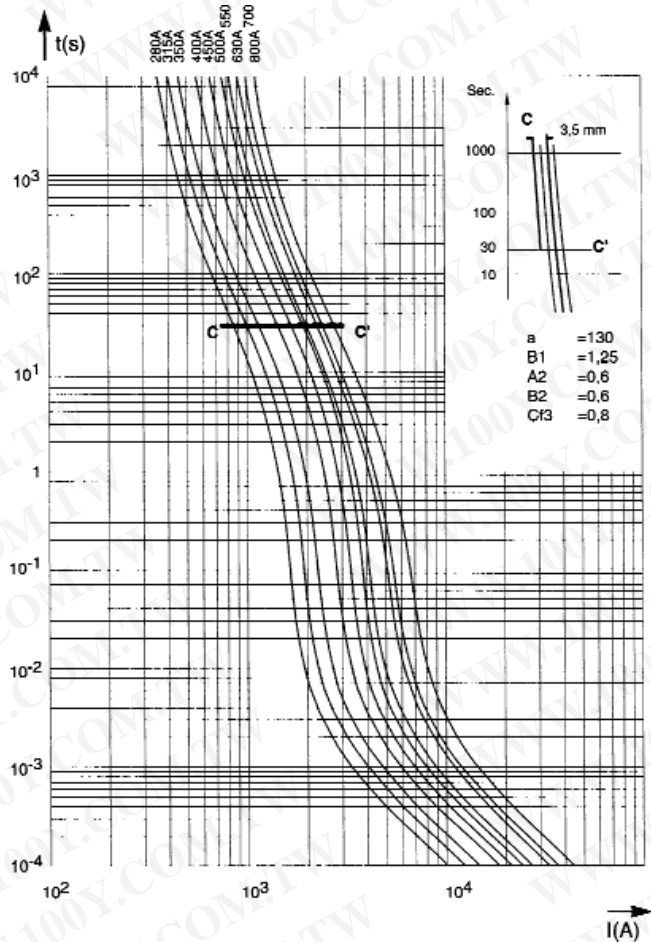

Time-current characteristics

Above, left: Curves indicating pre-arcing time for each rated current as a function of RMS value of pre-arcing current I .

- Tolerances on this current $\pm 8\%$.
- Beyond 30 sec, small overloads must be eliminated by another device.
- Curve CC' represents the maximum times taken by the associated device to clear small overloads; only its horizontal line is represented. Its oblique line must be plotted according to sketch, top right corner.
- The intersection of the fuse and CC' curves indicates the minimum breaking current I_{pm} of the fuse.

Maximum values of total operating I^2t and total operating times

Left: Horizontal curves indicating the maximum values of total operating I^2t (I^2t_t) as function of the prospective current I_p at 1000V or 850 V(*), $\cos \varphi = 0.15$. The oblique lines indicate the corresponding total operating time T_t , with pre-arcing time in brackets.

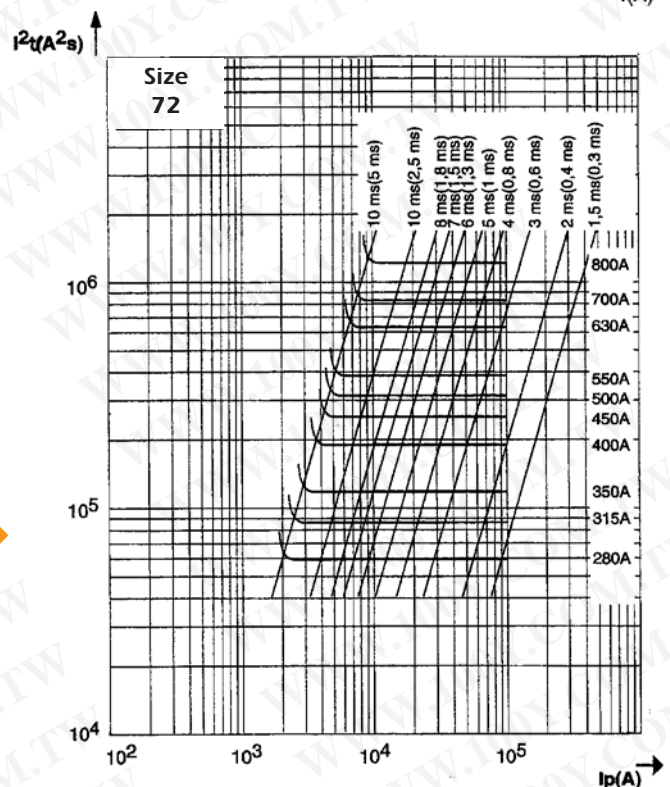

Semiconductor (AC) fuses

勝特力材料 886-3-5753170
 勝特力电子(上海) 86-21-34970699
 勝特力电子(深圳) 86-755-83298787
 Http://www.100y.com.tw

Protistor® Square-body Fuses PSC aR sizes 7x - 650 V to 1300 VAC Curves set

Size 73

Cut-off characteristics

Curves indicating for each rated current the peak value I_C that the current may reach as a function of the prospective fault current I_p .

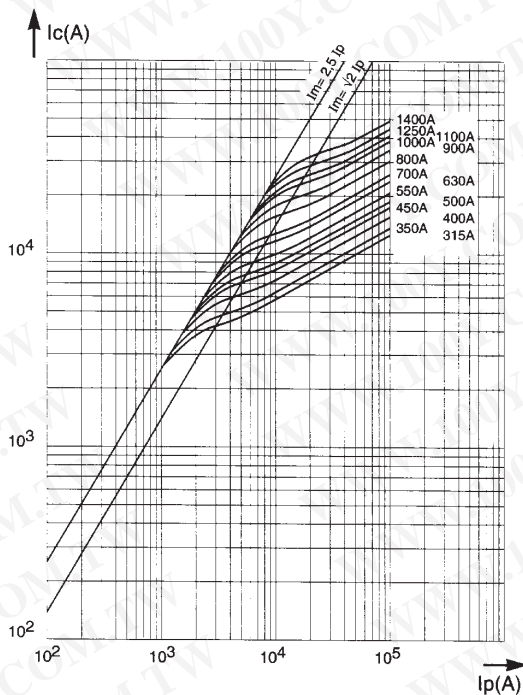

Time-current characteristics

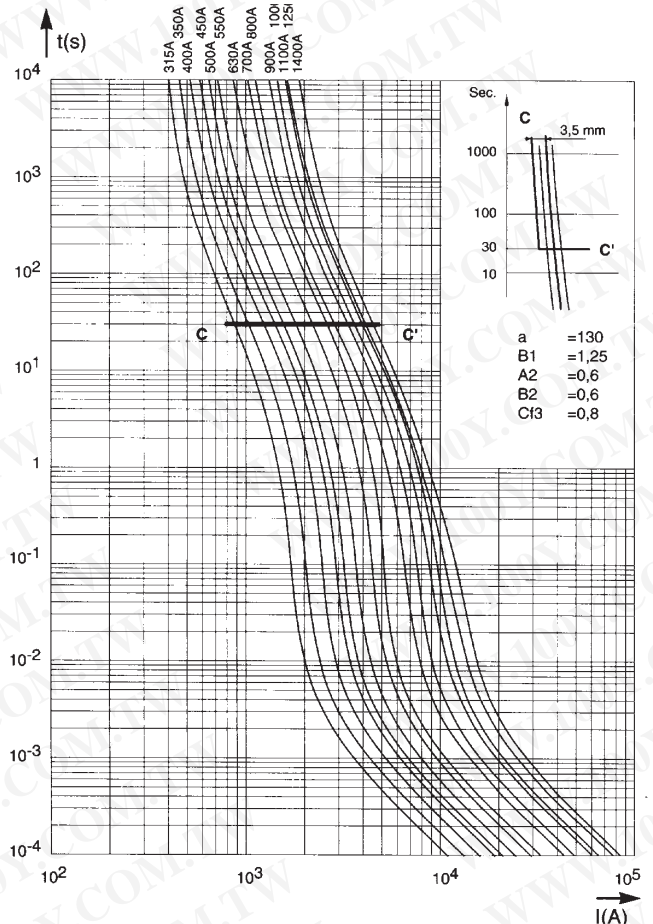

Time-current characteristics

Curves indicating pre-arcing time for each rated current as a function of RMS value of pre-arcing current I .

- Tolerances on this current $\pm 8\%$.
- Beyond 30 sec, small overloads must be eliminated by another device.
- Curve CC' represents the maximum times taken by the associated device to clear small overloads; only its horizontal line is represented. Its oblique line must be plotted according to sketch, top right corner.
- The intersection of the fuse and CC' curves indicates the minimum breaking current I_{pm} of the fuse.

Maximum values of total operating I^2t and total operating times

Horizontal curves indicating the maximum values of total operating I^2t (I^2t_t) as function of the prospective current I_p at 1000V or 850 V(*), $\cos \varphi = 0.15$.

The oblique lines indicate the corresponding total operating time T_t with pre-arcing time in brackets.

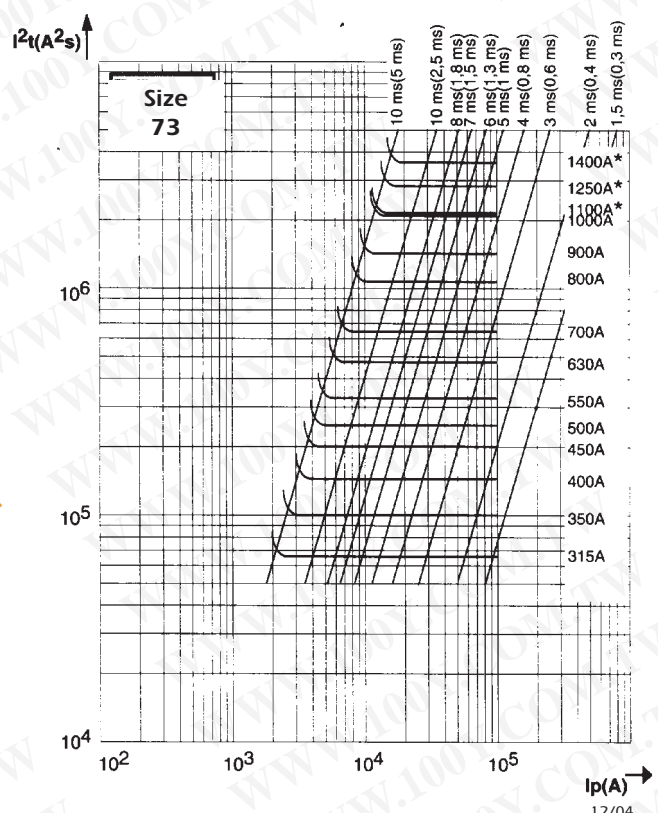

Semiconductor (AC) fuses



Protistor® Square-body Fuses PSC aR sizes 7x - 650 V to 1300 VAC Curves set

Size 2x72

Cut-off characteristics

Curves indicating for each rated current the peak value I_c that the current may reach as a function of the prospective fault current I_p .

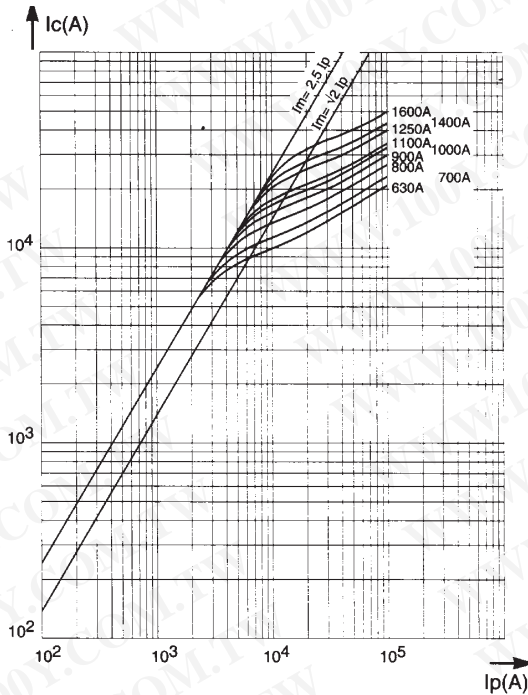

Time-current characteristics

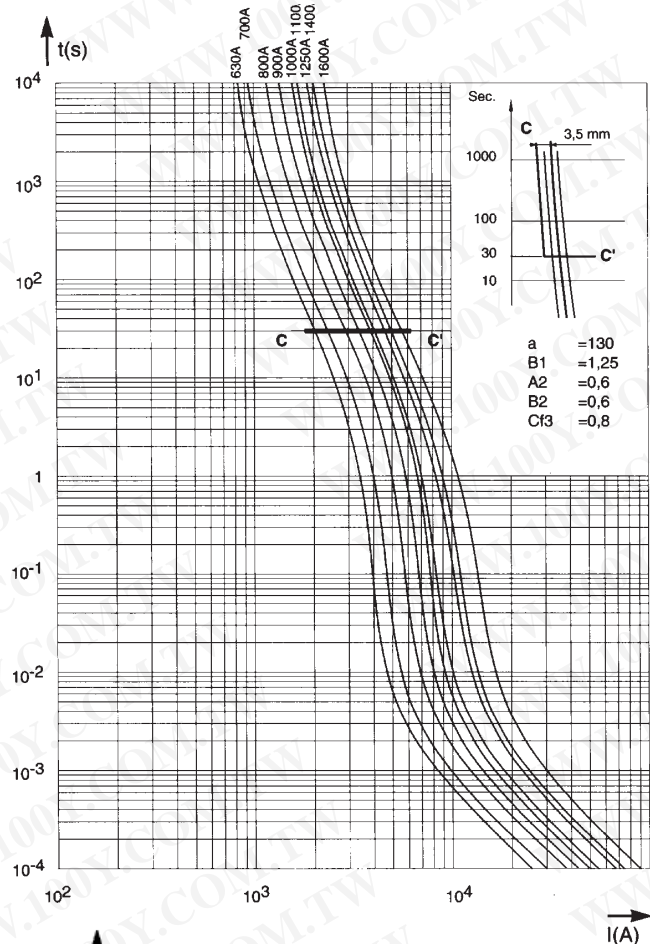

Time-current characteristics

Curves indicating pre-arcing time for each rated current as a function of RMS value of pre-arcing current I .

- Tolerances on this current $\pm 8\%$.
- Beyond 30 sec, small overloads must be eliminated by another device.
- Curve CC' represents the maximum times taken by the associated device to clear small overloads; only its horizontal line is represented. Its oblique line must be plotted according to sketch, top right corner.
- The intersection of the fuse and CC' curves indicates the minimum breaking current I_{pm} of the fuse.

Maximum values of total operating I^2t and total operating times

Horizontal curves indicating the maximum values of total operating I^2t (I^2t_t) as function of the prospective current I_p at 1000V or 850 V(*), $\cos \varphi = 0.15$.

The oblique lines indicate the corresponding total operating time T_t , with pre-arcing time in brackets.

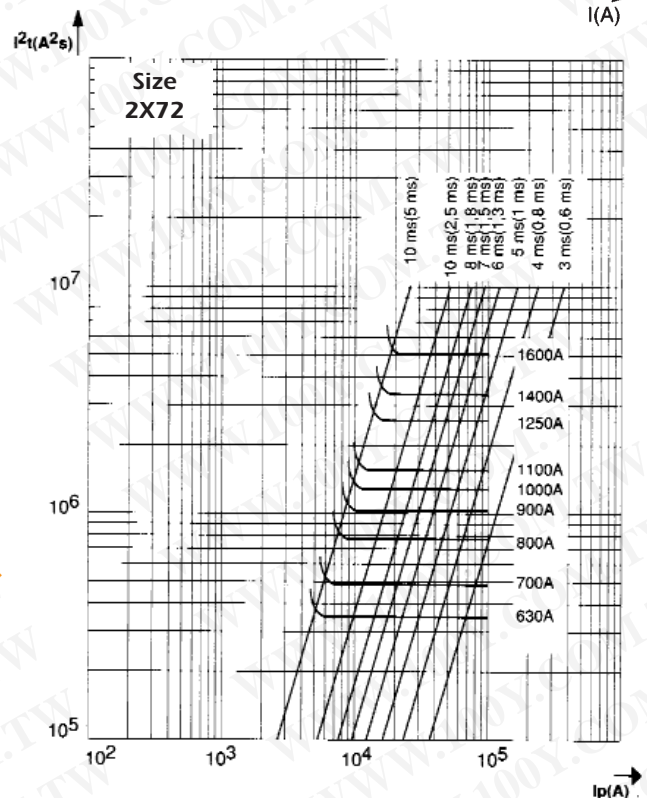

Semiconductor (AC) fuses

Protistor® Square-body Fuses PSC aR sizes 7x - 650 V to 1300 VAC Curves set

Cut-off characteristics

Curves indicating for each rated current the peak value I_C that the current may reach as a function of the prospective fault current I_p .

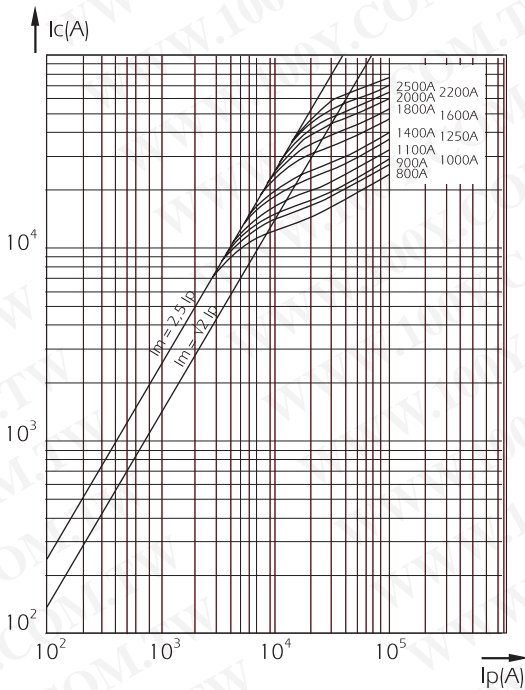

Size 2x73

Time-current characteristics

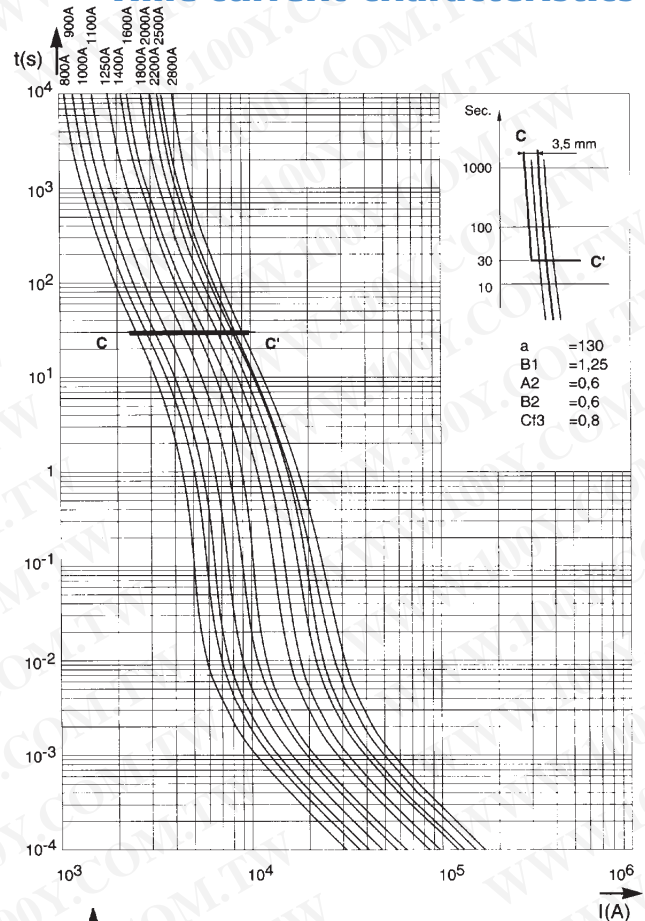

Time-current characteristics

Curves indicating pre-arcing time for each rated current as a function of RMS value of pre-arcing current I .

- Tolerances on this current $\pm 8\%$.
- Beyond 30 sec, small overloads must be eliminated by another device.
- Curve CC' represents the maximum times taken by the associated device to clear small overloads; only its horizontal line is represented. Its oblique line must be plotted according to sketch, top right corner.
- The intersection of the fuse and CC' curves indicates the minimum breaking current I_{pm} of the fuse.

Maximum values of total operating I^2t and total operating times

Horizontal curves indicating the maximum values of total operating I^2t (I^2t_t) as function of the prospective current I_p at 1000V or 850 V(*), $\cos \varphi = 0.15$.

The oblique lines indicate the corresponding total operating time T_t , with pre-arcing time in brackets.

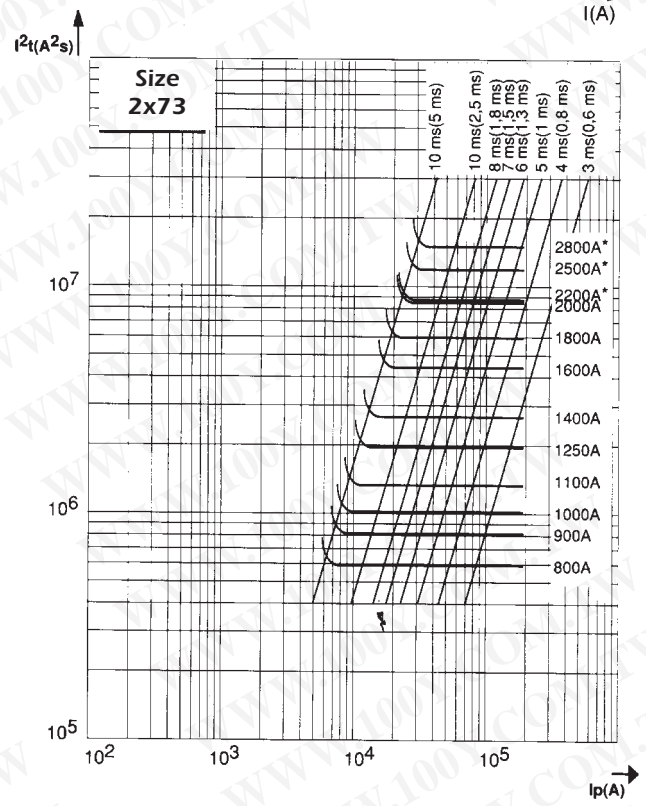

Semiconductor (AC) fuses



Protistor® Square-body Fuses PSC aR sizes 7x - 650 V to 1300 VAC Curves set

DC working voltage possibilities

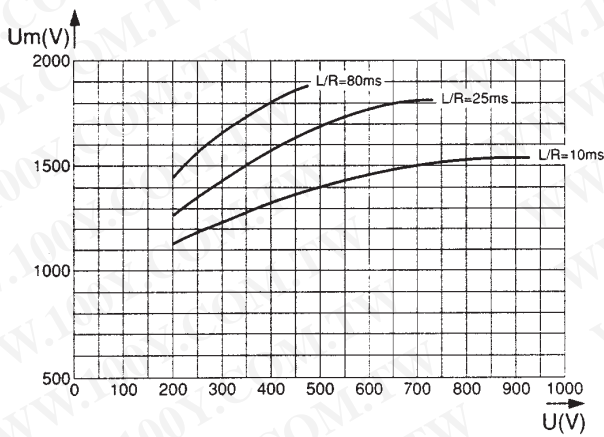
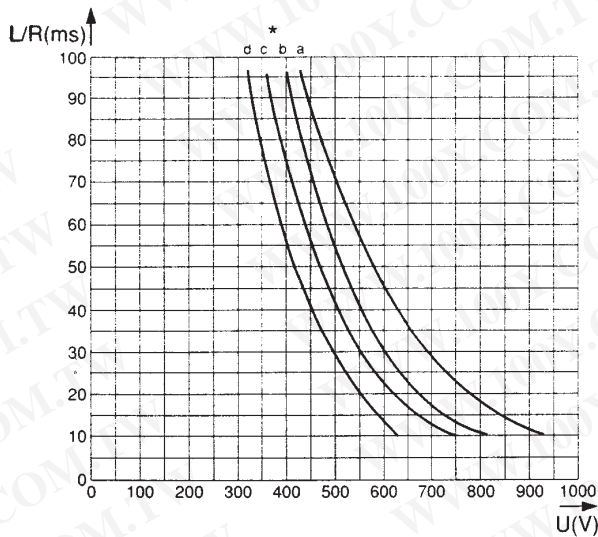

Top: Curves indicating the maximum time constant L/R of the fault path as a function of the DC voltage U , for the rated currents in the sizes indicated in the table.

I_{pm} (1) values indicate the minimum breaking current in Amperes (A).

Remark: When the fault current di/dt is very large, this condition can be exceeded. It is the case for faults occurring in voltage commutated inverters.

Below: Curves indicating peak arc voltage U_m which may appear across fuse terminals as a function of the DC working voltage U , for various time constant L/R of fault path.

Rated current I_N (A)	Curves (*) and I_{pm} (1) corresponding to the rating					
	70 * I_{pm} (A)	71 * I_{pm} (A)	72 * I_{pm} (A)	73 * I_{pm} (A)	2x72 * I_{pm} (A)	2x73 * I_{pm} (A)
63	a 270					
80	a 400					
100	a 520					
125	a 700					
160	a 950	a 950				
200	a 1300	a 1300				
250	a 1800	a 1800				
280	b 2200	a 2000	a 1800			
315	b 2600	a 2300	a 2200	a 2000		
350	c 3000	a 2700	a 2600	a 2400		
400		b 3500	a 3200	a 3000		
450		b 4000	a 3800	a 3500		
500		c 4800	a 4600	a 3900		
550		c 5200	b 5000	a 4400		
630		c 6400	b 6200	a 5300	a 4400	
700			c 6800	a 6000	a 5200	
800			c 8000	b 8000	a 6400	a 6000
900				b 9000	a 7600	a 7000
1000				c 11000	a 9200	a 7800
1100				c 12000	b 10000	a 8800
1250				c 13500	b 12400	a 10600
1400				c 15000	c 13600	a 12000
1600					c 16000	b 16000
1800						b 18000
2000						c 22000
2200						c 24000
2500						d 27000
2800						d 30000

Semiconductor (AC) fuses

Protistor® Square-body Fuses PSC aR sizes 7x - 650V to 1300 VAC Microswitches PSC 3x & 7x

- MICROSWITCH SYSTEMS ADAPTED TO THE FOLLOWING FERRAZ SHAWMUT FUSES ONLY:
- PSC sizes 30, 31, 32, 33, 2x32, 2x33 / 70, 71, 72, 73, 272, 273 except plain blades
- PSC LR sizes 33, 233, 73, 273
- PERMANENT INDICATION OF FUSE STATE: CONDUCTIVE
BLOWN
- MANUAL RESETTING
- STANDRAD AND LOW ELECTRICAL LEVEL WITH DIFFERENT INSULATION LEVELS
- BS TYPE FOR USE IN CORROSIVE ATMOSPHERE
- MS 3V 1-5 UR AND MS 7V 1-5 UR TYPE UL ARE RECOGNIZED



MS 7V 1-5

Main Characteristics

Code	AC Insulation voltage rating (***)	Positive operating voltage/current	Current rating	Current	Breaking Capacity						AC voltage withstand test (*)	Impulse voltage test Uimp1.2/50 µs (**)	Fire class according to UL 94
					Non inductive circuit			Inductive circuit : L/R = 25ms					
					30V	110V	250V	30V	110V	250V			
MS 3V 1-5	1000 V	20 V 50 mA	10 A	50/60 Hz	10 A	10 A	10 A	10 A	10 A	10 A	8,5 kV	14 kV	H.B
MS 3V 1-5 UR				DC	8 A	0,4 A	0,2 A	4 A	0,2 A	0,1 A			
MS 7V 1-5	1500V	10 V 10 mA	3 A	50/60 Hz	3 A	3 A	3 A	2 A	1 A	1 A	8,5 kV	14 kV	
MS 7V 1-5 UR				DC	3 A	0,5 A	0,25 A	3 A	0,2 A	0,1 A			
MS 3V 1-5 BS	1000 V	10 V 10 mA	3 A	50/60 Hz	3 A	3 A	3 A	2 A	1 A	1 A	8,5 kV	14 kV	
MS 3V 1-9 BS				DC	3 A	0,5 A	0,25 A	3 A	0,2 A	0,1 A			
MS 7V 1-5 BS	1500V	10 V 10 mA	3 A	50/60 Hz	3 A	3 A	3 A	2 A	1 A	1 A	8,5 kV	14 kV	
MS 7V 1-9 BS				DC	3 A	0,5 A	-	2 A	0,2 A	-			
MS 3V 1-5 ET	1000V	10 V	3 A	50/60 Hz	3 A	3 A	3 A	2 A	1 A	1 A	8,5 kV	14 kV	
MS 7V 1-5 ET	1500V	10 mA		DC	3 A	0,5 A	-	2 A	0,2 A	-	12 kV	20 kV	

* Between power circuit and microswitch terminals as per IEC 60 and 694 and NFC 64010 (50/60 Hz 1 min duration in dry air)

** Between power circuit and microswitch terminals Uimp: impulse voltage as per IEC 60947-1

*** Between power circuit and microswitch terminals

Warning: microswitch systems exclusively designed for FERRAZ SHAWMUT.
PSC Fuses fitted a patented trip-indicator, saving use of EDV



Protistor® Square-body Fuses PSC aR sizes 7x - 650V to 1300 VAC Microswitches for PSC 3x & 7x

Indication systems for PSC Fuse sizes 30 to 73 MS 3V...

These patented indication systems are exclusively hand resettable.

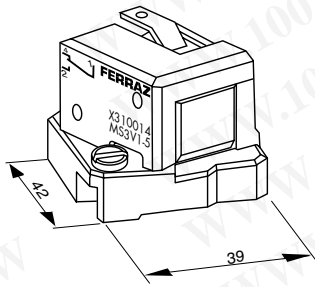

(fig. 1)

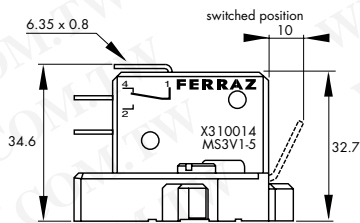

Fuse size	Designation	Ref. Number	Indication style	Weight (g)	Pack.	Catalog Number
30, 31 32, 33	MS 3V 1-5 (fig.1)	X310014	Standard NO-NC	34	3 pieces	MS3 V1-5
	MS 3V 1-5 UR	Y310038				MS3 V1-5-UR
	MS 3V 1-5 BS (3)	W310013	Low level NO-NC	34	3 pieces	MS3-V1-5BS
	MS 3V 1-9 BS (4)	T310011	Double pole Low level	44	3 pieces	MS3V1-9BS
	MS 3V 1-5 ET (fig.2)	R310009	Low level NO-NC IP 50 (9)	34	3 pieces	MS3V1-5 ETANCHE

(3) Same as fig.1

(4) Same dimensions as figure 1
but with 2 microswitches side by side

(9) Watertightness class

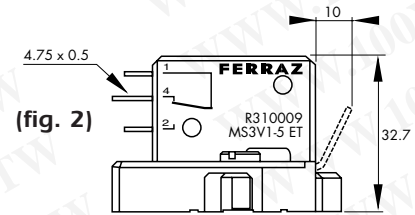

(fig. 2)

MS 7V...

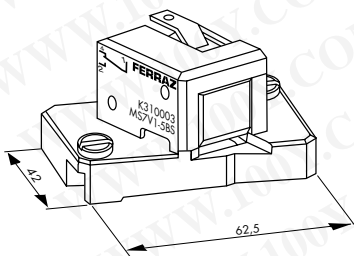

(fig. 5)

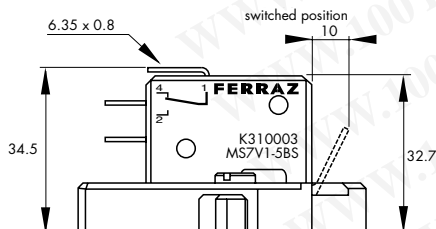

Fuse size	Designation	Ref. Number	Indication style	Weight (g)	Pack.	Catalog Number
70, 71 72, 73	MS 7V 1-5 (fig.5)	J310002	Standard NO-NC	45	3 pieces	MS7 V1-5
	MS 7V 1-5 UR	Z310039				MS7 V1-5-UR
	MS 7V 1-5 BS (3)	K310003	Low level NO-NC	45	3 pieces	MS7-V1-5BS
	MS 7V 1-9 BS (4)	P310007	Double pole Low level	55	3 pieces	MS7V1-9BS
	MS 7V 1-5 ET (fig.6)	S310010	Low level NO-NC IP 50 (9)	55	3 pieces	MS7V1-5 ETANCHE

(7) Same as fig. 5

(8) Same dimensions as figure 5 but with 2 microswitches side by side

(9) Watertightness class

Warning: Microswitch systems exclusively designed for FERRAZ SHAWMUT PSC fuses fitted with a patented trip-indicator, saving use of EDV.

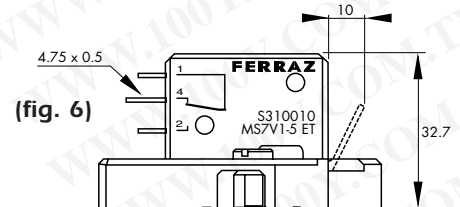



(fig. 6)

Semiconductor (AC) fuses

Protistor® Square-body Fuses PSC aR sizes 7x - 650 V to 1300 VAC Metric-studs

Metric studs for threaded terminal fuses



Type and fuse size	Designation	Ref. Number	Unit weight (g)	Pack.	Catalog Number
 Sizes 0 and 1	HC stud pair M8x30 & M8x35	S098801	23	6 pairs	STU M8x30 M8x35
	Size 2 HC stud pair M10x30 & M10x50	T098802	40	6 pairs	STU M10x30 M10x50
	Size 3 HC stud pair M12x35 & M12x50	V098803	60	6 pairs	STU M12x35 M12x50
 Size 2	HC stud pair M10x50	W098804	45	6 pairs	STU M10x50
	Size 3 HC stud pair M12x50	X098805	45	6 pairs	STU M12x50

We recommend the use of studs, whose quality is suited to all FERRAZ SHAWMUT square-body fuses with terminals

Stud mounting

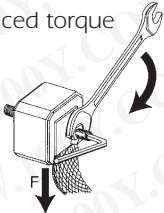
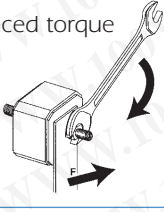
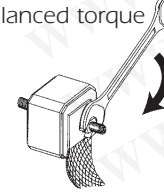
Torque type	Stud type	Maximum stud tightening torque (Nm) (1)	Maximum nut tightening torque (Nm) (1)
Balanced torque 	M8x30 & M8x35	10	13.5
	M10x30 & M10x50	15	26
	M12x35 & M12x50	15	46
Balanced torque 	M8x30 & M8x35	10	13.5
	M10x30 & M10x50	15	26
	M12x35 & M12x50	15	46
Unbalanced torque 	M8x30 & M8x35	10	13.5
	M10x30 & M10x50	15	26
	M12x35 & M12x50	15	46

(1) Factory limit on torque at 20°C ambient: +0, -2Nm; except on 46Nm value (+0, -4Nm)

Protistor® Square-body Fuses PSC aR sizes 9x - 1500 VAC Main characteristics



Ferraz Shawmut 1500 V PSC fuse-links provide maximum flexibility in equipment design and ultimate protection for today's power conversion equipment. These square body fuse-links are available in three different body sizes, each size having four worldwide acceptable mounting styles. The different mounting styles and body sizes along with a broad range of ampere ratings allow greatest flexibility in equipment design.

The Ferraz Shawmut PSC fuses have been engineered to provide state-of-the-art protection for SCRs, diodes, thyristors, GTO's and IGBT devices. They have pure silver die-cut elements embedded in solidified sand which helps control arcing characteristics for low I^2t and high breaking capacity. All contact surfaces are silver plated and all hardware is non-magnetic.

All fuse links are equipped with a low voltage trip-indicator. This trip-indicator can operate a field mountable microswitch which is easily mounted directly on to the fuse even while in service.

Highlights

- Extremely Fast Acting
- Current Limiting
- Very Low I^2t
- Worldwide Acceptability
- Superior Cycling Ability

Ratings

AC: 100 - 1500A
1500 VAC
200 KA IR

DC: Consult us

Approvals

C: Tested to IEC 60269.4 at UN +10 %

Features/Benefits

Choice of mounting styles gives wide choice for equipment design

Broad range of ampere ratings in a given body size for design flexibility

IEC 60269-4 compliance for fuses for worldwide semiconductor applications

Applications

Protection of rectifiers, inverters, DC drives, UPS Systems, reduced voltage motor starters, and other equipment in globally accepted applications

勝特力材料 886-3-5753170
勝特力电子(上海) 86-21-34970699
勝特力电子(深圳) 86-755-83298787
[Http://www.100y.com.tw](http://www.100y.com.tw)

Semiconductor (AC) fuses

Protistor® Square-body Fuses PSC aR sizes 9x - 1500 VAC Main characteristics

Voltage (V)	Size	Type	Rating (A)	Maximum I ² t under 1500V (kA ² S)	Power losses in watts				Breaking capacities kA
					End contacts 0,8 In	In	Blades 0,8 In	In	
1 500 V	91	URF	100	10	18,5	35	18,5	35	1 500 V 200 kA
		URF	125	15	23	43	23	43	
		URF	160	24,5	29	55	29	55	
		URF	180	32,5	33	62	33	63	
		URG	200	50	27,5	52	28	53,5	
		URK	225	78	31	58,5	31	59	
		URH	250	246	25	47	25	47	
		URH	315	384	31	59	31	59	
	92	URH	350	466	35	66	35	66	
		URF	200	40	36,5	69	37,5	71	
		URG	250	84	37,5	73	39	76	
		URK	315	144	46	91	46,5	95	
		URK	350	200	51	101	52	106	
		URH	400	669	41,5	83	44	90	
	93	URH	500	983	50,5	101	53,5	109	
		URH	550	1 190	57,5	115	61	124	
		URF	250	60	48	95	49,5	98	
		URF	315	94	61	120	62	123	
		URF	350	135	67	133	69	137	
		URG	375	185	62	125	64,5	130	
		URK	400	240	60	122	61,5	128	
		URK	450	305	67	137	69	144	
	2X92	URK	500	375	77	158	79	165	
		URH	630	1 570	62,5	125	67	136	
		URJ	700	2 500	67	131	73	143	
		URB	750	3 000	73	143	80	156	
		URG	500	335	77,5	152			
		URK	630	576	93	190			
		URK	700	800	104	212			
	2X93	URH	800	2 680	87	177			
		URH	1 000	3 930	106	216			
		URH	1 100	4 760	120	246			
		URG	750	740	129	260			
		URK	800	960	122	256			
		URK	900	1 220	138	288			
		URK	1 000	1 500	160	332			
URH	URH	1 250	6 280	131	268				
	URJ	1 400	10 000	143	280				
	URB	1 500	12 000	148	310				

Semiconductor (AC) fuses

Protistor® Square-body Fuses PSC aR sizes 9x - 1500 VAC French End contacts

Size	Designation	Reference Number	Weight (g)	Packaging	Catalog Number
91	15 URF 91 TTF 0100	W 076 149	650	1	PC91UF15C100TF
	15 URF 91 TTF 0125	X 076 150			PC91UF15C125TF
	15 URF 91 TTF 0160	Y 076 151			PC91UF15C160TF
	15 URG 91 TTF 0200	A 076 153			PC91UG15C200TF
	15 URK 91 TTF 0225	B 076 154			PC91UK15C225TF
	15 URH 91 TTF 0250	C 076 155			PC91UH15C250TF
	15 URH 91 TTF 0315	D 076 156			PC91UH15C315TF
	15 URH 91 TTF 0350	E 076 157			PC91UH15C350TF
92	15 URF 92 TTF 0200	F 076 158	900	1	PC92UF15C200TF
	15 URG 92 TTF 0250	G 076 159			PC92UG15C250TF
	15 URK 92 TTF 0315	H 076 160			PC92UK15C315TF
	15 URK 92 TTF 0350	J 076 161			PC92UK15C350TF
	15 URH 92 TTF 0400	K 076 162			PC92UH15C400TF
	15 URK 92 TTF 0400	M 076 003			PC92UK15C400TF
	15 URH 92 TTF 0500	V 076 194			PC92UH15C500TF
	15 URH 92 TTF 0550	L 076 163			PC92UH15C550TF
93	15 URF 93 TTF 0230	L 097 829	1250	1	PC93UF15C230TF
	15 URF 93 TTF 0250	M 076 164			PC93UF15C250TF
	15 URF 93 TTF 0315	N 076 165			PC93UF15C315TF
	15 URF 93 TTF 0350	P 076 166			PC93UF15C350TF
	15 URG 93 TTF 0375	Q 076 167			PC93UG15C375TF
	15 URK 93 TTF 0400	R 076 168			PC93UK15C400TF
	15 URK 93 TTF 0450	J 076 092			PC93UK15C450TF
	15 URK 93 TTF 0500	T 076 170			PC93UK15C500TF
	15 URH 93 TTF 0630	V 076 171			PC93UH15C630TF
	15 URJ 93 TTF 0700	W 076 172			PC93UJ15C700TF
	15 URB 93 TTF 0750	X 076 173			PC93UB15C750TF

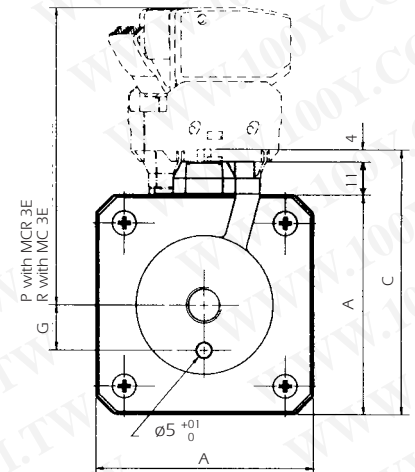
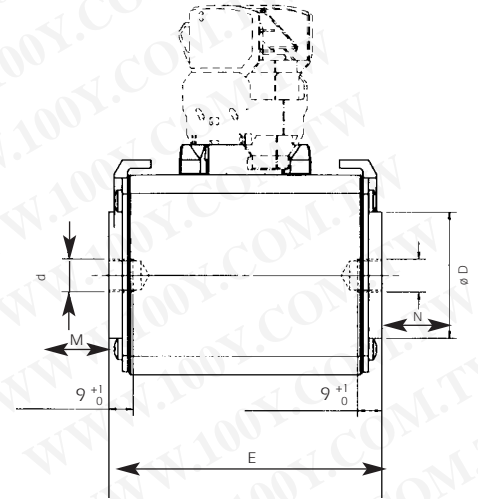

Microswitches : MC3E1-5N - Ref. D310020
 MC3E1-5NBS - Ref. E310021
 MC3E1-9NBS - Ref. F310022
 MC3E1-5NET - Ref. L310027
 MCR3E1-5N - Ref. G310023
 MCR3E1-5NBS - Ref. P310030
 MCR3E1-9NBS - Ref. H310024
 MCR3E1-5NET - Ref. Q310031

For operating voltage
 1250 VAC - DC max.

Insulation voltage 2200 VAC - DC

Threaded studs and microswitches supplied separately

Size	A	C	D	M [±]	N [±]	E ^{±1,7}	d	G ^{±0,1}	P	R
91	51	66	30	19	24	101	M8	9	87,5	72,5
	2"	2,6"	1-3/16"			3,98"		23/64"	3,45"	2,85"
92	60	74	38	19	39	101	M10	15	91,5	76,5
	2-3/8"	2,95"	1-1/2"			3,98"		19/32"	3,6"	3"
93	74,5	88	46	24	39	101	M12	15	98,5	83,5
	2-15/16"	3,5"	1-13/16"			3,98"		19/32"	3,9"	3,29"

Note : dimensions in mm and inches

M and N dimensions are with Metric studs Ref. Number S098801 for size 91 T098802 for size 92 and V098803 for size 93.

Maximum balanced nut tightning torque: 13,5 Nm (M8) - 26 Nm (M10)

46 Nm (M12)

Semiconductor (AC) fuses

Protistor® Square-body Fuses PSC aR sizes 9x - 1500 VAC French End contacts

Size	Designation	Reference Number	Weight (g)	Packaging	Catalog Number
2x92	15 URG 292 TTF 0500	Y 076 174	2460	1	PC292UG15C500TF
	15 URK 292 TTF 0630	Z 076 175			PC292UK15C630TF
	15 URK 292 TTF 0700	A 076 176			PC292UK15C700TF
	15 URH 292 TTF 0800	B 076 177			PC292UH15C800TF
	15 URH 292 TTF 1000	C 076 178			PC292UH15C10CTF
	15 URH 292 TTF 1100	D 076 179			PC292UH15C11CTF
2x93	15 URG 293 TTF 0750	P 081 755	3450	1	PC293UG15C750TF
	15 URK 293 TTF 0800	F 076 181			PC293UK15C800TF
	15 URK 293 TTF 0900	G 076 182			PC293UK15C900TF
	15 URK 293 TTF 1000	Q 081 756			PC293UK15C10CTF
	15 URH 293 TTF 1250	R 081 757			PC293UH15C13CTF
	15 URJ 293 TTF 1400	S 081 758			PC293UJ15C14CTF
	15 URB 293 TTF 1500	X 081 854			PC293UB15C15CTF

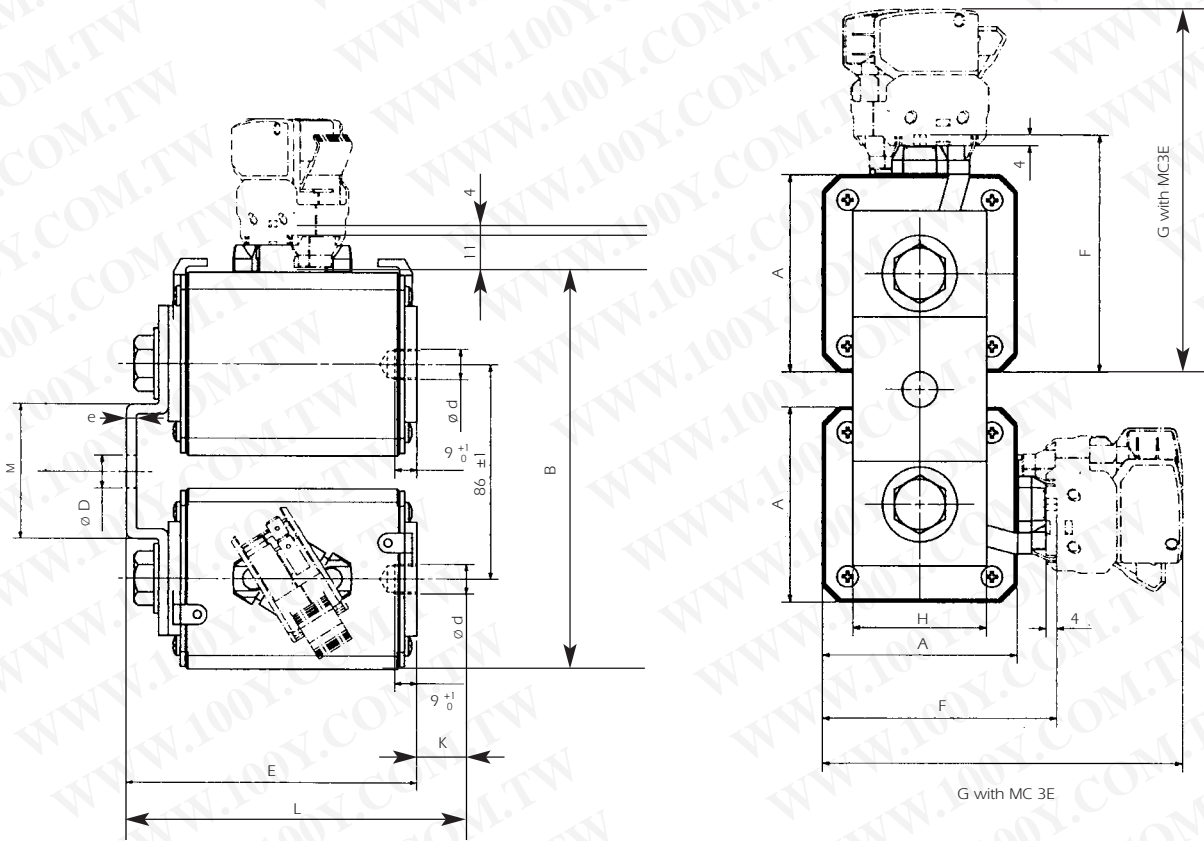

Threaded studs and microswitches supplied separately

Size	A	B	D	E ^{±1.7}	F	G	H	K	d	e	L	M	N
2x92 TT	60	147	11	118	74	106,5	35	40	M10	4	158	48	72
2x93 TT	74,5	164	13	118	88	121	50	40	M12	4	158	54	86

Dimensions in mm

K dimensions are with studs Ref. Number W098804 in size 2x92 and X098805 in size 2x93.

Maximum balanced nut tightening torque: 26 Nm (M10) and 46 Nm - (M12)

Semiconductor (AC) fuses

Protistor® Square-body Fuses PSC aR sizes 9x - 1500 VAC German Blades (DIN 140)

Size	Designation	Reference Number	Weight (g)	Packaging	Catalog Number
91	15 URF 91 D14F 0100	Z 076 060	800	1	PC91UH15C100D4F
	15 URF 91 D14F 0125	A 076 061			PC91UF15C125D4F
	15 URF 91 D14F 0160	B 076 062			PC91UF15C160D4F
	15 URF 91 D14F 0180	C 076 063			PC91UF15C180D4F
	15 URG 91 D14F 0200	D 076 064			PC91UG15C200D4F
	15 URH 91 D14F 0250	T 076 101			PC91UH15C250D4F
	15 URH 91 D14F 0315	V 076 102			PC91UH15C315D4F
	15 URH 91 D14F 0350	W 076 103			PC91UH15C350D4F
	15 URF 91 D14A 0100	V 221 232*			PC91UF15C100D4A
	15 URF 91 D14A 0125	M 210 737*			PC91UF15C125D4A
	15 URF 91 D14A 0160	L 077 037*			PC91UF15C160D4A
	15 URF 91 D14A 0180	-			
	15 URG 91 D14A 0200	A 221 214*			PC91UG15C200D4A
	15 URH 91 D14A 0250	D 221 309*			PC91UH15C250D4A
	92	15 URF 92 D14F 0200			F 076 066
15 URG 92 D14F 0250		G 076 067	PC92UG15C250D4F		
15 URK 92 D14F 0315		H 076 068	PC92UK15C315D4F		
15 URK 92 D14F 0350		J 076 069	PC92UK15C350D4F		
15 URH 92 D14F 0400		X 076 104	PC92UH15C400D4F		
15 URH 92 D14F 0500		Y 076 105	PC92UH15C500D4F		
15 URH 92 D14F 0550		Z 076 106	PC92UH15C550D4F		
15 URF 92 D14A 0200		-			
15 URG 92 D14A 0250		-			
15 URK 92 D14A 0315		C 097 959*	PC92UK15C315D4A		
15 URK 92 D14A 0350		-			
15 URH 92 D14A 0400		-			
15 URH 92 D14A 0500		-			
15 URH 92 D14A 0550		K 078 278*	PC92UH15C550D4A		
93		15 URF 93 D14F 0250	K 076 070	1800	1
	15 URF 93 D14F 0315	L 076 071	PC93UF15C315D4F		
	15 URF 93 D14F 0350	M 076 072	PC93UF15C350D4F		
	15 URG 93 D14F 0375	N 076 073	PC93UG15C375D4F		
	15 URK 93 D14F 0400	P 076 074	PC93UK15C400D4F		
	15 URK 93 D14F 0450	Q 076 075	PC93UK15C450D4F		
	15 URK 93 D14F 0500	R 076 076	PC93UK15C500D4F		
	15 URH 93 D14F 0630	A 076 107	PC93UH15C630D4F		
	15 URJ 93 D14F 0700	B 076 108	PC93UJ15C700D4F		
	15 URB 93 D14F 0750	S 076 123	PC93UB15C750D4F		
	15 URF 93 D14A 0250	-			
	15 URF 93 D14A 0315	-			
	15 URF 93 D14A 0350	-			
	15 URG 93 D14A 0375	-			
	15 URK 93 D14A 0400	-			
15 URK 93 D14A 0450	J078277	PC93UK15C450D4A			
15 URK 93 D14A 0500	-				

* D14A Type

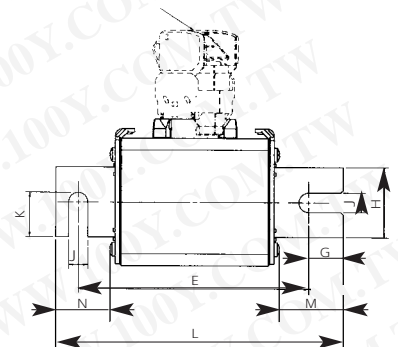

D14F Type

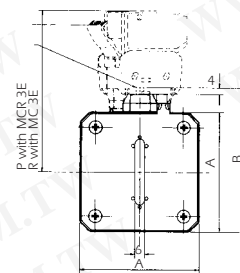
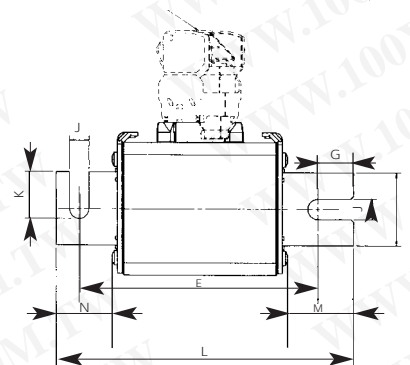

Fuse Size	A	B	E ^{±2}	H	J	K	L ^{±2}	M	N	P	R
91 DIN 140	51	66	133-145	25	11,1	17,7	166	37,2	31,6	87,5	72,5
92 DIN 140	60	74	133-145	32	11,1	21,5	166	37,2	31,6	91,5	76,5
93 DIN 140	74,5	88	133-145	40	11,1	25,5	166	36,7	31,1	98,3	83,5

For other terminals: "US blades"; "D17A"; D17F; "D21A"; "D21F" consult us.
Microswitches supplied separately

Semiconductor (AC) fuses

Protistor® Square-body Fuses PSC aR sizes 9x - 1500 VAC Curves set

I²t corrective K factor

URF/URG/URK

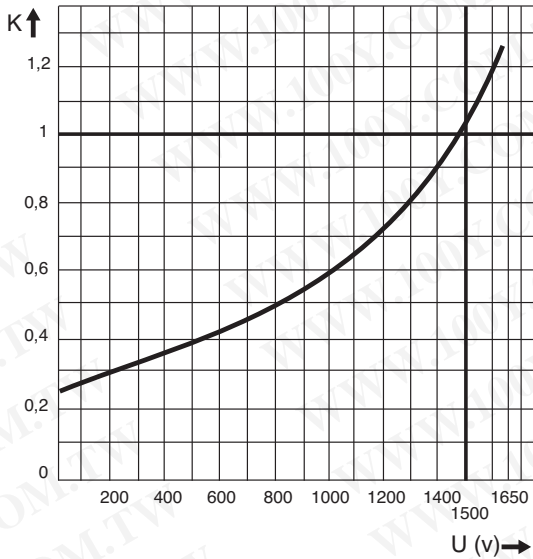

URB/URH/URJ

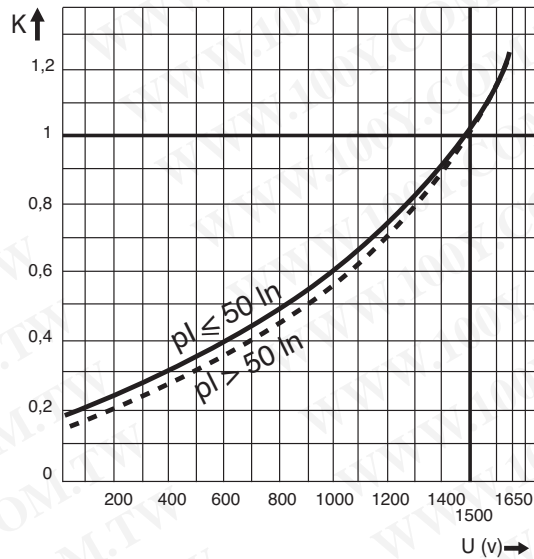

U: R.M.S. working voltage V
K: I²t corrective coefficient versus U

pl: Prospective Current in the fuse

Arc voltage

URF/URG/URK

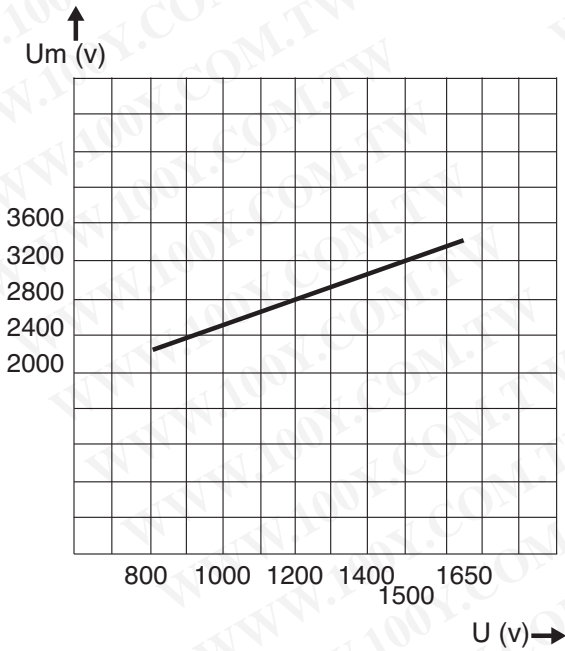

URB/URH/URJ

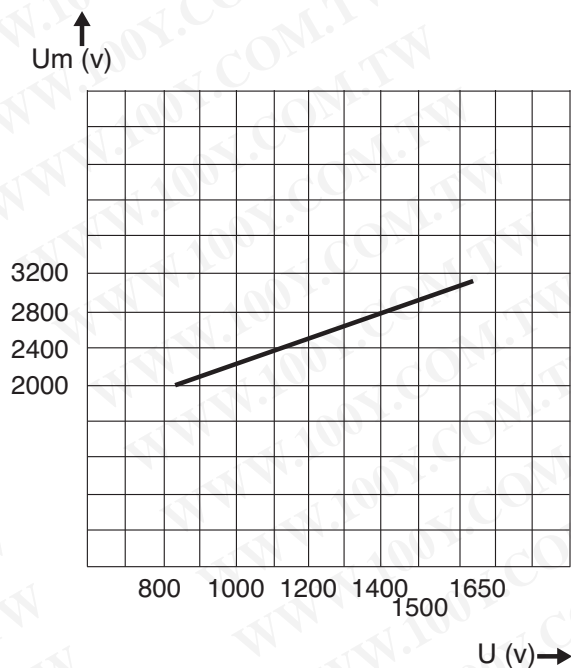

Um: arc voltage
U: R.M.S. working voltage V

Semiconductor (AC) fuses

Protistor® Square-body Fuses PSC aR sizes 9x - 1500 VAC Curves set

Times/Current Characteristics

URF

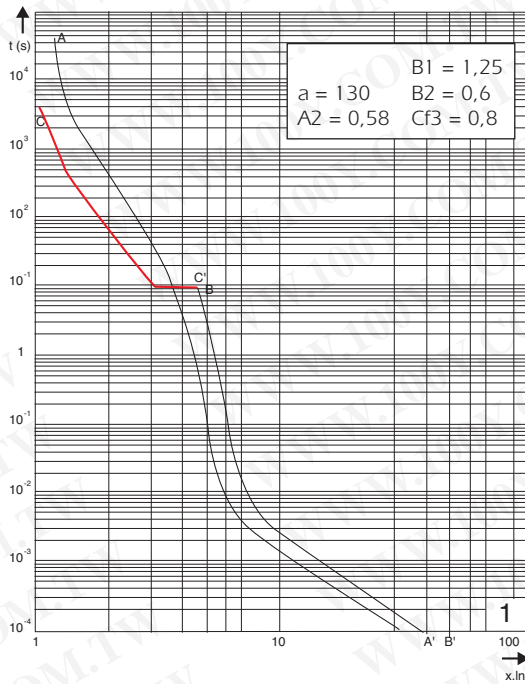

URG

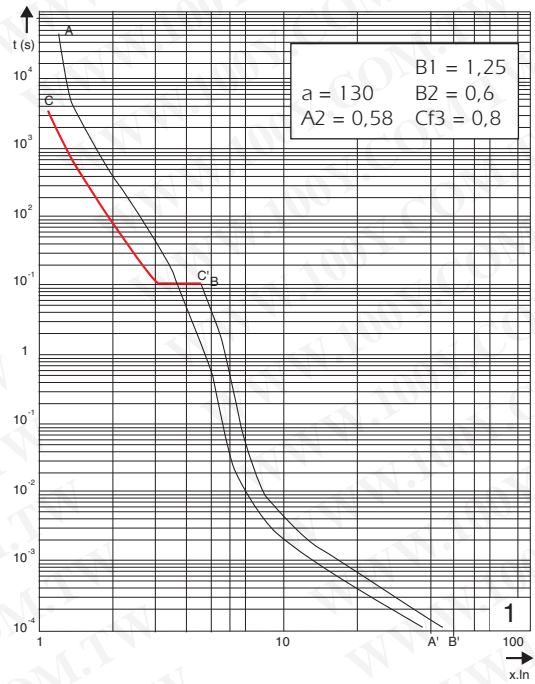

t: actual prearcing time (s) (average value)
x.In: R.M.S. value of prearc current in multiples of rated current

URK

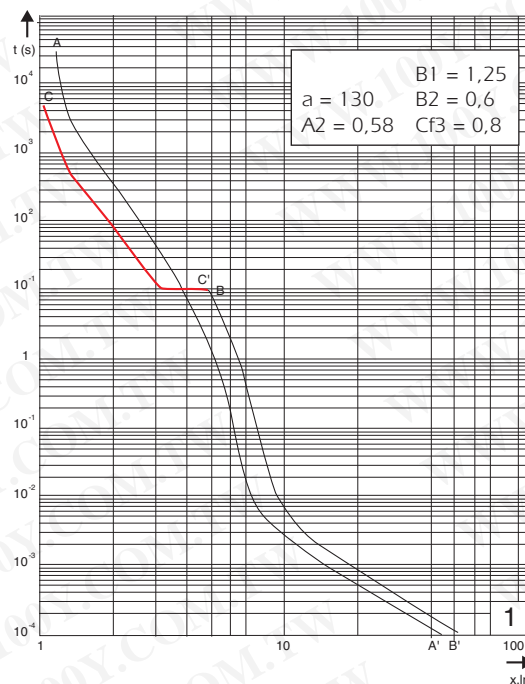

Semiconductor (AC) fuses

Protistor® Square-body Fuses PSC aR sizes 9x - 1500 VAC Curves set

URB

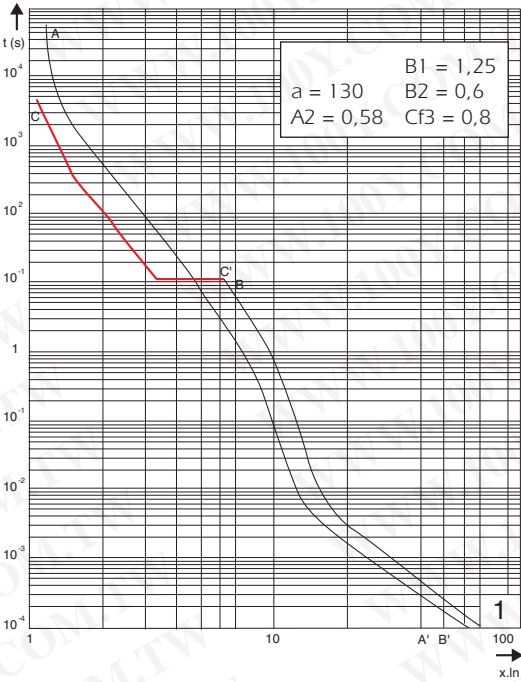

URH

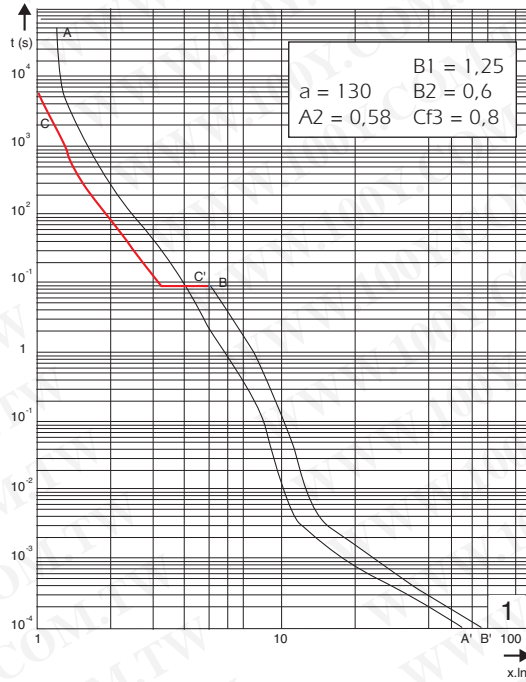

URJ

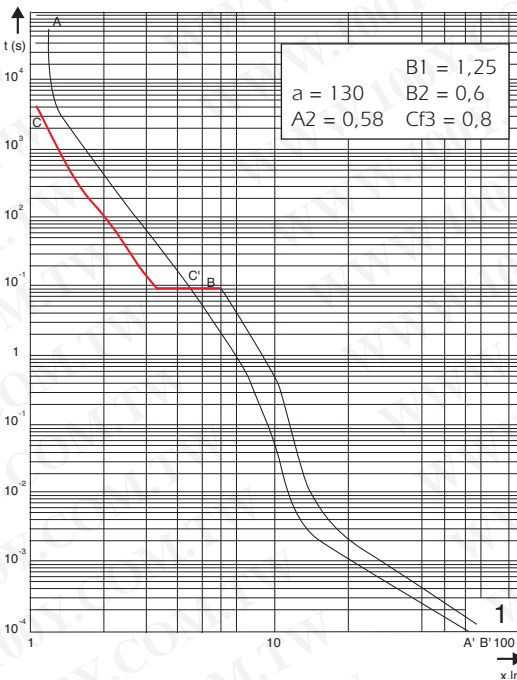

Protistor® Square-body Fuses PSC aR sizes 9x - 1500 VAC Fuses bases for German Blades (DIN 140)

Fuse Holders

For D14F size 91 use fuse holder SE 43-91 Ref Number X226179

For D14F sizes 92 and 93 use fuse holder SE 43-92 Ref Number Y226180

For D14F size 93 use fuse holder SF 50-93 Ref X209090

These fuse holders are usable with D14F fuses and MC3E1-. N.microswitches.

For D14A size 91 use fuse holder SE 43-91 Ref Number X226179

For D14A size 92 and 93 use fuse holder SE 43-92 Ref Number Y226180

For D14A size 93 use fuse holder SF 50-93 Ref. X209090

These fuses D14A are usable with all MC3E1-.N.and MCR 3E1-.N microswitches on all fuses holders.

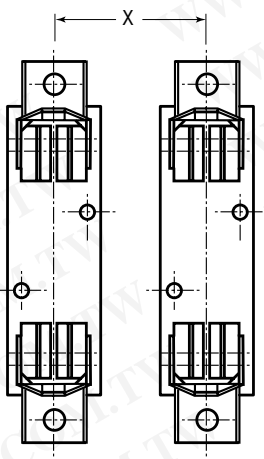

Fuses bases		Distance "X" between poles axes (without partition)		
		Operating Voltage		
		1000 V	1250 V	1500 V
SE 43-91	X226179	71	76	79
SE 43-92	Y226180	80	85	88
SF 50-93	X209090	94,5	99,5	102,5

Semiconductor (AC) fuses

Protistor® Square-body Fuses

PSC aR sizes 9x - 1500 VAC

Fuses bases for German Blades (DIN 140)

"SF" BOLTED TIGHTENING (SF 50-93)

fig. 1

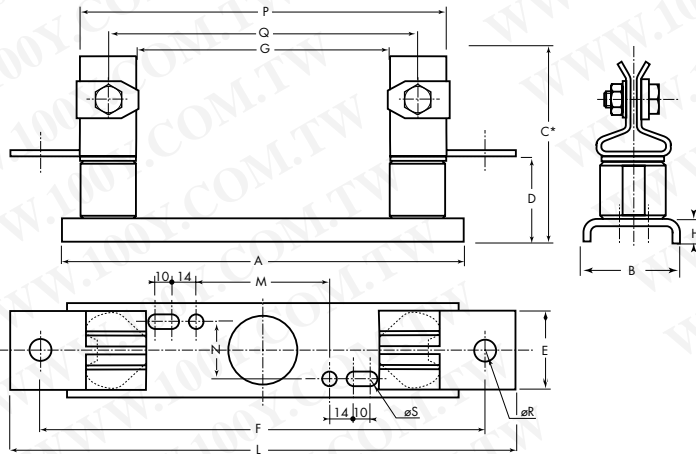

"SE" ELASTIC TIGHTENING (SE 43-91 ; SE 43-92)

fig. 2

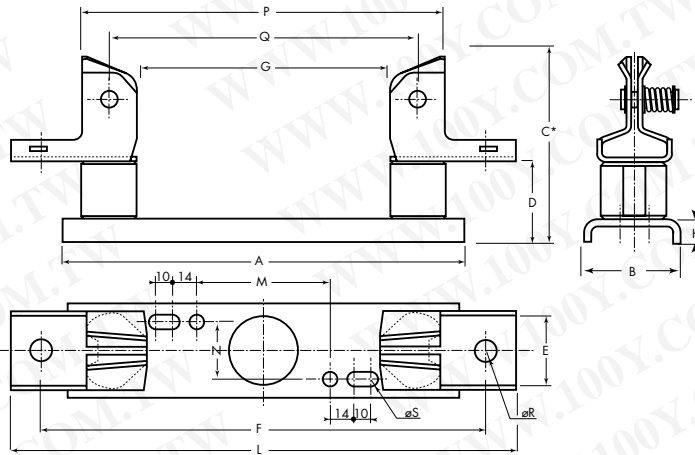

Reference Number	Designation	Drawing#	Catalog Number	A	B	C*	D	E	F	G	H	L	M	N	P	Q	ØR	ØS
X226179	SE 43-91	2	SE43-91	174	42	121	53	32	209	111	10	241	86	28	161	136	10,5	5,5
Y226180	SE 43-92	2	SE43-92	176	54	131	55	42	230	106	15	266	23	35	176	141	12,5	8,5
X209090	SF 50-93	1	SF50-93	200	60	176	70	40	236	106	15	276	47	35	176	141	18	8,5

* C are the dimensions to the top of the "D14F" fuses

Protistor® Square-body Fuses PSC aR sizes 9x - 1500 VAC Microswitches for other square-body Protistor®



- REMOTE SIGNALING SYSTEMS FOR FITTING ON FERRAZ SHAWMUT FUSES EQUIPPED WITH MICROSWITCH SUPPORT:
all square-body sizes 44 / 8X / 9X / 12X / 17X / 30X and 60X
- PERMANENT INDICATION OF FUSE STATE
 - CONDUCTIVE
 - BLOWN
- MANUAL RESETTING
- STANDARD AND LOW ELECTRICAL LEVEL WITH DIFFERENT INSULATION LEVELS
- VAPOR AND WATERTIGHT MODEL FOR USE IN CORROSIVE ATMOSPHERE

Main Characteristics

Type	Designation	AC or DC Insulation voltage rating U _i (V)	AC voltage withstand test (*)	Impulse voltage test U _{imp} 1,2/50 μs (**)	Positive operating min. voltage /min. current	Current rating	Interrupting rating						
							Current	Non-inductive circuit			Inductive circuit: L/R = 25ms		
								30V	110V	250V	30V	110V	250V
Standard	MC3E 1-5N	1250V	15 kV	20 kV	20 V	5 A	50/60 Hz	10 A	10 A	7 A			6 A
	MCR3E 1-5N	2200	20 kV	30 kV	50 mA		DC	5 A	0.5 A			1.6 A	0.3 A
Low level	MC3E 1-5NBS	1250 V	15 kV	20 kV	10 V 10 mA	3 A	50/60 Hz	3 A	3 A	3 A	2 A	1 A	1 A
	MC3E 1-9NBS							2200 V	20 kV (1)	30 kV	3 A	3 A	3 A
	MCR3E 1-5NBS	20 kV (1)	40 kV	3 A			0.5 A		0.25A		3 A	0.2 A	0.1 A
	MCR3E 1-9NBS	23 kV (2)		3 A			0.5 A	0.25A	3 A	0.2 A	0.1 A		
Watertight IP 50	MC2R3E 1-5NBS	6000 V	24 kV (1)	40 kV	10 V 10 mA	3 A	50 Hz	3 A	3 A		1 A	1 A	
	MC2R3E 1-5NBS		26 kV (2)					3 A	3 A		1 A	1 A	
	MC2R3E 1-9NBS	32 kV (3)	3 A				0.5 A		0.2 A				
Watertight IP 50	MC3E 1-5NET	1250 V	11 kV	16 kV	10 V 10 mA	3 A	50 Hz	3 A	3 A		1 A	1 A	
	MCR3E 1-5NET	2200 V	20 kV (1)	30 kV				3 A	3 A		0.2 A		
	MC2R3E 1-5NET	6000 V	24 kV (2)	40 kV				3 A	0.5 A		0.2 A		

Catalog Numbering system: MC3E 1-5 single pole microswitch - MC3E 1-9 double pole microswitch - MCR, MC2R reinforced insulation microswitch.

* Between power circuit and microswitch terminals as per IEC 60 and 694 and NFC 64010 (50/60 Hz 1 min duration in dry air).

** Between power circuit and microswitch terminals U_{imp}: impulse voltage according to IEC 947-1.

*** Between power circuit and microswitch terminals

(1) fitting sizes 44 - 70 - 71 - 72 - 73 - 83 - 84 fuses.

(2) fitting sizes 91 - 92 - 93 - 94 -120 - 121 - 122 - 123 - 124 fuses.

(3) fitting sizes 171 - 172 - 173 - 174 - 300 - 302 - 600 - 602 fuses.

勝特力材料 886-3-5753170
勝特力电子(上海) 86-21-34970699
勝特力电子(深圳) 86-755-83298787
[Http://www.100y.com.tw](http://www.100y.com.tw)

Semiconductor (AC) fuses

Protistor® Square-body Fuses

PSC aR sizes 9x - 1500 VAC

Microswitches for other square-body Protistor®

Remote signaling with 1250 V AC/DC insulation voltage

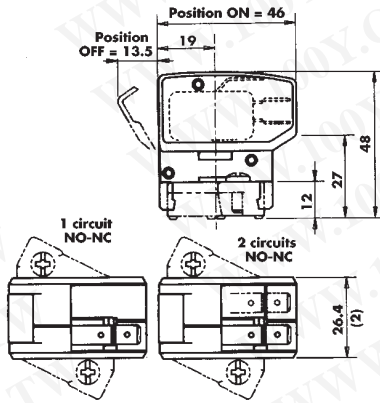

Quantity of NO-NC separated circuits	Contact	Designation	Ref. Number	Weight (g)	Pack. (1)	Catalog Number
1	standard	MC3E 1-5N	D310020	39.5	3	MC3E1-5N
1	low level	MC3E 1-5NBS	E310021	39.5	3	MC3E1-5NBS
2	low level	MC3E 1-9NBS	F310022	45.7	3	MC3E1-9NBS
1	watertight	MC3E 1-5NET	L310027	40.2	3	MC3E1-5N ETANCHE

Remote signaling with insulation voltage up to 2200 V AC/DC

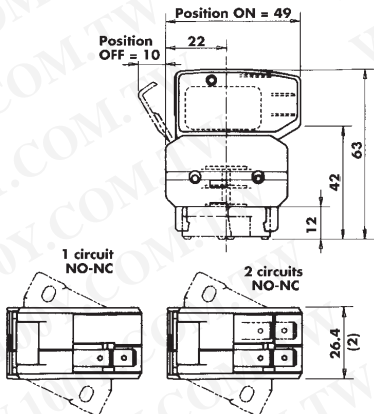

Quantity of NO-NC separated circuits	Contact	Designation	Ref. Number	Weight (g)	Pack. (1)	Catalog Number
1	standard	MCR3E 1-5N	G310023	51.7	1	MCR3E1-5N
1	low level	MCR3E 1-5NBS	P310030	51.7	1	MCR3E1-5NBS
2	low level	MCR3E 1-9NBS	H310024	58.0	1	MCR3E1-9NBS
1	watertight	MCR3E 1-5NET	Q310031	52.5	1	MCR3E1-5N ETANCHE

Remote signaling with insulation voltage up to 6000 V AC/DC

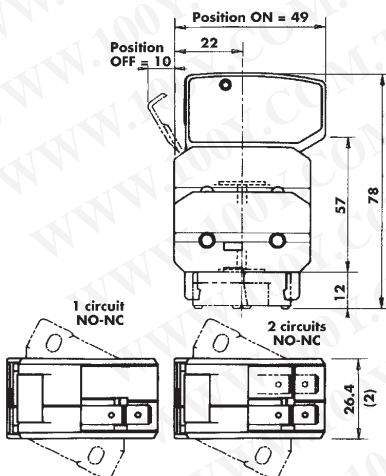

Quantity of NO-NC separated circuits	Contact	Designation	Ref. Number	Weight (g)	Pack. (1)	Catalog Number
1	low level	MC2R3E 1-5NBS	J310025	64.0	1	MC2R3E1-5NBS
1	watertight	MC2R3E 1-5NET	N310029	64.8	1	MC2R3E1-5NET
2	low level	MC2R3E 1-9NBS	K310026	70.3	1	MC2R3E1-9NBS

Electrical diagram of each microswitch circuit

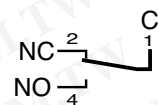

Non-blown fuse
Microswitch ON

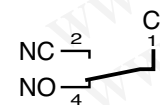

Blown fuse
Microswitch OFF

All of these signalling systems are hand resettable and fitted with silver-plated 3-terminal microswitch C, NO and NC. The C terminal is on the top and connection is made via 6.35 mm clips except for watertight models whose clips are 4.8 mm wide.

NOTE (2): The 26.4 dimension is the same with 1 or 2 separated circuits NO-NC.

Tests with sine vibrations carried out at ambient with scanning of the three main holder axes.

Spectrum: 1st segment (2 to 16 Hz) constant trip $x = 5$ mm peak.

2nd segment (16 to 250 Hz) constant acceleration $g = 5$ g peak.

Exponential scanning speed : 1 octave per minute.



Duration: 2 hours per axis.

Semiconductor (AC) fuses

Protistor® Square-body Fuses PSC aR sizes 9x - 1500 VAC Metric-studs

Metric studs for threaded terminal fuses



Type and fuse size	Designation	Ref. Number	Unit weight (g)	Pack.	Catalog Number
 Sizes 0 and 1	HC stud pair M8x30 & M8x35	S098801	23	6 pairs	STU M8x30 M8x35
	Size 2 HC stud pair M10x30 & M10x50	T098802	40	6 pairs	STU M10x30 M10x50
	Size 3 HC stud pair M12x35 & M12x50	V098803	60	6 pairs	STU M12x35 M12x50
 Size 2	HC stud pair M10x50	W098804	45	6 pairs	STU M10x50
	Size 3 HC stud pair M12x50	X098805	45	6 pairs	STU M12x50

We recommend the use of studs, whose quality is suited to all FERRAZ SHAWMUT square-body fuses with terminals

Stud mounting

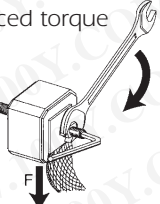
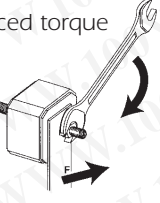
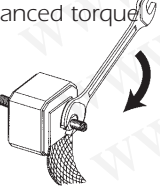
Torque type	Stud type	Maximum stud tightening torque (Nm) (1)	Maximum nut tightening torque (Nm) (1)
Balanced torque 	M8x30 & M8x35	10	13.5
	M10x30 & M10x50	15	26
	M12x35 & M12x50	15	46
Balanced torque 	M8x30 & M8x35	10	13.5
	M10x30 & M10x50	15	26
	M12x35 & M12x50	15	46
Unbalanced torque 	M8x30 & M8x35	10	13.5
	M10x30 & M10x50	15	26
	M12x35 & M12x50	15	46

(1) Factory limit on torque at 20°C ambient: +0, -2Nm; except on 46Nm value (+0, -4Nm)

Protistor® Square-body Fuses PSC - LR (large rectifier) PSC - LR ranges



25 URD 123 TTF 630



4 URD TDF 1000



9,5 URD 94 PPASF 3800
+ MC3E 1-5N



13,5 URD 283 PLAF 1600
+ MCR3E 1-5NBS

Ferraz Shawmut PSC-LR fuse-links provide maximum flexibility in equipment design and ultimate protection for today's power conversion equipment. These square body fuse-links are available in various body sizes with a broad range of ampere ratings allowing the greatest flexibility in equipment design.

The Ferraz Shawmut PSC-LR fuse range has been engineered to provide state of the art protection for high power semiconductors such as diodes, thyristors, GTO's, IGCT's and IGBT's.

They have pure silver fuse elements embedded in solidified sand which provides optimized I^2t and high interrupting rating. All contact surfaces are plated and all hardware non-magnetic.

All fuses are standard with a low voltage blown fuse indicator. This indicator can operate a microswitch which is easily mounted directly onto the fuse in service.

Features/Benefits

Customized terminals

available under request

Wide range of mounting styles

Broad range of ampere ratings in each body size for design flexibility

IEC 60269-4 compliance for fuses for worldwide semiconductor applications

Highlights

- Highly current limiting.
- Isolating fuse
- High breaking capacities
- High capability of selection in case of external fault
- Worldwide acceptance.
- Superior cycling ability.
- High withstanding in rush current and overloads
- Optimized coordination ratio

Ratings

AC: up to 10 000A
130 V - 3 800V
100 - 240 kA IR

DC: Consult Factory

Applications

Protection of large rectifiers, inverters, static transfer switch, AC & DC drives and UPS systems.

Approvals

AC: Tested to IEC 60269-4



13,5 URD 294 TDSFF 3400
+ MCR3E 1-5NBS



13 URD 84 TQFPLA 0900

Semiconductor (AC) fuses

Protistor® Square-body Fuses PSC - LR (large rectifier) PSC - LR ranges

This selection chart shows the global PSC-LR fuse link range and help to select the proper fuse size for your technical needs.

On the following pages, fuse technical data are shown from size 33 up to size 2 x 174.

In addition, you will find a selection of accessories such as threaded studs, micro switches as well as mounting torque and clamping force information.

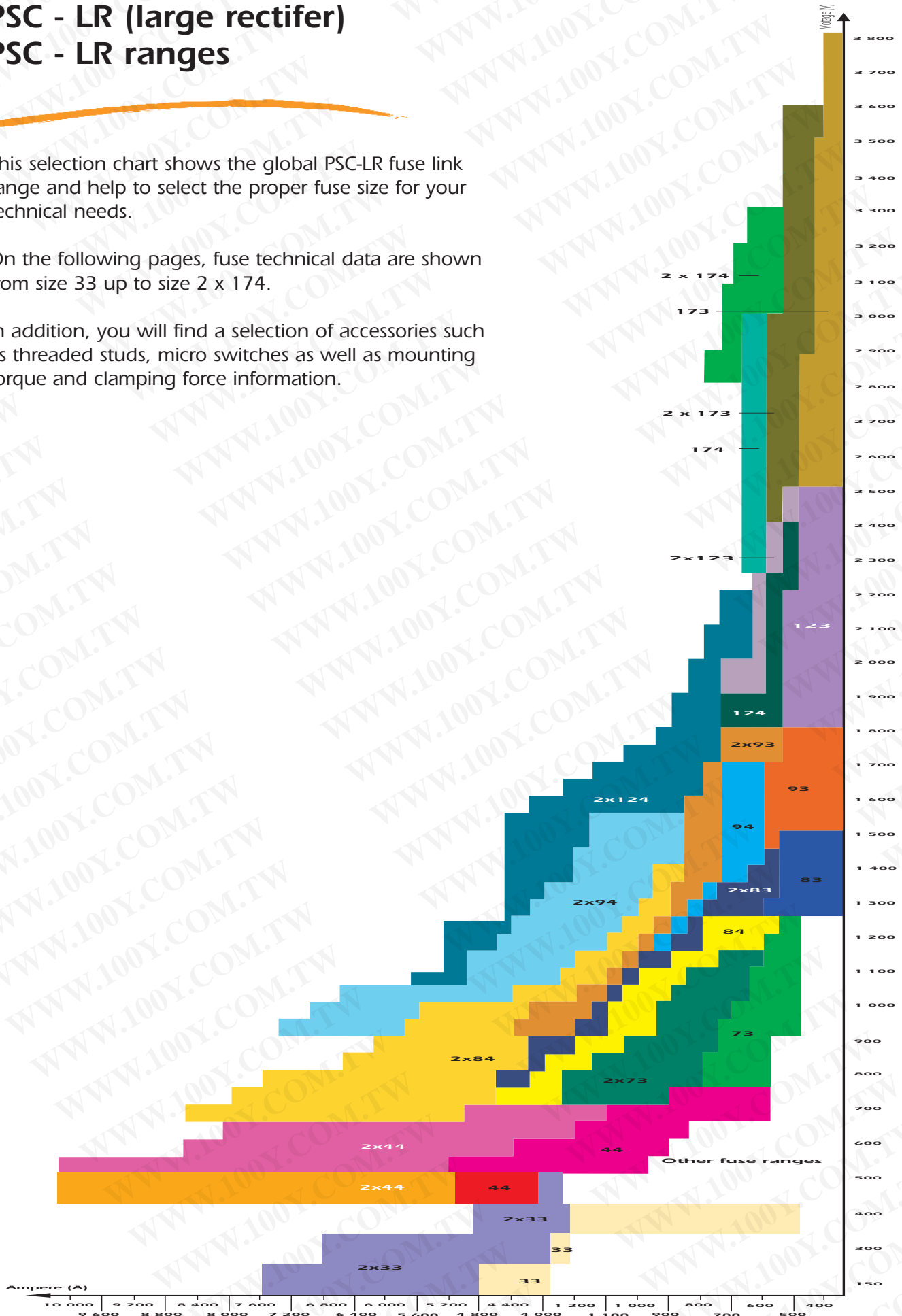

Protistor® Square-body Fuses PSC - LR (large rectifier) Microswitches for other Square-body Protistor®

Microswitch system for round and square-body fuses (except PSC line)

- REMOTE SIGNALING SYSTEMS FOR FITTING ON FERRAZ SHAWMUT FUSES EQUIPPED WITH MICROSWITCH SUPPORT:
all square-body sizes 44 / 8X / 9X / 12X / 17X / 30X and 60X
- PERMANENT INDICATION OF FUSE STATE
 - CONDUCTIVE
 - BLOWN
- MANUAL RESETTING
- STANDARD AND LOW ELECTRICAL LEVEL WITH DIFFERENT INSULATION LEVELS
- VAPOR AND WATERTIGHT MODEL FOR USE IN CORROSIVE ATMOSPHERE



Main Characteristics

Type	Designation	AC or DC Insulation voltage rating U _i (V)	AC voltage withstand test (*)	Impulse voltage test U _{imp} 1,2/50 µs (**)	Positive operating min. voltage /min. current	Current rating	Interrupting rating						
							Current	Non-inductive circuit			Inductive circuit: L/R = 25ms		
								30V	110V	250V	30V	110V	250V
Standard	MC3E 1-5N	1250V	15 kV	20 kV	20 V	5 A	50/60 Hz	10 A	10 A	7 A			6 A
	MCR3E 1-5N	2200	20 kV	30 kV	50 mA		DC	5 A	0.5 A			1,6 A	0,3 A
Low level	MC3E 1-5NBS	1250 V	15 kV	20 kV	10 V 10 mA	3 A	50/60 Hz	3 A	3 A	3 A	2 A	1 A	1 A
	MC3E 1-9NBS							2200 V	20 kV (1)	30 kV	3 A	3 A	3 A
	MCR3E 1-5NBS	20 kV (1)	40 kV	3 A			0.5 A		0.25A		3 A	0,2 A	0,1 A
	MCR3E 1-9NBS	23 kV (2)		3 A			0.5 A	0,2 A	0,1 A				
Watertight IP 50	MC3E 1-5NET	1250 V	11 kV	16 kV	10 V 10 mA	3 A	50 Hz	3 A	3 A		1 A	1 A	
	MCR3E 1-5NET	2200 V	20 kV (1)	30 kV				0.5 A		0,2 A			
	MC2R3E 1-5NET	6000 V	24 kV (2)	40 kV						0,2 A			

Catalog Numbering system: MC3E 1-5 single pole microswitch - MC3E 1-9 double pole microswitch - MCR, MC2R reinforced insulation microswitch.

* Between power circuit and microswitch terminals as per IEC 60 and 694 and NFC 64010 (50/60 Hz 1 min duration in dry air).

** Between power circuit and microswitch terminals U_{imp}: impulse voltage according to IEC 947-1.

*** Between power circuit and microswitch terminals

(1) fitting sizes 44 - 70 - 71 - 72 - 73 - 83 - 84 fuses.

(2) fitting sizes 91 - 92 - 93 - 94 -120 - 121 - 122 - 123 - 124 fuses.

(3) fitting sizes 171 - 172 - 173 - 174 - 300 - 302 - 600 - 602 fuses.

Semiconductor (AC) fuses

Protistor® Square-body Fuses

PSC - LR (large rectifier)

Microswitches for other Square-body Protistor®

Remote signaling with 1250 V AC/DC insulation voltage

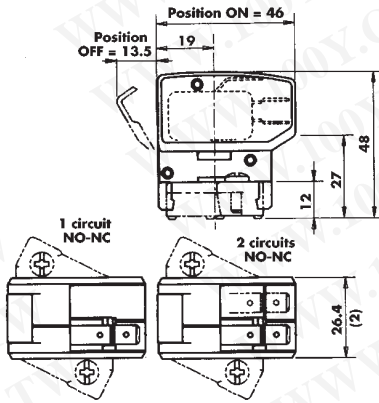

Quantity of NO-NC separated circuits	Contact	Designation	Ref. Number	Weight (g)	Pack. (1)	Catalog Number
1	standard	MC3E 1-5N	D310020	39.5	3	MC3E1-5N
1	low level	MC3E 1-5NBS	E310021	39.5	3	MC3E1-5NBS
2	low level	MC3E 1-9NBS	F310022	45.7	3	MC3E1-9NBS
1	watertight	MC3E 1-5NET	L310027	40.2	3	MC3E1-5N ETANCHE

Remote signaling with insulation voltage up to 2200 V AC/DC

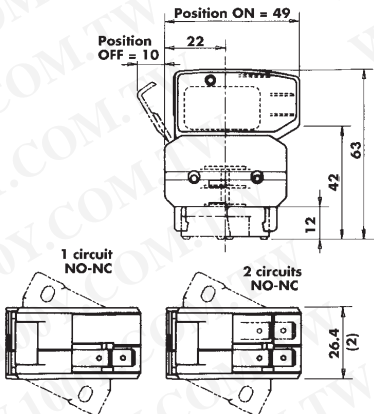

Quantity of NO-NC separated circuits	Contact	Designation	Ref. Number	Weight (g)	Pack. (1)	Catalog Number
1	standard	MCR3E 1-5N	G310023	51.7	1	MCR3E1-5N
1	low level	MCR3E 1-5NBS	P310030	51.7	1	MCR3E1-5NBS
2	low level	MCR3E 1-9NBS	H310024	58.0	1	MCR3E1-9NBS
1	watertight	MCR3E 1-5NET	Q310031	52.5	1	MCR3E1-5N ETANCHE

Remote signaling with insulation voltage up to 6000 V AC/DC

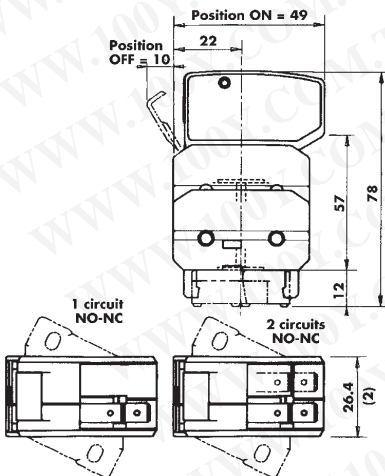

Quantity of NO-NC separated circuits	Contact	Designation	Ref. Number	Weight (g)	Pack. (1)	Catalog Number
1	low level	MC2R3E 1-5NBS	J310025	64.0	1	MC2R3E1-5NBS
1	watertight	MC2R3E 1-5NET	N310029	64.8	1	MC2R3E1-5NET
2	low level	MC2R3E 1-9NBS	K310026	70.3	1	MC2R3E1-9NBS

Electrical diagram of each microswitch circuit

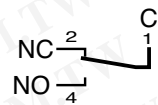

Non-blown fuse
Microswitch ON

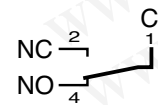

Blown fuse
Microswitch OFF

All of these signalling systems are hand resettable and fitted with silver-plated 3-terminal microswitch C, NO and NC. The C terminal is on the top and connection is made via 6.35 mm clips except for watertight models whose clips are 4.8 mm wide.

NOTE (2): The 26.4 dimension is the same with 1 or 2 separated circuits NO-NC.

Tests with sine vibrations carried out at ambient with scanning of the three main holder axes.

Spectrum: 1st segment (2 to 16 Hz) constant trip $x = 5$ mm peak.

2nd segment (16 to 250 Hz) constant acceleration $g = 5$ g peak.

Exponential scanning speed : 1 octave per minute.



Duration: 2 hours per axis.

Semiconductor (AC) fuses

Protistor® Square-body Fuses PSC - LR (large rectifier) Metric-studs

Metric studs for threaded terminal fuses



Type and fuse size	Designation	Ref. Number	Unit weight (g)	Pack.	Catalog Number
 Sizes 0 and 1	HC stud pair M8x30 & M8x35	S098801	23	6 pairs	STU M8x30 M8x35
	HC stud pair M10x30 & M10x50	T098802	40	6 pairs	STU M10x30 M10x50
	HC stud pair M12x35 & M12x50	V098803	60	6 pairs	STU M12x35 M12x50
 Size 2	HC stud pair M10x50	W098804	45	6 pairs	STU M10x50
	HC stud pair M12x50	X098805	45	6 pairs	STU M12x50

We recommend the use of studs, whose quality is suited to all FERRAZ SHAWMUT square-body fuses with terminals

Stud mounting

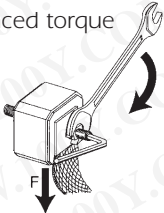
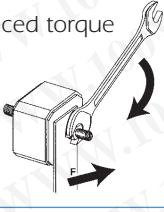
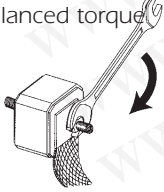
Torque type	Stud type	Maximum stud tightening torque (Nm) (1)	Maximum nut tightening torque (Nm) (1)
Balanced torque 	M8x30 & M8x35	10	13.5
	M10x30 & M10x50	15	26
	M12x35 & M12x50	15	46
Balanced torque 	M8x30 & M8x35	10	13.5
	M10x30 & M10x50	15	26
	M12x35 & M12x50	15	46
Unbalanced torque 	M8x30 & M8x35	10	13.5
	M10x30 & M10x50	15	26
	M12x35 & M12x50	15	46

(1) Factory limit on torque at 20°C ambient: +0, -2Nm; except on 46Nm value (+0, -4Nm)

Other Protistor® Fuses Ferrule Fuses 10x38 gRB - 690VAC

690V AC
gRB - from 1 up to 30 A
Size: 10x38



The fuse preselection table below indicates: 

- rated current (or rating) I_N
- pre-arcing I^2t (I^2t_D) at 1 ms
- total operating I^2t (I^2t_{tt}) at 690V, $\cos \varphi=0.15$, and for a total operating time from 8 to 10 ms
- dissipated power P_N at the rated current I_N , and at $0.8 I_N$, in steady state
- Nominal breaking capacity, checked by tests made in accordance with IEC standard.

Voltage Rating (VAC)	Rated current I_N (A)	Pre-arcing I^2t I^2t_p (A ² s)	Total I^2t at 660VAC I^2t_{tt} (A ² s)	Dissipated power		Peak arc voltage (V)	Breaking capacity I (kA)
				at I_N (W)	at $0.8 I_N$ (W)		
690	1	0,075	0,28	0,9	0,52	2500	160 kA 690 V (IEC)
	1,25	0,115	0,36	1,25	0,7		
	1,5	0,185	0,57	1,5	0,81		
	2	0,42	1,3	2	1,1		
	2,5	0,88	2,7	2,1	1,15		
	3	1,55	4,6	2,3	1,25		
	4	4	12	2,6	1,35		
	5	8,6	25	2,7	1,4	1450	
	6	15	44	2,9	1,5		
	8	3,3	33	2,4	1,35		
	10	5,4	55	3,4	1,85		
	12,5	8,5	82	3,4	1,9		
	16	16	145	4,1	2,3		
	20	230	250	4,3	2,4		
25	58	470	4,7	2,7			
30 (32*)	96	740	5	2,9			

* Non approval rating

Semiconductor (AC) fuses

Other Protistor® Fuses French Ferrule 10x38 gRB - 690VAC

Maximum values of total operating I^2t and total operating times

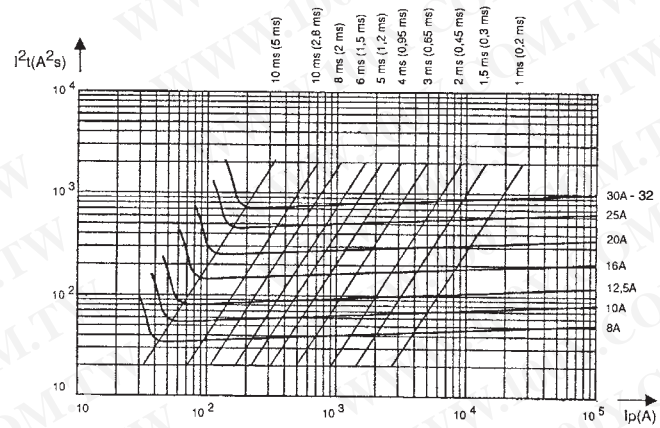
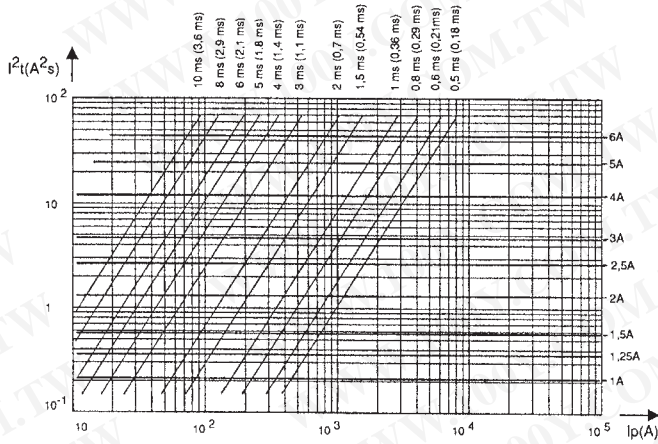

Arc voltage

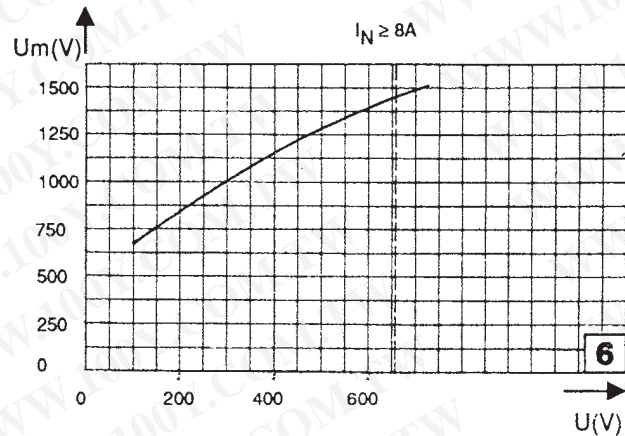
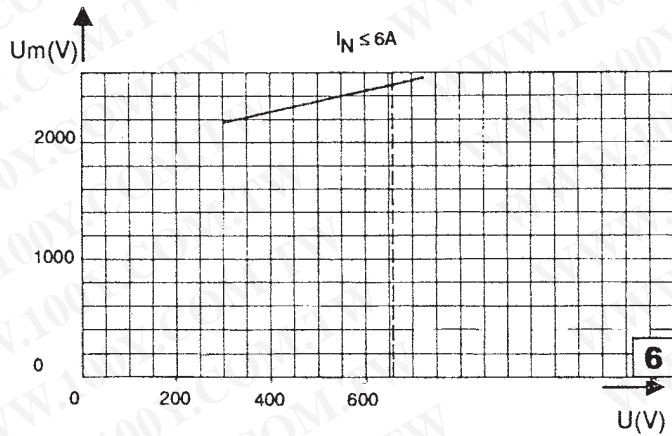

Multiplier coefficient

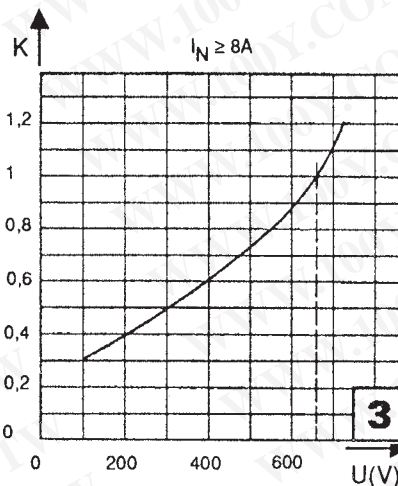
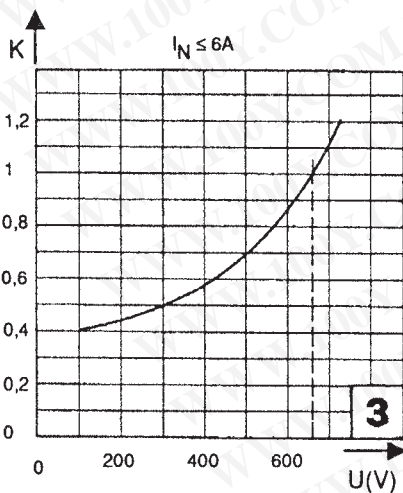

Semiconductor (AC) fuses

Other Protistor® Fuses
 Ferrule Fuses
 10x38 gRB - 690VAC

Time-current characteristics (1 to 6 A)

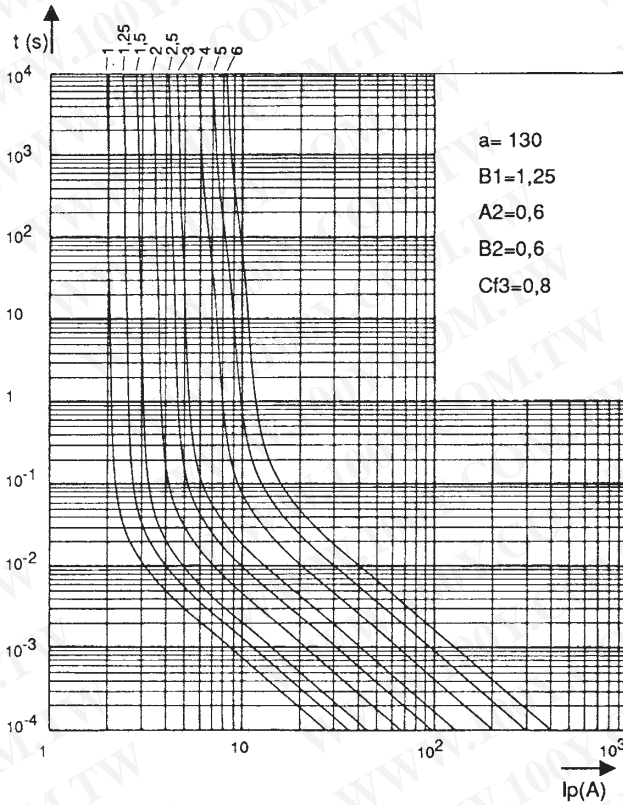

Cut-off characteristics

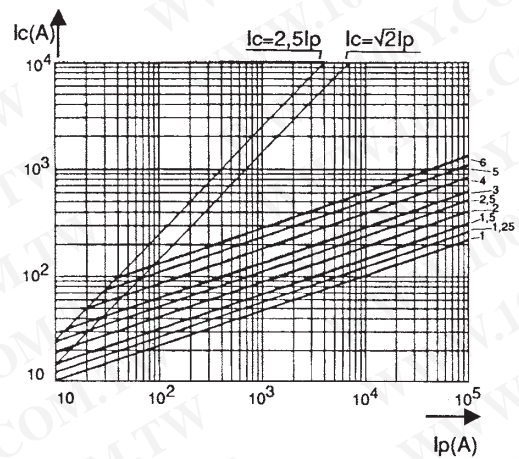

Time-current characteristics (8 to 30 A)

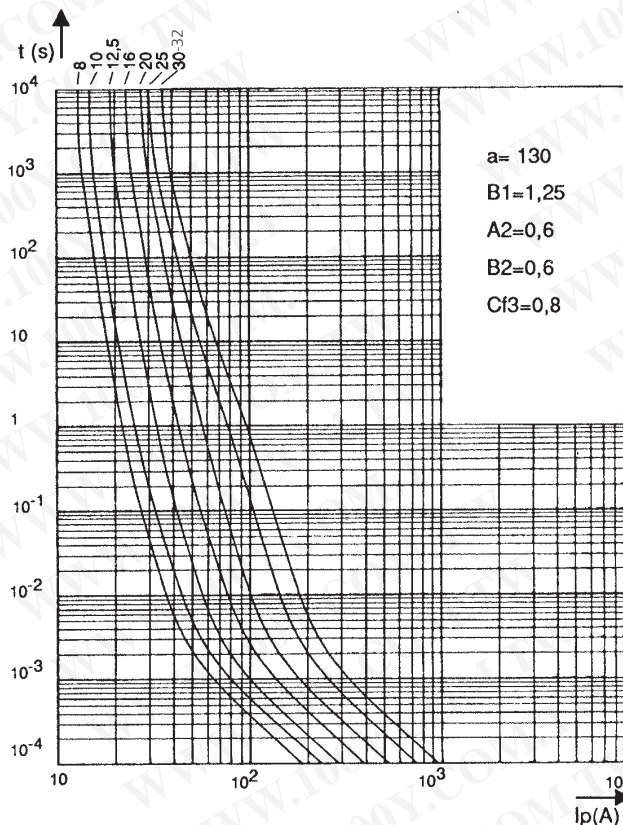

Cut-off characteristics

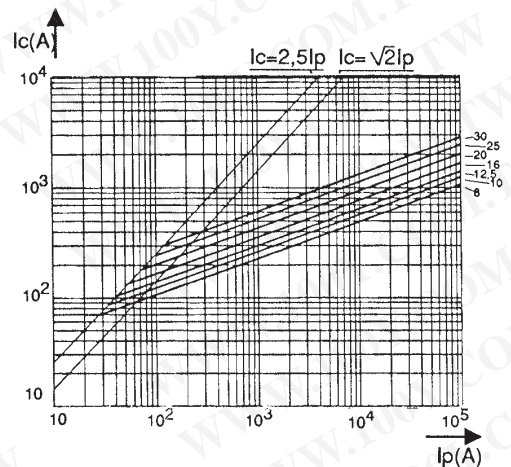

Semiconductor (AC) fuses

Other Protistor® Fuses Ferrule Fuses 10x38 gRB - 690VAC

Dimensions / Reference / Ref. No. 

Rating (A)	Designation	Ref. Number	Catalog Number
1	6,9 gRC 10-01 - A070 gRC 01 T13	Z330279	FR10GB69V1
1,25	6,9 gRB 10-1,25 - A070 gRB 1.25 T13	X330001	FR10GB69V1.25
1,5	6,9 gRB 10-1,5 - A070 gRB 1.5 T13	Y330002	FR10GB69V1.5
2	6,9 gRB 10-02 - A070 gRB 02 T13	Z330003	FR10GB69V2
2,5	6,9 gRB 10-2,5 - A070 gRB 2.5 T13	A330004	FR10GB69V2.5
3	6,9 gRB 10-03 - A070 gRB 03 T13	B330005	FR10GB69V3
4	6,9 gRB 10-04 - A070 gRB 04 T13	C330006	FR10GB69V4
5	6,9 gRB 10-05 - A070 gRB 05 T13	D330007	FR10GB69V5
6	6,9 gRB 10-06 - A070 gRB 06 T13	E330008	FR10GB69V6
8	6,9 gRB 10-08 - A070 gRB 08 T13	F330009	FR10GB69V8
10	6,9 gRB 10-10 - A070 gRB 10 T13	G330010	FR10GB69V10
12,5	6,9 gRB 10-12,5 - A070 gRB 12.5 T13	H330011	FR10GB69V12.5
16	6,9 gRB 10-16 - A070 gRB 16 T13	J330012	FR10GB69V16
20	6,9 gRB 10-20 - A070 gRB 20 T13	K330013	FR10GB69V20
25	6,9 gRB 10-25 - A070 gRB 25 T13	L330014	FR10GB69V25
30	6,9 gRB 10-30 - A070 gRB 30T13	M330015	FR10GB69V30
32*	6,9 gRB 10-32 - A070 gRB 32T13	Y330278	FR10GB69V32

* Non approval rating

DC working voltage possibilities

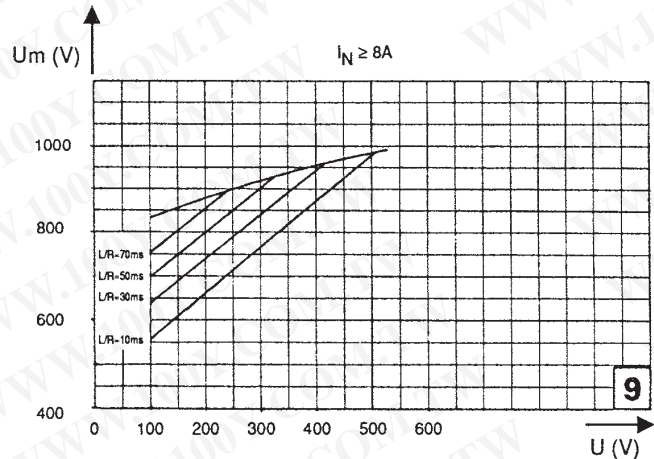
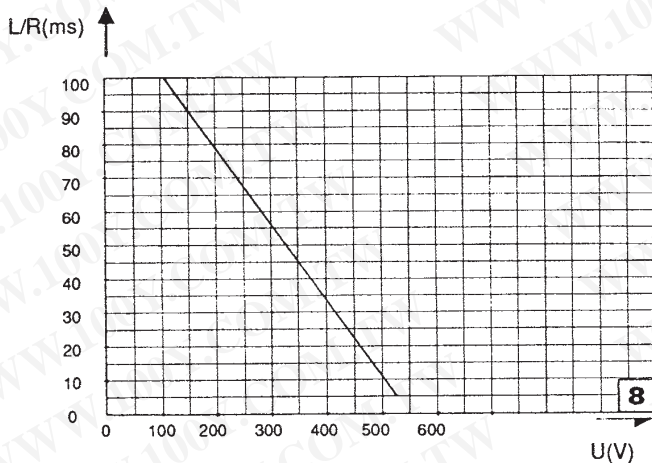

↑ Above: Curve indicating the maximum time constant L/R of the fault path as a function of the DC voltage U, for the rated currents from 1 to 30 A of this range.

Time-current characteristics: Curves indicate, for each rated current, pre-arcing time as a function of RMS value of pre-arcing current I.

Tolerances on this current:
±10% = ratings from 1 to 6 A
±9% = ratings from 8 to 30 A

Fuses with "gR" characteristics can eliminate all overloads.

They do not show any minimum breaking capacity but limit currents of non-operation or operation in compliance with standard VDE 636/23.

Cut off characteristics: Curves indicate, for each rated current, the peak value I_c that the current may reach as a function of prospective fault current I_p.

Without trip-indicator
Max. weight 10g
Packaging: per 10 pieces

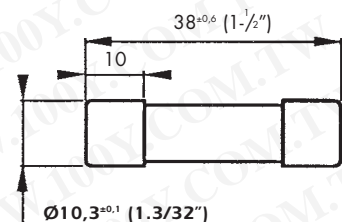

Other Protistor® Fuses Ferrule Fuses 10x38 URB/URD/URL - 500 to 600 VAC



Extremely high breaking capacity fuses:
Protection of power semiconductors complying with IEC standard 60269.1 and 4.

500 - 600 VAC voltage rating

aR-CLASS according to VDE 636-23 IEC 60269-4

Without blown fuse indication 0.10 up to 0.80 A**

With trip-indicator (1 to 30 A), a Ferraz Shawmut speciality*

Main Characteristics

Voltage rating U_N (VAC)	Class	Current rating I_N (A)	Pre-arcing $I^2t @ 1 \text{ ms}$ I^2tp (A ² s)	Total clearing $I^2t @ U_N$ I^2tt (A ² s)	Watts loss		Tested breaking capacity
					0.8 I_N	I_N	
600 V without blown fuse indicator	URD **	100 mA	/	1.2 10 ⁻³	0.23	0.4	200 kA @ 600 V
		125 mA		2.3 10 ⁻³	0.25	0.44	
		160 mA		5.2 10 ⁻³	0.28	0.48	
		200 mA		8 10 ⁻³	0.34	0.58	
		250 mA		18 10 ⁻³	0.35	0.60	
		315 mA		33 10 ⁻³	0.42	0.73	
		400 mA		56 10 ⁻³	0.46	0.80	
		500 mA		0.100	0.46	0.80	
		630 mA		0.18	0.52	0.90	
800 mA	0.44	0.58	1				
500 V with trip-indicator	URD	1 A	0.40	3.6	2.8	0.5	50 kA @ 500 V
		1.25 A	0.13	1.7	0.52	0.91	
		1.6 A	0.31	2.2	0.58	1	
		2 A	0.65	3.1	0.63	1.1	
		2.5 A	1.65	5.9	0.63	1.1	
		3.15 A	2.80	9	0.86	1.5	
	4 A	5.30	16	1.1	1.8		
	5 A	12.7	36	1.1	1.8		
	URD	6 A	1.3	47	0.73	1.35	50 kA @ 500 V
		8 A	2.3	80	0.83	1.55	
		10 A	3.6	110	1	1.9	
		12 A	5.25	150	1.3	2.3	
		16 A	9.30	200	1.7	3.1	
	20 A	16	290	1.7	3.2		
	URL	25 A	37	580	2.9	4.25	50 kA @ 500 V
30 A		58	900	3.5	5.1		

* minimum operating voltage for trip-indicator: 20 V

** higher ratings without blown fuse indicator see 10x38gRB - 690 VAC



Other Protistor® Fuses

Ferrule Fuses

10x38 URB/URD - 500 to 600 VAC

10.3x38 - Without blown fuse indicator

Current Rating	Designation	Ref. Number	Catalog Number
100 mA	A 060 URD 0.100T13	H077632	A060UD0.100T13
125 mA	A 060 URD 0.125T13	J077633	A060UD0.125T13
160 mA	A 060 URD 0.160T13	K077634	A060UD0.160T13
200 mA	A 060 URD 0.200T13	L077635	A060UD0.200T13
250 mA	A 060 URD 0.250T13	M077636	A060UD0.250T13
315 mA	A 060 URD 0.315T13	N077637	A060UD0.315T13
400 mA	A 060 URD 0.400T13	P077638	A060UD0.400T13
500 mA	A 060 URD 0.500T13*	Q077639	A060UD0.500T13
630 mA	A 060 URD 0.630T13*	R077640	A060UD0.630T13
800 mA	A 060 URD 0.800T13*	S077641	A060UD0.800T13

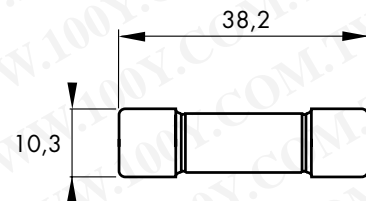

* UL Recognized 

Fuses mounted in clips or fuse disconnectors

10.3x38 - With trip-indicator

Current Rating	Designation	Ref. Number	Catalog Number
1 A	A 050 URD 001 T13 I	P076925	A050URD1T13I
1.25 A	A 050 URD 001.2 T13 I	H076597	A050URD1.2T13I
1.6 A	A 050 URD 001.6 T13 I	G076596	A050URD1.6T13I
2 A	A 050 URD 002 T13 I	Q076926	A050URD2T13I
2.5 A	A 050 URD 002.5 T13 I	F076595	A050URD2.5T13I
3.15 A	A 050 URD 003 T13 I	R076927	A050URD3T13I
4 A	A 050 URD 004 T13 I	S076928	A050URD4T13I
5 A	A 050 URD 005 T13 I	T076929	A050URD5T13I
6 A	A 050 URB 006 T13 I	V076930	A050URB6T13I
8 A	A 050 URB 008 T13 I	W076931	A050URB8T13I
10 A	A 050 URB 010 T13 I	X076932	A050URB10T13I
12 A	A 050 URB 012 T13 I	Y076933	A050URB12T13I
16 A	A 050 URB 016 T13 I	Z076934	A050URB16T13I
20 A	A 050 URB 020 T13 I	A076935	A050URB20T13I
25 A	A 050 URL 025 T13 I	B076936	A050URL25T13I
30 A	A 050 URL 030 T13 I	C076937	A050URL30T13I

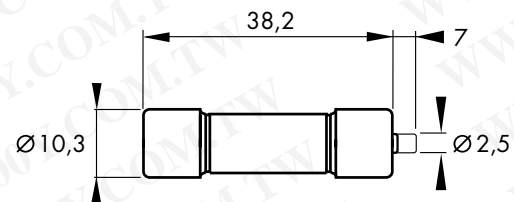

Fuses with trip indicator mounted in clips

Semiconductor (AC) fuses

Other Protistor® Fuses Ferrule Fuses

10x38 URB/URD - 500 to 600 VAC

Electrical characteristics

Time vs current characteristics

WITHOUT BLOWN FUSE INDICATOR

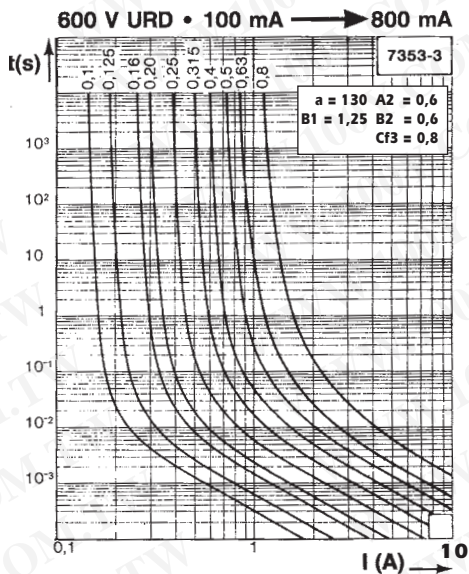

WITH TRIP INDICATOR

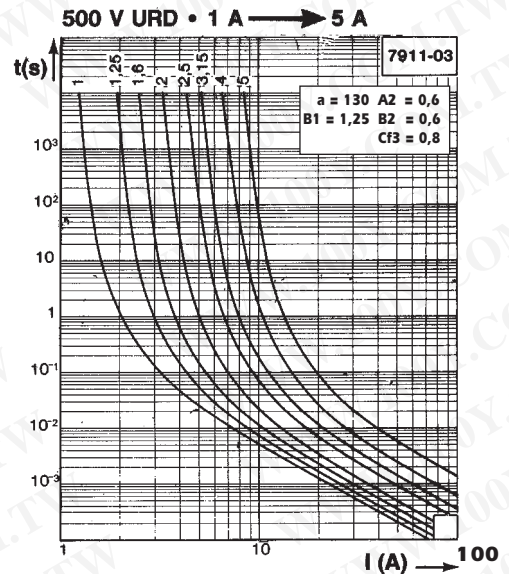

These curves indicate, for each rated current, pre-arcing time vs. R.M.S. pre-arcing current.
 Tolerance for mean pre-arcing current $\pm 10\%$

WITH TRIP INDICATOR

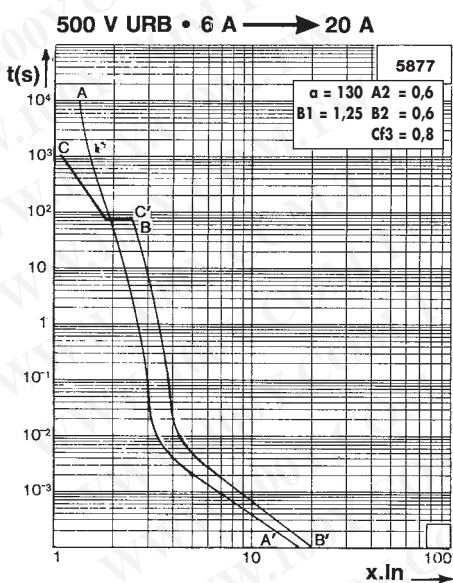

WITH TRIP INDICATOR

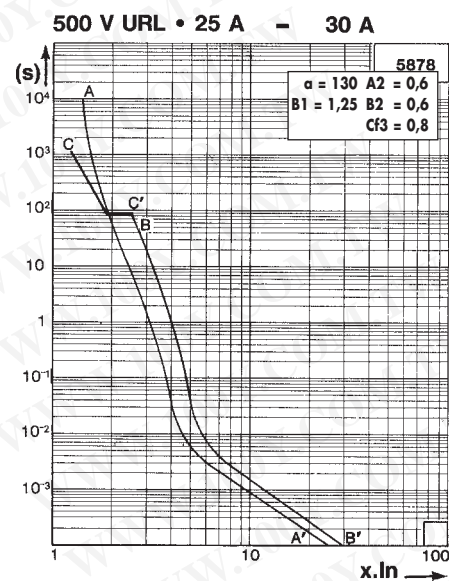

These curves indicate, for each rated current, pre-arcing time vs. R.M.S. pre-arcing current.
 as a multiple of current rating.

Semiconductor (AC) fuses

Other Protistor® Fuses

Ferrule Fuses

10x38 URB/URD - 500 to 600 VAC

Corrective factor - Peak arc voltage

Corrective factor

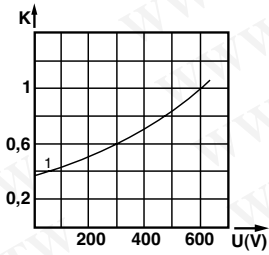

600 V UR
1 : 0.1 up to 0.8 A

These mean curves show the variation of the total clearing time (I^2t_t) and the total clearing duration t_t as a function of operating voltage U.

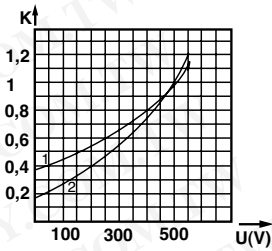

500 V UR
1 : 1 up to 5 A
2 : 6 up to 30 A

Peak arc voltage

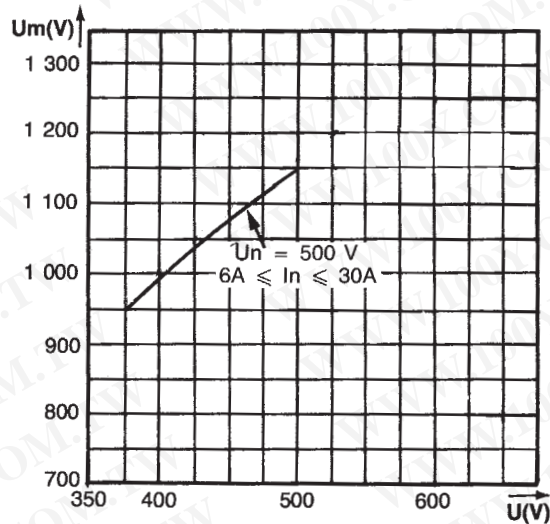

This curve shows the peak value U_m of the arc voltage which appears across the fuse link as a function of the operating voltage U @ $\cos \varphi = 0.15$.

D.C. Application data for fuses with trip indicator

500 V URD $I_N \geq 6A$

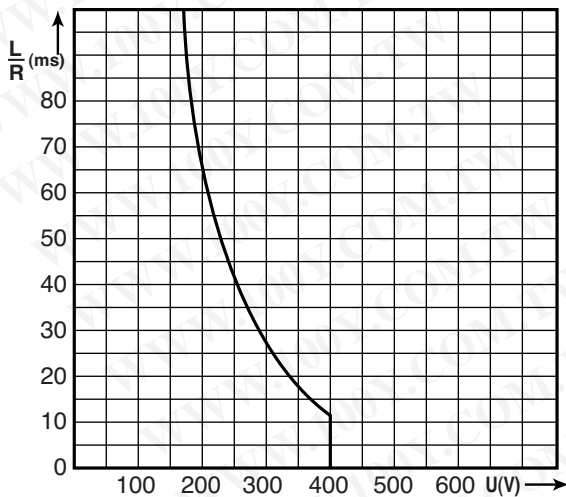

500 V URD $I_N \geq 6A$

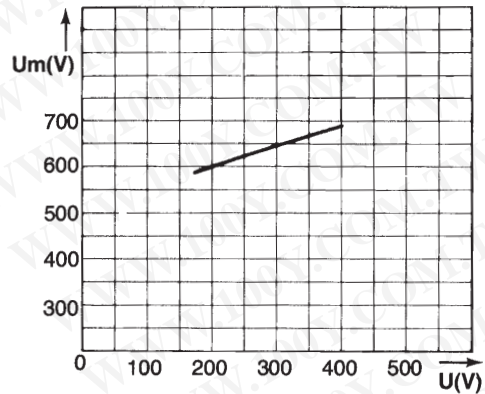

This curve shows the peak value U_m of the arc voltage which appears across the fuse link as a function of the operating voltage U.

Semiconductor (AC) fuses

Other Protistor® Fuses

Ferrule Fuses

14x51 gRC(URC) - 600 V to 690 VAC



600 - 690 V ~
gRC - URC from 1 to 63 A
Size: 14 x 51

EXTREMELY HIGH BREAKING CAPACITY FUSES: PROTECTION OF SEMICONDUCTORS
COMPLYING WITH IEC STANDARD 60269.1 AND 4

600V - 690 V VOLTAGE RATING (CURRENT RATING 1 TO 50 A)
AS PER IEC 33

gR CLASS (CURRENT RATING 1 TO 50 A) AS PER VDE 636-23

- CLEARING ALL OVERLOADS
- IMPROVED SAFETY AND PROTECTION
- ENABLING SELECTIVE COORDINATION AMONG ALL DISTRIBUTION CIRCUIT FUSES

aR CLASS (CURRENT RATING 63 A) ACCORDING TO VDE 636-23 AND IEC 60269.4

TWO MODELS: WITH OR WITHOUT TRIP-INDICATOR

gRC fuses FROM 8 TO 50 A are 700VAC-DC UL Recognized 

Main Characteristics

Voltage rating U_N U_V	Class	Current rating I_N (A)	Pre-arcing $I^2t @ 1 \text{ ms}$ I^2tp (A ² s)	Total clearing $I^2t @ U_N$ I^2tt (A ² s)	Watts loss		Tested Breaking capacity	Estimated Breaking capacity
					$0.8 I_N$	I_N		
690	gRC	1	0.8/0.31*	3.5/1.4*	0.17	0.35	100k A @ 690 V	300k A @ 690 V
		2	1.5/1*	6.7/4.3*	0.33	0.60		
		4	7.2/6.7*	33/30*	0.77	1.4		
		6	1.4	19	1.3	2.5		
		8	2.4	30	1.5	3.0		
		10	4.3	44	1.75	3.3		
		12	5.4	65	2.25	4.25		
		16	13	110	2.5	4.8		
		20	27	175	2.75	5.25		
		25	53	300	3.0	5.8		
		32	97	550	3.5	7.0		
		40	210	1210	4.5	8.8		
50	390	2250	5.0	10				
600	URC	63	440	2200	8.0	16	100k A @ 600 V	300k A @ 600 V

* I^2t values for fuses without trip-indicator.

Minimum operating voltage for the trip-indicator : 20 V

See Gears and Fuse gears section

Semiconductor (AC) fuses

Other Protistor® Fuses

Ferrule Fuses

14x51 gRC(URC) - 600 V to 690 VAC

14 X 51 Without trip-indicator

Current Rating	Designation	Ref. Number	Catalog Number
1	6.900 Cp gRC 14.51 1	E221080	FR14GC69V1
2	6.900 Cp gRC 14.51 2	H081473	FR14GC69V2
4	6.900 Cp gRC 14.51 4	J081474	FR14GC69V4
6	6.900 Cp gRC 14.51 6	T220909	FR14GC69V6
8	6.900 Cp gRC 14.51 8	S220908	FR14GC69V8
10	6.900 Cp gRC 14.51 10	R220907	FR14GC69V10
12	6.900 Cp gRC 14.51 12	Q220906	FR14GC69V12
16	6.900 Cp gRC 14.51 16	P220905	FR14GC69V16
20	6.900 Cp gRC 14.51 20	E220735	FR14GC69V20
25	6.900 Cp gRC 14.51 25	N220904	FR14GC69V25
32	6.900 Cp gRC 14.51 32	W220819	FR14GC69V32
40	6.900 Cp gRC 14.51 40	M220903	FR14GC69V40
50	6.900 Cp gRC 14.51 50	L220902	FR14GC69V50

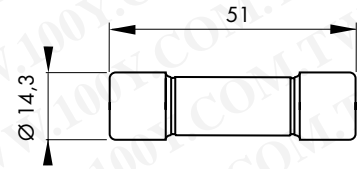

Weight: 18 g
Packaging: 10 pieces

14 X 51 With trip-indicator

1	6.921 Cp gRC 14.51 1	F221081	FR14GC69V1T
2	6.921 Cp gRC 14.51 2	L081476	FR14GC69V2T
4	6.921 Cp gRC 14.51 4	F081517	FR14GC69V4T
6	6.921 Cp gRC 14.51 6	B220939	FR14GC69V6T
8	6.921 Cp gRC 14.51 8	A220938	FR14GC69V8T
10	6.921 Cp gRC 14.51 10	Z220937	FR14GC69V10T
12	6.921 Cp gRC 14.51 12	Y220936	FR14GC69V12T
16	6.921 Cp gRC 14.51 16	X220935	FR14GC69V16T
20	6.921 Cp gRC 14.51 20	W220934	FR14GC69V20T
25	6.921 Cp gRC 14.51 25	V220933	FR14GC69V25T
32	6.921 Cp gRC 14.51 32	V220818	FR14GC69V32T
40	6.921 Cp gRC 14.51 40	M220949	FR14GC69V40T
50	6.921 Cp gRC 14.51 50	N220950	FR14GC69V50T
63	6.21 Cp URC 14.51 63	V220910	FR14UC60V63T

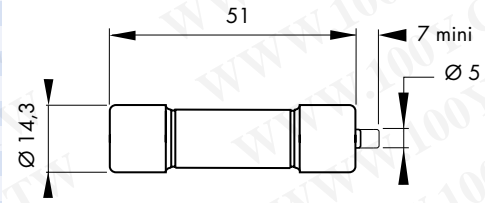

Weight: 18 g
Packaging: 10 pieces



except 1 to 6 and 63A rating

Time vs current characteristics

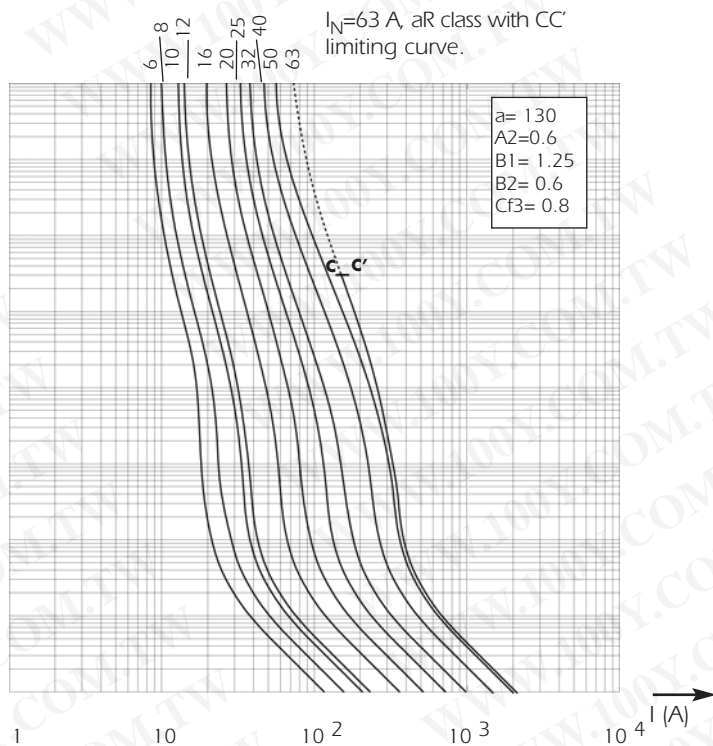
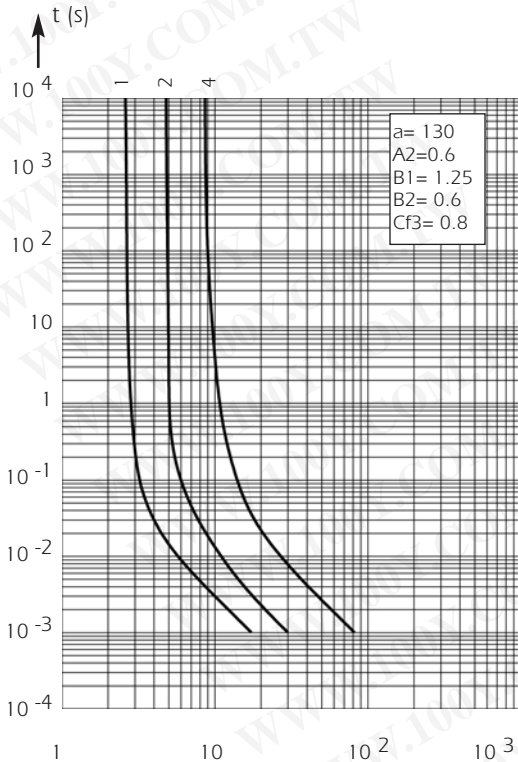

Tolerance for mean pre-arcing current
± 10% for current rating 1, 2, 4 A
± 8% for current rating 6 to 63 A

Semiconductor (AC) fuses

Other Protistor® Fuses Ferrule Fuses

14x51 gRC(URC) - 600 V to 690 VAC

Total clearing I²t

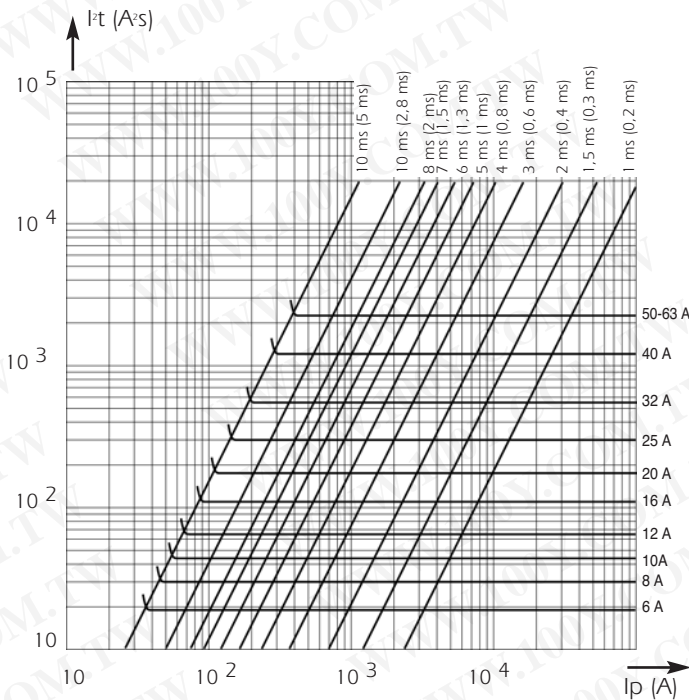

Horizontal curves show maximum values of total clearing I^2t (I^2t_t) for each rated current as a function of prospective current I_p @ 690 V. $\cos \phi = 0.15$ (for 63 A @ 600 V. $\cos \phi = 0.15$).
Oblique lines indicate total clearing duration T_t , with associated pre-arcing duration in brackets.

I²t corrective factor

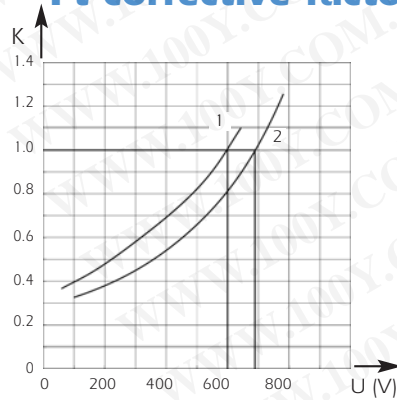

Mean curves showing variation of total clearing time (I^2t_t) and total clearing duration T_t as a function of operating voltage U .
1- 63 A rating - 600 V
2- 1 to 50 A rating - 690 V

Peak arc voltage

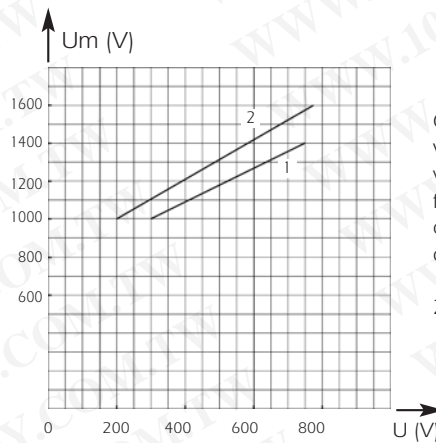

Curves showing peak value U_m of arc voltage which appears across fuse-link as a function of operating voltage U @ $\cos \phi = 0.15$
1-63A rating 600V
2-1 to 50A rating 690V

Current limitation curves

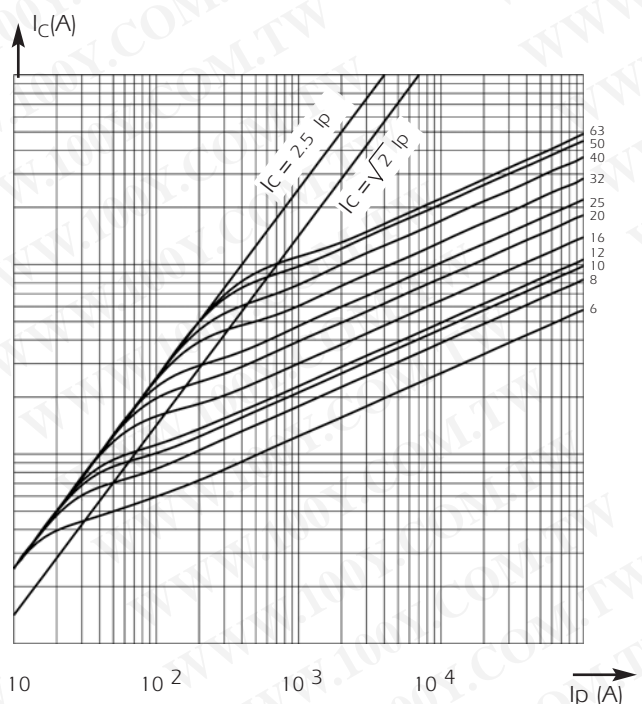
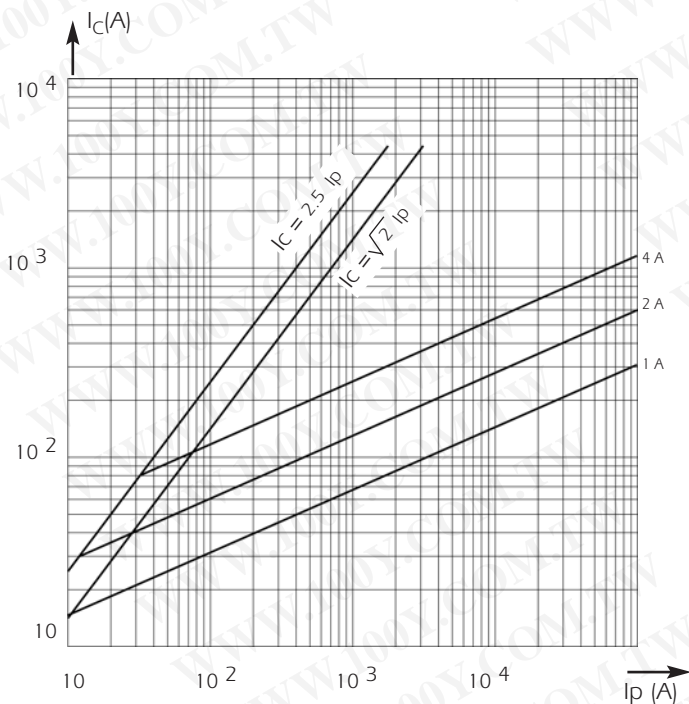

Curves show, for each rating, value of peak let-through current I_c as a function of available fault current I_p .

Semiconductor (AC) fuses

Other Protistor® Fuses

Ferrule Fuses

14x51 gRC(URC) - 600 V to 690 VAC

DC Application data

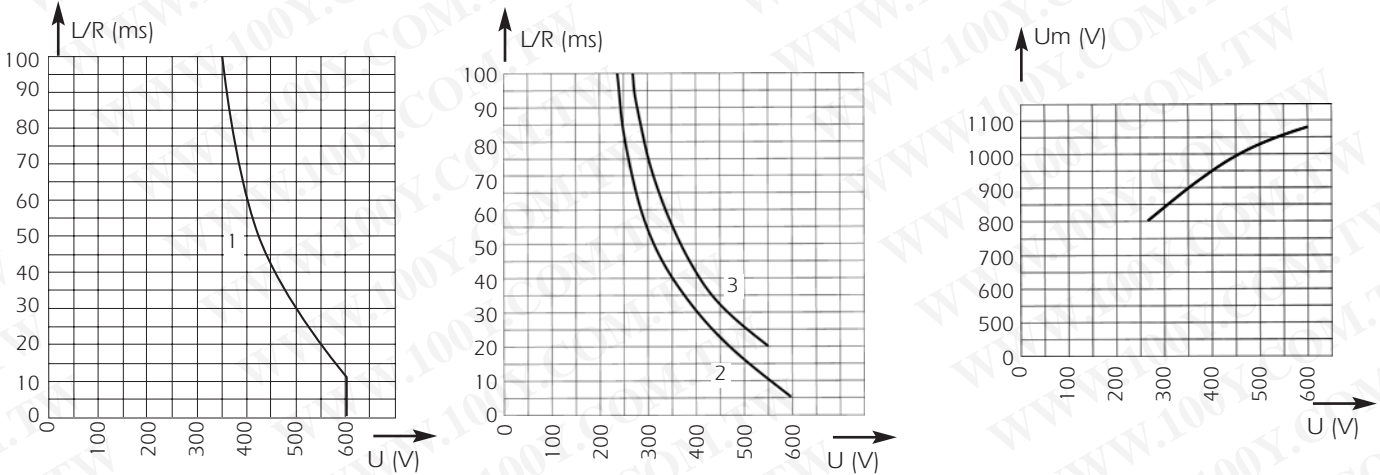

Above, left and center: Curves indicate the permissible value of time constant L/R as a function of DC working voltage:

- 1- For rating 1, 2 and 4 A (gRC) $I_p \geq 1,6 I_N$
- 2- $I_p \geq 1,6 I_N$ for gRC only (rating 6 to 50 A)
- 3- $I_p \geq 2,5 I_N$ for gRC and URC (rating 6 to 63 A)

Above, right: Curve indicates peak arc voltage U_m which may appear across fuse terminals at working voltage U.

NEW gR-CLASS

OPTIMAL PROTECTION OF POWER EQUIPMENT

Thanks to recent technological developments, Ferraz Shawmut today markets gR-class PROTISTOR® fuses capable of clearing all types of overloads, from low multiples of current ratings up to very high short-circuit currents. Enhanced performance enables these fuses to provide solutions to many previously unsolved problems in power electronics: protection of cables without the use of additional components, protection of equipment from fire hazards, selective coordination of different fuses within a single power distribution installation...

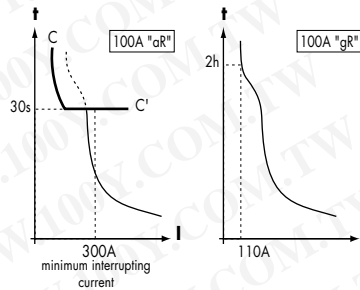

Example:
100A aR vs. 100A gR

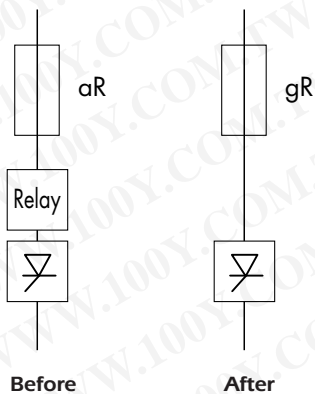

aR-CLASS vs. gR-CLASS

aR-class fuses feature a high minimum interrupting current as compared with their current rating. The primary time-current characteristic of aR-class fuses is the CC' curve, above which another protection device must be associated. The gR-class fuse represents considerably improved performance in semiconductor protection

SELECTIVE COORDINATION

gR-class semiconductor fuses can be utilized in association with gI and gG-class low voltage power distribution fuses of the same current rating, installed upstream. In a "selectively coordinated" distribution installation, melting is limited to the fuse associated with the faulted circuit, while upstream fuses remain intact. This prevents unnecessary down-time due to power blackouts in non-faulted branches.

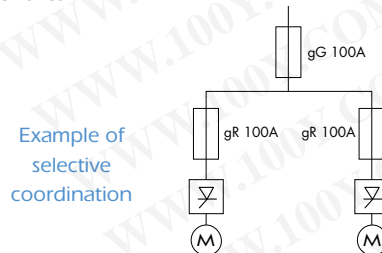

Example of
selective
coordination

FERRAZ SHAWMUT EXPERTISE

gR-class fuses should be used in the design of low voltage equipment and in the protection of power electronics equipment. Designers can often substitute a gR-class fuse for an aR-class fuse (10x38, 14x51, 22x58, PSC 000 and 17x49 DIN80 or BS 88-4) but the reverse is not true: an aR fuse can never replace a gR fuse. Start protecting your new equipment with gR-class fuses today. The application of gR class fuses, with current ratings less than 100 Amps, offers enhanced protection, safety and reliability, along with reduced risk of replacement errors and assembly costs.

Other Protistor® Fuses Ferrule Fuses 22x58 gRC (URD) - 600 V to 690 VAC

EXTREMELY BREAKING CAPACITY RATING FUSES: PROTECTION OF SEMICONDUCTORS
IN COMPLIANCE WITH IEC STANDARD 60269.1 AND 4

600 - 690 V VOLTAGE RATING (CURRENT RATING 12 TO 135 A)
AS PER IEC 33

gR CLASS (CURRENT RATING 12 TO 100 A) ACCORDING TO VDE 636-23

- CLEARING ALL OVERLOADS
- IMPROVED SAFETY AND PROTECTION
- ENABLING SELECTIVE COORDINATION AMONG ALL DISTRIBUTION CIRCUIT FUSES

aR CLASS (CURRENT RATING 125 AND 135 A) AS PER VDE 636-23 AND IEC 60269.4

TWO MODELS COMPLYING WITH NF C 63210 AND 63211
WITH OR WITHOUT TRIP-INDICATOR

gRC FUSES ARE 700VAC-DC UL RECOGNIZED



Main Characteristics

Voltage rating U_N (V)	Class	Current rating I_N (A)	Pre-arcing $I^2t @ 1 \text{ ms}$ I^2tp (A ² s)	Total clearing $I^2t @ U_N$ I^2tt (A ² s)	Watts loss		Tested Breaking capacity	Estimated Breaking capacity
					0.8 I_N	I_N		
690	gRC	20	17	125	4.0	6.5	100k A @ 690 V	300k A @ 690 V
		25	39	280	4.5	7.5		
		32	72	490	5.0	9.0		
		40	118	785	5.5	10		
		50	242	1390	7.0	11.5		
		63	430	2460	8.0	13.5		
		80	970	5565	9.0	15.5		
600	URD	125	2900	14000	14	22	100k A @ 600 V	300k A @ 600 V
		135	3360	17700	15	25		

Minimum operating voltage for the trip-indicator: 20 V

See Fuse Blocks and Fuse Holders section

勝特力材料 886-3-5753170
勝特力电子(上海) 86-21-34970699
勝特力电子(深圳) 86-755-83298787
[Http://www.100y.com.tw](http://www.100y.com.tw)

Semiconductor (AC) fuses

Other Protistor® Fuses

Ferrule Fuses

22x58 gRC (URD) - 600 V to 690 VAC

22 X 58 Without trip-indicator

Current rating	Designation	Ref. Number	Catalog Number
12	6,900 CP gRC 22.58 12	F232719	FR22GC69V12
16	6,900 CP gRC 22.58 16	G232720	FR22GC69V16
20	6,900 CP gRC 22.58 20	C220940	FR22GC69V20
25	6,900 CP gRC 22.58 25	B220916	FR22GC69V25
32	6,900 CP gRC 22.58 32	A220915	FR22GC69V32
40	6,900 CP gRC 22.58 40	Z220914	FR22GC69V40
50	6,900 CP gRC 22.58 50	Y220913	FR22GC69V50
63	6,900 CP gRC 22.58 63	X220912	FR22GC69V63
80	6,900 CP gRC 22.58 80	Y220821	FR22GC69V80
100	6,900 CP gRC 22.58 100	W220911	FR22GC69V100

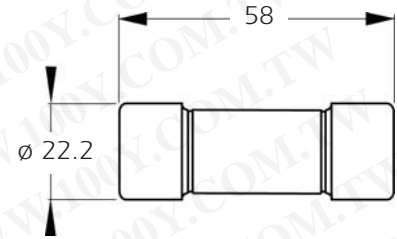

Weight: 57 g
Packaging: 10 pieces

22 X 58 With trip-indicator

20	6,921 CP gRC 22.58 20	D220734	FR22GC69V20T
25	6,921 CP gRC 22.58 25	G220921	FR22GC69V25T
32	6,921 CP gRC 22.58 32	F220920	FR22GC69V32T
40	6,921 CP gRC 22.58 40	E220919	FR22GC69V40T
50	6,921 CP gRC 22.58 50	D220918	FR22GC69V50T
63	6,921 CP gRC 22.58 63	C220733	FR22GC69V63T
80	6,921 CP gRC 22.58 80	X220820	FR22GC69V80T
100	6,921 CP gRC 22.58 100	C220917	FR22GC69V100T
125	621 CP URD 22.58 125	A220708	FR22UD60V125T
135	621 CP URD 22.58 135	B220709	FR22UD60V135T

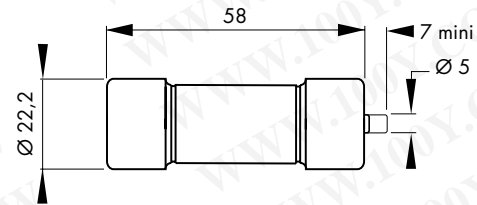

Weight: 57 g
Packaging: 10 pieces



except 125 and 135A rating

Electrical characteristics

Time vs current characteristics

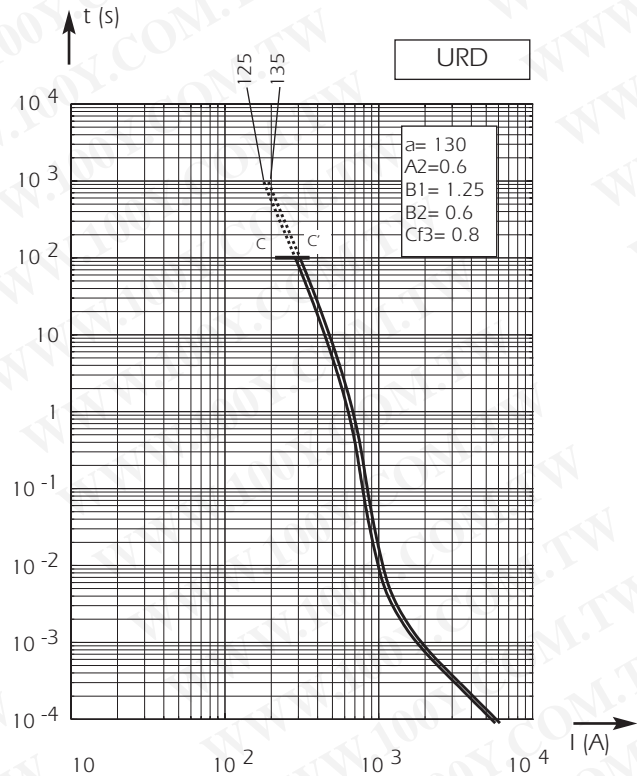
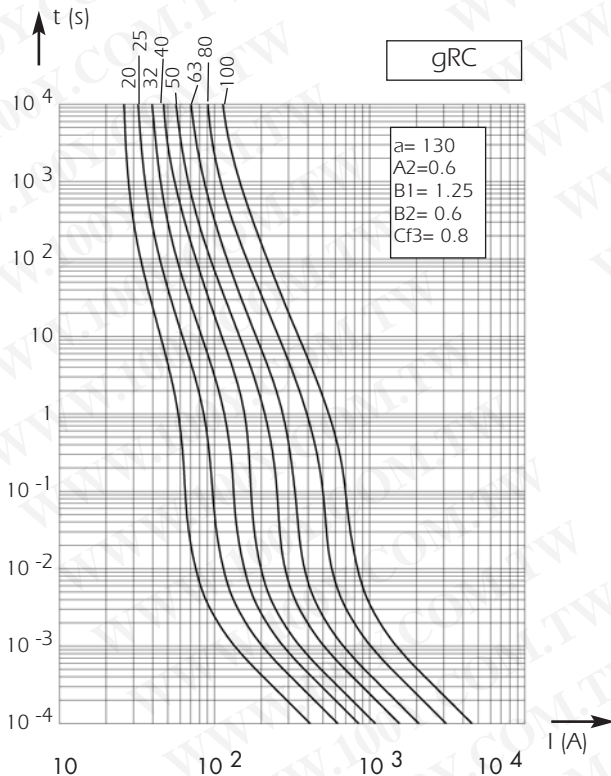

These curves indicate, for each rated current, pre-arcing time vs. R.M.S. pre-arcing current

Tolerance for mean pre-arcing current $\pm 9\%$ for all current ratings

Semiconductor (AC) fuses

Other Protistor® Fuses Ferrule Fuses 22x58 gRC (URD) - 600 V to 690 VAC

Total clearing I²t

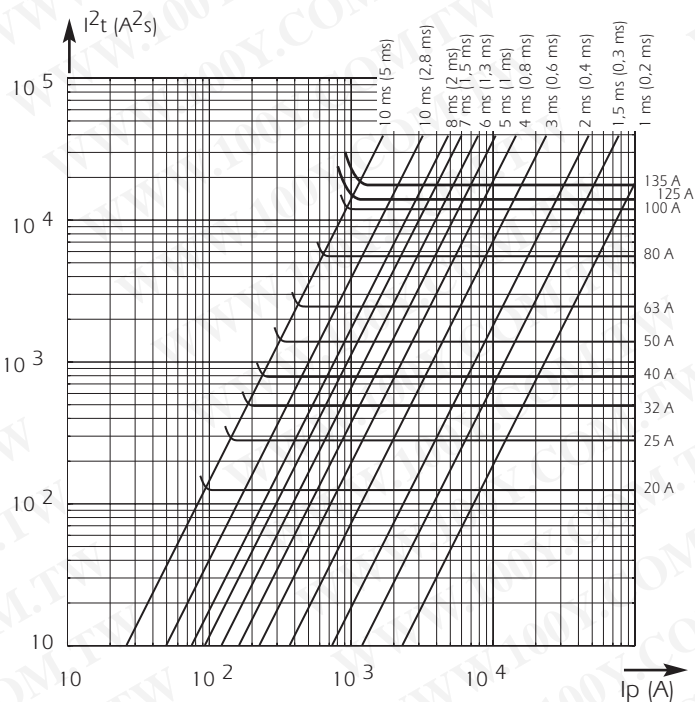

Above: Horizontal curves show, for each rated current, maximum values of total clearing I^2t (I^2t_t) as a function of prospective current I_p @ 690 V. $\cos\phi = 0.15$ (125-135 A @ 600 V. $\cos\phi = 0.15$)
Oblique lines indicate total clearing duration T_t with associated pre-arcing duration in brackets.

I²t corrective factor

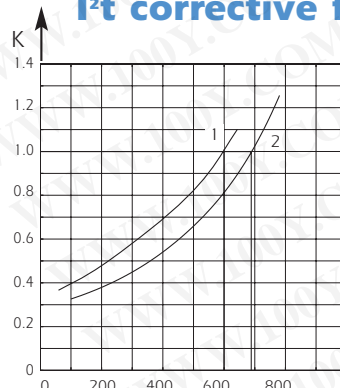

Mean curves showing variation of total clearing time (I^2t_t) and total clearing duration T_t as a function of operating voltage U .
1- 125 and 135 A rating
2- 20 to 100 A rating

Peak arc voltage

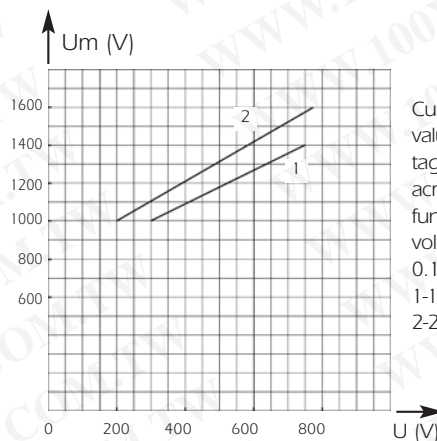

Curve showing peak value U_m of arc voltage which appears across fuse-link as a function of operating voltage U @ $\cos\phi = 0.15$
1- 125 and 135 A rating
2- 20 to 100 A rating

Current limitation curves

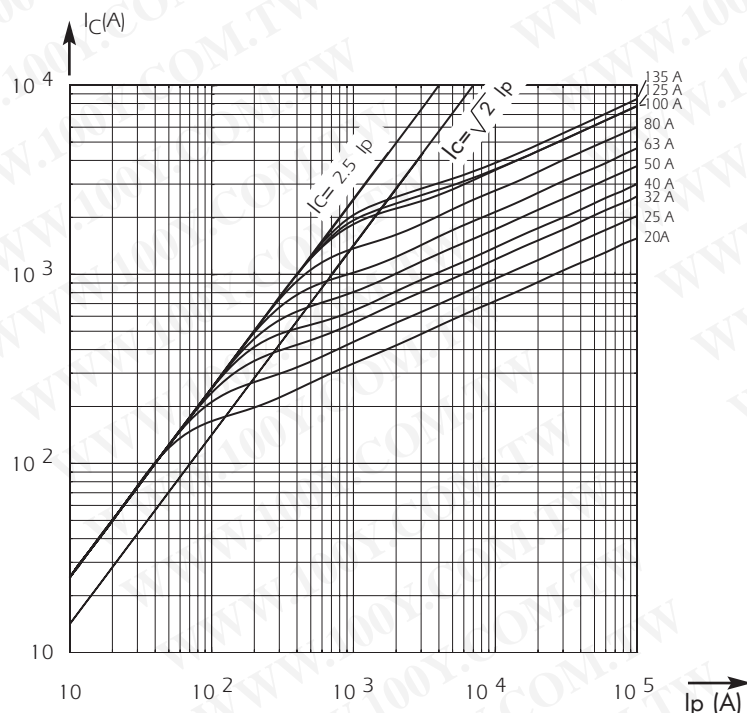

Left: Curves show value of peak let-through current I_c as a function of the available fault current I_p .

Semiconductor (AC) fuses

Other Protistor® Fuses

Ferrule Fuses

22x58 gRC (URD) - 600 V to 690 VAC

DC Application data

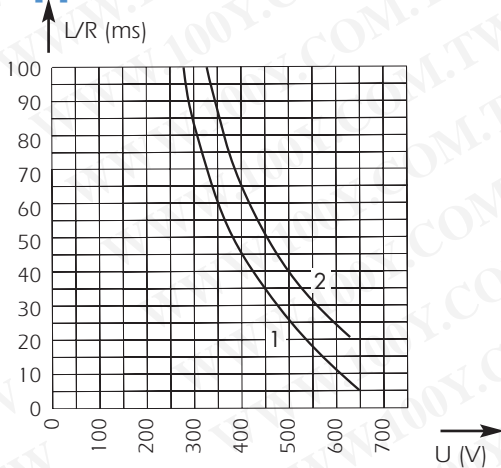

Ces courbes indiquent la constante de temps L/R maximale admissible en fonction de la tension d'utilisation

Courbe 1 : $I_p \geq 1,6 I_n$ pour fusibles gRC uniquement (calibres de 12 à 100 A)

Courbe 2 : $I_p \geq 2,5 I_n$ pour fusibles gRC et URD

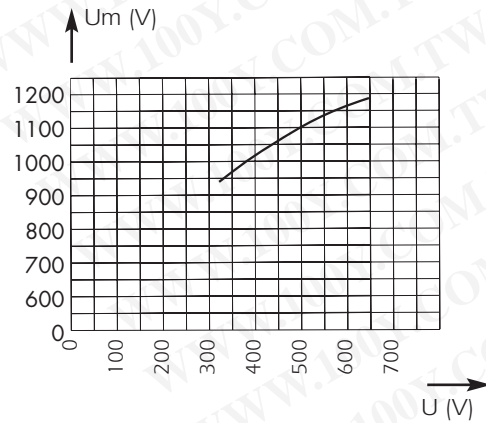

Above: Curve indicates peak arc voltage U_m which may appear across fuse terminals at working voltage U.

NEW gR-CLASS

OPTIMAL PROTECTION OF POWER EQUIPMENT

Thanks to recent technological developments, Ferraz Shawmut today markets gR-class PROTISTOR® fuses capable of clearing all types of overloads, from low multiples of current ratings up to very high short-circuit currents. Enhanced performance enables these fuses to provide solutions to many previously unsolved problems in power electronics: protection of cables without the use of additional components, protection of equipment from fire hazards, selective coordination of different fuses within a single power distribution installation...

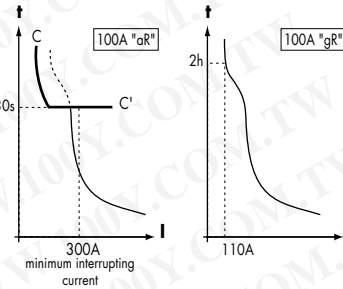

Example:
100A aR vs. 100A gR

SELECTIVE COORDINATION

gR-class semiconductor fuses can be utilized in association with gI and gG-class low voltage power distribution fuses of the same current rating, installed upstream. In a "selectively coordinated" distribution installation, melting is limited to the fuse associated with the faulted circuit, while upstream fuses remain intact. This prevents unnecessary down-time due to power blackouts in non-faulted branches.

Example of
selective
coordination

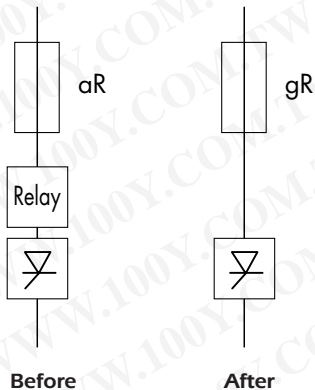
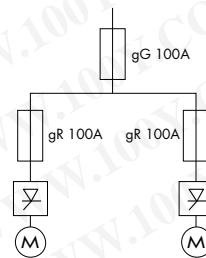

aR-CLASS vs. gR-CLASS

aR-class fuses feature a high minimum interrupting current as compared with their current rating. The primary time-current characteristic of aR-class fuses is the CC' curve, above which another protection device must be associated. The gR-class fuse represents considerably improved performance in semiconductor protection

FERRAZ SHAWMUT EXPERTISE

gR-class fuses should be used in the design of low voltage equipment and in the protection of power electronics equipment. Designers can often substitute a gR-class fuse for an aR-class fuse (10x38, 14x51, 22x58, PSC 000 and 17x49 DIN80 or BS 88-4) but the reverse is not true: an aR fuse can never replace a gR fuse. Start protecting your new equipment with gR-class fuses today. The application of gR class fuses, with current ratings less than 100 Amps, offers enhanced protection, safety and reliability, along with reduced risk of replacement errors and assembly costs.

勝特力材料 886-3-5753170
 勝特力电子(上海) 86-21-34970699
 勝特力电子(深圳) 86-755-83298787
[Http://www.100y.com.tw](http://www.100y.com.tw)

Semiconductor (AC) fuses

Other Protistor® Fuses Ferrule Fuses

14x51 & 22x58 URC / URD - 600 to 690 VAC



EXTREMELY BREAKING CAPACITY RATING FUSES:
 PROTECTION OF POWER SEMI CONDUCTORS COMPLYING WITH IEC STANDARD 60269.1 AND 4

600 - 690 V AC VOLTAGE RATING

aR-CLASS ACCORDING TO VDE 636-23 AND IEC 60269.4

WITH AND WITHOUT TRIP-INDICATOR FOR SIZES 14 x 51 AND 22 x 58

UL RECOGNIZED (EXCEPT 6 A)*

Main Characteristics

Voltage rating U_N (VAC)	Size	Class	Current rating I_N (A)	Pre-arcing $2t @ 1 \text{ ms}$ I^2t_p (A ² s)	Total clearing $I^2t @$ (A ² s)		Watts loss		Breaking Capacity
					$7 I_N < I_p < 30 I_N$	$I_p \geq 30 I_N$	$0.8 I_N$	I_N	
690 V	14 x 51	URC	6	1.3	17.5* @ 660V		1.1	2	100 kA @ 690 V
			8	2.4	27.5@ 660V		1.6	2.8	
			10	4.3	40@ 660V		2	3.5	
			12	5.4	60@ 660V		2.45	4.4	
			16	13.2	100@ 660V		2.7	4.8	
			20	27	160@ 660V		2.9	5.2	
			25	53	275@ 660V		3.2	5.8	
			32	98	500@ 660V		3.9	7	
690 V	14 x 51	URD	40 (1)	130	700@ 660V		6	10.7	100 kA @ 690 V
			50 (1)	280	1500@ 660V		6.3	11.6	
			40 (2)	130	850@660V	700@660V	6	10.7	
			50 (2)	280	1850@660V	1500@660V	6.3	11.6	
690 V	22 x 58	URD	25	22	125@ 660V		5.2	10	100 kA @ 690 V
			32	49	275@ 660V		5.7	11	
			40	88	480@ 660V		6.8	13	
			50	155	800@ 660V		7.8	14.9	
			63	350	1850@ 660V		8.4	16	
			80	730	3800@ 660V		9.4	17.8	
600 V	22X58	URD	125	2900	14000@600V		14	22	100 kA @ 600 V
			130	3360	17700@600V		15	25	

* Without trip-indicator $I^2t : 15 \text{ A}^2\text{s}$.

(1) No trip-indicator available for this model.

(2) Models available only with trip-indicator.

Semiconductor (AC) fuses

Other Protistor® Fuses

Ferrule Fuses

14x51 & 22x58 URC / URD - 600 to 690 VAC

All the fuses presented on this page are (except 6 A)*



14x51 - Without blown fuse indication

Current Rating	Designation	Ref. Number	Catalog Number
6 A	6.900 CP URC 14.51/6*	K081475	FR14UC69V6
8 A	6.900 CP URC 14.51/8	S093902	FR14UC69V8
10 A	6.900 CP URC 14.51/10	T093903	FR14UC69V10
12 A	6.900 CP URC 14.51/12	V093904	FR14UC69V12
16 A	6.900 CP URC 14.51/16	W093905	FR14UC69V16
20 A	6.900 CP URC 14.51/20	X093906	FR14UC69V20
25 A	6.900 CP URC 14.51/25	Y093907	FR14UC69V25
32 A	6.900 CP URC 14.51/32	Z093908	FR14UC69V32
40 A	6.900 CP URC 14.51/40	A093909	FR14UC69V40
50 A	6.900 CP URC 14.51/50	B093910	FR14UC69V50

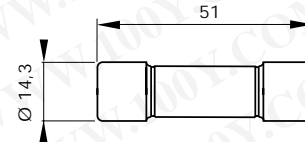

Weight : 18g
Packaging : 10 pieces

14x51 - With trip-indicator

Current Rating	Designation	Ref. Number	Catalog Number
6 A	6.921 CP URC 14.51/6*	G081518	FR14UC69V6T
8 A	6.921 CP URC 14.51/8	C093911	FR14UC69V8T
10 A	6.921 CP URC 14.51/10	D093912	FR14UC69V10T
12 A	6.921 CP URC 14.51/12	E093913	FR14UC69V12T
16 A	6.921 CP URC 14.51/16	F093914	FR14UC69V16T
20 A	6.921 CP URC 14.51/20	G093915	FR14UC69V20T
25 A	6.921 CP URC 14.51/25	H093916	FR14UC69V25T
32 A	6.921 CP URC 14.51/32	J093917	FR14UC69V32T
40 A	6.921 CP URD 14.51/40	T100136	FR14UD69V40T
50 A	6.921 CP URD 14.51/50	V100137	FR14UD69V50T

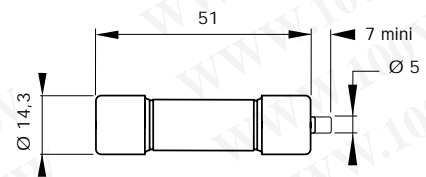

Weight : 18g
Packaging : 10 pieces

22x58 - Without blown fuse indication

Current Rating	Designation	Ref. Number	Catalog Number
25 A	6.900 CP URD 22x58/25	B093956	FR22UD69V25
32 A	6.900 CP URD 22x58/32	Z094828	FR22UD69V32
40 A	6.900 CP URD 22x58/40	S094822	FR22UD69V40
50 A	6.900 CP URD 22x58/50	W094779	FR22UD69V50
63 A	6.900 CP URD 22x58/63	T094823	FR22UD69V63
80 A	6.900 CP URD 22x58/80	A094829	FR22UD69V80
100 A	6.900 CP URD 22x58/100	Y094827	FR22UD69V100

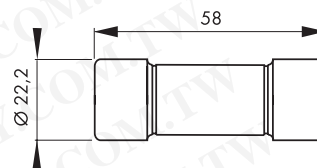

Weight: 57 g
Packaging: 10 pieces

22x58 - With trip-indicator

Current Rating	Designation	Ref. Number	Catalog Number
25 A	6,921 CP URD 22x58/ 25	H093801	FR22UD69V25T
32 A	6,921 CP URD 22x58/ 32	C093957	FR22UD69V32T
40 A	6,921 CP URD 22x58/ 40	J093802	FR22UD69V40T
50 A	6,921 CP URD 22x58/ 50	D093958	FR22UD69V50T
63 A	6,921 CP URD 22x58/ 63	K093803	FR22UD69V63T
80 A	6,921 CP URD 22x58/ 80	E093959	FR22UD69V80T
100 A	6,921 CP URD 22x58/100	F093960	FR22UD69V100T
125 A	621 CP URD 22x58/125	A220708	FR22UD60V125T
135 A	621 CP URD 22x58/135	B220709	FR22UD60V135T

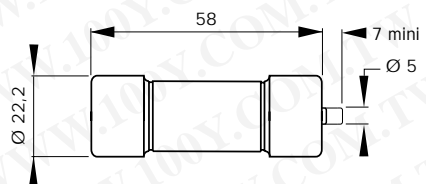

Weight: 57 g
Packaging: 10 pieces

Fuseholder Solution: See Gears and Fuse gears section

Semiconductor (AC) fuses

Other Protistor® Fuses Ferrule Fuses

14x51 & 22x58 URC / URD - 600 to 690 VAC

Time vs current characteristics

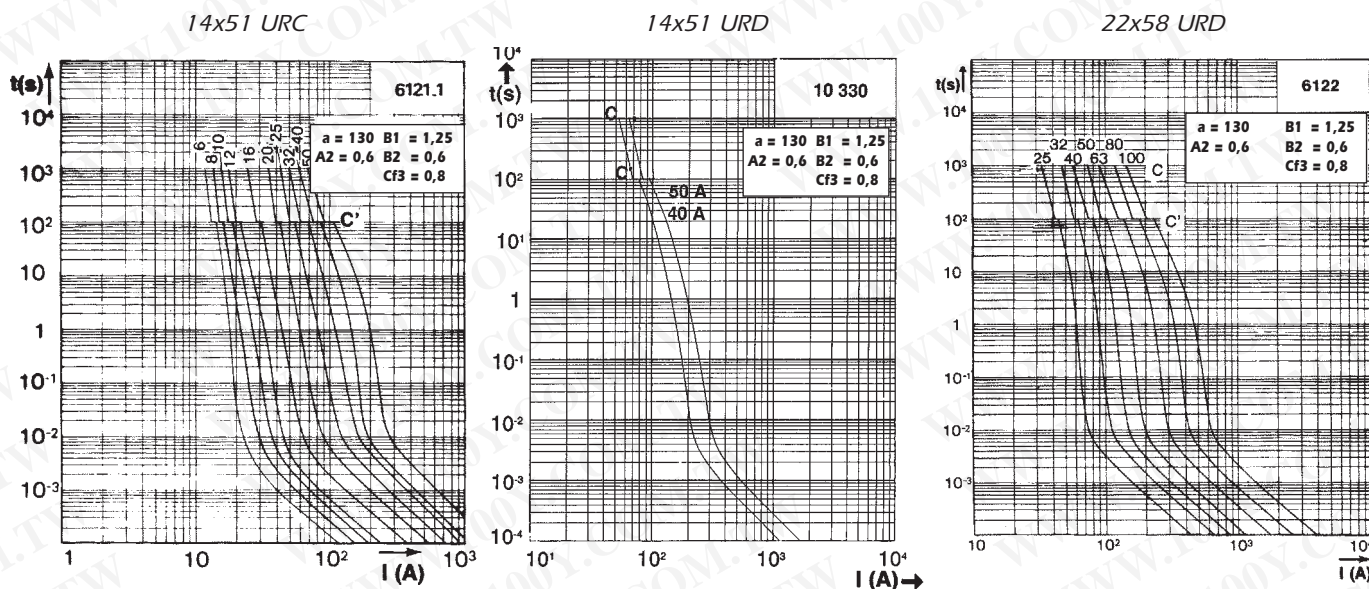

These curves indicate, for each rated current, pre-arcing time vs. R.M.S. pre-arcing current.

Tolerance for mean pre-arcing current $\pm 10\%$

Corrective factor - Peak arc voltage

Corrective factor

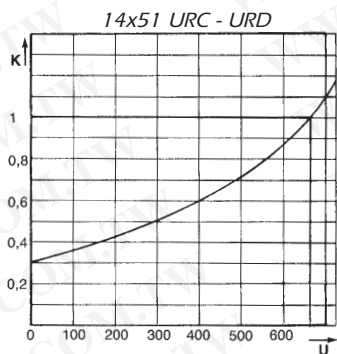

The mean curves show the variation of the total clearing Pt_t and the total clearing duration t_t as a function of operating voltage U .

Peak arc voltage

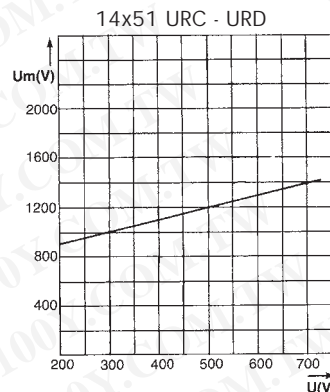

This curve shows the peak value U_m of the arc voltage which appears across the fuse-link as a function of the operating voltage $U @ \cos j = 0.15$.

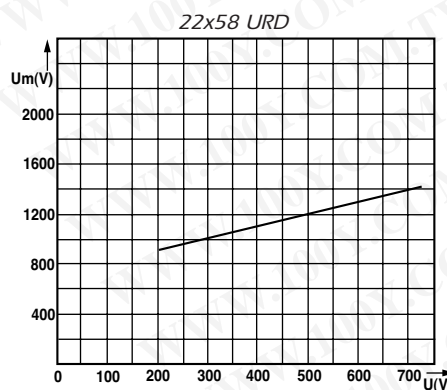
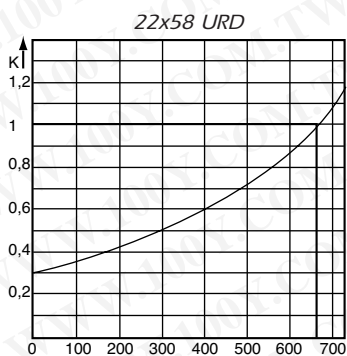

Semiconductor (AC) fuses

Other Protistor® Fuses

Ferrule Fuses

14x51 & 22x58 URC / URD - 600 to 690 VAC

DC Application data

14x51 URC - URD

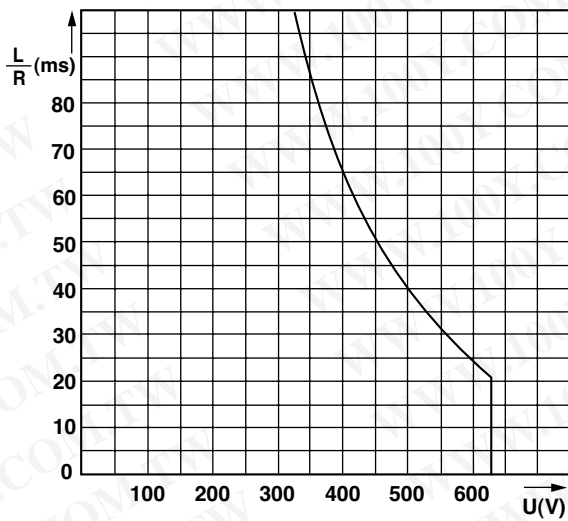

14x51 URC - URD

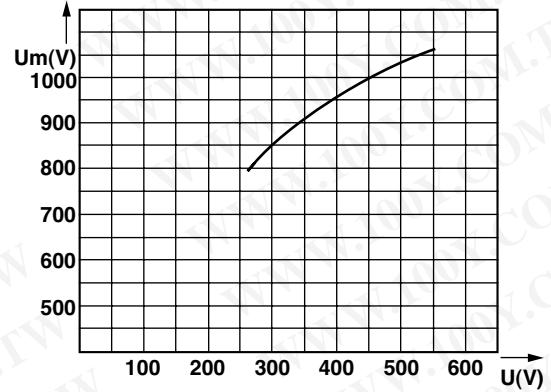

Minimum breaking current: see time-current characteristics

22x58 URD

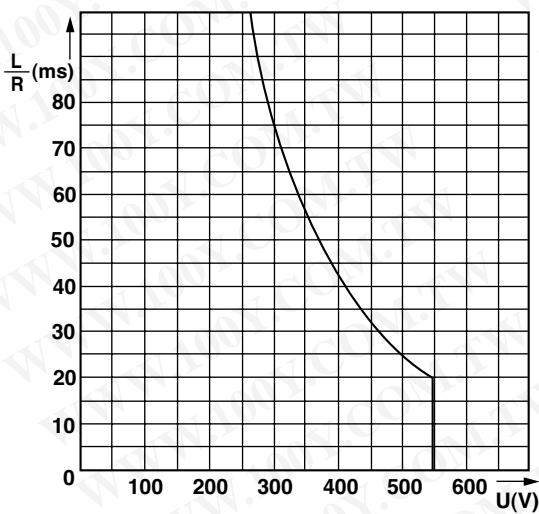

22x58 URD

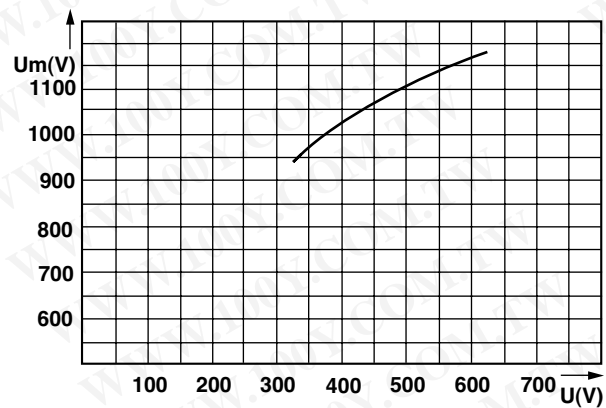

This curve indicates the permissible value of time constant L/R as a function of DC working voltage

This curve shows the peak value U_m of the arc voltage which appears across the fuse-link as a function of the operating voltage U .

Other Protistor® Fuses Ferrule Fuses

14x51 URGB & 22x58 URGA - 600 V to 690 VAC



EXTREMELY HIGH BREAKING CAPACITY FUSES:
PROTECTION OF POWER SEMICONDUCTORS AS PER
IEC STANDARD 60269.1 AND 4

600 V - 690 V AC VOLTAGE RATING

aR CLASS AS PER VDE 636-23 AND IEC 60269.4

WITH AND WITHOUT TRIP-INDICATOR
FOR SIZES 14 x 51 AND 22 x 58

Main Characteristics

Voltage rating U_N (VAC)	Size	Class	Current rating I_N (A)	Pre-arcing $I^2t @ 1 ms$ I^2tp (A ² s)	Total clearing $I^2t @ A^2s$		Watts loss		Tested Breaking capacity
					660 V		$0,8 I_N$	I_N	
					$I_p \leq 30 I_N$	$I_p > 30 I_N$			
690 V	14 x 51	URGB	8	3.3	20	17	1.45	2.7	200 kA @ 690 V
			10	6.0	37	30	1.85	3.4	
			12	9.3	75	60	2.5	4.6	
			16	15.6	95	75	3.4	6.2	
			20	30.0	175	145	4	7.4	
			25	53.5	300	250	4.7	8.6	
			32	100	550	460	5.7	10.6	
			40	214	1150	940	6.2	11.5	
600* - 690 V	22 x 58	URGA	25	45		210	4.7	8.5	200 kA @ 690 V
			32	84		400	5.7	10.3	
			40	150		700	7.1	12.8	
			50	270		1270	8.7	15.7	
			63	595		2770	9.8	17.7	
			80	1165		5500	12	21.7	
600* - 690 V	22 x 58	URGA	100*	2150		9000*	14.2	25.6	200 kA @600 V

*Operating voltage limited to 600 V for the model with blown fuse trip-indicator / Total clearing $I^2t @ 600 V = 9000 A^2s$
Minimum operating voltage for built-in trip-indicator: 20 V

Semiconductor (AC) fuses

Other Protistor® Fuses

Ferrule Fuses

14x51 URGB & 22x58 URGA - 600 V to 690 VAC

References

14x51 - Without blown fuse trip-indicator

Current Rating	Designation	Ref. Number	Catalog Number
8 A	6.900 CP URGB 14.51/8	T078033	FR14UB69V8
10 A	6.900 CP URGB 14.51/10	V078034	FR14UB69V10
12 A	6.900 CP URGB 14.51/12	W078035	FR14UB69V12
16 A	6.900 CP URGB 14.51/16	X078036	FR14UB69V16
20 A	6.900 CP URGB 14.51/20	Y078037	FR14UB69V20
25 A	6.900 CP URGB 14.51/25	Z078038	FR14UB69V25
32 A	6.900 CP URGB 14.51/32	A078039	FR14UB69V32
40 A	6.900 CP URGB 14.51/40	B078040	FR14UB69V40
50 A	6.900 CP URGB 14.51/50	C078041	FR14UB69V50

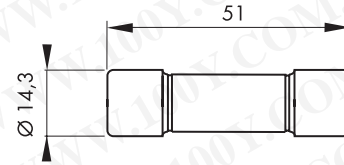

Weight: 18 g
Packaging: 10 pieces

14x51 - With trip-indicator

Current Rating	Designation	Ref. Number	Catalog Number
8 A	6.921 CP URGB 14.51/8	D078042	FR14UB69V8T
10 A	6.921 CP URGB 14.51/10	E078043	FR14UB69V10T
12 A	6.921 CP URGB 14.51/12	F078044	FR14UB69V12T
16 A	6.921 CP URGB 14.51/16	G078045	FR14UB69V16T
20 A	6.921 CP URGB 14.51/20	H078046	FR14UB69V20T
25 A	6.921 CP URGB 14.51/25	J078047	FR14UB69V25T
32 A	6.921 CP URGB 14.51/32	K078048	FR14UB69V32T
40 A	6.921 CP URGB 14.51/40	L078049	FR14UB69V40T
50 A	6.921 CP URGB 14.51/50	M078050	FR14UB69V50T

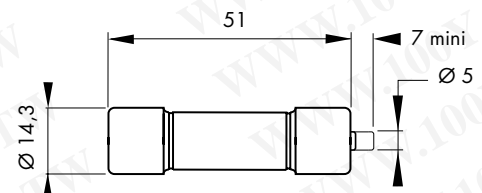

Weight: 18 g
Packaging: 10 pieces

22x58 - Without blown fuse trip-indicator

Current Rating	Designation	Ref. Number	Catalog Number
25 A	6.900 CP URGA 22.58/25	C095245	FR22UA69V25
32 A	6.900 CP URGA 22.58/32	D095246	FR22UA69V32
40 A	6.900 CP URGA 22.58/40	E095247	FR22UA69V40
50 A	6.900 CP URGA 22.58/50	F095248	FR22UA69V50
63 A	6.900 CP URGA 22.58/63	G095249	FR22UA69V63
80 A	6.900 CP URGA 22.58/80	H095250	FR22UA69V80
100 A	6.900 CP URGA 22.58/100	N078051	FR22UA69V100

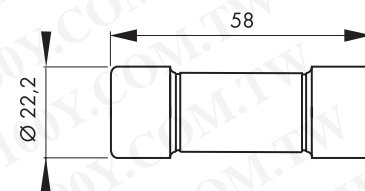

Weight: 57 g
Packaging: 10 pieces

22x58 - With trip-indicator

Current Rating	Designation	Ref. Number	Catalog Number
25 A	6.921 CP URGA 22.58/25	T095260	FR22UA69V25T
32 A	6.921 CP URGA 22.58/32	V095261	FR22UA69V32T
40 A	6.921 CP URGA 22.58/40	W095262	FR22UA69V40T
50 A	6.921 CP URGA 22.58/50	X095263	FR22UA69V50T
63 A	6.921 CP URGA 22.58/63	Y095264	FR22UA69V63T
80 A	6.921 CP URGA 22.58/80	Z095265	FR22UA69V80T
100 A	6.21 CP URGA 22.58/100	N098222	FR22UA60V100T

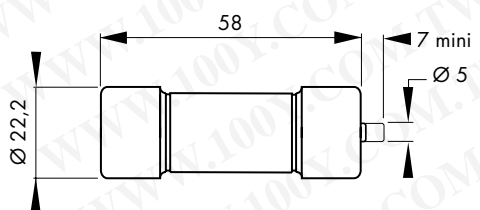

Weight: 57 g
Packaging: 10 pieces

See Gears and Fuse gears section

Other Protistor® Fuses Ferrule Fuses

14x51 URGB & 22x58 URGA - 600 V to 690 VAC

Electrical Characteristics

Time vs current characteristics

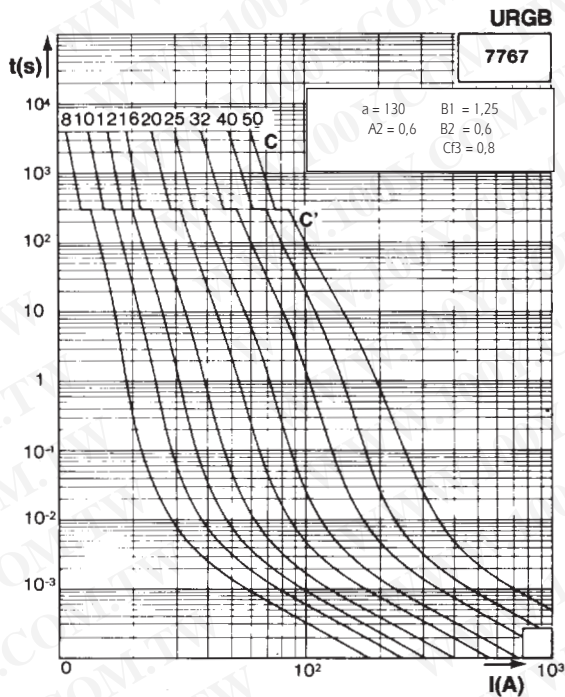

TOLERANCE OF MEAN PRE-ARCING CURRENT $\pm 10\%$

These curves indicate, for each rated current, pre-arcing time vs. R.M.S. pre-arcing current.

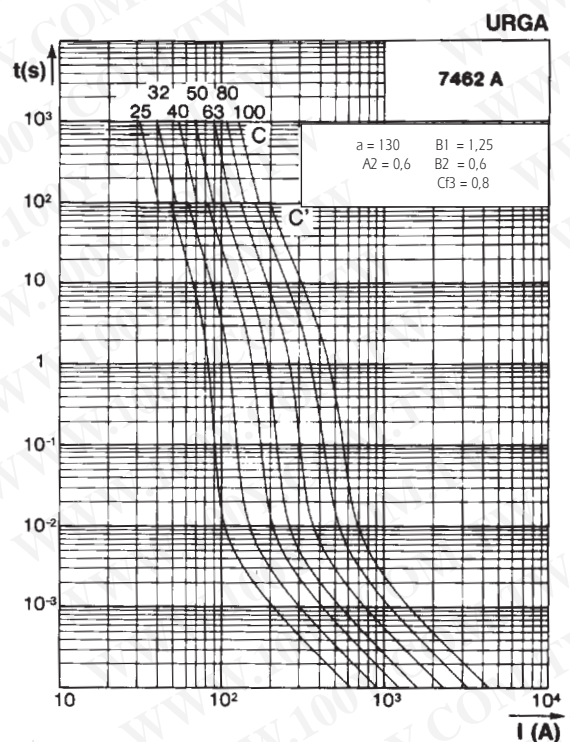

TOLERANCE FOR MEAN PRE-ARCING CURRENT $\pm 8\%$.

Semiconductor (AC) fuses

Other Protistor® Fuses

Ferrule Fuses

14x51 URGB & 22x58 URGA - 600 V to 690 VAC

Corrective factor - Peak arc voltage

Corrective factor

Peak arc voltage

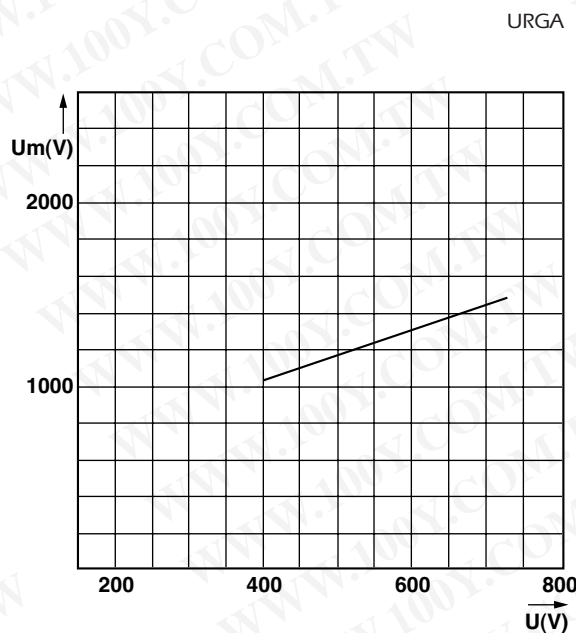
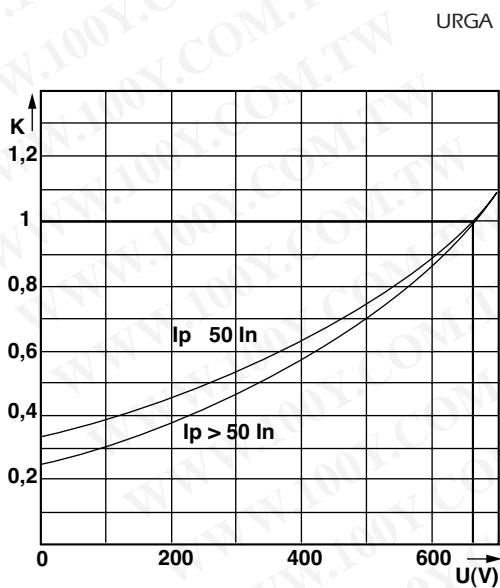
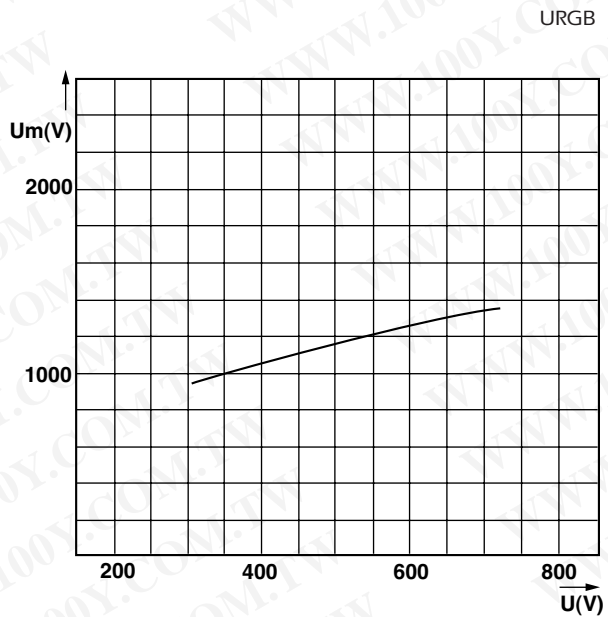
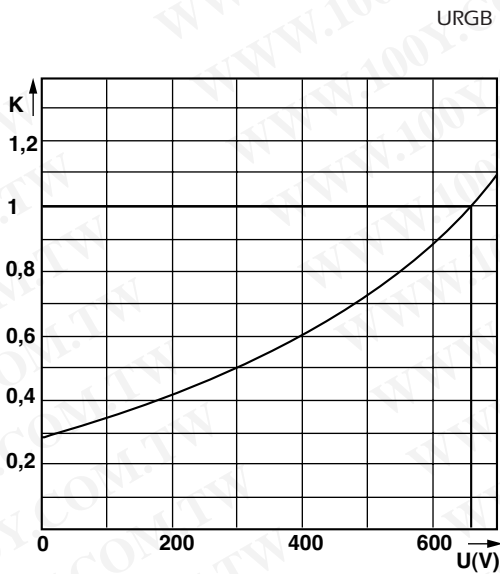

These mean curves show the variation of the total clearing time (I^2t_t) and the total clearing duration t_t as a function of operating voltage U .

This curve shows the peak value U_m of the arc voltage which appears across the fuse link as a function of operating voltage U @ $\cos \varphi = 0.15$.

Semiconductor (AC) fuses

勝特力材料 886-3-5753170
 勝特力电子(上海) 86-21-34970699
 勝特力电子(深圳) 86-755-83298787
 Http://www.100y.com.tw

Other Protistor® Fuses Ferrule Fuses 27x60 gRB - 800 VAC

800 VAC
 gRB from 8 to 110 A
 Size: 27 x 60

EXTREMELY HIGH BREAKING CAPACITY FUSES: PROTECTION
 OF POWER SEMICONDUCTORS
 COMPLYING WITH IEC STANDARDS 60269-1 AND 4

800 V VOLTAGE RATING ACCORDING TO IEC 33

- gR CLASS AS PER IEC 60269-4
- CLEARING ALL OVERLOADS
- IMPROVED SAFETY AND PROTECTION
- ENABLING SELECTIVE COORDINATION WITH OTHER FUSES

WITH TRIP INDICATOR

Dimensions

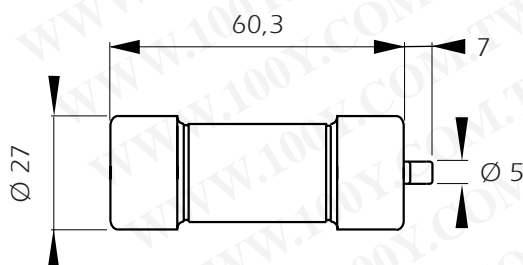

Unit weight
 78 g

Trip indicator force: 4.5N at 0mm - 2.5N at 7mm

Main Characteristics

Voltage rating U_N (V)	Class	Current rating I_N (A)	Pre-arcing $I^2t @ 1 \text{ ms}$ I^2tp (A2s)	Total clearing $I^2t @ U_N$ I^2tt (A2s)	Watts loss		Tested Breaking capacity	Designation	Ref. Number	Pack	Catalog Number
					0.8 I_N	I_N					
800	gRB	8	4.25	70	1.2	2.0	175 kA @ 700V	821 CP GRB27.60 8	R221436	10	FR27GB80V 8T
		10	8.0	100	1.3	2.3		821 CP GRB27.60 10	S221437	10	FR27GB80V 10T
		12	17.0	180	1.4	2.5		821 CP GRB27.60 12	T221438	10	FR27GB80V 12T
		16	26.5	250	1.9	3.5		821 CP GRB27.60 16	V221439	10	FR27GB80V 16T
		20	38.5	350	2.4	4.0		821 CP GRB27.60 20	W221440	10	FR27GB80V 20T
		25	73.0	600	2.8	5.0	90 kA @ 800V	821 CP GRB27.60 25	X221441	10	FR27GB80V 25T
		32	130	1000	3.5	6.0		821 CP GRB27.60 32	Y221442	10	FR27GB80V 32T
		40	195	1400	4.7	8.0		821 CP GRB27.60 40	Z221443	10	FR27GB80V 40T
		50	430	2700	4.8	8.5		821 CP GRB27.60 50	A221444	10	FR27GB80V 50T
		63	965	5500	5.6	10		821 CP GRB27.60 63	B221445	10	FR27GB80V 63T
		80	1890	11000	6.4	11.5		821 CP GRB27.60 80	C221446	10	FR27GB80V 80T
		100	3480	19000	7.4	13		821 CP GRB27.60 100	D221447	10	FR27GB80V 100T
		110	4670	27000	7.7	14		821 CP GRB27.60 110	E221448	10	FR27GB80V 110T

Minimum operating voltage for trip-indicator: 20 V

Fuseholder Solution: See Gears and Fuse gears section

Semiconductor (AC) fuses

Other Protistor® Fuses Ferrule Fuses 27x60 gRB - 800 VAC

Total clearing I^2t

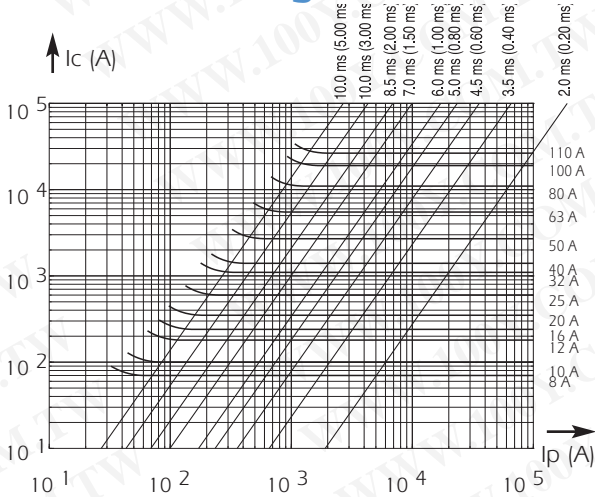

Above: Horizontal curves show maximum values of total clearing I^2t (I^2t_t) as function of prospective current I_p . @ U_N with $\cos \varphi = 0.15$. Oblique lines indicate total clearing duration T_t and associated pre-arcing duration in brackets.

Current limitation curves

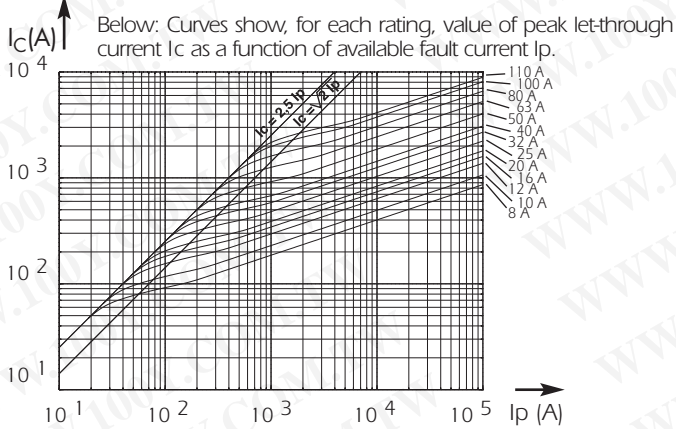

Below: Curves show, for each rating, value of peak let-through current I_c as a function of available fault current I_p .

Time vs current characteristics

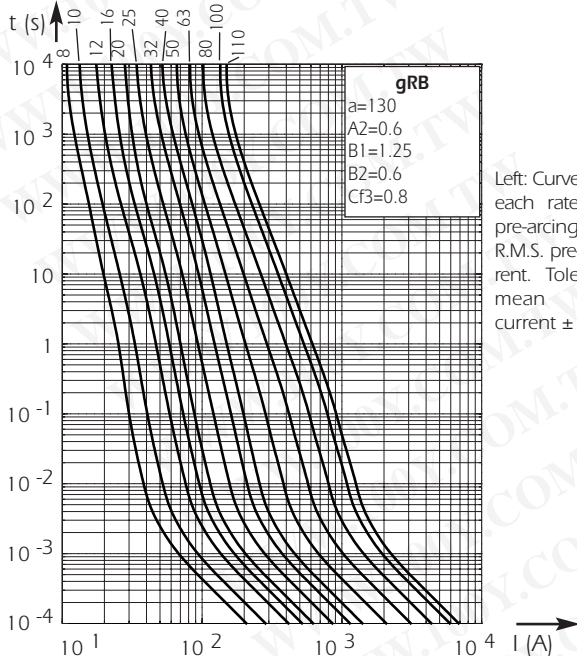

Left: Curves show, for each rated current, pre-arcing time vs. R.M.S. pre-arcing current. Tolerance for mean pre-arcing current $\pm 8\%$.

DC Application data

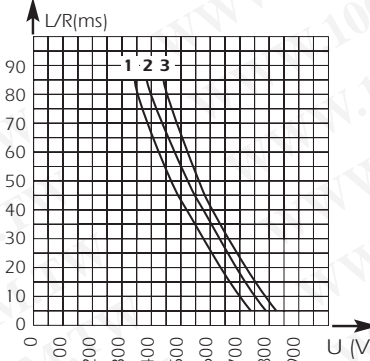

Above: Curves indicate permissible value of time constant L/R as a function of DC working voltage.
1 - I_N from 80 to 110 A / 2 - I_N from 25 to 63 A
3 - I_N from 8 to 12 A

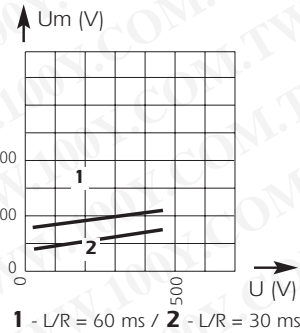

Above: Curve indicates peak arc voltage U_m which may appear across fuse terminals at working voltage U , for different values of time constant L/R of the fault circuit.
1 - $L/R = 60$ ms / 2 - $L/R = 30$ ms

I^2t corrective factor

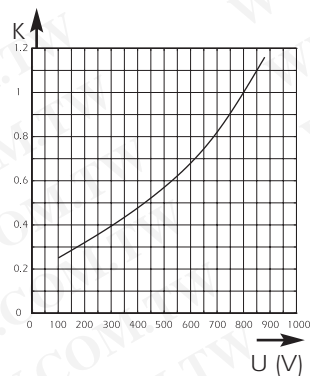

Left: Mean curve shows variation of total clearing time (I^2t_t) and total clearing duration T_t as a function of operating voltage U .

Peak arc voltage

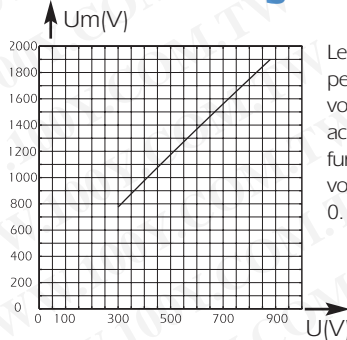

Left: Curve shows peak value U_m of arc voltage which appears across the fuse link as a function of operating voltage U @ $\cos \varphi = 0.15$

Watts loss

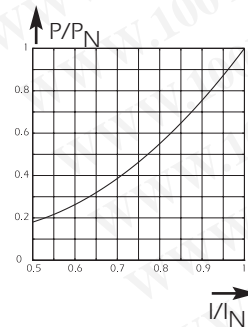

Left: Curve enables computation of power losses P for a I_N -rated fuse as a function of the R.M.S. current I (as a multiple of I_N for steady state operation)

Semiconductor (AC) fuses

Other Protistor® Fuses Ferrule Fuses

27x60 URGD - 600 V to 690 VAC



EXTREMELY BREAKING CAPACITY RATING FUSES:
PROTECTION OF POWER SEMICONDUCTORS ACCORDING TO
IEC STANDARD 60269.1 AND 4

600 V - 690 V AC VOLTAGE RATING

aR- CLASS ACCORDING TO VDE 636-23 AND IEC 60269.4

Main Characteristics

Voltage rating U_N (VAC)	Class	Current rating I_N (A)	Pre-arcing $I^2t @ 1 \text{ ms}$ I^2t_p (A ² s)	Total clearing I^2t I^2t_t (A ² s)	Watts loss		Tested Breaking capacity
					$0.8 I_N$	I_N	
690 V	URGD	63	405	1840 @ 660 V	12	22	200 kA @ 690 V
		80	860	3750 @ 660 V	13.5	24.6	
		100	1620	6800 @ 660 V	15	27	
		125	3425	13600 @ 660 V	16	29.5	
		160	6480	24600 @ 660 V	17	32.5	
		200	13700	61500 @ 660 V	18.5	35.7	
600 V	URGD	250	29600	107000 @ 600 V	21	40	200 kA @ 600 V

Minimum operating voltage for trip-indicator: 20 V

Ref. Numbers

27x60 - With trip-indicator

Type	Voltage	Current rating	Designation	Ref. Number	Catalog Number
URGD	690 V	63 A	6.921 CP URGD 27x60/ 63	A076820	FR27UD69V63T
		80 A	6.921 CP URGD 27x60/ 80	B076821	FR27UD69V80T
		100 A	6.921 CP URGD 27x60/100	C076822	FR27UD69V100T
		125 A	6.921 CP URGD 27x60/125	D076823	FR27UD69V125T
		160 A	6.921 CP URGD 27x60/160	E076824	FR27UD69V160T
URGD	600 V	200 A	6.921 CP URGD 27x60/200	F076825	FR27UD69V200T
		250 A	6.21 CP URGD 27x60/250	W076264	FR27UD60V250T

Fuseholder Solution: See Gears and Fuse gears section

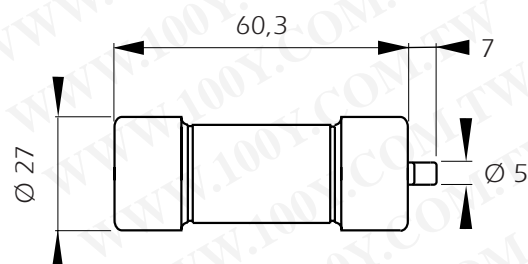

Semiconductor (AC) fuses

Other Protistor® Fuses

Ferrule Fuses

27x60 URGD - 600 V to 690 VAC

Time vs current characteristics

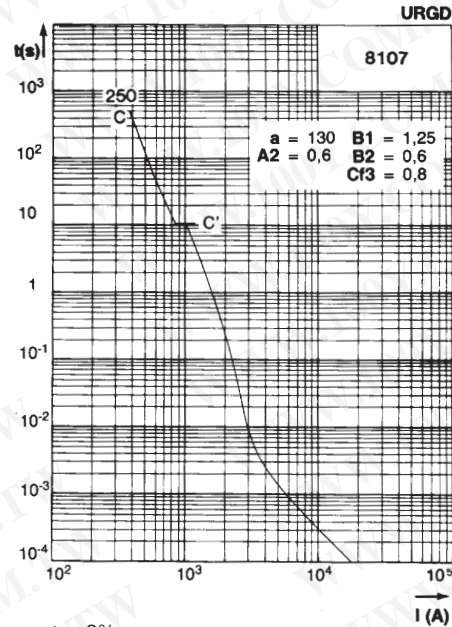
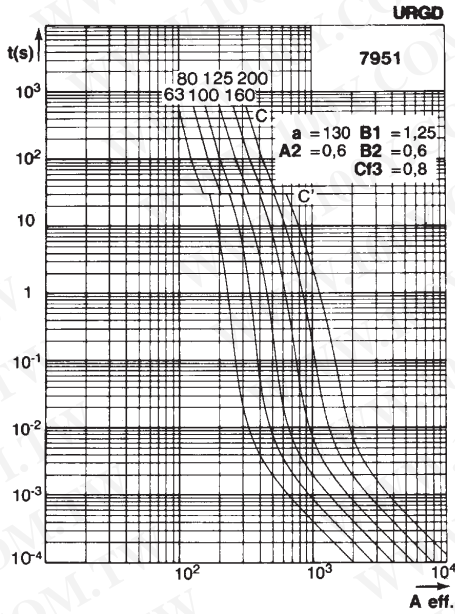

Tolerance for mean pre-arcing current $\pm 8\%$

These curves indicate, for each rated current, pre-arcing time vs. R.M.S. pre-arcing current.

Corrective factor

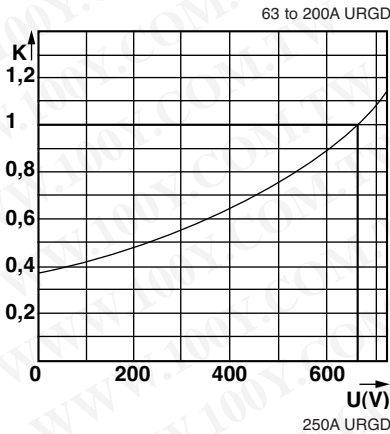

Left: Mean curves showing variation of total clearing time ($I^2 t_t$) and the total clearing duration t_t as a function of the operating voltage U

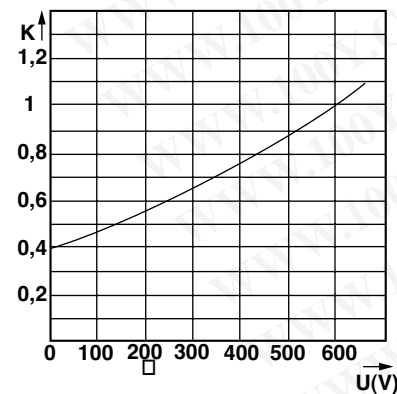

Peak arc voltage

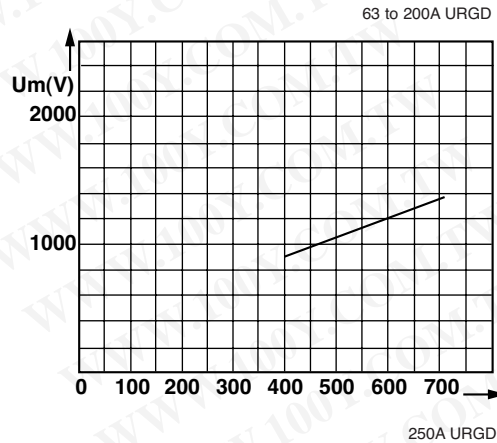

Left: Curves show peak value U_m of arc voltage which appears across the fuse-link as a function of operating voltage $U @ \cos \varphi = 0.15$.

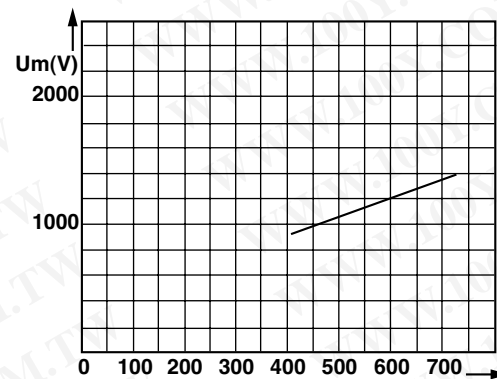

Other Protistor® Fuses Ferrule Fuses 27x60 URO/URS/URB - 690 V to 1000 VAC



EXTREMELY HIGH IBREAKING CAPACITY FUSES:

PROTECTION OF POWER SEMI CONDUCTORS ACCORDING TO IEC STANDARD 60269.1 AND 4

690 V - 1000 V AC VOLTAGE RATING

aR-CLASS ACCORDING TO VDE 636-23 AND IEC 60269.4

690V URO and 1000V URB are UL RECOGNIZED

Main Characteristics

Voltage rating U_N (VAC)	Class	Current rating I_N (A)	Pre-arcing $I^2t @ 1 \text{ ms}$ I^2t_p (A ² s)	Total clearing I^2t I^2t_t (A ² s)	Watts loss		Tested Breaking capacity
					0,8 I_N	I_N	
690 V	URO	50	110	610 @ 660 V	8.4	16	200 kA @ 690 V
		63	155	860 @ 660 V	11.1	21	
		80	350	1880 @ 660 V	12.6	24	
		100	625	3210 @ 660 V	14.2	27	
		125	1400	6970 @ 660 V	15.7	30	
		160	3150	15000 @ 660 V	17.7	34	
		200	6580	30000 @ 660 V	19.4	38	
690 V	URS	250	15570	63000 @ 660 V	22.6	45	200 kA @ 690 V
		125	2790	13000 @ 660 V	14.5	25	
1000 V	URB	160	5500	24000 @ 660 V	17.5	30	100 kA @ 1000 V
		32	33	250 @ 1000 V	7.4	14.5	
		40	60	450 @ 1000 V	8.7	17	
		50	110	840 @ 1000 V	9.7	19	
		63	200	1470 @ 1000 V	11.3	22	
		80	435	3300 @ 1000 V	12.3	24	
		100	975	6000 @ 1000 V	14	27	
		125	1910	12500 @ 1000 V	16	31	
160	3890	26700 @ 1000 V	18	35			
		170	4710	36000 @ 1000 V	19	37	

* Minimum operating voltage for trip-indicator: 20 V
Fuseholder Solution: See Gears and Fuse gears section

Semiconductor (AC) fuses

Other Protistor® Fuses

Ferrule Fuses

27x60 URQ/URS/URB - 690 V to 1000 VAC

27x60 - With trip-indicator

 Except 125 and 160A URS

Type	Voltage	Current rating	Designation	Ref. Number	Catalog Number
URQ	690 V	50 A	6.921 CP URQ 27x60/ 50	N075958	FR27UQ69V50T
		63 A	6.921 CP URQ 27x60/ 63	V076309	FR27UQ69V63T
		80 A	6.921 CP URQ 27x60/ 80	W076310	FR27UQ69V80T
		100 A	6.921 CP URQ 27x60/100	R078330	FR27UQ69V100T
		125 A	6.921 CP URQ 27x60/125	S078331	FR27UQ69V125T
		160 A	6.921 CP URQ 27x60/160	X076311	FR27UQ69V160T
		200 A	6.921 CP URQ 27x60/200	T078332	FR27UQ69V200T
		250 A	6.921 CP URQ 27x60/250	T076308	FR27UQ69V250T
URS	690 V	125 A	6.921 CP URS 27x60/125	P209865	FR27US69V125T
		160 A	6.921 CP URS 27x60/160	Q209866	FR27US69V160T
URB	1000 V	32 A	1021 CP URB 27x60/ 32	S081298	FR27UB10C32T
		40 A	1021 CP URB 27x60/ 40	R081297	FR27UB10C40T
		50 A	1021 CP URB 27x60/ 50	Q081296	FR27UB10C50T
		63 A	1021 CP URB 27x60/ 63	P081295	FR27UB10C63T
		80 A	1021 CP URB 27x60/ 80	N081294	FR27UB10C80T
		100 A	1021 CP URB 27x60/100	M081293	FR27UB10C100T
		125 A	1021 CP URB 27x60/125	L081292	FR27UB10C125T
		160 A	1021 CP URB 27x60/160	K081291	FR27UB10C160T
		170 A	1021 CP URB 27x60/170	Z080338	FR27UB10C170T

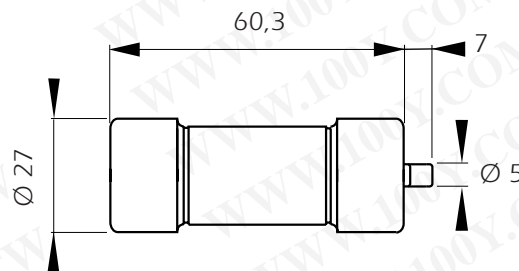

勝特力材料 886-3-5753170
 勝特力电子(上海) 86-21-34970699
 勝特力电子(深圳) 86-755-83298787
[Http://www.100y.com.tw](http://www.100y.com.tw)

Semiconductor (AC) fuses

Other Protistor® Fuses Ferrule Fuses

27x60 URQ/URS/URB - 690 V to 1000 VAC

Time vs current characteristics

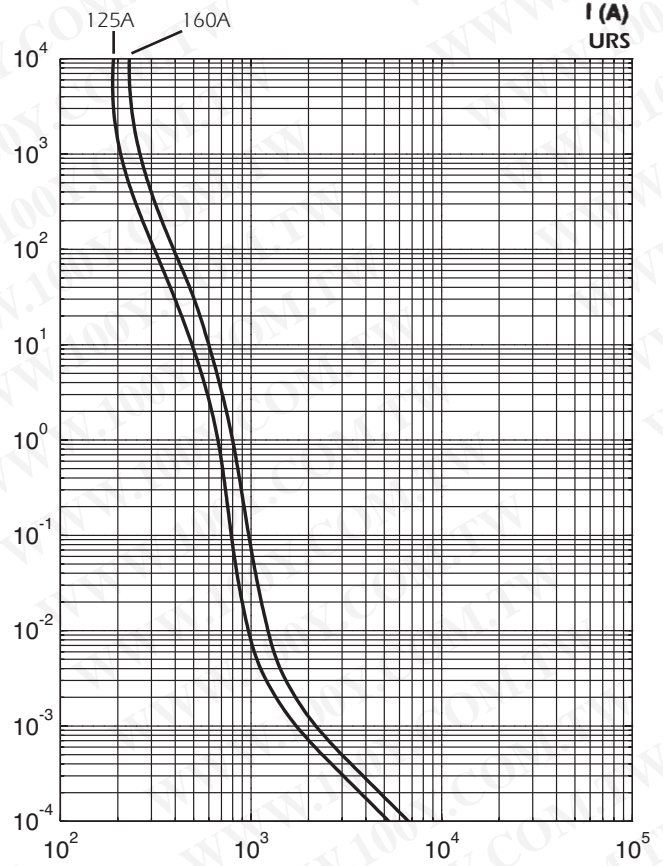
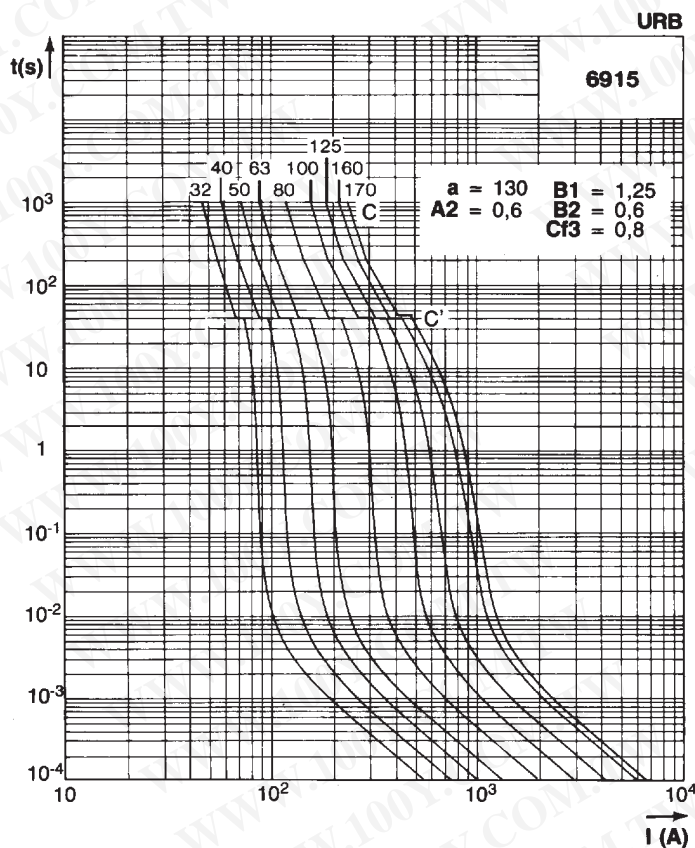
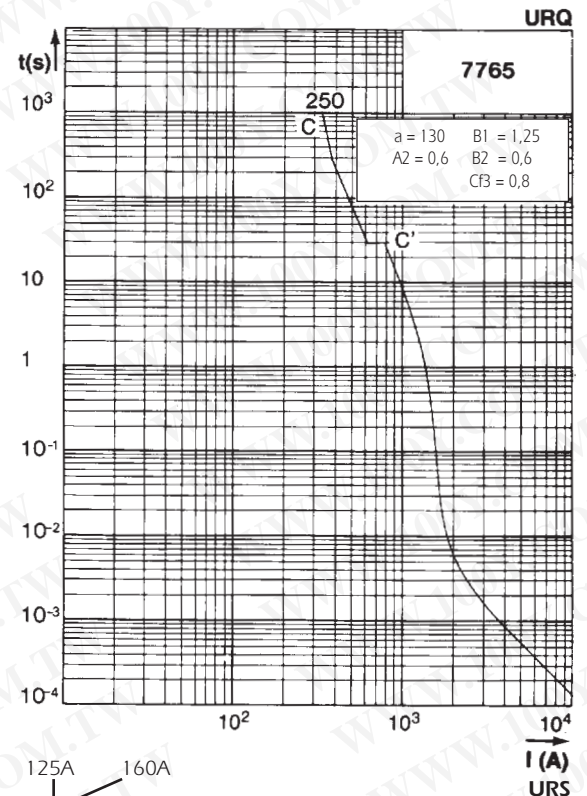
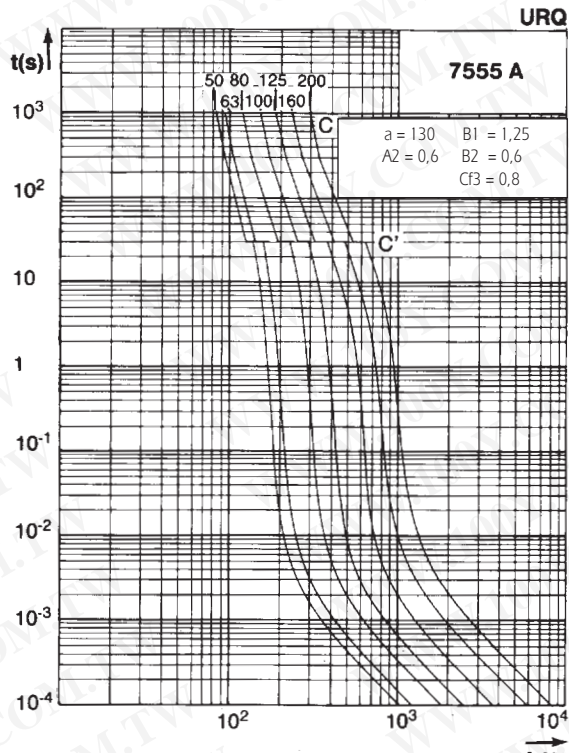

These curves indicate, for each rated current, pre-arcing time vs. R.M.S. pre-arcing current.

Tolerance for mean pre-arcing current $\pm 8\%$.

Semiconductor (AC) fuses

Other Protistor® Fuses

Ferrule Fuses

27x60 URQ/URS/URB - 690 V to 1000 VAC

Peak arc voltage

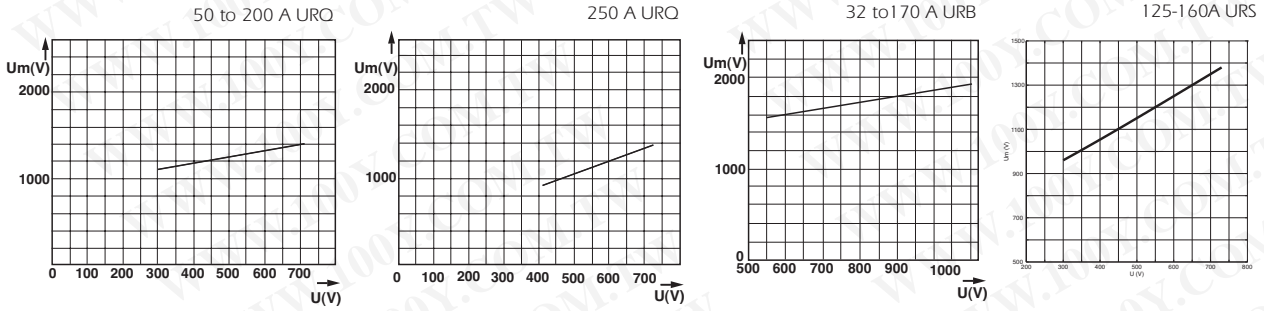

These curves show peak value U_m of arc voltage which appears across the fuse-link as a function of operating voltage $U @ \cos \varphi = 0.15$.

Corrective factor

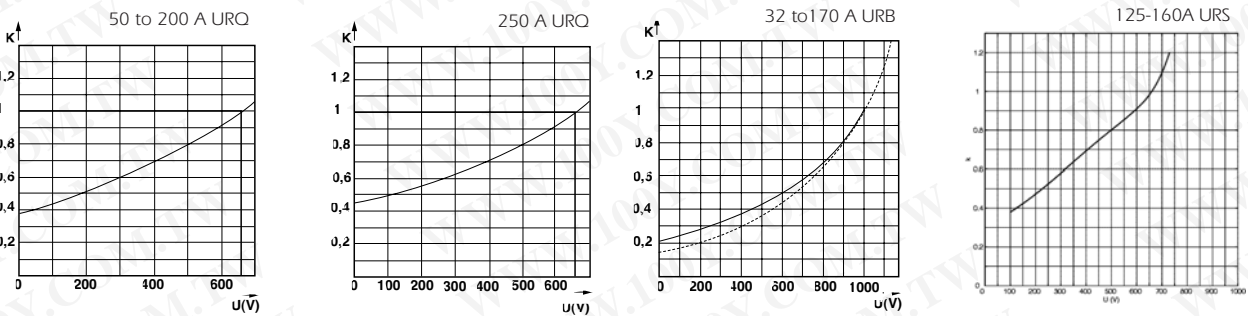

Above: Mean curves show variation of total clearing time (I^2tt) and total clearing duration tt as a function of operating voltage U .

DC Application data

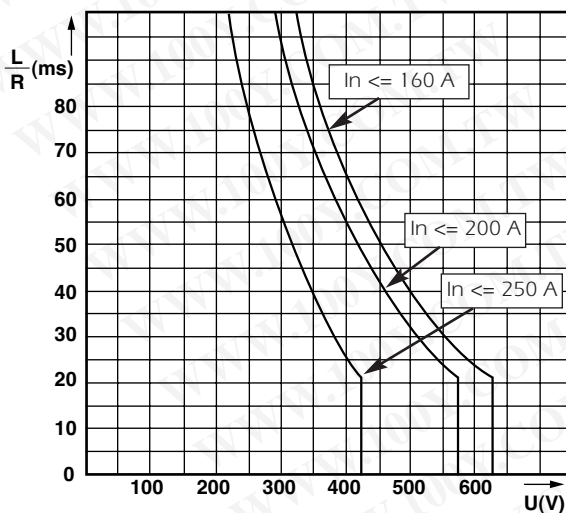

Left: Curves indicate permissible value of time constant L/r as a function of the DC working voltage

Other Protistor® Fuses DIN Bracket Ferrule Fuses 17x49 gRB/URB - 690 VAC



EXTREMELY HIGH BREAKING CAPACITY FUSES:
PROTECTION OF SEMICONDUCTORS
AS PER IEC STANDARD 60269.1 AND 4

690 V VOLTAGE RATING AS PER IEC 33

gR CLASS (CURRENT RATING 12 TO 90 A) AS PER
VDE 636-23

- CLEARING ALL OVERLOADS
- IMPROVED SAFETY AND PROTECTION
- ENABLING SELECTIVE COORDINATION WITH ALL FUSES
WITHIN DISTRIBUTION CIRCUIT

aR CLASS (CURRENT RATING 100 A) ACCORDING TO VDE
636-23 AND IEC 60269.4

CONNECTION AS PER:

- GERMAN STANDARD DIN 43653/00C
- BRITISH STANDARD BS 88-4

These fuses are UL Recognized



Main Characteristics

Voltage rating U_N (V)	Class	Current rating I_N (A)	pre-arcing I^2_t @ 1 ms I^2_{tp} (A ² s)	Total clearing I^2_t @ U_N I^2_{tt} (A ² s)	Watts loss		Tested Breaking capacity	Estimated Breaking capacity
					0.8 I_N	I_N		
690	gRB	12	4.2	30	1.95	3.5	200 kA @ 690 V	300 kA @ 690 V
		16	9.6	65	2.2	4.0		
		20	17.1	110	3.0	5.5		
		25	26.8	170	4.4	8.0		
		32	52.5	330	5.0	9.0		
		35	69	430	5.2	9.5		
		40	96	610	5.8	10.5		
		45	130	820	6.3	11.5		
		50	154	970	7.2	13		
		55	210	1320	7.4	13.5		
		63	310	1950	8.0	14.5		
		75	520	3250	8.8	16		
80	620	3900	9.4	17				
90	840	5300	11	20				
690	URB	100	965	6150	13	23.5	200 kA @ 690 V	300 kA @ 690 V

Minimum operating voltage for separate trip-indicator: 20 V

Semiconductor (AC) fuses

Other Protistor® Fuses DIN Bracket Ferrule Fuses 17x49 gRB/URB - 690 VAC

German standard without blown fuse indication

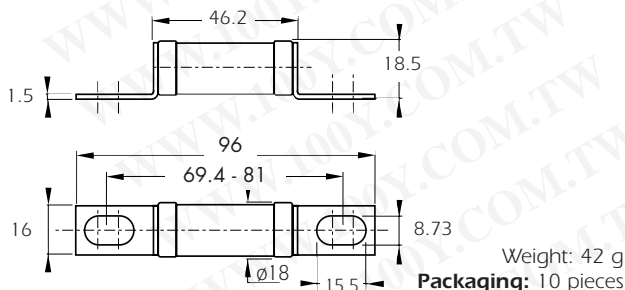

German standard with separate trip-indicator DIN 43623/00C

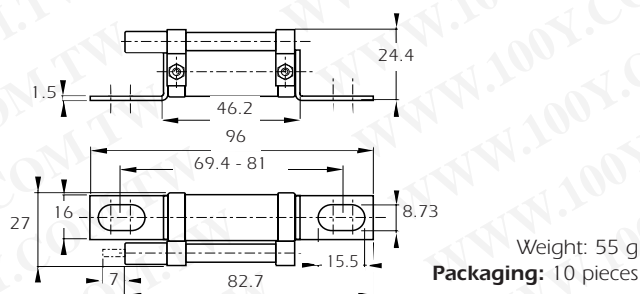

British standard without blown fuse indication

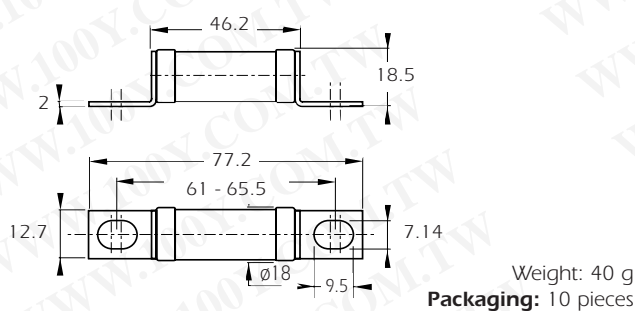

British standard with separate trip-indicator BS 88-4

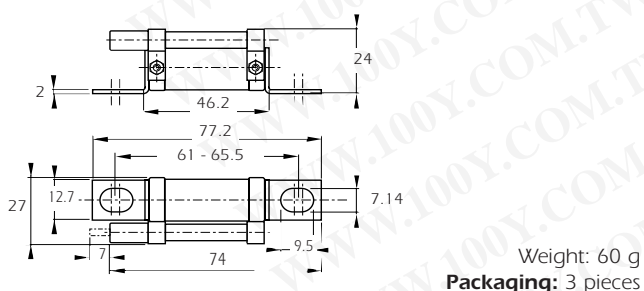

Current rating	Designation	Ref. Number	Catalog Number
12	6,9 gRB 17 D08/12	M220972	DN17GB69V12
16	6,9 gRB 17 D08/16	N220973	DN17GB69V16
20	6,9 gRB 17 D08/20	P220974	DN17GB69V20
25	6,9 gRB 17 D08/25	Q220975	DN17GB69V25
32	6,9 gRB 17 D08/32	R220976	DN17GB69V32
35	6,9 gRB 17 D08/35	S220977	DN17GB69V35
40	6,9 gRB 17 D08/40	T220978	DN17GB69V40
45	6,9 gRB 17 D08/45	V220979	DN17GB69V45
50	6,9 gRB 17 D08/50	W220980	DN17GB69V50
55	6,9 gRB 17 D08/55	X220981	DN17GB69V55
63	6,9 gRB 17 D08/63	Y220982	DN17GB69V63
75	6,9 gRB 17 D08/75	Z220983	DN17GB69V75
80	6,9 gRB 17 D08/80	A220984	DN17GB69V80
90	6,9 gRB 17 D08/90	B220985	DN17GB69V90
100	6,9 URB 17 D08/100	C220986	DN17UB69V100

Current rating	Designation	Ref. Number	Catalog Number
12	6,9 gRB 17 D08P 12	X221004	DN17GB69V12P
16	6,9 gRB 17 D08P 16	Y221005	DN17GB69V16P
20	6,9 gRB 17 D08P 20	Z221006	DN17GB69V20P
25	6,9 gRB 17 D08P 25	A221007	DN17GB69V25P
32	6,9 gRB 17 D08P 32	B221008	DN17GB69V32P
35	6,9 gRB 17 D08P 35	C221009	DN17GB69V35P
40	6,9 gRB 17 D08P 40	D221010	DN17GB69V40P
45	6,9 gRB 17 D08P 45	E221011	DN17GB69V45P
50	6,9 gRB 17 D08P 50	F221012	DN17GB69V50P
55	6,9 gRB 17 D08P 55	G221013	DN17GB69V55P
63	6,9 gRB 17 D08P 63	H221014	DN17GB69V63P
75	6,9 gRB 17 D08P 75	J221015	DN17GB69V75P
80	6,9 gRB 17 D08P 80	K221016	DN17GB69V80P
90	6,9 gRB 17 D08P 90	L221017	DN17GB69V90P
100	6,9 URB 17 D08P 100	M221018	DN17UB69V100P

Current rating	Designation	Ref. Number	Catalog Number
12	6,9 gRB 17/12	W220957	BS17GB69V12
16	6,9 gRB 17/16	X220958	BS17GB69V16
20	6,9 gRB 17/20	Y220959	BS17GB69V20
25	6,9 gRB 17/25	Z220960	BS17GB69V25
32	6,9 gRB 17/32	A220961	BS17GB69V32
35	6,9 gRB 17/35	B220962	BS17GB69V35
40	6,9 gRB 17/40	C220963	BS17GB69V40
45	6,9 gRB 17/45	D220964	BS17GB69V45
50	6,9 gRB 17/50	E220965	BS17GB69V50
55	6,9 gRB 17/55	F220966	BS17GB69V55
63	6,9 gRB 17/63	G220967	BS17GB69V63
75	6,9 gRB 17/75	H220968	BS17GB69V75
80	6,9 gRB 17/80	J220969	BS17GB69V80
90	6,9 gRB 17/90	K220970	BS17GB69V90
100	6,9 URB 17/100	L220971	BS17UB69V100

Current rating	Designation	Ref. Number	Catalog Number
12	6,9 gRB 17P12	D220987	BS17GB69V12P
16	6,9 gRB 17P16	E220988	BS17GB69V16P
20	6,9 gRB 17P20	F220989	BS17GB69V20P
25	6,9 gRB 17P25	G220990	BS17GB69V25P
32	6,9 gRB 17P32	H220991	BS17GB69V32P
35	6,9 gRB 17P35	J220992	BS17GB69V35P
40	6,9 gRB 17P40	K220993	BS17GB69V40P
45	6,9 gRB 17P45	L220994	BS17GB69V45P
50	6,9 gRB 17P50	M220995	BS17GB69V50P
55	6,9 gRB 17P55	N220996	BS17GB69V55P
63	6,9 gRB 17P63	P220997	BS17GB69V63P
75	6,9 gRB 17P75	Q220998	BS17GB69V75P
80	6,9 gRB 17P80	R220999	BS17GB69V80P
90	6,9 gRB 17P90	S221000	BS17GB69V90P
100	6,9 URB 17P100	T221001	BS17UB69V100P

Semiconductor (AC) fuses

Other Protistor® Fuses DIN Bracket Ferrule Fuses 17x49 gRB/URB - 690 VAC

Total clearing I^2t

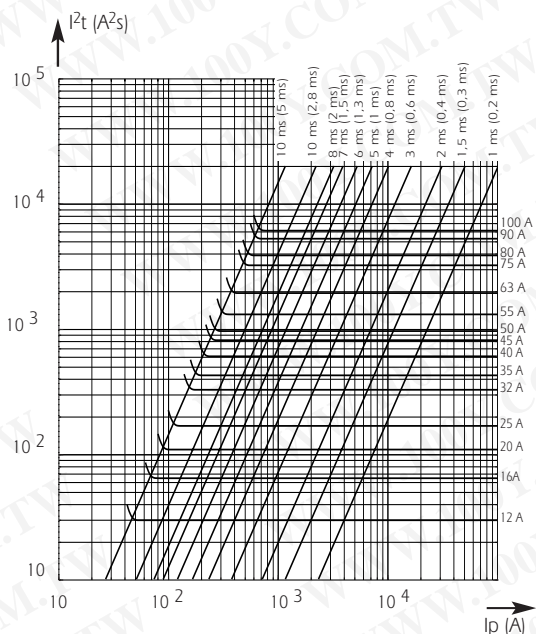

Above: Horizontal curves show for each rated current maximum values of total clearing I^2t (I^2t_t) as a function of prospective current I_p . @ 690 V. $\cos \varphi = 0.15$.
Oblique lines indicate total clearing duration T_t and associated pre-arcing duration in brackets.

I^2t corrective factor

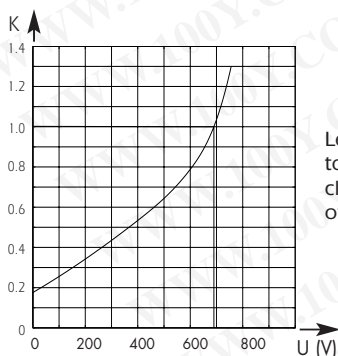

Left: Curve shows variation of total clearing time (I^2t_t) and total clearing duration T_t as a function of operating voltage U .

Peak arc voltage

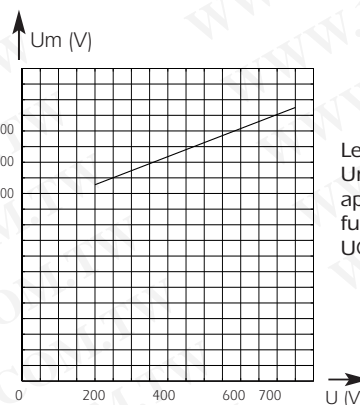

Left: Curve shows peak value U_m of arc voltage which appears across fuse-link as a function of operating voltage U @ $\cos \varphi = 0.15$.

Time vs current characteristics

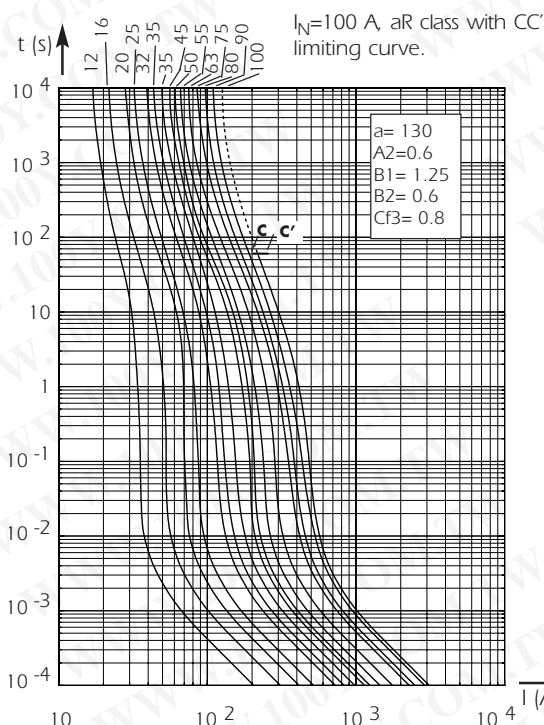

Tolerance for mean pre-arcing current $\pm 9\%$.

Above: Curves indicate, for each rated current, pre-arcing time vs. R.M.S. pre-arcing current

Current limitation curves

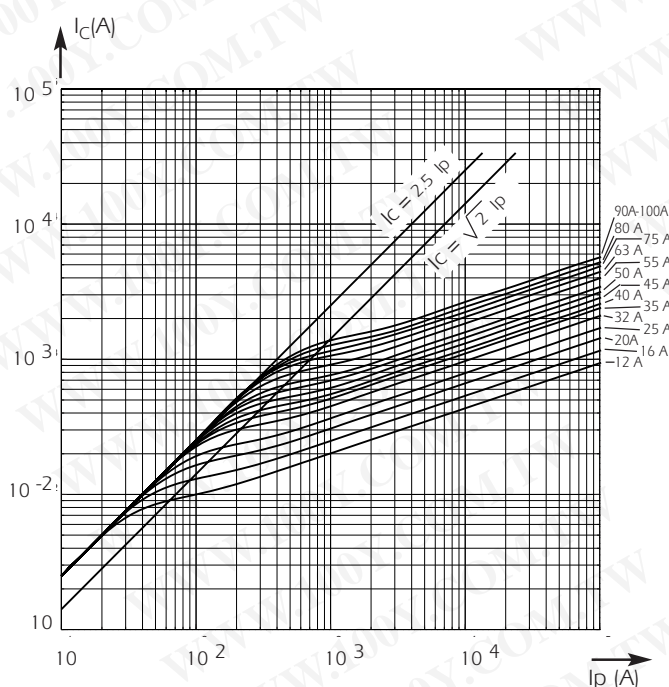

Above: Curves show, for each rating, value of peak let-through current I_c as a function of available fault current I_p .

Semiconductor (AC) fuses

Other Protistor® Fuses DIN Bracket Ferrule Fuses 17x49 gRB/URB - 690 VAC

DC Application data

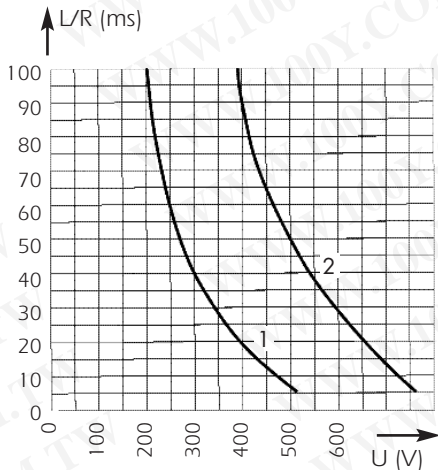

Above: Curves indicate permissible value of time constant L/R as a function of DC working voltage.

Curve 1: $I_p \geq 1,6$ IN only for fuses gRB (current rating from 12 to 50 A)
Curve 2: $I_p \geq 8$ IN for fuses gRB et URB

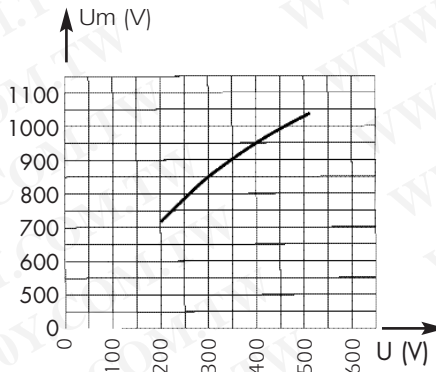

Curve indicates peak arc voltage U_m which may appear across the fuse terminals at working voltage U.

Microswitch

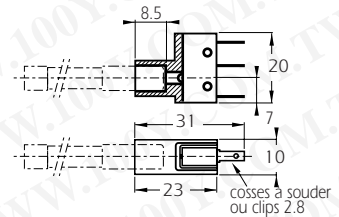

Designation	Ref. Num.	Weight	Pack.
MC 6,3 GR 2.5	Y 310015	10 g	3 pieces

Electrical characteristics:
 $I_N = 3$ A - $U_N = 250$ VAC
 $I_N = 2$ A - $U_N = 30$ VDC

Certain minimum operating voltage/current
20 V-100 mA

NEW gR-CLASS

OPTIMAL PROTECTION OF POWER EQUIPMENT

Thanks to recent technological developments, Ferraz Shawmut today markets gR-class PROTISTOR® fuses capable of clearing all types of overloads, from low multiples of current ratings up to very high short-circuit currents. Enhanced performance enables these fuses to provide solutions to many previously unsolved problems in power electronics: protection of cables without the use of additional components, protection of equipment from fire hazards, selective coordination of different fuses within a single power distribution installation...

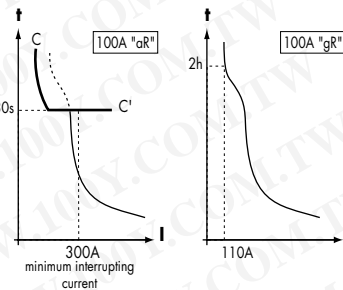

Example:
100A aR vs. 100A gR

SELECTIVE COORDINATION

gR-class semiconductor fuses can be utilized in association with gI and gG-class low voltage power distribution fuses of the same current rating, installed upstream. In a "selectively coordinated" distribution installation, melting is limited to the fuse associated with the faulted circuit, while upstream fuses remain intact. This prevents unnecessary down-time due to power blackouts in non-faulted branches.

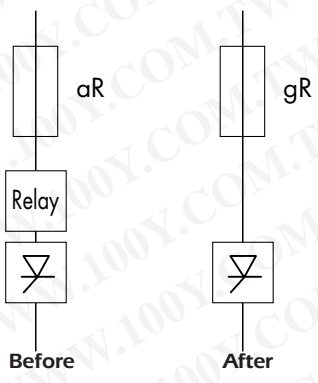
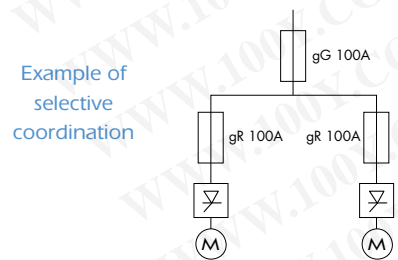

aR-CLASS vs. gR-CLASS

aR-class fuses feature a high minimum interrupting current as compared with their current rating. The primary time-current characteristic of aR-class fuses is the CC' curve, above which another protection device must be associated. The gR-class fuse represents considerably improved performance in semiconductor protection.

FERRAZ SHAWMUT EXPERTISE

gR-class fuses should be used in the design of low voltage equipment and in the protection of power electronics equipment. Designers can often substitute a gR-class fuse for an aR-class fuse (10x38, 14x51, 22x58, PSC 000 and 17x49 DIN80 or BS 88-4) but the reverse is not true: an aR fuse can never replace a gR fuse. Start protecting your new equipment with gR-class fuses today. The application of gR class fuses, with current ratings less than 100 Amps, offers enhanced protection, safety and reliability, along with reduced risk of replacement errors and assembly costs.

Semiconductor (AC) fuses

Other Protistor® Fuses BS88-4 Fuses 10x28, 17x27 - 250 VAC

BRITISH STANDARD
250 VAC - URE - URGS - URZ
From 5 to 180 A
Sizes 10x28 - 17x27

Extremely high breaking capacity fuses:
protection of power semiconductors as per
IEC standard 60269.1 and 4

250 V voltage rating complying with IEC 33

gr class (ratings from 5 to 32 a)
AS PER VDE 636-23 AND IEC 60269.4

aR CLASS (RATINGS FROM 7 to 180 A) COMPLYING WITH
VDE 636-23 AND IEC 60269.4

TWO MODELS COMPLYING WITH BS 88-4

- WITHOUT INDICATOR
- WITH SEPARATE TRIP-INDICATOR (SIZE 17x27)

17x27 URGS are UL Recognized



Main Characteristics

Voltage rating U_N (V)	Size	Class	Current rating I_N (A)	Pre-arcing $I^2t @ 1 \text{ ms}$ I^2tp (A ² s)	Total clearing $I^2t @ U_N$ A ² s		Watts loss		Tested breaking capacity
					$I_p \leq 30I_N$	$I_p > 30I_N$	$0.8 I_N$	I_N	
250V	10 x28	URE	5	1.3	10	11	0.6	1	160k A @ 250 V
			6	1.8	13	15	0.7	1.2	
			10	2.4	18	20	1.2	2.1	
			12	4.3	28	33	1.6	2.8	
			15	6.7	41	48	2.0	3.5	
			20	15.0	85	100	2.2	4.0	
			25	27.0	135	160	2.6	4.7	
	32	53.0	240	280	3.0	5.4			
	17x27	URGS	7	1.3	8,5	9,8	0.56	1	160k A @ 250 V
			10	4.5	21	23,8	0.84	1.5	
			12	5.9	27	31	1.1	2.0	
			16	11.2	50	59	1.7	3.0	
			20	15.6	80	100	2.2	3.9	
			25	30.0	130	160	2.7	4.8	
30			45.0	195	235	3.2	5.6		
35			63.0	270	330	3.7	6.5		
URZ		50	180.0	7890	940	4.9	8.8	160k A @ 250 V	
		60	250.0	1100	1310	5.8	10.4		
		75	380.0	1670	1990	7.2	13.6		
		80	480.0	2100	2530	7.25	13.7		
		100	730.0	3350	4060	6.5	11.5		
		125	850.0	5720	6920	6.7	12.3		
		150	1250.0	7930	9590	7.4	13.6		
		160	1730.0	9600	11700	8.8	15.6		
		180	2090.0	14500	17500	9.5	17		

Minimum Operating voltage for separate trip indicator = 20 V



Other Protistor® Fuses

BS88-4 Fuses

10x28, 17x27 - 250 VAC

CP 10x28 - Without trip-indicator

Size	Designation	Ref. Number	Pack.	Catalog Number
10x28	2.5 URE 10/5	M082489		BS10UE25V5
	2.5 URE 10/6	E097478		BS10UE25V6
	2.5 URE 10/10	L082488		BS10UE25V10
	2.5 URE 10/12	P097487	10	BS10UE25V12
	2.5 URE 10/15	K082487	(11g)	BS10UE25V15
	2.5 URE 10/20	J082486		BS10UE25V20
	2.5 URE 10/25	X097494		BS10UE25V25
	2.5 URE 10/32	N081984		BS10UE25V32

**BBS 88 part 4 requires respectively Ø8.7 and 8.8

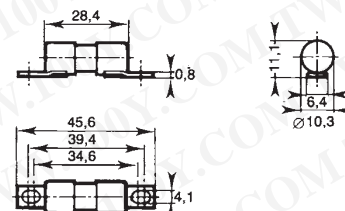

CP 17x27 - Without trip-indicator

Size	Designation	Ref. Number	Pack.	Catalog Number
17x27	2.5 URGS 17/7	M076647		BS17US25V7
	2.5 URGS 17/10	N076648		BS17US25V10
	2.5 URGS 17/12	P076649		BS17US25V12
	2.5 URGS 17/16	Q076650		BS17US25V16
	2.5 URGS 17/20	L097507		BS17US25V20
	2.5 URGS 17/25	R076651		BS17US25V25
	2.5 URGS 17/30	S076652	10	BS17US25V30
	2.5 URGS 17/35	T076653	(30g)	BS17US25V35
	2.5 URGS 17/50	V076654		BS17US25V50
	2.5 URGS 17/60	W076655		BS17US25V60
	2.5 URGS 17/75	X076656		BS17US25V75
	2.5 URGS 17/80	Z085559		BS17US25V80
	2.5 URZ 17/100	Y085558		BS17UZ25V100
	2.5 URZ 17/125	G097526		BS17UZ25V125
	2.5 URZ 17/150	W085556		BS17UZ25V150
	2.5 URZ 17/160	H097527		BS17UZ25V160
2.5 URZ 17/180	N097532		BS17UZ25V180	

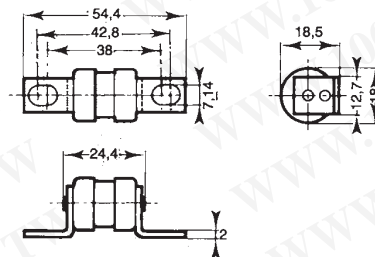

CP 17x27 - With separated trip-indicator BS88-4

Size	Designation	Ref. Number	Pack.	Catalog Number
17x27	2.5 URGS 17P7	P097533		BS17US25V7P
	2.5 URGS 17P10	Q097534		BS17US25V10P
	2.5 URGS 17P12	S097536		BS17US25V12P
	2.5 URGS 17P16	X097540		BS17US25V16P
	2.5 URGS 17P20	B097544		BS17US25V20P
	2.5 URGS 17P25	D097546		BS17US25V25P
	2.5 URGS 17P30	E097547	10	BS17US25V30P
	2.5 URGS 17P35	F097548	(40g)	BS17US25V35P
	2.5 URGS 17P50	J097551		BS17US25V50P
	2.5 URGS 17P60	H081082		BS17US25V60P
	2.5 URGS 17P75	K097552		BS17US25V75P
	2.5 URGS 17P80	L097553		BS17US25V80P
	2.5 URZ 17P100	P097556		BS17UZ25V100P
	2.5 URZ 17P125	Q097557		BS17UZ25V125P
	2.5 URZ 17P150	R097558		BS17UZ25V150P
	2.5 URZ 17P160	S097559		BS17UZ25V160P
2.5 URZ 17P180	T097560		BS17UZ25V180P	

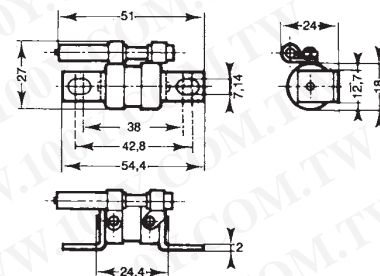

Microswitch MC6.3 GR 2-5N Ref: Y301015

勝特力材料 886-3-5753170
 胜特力电子(上海) 86-21-34970699
 胜特力电子(深圳) 86-755-83298787
[Http://www.100y.com.tw](http://www.100y.com.tw)

Other Protistor® Fuses BS88-4 Fuses 10x28, 17x27 - 250 VAC

Electrical characteristics

Times vs current characteristics

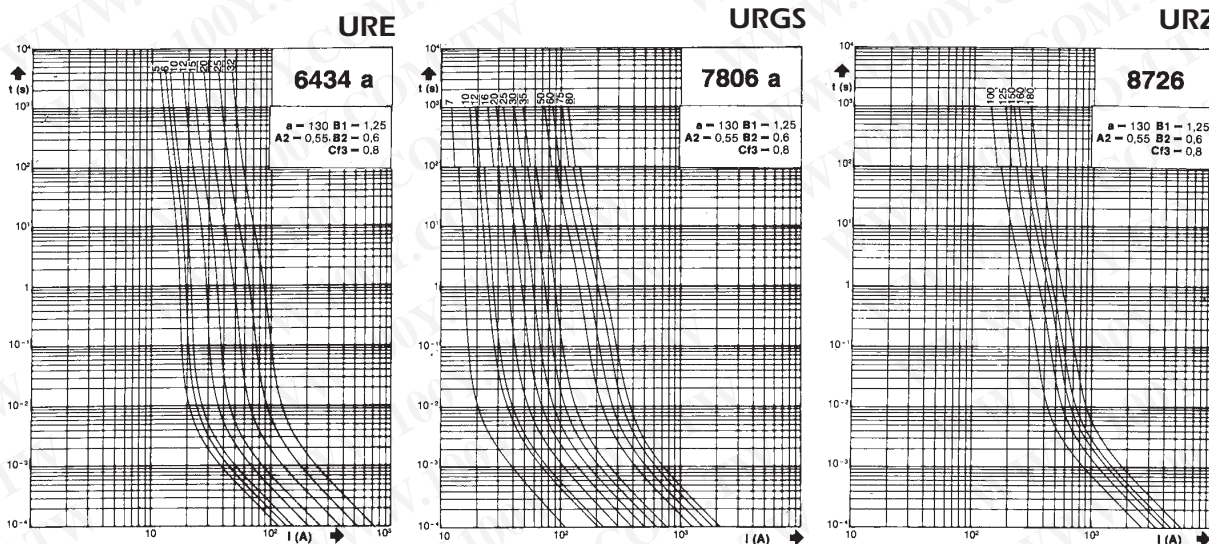

* These curves indicate, for each rated current, the pearcing time vs. the R.M.S. pre-arcing current.

* Tolerance for the mean pre-arcing current $\pm 10\%$

Corrective factor - Peak arc voltage

Corrective factor

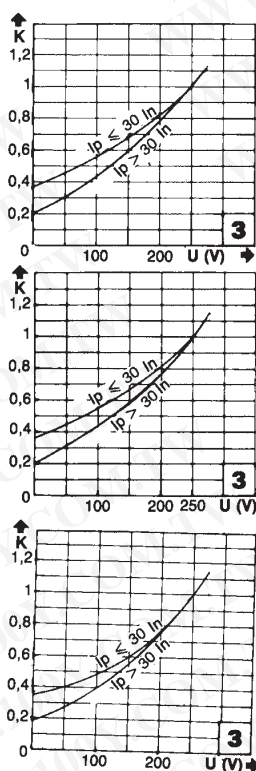

URE

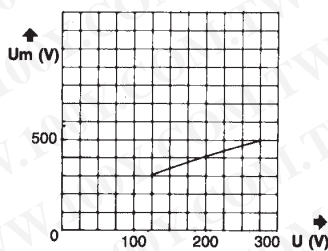

Peak arc voltage

URGS

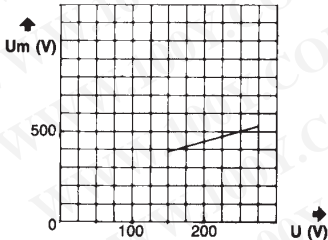

URZ

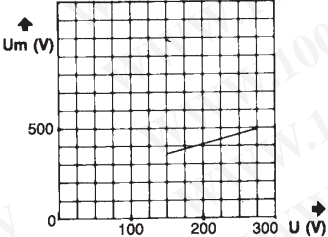

* The mean curves show the variation of the total clearing time (I^2t_f) and the total clearing duration t_f as a function of operating voltage U

This curve show the peak value U_m of the arc voltage which appears across the fuse link as a function of the operating voltage U @ $\cos \varphi = 0.15$.



Other Protistor® Fuses BS88-4 Fuses 10x28, 17x27 - 250 VAC

D.C Applications data

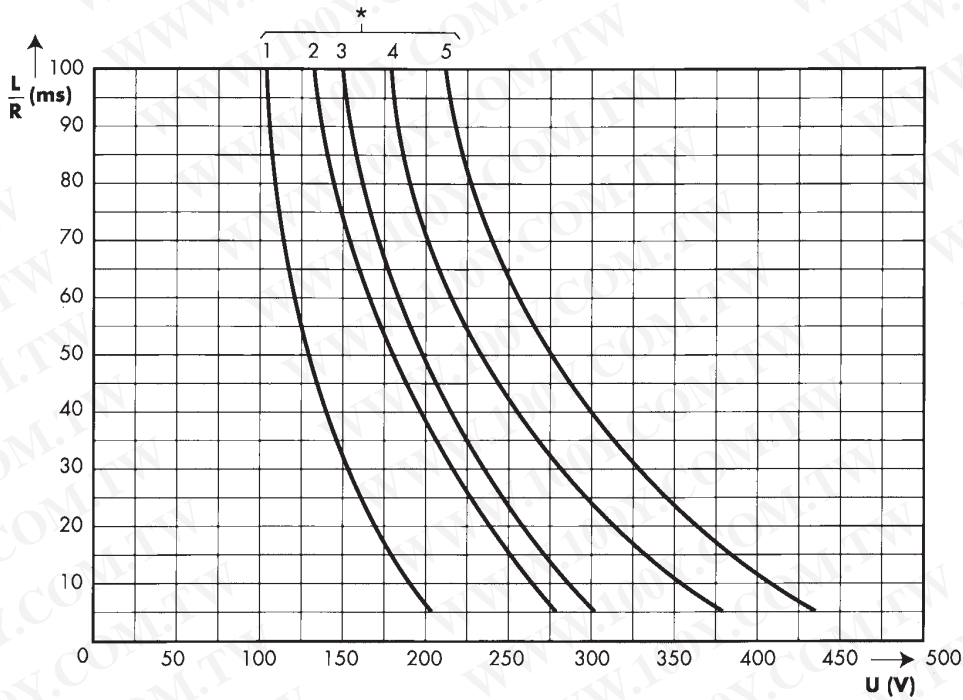

These curves indicate the permissible value of time constant L/R as a function of the D.C. working voltage.

These I_{pm} values give the minimum DC interrupting current in amps.

Curves # and I_{pm} for each rating			
Class	Rated current	*	$I_{pm}(A)$
URE	5	5	40
	6	5	50
	10	5	55
	12	5	80
	15	5	100
	20	5	130
	25	5	175
URGS	32	5	255
	7	5	40
URZ	100	4	190
	125	3	250
	150	2	300
	160	2	330
	180	1	400

for URGS class fuses, consult us.

Semiconductor (AC) fuses

Other Protistor® Fuses BS88-4 Fuses 36x27, 2X36x27, - 250 VAC



Extremely high breaking capacity fuses:
protection of power semiconductors as per IEC standard 60269.1 and 4

250 V voltage rating COMPLYING WITH IEC 33

gr class (ratings from 50 to 350 a URGG - 300 to 700 A URGH) AS PER VDE 636-23 AND IEC 60269.4

aR CLASS (RATINGS FROM 400 to 525 A URGG - 800 to 1050 A URGH) COMPLYING WITH VDE 636-23 AND IEC 60269.4

TWO MODELS COMPLYING WITH BS 88-4

- WITHOUT INDICATOR
- WITH SEPARATE TRIP-INDICATOR

Main Characteristics

Voltage rating U_N (V)	Size	Class	Current rating I_N (A)	Pre-arcing $I^2t @ 1 \text{ ms}$ I^2tp (A ² s)	Total clearing $I^2t @ U_N$ A ² s	Watts loss		Tested Breaking capacity
						0.8 I_N	I_N	
250V	36x27	URGG	50	120	500	4.75	9.5	100k A @ 250 V
			75	330	1380	6.3	12.6	
			100	745	3060	7.8	15.7	
			125	1340	5500	9.1	18.2	
			150	1930	7950	10.8	21.6	
			200	4020	16400	13.5	27.0	
			250	5350	30000	16.3	32.6	
			300	7290	49600	18.6	37.2	
			350	18000	74000	21	42.0	
			400	25100	128000	23.4	46.7	
	450	33500	170000	27.1	54.1			
	500	43000	219000	30.4	60.8			
	525	48200	245000	33.2	66.4			
	2x36x27	URGH	300	7700	31800	21.6	43.2	100k A @ 250 V
			350	11500	48700	24.3	48.6	
			400	16000	65600	27	54.0	
			500	29100	120000	32.6	65.2	
			600	48200	198500	37.2	74.4	
			700	72000	276000	42.0	84.0	
800			100000	512000	46.7	93.4		
900			134000	680000	54.1	108.2		
1000			172000	876000	60.8	121.6		
1050			193000	980000	66.4	132.8		

Minimum operating voltage for separate or integrated trip indicator = 20 V

Semiconductor (AC) fuses



Other Protistor® Fuses

BS88-4 Fuses

36x27, 2X36x27, - 250 VAC

CP 36x27 Without trip-indicator

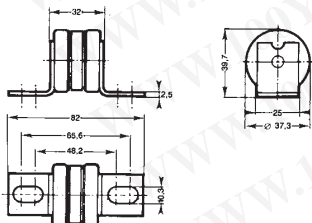

Size	Designation	Ref. Number	Pack.	Catalog Number
36x27	2.5 URGG 36/50	J080945		BS36UG25V50
	2.5 URGG 36/75	K080946		
	2.5 URGG 36/100	L080947		BS36UG25V100
	2.5 URGG 36/125	R082470		BS36UG25V125
	2.5 URGG 36/150	Q082469		BS36UG25V150
	2.5 URGG 36/200	P082468	3	BS36UG25V200
	2.5 URGG 36/250	N082467	(170g)	BS36UG25V250
	2.5 URGG 36/300	M082466		BS36UG25V300
	2.5 URGG 36/350	L082465		BS36UG25V350
	2.5 URGG 36/400	G075538		BS36UG25V400
	2.5 URGG 36/450	H075539		BS36UG25V450
	2.5 URGG 36/500	J075540		BS36UG25V500
	2.5 URGG 36/525	K075541		BS36UG25V525

CP 36x27 With built-in trip-indicator

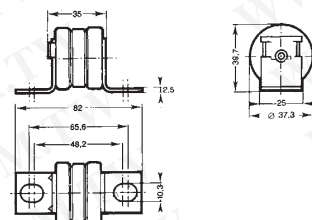

Size	Designation	Ref. Number	Pack.	Catalog Number
36x27	2.5 URGG 36T50	F080942		BS36UG25V50T
	2.5 URGG 36T75	G080943		BS36UG25V75T
	2.5 URGG 36T100	H080944		BS36UG25V100T
	2.5 URGG 36T125	W082382		BS36UG25V125T
	2.5 URGG 36T150	V082381		BS36UG25V150T
	2.5 URGG 36T200	T082380	3	BS36UG25V200T
	2.5 URGG 36T250	S082379	(170g)	BS36UG25V250T
	2.5 URGG 36T300	R082378		BS36UG25V300T
	2.5 URGG 36T350	Q082377		BS36UG25V350T
	2.5 URGG 36T400	L075542		BS36UG25V400T
	2.5 URGG 36T450	M075543		BS36UG25V450T
	2.5 URGG 36T500	N075544		BS36UG25V500T
	2.5 URGG 36T525	P075545		BS36UG25V525T

Microswitch MC 36 GR 2.5 - Ref. P 092496

CP 36x27 With separated trip-indicator BS88

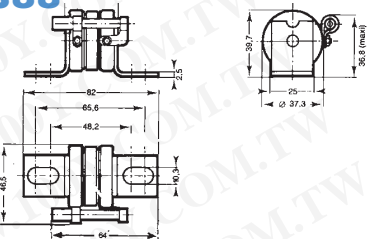

Size	Designation	Ref. Number	Pack.	Catalog Number
36x27	2.5 URGG 36P50	C080939		BS36UG25V50P
	2.5 URGG 36P75	D080940		BS36UG25V75P
	2.5 URGG 36P100	E080941		BS36UG25V100P
	2.5 URGG 36P125	Y081004		BS36UG25V125P
	2.5 URGG 36P150	X081003		BS36UG25V150P
	2.5 URGG 36P200	W081002	3	BS36UG25V200P
	2.5 URGG 36P250	V081001	(185g)	BS36UG25V250P
	2.5 URGG 36P300	T081000		BS36UG25V300P
	2.5 URGG 36P350	S080999		BS36UG25V350P
	2.5 URGG 36P400	V075504		BS36UG25V400P
	2.5 URGG 36P450	W075505		BS36UG25V450P
	2.5 URGG 36P500	X075506		BS36UG25V500P
	2.5 URGG 36P525	Y075507		BS36UG25V525P

Microswitch MC 36 GR 2.5 N - Ref. Y 310005

CP 2x36x27 Without trip-indicator

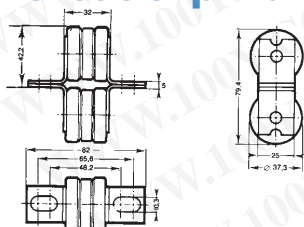

Size	Designation	Ref. Number	Pack.	Catalog Number
2x36x27	2.5 URGH 236/300	K082464		BS236UH25V300
	2.5 URGH 236/350	J082463		BS236UH25V350
	2.5 URGH 236/400	H082462		BS236UH25V400
	2.5 URGH 236/500	G082461		BS236UH25V500
	2.5 URGH 236/600	F082460		BS236UH25V600
	2.5 URGH 236/700	E082459	3	BS236UH25V700
	2.5 URGH 236/800	Q075546	(290g)	BS236UH25V800
	2.5 URGH 236/900	R075547		BS236UH25V900
	2.5 URGH 236/1000	S075548		BS236UH25V1000
	2.5 URGH 236/1050	T075549		BS236UH25V1050

CP 2x36x27 With built-in trip-indicator

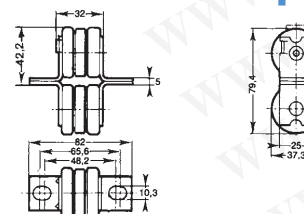

Size	Designation	Ref. Number	Pack.	Catalog Number
2x36x27	2.5 URGH 236T300	P082376		BS236UH25V300T
	2.5 URGH 236T350	N082375		BS236UH25V350T
	2.5 URGH 236T400	M082374		BS236UH25V400T
	2.5 URGH 236T500	L082373		BS236UH25V500T
	2.5 URGH 236T600	K082372		BS236UH25V600T
	2.5 URGH 236T700	J082371	3	BS236UH25V700T
	2.5 URGH 236T800	V075550	(290g)	BS236UH25V800T
	2.5 URGH 236T900	R075501		BS236UH25V900T
	2.5 URGH 236T1000	S075502		BS236UH25V1000T
	2.5 URGH 236T1050	T075503		BS236UH25V1050T

Microswitch MC 36 GR 2.5 N - Ref. P 092496

Semiconductor (AC) fuses

Other Protistor® Fuses BS88-4 Fuses 36x27, 2X36x27, - 250 VAC

CP 36x27 With separated trip-indicator BS88

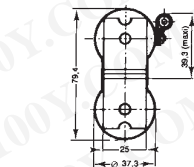
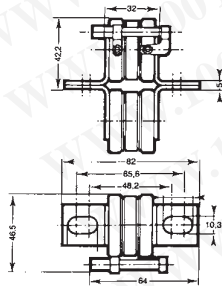

Microswitch MC 6.3 GR 2.5 N - Ref. Y 310005

Size	Designation	Ref. Number	Pack.	Catalog Number
2x36x27	2.5 URGH 236P300	R080998	3 (900g)	BS236UH25V300P
	2.5 URGH 236P350	O080997		BS236UH25V350P
	2.5 URGH 236P400	P080996		BS236UH25V400P
	2.5 URGH 236P500	N080995		BS236UH25V500P
	2.5 URGH 236P600	M080994		BS236UH25V600P
	2.5 URGH 236P700	L080993		BS236UH25V700P
	2.5 URGH 236P800	Z075508		BS236UH25V800P
	2.5 URGH 236P900	A075509		BS236UH25V900P
	2.5 URGH 236P1000	B075510		BS236UH25V1000P
	2.5 URGH 236P1050	C075511		BS236UH25V1050P

Electrical characteristics

Times vs current characteristics

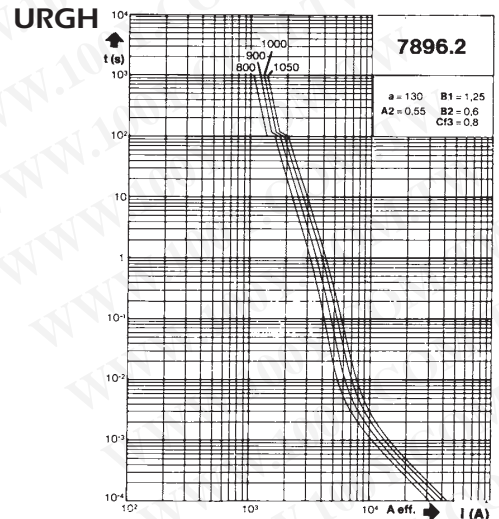
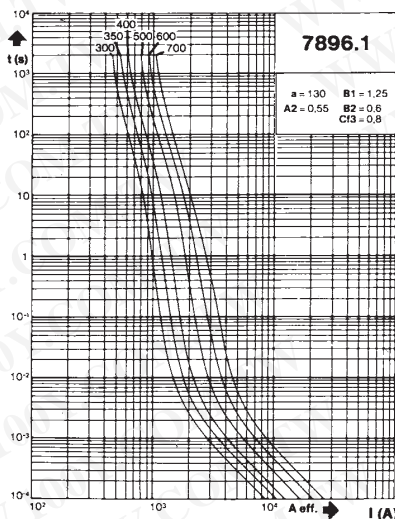
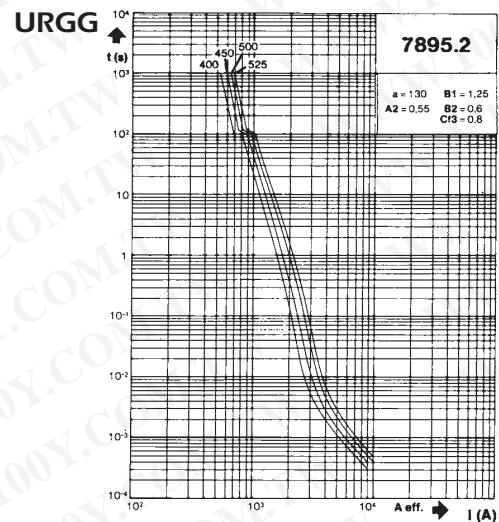
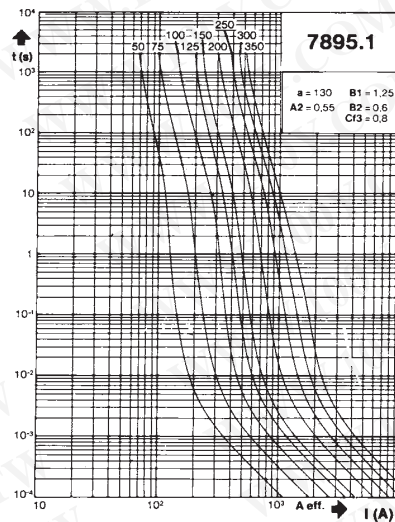

- These curves indicate, for each rated current, the pre-arcing time vs. the R/M.S. pre-arcing current.
- Tolerance for the mean pre-arcing current $\pm 10\%$

Semiconductor (AC) fuses



Other Protistor® Fuses BS88-4 Fuses 36x27, 2X36x27, - 250 VAC

Corrective factor - Peak arc voltage

Corrective factor

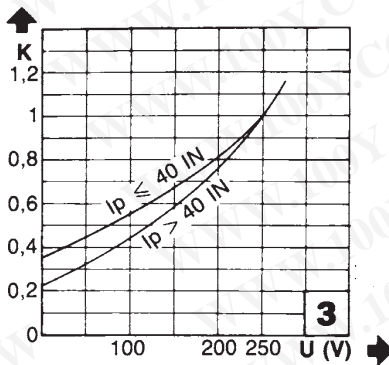

URGG
From 50 to 350 A

URGH
From 300 to 700 A

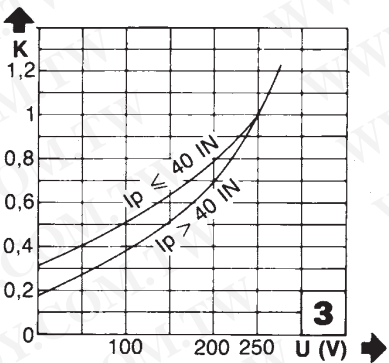

URGG
From 400 to 525 A

URGH
From 800 to 1050 A

Peak arc voltage

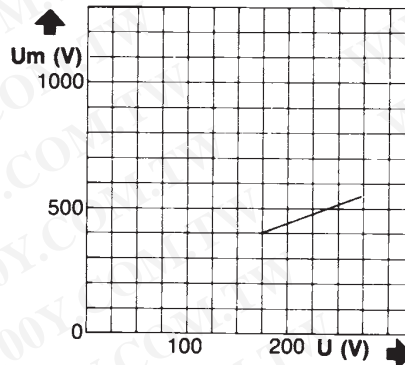
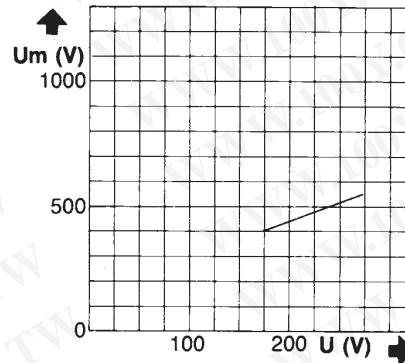

Corrective factor

* The mean curves show the variation of the total clearing time (I^2t_t) and the total clearing duration t_t as a function of operating voltage U

Peak arc voltage

This curve shows the peak value U_m of the arc voltage which appears across the fuse link as a function of the operating voltage U @ $\cos \varphi = 0.15$.

Semiconductor (AC) fuses

Other Protistor® Fuses

BS88-4 Fuses

10x51, 17x49, 2X17x49, - 690 VAC



EXTREMELY HIGH BREAKING CAPACITY FUSES:
PROTECTION OF POWER SEMICONDUCTORS AS PER
IEC STANDARD 60269.1 AND 4

690 V VOLTAGE RATING COMPLYING WITH IEC 33

GR CLASS (RATINGS FROM 5 TO 160 A)
AS PER VDE 636-23 AND IEC 60269.4

TWO MODELS COMPLYING WITH BS 88-4

- WITHOUT INDICATOR
- WITH SEPARATE TRIP-INDICATOR
(SIZES 17x49 AND 2x17x49)

17x49 URS fuses are UL Recognized 

Main Characteristics

Voltage rating U_N (V)	Size	Class	Current rating I_N (A)	Pre-arcing $I^2t @ 1 \text{ ms}$ I^2_{tp} (A ² s)	Total clearing $I^2t @ 660 \text{ V}$ A ² s		Watts loss		Tested Breaking capacity
					$I_p \leq 30I_N$	$I_p > 30I_N$	$0.8 I_N$	I_N	
690V	10 x51	URE	5	1.3	10	15	1.05	2	200k A @ 690 V
			6	1.3	13.5	20.5	1.3	2.5	
			10	3.3	25	35	2.2	4.1	
			12	5.5	40	58	2.3	4.3	
			15	9.7	70	100	2.4	4.4	
			20	19.4	120	200	3.1	5.8	
	17x49	URS	16	9.7	75	107	2.7	4.8	200k A @ 690 V
			20	17.3	130	185	2.9	5.3	
			25	27	200	285	3.7	6.7	
			32	53	400	570	4.7	8.6	
			35	70	510	725	5.2	9.6	
			40	98	760	1080	5.7	10.5	
			45	130	900	1280	6.2	11.4	
			50	156	1000	1420	6.8	12.6	
			55	210	1380	1970	7.2	13.3	
			63	315	2000	2850	7.5	13.9	
			75	525	3350	4630	7.8	14.4	
			80	625	3900	5700	8.5	15.8	
	2x17x49	URT	65	210	1590	2270	9.5	17.4	200k A @ 690 V
			75	310	2300	3280	10.9	20	
			85	430	3050	4350	11.9	21.9	
			90	252	3600	5130	12.4	22.8	
			110	850	5500	7840	13.8	26.5	
			145	1730	11000	15700	15.5	28.5	
150			2090	13400	18500	15.6	28.7		
160			2500	15600	22800	16.9	31.5		

Minimum operating voltage for separate trip indicator = 20 V

勝特力材料 886-3-5753170
 勝特力电子(上海) 86-21-34970699
 勝特力电子(深圳) 86-755-83298787
[Http://www.100y.com.tw](http://www.100y.com.tw)

Semiconductor (AC) fuses



Other Protistor® Fuses

BS88-4 Fuses

10x51, 17x49, 2X17x49, - 690 VAC

CP 10x51 Without trip-indicator

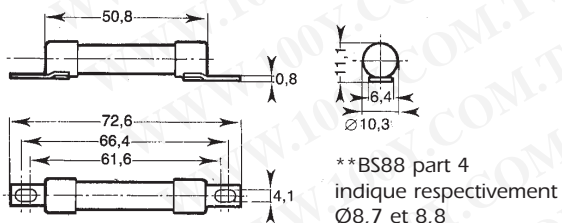

Size	Designation	Ref. Number	Pack.	Catalog Number
10x51	6,9 URE 10/5	D082458		BS10UE69V5
	6,9 URE 10/6	X097057		BS10UE69V6
	6,9 URE 10/10	C082457	10	BS10UE69V10
	6,9 URE 10/12	Z097059	(13g)	BS10UE69V12
	6,9 URE 10/15	B082456		BS10UE69V15
	6,9 URE 10/20	A082455		BS10UE69V20

CP 17x49 Without trip-indicator

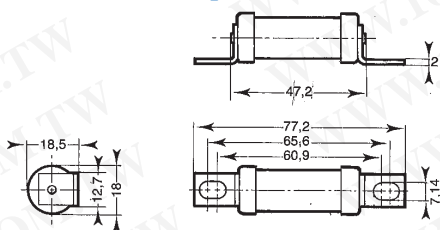

Size	Designation	Ref. Number	Pack.	Catalog Number
17x49	6,9 URS 17/16	G075883		BS17US69V16
	6,9 URS 17/20	H075884		BS17US69V20
	6,9 URS 17/25	J075885		BS17US69V25
	6,9 URS 17/32	K075886		BS17US69V32
	6,9 URS 17/35	L075887		BS17US69V35
	6,9 URS 17/40	M075888	10	BS17US69V40
	6,9 URS 17/45	N075889	(51g)	BS17US69V45
	6,9 URS 17/50	P075890		BS17US69V50
	6,9 URS 17/55	Q075891		BS17US69V55
	6,9 URS 17/63	R075892		BS17US69V63
	6,9 URS 17/75	S075893		BS17US69V75
	6,9 URS 17/80	T075894		BS17US69V80

CP 17x49 With separated trip-indicator BS88

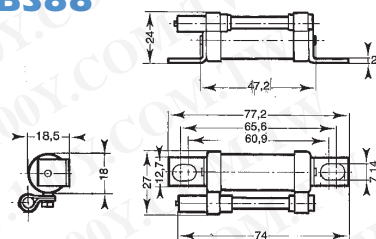

Size	Designation	Ref. Number	Pack.	Catalog Number
17x49	6,6 URS 17P16	V075895		BS17US69V16P
	6,9 URS 17P20	W075896		BS17US69V20P
	6,9 URS 17P25	X075897		BS17US69V25P
	6,9 URS 17P32	Y075898		BS17US69V32P
	6,9 URS 17P35	Z075899		BS17US69V35P
	6,9 URS 17P40	A075900	10	BS17US69V40P
	6,9 URS 17P45	B075901	(61g)	BS17US69V45P
	6,9 URS 17P50	K081084		BS17US69V50P
	6,9 URS 17P55	C075902		BS17US69V55P
	6,9 URS 17P63	D075903		BS17US69V63P
	6,9 URS 17P75	E075904		BS17US69V75P
	6,9 URS 17P80	F075905		BS17US69V80P

CP 2x17x49 Without trip-indicator

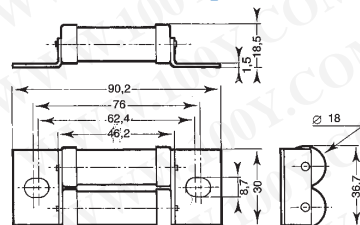

Size	Designation	Ref. Number	Pack.	Catalog Number
2x17x49	6,6 URT 217/65	G075906		BS217UT69V65
	6,9 URT 217/75	F099572		BS217UT69V75
	6,9 URT 217/85	H075907		BS217UT69V85
	6,9 URT 217/90	A099958		BS217UT69V90
	6,9 URT 217/110	B099959	5	BS217UT69V110
	6,9 URT 217/140	J075908	(82g)	BS217UT69V140
	6,9 URT 217/150	C099960		BS217UT69V150
	6,9 URT 217/160	K075909		BS217UT69V160

CP 2x17x49 With separated trip-indicator

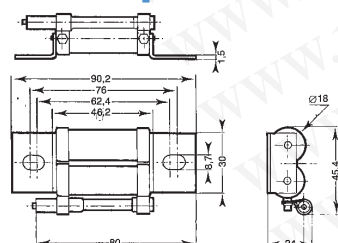

Size	Designation	Ref. Number	Pack.	Catalog Number
2x17x49	6,6 URT 217P65	L075910		BS217UT69V65P
	6,9 URT 217P75	M075911		BS217UT69V75P
	6,9 URT 217P85	N075912		BS217UT69V85P
	6,9 URT 217P90	P075913		BS217UT69V90P
	6,9 URT 217P110	Q075914		BS217UT69V110P
	6,9 URT 217P140	R075915	5	BS217UT69V140P
	6,9 URT 217P150	S075916	(95g)	BS217UT69V150P
	6,9 URT 217P160	T075917		BS217UT69V160P

Semiconductor (AC) fuses

Other Protistor® Fuses

BS88-4 Fuses

10x51, 17x49, 2X17x49, - 690 VAC

Times vs current characteristics

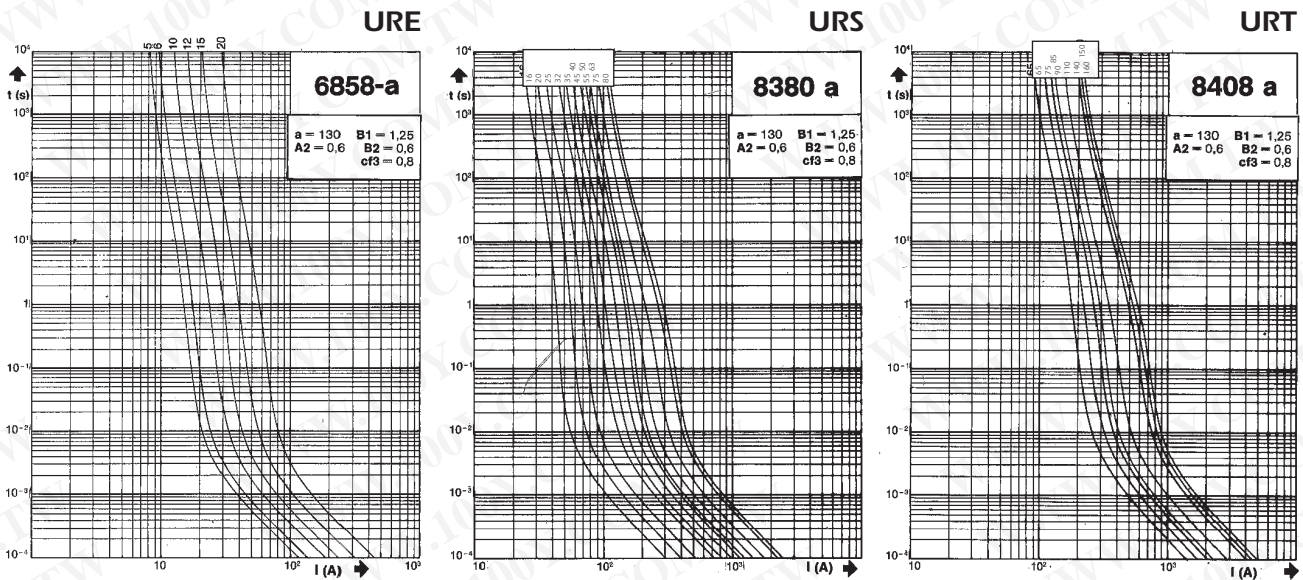

- These curves indicate, for each rated current, the pre-arcing time vs. the R/M.S. pre-arcing current.
- Tolerance for the mean pre-arcing current $\pm 10\%$

Corrective factor - Peak arc voltage

Corrective factor

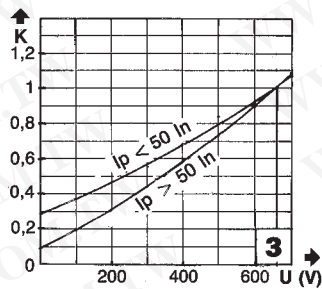

URE

URS
URT

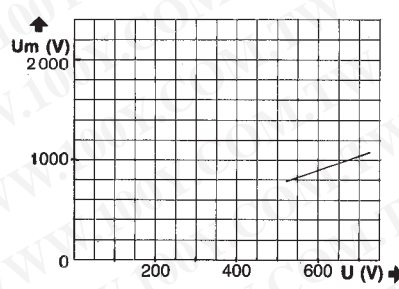
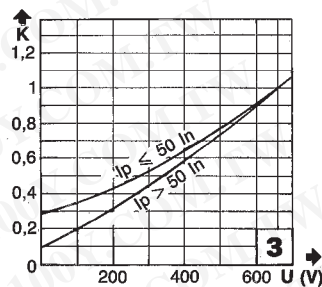

Peak arc voltage

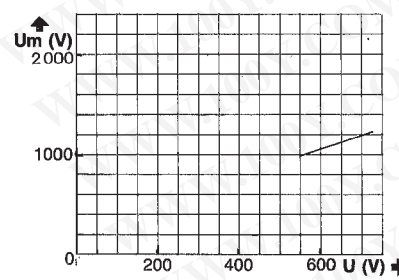

Corrective factor

* The mean curves show the variation of the total clearing time (I^2t_t) and the total clearing duration t_t as a function of operating voltage U

Peak arc voltage

This curve show the peak value U_m of the arc voltage which appears across the fuse link as a function of the operating voltage U @ $\cos \varphi = 0.15$.

Semiconductor (AC) fuses



Other Protistor® Fuses

BS88-4 Fuses

10x51, 17x49, 2X17x49, - 690 VAC

D.C Applications data

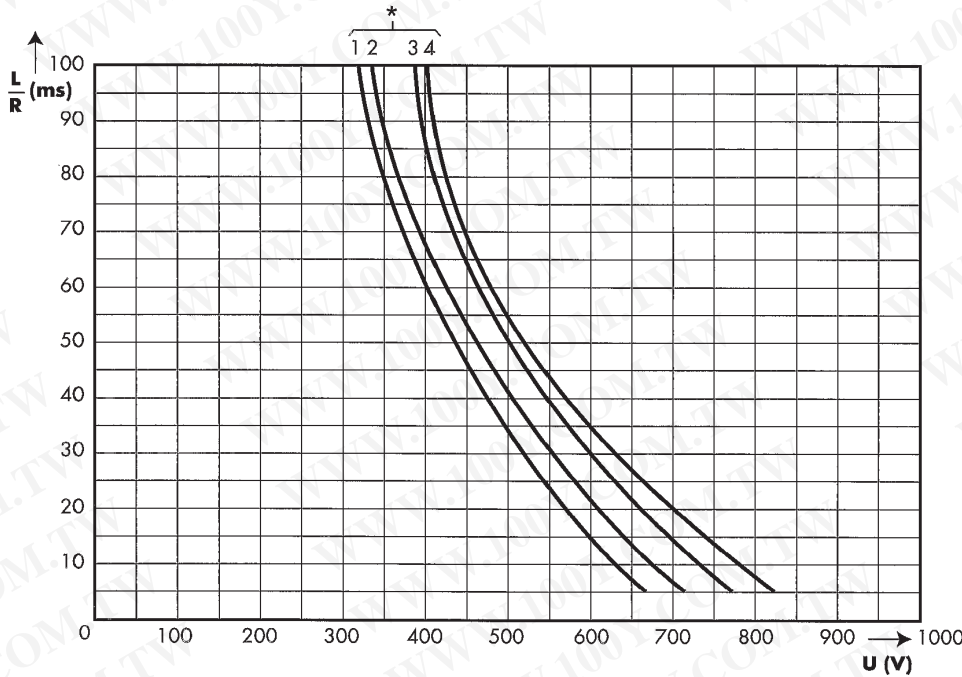

▪ These curve indicate the permissible value of time constant L/R as a function of the D.C. working voltage.

▪ These I_{pm} values give the minimum DC interrupting current in amps.

Curves and I_{pm} for each rating			
Class	Rated current	*	$I_{pm}(A)$
URE	5	4	40
	6	4	48
	10	4	60
	12	4	84
	15	4	112
	20	4	140
URS	16	3	96
	20	3	140
	25	3	175
	32	3	255
	35	3	300
	40	3	320
	45	3	335
	50	3	350
	55	3	365
	63	3	390
75	2	425	
URT	80	1	440
	65	3	510
	75	3	550
	85	3	590
	90	3	610
	110	3	685
	140	3	800
150	2	840	
	160	1	880

Other Protistor® Fuses BS88-4 Fuses 000 BS88 - 500 V to 690 VAC



EXTREMELY HIGH BREAKING CAPACITY FUSES: PROTECTION OF POWER SEMICONDUCTORS AS PER IEC STANDARD 60269.1 AND 4, AND EN 60269-1 AND 4

500- 690 V VOLTAGE RATING (RATING 20 TO 400 A)

gR CLASS (gRB RATINGS 20 TO 125 A) ACCORDING TO VDE 636-23

- CLEARING ALL OVERLOADS
- IMPROVED SAFETY AND PROTECTION
- ENABLING SELECTIVE COORDINATION WITH ALL FUSES

aR CLASS (URB RATINGS 75 TO 400 A) ACCORDING TO VDE 636-23 AND IEC 269.4

TWO MODELS ACCORDING TO BS 88-4 AND EN 60 269 .4 STANDARDS; Z3 DRAWING (74 mm BETWEEN AXES) WITHOUT BLOWN FUSE INDICATION - WITH SEPARATE TRIP INDICATOR

These fuses are UL Recognized 

Main Characteristics

Voltage rating U_N (V)	Class	Current rating I_N (A)	Pre-arcing $I^2t @ 1 \text{ ms}$ I^2t_p (A ² s)	Total clearing I^2t (A ² s)	Watts loss		Tested Breaking capacity	Estimated Breaking capacity
					0.8 I_N	I_N		
690 V	gRB	20	12	80 @ 660 V	3.8	7	200k A @ 690 V	300k A @ 690 V
		25	20	150 @ 660 V	5.0	9		
		32	39	270 @ 660 V	5.5	10		
		40	70	460 @ 660 V	6.6	12		
		50	102	730 @ 660 V	7.7	14		
		63	210	1500 @ 660 V	8.8	16		
		80	475	2900 @ 660 V	9.9	18		
		100	970	6000 @ 660 V	11	20		
125	1900	11800 @ 660 V	11.6	21				
690 V	URB	75	350	2250 @ 660 V	11.2	20.5	200k A @ 690 V	300k A @ 690 V
		80	390	2500 @ 660 V	11.6	21		
		100	690	4200 @ 660 V	12.7	23		
		110	950	6800 @ 660 V	13.5	24.5		
		125	1300	8900 @ 660 V	14.3	26		
		160	2700	16000 @ 660 V	17.0	31		
		200	5250	31500 @ 660 V	19.8	36		
		250	9900	52000 @ 660 V	24.8	45		
315	15500	82000 @ 660 V	31.9	58				
500 V	URB	350	22400	110000 @ 500 V	31.9	58	120k A @ 500 V	
		400	33200	160000 @ 500 V	36.3	66		

Minimum operating voltage for separate trip indicator = 20 V

Semiconductor (AC) fuses



Other Protistor® Fuses

BS88-4 Fuses

000 BS88 - 500 V to 690 VAC

References

British standard without blown fuse indicator

Current rating	Designation	Ref. Number	Catalog Number
20	6,9 gRB 000 BS88/020	T330044	BS000GB69V20
25	6,9 gRB 000 BS88/025	V330045	BS000GB69V25
32	6,9 gRB 000 BS88/032	W330046	BS000GB69V32
40	6,9 gRB 000 BS88/040	X330047	BS000GB69V40
50	6,9 gRB 000 BS88/050	Z330049	BS000GB69V50
63	6,9 gRB 000 BS88/063	A330050	BS000GB69V63
80	6,9 gRB 000 BS88/080	N330108	BS000GB69V80
100	6,9 gRB 000 BS88/100	H330103	BS000GB69V100
125	6,9 gRB 000 BS88/125	P330109	BS000GB69V125

75	6,9 URB 000 BS88/075	B330051	BS000UB69V75
80	6,9 URB 000 BS88/080	C330052	BS000UB69V80
100	6,9 URB 000 BS88/100	D330053	BS000UB69V100
110	6,9 URB 000 BS88/110	E330100	BS000UB69V110
125	6,9 URB 000 BS88/125	E330054	BS000UB69V125
150	6,9 URB 000 BS88/150	F330101	BS000UB69V150
160	6,9 URB 000 BS88/160	F330055	BS000UB69V160
200	6,9 URB 000 BS88/200	G330056	BS000UB69V200
250	6,9 URB 000 BS88/250	H330057	BS000UB69V250
315	6,9 URB 000 BS88/315	J330058	BS000UB69V315
350	5 URB 000 BS88/350	X330116	BS000UB50V350
400	5 URB 000 BS88/400	G330194	BS000UB50V400

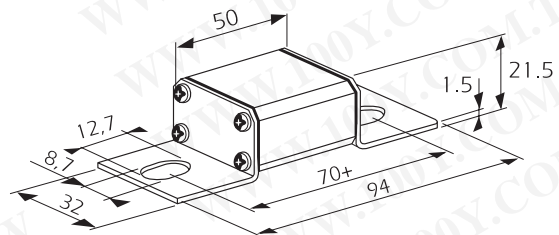

Weight: 125 g
Packaging: 3 pieces

British standard with separate blown fuse trip-indicator

Current rating	Designation	Ref. Number	Catalog Number
20	6,9 gRB 000 BS88P020	Y330117	BS000GB69V20P
25	6,9 gRB 000 BS88P025	Z330118	BS000GB69V25P
32	6,9 gRB 000 BS88P032	A330119	BS000GB69V32P
40	6,9 gRB 000 BS88P040	B330120	BS000GB69V40P
50	6,9 gRB 000 BS88P050	C330121	BS000GB69V50P
63	6,9 gRB 000 BS88P063	D330122	BS000GB69V63P
80	6,9 gRB 000 BS88P080	E330123	BS000GB69V80P
100	6,9 gRB 000 BS88P100	F330124	BS000GB69V100P
125	6,9 gRB 000 BS88P125	G330125	BS000GB69V125P

75	6,9 URB 000 BS88P075	H330126	BS000UB69V75P
80	6,9 URB 000 BS88P080	J330127	BS000UB69V80P
100	6,9 URB 000 BS88P100	K330128	BS000UB69V100P
110	6,9 URB 000 BS88P110	L330129	BS000UB69V110P
125	6,9 URB 000 BS88P125	M330130	BS000UB69V125P
150	6,9 URB 000 BS88P150	N330131	BS000UB69V150P
160	6,9 URB 000 BS88P160	P330132	BS000UB69V160P
200	6,9 URB 000 BS88P200	Q330133	BS000UB69V200P
250	6,9 URB 000 BS88P250	R330134	BS000UB69V250P
315	6,9 URB 000 BS88P315	S330135	BS000UB69V315P
350	5 URB 000 BS88P350	T330136	BS000UB50V350P
400	5 URB 000 BS88P400	H330195	BS000UB50V400P

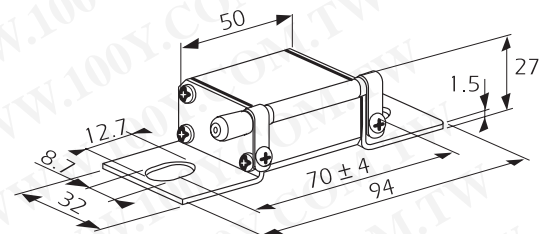

Weight: 135 g
Packaging: 3 pieces

The use of MC 6.3 GR 2-5N blown fuse remote sensing microswitch is possible.

Ref. Number : Y 310015 mounted on separate trip-indicator.

See Microswitch section

Semiconductor (AC) fuses

Other Protistor® Fuses BS88-4 Fuses 000 BS88 - 500 V to 690 VAC

Total clearing I^2t

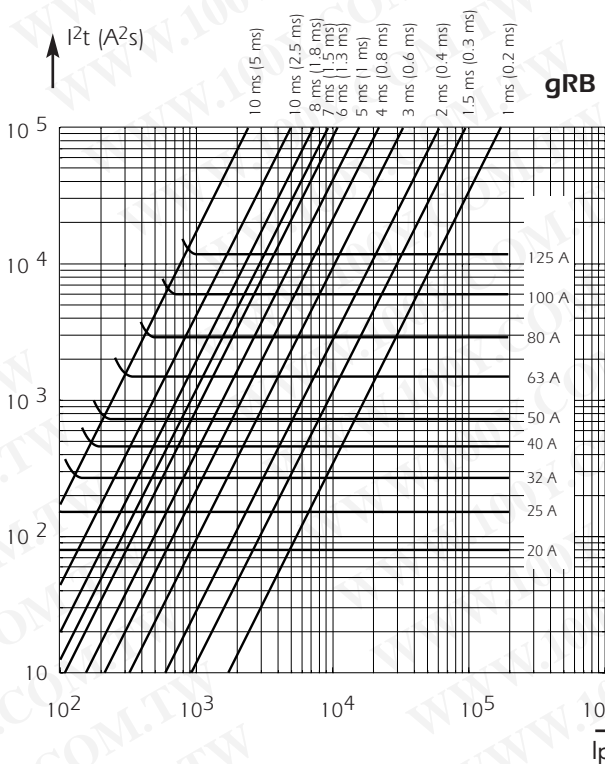

Above: Horizontal curves show, for each rated current, maximum values of total clearing I^2t (I^2t_t) as a function of prospective current I_p . @ UN with $\cos \varphi = 0.15$.
Oblique lines indicate total clearing duration T_t , with associated pre-arcing duration in brackets.

I^2t corrective factor

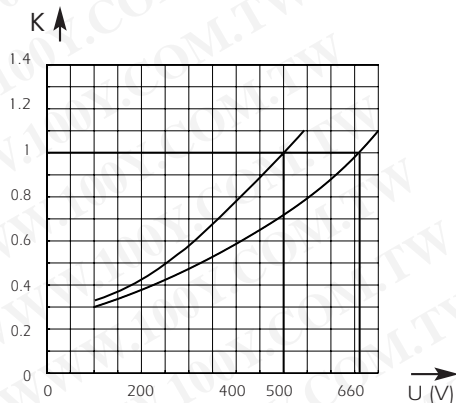

Above: Mean curves show variation of total clearing time (I^2t_t) and total clearing duration T_t as a function of operating voltage U .

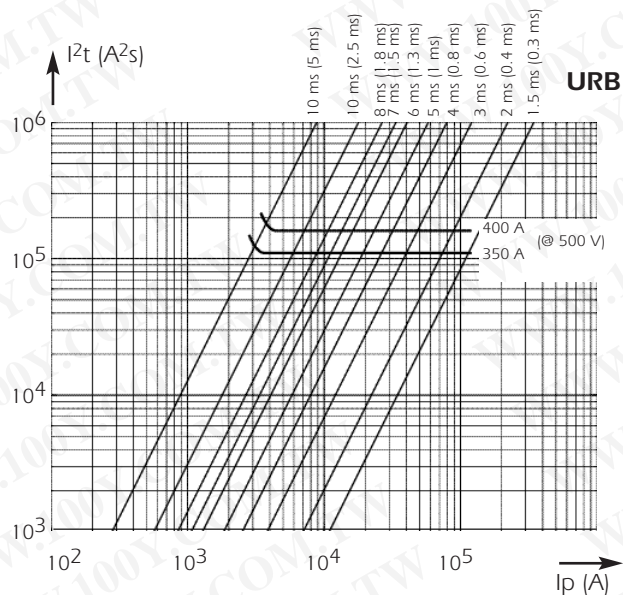
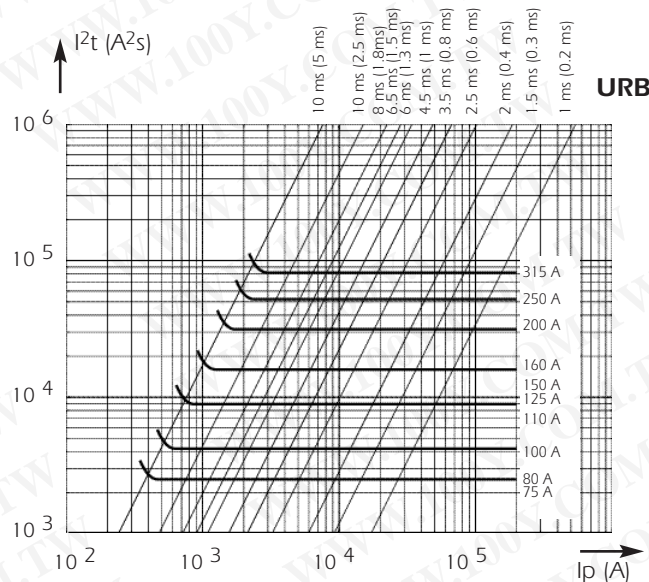

Peak arc voltage

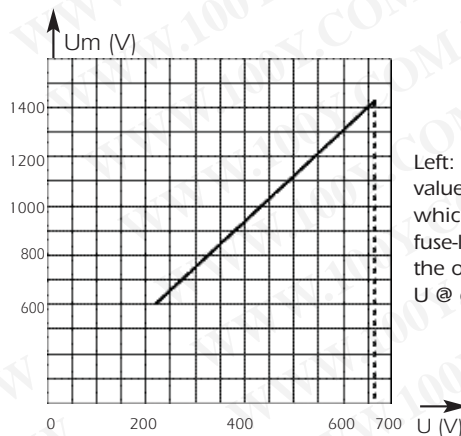

Left: Curve shows peak value U_m of arc voltage which appears across fuse-link as a function of the operating voltage U @ $\cos \varphi = 0.15$

Semiconductor (AC) fuses



Other Protistor® Fuses

BS88-4 Fuses

000 BS88 - 500 V to 690 VAC

DC Application data

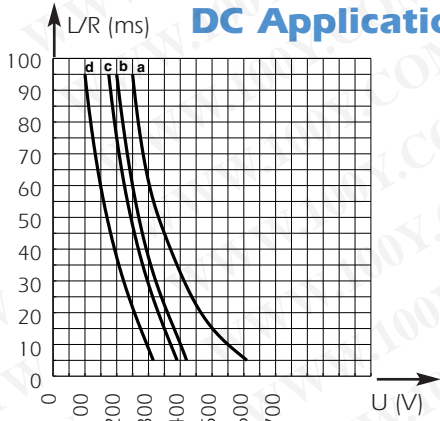

Above: curves indicate permissible value of time constant L/R as a function of DC working voltage.
 Curve a: for ratings from 20 to 160 A
 Curve b: for ratings from 180 to 200 A
 Curve c: for ratings from 250 to 315 A
 Curve d: for ratings from 350 to 400 A

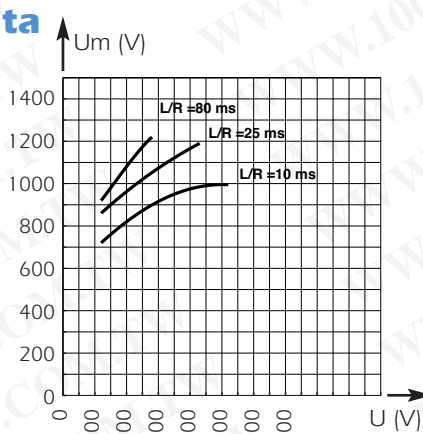

Above: Curves indicate peak arc voltage U_m which may appear across the fuse terminals at working voltage U .

Rated current	Curve	I_{pm} (A)
20	a	60
25	a	65
32	a	90
40	a	120
50	a	150
63	a	200
80	a	270
100	a	370
125	a	500
160	a	700
200	b	1200
250	c	1800
315	c	2200
350	d	2600
400	d	3100

I_{pm} values give minimum DC interrupting current in amps.

Current limitation curves

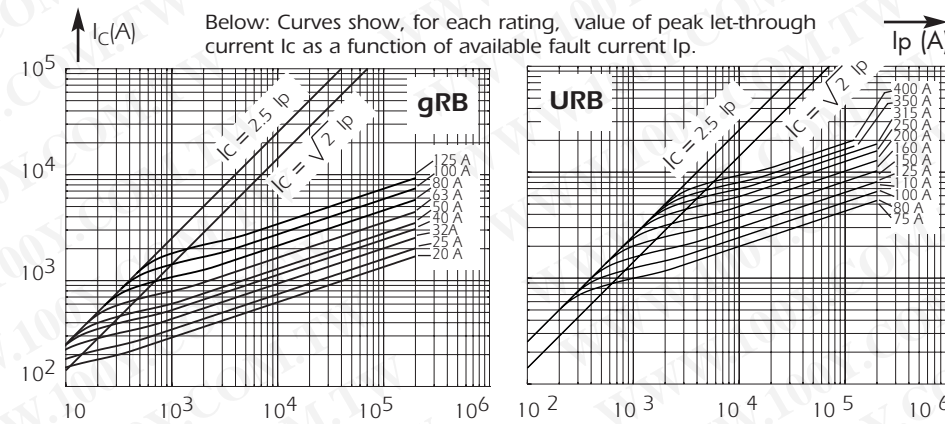

Below: Curves show, for each rating, value of peak let-through current I_c as a function of available fault current I_p .

Watts loss

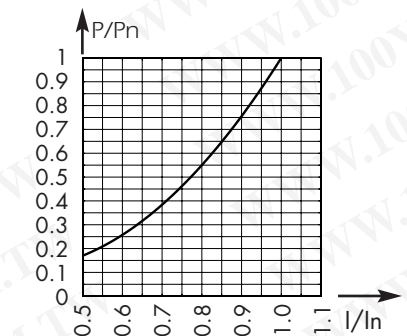

Above: Curve enables computation of power losses P for a I_N -rated fuse as a function of the R.M.S. current I (as a multiple of I_N for steady state operation)

Time vs current characteristics

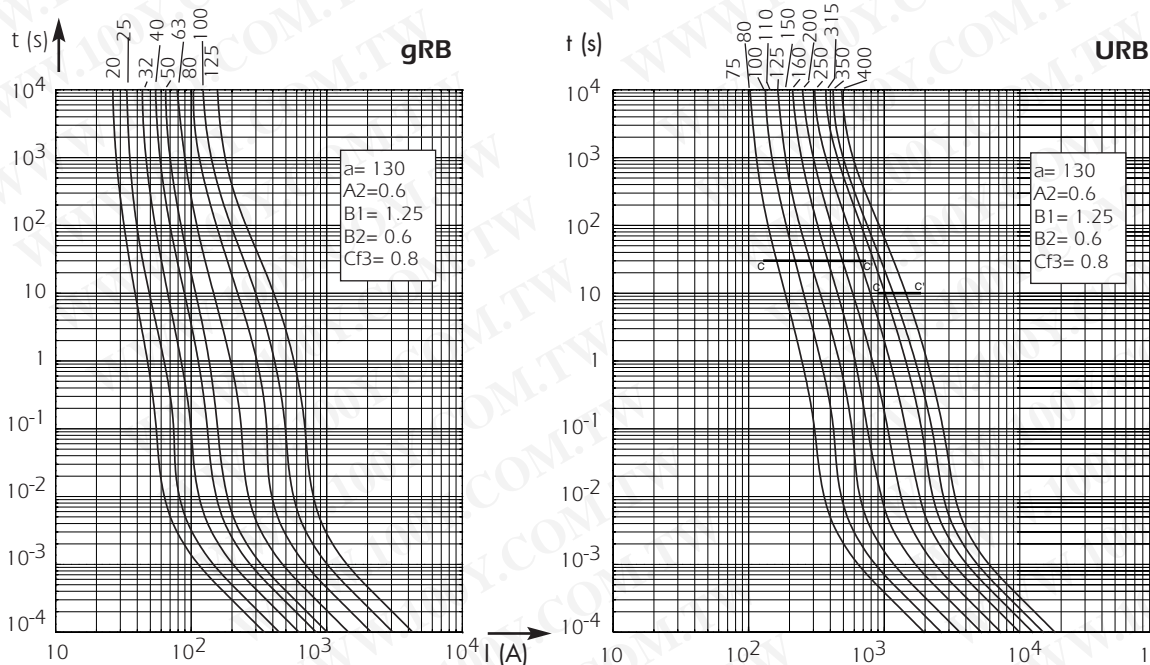

Left: Curves indicate, for each rated current, pre-arcing time vs. R.M.S. pre-arcing current

Tolerance for mean pre-arcing current $\pm 8\%$.

Semiconductor (AC) fuses

Other Protistor® Fuses

BS88-4 Fuses

000, 2.000 BS88Z - 690 VAC

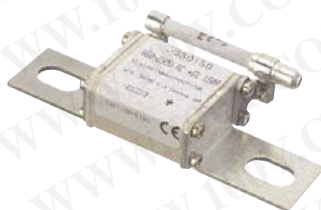

EXTREMELY HIGH BREAKING CAPACITY FUSES: PROTECTION OF POWER SEMICONDUCTORS AS PER IEC STANDARD 60269.1 AND 4 690 V VOLTAGE RATING (RATINGS 50 TO 500 A)

gR CLASS (gRB RATINGS 50 AND 65 A) COMPLYING WITH VDE 636-23

- CLEARING ALL OVERLOADS
- IMPROVED SAFETY AND PROTECTION
- ENABLING SELECTIVE COORDINATION WITH ALL FUSES

aR CLASS (URC AND URD RATINGS 75 TO 500 A) ACCORDING TO VDE 636-23 AND IEC 60269.4

FOUR MODELS: SINGLE AND TWIN BODY AS PER BS 88-4 STANDARD ; Z2 DRAWING (92 mm BETWEEN AXES) WITHOUT BLOWN FUSE INDICATOR - WITH SEPARATE TRIP-INDICATOR

These fuses are UL Recognized 

Main Characteristics

勝特力材料 886-3-5753170
 勝特力电子(上海) 86-21-34970699
 勝特力电子(深圳) 86-755-83298787
[Http://www.100y.com.tw](http://www.100y.com.tw)

Voltage rating U_N (V)	Size	Class	Current rating I_N (A)	Pre-arcing $I^2t @ 1 \text{ ms}$ I^2t_p (A ² s)	Total clearing $I^2t @ 660 \text{ V}$ I^2t_t (A ² s)	Watts loss		Tested Breaking capacity	Estimated Breaking capacity
						0.8 I_N	I_N		
690	000	gRB	50	102	730	7.7	14	200 kA @ 690 V	300 kA @ 690 V
			65	210	1500	8.8	16		
		URC	75	390	2500	9.4	17		
			85	540	3300	10.5	19		
			90	690	4200	13.2	24		
			110	1300	8900	13.8	25		
			150	2700	16000	14.3	26		
			180	5250	31500	14.9	27		
	URD	200	9900	52000	15.4	28			
		250	15500	82000	17.6	32			
	280	15500	82000	23.7	43				
	2.000	URC	175	2760	16800	18.2	33	200 kA @ 690 V	300 kA @ 690 V
			200	3800	25000	20.4	37		
			235	5200	35600	24.2	44		
			300	10800	64000	28.6	52		
			325	15400	92400	29.1	53		
355			21000	126000	29.7	54			
400			39600	208000	30.8	56			
450			40000	210000	33	60			
500	62000	328000	35.2	64					

Minimum operating voltage for separate trip-indicator: 20 V

Semiconductor (AC) fuses



Other Protistor® Fuses

BS88-4 Fuses

000, 2.000 BS88Z - 690 VAC

British standard without blown fuse indicator



Current rating	Designation	Ref. Number	Catalog Number
50	6,9 gRB 000 BS88Z/050	V330137	BZ000GB69V50
65	6,9 gRB 000 BS88Z/065	W330138	BZ000GB69V65
75	6,9 URC 000 BS88Z/075	X330139	BZ000UC69V75
85	6,9 URC 000 BS88Z/085	Y330140	BZ000UC69V85
90	6,9 URC 000 BS88Z/090	Z330141	BZ000UC69V90
110	6,9 URC 000 BS88Z/110	A330142	BZ000UC69V110
150	6,9 URC 000 BS88Z/150	B330143	BZ000UC69V150
180	6,9 URC 000 BS88Z/180	C330144	BZ000UC69V180
200	6,9 URD 000 BS88Z/200	D330145	BZ000UD69V200
250	6,9 URD 000 BS88Z/250	E330146	BZ000UD69V250
280	6,9 URC 000 BS88Z/280	F330147	BZ000UC69V280

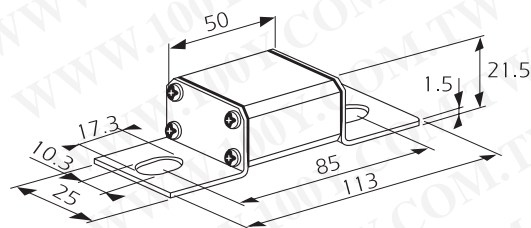

Weight: 140 g
Packaging: 3 pieces

175	6,9 URC 2000 BS88Z/175	P330155	BZ2000UC69V175
200	6,9 URC 2000 BS88Z/200	Q330156	BZ2000UC69V200
235	6,9 URC 2000 BS88Z/235	R330157	BZ2000UC69V235
300	6,9 URC 2000 BS88Z/300	S330158	BZ2000UC69V300
325	6,9 URC 2000 BS88Z/325	T330159	BZ2000UC69V325
355	6,9 URC 2000 BS88Z/355	V330160	BZ2000UC69V355
400	6,9 URD 2000 BS88Z/400	W330161	BZ2000UD69V400
450	6,9 URC 2000 BS88Z/450	X330162	BZ2000UC69V450
500	6,9 URD 2000 BS88Z/500	Y330163	BZ2000UD69V500

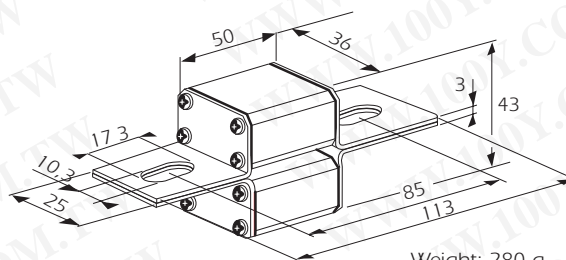

Weight: 280 g
Packaging: 3 pieces

British standard with separate trip-indicator



Current rating	Designation	Ref. Number	Catalog Number
90	6,9 URC 000 BS88ZP090	G330148	BZ000UC69V90P
110	6,9 URC 000 BS88ZP110	H330149	BZ000UC69V110P
150	6,9 URC 000 BS88ZP150	J330150	BZ000UC69V150P
180	6,9 URC 000 BS88ZP180	K330151	BZ000UC69V180P
200	6,9 URD 000 BS88ZP200	L330152	BZ000UD69V200P
250	6,9 URD 000 BS88ZP250	M330153	BZ000UD69V250P
280	6,9 URC 000 BS88ZP280	N330154	BZ000UC69V280P

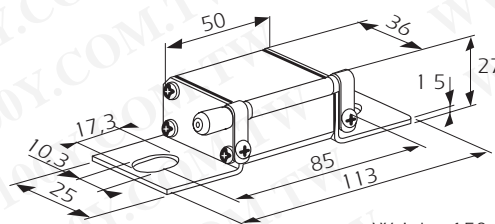

Weight: 150 g
Packaging: 3 pieces

175	6,9 URC 2000 BS88ZP175	Z330164	BZ2000UC69V175P
200	6,9 URC 2000 BS88ZP200	A330165	BZ2000UC69V200P
235	6,9 URC 2000 BS88ZP235	B330166	BZ2000UC69V235P
300	6,9 URC 2000 BS88ZP300	C330167	BZ2000UC69V300P
325	6,9 URC 2000 BS88ZP325	D330168	BZ2000UC69V325P
355	6,9 URC 2000 BS88ZP355	E330169	BZ2000UC69V355P
400	6,9 URD 2000 BS88ZP400	F330170	BZ2000UD69V400P
450	6,9 URC 2000 BS88ZP450	G330171	BZ2000UC69V450P
500	6,9 URD 2000 BS88ZP500	H330172	BZ2000UD69V500P

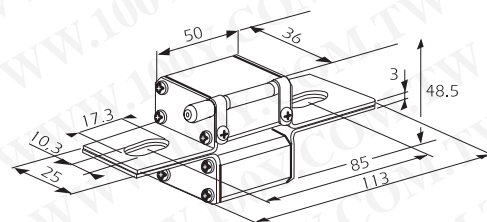

Weight: 290 g
Packaging: 3 pieces

The use of MC 6.3 GR 2-5N blown fuse remote sensing microswitch is possible.
Ref. Number: Y 310015 mounted on separate trip-indicator.

Semiconductor (AC) fuses

Other Protistor® Fuses

BS88-4 Fuses

000, 2.000 BS88Z - 690 VAC

Total clearing I^2t

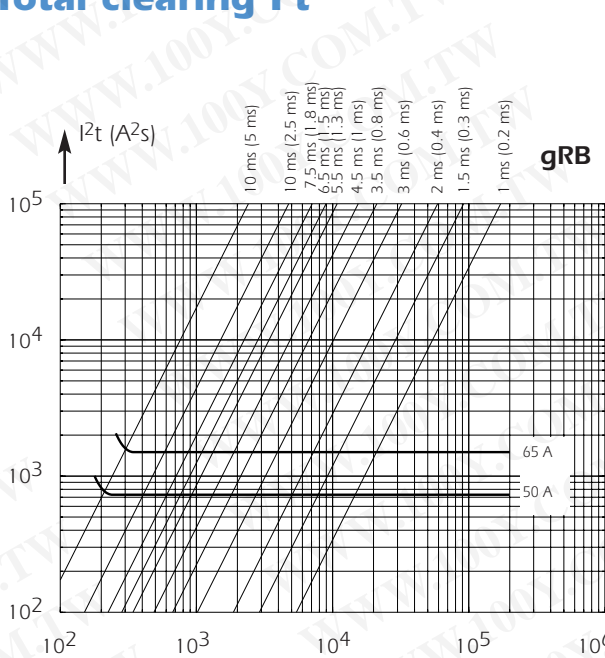

Above and right: Horizontal curves show, for each rated current, maximum values of total clearing I^2t (I^2t_t) as a function of prospective current I_p @ UN with $\cos \varphi = 0.15$. Oblique lines indicate total clearing duration T_t , with associated pre-arcing duration in brackets.

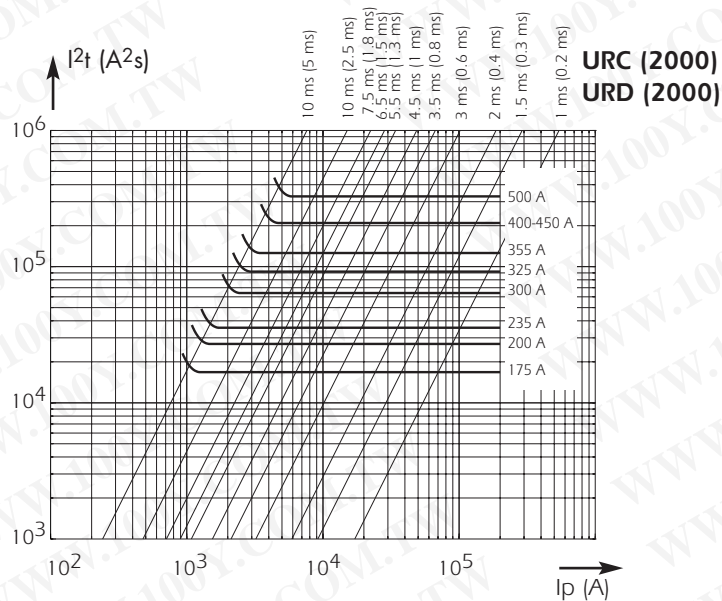
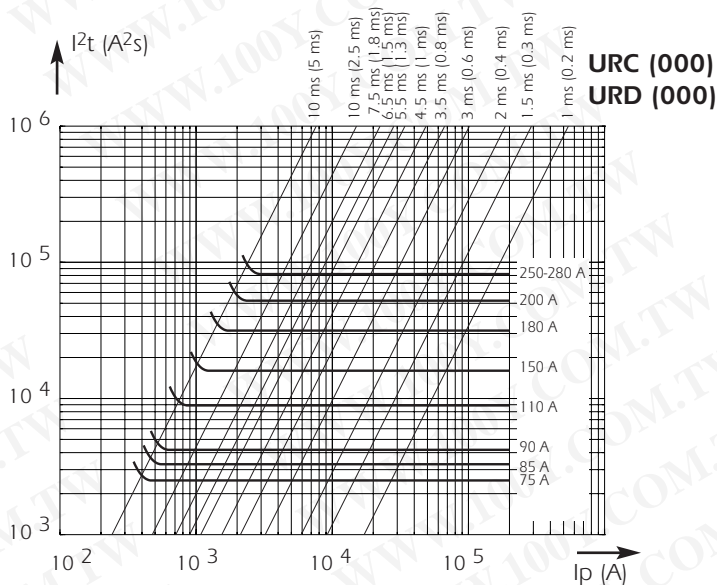

I^2t corrective factor

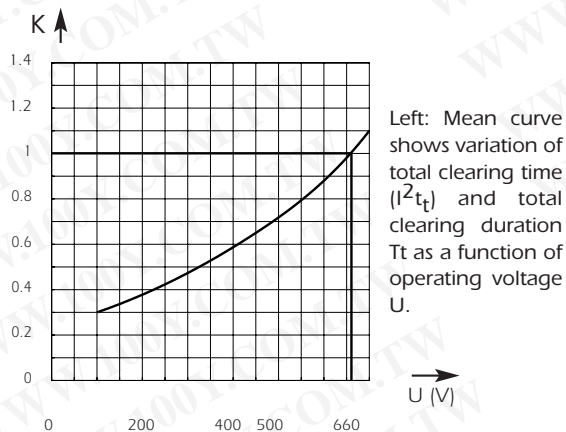

Peak arc voltage

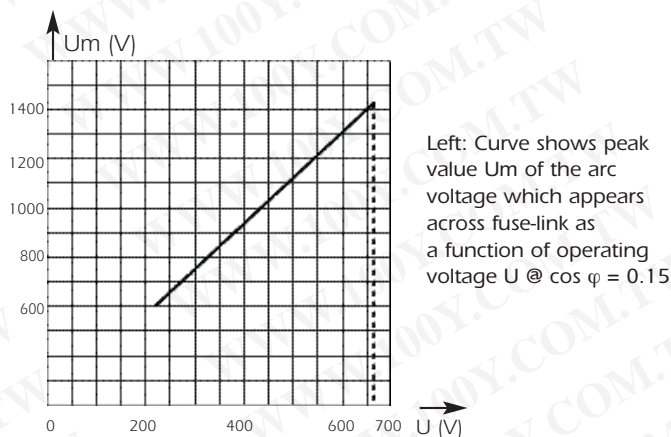

Watts loss

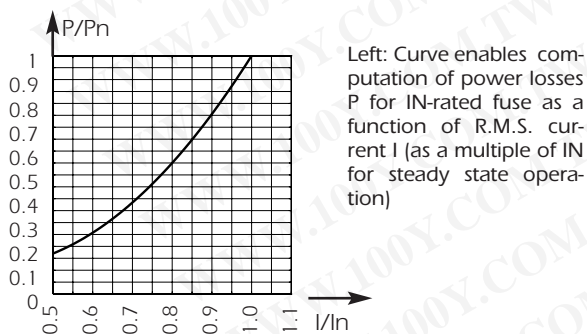

Semiconductor (AC) fuses



Other Protistor® Fuses

BS88-4 Fuses

000, 2.000 BS88Z - 690 VAC

DC Application data

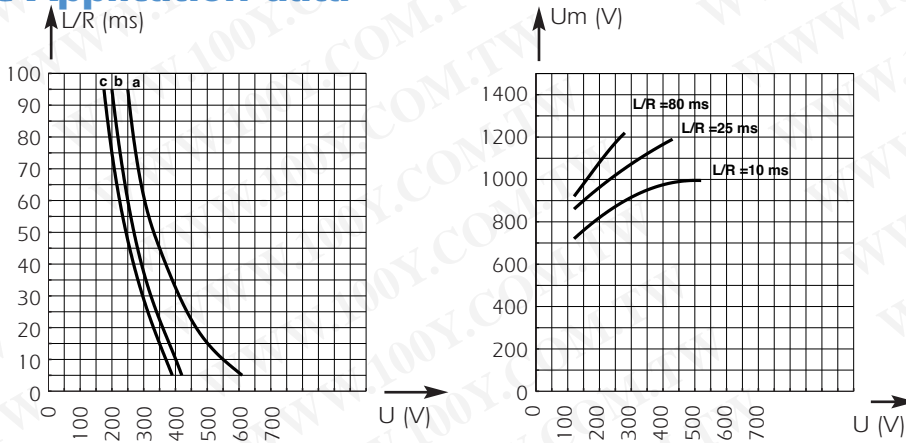

Above: Curves indicate permissible value of time constant L/R as a function of DC working voltage.
 Curve a: Ratings from 175 to 300 A
 Curve b: Rating 325 A
 Curve c: Ratings from 355 to 500 A

Above: Curves indicate peak arc voltage U_m which may appear across fuse terminals at working voltage U.

Rated current	Curve	I_{pm} (A)
50	a	150
65	a	200
75	a	270
85	a	350
90	a	370
110	a	500
150	a	700
180	b	1200
200	c	1800
250	c	2200
280	c	2200
175	a	740
200	a	870
235	a	1000
300	a	1400
325	b	1900
355	b	2400
400	c	3600
450	c	4400
500	c	4400

I_{pm} values give minimum DC interrupting current in amps.

Current limitation curves

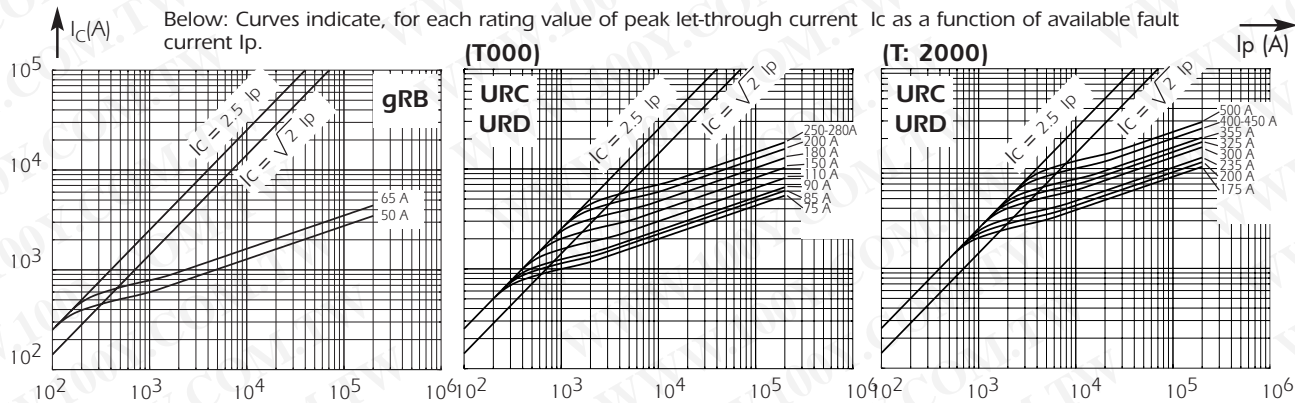

Below: Curves indicate, for each rating value of peak let-through current I_c as a function of available fault current I_p .

Time vs current characteristics

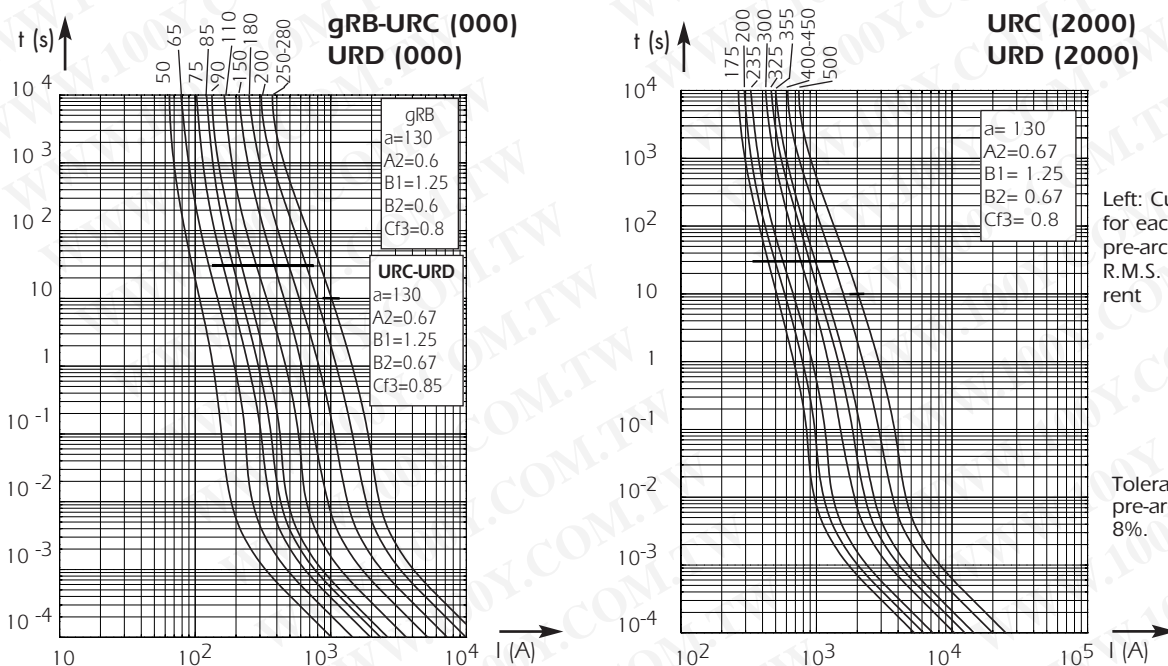

Left: Curves indicate, for each rated current, pre-arcing time vs. R.M.S. pre-arcing current

Tolerance for mean pre-arcing current $\pm 8\%$.

Semiconductor (AC) fuses

Other Protistor® Fuses BS88-4 Fuses 36x55, 2x36x55 - 690 VAC



EXTREMELY HIGH BREAKING CAPACITY FUSES:
PROTECTION OF POWER SEMICONDUCTORS AS PER IEC
STANDARD 60269.1 AND 4
690 V VOLTAGE RATING COMPLYING WITH IEC 33
AR CLASS (RATINGS FROM 75 TO 800 A) AS PER VDE 636-23
AND IEC 60269.4
THREE MODELS COMPLYING WITH BS 88-4
- WITHOUT INDICATOR
- WITH SEPARATE TRIP-INDICATOR
- WITH BUILT-IN TRIP-INDICATOR

Main Characteristics

Voltage rating U_N (V)	Size	Class	Current rating I_N (A)	Pre-arcing $I^2t @ 1 \text{ ms}$ I^2tp (A ² s)	Total clearing $I^2t @ 660 \text{ V}$ A ² s		Watts loss		Tested Breaking capacity
					$I_p \leq 50 I_N$	$I_p > 50 I_N$	$0.8 I_N$	I_N	
690V	36x55	URR	75	350	1800	2000	9.7	19.5	200k A @ 690 V
			110	1180	6000	67000	11.3	22.8	
			200	3900	18500	20500	21.8	41.4	
			250	8760	41000	46000	23.6	44.1	
		URGL	50	180	860	990	7.3	14.0	
			65	335	1600	1840	8.8	17.1	
			85	480	3450	4000	12.2	23.5	
			90	720	41000	4700	13.2	25.5	
			150	2880	12600	14500	18.9	35.3	
			180	5350	22500	25500	19.1	35.7	
	URU	200	9510	40000	46000	17.7	33.1		
		250	21400	97000	11000	18.7	34.5		
		280	29100	125000	145000	20.3	38.0		
		315	38100	157000	180000	222.77	42.6		
		355	48200	190000	215000	25.9	48.5		
		400	72000	265000	305000	26.7	50.0		
		200	4700	24000	27000	18.4	33.0		
		235	6920	34500	39000	21.0	37.6		
	2x36x55	URGM	400	21200	100000	110000	34.8	62.3	200k A @ 690 V
			500	35000	164000	184000	47.2	88.2	
			630	97300	515000	575000	41.1	73.2	
			175	2880	13800	16000	24.7	47.6	
			300	13700	660000	68000	31.5	59.0	
		325	21400	900000	102000	30.0	54.0		
355		25200	106000	120000	33.1	62.0			
450		65600	300000	340000	34.6	63.8			
500		85600	390000	440000	37.44	69.0			
630		152000	630000	720000	45.4	85.2			
710	193000	760000	860000	51.8	97.0				
800	282000	1.22 10 ⁶	1.22 10 ⁶	53.4	100.0				

Minimum operating voltage for built-in and separate trip indicator = 20 V

Semiconductor (AC) fuses



Other Protistor® Fuses

BS88-4 Fuses

36x55, 2x36x55 - 690 VAC

Ref. Numbers

CP 36x55

without trip-indicator

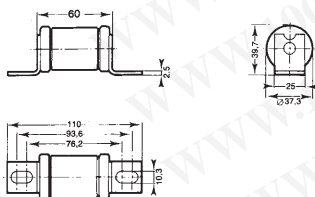

CP 36x55

with built-in trip-indicator

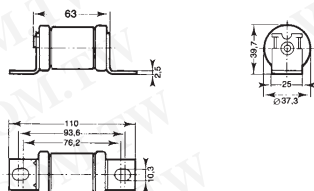

Microswitch MC 36 GR 2.5 - Ref. P 092496

CP 36x55

with separated trip-indicator

BS88-4

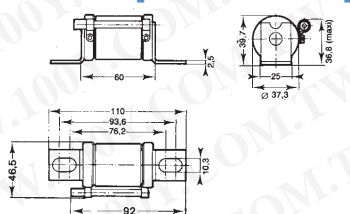

Microswitch MC 36 GR 2.5 - Ref. Y 310015

CP 2x36x55

without trip-indicator

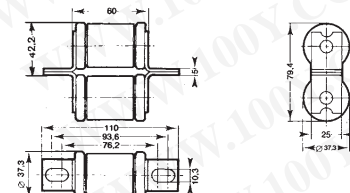

CP 2x36x55

with built-in trip-indicator

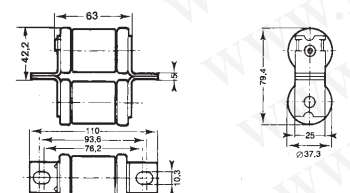

Microswitch MC 36 GR 2.5 - Ref. P 092496

Size	Designation	Ref. Number	Pack.	Catalog Number
36x55	6,9 URGL 36/50	X097103		BS36UL69V50
	6,9 URGL 36/65	H097113		BS36UL69V65
	6,9 URR 36/75	H097136		BS36UR69V75
	6,9 URGL 36/85	M097163		BS36UL69V85
	6,9 URGL 36/90	N097164		BS36UL69V90
	6,9 URR 36/110	P097165	6	BS36UR69V110
	6,9 URGL 36/150	O097166	(220g)	BS36UL69V150
	6,9 URGL 36/180	R097167		BS36UL69V180
	6,9 URR 36/200	S097168		BS36UR69V200
	6,9 URGL 36/200	T097169		BS36UL69V200
	6,9 URR 36/250	V097170		BS36UR69V250
	6,9 URGL 36/250	W097171		BS36UL69V250
	6,9 URGL 36/280	A097175		BS36UL69V280
	6,9 URGL 36/315	B097176		BS36UL69V315
6,9 URGL 36/355	C097177		BS36UL69V355	
6,9 URGL 36/400	D097178		BS36UL69V400	

Size	Designation	Ref. Number	Pack.	Catalog Number
36x55	6,6 URGL 36T50	N097210		BS36UL69V50T
	6,9 URGL 36T65	K097230		BS36UL69V65T
	6,9 URR 36T75	H099965		BS36UR69V75T
	6,9 URGL 36T85	M097255		BS36UL69V85T
	6,9 URGL 36T90	N097256		BS36UL69V90T
	6,9 URR 36T110	R099973	6	BS36UR69V110T
	6,9 URGL 36T150	Z082178	(220g)	BS36UL69V150T
	6,9 URGL 36T180	P097257		BS36UL69V180T
	6,9 URR 36T200	A085560		BS36UR69V200T
	6,9 URGL 36T200	R097259		BS36UL69V200T
	6,9 URR 36T250	W097263		BS36UR69V250T
	6,9 URGL 36T250	X097264		BS36UL69V250T
	6,9 URGL 36T280	Y097265		BS36UL69V280T
	6,9 URGL 36T315	Z097266		BS36UL69V315T
6,9 URGL 36T355	A097267		BS36UL69V355T	
6,9 URGL 36T400	C097269		BS36UL69V400T	

Size	Designation	Ref. Number	Pack.	Catalog Number
36x55	6,9 URGL 36P90	H097182		BS36UL69V90P
	6,9 URR 36P110	J097183		BS36UR69V110P
	6,9 URGL 36P150	K097184		BS36UL69V150P
	6,9 URGL 36P180	L097185		BS36UL69V180P
	6,9 URR 36P200	M097186		BS36UR69V200P
	6,9 URGL 36P200	N097187	6	BS36UL69V200P
	6,9 URR 36P250	P097188	(230g)	BS36UR69V250P
	6,9 URGL 36P250	O097189		BS36UL69V250P
	6,9 URGL 36P280	R097190		BS36UL69V280P
	6,9 URGL 36P315	V097193		BS36UL69V315P
	6,9 URGL 36P355	Y097196		BS36UL69V355P
	6,9 URGL 36P400	M097209		BS36UL69V400P

Size	Designation	Ref. Number	Pack.	Catalog Number
2x36x55	6,9 URGM 236/175	D097270		BS236UM69V175
	6,9 URU 236/200	F097272		BS236UU69V200
	6,9 URU 236/235	J097275		BS236UU69V235
	6,9 URGM 236/300	K097276		BS236UM69V300
	6,9 URGM 236/325	R097282		BS236UM69V325
	6,9 URGM 236/355	S097283	3	BS236UM69V355
	6,9 URU 236/400	T097284	(400g)	BS236UU69V400
	6,9 URGM 236/450	Y097288		BS236UM69V450
	6,9 URGM 236/500	Z097289		BS236UM69V500
	6,9 URU 236/500	A097290		BS236UU69V500
	6,9 URGM 236/630	B097291		BS236UM69V630
	6,9 URU 236/630	R097351		BS236UU69V630
	6,9 URGM 236/710	S097352		BS236UM69V710
	6,9 URGM 236/800	Y097357		BS236UM69V800

Size	Designation	Ref. Number	Pack.	Catalog Number
2x36x55	6,9 URGM 236T175	F097456		BS236UM69V175T
	6,9 URU 236T200	G097457		BS236UU69V200T
	6,9 URU 236T235	A082179		BS236UU69V235T
	6,9 URGM 236T300	S085553		BS236UM69V300T
	6,9 URGM 236T325	J097459		BS236UM69V325T
	6,9 URGM 236T355	N097463	3	BS236UM69V355T
	6,9 URU 236T400	P097464	(400g)	BS236UU69V400T
	6,9 URGM 236T450	O097465		BS236UM69V450T
	6,9 URGM 236T500	R097466		BS236UM69V500T
	6,9 URU 236T500	S097467		BS236UU69V500T
	6,9 URGM 236T630	V097469		BS236UM69V630T
	6,9 URU 236T630	W097470		BS236UU69V630T
	6,9 URGM 236T710	C097476		BS236UM69V710T
	6,9 URGM 236T800	D097477		BS236UM69V800T

Semiconductor (AC) fuses

勝特力材料 886-3-5753170
 勝特力电子(上海) 86-21-34970699
 勝特力电子(深圳) 86-755-83298787
[Http://www.100y.com.tw](http://www.100y.com.tw)

Other Protistor® Fuses

BS88-4 Fuses

36x55, 2x36x55 - 690 VAC

CP 2x36x55 with separated trip-indicator BS88-4

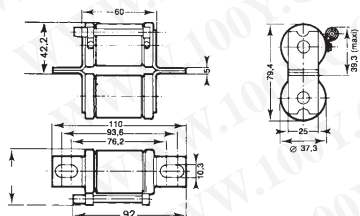

Microswitch MC 6,3 GR 2.5 - Ref. Y 310015

Size	Designation	Ref. Number	Pack.	Catalog Number
2x36x55	6,9 URGM 236P175	A097359	3 (410g)	BS236UM69V175P
	6,9 URU 236P200	E097363		BS236UU69V200P
	6,9 URU 236P235	F097364		BS236UU69V235P
	6,9 URGM 236P300	G097365		BS236UM69V300P
	6,9 URGM 236P325	Q097373		BS236UM69V325P
	6,9 URGM 236P355	R097374		BS236UM69V355P
	6,9 URU 236P400	S097375		BS236UU69V400P
	6,9 URGM 236P450	T097376		BS236UM69V450P
	6,9 URU 236P500	V097377		BS236UU69V500P
	6,9 URGM 236P500	E097386		BS236UM69V500P
6,9 URU 236P630	J097390	BS236UU69V630P		
6,9 URGM 236P630	P097395	BS236UM69V630P		
6,9 URGM 236P710	B097452	BS236UM69V710P		
6,9 URGM 236P800	E097455	BS236UM69V800P		

Electrical characteristics Times vs current characteristics

690 V URR

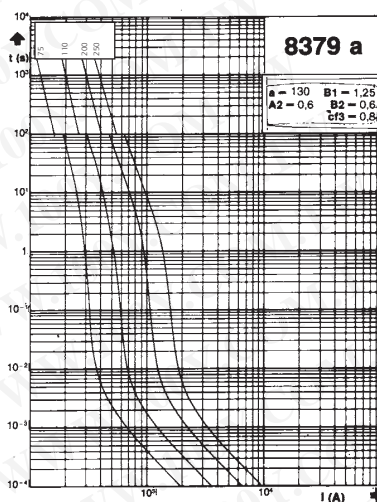

690 V URGL

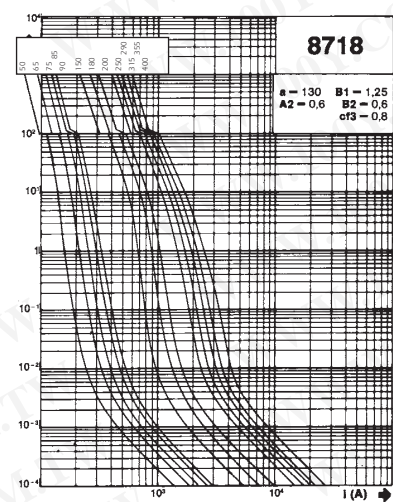

690 V URU

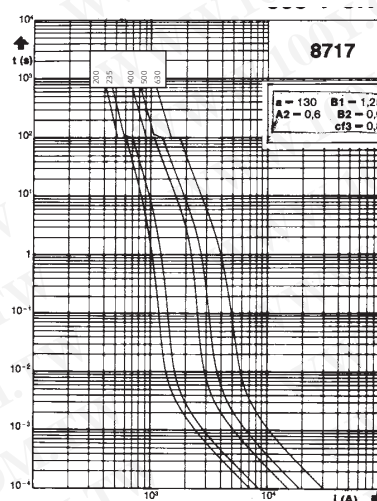

690 V URGM

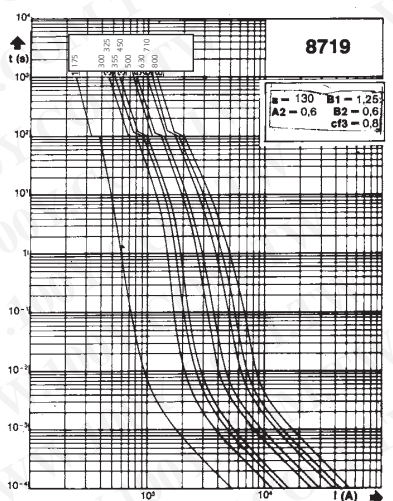

- These curves indicate, for each rated current, the pre-arcing time vs. the R/M.S. pre-arcing current.
- Tolerance for the mean pre-arcing current $\pm 10\%$

Semiconductor (AC) fuses



Other Protistor® Fuses

BS88-4 Fuses

36x55, 2x36x55 - 690 VAC

Corrective factor - Peak arc voltage

Corrective factor

Peak arc voltage

Corrective factor

Peak arc voltage

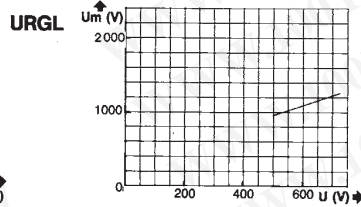
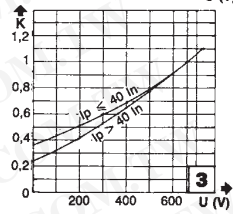
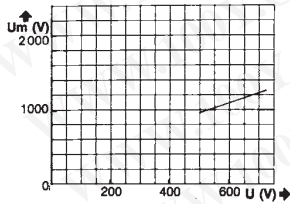
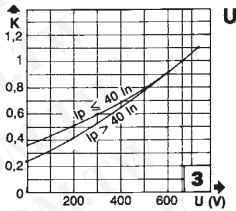
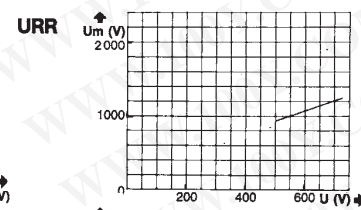
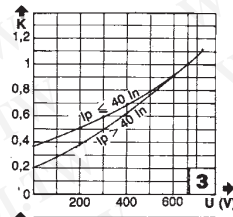
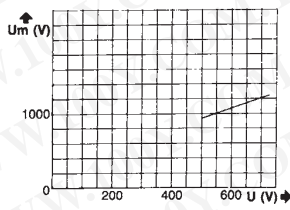
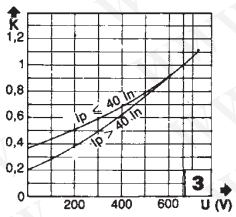

Corrective factor

The mean curves shows the variation of total clearing time (I^2t) and total clearing duration T_t as a function of operating voltage U .

Peak arc voltage

This curve shows peak value U_m of the arc voltage which appears across the fuse-link as a function of the operating voltage $U @ \cos j = 0.15$

DC Application data

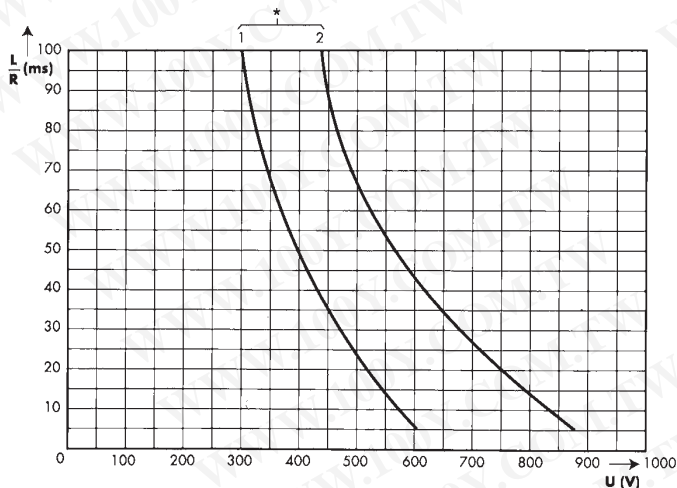

- This curves indicate the permissible value of time constant L/R as a function of DC working voltage
- I_{pm} values give the minimum DC interrupting current in amps.

Curves and I_{pm} for each rating

Class	Rated current	Curve*	I_{pm} (A)
URR	75	2	225
	110	2	330
	200	2	600
	250	2	750
URU	200	2	600
	235	2	700
	400	2	1200
	500	2	1500
	630	1	1890

Other Protistor® Fuses BS88-4 Fuses 17x49 gRB/URB - 690 VAC



EXTREMELY HIGH BREAKING CAPACITY FUSES:
PROTECTION OF SEMICONDUCTORS
AS PER IEC STANDARD 60269.1 AND 4

690 V VOLTAGE RATING AS PER IEC 33

gR CLASS (CURRENT RATING 12 TO 90 A) AS PER
VDE 636-23

- CLEARING ALL OVERLOADS
- IMPROVED SAFETY AND PROTECTION
- ENABLING SELECTIVE COORDINATION WITH ALL FUSES
WITHIN DISTRIBUTION CIRCUIT

aR CLASS (CURRENT RATING 100 A) ACCORDING TO VDE
636-23 AND IEC 60269.4

CONNECTION AS PER:

- GERMAN STANDARD DIN 43653/00C
- BRITISH STANDARD BS 88-4

These fuses are UL Recognized 

Main Characteristics

Voltage rating U_N (V)	Class	Current rating I_N (A)	pre-arcing $I^2t @ 1 \text{ ms}$ I^2tp (A ² s)	Total clearing $I^2t @ U_N$ I^2tt (A ² s)	Watts loss		Tested Breaking capacity	Estimated Breaking capacity
					0.8 I_N	I_N		
690	gRB	12	4.2	30	1.95	3.5	200 kA @ 690 V	300 kA @ 690 V
		16	9.6	65	2.2	4.0		
		20	17.1	110	3.0	5.5		
		25	26.8	170	4.4	8.0		
		32	52.5	330	5.0	9.0		
		35	69	430	5.2	9.5		
		40	96	610	5.8	10.5		
		45	130	820	6.3	11.5		
		50	154	970	7.2	13		
		55	210	1320	7.4	13.5		
		63	310	1950	8.0	14.5		
		75	520	3250	8.8	16		
80	620	3900	9.4	17				
90	840	5300	11	20				
690	URB	100	965	6150	13	23.5	200 kA @ 690 V	300 kA @ 690 V

Minimum operating voltage for separate trip-indicator: 20 V

Semiconductor (AC) fuses



Other Protistor® Fuses

BS88-4 Fuses

17x49 gRB/URB - 690 VAC

German standard without blown fuse indication

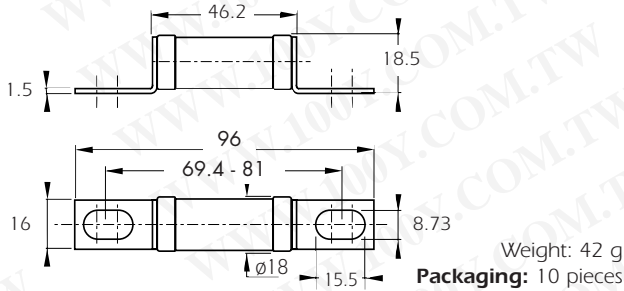

German standard with separate trip-indicator DIN 43623/00C

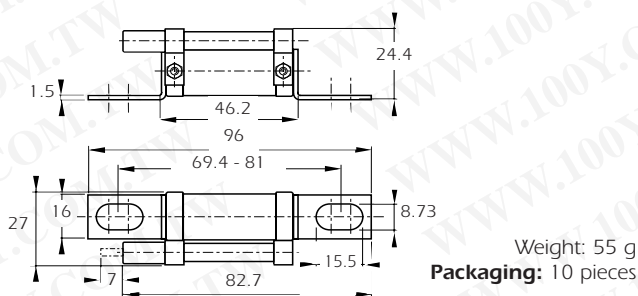

British standard without blown fuse indication

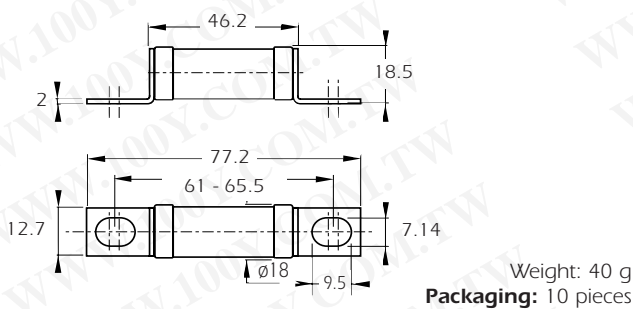

British standard with separate trip-indicator BS 88-4

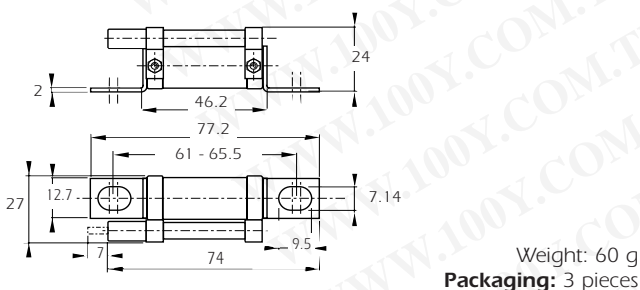

Current rating	Designation	Ref. Number	Catalog Number
12	6,9 gRB 17 D08/12	M220972	DN17GB69V12
16	6,9 gRB 17 D08/16	N220973	DN17GB69V16
20	6,9 gRB 17 D08/20	P220974	DN17GB69V20
25	6,9 gRB 17 D08/25	Q220975	DN17GB69V25
32	6,9 gRB 17 D08/32	R220976	DN17GB69V32
35	6,9 gRB 17 D08/35	S220977	DN17GB69V35
40	6,9 gRB 17 D08/40	T220978	DN17GB69V40
45	6,9 gRB 17 D08/45	V220979	DN17GB69V45
50	6,9 gRB 17 D08/50	W220980	DN17GB69V50
55	6,9 gRB 17 D08/55	X220981	DN17GB69V55
63	6,9 gRB 17 D08/63	Y220982	DN17GB69V63
75	6,9 gRB 17 D08/75	Z220983	DN17GB69V75
80	6,9 gRB 17 D08/80	A220984	DN17GB69V80
90	6,9 gRB 17 D08/90	B220985	DN17GB69V90
100	6,9 URB 17 D08/100	C220986	DN17UB69V100

Current rating	Designation	Ref. Number	Catalog Number
12	6,9 gRB 17 D08P 12	X221004	DN17GB69V12P
16	6,9 gRB 17 D08P 16	Y221005	DN17GB69V16P
20	6,9 gRB 17 D08P 20	Z221006	DN17GB69V20P
25	6,9 gRB 17 D08P 25	A221007	DN17GB69V25P
32	6,9 gRB 17 D08P 32	B221008	DN17GB69V32P
35	6,9 gRB 17 D08P 35	C221009	DN17GB69V35P
40	6,9 gRB 17 D08P 40	D221010	DN17GB69V40P
45	6,9 gRB 17 D08P 45	E221011	DN17GB69V45P
50	6,9 gRB 17 D08P 50	F221012	DN17GB69V50P
55	6,9 gRB 17 D08P 55	G221013	DN17GB69V55P
63	6,9 gRB 17 D08P 63	H221014	DN17GB69V63P
75	6,9 gRB 17 D08P 75	J221015	DN17GB69V75P
80	6,9 gRB 17 D08P 80	K221016	DN17GB69V80P
90	6,9 gRB 17 D08P 90	L221017	DN17GB69V90P
100	6,9 URB 17 D08P 100	M221018	DN17UB69V100P

Current rating	Designation	Ref. Number	Catalog Number
12	6,9 gRB 17/12	W220957	BS17GB69V12
16	6,9 gRB 17/16	X220958	BS17GB69V16
20	6,9 gRB 17/20	Y220959	BS17GB69V20
25	6,9 gRB 17/25	Z220960	BS17GB69V25
32	6,9 gRB 17/32	A220961	BS17GB69V32
35	6,9 gRB 17/35	B220962	BS17GB69V35
40	6,9 gRB 17/40	C220963	BS17GB69V40
45	6,9 gRB 17/45	D220964	BS17GB69V45
50	6,9 gRB 17/50	E220965	BS17GB69V50
55	6,9 gRB 17/55	F220966	BS17GB69V55
63	6,9 gRB 17/63	G220967	BS17GB69V63
75	6,9 gRB 17/75	H220968	BS17GB69V75
80	6,9 gRB 17/80	J220969	BS17GB69V80
90	6,9 gRB 17/90	K220970	BS17GB69V90
100	6,9 URB 17/100	L220971	BS17UB69V100

Current rating	Designation	Ref. Number	Catalog Number
12	6,9 gRB 17P12	D220987	BS17GB69V12P
16	6,9 gRB 17P16	E220988	BS17GB69V16P
20	6,9 gRB 17P20	F220989	BS17GB69V20P
25	6,9 gRB 17P25	G220990	BS17GB69V25P
32	6,9 gRB 17P32	H220991	BS17GB69V32P
35	6,9 gRB 17P35	J220992	BS17GB69V35P
40	6,9 gRB 17P40	K220993	BS17GB69V40P
45	6,9 gRB 17P45	L220994	BS17GB69V45P
50	6,9 gRB 17P50	M220995	BS17GB69V50P
55	6,9 gRB 17P55	N220996	BS17GB69V55P
63	6,9 gRB 17P63	P220997	BS17GB69V63P
75	6,9 gRB 17P75	Q220998	BS17GB69V75P
80	6,9 gRB 17P80	R220999	BS17GB69V80P
90	6,9 gRB 17P90	S221000	BS17GB69V90P
100	6,9 URB 17P100	T221001	BS17UB69V100P

Semiconductor (AC) fuses

勝特力材料 886-3-5753170
 勝特力电子(上海) 86-21-34970699
 勝特力电子(深圳) 86-755-83298787
 Http://www.100y.com.tw

Other Protistor® Fuses BS88-4 Fuses 17x49 gRB/URB - 690 VAC

Total clearing I^2t

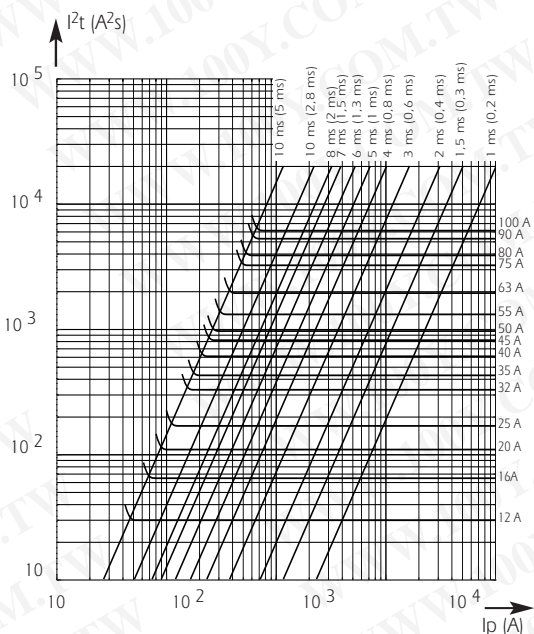

Above: Horizontal curves show for each rated current maximum values of total clearing I^2t (I^2t_t) as a function of prospective current I_p @ 690 V. $\cos \varphi = 0.15$. Oblique lines indicate total clearing duration T_t and associated pre-arcing duration in brackets.

I^2t corrective factor

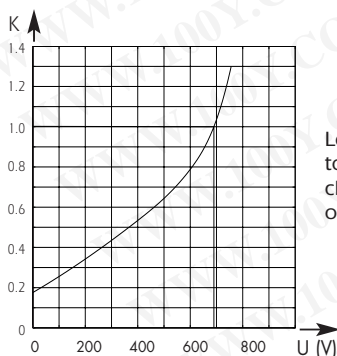

Left: Curve shows variation of total clearing time (I^2t_t) and total clearing duration T_t as a function of operating voltage U .

Peak arc voltage

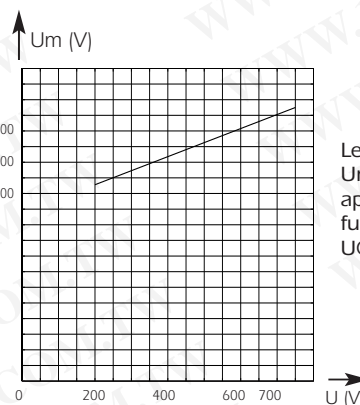

Left: Curve shows peak value U_m of arc voltage which appears across fuse-link as a function of operating voltage U @ $\cos \varphi = 0.15$.

Time vs current characteristics

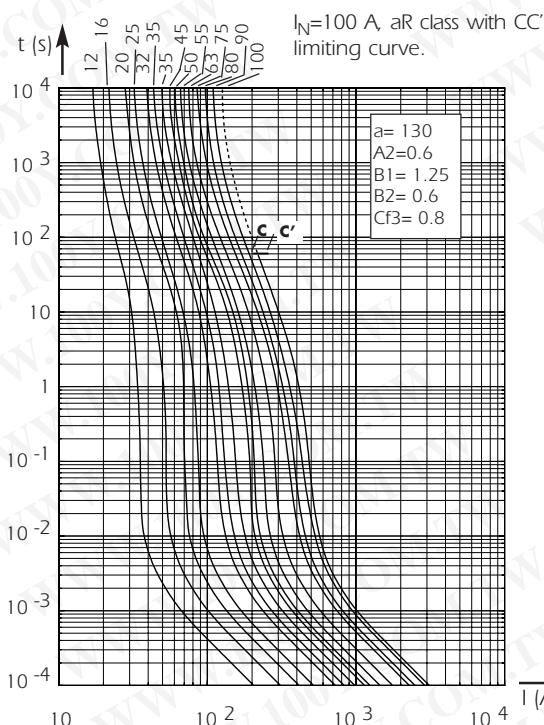

Tolerance for mean pre-arcing current $\pm 9\%$.

Above: Curves indicate, for each rated current, pre-arcing time vs. R.M.S. pre-arcing current

Current limitation curves

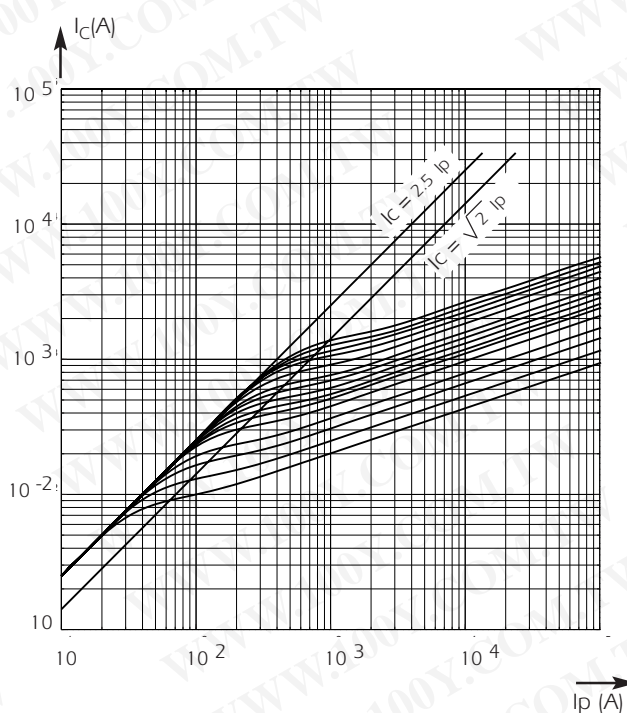

Above: Curves show, for each rating, value of peak let-through current I_c as a function of available fault current I_p .

Semiconductor (AC) fuses



Other Protistor® Fuses BS88-4 Fuses 17x49 gRB/URB - 690 VAC

勝特力材料 886-3-5753170
勝特力电子(上海) 86-21-34970699
勝特力电子(深圳) 86-755-83298787
[Http://www.100y.com.tw](http://www.100y.com.tw)

DC Application data

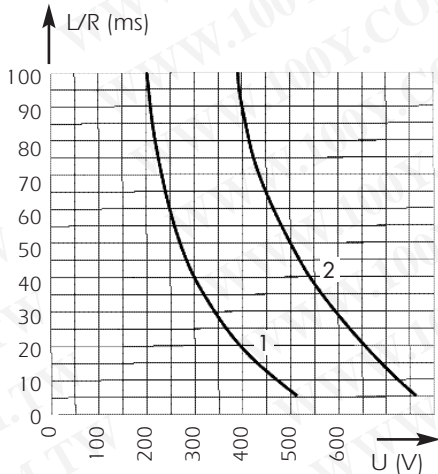

Above: Curves indicate permissible value of time constant L/R as a function of DC working voltage.
Curve 1: $I_p \geq 1,6 I_N$ only for fuses gRB (current rating from 12 to 50 A)
Curve 2: $I_p \geq 8 I_N$ for fuses gRB et URB

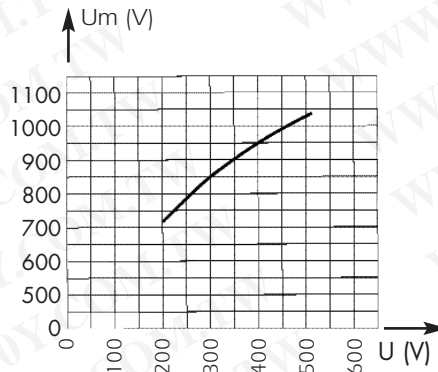

Curve indicates peak arc voltage U_m which may appear across the fuse terminals at working voltage U.

Microswitch

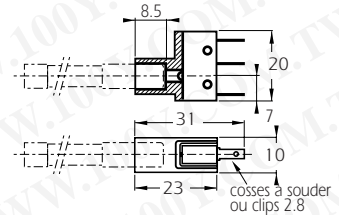

Designation	Ref. Num.	Weight	Pack.
MC 6,3 GR 2.5	Y 310015	10 g	3 pieces

Electrical characteristics:
 $I_N = 3 A - U_N = 250 VAC$
 $I_N = 2 A - U_N = 30 VDC$

Certain minimum operating voltage/current
20 V-100 mA

NEW gR-CLASS

OPTIMAL PROTECTION OF POWER EQUIPMENT

Thanks to recent technological developments, Ferraz Shawmut today markets gR-class PROTISTOR® fuses capable of clearing all types of overloads, from low multiples of current ratings up to very high short-circuit currents. Enhanced performance enables these fuses to provide solutions to many previously unsolved problems in power electronics: protection of cables without the use of additional components, protection of equipment from fire hazards, selective coordination of different fuses within a single power distribution installation...

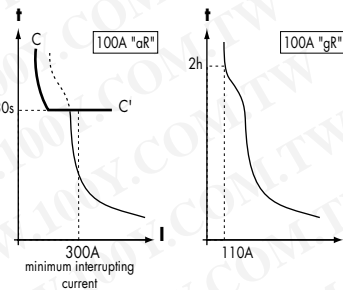

Example:
100A aR vs. 100A gR

SELECTIVE COORDINATION

gR-class semiconductor fuses can be utilized in association with gI and gG-class low voltage power distribution fuses of the same current rating, installed upstream. In a "selectively coordinated" distribution installation, melting is limited to the fuse associated with the faulted circuit, while upstream fuses remain intact. This prevents unnecessary down-time due to power blackouts in non-faulted branches.

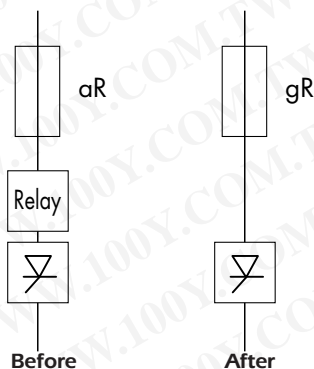
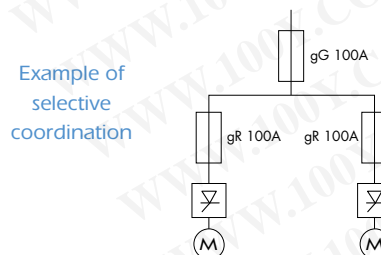

aR-CLASS vs. gR-CLASS

aR-class fuses feature a high minimum interrupting current as compared with their current rating. The primary time-current characteristic of aR-class fuses is the CC' curve, above which another protection device must be associated. The gR-class fuse represents considerably improved performance in semiconductor protection.

FERRAZ SHAWMUT EXPERTISE

gR-class fuses should be used in the design of low voltage equipment and in the protection of power electronics equipment. Designers can often substitute a gR-class fuse for an aR-class fuse (10x38, 14x51, 22x58, PSC 000 and 17x49 DIN80 or BS 88-4) but the reverse is not true: an aR fuse can never replace a gR fuse. Start protecting your new equipment with gR-class fuses today. The application of gR class fuses, with current ratings less than 100 Amps, offers enhanced protection, safety and reliability, along with reduced risk of replacement errors and assembly costs.

Other Protistor® Fuses BS88-4 Fuses

Microswitches for BS88-4 Protistor®

MICROSWITCH SYSTEMS ADAPTED
TO THE FOLLOWING FUSES:

- BS88 - 4 separated trip-indicator
- BS88 - 4 built-in trip-indicator

勝特力材料 886-3-5753170
勝特力电子(上海) 86-21-34970699
勝特力电子(深圳) 86-755-83298787
[Http://www.100y.com.tw](http://www.100y.com.tw)

Main Characteristics

Code	AC Insulation voltage rating (***)	Positive operating voltage/current	Current rating	Current	Interrupting rating						AC voltage withstand test (*)	Impulse voltage test Uimp1.2/50 μs (**)	Fire class according to UL 94
					Non inductive circuit		Inductive circuit : L/R = 25ms						
					30V	110V	250V	30V	110V	250V			
MC 6,3 GR 2-5 N	1000 V	20 V 100 mA	5 A	50/60 Hz	-	5 A	0,3 A	-	3 A	2 A	3.5 kV	-	H.B.
				DC	4 A	0.4 A	-	3 A	0.4 A	-			
MC 36 GR 2-5	1000 V	20 V 100 mA	5 A	50/60 Hz	-	5 A	5 A	-	5 A	5 A	7.5 kV	-	H.B.
				DC	4 A	0.4 A	-	2 A	0.4 A	-			

* Between power circuit and microswitch terminals as per IEC 60 and 694 (50/60 Hz 1 min duration in dry air)

** Between power circuit and microswitch terminals Uimp: impulse voltage as per IEC 947-1

*** Between power circuit and microswitch terminals

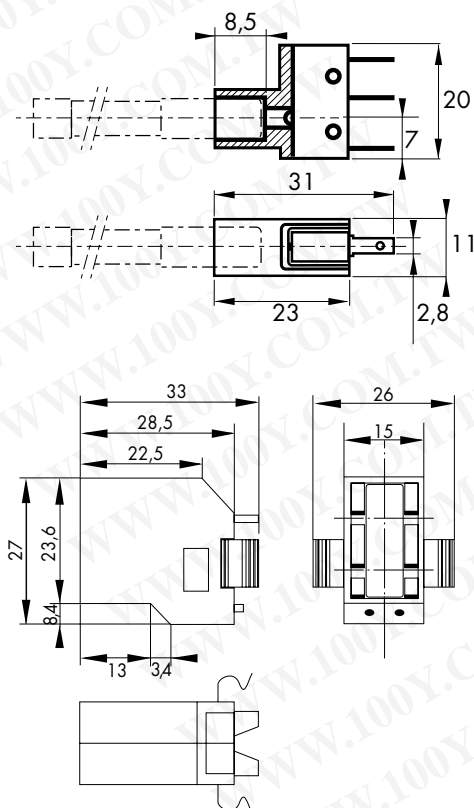

Catalog Number	Ref. Number	Weight (g)	Pack.
MC 6,3 GR 2-5 N (for separate trip-indicator)	Y 310015	10	3

Catalog Number	Ref. Number	Weight (g)	Pack.
MC 36 GR 2-5 (for built-in trip-indicator)	P 092496	10	3



Semiconductor (AC) fuses

DIN Recticur fuses D - Type gR Fuses (DIAZED)

RECTICUR - D Fuse links "ultra rapide"

Specifications : IEC 60 269-4
 DIN-VDE 0636 Part 23 and Part 33
 DIN 43653
 DIN 49515
 DIN 49522
 DIN 43620

RECTICUR-type ultra-rapid fuses are used to protect semiconductor components in power converters. D fuse links are designed for rated voltages of 500 V AC with rated currents extending from 2 to 100A.

Technical Notes

RECTICUR fuse links are equipped with fuse elements made of fine silver. The number and shape of their reductions in cross-section ensure satisfactory disconnection and optimum operating characteristics.

The design of the fuse element determines the characteristic curve and the remaining electrical properties of this fuse link.

Fuse links with gR characteristic provide total protection against overloading and against short-circuit currents.

Breaking Capacity

The switching reliability of RECTICUR semiconductor fuses has been verified in numerous tests extending up to the highest short-circuit currents. Rated braking capacity is 100 kA (RMS) for D-fuse links.

RECTICUR D Fuse bases

RECTICUR D fuse links can be fitted in all normal fuse-bases of the D system, using all usual accessories such as screw-cap and adaptor sleeve.

1 - This indicates the following maximum loadings for the various individual fuse links :

- 63-A fuse link : $I_{max} = 63 \text{ A} \times 0.7 = 44\text{A}$
- 50-A fuse link : $I_{max} = 50 \text{ A} \times 0.7 = 35\text{A}$
- 35-A fuse link : $I_{max} = 35 \text{ A} \times 0.7 = 25\text{A}$
- 25-A fuse link : $I_{max} = 25 \text{ A} \times 0.9 = 22.5\text{A}$
- 20-A fuse link : $I_{max} = 20 \text{ A} \times 0.9 = 18\text{A}$
- 16-A fuse link : $I_{max} = 16 \text{ A} \times 1 = 16\text{A}$
- 10-A fuse link : $I_{max} = 10 \text{ A} \times 1 = 10\text{A}$
- 6-A fuse link : $I_{max} = 6 \text{ A} \times 1 = 6\text{A}$

2 - The following additional reduction-factors must be used in installation sites with ambient temperatures $> 25^\circ\text{C}$

Ambient temp. ($^\circ\text{C}$) T	$T \leq 25$	$25 < T \leq 30$	$30 < T \leq 35$	$35 < T \leq 40$	$40 < T \leq 45$	$45 < T \leq 50$	$50 < T \leq 55$
Max. loading of fuse link (%)	100	94	88	82	75	67	58

Semiconductor (AC) fuses



DIN Recticur fuses D - Type Gr Fuses (DIAZED)

勝特力材料 886-3-5753170
 勝特力电子(上海) 86-21-34970699
 勝特力电子(深圳) 86-755-83298787
[Http://www.100y.com.tw](http://www.100y.com.tw)

RECTICUR - D Fuse links "ultra rapide"

RECTITUR D-Fuse links can be used in all fuse bases of the D-system using the usual accessories such as screw caps and gauge pieces.

RECTITUR D

Fuse links

500 VAC - 400 VDC

size D II, D III, D IV, operating class gR

Main characteristics

For base	Rated current (A)	Pre-arcing I ^t value (A ² s)	Total I ^t value at 380V (RMS) (A ² s)	Total I ^t value at 500V (RMS) (A ² s)	Power loss (W)	Kg/100 pcs.
D II	2	1	2	3	1,8	3,1
	4	2	4	5	3,1	3,1
	6	4	6	9	3,2	3,1
	10	10	14	20	5,0	3,1
	16	26	40	55	5,8	3,1
	20	40	60	85	8,0	3,1
D III	25	95	140	200	12,2	3,1
	35	490	790	1100	14	5,3
	50	900	1480	2050	16	5,3
D IV	63	1580	2400	3200	19	5,3
	80	3200	5200	7300	35	11,0
	100	5600	10100	14000	41	11,0

Dimensions

Dimensions	a	b∅
D II	50	22
DIII	50	27
DIV	57	33

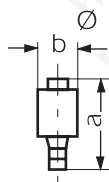

Semiconductor (AC) fuses

勝特力材料 886-3-5753170
 勝特力电子(上海) 86-21-34970699
 勝特力电子(深圳) 86-755-83298787
[Http://www.100y.com.tw](http://www.100y.com.tw)

DIN Recticur fuses D - Type gR Fuses (DIAZED)

RECTICUR - D
 Fuse links "ultra rapide"

Size	Intensité (A)	Tension (VAC)	Reference	Previous Ref.	Catalog Number
D II	2	500VAC/ 400 VDC	Z212542	5970028	DIIGR50V2
D II	4	500VAC/ 400 VDC	K213058	5970048	DIIGR50V4
D II	6	500VAC/ 400 VDC	E214065	5970068	DIIGR50V6
D II	10	500VAC/ 400 VDC	M214578	5970108	DIIGR50V10
D II	16	500VAC/ 400 VDC	T215090	5970168	DIIGR50V16
D II	20	500VAC/ 400 VDC	T215596	5970208	DIIGR50V20
D II	25	500VAC/ 400 VDC	B216109	5970258	DIIGR50V25
D II	30	500VAC/ 400 VDC	Y216612	5970308	DIIGR50V30
D III	35	500VAC/ 400 VDC	K217129	5980358	DIIGR50V35
D III	50	500VAC/ 400 VDC	Q217640	5980508	DIIGR50V50
D III	63	500VAC/ 400 VDC	Y218153	5980638	DIIGR50V63
D IV	80	500VAC/ 400 VDC	B201251	5980808	DIVGR50V80
D IV	100	500VAC/ 400 VDC	M201767	5981008	DIVGR50V100
D V	125	500VAC/ 400 VDC	J207054	5961258	DIVGR50V125
D V	160	500VAC/ 400 VDC	C211510	5961608	DIVGR50V160
D.V	200	500VAC/ 400 VDC	G212020	5962008	DIVGR50V200

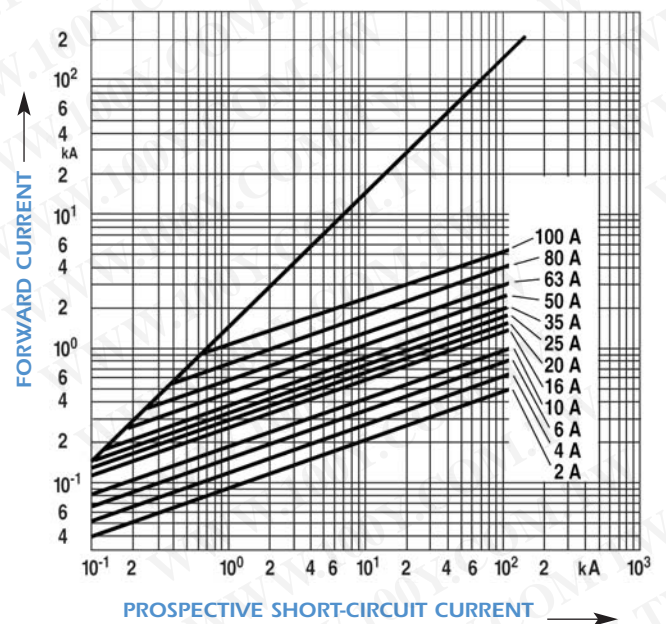
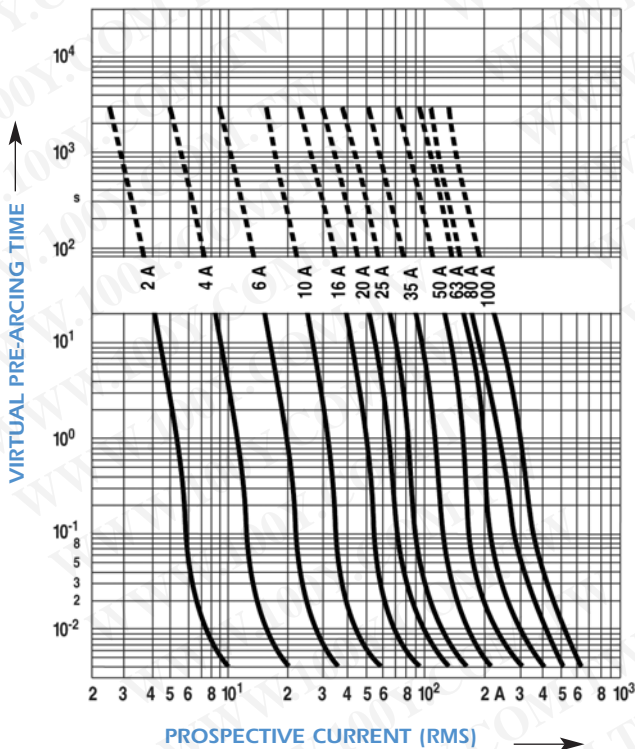



DIN Recticur fuses D0 - Type gR Fuses (NEOZED)

勝特力材料 886-3-5753170
勝特力电子(上海) 86-21-34970699
勝特力电子(深圳) 86-755-83298787
[Http://www.100y.com.tw](http://www.100y.com.tw)

RECTICUR - D0 Fuse links "ultra rapide"

Specifications : IEC 60 269-4
DIN-VDE 0636 Part 23 and Part 33
DIN 43653
DIN 49515
DIN 49522
DIN 43620

RECTICUR-type ultra-rapid fuses are used to protect semiconductor components in power converters. DO fuse links have a rated voltage of 440 V AC and are available within the rated current range extending from 2 to 100A.

Technical Notes

RECTICUR fuse links are equipped with fuse elements made of fine silver. The number and shape of their reductions in cross-section ensure satisfactory disconnection and optimum operating characteristics. The design of the fuse element determines the characteristic curve and the remaining electrical properties of this fuse link.

Fuse links with gR characteristic provide total protection against overloading and against short-circuit currents.

Breaking Capacity

The switching reliability of RECTICUR semiconductor fuses has been verified in numerous tests extending up to the highest short-circuit currents. Rated braking capacity is 160 kA (RMS) for D0 fuse links.

RECTICUR DO Fuse links

RECTICUR DO fuse links can be fitted in all normal fuse-bases of the D0 system, using all usual accessories such as screw-cap and adaptor sleeve.

Fitting of LINO CUR switch-disconnector-fuse with RECTICUR D0 Fuse Links

This means that the use of D0 fuse links in combination with the LINO CUR switch-disconnector-fuse is subject to certain conditions.

1 - This indicates the following maximum loadings for the various individual fuse links :

- 63-A fuse link : $I_{max} = 63 \text{ A} \times 0.7 = 44\text{A}$
- 50-A fuse link : $I_{max} = 50 \text{ A} \times 0.7 = 35\text{A}$
- 35-A fuse link : $I_{max} = 35 \text{ A} \times 0.7 = 25\text{A}$
- 25-A fuse link : $I_{max} = 25 \text{ A} \times 0.9 = 22.5\text{A}$
- 20-A fuse link : $I_{max} = 20 \text{ A} \times 0.9 = 18\text{A}$
- 16-A fuse link : $I_{max} = 16 \text{ A} \times 1 = 16\text{A}$
- 10-A fuse link : $I_{max} = 10 \text{ A} \times 1 = 10\text{A}$
- 6-A fuse link : $I_{max} = 6 \text{ A} \times 1 = 6\text{A}$

2 - The following additional reduction-factors must be used in installation sites with ambient temperatures $> 25^{\circ}\text{C}$

Ambient temp. ($^{\circ}\text{C}$) T	$T \leq 25$	$25 < T \leq 30$	$30 < T \leq 35$	$35 < T \leq 40$	$40 < T \leq 45$	$45 < T \leq 50$	$50 < T \leq 55$
Max. loading of fuse link (%)	100	94	88	82	75	67	58

DIN Recticur fuses D0 - Type gR Fuses (NEOZED)

RECTICUR - D0 Fuse links "ultra rapide"

RECTITUR D0

Fuse links

440 VAC up to 100 A

size D0 1, D0 2, D0 3, operating class gR

勝特力材料 886-3-5753170
勝特力电子(上海) 86-21-34970699
勝特力电子(深圳) 86-755-83298787
[Http://www.100y.com.tw](http://www.100y.com.tw)

Main characteristics

For base	Rated current (A)	Pre-arcing I ² t value (A ² s)	Total I ² t value at 440V (RMS) (A ² s)	Power loss (W)	Kg/100 pcs.
D01	2	3	3	1,5	0,62
	4	4	5	2,0	0,62
	6	5	10	2,3	0,62
	10	12	25	2,2	0,62
	16	40	75	3,3	0,62
D02	20	60	110	4,3	1,40
	25	90	180	6,0	1,40
	35	210	410	8,4	1,40
D03	50	830	1650	10,0	1,40
	63	1300	2500	13,9	1,40
	80	2100	4300	17,6	3,70
	100	3300	6600	21,0	4,10

Dimensions

Dimensions	a	bØ
D01	36	11
D02	36	15,3
D03	43	22,5

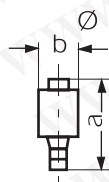

Semiconductor (AC) fuses



DIN Recticur fuses D0 - Type gR Fuses (NEOZED)

勝特力材料 886-3-5753170
 勝特力电子(上海) 86-21-34970699
 勝特力电子(深圳) 86-755-83298787
[Http://www.100y.com.tw](http://www.100y.com.tw)

RECTICUR - D0 Fuse links "ultra rapide"

Size	Intensité (A)	Tension (VAC)	Reference	Previous Ref.	Catalog Number
D01	2	440V	M215038	17000026	D01GR44V2
D01	4	440V	N218673	17000046	D01GR44V4
D01	6	440V	B219191	17000066	D01GR44V6
D01	10	440V	F219724	17000106	D01GR44V10
D01	16	440V	N222169	17000166	D01GR44V16
D02	20	440V	H222923	17010206	D02GR44V20
D02	25	440V	R200713	17010256	D02GR44V25
D02	35	440V	F201255	17010356	D02GR44V35
D02	50	440V	R201771	17010506	D02GR44V50
D02	63	440V	Y207113	17010636	D02GR44V63
D03	80	440V	G211514	17020806	D03GR44V80
D03	100	440V	L212024	17021006	D03GR44V100

Packaging:
 D01 50 pieces
 D02 25 pieces
 D03 10 pieces

