

# Global Partners



Intermatic Incorporated, along with its European subsidiary Grässlin GmbH, are focusing on the objectives and resources of businesses around the world to develop practical energy-management solutions. This global partnership helps businesses become more efficient and keeps our environment clean.

To help extend our reach to a global audience, we offer additional first-class service and solutions for our worldwide distributors on the Grässlin website. Visit [www.graesslin.de](http://www.graesslin.de) to learn more about Grässlin solutions.

[www.intermatic.com](http://www.intermatic.com)

7777 Winn Road, Spring Grove, IL 60081 Phone: (815) 675-2321

©2013 Intermatic Inc.  
300TS10098

INTERMATIC

Product Catalog

GRÄSSLIN  
Iss. 2013

# INTERMATIC®

## Product Catalog



## Energy Management Control Solutions

**Energy Control Panels**

**Timers Weatherproof**

HVACR **Time Switches**

Hour Meters Surge Protection

**Defrost Timers Sensors**

Pool & Spa Controls

**GRÄSSLIN™**  
by INTERMATIC®



**Founded:** 1891

**Headquarters:** Spring Grove, Illinois

**Facilities:** El Paso, Texas; Juarez, Mexico; Mississauga, Canada;  
St. Georgen, Germany; Peterzell, Germany; Madrid, Spain

**Total Employees:** 800

Since 1891, Intermatic has been a family-owned business dedicated to delivering quality service to its customers. This steadfast commitment has helped Intermatic become a global leader in energy management solutions.

From its trademark yellow dial time switch to electronic energy controls, Intermatic is a leading manufacturer of energy-management solutions for electrical, HVACR, pool/spa, and OEM markets. Intermatic products cover a wide range of solutions, including facility management, municipalities, manufacturing, agricultural, and construction.

Intermatic bolsters its innovative solutions with a best-in-class Technical Service team for distributors, contractors, specifiers, and OEMs.

***This new product catalog reinforces our now 122-year commitment to excellence.***

# Control & Protect

HVACR equipment

Boilers  
Pumps  
**AC**  
Heaters

Attic Fans  
Freezers

Furnaces Refrigerators

Water Heaters Filters

Irrigation Ventilation Systems



G8000 Series



AG3000



DTAV40E2

# Table of Contents



**Electronic Time Switches**  
Pages 9-25



**Electromechanical Time Switches**  
Pages 27-29



**Mechanical Time Switches**  
Pages 31-46



**Timers**  
Pages 47-59



**Sensors**  
Pages 61-77



**Hour Meters**  
Pages 79-85



**Defrost/HVACR**  
Pages 87-92



**Surge**  
Pages 93-103



**Weatherproof Covers**  
Pages 105-111



**Pool & Spa Controls**  
Pages 113-144



**Enclosures & Accessories**  
Pages 145-154

# A Powerful New Way to See Intermatic

www.intermatic.com

Improved navigation makes it easier to learn about all our capabilities

Sleek new design makes it quicker to find the right info

Quick links to our dedicated customer & product support



Keeps you in tune with our latest Innovations

HVACR solutions center provides a reservoir of info to find the solution you need

## Find Your Energy Management Solution

*with our new dynamic solutions tab*

Solution tab helps you navigate deeper and faster through our solutions

Vivid application imaging

Intuitive industry tabs removes guess work from your search

In-depth application list facilitates a quicker search to find your solutions



# Find the Resource you Need with Our New Multimedia Library



**Instruction Manuals & Product Brochures**  
Find everything you need to make our products work for you!

**Videos**  
How-to and promotional videos featuring our newest and most innovative products!

**Cross Reference**  
An easy, interactive addition to our printed cross reference, helping you make the switch to Intermatic.

**Downloadable Forms**  
Order trippers hassle free with our downloadable form.

# Icon Legend:

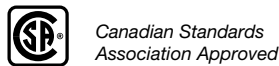
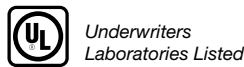
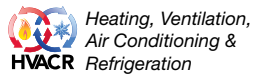

# Product Index

## Symbols

2T308A	150
2T511GA	147, 148
2T2040GA	148
2T2331GA	148
2T2365GA	150
2T2485GA	148
2T2500GA	149
2T2502GA	149
2T2926A	149
6LV1352	68
6LV1352R	68
21T156A	144, 154
21T166A	144
22--00012	153
22T338GR	150, 152
22T904A	144, 154
24EB5495	154
24EB5524	154
24EG5133	101
24T5265A	154
101--00040	153
107SB189	153
107SB192	153
107SB216	153
107SB217	153
107SB234	153
107T73	153
107T119	153
107TN221	153
107TN222	153
119T86A	153
119T267	153
119T340	153
124T1948	152
124T1952	152
124T2097	153
124T2247	153
124T2411A	152
124T2530A	153
124TP2608A	153
131T68GA	153
133RC1144	153
133T698A	153
133T700A	153
133T701A	153
133T773A	153
133T1115A	153
143PS307	153
143RC126	153
143RC140	153
143RC151	152
143T135	152, 153
143T136	152, 153
143T145A	153
146MT573	154
146MT574	154
146MT575	154
146MT577	154
146MT579	154
148FD5024	154
148FD5025	154
148FD5029	154
148FD5030	154
148FD5031	154
148FD5032	154
148FD5033	154
148FD5034	154
148FD5035	154
148FD5036	154

148FD5037	154
148FD5038	154
148FD5039	154
148FD5052	154
148FD5054	154
148FD5056	154
148FD5059	154
148FD5060	154
148FD5061	154
148FD5062	154
148FD5063	154
148FD5064	154
148FD5066	154
148FD5068	154
148FD5070	154
148FD5071	154
148FD5072	154
148FD5073	154
148FD5075	154
148FD5076	154
148FD5077	154
148FD5078	154
148FD5079	154
148FD5080	154
156--01318A	153
156EB1945A	153
156PA13713A	154
156PA13714A	154
156PA13715A	154
156PA14336A	154
156PB10398A	152
156T1948A	153
156T1949A	153
156T1950A	153
156T1954A	153
156T1957A	153
156T1978A	152
156T2548A	153
156T3085A	153
156T3230A	153
156T3492A	153
156T4042A	144, 154
156T6738A	152
176ET9A	154
176ET10A	154
178PA28A	115, 154
178T24	154

## A

AG1BRKT	100, 154
AG240C3	100
AG2083C3	95, 100
AG2401C3	95
AG2403C3	95, 100
AG3000	95, 97, 143
AG4801C3	95
AG4803C3	95, 100
AG6503C3	95, 100
AG6503L3	95, 100
AG24013	100
AG48013	100
AG Series	100

## B

BEZ-55BLACKU	83, 153
BEZ-55GRAYU	83, 153
BEZ-72PU	83, 153
BEZ-72U	83, 153

## C

C8800 Series	38
C8815	38
C8835	38
C8845	38
C8865	38
C8866	38
CA8750	154
CT2000	25

## D

DC-FME	153
DC-FME-A	153
DT620	59
DTAV40	91
DTAV40E	89
DTAV40E2	89
DTAV40IM	91
DTAV40M	91
DTAV40Q	91
DTAV40Q-M	91
DTAV40 Series	91
DT-B	91, 153

## E

E150	151
E150 Type 1 Enclosure	151
E200	151
E200 Type 3R Rainproof Enclosure	151
E300 Compact Type 3R Rainproof Enclosure	151
E1010	57
E1020	57
EH10	25
EH40	25
EI200	53
EI200LA	53
EI200 Series	53
EI200W	53
EI205	53
EI205LA	53
EI205W	53
EI210	53
EI210LA	53
EI210W	53
EI215	53
EI215LA	53
EI215W	53
EI220	53
EI220LA	53
EI220W	53
EI230	53
EI230LA	53
EI230W	53
EI235	53
EI235LA	53
EI235W	53
EI400C	52
EI400LAC	52
EI400 Series	52
EI400WC	52
EI500C	49
EI500LAC	49
EI500 Series	49
EI500WC	49
EI600C	48
EI600LAC	48
EI600 Series	48

EI600WC	48
EJ351	51
EJ500	51
EJ600	51
EJ600A	51
EJ600 Series	51
EK4536	73
ET801M	17
ET1105C	17
ET1105CPD82	17
ET1105CR	17
ET1105M	17
ET1115C	17
ET1115CPD82	17
ET1115CR	17
ET1115M	17
ET1125C	17
ET1125CPD82	17
ET1125CR	17
ET1125M	17
ET1705C	17
ET1705CPD82	17
ET1705CR	17
ET1705M	17
ET1715C	17
ET1715CPD82	17
ET1715CR	17
ET1715M	17
ET1725C	17
ET1725CPD82	17
ET1725CR	17
ET1725M	17
ET8015C	17
ET8015CPD82	17
ET8015CR	17
ET8115C	17
ET8115CPD82	17
ET8115CR	17
ET8115M	17
ET8215C	17
ET8215CPD82	17
ET8215CR	17
ET8215M	17
ET8415CR	15
ET9100	14, 153
ET9232	14, 153
ET9250	14, 153
ET90000 Series	13
ET90115C	13
ET90115CE	13
ET90115CR	13
ET90115CRE	13
ET90115M	13
ET90215C	13
ET90215CE	13
ET90215CR	13
ET90215CRE	13
ET90215M	13
ET90415CR	13
ET90815CR	13
ET91215CR	13
ET91615CR	13
ET Series	17
Extra-Duty Die-Cast Covers	107

## F

FD2H	54
FD2HW	54
FD4H	54
FD4HW	54

FD5M	54
FD5MW	54
FD6H	54
FD6HH	54
FD6HHW	54
FD6HW	54
FD12HC	54
FD12HH	54
FD12HHP	154
FD12HHW	54
FD12HWC	54
FD15MAC	54
FD15MC	54
FD15MH	54
FD15MHW	54
FD15MP	154
FD15MPW	154
FD15MWC	54
FD30MAC	54
FD30MC	54
FD30MH	54
FD30MP	154
FD30MPW	154
FD30MWC	54
FD30MWH	54
FD32H	54
FD32HW	54
FD34H	54
FD34HW	54
FD36H	54
FD46H	54
FD46HW	54
FD60MAC	54
FD60MC	54
FD60MH	54
FD60MHW	54
FD60MP	154
FD60MPW	154
FD60MWC	54
FD415M	54
FD430M	54
FD430MW	54
FD460M	54
FD460MW	54
FD Decorator Series	54
FF2H	55
FF4H	55
FF5M	55
FF5MH	55
FF6H	55
FF6HH	55
FF12HC	55
FF12HHC	55
FF15MC	55
FF15MH	55
FF15MP	154
FF30MC	55
FF30MH	55
FF30MP	154
FF32H	55
FF32HH	55
FF34H	55
FF34HH	55
FF36H	55
FF46H	55
FF60MC	55
FF60MHC	55
FF60MP	154
FF312H	55
FF312HH	55

FF315M	55
FF330M	55
FF360M	55
FF412H	55
FF415M	55
FF430M	55
FF460M	55
FF Commercial Series	55
FM1D14-12U	22
FM1D14-24U	22
FM1D14-AV-U	22
FM1D14 Series	22
FM1D20-24U*	24
FM1D20-120U	24
FM1D20-240U	24
FM1D20A-24*	24
FM1D20A-120	24
FM1D20A-240	24
FM1D20E-24*	24
FM1D20E-120	24
FM1D20E-240	24
FM1D20 Series	24
FM1D50-12U	23
FM1D50-24U	23
FM1D50-120U	23
FM1D50-240U	23
FM1D50A-12	23
FM1D50A-24	23
FM1D50A-120	23
FM1D50A-240	23
FM1D50E-12	23
FM1D50E-24	23
FM1D50E-120	23
FM1D50E-240	23
FM1D50 Series	23
FM1QTUZ-120U	42
FM1QTUZH-24U	42
FM1QTUZH-120U	42
FM1QWUZ-120U	42
FM1QWUZ-240U	42
FM1QWUZH-120U	42
FM1QWUZH-240U	42
FM1QWUZH-BW-24U	42
FM1QWUZH-BW-24U*	42
FM1S12HU-120U	40
FM1 Series	42
FM1STUZ-24U	42
FM1STUZ-120U	42
FM1STUZ220/50	42
FM1STUZ-240U	42
FM1STUZH-24U	42
FM1STUZH220/50	42
FM1STUZH-240U	42
FM1SWUZ-24U	42
FM1SWUZ-120U	42
FM1SWUZ-240U	42
FM1SWUZH-24U	42
FM1SWUZH-120U	42
FM1SWUZH-240U	42
FM2D50-24	22
FM2D50-120	22
FM2D50-240	22
FM2D50 Series	22
FM-FU	153
FM-SU	153
FWZ53	80
FWZ53-24U	80
FWZ53-120/50U	80
FWZ53-120U	80
FWZ53-220/50U	80
FWZ53 Series	80
FWZ55	80
FWZ55-120U	80
FWZ55-220/50	80
FWZ55K-120U	80
FWZ55K-220/50	80
FWZ55K-240U	80
FWZ55 Series	80
FWZ72-24U	81
FWZ72-120U	81
FWZ72B-120U	81
FWZ72B-240U	81
FWZ72C-120	81
FWZ72K-240U	81
FWZ72 Series	81
FWZ72 Series Gasket	81

## G

G-53U	80
G-55U	80, 153
G-72U	81, 153
G8000 Series	88
G8045-00	88
G8045-20	88
G8145-00	88
G8145-20	88
GM40AV	29
GM40AVE	20
GM40AV-M	29
GM40AV-Q	29
GM40AV-QW	29
GM40AV-W	29
GMX2FM2D50I-24	21
GMX2FM2D50I-120	21
GMX2FM2D50I-240	21
GMX2FM2D500-120	21
GMX121-0-120*	40
GMX894-I-120	19
GMX894-0-120	19
GMXFM1D20-I-24	21
GMXFM1D20-I-120	21
GMXFM1D20-I-240	21
GMXFM1D20-0-24	21
GMXFM1D20-0-120	21
GMXFM1D20-0-240	21
GMXFM1D50-I-12	21
GMXFM1D50-I-24	21
GMXFM1D50-I-120	21
GMXFM1D50-I-240	21
GMXFM1D50-0-12	21
GMXFM1D50-0-120	21
GMX/FM1 Series	21
GMXQT-I-120	43
GMXQT-0-120	43
GMXQW-I-240	43
GMXQW-0-120	43
GMX Series	43
GMXST-I-120	43
GMXST-I-240	43
GMXST-0-24	43
GMXST-0-120	43
GMXST-0-240	43
GMXSW-I-24	43
GMXSW-I-240	43
GMXSW-0-24	43
GMXSW-0-120	43
GMXSW-0-240	43
GZ40AU	84
GZ40BU	84
GZ52BU	84

## H

HB110 Series	58
HB112	58
HB113	58
HB114	58
HB880R	59

## I

IG1C3R	103
IG1CM	103
IG1CM3R	103
IG1C Spare	103
IG2T3R	102
IG2TM	102
IG2T Spare	103
IG4TM	102
IG20B123	101
IG1200RC3	98, 98, 143
IG1240FMP33	99
IG1240RC3	95, 98
IG1300-2T-1C3	95, 99
IG1300-4T-1C3	99
IG1300-4T-2C3	95, 99
IG2012B153	101
IG3240FMP33	99
IG3240RC3	95, 98
IG20663	101
IG112463	101
IG112663	101
IG112663BLK10	101
IG206153	101
IG Flush Mount Kit	103
IOS-CMP-LV	74

IOS-CMP-U	74
IOS-DDR Series	75
IOS-DDR-WH	75
IOS-DOV-IV	75
IOS-DOV-NL-IV	75
IOS-DOV-NL-WH	75
IOS-DOV Series	75
IOS-DOV-WH	75
IOS-DPBIF2-IV	76
IOS-DPBIF2 Series	76
IOS-DPBIF2-WH	76
IOS-DPBIF-IV	77
IOS-DPBIF Series	77
IOS-DPBIF-WH	77
IOS-DPBIMF-IV	77
IOS-DPBIMF Series	77
IOS-DPBIMF-WH	77
IOS-DSIF-IV	76
IOS-DSIF Series	76
IOS-DSIF-WH	76
IOS-DSIMF-IV	76
IOS-DSIMF Series	76
IOS-DSIMF-WH	76
IOS-DSR-IV	75
IOS-DSR Series	75
IOS-DSR-WH	75
IOS-HB-U	74
IOS-PP24	74

## K

K42-SW-A	71
K121	71
K121-30	71
K122	71
K1100 Series	72
K1121	72
K1122	72
K1200 Series	72
K1221	72
K1222	72
K4000C Series	68
K4021C	68
K4023C	68
K4027	68
K4035	68
K4100 Series	69
K4121C	36, 69
K4123C	69
K4127	69
K4135	69
K4136M	69
K4141C	69
K4200 Series	70
K4221C	70
K4223C	70
K4227	70
K4235	70
K4236C	70
K4251	70
K4253	70
K4321C	68
K4400 Series	69
K4421M	69
K4423M	69
K4500	71
K4500 Series	70
K4521	70
K4522	70
K4524	70
K4533	70
K4535	70
K4536SS	73
K4536SST	73
KM2 Series	56
KM2ST-1G	56
KM2ST-2D	56
KM2ST-2G	56
KM2ST-2R	56
KM2ST-3D	56
KM2ST-3G	56
KM2ST-4G	56
KM2STU-1G	56

## L

LC2000	72
LC2000 Series	72
LC4500 Series	71

LC4521C	71
LC4521LA	71
LC4523	71
LC4523LA	71
LC4527	71
LC4535	71
LC4535LA	71
LC4536C	71
LC4536LAC	71
LM2-0-882T	64
LM2-0-120	65
LM2-0-882T	64
Low Voltage Power Packs	46
LS1	67
LS2	67
LS2 Sensor	64, 65
LS Series	67

## M

MB-48V	153
MB-DIN	22, 153
MIL72AQTUZ-120	44
MIL72AQTUZ-240	44
MIL72AQTUZH-24*	44
MIL72AQTUZH-120	44
MIL72AQWUZ-120	45
MIL72AQWUZH-24*	45
MIL72AQWUZH-120	45
MIL72ASTUZ-24	44
MIL72ASTUZ-120	44
MIL72ASTUZ220	44
MIL72ASTUZ-240	44
MIL72ASTUZH-24	44
MIL72ASTUZH-120	44
MIL72ASWUZ-24	45
MIL72ASWUZ-120	45
MIL72ASWUZH-24	45
MIL72ASWUZH-120	45
MIL72ASWUZH-240	45
MIL72EQTUZ-24*	44
MIL72EQTUZ-120	44
MIL72EQTUZ-240	44
MIL72EQTUZH-24*	44
MIL72EQTUZH-120	44
MIL72EQUWUZ-120	45
MIL72EQUWUZH-120	45
MIL72EQWUZH-240	45
MIL72ESTUZ1A240	44
MIL72ESTUZ-24	44
MIL72ESTUZ-120	44
MIL72ESTUZ-240	44
MIL72ESTUZH-24	44
MIL72ESTUZH-120	44
MIL72ESTUZH220	44
MIL72ESTUZH-240	44
MIL72ESWUZ-24	45
MIL72ESWUZ-120	45
MIL72ESWUZH-24	45
MIL72ESWUZH-120	45
MIL72ESWUZH-240	45
MIL72 Series	44, 45
ML44T	46
ML88T	46
ML100THB	46
ML121RT	46
ML200RT	46
ML200RTW	46
ML300RTW	46
ML300RTWSN	46
ML600TW	46
ML600TWSN	46
ML814DRP	46
ML900TW	46
ML900TWSN	46
Mounting Brackets	150
MultiWave Control System	114

## N

NE1C	69
------	----

## P

P1000	137
P1100 Series	139
P1101	139

P1103FE	137
P1121	139
P1131	139
P1200 Series	139
P1251P	139
P1261P	139
P1353ME	120
P1403ME	119
P4043ME	118
P4243ME	118
P7000	137
P7103ME	137
PA102	154
PA114	141, 154
PA115	152
PA117	154
PA120	154
PA122	115, 154
PA600	144, 154
PB300 Series	136
PB313E	136
PB313EK	136, 154
PB314E	136
PB314EK	154
PB314EK*	136
PB373E	136
PB374E	136
PB800	138
PB873MKZ	138
PB900	138
PB913N	138
PB913N66	138, 154
PB913N84	138
PB914N	138
PB914N66	138
PB914N84	138
PC1-120	67
PC1-120-LS1	66, 67
PC1-120-LS2	66
PC2-120	67
PC2-120-LS1	66, 67
PC2-120-LS2	66
PC Series	66
PE24VA	141
PE100 Series	121
PE103	119
PE140	118
PE153	121
PE153F	121
PE153P	121
PE153PF	121
PE650	154
PE653	115, 154
PE653RC	114
PE953	115, 154
PE1403ME	119
PE10000	122, 144
PE10000 Series	122
PE15300	122
PE15300F	122
PE20000	122
PE20000RC Series Kits	116
PE20000 Series	122
PE20065RC	116
PE24065RC	116
PE25300	122
PE25300F	122
PE30000	123
PE30000RC	117
PE30000 Series	123
PE30000T3	123
PE30065RC	117
PE34065RC	117
PE35300	123
PE40000	123
PE40000 Series	123
PE45300	123
PF1100	133
PF1100 Series	132
PF1102	132
PF1102M	132
PF1102MT	132
PF1102T	132
PF1103	132
PF1103M	132
PF1103MT	132
PF1103T	132
PF1112T	133





# Electronic Time Switches



***Air Conditioners***    **Bell Ringing**

***Office Lighting***    Water Heaters

***Signs***    Parking Lot Lighting

**Ventilation Systems**

Outdoor Lighting    **Billboards**

# Building Automation Systems (BAS)

*Energy savings has become an international currency.*

Industries and businesses around the world are looking for practical and cost-effective methods to save energy and money. That's why Intermatic is taking the initiative to help your business use energy efficiently and ultimately save money with its Building Automation System (BAS) solutions.

These systems provide practical energy saving solutions for businesses across the globe. They help centralize energy management controls in buildings to maximize efficiency and performance.

Building automation systems integrate existing energy controls into energy conscious solutions. This is a vital part of reducing energy consumption. Most energy control products are designed to outdo the competition and not serve the business. Intermatic's BAS solutions are designed to meet the customer needs today and in the future.

*Why waste another dollar on inefficient energy control systems?*  
Let Intermatic give you the cost-effective solutions for your building.

## Common Components Controlled by a Building Automation System

- Indoor Lighting
- Outdoor Lighting
- HVACR Equipment
- Pump Controls
- Irrigation Controls
- Water Heating Equipment
- Signals/Alarms
- Security Controls
- Food Preparation

# Imagine all the Possibilities

Electronic Time Switches

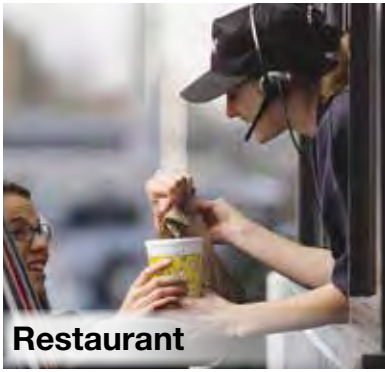

**Restaurant**

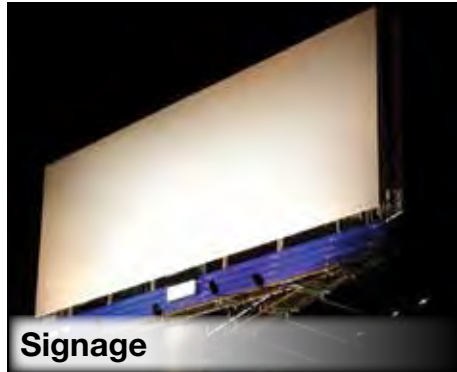

**Signage**



**Service**



**Retail**



**Alarm**



**Lobby**



**Facilities**



**Outdoor Lighting**



**Parking Area**



**Educational**



**Offices**

# Introducing the New ET90000 Series Energy Controls



# Are you tired of stopping at every timer to update software?

The ET90000's USB connection and Ethernet capabilities enable in-field schedule updates and firmware upgrades to be installed from one central location.

## ET90000 Series 365-Day Astronomic Time Switches

- Automatically detects input voltages between 120 and 277 VAC
- Up to 4,000 events plus holidays scheduling
- USB connection for easy program transfer, schedule backup, and firmware updates
- Ethernet capable for upgrading firmware and networking time switches and PC tools
- Up to 8 external overrides for remote circuit control
- 100+ hour supercapacitor maintains date and time in case of power outage
- Easy-to-follow on-screen menu
- Supports relative dates, such as “4th Thursday of November”
- Password protection
- Firmware upgradeable
- Schedule review mode
- Saved activity log

Load Type	Normally Open N.O.	Normally Closed N.C.	Voltage
General Purpose & Resistive	30 A	—	12-240 VAC
General Purpose & Resistive	20 A	10 A	12-240 VAC
Resistive	20 A	10 A	28 VDC
Inductive Ballast	20 A	3 A	120-277 VAC
Tungsten	5 A	—	12-120 VAC
Pilot Duty	470 VA	275 VA	120-240 VAC
Motor	1 HP	¼ HP	120 VAC
Motor	2 HP	½ HP	240 VAC

### Ratings:

**Note:** The electronic mechanism snaps into the standard Intermatic enclosure for easy upgrading of mechanical mechanisms, if desired.

**Cycle:** 50/60 Hz.

**Wiring Terminals:** #20 to #6 AWG wire

**Min. ON/OFF Times:** 1 second

**Max. ON/OFF Times:** 365 days

**Operating Temperature:** -40°F to 104°F (-40°C to 40°C)

**Warranty:** Limited 1 year

Model #	Circuits	Enclosure	Ethernet
ET90115C	1	Type 1 Steel	Optional
ET90115CE	1	Type 1 Steel	Included
ET90115CR	1	Type 3R Steel	Optional
ET90115CRE	1	Type 3R Steel	Included
ET90115M*	1	—	Optional
ET90215C	2	Type 1 Steel	Optional
ET90215CE	2	Type 1 Steel	Included
ET90215CR	2	Type 3R Steel	Optional
ET90215CRE	2	Type 3R Steel	Included
ET90215M*	2	—	Optional
ET90415CR	4	Type 3R Steel	Included
ET90815CR	8	Type 3R Steel	Included
ET91215CR	12	Type 3R Steel	Included
ET91615CR	16	Type 3R Steel	Included

\*Replacements for 1 & 2 circuits only

See Replacement Enclosures 2T2040GA & 2T511GA on Page 148

# Control Your ET90000 Remotely!

**NEW**



The new ET90000 PC Application gives you remote control of your device from any location. Gain real-time remote control of circuits, perform firmware updates, or download events, zones, and holidays anywhere! The PC App is great for creating schedules before, during, or after installation.

## ET90000 Series Accessories



The ET9100 Replacement Door Assembly includes a display, keypad, Ethernet, and remote override connections. The door assembly can be replaced without installing a new panel or rewiring any circuits. The replacement door is for use with the ET90415CR, ET90815CR, ET91215CR, and ET91615CR.



Extend the versatility of the ET90000 series with remote control over Ethernet. This module can be used as an upgrade or replacement part to enable ET90000 series controllers to be configured, monitored, and controlled remotely with software for the PC. Works with all ET90000 models.

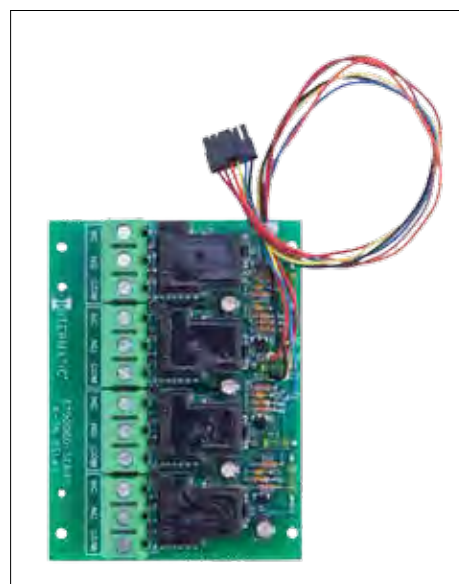

The ET9250 Relay Module can be used as a replacement part or for upgrading the number of circuits in the ET90000 controller. The relay module comes in 4-circuit packs for upgrading to a maximum of 16 circuits. Each module includes four SPDT 30 Amp relays, to be used with ET90415CR, ET90815CR, ET91215CR, and ET91615CR.

Model #	Description
ET9100	Door Assembly

Model #	Description
ET9232	Ethernet Module

Model #	Description
ET9250	Relay Module

# Manage Intuitively

The ET8415 7-Day Astronomic Time Switch is the ultimate tool for energy management. Complete with 4-circuit control to cover different areas of your facility, the ET8415 features easy-to-use, to-the-minute programming for reduced energy costs. Just name the application and the ET8415CR is in tune with your facility demands.

**NEW**

## ET8415CR 7-Day Astronomic Time Switch



- Automatically adjusts voltages between 120 and 277 VAC, 50/60Hz
- 56 ON/OFF events per week
- 8 astronomic events
- 100+ hour supercapacitor maintains time and date after power loss
- To-the-minute accuracy
- Temporary override or permanent manual override
- Automatic Daylight Saving Time adjustment

Model #	Circuits	Enclosure
ET8415CR	4 x SPST	Type 3R Steel Indoor/Outdoor

### Ratings:

**Note:** The electronic mechanism snaps into Intermatic enclosure 2T511GA, replacing mechanical mechanisms, if desired.  
**Input Voltage:** 120/208/240/277 VAC  
**Cycle:** 50/60 Hz.  
**Switch Rating:** 30 Amp Inductive/Resistive, 120, 240 VAC, 20 Amp Resistive, 28 VDC, 1 HP, 120 VAC, 2 HP, 240 VAC, 5 Amp Tungsten, 120-240 VAC, 20 Amp Ballast, 120-277 VAC  
**Wiring Terminals:** #18 to #10 AWG wire  
**Min. ON/OFF Times:** 1 minute  
**Max. ON/OFF Times:** 6 days 23 hours 59 minutes  
**Warranty:** Limited 1 year



## Common ET8415 Applications

- Indoor Lighting
- Outdoor Lighting
- Bell Ringing
- Billboard Lighting
- Gas Stations
- Security Lighting

# Meet Your New Time Switch!

Our mission is to help you find the ET Series time switch that meets your demands. Simply create your time switch profile in 3 easy steps and then find your perfect match.

The versatile 24-Hour, 7-Day ET series time switches feature one SPST circuit, one SPDT circuit, or two SPST circuits. They can be installed in an indoor or rainproof enclosure or shipped as a mechanism only.

You name the application and we'll deliver the practical solution for you!

## Find Your Time Switch Match in 3 Easy Steps!

**1** Choose your schedule from these options:

24-Hour
7-Day
7-Day Astronomic

**2** Choose your circuit/switch type from these options:

One SPST Circuit	
One SPDT Circuit	
Two SPST Circuits	

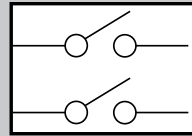
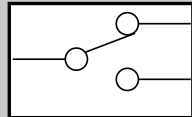
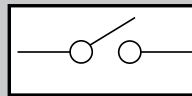

**3** Choose your enclosure from these options:

Indoor Type 1 Steel
Outdoor Type 3R Plastic
Outdoor Type 3R Steel
Mechanism Only

Find the time switch that matches your profile from the table on the next page!





Indoor Type 1 Steel



Outdoor Type 3R Plastic



Outdoor Type 3R Steel

**ET Series  
Time Switches**



- Automatic Daylight Saving Time adjustment
- Temporary and permanent manual overrides
- To-the-minute programming accuracy
- Field-replaceable 3-year battery backup
- Astronomic programming can be combined with independent programs to provide a sunset ON and time OFF program
- 28 setpoints (14 ON/OFF per channel)

**24-Hour Schedule**

**1 Circuit SPST Switch**

Model #	Enclosure
ET1105CM	-
ET1105C	Indoor Type 1 Steel
ET1105CPD82	Outdoor Type 3R Plastic
ET1105CR	Outdoor Type 3R Steel

**1 Circuit SPDT Switch**

Model #	Enclosure
ET1115CM	-
ET1115C	Indoor Type 1 Steel
ET1115CPD82	Outdoor Type 3R Plastic
ET1115CR	Outdoor Type 3R Steel

**2 Circuits SPST Switch**

Model #	Enclosure
ET1125CM	-
ET1125C	Indoor Type 1 Steel
ET1125CPD82	Outdoor Type 3R Plastic
ET1125CR	Outdoor Type 3R Steel

**7-Day Schedule**

**1 Circuit SPST Switch**

Model #	Enclosure
ET1705CM	-
ET1705C	Indoor Type 1 Steel
ET1705CPD82	Outdoor Type 3R Plastic
ET1705CR	Outdoor Type 3R Steel

**1 Circuit SPDT Switch**

Model #	Enclosure
ET1715CM	-
ET1715C	Indoor Type 1 Steel
ET1715CPD82	Outdoor Type 3R Plastic
ET1715CR	Outdoor Type 3R Steel

**2 Circuits SPST Switch**

Model #	Enclosure
ET1725CM	-
ET1725C	Indoor Type 1 Steel
ET1725CPD82	Outdoor Type 3R Plastic
ET1725CR	Outdoor Type 3R Steel

**7-Day Schedule Astronomic**

**1 Circuit SPST Switch**

Model #	Enclosure
ET8015CM	-
ET8015C	Indoor Type 1 Steel
ET8015CPD82	Outdoor Type 3R Plastic
ET8015CR	Outdoor Type 3R Steel

**1 Circuit SPDT Switch**

Model #	Enclosure
ET8115CM	-
ET8115C	Indoor Type 1 Steel
ET8115CPD82	Outdoor Type 3R Plastic
ET8115CR	Outdoor Type 3R Steel

**2 Circuits SPST Switch**

Model #	Enclosure
ET8215CM	-
ET8215C	Indoor Type 1 Steel
ET8215CPD82	Outdoor Type 3R Plastic
ET8215CR	Outdoor Type 3R Steel

See Accessories/enclosures on Page 146

**Ratings:**

**Note:** The electronic mechanism snaps into Intermatic time switch enclosure models 2T2040GA, 2T511GA, 2T2500GA, and 2T2926A, replacing mechanical mechanisms, if desired.

**Input Voltage:** 120/208/240/277 VAC

**Cycle:** 50/60 Hz.

**Switch Rating:** 30 A Inductive/Resistive, 120/240 VAC, 20 A Resistive, 28 VDC, 1 HP, 120 VAC, 2 HP, 240 VAC, 5 A Tungsten, 120/240 VAC, 20 A Ballast, 120-277 VAC

**SPDT models Normally Open (NO), Normally Closed (NC) contact ratings:** 20 A (NO), 10 A (NC) Resistive/Inductive, 120/240 VAC, 1 HP (NO), ¼ HP (NC), 120 VAC, 2 HP (NO), ½ HP (NC), 240 VAC, 5 A Tungsten (NO), 120/240 VAC, 20 A (NO), 3 A (NC) Ballast, 120-277 VAC

**Simultaneous Feature:** 2-circuit models can be configured for simultaneous (DPST) operation.

**Pulse Feature:** 2-circuit models feature 2-second pulse option for contactor and bell ringing applications

**Wiring Terminals:** #18 to #10 AWG wire

**Min. ON/OFF Times:** 1 minute

**Max. ON/OFF Times:** 23 hours 59 minutes for 24-Hour models, 6 days 23 hours 59 minutes for 7-Day models

**Warranty:** Limited 1 year

# Having Trouble Keeping Track of Your Maintenance Schedule?

# Count On The Pro

The Talento882 DIN Rail timer's hour meter and service indicator keeps you in tune with your application so you avoid costly service interruptions. Whether it's a lighting panel, boiler, water treatment control, irrigation pump, or other heavy-duty industrial application, the Talento882 removes the guesswork from your service schedule.

**NEW**



## TalentoPro

**Digital DIN Rail Mount 365-Day Time Switch with Intelligent Scheduling**



- Cumulative load monitoring hour counter with service indicator keeps track of runtime for maintenance schedules
- Automatically detects and adjusts input voltages (24 VAC/VDC through 240 VAC)
- Non-volatile memory (EEPROM)
- Random program switching function
- Assignable external input for countdown, override, or pulse function
- Weekly, Annual, and Holiday program scheduling (ON/OFF, Pulse, Cycle)
- Backlit LCD with load status indicator
- Automatic Daylight Saving Time adjustment
- Astronomic program scheduling (with OFF time capability)
- 400 memory spaces
- Replaceable battery provides backup with a 10-year carryover
- Shortest switching time: 1 second
- Manual switch: Automatic/Override/Fix ON/OFF
- Security features include lockable keypad cover and PIN code
- 2-circuit independent programming
- Optional PC Data transfer via IR remote interface (Talento Taxxi-P)

Model #	Circuits	Input Voltage
Talento882	2	24 VAC/VDC, 120-240 VAC, 50/60Hz

### Ratings:

**Power Consumption:** 3.7 VA

**Switch Type:** Circuit 1 SPDT, Circuit 2 SPST

**N.O. and N.C. Contacts:** 240 VAC, 16 A Resistive, 10 A General Purpose, 10 A Tungsten, 8 A Ballast, Pilot Duty B300

**Wire Connections:** Screw Terminals for #16 to #10 AWG

**Dimensions:** 3.35" H x 1.38" W (85 mm H x 35 mm W)

**Warranty:** 1 year

# Spending Too Much Time Updating Your Timers? Hail the Talento Taxxi

Streamline the programming process in your facility with the Talento Taxxi Dialog Set. Simply create schedules from your PC and then transfer the data via the hand-held programmer to each Talento882 or Talento890 Series.



## Remote Programming in 4 Easy Steps:

1. Load the CD-ROM into your PC.
2. Program your fixed, holiday, and astronomic schedules from your PC.
3. Transfer programs to the hand-held programmer.
4. Transfer programs at each Talento timer via the programmer's infrared interface.

- Talento Taxxi includes:**
- Windows-based software
  - Hand-held programmer
  - CD-ROM
  - USB Interconnect cable

## Talento Taxxi Remote PC Programmer

- Astronomic programming
- Fixed and floating holidays
- Stores up to 4 independent schedules

Model #	Description	Qty.
TalentoTaxxi	Hand-held remote programming tool for Talento890 Series	1
TalentoTaxxi-P	Hand-held remote programming tool for Talento882	1

### Mechanism Only, DIN Rail Mounting

Model #	Circuits	Input Voltage
Talento891-24*	1	24 VAC, 50/60 Hz
Talento892-24*	2	24 VAC, 50/60 Hz
Talento894-120*	4	120 VAC, 50/60 Hz
Talento894-24*	4	24 VAC, 50/60 Hz

### Type 3R, Outdoor Enclosure Mounting

Model #	Circuits	Input Voltage
GMX894-0-120*	4	120 VAC, 50/60 Hz

### Type 1, Indoor Enclosure Mounting

Model #	Circuits	Input Voltage
GMX894-I-120*	4	120 VAC, 50/60 Hz

\*Limited stock available

- Ratings:**  
**Switch Type:** SPDT  
**Switch Rating:** 16 A Resistive, 250 VAC per circuit  
**Environmental Rating:** -13°F to 131°F (-25°C to 55°C)  
**Mounting Surface:** DIN Rail (Type 1 & 3R available)  
**Shortest Switching Time:** 1 second



## Talento 800 Series Digital Din/Rail 365-Day Astronomic Timer Module



- Automatic Daylight Saving Time adjustment
- Programmable pulse events from 1 second or longer
- Cycle function is programmable for both total cycle duration and ON duration in minutes or seconds
- Non-volatile memory (EEPROM)
- Astronomic programming (via PC data transfer)
- 400 program spaces

# No Tools Required! Mechanism Snaps Into Alternative Enclosures

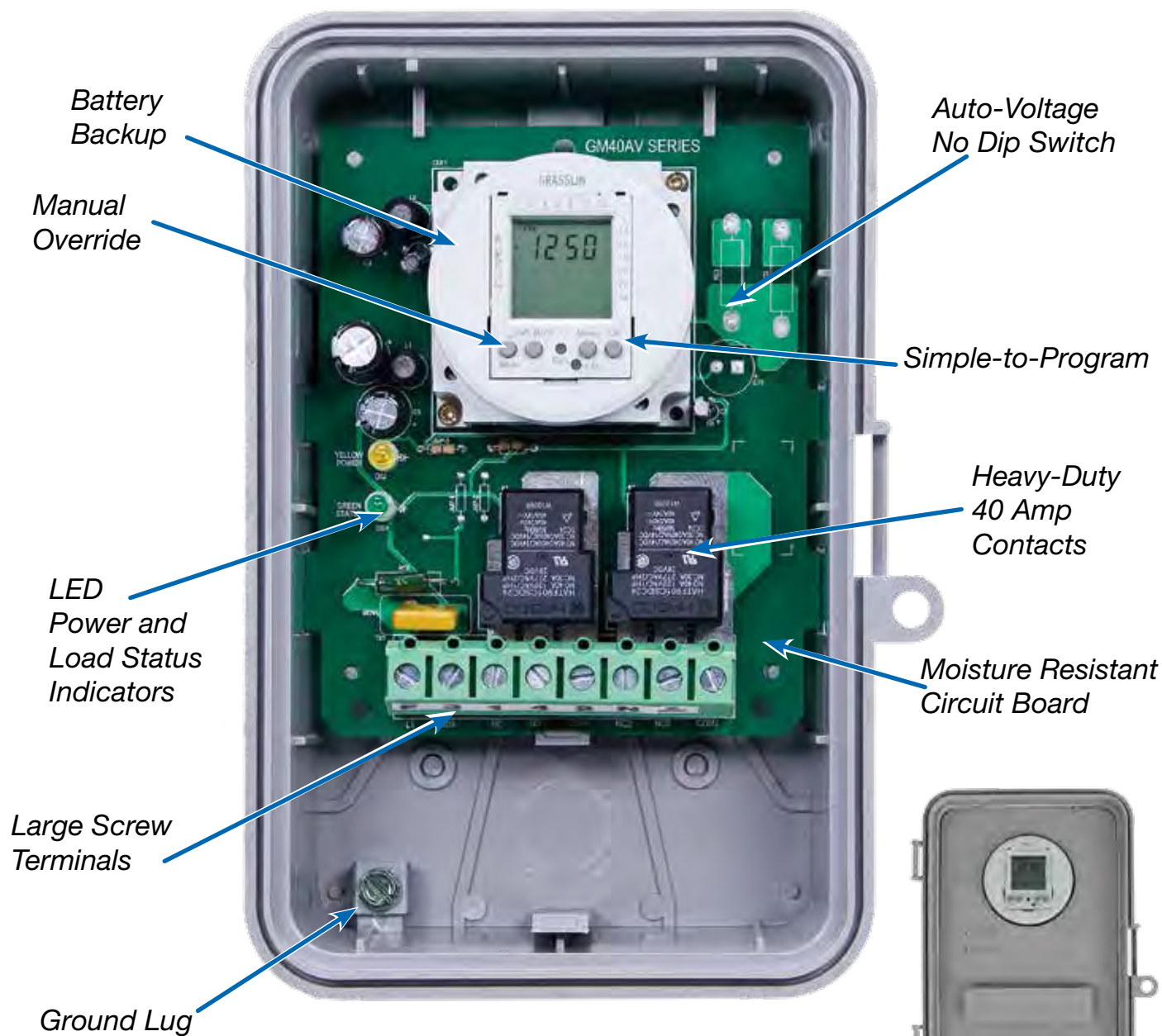

## GM40AVE 40 Amp Auto-Voltage Time Switch



- Automatically adjusts voltages between 120-277 VAC
- 24-Hour/7-Day flexible scheduling
- Power and Status LED indicators
- DPDT Switching Configuration (2 N.O. and 2 N.C. Contacts)
- 20 Setpoint programs
- Temporary Manual Override
- Lithium battery with 7-year carryover
- Type 3R enclosure with lockable hasp
- To-the-minute accuracy
- Heavy-duty 40 Amp contact rating

### Ratings:

#### N.O. Contacts:

40 A, Resistive, 120-277 VAC, 1 HP (16 FLA, 90 LRA), 120 VAC,  
2 HP (12FLA, 52LRA), 208-277 VAC, 30A, Ballast, 120 VAC,  
20 A, Ballast, 277 VAC, 15 A, Tungsten, 120 VAC

#### N.C. Contacts:

30 A, Resistive, 120-277 VAC, 1 HP (12 FLA, 30 LRA), 120 VAC,  
2 HP (10 FLA, 30 LRA), 240 VAC, 2 A, Tungsten, 120 VAC, 10 A, Ballast, 277 VAC

**Wiring Connections:** Screw box lug terminals up to (1) #8 AWG wire

**Operating Temperature:** -40°F to 131°F (-40°C to 55°C)

**Operating Humidity:** 0 to 95% RH, non-condensing

**Electrical Life:** 50,000 Operations at Full Load

**Warranty:** Limited 1 year

Model #	Input Voltage	Switch Type	Battery Backup
GM40AVE	120-277 VAC, 50/60 Hz	DPDT	Yes

For enclosure dimensions, see Page 151

## GMX/FM1 Series One and Two-Circuit Electronic Time Switches



- 24-Hour or 7-Day applications
- Finger-safe terminals
- Manual Daylight Saving Time adjustment (D20 Models)
- Auto Daylight Saving Time adjustment (D50 Models)
- Manual override with load status indication
- GMXFM1D50 & GMX2DFM50 available in 7 languages: English, German, French, Italian, Spanish, Dutch, and Portuguese
- Heavy-duty relay contacts for switching low or line voltage loads
- Enclosure provides space for field added contactor or other accessories



A.

### 1 Circuit

Model #	Input Voltage	Setpoint Programs	Enclosure	Battery Backup Carryover
A. GMXFM1D20-I-120	120 VAC, 50/60 Hz	20	Type 1 Indoor	7 years
GMXFM1D20-I-24	24 VAC/VDC, 50/60 Hz	20	Type 1 Indoor	7 years
GMXFM1D20-I-240	240 VAC, 50/60 Hz	20	Type 1 Indoor	7 years
GMXFM1D50-I-12	12 VAC/VDC, 50/60 Hz	50	Type 1 Indoor	3 years
GMXFM1D50-I-120	120 VAC, 50/60 Hz	50	Type 1 Indoor	3 years
GMXFM1D50-I-24	24 VAC/VDC, 50/60 Hz	50	Type 1 Indoor	3 years
GMXFM1D50-I-240	240 VAC, 50/60 Hz	50	Type 1 Indoor	3 years
GMXFM1D20-O-120	120 VAC, 50/60 Hz	20	Type 3R Outdoor	7 years
GMXFM1D20-O-24	24 VAC/VDC, 50/60 Hz	20	Type 3R Outdoor	7 years
GMXFM1D20-O-240	240 VAC, 50/60 Hz	20	Type 3R Outdoor	7 years
GMXFM1D50-O-12	12 VAC/VDC, 50/60 Hz	50	Type 3R Outdoor	3 years
GMXFM1D50-O-120	120 VAC, 50/60 Hz	50	Type 3R Outdoor	3 years

### 2 Circuit

Model #	Input Voltage	Setpoint Programs	Enclosure	Battery Backup Carryover
GMX2FM2D50I-120	120 VAC, 50/60 Hz	50	Type 1 Indoor	3 years
GMX2FM2D50I-24	24 VAC/VDC, 50/60 Hz	50	Type 1 Indoor	3 years
GMX2FM2D50I-240	240 VAC, 50/60 Hz	50	Type 1 Indoor	3 years
GMX2FM2D500-120	120 VAC, 50/60 Hz	50	Type 3R Outdoor	3 years

<b>Ratings:</b>	<b>N.O. Contact</b>	<b>Warranty:</b> Limited 1 Year
<b>Power Consumption:</b> 4 VA	½ HP, 120 VAC	
<b>Switch Type:</b> SPDT relay	1 HP, 240 VAC	
<b>Wiring Connections:</b> Screw terminal connections	16 A, 277 VAC Resistive	
<b>N.C. Contact:</b>	12 A, 120 VAC, Ballast	
16 A, 277 VAC, Resistive	8 A, 240 VAC, Ballast	
8 A, 24 VDC	720 VA, 240 VAC, Pilot Duty	
360 VA, 120 VAC, Pilot Duty	360 VA, 120 VAC, Pilot Duty	
	600 W, 120 VAC, Tungsten	
	1000 W, 240 VAC, Tungsten	

For enclosure dimensions, see Page 151

**NEW**



**FM1D14 Series  
One-Circuit Panel Mount**



- 24-Hour or 7-Day applications
- 14 setpoint programs
- Simple-to-use programming
- Manual override with status indication
- Rechargeable battery backup with industry-leading 2500-Hour carryover
- 5 preset adjustable block programs

Model #	Input Voltage
FM1D14-12U	12 VDC
FM1D14-24U	24 VAC/VDC, 50/60Hz
FM1D14-AV-U	120-277 VAC, 50/60Hz

NOTE: Clear dust cover order #DC-FME

**Ratings:**

**Power Consumption:** 1.4 W  
**Switch Type:** SPDT relay  
**N.O. Contact:**  
 15A, 277 VAC, General Use  
 10 FLA, 60 LRA, 250 VAC  
 ½ HP, 120 VAC, 1 HP, 250 VAC  
 1000 W, 120 VAC, Tungsten  
 8 A, 277 VAC, STD Ballast  
 B300 Pilot Duty  
 4.9 A, 120 VAC, Electronic Ballast

**N.C. Contact:**

15 A, 277 VAC, General Use  
 10 FLA, 60 LRA, 250 VAC  
 ½ HP, 120/240 VAC  
 12 A, 24 VDC, Resistive  
 8 A, 120 VAC, STD Ballast  
**Dimensions:**  
 2.36" x 2.36" (60 mm x 60 mm)  
**Wiring Connections:**  
 ¼" quick connect terminals  
**Operating Temperature:**  
 -40°F to 131°F (-40°C to 55°C)  
 (limited display function at -13°F)  
**Warranty:** 1-year limited



**FM2D50 Series  
Two-Circuit  
Surface and Flush Mount**



- 24-Hour or 7-Day applications
- Screw terminals for #10 to #24 AWG
- Clear dust cover
- 50 setpoint programs
- Free weekday block formation
- Selectable languages: English, German, French, Italian, Spanish, Portuguese, and Dutch
- Auto Daylight Saving Time adjustment
- Easy-to-follow menu driven programming
- Manual override with load status indication
- Battery backup with 3-year carryover
- Each circuit operates independently or combined
- Heavy-duty relay contacts for switching low or line voltage loads

Model #	Input Voltage
FM2D50-24	24 VAC/VDC, 50/60 Hz
FM2D50-120	120 VAC, 50/60 Hz
FM2D50-240	240 VAC, 50/60 Hz

**Ratings:**

**Power Consumption:** 4 VA  
**Switch Type:** 2x SPDT Relay  
**N.O. and N.C. Contact:**  
 16 A, 277 VAC Resistive  
 ½ HP, 120 VAC, 1 HP, 240 VAC  
 12 A, Ballast 120 VAC, 8A, Ballast 240 VAC  
 720 VA, 240 VAC Pilot Duty 360 VA, 120 VAC Pilot Duty  
 600 W, Tungsten, 120 VAC 100 W, Tungsten 240 VAC  
**Wiring Connection:** Screw terminals for #10 to #24 AWG  
**Warranty:** 1 year



For DIN rail mounting, order MB-DIN  
 (DIN Rail Mounting Base)  
 See Accessories on Page 153

**The FMD Series**  
**modules are ideal for**  
*HVAC, pumps, lighting, and other*  
*industrial and commercial equipment.*

**FM1D50 Series**  
**One-Circuit Surface/DIN Rail**  
**and Flush Mount**



- 50 setpoint programs
- Free weekday block formation
- Selectable languages: English, German, French, Italian, Spanish, Portuguese, and Dutch
- Auto Daylight Saving Time adjustment
- 24-Hour or 7-Day applications
- Easy-to-follow menu driven programming
- Manual override with load status indication
- Battery backup with 3-year carryover
- Heavy-duty relay contacts for switching low or line voltage loads

**A. Panel Mounting**

Model #	Input Voltage	Clear Dust Cover
FM1D50-12U	12 VAC/VDC, 50/60 Hz	No
FM1D50-120U	120 VAC, 50/60 Hz	No
FM1D50-24U	24 VAC/VDC, 50/60 Hz	No
FM1D50-240U	240 VAC, 50/60 Hz	No

Note: Clear dust cover order DC-FME

**B. Flush Mounting**

Model #	Input Voltage	Clear Dust Cover
FM1D50E-12	12 VAC/VDC, 50/60 Hz	Yes
FM1D50E-120	120 VAC, 50/60 Hz	Yes
FM1D50E-24	24 VAC/VDC, 50/60 Hz	Yes
FM1D50E-240	240 VAC, 50/60 Hz	Yes

**C. Surface/DIN Rail Mounting**

Model #	Input Voltage	Clear Dust Cover
FM1D50A-12	12 VAC/VDC, 50/60 Hz	Yes
FM1D50A-120	120 VAC, 50/60 Hz	Yes
FM1D50A-24	24 VAC/VDC, 50/60 Hz	Yes
FM1D50A-240	240 VAC, 50/60 Hz	Yes

**Ratings:**

**Power Consumption:** 4 VA  
**Switch Type:** SPDT Relay  
**N.O. Contact:**  
 ½ HP, 120 VAC  
 1 HP, 240 VAC  
 12 A, Ballast 120 VAC  
 8 A, Ballast 240 VAC  
 720 VA, 240 VAC Pilot Duty  
 360 VA, 120 VAC Pilot Duty  
 600 W, Tungsten 120 VAC  
 1000 W, Tungsten 240 VAC

**N.C. Contact:**  
 16 A, 277 VAC Resistive  
 8 A, 24 VDC  
 360 VA, 120 VAC Pilot Duty

**Dimensions:**  
 FM1D50A 2.83" W x 4" H (72 mm x 102.5 mm)  
 FM1D50E 2.83" W x 4" H (72 mm x 102.5 mm)  
 FM1D50 2.36" W x 2.36" H (60 mm x 60 mm)

**Wiring Configurations:**  
 FM1D50 and FM1D50E: ¼" quick connect terminals  
 FM1D50A: Screw terminals for #10 to #24 AWG wire

**Operation Temperature:** -13°F to 131°F  
 (-25°C to 55°C) (Limited display function at -13°F)

**Warranty:** 1 year



A.



B.



C.



A.



B.



C.

Perfect for controlling lighting, ventilation, heating, cooling, or other electrical loads in commercial and industrial applications.

## FM1D20 Series One-Circuit Electronic Time Switches



- 20 setpoint programs
- 3 preset adjustable block programs
- Daylight Saving Time adjustment
- 24-Hour or 7-Day applications
- Simple-to-use programming
- Manual override with load status indication
- Battery backup with 7-year carryover

### A. Panel Mounting

Model #	Input Voltage	Clear Dust Cover
FM1D20-120U	120 VAC, 50/60 Hz	No
FM1D20-24U	24 VAC/VDC, 50/60 Hz	No
FM1D20-240U	240 VAC, 50/60 Hz	No

### B. Flush Mounting

Model #	Input Voltage	Clear Dust Cover
FM1D20E-120	120 VAC, 50/60 Hz	Yes
FM1D20E-24	24 VAC/VDC, 50/60 Hz	Yes
FM1D20E-240	240 VAC, 50/60 Hz	Yes

### C. Surface / DIN Rail Mounting

Model #	Input Voltage	Clear Dust Cover
FM1D20A-120	120 VAC, 50/60 Hz	Yes
FM1D20A-24	24 VAC/VDC, 50/60 Hz	Yes
FM1D20A-240	240 VAC, 50/60 Hz	Yes

#### Ratings:

**Power Consumption:** 4 VA

**Switch Type:** SPDT Relay

#### N.O. Contact:

½ HP, 120 VAC

1 HP, 240 VAC

16 A, 277 VAC Resistive

12 A, Ballast 120 VAC

8 A, Ballast 240 VAC

720 VA, 240 VAC Pilot Duty

360 VA, 120 VAC Pilot Duty

600 W, Tungsten 120 VAC

1000 W, Tungsten 240 VAC

#### N.C. Contact:

16A, 277 VAC Resistive

8A, 24 VDC

360 VA, 120 VAC Pilot Duty

#### Dimensions:

FM1D20A: 2.83" W x 4" H (72 mm x 102.5 mm)

FM1D20E: 2.83" W x 2.83" H (72 mm x 72 mm)

FM1D20: 2.36" W x 2.36" H (60 mm x 60 mm)

#### Wiring Connections:

"A" Models: Screw terminals for #10 to #24 AWG Wire

"E" Models: ¼" Quick connect terminals

**Warranty:** 1 year



## EH10 and EH40 Electronic Water Heater Time Switches



- 42 ON/OFF events per week
- 7-day scheduling
- To-the-minute programming and time-keeping accuracy
- External override switch
- LED load indicator
- Replaceable battery backup

Model #	Input Voltage	Switch	Watts	Enclosure
EH10	120 VAC	SPST	3600	Type 1 Indoor Steel
D. EH40	240 VAC	DPST	7200	Type 1 Indoor Steel

**Ratings:**  
**Switch Rating for EH10:**  
 30 A Inductive, 120 VAC 60Hz  
 30 A Resistive, 120 VAC 60Hz  
 5 A Tungsten, 120 VAC, 1 HP, 120 VAC  
**Switch Rating for EH40:**  
 30 A Inductive, 240 VAC 60Hz  
 30 A Resistive, 240 VAC 60Hz  
 5 A Tungsten, 240 VAC, 1 1/2 HP, 240 VAC



D.

## CT2000 Percentage Cycle Time Switch



- Provides 8 field selectable timer durations of 30 seconds, 1, 3, 5, 10, 30 minutes and 1 or 4 hours
- Front cover buttons enable true flexibility for repetitive cycle times
- Temporary and permanent manual overrides
- 30 separate positions enable precise percentage ON time selection
- User settings stored in non-volatile memory
- No DIP switches to program cycle time
- Functions in dusty, ammonia, and wash-down environments
- Withstands surges of up to 6,000 VAC
- Type 3R Indoor/Outdoor Aluminum Enclosure

Model #	Input Voltage	Switch
E. CT2000	120 or 240 VAC, 60 Hz	SPST

**Ratings:**  
**Resistive:** 20 A, 120/240 VAC, 28 VDC  
**Motor:** 1 HP, 120 VAC, 2 HP, 240 VAC  
**General Purpose:** 20 A, 240 VAC  
**Tungsten (Incandescent):** 5 A, 240 VAC  
**Pilot Duty:** 470 VA, 240 VAC  
**Ballast (Fluorescent):** 10 A, 277 VAC  
**Surge Protection:** up to 6,000 VAC  
**Warranty:** Limited 1 year



E.

# Invest in peace of mind

## **INTERMATIC®** **AG Series**

**SURGE PROTECTIVE DEVICE**

ANSI/UL1449 3rd EDITION  
Type 4X ENCLOSURE

**Model: AG3000**

### GREEN INDICATOR

**ON: UNIT OPERATING CORRECTLY**

**OFF: PROTECTION DIMINISHED,  
REPLACE UNIT**

120/240 VAC 50-60 Hz  
In : 10kA SCCR: 20kA

MCOV: L-N: 150V L-L: 300V  
VPR: L-N/G: 600 L-L: 900  
TYPE 1 or 2 SPD

**INTERMATIC INCORPORATED**  
Spring Grove, Illinois 60081-9698

**MADE IN MEXICO**



US  
LR38068  
TYPE 1



C US  
LR38068  
TYPE 2

# **INTERMATIC®**



For more information on the AG3000, see page 97

# Electromechanical Time Switches



**Landscape lighting control**    Agricultural facilities

Ventilation    *Lighting*    Access controls    **Motors**

**Hydroponic systems**    Waste water Management

**Manufacturing facilities**    *Hot Water Heaters*

**Pumps**    *Security*    Pump control    Animal feeders

*Environmental chamber*    **Pool and Spa control**

**Food equipment**    General purpose electrical circuits



## WHAHQ Series Auto Volt 24-Hour/7-Day Water Heater Time Switches



- Heavy-duty 40 Amp contact rating
- Controls commercial, industrial, or residential electric water heaters up to 10,000 Watts capacity running at 250 VAC
- Type 3R Outdoor Enclosure
- Manual override switch (ON/Auto/OFF)
- Battery backup with 7-Day carryover
- Power and status LED indicators
- Automatically adjusts voltages between 120 and 277 VAC
- 96 captive trippers 48 ON/OFF
- Easy-to-set true clockface

Model #	Programming	Switch Type	Timing Interval
WHAHQ4	24-Hour	DPDT	15 min.
WHAHQ7	7-Day	DPDT	2 hr.

<b>Ratings:</b> <b>Input Voltage:</b> 120-277 VAC, 50/60 Hz <b>Switch Rating:</b> <b>N.O. Contacts:</b> 40 A Resistive, 250 VAC 10,000 W <b>N.C. Contacts:</b> 30 A Resistive, 250 VAC 7,500 W <b>Wiring Connections:</b> Screw box lug terminals	<b>Environmental Ratings:</b> <b>Operating Temperature:</b> -4°F to 104°F (-20°C to 40°C) <b>Operating Humidity:</b> 0 to 95% RH, non-condensing <b>Electrical Life:</b> 50,000 operations at full load <b>Patent Pending</b> <b>Warranty:</b> 1 year
---	---

For enclosure dimensions, see page 151

# 100 Mechanical Timers All-In-One



## No Battery Backup

Model #	Programming	Switch Type	Minimum On/Off Time
GM40AV	24-Hour	DPDT	15 min.
GM40AV-W	7-Day	DPDT	2 hr.
GM40AV-M*	24-Hour	DPDT	15 min.

## Battery Backup (7-Day Carryover)

Model #	Programming	Switch Type	Minimum On/Off Time
GM40AV-Q	24-Hour	DPDT	15 min.
GM40AV-QW	7-Day	DPDT	2 hrs.

\* Mechanism only

## GM40AV 40 Amp Auto-Voltage Time Switch



- 96 captive trippers enable 48 ON/OFF operations each day
- Automatically adjusts voltages between 120 and 277 VAC
- Type 3R Outdoor Enclosure
- Manual override switch (ON/Auto/OFF)
- Easy-to-set true clockface
- Power and status LED indicators
- Mechanism simply snaps into many enclosures

<b>Ratings:</b> <b>N.O. Contacts:</b> 40 A Resistive, 120-277 VAC 1 HP (16 FLA, 90 LRA), 120 VAC 2 HP (12 FLA, 52 LRA), 208-277 VAC 30 A Ballast, 120 VAC 20 A Ballast, 277 VAC 15 A Tungsten, 120 VAC 300 VA Pilot Duty, 120-240 VAC	<b>N.C. Contacts:</b> 30 A Resistive, 120-277 VAC 1 HP (12 FLA, 30 LRA), 120 VAC 2 HP (10 FLA, 30 LRA), 240 VAC 2 A Tungsten, 120 VAC 10 A Ballast, 277 VAC  <b>Operating Temperature Range:</b> -40°F to 131°F (-40°C to 55°C)  <b>Battery Backup Models:</b> -4°F to 131°F	<b>Operating Humidity:</b> 0 to 95% non-condensing <b>Wire Connections:</b> Screw box lug terminals up to one #8 AWG wire <b>Electrical Life:</b> 50,000 operations at full load <b>Patent Pending</b> <b>Warranty:</b> 1 year
---	--	--

For enclosure dimensions, see page 151

cut through the  
darkness

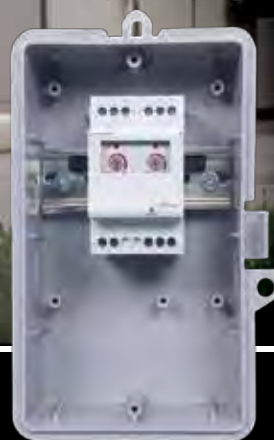
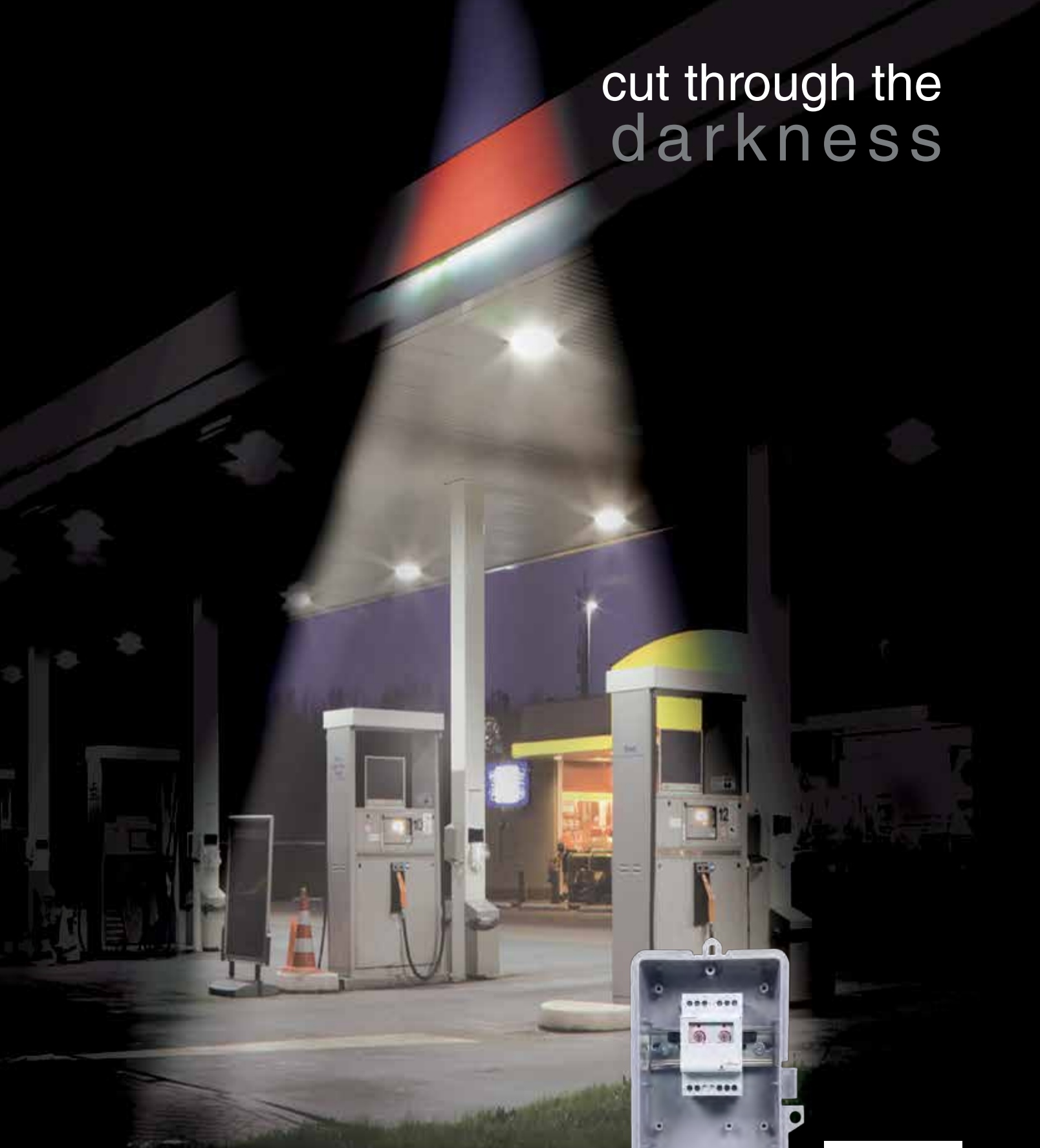

**INTERMATIC®**

*For more information on LightMaster, see pages 62-67*

# Mechanical Time Switches



Agricultural *Billboards*

**Signs** Indoor / Outdoor Lighting

HVACR *Ventilation* Fountains

Heaters Landscape Lighting

**Fans** *Oil Well Pumps* **Pools**

**Control Panels** *Water Heaters*



## T100 Series 24-Hour Time Switches



- Direct 24-Hour control of most loads
- Up to 12 ON/OFF operations each day with minimum ON/OFF times of one hour
- Manual override
- One ON and one OFF tripper included

### A. Mechanism Only

Model #	Switch	Input Voltage	HP Rating
T101M	SPST	125 VAC, 60Hz	2
T103M	DPST	125 VAC, 60Hz	2
T104M	DPST	208-277 VAC, 60Hz	5
T106M **	1NO/1NC	208-277 VAC, 60Hz	5

### B. Steel Indoor Enclosure

Model #	Switch	Input Voltage	HP Rating
T101	SPST	125 VAC, 60Hz	2
T102	SPST	208-277 VAC, 60Hz	5
T103	DPST	125 VAC, 60Hz	2
T104	DPST	208-277 VAC, 60Hz	5
T104-50	DPST	208-277 VAC, 50Hz	5
T101B*	SPST	125 VAC, 60Hz	2
T105 **	1NO/1NC	125 VAC, 60Hz	2

### C. Steel Indoor/Outdoor Enclosure

Model #	Switch	Input Voltage	HP Rating
T101R	SPST	125 VAC, 60Hz	2
T102R	SPST	208-277 VAC, 60Hz	5
T103R	DPST	125 VAC, 60Hz	2
T104R	DPST	208-277 VAC, 60Hz	5
T106R**	1NO/1NC	208-277 VAC, 60Hz	5

### D. Plastic Indoor/Outdoor Enclosure

Model #	Switch	Input Voltage	HP Rating
T101P	SPST	125 VAC, 60Hz	2
T102P	SPST	208-277 VAC, 60Hz	5
T103P	DPST	125 VAC, 60Hz	2
T104P	DPST	208-277 VAC, 60Hz	5

### E. See-Through Indoor/Outdoor Enclosure

Model #	Switch	Input Voltage	HP Rating
T101PCD82	SPST	125 VAC, 60Hz	2
T103PCD82	DPST	125 VAC, 60Hz	2
T104PCD82	DPST	208-277 VAC, 60Hz	5

\*Separate clock motor terminals for switching circuits not on line voltage.  
\*\*Can be wired as SPDT

**Ratings:**  
**Switch Ratings:** 40 A Resistive each pole, 120-480 VAC, 40 A Inductive Tungsten, 120, 240 or 277 VAC, 1000 VA Pilot Duty each pole, 120-277 VAC, 2 HP, (24 FLA), 120 VAC, 5 HP, (28 FLA), 240 VAC

**Power Consumption:** 3 W max.  
**Operating Temperature:** -40°F to 130°F (-40°C to 54°C)  
**Warranty:** 1 year

For optional enclosure, see page 146; For additional trippers, see page 153; For replacement motors, see page 153





Indoor Enclosure		
Model #	Switch	Input Voltage
T171	SPST	125 VAC, 60Hz
T172	SPST	208-277 VAC, 60Hz
T173	DPST	125 VAC, 60Hz
T174	DPST	208-277 VAC, 60Hz
T175**	1NO/1NC	125 VAC, 60Hz
F. T176**	1NO/1NC	208-277 VAC, 60Hz

Outdoor Enclosure		
Model #	Switch	Input Voltage
T173R	DPST	125 VAC, 60Hz
T174R	DPST	208-277 VAC, 60Hz
G. T1471BR*	4PST	125 VAC, 60Hz
T1472BR*	4PST	208-277 VAC, 60Hz
T1475BR*	4PST	480 VAC, 60Hz
T1871BR* †	2NO/2NC	125 VAC, 60Hz
H. T171CR	SPST	125 VAC, 60Hz
T173CR	DPST	125 VAC, 60Hz
T174CR	DPST	208-277 VAC, 60Hz
T1471BCR*	4PST	125 VAC, 60Hz

\*Separate clock motor terminals for switching circuits not on line voltage  
 \*\*Can be wired as SPDT  
 † Can be wired as DPDT

### T170, T1400 and T1800 Series 24-Hour Time Switches with Skipper and Carryover



- For commercial, industrial and residential applications
- Controls loads up to 40 Amps per pole
- Direct 24-Hour control of most loads
- Up to 10 ON/OFF operations each day
- Minimum ON/OFF times of one hour
- Manual override
- One ON and one OFF tripper and three day-skipper screws

#### Models with Carryover (T171CR, T173CR, T174CR, T1471BCR)

- Minimum of 16 hours carryover operation
- Carryover automatically rewinds for one hour after power resumes
- 4PST models are ideal for 3-phase load control

**Ratings:**  
**Switch Ratings:** 40 A Resistive each pole, 120-480 VAC, 40 A Inductive, Tungsten, 120, 240 or 277 VAC, 1000 VA Pilot Duty each pole, 120-277 VAC, 2 HP, (24 FLA), 120 VAC, 5 HP, (28 FLA), 240 VAC 4PST models also 7.5 HP (28 FLA) 208 VAC, 10 HP (28 FLA) 240 VAC 3-phase  
**Power Consumption:** 3 W max.  
**Operating Temperature:** -40°F to 130°F (-40°C to 54°C)  
**Warranty:** 1 year

For additional trippers, see page 153; For additional skipper screws, see page 152; For replacement motors, see page 153



A.



B.



C.

## T1900 Series and T1970 Series 24-Hour Time Switches with Skipper



- Provides up to 96 operations (48 ON/48 OFF) every 24 hours
- Skipper models provide 80 operations daily and can be omitted on selected day(s) of the week
- 15-minute intervals
- Trippers slide in and out of dial for fast, accurate setting

### Ratings:

Switch Ratings: 20 A, 125, 208-277 and 480 VAC, ½ HP, 120 VAC, 1 HP 240 VAC  
Power Input: 3 W Max.

Operating Temperature: -40°F to 130°F (-40°C to 54°C)

Warranty: 1 year

### Indoor Enclosure

Model #	Switch	Input Voltage	Skipper Wheel
A. T1905*	SPDT	125 VAC, 60 Hz	No
T1905E*	SPDT	480 VAC, 60 Hz	No
T1906*	SPDT	208-277 VAC, 60 Hz	No
T1975†	SPDT	125 VAC, 60 Hz	Yes
T1976†	SPDT	208-277 VAC, 60 Hz	Yes
T1975E†	SPDT	480 VAC, 60 Hz	Yes

### Steel Indoor/Outdoor Enclosure

Model #	Switch	Input Voltage	Skipper Wheel
B. T1975R†	SPDT	125 VAC, 60 Hz	Yes
T1976R†	SPDT	208-277 VAC, 60 Hz	Yes
T1975ER†	SPDT	480 VAC, 60 Hz	Yes

### Plastic Indoor/Outdoor Enclosure

Model #	Switch	Input Voltage	Skipper Wheel
C. T1905P*	SPDT	125 VAC, 60 Hz	No

\*Replacement Snap Switch 133T701A

†Replacement Snap Switch 133T698A

For additional trippers (156T1950A), see page 153;

For replacement motors, see page 153

# Industrial Grade Toughness

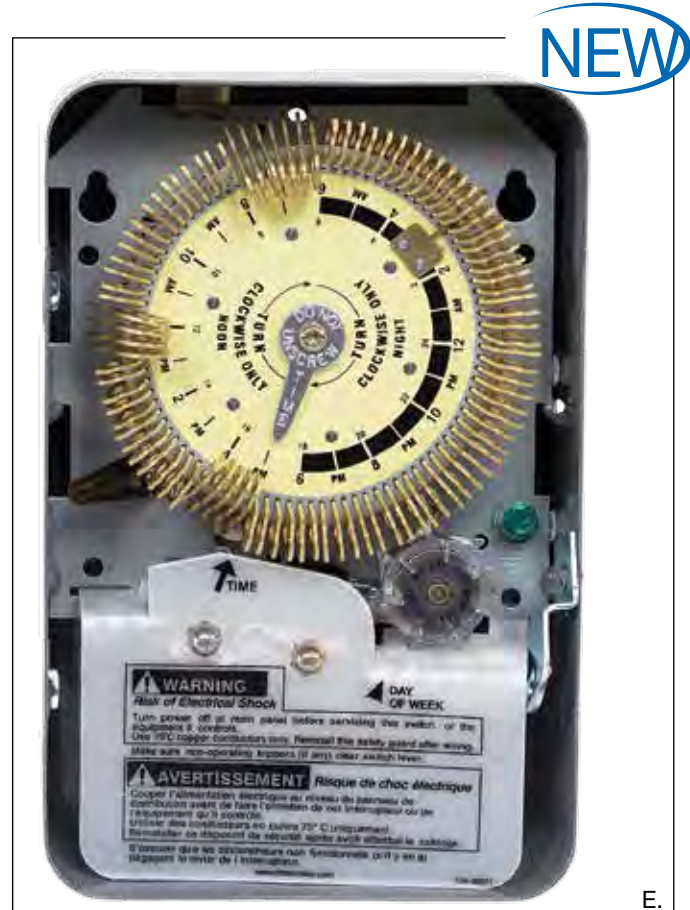

## T1905HD and T1975EHD Heavy-Duty Time Switch



- Heavy-duty metal dial withstands the most punishing environmental conditions
- Easy-to-set trippers slide in/out for fast, accurate setting
- Up to 96 operations (48 ON/48 OFF) every 24 hours
- 15-minute intervals
- Indoor enclosure

Model #	Switch	Input Voltage	Skipper Wheel	Motor
D. T1905HD	SPDT	120 VAC 60 Hz	No	120 VAC motor with protected gears
E. T1975EHD	SPDT	480 VAC 60 Hz	Yes	480 VAC, encapsulated motor

### Ratings:

**Switch Ratings:** 20 A Max., 120, 208-277 and 480 VAC, ½ HP, 120 VAC, 1 HP 240 VAC

**Power Input:** 3 W Max.

**Operating Temperature:** -40°F to 130°F (-40°C to 54°C)

**Warranty:** 1 year

*For maximum performance, Intermatic recommends adding a 5 to 8 minute offset to your ON/OFF events.*



A.

B.

## T50000 Series 7-Day Timing Control Centers with Carryover



- Includes photo control initiated/time switch terminated control
- Enable different ON/OFF programs each day of the week
- Recommended for applications needing to turn a load ON at dusk and OFF at a preset time
- Minimum of 16 hours carryover for maintaining preset schedules during power failures
- Only one hour of rewinding time required for every two hours of power outage
- Carryover automatically rewinds when power resumes
- Light level adjustment
- Single pole double throw switches and manual circuit bypass switches
- Controls the contactor coil circuit only

Model #	Circuits	Voltage
A. T51211BC	2	120 VAC, 60 Hz
B. T51311BC	3	120 VAC, 60 Hz

*Note: All models have separate clock motor terminals for switching circuits not on line voltage. They may be used with 24 volt systems if wired in accordance with NEC regulations. Not recommended for direct switching of tungsten, mercury vapor, or similar loads.*

**Rating:**  
**Enclosure:** Type 1 rated indoor steel 12 1/2" H x 8 3/4" W x 3 7/8" D  
**Contact Ratings:** 15 A, 1/2 HP, 125-250 VAC, 420 VA Pilot Duty, 150 W Tungsten, 125 VAC  
**Operating Temperature Range:** -40°F to 130°F (-40°C to 54°C)  
**Warranty:** 1 year



Includes  
K4121C Photo Control

For additional trippers (156T2548A), see page 153

# T7000B Series 7-Day Time Switches With Optional Carryover



- Different ON/OFF programs each day of the week
- True 7-day load control with minimum ON/OFF time of 3 ½ hours
- Separate clock motor terminals for switching loads not on-line voltage
- Carryover automatically rewinds when power resumes
- Minimum of 16 hours carryover for maintaining preset schedules during power failures

### Type 1 Steel Indoor Enclosure Without Carryover

Model #	Switch	Input Voltage
C. T7401B	4PST N.O.	120 VAC, 60 Hz
T7402B	4PST N.O.	208-277 VAC, 60 Hz
T7801B*	2 N.O./ 2 N.C.	120 VAC, 60 Hz
T7802B*	2 N.O./ 2 N.C.	208-277 VAC, 60 Hz

### Type 3R Steel Outdoor Enclosure With Carryover

Model #	Switch	Input Voltage
D. T7401BCR	4PST N.O.	120 VAC, 60 Hz

### Type 1 Steel Indoor Enclosure With Carryover

Model #	Switch	Input Voltage
T7401BC	4PST N.O.	120 VAC, 60 Hz
T7402BC	4PST N.O.	208-277 VAC, 60 Hz
T7801BC*	2 N.O./ 2 N.C.	120 VAC, 60 Hz

\*Can be wired as (2) DPDT

Note: All models have separate clock motor terminals for switching circuits not on-line voltage. They may be used with 24 volt systems if wired in accordance with NEC regulations.

#### Rating:

**Enclosure:** Type 3R rated outdoor steel enclosure  
Type 1 rated indoor steel in gray finish with separate grounding terminal.  
12 ½" (31.7 cm) H x 8 ¼" (21.0 cm) W x 4" (10.2 cm) D  
**Knockouts:** Combination ½" – ¾" nominal knockouts, two on back, one on each side and two on bottom. Also one 1" nominal on bottom center.  
**Switch Rating:** Each Pole 40 A Resistive, 120-480 VAC, 40 A Tungsten, 120-277 VAC 1000 VA Pilot Duty, 120-277 VAC, 2 HP (24 FLA) 120 VAC, 5 HP (28 FLA) 240 VAC single phase; 7 ½ HP (28 FLA) 208 VAC 3 phase, 10 HP (28 FLA) 240 VAC 3 phase.  
**Operating Temperature Range:** -40°F to 130°F (-40°C to 54°C)  
**Warranty:** 1 year

For additional trippers (156T2548A), see page 153;  
For replacement motors, see page 153

# T2000 Series Compact 7-Day Time Switches



- Minimum 2-hour timing intervals
- Up to 42 ON/OFF operations per week
- Type 1 indoor steel enclosure

Model #	Switch	Input Voltage	HP
E. T2005	SPDT	120 VAC, 60 Hz	½
T2006	SPDT	208, 277 VAC, 60 Hz	1

#### Rating:

**Switch Rating:** 20 A Resistive, 125 and 208-277 VAC  
**Operating Temperature Range:** -40°F to 130°F (-40°C to 54°C)  
**Warranty:** 1 year

For additional trippers (156T1950A), see page 153;  
For replacement motors, see page 153;  
For replacement snap switch 133T701A, see page 153



C.



D.



E.



A.



B.

## C8800 Series Short Range Cycle Time Switches



- Repeat cycling for ON times
- 10 trippers provided
- Dials have 120 slots
- Type 1 indoor steel enclosure

	Model #	Clock Motor Voltage	Dial Cycle	Tripper Actuating Time	Switch
	<b>C8815</b>	125 VAC, 60 Hz	10 Min.	5 Sec.	SPDT
A.	<b>C8835</b>	125 VAC, 60 Hz	30 Min.	15 Sec.	SPDT
	<b>C8845</b>	125 VAC, 60 Hz	4 Hr.	120 Sec.	SPDT
B.	<b>C8865</b>	125 VAC, 60 Hz	1 Hr.	30 Sec.	SPDT
	<b>C8866</b>	208-277 VAC, 60 Hz	1 Hr.	30 Sec.	SPDT

*Note: The life of the switch contacts is affected by the size and type of the controlled load.  
The expected minimum life at 20 Amps (resistive) load is 100,000 cycles.*

### Ratings:

**Switch Rating:** 20 A Resistive, 120-480 VAC, ½ HP,  
120 VAC, 1 HP, 240 VAC

**Operating Temperature:** -40°F to 130°F (-40°C to 54°C)

**Warranty:** 1 year

For additional trippers (156T1950A), see page 153

For replacement switch (133T773A), see page 153

For enclosure dimensions, see page 146

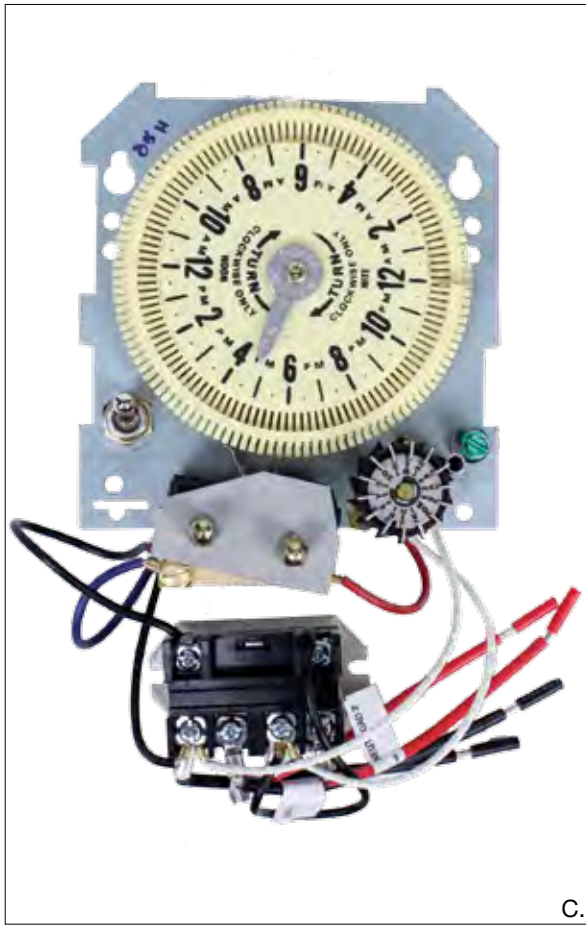

C.

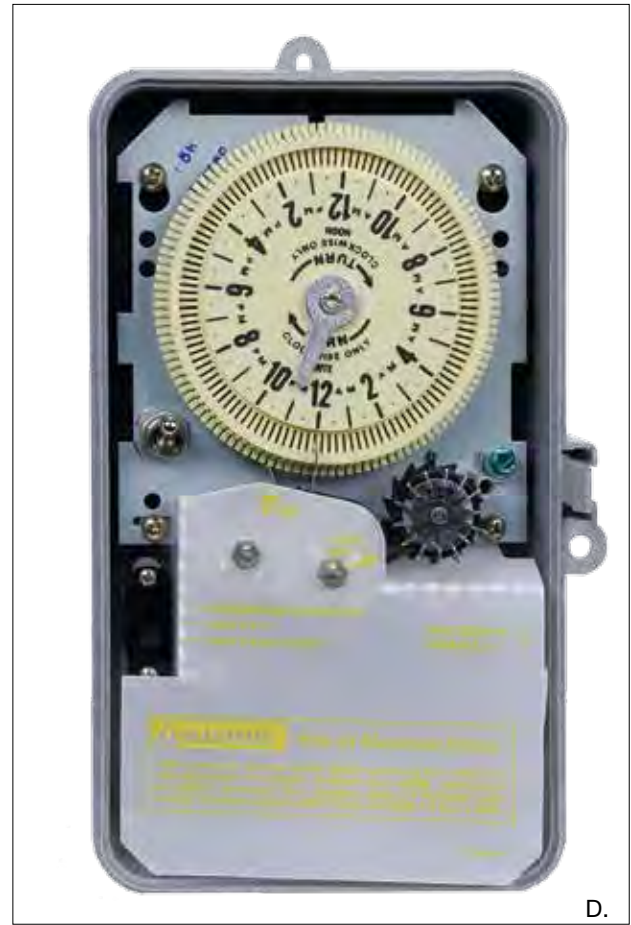

D.

## R8800 and T8800 Series Sprinkler/Irrigation Time Switches with 14-Day Skipper



- Up to 44 ON/OFF settings per day
- Water metering increments from 12 minutes to 20 hours and 45 minutes
- 14-Day Skipper enables irrigation to be omitted on selected day(s)
- Provides for “every other” day operation
- ON/OFF/AUTOMATIC switch enables shutdown during rainy days and extended watering during dry periods without disturbing the cycle set on dial

### Mechanism Only

Model #	Switch	Clock Motor Voltage	Load Voltage	Amps (per pole)	HP
T8805M101C	SPST	120 VAC, 60 Hz	120 VAC, 60 Hz	15	½
C. R8806M101C	DPST	240 VAC, 60 Hz	240 VAC, 60 Hz	25	2

### Plastic Type 3R Enclosure

Model #	Switch	Clock Motor Voltage	Load Voltage	Amps (per pole)	HP
D. T8805P101C	SPST	120 VAC, 60 Hz	120 VAC, 60 Hz	15	½
R8806P101C	DPST	240 VAC, 60 Hz	240 VAC, 60 Hz	25	2
R8815P101C*	DPST	120 VAC, 60 Hz	120 VAC, 60 Hz	25	1½
R8816P101C*	DPST	240 VAC, 60 Hz	240 VAC, 60 Hz	30	3
T8845PV**	SPST	120 VAC, 60 Hz	24 VAC, 60 Hz	20 VA	-

\*Rain sensor enabled (rain sensor not included)

\*\*Includes 24 Volt, 20VA transformer

#### Ratings:

Operating Temperature: -40°F to 130°F (-40°C to 54°C)

Warranty: 1 year

For additional trippers (156T1950A), see page 153  
 For replacement switch (133T700A), see page 153  
 For additional skipper pins (156T1954A), see page 153  
 For enclosure dimensions, see page 146



A.

### Talento 121 One-Hour Repeat Cycle Mechanical Time Switch



- Synchronous motor
- Low cost repeat cycle timer for industrial processes and other applications
- Continuous ON/OFF load cycling in a one-hour repeating pattern
- Captive trippers enable up to 24 ON and 24 OFF times in 1.25 minute increments over a one-hour period
- Can be used with an Intermatic 24-Hour or 7-Day time switch to provide repeat cycle switching during selected periods
- Surface or DIN Rail mounted with panels or mounted in an Intermatic indoor or outdoor enclosure
- Available with 3-way override

Model #	Input Voltage	Total Cycle Time	Timing Interval	Switch Output
A. TALENTO121-120	120 VAC	1 Hr.	1.25 Min.	SPDT, 16 Amp
TALENTO121-240	208-240 VAC	1 Hr.	1.25 Min.	SPDT, 16 Amp
GMX121-0-120*	120 VAC	1 Hr.	1.25 Min.	SPDT, 16 Amp

\* Mounted in Type 3R enclosure

**Ratings:**

**Dimensions:**  
3.31" (8.41 cm) H x 2.13" (5.41 cm) W x 2.56" (6.5 cm) D  
**Minimum Switching Time:** 1.25 minutes  
**Switch Output:** SPDT isolated contacts  
16 A Resistive, 125-250 VAC  
750 W Tungsten, 250 VAC  
**Operating Temperature:** 32°F to 131°F (0°C to 55°C)  
**Operating Humidity:** 0 to 95% RH non-condensing  
**Wiring Connections:** Screw terminals for up to #12 AWG wire



B.

### FM1S12HU-120U 12-Hour Repeat Cycle Time Switch



- 21 Amp STDT switch
- Panel mount
- Captive trippers enable up to 48 ON and 48 OFF times in 7.5 minute intervals

Model #	Input Voltage	Total Cycle Time	Timing Interval
B. FM1S12HU-120U	120 VAC	12 Hr.	7.5 Min.

**Ratings:**

**Dimensions:** 2.36" H x 2.36" W (60 mm H x 60 mm W)  
**Supply Voltage:** 120 VAC  
**Power Consumption:** 1 VA  
**Switch Rating:** SPDT  
**Resistive:** 21 A, 250 VAC  
**Inductive:** 1 HP, 125 VAC, 2 HP, 240 VAC  
**Wiring Connections:** ¼" quick-connects



# V45000 Series Astronomic Dial Time Switches with Skipper



- Adjusts for seasonal changes
- 3PST switch configuration
- Three Skipper screws furnished
- Independent clock motor terminals
- Only one hour required to rewind the carryover for every two hours of outage

30° Latitude		
Model #	Carryover	VAC 60 Hz
V45472CR30	Yes	120
V45472CR30	Yes	208-277
V45471R30	No	120
V45472R30	No	208-277
34° Latitude		
Model #	Carryover	VAC 60 Hz
V45471CR34	Yes	120
V45472CR34	Yes	208-277
V45471R34	No	120
V45472R34	No	208-277
42° Latitude		
Model #	Carryover	VAC 60 Hz
V45471CR42	Yes	120
V45472CR42	Yes	208-277
C. V45471R42	No	120
V45472R42	No	208-277

**Ratings:**  
**Enclosure:** Type 3R rated steel, gray finish with hasp, with hole for lock, holds permanently attached, side hinged door closed. Mounting bracket plus two holes below switch on back for mounting. Separate grounding terminal. 8¼" (20.95 cm) H x 5¼" (13.34 cm) W x 4¾" (12.07 cm) D  
**Knockouts:** Combination ½" – ¾" nominal knockouts, one on back and each side of enclosure and two on bottom.  
**Switch Rating:** Each pole 40 A Resistive 120-277 VAC, 40 A Tungsten 120 VAC, 690 VA Pilot Duty 120-277 VAC, 1 HP, 120-277 VAC, 5 HP, 240 VAC  
**Operating Temperature:** 32°F to 104°F (0°C to 40°C)  
**Warranty:** 1 year



C.

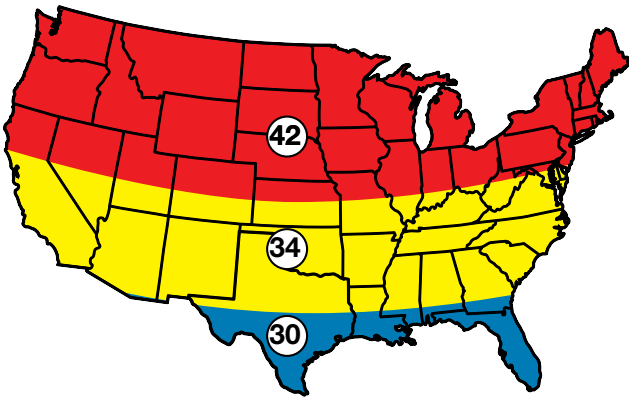

**Ordering Guidelines:** See map to find your latitude zone. Add the zone to the end of the model number. For example: If you are in Zone 42 (Red), the order number is V45471CR42.

# T104-20, WH21 and WH40 Mechanical Water Heater Time Switches



- Three sets of ON/OFF trippers
- Enables shifting electricity use into off-peak hours to reduce energy costs
- Convenient external override switch (WH40 and WH21 models)

Model #	Switch Type	Clock Motor		Amps per pole	Watts Resistive	External Override
		VAC	Cycle			
T104-20	DPST	208-240	60	40	10000	No
WH21	SPST	208-240	60	25	6250	Yes
D. WH40	DPST	208-240	60	40	10000	Yes

**Ratings:**  
**Enclosure:** Type 1 Indoor Steel  
**Power Consumption:** 3 W max.  
**Operating Temperature Range:** -40°F to 130°F (-40°C to 54°C)  
**Warranty:** 1 year



D.



A.

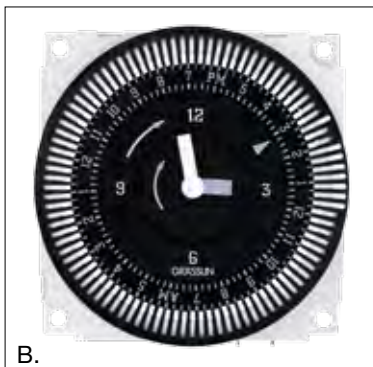

B.

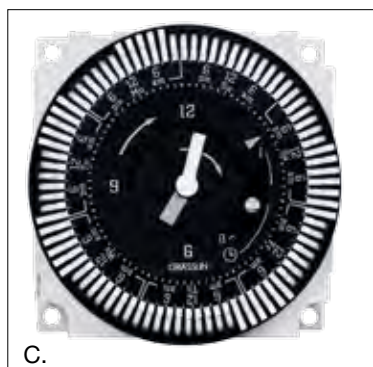

C.

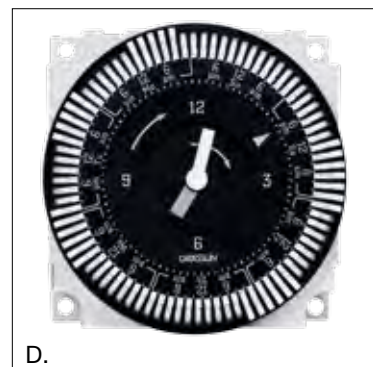

D.

## FM1 Series Panel Mount Timer Modules



- 21 Amp SPDT Switch
- Captive Trippers
- ¼" quick-connect terminals
- Noise resistant - ideal for robust applications
- Available with synchronous drive or quartz drive with battery backup (7-Day carryover)
- Easy-to-set true clock face
- Available with manual override (ON/Auto/OFF)
- Compact size fits in small areas

### A. 24-Hour (15-Minute ON/OFF Time) with Override

Model #	Input Voltage	Battery Backup
FM1QTUZH-120U	120	Yes
FM1QTUZH-24U*	12, 24	Yes
FM1STUZH-120U	120	No
FM1STUZH220/50	220 (50 Hz)	No
FM1STUZH-240U	208/240	No
FM1STUZH-24U	24	No

### B. 24-Hour (15-Minute ON/OFF Time) without Override

Model #	Input Voltage	Battery Backup
FM1QTUZ-120U	120	Yes
FM1QTUZ-240U	208/240	Yes
FM1QTUZ-24U*	12, 24	Yes
FM1STUZ-120U	120	No
FM1STUZ-240U	208/240	No
FM1STUZ220/50	220 (50 Hz)	No
FM1STUZ-24U	24	No

### C. 7-Day (2-Hour ON/OFF Time) with Override

Model #	Input Voltage	Battery Backup
FM1QUZH-120U	120	Yes
FM1QUZH-240U	208/240	Yes
FM1QUZH-BW-24U*	12, 24	Yes
FM1SWZH-120U	120	No
FM1SWZH-240U	208/240	No
FM1SWZH-24U	24	No

### D. 7-Day (2-Hour ON/OFF Time) without Override

Model #	Input Voltage	Battery Backup
FM1QUZ-120U	120	Yes
FM1QUZ-240U	208/240	Yes
FM1SWZ-120U	120	No
FM1SWZ-240U	208/240	No
FM1SWZ-24U	24	No

Note: Clear plastic cover available (DC-FME-A)

Note: FM1 models with Q suffix are quartz models. FM1 models with S suffix are synchronous models.

\*Quartz 24= 12-24 VDC/VAC

#### Ratings

**Dimensions:** 2.36" H x 2.36" W (60 mm H x 60 mm W)  
**Input Voltage:** Synchronous: 24, 120, 208/240 VAC, 60 Hz; 220 Hz, 50 Hz  
 Quartz: 12, 24 VAC/DC, 120, 208/240 VAC 50/60 Hz  
**Power Consumption:** 1 VA

**Wire Connections:** ¼" Quick connect  
**Switch Rating:** 21 A Resistive, 120-250 VAC, 1 HP, 120 VAC, 2 HP, 250 VAC, 1350 W Tungsten, 240 VAC  
**Operating Temperature:** Synchronous: -40°F to 185°F (-40°C to 85°C)  
 Quartz: -4°F to 131°F (-20°C to 55°C)





## GMX Series 24-Hour/7-Day General Purpose Time Switch



- Manual override (ON/Auto/OFF)
- 21 Amp SPDT Switch
- Captive trippers
- Easy-to-set true clock face
- Finger-safe terminals
- Extra space in enclosure for field-added contractor or accessories
- Available with synchronous drive or quartz drive with battery backup

24-Hour (15-Minute ON/OFF time)				7-Day (2-Hour ON/OFF time)			
Model #	Input Voltage	Enclosure	Battery Backup	Model #	Input Voltage	Enclosure	Battery Backup
GMXQT-I-120	120	Type 1 Indoor	Yes	GMXQW-I-120	120	Type 1 Indoor	Yes
GMXQT-I-24*	24	Type 1 Indoor	Yes	GMXQW-I-24*	24	Type 1 Indoor	Yes
GMXQT-O-120	120	Type 3R Outdoor	Yes	GMXQW-I-240	208/240	Type 1 Indoor	Yes
GMXST-I-120	120	Type 1 Indoor	No	GMXQW-O-120	120	Type 3R Outdoor	Yes
GMXST-I-24	24	Type 1 Indoor	No	GMXSW-I-120	120	Type 1 Indoor	No
GMXST-I-240	208/240	Type 1 Indoor	No	GMXSW-I-24	24	Type 1 Indoor	No
GMXST-O-120	120	Type 3R Outdoor	No	GMXSW-I-240	208/240	Type 1 Indoor	No
GMXST-O-24	24	Type 3R Outdoor	No	GMXSW-O-120	120	Type 3R Outdoor	No
GMXST-O-240	208/240	Type 3R Outdoor	No	GMXSW-O-24	24	Type 3R Outdoor	No
				GMXSW-O-240	208/240	Type 3R Outdoor	No

\*Quartz 24 = 12-24 VDC/VAC

Note: FM1 models with Q suffix are quartz models. FM1 models with S suffix are synchronous models.

**Ratings:**  
**Switch Rating:** 21A Resistive, 120-250 VAC, 1 HP, 120 VAC, 2 HP, 240 VAC, 1,350W Tungsten, 240 VAC  
**Wiring Connections:** Screw terminal accepts up to #12 AWG wire  
**Operating Temperature:** Synchronous: -40°F to 185°F (-40°C to 85°C)  
 Quartz: -4°F to 131°F (-20°C to 55°C)  
**Operating Humidity:** 0 to 95% non-condensing  
**Enclosure Dimensions:** 10" H x 6.5" W x 3.75" D (25.4 cm H x 16.51 cm W x 9.53 cm D)  
**Battery Backup Option:** 7-Day carryover (Quartz models only)  
**Input Voltage:** Synchronous: 24, 120, 208/240 VAC, 60 Hz  
 Quartz: 12, 24 VDC/VAC 120, 208/240 VAC 50/60 Hz



**MIL72 Series 24 Hour Surface/DIN Rail or Flush Mount Timer Modules**



- Designed for use in a control panel
- 15-minute minimum ON/OFF times
- 21 Amp SPDT switch
- Captive trippers
- Available with synchronous drive or quartz drive with battery backup
- Easy-to-set true clock face
- Available with or without manual override (ON/Auto/OFF)
- Clear plastic dust cover

A. Surface/DIN Rail Mount			
Model #	Input Voltage	Override	Battery Backup
MIL72AQTUZ-120	120	No	Yes
MIL72AQTUZ-240	208/240	No	Yes
MIL72AQTUZH-120	120	Yes	Yes
MIL72AQTUZH-24*	24	Yes	Yes
MIL72ASTUZ-120	120	No	No
MIL72ASTUZ-24	24	No	No
MIL72ASTUZ-240	208/240	No	No
MIL72ASTUZH-120	120	Yes	No
MIL72ASTUZH-24	24	Yes	No
MIL72ASTUZ-240	208/240	Yes	No
MIL72ASTUZ220	220	Yes	No

B. Flush Mount			
Model #	Input Voltage	Override	Battery Backup
MIL72EQTUZ-120	120	No	Yes
MIL72EQTUZ-24*	24	No	Yes
MIL72EQTUZ-240	208/240	No	Yes
MIL72EQTUZH-120	120	Yes	Yes
MIL72EQTUZH-24*	24	Yes	Yes
MIL72ESTUZ-120	120	No	No
MIL72ESTUZ-24	24	No	No
MIL72ESTUZ-240	208/240	No	No
MIL72ESTUZ1A240	208/240	No	No
MIL72ESTUZH-120	120	Yes	No
MIL72ESTUZH-24	24	Yes	No
MIL72ESTUZH-240	208/240	Yes	No
MIL72ESTUZH220	220	Yes	No

\*Quartz 24 = 12-24VDC/VAC  
 Note: FM1 models with Q suffix are quartz models. FM1 models with S suffix are synchronous models.

**Ratings:**  
**Switch Rating:** 21 A Resistive, 120-250 VAC, 1 HP, 125 VAC, 2 HP, 250 VAC, 1350 W Tungsten, 120 VAC  
**Wiring Connections:** Screw terminal connections (MIL72A) ¼" quick connects (MIL72E) accepts up to #12 GA wire  
**Operating Temperature:** -40°F to 185°F (-40°C to 85°C) with battery backup -4°F to 131°F (-20°C to 55°C)  
**Operating Humidity:** 0 to 95% non-condensing  
**Battery Backup Option:** 7-Day carryover (Quartz models only)

**Input Voltage:** Synchronous models: 24, 120, and 208/240 VAC, 60 Hz ; 220 VAC, 50 Hz Quartz: 24 VAC/DC, 120 and 208/240 VAC 50/60 Hz, 50 Hz  
**Power Consumption:** 24 VAC: 0.1 VA, 120 VAC: 0.5 VA, 240 VAC: 1.0 VA  
**Installation:** Standalone or with Indoor/Outdoor enclosure



C.



D.

## MIL72 Series 7 Day Surface/DIN Rail or Flush Mount Timer Modules



- Designed for use in a control panel
- 2-hour minimum ON/OFF times
- Clear plastic dust-cover
- 21 Amp SPDT switch
- Captive trippers
- Available with synchronous drive or quartz drive with battery backup
- Easy-to-set true clock face
- Available with or without manual override (ON/Auto/OFF)

C. Surface/DIN Rail Mount			
Model #	Input Voltage	Override	Battery Backup
MIL72AQWUZ-120	120	No	Yes
MIL72AQWUZH-120	120	Yes	Yes
MIL72AQWUZH-24*	24	Yes	Yes
MIL72AQWUZH-240	208/240	Yes	Yes
MIL72ASWUZ-120	120	No	No
MIL72ASWUZ-24	24	No	No
MIL72ASWUZ-240	208/240	No	No
MIL72ASWUZH-120	120	Yes	No
MIL72ASWUZH-24	24	Yes	No
MIL72ASWUZH-240	208/240	Yes	No

D. Flush Mount			
Model #	Input Voltage	Override	Battery Backup
MIL72EQWUZ-120	12	No	Yes
MIL72EQWUZH-120	120	Yes	Yes
MIL72EQWUZH-24*	24	Yes	Yes
MIL72EQWUZH-240	208/240	Yes	Yes
MIL72ESWUZ-120	120	No	No
MIL72ESWUZ-24	24	No	No
MIL72ESWUZH-120	120	Yes	No
MIL72ESWUZH-24	24	Yes	No
MIL72ESWUZH-240	208/240	Yes	No

\*Quartz 24= 12-24VDC/VAC  
 Note: FM1 models with Q suffix are quartz models. FM1 models with S suffix are synchronous models.

### Ratings

**Switch Rating:** 21 A Resistive, 120-250 VAC 1 HP, 125 VAC, 2 HP, 250 VAC, 1350 W Tungsten, 120 VAC  
**Wiring Connections:** Screw terminal connections (MIL72A) ¼" quick connects (MIL72E) accepts up to #12 GA wire  
**Operating Temperature:** -40°F to 185°F (-40°C to 85°C) with battery backup -4°F to 131°F (-20°C to 55°C)  
**Operating Humidity:** 0 to 95% non-condensing  
**Battery Backup Option:** 7-Day carryover (Quartz models only)  
**Input Voltage:** Synchronous: 24, 120, and 208/240 VAC, 60 Hz models  
 Quartz: 24 VAC/DC, 120 and 208/240 VAC 50/60 Hz  
**Power Consumption:** 24 VAC: 0.1 VA 120 VAC: 0.5 VA, 240 VAC: 1.0 VA  
**Installation:** Standalone or with Indoor/Outdoor enclosure



## Low Voltage Power Packs



- 120 VAC input, 12 VAC output
- Available from 44 to 900 Watts
- Keyhole mounting for easy installation and operation
- For outdoor use only

Model #	Description	Max. Wattage Output	Color
A. <b>ML44T</b>	Timer with 2 sets of trippers	44 Lamp Watts	Black
<b>ML88T</b>	Timer with 2 sets of trippers	88 Lamp Watts	Black
B. <b>ML100THB</b>	Electronic timer and photo control	100 Lamp Watts	Black
C. <b>ML121RT</b>	Timer with 2 sets of trippers	121 Lamp Watts	Black
<b>ML200RT</b>	Timer with 2 sets of trippers	200 Lamp Watts	Black
<b>ML200RTW</b>	Timer with 2 sets of trippers and ground shield	200 Lamp Watts	Black
D. <b>ML300RTW</b>	Timer with 2 sets of trippers and ground shield	300 Lamp Watts	Black
E. <b>ML300RTWSN</b>	Timer with 2 sets of trippers and ground shield	300 Lamp Watts	Sand
F. <b>ML600TW</b>	Timer with 2 sets of trippers and ground shield	600 Lamp Watts	Black
G. <b>ML600TWSN</b>	Timer with 2 sets of trippers and ground shield	600 Lamp Watts	Sand
H. <b>ML900TW</b>	Timer with 2 sets of trippers and ground shield	900 Lamp Watts	Black
J. <b>ML900TWSN</b>	Timer with 2 sets of trippers and ground shield	900 Lamp Watts	Sand

*Note: When planning your lighting, total bulb wattage must not exceed maximum transformer output.*



## ML814DRP Photo Eye Accessory

- Automatically controls low voltage transformers based on sunrise & sunset
- Used with 100 Watt or greater transformers

Model #	Voltage	Watts Tungsten
<b>ML814DRP</b>	12 VAC 50/60 Hz	300



# Timers

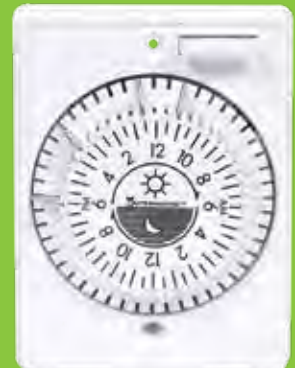

***Bathroom Lighting***

Hallway Lighting

Holiday Lights ***Lamps***

**Entry Lighting** Display Lighting

Saunas ***Small Appliances***

Security Lighting Whirlpools

# Set It And Forget It



A.



B.



C.

## EI600 Series Heavy-Duty Electronic In-Wall Timers



- Versatile 7-Day scheduling
- Up to 40 programmable ON/OFF events
- No neutral required
- Random setting turns lights ON/OFF at different times so it appears someone is always at their home or business
- Auto Daylight Saving Time adjustment
- Astronomic feature can be combined with specific timed ON/OFF programming
- Incandescent/Fluorescent/CFL/LED compatible
- Can control switched outlets
- Controls AC or DC loads
- Non-volatile memory stores user programs
- Manual override
- Replaceable CR2 lithium battery provides up to 3 years of operation without AC power
- Single-pole or 3-way compatible
- Able to install in multi-gang installations without derating
- For use with decorator-style wall plate (not included)
- Isolated Single-Pole Single-Throw switch allows the timer to switch any load type
- Limited 5-year warranty

Model #	Color
A. EI600C	Ivory
B. EI600WC	White
C. EI600LAC	Light Almond

### Ratings:

**Resistive (heater):** 20 A, 120-277 VAC

**Tungsten (incandescent):** 15 A, 120 VAC; 6 A, 208-277 VAC

**Inductive Ballast:** 16 A, 120-277 VAC

**Motor:** 1 HP, 120 VAC, 2 HP, 240 VAC

**DC Loads:** 4 A, 12 VDC, 2 A, 28 VDC

**Max. Wattage:** 2400 W, 120 VAC, 5540 W, 277 VAC

**Operating Temperature:** 32°F to 104°F (0°C to 40°C)

*Not for use with sunlamps, saunas, or loads that could cause personal injury if timed incorrectly*





D.



E.



F.

Model #	Color
D. EI500C	Ivory
E. EI500WC	White
F. EI500LAC	Light Almond

**Ratings:****General Purpose:** 15 A**Resistive (heater):** 15 A**Tungsten (incandescent):** 1000 W**Inductive Ballast:** 8 A**Electronic Ballast:** 500 VA**Motor:** ¼ HP**Input Voltage:** 125 VAC 60 Hz.**Max. Wattage:** 1875 W**Operating Temperature:** 32°F to 107°F (0°C to 40°C)**Switch:** Single Pole Single Throw**Warranty:** Limited 1 year

*Not for use with sunlamps, saunas, or loads that could cause personal injury if timed incorrectly*

## EI500 Series Electronic In-Wall Timers



- Up to 14 programmable ON/OFF events
- Random setting turns lights ON/OFF at different times so it appears someone is always at their home or business
- Incandescent/Fluorescent/CFL/LED compatible
- 24-Hour or 7-Day load control of lights, fans, pumps and other medium-duty loads
- Built-in rechargeable battery backup
- For use with decorator-style wall plate (not included)
- Easy to program
- Replaces single-pole switches in many applications
- Requires neutral wire
- Continuously displays time of day, mode and load status

## Is Your Home Protected?

Add an AG3000 Surge Protective Device to your home to protect your furnace and air conditioner from power surges and spikes. For more information about the AG3000, turn to page 97.



A.

B.

## ST01 and ST01A Heavy-Duty In-Wall Timers



- Versatile 7-Day scheduling
- Up to 40 ON/OFF programmable events per week
- No neutral required
- Random setting turns lights ON/OFF at different times so it appears someone is always at their home or business
- Auto Daylight Saving Time adjustment
- Astronomic feature can be combined with specific timed ON/OFF programming
- Incandescent/Fluorescent/CFL/LED compatible
- Can control switched outlets
- Controls AC or DC loads
- Programs stored in non-volatile memory
- Manual override
- Single-pole or 3-way compatible
- For use with decorator-style wall plate (not included)
- Replaceable CR2 lithium battery provides up to 3 years of operation without AC power

Model #	Color
A. ST01	White
B. ST01A	Almond

### Ratings:

**Resistive (heater):** 15 A, 120-277 VAC

**Tungsten (incandescent):** 15 A, 120 VAC, 6 A,  
208-277 VAC

**Ballast (Fluorescent):** 8 A, 120 VAC, 4 A, 208-277 VAC

**Motor:** 1 HP, 120 VAC, 2 HP, 240 VAC

**DC Loads:** 4 A 12 VDC, 2 A, 28 VDC

**Operating Temperature:** 32°F to 122°F (0°C to 50°C)

**Warranty:** Limited 1 year

*Not for use with sunlamps, saunas, or loads that could cause personal injury if timed incorrectly*

## EJ600 Series 24-Hour or 7-Day In-Wall Timers



- Up to 14 (7 ON/OFF) programmable events per day
- Random setting turns lights ON/OFF at different times so it appears someone is always at their home or business
- Auto Daylight Saving Time adjustment
- Incandescent/Fluorescent/CFL/LED compatible
- Astronomic feature auto adjusts to sunrise/sunset
- Can be used for 24-Hour or 7-Day load control of lights, fans, pumps and other medium-duty loads
- Built-in rechargeable lithium ion battery backup
- Single-pole or 3-way compatible
- For use with decorator-style wall plate (not included)
- Requires neutral wire

Model #	Color
C. EJ600	White
D. EJ600A	Almond

<b>Ratings:</b>	
<b>Input Voltage:</b> 120 VAC, 60 Hz.	<b>Inductive Ballast:</b> 500 VA
<b>General Purpose:</b> 12 A, 120 VAC, 60 Hz.	<b>Motor:</b> 1/2 HP
<b>Resistive (heater):</b> 12 A, 120 VAC, 60 Hz.	<b>Operating Temperature:</b> 32°F to 104°F (0°C to 40°C)
<b>Tungsten (incandescent):</b> 15 A single-gang, 12 A multi-gang	<b>Warranty:</b> Limited 1 year



C.

D.



E.



F.

## EJ351 Programmable 24-Hour Security Timer



- Up to 48 ON/OFF programmable events
- No neutral required
- Self learning, adapts to your schedule to meet your demands
- Random setting turns lights ON/OFF at different times so it appears someone is always at their home or business
- Controls incandescent lighting
- 15-minute memory guard protects against power failure
- For use with standard or decorator-style wall plate (not included)

<b>Ratings:</b>
<b>Input Voltage:</b> 120 VAC, 60 Hz.
<b>Min. Wattage:</b> 40 W
<b>Max. Wattage:</b> 500 W Incandescent
<b>Inductive Ballast:</b> 4 A
<b>Operating Temperature:</b> 32°F to 104°F (0°C to 40°C)
<b>Warranty:</b> Limited 1 year

Model #	Color
E. EJ351	White

*Not for use with CFL/LED bulb*

## EJ500 Electronic In-Wall Switch Timer



- Versatile 7-Day scheduling
- Up to 14 (7 ON/OFF) programmable events per day
- No neutral required
- Random setting turns lights ON/OFF at different times so it appears someone is always at their home or business
- Auto Daylight Saving Time adjustment
- Astronomic feature auto adjusts to sunrise/sunset
- Controls incandescent lighting
- Battery backup
- Single-pole or 3-way compatible
- For use with decorator-style wall plate (not included)

<b>Ratings:</b>	<b>Tungsten:</b> 4 A
<b>Input Voltage:</b> 120 VAC, 60 Hz.	<b>Inductive Ballast:</b> 4 A
<b>Min. Wattage:</b> 40 W	<b>Operating Temperature:</b> 32°F to 104°F (0°C to 40°C)
<b>Max. Wattage:</b> 500 W Incandescent	<b>Warranty:</b> Limited 1 year

Model #	Color
F. EJ500	White

*Not for use with CFL/LED bulbs*



A.



B.



C.

## EI400 Series Electronic Auto-Off In-Wall Timers



- To-the-second accuracy time range from 1 second to 24 hours
- Single-pole or 3-way compatible
- No neutral required
- Replaceable CR2 lithium battery provides up to 3 years of operation without AC Power
- Non-volatile memory stores user programs
- ADA Compliant
- Audible and/or visual load switch OFF warning
- Controls all voltages and frequencies within the correct ratings with no adjustments required
- CFL/LED compatible
- For use with decorator-style wall plate (not included)
- Low battery indicator
- Limited 5-year warranty

Model #	Color
A. EI400C	Ivory
B. EI400WC	White
C. EI400LAC	Light Almond

### Ratings:

**Input Voltage:** 120-277 VAC, 12-28 VDC 50/60 Hz.  
**Resistive (heater):** 20 A, 120-277 VAC  
**Tungsten (incandescent):** 15 A, 120 VAC, 6 A, 208-277 VAC  
**Inductive Ballast:** 16 A, 120-277 VAC  
**Motor:** 1 HP, 120 VAC, 2 HP, 240 VAC  
**DC Loads:** 4 A, 12 VDC, 2 A 28 VDC  
**Max. Wattage:** 2400 W at 120 VAC, 5540 W at 277 VAC  
**Operating Temperature:** 32°F to 122°F ( 0°C to 50°C)

*Not for use with sunlamps, saunas, or loads that could cause personal injury if timed incorrectly*



Ivory



White With Hold



Light Almond

## EI200 Series Electronic Countdown In-Wall Timers



- Provides silent operation in time ranges from 5 minutes to 12 hours
- Replaces single-pole switches in a variety of applications
- Single button time selection
- Operates most load types
- Requires neutral wire
- For use with decorator-style wall plate (not included)

Ivory			White			Light Almond		
Model #	Time Range	Hold	Model #	Time Range	Hold	Model #	Time Range	Hold
EI200	5,10,15, 30 Min.	Yes	EI200W	5, 10, 15, 30 Min.	Yes	EI200LA	5, 10, 15, 30 Min.	Yes
EI205*	5, 15, 30, 45, 60 Min.	No	EI205W*	5, 15, 30, 45, 60 Min.	No	EI205LA*	5, 15, 30, 45, 60 Min.	No
EI210	10, 20, 30, 60 Min.	Yes	EI210W	10, 20, 30, 60 Min.	Yes	EI210LA	10, 20, 30, 60 Min.	Yes
EI215**	15, 30, 60 Min., 2, 4 Hr.	No	EI215W**	15, 30, 60 Min., 2, 4 Hr.	No	EI215LA**	15, 30, 60 Min., 2, 4 Hr.	No
EI220	1, 2, 4, 8 Hr.	Yes	EI220W	1, 2, 4, 8 Hr.	Yes	EI220LA	1, 2, 4, 8 Hr.	Yes
EI230	2, 4, 8, 12 Hr.	Yes	EI230W	2, 4, 8, 12 Hr.	Yes	EI230LA	2, 4, 8, 12 Hr.	Yes
EI235*	15, 30, 45, 60, 120 Min.	No	EI235W*	15, 30, 45, 60, 120 Min.	No	EI235LA*	15, 30, 45, 60, 120 Min.	No

\* Meets or exceeds ASHRAE 90.1 and IECC requirements for enclosed spaces.

\*\* Meets or exceeds ASHRAE 90.1 requirements for enclosed spaces.

### Ratings:

**Input Voltage:** 120 VAC, 60 Hz.

**Resistive (heater):** 15 A, 120 VAC, 1800 W

**Tungsten (incandescent):** 8.3 A, 120 VAC, 1000 W

**Inductive Ballast:** 8 A, 120 VAC, 1000 VA

**Electronic Ballast:** 500 VA

**Motor:** ¼ HP, 120 VAC

**Operating Ambient Temperature Range:** 32°F to 122°F (0°C to 50°C)

**Switch:** Single Pole Single Throw

**Warranty:** Limited 1 year

*Not for use with sunlamps, saunas, or loads that could cause personal injury if timed incorrectly*



Ivory No Hold



White With Hold



Almond No Hold

## FD Decorator Series

### Auto-Off Timers

- No electricity required to operate
- Replaces any standard single or multi-gang wall switch
- Automatically limits ON time for energy consuming loads
- Quick and easy installation
- Time-saving up front terminal connection with teeter-type terminals
- For use with decorator or toggle style switch plates (not included)

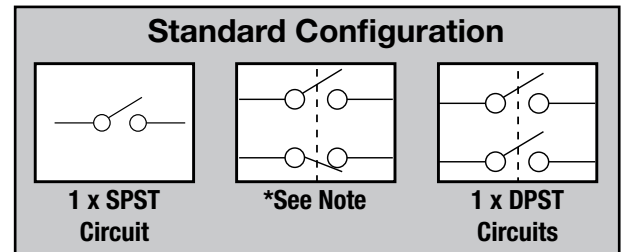

Ivory				Ivory				Ivory			
Model #	Time Cycle	Switch	Hold	Model #	Time Cycle	Switch	Hold	Model #	Time Cycle	Switch	Hold
FD5M	5 Min.	SPST	No	FD4H	4 Hr.	SPST	No	FD36H	6 Hr.	*See Note	No
FD15MC	15 Min.	SPST	No	FD6H	6 Hr.	SPST	No	FD415M	15 Min.	DPST	No
FD15MH	15 Min.	SPST	Yes†	FD6HH	6 Hr.	SPST	Yes†	FD430M	30 Min.	DPST	No
FD30MC	30 Min.	SPST	No	FD12HC	12 Hr.	SPST	No	FD460M	60 Min.	DPST	No
FD30MH	30 Min.	SPST	Yes†	FD12HH	12 Hr.	SPST	Yes†	FD46H	6 Hr.	DPST	No
FD60MC	60 Min.	SPST	No	FD32H	2 Hr.	*See Note	No				
FD60MH	60 Min.	SPST	Yes†	FD34H	4 Hr.	*See Note	No				
FD2H	2 Hr.	SPST	No								

White				White				White			
Model #	Time Cycle	Switch	Hold	Model #	Time Cycle	Switch	Hold	Model #	Time Cycle	Switch	Hold
FD5MW	5 Min.	SPST	No	FD4HW	4 Hr.	SPST	No	FD430MW	30 Min.	DPST	No
FD15MWC	15 Min.	SPST	No	FD6HW	6 Hr.	SPST	No	FD460MW	60 Min.	DPST	No
FD15MHW	15 Min.	SPST	Yes†	FD6HWW	6 Hr.	SPST	Yes†	FD46HW	6 Hr.	DPST	No
FD30MWC	30 Min.	SPST	No	FD12HWC	12 Hr.	SPST	No				
FD30MHW	30 Min.	SPST	Yes†	FD12HWW	12 Hr.	SPST	Yes†				
FD60MWC	60 Min.	SPST	No	FD32HW	2 Hr.	*See Note	No				
FD60MHW	60 Min.	SPST	Yes†	FD34HW	4 Hr.	*See Note	No				
FD2HW	2 Hr.	SPST	No								

Almond			
Model #	Time Cycle	Switch	Hold
FD15MAC	15 Min.	SPST	No
FD30MAC	30 Min.	SPST	No
FD60MAC	60 Min.	SPST	No

† Hold feature enables auto shut-off override

\*1 x SPST N.O. connected to 1 x SPST N.C. Switch can be configured at 1 x SPDT by jumpering input terminals together

Replacement knob information see page 154.

**Ratings:**

**Resistive (heater):** 20 A, 125 VAC, 60 Hz., 10 A, 250/277 VAC, 60 Hz.

*Not for use with sunlamps, saunas, or loads that could cause personal injury if timed incorrectly*

**Tungsten (incandescent):** 7 A, 125 VAC

**Motor:** 1 HP, 125 VAC, 60 Hz, 2 HP, 250 VAC, 60 Hz.

**Warranty:** Limited 1 year





No Hold



Hold

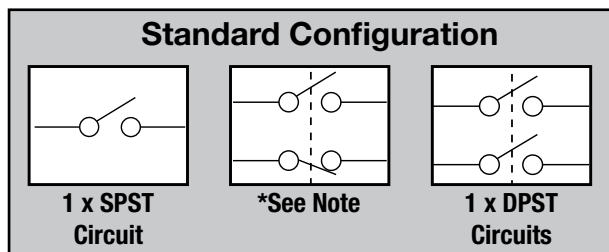

### FF Commercial Series Auto-Off Timers



- No electricity required to operate
- Replaces any standard single or multi-gang wall switch
- Automatically limits ON time for energy consuming loads
- Quick and easy installation
- Time-saving up-front terminal connection with teeter-type terminals
- Brushed metal finish switch plate meets NEC requirements

Hold† Single Pole Single Throw			No Hold Single Pole Single Throw			No Hold Single Pole Double Throw		
Model #	Time Cycle	Switch	Model #	Time Cycle	Switch	Model #	Time Cycle	Switch
FF5MH	5 Min.	SPST	FF5M	5 Min.	SPST	FF315M	15 Min.	*See Note
FF15MH	15 Min.	SPST	FF15MC	15 Min.	SPST	FF330M	30 Min.	*See Note
FF30MH	30 Min.	SPST	FF30MC	30 Min.	SPST	FF360M	60 Min.	*See Note
FF60MHC	60 Min.	SPST	FF60MC	60 Min.	SPST	FF32H	2 Hr.	*See Note
FF6HH	6 Hr.	SPST	FF2H	2 Hr.	SPST	FF34H	4 Hr.	*See Note
FF12HHC	12 Hr.	SPST	FF4H	4 Hr.	SPST	FF36H	6 Hr.	*See Note
FF32HH	2 Hr.	*See Note	FF6H	6 Hr.	SPST	FF312H	12 Hr.	*See Note
FF34HH	4 Hr.	*See Note	FF12HC	12 Hr.	SPST	<b>No Hold Double Pole Single Throw</b>		
FF312HH	12 Hr.	*See Note				Model #	Time Cycle	Switch
						FF415M	15 Min.	DPST
						FF430M	30 Min.	DPST
						FF460M	60 Min.	DPST
						FF46H	6 Hr.	DPST
						FF412H	12 Hr.	DPST

† Hold feature enables auto shut-off override  
 \*1 x SPST N.O. connected to 1 x SPST N.C. Switch can be configured at 1 x SPDT by jumpering input terminals together  
 Replacement knob information see page 154.

**Ratings:**  
**Resistive (heater):** 20 A, 125 VAC, 60 Hz, 10 A, 250/277 VAC, 60 Hz.  
**Tungsten (incandescent):** 7 A, 125 VAC      **Motor:** 1 HP, 125 VAC, 60 Hz., 2 HP, 250 VAC, 60 Hz.  
**Warranty:** Limited 1 year  
 Not for use with sunlamps, saunas, or loads that could cause personal injury if timed incorrectly



A.

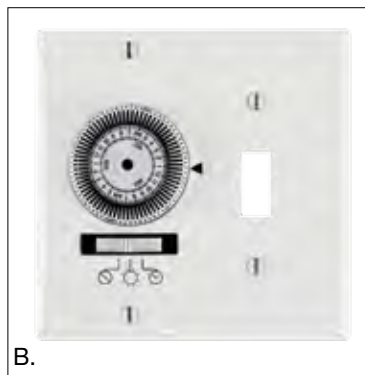

B.

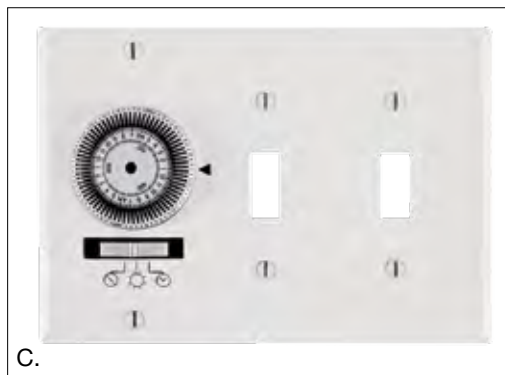

C.

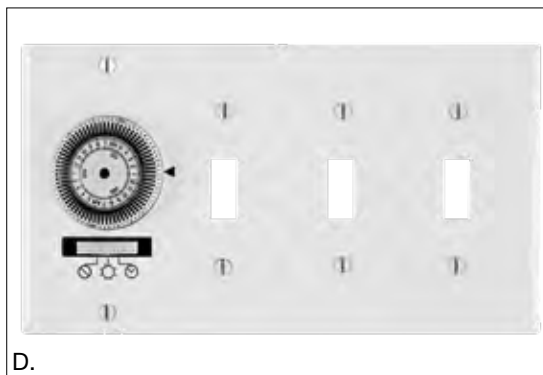

D.

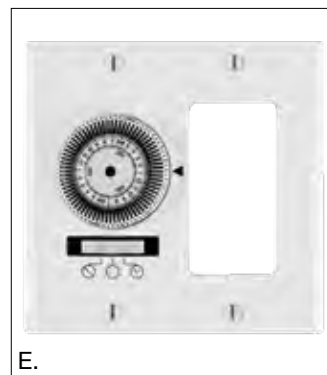

E.

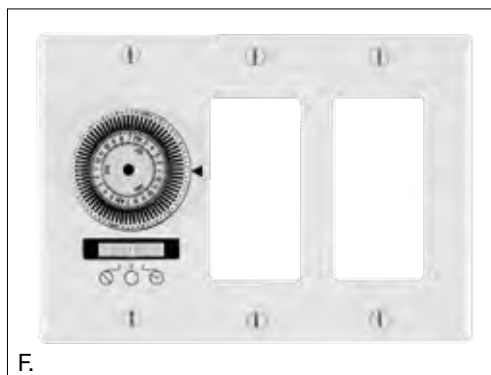

F.

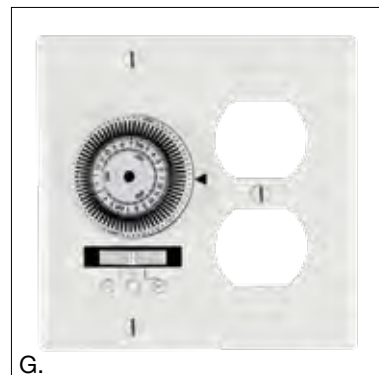

G.

## KM2 Series Mechanical In-Wall Timers



- Captive trippers with 20-minute switching interval
- Replaces standard wall switches
- Multiple plates available
- Reliable synchronous timer motor
- Easy wiring and installation
- Works with fluorescent and compact fluorescent lights
- 3-way (SPDT) switch available
- 3-way ON/AUTO/OFF override provides continuous ON or OFF positions
- Heavy-duty 20 Amp rating
- 72 trippers provide 36 ON/OFF events per 24-hour period
- Automatic control of outdoor or indoor lighting, fans, pumps, office equipment and other types of circuits

Model #	Wall Plate	Configuration	Switch
A. <b>KM2ST-1G</b>	Single-gang	—	SPST
<b>KM2STU-1G</b>	Single-gang	3-Way	SPDT
B. <b>KM2ST-2G</b>	Two-gang	Toggle	SPST
C. <b>KM2ST-3G</b>	Three-gang	Toggle	SPST
D. <b>KM2ST-4G</b>	Four-gang	Toggle	SPST
E. <b>KM2ST-2D</b>	Two-gang	Decorator	SPST
F. <b>KM2ST-3D</b>	Three-gang	Decorator	SPST
G. <b>KM2ST-2R</b>	Two-gang	Receptacle	SPST

### Ratings:

**Switch Rating:** 20 A, 120 VAC, 60 Hz. Resistive, 1 HP, 120 VAC

**Operating Humidity:** 0 to 95% non-condensing

**Wiring Connections:** (3) #14 AWG color coded lead wires:

Hot – Black, Switched – Red, Neutral – White

**Warranty:** 1 year



## E1020

### Heavy-Duty In-Wall Time Switch



- Includes two ON and OFF Trippers
- Dial accomodates a total of 12 ON and 12 OFF events
- Turns ON/OFF heavy-duty loads for energy savings, security, and convenience
- Mounts to any standard junction box
- Neutral wire required
- Manual override

Model #	Switch	Color
H. E1020	SPST	Stonedust White Housing

*Additional trippers (156EB1945A) sold separately page 153*

**Ratings:**

**Switch:** SPST

**Switch Rating:** 125 VAC, 60 Hz., 1500 W Tungsten, 12 FLA, 15 A Resistive

**Max. Wattage:** 1800 W

**Timing Cycle:** Minimum ON time ½ hour, Maximum ON time 22 ½ hours

Minimum time between any two ON trippers (or 2 OFF trippers) is 2 hours

**Dimensions:** 4 ¼" (10.8 cm) H x 3 ¼" (9.5 cm) W x 1 ⅝" (3.5 cm) D

**Warranty:** Limited 1 year



H.

## E1010

### Heavy-Duty In-Wall Time Switch



- Permanently attached ON/OFF tripper permits single ON/OFF control every 24 hours
- 24-Hour dial divided in 30 minute increments
- Turns ON/OFF heavy-duty loads for energy savings, security, and convenience
- Mounts to any standard junction box
- Neutral wire required
- Manual override

Model #	Switch	Color
J. E1010	SPST	Stonedust White Housing

**Ratings:**

**Switch:** SPST

**Switch Rating:** 125 VAC, 60 Hz., 1500 W Tungsten, 12 FLA, 15 A Resistive

**Max. Wattage:** 1800 W

**Timing Cycle:** Minimum ON time ½ hour, Maximum ON time 22 ½ hours

Only 1 ON and 1 OFF Tripper

**Dimensions:** 4 ¼" (10.8 cm) H x 3 ¼" (9.5 cm) W x 1 ⅝" (3.5 cm) D

**Warranty:** Limited 1 year



J.



A.



B.



C.

### HB110 Series Air Conditioner & Appliance Timer



- Plugs directly into wall outlet
- 2 ON/OFF settings per day
- 3-prong grounded plug and receptacle
- Manual override ON/OFF switch
- Auto controls air conditioners, heaters, and heavy-duty appliances
- Minimum ON/OFF times 30 mins.

Model #	Voltage	Motor	Resistive	Inductive	Tungsten	Pilot Duty	Air Conditioner
A. <b>HB112</b>	240 VAC, 60 Hz	2 HP (8 FLA, 48 LRA)	15 A	8 A	–	768 VA	8 A
B. <b>HB113</b>	125 VAC, 60 Hz	1 HP (12 FLA, 72 LRA)	20 A	8 A	1250 W	576 VA	12 A
C. <b>HB114</b>	240 VAC, 60 Hz	2 HP (8 FLA, 48 LRA)	20 A	8 A	–	768 VA	8 A

*For additional trippers see page 154, (107SB189 red & 107SB192 black)  
Limited 1-year warranty*



D.

### TN311

#### Heavy-Duty Indoor Timer

- Grounded receptacle and 3-prong plug
- 3 ON/3 OFF settings per day
- Plugs directly into wall outlet

Model #	Voltage
D. TN311	125 VAC, 60 Hz

**Rating:**

15 A Resistive, 15 A Inductive, 1875 W Tungsten, 12 FLA, 72 LRA  
**Warranty:** Limited 1 year



E.

### DT620

#### Heavy-Duty Indoor Digital Timer

- 2 grounded receptacles and grounded plug
- 28 ON/OFF settings
- Astronomic settings with automatic Daylight Saving Time adjustment

Model #	Voltage	HP
E. DT620	125 VAC, 60 Hz	1/2

**Rating:**

15 A Resistive, 12 A Inductive, 1000 W Tungsten, 1/2 HP Motor  
**Warranty:** Limited 1 year



F.

### TN111RM40

#### Plug-In Mechanical Timer

- 24-Hour timing
- 2 ON/OFF settings per day
- Manual override
- Rated for outdoor use in a Type 3R outdoor enclosure

Model #	Voltage
F. TN111RM40	125 VAC, 60 Hz

*Additional Trippers see page 153  
 (107TN221 red, 107TN222 turquoise)*

**Rating:**

9.5 A Resistive, 1185 W Inductive  
**Warranty:** Limited 1 year



G.

### HB880R

#### Heavy-Duty Outdoor Digital Timer

- 2 grounded receptacles with 24" cord and grounded plug
- Controls incandescent, fluorescent, LED, and CFL
- Multiple programming options
- AA battery backup
- Astronomic settings with automatic Daylight Saving Time adjustment

Model #	Voltage	HP
G. HB880R	120 VAC, 60 Hz	1/2

**Rating:**

15 A General Purpose, 1000 W Tungsten, 500 VA Electronic Ballast, 8.3 A Ballast (Inductive)  
**Warranty:** Limited 1 year



**{ 9 Buttons }**  
**Hundreds of Options**  
MultiWave



For more information on the MultiWave, see pages 114-117



# Sensors



Parking Lot Lighting

**Street Lighting**

Highway Lighting

***Security Lighting***

**Entry Lighting**

**Bridge Lighting**

*Bathroom Lighting*

***Hallway Lighting***

Landscape Lighting

**Outdoor Lighting**

The LightMaster lighting control system gives **YOU** the power to independently control two circuits based on the amount of natural light in an area. Simply adjust the LightMaster foot-candle dials to a desired light level and you instantly manage light the way you see it.

Imagine the energy savings. Instead of being stuck with a lighting control that only turns lights ON/OFF in an area, you could have a LightMaster that can turn lights ON in part of an area and OFF in another. ***This helps reduce your energy consumption by as much as 50%.***

LightMaster is ideal for any lighting application where operation is based on natural light. The sensors can be installed in a 330-foot radius from the controller in different accessible areas, such as a rooftop or a window, for easy service access and reduced maintenance costs.

On top of the easy accessibility, LightMaster is virtually ***maintenance free for the first 10 years of operation*** thanks to its durable sensor lifespan that outlasts many thermal photocontrol sensors.

LightMaster also features unmatched accuracy with independent settings that enable indoor lighting to stay off until natural lighting is reduced, while outdoor lighting turns on when natural light is lost. The unique lighting control system turns lights ON during inclement weather and avoids nuisance ON/OFF switching caused from lightning or car lights. A single LightMaster can provide a signal for up to 20 circuits to help conserve energy and promote a safer lit area for customers and workers.

**LightMaster**<sup>TM</sup>  
Manage light the way **you** see it

# LightMaster in Action

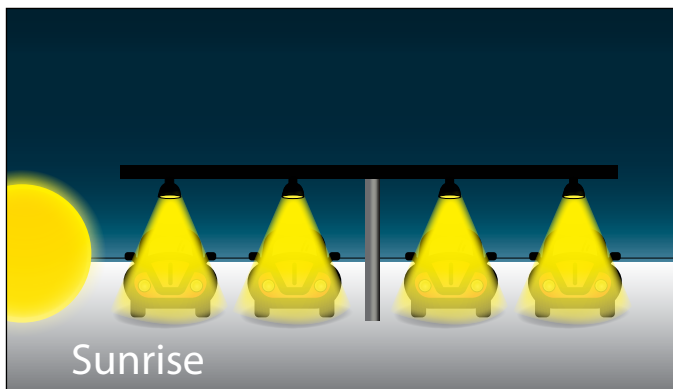

At sunrise, no natural light is available, so lights are ON.

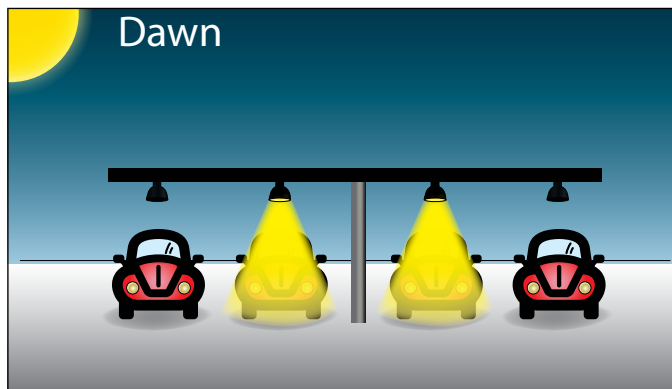

At dawn, natural light reaches the outer areas. Only inside area lights remain ON. Energy costs are reduced by up to 50%.

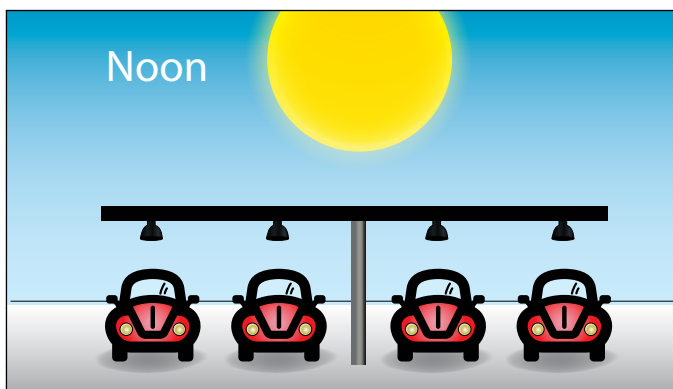

At noon, natural light is available, so lights are turned OFF.

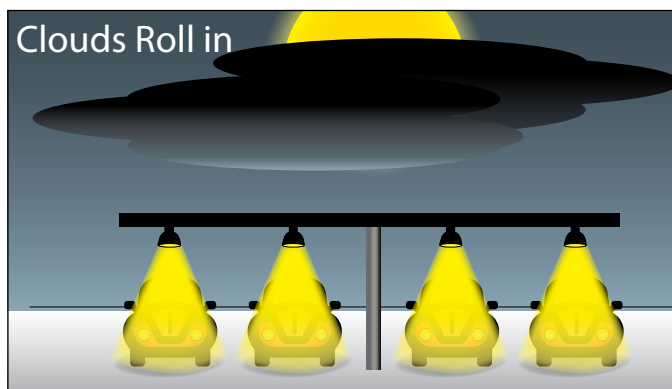

A storm rolls in and reduces sunlight. LightMaster ensures all areas are adequately lit, for maximum safety, no matter what time of day.

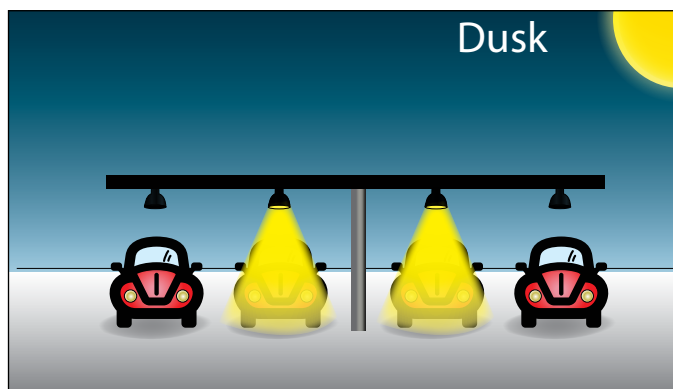

At dusk, natural light still reaches the outer areas. Only inside areas turn ON. Energy costs are reduced by up to 50%.

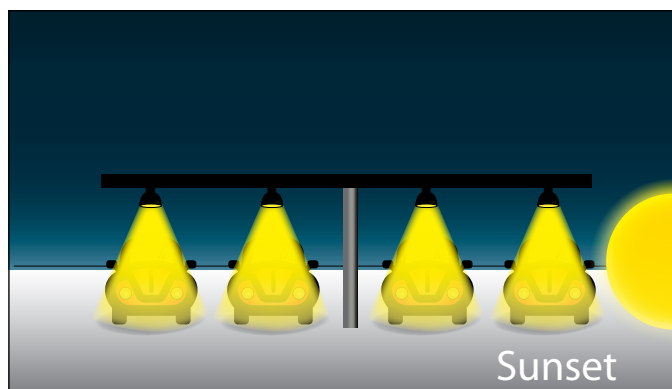

At sunset, the area is dark and the lights are ON.

## Applications

- Security Lighting
- Atriums
- ATM/Banks
- Awnings, Shades, Blinds
- Parking Garages
- Industrial Yards, Off-Shore Rigs, Shipyards
- Site Lighting
- 24-Hour Retail Convenience Store/ Service Establishments
- Perimeter Lighting
- Accessways, Walkways, Driveways
- Exterior Lighting
- Signage

NEW



Kit includes LS2 Sensor

## LM2-O-882T

### LightMaster Control System with Timer



- 2-circuit control unit
- One sensor controls both circuits
- Independent light level and time delay adjustments for each circuit
- Timer turns lighting ON/OFF as needed to maximize energy savings
- 365-Day and holiday scheduling for maximum flexibility without additional maintenance expenses

Model #	Sensor	Sensor Type	Foot-Candle Range
LM2-O-882T	LS2	Dark	10 to 1,000 fc

For enclosure options and dimensions, see page 151

#### Rating:

**Enclosure:** Type 3R Rainproof Enclosure

**Input Voltage:** 120 VAC

**Operating Temperature:**

**Control:** -4°F to 131°F (-20°C to 55°C)

**Sensor:** -22°F to 158°F (-30°C to 70°C)

**Switch Configuration:** SPDT "dry" contacts per circuit

**Resistive Rating:** 10 A, 277 VAC per circuit

**Inductive Rating:** 8 A, 277 VAC per circuit

**Relay:** SPDT "dry" contacts per circuit

**Sensor Variations:** LS1 Transparent Sensor 0.2 to 50

Foot-Candles, Transparent case (IP65),

LS2 Dark Sensor 10 to 1,000 Foot-Candles,

Dark UV Filter case (IP65)

**Sensor Time Delay:** 0 to 100 seconds

**Humidity Range:**

**Control:** 0 to 95% RH non-condensing

**Sensor:** 0 to 100% RH





Kit includes LS2 Sensor

**Rating:**

**Enclosure:** Type 3R Rainproof Enclosure

**Input Voltage:** 120 VAC

**Operating Temperature:**

**Control:** -4°F to 131°F (-20°C to 55°C)

**Sensor:** -22°F to 158°F (-30°C to 70°C)

**Switch Configuration:** SPDT "dry" contacts per circuit

**Resistive Rating:** 10 A, 277 VAC per circuit

**Inductive Rating:** 8 A, 277 VAC per circuit

**Sensor Variations:** LS1 Transparent Sensor 0.2 to 50 Foot-Candles, Transparent case (IP65), LS2 Dark Sensor 10 to 1,000 Foot-Candles, Dark UV Filter case (IP65)

**Sensor Time Delay:** 0 to 100 seconds

**Humidity Range:**

**Control:** 0 to 95% RH non-condensing

**Sensor:** 0 to 100% RH

## LM2-O-120 LightMaster Control System



- 2-circuit control unit
- One sensor controls both circuits
- One sensor can provide a signal for up to 10 LightMaster control modules
- Independent light level and time delay adjustments for each circuit

Model #	Sensor	Sensor Type	Foot-Candle Range
---------	--------	-------------	-------------------

LM2-O-120	LS2	Dark	10 to 1,000 fc
-----------	-----	------	----------------

For enclosure options and dimensions, see page 151



A.



B.



C.



D.

## PC Series

### LightMaster Control Modules with Sensor

- Transparent and dark sensor types available to accommodate your distinct light-level needs
- Adjustable light-level sensitivity control
- Surface/DIN Rail mountable
- 0-to-100-second adjustable sensor time delay

Model #	Sensor	Circuits	Sensor Type	Foot-Candle Range
A. PC2-120-LS1	LS1	2	Transparent	0.2 to 50 fc
B. PC2-120-LS2	LS2	2	Dark	10 to 1,000 fc
C. PC1-120-LS1	LS1	1	Transparent	0.2 to 50 fc
D. PC1-120-LS2	LS2	1	Dark	10 to 1,000 fc

For ratings, See pages 66 & 67

For enclosure options and dimensions, see page 151



E.



F.

## PC1-120 & PC2-120 LightMaster Control Modules

- 1 or 2 circuit control units
- 1 light-level setpoint per circuit
- Adjustable dials for setting foot-candle levels
- 0-to-100-second sensor time delay adjustment dials
- Surface/DIN Rail mountable

Model #	Circuits
E. PC1-120	1
F. PC2-120	2

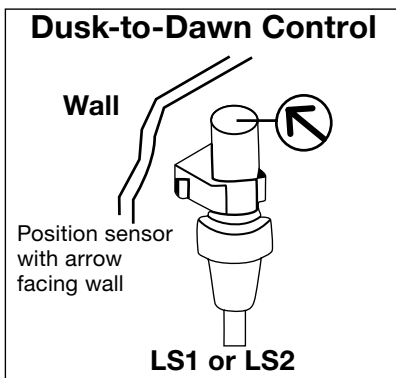

G.



H.

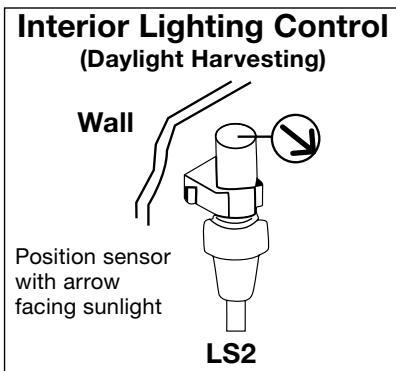

## LS Series LightMaster Ambient Light Sensors

- Transparent and opaque sensors for all lighting applications
- One sensor can provide a signal for up to 10 LightMaster control modules
- Accurate, reliable measurement for precise foot-candle light-level settings

Model #	Sensor	Sensor Type	Foot-Candle Range	Mounting Type
G. LS1	LS1	Transparent	0.2 to 50 fc	½" conduit fitting
H. LS2	LS2	Dark	10 to 1,000 fc	½" conduit fitting

For ratings, see pages 66 & 67

For enclosure options and dimensions, see page 151



A.



B.

## K4000C Series

### Thermal-Type Photo Controls with Fixed Position Mounting

- Fits into standard outlet box, post lamp or wall packs
- Model K4321C includes a weatherproof wallplate with neoprene gasket
- Includes  $\frac{3}{8}$ " npsm with  $\frac{3}{4}$ " long stem locking nut and washer gasket
- 2-year warranty

Model #	Watts Tungsten	VA Ballast*	Input Voltage	Agency/Listing
A. <b>K4021C</b>	1800	1000	120 VAC	UL C US
<b>K4023C</b>	3100-4150	1700-2300	208-277 VAC	UL C US
<b>K4027</b>	5205	2880	347 VAC	C US
<b>K4035</b>	7200	4000	480 VAC	—
B. <b>K4321C†</b>	1800	1000	120 VAC	UL C US

\*The ballast wattage rating is based upon a 50% power factor

†UL listing for K4321C applies to the entire plate assembly when properly mounted to an approved outdoor junction box

#### Rating:

Inductive Ballast: 8.3 A

Tungsten: 15 A

Activation: 1-5 FC ON, 3-15 FC OFF (without shield)

Operating Temperature: -40°F to 158°F (-40°C to 70°C)

Color: Gray

Lead Length: 9" leads

#### Dimensions:

Plate - 4  $\frac{1}{2}$ " (11.4 cm) H x 2  $\frac{3}{4}$ " (7.0 cm) W

Mechanism -  $\frac{15}{16}$ " (3.3 cm) W x 1  $\frac{13}{16}$ " (4.6 cm) L x  $\frac{13}{16}$ " (2.1 cm) D



### 6LV1352 Light Shield

- Fits K40 Series

Model #	Qty.
6LV1352	1

## Accessory for Fixed Position Thermal-Type Photo Controls

## K4100 & K4400 Series Thermal-Type Photo Controls with Stem Mounting

- Single and multi-volt models
- Dusk-to-Dawn lighting control
- Delay feature prevents unwanted OFF switching
- Lightlevel slide adjustment
- Cadmium sulfide photocell
- 1/2"-14 threaded stem
- Washer gasket and locking nut included



Model #	Watts Tungsten	VA Ballast	Amps Tungsten	Amps Ballast	Input Voltage	Agency/Listing	Warranty
C. <b>K4121C</b>	1800	1000	15	8.3	120 VAC		2 year
<b>K4123C</b>	3100-4150	1700-2300	15	8.3	208-277 VAC		2 year
<b>K4127</b>	5205	2880	15	8.3	347 VAC		2 year
<b>K4135</b>	7200	4000	15	8.3	480 VAC	-	2 year
<b>K4141C</b>	3000	3000	25	25	120 VAC	-	1 year
D. <b>K4421M*</b>	1800	1000	15	8.3	120 VAC		2 year
<b>K4423M*</b>	3100-4150	1700-2300	15	8.3	208-277 VAC		2 year
<b>K4136M*</b>	2000-4625	1800	16.7	15	120 or 277 VAC		2 year

\*Models with "M" suffix have heavy-duty die cast housing

**Rating:**

**Dimensions:** 1 9/16" (4.0 cm) Sq x 3" (7.6 cm) L  
**Power Consumption:** Under 1 W  
**Operating Temperature:** -40°F to 158°F (-40°C to 70°C)

## Screw-In Photo Control

- Controls interior and exterior lights
- ON at dusk, OFF at dawn
- Accommodates any incandescent light
- Limited 1-year warranty

Model #	Voltage	Watts
<b>NE1C</b>	120 VAC/60 Hz	150 Max

Note: Not for use with CFL and LED lights





## K4200 Series Thermal-Type Photo Controls with Stem & Swivel Mounting

- Single and multi-volt models
- Delay feature prevents unwanted OFF switching
- Cadmium sulfide photocell
- Dual temperature compensating bi-metal and composite resistor
- Washer gasket and locking nut included

### Photo Eye on Side with Light-Level Adjustment

Model #	Watts Tungsten	VA Ballast	VAC	Agency/Listing	Warranty
A. K4221C	1800	1000	120	UL, SFC US	2 year
K4223C	3100-4150	1700-2300	208-277	SFC US	2 year
K4227	5205	2880	347	SFC US	2 year
K4235	7200	4000	480	-	2 year

### Photo Eye on Top (for spot/flood fixtures)

Model #	Watts Tungsten	VA Ballast	VAC	Agency/Listing	Warranty
B. K4251	1800	1000	120	SFC US	1 year
K4253	3100-4150	1700-2300	208-277	SFC US	1 year
C. K4236C	1800-4150	1000-2300	120-277	UL, SFC US	2 year

#### Rating:

Tungsten Amps: 15

Ballast Amps: 8.3

Power Consumption: Averages under 2 W

Activation: 1-5 FC ON, 3-15 FC OFF (photo eye clear models with shield)

Operating Temperature: -40°F to 158°F (-40°C to 70°C)

Lead Length: 6"

Dimensions: K4200 Series: ½"- 14 threaded swivel, 1 ⅞" (4.0 cm) Sq. x 5 ½" (14.0 cm) L

K4236C: 5 ¾" (14.6 cm) H x 3" (7.6 cm) Ø

K4251 and K4253: 4" (10.2 cm) H x 1 ⅜" (3.5 cm) Ø

K4200 Series A. only: 6 ¼" (15.9 cm) Ø

## K4500 Series

### Thermal-Type Photo Controls with Locking-Type Mounting

- Dusk-to-Dawn lighting control
- Cadmium sulfide photocell
- Easy-to-install
- Standard 3-prong locking-type plug connections
- Delay feature prevents unwanted OFF switching
- Dual temperature compensating bi-metal and compositor resistor
- Sonic welded case and lens seal out moisture
- 2-year warranty



Model #	Watts Tungsten	VA Ballast	VAC 50/60 Hz	Agency/Listing
D. K4521	1800	1000	120	UL, SFC US
K4522	3600	2000	240	UL, SFC US
K4524	3100	1700	208	UL, SFC US
K4533	4155	2300	277	UL, SFC US
K4535	7200	4000	480	UL, SFC US

#### Rating:

Tungsten Amps: 15

Ballast Amps: 8.3

Power Consumption: Averages under 2 W

Activation: 1-5 FC ON, 3-15 FC OFF

Operating Temperature: -40°F to 158°F (-40°C to 70°C)

Dimensions: 3 ¼" (8.3 cm) H x 3" (7.6 cm) Ø

## LC4500 Series Thermal-Type Photo Controls

- Locking-Type Mounting
- Controls street lighting and other applications requiring twist and lock plug connection
- Integral high impact thermoplastic housing
- Complies with ANSI C136.10 Standard
- Dual temperature compensating bi-metal and composite resistor
- Dusk-to-Dawn lighting control
- Delay feature prevents unwanted OFF switching
- 2-year warranty



E.

Model #	Watts Tungsten	VA Ballast	Voltage 50/60 Hz	Agency/Listing
E. LC4521C	1800	1000	120	UL, SF US
LC4523	3100-4155	1700-2300	208-277	UL, SF US
LC4527	5205	2880	347	SF US
LC4535	7200	4000	480	UL, SF US
LC4536C	1800-4155	1000-2290	120-277	UL, SF US
LC4521LA*	1800	1000	120	UL, SF US
LC4523LA*	3100-4155	1700-2300	208-277	UL, SF US
LC4535LA*	7200	4000	480	UL, SF US
LC4536LAC*	1800-4155	1000-2290	120-277	UL, SF US

\*Models equipped with a 2400 volt open type spark gap arrester.

### Rating:

**Tungsten Amps:** 15

**Ballast Amps:** 8.3

**Power Consumption:** Averages under 1 W

**Activation:** .5 FC minimum ON, 15 FC maximum OFF

**Color:** Translucent with color-coded band for voltage identification

**Dimensions:** 2 3/4" (7.0 cm) H x 3" (7.6 cm) Ø

## Accessories for Photo Controls



F.



G.



H.



J.

Model #	Description	Rating	Agency Listing
F. K122	Outdoor Locking-Type Receptacle with Pole Bracket	15 A Max, 480 Volt Max.	UL US
G. K121	Locking-Type Receptacle with 9" Leads	15 A Max, 480 Volt Max.	UL US
K121-30	Locking-Type Receptacle with 30" Leads	15 A Max, 480 Volt Max.	SF US
H. K4500	Shorting Cap	15 A Max, 480 Volt Max.	UL, SF US
J. K42-SW-A	Swivel Assembly for K4100, K4200 Series	-	-

### Rating:

**Pole Bracket Adapters:** For use with all locking-type photo controls

**Shorting Cap K4500:** 105-480 Volts; replaces locking-type photo control to complete circuit

**Dimensions:** 2 3/4" (7.0 cm) H x 3" (7.6 cm) Ø



A.

## K1100, K1200 Series Relay-Type Photo Controls with Locking-Type or Adjustable-Stem Mounting



- Instant ON/OFF switching with two mounting types
- K1100 models have three 6" color-coded leads
- K1200 models have 2400 volt open-type spark gap arrester and standard 3-prong connector
- Adjustable stem models can be set at any angle up to 80 degrees
- 2-year warranty

### Adjustable Stem

Model #	Voltage	Amps Tungsten	Amps Ballast
A. K1121	105-130 VAC, 50/60 Hz	15	15
K1122	208-240 VAC, 50/60 Hz	7.5	7.5

### Twist Lock

Model #	Voltage	Amps Tungsten	Amps Ballast
B. K1221	105-130 VAC, 50/60 Hz	15	8.3
K1222	208-240 VAC, 50/60 Hz	7.5	7.5

#### Rating:

**Watts Tungsten:** 1800

**VA Ballast:** 1800

**Activation:** 1 FC ON, 3 – 10 FC OFF

**Operating Temperature:** -40°F to 158°F (-40°C to 70°C)

**Dimensions: K1100 Series:** 5 3/4" (14.6 cm) H x 3" (7.6 cm) ø, 1/2" – 14 NPT Stem

**K1200 Series:** 3 3/4" (9.5 cm) H x 3" (7.6 cm) ø



B.

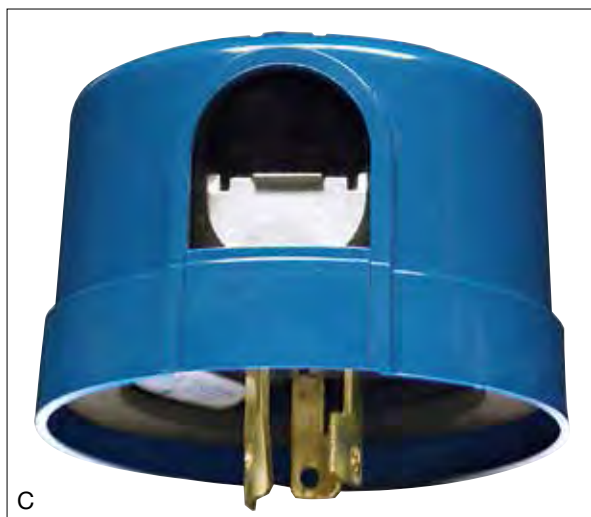

C.

## LC2000



### Low Cost Relay-Type Photo Control with Locking-Type Mounting

- Complies with ANSI C136.10 Standard
- Easy-to-install plug-in locking-type connector
- Heavy-duty relay designed for long life switching
- Instant ON/OFF switching
- 2-year warranty

Model #	Voltage	Watts Tungsten	VA Ballast
C. LC2000	110-277 VAC, 50/60 Hz	1000	1800

#### Rating:

**Activation:** 1 to 3 FC ON, Turn OFF to turn ON ratio is 4

**Dimensions:** 2 3/8" (5.6 cm) H x 3 3/16" (8.1 cm) ø



# EK4536

## Electronic Photo Controls Locking-Type

- Specifically designed to provide long life and superior surge protection when used with LED luminaires
- Twice the lifespan of comparable photo controls
- Photo control relay exceeds 10,000 operations at full load
- Zero crossing preserves contacts for longer lifespan
- Conformal coated board protects against environmental conditions
- Complies with ANSI C136.10-2010 Standard
- CSA certified to both UL & CSA standards
- High-tech silicon light sensing for consistent, repeatable operation
- Filters out all sources of infrared light to match human eye response
- 370 Joule MOV
- 8-year manufacturer's warranty

Model #	Voltage	Photo Sensor
F. <b>EK4536</b>	120-277 VAC, 50/60 Hz	Silicon - IR filtered

**Rating:**  
**Tungsten:** 1000 W  
**Inductive Ballast:** 1800 VA  
**Activation Type:** Instant ON – 2-5 Sec. Delay OFF  
**Light Level:** 1.2-3 FC ON, 2- 5 FC OFF  
**Operating Temperature:** -40°F to 158°F (-40°C to 70°C)



Model #	Timer	Voltage	Photo Sensor
D. <b>K4536SS</b>	-	120-277 VAC	Silicon - IR filtered
E. <b>K4536SST</b>	Yes	120-277 VAC	Silicon - IR filtered

**Rating:**  
**Tungsten:** 1000 W  
**Ballast:** 1800 W  
**Activation:** 3 FC ON, 2-4 FC OFF  
**Operation:** Instant ON, 10 Second Delay OFF  
**Operating Temperature:** -40°F to 158°F (-40°C to 70°C)  
**Color:** Translucent with color coded band for voltage identification  
**Dimensions:** 2 3/4" (7.0 cm) H x 3" (7.6 cm) ø

## K4536SS & K4536SST Solid-State Photo Controls Locking-Type

- Dusk-to-Dawn lighting control
- Electronically calibrated – does not require resetting
- Reliable control of street lighting and other applications requiring plug-in twist and lock connection
- Complies with ANSI C136.10 Standard and Federal and Dark Sky Initiative
- Fits in ordinary locking-type socket
- Automatically resets after power outage
- Retro-fits any standard locking-type photo control
- 430 Joule MOV
- 3-year warranty



## IOS-CMP-U

- Zero crossing
- Adjustable time delay
- Adjustable ambient light sensor
- Suitable for use with electronic ballast
- Limited 2-year warranty

Model #	Voltage	Mounting Height	Coverage
IOS-CMP-U	120-277 VAC	8'	1,200 sq. ft.

### Rating:

**Voltage:** 120-277 VAC, 60 Hz.

**Adjustable Light Level:** 10fc - 150fc

**Adjustable Time Delay:** 15 sec. - 30 min.

**Coverage Pattern:** 360° 1200 sq. ft.

**Incandescent:** 800 W, 120 VAC, 60 Hz.

**Inductive Ballast:** 800 VA, 120 VAC, 60 Hz. 1600 VA at 277 VAC, 60 Hz.

**Electronic Ballast:** 800 VA, 120 VAC, 60 Hz. 1600 VA at 277 VAC, 60 Hz.

**Motor:** ¼ HP, 120 VAC, 60 Hz.

**Operating Temperature:** 32°F to 131°F (0°C to 55°C)



## IOS-HB-U

- Zero crossing
- Adjustable time delay
- Adjustable ambient light sensor
- Suitable for use with electronic ballast
- Limited 2-year warranty

Model #	Voltage	Mounting Height	Coverage
IOS-HB-U	120-277 VAC	15'-50'	1200 sq. ft. (Lens 1) 2800 sq. ft. (Lens 2)

### Rating:

**Voltage:** 120-277 VAC, 60 Hz.

**Adjustable Light Level:** 10fc - 150fc

**Adjustable Time Delay:** 15 sec. - 30 min.

**Coverage Pattern:** (Lens 1) 360° 1200 sq. ft. (Lens 2) 360° 2800 sq. ft.

**Incandescent:** 800 W, 120 VAC, 60 Hz.

**Inductive Ballast:** 800 VA, 120 VAC, 60 Hz. 1600 VA at 277 VAC, 60 Hz.

**Electronic Ballast:** 800 VA, 120 VAC, 60 Hz. 1600 VA at 277 VAC, 60 Hz.

**Motor:** ¼ HP, 120 VAC, 60 Hz.

**Operating Temperature:** 32°F to 131°F (0°C to 55°C)



## IOS-CMP-LV

- Low Voltage remote mounted sensor
- Adjustable time delay
- Walk through detection
- Adjustable ambient light sensor
- Powered by IOS-PP24 power pack
- Limited 2-year warranty

Model #	Voltage	Mounting Height	Coverage
IOS-CMP-LV	24 VDC	8'	1,200 sq. ft.

### Rating:

**Voltage:** 24 VDC

**Adjustable Light Level:** 10fc - 150fc

**Adjustable Time Delay:** 15 sec. - 30 min.

**Operating Temperature:** 32°F to 131°F (0°C to 55°C)

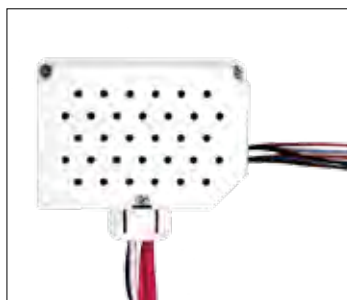

## IOS-PP24

- Zero crossing
- Controls up to 6 IOS-CMP-LV
- Suitable for use with electronic ballast
- Multiple switching operations
- Limited 2-year warranty

Model #	Voltage
IOS-PP24	120-277 VAC

### Rating:

**Voltage:** 120-277 VAC, 50/60 Hz.

**Incandescent:** 15 A, 120 VAC, 50/60 Hz.

**Inductive Ballast:** 20 A, 120/240/277 VAC, 50/60 Hz.

**Motor:** 1 HP, 120/240 VAC, 50/60 Hz.

**Operating Temperature:** 32°F to 131°F (0°C to 55°C)

## IOS-DDR / DSR In-Wall Occupancy/Vacancy Sensor



- Zero crossing
- Self-Adaptive feature automatically adjusts time delay based on occupant patterns
- “Walk-through” feature detects when areas are briefly occupied and turns lighting OFF based on a shorter time delay to maximize energy savings
- No neutral required
- Passive Infrared technology
- Standard decorator wall plate
- Adjustable ambient light sensor
- Suitable for use with electronic ballast
- Limited 5-year warranty

Model #	Color
<b>2 Circuit</b>	
A. IOS-DDR-WH	White
<b>1 Circuit</b>	
B. IOS-DSR-WH	White
IOS-DSR-IV	Ivory

### Ratings:

**Voltage:** 120/277 VAC, 60 Hz.  
**Time Delay:** 15 sec. - 30 min.  
**Coverage Area:** 180°, 1200 sq. ft.  
**Light Level:** 30 Lux-Daylight  
**Incandescent:** 800 W, 120 VAC

**Inductive Ballast:** 800 VA at 120 VAC,  
 1600 VA, 277 VAC  
**Motor:** ¼ HP, 120 VAC  
**Operating Temperature:**  
 32°F to 131°F (0°C to 55°C)



A.

B.

## IOS-DOV Series In-Wall Occupancy/Vacancy Sensors



- Zero crossing
- Automatic ON/OFF Control
- Passive Infrared technology
- Adjustable ambient light sensor
- Standard decorator wall plate
- Suitable for use with electronic ballast
- Optional night light for vacancy sensing
- Limited 5-year warranty

Model #	Night Light	Color	Requires Neutral
C. IOS-DOV-WH	No	White	Yes
IOS-DOV-NL-WH	Yes	White	Yes
D. IOS-DOV-IV	No	Ivory	Yes
IOS-DOV-NL-IV	Yes	Ivory	Yes

### Ratings:

**Voltage:** 120 VAC, 60 Hz.  
**Incandescent:** 800 W, 120 VAC  
**Inductive Ballast:** 800 VA, 120 VAC  
**Resistive:** 800W, 120 VAC  
**Time Delay:** 15 sec. - 30 min.

**Coverage Area:** 180°, 1200 sq. ft.  
**Motor:** ¼ HP, 120 VAC  
**Operating Temperature:**  
 32°F to 131°F (0°C to 55°C)



D.

C.



# Which Sensor Works Better for You?

## Occupancy Sensors

Lights automatically turn ON when entering a room  
Lights automatically turn OFF when room is vacant

## Vacancy Sensors

Requires manually turning lights ON when entering a room  
Lights automatically turn OFF when room is vacant

## IOS-DPBIF2 Series In-Wall Vacancy Sensors

- Can be used with electronic or magnetic ballasts
- Standard decorator wall plate included
- Limited 2-year warranty

Model #	Color	Requires Neutral
IOS-DPBIF2-WH	White	Yes
IOS-DPBIF2-IV	Ivory	Yes

### Ratings:

**Input Voltage:** 120 VAC, 60 Hz.

**Adjustment:** Manual

**Coverage Area:** 150°, 980 sq. ft.

**Tungsten:** 500 W, 120 VAC

**Resistive:** 500 W, 120 VAC

**Inductive Ballast:** 500 VA, 120 VAC

**Motor:** 1/8 HP, 120 VAC

**Operating Temperature:**  
32°F to 131°F (0°C to 55°C)



## IOS-DSIF / DSIMF Series In-Wall Occupancy Sensors

- Automatic ON/OFF Control
- Standard decorator wall plate included
- Ambient light sensor
- Limited 2-year warranty

Model #	Color	Requires Neutral
<b>Electronic Ballast</b>		
IOS-DSIF-WH	White	Yes
IOS-DSIF-IV	Ivory	Yes
<b>Inductive Ballast</b>		
IOS-DSIMF-WH	White	No
IOS-DSIMF-IV	Ivory	No

### Ratings:

**Input Voltage:** 120 VAC, 60 Hz.

**Adjustment:** Manual

**Coverage Area:** 150°, 980 sq. ft.

**Resistive:** 500 W, 120 VAC

**Tungsten:** 500 W, 120 VAC

**Inductive Ballast:** 500 VA, 120 VAC

**Motor:** 1/8 HP, 120 VAC

**Operating Temperature:**  
32°F to 131°F (0°C to 55°C)

## IOS-DPBIF / DPBIMF Series In-Wall Occupancy Sensors

- Automatic ON/OFF control
- Standard decorator wall plate included
- Ambient light sensor
- Limited 2-year warranty

Model #	Color	Requires Neutral
<b>Electronic Ballast</b>		
IOS-DPBIF-WH	White	Yes
IOS-DPBIF-IV	Ivory	Yes
<b>Inductive Ballast</b>		
IOS-DPBIMF-WH	White	No
IOS-DPBIMF-IV	Ivory	No

### Ratings:

**Input Voltage:** 120 VAC, 60 Hz.

**Adjustment:** Manual

**Coverage Area:** 150°, 980 sq. ft.

**Tungsten:** 500W, 120 VAC

**Resistive:** 500 W, 120 VAC

**Inductive Ballast:** 500 VA, 120 VAC

**Motor:** 1/8 HP, 120 VAC

**Operating Temperature:**

32°F to 131°F (0°C to 55°C)



## *How often have you stubbed your toe in a dark room or entered your home with every light ON?*

Intermatic's occupancy and vacancy sensors can finally put an end to these common annoyances. The intuitive sensors make sure room lights turn ON/OFF when needed, and not a second more. Take the pain out of your toes and your wallet today with an occupancy or vacancy sensor.

# CAN YOU DO 4,000 THINGS AT ONCE?



**INTERMATIC®**

*For more information on the ET90000, see pages 12-14*





# Hour Meters



**Boilers** Construction *Waste oil furnaces*

Custom UL Panels **Industrial air compressors**

**Irrigation pumps Escalators Generators**

Battery chargers *Elevators* Power Supplies

**Medical / Dental Automotive** Fire / Rescue

**Schools Central Vacuums** Manufacturing facilities

Wastewater pump panels *Production automation*



A.

## FWZ53 Series AC Hour Meters



- Non resettable
- Optional gasket to achieve IP54 rating
- White numerals on black background with tenths/hundredths numerals in yellow

	Model #	Input Voltage	Frequency
A.	FWZ53-120/50U	120 VAC	50 Hz
	FWZ53-120U	120 VAC	60 Hz
	FWZ53-220/50U	220 VAC	50 Hz
	FWZ53-24U	24 VAC	60 Hz

### Ratings:

**Bezel:** 2.09" x 1.02" (53 mm x 26 mm)

**Capacity:** 99,999.99 hours

**Digits:** 0.16" high numerals

**Power Consumption:** 1 VA

**Operating Temperature:** -40°F to 160°F (-40°C to 72°C)

**Termination:** Combination ¼" spade and screw clamp

**Mounting:** Flush-panel retainer mounted (2) 0.150" holes for #6 screws

**Panel Opening:** 1.50" x 1.00" rectangular (38 x 25 mm)

## FWZ55 Series AC Hour Meters



- Non resettable
- Optional gasket to achieve IP54 rating
- White numerals on black background with tenths/hundredths numerals in yellow

	Model #	Input Voltage	Frequency
B.	FWZ55-120U	120 VAC	60 Hz
	FWZ55-220/50	220 VAC	50 Hz
	FWZ55K-120U	120 VAC	60 Hz
	FWZ55K-220/50	220 VAC	50 Hz
	FWZ55K-240U	240 VAC	60 Hz

### Ratings:

**Bezel:** 2.36" x 1.36" (60 mm x 34.5 mm)

**Capacity:** 99,999.99 hours

**Digits:** 0.16" high numerals

**Operating Temperature:** -40°F to 160°F (-40°C to 72°C)

**Power Consumption:** 1 VA

**Termination:** Combination ¼" spade and screw clamp. Rear access screw terminals available (models with "K" suffix)

**Mounting:** Flush-panel retainer mounted with slip-on plastic retaining bracket

**Panel Opening:** 2.06" x 1.08" rectangular (52 mm x 27.5 mm)

## FWZ53 & FWZ55 Series Gasket

Model #	Description
G-55U	Gasket for FWZ53 & FWZ55
G-53U	Gasket for FWZ53



# Rugged and Tough

*Hour Meters built to withstand up to an environmental rating of IP54*



C.

## FWZ72 Series

### AC Hour Meters



- Non resettable
- Optional gasket to achieve IP54 rating
- White numerals on black background with tenths and hundredths numerals in yellow

Model #	Input Voltage	Frequency	Color
C. FWZ72-120U	120 VAC	60 Hz	Black
FWZ72-24U	24 VAC	60 Hz	Black
D. FWZ72B-120U	120 VAC	60 Hz	Blue, Silver, Clear
FWZ72B-240U	240 VAC	60 Hz	Blue, Silver, Clear
E. FWZ72C-120	120 VAC	60 Hz	Clear Frosted
FWZ72K-240U	240 VAC	60 Hz	Black



D.



E.

#### Ratings:

**Bezel:** 2.83" round (72 mm), 3 hole

**Capacity:** 99,999.99 hours

**Digits:** 0.16" high numerals

**Power Consumption:** 1VA

**Operating Temperature:** -40°F to 160°F (-40°C to 72°C)

**Termination:** Combination ¼" spade and screw clamp

Rear access screw terminals available (models with "K" suffix)

**Mounting:** Flush-panel mounted with three 0.185" holes for #8 screws

**Panel Opening:** 1.75" round (44.5 mm) or 1.50"x 1" rectangular (38 mm x 24 mm)

## FWZ72 Series Gasket

Model #

G-72U

Description

Gasket for FWZ72

# Get to Know The UWZ Series AC Hour Meters

There is no mistaking a Grässlin by Intermatic UWZ Series AC Hour Meter. The non-resettable meters meet the IP20 environmental rating for indoor applications and come standard with an accurate synchronous motor. All models have the trademark light gray color with white numerals on black background and yellow tenths and hundredths numerals. An orange dial adjacent to the hundredths digit provides running indication. An orange dial adjacent to the hundredths digit provides running indication.



## UWZ48 Series Surface Mount



- For use where terminal protection is not required
- Easy-to-install socket base
- Can be installed in panels or mounted indoors

Model #	Input Voltage
UWZ48-24U	24 VAC, 60 Hz
UWZ248-120U	120 VAC, 60 Hz
UWZ48-240U	240 VAC, 60 Hz

### Ratings:

**Bezel:** 1.89" x 1.89" (48 mm x 48 mm)  
**Capacity:** 99,999.99 hours  
**Digits:** 0.16" high numerals  
**Power Consumption:** 1VA

### Termination:

**Screw lugs**  
**Operating Temperature:**  
 -40°F to 160°F (-40°C to 72°C)  
*Accuracy synchronous to network*



## UWZ48A Series Enclosed Surface Mount



- For use where terminal protection is required
- Terminal cover for added safety
- Easy-to-install socket base

Model #	Input Voltage
UWZ48A-24U	24 VAC, 60 Hz
UWZ248A-120U	120 VAC, 60 Hz

### Ratings:

**Bezel:** 1.89" x 1.89" (48 mm x 48 mm)  
**Capacity:** 99,999.99 hours  
**Digits:** 0.16" high numerals  
**Power Consumption:** 1VA

### Termination:

**Screw lugs**  
**Operating Temperature:**  
 -40°F to 160°F (-40°C to 72°C)  
*Accuracy synchronous to network*

## UWZ48E Series Flush Mount with Bracket



- Fits into 1.79" x 1.79" (45.5 mm x 45.5 mm) cut-out
- Flush mount panel thickness up to 0.35" (9 mm)
- Fits square or round 72 mm opening with optional bezel
- Unit is secured by a plastic slip-on retaining bracket

Model #	Input Voltage
UWZ48E-120U	120 VAC, 60 Hz
UWZ48E-120/50U	120 VAC, 50 Hz
UWZ48E-220/50U	220 VAC, 50 Hz
UWZ48E-24U	24 VAC, 60 Hz
UWZ48E-24/50U	24 VAC, 50 Hz
UWZ48E-240U	240 VAC, 60 Hz

<b>Rating:</b> Bezel: 1.89" x 1.89" (48 mm x 48 mm) Capacity: 99,999.99 hours Digits: 0.16" high numerals	<b>Termination:</b> Combination ¼" spade and screw clamp <b>Operating Temperature:</b> -40°F to 160°F (-40°C to 72°C) <i>Accuracy synchronous to network</i>
--	--



## UWZ48V Series DIN Rail Mount



- Snap-on socket base
- Unit can be fitted to DIN Rail quickly and easily

Model #	Input Voltage
UWZ48V-24U	24 VAC, 60 Hz
UWZ48V-120U	120 VAC, 60 Hz

<b>Rating:</b> Bezel: 1.89" x 1.89" (48 mm x 48 mm) Capacity: 99,999.99 hours Digits: 0.16" high numerals Termination: Screw lugs	<b>Operating Temperature:</b> -40°F to 160°F (-40°C to 72°C) <i>Accuracy synchronous to network</i>
---	---



## UWZ52E Series Flush Mount with Bracket



- Fits into 1.79" x 1.79" (45 mm x 45 mm) cut-out
- Round face fastened with a plastic slip-on retaining bracket
- Flush mount panel thickness up to 0.35" (9 mm)

Model #	Input Voltage
UWZ52E-120U	120 VAC, 60 Hz

<b>Rating:</b> Bezel: 2.28" (58 mm) diameter Capacity: 99,999.99 hours Digits: 0.16" high numerals	<b>Termination:</b> Combination ¼" spade and screw clamp <b>Operating Temperature:</b> -40°F to 160°F (-40°C to 72°C) <i>Accuracy synchronous to network</i>
---	--



## UWZ48E Series Accessories Bezels

Model #	Description	Color
BEZ-55BLACKU	55 mm Bezel	Black
BEZ-55GRAYU	55 mm Bezel	Gray
BEZ-72U	72 mm Bezel	Gray
BEZ-72PU	72 mm Bezel with 3 pins for round 3-bolt hole openings	Gray



### GZ40AU DC Hour Meter

- Flush mount
- Operates on DC Voltages
- Measures up to six digits to determine usage
- Dustproof and splashproof construction

Model #	Input Voltage
A. GZ40AU	10-80 VDC

**Rating:**  
**SAE Bezel:** 2.31" diameter (59 mm)  
**Capacity:** 99,999.9 hours  
**Digits:** 6 – 0.125 high numerals, Hours: white on black, Tenths: red on white  
**Power Consumption:** .03 W, 12VDC; .70 W, 48 VDC  
**Temperature:** -22°F to 150°F (-30°C to 65°C)  
**Vibration Resistance:** 10-75 Hz, 1-8 g  
**Protected From:** Reverse Polarity, inductive switching  
**Termination:** ¼" spade terminals  
**Environmental Rating:** IP66



### GZ52BU DC Hour Meter



- Operates on DC Voltage
- Measures up to six digits to determine usage
- Quartz stabilized vibration proof
- LED operation indicator
- Dustproof and splashproof construction

Model #	Input Voltage
B. GZ52BU	8-30 VDC

**Rating:**  
**Current Consumption:** < 3 mA, 12 VDC  
**Accuracy:** ±0.5 sec/day at 20°C  
**Mechanical Movement:** 2-Phase Step Motor  
**Display:** 6 Digits (99999.9 Hours)  
**Bezel:** 2.28" (58 mm)  
**Electrical Connection:** ¼" Quick Connectors  
**Polarity Protection:** Reverse Polarity-Diode  
**Mounting:** Flush (screw adj.)  
**Operating Temperature:** -40°F to 185°F (-40° C to 85°C)  
**Storage Temperature:** -40°F to 194°F (-40° C to 90°C)  
**Environmental Rating:** IP65  
**Shock Resistance:** DIN EN60068-2-27  
**Vibration Resistance:** DIN EN60068-2-64



### GZ40BU DC Hour Meter

- Surface mount
- Operates on DC Voltages
- Measures up to six digits to determine usage
- Dustproof and splashproof construction

Model #	Input Voltage
C. GZ40BU	10-80 VDC

**Rating:**  
**3-Hole Bezel:** 2.80" diameter (72 mm)  
**Totally sealed enclosure**  
**Capacity:** 99,999.9 hours  
**Digits:** 6 – 0.125 high numerals, Hours: white on black, Tenths: red on white  
**Voltage:** 10-80 VDC  
**Power Consumption:** .03 W, 12 VDC, 70 W, 48 VDC  
**Temperature:** -22°F to 150°F (-30°C to 65°C)  
**Vibration Resistance:** 10-75 Hz, 1-8 g  
**Termination:** ¼" spade terminals  
**Protected From:** reverse polarity, inductive switching  
**Environmental Rating:** IP66

# NO Power Needed...

The RZ Series Vibration Hour Meters convert vibrations into energy to drive the minute hand. The sensitive hour meters can operate from the slightest vibrations, such as a moving car.



	Model #	Installation	Quantity
A.	RZ52HU	Horizontal	1
	RZ52VU	Vertical	1

#### Ratings

**Dimensions:** (Ø x D) 2.28" x 2.05" (58 mm x 75 mm)

**Panel Cutouts:** Ø 2.05" (52 mm)

**Mounting Depth:** 2.95" (75 mm)

**Ambient Temperature:** 5°F to 140°F (-15°C to 60°C)

**Protection Quality:** IP65

**Accuracy:** +/-3% at uninterrupted operation

**Counting Range:** 99,999 hours

**Mounting:** Flush mount

**Mounting Position:** RZ 52 H to 45° RZ 52 V to 45°

## RZ Series Vibration Hour Meters



- No electrical connection required
- Automatic mechanism converts vibrations into energy to drive meter
- Horizontal and vertical installation
- Front panel is dustproof and waterproof
- High-sensitivity level

# On DEMAND

## *Lighting Controls*



**INTERMATIC®**



*For more information on the In-wall timers, see pages 48-55*

# Defrost / HVACR



## *Commercial Refrigeration Systems*

Food processing facilities

**Food equipment**

Free standing coolers

**Food Storage facilities**

**Blast chillers**

**Ice Machines**

Food Display cases

Supermarkets

**Walk-in coolers**

Beverage equipment

**Reach-in coolers**

**NEW**

# Set in 3 Easy Steps

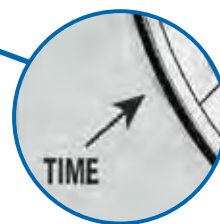

1) Set Time

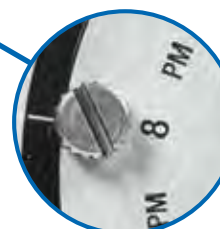

2) Set Defrost

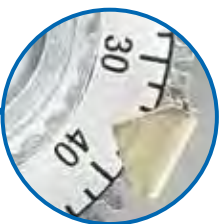

3) Set Defrost Duration

## G8000 Series Durable Mechanical Defrost Timer

- Long life welded silver contacts rated at 40 Amps, 2 HP rating
- Encapsulated time module design prevents dust and dirt buildup
- Heavy-duty synchronous motor
- Mechanism snaps into many existing enclosures and brackets
- Heavy-duty steel enclosure with knockouts on bottom, back, and sides
- Up to six defrost cycles per day
- Includes 4 trippers
- Defrost termination from 4 to 110 minutes in 2 minute increments
- Works with external temperature or pressure sensors
- Positive switch action slide bar
- Quick and easy installation
- 2-year warranty



**Ratings:**  
**Electrical Ratings:** 40 A Resistive, 2 HP  
**Pilot Duty:** 1000VA  
**Enclosure:** Type 1 Indoor

Model #	Description	Input Voltage	Switch Type
G8045-00	Time Initiated. Time Terminated.	120 VAC, 60 Hz	1N.O./1N.C.
G8045-20	Time Initiated. Time Terminated.	208-240 VAC, 60 Hz	1N.O./1N.C.
G8145-00	Time Initiated. Temperature, Pressure or Time Terminated.	120 VAC, 60 Hz	1N.O./1N.C.
G8145-20	Time Initiated. Temperature, Pressure or Time Terminated.	208-240 VAC, 60 Hz	1N.O./1N.C.

For enclosure dimensions, see page 146



# No Tools Required

*Snaps into existing enclosures*

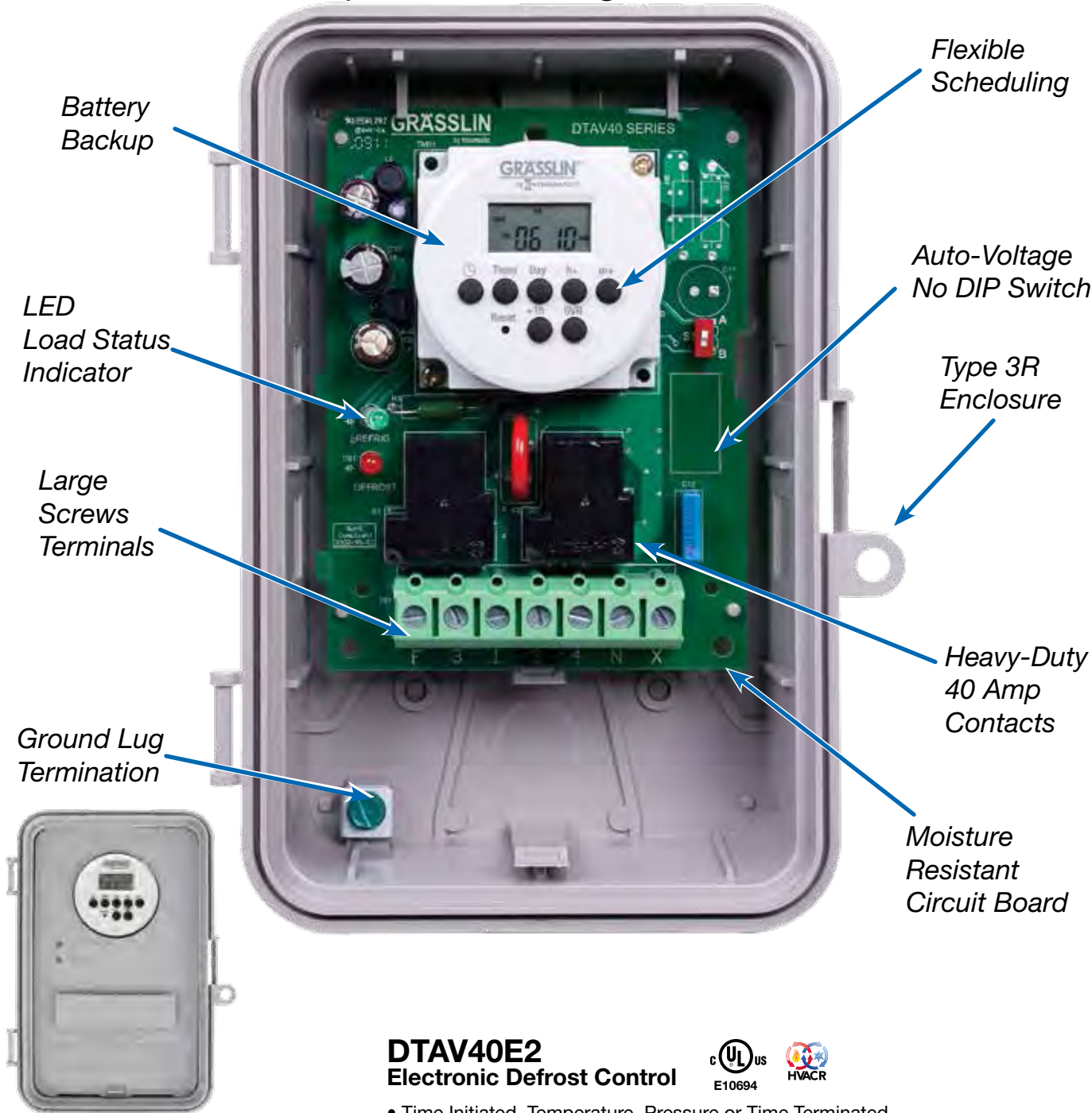

## DTAV40E2 Electronic Defrost Control



- Time Initiated. Temperature, Pressure or Time Terminated
- Automatically adjusts voltages between 120-240 VAC, 50/60 Hz
- 24-Hour/7-Day flexible scheduling increases system efficiency
- Rechargeable battery backup (with 2500-hour carryover)
- Simple to program
- Heavy-duty 40 Amp contact rating
- LED indicators for defrost and refrigeration cycles
- To-the-minute defrost duration improves system efficiency
- Large screw terminals for easy wiring #8 awg

### Ratings:

#### Contact Switch Rating:

40A Resistive, 120-240 VAC  
2 HP, 240VAC: 1 HP, 120 VAC

#### Wiring Connections:

Screw box lug terminals. Up to one #8AWG Wire

**Minimum ON/OFF:** 1 minute

#### Environmental Ratings:

**Operating Temperature Range:**

-13°F to 104°F (-25°C to 40°C)

**Operating Humidity:** 0-95% RH non-condensing

**Electrical Life:** 50,000 operations at full load

**Warranty:** 1 year

Model #	Voltage	Enclosure
DTAV40E2	120, 240 VAC, 50/60 Hz	Type 3R Plastic

For enclosure dimensions, see page 151

# No Tools Required

*Snaps into existing enclosures*

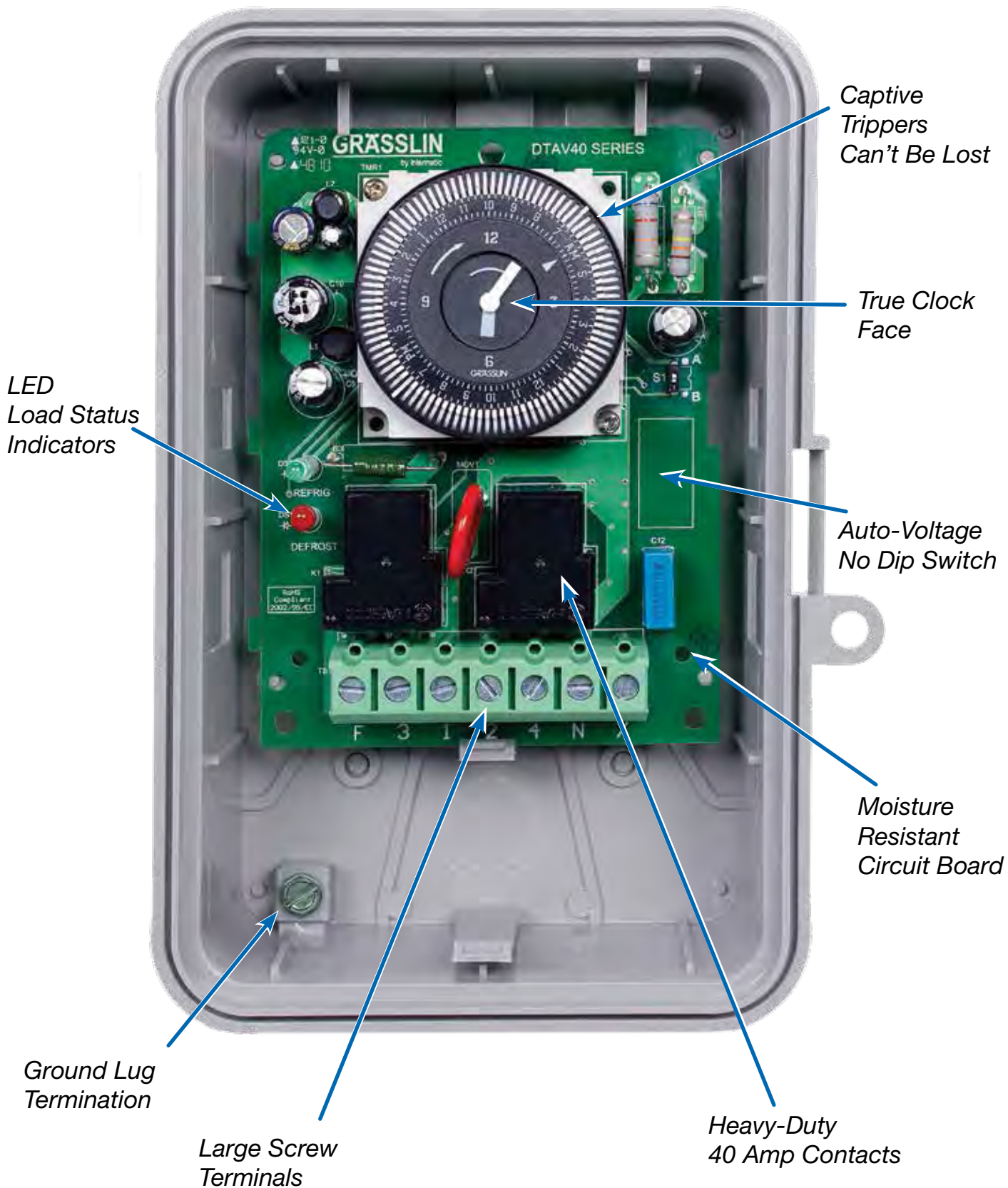

Captive  
Trippers  
Can't Be Lost

True Clock  
Face

LED  
Load Status  
Indicators

Auto-Voltage  
No Dip Switch

Moisture  
Resistant  
Circuit Board

Ground Lug  
Termination

Large Screw  
Terminals

Heavy-Duty  
40 Amp Contacts



B.



C.



A.

## DTAV40 Series Auto-Voltage Defrost Timer



- Time Initiated. Temperature, Pressure or Time Terminated
- Replaces over 40 competitive models
- Automatically adjusts voltages between 120 and 240 VAC
- No tools required, mounts in existing enclosures
- Heavy-duty 40 Amp contact ratings
- Programmable defrost times in 15-minute intervals
- Moisture resistant conformal coated board
- Independently programmed defrost cycles
- LED indicators for defrost and refrigeration cycles
- True clock face for quick, easy and accurate setting

### Ratings:

**Auto Voltage:** 120-240 VAC, 60 Hz  
**Quartz:** 120-240 VAC 50/60 Hz  
**Electrical Ratings:** 40 A Resistive, 120-240 VAC 1 HP, 120 VAC, 2 HP, 240 VAC  
**Operating Humidity:** 0-95% RH, non-condensing  
**Min. ON/OFF:** 15 minutes  
**Max. ON/OFF:** 23 hours, 45 minutes  
**Electrical Life:** 50,000 operations at full load  
**Wire Size:** #8 AWG  
**Temp Rating:** -40°F to 104°F (-40°C to 40°C)  
**Quartz Temp Rating:** -4°F to 104°F (-20°C to 40°C)  
**Warranty:** 1 year

Model #	Input Voltage	Enclosure	Timer Type	Battery Backup
A. <b>DTAV40</b>	120, 208/240 VAC	Type 3R Plastic	Synchronous	No
B. <b>DTAV40IM</b>	120, 208/240 VAC	Type 1 Metal	Synchronous	No
C. <b>DTAV40M</b>	120, 208/240 VAC	Mechanism Only	Synchronous	No
<b>DTAV40Q</b>	120, 208/240 VAC	Type 3R Plastic	Quartz	Yes (7-Day Carryover)
<b>DTAV40Q-M</b>	120, 208/240 VAC	Mechanism Only	Quartz	Yes (7-Day Carryover)

### Accessory

Model #	Description
<b>DT-B</b>	Bracket accessory for mounting

For enclosure dimensions, see page 151.

Grässlin by Intermatic's Vapor Tight Light Fixtures never blink at extreme conditions. They feature a powder coat finish that maximizes durability and a seamless, die-cast design that prevents moisture penetration. A heat-resistant glass globe protects the enclosed light.

The vapor tight light fixtures are great for areas with extreme climate conditions, such as construction sites, subways, bridges, tunnels, freezers, walk-in coolers, and wastewater and sewage treatment plants.



A.



B.



C.

## Vapor Tight Fixtures



- Industrial grade, fully enclosed with gasket
- Rugged, seamless, die-cast construction
- Powder coat finish for maximum durability
- Heat-resistant glass globe
- CFL compatible
- Protective guard prevents damage of glass globe

Model #	Wattage	Voltage	Mounting Style
A. <b>VPXG-11-CGI</b>	100	120 VAC	Ceiling
B. <b>VPKG-11-CGI</b>	100	120 VAC	Pendant
C. <b>VWVG-01-CGI</b>	100	120 VAC	Wall

*Lamp not included*

# Surge

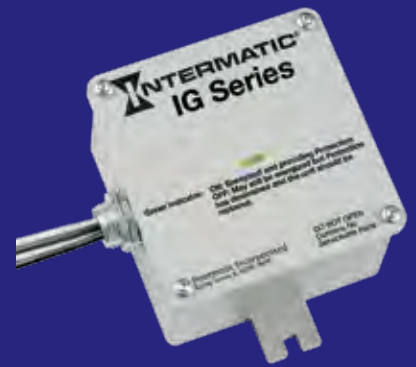

Retail Space *Light Industrial Manufacturing*  
**Servers** Pumps Motors **Facilities**  
*Health Care Facilities* *Lighting Ballasts*  
Institutional Buildings *Single Residences* Modems  
*Telecom Equipment* *Multi-Family Residences*  
Security Systems **Televisions** Computers  
**HVAC** Hospitality **Commercial Office Space**

# What is Surge Protection?

**ANSI/IEEE** defines common electrical disturbances that occur in modern facilities as: Voltage, Waveform, Current Waveform, and 100 kHz Ring Wave. Depending on the proximity of the equipment to your power entry points, the severity increases. As the transient surge event propagates throughout your building, it degrades your electronic components with excess voltage and current.

## ANSI/UL 1449 3rd Edition Surge Protection Definitions

As of September 30, 2009 ANSI/UL 1449 3<sup>rd</sup> Edition replaced UL 1449 2.5. SPDs manufactured after September 30, 2009 need to meet ANSI/UL 1449 3<sup>rd</sup> Edition standards. Any products manufactured before this date may still be sold as a UL 1449 2.5 compliant product. Electrical components in devices are susceptible to transient surge overvoltage and can create significant downtime, equipment replacement, and costly repairs.

**Surge Protective Devices (SPDs) are classified into Type 1, Type 2 and Type 3.**

**TYPE 1:** Permanently connected SPD is installed between the secondary transformer and the line side of the service equipment.

**TYPE 2:** Permanently connected SPD is installed on the load side of the service equipment over current device.

**TYPE 3:** Cord connected SPD is installed at the point of use.

## Industrial

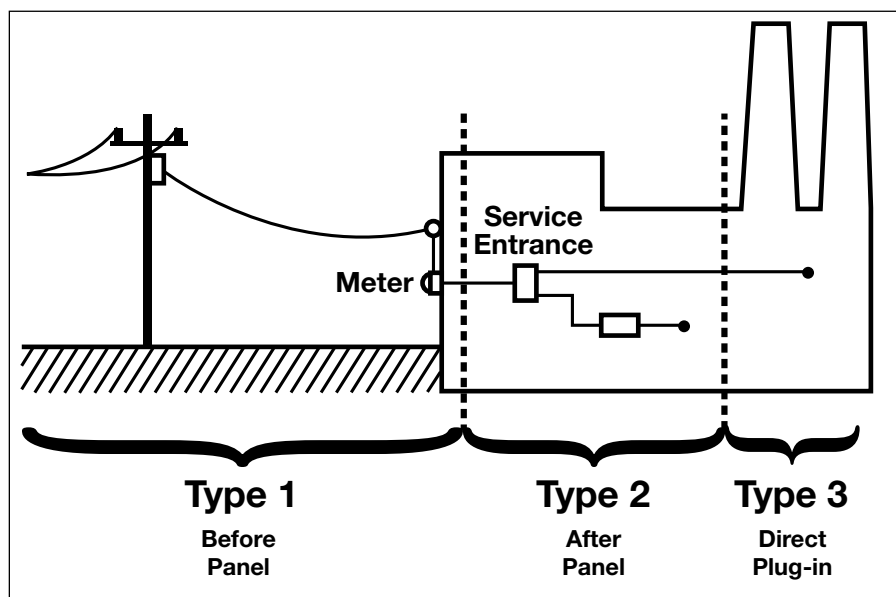

## Residential

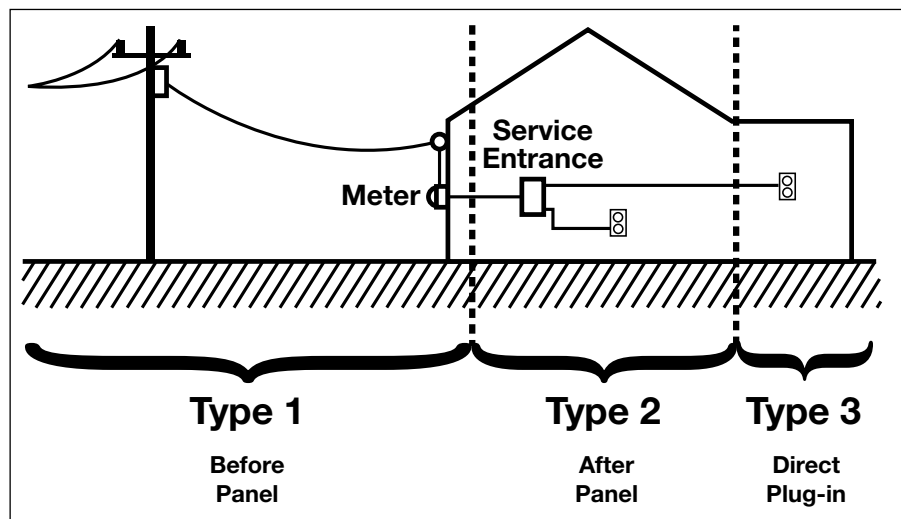

# Guidelines to consider when choosing a Surge Protective Device (SPD)

## 1. Desired Geographic Location of the SPD

- How much exposure is there to utility grid switching?
- Is the location susceptible to brownouts or frequent utility power switching?

## 2. Point of Installation. *What type of SPD do you need?*

See SPD classifications on previous page.

## Common Voltage Configurations

The wiring diagrams below illustrate the common voltage configurations for Intermatic surge products. Locate the desired voltage configuration and surge protector part number, and then go to the applicable product page to order the desired item(s).

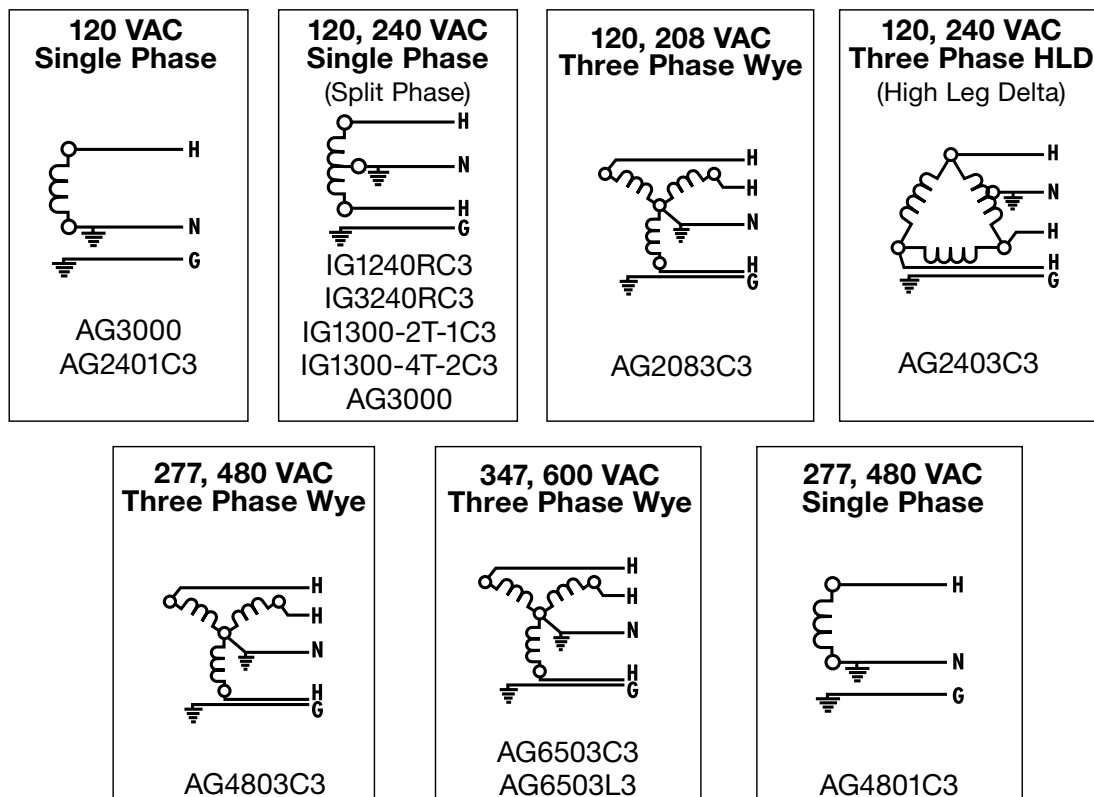

**NOTE:** All SPDs protect against surges that travel along the electrical pathway and are not applicable to direct lightning strikes that travel down non-electrical paths. Be sure to have at least a 20 amp dual pole breaker(s) to help prevent the circuits from shorting. Type 1 SPDs are normally mounted before panels, which would not include a breaker.

## Surge Glossary

**Surge:** A sudden, sharp increase of current or voltage within electric circuits.

**Surge Protective Device (SPD):** A device used to divert or limit a surge on a piece of equipment. SPDs were previously known as Transient Voltage Surge Suppressors or Secondary Surge Arresters.

**Short Circuit Current Rating (SCCR):** The measurement of how much current the electrical system can supply during a fault condition. This value determines where an SPD may be installed. (Listed on the product)

**Nominal Discharge Current:** Peak value of the current through the SPD having a current wave shape of 8/20 where the SPD remains functional after 15 surges. (Listed on the product)

**Nominal System Voltage:** The voltage level at which a system normally operates. Nominal system voltages include, but are not limited to, 120, 208, 240, 277, 347, 480, 600 VAC. (Listed on the product)

**Modes of Protection:** Electrical paths within a system that an SPD defends against surge events, such as Line to Neutral (L-N), Line to Ground (L-G), Line to Line (L-L) and Neutral to Ground (N-G). (Listed on the product)

**Voltage Protection Rating (VPR):** The value assigned by UL which specifies the measured limited voltage value of the SPD. VPR rating is formally known as the suppressed voltage rating. (Listed on the product)

**Maximum Continuous Operating Voltage (MCOV):** The maximum RMS voltage that may be applied to each mode of a surge protection device. (Listed on the product)

**Three Phase WYE:** Consists of 3 hot lines or phases, commonly referred to as X, Y, Z, a neutral and ground wire for a total of 5 wires in a power distribution cable.

**High Leg Delta:** Type of electrical service connection for three phase electric power installations. It is one of the several types of three phase service setups. It is used to provide an additional voltage that is half the phase to phase voltage.

# Why Surge Protection Matters to You

Surge Protection is one of the most overlooked safeguards. Most people protect their electronics but leave more valued equipment unsecured from surges and spikes. An estimated \$250-\$500 million\* a year is lost from property damage caused by power surges and spikes.

Don't be the next victim. Safeguard your equipment with Intermatic Surge Protection. Intermatic offers a complete line of surge protective devices for single family residences, commercial office spaces, HVACR equipment, and pool/spas. It covers everything from irrigation and farm equipment to pumps, lighting fixtures, traffic lights, and motors.

*Why take the costly risk?*

Invest in peace of mind with Intermatic surge protective devices.

\* National Lightning Detection Network



# AG3000

## HVAC Surge Protective Device



### AG3000 HVAC Surge Protective Device



- Meets ANSI UL1449 3rd Edition Standards
- 120/240 VAC single split phase SPD for use on a variety of HVAC equipment
- Green LED protection indicator
- Type 4x enclosure
- ½" x 20 threaded nipple (weatherproof and UV resistant)
- TPMOV™ technology
- 3 modes of protection
- 3 leads
- 18" lead length
- 10 gauge leads
- 3-year warranty
- \$7,500 connected equipment warranty

Model #	Service Voltage	SPD Type	Nominal Discharge Current	MCOV*		Wiring Configuration	SCCR**	Voltage Protection Rating (VPR)		
				L-N	L-L			L-N/G	N-G	L-L
AG3000	120/240 VAC	1 or 2	10kA	150V	300V	L1, L2, L/N-G	20kA	600		900

\* MCOV Maximum Continuous Operation Voltage

\*\*SCCR Short Circuit Current Rating



A.

## IG1200RC3 Plastic Housing

- Type 1 or 2 SPD applications
- Green LED indicator provides status of protection
- Type 3R rainproof enclosure
- 5.65" H x 4.18" W x 3.33" D
- 3 modes of surge protection (L1-N, L2-N, L1-L2)
- 3-year product warranty
- \$7,500 connected equipment warranty for 3 years on appliances and electronics



B.

## IG1240RC3 Plastic Housing

- Type 1 or 2 SPD applications
- Green LED indicator provides status of protection
- Type 3R rainproof enclosure
- 5.65" H x 4.18" W x 3.33" D
- 6 modes of surge protection: L1-N, L2-N, L1-G, L2-G, N-G, L1-L2
- 5-year product warranty
- \$10,000 connected equipment warranty for 5 years on appliances and electronics



C.

## IG3240RC3 Metal Housing

- Type 1 or 2 SPD applications
- Green LED indicator provides status of protection
- Type 3R rainproof enclosure
- 5.28" H x 4.4" W x 3.25" D
- 6 modes of surge protection: L1-N, L2-N, L1-G, L2-G, N-G, L1-L2
- 10-year product warranty
- \$25,000 connected equipment warranty for 10 years on appliances and electronics

Model #	Service Voltage	No. of Leads	Lead Length	Wiring Config.	Nominal Discharge Current	MCOV*	SCCR**	Voltage Protection Rating (VPR)					
								L-N/G	L-N	L-G	N-G	L-L	
A. <b>IG1200RC3</b>	120, 240 VAC	3	30"	L1, L2, N/G	20 kA		50 kA	700					1200
B. <b>IG1240RC3</b>	120, 240 VAC	4	30"	L1, L2, N, G	20 kA	150 L-N, N-G† 300 L-L, L-G†	50 kA		700	1200	700	1200	
C. <b>IG3240RC3</b>	120, 240 VAC	4	30"	L1, L2, N, G	20 kA		50 kA		700	1200	700	1200	

\* MCOV Maximum Continuous Operating Voltage

\*\*SCCR Short Circuit Current Rating

†Applies to all models

## IG1300-2T-1C3

- Type 2 SPD applications
- 12 gauge wire
- Provides protection for 2 telephone lines (Analog phone line, modem, or DSL) and 1 coax line (cable TV, cable Internet or Satellite TV)
- Type 3R outdoor rainproof enclosure for indoor/outdoor installations (9.38" H x 5.25" W x 4" D)
- 6 modes of surge protection:  
L1-N, L2-N, L1-G, L2-G, N-G, L1-L2
- 5-year product warranty
- \$10,000 connected equipment warranty for 5 years on appliances and electronics



D.

## IG1300-4T-2C3

- Type 2 SPD applications
- 12 gauge wire
- Provides protection for 4 telephone lines (Analog phone line, modem, or DSL) and 2 coax lines (cable TV, cable Internet or Satellite TV)
- Type 3R outdoor rainproof enclosure for indoor/outdoor installations (9.38" H x 5.25" W x 4" D)
- 6 modes of surge protection:  
L1-N, L2-N, L1-G, L2-G, N-G, L1-L2
- 5-year product warranty
- \$10,000 connected equipment warranty for 5 years on appliances and electronics



E.

Model #	Service Voltage	No. of Leads	Lead Length	Wiring Config.	Nominal Discharge Current	MCOV*	SCCR**	Voltage Protection Rating (VPR)				
								L-N/G	L-N	L-G	N-G	L-L
D. <b>IG1300-2T-1C3</b>	120, 240 VAC	4	24"	L1, L2, N, G	20 kA	150 L-N, N-G†	50 kA	700	1200	700	1200	
E. <b>IG1300-4T-1C3</b>	120, 240 VAC	4	24"	L1, L2, N, G	20 kA	300 L-L, L-G†	50 kA	700	1200	700	1200	

\*MCOV Maximum Continuous Operating Voltage

\*\*SCCR Short Circuit Current Rating

†Applies to all models

## Flushmount Kit

- For IG1200RC3, IG1240RC3 and IG3240RC3
- Includes mounting plate, screws and mounting bracket
- Easy to use

Model #	H x W
F. <b>IG1240FMP33</b>	7" x 7.5"
G. <b>IG3240FMP33</b>	7" x 7.5"



F.



G.

# Protect Your Outdoor Equipment

Irrigation equipment, pumps, lighting fixtures, traffic signaling devices, farm equipment, HVACR controls and motors



## AG Series Surge Protective Devices



- SPD Type 1/Type 2 applications
- For outdoor installations on service entrances and utility meter cabinets
- UV resistant polycarbonate housing with ½" x 20" nominal nipple
- Type 4 outdoor rainproof enclosure
- Nominal Discharge Current 20 kA
- Green LED protection indicator
- Limited 1-year warranty



AG1BRKT Mounting Bracket

Model #	Poles	Lead Length	Wiring Config.	MCOV*		SCCR**	Voltage Protection Rating (VPR)	
				L-N/G	L-L		L-N/G	L-L
<b>Service Voltage 120/240 VAC</b>								
AG24013	Single Phase	18"	L1, L2, N/G	150	300	50kA	700	1200
AG2401C3	Single Phase	18"	L1, L2, N/G	150	300	50kA	700	1200
<b>Service Voltage 208 VAC</b>								
AG2083C3	3 Pole, 4 Wire	18"	L1, L2, L3, N/G	150	300	50kA	700	1200
<b>Service Voltage 277/480 VAC</b>								
AG48013	Single Phase, 2 Pole, 3 Wire	18"	L1, L2, N/G	320	640	50kA	1200	2000
AG4803C3	3 Pole, 4 Wire	18"	L1, L2, L3, N/G	320	640	50kA	1200	2000
<b>Service Voltage 347/600 VAC</b>								
AG6503C3	3 Pole, 4 Wire	18"	L1, L2, L3, N/G	420	840	50kA	1500	2500
AG6503L3	3 Pole, 4 Wire	36"	L1, L2, L3, N/G	420	840	50kA	1500	2500
<b>Service Voltage 120/208/240 VAC</b>								
AG2403C3	3 Pole, 4 Wire	18"	L1, L2, L3, N/G	150 L1/L3 - N/G 270 L2 - N/G	300 L1-L3 420 L1/L3 - L2	50kA	700 L1/L3 - N/G 1000 L2 - N/G	1200 L1-L3 1500 L1/L3-L2

\*MCOV Maximum Continuous Operating Voltage

\*\*SCCR Short Circuit Current Rating

To order AG1BRKT Mounting Bracket, see page 154



A.



B.



C.

## Surge Protective Strips



### Type 3 SPD Point-of-Use

- For heavy-duty industrial use
- 14 gauge SJT power cord with molded plug
- LED protection indicator
- Electrical rating: 15 Amp 125 VAC
- 15 Amp resettable breaker
- 5-year warranty



D.



E.

#### Without EMI/RFI Noise Filtration

Model #	Coverage Warranty	Cord Length	Outlets	VPR* L-N/L-G/N-G
A. IG112463†	\$10,000	6'	4	700/600/600
B. IG112663†	\$10,000	6'	6	700/600/600
C. IG112663BLK10†	\$10,000	10'	6	700/600/600

#### With EMI/RFI Noise Filtration

Model #	Coverage Warranty	Cord Length	Outlets	VPR* L-N/L-G/N-G
D. IG20663	\$25,000	6'	6	400/400/500
IG206153	\$25,000	15'	6	400/400/500
E. IG20B123	\$5,000	6'	6	700/600/600
IG2012B153	\$5,000	15'	6	700/600/600

\*Voltage Protection Rating

†Comes with illuminating ON/OFF switch

## Mounting Bracket Plate

- Secure mounting bracket for all IG strips
- Extruded aluminum alloy

Model #	L x W
24EG5133	6" x 1.95"

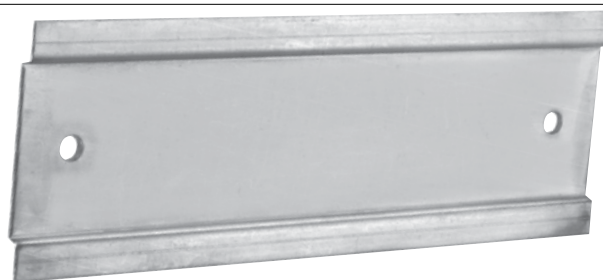

# Phone, Modem and DSL Surge Protective Devices



A.

## A. IG2TM

- Protects 2 lines
- Type 1 enclosure
- Tip-To-Ground, Tip-To-Ring and Ring-To-Ground Modes
- 40 kA surge protection per line
- #24 to #16 gauge AWG
- Gas tube protection 350 VDC breakdown
- UL497A



B.

## B. IG4TM

- Protects 4 lines
- Type 1 enclosure
- Tip-To-Ground, Tip-To-Ring and Ring-To-Ground Modes
- 40 kA surge protection per line
- #24 to #16 gauge AWG
- Gas tube protection 350 VDC breakdown
- UL497A



C.

## C. IG2T3R

- Protects 2 lines (expandable to 12 Lines)
- Type 3R rainproof enclosure
- Tip-To-Ground, Tip-To-Ring and Ring-To-Ground Modes
- 40 kA surge protection per line
- #24 to #16 gauge AWG
- Gas tube protection 350 VDC breakdown
- UL497A

Model #	Lines	Wire Configuration	Location
A. IG2TM	2	4	Indoor
B. IG4TM	4	8	Indoor
C. IG2T3R	2 (up to 12)	4 (up to 24 wire)	Indoor/Outdoor

# Standalone Antenna, Cable Satellite, Cable Internet Surge Protective Devices



D.



E.

## IG1CM & IG1CM3R

- 10 kA surge protection per line
- Gas tube protection 90 VDC breakdown

Model #	Lines	Thread Type	Location	Enclosure
D. <b>IG1CM</b>	1 (up to 2)	F	Indoor	—
E. <b>IG1C3R</b>	1 (up to 6 coax)	F	Indoor/Outdoor	Type 3R

## Surge Accessories



F.



G.



H.

Model #	Description	Lines	For Use In
F. <b>IG2T</b>	Spare telephone/modem/DSL Internet protection module	2	IG2TM, IG1CM, IG2T3R, IG1C3R, IG1300-2T-1C3
G. <b>IG1C</b>	Spare coax cable protection module	1	IG1CM, IG1C3R, IG2TM, IG4TM, IG2T3R
H. <b>IGFlush</b>	Flush Mount Kit	—	IG2TM, IG4TM, IG1CM

# Switch It Up!



**INTERMATIC**<sup>®</sup>



*For more information on the G8000, see page 88*





# Weatherproof Covers



*Residential*  
*Commercial*  
**Industrial**  
Agricultural  
**Signage**  
*Sports Fields*

# All Intermatic Weatherproof Covers meet the 2011 NEC current code requirements

## Code Requirements:

Intermatic's line of Type 3R receptacle covers ensures compliance with 2011 NEC Article 406.9 (B1) which requires that 15 and 20 ampere, 125 and 250 volt receptacles installed in a wet location have an enclosure that is weatherproof whether or not the attachment plug cap is inserted. They are designed to meet the 2011 NEC Article 210-60(b), which requires that receptacles installed behind beds in hotels and motels, be protected with a suitable guard.

## Type 3R

Meets UL and CSA Cold Impact Testing at -60°F (-51°C)

## Specifications:

All covers can be used for flush mount, surface mount or FS junction box mounting

Cover: Clear (gray or white on selected models) UV stabilized polycarbonate

Mounting Base and Inserts: Black UV stabilized polycarbonate

Gasket: Neoprene – 1/8" (4.8 mm) thick with slits for mounting screws

These Flexi-Guard Inserts fit single-gang or double-gang models of clear, gray, or white plastic, and extra-duty die-cast designs. Each insert package can be purchased separately. All weatherproof covers come with Flexi-Guard inserts and mounting screws. The double-gang inserts (WP217, WP101, WP102, WP107, and WP213) include a special double-gang gasket.

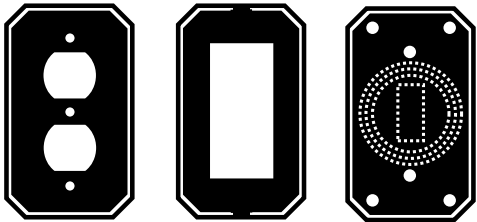

## WP17

### Single-Gang Flexi-Guard Inserts

3 standard Flexi-Guard inserts – 16 possible configurations

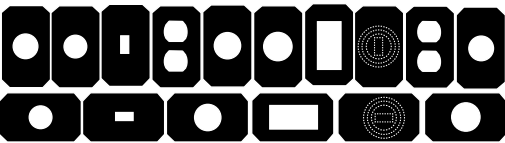

- Standard in all Flexi-Guard single-gang covers
- 3 separate inserts can be configured into 16 different receptacles or switches
- Converts to either toggle or round receptacle sizes: 1.375", 1.625", 1.75", or 2.125"

## WP217

### Double-Gang Flexi-Guard Inserts

6 Standard Flexi-Guard inserts – 70 possible configurations

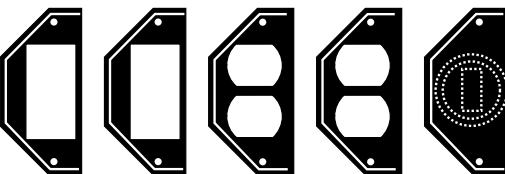

- Can be combined to make the illustrated configurations for double-gang covers

- Converts to either toggle or round receptable sizes: 1.375" or 1.625"

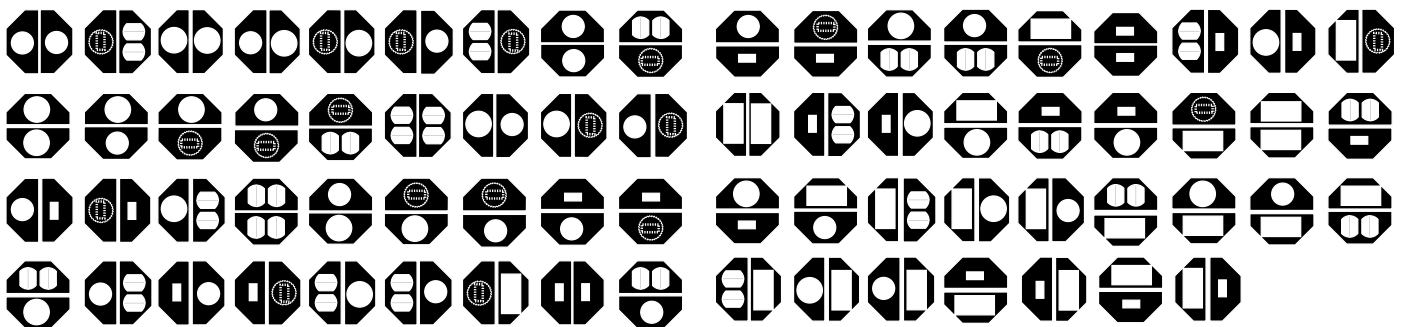

## Additional Inserts Available for Flexi-Guard Series:

WP101

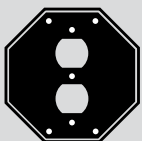

Double-Gang Duplex

WP102

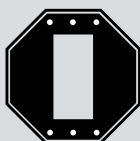

Double-Gang GFCI

WP107

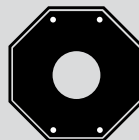

Double-Gang Round  
1.375", 1.625", 1.75"

WP213

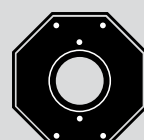

Double-Gang Round  
1.375", 1.625", 1.75"

# Meets/Exceeds All 2011 NEC Requirements for Extra-Duty Applications and Wet Locations\*



A.



B.



C.



D.



E.



F.



Single-Gang WP17 Inserts



Double-Gang WP217 Inserts

## Extra-Duty Die-Cast Covers Single and Double-Gang



- Type 3R enclosure rating
- Lockable hasp
- Die-Cast aluminum construction
- Impact rated
- Sleek industrial design
- Reinforced hinge
- Can be used with 12 gauge cord sets. Recommended for 14 gauge or lighter cord sets

### Single-Gang Vertical

Model #	Flexi-Guard Inserts	Length	Width	Height	Depth
A. WP3110MXD	WP17	6.375"	3.875"	2.875"	2 3/4"
B. WP1010MXD	WP17	6.375"	3.875"	3.25"	3 1/8"
C. WP1250MVXD	WP17	6.375"	3.875"	4.75"	4 5/8"

### Double-Gang

Model #	Flexi-Guard Inserts	Length	Width	Height	Depth
D. WP1030MXD	WP217	6.312"	5.75"	3.25"	3 1/8"
E. WP1250MXD	WP217	6.312"	5.75"	4.75"	4 5/8"

### Single-Gang/Horizontal

Model #	Flexi-Guard Inserts	Length	Width	Height	Depth
F. WP1010HMXD	WP17	4.375"	5.75"	3.25"	3 1/8"

\*2011 NEC Article 406.9 (B1)



A.



B.



C.



D.



E.

## Plastic In-Use Covers Single-Gang



- Complies with 2011 NEC Article 406.9 (B1)
- Heavy-duty polycarbonate construction
- Vertical/horizontal hinge configuration
- Pre-adhered gasket
- Meets requirements for Cold Impact Testing at -60°F (-51°C)
- Packaged with 3 patented inserts for GFCI, duplex, toggle, or round receptacles
- Limited 1-year warranty

Model #	Flexi-Guard Inserts	Cord Diam.	Max. Cord Gauge	Depth	Color	Lockable Hasp Diam.
A. WP3100C*	WP17	0.5"	(2) 14 or (1) 12 Gauge	2 3/4"	Clear	For .125" lock
B. WP3103C**	WP17	0.5"	(2) 14 or (1) 12 Gauge	2 3/4"	Clear	For .125" lock
C. WP1100C	WP17	0.5"	(2) 14 or (1) 12 Gauge	2 3/4"	Clear	For .250" lock
D. WP1100WC	WP17	0.5"	(2) 14 or (1) 12 Gauge	2 3/4"	White	For .250" lock
WP1110C	WP17	0.5"	(2) 14 or (1) 12 Gauge	3 5/8"	Clear	For .250" lock
E. WP1110GC	WP17	0.5"	(2) 14 or (1) 12 Gauge	3 5/8"	Gray	For .250" lock
WP1110WC	WP17	0.5"	(2) 14 or (1) 12 Gauge	3 5/8"	White	For .250" lock

\*Hidden hinge

\*\*Includes 3/0 Adapter Plate for 3" Round Box



**Hinge Configuration Vertical**

	Model #	Flexi-Guard Inserts	Cord Diam.	Depth	Color
F.	WP1000C	WP17	0.5"	2 ¼"	Clear
G.	WP1000GC	WP17	0.5"	2 ¼"	Gray
H.	WP1010C	WP17	0.5"	3 ⅞"	Clear
J.	WP1000WC	WP17	0.5"	2 ¼"	White

**Hinge Configuration Horizontal**

	Model #	Flexi-Guard Inserts	Cord Diam.	Depth	Color
K.	WP1000HC	WP17	0.5"	2 ¼"	Clear
L.	WP1000HGC	WP17	0.5"	2 ¼"	Gray
M.	WP1010HC	WP17	0.5"	3 ⅞"	Clear

Note: See page 106 for inserts

**Plastic In-Use Covers** 

- Complies with 2011 NEC Article 406.9 (B1)
- Heavy-duty polycarbonate construction
- Vertical and horizontal mount
- Meets Cold Impact Testing requirements at -60°F (-51°C)
- Limited 1-year warranty



## Plastic In-Use Covers Double-Gang or Single-Gang



- Complies with 2011 NEC Article 406.9 (B1)
- Heavy-duty polycarbonate construction
- Vertical hinge configuration
- Pre-adhered gasket
- 3 inserts for GFCI, duplex, toggle, or round receptacles
- Meets Cold Impact Testing requirements at -60°F (-51°C)

Model #	Flexi-Guard Inserts	Cord Diam.	Max. Cord Gauge	Depth	Color
A. <b>WP1020C</b>	WP101 & WP102	0.5"	(2) 14 or (1) 12 Gauge	2 ¼"	Clear
B. <b>WP1020GC</b>	WP101 & WP102	0.5"	(2) 14 or (1) 12 Gauge	2 ¼"	Gray
C. <b>WP1020WC</b>	WP101 & WP102	0.5"	(2) 14 or (1) 12 Gauge	2 ¼"	White
D. <b>WP1030C</b>	WP101 & WP102	0.5"	(2) 14 or (1) 12 Gauge	3 ¼"	Clear
E. <b>WP1050</b>	WP101 & WP102	0.8"	(2) 14 or (1) 10 Gauge	4 ¾"	Clear

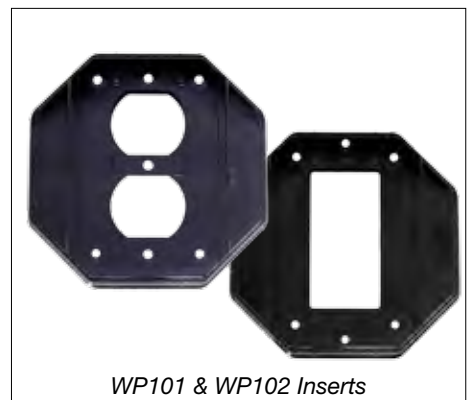

WP101 & WP102 Inserts

Note: Lockable hasp accepts up to .125" (3.175 mm) diameter shank



## Plastic In-Use Covers Double-Gang



- Complies with 2011 NEC Article 406.9 (B1)
- Heavy-duty polycarbonate construction
- Vertical hinge configuration
- Pre-adhered gasket
- 3 inserts for GFCI, duplex, toggle, or round receptacles
- Meets Cold Impact Testing requirements at -60°F (-51°C)

Model #	Flexi-Guard Inserts	Cord Diam.	Max. Cord Gauge	Depth	Color
F. WP1150C	WP17	0.8"	(2) 14 or (1) 10 Gauge	4 ¾"	Clear
G. WP1220C	WP217	0.5"	(2) 14 or (1) 12 Gauge	2 ¼"	Clear
H. WP1220GC	WP217	0.5"	(2) 14 or (1) 12 Gauge	2 ¼"	Gray
J. WP1220WC	WP217	0.5"	(2) 14 or (1) 12 Gauge	2 ¼"	White
K. WP1230C	WP217	0.5"	(2) 14 or (1) 12 Gauge	3 ⅞"	Clear
L. WP1250C	WP217	0.8"	(2) 14 or (1) 10 Gauge	4 ¾"	Clear

# WANTED

*for Exceeding the Code*



**AKA SLIM**



**AKA NORM**



**AKA BOSS**



**AKA BIG PAPA**



**AKA CHUBS**



**AKA STRETCH**

---

## **INTERMATIC'S XTRA TOUGH LINEUP**

---



For more information on the extra duty weatherproof covers, see page 107





# Pool & Spa Controls



**Irrigation**

*Fountains*

Saunas

**Pools**

**Ponds**

*Koi Ponds*

Spas

**Heaters**

**Filters**

*Pumps*

**Sprinklers**



# Nine Buttons, Hundreds of Options

*Convenient, Easy-to-Use*

*Wireless Pool or Spa Controls*

The MultiWave Wireless Control System is the best solution for pool or spa automation. It features a wireless remote and receiver for on-demand control from the palm of your hand. It also controls five circuits for single and two-speed pumps, along with the Pentair® variable speed pumps. Choose between the standard MultiWave that controls a single body of water, or the PE34065RC that controls pool and spa combination systems. The MultiWave is easily upgradeable from any Intermatic mechanical timer or energy-efficient pump.



A. Pool OR Spa

## MultiWave Control System



- Wireless control for pool/spa equipment
- Controls 5 circuits
- Operates single, two, and variable-speed pumps
- 24-hour timing with 3 ON/OFF events per circuit
- Includes receiver, wireless remote, water and air temperature sensors, (3) AA batteries, equipment labels, and flathead screwdriver
- Controls filters, lights, cleaners, and heaters

Model #	Enclosure
A. PE653RC	Type 3R steel indoor/outdoor

### Rating:

**Control Supply:** 120, 240 VAC, 50/60 Hz., 5 W max.

**Circuit 1:** 20 A Resistive (17 FLA, 80 LRA), 120, 240 VAC 50/60 Hz.

**Circuits 2-5:** 15 A Resistive (10 FLA, 60 LRA), 120, 240 VAC, 50/60 Hz.

**Enclosure Dimensions (HxWxD):** 9 3/8" x 5 1/2" x 3 3/4" (23.8 cm x 13.97 cm x 9.5 cm)

**Knockouts:** Combination 1/2" - 3/4" (1) on back, (1) each side, (2) on bottom

**Warranty:** 2 year

Pentair® is a registered trademark of Pentair Ltd.

**MULTI  
WAVE™**



**INTERMATIC®**

# MultiWave Accessories



B.



C.

## PE653

### MultiWave 5-Circuit Wireless Receiver

- Ideal for adding to an existing enclosure installation
- Works with PA122 water temperature sensor and 1789PA28A air sensor
- Communicates with variable-speed pumps, chlorinators, and water temperature sensors
- Ideal for upgrading from any Intermatic mechanical timer
- 2-year warranty

Model #	Description	Qty.
B. PE653	Panel Mount Receiver	1

## PE953

### MultiWave Wireless Remote

- Water-resistant backlit display
- Displays time of day, equipment status, water and air temperatures, and ON/OFF schedules
- On-demand control of PE653 circuits, temperatures, and other Z-Wave devices
- Operates single, two, and variable-speed pumps and motorized valve actuators
- 2-year warranty

Model #	Description	Qty.
C. PE953	Wireless Hand-Held Remote	1

(3) AA batteries and equipment labels included



D.



E.

## PA122

### Water Temperature Sensor

- Monitors pool/spa water temperatures
- Connects to PE653 receiver to communicate water temperature
- 1-year warranty

Model #	Description	Qty.
D. PA122	Water Temperature Sensor	1

Needed to enable thermostat feature on the PE653RC

## 178PA28A

### Freeze (Air Temperature) Sensor

- Protects pool/spa equipment and plumbing
- Perfect for below-freezing outdoor environment
- Monitors outside air temperature
- 1-year warranty

Model #	Description	Qty.
E. 178PA28A	Freeze Sensor	1

Needed to enable freeze protection feature on the PE653RC



**Control Your Pool AND Spa Combo**

**PE24065RC Kit Includes:**

- PE20000 Load Center with 60 Amp Base
- PE653RC MultiWave Control System
- Water and Air Sensor with Mounting Hardware
- P4043ME Actuator Controller
- (2) PE24VA Valve Actuators
- Equipment Labels

**PE20000RC Series Kits**  
**60 Amp MultiWave Control System**



- For a single pool or spa or a pool/spa combo
- Load center with four position 60 Amp breaker base
- Two knockouts for GFCIs and switches
- Controls 5 circuits
- Full thermostat control
- Operates single, two, and variable-speed pumps
- 24-hour scheduling capability for all connected equipment
- Type 3R indoor/outdoor 0.048" steel load center

Model #	Application	Actuator Control	Valve Actuators
A. PE20065RC	Pool or Spa	—	—
B. PE24065RC	Pool/Spa Combo	P4043ME	2 (PE24VA)

*Each kit also includes (3) AA batteries and a flathead screwdriver.*

**Ratings:**  
**Load Center Rating:** 60 A, 120/240 VAC or 120/208 VAC single phase  
**Control Supply:** 120/240 VAC, 50/60 Hz, 5 W max.  
**Circuit 1:** 20 A Resistive (17 FLA, 80 LRA) 120, 240 VAC 50/60 Hz.  
**Circuits 2-5:** 15 A Resistive (10 FLA, 60 LRA) 120, 240 VAC 50/60 Hz.  
**Load Center Dimensions:** 16 1/2" (41.9 cm) H x 10 1/8" (27.6 cm) W x 4 1/4" (10.8 cm) D

**Knockouts:**  
**Bottom:** (2) 1.09" ø through holes, (6) combination 1/2" – 3/4", (3) combination 3/4" – 1"  
**Left:** (2) combination 1/2" – 3/4"  
**Back:** (1) combination 3/4" – 1"  
**Right:** (1) 1 3/4" x 2 3/4" for mounting switches or GFCI  
**Warranty:** 2 year



## PE3000RC Series Kits

### 80 Amp MultiWave Control System

- For a single pool or spa or a pool/spa combo
- Load center with eight position 80 Amp breaker base
- Four knockouts for GFCIs and switches
- Controls 5 circuits
- Full thermostat control
- Operates single, two, and variable-speed pumps
- 24-hour scheduling capability for all connected equipment
- Type 3R indoor/outdoor 0.048" steel load center

Model #	Application	Actuator Control	Valve Actuators
C. PE30065RC	Pool or Spa	—	—
D. PE34065RC	Pool and Spa Combo	P4043ME	2 (PE24VA)

Each kit also includes (3) AA batteries and a flathead screwdriver.

#### Ratings:

**Load Center Rating:** 80 A, 120, 240 VAC or 120, 208 VAC single phase

**Control Supply:** 120, 240 VAC, 50/60 Hz., 5 W max.

**Circuit 1:** 20 A Resistive (17 FLA, 80 LRA) 120, 240 VAC 50/60 Hz.

**Circuits 2-5:** 15 A Resistive (10 FLA, 60 LRA) 120, 240 VAC 50/60 Hz.

**Load Center Dimensions:** 22" (55.9 cm) H x 14 3/4" (37.5 cm) W x 4 1/4" (10.8 cm) D

#### Knockouts:

**Bottom:** (2) 1.09"  $\varnothing$  through holes, (6) combination 1/2" – 3/4", (2) combination 3/4", 1", 1 1/4", (4) 1/2"

**Left:** (2) combination 1/2" – 3/4"

**Back:** (4) combination 1/2" – 3/4", and (2) combination 3/4" – 1"

**Right:** (1) 1 3/4" x 2 3/4" for mounting switches or GFCI

**Warranty:** 2 year

## Control Your Pool AND Spa Combo

### PE34065RC Kit Includes:

- PE30000 Load Center with 80 Amp Base
- PE653RC MultiWave Control System
- Water and Air Sensor with Mounting Hardware
- P4043ME Actuator Controller
- (2) PE24VA Valve Actuators
- Equipment Labels



A.



B.



C.

## P4043ME and PE140 Valve Actuator Controls



- Easily snap into most existing Intermatic enclosures with available mechanism support bracket
- Controls up to three valve actuators
- Switches heater thermostat HIGH/LOW
- Remote control capabilities

Model #	Description
A. P4043ME	Mechanism Only
B. PE140	P4043ME with Type 3R Enclosure

**Ratings:**  
**Input Voltage:** 120 or 240 VAC, 50/60 Hz.  
**Valve Actuator Supply:** 24 VAC, 40 VA  
**Warranty:** 1 year

## P4243ME Valve/Pump Switch Mechanism



- Controls up to 2 circuits associated with pool/spa combos
- Snaps into most Intermatic enclosures
- Automatic HIGH/LOW water temperature selector
- Manual load control
- Wireless remote and master controller connections

Model #	Description	Actuator Supply
C. P4243ME	Mechanism Only	(3) 24 VAC Actuators

**Ratings:**  
**Each Circuit:**  
 Valve Actuator Supply: 24 VAC, 40 VA  
 17 A Resistive, 120-240 VAC, 50/60 Hz.  
 1.5 HP, 120 VAC, 50/60 Hz.  
 3 HP, 240 VAC, 50/60 Hz.  
 10 A Tungsten, 120 VAC, 50/60 Hz.  
**Warranty:** 1 year

# Save up to 40% In Monthly Utility Bills

## P1403ME and PE103 Electronic 1 or 2-Speed Pump Timer with Seasonal Adjust



- Saves up to 40% in monthly utility bills compared to standard timers
- Meets most rebate incentives
- Full single and two-speed pump control
- Enables separate daily schedules
- Additional circuit for auxiliary equipment
- Easy-to-follow on-screen setup for programming
- Auto-Voltage adjust
- Automatically adjusts pump operation according to season
- Efficient low-speed operation for all seasons
- User-programmable high and low-speed events
- 100+ hour supercapacitor memory retention

Model #	Description	Input Voltage	Switch
D. P1403ME	Mechanism Only	120, 240 VAC, 50/60 Hz	4-SPST
E. PE103	P1403ME with Type 3R Enclosure	120, 240 VAC, 50/60 Hz	4-SPST

**Ratings:**  
**Power Consumption:** 7 W max.  
**Contact Ratings (SPST) Each Circuit:**  
 30 A Inductive and Resistive at 24 VAC, 120-277 VAC  
 16 FLA, 96 LRA at 120 VAC  
 17 FLA, 80 LRA at 240 VAC  
 20 A Resistive at 28 VDC  
 5 A Tungsten at 120-277 VAC  
**Clock Source Voltage:** 120-277 VAC, 50/60 Hz.  
**Warranty:** 1 year



D.



E.



## P1353ME

### Digital 3-Circuit Time Switch Mechanism



- Perfect upgrade for your T100 Series time switch
- Three ON/OFF events per day per circuit
- Seven pre-programmed modes
- Memory backup
- Freeze and heater protection
- LCD readout
- Countdown and override features enable programs to be overridden and automatically resumed without requiring the user to reprogram the system

Model #	Input Voltage	Switch
A. P1353ME	120/240 VAC, 50/60 Hz	3-SPST

**Rating:**  
**Contacts:**  
 17 A Resistive, 120/240 VAC, 50/60 Hz.  
 (20 FLA, 96 LRA), 120 VAC, 50/60 Hz.  
 (17 FLA, 80 LRA) 240 VAC, 50/60 Hz.  
 5 A Tungsten, 120/240 VAC, 50/60 Hz.  
**Warranty:** 1 year

For replacement parts see page 151

A.

## Pre-Programmed Modes

### Mode 1 – (Aux1, Aux2, Aux3)

- All 3 switches control auxiliary devices

### Mode 2 – (Pump High, Pump Low, Aux3)

- 1st and 2nd switch controls a two-speed pump
- 3rd switch controls an auxiliary device
- Two-speed pump timing and protection

### Mode 3 – (Pump, Aux2, Cleaner Pump)

- 1st switch controls a single-speed pump
- 2nd switch controls an auxiliary device
- 3rd switch controls a booster/cleaner pump
- Filter/cleaner pump timing and protection

### Mode 4 – (Pump High, Pump Low, Cleaner Pump)

- 1st and 2nd switch controls a two-speed pump
- 3rd switch controls a booster/cleaner pump
- Two-speed and filter/cleaner pump timing and protection

### Mode 5 – (Pump L1, Pump L2, Aux3)

- 1st and 2nd switch controls a 240 VAC pump, where L1 and L2 are disconnected when the pump is OFF
- 3rd switch controls any auxiliary device

### Mode 6 – (Aux1, Aux2, Aux3) Heater green mode

- Identical to Mode 1, with capability to run a heater when the filter pump is manually turned ON only
- This mode is ideal for connecting Circuit 1 to a circulation pump in a spa. *NOTE: When spa is not in use, the clock does not turn the heater ON. When spa is in use, the heater can be activated by manually switching Circuit 1 ON.*

### Mode 7 – (Pump High, Pump Low, Common) Break both lines

- Identical to Mode 2, with the capability to break both hot lines of a 240 VAC two-speed pump connection
- 1st and 2nd circuits connect to High and Low lines of a two-speed pump and 3rd circuit connects to the common hot leg
- Two-speed pump timing and protection





B.



Freeze Probe included

C.



D.



Freeze Probe included

E.

## PE100 Series

### Digital 3-Circuit Time Switch in Enclosure



- Controls single and two-speed pumps and cleaner/booster pumps
- Three ON/OFF events per circuit per day
- Seven pre-programmed modes
- Freeze and heater protection
- LCD readout
- Multi-voltage input and output
- Countdown and override features enable programs to be overridden and automatically resumed without requiring the user to reprogram the system

**Rating:**

**Input Voltage:** 120/240 VAC, 50/60 Hz.  
 17 A Resistive, 120/240 VAC, 50/60 Hz.  
 (20 FLA, 96 LRA), 120 VAC, 50/60 Hz.  
 (17 FLA, 80 LRA), 240 VAC, 50/60 Hz.  
 5 A Tungsten, 120/240 VAC, 50/60 Hz.  
**Warranty:** 1 year

Model #	Input Voltage	Accessory	Switch	Enclosure
B. PE153	120, 240 VAC, 50/60 Hz	—	3-SPST	Type 3R Steel
C. PE153F	120, 240 VAC, 50/60 Hz	Freeze Probe	3-SPST	Type 3R Steel
D. PE153P	120, 240 VAC, 50/60 Hz	—	3-SPST	Type 3R Plastic
E. PE153PF	120, 240 VAC, 50/60 Hz	Freeze Probe	3-SPST	Type 3R Plastic

For replacement parts and accessories, see page 154  
 For enclosures see page 146

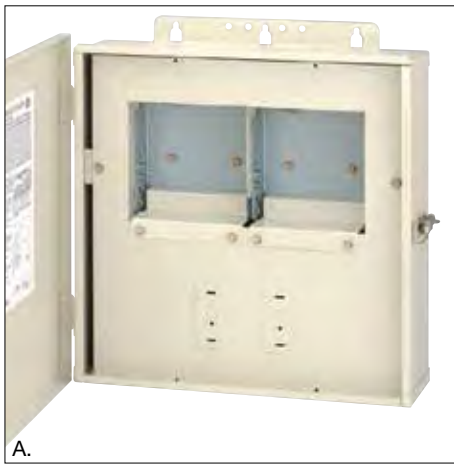

## PE10000 Series Pool/Spa Control System with Type 3R Power Center

- Includes P1353ME 3-circuit mechanism and power center
- P1353ME controls single and two-speed filter pumps, cleaner/booster pumps, and pool/spa landscape lighting

	Model #	Mechanism	Accessory	Switch
A.	PE10000	Power Center only	—	—
	PE15300	P1353ME	—	3-SPST
B.	PE15300F	P1353ME	Freeze Probe	3-SPST

### Ratings:

**P1353ME Switch Ratings Each Circuit (SPST):**  
**Input Voltage:** 120/240, VAC 50/60 Hz.

**Contacts:**  
 17 A Resistive 120/240 VAC,  
 5 A Tungsten 120/240 VAC,  
 17 FLA, 80 LRA 120/240 VAC  
**Auxiliary Switch:** 2 A, 24 VAC

**Power Center Dimensions:** 16 1/2" (41.9 cm) H x  
 10 3/8" (27.6 cm) W x 4 1/4" (10.8 cm) D

### Knockouts:

**Bottom:** (1) 1.09"  $\emptyset$  through hole,  
 (3) 1/2", (7) 1/2" - 3/4", (2) 3/4" - 1"

**Left:** Two 1/2" - 3/4"

**Back:** (1) 1/2" - 3/4", (1) 3/4" - 1"

**Right:** (1) 1 3/4" x 2 3/4"

**Warranty:** 1 year

## PE20000 Series 60 Amp Pool/Spa Control System with Type 3R Load Center

- 60 Amp 4-position breaker base
- Includes P1353ME 3-circuit mechanism and load center
- P1353ME controls single and two-speed filter pumps, cleaner/booster pumps, and pool/spa landscape lighting

	Model #	Mechanism	Accessory	Switch
C.	PE20000	Load Center only	—	—
	PE25300	P1353ME	—	3-SPST
D.	PE25300F	P1353ME	Freeze Probe	3-SPST

### Ratings:

**P1353ME Switch Ratings For Each Circuit (SPST):**  
**Input Voltage:** 120/240 VAC, 50/60 Hz.

**Contacts:**  
 17 A Resistive 120/240 VAC,  
 5 A Tungsten 120/240 VAC,  
 17 FLA, 80 LRA 120/240 VAC  
**Auxiliary Switch:** 2 A, 24 VAC

**Load Center Dimensions:** 14 3/4" (37.5 cm) H x  
 14 3/4" (37.5 cm) W x 4 1/4" (10.8 cm) D

### Knockouts:

**Bottom:** (1) 1.09"  $\emptyset$  through hole,  
 (6) 1/2" - 3/4", (3) 3/4" - 1"

**Left:** (2) 1/2" - 3/4"

**Back:** (1) 3/4" - 1"

**Right:** (1) 1 3/4" x 2 3/4" for mounting  
 switches or GFCI

**Warranty:** 1 year

For further information on P1353ME mechanism, see page 120.

Wiring devices may be installed in the power and load centers  
 (order (4) 21T156A standoffs for mounting). See page 154.

For accessories, see page 153.

## PE30000 Series 80 Amp Pool/Spa Control System with Type 3R Load Center



- 80 Amp 8-position breaker base
- Includes P1353ME 3-circuit mechanism and load center
- P1353ME controls single and two-speed filter pumps, cleaner/booster pumps, and pool/spa landscape lighting

	Model #	Mechanism	Switch	Transformer
E.	PE30000	Load Center only	—	—
	PE30000T3	Load Center only	—	300W
F.	PE35300	P1353ME	3-SPST	—

<p><b>Ratings:</b>  <b>P1353ME Switch Ratings Each Circuit (SPST):</b>  <b>Input Voltage:</b> 120/240 VAC, 50/60 Hz.  <b>Contacts:</b>                      17 A Resistive 120/240 VAC,                      5 A Tungsten 120/240 VAC,                      17 FLA, 80 LRA 120/240 VAC  <b>Auxiliary Switch:</b> 2 A, 24 VAC  <b>Load Center Dimensions:</b> 22" (55.9 cm) H x                      14 3/4" (37.5 cm) W x 4 1/4" (10.8 cm) D</p>	<p><b>Knockouts:</b>  <b>Bottom:</b> (1) 1.09"Ø through hole,                      (6) 1/2" - 3/4", (2) 3/4" - 1" - 1 1/4", (4) 1/2"  <b>Left:</b> (2) 1/2" - 3/4"  <b>Back:</b> (4) 1/2" - 3/4", (2) 3/4" - 1"  <b>Right:</b> (1) 1 3/4" x 2 3/4" for mounting                      switches or GFCI  <b>Warranty:</b> 1 year</p>
--	--



E.



F.

## PE40000 Series 125 Amp Pool/Spa Control System with Type 3R Load Center



- 125 Amp 8-position breaker base
- Includes P1353ME 3-circuit mechanism and load center
- P1353ME controls single and two-speed filter pumps, cleaner/booster pumps, and pool/spa landscape lighting

	Model #	Mechanism	Switch
G.	PE40000	Load Center only	—
H.	PE45300	P1353ME	3-SPST

<p><b>Ratings:</b>  <b>P1353ME Switch Ratings Each Circuit (SPST):</b>  <b>Input Voltage:</b> 120/240 VAC, 50/60 Hz.  <b>Contacts:</b>                      17 A Resistive 120/240 VAC,                      5 A Tungsten 120/240 VAC,                      17 FLA, 80 LRA 120/240 VAC  <b>Auxiliary Switch:</b> 2 A, 24 VAC  <b>Load Center Dimensions:</b> 26" (66.3 cm) H x                      18" (45.9 cm) W x 5 1/2" (14 cm) D</p>	<p><b>Knockouts:</b>  <b>Bottom:</b> (1) 1.09"Ø through hole,                      (13) 1/2" - 3/4", (2) 3/4" - 1" - 1 1/4",  <b>Left:</b> (1) 1/2" - 3/4", (2) 3/4" - 1"  <b>Back:</b> (4) 1/2" - 3/4", (2) 3/4" - 1"  <b>Right:</b> (1) 1 3/4" x 2 3/4" for mounting                      switches or GFCI  <b>Warranty:</b> 1 year</p>
--	---



G.



H.

For further information on P1353ME mechanism, see page 120.

Wiring devices may be installed in this load center  
(order (4) 21T156A standoffs for mounting). See page 154.

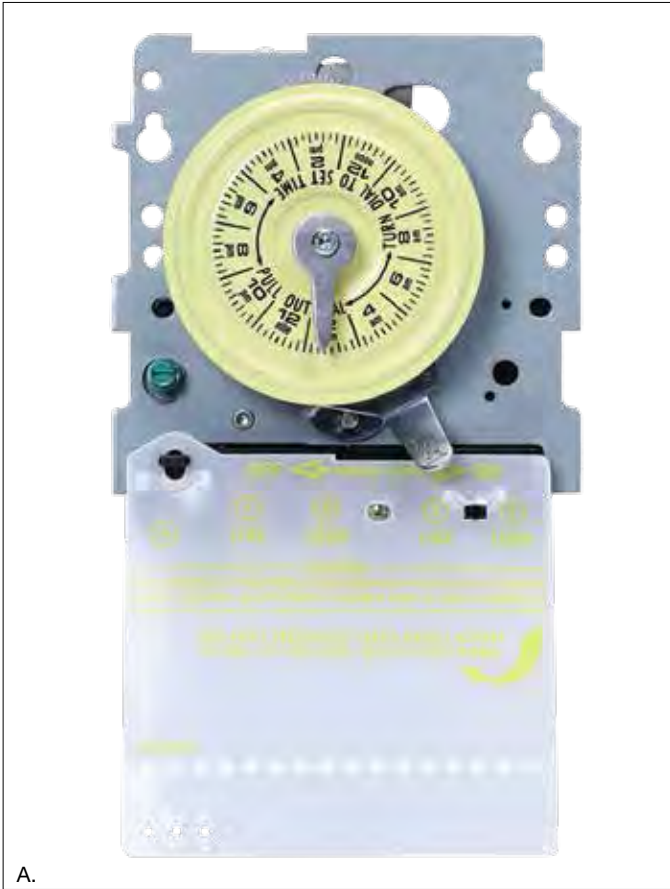

A.



B.

## T100M Series 24-Hour Mechanical Time Switches



- Highest motor load ratings in the industry
- 12 ON/OFF operations per day
- ON/OFF trippers included
- Can be installed in most Intermatic enclosures
- Available with pool heater protection

### Without Pool Heater Protection

	Model #	Switch	Input Voltage
A.	<b>T101M</b>	SPST	120 VAC, 60Hz
	<b>T103M</b>	DPST	120 VAC, 60Hz
	<b>T104M</b>	DPST	208-277 VAC, 60Hz
	<b>T106M</b>	SPDT	208-277 VAC, 60Hz

### With Pool Heater Protection

B.	<b>T104M201</b>	DPST	208-277 VAC, 60Hz
----	-----------------	------	-------------------

#### Rating:

##### Switch Rating:

- 40 A Resistive each pole, 120-480 VAC
- 40 A Tungsten, Inductive or 1000 VA Pilot Duty each pole 120-277 VAC
- 2 HP (24 FLA) 120 VAC
- 5 HP (28 FLA) 240 VAC

**Heater Control Circuit:** 10 A, 240 VAC max.

**Operating Temperature Range:** -40°F to 130°F (-40°C to 54°C)

**Warranty:** 1 year

For parts, trippers and accessories, see page 153

## T100 Series 24-Hour Mechanical Time Switches in Enclosure



- Highest motor load ratings in the industry
- 12 ON/OFF operations per day
- ON/OFF trippers included
- Available with pool heater protection

### Without Pool Heater Protection

Model #	Enclosure	Switch	Input Voltage
T101P3	Type 3R Plastic	SPST	120 VAC, 60 Hz
C. T104P3	Type 3R Plastic	DPST	208-277 VAC, 60 Hz
T106P3	Type 3R Plastic	1 N.O./1 N.C.	208-277 VAC, 60 Hz
D. T101R3	Type 3R Steel	SPST	120 VAC, 60 Hz
T104R3	Type 3R Steel	DPST	208-277 VAC, 60 Hz

### With Pool Heater Protection

Model #	Enclosure	Switch	Input Voltage
T101P201	Type 3R Plastic	SPST	120 VAC, 60 Hz
T104P201	Type 3R Plastic	DPST	208-277 VAC, 60 Hz
E. T101R201	Type 3R Steel	SPST	120 VAC, 60 Hz
T104R201	Type 3R Steel	DPST	208-277 VAC, 60 Hz

#### Rating:

#### Switch Rating:

- 40 A Resistive each pole, 120-480 VAC
- 40 A Tungsten, Inductive or 1000 VA Pilot Duty each pole 120-277 VAC
- 2 HP (24 FLA) 120 VAC
- 5 HP (28 FLA) 240 VAC

Heater Control Circuit: 10 A, 240 VAC max.

Operating Temperature Range: -40°F to 130°F (-40°C to 54°C)

Warranty: 1 year

For replacement parts, trippers and accessories, see page 153.  
For additional enclosures, see page 146.



C.



D.



E.



A.



B.



C.

## T1000R Series Control System with Type 3R Power Centers



- Available with one or two heavy-duty time switch mechanisms
- Accepts any combination of PF1000M, P1403ME, P1353ME, P4043ME, P4243ME, T100M, or RC2000M Series mechanisms
- GFCI and switch mounting capabilities

Model #	Mechanism(s)	Switch	Mechanism Supply Voltage
A. T1000R	Power Center only	—	—
B. T10004R	(1) T104M	DPST	240 VAC, 60 Hz
T10006R	(1) T106M	SPDT	240 VAC, 60 Hz
C. T10101R	(2) T101M	SPST/SPST	120/120 VAC, 60 Hz
T10404R	(2) T104M	DPST/DPST	240/240 VAC, 60 Hz
T10604R	T106M & T104M	SPDT/DPST	240/240 VAC, 60 Hz
T12404R*	T104M201 & T104M	DPST/DPST	240/240 VAC, 60 Hz

\*The heater protection switch is closed when the time switch contacts are open to allow remote operation of heater. A flow or pressure switch must always be part of heater control circuit.

For replacement parts, trippers and accessories, see page 153.

See page 125 for further information on mechanism.

Wiring devices may be installed in this power center (order (4) 21T156A standoffs for mounting). See page 154.

### Ratings:

#### Switch Rating:

- 30 A Resistive/Inductive, Tungsten or 1000 VA Pilot Duty each pole 120, 208, 240 VAC
- 2 HP (24 FLA), 120 VAC
- 5 HP (28 FLA), 240 VAC

#### Operating Temperature Range:

-40°F to 130°F (-40°C to 54°C)

#### Power Center Dimensions:

12" (30.5 cm) H x 12" (30.5 cm) W x 4 ¼" (10.8 cm) D

#### Knockouts:

**Bottom:** (5) combination ½" – ¾" and (2) combination ¾" – 1"

**Left:** (1) combination ½" – ¾"

**Back:** (1) combination ¾" – 1", (1) ½" – ¾"

**Right:** (1) 1 ¾" x 2 ¾" for mounting switches or GFCI

**Warranty:** 1 year



D.



E.

## T2000R Series 60 Amp Pool/Spa Control System with Type 3R Load Center



- Comes with 4/8 position breaker base, equipment grounding bar, and mechanical time switch mechanism
- Accepts PF1000M, P1403ME, P1353ME, P4043ME, P4243ME, T100M, or RC2000M Series mechanisms
- Accepts many interchangeable-type breakers
- GFCI and switch mounting capabilities

### Ratings:

**Load Center Rating:** 60 A, 120, 240 VAC or 120, 208 VAC 60 Hz., Single Phase, 60 Hz.

### Switch Rating:

- 30 A Resistive/Inductive, Tungsten or 1000 VA Pilot Duty each pole 120, 208, 240 VAC
- 2 HP (24 FLA), 120 VAC
- 5 HP (28 FLA), 240 VAC

**Operating Temperature Range:** -40°F to 130°F (-40°C to 54°C)

### Load Center Dimensions:

16 3/4" (42.6 cm) H x 8 7/8" (22.5 cm) W x 4 3/8" (11.1 cm) D

### Knockouts:

**Bottom:** (5) combination 1/2" – 3/4" and (3) combination 3/4" – 1"

**Left:** (1) combination 1/2" – 3/4"

**Back:** (1) combination 3/4" – 1"

**Right:** (1) 1 3/4" x 2 3/4" for mounting switches or GFCI

**Warranty:** 1 year

	Model #	Mechanism	Switch	Mechanism Supply Voltage
D.	<b>T21000R</b>	Load Center Only	—	—
E.	<b>T21001R</b>	T101M	SPST	120 VAC, 60 Hz
	<b>T21004R</b>	T104M	DPST	240 VAC, 60 Hz

For replacement parts, trippers and accessories, see page 153.

See page 125 for further information on mechanism.

Wiring devices may be installed in this load center (order (4) 21T156A standoffs for mounting). See page 154.

# All-In-One



A.



B.



C.

## T30000R Series

### 100 Amp Pool/Spa Control System with Type 3R Load Center



- Comes with an 8/16 circuit breaker base, equipment grounding bar, and a mechanical time switch(es)
- Reduces installation costs
- Eliminates the need for additional service panels
- Accepts any combination of PF1000M Series, P1403ME, P1353ME, P4043ME, P4243ME, T100M Series, or RC2000M Series mechanisms
- Fully compatible with all electrical requirements for pool/spa installations
- GFCI and switch mounting capabilities

	Model #	Mechanism(s)	Switch	Mechanism Supply Voltage
A.	T30000R5	Load Center only	—	—
B.	T30004R	(1) T104M	DPST	240 VAC, 60Hz
C.	T30401R	T104M & T101M	DPST/SPST	240/120 VAC, 60Hz
	T30404R	(2) T104M	DPST/DPST	240/240 VAC, 60Hz
	T30604R	T106M & T104M	SPDT/DPST	240/240 VAC, 60Hz
	T32404R*	T104M201 & T104M	DPST/DPST	240/240 VAC, 60Hz

\*The heater protection switch is closed when the time switch contacts are open to allow remote operation of heater. A flow or pressure switch must always be part of heater control circuit.

See page 124 for further information on mechanisms.

Wiring devices may be installed in this load center (order 4) 21T156A standoffs for mounting). See page 154.

For replacement parts, trippers and accessories see page 153.

#### Ratings:

**Load Center Rating:** 100 A, 120, 240 VAC or 120, 208 VAC single phase, 60 Hz

#### Switch Rating:

- 30 A Resistive/Inductive, Tungsten or 1000 VA Pilot Duty each pole 120, 208, 240 VAC
- 2 HP (24 FLA), 120 VAC
- 5 HP (28 FLA), 240 VAC

**Operating Temperature Range:** -40°F to 130°F (-40°C to 54°C)

**Load Center Dimensions:** 16 1/2" (41.9 cm) H x 10 7/8" (27.6 cm) W x 4 1/2" (11.43 cm) D

#### Knockouts:

**Bottom:** (4) 1/2" - 3/4", (3) 1/2", (2) 3/4" - 1"

**Left:** (1) 3/4" - 1"

**Back:** (5) 1/2" - 3/4"

**Right:** (1) 1 3/4" x 2 3/4" for mounting switches or GFCI

**Warranty:** 1 year



# Electrical Load Center

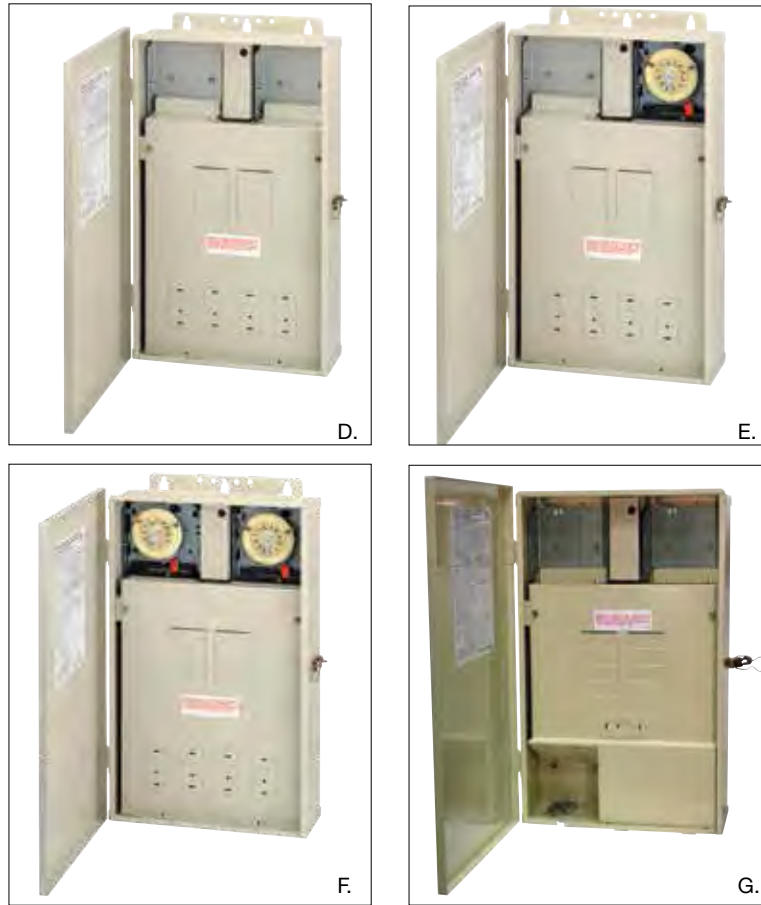

## T4000R Series 125 Amp Pool/Spa Control System with Type 3R Load Center

- Comes with an 8/16 circuit breaker base, equipment grounding bar, and mechanical time switch(es)
- Reduces installation costs
- All-in-one electrical load center eliminates the need for additional service panels
- Accepts any combination of PF1000M Series, P1403ME, P1353ME, P4043ME, P4243ME, T100M Series, or RC2000M Series mechanisms
- Fully compatible with all electrical requirements for pool/spa installations
- GFCI and switch mounting capabilities

### Ratings:

**Load Center Rating:** 125 A max. 120, 240 VAC or 120, 208 VAC single phase, 60 Hz.

### Switch Rating:

- 30 A Resistive/Inductive, Tungsten or 1000 VA Pilot Duty each pole 120, 208, 240 VAC
- 2 HP (24 FLA), 120 VAC
- 5 HP (28 FLA), 240 VAC

**Operating Temperature Range:** -40°F to 130°F (-40°C to 54°C)

**Load Center Dimensions:** 20 3/4" (52.7 cm) H x 12 3/4" (32.4 cm) W x 4 1/2" (11.43 cm) D

### Knockouts:

**Bottom:** (5) 1/2" - 3/4", (4) 1/2", (2) 3/4" - 1", 1 1/4"

**Left:** (1) 1/2" - 3/4"

**Back:** (4) 1/2" - 3/4", (2) 3/4" - 1"

**Right:** (1) 1 3/4" x 2 3/4" for mounting switches or GFCI

**Warranty:** 1 year

	Model #	Mechanism(s)	Switch	Mechanism Supply Voltage
D.	<b>T4000R</b>	Load Center	—	—
E.	<b>T40004R</b>	(1) T104M	DPST	240 VAC, 60 Hz
F.	<b>T40404R</b>	(2) T104M	DPST	240/240 VAC, 60 Hz
G.	<b>T40000R4</b>	Load Center with GCFI	—	—

See page 124 for further information on mechanisms.

Wiring devices may be installed in this load center (order (4) 21T156A standoffs for mounting). See page 154.

For replacement parts, trippers and accessories see page 153.



A.



B.



C.



D.

## PX50, PX100, PX300, & PX600 Series Safety Transformers



- Supply 12 volts to pool/spa lights, submersible fixtures, and outdoor garden lights
- Mounting brackets on the top and bottom

### 3R Beige Steel Enclosure

	Model #	Input Voltage	Output Voltage	Watts
A.	PX50	120 VAC, ½ Amp	12 or 13 VAC	50
	PX100	120 VAC, 1 Amp	12 or 13 VAC	100
	PX300	120 VAC, 3 Amp	12, 13, or 14 VAC	300
B.	PX600	120 VAC, 6 Amp	12, 13, or 14 VAC	600

### 3R Stainless Steel Enclosure

	Model #	Input Voltage	Output Voltage	Watts
C.	PX50S	120 VAC, ½ Amp	12 or 13 VAC	50
	PX100S	120 VAC, 1 Amp	12 or 13 VAC	100
	PX300S	120 VAC, 3 Amp	12, 13, or 14 VAC	300
D.	PX600S	120 VAC, 6 Amp	12, 13, or 14 VAC	600

#### Rating:

#### PX50/S, PX100/S, PX300/S

Size: 7 ¼" (18.4 cm) H x 5 ¼" (13.3 cm) W x 4 ½" (11.4 cm) D

#### Knockouts:

Bottom: (4) combination ½" – ¾"

Left: (2) combination ½" – ¾"

Back: (2) combination ½" – ¾"

Right: (2) combination ½" – ¾"

#### PX600/S

Size: 10" (25.4 cm) H x 10" (25.4 cm) W x 5" (12.7 cm) D

#### Knockouts:

Bottom: (2) combination ½" – ¾", (4) combination ¾" – 1"

Left: (2) combination ½" – ¾"

Back: (2) combination ½" – ¾"

Right: (2) combination ½" – ¾"



E.



F.



G.

## T1000RT, T4000RT Series Control System with Transformer and Power or Load Center



- All-in-one control power for pool/spa installation
- Easy to wire
- Can house additional Intermatic mechanisms and components
- Heavy-duty Type 3R steel Indoor/Outdoor power and load centers

Model #	Description	Mechanism Supply Voltage	Watts	Transformer	
				Input Voltage, 60 Hz	Output Voltage
E. <b>T1000RT1</b>	Power Center with T104M	240 VAC	100	120 VAC, 1 Amp	12 or 13 VAC
<b>T1000RT3</b>	Power Center with T104M	240 VAC	300	120 VAC, 3 Amp	12, 13, or 14 VAC
F. <b>T4000RT3</b>	Load Center with T103M	120 VAC	300	120 VAC, 3 Amp	12, 13, or 14 VAC
<b>T4000RT1</b>	Load Center with T104M	240 VAC	100	120 VAC, 1 Amp	12 or 13 VAC
<b>T4000RT3</b>	Load Center with T104M	240 VAC	300	120 VAC, 3 Amp	12, 13, or 14 VAC
G. <b>T4000RT3</b>	Load Center Only	—	300	120 VAC, 3 Amp	12, 13, or 14 VAC

**Ratings:**

**T1000RT Series:**

**Power Center Rating:** 62 A per leg, 168 A max., 120, 240 VAC or 120, 208 VAC single phase, 60 Hz.

**Power Center Dimensions:** 12" (30.5 cm) H x 12" (30.5 cm) W x 4 1/4" (10.8 cm) D

**T4000RT Series:**

**Load Center Rating:** 100 A, 120, 240 VAC or 120, 208 VAC single phase, 60 Hz.

**Load Center Dimensions:** 20 3/4" (52.7 cm) H x 12 3/4" (32.4 cm) W x 4 1/4" (10.8 cm) D

**Switch Rating:**

- 30 A Resistive/Inductive, Tungsten or 1000 VA Pilot Duty each pole 120, 208, 240 VAC
- 2 HP (24 FLA), 120 VAC
- 5 HP (28 FLA), 240 VAC

**Operating Temperature Range:** -40°F to 130°F (-40°C to 54°C)

**Warranty:** 1 year

## Did You Know?

Many transformers that power LED's do not comply with the NEC Code 680.23 requirements. The code states transformers used for the supply of underwater luminaries must be listed and marked for pool and spa transformer use. Listed pool and spa transformers must comply with UL-379 and CSA TILB44A standards.

Non-compliant transformers increase the potential for severe injury and electrocution and raise liability concerns for contractors and installers.

See page 124 for further information on mechanisms.

Wiring devices may be installed in this power or load center (order (4) 21T156A standoffs for mounting). See page 154.

For replacement parts, trippers and accessories see page 153.



A.



B.



C.



D.

## PF1100 Series Single-Circuit Freeze Protection Controls



- Protect pool/spa equipment against freeze damage
- Turn pump and heater ON when outdoor temperature drops below user-adjustable setpoint on thermostat

**Rating:**  
**Thermostat Range:** 33°F to 42°F (0.6°C to 5.5°C)  
 with 5°F differential  
**Warranty:** 1 year

### Thermostat without Mechanism

Model #	Enclosure	Input Voltage	HP
A. PF1102M	Thermostat only	240 VAC	3
PF1103M*	Thermostat only	120/240 VAC	1.5/3
B. PF1102	Type 3R steel	240 VAC	3
PF1103*	Type 3R steel	120/240 VAC	1.5/3

### Thermostat with Mechanism

Model #	Enclosure	Input Voltage	HP
C. PF1102MT	Mechanism only	240 VAC	3
PF1103MT*	Mechanism only	120/240 VAC	1.5/3
D. PF1102T	Type 3R steel	240 VAC	3
PF1103T*	Type 3R steel	120/240 VAC	1.5/3

\*Neutral must be installed

For replacement parts, trippers and accessories, see page 153.

# The Ultimate Ice Breaker



E.



F.



G.

**Rating:**

**PF112T, PF120T**

**Power Center Rating:** 92 A per leg, 168 A max.  
120/ 240 VAC or 120/240 VAC single phase, 60 Hz.  
**Power Center Dimensions:** 12" (30.5 cm) H x  
12" (30.5 cm) W x 4 1/4" (10.8 cm) D

**PF1222TB1**

**Load Center Rating:** 85 A max., 120, 240 VAC or  
120, 208 VAC single phase, 60 Hz.  
**Load Center Dimensions:** 20 3/4" (52.7 cm) H x  
12 3/4" (32.4 cm) W x 4 1/4" (10.8 cm) D

**Thermostat Range:** 33°F to 42°F (0.5°C to 5.5°C)  
with 5°F differential

**Switch Rating:**

- 30 A Resistive/Inductive, Tungsten or  
1000 VA Pilot Duty each pole 120, 208, 240 VAC
- 2 HP (24 FLA), 120 VAC
- 5 HP (28 FLA), 240 VAC

**Warranty:** 1 year

## PF1100 and PF1200 Series Control System with Freeze Protection and Power or Load Center



- For pools/spas requiring one or two time switches
- Protects pool/spa equipment against freeze damage
- GFCI and switch mounting capabilities
- Turns pump and heater ON when outdoor temperature drops below user-adjustable setpoint on thermostat
- Heavy-duty Type 3R steel Indoor/Outdoor power and load centers

Model #	Description	Input Voltage	HP	Heater Protection
E. PF112T	Power Center with (1) Time Switch	240 VAC	3	No
F. PF120T	Power Center with (2) Time Switches	240 VAC	3	No
G. PF1222TB1*	Load Center with (2) Time Switches	240 VAC	3	Yes

\*4/8 Breaker base and heater protection

For replacement parts, trippers and accessories see page 153

Wiring devices may be installed in this power or load center  
(order (4) 21T156A standoffs for mounting). See page 154.



A.

## RC2103S Air Actuated Remote Control



- Safely controls loads without electricity at a pool/spa
- Type 3R plastic Indoor/Outdoor enclosure
- Controls one piece of equipment with one air button (button not included)

Model #	Switch	Range
A. <b>RC2103S</b>	SPST	100 ft.

**Rating:**  
**Input Voltage:** 120 VAC, (Line and Neutral) or 240 VAC, (Line 1, and Line 2 and Neutral) 60 Hz.  
**Switch Rating:** 20 A Resistive 120, 240 VAC, 1 HP 120 VAC, 2 HP 240 VAC  
**Dimensions** 4 1/8" (10.5 cm) H x 4 1/8" (10.5 cm) W x 3 3/8" (8.6 cm) D  
**Warranty:** 1 year



B.



C.



D.



E.



F.

## RC Series Air Switches and Accessories



- For air control equipment
- Replaces existing buttons

Model #	Description	Range	Length
B. <b>RC4G</b>	Air button for gunite spas	100 ft.	—
C. <b>RC6F</b>	Air button - universal	150 ft.	—
D. <b>RC117</b>	Air tubing	—	75 ft.
	<b>RC150</b>	—	500 ft.
E. <b>RC122B</b>	Air tubing and RC4G	—	25 ft.
	<b>RC127B</b>	—	75 ft.
F. <b>RC510</b>	(10) Air tubing coupler	—	—

## RC2000 Series Multi-Function Air Switches with 24-Hour Timer



- Remote control for one or two separate loads
- Multiple ON/OFF settings per day
- Flexible airhose enables operation up to 75 feet
- Type 3R plastic Indoor/Outdoor enclosure

Model #	Description	Switch	Input Voltage
G. RC2123PT	Timer with ON/OFF or HIGH/LOW	SPDT	120/240 VAC, 60 HZ
RC2343PT	2-circuit timer with sequential operations	4-function	120/240 VAC, 60 Hz

**Rating:**  
**Switch Rating:** 20 A Resistive, 120, 240 VAC, 1 HP, 120 VAC, 2 HP, 240 VAC, each circuit  
**Enclosure Dimensions:** 9 5/8" (23.82 cm) H x 5 1/2" (13.97 cm) W x 3 3/4" (9.53 cm) D  
**Warranty:** 1 year



G.

## RC2100 Series Air Switch Control System



- Controls pool/spa combos
- Heater control
- Override timer for spa mode
- (2) PE24VA 24-volt valve actuators
- Heavy-duty Type 3R steel Indoor/Outdoor load center

Model #	Remote Command	Input Voltage
H. RC2163BE	1-Air Button	120/240 VAC
RC2163BEF	Any SPST switch*	120/240 VAC

\*Sold separately

**Rating:**  
**Load Center Rating:** 100 A, 120, 240 VAC or 120, 208 VAC single phase, 60 Hz.  
**Filter Pump:**  
 Single Speed Only: 1.5 HP - 120 VAC, 3 HP - 240 VAC  
 Single or Two Speed: 1 HP - 120 VAC, 2 HP - 240 VAC  
**Breaker Spaces:** 8/16  
**Number of Actuator Connections:** 3  
**Load Center Dimensions:**  
 16 1/2" (41.9 cm) H x 10 7/8" (27.6 cm) W x 4 1/4" (10.8 cm) D  
**Warranty:** 1 year



H.

For replacement parts, trippers and accessories, see page 153.



## PB300 Series Electronic Panel Mount Timers

- 24-Hour and 7-Day models
- Perfect for applications where equipment needs to be cycled ON/OFF up to 8 times per day
- Select feature enables timers to be continuously ON, OFF, or in AUTO mode
- Rugged construction
- 3-year service life replaceable lithium battery

		24-Hour				
	Model #	Input Voltage	Switch	Amps	HP	FLA
A.	PB313E	120 VAC, 50/60 Hz	SPDT	16	1/2	8
	PB313EK*	120 VAC, 50/60 Hz	SPDT	16	1/2	8
	PB314E	240 VAC, 50/60 Hz	SPDT	16	1/2	8
	PB314EK*	240 VAC, 50/60 Hz	SPDT	16	1/2	8

		7-Day				
	Model #	Input Voltage	Switch	Amps	HP	FLA
B.	PB373E**	120 VAC, 50/60 Hz	SPST	20	1	16
	PB374E**	240 VAC, 50/60 Hz	SPST	20	2	12

**Rating:**  
**Enclosure:** Beige electrical grade plastic  
**Dimensions:** 2 3/8" (6 cm) H x 2 3/8" (6 cm) W x 1 1/8" (28 cm) D  
**Warranty:** 1 year

# Replacing an existing PB Series Timer?

Be sure to order an EK model replacement kit!



# Up To 8 ON/OFF Times per Day



C.



D.

## P1000 and P7000 Series 24-Hour/7-Day Electronic Time Switch Mechanisms



- Perfect for applications that turn equipment ON/OFF up to 8 times per day
- To-the-minute programming accuracy
- Dual voltage input (3-wire)
- Safety door prevents unwanted entry into wiring compartment
- Timer override
- Select feature enables timers to turn ON/OFF in AUTO mode
- 24-Hour and 7-Day models
- 3-year service life replaceable lithium battery

Model #	Description	Switch
C. <b>P7103ME*</b>	7-Day Mechanism Only	DPST
D. <b>P1103FE</b>	24-Hour with Type 3R Plastic Enclosure	DPST

\*Standard mechanism fits in all standard Intermatic enclosures and power and load centers.

<p><b>Rating:</b>  <b>Clock Supply Voltage:</b> 120 VAC, 50/60 Hz.  <b>Switch Rating:</b>                  20 A Resistive, 120-240 VAC                  10 A Tungsten, 120 VAC                  1.5 HP, 120 VAC, 3 HP, 240 VAC 50/60 Hz.  <b>Warranty:</b> 1 year</p>
---

For replacement parts, trippers and accessories, see page 153.  
 For additional enclosures see page 146.



A.



B.



C.



D.

## PB800 and PB900 Series Mechanical Panel Mount Timers



- Automated control for pumps, cleaners, and other types of loads
- 3 different mounting methods
- Quick connect terminals for easy installation

Model #	Switch	Dial	Input Voltage	No. of Trippers	Manual Override
A. <b>PB873MKZ</b>	SPST	7-Day	120 VAC, 60 Hz	56	No
<b>PB913N</b>	SPST	24-Hour	120 VAC, 60 Hz	48	No
B. <b>PB914N</b>	SPST	24-Hour	208-277 VAC, 60 Hz	48	No
<b>PB913N66</b>	SPST	24-Hour	120 VAC, 60 Hz	48	Yes
C. <b>PB914N66</b>	SPST	24-Hour	208-277 VAC, 60 Hz	48	Yes
<b>PB913N84</b>	SPST	24-Hour	120 VAC, 60 Hz	4	Yes
D. <b>PB914N84</b>	SPST	24-Hour	208-277 VAC, 60 Hz	4	Yes

For replacement parts, trippers and accessories, see page 153.

### Rating:

#### Switch Rating:

20 A Resistive, 120-277 VAC  
 1250 W Tungsten 125 VAC  
 1 HP (16 FLA), 120 VAC  
 2 HP (12 FLA), 240 VAC  
 360 VA Pilot Duty, 120-240 VAC

**Timing Cycle:** 24-Hour – minimum ON time 1 hour, maximum ON time 23 hours, 30-minute intervals  
 7-Day – minimum ON time 6 hours, maximum ON time 162 hours, 3-hour intervals

**Quick Connect Terminals:** (4) ¼" male (2) for load and (2) for independent clock motor

**Dimensions:** 3 ½" (84.8 cm) H x 2 ⅞" (17.4 cm) W x 1 ⅝" (49.6 cm) D

**Warranty:** 1 year



E.



F.



G.

### P1100 Series Portable Outdoor Timers

- Control filter pumps
- Turn outdoor decorations, engine block heaters, and other appliances ON/OFF

	Model #	Description	Plug & Receptacle	Cord Length
E.	P1101	24-Hour timer	5-15	22"
F.	P1121	24-Hour timer	5-15	13"
G.	P1131	Heavy-duty 24-Hour timer with twist-lock plug and receptacle	5L-20	22"

**Ratings:**  
**Enclosure:** Outdoor grade plastic Dimensions: 5" (12.7 cm) H x 5 1/2" (13.97 cm) W x 3 3/4" (9.52 cm) D  
**Cord:** 3 wire, outdoor grade with grounded plug  
**Timer:** 24-Hour with 23 1/2 hour maximum ON time. Two ON, two OFF trippers standard. Accepts up to 12 sets of trippers.  
**Switch Rating:**  
 P1101 and P1121: 15 A (1800 W), Resistive or Tungsten, 1 HP Air Conditioner, (15 FLA, 90 LRA), Motor Load  
 P1131: 20 A Resistive, 1 HP, (15 FLA, 90 LRA) Motor Load  
**Warranty:** 1 year

For replacement parts, trippers and accessories, see page 153.

### P1200 Series Two-Circuit Portable Outdoor Timers

- Incorporate a plug-in for a timed circuit and a plug-in for a live circuit
- Built-in GFCI protected circuits and three-prong grounded plug for time switch supply
- Great for above ground pool pumps, lights, or fountains
- Type 3R plastic Indoor/Outdoor enclosure



H.



J.

	Model #	Photo Control	Plug & Receptacle
H.	P1251P	Yes	5-15
J.	P1261P	No	5-15

**Ratings:**  
**Timer:** 24-Hour with 23 1/2 hour maximum ON time. Two ON, two OFF trippers standard. Accepts up to 12 sets of trippers.  
**Switch Rating:**  
 15 A (1800 W), Resistive or Tungsten, 1 HP (15 FLA, 90 LRA) 120 VAC Motor Load  
**Enclosure Dimensions:** 9 3/8" H x 5 1/2" W x 3 3/4" D  
**Cord:** 3 wire, outdoor grade, 24" with grounded plug  
**Warranty:** 1 year

For replacement parts, trippers and accessories, see page 153.



A.



B.

## RC600 Series Outdoor Radio Receivers

- Respond to handheld transmitter signals
- For indoor/outdoor use
- Handle a variety of switching applications
- Enable connected loads to be turned ON/OFF remotely

Model #	Description	Switch Rating	Motor Load
A. <b>RC613</b>	Receiver with manual ON/OFF button, 6" leads	15 Amp Resistive 10 Amp (1200W) Tungsten	1 HP, 120 VAC
<b>RC613L</b>	Receiver with manual ON/OFF button (3) 36" leads	15 Resistive 10 Amp (1200W) Tungsten	1 HP, 120 VAC
<b>RC615</b>	Timer interface module	15 Resistive 10 Amp (1200W) Tungsten	1 HP, 120 VAC
B. <b>RC613R</b>	Heavy-duty receiver module	20 Resistive 12.5 Amp (1500W) Tungsten	1.5 HP, 120 VAC 3 HP, 240 VAC

**Rated:**  
**Enclosure:** Beige outdoor grade plastic  
**Maximum Range:** 100 ft. See transmitter model RC939  
**Dimensions: RC613/L, RC615:**  
 4 1/2" (11.4 cm) H x 3" (7.6 cm) W x 1 1/4" (4.0 cm) D  
**RC613R:**  
 7 3/4" (19.7 cm) H x 4" (10.7 cm) W x 3 1/2" (8.9 cm) D  
**Warranty:** 1 year



C.

## RC939 Handheld 3-Channel Radio Transmitter

- Controls shared pool/spa equipment, including booster pump, blowers, and lights
- Operates up to three RC600 Series receivers

Model #	Description	Range	Battery
C. <b>RC939</b>	3-Channel Radio Transmitter	100 ft.*	CR2D32

\*Range depends on many factors including age of battery, proximity of large metal objects, location of receiver, and environmental conditions at the time of transmission.

**Rating:**  
**Dimensions:** 2 1/2" (6.35 cm) H x 1 1/4" (3.18 cm) W x 1/2" (1.27 cm) D  
**Warranty:** 1 year



D.



E.

**PJB Series**  
**Pool/Spa Light Junction Boxes**



- For pools or spas, pool/spa combinations, and landscape applications
- Safe and reliable connection for up to four lights
- Accommodates flexible cords from #16-3 to #10-3 and non-metallic conduits from 1/2" to 1"
- Watertight, multi-fixture enclosure
- Easy access groundbar
- 1-year warranty

	Model #	Light Connections	Dimensions L x W x D
D.	<b>PJB2175</b>	2	7" (17.78 cm) x 3" (7.62 cm) x 4" (10.16 cm)
E.	<b>PJB4175</b>	4	7 1/2" (19.05 cm) x 4 3/4" (12.01 cm) x 5" (12.7 cm)



F.

**Accessory**

F.	<b>PA114</b>	Wall/Post mounting bracket (sold separately)
----	--------------	--

**PE24VA**  
**24-Volt Valve Actuator**



- Reliable control of 2-way and 3-way diverter valves for pool/spa combinations and water features
- Easy-to-adjust cam rotates valves to multiple settings
- Compatible with all pool/spa valves and controls
- 1-year warranty

	Model #	Input Voltage
G.	<b>PE24VA</b>	24 VAC



G.

# No matter where you live...

*Your pool equipment will experience power surges and spikes*

The new Intermatic PS3000 and IG1200RC3 pool/spa surge protectors provide industry-leading protection from power surges and spikes. These unrelenting surge protectors deliver an unmatched 3-year product warranty and a \$7,500 connected equipment warranty. They provide the perfect add-on for pool and spa equipment. Don't let a power surge burn a hole in your wallet. Safeguard your pool/spa equipment with a heavy-duty surge protector from Intermatic.

An estimated \$250-\$500\* million dollars a year is lost from property damages caused by power surges. Your new pool pad equipment can cost over \$3000 to replace.



## PS3000 Pool and Spa Surge Protective Device



- Meets ANSI UL1449 3rd Edition Standards
- 120/240 VAC single split phase SPD for use on a variety of pool equipment
- Green LED Protection Indicator
- Type 4x enclosure
- ½" x 20 threaded nipple (weatherproof and UV resistant)
- TPMOV® Technology
- 3 modes of protection
- 3 leads
- 18" lead length
- 10 gauge leads
- 3-year warranty
- \$7,500 connected equipment warranty

Model #	Service Voltage	SPD Type	Nominal Discharge Current	MCOV*		Wiring Configuration	SCCR**	Voltage Protection Rating (VPR)		
				L-N	L-L			L-N/G	N-G	L-L
PS3000	120/240 VAC	1 or 2	10kA	150V	300V	L1, L2, L/N-G	20kA	600		900

\*MCOV Maximum Continuous Operating Voltage  
\*\*SCCR Short Circuit Current Rating

## IG1200RC3 Plastic Housing



- Green LED Protection Indicator
- Type 3R rainproof enclosure
- 5.65" (14.35 cm) H x 4.18" (10.62 cm) W x 3.33" (8.46 cm) D
- 3 modes of surge protection (L1-N,L2-N,L1-L2)
- 3 leads
- 30" lead length
- 3-year warranty
- \$7,500 connected equipment warranty



Model #	Service Voltage	Type	Wiring Configuration	Nominal Discharge Current	MCOV*	SCCR**	Voltage Protection Rating (VPR)				
							L-N/G	L-N	L-G	N-G	L-L
IG1200RC3	120, 240 VAC	1 or 2	L1, L2, N/GND	20 kA	150 L-N, N-G 300 L-L, L-G	50 kA	700			1200	

\*MCOV Maximum Continuous Operating Voltage  
\*\*SCCR Short Circuit Current Rating



**PA600**  
Emergency Shut-Off Switch

- Fits in single-gang junction box
- Rated for outdoor installation
- Disconnects electrical equipment from its power source in case of emergency

Model #	Voltage
A. PA600	120/240 VAC

**Ratings:**  
**Electrical Rating:** 1 HP, 120 VAC, 3 HP, 240 VAC, 20 A Resistive, 120, 240 VAC DPST  
**Housing:** Electrical grade plastic  
**Faceplate:** Beige powder coated steel

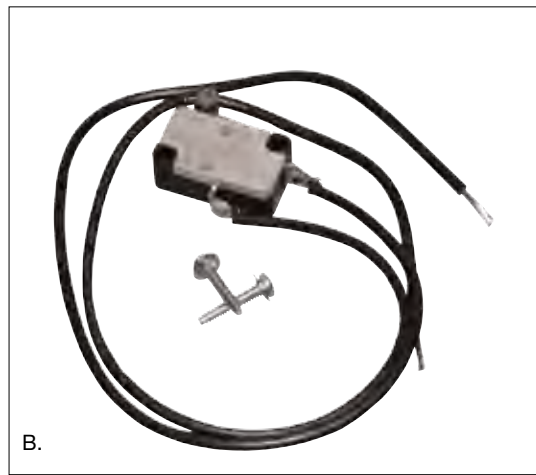

**156T4042A**  
Fireman Switch

- Coordinated control for pool/spa heaters and filter pumps
- Turns OFF gas pool/spa heater before filter pump shuts down to extend heater life

Model #	Switch Rating
B. 156T4042A	10 Amp, 250 VAC Maximum



**21T166A & 21T156A**  
Standoff Posts

- Great for mounting toggle switches and GFCIs inside any Intermatic pool/spa power or load center
- Connects to back panel of power and load centers

Model #	Quantity
C. 21T166A	2
21T156A	4



**22T904A**  
Back-Feed Retainer Kit

- Additional fastener/retainer kit is required per NEC Article 408.36 (F) –2005

Model #
D. 22T904A



# Enclosures and Accessories



**Parking Lot Lighting**

***Bell Ringing***

Entry Lighting

**Outdoor Lighting**

Security Lighting

***Pools***

Spas

Pumps

***Water Heaters***

**Lobby Lighting**

# *Not Sure Which Enclosure Works for Your Time Switch?*

## **Find Your Enclosure in 5 Easy Steps**

1. Do you need an enclosure for an  **INTERMATIC**® or **GRÄSSLIN** time switch?
2. Do you need an **indoor** or **outdoor** enclosure?
3. Do you need a **plastic** or **metal** enclosure?
4. Do you need a **compact** or **oversized** enclosure?
5. Will your enclosure be **surface** or **flush** mounted?

*Match your answers with the applicable enclosure on the following pages.*

Corrosion Resistant Paint

Mounting Bracket

20 Gauge Steel

Lockable Hasp

Knockouts (5)

Rainproof Gasket

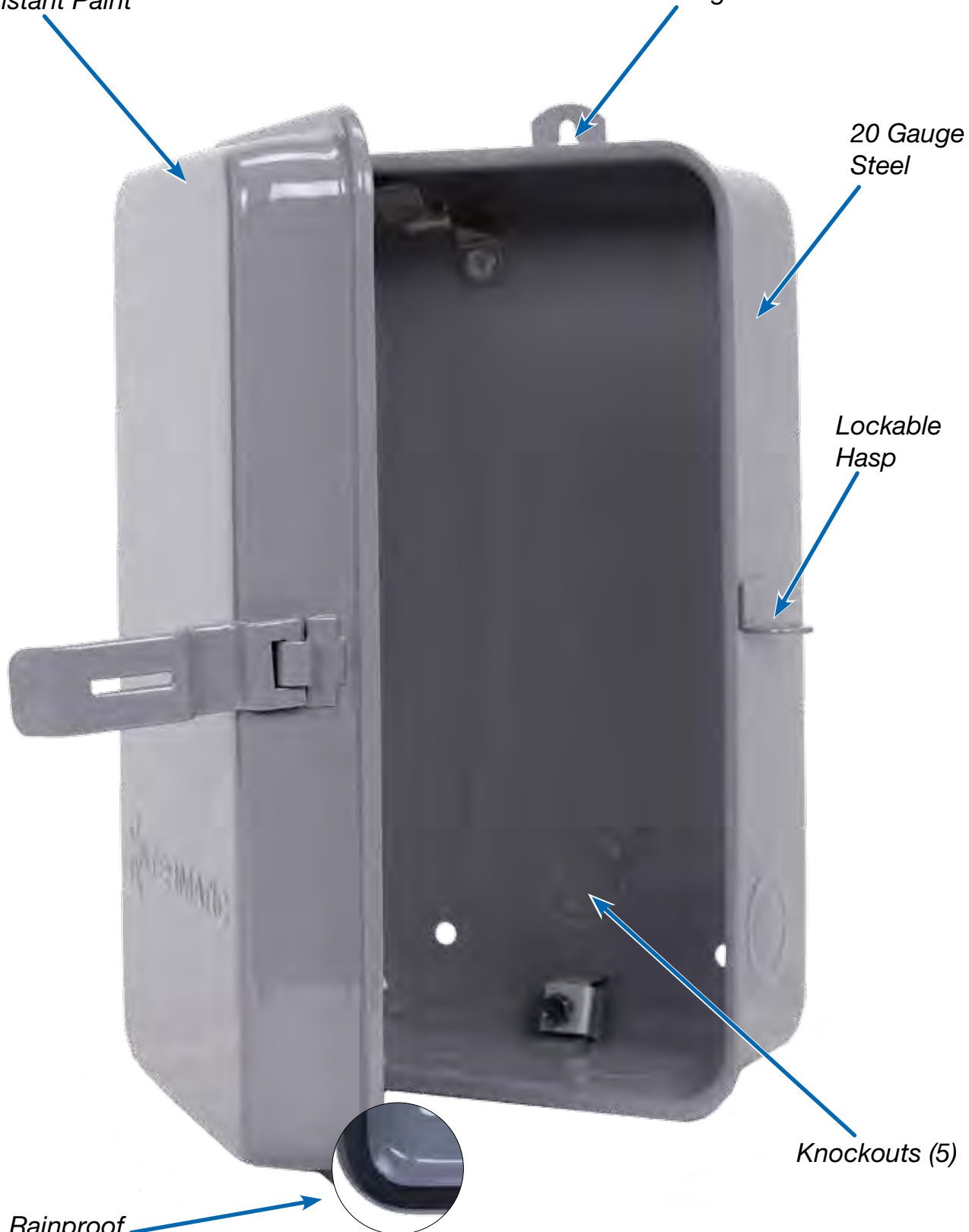

2T511GA Shown



A.



## Indoor Steel Enclosure

### Type 1 Enclosure

- Drawn steel with gray powder coat paint finish
- Combination 1/2" and 3/4" nominal knockouts with one on back and each side of enclosure, and two on bottom
- Convenient mounting holes
- Lockable hasp holds door closed

Model #	Color	H x W x D
A. <b>2T2040GA</b>	Gray	7 3/4" x 5" x 3"

Accepts a wide range of Intermatic time switches, including most T100, T170, T1900, T2000, C8800, EH, ET1100, ET1700, ET8000, ET90115, and ET90215 Series units



B.



## Outdoor Steel Enclosures

### Type 3R Rainproof Enclosures

- Drawn steel with gray or beige powder coat paint finish
- Combination 1/2" - 3/4" nominal knockouts with one on back and each side of enclosure, and two on bottom
- Separate grounding terminal
- Convenient mounting holes
- Lockable hasp holds door closed

Model #	Description	Color	H x W x D
B. <b>2T511GA*</b>	For Time Switch Models That Snap into Enclosures	Gray	9 3/8" x 5 1/2" x 3 5/8"
C. <b>2T2485GA*</b>	For Time Switch Models That Snap into Enclosures	Beige	9 3/8" x 5 1/2" x 3 5/8"
<b>2T2331GA**</b>	For Time Switch Models with Carryover	Gray	9 3/8" x 5 1/2" x 3 5/8"

\*Available for T100, T170, T1900, T2000, C8800, EH, ET1100, ET1700, ET8000, ET90115, and ET90215 Series units

\*\*Available for T100CR, T170CR, T1400, and T1800 Series units



C.



# Outdoor Plastic Enclosures

## Type 3R Rainproof Enclosures

- Heavy-duty industrial grade plastic
- Perfect for high humidity and dust environments
- Combination 1/2" and 3/4" nominal knockouts with one on back and each side of enclosure, and two on bottom
- Lockable hasp holds door closed

Model #	Description	H x W x D
D. 2T2500GA	Gray	9 3/8" x 5 1/2" x 3 3/4"
E. 2T2502GA	Beige	9 3/8" x 5 1/2" x 3 3/4"
F. 2T2926A	Gray with see-through window	9 3/8" x 5 1/2" x 3 3/4"

Available for T100, T170, T1400, T1900, T2000, C8800, EH, ET1100, ET1700, ET8000, ET8215, ET90115, and ET90215 Series units



D.



E.



F.



A.



## Flush Mount Steel Enclosures

### Type 1 Rated Enclosure

- Provides a finished, flush appearance
- Heavy-duty construction with hinged door
- Lockable door with key
- Various mounting holes

Model #	Description	H x W x D	Door Opening
A. 2T2365GA*	Riveted Mounting Bracket	9 $\frac{1}{8}$ " x 6" x 4 $\frac{1}{8}$ "	11" x 8"
2T308A**	Adjustable Bracket Mount Locations	9 $\frac{1}{8}$ " x 6" x 4 $\frac{1}{8}$ "	11" x 8"

\*Available for ET1100, ET1700, ET8000, EH, ET90115, and ET90215 series units

\*\*Available for T100, T170, T1900, T2000, and C8800 series units

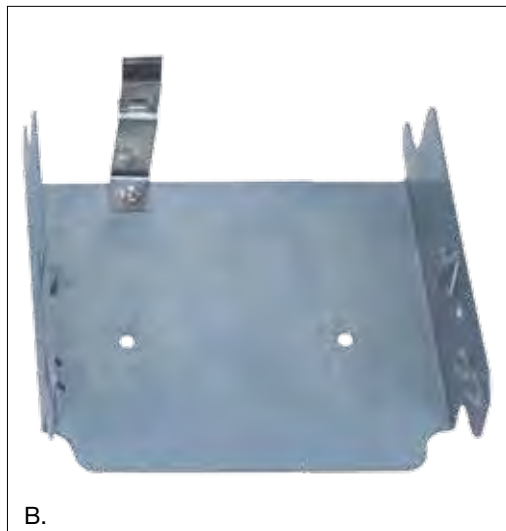

B.



## Surface Mount Bracket

### Mounting Brackets

- Mounts to a standard symmetrical rail TS35 according to DIN46277 and EN50022
- Ideal for panel mounting mechanical or electronic time switch controls

Model #	Description	H x W x D
B. 22T338GR	Surface Mount Snap-in Bracket	6" x 5" x 2"

Accepts a wide range of Intermatic time switches, including most T100, T170, T1900, T2000, C8800, ET1100, ET1700, ET8000, ET90115, and ET90215 series units

# GRÄSSLIN

## Indoor Plastic Enclosure

### E150 Type 1 Enclosure

- Lockable hinged door with latch
- Provisions for mounting ANY Grässlin time control
- Five ½" – ¾" knockouts. One on each side, two on the bottom, and one on back.

Model #	H x W x D
E. E150	10" x 6.5" x 3.75"



E.

# GRÄSSLIN

## Outdoor Plastic Enclosures

### E200 Type 3R Rainproof Enclosure

- Lockable hinged door with latch
- Provisions for mounting ANY Grässlin time control
- Five ½" and ¾" knockouts with, one on each side, two on the bottom, and one on back

Model #	H x W x D
F. E200	10" x 6.5" x 3.75"



F.

### E300 Compact Type 3R Rainproof Enclosure

- Lockable hinged door with latch
- Provisions for mounting Grässlin timer modules
- Five ½" and ¾" knockouts with, one on each side, two on the bottom, and one on back

Model #	H x W x D
G. E300	8.795" x 6.631" x 2.935"



G.

# Accessories



A.



B.



C.



D.



E.



F.



G.



H.

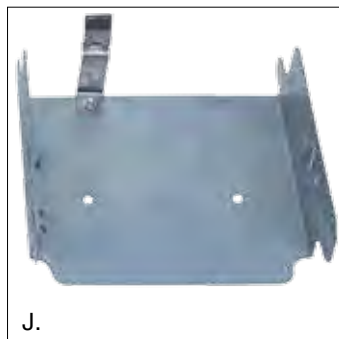

J.

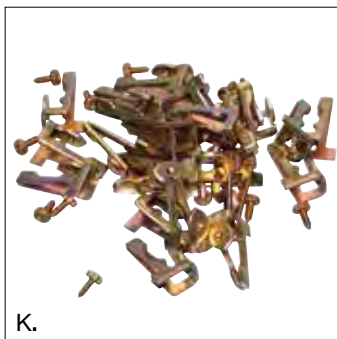

K.



L.

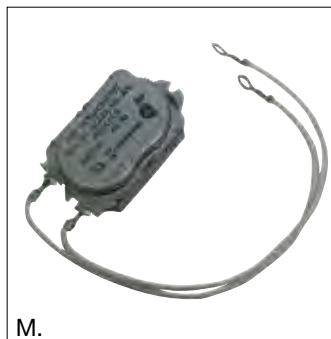

M.

	Model #	Description	Used With
A.	<b>124T1948</b>	Insulator for T101 & T102 Series - Clear	T101 and T102 Series Time Switches
	<b>124T1952</b>	Insulator for T103 & T104 Series - Clear	T103 and T104 Series Time Switches
B.	<b>124T2411A</b>	(10) Insulators for T100 Series - Black, Rigid	T100 Series Time Switches
C.	<b>143T135</b>	DPST Relay with 240 VAC Coil	PF1102 and PF1200 Series
D.	<b>143T136</b>	DPST Relay with 120 VAC Coil	PF1103 Series, RC2200E Series, RC613R, P7103ME
E.	<b>143RC151</b>	DPST Relay with 24 VDC Coil	RC2100FE and RC2100E Series
F.	<b>156PB10398A</b>	2 ON and 2 OFF Trippers	P1100 Series, P1261P, and PB913N84 Series
G.	<b>156T1978A</b>	1 ON and 1 OFF Tripper	T100 Series Time Switches
H.	<b>156T6738A</b>	(10) Insulators for Time Switch Manual Lever	T100 Series Time Switches
J.	<b>22T338GR</b>	Snap-In Time Switch Mounting Bracket	All Pool/Spa Enclosures and T100 Series Time Switches
K.	<b>PA115</b>	(25) OFF Trippers and Screws	T100 Series Time Switches
L.	<b>WG1570-10D</b>	120 VAC Clock Motor	T100 Series Time Switches
M.	<b>WG1573-10D</b>	208-277 VAC Clock Motor	T100 Series Time Switches



Model #	Description
<b>Electronic Timers</b>	
101--00040	Battery holder for ET100
22T338GR	Snap-In bracket for ET Series, T100, T170, T180, T1900, T2000, & C8800 Series
ET9100	ET90000 replacement door assembly for 4, 8, 12, 16-circuit models
ET9232	Ethernet Module for upgrade or replacement
ET9250	4-circuit module for upgrade or replacement for ET90000 4, 8, 12, 16-circuit models
<b>Grässlin by Intermatic</b>	
22--00012	4" Metal DIN Rail
156--01318A	DTAV40 Retro fit plate assembly
DC-FME	Clear dust cover for Grässlin FMD Electronic
DC-FME-A	Clear dust cover for Grässlin FM Mechanical
DT-B	Bracket mount for DTAV40 series timer mechanism
FM-FU	FM1 Flush mount housing kit
FM-SU	FM1 Surface/DIN Rail Kit
MB-DIN	DIN Rail mounting base for FM2D50
<b>Hour Meters</b>	
BEZ-55BLACKU	Bezel adapter for UWZ48E, black, 55 mm sq.
BEZ-55GRAYU	Bezel adapter for UWZ48E, gray, 55 mm sq.
BEZ-72PU	Bezel adapter with pins for 3-hole pattern for UWZ48E, gray, 72 mm sq.
BEZ-72U	Bezel adapter for UWZ48E, gray, 72 mm sq.
G-55U	Gasket for all FWZ55 flush mount models
G-72U	Gasket for all FWZ72 flush mount models
MB-48V	Mounting base for UWZ48V
<b>Mechanical Timers</b>	
107T119	Tripper (silver) for T8800 and R8800 Series
107T73	Day Wheel Pin for T8800 and R8800 Series
119T86A	Transformer for T8845PV
124T1948	Insulator for single pole time switches
124T1952	Insulator for double pole time switches
124T2097	Plastic Insulator for T8800 and R8800 Series
124T2247	Insulator old style replaces 124T1607
131T68GA	125 VAC, 60 Hz motor and carryover T7400BC and T7800BC Series
133T1115A	Toggle switch for T8800 and R8800 Series
133T698A	Replacement snap switch for T1970 Series
133T700A	Micro switch for T8800 and R8800 Series
133T701A	Replacement snap switch for T1900 and T2000 Series
133T773A	Replacement snap switch for C8800 Series
156EB1945A	Trippers (2) Sets (ON / OFF) for E1020, E1022, EB11, EB11R, and WH21
WG1380-11	Motor - Boxed, 125 VAC, 60 Hz for T1400BCR
WG1383-11	Motor - Boxed, 208/277 VAC, 60 Hz for T1800BCR
WG1570-10D	Motor - Boxed, 125 VAC, 60 Hz for T101, T103, and T105
WG1571-10D	Motor - Boxed, 125 VAC, 50 Hz for T101, T102, T103, T104, T105, T100R201, and WH10
WG1573-10D	Motor - Boxed, 208/277 VAC, 60 Hz for T102, T104, WH10 and WH30
WG1574-10D	Motor - Boxed, 208/277 VAC, 50 Hz for T100R301
WG1576-10D	Motor - Boxed, 480 VAC, 60 Hz for WH40, WH70 and WH80
WG1600-11	Motor - Boxed, 125 VAC, 60 Hz for T7400B and T7800B
WG1603-11D	Motor - Boxed, 208/277 VAC, 60 Hz for T7400B and T7800B
WG190-15D	Motor - Boxed, 125 VAC, 60 Hz

Model #	Description
<b>Mechanical Timers</b>	
WG433-20D	Motor - Boxed, 208/277 VAC, 60 Hz for T180 and T500
WG436-20	Motor - Boxed, 480 VAC, 60 Hz for WH10 and WH30
WG630D	Motor - Boxed, 125 VAC, 60 Hz
WG720-10D	Motor - Boxed, 125 VAC, 60 Hz for T2000 Series
WG730-14D	Motor - Boxed, 125 VAC, 60 Hz for R8800, T1900, T1970, T8800 Series
WG733-14D	Motor - Boxed, 208/277 VAC, 60 Hz for R8800, T1900, T1970, T8800 Series
WG736-14D	Motor - Boxed, 480 VAC, 60 Hz for R8800, T1975E, and T1976E Series
WG750-10	Motor - Boxed, 125 VAC, 60 Hz for C8845
WG760-10	Motor - Boxed, 125 VAC, 60 Hz for C8825 (timer obsolete)
WG770-10	Motor - Boxed, 125 VAC, 60 Hz for C8866
WG770-10D	Motor - Boxed, 125 VAC, 60 Hz for C8865
WG773-10	Motor - Boxed, 208/277 VAC, 60 Hz for C8866
WG780-12D	Motor - Boxed, 125 VAC, 60 Hz for C8835
WG790-11D	Motor - Boxed, 125 VAC, 60 Hz for C8815
<b>Metal Trippers</b>	
156T1948A	Trippers (1) Set (ON/OFF/ON Cutout) for T170, P171, T1400, and T1800 Series
156T1949A	Tripper variable (10 to 60 minutes) for Model T185
156T1950A	Trippers (12 ON or OFF) for T1900, T2000, C8800, R8800 and T8800 Series
156T1954A	14 Pins for R8800 and T8800 Series
156T1957A	Skipper screws (3 per package)
156T1978A	Trippers (1 ON / 1 OFF) for T100, T7000, and WH40
156T2548A	Trippers 7 Sets (ON / OFF) for T7400 and T7800 Series
156T3085A	3 Skipper Screws for T170, P171, T1400, T1800 and WH Series
156T3230A	Trippers (1 ON / 1 OFF / 1 On Cutout) for WH Series
156T3492A	Trippers WH40
<b>Plastic Trippers</b>	
107SB189	ON trippers for HB11, HB35R, HB112C, HB113C, HB114C, AL300RTW, AL600TW, AL900TW, AL60TW, and ML Series Transformer Timers
107SB192	OFF Trippers for HB11, HB112C, HB113C, HB114C, AL300RTW, AL600TW, AL900TW, AL60TW, and ML Series Transformer Timers
107SB216	ON trippers for HB31R and P1121
107SB217	OFF trippers for HB31R and P1121
107SB234	OFF trippers for HB35R
107TN221	OFF trippers for TN, PB, TB Series, P1101, P1131, P1161, P1261, AL300TPWS, AL600TPWS, and AL900TPWS
107TN222	ON trippers for TN, PB, TB Series, P1101, P1131, P1161, P1261, AL300TPWS, AL600TPWS, and AL900TPWS
<b>Pool and Spa</b>	
119T267	Transformer - 100 Watt
119T340	Transformer - 300 Watt
124T2530A	8-pole buss bar assembly
124TP2608A	4-pole buss bar assembly
133RC1144	Pressure sensing momentary air switch 3 A
143PS307	DPST relay with 24 VDC coil
143RC126	Bi-Stable Relay SPDT, 1 H.P.-120 VAC, 2 HP - 240 VAC
143RC140	120 VAC Coil
143T135	Four function stepper relay
143T136	Double pole single throw relay with 240 VAC coil
143T145A	Double pole single throw relay with 120 VAC coil

Model #	Description
<b>Pool and Spa</b>	
156PA13713A	½" non-metallic hub kit for direct connection to underwater pool lights
156PA13714A	¾" non-metallic hub kit for direct connection to underwater pool lights
156PA13715A	1" non-metallic hub kit for direct connection to underwater pool lights
156PA14336A	½" metallic hub kit for direct connection to underwater pool lights
156PB10398A	(2) ON (2) OFF trippers for P1000 series timer
156T4042A	Heater control (Fireman) switch kit
178PA28A	Freeze protection thermostat for P1353ME digital control
178T24	½" metallic hub kit for direct connection to underwater pool lights
21T156A	Freeze protection thermostat for PF series freeze protection models
22T904A	Hold-down kit for circuit breakers
24T5265A	Snap-in bracket for (2) wiring devices
CA8750	CA USB stick with base
PA102	Replacement thermostat relay assembly for PF1202T and PF1222TB
PA114	Plastic pool/spa light junction box mounting bracket
PA115	25 OFF trippers only and screws
PA117	Replacement latch kit
PA120	Double pole single throw relay with 24 VAC coil
PA122	Water temperature sensor for PE650 transceiver (I-Wave)
PA600	Pump shut-off switch
PB313EK	Electronic 24 Hr 120 VAC, 50/60 Hz replacement clock kit for mechanical PB clock
PB314EK	Electronic 24 Hr 240 VAC, 50/60 Hz replacement clock kit for mechanical PB clock
PB913N66	24 Hr. panel mount timer, 120 VAC for PF and RC series products
PE650	Wireless I-Wave panel mount receiver for P1353ME and/or P4243ME mechanisms (PE950 transmitter required)
PE653	Wireless 5-circuit pool/spa/variable speed receiver (MultiWave)
PE953	Wireless hand held transmitter for all Wave Series products
PJB2175	Plastic pool/spa light junction box - two light capacity with conduit sizes from ½" to 1"
PJB4175	Plastic pool/spa light junction box - four light capacity with conduit sizes from ½" to 1"
RC117	Air tubing - 75 ft. long
RC122B	Air tubing - 25 ft. long with RC4G button
RC127B	Air tubing - 75 ft. long with RC4G air button
RC150	Air tubing - 500 ft. long
RC510	Tube coupler - 10 units
RC6F	Air button for gunite/fiberglass construction - 150 ft. range
<b>Replacement Plates</b>	
24EB5495	Replacement plate for E1120, KM2ST-1G & KM2SW-1G
24EB5524	Replacement plate for E1221, KM2ST-2D & KM2SW-2D
<b>Spring Wound Timers</b>	
146MT573	Small ivory knob
146MT574	Small white knob
146MT575	Small almond knob
146MT577	Large white knob

Model #	Description
<b>Pool and Spa</b>	
146MT579	Large black knob
148FD5024	Plate for FF5MH
148FD5025	Plate for FF5M
<b>Spring-Wound Timers</b>	
148FD5029	Plate for FF60MH
148FD5030	Plate for FF6H, FF36H and FF46H
148FD5031	Plate for FF6HH
148FD5032	Plate for FF12H, FF312H and FF412H
148FD5033	Plate for FF12HH and FF312HH
148FD5034	Plate for FF2H and FF32H
148FD5035	Plate for FF32HH
148FD5036	Plate for FF4H and FF34H
148FD5037	Plate for FF34HH
148FD5038	Plate for FF30MH
148FD5039	Plate for FF15MH
148FD5052	Plate for FD5MW
148FD5054	Plate for FD15MHW
148FD5056	Plate for FD30MHW
148FD5059	Plate for FD6HW and FD46HW
148FD5060	Plate for FD6HHW
148FD5061	Plate for FD12HW and FD312HW
148FD5062	Plate for FD12HHW
148FD5063	Plate for FD2HW and FD32HW
148FD5064	Plate for FD5M
148FD5066	Plate for FD15MH
148FD5068	Plate for FD30MH
148FD5070	Plate for FD60MH
148FD5071	Plate for FD6H, FD36H and FD46H
148FD5072	Plate for FD6HH
148FD5073	Plate for FD12H
148FD5075	Plate for FD2H and FD32H
148FD5076	Plate for FD4H and FD34H
148FD5077	Plate for FD15MAC
148FD5078	Plate for FD30MAC
148FD5079	Plate for FD60MAC
148FD5080	Plate for FD4W and FD34HW
FD12HHP	Plate for FD12HH
FD15MP	Plate for FD15M and FD415M
FD15MPW	Plate for FD15MW
FD30MP	Plate for FD30M and FD430M
FD30MPW	Plate for FD30MW and FD430MW
FD60MP	Plate for FD60M, FD360M and FD460M
FD60MPW	Plate for FD60MW and FD460MW
FF15MP	Plate for FF15M, FF315M and FF415M
FF30MP	Plate for FF30M, FF330M and FF430M
FF60MP	Plate for FF60M, FF360M and FF460M
<b>Surge</b>	
176ET10A	Surge Suppressor - for switching inductive 240 VAC nominal loads
176ET9A	Surge Suppressor - for switching inductive 120 VAC nominal loads
AG1BRKT	L bracket for AG series



# Reference

*Timer Selection Chart*

**Cross Reference**

*IP Classifications*

Glossary

**Switch Type**

# Timer Selection Chart

Mechanical/ Electronic	Time Switch Type	24-Hr, 7-Day or 365 Day	# of Circuits	Amp Rating	Switch Rating
Mechanical	Auto-Voltage or Multi-Voltage	24-Hr. or 7-Day	1	40	SPDT, DPDT
Mechanical	General Purpose	24-Hr.	1	40	SPST, SPDT, 1.N.O/1.N.C, DPST
Mechanical	24-Hr. with Skipper	24-Hr.	1	40	SPST, SPDT, 1.N.O/1.N.C, 2.N.O/2.N.C, DPDT, 4-PST
Mechanical	24-Hr. with Skipper	24-Hr.	1	20	SPDT
Mechanical	Short Range Cycle Timer	10, 30 min. 1, 4-Hr.	1	20	SPDT
Mechanical	Percentage Cycle Timer	30 sec., 1, 3, 5, 10, 30 Min. 1, 4 Hr.	1	20	SPST
Mechanical	Irrigation/Sprinkler	24-Hr.	1	15-30	SPST, DPST
Mechanical	7-Day with Photo Control	7-Day	1, 2, & 3	15	SPDT
Mechanical	Compact 7-Day	7-Day	1	20	SPDT
Mechanical	7-Day Dial With/Without Carryover	7-Day	1	40	4-PST
Mechanical	Water Heater	24-Hr.	1	40	DPST
Mechanical	Astronomic Dial with Skipper	7-Day	1	40	3-PST
Mechanical	Defrost Timer	24-Hr.	1	40	N/A
Mechanical	In-Wall Spring Wound	Decorator and Commercial Style	1	15	Varies
Mechanical	In-Wall Mechanical	24-Hr.	1	20	SPST
Electronic	Auto-Voltage 120-277 VAC	24-Hr. or 7-Day	1	40	SPDT, DPDT
Electronic	24-Hour Electronic Multi-Voltage	24-Hr.	1 & 2	30	SPST, DPST
Electronic	7-Day (Weekly) Electronic Multi-Voltage	7-Day	1 & 2	30	SPST, SPDT, DPST
Electronic	7-Day Astronomic Multi-Voltage	7-Day	1, 2, & 4	30	SPST, SPDT, DPST
Electronic	ET90000	365-Day	1, 2, 4, 8, 12 & 16	20	SPDT, DPST
Electronic	Water Heater	7-Day	1	30	SPST, DPST
Electronic	In-Wall	Countdown timers in various increments	1	15	SPST
Electronic	In-Wall	Programmable Countdown Timer 24-Hr.	1	20	Single Pole/Three Way
Electronic	In-Wall	Programmable 7-Day	1	15	Single Pole
Electronic	In-Wall	Programmable 7-Day with Astro	1	15/20	Single Pole/Three Way
Electronic	In-Wall	Programmable 7-Day with Astro	1	15	Single Pole/Three Way

Total ON/OFF Events	Minimum ON/OFF Time	Skip-A-Day	Carryover	Astro	Daylight Savings Time	Product Series	Catalog Page(s)
96 Events for 24 Hr./48 Events for Weekly	15 Min. for 24 Hr./ 4 hr 15 min/ 2 hr for Weekly	Yes 7-Day versions	Optional	No	No	GM40AV	27
12	1 Hr.	No	No	No	No	T100	32
10	1 Hr.	Yes	Optional	No	No	T170	33
96	15 Min.	Yes	Optional	No	No	T1900	34
10	5 Sec.	No	No	No	No	C88	38
3% to 97% Cycle Duration	1 Sec.	No	No	No	No	CT	25
60	12 Min.	Yes	No	No	No	R88/T88	39
3 per day	3.5 Hr.	No	Yes	No	No	T51	36
84	2 Hr.	No	No	No	No	T2000	37
3 per day	3.5 Hr.	No	Optional	No	No	T74/T78	37
T104-20 (12 ON/OFF per Day) WH/WQ (12/46 24-Hr. 12-Weekly)	1 Hr.	No	Yes	No	No	T104-20/ WH/	41
						WHQ	28
N/A	N/A	Yes	Yes	Yes	No	V	41
1 to 24/24 Hour Period	15 Min. minimum ON/OFF Time	No	NO	No	No	DTAV40	90-91
Various increments with/without "HOLD"	Varies	N/A	N/A	N/A	N/A	FD & FF	54-55
36 (72 Captive Trippers in 20 Minute Increments)	20 Min.	N/A	N/A	N/A	N/A	KM2	56
20 Events	1 Min.	Yes	Yes	No	No	GM40AVE	20
28	1 Min.	No	Yes	No	Yes	ET1100	16-17
28	1 Min.	Yes	Yes	No	Yes	ET1700	16-17
28	1 Min.	Yes	Yes	Yes	Yes	ET8000	16-17
4000+	1 Min.	Yes	Yes	Yes	Yes	ET90000	12-14
42	1 Min.	Yes	Yes	No	No	EH	25
N/A	Varies	N/A	N/A	N/A	N/A	EI200	53
1	1 Sec.	N/A	N/A	No	No	EI400	52
7	1 Min.	Yes	Yes	No	No	EI500	49
40/Week	1 Min.	Yes	Yes	Yes	Yes	EI600	48
						ST01	50
14 ON/OFF Per Week	1 Min.	Yes	Yes	Yes	Yes	EJ600	51

ALR Model #	Intermatic Model #
AA-105	K4021C
AA-105HA, AA-105W	K4321C
AA-1068, AA-1068W	K4023C
AA-305	K4021C
AM-1-A, AM-1-A-NB, AM-2-A, AM-2-A-NB	K122
AT-15	K4136M, K4421M
AT-168	K4123M, K4423M
AT-19	K4135
AT-30	K4141C
BF-120	LC4521C, K4251
BF-208-277	LC4523
BF-480	K4535
ET3001A	ET1105C
FC12HH	FF12HHC
FC15M	FF15MC
FC30M	FF30MC
FC5M	FF5M
FC60M	FF60MC
JB1000, JB1001	K4536SST
LC-120	LC4521C
LC-208-277	LC4523
LM1000, LM1001	K4536SST
M-120	K1221
M-208-277	LC4523
M-480	K4535
MA512H	FD12HH
MA512HW	FD12HHW
MA515M	FD15MC
MA515MW	FD15MWC
MA530M	FD30MC
MA530MW	FD30MWC
MA560M	FD60MC
MA560MW	FD60MWC
MC-10	K4500
PC-101-R	T101P, GM40AV
PC-103-R	T103P, GM40AV
PC-104-R	T104P, GM40AV
PT-15	K4121C
PT-168	K4123C
PT-19	K4135
SC-10	K4500
SPT-15	K4221C
SPT-168	K4223C, K4123C
SPT-19	K4235
SST-120, SST-240, SST-IES, SST-PV	K4536SS
TC-101	T101P, GM40AV
TC-101-R	T101R, GM40AV
TC-101R201	T101R201
TC-103	T103, GM40AV
TC-103-R	T103R, GM40AV
TC-104	T104, GM40AV
TC-104-R	T104R, GM40AV
TC-104R201	T104R201
TC-173	T173, GM40AV

ALR Model #	Intermatic Model #
TC-174	T174, GM40AV
TC-7401B	T7401B, GM40AV-W
TC-7402B	T7402B, GM40AV-W
TC-7801B	T7801B, GM40AV-W
TC-7802B	T7802B, GM40AV-W
TL-115	K4251
PC-101R	T101P, GM40AV
PC-103R	T103P, GM40AV
PC-104R	T104P, GM40AV
FC-15M	FF15MC
FC-30M	FF30MC
FC-60M	FF60MC
Arlington Model #	Intermatic Model #
DBU1C	WP1100C, WP3100C, WP3103C
60HC	WP3100C, WP3103C
DBUL1	WP1100WC
DBUL1DC	WP1020C
DBVSeries	WP1000RC, WP1000HRC
FisherPierce Model #	Intermatic Model #
FA-105	K4021C
FA-105-W	K4321C
FA-1068	K4023C
FA-305	K4021C
FE100C	
FE101C	ET1105C
FE171C	
FE715C	ET1715C
FL115	K4251
FP101	T101, GM40AV
FP101R	T101R, GM40AV
FP103	T103, GM40AV
FP104	T104, GM40AV
FP104R	T104R, GM40AV
FP171	T171, GM40AV
FP173	T173, GM40AV
FP7401B	T7401B
FT15	K4121C
FT168	K4123C
FT19	K4135
N1038-1	K4500
N6401-NS	K4521
N6690B	LC2000
N7760, N7762E	K1221
N7772E	K1222
N7790B	LC4536LAC
N7794	LC4535LA
N9901S-MHL	K4536SS
NAT9021	K121
NFP120	K4521
NFP277	LC4523
NFP480	LC4535LA
NFP480-ELS	K4535
NS476-71	K122
NS476-73, NS47681	K121
SFT15	K4221C
SFT168	K4223C

FisherPierce Model #	Intermatic Model #
SFT19	K4235
Mulberry Model #	Intermatic Model #
30825	K4121C
30827, 30829, 30831	K4123C
30834	LC4521C
30836	K4524
30838	K4522
30840	K4533
30842	K4535
30850	K4021C
30851	K4123C
30852	K4123C
30855	K4321C
30868	K4221C
Paragon Model #	Intermatic Model #
1015-00RS	T1975
1015-40TS	T1975E
4001-00	T101, GM40AV
4001-00M	T101M, GM40AV-M
4001-00-RT	T101, GM40AV
4002-20, 4002-71	T102, GM40AV
4003-00	T103, GM40AV
4003-00M	T103M, GM40AV-M
4003-00-RT	T103, GM40AV
4003-00S, 4003-00SM	T173, GM40AV
4004-20	T104, GM40AV
4004-20S	T174, GM40AV
4004-71	T104, GM40AV
4004-71M	T104M, GM40AV-M
4004-71-RT	T104, GM40AV
4004-71S	T174, GM40AV
4005-00	T105, GM40AV
4005-00S	T175, GM40AV
4006-20S	T176, GM40AV
4006-21	T106, GM40AV
4006-71S	T176, GM40AV
4011-00	T101R, GM40AV
4011-00P, 4011-00PC-RT	T101PCD82, GM40AV
4012-20, 4012-71	T102R, GM40AV
4013-00	T103R, GM40AV
4013-00P	T103P, GM40AV
4013-00PC-RT	T103PCD82, GM40AV
4013-00S	T173R, GM40AV
4014-20, 4014-71	T104R, GM40AV
4014-71P	T104P, GM40AV
4014-71PC-RT	T104PCD82, GM40AV
4014-71S	T174R, GM40AV
41011-00	T101R201
41014-20	T104R201
42001-00	T1905
42011-20	T1906
42013-20	T1976R
44001-00, 44005-00	C8845
4912-99	T21001R
4918-99	T21004R

Paragon Model #	Intermatic Model #	
7007-00	T7401B	
7007-20	T7402B	
7007-71		
7008-00	T7801B	
7008-20, 7008-71	T7802B	
8045-00	G8045-00	
8045-20	G8045-20	
8145-00	G8145-00	
8145-20	G8145-20	
8041-00, 8041-20, 8043-00, 8043-20	DTAV40	
8045-00, 8045-20, 8046-00, 8046-20		
8047-00, 8047-20, 8141-00, 8141-20		
8143-00, 8143-20, 8145-00, 8145-20		
8243-20, 8245-20, 8247-20		
CW201-00, CW201-00-RT		K4121C
CW201-70		K4136M
CW201-71		K4123C
CW201-S-00	K4221C	
CW201-S71	K4223C	
CW302-00	K4136M, K4421C	
CW302-70	K4136M	
CW302-71	K4421M	
EC11D/120VAC	FM1D20A-120	
EC11D/240VAC	FM1D20A-240	
EC365DST1/120VAC	ET90115CR	
EC365DST2/120VAC	ET90215CR	
EC365DST2/277VAC		
EC4000/120VAC	ET1115C	
EC4000/208-277VAC	ET1105C	
EC40004/208-277VAC	ET1115C	
EC40004PC/120-RT	ET1115CPD82	
EC4000PC/120-RT	ET1115C	
EC4000PC/120VAC	ET1115CPD82	
EC4000PC/208-277VAC		
EC4004/120VAC	ET1105C	
EC4004/120V-RT		
EC4004/208-277VAC		
EC4004/208-277VAC-RT		
EC4004120VAC-RT		
EC4004PC/120VAC		ET1105CPD82
EC4004PC/120VAC-RT	ET1105CR	
EC4004PC/208-277VAC	ET1105CPD82	
EC4004PC/208-277VAC-RT	ET1105CR	
EC4005PC/120, 240-RT	ET1125CR	
EC7000/120VAC	ET1715C	
EC7000/120VAC-RT		
EC7000/208-277VAC		
EC7001/120VAC	ET1725C	
EC7001/208-277VAC	ET90115C	
EC7001PC/120VDC	ET1715C	
EC7004/120VAC	ET1705CR	
EC7004/208-277VAC	ET90115C, ET1725C	

Paragon Model #	Intermatic Model #
EC7005/120VAC	ET1725C
EC7005PC/120-240VAC	ET1725CPD82
EC7005PC/277VAC	ET1725CPD82
EC71D/18S/120VAC, EC71D/18S/240VAC	ET90115C
EC71D/30M/120VAC	ET1725C
EC71D/30M/240VAC	ET90115C
EC71D/30S/120VAC	FM1D20A-120
EC71D/30S/240VAC	ET90115C
EC71D/30S/24VAC	FM1D20A-24
EC72D/120VAC, EC72D/240VAC	ET90215C
EC74/50S/120VAC, EC74/50S/240VAC	ET90415CR
EL71/120VAC, EL71/208-240VAC	ET90115C
EL71/277VAC, EL7100/120VAC	ET90115C
EL7100/208-240VAC	ET90115C
EL7100PC/120VAC	ET90115CR
EL7100PC/208-240VAC	ET90115CR
EL712	ET91615CR
EL71PC/120VAC, EL71PC/208-240VAC, EL71PC/277VAC	ET90115CR
EL72/120VAC, EL72/208-240VAC	ET90215C
EL72/277VAC, EL7200/120VAC, EL7200/208-240VAC	
EL7200/120VAC, EL7200/208-240VAC	
EL7200PC/120VAC, EL7200PC/208-240VAC	ET90215CR
EL72PC/120VAC, EL72PC/208-240V, EL72PC/277VAC	
EL74	ET90415CR
EL78	ET90815CR
ET100/3WAY, ET100F/3WAY, ET1100	EI400C
ET1100/3WAY	
ET1100/W	EI400WC
ET1100F	EI400C
ET1100F/3WAY	
ET1100F/W	EI400WC
ET2000	EI400C
ET2000/W	EI400WC
ET2000F	EI400C
ET2000F/W	EI400WC
JW10-00, JW10-00PC, JW10-20, JW10-20PC	CT2000
JW30-00, JW30-00PC, JW30-20, JW30-20PC	
JW5-00, JW5-00PC, JW5-20, JW5-20PC	
JW60-00, JW60-00PC, JW60-20, JW60-20PC	K4021C
LB201-00, LB201-00-RT	
LB201-71	
LB201W-00, LB201W-00-RT	K4321C
P101-00	T101, GM40AV

Paragon Model #	Intermatic Model #
P101-00M	T101M, GM40AV-M
P101-00P	T101P, GM40AV
P101-00PC-RT	T101PCD82, GM40AV
P101-00PS	T171, GM40AV
P101-00RT	T101, GM40AV
P101-00S	T171, GM40AV
P103-00	T103, GM40AV
P103-00M	T103M, GM40AV-M
P103-00P	T103PCD82, GM40AV
P103-00PC-RT	T103, GM40AV
P103-00PC-RT	T103PCD82, GM40AV
P103-00PS	T173, GM40AV
P103-00RT	T103, GM40AV
P103-00S	T173, GM40AV
P104-71	T104, GM40AV
P104-71	T104M, GM40AV-M
P104-71P	T104P, GM40AV
P104-71PC-RT	T104PCD82, GM40AV
P104-71PS	T174, GM40AV
P104-71RT	T104, GM40AV
P104-71S	T174, GM40AV
PN201-00, PN201-00-RT	K4251
SC201-99	K4500
SWP12H	FF12HC
SWP12HH	FF12HH
SWP15M	FF15MC
SWP15MH	FF15MH
SWP2H	FF2H
SWP2HH	FF32HH
SWP30M	FF30MC
SWP30MH	FF30MH
SWP4H	FF4H
SWP5M	FF5M
SWP60M	FF60MC
SWP60MH	FF60MHC
SWP6H	FF6H
SWP6HH	FF6HH
SWPD12H	FD12HC
SWPD12HH	FD12HH
SWPD12HH-W	FD12HHW
SWPD12H-W	FD12HWC
SWPD15M	FD15MC
Precision Model #	Intermatic Model #
8660	K1221
8672	K1222
8690	LC2000
102FAA	K4251
6041-0	DTAV40
6041-20	
6043-0	
6043-20	
6045-0	
6045-20	
6047-0	

Precision Model #	Intermatic Model #
6047-20	DTAV40
6141-0	
6141-20	
6143-0	
6143-20	
6145-0	
6145-20	
6045-0	G8045-00
6045-20	G8045-20
6145-0	G8145-00
6145-20	G8145-20
8690N	LC2000
A-105	K4021C
A-105W	K4321C
A-1068	K4023C
CD101	T101, GM40AV
CD101P	T101P, GM40AV
CD101R-201	T101R201
CD101RH	T101R, GM40AV
CD102	T102, GM40AV
CD102P	T102P, GM40AV
CD102RH	T102R, GM40AV
CD103	T103, GM40AV
CD103P	T103P, GM40AV
CD103RH	T103R, GM40AV
CD103S	T173, GM40AV
CD104	T104, GM40AV
CD104-20	T104-20, WHAVQ4
CD104P	T104P, GM40AV
CD104R-201	T104R201
CD104RH	T104R, GM40AV
CD104S	T174, GM40AV
CD105	T105, GM40AV
CD105RH	T105R, GM40AV
CD105S	T175, GM40AV
CD106	T106, GM40AV
CD106RH	T106R, GM40AV
CD106S	T176, GM40AV
CD115-00	T1905
CD115-00S	T1975
CD115-20	T1906
CD115-20S	T1976
CD115-40	T1975E
CD2101R	T21001R
CD2104R	T21004R
ET115	K4251
JP-275	K4500
M2A	K122
M2ANA, M2ANB	K121
P-2275	K4521
P68275	LC4523
P-7275	K4535
SD7007-00/20	T7401B
SD7008-00/20	T7801B
ST-15	K4221C
ST-168	K4223C
ST-19	K4235

Precision Model #	Intermatic Model #
T-15	K4121C
T-168	K4123C
T-19	K4135
Marktime MH Rhodes Model #	Intermatic Model #
93303	FF360M
93504	FD32H, FD32HW
93505	FD6H, FD6HW
93507	FD34H, FD34HW
93301	FF315MH
93302	FF330M
93304	FF32H
93306	FF36H
93307	FF312H
93305	FF34H
93312	FF330M
93317	FF312HH
Supco Model #	Intermatic Model #
CD100 Series	T100 Series
M814520	DTAV40-M
S804100, S804120, S804500, S804520	DTAV40-M
S814100, S814120, S814500, S814520	
T&B Model #	Intermatic Model #
2CKD	WP1030MXD
2CKNM	WP1220C
CKMD	WP1010HMXD
CKNM	WP1100C, WP3100C, WP3103C
CKSDV	WP1010MXD
Taymac Model #	Intermatic Model #
MM2440C	WP1020C, WP1220C
MM400C	WP1100C, WP3100C, WP3103C
MM740C	WP1150C
MM7440C	WP1050, WP1250C
MX3200	WP1010MXD
MX3300	WP1010HMXD
MX6200	WP1030MXD
Tork Model #	Intermatic Model #
1101	T101, GM40AV
1102	T102, GM40AV
1103	T103, GM40AV
1104	T104, GM40AV
1191	T101, GM40AV
1962	T103, GM40AV
2000	K4121C
2001	K4221C
2002	K4236C
2003	LC4521C, K4521
2004	LC4523
2005	K1221
2007	LC4536LAC
2008	LC4535LA, K4535
2021	K4251
2022	K4253

Tork Model #	Intermatic Model #
2100	K4121C
2101	K4121C, K4136M, K4421M
2102	K4236C
2104	K4236C, K4123M, K4423M
2105	K4141C
2107	K4136M
2223, 2224	K121
2421, 2422	K1221
2500	K4500
3000	K4021C
3002	K4023C
3002	K4023C
3010	K4321C
3020	K4221C
3121	T105, GM40AV
5500	K4500
7100	T171
7102	T172
7120	T175, GM40AV
7122	T176, GM40AV
7200	T173, GM40AV
7202	T174, GM40AV
7220	T1871BR
7222	T1872BR
7300	T1471BR
7302	T1472BR
8001	T1905
8004	T1906
8007	T1975
8008	T1976
8061	C8865
8121	C8815
8301	C8835
8601	C8865
8602	C8866
1101-0	T101R, GM40AV
1101D	T10101R
1101M, 1101M-IAP	T101M
1101-N	T101P, GM40AV
1101-NC	T101PCD82, GM40AV
1102M	T102M
1103-0	T103R, GM40AV
1103M, 1103M-IAP	T103M
1103-N	T103P, GM40AV
1103-NC	T103PCD82, GM40AV
1104-0	T104R, GM40AV
1104D	T10404R
1104DF	T12404R
1104FM	T104R201
1104M, 1104M-IAP	T104M
1104-N	T104P, GM40AV
1104-NC	T104PCD82, GM40AV
1191-0	T101R, GM40AV
1847A, 1847AL, 1847AW, 1847AWL	ET1725C
1847AZ, 1847AZL	ET90215C
1848AZL	





Tork Model #	Intermatic Model #
1962-0	T103R
2000-2	K4123C
2000-7	K4236C
2003S	LC4521LA
2004S	LC4523LA
2007D	LC4536LAC
2008D	LC4535LA
401A	TN111RM40
5001M	LC4521LA
5001S	LC4521C, K4521
5004M	LC4523LA
5004S	LC4523
5007M	LC2000
5007S	LC4536LAC
5008M, 5008S	LC4535LA
5021M, 5021S	LC4521LA
5024M, 5024S	LC4523LA
5717-T4, 5717-T5, 5717-T6, 5717-T7, 5717-T8	K4536SST
5717-TM	K4536SS
5717-TZ	K4536SST
5737TM	K4536SS
5737TZ	K4536SST
701A	KM2ST-1G
701A-2G	
701AC	
7100-0	T171R
7102-0	T172R
7120Z, 7120ZL	ET90115C
7122ZL	ET90115CR
7200-0	T173R, GM40AV
7200L	T173CR
7200Z	V45471R
7200ZL	V45471CR
7202-0	T174R, GM40AV
7202L	T174CR
7202Z	V45472R
7202ZL	V45472CR
7300Z	V45471R
7300ZL	V45471CR
7302Z	V45472R
7302ZL	V45472CR
8001U	T1975E
8007V	R8815P101C
A1200, A1600	ET91615CR
A502H	FD2H
A502HH	FD32HH
A502HW	FD32HHW
A504H	FD4H
A504HH	FD34HH
A504HHW	FD34HHW
A504HW	FD4HW
A505M	FD5M
A505MW	FD5MW
A506H, A506HD	FD6H
A506HH	FD6HH

Tork Model #	Intermatic Model #
A506HHW	FD6HHW
A506HW	FD6HW
A512H	FD12HC
A512HH, A512HHC	FD12HH
A512HHW, A512HHWC	FD12HHW
A512HW	FD12HWC
A515M, A515MC	FD15MC
A515MH	FD15MH
A515MHW	FD15MHW
A515MW, A515MWC	FD15MWC
A530M, A530MC	FD30MC
A530MH	FD30MH
A530MHW	FD30MHW
A530MW, A530MWC	FD30MWC
A560M, A560MC	FD60MC
A560MH, A560MHC	FD60MH
A560MHW, A560MHWC	FD60MHW
A560MW, A560MWC	FD60MWC
ACT120M, ACT120M-24, ACT120MFS	CT2000
ACT120MFS-24, ACT120S, ACT120S-24	
ACT120SFS, ACT120SFS-24, ACT30M	
ACT30M-24, ACT30MFS, ACT30MFS-24	
C502H	FF2H
C504H	FF4H
C505M	FF5M
C506H	FF6H
C506HH	FF6HH
C512H	FF12HC
C512HH	FF12HHC
C515M	FF15MC
C515MH	FF15HH
C530M	FF30MC
C530MH	FF30MH
C560M	FF60MC
C560MH	FF60MHC
DCL400 BP	LM2-0-120
DG100	ET1705CR
DG100-2	ET1725CR
DG100-3, DG180, DG180-2, DG180-3	ET90115CR
DGM100	ET90115C
DGM100-2, DGM100-3, DGS100, DGS100-2	ET90115CR
DGS100-3, DGS180, DGS180-2, DGS180-3	
DIN100A, DIN101A, DIN101B	ET90115C
DIN103A	ET90415CR
DIN200, DIN201B	ET90215C
DS200, DS200-2, DS200-3	ET90215CR
DT100, DT100-2, DT100-3	ET90115C
DT200, DT200-2, DT200-3	ET90215C
DTS100A	ET90115CR
DTS200A	ET90215CR
DTS400A	ET90415CR

Tork Model #	Intermatic Model #
DW100A, DW100AY	ET90115C
DW200AY	ET90215C
DZM200, DZM200-2, DZM200-3, DZM200-A	ET90215CR
DZS100, DZS100-3, DZS100A	ET90115CR
DZS200, DZS200-2, DZS200-3, DZS200A	ET90215CR
DZS400A	ET90415CR
E101	ET1105C
E101-2, E101-3	
E101-NC	
E103	ET1125C
E103-2	
E103-2NC	
E103-3	
E103NC	ET1125C
E120	ET1105C
E120-2, E120-3, E120NC	
EH10	EH10
EH20	EH40
ES101	ET1705C
ES101-2, ES101-2NC	ET1725C
ES103	
ES103-2	
ES103-2NC	
ES103-3	
ES103NC	
ES120	
ES120-2, ES120-3	
ES120NC	ET1705C
EW101	
EW101-2	
EW103	
EW103-2, EW103-3	ET1725C
EW103NC	
EW120, EW120NC	ET1715C
K400Z, K400Z-2, K401Z, K401Z-2	ET90415CR
K600Z, K600Z-2, K601Z	ET90815CR
K601Z-2	ET90415CR
K800Z, K800Z-2, K801Z	ET90815CR
K801Z-2	ET90415CR
SS13B, SS13F, SS20, SS20F	EI400C
SS700	STO1
SSA100, SSA100R-24, SSA200	EI400C
TU40	GM40AV
DTU40	GM40AVE
T920L	T51211BC
T930L	T51311BC
TW220L	T51211BC
TW300L	T51311BC
TZ220L, TZ222L, TZ300L, TZ302L	ET90415CR
W100	T7401B
W120	T7801B

Tork Model #	Intermatic Model #
W200	T7401B
W202	T7402B
W220	T7801B
W220L	T7801BC
W222	T7802B
W222L	T7802BC
W300	T7401B
W300L	T7401BC
W302	T7402B
W302L	T7402BC
W400, W400A	T7401B
W400AL, W400AL-0	T7401BC
W402, W402A	T7402B
W402AL-0	T7402BC
WH2	WH40, WHAVQ4
Z400B, Z400B-2	ET90415CR
ELC71PC/120	ET90115CR
ELC71PC/208-240	
EL71PC/277	
ELC72PC/120	ET90215CR
ELC72PC/208-240	
ELC72PC/277	
ELC74	ET90415CR (Except 24 Volt Models)
ELC78	ET90815CR (Except 24 Volt Models)
ELC712	ET91215CR (Except 24 Volt Models)
Cooper Model #	Intermatic Model #
LiteKeeper 4 - LK4	ET90415CR
LiteKeeper 8 - LK8	ET90815CR
Leviton Model #	Intermatic Model #
EZ Max R08BD-L04	ET90415CR
EZ Max R08BD-L08	ET90815CR
EZ Max R24BD-L16	ET91615CR
Hubbell Model #	Intermatic Model #
CX042S042NN	ET90415CR
CX042S043LN	
CX042S04TNN	
CX042S00SPN	
CX082S082NM	ET90815CR
CX082S083LM	
CX082S08TNN	
CX082S00SPM	
CX082S00SPM	
WattStopper Model #	Intermatic Model #
LP8 Peanut Panel	ET90815CR
Grässlin Old Model #	Intermatic Model #
KLT5M	FD5M
KLT15M	FD15MC
KLT15MH	FD15MH
KLT30M	FD30MC
KLT30MH	FD30MH
KLT60M	FD60MC
KLT60MH	FD60MH
KLT2H	FD2H
KLT4H	FD4H
KLT6H	FD6H

Grässlin Old Model #	Intermatic Model #
KLT6HH	FD6HH
KLT12H	FD12HC
KLT12HH	FD12HH
KLT2H	FD32H
KLT4H	FD34H
KLT6H	FD36H
KLT5M-W	FD5MW
KLT15M-W	FD15MWC
KLT15MH-W	FD15MWH
KLT30M-W	FD30MWC
KLT30MH-W	FD30MWH
KLT60M-W	FD60MWC
KLT60MH-W	FD60MWH
KLT2H-W	FD2HW
KLT4H-W	FD4HW
KLT6H-W	FD6HW
KLT6HH-W	FD6HHW
KLT12H-W	FD12HWC
KLT12HH-W	FD12HHW
KLT2H-W	FD32HW
KLT4H-W	FD34HW
KLT6H-W	FD36HW
KLT5M-A	FF5M
KLT5MH-A	FF5MH
KLT15M-A	FF15MC
KLT15MH-A	FF15MH
KLT30M-A	FF30MC
KLT30MH-A	FF30MH
KLT60M-A	FF60MC
KLT60MH-A	FF60MHC
KLT2H-A	FF2H
KLT4H-A	FF4H
KLT6H-A	FF6H
KLT6HH-A	FF6HH
KLT12H-A	FF12HC
KLT12HH-A	FF12HHC
KLT15MH-A	FF315M
KLT30MH-A	FF330M
KLT60MH-A	FF360M
KLT2H-A	FF32H
KLT4H-A	FF34H
KLT6H-A	FF36H
KLT12H-A	FF312H
KLT12HH-A	FF312HH
GMXDIGI120-I-120	GMXFM1D20-I-120
GMXDIGI120-O-120	GMXFM1D20-O-120
DIGI20E-120	FM1D20E-120
DIGI20A-120	FM1D20A-120
FM1DIGI20-120U	FM1D20-120U
GMXDIGI20-O-240	GMXFM1D20-O-240
GMXDIGI20-I-240	GMXFM1D20-I-240
DIGI20E-240	FM1D20E-240
DIGI20A-240	FM1D20A-240

Grässlin Old Model #	Intermatic Model #
FM1DIGI20-240U	FM1D20-240U
GMXDIGI20-O-24	GMXFM1D20-O-24
GMXDIGI20-I-24	GMXFM1D20-I-24
DIGI20E-24	FM1D20E-24
DIGI20A-24	FM1D20A-24
FM1DIGI20-24U	FM1D20-24U
DIGI42A-24	FM1D50A-24
DIGI42E-24	FM1D50E-24
GMXDIGI42-I-24	GMXFM1D50-I-24
FM1DIGI42-24U	FM1D50-24U
GMXDIGI42-I-120	GMXFM1D50-I-120
GMXDIGI42-O-120	GMXFM1D50-O-120
DIGI42A-120	FM1D50A-120
DIGI42E-120	FM1D50E-120
FM1DIGI42-120U	FM1D50-120U
GMXDIGI42-O-12	GMXFM1D50-O-12
DIGI42A-12	FM1D50A-12
GMXDIGI42-I-12	GMXFM1D50-I-12
DIGI42E-12	FM1D50E-12
FM1DIGI42-12U	FM1D50-12U
GMXDIGI42-I-240	GMXFM1D50-I-240
DIGI42A-240	FM1D50A-240
DIGI42E-240	FM1D50E-240
FM1DIGI42-240U	FM1D50-240U
GMX2DIGI42I-24	GMX2FM2D50I-24
GMX2DIGI42I-120	GMX2FM2D50I-120
GMX2DIGI42O-120	GMX2FM2D50O-120
GMX2DIGI42I-240	GMX2FM2D50I-240
GM40	GM40AV
GM40W	GM40AV-W
GM40Q	GM40AV-Q
GM40QW	GM40AV-QW
GM40M	GM40AV-M
DTMV40	DTAV40
DTQMV40	DTAV40Q
DTMV40-M	DTAV40-M
DTQMV40-M	DTAV40Q-M
WHQ4	WHAVQ4
WHQ7	WHAVQ7

For Complete and Current  
Cross Reference List Please  
Visit [www.intermatic.com](http://www.intermatic.com)

# IP Classifications

The Ingress Protection (IP) rating is used to specify the environmental protection for enclosures. Below is the IP protection definitions in accordance with IEC529. A two-digit code is used to specify the type of protection. The table below provides a definition of the codes for protection against solid objects and water.

First Digit		Second Digit	
Represents the type of protection against solid objects		Represents the type of protection against water	
0	No special protection	0	No special protection
1	Protection against solid objects with a diameter over 50 mm. No protection against deliberate access, e.g. with a hand, but large surfaces of the body are prevented from approach.	1	Protection against vertically falling drops of water, such as condensation.
2	Protection against penetration by solid objects with a diameter over 12 mm., such as fingers or similar objects.	2	Protection against dripping water falling vertically when the equipment (enclosure) is tilted at an angle up to 15° from its normal position.
3	Protection against solid objects with a diameter of more than 2.5 mm., such as tools and wires with a thickness of more than 2.5 mm.	3	Protection against water falling at any angle up to 60° from the vertical.
4	Protection against solid objects with a diameter over 1 mm., such as tools and wires with a thickness of more than 1 mm.	4	Protection against water splashed against the equipment (enclosure) from any direction.
5	Protection against the ingress of harmful dust deposits.	5	Protection from water projected from a nozzle against the equipment (enclosure) from any direction.
6	Complete protection against the ingress of dust	6	Protection against heavy seas or powerful water jets.
		7	Protection against water when the equipment (enclosure) is immersed in water under defined conditions of pressure and time.
		8	The equipment (enclosure) is suitable for continuous submersion in water under conditions which must be specified by the manufacturer.

Glossary of Terms	
Term	Definition
<b>Electrical Terms</b>	
<b>Alternating Current (AC)</b>	Electrical current which, when being produced by a dynamo or generator, continually reverses its direction of travel. The dynamo or generator that produces alternating current is called an alternator. AC current can be changed to direct current through use of a rectifier. Voltage of AC current can be readily stepped up or down through use of a transformer.
<b>Amperes (Amps, A)</b>	The basic unit for measuring electric current passing through a line in a given time. Amperage is equal to power (in watts) divided by voltage (in volts).
<b>Apparent Power (Volt-Ampere, VA)</b>	The amount of power that appears to be used by the circuit based upon the output of that circuit. The apparent power is equal to voltage (in volts) times amperage (in amps) for a circuit, times the power factor of that circuit.
<b>Cycle</b>	One complete reversal of the direction of current flow in a conductor. Used in conjunction with alternating current.
<b>Direct Current (DC)</b>	Electrical current that flows only in one direction. The most common source of DC is from various types of storage batteries. DC can also be produced by a generator for use on DC motors and other applications.
<b>Electromagnetic Interference (EMI)</b>	Any electrical or magnetic signal found in addition to a supplied signal. Electromagnetic interference is commonly detected on the power line between a power supply and an energy control or between an energy control and a load. Electromagnetic interference can adversely affect normal operation by causing excessively high or low voltages or by causing irregularities in the power supply signal.
<b>Frequency (Hertz, Hz)</b>	The number of cycles per second in alternating current.
<b>Ground Connection</b>	The connection from the device to Earth ground as a return path. This connection is in addition to the neutral connection and is provided as a secondary return path for safety and emergency use.
<b>Line Connection</b>	The connection from the power supply to the energy control.
<b>Load Connection</b>	The connection from the energy control to the load(s).
<b>Neutral Connection</b>	The connection from the energy control and/or load to the power supply as a return path.
<b>Noise Filter</b>	An electrical noise filter is a network of electrical components designed to offer a comparatively high resistance to voltages and/or frequencies outside of an acceptable range, generally used to mitigate the effects of electromagnetic interference.
<b>Overvoltage</b>	An increase in voltage in an electrical circuit for a significant length of time. Overvoltages are typically caused by sources outside of a building. Overvoltages can cause permanent damage to energy controls and loads if the energy controls are properly protected.
<b>Power Factor</b>	A measurement of the efficiency of a circuit, between zero and one. The closer a power factor is to zero, the more energy that is lost within the operation of the circuit. The closer a power factor is to one, the more energy that is transferred efficiently to the load.
<b>Radio Frequency Interference (RFI)</b>	A type of electromagnetic interference associated specifically with radio frequency or wireless sources.
<b>Real Power (Watts, W)</b>	The capacity of the circuit for performing work; the actual amount of power used by the circuit over time. The real power is equal to voltage (in volts) times amperage (in amps) for a circuit.
<b>Surge</b>	Any unsustained increase in electrical energy. Surges include transients and overvoltages.
<b>Surge Suppressor</b>	A device designed to mitigate or prevent the adverse effects of surges. Most surge suppressors are intended only for specific types of surges within specific operating conditions.
<b>Transient</b>	A brief spike in voltage in an electrical circuit. Transient voltages are commonly in excess of 1,000 volts, but for a duration of less than 1/1,000 second. Transient voltages are typically caused by sources inside of a building, between the power supply and other devices. Transient voltages can cause intermittent or nuisance operation in energy controls, such as not turning ON when scheduled, or the display temporarily turning OFF.
<b>Traveler Connection</b>	The connection from the energy management system to another device, such that either device can control the load. Often referred to as a three-way connection. An example would be a light switch at the top and bottom of a flight of stairs, where either switch could control the stairway light.
<b>Volts (V)</b>	The basic unit for measuring the amount of electrical potential in a conductor. Voltage is equal to power (in watts) divided by amperage (in amps).

Term	Definition
<b>Product Features</b>	
<b>Astronomic</b>	Products with the Astronomic feature are able to calculate sunrise and sunset times based upon the current date and geographical location, allowing them to automatically control outputs based on sunrise and sunset times without the use of a photocontrol.
<b>Auto-Voltage</b>	A type of power supply that contains a single connection for multiple voltages or voltage ranges. The selection of the proper voltage or voltage range occurs automatically within the control.
<b>Dry Contact</b>	Switch externally supplied power that does not have its own source of power for the loads. This type of contact can switch any load within its ratings.
<b>Duty Cycling</b>	Switching loads ON/OFF on a rotating schedule to reduce energy consumption and reduce peak demand charges by ensuring that selected loads are not ON simultaneously.
<b>Holiday</b>	An exception from the standard schedule of events. Holidays can be traditional holidays, such as New Year's Day, or other exceptions, such as maintenance done on the last Friday of every month. During holidays, the standard schedule of events is generally suppressed and a separate schedule may be used specifically for that holiday.
<b>Holiday Schedule</b>	A schedule of events different from the standard schedule of events in an energy control meant to be used only during a defined holiday period.
<b>Independent Circuit</b>	Sometimes called independent channels, referring to the number of loads that can be independently controlled based on the same time of day control system. Any of the independent circuits may control more than one load by switching those loads simultaneously.
<b>Multi-Tap</b>	A type of power supply that contains multiple connections that are each for a different voltage or voltage range.
<b>Multi-Volt</b>	A type of power supply that contains a single connection for multiple voltages or voltage ranges. The selection of the proper voltage or voltage range is done manually, generally via a switch located near the connection.
<b>Offset</b>	A configurable difference between a calculated value and the desired control value. For example, sunset may be offset to occur 15 minutes earlier than calculated.
<b>Override</b>	A secondary control used to manually turn a load ON/OFF when a schedule of events is active on the primary control.
<b>Pulse</b>	Pre-defined duration for the controlled output to remain in the ON state. Typically, a pulse is only for a few seconds, such as when used with bells or alarms. However, some controls do allow for significantly longer durations to simplify scheduling, eliminating the need for separate ON and OFF events.
<b>Zone</b>	A group of circuits or a defined space within a building where energy demand requirements are sufficiently similar so that safe, convenient, and energy conscious conditions can be maintained throughout by a single controlling device.
<b>Ratings</b>	
<b>British Thermal Unit (BTU)</b>	A unit of heat equal to 252 calories. The quantity of heat required to raise the temperature of one pound of water from 62 °F to 63 °F.
<b>Electronic Ballast</b>	A load category referring to any load that utilizes a modern electronic ballast to start, typically found in LED lighting.
<b>Full Load Amp (FLA) Ratings</b>	The amount of current used by a motor when it is in normal operation with a load, typically the minimum amount of current that a motor requires to remain ON.
<b>Inductive Ballast</b>	A load category referring to any load that utilizes a traditional inductive or magnetic ballast to start, typically found in fluorescent lighting.
<b>Inductive Load</b>	A load category referring to any load that utilizes an inductor, including motors, relays, solenoids, and transformers.
<b>Lock Rotor Amp (LRA) Ratings</b>	The amount of current used by a motor when it is powered but not rotating, typically the maximum amount of current that a motor requires to turn ON.
<b>Pilot Duty Rating</b>	A load category designed to switch the coil of electromagnetic devices such as solenoids, relays, contactors, or motor starters. The VA rating of the controlling contacts must be equal to or greater than the sealed VA, not the inrush VA, of the controlled coil in order to prevent excessive contact wear or contact welding.
<b>Rating</b>	The limits of the ability of a device to operate safely and satisfactorily within its normal environmental extremes.

Term	Definition
<b>Ratings</b>	
<b>Resistive Load</b>	A load category for any purely resistive load, such as a heater. Contact ratings are resistive unless otherwise marked.
<b>Tungsten Load</b>	A load category referring to any load that utilizes a tungsten filament, typically found in incandescent and halogen lighting.
<b>Type 1 Enclosure</b>	Any enclosure that meets specific safety and performance testing standards for use indoors, protecting the enclosed equipment against dust and dirt, and providing protection against incidental contact with the enclosed equipment.
<b>Type 3R Enclosure</b>	Any enclosure that meets specific safety and performance testing standards for use indoors or outdoors, protecting the enclosed equipment against dust, dirt, rain, sleet, snow, and ice and providing protection against incidental contact with the enclosed equipment.
<b>Type 4X Enclosure</b>	Any enclosure that meets specific safety and performance testing standards for use indoors or outdoors, protecting the enclosed equipment against dirt, rain, sleet, snow, ice, windblown dust, splashing water, hose-directed water, and corrosion.
<b>Products and Components</b>	
<b>Contactors</b>	An electromechanical device used for direct control of a load, comparable to a heavy-duty relay.
<b>Cycle Timer</b>	A specific schedule type that repeats on a frequent basis, also referred to as duty cycle. The schedule consists of an ON duration and an OFF duration, which repeat continuously. For example, a control could be set to be ON for 20 minutes, then OFF for 40 minutes, and then turn back ON for 20 minutes, etc., repeating every hour. This type of control is commonly used for feeders, misters, blowers, and similar outputs.
<b>DIN Rail</b>	A specific type of mounting style used by several controls, named for the German Institute for Standardization "Deutsches Institut für Normung". Controls with this mounting style are generally small, low profile devices ideal for custom panel and OEM applications.
<b>Electrically-Held Contactor</b>	A contactor that is electrically held in the open position or the closed position by applying continuous electrical current to the contactor control circuit.
<b>Lighting Contactor</b>	A contactor specifically designed for controlling filament loads commonly found in the lighting industry.
<b>Mechanically-Held Contactor</b>	A contactor that requires only a brief supply of electrical current (pulse) to switch between the open and closed positions. After switching, the contactor is then retained in the new position by means of a mechanical latch.
<b>Self-Clearing Latching Contactor</b>	A type of mechanically-held contactor that has a common input for its open and closed position. Each brief supply of electrical current (pulse) causes the contactor to alternate between its open and closed state.
<b>Trippler</b>	A tripper is a component used in setting the schedule on a mechanical timer. Each tripper is inserted or fastened near a representative time slot to inform the control when to turn ON or OFF. Each time the time slot aligns with the actual time, the tripper makes contact with or "trips" a mechanical connection that adjusts the output.
<b>Industry Terms</b>	
<b>Cycling</b>	The action of switching ON or OFF.
<b>Event</b>	A single setpoint within a schedule. Each event generally contains a date, time, controlled outputs, and an ON/OFF setting. For example, one scheduled event could be to turn all lights on at sunset.
<b>HVAC</b>	Abbreviation for Heating, Ventilation, and Air Conditioning.
<b>HVACR</b>	Abbreviation for Heating, Ventilation, Air Conditioning, and Refrigeration.
<b>Load</b>	The device or devices controlled by the energy control either directly or indirectly through a control circuit.

# Switch Type

Abbreviation	Definition	Description	Symbol
1 x SPST	Single Pole, Single Throw	A simple ON/OFF switch. The two terminals are either connected together or disconnected from each other. An example is a light switch.	
2 x SPST	Single Pole, Single Throw	Equivalent to two SPST switches controlled by separate mechanisms.	
1 x DPST	Double Pole, Single Throw	Equivalent to two SPST switches controlled by a single mechanism.	
1 x SPDT	Single Pole, Double Throw	A simple changeover switch. Common (COM) is connected to the Normally Closed (NC) output when in the default position. Common (COM) is connected to the Normally Open (NO) output when in the switched position.	
2 x SPDT	Single Pole, Double Throw	Equivalent to two SPDT switches controlled by separate mechanisms.	
1 x DPDT	Double Pole, Double Throw	Equivalent to two SPDT switches controlled by a single mechanism.	

# Voltage / Phase Diagrams

## 120 VAC Single Phase

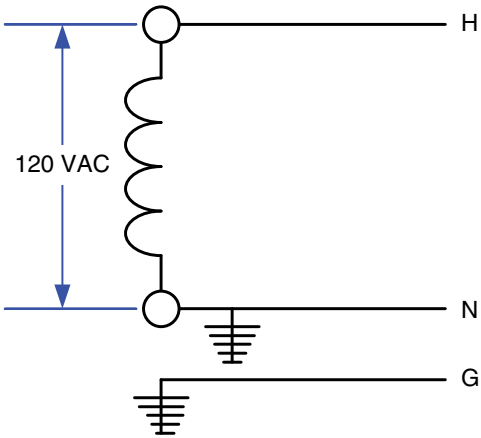

## 277 VAC Single Phase

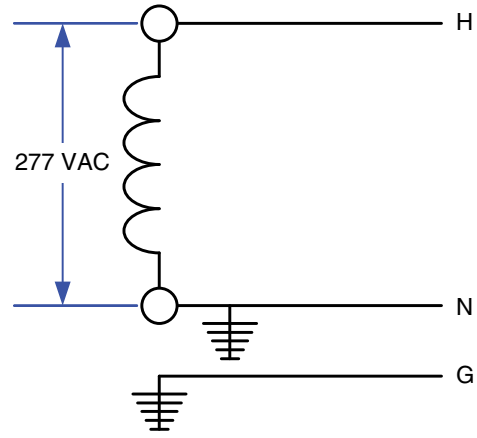

## 480 VAC Single Phase

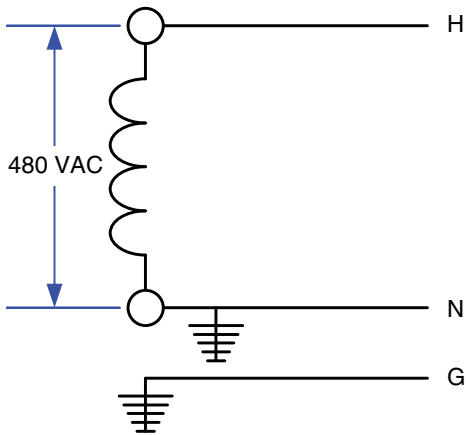

## 120/240 VAC Split Phase

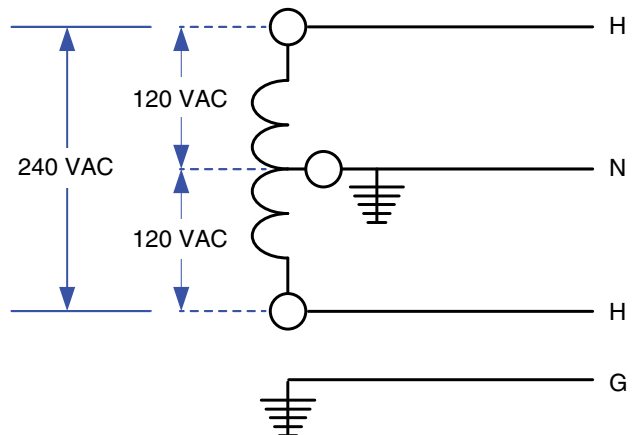



### 120/208 VAC Three Phase Wye

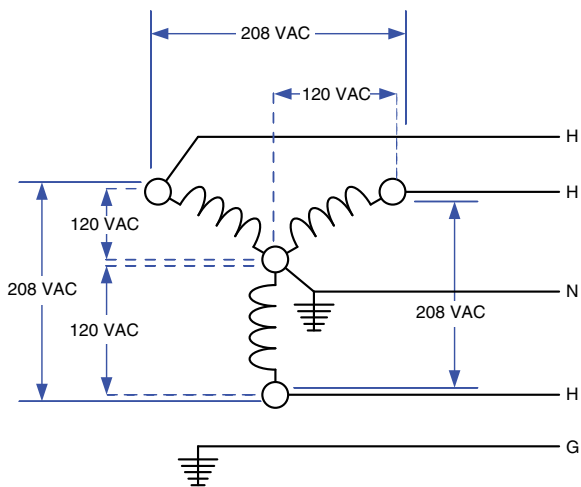

### 120/240 VAC Three Phase HLD (High Leg Delta)

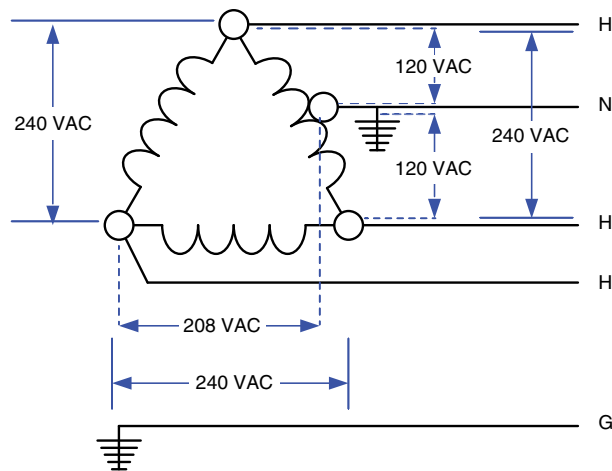

### 277/480 VAC Three Phase Wye

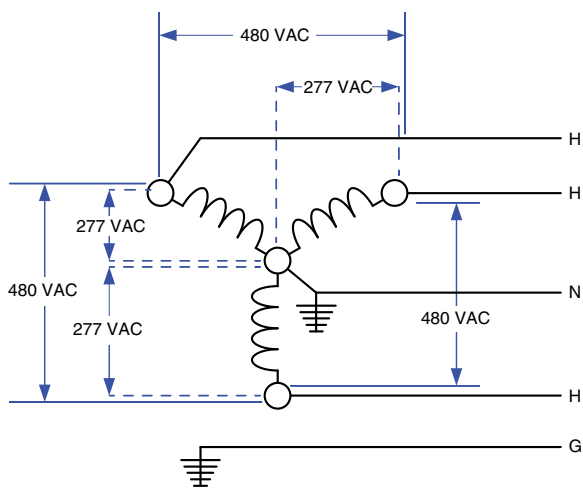

### 240 VAC Three Phase Delta

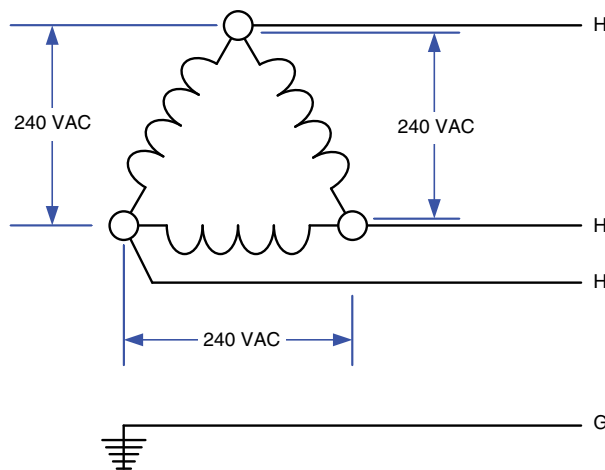

### 347/600 VAC Three Phase Wye

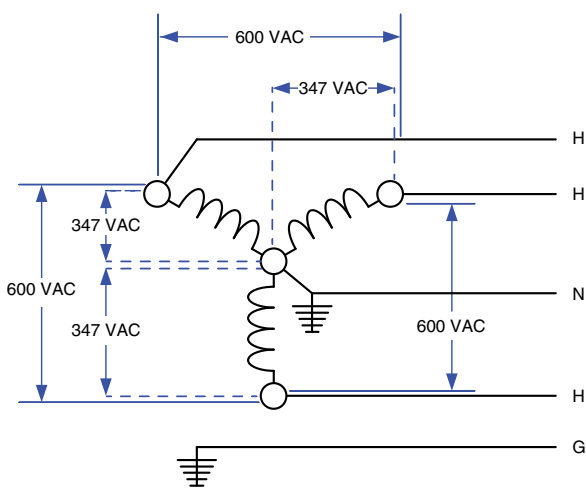

### 480 VAC Three Phase Delta

