

SL Signal Towers



EATON

Powering Business Worldwide

SL signal towers

Signal towers

System overview

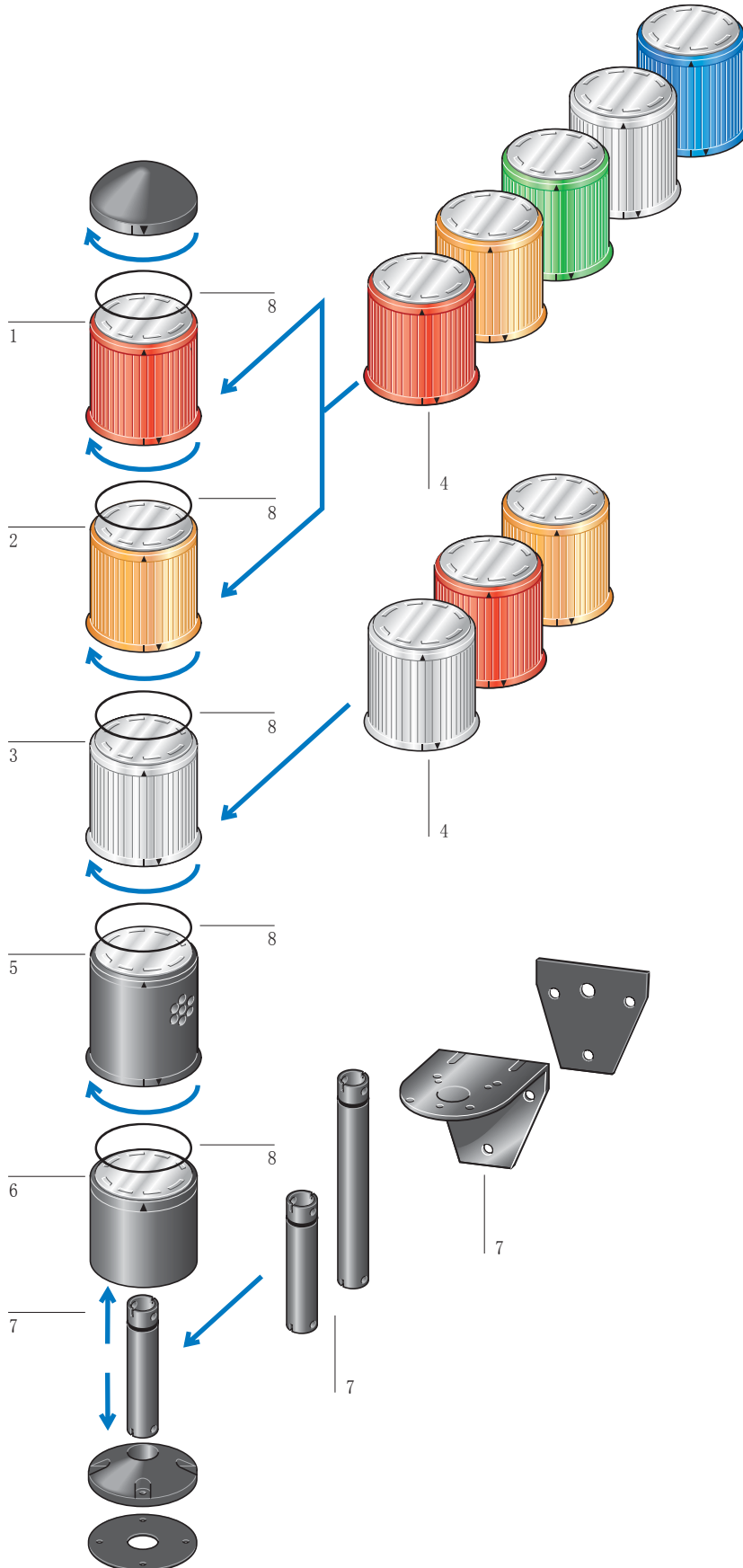

Continuous light 1	Strobe light 3	Base module 6
Easy mounting with bayonet fitting	Easy mounting with bayonet fitting	Easy mounting with bayonet fitting
Modules can be arranged in any order	Modules can be arranged in any order	Protection type IP54
Protection type IP54	Protection type IP54	For bottom mounting or in tubular column
Up to five levels can be actuated independently	Up to five levels can be actuated independently	Terminal connection capacity 6 × 1.5 mm ²
Operating mode: 100 % DF	Operating mode: 100 % DF	With top cover
Without light elements	Flash power 1 Ws	→Page 3
→ Page 3	Flashing frequency: approx. 1 Hz	
	→Page 5	
Flashing light 2	Caps 4	Accessories 7
Easy mounting with bayonet fitting	Color: red, yellow, green, white, blue	Spacer available in four lengths
Modules can be arranged in any order	Fresnel grooves ensure even light distribution	Filament bulbs, LEDs
Protection type IP54		90° wall mounting with commercial four-hole fixing
Up to five levels can be actuated independently		→Page 6
Operating mode: 100 % DF	Acoustic device 5	Gaskets 8
With filament bulb	Easy mounting with bayonet fitting	For increasing the degree of protection type to IP65
Flashing frequency: approx. 1 Hz	Modules can be arranged in any order	→ Page 6
→ Page 4	Protection type IP20	
	Operating mode: 100 % DF	
	Continuous tone or pulsed tone	
	Sound pressure: about 90 dB at 60 cm	
	Frequency: 2750 Hz	
	→ Page 4	

Product feature of SL

- Individual programming by jumper: max. 5 modules and base module
- Customized combinations →Page 2/104

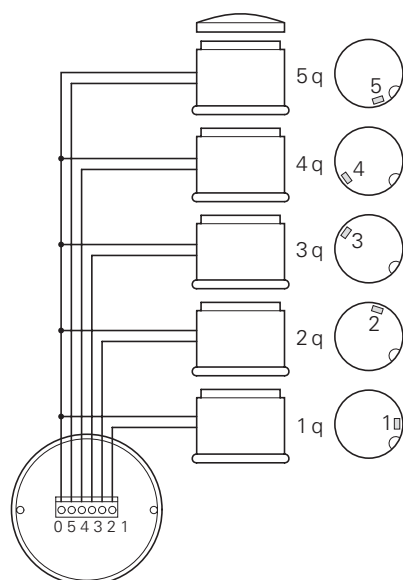

SL signal towers

Modules

Rated operational voltage U_e V	Modules Number	Color	Part no. Article no.	Price See price list	Std. pack	Information relevant for export to North America
Complete units Base module with foot and 100 mm tube including filament lamp Continuous light, IP54						
24 V AC/DC	3		SL-100-L-RYG/24 205352		1 off 	Product Standards IEC/EN 60947-5; UL 508; CSA-C22.2 No. 14-05; CSA-C22.2 No. 94-91; CE marking UL File No. E29184 UL CCN NKCR CSA File No. 012528 CSA Class No. 3211-03 NA Certification UL Listed, CSA certified Degree of Protection UL/CSA Type 12, with additional SL-IP65: part no. 4X
24 V AC/DC	2		SL-100-L-RG/24 205354		1 off 	

Customized complete unit

To order use form FO315,
→ Data sheet in Online Catalog
* = Freely selectable customer identification or stock no.;
Maximum 10 characters

–	–	–	SL-COMBINATION-* 229655		1 off 	Product Standards IEC/EN 60947-5; UL 508; CSA-C22.2 No. 14-05; CSA-C22.2 No. 94-91; CE marking UL File No. E29184 UL CCN NKCR CSA File No. 012528 CSA Class No. 3211-03 NA Certification UL Listed, CSA certified
---	---	---	-----------------------------------	--	-----------	--

SL...

	Terminal type	Part no. Article no.	Price See price list	Std. pack	Notes	Information relevant for export to North America
Base module Black, with cover 	Screw terminals	SL-B 205311		1 off 		Product Standards IEC/EN 60947-5; UL 508; CSA-C22.2 No. 14-05; CSA-C22.2 No. 94-91; CE marking UL File No. E29184 UL CCN NKCR CSA File No. 012528 CSA Class No. 3211-03 NA Certification UL Listed, CSA certified
	Cage clamp Cage clamp is a registered trademark of Wago Kontakttechnik GmbH, Minden,	SL-CB 218483				
	Connection to AS-Interface	SL-B-ASI 222174		1 off 	Base module (printed circuit board in base enclosure with 3 outputs):	<ul style="list-style-type: none"> • Total power supply from AS-Interface (max. 250 mA) using 2-way screw terminal • Combination of 3 surface mounting modules with different functions (continuous, flashing, strobe light and acoustic indication) • Status indication via LEDs • Order stacking modules separately



















Continuous light module



Without light elements, filament lamps
→ Page 6, LED → Page 6







	SL-L-W 205312		1 off 		Product Standards IEC/EN 60947-5; UL 508; CSA-C22.2 No. 14-05; CSA-C22.2 No. 94-91; CE marking UL File No. E29184 UL CCN NKCR CSA File No. 012528 CSA Class No. 3211-03 NA Certification UL Listed, CSA certified
	SL-L-R 205313				
	SL-L-G 205314				
	SL-L-Y 205315				
	SL-L-B 205316				

SL...

	Rated operational voltage	Color	Part no. Article no.	Price See price list	Std. pack	Information relevant for export to North America
	U _e V					 
Flashing light module						
Without light element, f ≈ 1 Hz						
	24 V AC/DC (+10 %/-15 %)		SL-BL24-W 205317	1 off  	Product Standards	IEC/EN 60947-5; UL 508; CSA-C22.2 No. 14-05; CSA-C22.2 No. 94-91; CE marking E29184 NKCR 012528 3211-03 UL Listed, CSA certified
			SL-BL24-R 205318			
			SL-BL24-Y 205320			
			SL-BL24-G 205319			
			SL-BL24-B 205321			
	110 - 130 V AC		SL-BL130-W 205322	1 off  	Product Standards	IEC/EN 60947-5; UL 508; CSA-C22.2 No. 14-05; CSA-C22.2 No. 94-91; CE marking E29184 NKCR 012528 3211-03 UL Listed, CSA certified
			SL-BL130-R 205323			
			SL-BL130-G 205324			
			SL-BL130-Y 205325			
			SL-BL130-B 205326			
	230 V AC		SL-BL230-W 205327	1 off  	Product Standards	IEC/EN 60947-5; UL 508; CSA-C22.2 No. 14-05; CSA-C22.2 No. 94-91; CE marking E29184 NKCR 012528 3211-03 UL Listed, CSA certified
			SL-BL230-R 205328			
			SL-BL230-G 205329			
			SL-BL230-Y 205330			
			SL-BL230-B 205331			

Acoustic module

IP20

	Continuous tone f = 2750 Hz In 60 cm spacing 12 V: 77 dB 24 V: 83 dB 36 V: 90 dB	12 - 36 V AC/DC 8 - 12 mA		SL-A24 205341	1 off  	Product Standards	IEC/EN 60947-5; UL 508; CSA-C22.2 No. 14-05; CSA-C22.2 No. 94-91; CE marking E29184 NKCR 012528 3211-03 UL Listed, CSA certified
	Continuous tone f = 2750 Hz In 60 cm spacing 110 V: 72 dB 230 V: 78 dB	110-230 V AC/DC 4 - 8 mA		SL-A110-230 205342			
	Pulsed tone 5 Hz with f = 2750 Hz In 60 cm spacing 12 V: 61 dB 24 V: 66 dB 36 V: 77 dB	12 - 36 V AC/DC 8 - 12 mA		SL-AP24 205343			
	Pulsed tone 5 Hz with f = 2750 Hz In 60 cm spacing 110 V: 67 dB 230 V: 73 dB	110-230 V AC/DC 4 - 8 mA		SL-AP110-230 205344			

SL signal towers

Modules

Strobe light module

With flash tube, 1 Ws, $f \approx 1$ Hz



SL...

Rated operational voltage

Color

Part no.
Article no.

Price
See price list

Std. pack

Information relevant for export to North America



U_e
V

24 V AC/DC
(+10 ... -15 %)
 $I_{\text{emax}} = 190$ mA



SL-FL24-W
205332

1 off

Product Standards

IEC/EN 60947-5; UL 508;
CSA-C22.2 No. 14-05;
CSA-C22.2 No. 94-91; CE marking



SL-FL24-R
205333



SL-FL24-Y
205334

UL File No.

E29184

UL CCN

NKCR

CSA File No.

012528

CSA Class No.

3211-03

NA Certification

UL Listed, CSA certified

110 - 130 V AC
 $I_{\text{emax}} = 31$ mA



SL-FL130-W
205335



SL-FL130-R
205336



SL-FL130-Y
205337

230 V AC
 $I_{\text{emax}} = 28$ mA



SL-FL230-W
205338



SL-FL230-R
205339



SL-FL230-Y
205340

SL...

Lifespan
EN 60064 at
 $t_a = +25\text{ }^\circ\text{C}$
 $t_{\text{average(AC)}}$
h

Rated
operational
voltage
 U_e
V

Color

Part no.
Article no.

Price
See price
list

Std. pack

Information relevant for export to
North America



Accessories Stand with spacer

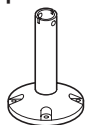

100 mm, plastic, black	–	–	–	SL-F100 205345
100 mm, metal	–	–	–	SL-F100M 265359
250 mm, plastic, black	–	–	–	SL-F250 205346
250 mm, metal	–	–	–	SL-F250M 268925
400 mm, metal	–	–	–	SL-F400 215275
800 mm, metal	–	–	–	SL-F800 215276

1 off

Product Standards IEC/EN 60947-5; UL 508;
CSA-C22.2 No. 14-05;
CSA-C22.2 No. 94-91; CE marking
UL File No. E29184
UL CCN NKCR
CSA File No. 012528
CSA Class No. 3211-03
NA Certification UL Listed, CSA certified

Fixing bracket 90°, for wall mounting



Metal	–	–	–	SL-FW 205347
-------	---	---	---	------------------------

Filament bulb BA 15d, 5 - 7 W



	2000	24 V	–	SL-L24 205348
	5000	110 - 130 V	–	SL-L130 205349
	5000	200 - 260 V	–	SL-L230 205350

Multiple LED BA 15d



100000	18 - 30 V AC/DC 50/60 Hz 13 - 50 mA		SL-LED-W 215278
			SL-LED-R 215279
			SL-LED-G 215280
			SL-LED-Y 215281
			SL-LED-B 215282
		100000	110 - 230 V AC, 50/60 Hz 9 - 17 mA
	SL-LED230-R 285533		
	SL-LED230-G 285534		
	SL-LED230-Y 285535		
	SL-LED230-B 285536		



Gasket set
For increasing the degree of protection type to IP65
(Not for the acoustic device)
for 3 modules \triangleq 4 units

–	–	–	–	SL-IP65 215277	1 off 	Product Standards IEC/EN 60947-5; UL 508; CSA-C22.2 No. 14-05; CSA-C22.2 No. 94-91; CE marking UL File No. E29184 UL CCN NKCR CSA File No. 012528 CSA Class No. 3211-03 NA Certification UL Listed, CSA certified Degree of Protection UL/CSA Type 4X
---	---	---	---	--------------------------	-----------	---

SL signal towers

Modules

Technical data

SL signal towers

General			
Standards			IEC/EN 60947, VDE 0660
Protection type, IEC/EN 60529			IP54, IP65 with SL-IP65 gasket, IP20 with acoustic module SL-A
Climatic proofing			Damp heat, constant as per IEC 60068-2-78 Damp heat, cyclic, to IEC 60068-2-30
Mounting position			Any
Mechanical shock resistance to IEC 60068-2-27 Shock duration 11 ms, half-sinusoidal	g		> 15
Terminal capacity			
Solid	mm ²		0.75 - 2.5
Stranded	mm ²		0.5 - 2.5
Contacts			
Rated impulse withstand voltage	U _{imp}	V AC	4000
Rated insulation voltage	U _i	V	250
Overvoltage category/pollution degree			III/3

SL-B-ASI base module for signal towers

General			
Connection to AS-Interface cable			Screw terminal on printed circuit board
Addressing			Via connection to AS-Interface cable
Maximum total current	mA		≲250
Energy supply			Completely from the AS-Interface cable
Ambient temperature	°C		-25 - +55
Status LEDs on the printed circuit board			Status. Output Q0/function module position 1: green Status. Output Q1/function module position 2: green Status. Output Q2/function module position 3: green AS-Interface power line: green AS-Interface error, AS-Interface master failure: red
Profile			S-9.A.E

Dimensions

Signal towers

SL-100-...

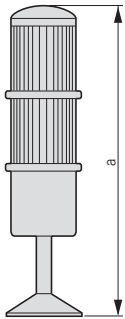

Number of modules	
1	227
2	289
3	351
4	413
5	475

Stand with spacer

SL-F...

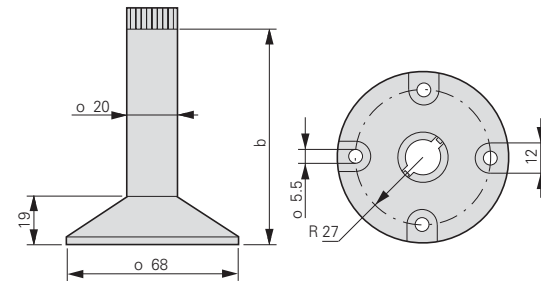

	b
SL-F100	85
SL-F250	235
SL-F400	402
SL-F800	802

Modules

SL-L...

SL-BL...

SL-A...

SL-FL...

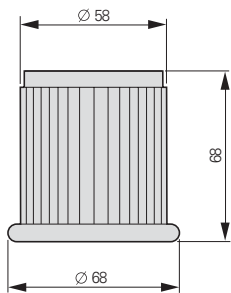

Basic modules with cover

SL-(QB...

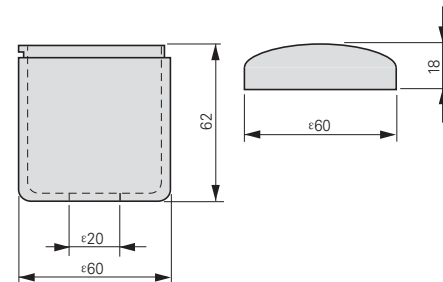

Fixing bracket

SL-FW

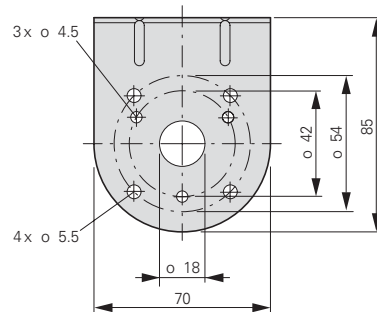
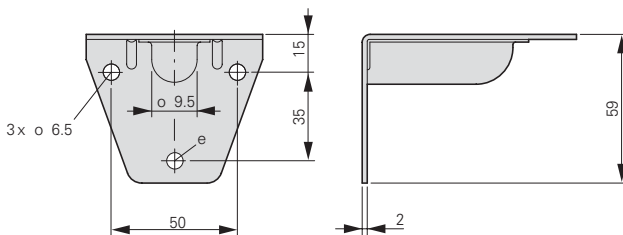

EAT•N

The power of fusion.



EAT•N

Powering Business Worldwide

There's a certain energy at Eaton. It's the power of uniting some of the world's most respected names to build a brand you can trust to meet your every power management need. The energy created supports our commitment to powering business worldwide.

From power distribution to power quality and control, Eaton allows you to proactively manage your complete power system by providing electrical solutions that make your applications more reliable, efficient and safe. Visit Eaton.com/electrical.

All of the above are trademarks of Eaton Corporation or its affiliates. Eaton has a license to use the Westinghouse name in Asia Pacific. ©2010 Eaton Corporation.

Eaton is dedicated to ensuring that reliable, efficient and safe power is available when it's needed most. With unparalleled knowledge of electrical power management across industries, experts at Eaton deliver customized, integrated solutions to solve our customers' most critical challenges.

Our focus is on delivering the right solution for the application. But, decision makers demand more than just innovative products. They turn to Eaton for an unwavering commitment to personal support that makes customer success a top priority. For more information, visit www.eaton.com/electrical.

Eaton Corporation
Asia Pacific Headquarter
No.3, Lane 280, Linhong Road,
Changning District,
Shanghai 200335
Tel: 86-21-52000999
Fax: 86-21-52000200

© 2011 Eaton Corporation
All Rights Reserved
Printed in China
SL-EN(12-2011)



Eaton is a registered trademark
of Eaton Corporation.

All trademarks are property of their
respective owners.